

DIRECTION FINDERS FOR SMALL BOATS

Radio-Electronics

HUGO GERNSBACK, Editor

Construct This Simple
Rain and Humidity Alarm

Speedy TV Service
by Tube Changing

Golden Ears or Bats' Ears?

ET

Electronics
and
Circuit Components

35c
U.S. and Canada

HEAR

BASS NOTES DOWN TO 35 CPS... BUILD THE ELECTRO-VOICE ARISTOCRAT

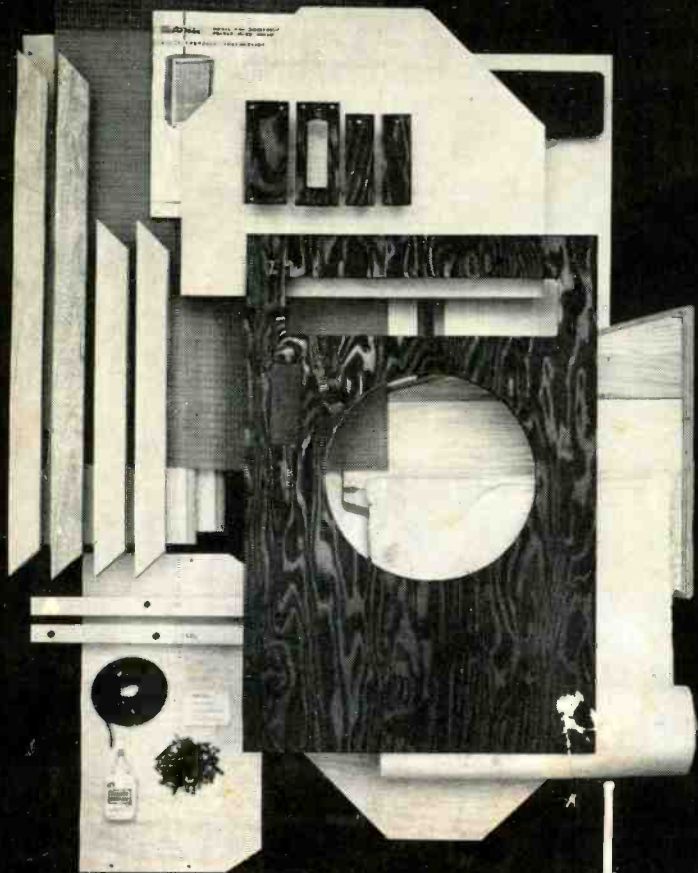

DRAMATIC PERFORMANCE has made the Electro-Voice Aristocrat the world's most popular enclosure for 12" loudspeakers. The Aristocrat will make an exciting difference in the performance of your loudspeaker—hear deep, extended bass response without annoying boom; sharp, well-defined low frequency transients, and all with greatly increased power handling capacity.

ASSEMBLE THE ARISTOCRAT YOURSELF AND SAVE 50%. When completed, the KD6 Aristocrat Kit interior construction is identical to E-V's factory-assembled Aristocrat enclosure, but with this difference: you save 50% and have an evening's fun.

AS EASY AS ONE . . . TWO . . . THREE. The KD6 Aristocrat Kit can be assembled in only one evening with E-V's exclusive sub-assembled parts and exploded view, step-by-step instructions. All you need is a screw driver; the rest is in the box. And E-V's accurately milled, furniture grade woods and veneers plus a choice of six finishing kits create an enclosure that will match your finest furniture.



2



3

- Model KD6 Aristocrat Kit
Audiophile Net. \$39.00
- Model FK Finishing Kits, each
Audiophile Net. 5.00
- Factory Finished Aristocrat Enclosure, Mahogany
Audiophile Net. 72.00
- Limed Oak or Walnut
Audiophile Net. 79.00

Mail this coupon for free illustrated literature . . . see why more E-V Enclosure Kits have been built than all others combined.

E-V *Electro-Voice* [®] **INC.**

BUCHANAN, MICHIGAN

Superb New Products Through Research:

- Microphones—Phono Cartridges—
- High Fidelity Loudspeakers and Enclosures—
- Public Address Speakers—
- Marine Instruments—Communication Equipment—
- Electronic Test Instruments and
- Material for Defense.

Electro-Voice, Inc.
Buchanan, Michigan

Dept. 59-E

Gentlemen: Please send me free illustrated literature on E-V kits, enclosures and speakers.

NAME _____

ADDRESS _____

CITY _____ ZONE _____ STATE _____

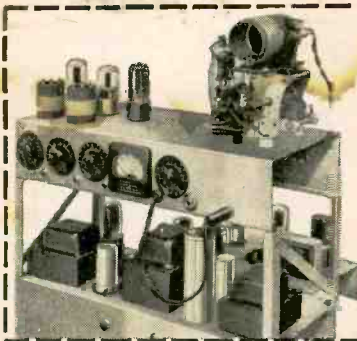

YOU BUILD Broadcasting Transmitter

As part of N.R.I. Communications Course you build this low power Transmitter; use it to learn methods required of commercial broadcasting operators, train for FCC license.

YOU BUILD Signal Generator

N.R.I. sends kits of parts to build this Signal Generator. You get practical experience, conduct tests to compensate Radio frequency amplifiers, practice aligning a typical I.F. video amplifier in TV circuit, many other experiments.

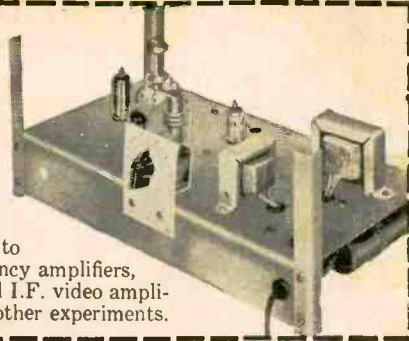

YOU BUILD Vacuum Tube Voltmeter

Use it to get practical experience, earn extra cash fixing neighbors' sets in spare time, gain knowledge to help you work in Radio, Television, Color TV. With N.R.I. training you work on circuits common to both Radio and TV. Equipment you build "brings to life" things you learn in N.R.I.'s easy-to-understand lessons. 64 page Catalog FREE, shows all equipment you get.



YOU BUILD AC-DC Superhet Receiver

N.R.I. servicing training supplies all parts, everything is yours to keep. Nothing takes the place of practical experience. You get actual servicing experience by practicing with this modern receiver; you learn-by-doing.



Learn RADIO TELEVISION by Practicing at Home

WHAT GRADUATES DO AND SAY

Chief Engineer

"I am Chief Engineer of Station KGCU in Mandan, N. D. I also have my own spare time business servicing high frequency two-way communications systems." R. BARNETT, Bismarck, North Dakota.



Paid for Instruments

"I am doing very well in spare time TV and Radio. Sometimes have three TV jobs waiting and also fix car Radios for garages. I paid for instruments out of earnings." G. F. SEAMAN, New York, N. Y.



Has Own TV Business

"We have an appliance store with our Radio and TV servicing, and get TV repairs. During my Army service, NRI training helped get me a top rated job." W. M. WEIDNER, Fairfax, South Dakota.



NEED FOR TECHNICIANS INCREASING Fast Growing Field Offers Good Pay, Bright Future

Today's OPPORTUNITY field is Radio-Television. Over 125 million home Radios plus 30 million sets in cars and 40,000,000 Television sets mean big money for trained Radio-TV Technicians. More than 4,000 Radio and TV Broadcasting stations offer interesting and important positions for technicians, operators. Color television, portable TV sets, Hi-Fi, other developments assure future growth.

It's the trained man who gets ahead. The fellow who uses his spare time to develop knowledge and skill gets the better job, drives a better car, lives in a better home, is respected for what he knows

and can do. So plan now to get into Radio-TV.

Keep your job while training with N.R.I. You learn at home in your spare time. N.R.I. is oldest and largest home study Radio-TV School. Our methods have proved successful for more than 40 years, provide practical experience.

Soon after enrolling, many N.R.I. students start to earn \$10, \$15 a week extra in spare time fixing sets. Many open their own full time Radio-TV shops after getting N.R.I. Diploma. Find out more. Mail Coupon. Cost is low, terms easy; includes all equipment. Address: National Radio Institute, Dept. 9EF, Washington 16, D.C.

Send for LESSON and CATALOG FREE

VETERANS Available Under G.I. Bills



MAIL COUPON NOW

NATIONAL RADIO INSTITUTE Dept. 9EF, Washington 16, D. C.

Mail me Sample Lesson and 64-Page Catalog, FREE. (No Salesman will call. Please write plainly.)

Name _____ Age _____

Address _____

City _____ Zone _____ State _____

ACCREDITED MEMBER, NATIONAL HOME STUDY COUNCIL



MAY, 1959

Radio-Electronics

Formerly RADIO-CRAFT ■ Incorporating SHORT WAVE CRAFT ■ TELEVISION NEWS ■ RADIO & TELEVISION

EDITORIAL

- 29 The Business of Servicing—Hugo Gernsback

RADIO

- ✓ 30 RDF for Small Boats—Elbert Robberson
- 34 ABC's of Mobile Radio, Part IV—Leo G. Sands
- 37 The Single-Sideband Story—Edward M. Noll

ELECTRONICS

- 40 Electronics on the Highway (Cover Feature)—David Lachenbruch
- 43 Transistors Make Cars Run Better
- 44 Electronics in the Classroom, Part II—Sol D. Prensky
- 47 Road to Universe Opened
- ✓ 48 Water Is the Trigger—James A. McRoberts
- 49 A-Bomb Proves Earth's Magnetic Field

WHAT'S NEW

- 50 Pictorial Reports of New Developments

AUDIO-HIGH FIDELITY

- ✓ 51 Golden Ears or Bat's Ears?—George Fletcher Cooper
- 54 Baby-Monitoring Amplifier—James E. Pugh, Jr.
- 55 Audio Servicing Hints—John A. Comstock
- 56 All About the Reflex Enclosure, Part III—P. G. A. H. Voigt
- 58 Three-Tube Hi-Fi Amplifier
- 59 New Discs and Tapes, Stereo and Mono—Reviewed by Chester Santon

TEST INSTRUMENTS

- 74 Induced-Waveform Analyzer Speeds Signal Tracing—Robert F. Scott
- 78 The Multibias Box—Earl T. Hansen
- 82 Bridge-Type Transistor Checker—LeRoy Mahoney

TELEVISION

- 85 Freeze That Color Stripe—Robert G. Middleton
- ✓ 89 Tube Changing Can Be Profitable—Jack Darr
- 96 FM-TV Dx—Robert B. Cooper, Jr.
- 99 TV Service Clinic—Conducted by Robert G. Middleton

- 132 Books
- 127 Business and People
- 18 Correspondence
- 130 Literature
- 118 New Tubes and Semiconductors
- 6 News Briefs
- 104 Noteworthy Circuits
- 112 On the Market
- 125 Patents
- 106 Technicians' News
- 110 Technotes
- 122 Try This One
- 121 50 Years Ago

ON THE COVER

Story on page 40

Electronic traffic-control box on a Newark, N.J. street corner is tested and adjusted by Leo G. Sands as Claire O'Neill goes putt-putting by.

Color original by Jacques Saphier

Hugo Gernsback
..... Editor and Publisher

M. Harvey Gernsback
..... Editorial Director

Fred Shunaman
..... Managing Editor

Robert F. Scott
..... W2PWG, Technical Editor

Larry Steckler
..... Associate Editor

I. Queen
..... Editorial Associate

Robert G. Middleton
..... Television Consultant

Elizabeth Stalcup
..... Production Manager

Cathy Cocozza
..... Advertising Production

Wm. Lyon McLaughlin
..... Tech. Illustration Director

Sol Ehrlich
..... Art Director

Fred Neimast
..... Staff Artist

Lee Robinson
..... Director, Advertising Sales

John J. Lamson
..... Eastern Sales Manager

G. Aliquo
..... Circulation Manager

Adam J. Smith
..... Director, Newsstand Sales

Robert Fallath
..... Promotion Manager



Average Paid Circulation Over 199,000



RADIO-ELECTRONICS is indexed in *Applied Science & Technology Index* (Formerly *Industrial Arts Index*)

RADIO-ELECTRONICS, May, 1959, Vol. XXX, No. 5. Published monthly at Mt. Morris, Ill. by Gernsback Publications, Inc. Second-Class mail privileges authorized at Mt. Morris, Ill. Copyright 1959 by Gernsback Publications, Inc. All rights reserved under Universal, International and Pan-American Copyright Conventions.

SUBSCRIPTION RATES: U.S., U.S. possessions and Canada, \$4.00 for one year; \$7.00 for two years; \$10.00 for three years; single copies 35c, Pan-American countries \$5.00 for one year; \$8.00 for two years; \$13.00 for three years. All other countries \$5.50 a year; \$10.00 for two years; \$14.50 for three years.

SUBSCRIPTIONS: Address correspondence to Radio-Electronics, Subscription Dept., 154 West 14th St., New York 11, N.Y. When requesting a change of address, please furnish an address label from a recent issue. Allow one month for change of address.

GERNSBACK PUBLICATIONS, INC. Executive, Editorial and Advertising Offices, 154 West 14th St., New York 11, N.Y. Telephone Algonquin 5-7755. Hugo Gernsback, Chairman of the Board; M. Harvey Gernsback, President; G. Aliquo, Secretary.

BRANCH ADVERTISING OFFICES and FOREIGN AGENTS listed on page 135.

POSTMASTER: If undeliverable, send Form 3579 to: RADIO-ELECTRONICS, 154 West 14th St., New York 11, N.Y.

*Trademark registered U. S. Pat. Office.

RADIO-ELECTRONICS

NOW!
at a price
you can afford!

MAKE MORE MONEY in TELEVISION RADIO-ELECTRONICS

**BETTER...MORE COMPLETE...LOWER COST...
WITH NATIONAL SCHOOLS SHOP-METHOD
HOME TRAINING!**

BETTER... Training that is proved and tested in Resident School shops and laboratories, by a School that is the **OLDEST** and **LARGEST** of its kind in the world.

MORE COMPLETE... You learn **ALL PHASES** of *Television-Radio-Electronics*.

LOWER COST... Other schools make several courses out of the material in our **ONE MASTER COURSE . . .** and you pay more for less training than you get in our course at **ONE LOW TUITION!**



These **two FREE** books will show you how!

You get all information by mail . . . You make your own decision . . . at home! **NO SALESMAN WILL CALL**

TOP PAY... UNLIMITED OPPORTUNITIES LIFETIME SECURITY CAN BE YOURS!

You are needed in the Television, Radio, and Electronics industry! Trained technicians are in growing demand at excellent pay—in **ALL PHASES**, including Servicing, Manufacturing, Broadcasting and Communications, Automation, Radar, Government Missile Projects.

NATIONAL SCHOOLS SHOP-METHOD HOME TRAINING, with newly added lessons and equipment, trains you in your spare time at home, for these unlimited opportunities, including many technical jobs leading to supervisory positions.

YOU LEARN BY BUILDING EQUIPMENT WITH KITS AND PARTS WE SEND YOU. Your National Schools course includes thorough *Practical* training—**YOU LEARN BY DOING!** We send you complete standard equipment of professional quality for building various experimental and test units. You advance step by step, perform more than 100 experiments, and you build a complete TV set from the ground up, that is yours to keep! A big, new TV picture tube is included at no extra charge.

EARN AS YOU LEARN. We'll show you how to earn extra money right from the start. Many of our students pay for their course—and more—while studying. So can you!

RESIDENT TRAINING AT LOS ANGELES

If you wish to take your training in our Resident School at Los Angeles, the world's TV capital, start **NOW** in our big, modern Shops, Labs and Radio-TV Studios. Here you work with latest Electronic equipment - - professionally installed - - finest, most complete facilities offered by any school. Expert, friendly instructors. Personal attention. Graduate Employment Service. Help in finding home near school - - and part time job while you learn. Check box in coupon for full information.

LESSONS AND INSTRUCTION MATERIAL ARE **UP-TO-DATE, PRACTICAL, INTERESTING.** Every National Schools Shop-Method lesson is made easy to understand by numerous illustrations and diagrams. All instruction material has been developed and tested in our own Resident School Shops, Laboratories and Studios.

SEND FOR INFORMATION TODAY . . . it can mean the difference between **SUCCESS** and failure for you! Send for your **FREE BOOK** "Your Future in Television-Radio-Electronics" and **FREE Sample Lesson.** Do it **TODAY**, while you are thinking about your future. It doesn't cost you anything to investigate!

GET THE BENEFITS OF OUR OVER 50 YEARS EXPERIENCE

Approved for
GI Training



NATIONAL SCHOOLS

Los Angeles 37, Calif.

YOU GET...

- 19 Big Kits—**YOURS TO KEEP!**
- Friendly Instruction and Guidance
- Job Placement Service
- Unlimited Consultation
- Diploma—Recognized by Industry
- **EVERYTHING YOU NEED FOR SUCCESS!**

SHOP-METHOD HOME TRAINING COVERS ALL PHASES OF INDUSTRY

1. Television, including Color TV
2. Radio AM & FM
3. Electronics for Guided Missiles
4. Sound Recording and Hi-Fidelity
5. FCC License
6. Automation and Computers
7. Radar & Micro-Waves
8. Broadcasting and Communications

NATIONAL TECHNICAL SCHOOLS

WORLD-WIDE TRAINING SINCE 1905

MAIL NOW TO

NATIONAL SCHOOLS, Dept RG-59

4000 S. FIGUEROA ST. LOS ANGELES 37, CALIF.

Rush free TV-Radio "Opportunity" Book and sample lesson. No salesman will call.

NAME _____ AGE _____

ADDRESS _____

CITY _____ ZONE _____ STATE _____

Check if interested **ONLY** in Resident School training at Los Angeles.

VETERANS: Give date of Discharge _____

NEWS BRIEFS

PARAMETRIC AMPLIFIER, also known as the variable reactance amplifier, may bring improvement in signal-to-noise ratio for uhf television front ends at a low price. The parametric amplifier (described in detail in *RADIO-ELECTRONICS*, February, p. 78) is said to be practical for mass-produced uhf tuners. One research leader, Microwave Associates, Burlington, Mass., says such tuners could be built with noise figures of only 2 or 3 db, and could be in production next year. Microwave has researched the solid-state amplifiers for military applications.

The company said that silicon diodes for this application ought to be no more expensive than other uhf tuner diodes, but the circuit requires a very stable high-frequency oscillator, which might run the cost up somewhat unless further research develops inexpensive but stable uhf power source.

23-INCH TV SCREENS are expected from more than one manufacturer this fall. Short tubes will keep getting shorter, and separated tube and chassis arrangement, as well as more compact sets, are trends which will be accelerated.

RADIO SEXTANT operates off weak radiations from the moon, permitting marine navigation in fair weather or foul. This new navigational instrument was developed by Collins Radio for the Navy. It automatically tracks the position of the moon by picking up and following signals generated by moon atoms which have been excited by rays from the sun. Regular optical sextants

cannot be used in bad weather since moon and stars must be visible.

MAGNETIC RECORDING industry agreed to continue concentrating on two-track 7½-inch reel-to-reel stereo tapes, let cartridges and four-track 3¼-inch tapes wait for actual consumer delivery of the long-awaited cartridges and machines. Many had expected the recent meeting of the Magnetic Recording Industry Association in Chicago (MIRA) to do something about recommendations for *four-track 7½-inch* tape, believed to be a wise compromise by some leading engineers.

EDUCATIONAL TV stations may get much-needed financial support from a new plan just put into effect by two stations in East Lansing, Mich. WILX-TV, a commercial broadcaster, and Michigan State U's WMSB have set up to share channel 10 and transmitter equipment during different hours of the day. Plan may set a pattern which will be followed by many of the 38 educational stations now on the air and those expected in the future.

LOWER NOISE, longer life, and a better job are the advantages claimed for the Nuvistor, the new look in vacuum tubes. Using a construction technique in which elements are slipped together and brazed, the manufacturer ends up with a tube in a metal envelope, much smaller than conventional miniature types, that needs no mica supports or getter.

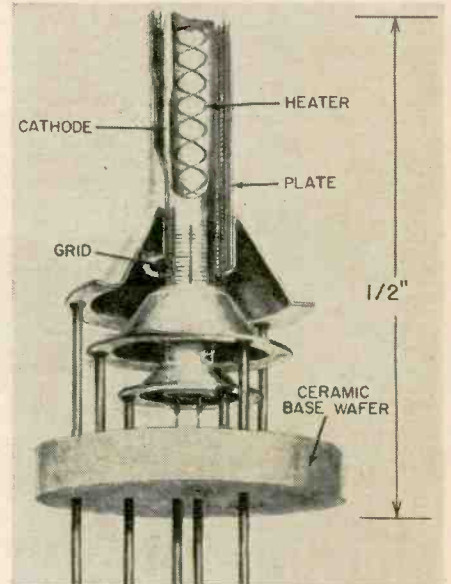

Developed by RCA, and now in the early advanced developmental stage, the tube has several advantages. It will withstand severe shock and vibration, and uses less current than standard types. Details of its construction, showing the single-ended cantilever-type support for the electrodes, can be seen in the photo.

While especially good for missile, miniaturization and mobile radio projects, the Nuvistor also has applications in home radio and TV. One TV tuner using these units was demonstrated. It operated with as little as 5 volts on the oscillator plate. Normal plate voltage range is from 40 to 100.

Developmental types include a triode, comparable to a 6BN4; a tetrode—similar to 6CY5, and a beam-power tube similar to a 6DQ6-A. Samples will go to equipment manufacturers by the end of the year, with limited production expected by the middle of 1960.

AM STEREOPHONY by two methods was proposed almost simultaneously by Bell Telephone and Westinghouse. The Bell system was for two-station transmission (one channel through the television receiver, the other through the AM or FM receiver, for example). The Westinghouse is a multiplex system, with both channels transmitted on the same AM frequency. It can be received with two ordinary broadcast receivers. Both are fully compatible with monophonic reception.

In the Westinghouse system, based on a 30-year-old patent by Dr. Frank Conrad, the broadcast-band carrier is



Ted Willis of Collins Radio is showing the sextant to Capt. John H. Brandt of the Compass Island, and Lt. John W. Kuncas, Navy Special Projects officer.

Don't Depend on **LUCK**

PLAN YOUR FUTURE!

1. PICK THE RIGHT FIELD!

You don't need a Four-Leaf Clover to prepare to get into Electronics, a profitable, fast-growing field with **GOOD JOBS, REAL MONEY, MORE SECURE FUTURE**, exciting work. What's more: you don't need an advanced education or previous technical experience either.

2. GET THE RIGHT TRAINING!

Why not increase your chances of building a solid future by investing part of your spare time in preparing for a profitable tomorrow? Do it at home or in day or evening classes in DeVry Tech's modern Chicago or Toronto laboratories. Send for **FREE** facts now!

3. LAND THE RIGHT JOB!

It isn't luck alone that gets you the right job! It isn't chance that helps you build a business of your own. After you complete your training, DeVry Tech will help you get started. This is the big push that most men need to succeed.

POCKET GUIDE
to
Real Earnings

FOR MEN
WHO LIKE THINGS
ELECTRICAL OR
MECHANICAL

DON'T GAMBLE With YOUR FUTURE! SEND FOR THIS FREE Electronics GUIDE NOW!

This handy pocket guide will give you free facts about how you may train to enter this billion dollar electronic industry. There are thousands of men unemployed or holding jobs they dislike who could prepare successfully to enter this fast-growing, profitable field but they are not aware of this fact. Are you one of these men? Mail the coupon NOW.

Accredited Member of National Home Study Council

DeVRY TECHNICAL INSTITUTE

4141 BELMONT AVENUE • CHICAGO 41, ILLINOIS
Formerly DeFOREST'S TRAINING, Inc.

DeVry Technical Institute

4141 Belmont Ave., Chicago 41, Ill., Dept. RE-5-P

Please give me a **FREE** copy of your unusual booklet, "Pocket Guide to Real Earnings," and tell me how I may prepare to enter one or more branches of Electronics.

NAME _____ AGE _____

PLEASE PRINT

STREET _____ APT. _____

CITY _____ ZONE _____ STATE _____

Check here if subject to military training.

DeVry Tech's Canadian Training Center is located at
2054 626 Roselawn Avenue, Toronto 12, Ontario

Operate your...

- tape recorder
- P. A. system
- portable TV set
- hand tools

FROM YOUR CAR, Boat or Plane!

with

ATR

INVERTERS



for changing your storage battery current to
A.C. HOUSEHOLD ELECTRICITY
Anywhere... in your own car!

OPERATES
PORTABLE TV SET
directly from your car!

OPERATES

- RADIOS
 - RECORD PLAYERS
 - MIXMASTERS, ETC.
- directly from your car!



MAKE YOUR CAR, BOAT OR PLANE
"A ROLLING OFFICE!"

OPERATES

- TAPE RECORDERS
 - DICTATING MACHINES
 - PUBLIC ADDRESS SYSTEMS
 - ELECTRIC SHAVERS
- directly from your car!



mounted out of sight under dash or in trunk compartment

ATR UNIVERSAL INVERTERS

Especially designed to change 6 or 12 volt D.C. to 110 volt A.C. 60 cycles.

for...

- EXECUTIVES
- SALESMEN
- OUTDOOR MEN
- POLICEMEN
- REPORTERS
- FIREMEN
- PUBLIC OFFICIALS

MODELS 6U-RHG (6 volts) 125 to 150 watts. Shipping weight 27 lbs. List price... \$89.95

DEALER NET PRICE... \$59.97

12U-RHG (12 volts) 150 to 175 watts. Shipping weight 27 lbs. List price... \$89.95

DEALER NET PRICE... \$59.97

Write for literature on other Sizes and Models of ATR INVERTERS, priced as low as \$9.95 list.

SEE YOUR JOBBER OR WRITE FACTORY

✓ NEW MODELS ✓ NEW DESIGNS ✓ NEW LITERATURE

- "A" Battery Eliminators
- DC-AC Inverters
- Auto Radio Vibrators



AMERICAN TELEVISION & RADIO CO.
Quality Products Since 1931
SAINT PAUL 1, MINNESOTA, U. S. A.

NEWS BRIEFS (Continued)

amplitude-modulated with the sum of the right and left channels and frequency-modulated with their difference. A narrow band is used and stereophonic information is transmitted in the band from 300 to 3,000 cycles.

At the receiver, the AM and FM signals are detected and matrixed to give the L and R outputs. (See "What Is Compatible Stereo FM Multiplex" RADIO-ELECTRONICS, April, 1958, page 91.) Reasonably good quality can be attained with two ordinary AM broadcast receivers. One is tuned slightly above, the other slightly below the signal frequency. The AM in the two receivers is identical, but the receivers tuned to each side of the FM transmission act somewhat like a Travis discriminator, with the result that the FM audio signal is in opposite phase in each. Thus one receiver may be said to be picking up AM + FM and the other, AM - FM. Since the AM is the sum and the FM the difference of the two channels, this resolves to L + R + (L - R) and L + R - (L - R), or left and right channels.

Since the Bell system depends on transmission by an AM and an FM station, or radio and TV station, it is not multiplex and doesn't require FCC authorization. It feeds the signal from both microphones to each channel, but the signal from the right channel is delayed about 10 milliseconds before being fed to the left, and vice versa.

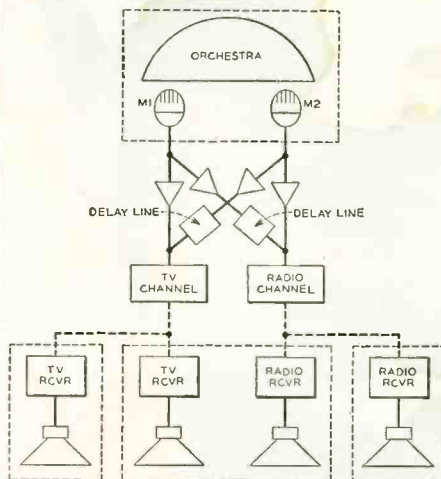

With only one receiver, the two channels blend into perfect monophonic reception; with two, the ear locates the sound as coming from the speaker from which it is heard first (apparently an old trick the ear has learned to distinguish the source of sound from echoes and reverberations). In practice, a true stereo effect is obtained.

The Bell approach was demonstrated on a Perry Como show shortly after its announcement. Westinghouse has applied to the FCC for permission to run tests on its system. RCA also announced a series of on-the-air tests for its proposed AM stereophonic broadcasting system.

MARS RADIO NET FORUM for May will continue the lecture series which has

Hi-Fi & Stereo experts demand Mullard

Britain's top quality audio tubes



EF86/6267

AF input pentode with exceptionally low noise, low hum, good microphony & high gain.

ECC83/12AX7

Specially constructed AF double triode with unique filament design for minimum hum levels as well as low microphony & low noise. Excellent replacement for 12AX7, 12AX7A & 7025.

EL84/6BQ5

Miniature AF power pentode. Particularly suited for compact stereo circuits providing up to 17 watts per channel in push-pull.

EL-37

AF output pentode requiring unusually low B+ voltage up to 60 watts per channel in push-pull circuitry. Replaces 6L6, KT66, 5881.

EL34/6CA7

High sensitivity & exceptional linearity makes this EL-34 the finest high power output pentode. Its efficiency & low drive voltage requirements make it ideal for compact stereo circuits up to 100 watts per channel in push-pull.

ECL82/6BM8

AF triode & output pentode with unusual sensitivity. Specially designed for compact stereo equipment. Up to 9.8 watts per channel in push-pull circuits.

EZ81/6CA4

Miniature full wave cathode type rectifier with high voltage & with good regulation supplying up to 150 MA.

GZ34/5AR4

Bantam full-wave rectifier with 5 volt, 1.9 amp heater & 250MA output. Replaces 5U4G & 5U4GA without circuit changes plus additional advantage of better regulation & controlled warm-up time.

It is easy to understand why MULLARD circuits & MULLARD PREFERRED Audio Tubes are being used by the most important manufacturers of quality audio equipment throughout the world. Every single tube in this range has been specifically designed to meet the exacting requirements of high fidelity sound reproduction in every respect.

See that YOUR customers get the BEST by supplying them with world-famous MULLARD TUBES!

Other MULLARD PREFERRED types

DM70/1M3	ECC82/12AU7	EC81/6AJ8
EB91/6AL5	ECC85/6AQ8	EL86/6CW5
EABC80/6AK8	ECC88/6DJ8	EM81/6DA5
EBF89/6DC8	ECC189/6ES8	EM84/6FG6
EC95/6ER5	ECCF80/6BL8	EZ80/6V4
ECC81/12AT7	ECCF82/6U8	

Engineering application data for the NEW MULLARD STEREO CIRCUITS available on request.

International
Electronics CORP.

81 SPRING STREET
NEW YORK 12, N.Y.



"Mullard" is the trademark of Mullard Ltd.

RADIO-ELECTRONICS

free! ALLIED'S 1959

value-packed 452-page
ELECTRONIC SUPPLY CATALOG

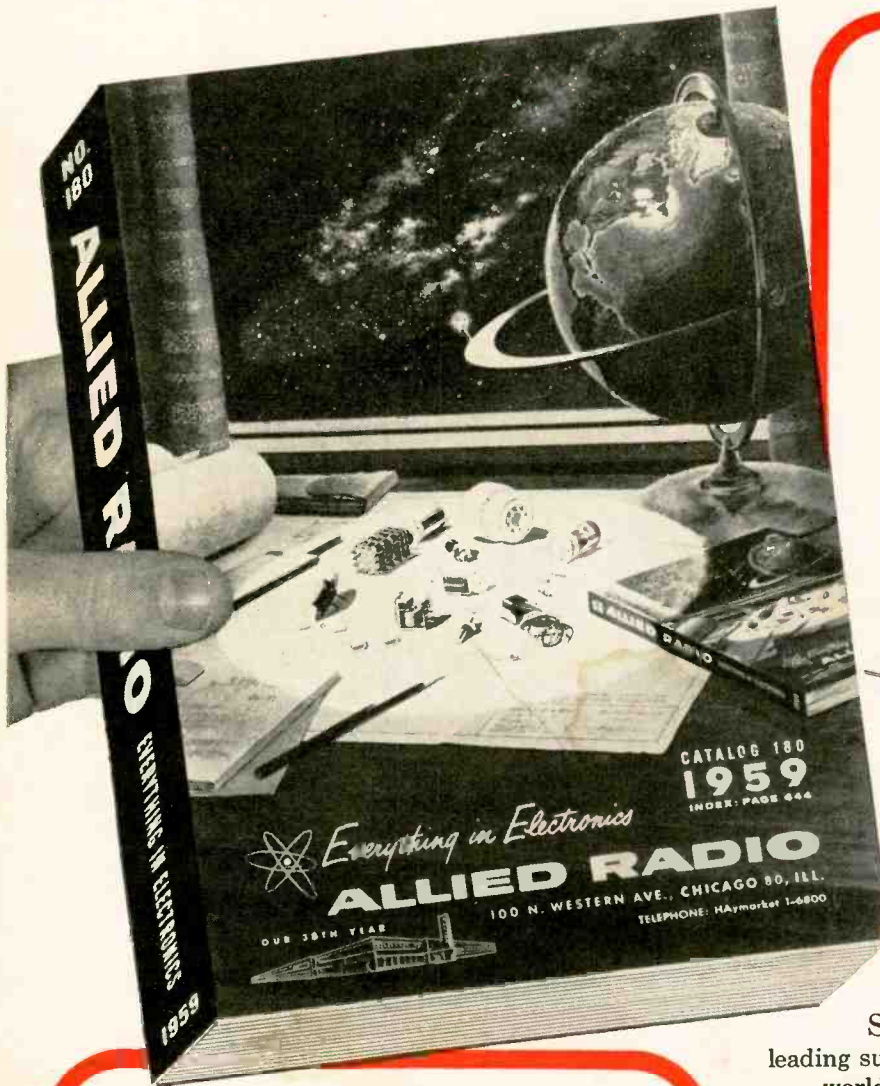

the only COMPLETE guide
to everything in electronics

WORLD'S LARGEST STOCKS

- Latest Stereo Hi-Fi Systems—
Everything in Hi-Fi Components
- Money-Saving, Build-Your-Own
KNIGHT-KITS—Latest Models
- Values in Recorders and Supplies
- Latest Public Address Systems,
Paging and Intercom Equipment
- Amateur Receivers, Transmitters
and Station Gear
- Test & Laboratory Instruments
- Specialized Electronic Equipment
for Industrial Application
- TV Tubes, Antennas, Accessories
- Huge Listings of Parts, Tubes,
Transistors, Tools, Books

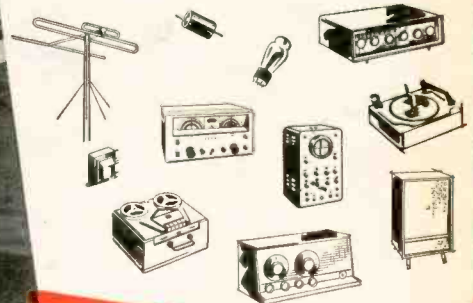

featuring:

MONEY-SAVING knight-kits: Finest electronic equipment in money-saving kit form. Complete selection of latest Hi-Fi amplifier, tuner and speaker kits (new Stereo units); Hobbyist kits; Test Instruments and Amateur kits. KNIGHT-KITS are an exclusive ALLIED product.

HI-FI! STEREO! See the world's largest selection of quality Hi-Fi music systems and famous name components. First with the latest in STEREO! Save on ALLIED-recommended complete systems. Own the best in Hi-Fi for less!

EASY PAY TERMS: Only 10% down; available on orders of \$20 or more. Fast handling—no red tape.

ALLIED RADIO

 our 38th year
World's Largest Electronic Supply House

Send for ALLIED's 1959 Catalog—it's the leading supply guide—452 pages packed with the world's largest selection of quality electronic equipment at lowest, money-saving prices. Get every buying advantage at ALLIED: fastest shipment, expert personal help, lowest prices, guaranteed satisfaction...

send for the leading
electronic supply guide

FREE!

ALLIED RADIO CORP., Dept. 2-E9
100 N. Western Ave., Chicago 80, Ill.

Send FREE 452-Page 1959 ALLIED Catalog

Name _____

Address _____

City _____ Zone _____ State _____

BACH OR BE-BOP WHILE YOU BARBECUE



**On patio or parade ground...
for home or commercial use...
there's a University
weatherproof 'LC'
speaker system
designed to give you
clean, wide-range
high fidelity sound**



MODEL MLC



MODEL BLC

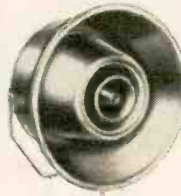

MODEL WLC

Only University gives you a choice of three *genuine* dual-range speakers (with separately driven woofer and tweeter) to cover any area you desire... wide or narrow, shallow or deep. Leave in place rain or shine, season after season... confident of their rugged dependability.

MODEL MLC — Compact, economical, exceptionally smooth tonal quality. Simply hook up to amplifier, phonograph, radio, or even TV. One-piece fiberglass reinforced polyester horn. 150-15,000 cps. 8 ohms. 15 watts. 12 $\frac{3}{4}$ " x 9 $\frac{1}{2}$ " x 10 $\frac{1}{2}$ " deep. Shpg. wt., 10 lbs. *User net: \$34.50.*

MODEL BLC — Meets the highest standards of the connoisseur. All metal construction. 70-15,000 cps. 8 ohms. 25 watts. Diameter: 22 $\frac{3}{4}$ ". Depth: 9 $\frac{1}{4}$ ". Shpg. wt., 21 lbs. *User net: \$53.70.*

MODEL WLC — Finest outdoor system made. For full-bodied sound at higher output levels. All metal construction. 50-15,000 cps. 8 ohms. 30 watts. Diameter: 33 $\frac{1}{2}$ ". Depth: 20". Shpg. wt., 72 lbs. *User net: \$150.00.*

For complete details, write for brochure.
Desk J-1, University Loudspeakers, Inc.,
80 South Kensico Ave., White Plains, N. Y.



NEWS BRIEFS (Continued)

been running on Wednesday nights at 9 PM (EST) on 4030 kc upper side-band. Schedule for May: May 6, "American Antarctic Communications Adventures," Amory Waite, Jr.; May 13, "Telemetering For Guided Missiles," J. Popkin-Clurman; May 20, "The Megacoder," Harry Kihn; May 27, "Novel Tuning Methods at Uhf and Lower Microwaves," Bernard Nadler. The Mars Technical Net will recess after May, and will start again in September.

ENGINEERING GRADUATES will find more employment opportunities in 1964 than in 1963 when they graduate from technical schools. Freshman enrollment in the fall of 1958 was down almost 12% from the year before, despite the accelerated national program of engineering training and calls from officials for more engineers.

AUTOMOBILE RADAR detects approaching objects up to 100 feet ahead, informing driver by sound or flashing red light. Using Doppler effect at 16,140 mc, this proximity warning device has two 10-inch reflectors mounted 4 feet apart on the front of General Motors' experimental car, the Cadillac Cyclone.

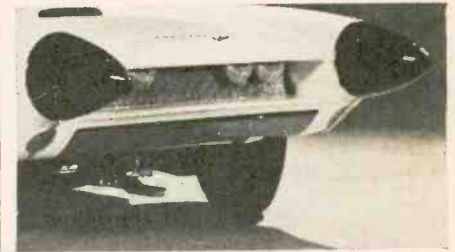

A reflex klystron generates microwave power which goes through a waveguide to the transmitting reflector, bounces off objects ahead and is picked up by the other reflector. A crystal detector mixes and compares the frequencies of transmitted and received signals. Transistors amplify differences in frequency caused by the approach of an object and deliver an audio output whose strength increases with speed of approach of object. The set works just as well whether the weather is bad or good.

MICROMODULE availability for military electronic applications was announced jointly recently by the US Army and RCA, at a special presentation where numbers of Micromodule devices were exhibited. It was suggested that they might become available for civilian use within 2 or 3 years.

Micromodules are extremely small modular units, $\frac{1}{8}$ inch square, each containing a transistor capacitor or other circuit element—or occasionally a number of elements. These are built up into cubes, 27 of which occupy 1 cubic inch. Though they have been mentioned previously (see RADIO-ELECTRONICS, June 1958, page 58), engineering samples have just become available.

In addition to almost incredible mini-
(Continued on page 14)

6 months
from today

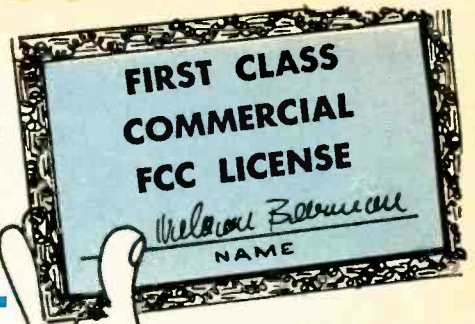

WHICH WILL YOU HOLD ...

OR

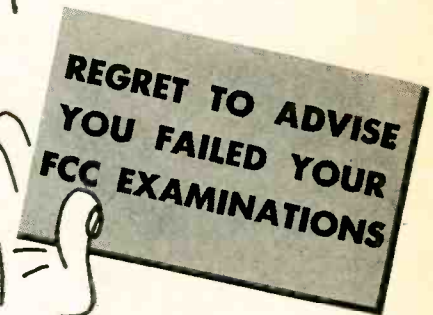

add technical training to your practical experience. Get your FCC license quickly!

then use our effective

Job Finding Service

Get your FCC Commercial License

or your money back

The Master Course in Electronics will provide you with the mental tools of the electronics technician and prepare you for a First Class FCC License (Commercial) with a radar endorsement. When you successfully complete the Master Course, if you fail to pass the FCC examination, you will receive a full refund of all tuition payments.

Employers Make Offers Like These

to Our Graduates Every Month

Broadcast Station in Illinois: "We are in need of an engineer with a first class phone license, preferably a student of Cleveland Institute of Radio Electronics; 40 hour week plus 8 hours overtime."

West Coast Manufacturer: "We are currently in need of men with electronics training or experience in radar maintenance. We would appreciate your referral of interested persons to us."

Our Trainees Get Jobs Like These Every Month

CHIEF ENGINEER

"Since enrolling with Cleveland Institute I have received my 1st class license, served as a transmitter engineer and am now Chief Engineer of Station WAIN. I also have a Motorola, 2-Way Service Station. Thanks to the Institute for making this possible."

Lewis M. Owen, Columbia, Ky.

TEST ENGINEER

"I am pleased to inform you that I recently secured a position as Test Engineer with Melpar, Inc. (Subsidiary of Westinghouse). A substantial salary increase was involved. My Cleveland Institute training played a major role in qualifying me for this position."

Boyd Daugherty, Falls Church, Va.

Names of Trainees in Your Area
Provided on Request

Carl E. Smith, E.E., President

CLEVELAND INSTITUTE OF RADIO ELECTRONICS
Dept. RE-29, 4900 Euclid Bldg., Cleveland 3, Ohio

Get these valuable
Booklets

FREE!

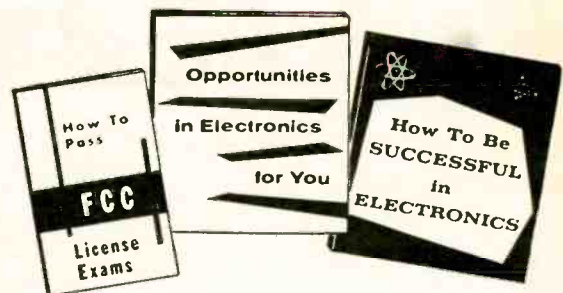

Accredited by National Home Study Council

Cleveland Institute of Radio Electronics

Dept. RE-29, 4900 Euclid Bldg., Cleveland, Ohio

Please send Free Booklets prepared to help me get ahead in Electronics. I have had training or experience in Electronics as indicated below:

- | | |
|---|---|
| <input type="checkbox"/> Military | <input type="checkbox"/> Broadcasting |
| <input type="checkbox"/> Radio-TV Servicing | <input type="checkbox"/> Home Experimenting |
| <input type="checkbox"/> Manufacturing | <input type="checkbox"/> Telephone Company |
| <input type="checkbox"/> Amateur Radio | <input type="checkbox"/> Other |

In what kind of work are you
now engaged?

In what branch of Electronics
are you interested?

Name Age

Address

City Zone State

RE-29

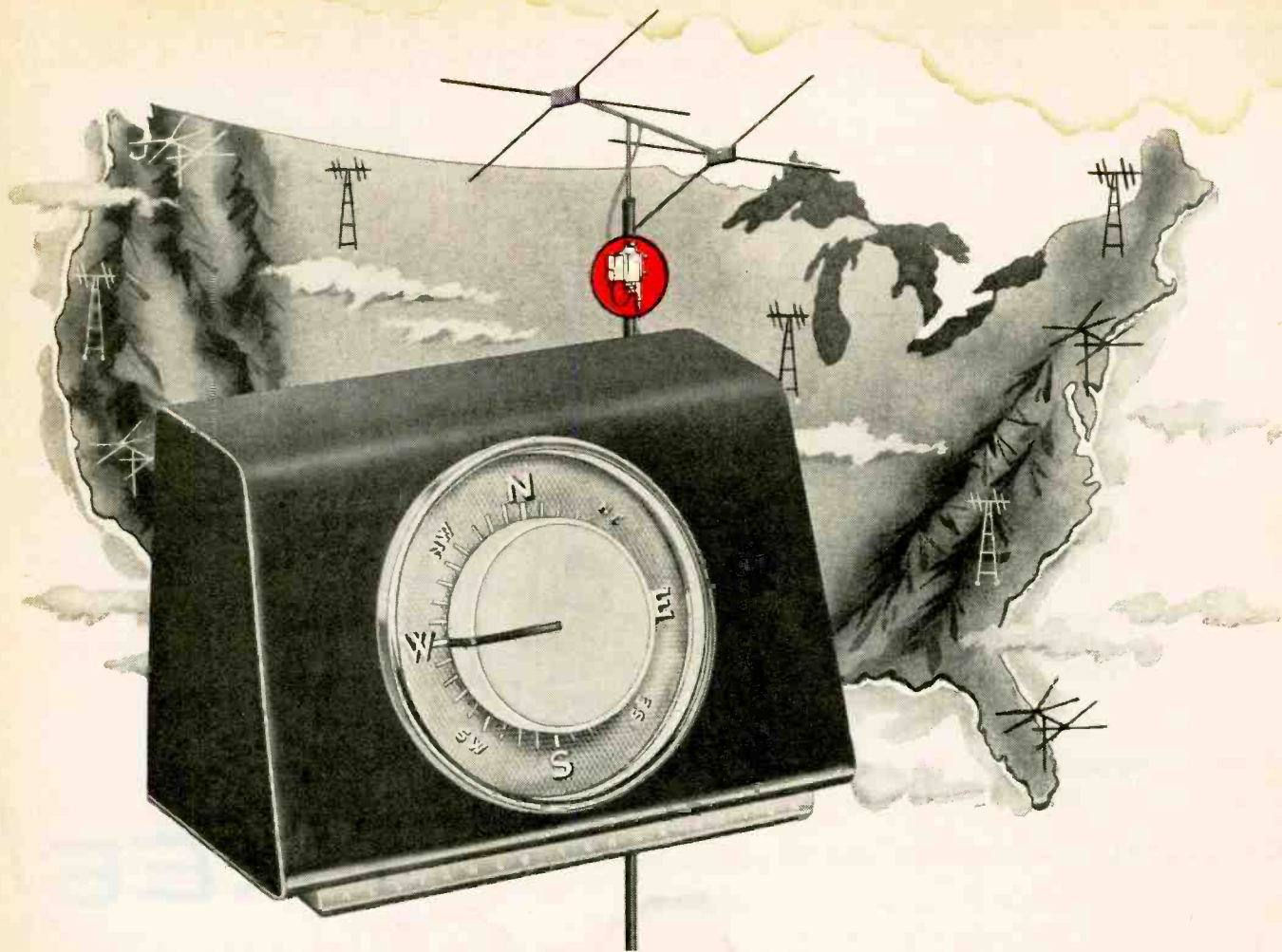

ALLIANCE TENNA-ROTOR

Increases Your Antenna Profits

Now is the time for you to get into the profitable antenna rotator market. Day by day, color TV, channel changes and new stations are increasing the need for this important antenna accessory.

You not only increase your profits by selling Alliance Tenna-Rotor . . . you also insure better viewing for your customers regardless of future changes in station locations or color.

Alliance Tenna-Rotor is your logical choice because it's the leader—backed by years of product research, national advertising and more than 4 million installations. Alliance Tenna-Rotor makes selling easy with a *complete* line, better design, competitive prices, sales helps and free ad mats. Write for dealer information, or—



See Us At The
Electronic Parts
Distributors Show!

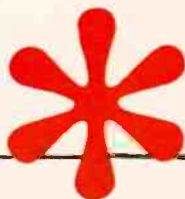

Conrad Hilton Hotel, Chicago—May 18-20
Booth No. 221 Hospitality Suite 2104-5-6-7

See a startling new Alliance electronics product
shown here for the very first time!

THE ALLIANCE MANUFACTURING COMPANY

(Division of Consolidated Electronics Industries Corp.) Alliance, Ohio

What Does F.C.C. Mean To You?

What is the F. C. C.?

F. C. C. stands for Federal Communications Commission. This is an agency of the Federal Government, created by Congress in 1934 to regulate all radio communication and radio and television broadcasting in the United States.

What is an F. C. C. Operator License?

The F. C. C. requires that only qualified persons be allowed to install, maintain, and operate electronic communications equipment, including radio and television broadcast transmitters. To determine who is qualified to take on such responsibility, the F. C. C. gives technical examinations. Operator licenses are awarded to those who pass these examinations. There are different types and classes of operator licenses, based on the type and difficulty of the examination passed.

What are the Different Types of Operator Licenses?

The F. C. C. grants three different types (or groups) of operator licenses—commercial radiotelePHONE, commercial radioteleGRAPH, and amateur.

COMMERCIAL RADIOTELEPHONE operator licenses are those required of technicians and engineers responsible for the proper operation of electronic equipment involved in the transmission of voice, music, or pictures. For example, a person who installs or maintains two-way mobile radio systems or radio and television broadcast equipment must hold a radiotelePHONE license. (A knowledge of Morse code is NOT required to obtain such a license.)

COMMERCIAL RADIOTELEGRAPH operator licenses are those required of the operators and maintenance men working with communications equipment which involves the use of Morse code. For example, a radio operator on board a merchant ship must hold a radioteleGRAPH license. (The ability to send and receive Morse is required to obtain such a license.)

AMATEUR operator licenses are those required of radio "hams"—people who are radio hobbyists and experimenters. (A knowledge of Morse code is necessary to be a "ham".)

What are the Different Classes of RadiotelePHONE licenses?

Each type (or group) of license is divided into different classes. There are three classes of radiotelePHONE licenses, as follows:

(1) **Third Class RadiotelePHONE License.** No previous license or on-the-job experience is required to qualify for the examination for this license. The examination consists of F. C. C. Elements I and II covering radio laws, F. C. C. regulations, and basic operating practices.

(2) **Second Class RadiotelePHONE License.** No on-the-job experience is required for this examination. However, the applicant must have already passed examination Elements I and II. The second class radiotelePHONE examination consists of F. C. C. Element III. It is mostly technical and covers basic radiotelePHONE theory (including electrical calculations), vacuum tubes, transistors, amplifiers, oscillators, power supplies, amplitude modulation, frequency modulation, measuring instruments, transmitters, receivers, antennas and transmission lines, etc.

(3) **First Class RadiotelePHONE License.** No on-the-job experience is required to qualify for this examination. However, the applicant must have already passed examination Elements I, II, and III. (If the applicant wishes, he may take all four elements at the same sitting, but this is

not the general practice.) The first class radiotelePHONE examination consists of F. C. C. Element IV. It is mostly technical covering advanced radiotelePHONE theory and basic television theory. This examination covers generally the same subject matter as the second class examination, but the questions are more difficult and involve more mathematics.

Which License Qualifies for Which Jobs?

The **THIRD CLASS** radiotelePHONE license is of value primarily in that it qualifies you to take the second class examination. The scope of authority covered by a third class license is extremely limited.

The **SECOND CLASS** radiotelePHONE license qualifies you to install, maintain, and operate most all radiotelePHONE equipment except commercial broadcast station equipment.

The **FIRST CLASS** radiotelePHONE license qualifies you to install, maintain, and operate every type of radiotelePHONE equipment (except amateur, of course) including all radio and television stations in the United States, and in its Territories and Possessions. This is the highest class of radiotelePHONE license available.

How Long Does it Take to Prepare for F. C. C. Exams?

The time required to prepare for FCC examinations naturally varies with the individual, depending on his background and aptitude. Grantham training prepares the student to pass FCC exams in a minimum of time.

In the *Grantham Correspondence Course*, the average beginner with NO previous experience or training in radioelectronics should obtain his second class radiotelePHONE license after from 200 to 300 hours of study. This same student should then prepare for his first class FCC license in approximately 100 additional hours of study.

In the *Grantham Resident Course*, the time required to complete the course and get your license (under normal circumstances) is as follows:

In the **DAY** course (5 days a week) you should get your second class license at the end of the first 9 weeks of classes, and your first class license at the end of 3 additional weeks of classes. This makes a total of 12 weeks (just a little less than 3 months) required to cover the whole course, from "scratch" through first class.

In the **EVENING** course (2 nights a week) you should get your second class license at the end of the 22nd week of classes and your first class license at the end of 8 additional weeks of classes. This makes a total of approximately

7 months required to cover the whole course, from "scratch" through first class, in the evening course.

The Grantham course is designed specifically to prepare you to pass FCC examinations. All the instruction is presented with the FCC examinations in mind. In every lesson test and pre-examination you are given constant practice in answering FCC-type questions, presented in the same manner as the questions you will have to answer on your FCC examinations.

Why Choose Grantham Training?

The Grantham Communications Electronics Course is planned primarily to lead to an F.C.C. license, but it does this by TEACHING electronics. This course can prepare you quickly to pass F. C. C. examinations because it presents the necessary principles of electronics in a simple "easy to grasp" manner. Each new idea is tied in with familiar ideas. Each new principle is presented first in simple, everyday language. Then after you understand the "what and why" of a certain principle, you are taught the technical language associated with that principle. You learn more electronics in less time, because we make the subject easy and interesting.

Is the Grantham Course a "Memory Course"?

No doubt you've heard rumors about "memory courses" or "cram courses" offering "all the exact FCC questions". Ask anyone who has an FCC license if the necessary material can be memorized. Even if you had the exact exam questions and answers, it would be much more difficult to memorize this "meaningless" material than to learn to understand the subject. Choose the school that teaches you to thoroughly understand—choose Grantham School of Electronics.

Is the Grantham Course Merely a "Coaching Service"?

Some schools and individuals offer a "coaching service" in FCC license preparation. The weakness of the "coaching service" method is that it presumes the student already has a knowledge of technical radio and approaches the subject on a "question and answer" basis. On the other hand, the Grantham course "begins at the beginning" and progresses in logical order from one point to another. Every subject is covered simply and in detail. The emphasis is on making the subject easy to understand. With each lesson, you receive an FCC-type test so you can discover daily just which points you do not understand and clear them up as you go along.

HERE'S PROOF that Grantham Students prepare for F.C.C. examinations in a minimum of time. Here is a list of a few of our recent graduates, the class of license they got, and how long it took them:

	License	Wks.
Robert H. Moore, 807 Grace St., Baldwin, L.I., N.Y.	1st	12
Otis A. Towns, 3638 Bates St., St. Louis, Mo.	1st	12
Robert A. Herrman, 608 Walker Ave., Baltimore, Md.	1st	14
Walter Menzel, Jr., 423 James St., Crystal Lake, Ill.	1st	8
Serge G. Miller, 1315 W. 15th St., San Pedro, Calif.	1st	12
John A. Hayes, 1519 Madison Ave., Memphis, Tenn.	1st	14
Franklin A. VanLeuven, 6061 Woodlawn Ave., Maywood, Calif.	1st	12
Robert A. Morgan, 25 Barrow St., New York, N.Y.	1st	9

OUR GUARANTEE: If you should fail the F. C. C. exam after finishing our course, we guarantee to give you additional training at NO ADDITIONAL COST. Read details in our free booklet.

THREE COMPLETE SCHOOLS

To better serve our many students throughout the entire country, Grantham School of Electronics maintains three complete schools—in Washington, D.C., Hollywood, Calif., and Seattle, Wash. All schools offer the same rapid courses in F.C.C. license preparation, either home study or resident classes.

For further details concerning F. C. C. licenses and our training, send for our FREE booklet, "Careers in Electronics". Clip the coupon below and mail it to the School nearest you.

Get your First Class Commercial F. C. C. License Quickly by training at



GRANTHAM SCHOOL OF ELECTRONICS

821-19th Street, N.W.
Washington 6, D.C.

1505 N. Western Ave.
Hollywood 27, Calif.

408 Marion Street
Seattle 4, Wash.

(Phone: ST 3-3614)

(Phone: HO 7-7727)

(Phone: MA 2-7227)

Mail This Coupon Now—No Salesman Will Call

MAIL TO SCHOOL NEAREST YOU

To: **GRANTHAM SCHOOL OF ELECTRONICS**

821-19th, NW 1505 N. Western 408 Marion
Washington Hollywood Seattle

Gentlemen:

Please send me your free booklet telling how I can get my commercial F.C.C. license quickly. I understand there is no obligation and no salesman will call.

Name _____ Age _____

Address _____

City _____ State _____

Interested in: Home Study, Resident Classes 94-E

BY SIMPLE DEFINITION...

Whale (hwāl), n. World's greatest mammal.

Astatic (āstāt'ĭk), n. World's greatest phono cartridge name.

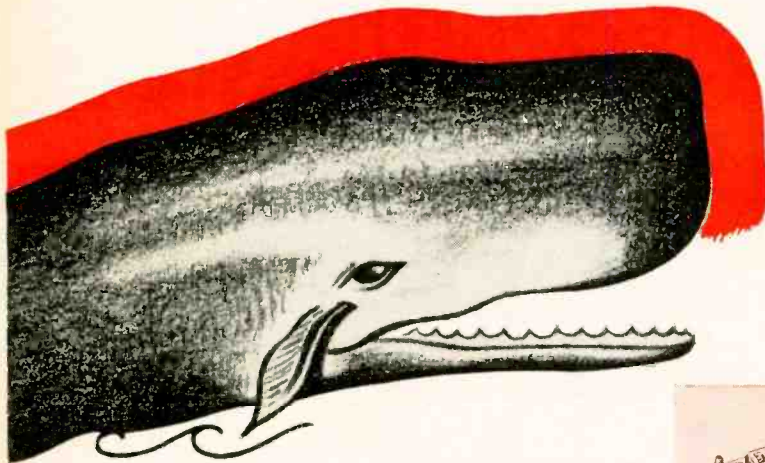

...ASTATIC IS A WHALE OF A PHONO CARTRIDGE LINE

Yes, there is ONE NAME that means more — far more — than any other in Phono Cartridges. Whether you are speaking of SIZE of the line, SIZE of original equipment sales or replacement sales made by distributors and dealers . . . whether you are speaking of COMPLETENESS of the line or the number of engineering FIRSTS which the line represents . . . the GREATER consumer preference, or the GREATER profits for distributors and dealers — NO MATTER HOW you look at it, there is ONE line that TOPS THEM ALL. That's Astatic. Over 100-million have been sold. Seldom in any industry does one line so greatly dominate and outsell all others. Whether YOU sell, install or use phono cartridges, Astatic has the best answer. IT'S A WHALE OF A LINE!

LOOK AT THESE RECENT ASTATIC CARTRIDGE FIRSTS

FIRST to bring to the public an efficient, mass-produced Stereo Cartridge.

FIRST with a COMPLETE Plug-in Phono Cartridge line, with diamond or sapphire tips.

FIRST to deal a direct knockout to cheap, inferior foreign cartridges, eliminating their one advantage — low cost — with an across-the-board Astatic price slash.

ASTATIC PHONO CARTRIDGES

CERAMIC CRYSTAL STEREO
 MONAURAL PLUG-IN CONVENTIONAL
 DIAMOND OR SAPPHIRE STYL

Leader with originals — first with replacements

GO BY BRAND . . . GO BUY ASTATIC

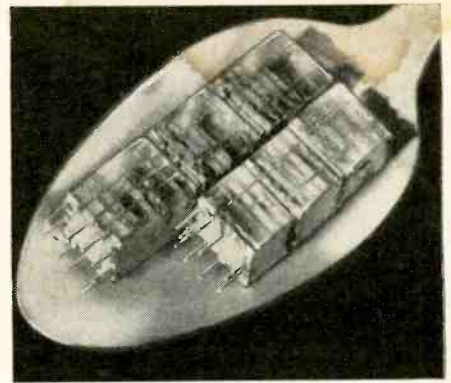
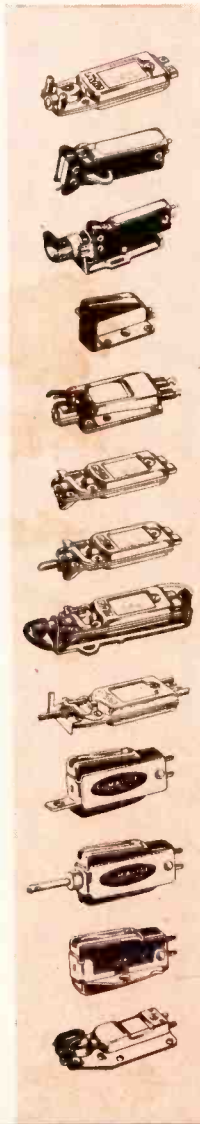

aturization, the new technique offers greater reliability, decreased maintenance, and, it is hoped, eventual lower costs. The order of miniaturization is illustrated by the photograph of a six-transistor military receiver in a tea-spoon. Sets of this size have already been built for use in future helmet radios.

Next to purely military applications, space electronics offer the most immediate field for Micromodule techniques. Their small size—units can be made at least 10 times smaller and lighter than by the next-best existing techniques—expands the possibilities of space-vehicle instrumentation enormously.

LAWRENCE COLOR TUBE may be ready for commercial use in home sets soon, if persistent stories leaking out of Paramount Pictures, owner of the patents, and Du Mont, at work for some time on perfecting the tube, are any indication. Many have believed that the Lawrence tube (described in RADIO-ELECTRONICS, January, 1954, p. 35) might prove one of the major breakthroughs needed to make color television economically practical for mass market. Since the tube requires some circuitry different from the present system, it might take a year or two even after perfection of picture tube itself before mass production could become a reality.

HIGHEST HI-FI sound yet may be the 10-billion-cycle "sound" waves recently produced by Dr. Edward Jacobsen of General Electric Research Labs. He applied microwave pulses to a quartz crystal in a cavity-resonator device at temperatures near absolute zero—2° Kelvin. Importance of the new sound is in its potential use as a tool for probing the properties of solid-state materials. Low-pitched ultrasonics are familiar to electronics in industrial applications for cleaning and soldering, and in instruments like the Reflectoscope, which uses a sonarlike technique to detect flaws in metal.

SIX NEW TV STATIONS and a repaired one lengthen our list this month:

- KUAT, Tucson, Ariz..... 6
- WMSB, Onondaga, Mich.....10
- KDPS-TV, Des Moines, Iowa.....11
- KVIE, Sacramento, Calif..... 6
- WMUB, Oxford, Ohio.....14
- WILX-TV, Onondaga, Mich.....10

WLEX-TX, Lexington, Ky., went off the air Jan. 21 when a storm wrecked

THE **Astatic** CORPORATION, CONNEAUT, OHIO KNOWN THE WORLD OVER

IN CANADA: CANADIAN ASTATIC LIMITED, TORONTO, ONTARIO

EXPORT SALES: ROBURN AGENCIES INC., 431 GREENWICH ST., N.Y. 13, N.Y., U.S.A.

ownership of a **PHOTOFACT** SERVICE DATA LIBRARY SPELLS SUCCESS FOR SERVICE TECHNICIANS

here's actual proof from the men who know



"I don't believe I would do business without PHOTOFACT and I don't see how any other serviceman can. The time saved is worth more than the PHOTOFACT cost, and the satisfaction in knowing I am doing the job right is something too."

—Emmett T. Cassidy
Gadsden, Alabama

Mr. Cassidy consults a time-saving tell-all S-Standard Notation Schematic—an exclusive PHOTOFACT feature.



HERE'S MORE PROOF...FROM COAST-TO-COAST

"In all the years we have been in business, we have used PHOTOFACT more than any other reference books. Couldn't have done the work without them."

—Claude C. Yeager,
Wichita, Kans.

"I have been using PHOTOFACT since I first started in business. I find them quite time saving. If I didn't think them worthwhile, I wouldn't have a standing order for all new ones as issued."

—Jerry Beccia,
Waterbury, Conn.

"PHOTOFACTS are the most valuable item in the shop."

—Ray Myers, Austin, Minn.

"PHOTOFACTS save time, time is money, and money is what we're in business for."

—Alexander Sarytchoff
Chicago, Ill.

"I find PHOTOFACT information invaluable in the conduct of my business. In addition to excellent schematic information, the parts replacement section is a great time saver."

—Matt Slifstein, Harrison, N.Y.

"In servicing all kinds of sets PHOTOFACT is a must. And the new file cabinets are a space and time saver to me."

—Raymond L. Griffin
Lawrenceburg, Tenn.

"I depend on PHOTOFACT on every TV repair job I turn out. I can do the job in half the time if PHOTOFACT is handy."

—Robert P. Bradley
Inverness, Miss.

"PHOTOFACTS mean just about everything in servicing TV and radio."

—Warren T. Stoudt
Boyerstown, Pa.

(These are just a few of hundreds of "Success with PHOTOFACT" letters in our files)

OWN A PHOTOFACT LIBRARY —
see your Sams Distributor today or write
to Howard W. Sams for full details



HOWARD W. SAMS & CO., INC.
2205 E. 46th St., Indianapolis 6, Ind.

- Send me Free booklet "Your Guide To Maximum Profits"
 I'm a Service Technician: full-time; part-time

My Distributor is: _____

Shop Name _____

Attn. _____

Address _____

City _____ Zone _____ State _____

NEW EASY-BUY PLAN!

It's the money-saving way to build your complete profit-making PHOTOFACT Library!

NO INTEREST—NO CARRYING CHARGE—AS LITTLE AS \$10 DOWN

FREE! Valuable steel file cabinets given to PHOTOFACT monthly subscribers and Library purchasers.

Valuable booklet shows you how PHOTOFACT boosts your profit-capacity
FREE
Send for it!



its tower, and resumed programming Feb. 24, using temporary equipment.

Onondaga's channel 10 is being shared by both WILX-TV and WMSB. WMSB is educational as are four other of our new stations, WMUB, KVIE, KDPS-TV and KUAT.

The following changes in call letters have been reported:

KPLR-TV, St. Louis, Mo.11
(formerly KCPP)
WONE-TV, Dayton, Ohio.22
(formerly WIFE)

We now have 555 TV stations operating in this country; 468 are vhf, and 87 uhf. The noncommercial total is now 42.

Calendar of Events

National Aeronautical Electronics Conference, May 4-6, Biltmore Hotel, Dayton, Ohio.

Society of Motion Picture and Television Engineers Convention, May 4-8, Fontainebleau Hotel, Miami, Fla.

URSI Spring Meeting, May 5-7, Washington, D. C.

1959 Electronic Components Conference, May 6-8, Ben Franklin Hotel, Philadelphia, Pa.

7th Regional IRE Technical Conference and Trade Show, May 6-8, University of New Mexico, Albuquerque, N. M.

Joint Conference on Automatic Techniques, May 11-13, Pick-Congress Hotel, Chicago, Ill.

Radio Technical Commission for Marine Services Meeting, May 11-13, Mt. Royal Hotel, Montreal, Canada.

1959 Electronic Parts Distributors Show, May 18-20, Conrad Hilton Hotel, Chicago, Ill. For manufacturers, representatives and distributors only. RADIO-ELECTRONICS will exhibit in Room 504 and GERNSBACK LIBRARY in Booth 107.

5th National Symposium on Instrumental Methods of Analysis, May 18-20, Shamrock-Hilton, Houston, Tex.

Annual EIA Convention, May 20-22, Sheraton Hotel, Chicago.

International Convention on Transistors, May 21-27, Earl's Court, London, England.

National Telemetry Conference, May 25-27, Brown Palace and Cosmopolitan Hotel, Denver, Colo.

National Symposium on Microwave Theory and Techniques, June 1-3, Harvard University, Cambridge, Mass.

National Conference on Production Techniques, June 4-5, Villa Hotel, San Mateo, Calif.

Symposium on Electro-magnetic Theory, June 15-20, University of Toronto, Toronto, Ontario, Canada.

International Conference on Information Processing, June 13-22, UNESCO House, Paris, France.

International Symposium on Circuit and Information Theory, June 16-18, University of California, Los Angeles, Calif.

National Convention on Military Electronics, June 29-July 1, Sheraton-Park Hotel, Washington, D. C.

Julius Finkel, founder and president of JFD Manufacturing Co., Brooklyn, N.Y. died at his home in Brooklyn on March 23 after a long illness. He was 72. He founded a wholesale electronics parts distributing company in Brooklyn in 1928 and the next year established JFD.

END

smoother listening with **THE ACOUSTICAL LENS**

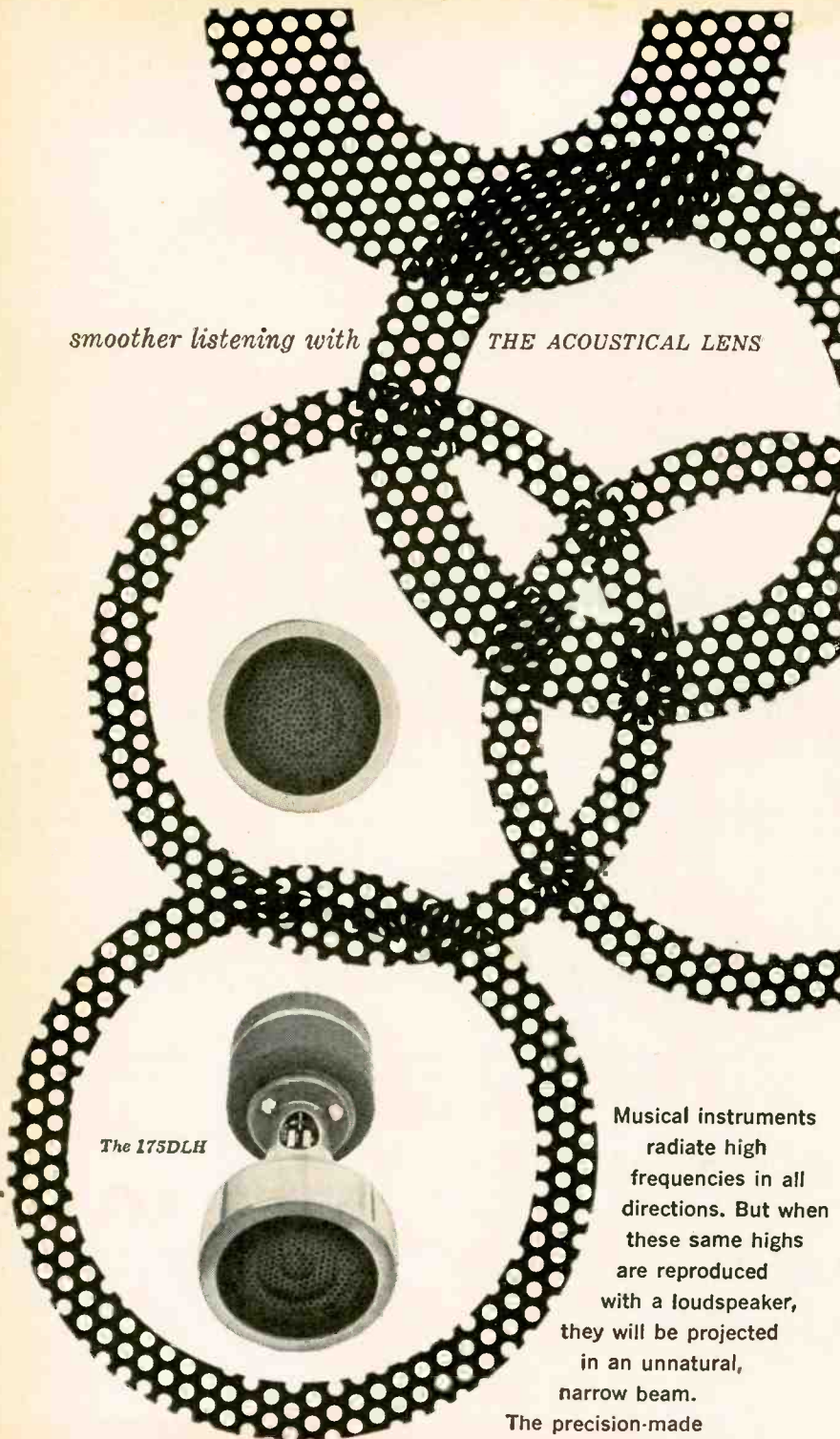

The 175DLH

Musical instruments radiate high frequencies in all directions. But when these same highs are reproduced with a loudspeaker, they will be projected in an unnatural, narrow beam.

The precision-made acoustical lens, an exclusive

James B. Lansing Sound, Inc., contribution to the art of high fidelity, disperses highs in the same way the lens in your slide projector bends light rays. Highs are vividly realistic.

No needle-sharp beam. No phase disturbance. The JBL Signature Acoustical Lens is the only completely successful solution to the beaming problem. Write for free acoustical lens bulletin.

"JBL" means

JAMES B. LANSING SOUND, INC.

3249 Casitas Ave., Los Angeles 39, Calif.



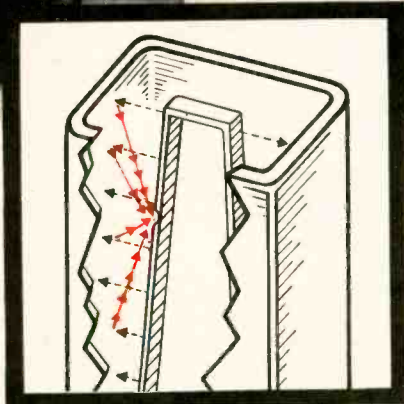

Back emission

MAJOR CAUSE OF POWER RECTIFIER FAILURES

eliminated in 5U4GB

HERE'S HOW IT HAPPENS. Back emission from overheated plate to filament brings about most rectifier failures. The reverse current mounts . . . filament coating is stripped . . . filament becomes overheated . . . soon burns out.

HERE'S HOW IT IS ELIMINATED. Recognizing the vulnerability of rectifiers to premature failures, CBS-Hytron instituted a continuing program to get rid of them. As a result, the 5U4GB, for example, has a new larger-diameter plate that runs cooler. And the plate material is non-emissive. A taller bulb also operates at lower temperatures; permits depositing the getter inside cooler dome for

improved getter action. Additional features include: a firmly anchored filament of purer tungsten . . . a rugged stem . . . and improved high-vacuum techniques.

Results? Dynamic "blast" tests brutally cycle the CBS-Hytron 5U4GB between 6.8 and 4 volts with 800 volts plate potential. Yet back emission is less than one microampere.

HERE'S WHAT IT MEANS TO YOU. Virtually eliminated callbacks for the 5U4GB put more money into your pocket. Prove it. Demand the CBS-Hytron 5U4GB. Insist on the premium quality at regular prices that is yours in all CBS-Hytron tubes.

THE CBS FAMILY • CBS-HYTRON • CBS INTERNATIONAL • CBS LABORATORIES
CBS NEWS • CBS RADIO • CBS TELEVISION NETWORK • CBS TELEVISION
STATIONS • COLUMBIA RECORDS • LEADERS IN ELECTRONIC COMMUNICATIONS



tubes

CBS-HYTRON, Danvers, Massachusetts
A Division of Columbia Broadcasting System, Inc.

Tung-Sol audio tubes
now twin-packed
in matched pairs
by the manufacturer



5881 For service in amplifiers of up to 50 watts.



6550 For service in amplifiers and commercial audio equipment of up to 100 watts.

Now you can come as close to faultless sound reproduction as the design and circuitry of your hi-fi equipment will permit. Tung-Sol 5881 and 6550 beam-power amplifier tubes are factory-matched to very tight performance limits and twin-packed to help you achieve lowest distortion levels at all volume levels.

Use of Tung-Sol 5881 and 6550 tubes has long been associated with amplifiers of the very finest design. These tubes have always been produced to closest possible tolerances with cathode current ranges held to an absolute minimum.

Now, in twin-packed pairs, they assure the hi-fi enthusiast and the commercial sound engineer of replacement tubes that will provide new standards of performance—a feature of special importance with the newest amplifiers and loudspeakers, particularly binaural sound equipment. See your parts supplier.

Tung-Sol Electric Inc., Newark 4, New Jersey.



STEREO REPLY

Dear Editor:

I found your March Stereo issue very interesting. One minor point seems to me worth correcting.

The article "Adapters Simplify Stereo Conversion" says that passive network stereo adapters suffer the disadvantage of insertion loss. This is not true of our DSC-1 unit, one of those described in the article. At least it is not true to the extent that the loss is audible. Our Dynakit stereo control has an insertion loss of only 0.5 db, less than audible.

We are able to do this by using an arrangement in which all resistance change is obtained in one-half the rotation of the control. With the control centered, there is no resistance on either side. Rotation in one direction introduces resistance into one side of the circuit and vice versa. The only loss comes from the 22,000-ohm series isolation resistors which prevent one side of the circuit from loading the other when the blend control is operated.

One other point of interest in our arrangement is that the adapter is inserted in the circuit at a point where there is no possibility of overload no matter how the user misadjusts the controls. Adapters which go between the amplifier and the preamplifier can be so adjusted in some cases.

DAVID HAFLER

*Dynaco, Inc.
Philadelphia, Pa.*

LEND A HAND . . . PLEASE

Dear Editor:

For the past 3 years I have been in charge of the educational program at the London Prison Farm, London, Ohio. During this time, we have had many requests for training in radio and television.

We plan to expand our vocational school to offer this training. The men who enroll in the program will attend classes in the evening when they have free time, giving up other leisure-time activities to do so. All men who enroll in the school are thoroughly screened.

Unfortunately, we have no budget to provide for equipment or parts. All our material must be obtained gratis. We have received some help from local and nationally known dealers, but still need all types of test equipment, parts, schematics and tools. Will you help us set up this course?

J. VON KANEL

*Director of Education
London Prison Farm
Box 69
London, Ohio*

(Are any readers—particularly in the area—in a position to help with this project? If so, Mr. von Kanel would be glad to hear from them.—*Editor*)

PERFORMANCE STANDARDS

Dear Editor:

For many years audio magazines have periodically complained about the absence of *performance* standards for high-fidelity equipment, usually pointing out how the lack of these standards contributes toward consumer confusion. Usually such articles (and we always applaud them) end with a pep talk entreating the industry to "do something" about it and give the perplexed consumer the break he has long deserved.

We think you will be happy to know that something finally *has* been done about it, by the High Fidelity Consumer's Bureau of Standards. This organization has been at work on the problem of hi-fi standards for the past 2 years and has defined that elusive term "high fidelity" in terms of technical performance specifications representing the minimum performance which can properly be considered *true* high fidelity.

The bureau is a completely independent, bias-free organization, and admits no manufacturers to membership. Thus the usual necessity for compromise with makers of substandard equipment is eliminated.

Two sets of performance standards have been published for each component as well as for packaged hi-fi sets. The Silver standard marks the lower tolerable limit for *true* high fidelity, and the Gold standard indicates premium quality high fidelity for those whose requirements are even higher. We arrange for laboratory testing of typical, random samples of equipment against our published standards. In the interest of absolute uniformity, measurement procedures developed by the Hirsch-Houck Laboratories (of Audiolab and Audio League fame) have been incorporated into our program. Equipment which meets these standards may then display one of the bureau's two official Seals of Approval, depending upon the test results.

Because of our determination to remain absolutely honest, our Seal of Approval on equipment, phonograph records and tapes will continue to provide consumers with the positive assurance of technical excellence they want and need. Without meaningful performance standards, there exists a situation of unfair competition between makers of higher- and lower-fidelity equipment.

(Continued on Page 22)

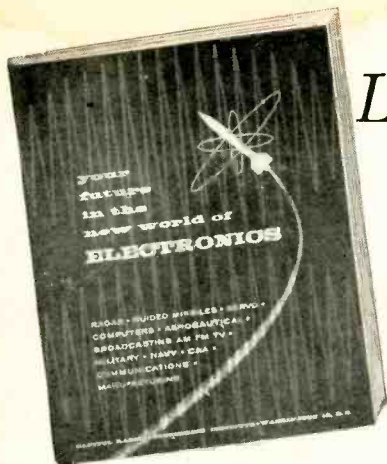

The data that } tells how
 Launched Thousands } you can be
 of Careers } successful in
 is yours FREE } **ELECTRONICS**

Automation, Instrumentation, Industrial Electronics, Aeronautical Electronics, Guided Missiles, Radar, Servo-Mechanisms, Computers, Astronautics, Telemetering, Communications, Manufacturing.

Send for your Free Copy today!

This is a brand new edition of the book which has launched thousands of men on good-paying careers in electronics. It brings you completely up to date—answers important questions on newest career developments in electronics, including Automation, Instrumentation, Industrial Electronics, Aeronautical Electronics, Guided Missiles, Radar, Servo-Mechanisms, Computers, Astronautics, Telemetering, Communications, Manufacturing.

This book, "Your Future in the New World of Electronics," also shows you how CREI Home Study leads the way to greater earnings in the booming electronics world. However, CREI does not promise you a "snap." With accredited technical school curricula such as CREI offers, you must study to convert your ambition into technical knowledge which you can sell in the fabulous field of Electronics. Since its founding in 1927, CREI has provided thousands of professional electronics men with technical education. During World War II, CREI trained thousands for the Armed Services. Leading firms recommend CREI training for their own personnel. Among them: United Air Lines, Canadian Broadcasting Corporation, Trans-Canada Airlines, Douglas Aircraft Co., The Martin Co., Columbia Broadcasting System, All-American Cables and Radio, Inc., Gates Radio Co., Canadair, Ltd., Federal Electric Corp., and U.S. Information Agency (Voice of America). CREI courses are prepared by recognized experts, in a practical, easily understood manner, and constantly revised to meet the new electronic challenges of our time. You get the benefit of time-tested study assignments under the personal supervision of a CREI staff instructor. Your studies are accomplished on your own time, during hours selected by you, and controlled by your own willpower. This complete training is the reason that graduates find their CREI diplomas keys-to-success in even the most advanced of electronic applications. CREI alumni hold top positions in America's leading firms. At your

service is the CREI Placement Bureau, which maintains constant contact with electronic industry, and cooperates with employers and graduates in making satisfactory placements. This free service is available to students, as well as graduates. Fill out the coupon below completely and mail it now. We'll promptly send you your free copy of "Your Future in the New World of Electronics." The rest—your future—is up to you!

CREI ALSO OFFERS residence training in Washington, D. C. . . . at the same high technical level. Day and evening classes start at regular intervals. Qualified residence school graduates earn degree as "Associate in Applied Science." You can qualify for CREI home study training if you have had electronic education, or experience in electronics—and realize the need of high level technical knowledge to make good in the better electronic jobs. (Electronics experience is not required for admission to CREI Residence School.) Check coupon if you prefer residence or home study information . . . or write Capitol Radio Engineering Institute, Dept. 145-F, 3224 - 16th St., N.W., Wash. 10, D. C.

INDUSTRY CALLS FOR CREI TRAINING BY NAME . . . SO SHOULD YOU!

ELECTRONIC TECHNICIANS

...ing Peninsula Co. has openings for 1st class electronic technicians to work directly with engineering in development of new products. Only those with CREI or equal training and 3 years minimum commercial experience will be considered. Top salaries to qualified applicants. Call Mr. McQueeny, A. 4-4733 for appointment. LTO SCIENTIFIC Co., Inc. 855 COMMERCIAL ST. PALO ALTO

ENGINEERING AIDES AND TECHNICIANS

Immediate Positions Available

CREI, or other formal electronic training desirable.

Experienced in reading schematics, bread board construction of electronic circuits and chassis preparation.

EMERSON RESEARCH LABORATORIES

Here you see actual help wanted ads—one from a San Francisco newspaper, another seen in Washington. They are just two of many which specify, "CREI or equal" education. This shows that industry approves CREI training, even insists on it. Experience has taught many, many companies that CREI students are taught what industry needs and wants them to know. Let this be your cue when you choose your educational program.

BRAND-NEW COURSE ADDED . . . AUTOMATION AND INDUSTRIAL ELECTRONICS ENGINEERING TECHNOLOGY. Complete course, covers all phases of automation. Special emphasis on theory, functioning, and applications of servomechanisms and computers. Also noteworthy: Lessons on machine control, instrumentation, data-processing, and telemetry.

MAIL TODAY FOR YOUR FREE BOOKLET

CAPITOL RADIO ENGINEERING INSTITUTE
 ECPD Accredited Technical Institute Curricula—Founded 1927
 Dept. 145-F, 3224 Sixteenth St., N.W., Washington 10, D. C.

Please send me your course outline and FREE illustrated Booklet, "Your Future in the New World of Electronics" . . . describing opportunities and CREI Home Study courses in Practical Electronic Engineering Technology.

CHECK FIELD OF GREATEST INTEREST

Radar, Servo and Computer Engineering Technology

Electronic Engineering Technology

Broadcast (AM, FM, TV) Engineering Technology

Television Engineering Technology

Aeronautical Electronic Engineering Technology

Automation and Industrial Electronics Engineering Technology

Name..... Age.....

Street

City..... Zone..... State.....

Check: Home Study Residence School Korean Veteran

To obtain fast, immediate service and to avoid delay, it is necessary that the following information be filled in:

Employed By.....

Type of Present Work.....

Education: Yrs. High School.....

Other.....

Electronics Experience.....

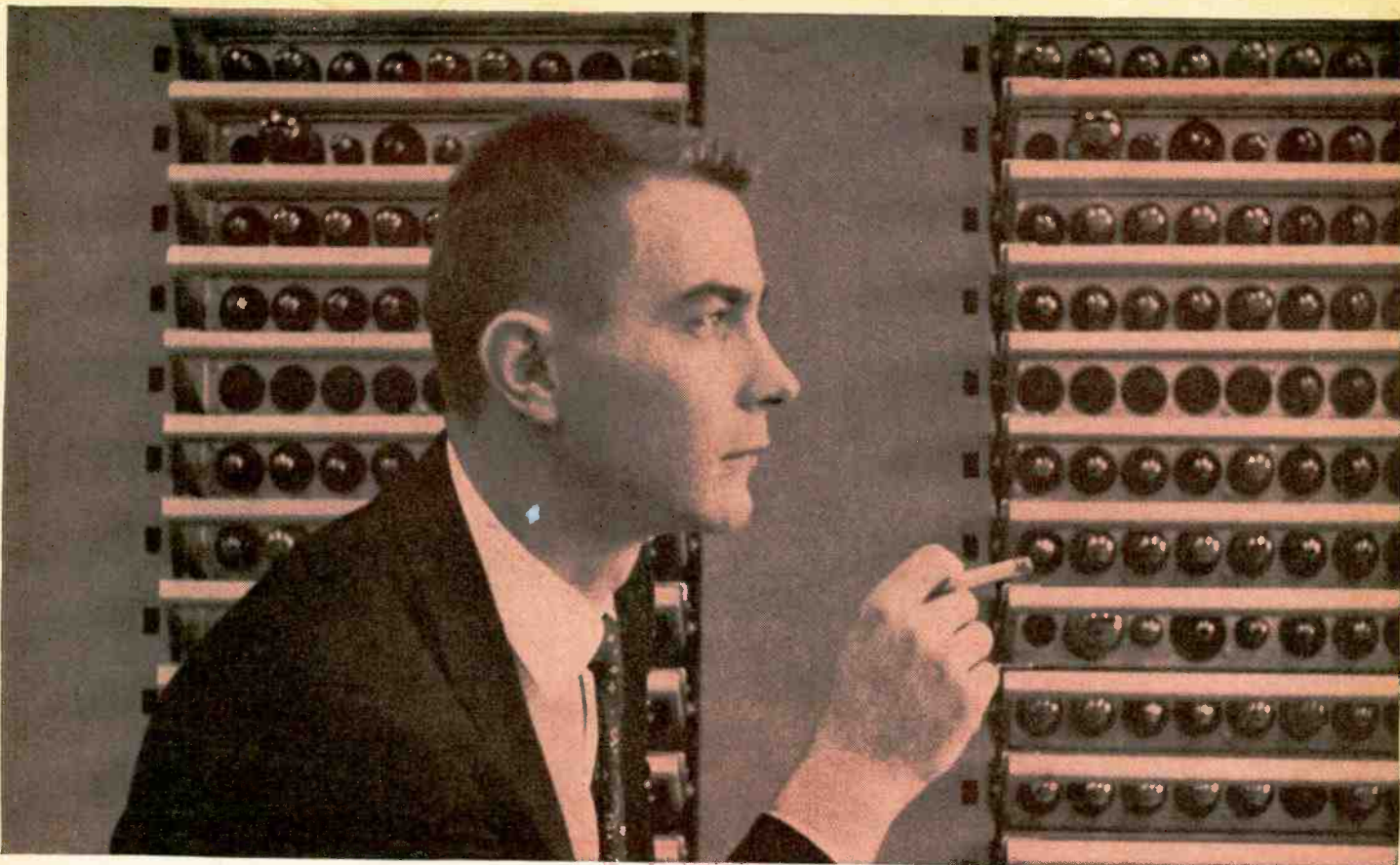

How far can you go in electronics . . .

“Just being called a Field Engineer—an impressive title for a man without a degree—that really gives me a lift.”

This is Jim Pieratt talking. With a high school education and Navy Technical training behind him, Jim holds a key job in one of America's most important electronic projects. He's an IBM Computer Units Field Engineer on Project SAGE.

Jim is 25, lean, crew-cut and soft-spoken. He smiles modestly when you ask him about his accomplishments. We were curious to know whether he had been technically inclined when he was a youngster.

“The truth is that I didn't become interested in electronics until I joined the Navy,” says Jim. “Before that, the only technical thing I might have done was to take a couple of alarm clocks apart. I chose electronics in the Navy because I thought there was a future in it.”

Change of attitude

“A lot of fellows may think, as I did, that a computer is too complicated for anybody but an Einstein to understand. It's not so. Even the largest computers like SAGE, which occupies space equivalent to a city block, can be comprehended by the ordinary man. But I didn't know this when I went for my employment interview—and I wondered if the algebra and trig I'd taken at Kalamazoo Central High would qualify me. Then my interviewer told me a little about computers . . . how they work and what my job would be after I finished IBM school. I made up my mind right then; I wanted this job.”

Training school

Soon, Jim and 21 other fellows like himself started training in Kingston, New York, getting on real intimate terms with IBM's electronic giant. Marvel of complexity though it is, when it sits on the floor and you study it part by part, the computer loses its mystery. Little by little, you begin to understand the whole from the sum of the components.

“The 20 weeks I spent in training were very happy,” says Jim. “It's interesting all the way. They encourage you to think for yourself and your efforts are recognized. During the training period, I received a living allowance in addition to my salary.”

Strategic job on Project SAGE

Jim is stationed in Virginia, near Richmond. His duties include installing, checking and testing out computer units. The giant electronic computers are the very heart and mind of Project SAGE (Semi-Automatic Ground Environment). To the in-input section of the computer comes data from radar sites, ships, reconnaissance planes and ground observer posts throughout the country. The display consoles give a visual representation of the complete air defense situation. Jim's prime responsibility is to keep the display consoles running.

8 pleasant hours a day

“I'm essentially my own boss and I'm encouraged to think for myself. For me, this is an ideal environment.

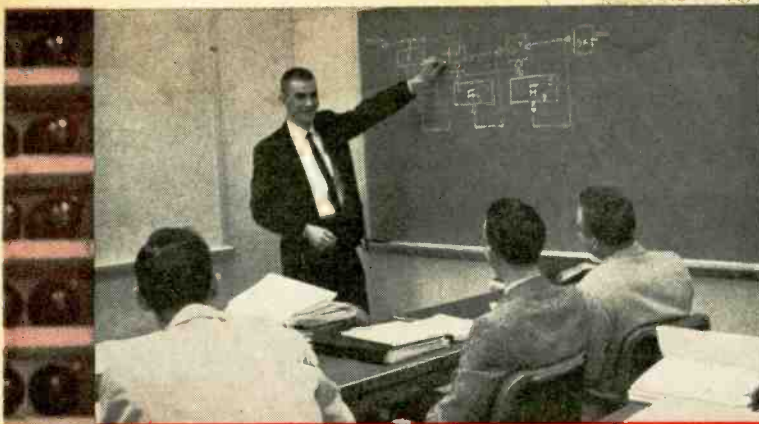

Jim discusses block diagram in class



He is testing a pluggable unit

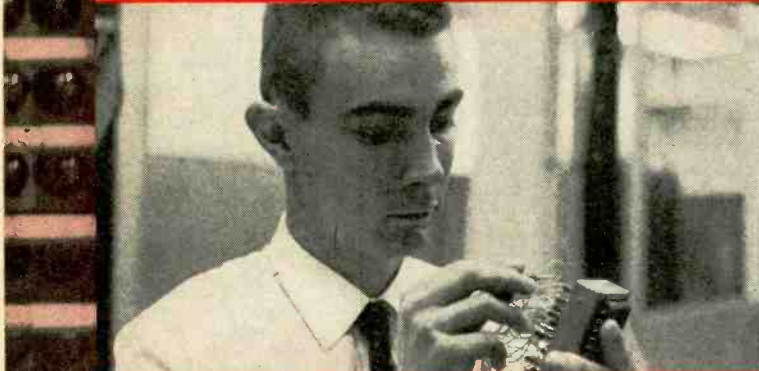

He is programming a control board



Adjusting console photo cell

• without a degree?

What do I like best about my job? Trouble-shooting, I think. I enjoy being able to repair anything that isn't working properly. As a Field Engineer, I have opportunities to assume other engineering functions. For instance, while I have nothing to do with design engineering, I do suggest changes for review by the Design Engineers. I also rewrite engineering procedures."

Where do you go from here, Jim?

"There's plenty of room for me to grow at IBM. My next step up should be to Systems Engineer. This calls for more headwork. After that, if I display enough initiative, I may become a Group Supervisor."

Family, friends, recreation

Jim, his wife and three-year-old daughter live in a pleasant ranch home, just a few miles from the site. Social life? "We've made quite a few friends here," says Jim. "Mostly among the IBM fellows and their wives. We play golf together."

Where do you go from here?

Can you look ahead, as Jim Pieratt does, and see yourself as a man on the way up? Maybe you should give some thought to IBM Military Products and the Project SAGE program. Opportunities are greater than ever. IBM's long-range program will continue to grow in importance and vast sums will be invested in hiring the right men to accomplish its vital objectives.

If you have a minimum of 3 years' technical schooling—or equivalent experience—you may be eligible for advanced training for 20 weeks as a Computer Units Field Engineer. While training, you receive full pay plus living allowance before assignment to a permanent location. You are paid a salary, not hourly wages, plus overtime.

From then on, you can go as far as your abilities and ambition will take you. IBM is the leader in a field that offers you unlimited horizons. And, as you may already know, at IBM you receive company-paid benefits that set standards for industry today.

Mr. N. H. Heyer
Dept. No. 649F
Military Products Division
IBM Corp., Kingston, N. Y.

WRITE TODAY TO:

You'll get a prompt reply. Personal interviews arranged in all areas of the United States.

IBM

®

MILITARY PRODUCTS

a real sweet combination...

the new

FASTATCH FDK-100

Dual Control Kit

with the

Centralab[®] SK-2

Shaft-Kut Tool

FREE!

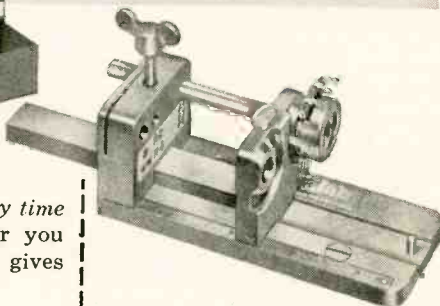
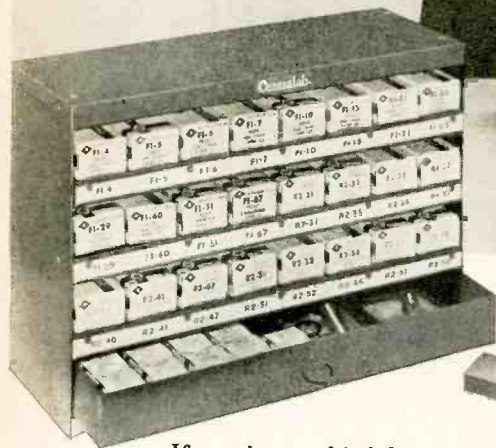
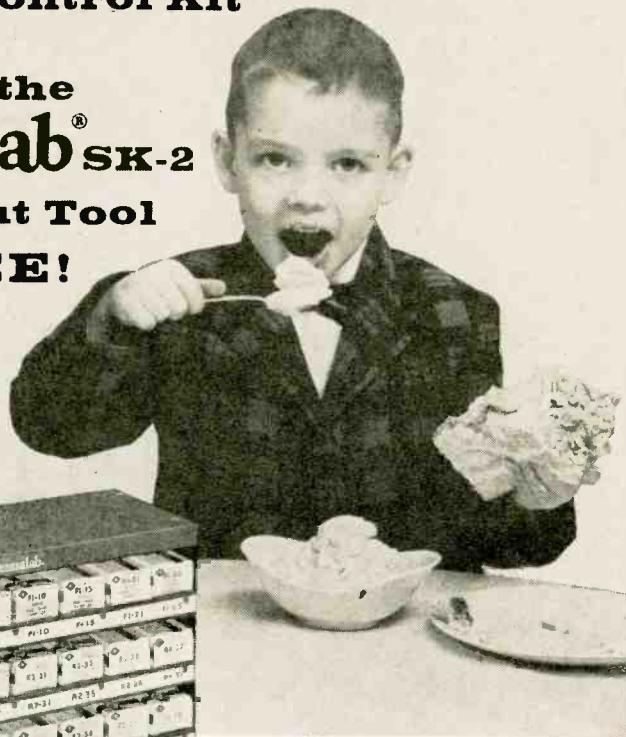

If you have a birthday any time this year, CENTRALAB has a present for you NOW... a real money-saving offer that gives you a \$41.90 value for only \$32.70.

This \$9.20 saving is yours when you buy the new CENTRALAB Fastatch FDK-100 Dual Control Kit and SK-2 Shaft-Kut Tool combination. The handy kit contains 24 controls and 9 switches—that let you quickly snap together any of 720 different dual control combinations.

The Shaft-Kut Tool assures you of precise control or switch shaft length... accurate to 1/4th of an inch. It is available separately, at \$4.95, actually less than half the price you would expect to pay for it.

So don't waste any more time with special trips to your distributor when you need a dual-concentric. Have the control you need at your fingertips with this wonderful kit-and-tool combination. But don't delay... this money-saving offer is for a limited time only!

Centralab
B-5940

A DIVISION OF GLOBE-UNION, INC.
922E E. KEEFE AVE. • MILWAUKEE 1, WIS.
In Canada: 669 Bayview Ave. • Toronto 17, Ont.

**CONTROLS • ROTARY SWITCHES • CERAMIC CAPACITORS
PACKAGED ELECTRONIC CIRCUITS • ENGINEERED CERAMICS**

HERE'S WHAT YOU GET

24 controls and 9 switches.....	\$32.70
all factory assembled and tested	
Sturdy steel cabinet.....	4.25
Shaft-Kut Tool.....	4.95
Actual value	\$41.90

REGULAR PRICE

You get all this for \$32.70—the cost of the controls alone! The Shaft-Kut Tool and steel cabinet are FREE!

CORRESPONDENCE (Continued from p. 18)

As a result, the makers of better equipment often tend to meet this unfair competition through exaggerated claims, shaving prices by cutting production corners or sacrificing quality control. Then superior products deteriorate to the level of the mediocre in the interest of survival. Honest performance standards prevent this by placing equipment of differing performance levels in their proper perspective.

More and more manufacturers are beginning to accept the bureau's axiom that, in the long run, "manufacturers are best served when consumers are best served." We believe we are in a position to do much to help hi-fi consumers select equipment more intelligently for more satisfying listening pleasure. Since equipment is tested only if the manufacturer requests it, the bureau depends upon consumers to encourage manufacturers to arrange for this bureau evaluation. For further information, write to the bureau.

WILLIAM J. GETTENS

Director, High Fidelity Consumer's Bureau of Standards
Box 268, Madison Square Station
New York, N. Y.

NOTES ON THIS AND THAT

Dear Editor:

In November, 1958 (page 58), you ran an article on soldering. I felt the article was very good, and many firms could do well to heed it. From my experience servicing European equipment, it becomes apparent that most of these practices have been in use for some time.

I built the Simple Super Time Base, by Tom Jaski, that appeared in the January, 1959, issue (page 61). In the article, the author mentions that R14 may be tough to get right. I found that by changing R12 from the listed 100,000 ohms to 50,000, the circuit became more stable and R14 was no longer critical. I feel that the circuit was underplayed as circuits of this type are very useful when it comes to collecting timing data—how long after the relay coil is energized do the contacts close, etc.

On page 151 of the March, 1959, issue there is a slight error in the item by Albert H. Taylor. The text mentions an spst switch. It should have been an spdt switch, to match the drawing.

THOMAS L. BARTHOLOMEW

Washington, D. C.

EDISON FIRESIDE PHONOGRAPH

Dear Editor:

Would you be kind enough to send me the names and addresses of anyone who might be interested in an old Edison Fireside phonograph—combination type, model A, serial No. 21399—which I have in my possession. Also, there are about 50 records in excellent condition.

LYMAN G. PORTEOUS

De Winton
Alberta, Canada

END

**WE'RE MAKING IT EASIER THAN EVER TO BECOME A WELL PAID
RADIO-TELEVISION SERVICE TECHNICIAN**

**NOW - Just \$6 Starts You Training in
RADIO-TELEVISION**

the SPRAYBERRY "Learn-by-Doing" Way . . .

**25 BIG, COMPLETE KITS
of PARTS & EQUIPMENT**

To help you learn /ast the practical side of Radio-Television, we send you expertly engineered training kits to test and assemble for interesting, valuable shop-bench practice!

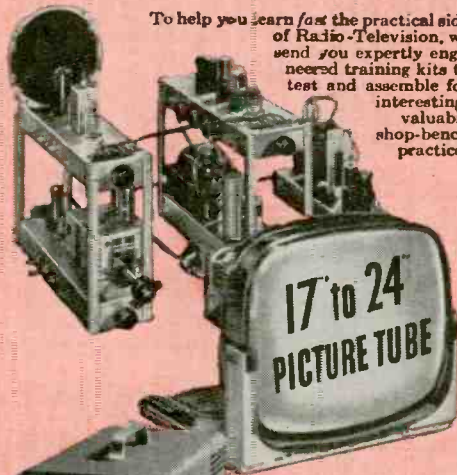

**17" to 24"
PICTURE TUBE**

• The new Sprayberry Training Television Receiver, built and tested in 5 sections.

• Now offered . . . this fine modern oscilloscope.

• You build this powerful two-band superheterodyne radio receiver.



**Big New
CATALOG
AND
Sample Lesson
FREE!**

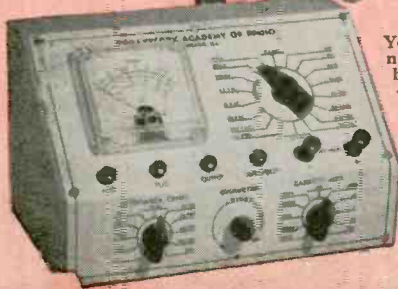

You build the new Sprayberry tester—a complete 18-range Volt-Ohm-Milliammeter test meter.



★ ★ ★ ★ This great industry is begging for trained men . . . to step into good paying jobs or a profitable business of their own! Our new plan opens the doors of Radio-Television wide to every ambitious man who is ready to act at once!

Men by the thousands . . . trained Radio-Television Service Technicians . . . are needed at once! Perhaps you've thought about entering this interesting, top paying field, but lack of ready money held you back. Now—just \$6 enrolls you for America's finest, most up to date home study training in Radio-Television! Unbelievable? No, the explanation is simple! We believe Radio-Television *must* have the additional men it needs as quickly as possible. We are willing to do our part by making Sprayberry Training available for less money down and on easier terms than ever before. This is your big opportunity to get the training you need . . . to step into a fine job or your own Radio-Television Service Business.

Complete Facts Free—Act Now; Offer Limited

Only a limited number of students may be accepted on this liberal and unusual basis. We urge you to act at once . . . mail the coupon below and get complete details plus our big new catalog and an actual sample lesson—all free. No obligation . . . no salesman will bother you.

HOME STUDY TRAINING IN SPARE TIME

Under world-famous 27-year old Sprayberry Plan, you learn entirely at home in spare time. You keep on with your present job and income. You train as fast or as slowly as you wish. You get valuable kits of parts and equipment for priceless shop-bench practice. And everything you receive, lessons and equipment alike, is all yours to keep.

LET US PROVE HOW EASILY YOU CAN LEARN!

Radio-Television needs YOU! And Sprayberry is ready to train you on better, easier terms, that any ambitious man can afford. Just \$6 starts you! Mail coupon today . . . let the facts speak for themselves. You have everything to gain. Let us prove the kind of opportunity that's in store for you!

SPRAYBERRY Academy of Radio-Television
1512 Jarvis Avenue, Dept. 20-V, Chicago 26, Illinois

Mail This Coupon Now—No Salesman Will Call

Sprayberry Academy of Radio-Television
Dept. 20-V, 1512 W. Jarvis Ave., Chicago 26, Ill.

Please rush all information on your ALL-NEW Radio-Television Training Plan. I understand this does not obligate me and that no salesman will call upon me. Include New Catalog and Sample Lesson FREE.

NAME..... Age.....

ADDRESS.....

CITY..... ZONE..... STATE.....

WE'RE LEARNING WHY TWO EARS ARE BETTER THAN ONE

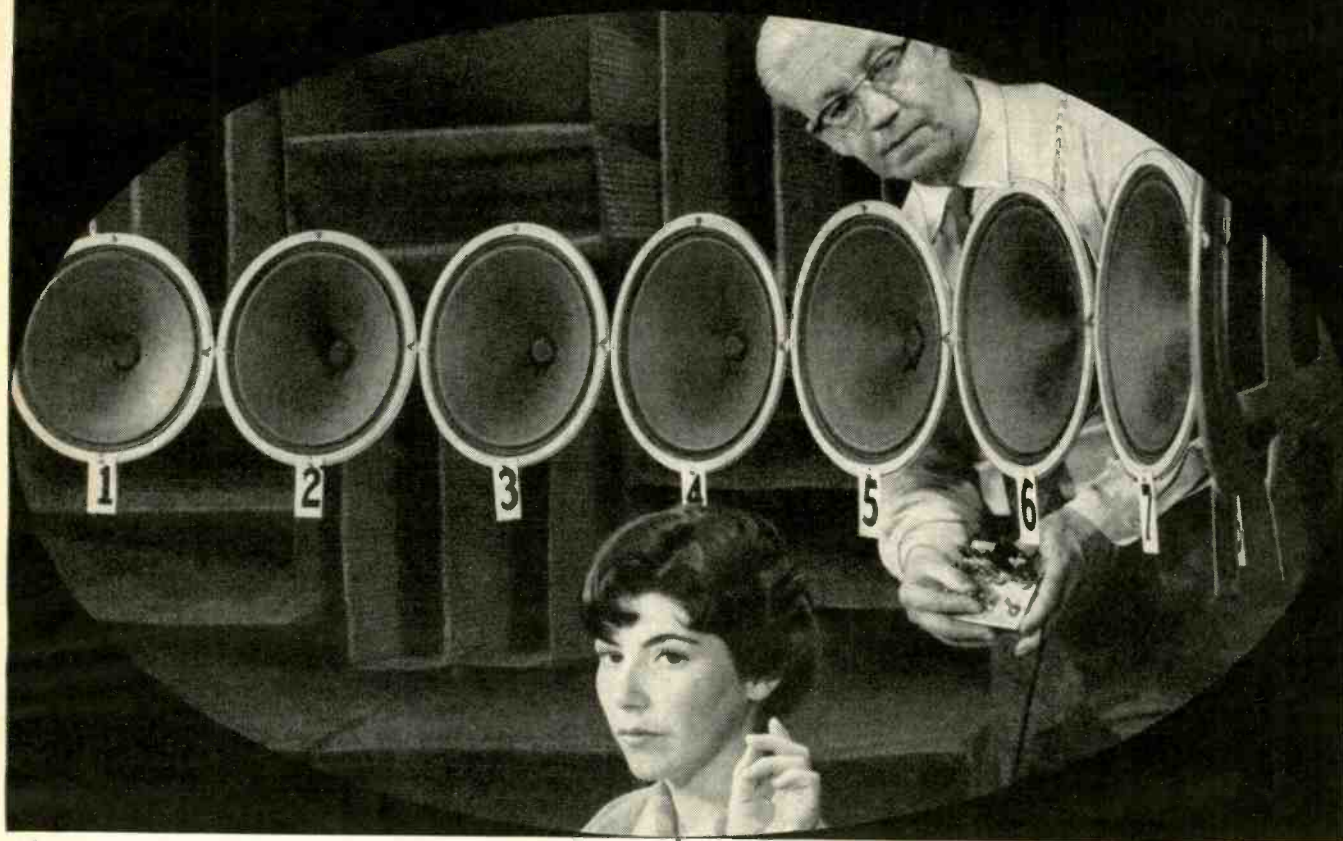

Which speaker is making the sound? In echoless chamber at Bell Labs, Robert Hanson measures test subject's ability to localize sounds — observes how two ears operate in partnership. This and other tests may point the way to better telephone instruments.

In listening to stereophonic music, how is it that our ears and brain construct a picture of the entire orchestra with but two samples (the sounds from two speakers) to work with?

How is it that our ears and brain are able to pinpoint *one* voice in a roomful of talkers—to listen to it alone and ignore the rest?

What makes *two* ears better than one?

Bell Telephone Laboratories scientists are searching for the answers. For in finding them, better telephone instruments and better ways of transmitting sound will surely result.

Our hearing performs feats that no electronic system can yet duplicate. How? Laboratories scientists believe the secret lies in the way our two ears function in partnership and in the way

our neural network connects them with our brain. *The problem:* to discover what functions the network performs and to see whether electronic duplication might enhance understanding.

The work is under way. Electronic circuits that simulate the operation of nerve cells have already been created—and conceptual models of the neural network are being constructed.

Alexander Graham Bell's interest in deafness and hearing led to the invention of the telephone. Bell Laboratories' current explorations in binaural sound may well lead to important new advances in the transmission of speech and music.



BELL TELEPHONE LABORATORIES

World center of communications research and development

CAVEAT EMPTOR *

*LET THE BUYER BEWARE

IMPORTANT NOTICE:

NO OTHER COMPANY has been authorized by Radio Shack or The Factory to sell or advertise the famous Electrostat-3, and no company other than Radio Shack has delivered or can deliver this unit!

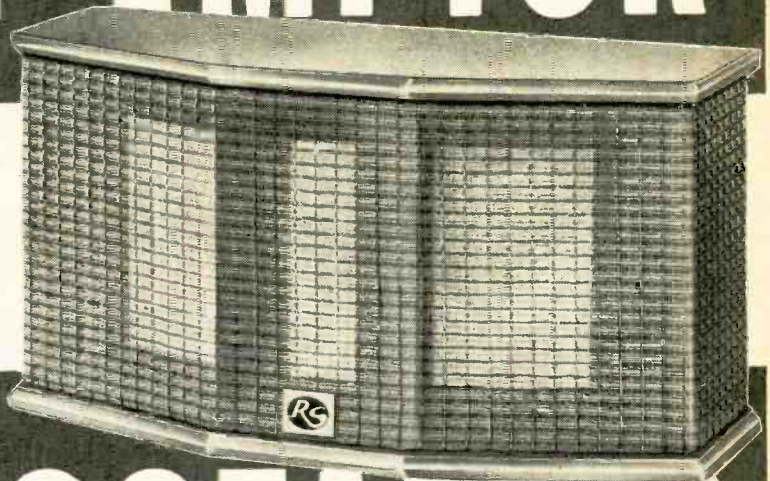

REALISTIC

ELECTROSTAT-3

THE MOST PUBLICIZED — MOST WANTED — TWEETER IN ALL HI-FI HISTORY!



3 ELECTROSTATIC ELEMENTS FOR 120° SOUND DISPERSION



BUILT-IN AC POWER SUPPLY TO PROVIDE EXACT VOLTAGE

This is the unique electrostatic tweeter—the only tweeter—that has been getting RAVE NOTICES from the hi-fi test laboratories. This is the tweeter that makes any speaker system a better speaker system by its addition. ONLY RADIO SHACK—in all the world—sells it, delivers it! When used with any good high compliance speaker system, Electrostat-3 adds a smooth and silky response from 5,000 cycles to 25,000 cycles—beyond the range of human hearing. And its wide dispersion angle carries its new world of acoustic brilliance to all corners of the room. Compact size: 11⁷/₈" wide x 5⁷/₈" high x 4¹/₂" deep. In mahogany, blond or walnut finish. ORDER TODAY and hear the "highs" that have brought the whole audio world to our door!

\$27.50

- ★ Mahogany
- ★ Blond
- ★ Walnut

ELECTROSTAT-3 CROSSOVER KIT

Includes coils, condensers and L pad, complete with simplified assembly instructions. Available for either 8 ohms or 16 ohms.....4.95

OTHER REALISTIC HI-FI PRODUCTS

REALISTIC "SOLO" SPEAKER \$15.95 **REALISTIC 16" STEREO ARM \$15.90** **REALISTIC FM-3 TUNER \$44.50** **REALISTIC 15 WATT AMP \$49.95**

RADIO SHACK CORPORATION

167 Washington St., Boston 8, Mass.
730 Commonwealth Ave., Boston 17, Mass.
230-234 Crown St., New Haven 10, Conn.



RADIO SHACK CORPORATION, Dept. 5E
730 Commonwealth Ave., Boston 17, Mass.
Please send me the following:

Quan.	REALISTIC	Sh. Wt.	Order No.	Sale
	ELECTROSTAT-3	7 lbs.	36CX017Y	\$27.50
	8-ohm X-over	2 lbs.	91L500	4.95
	16-ohm X-over	2 lbs.	91L505	4.95
	15-watt Amp	15 lbs.	90LX000Y	49.95
	16" Stereo Arm	3 lbs.	91L050	15.90
	FM-3 Tuner	11 lbs.	90LX040	44.50
	SOLO Speaker	12 lbs.	90LX250	15.95

Radio Shack 32-page Bargain Bulletin
 Check Money Order C.O.D.

Name _____
Address _____
City _____ Zone _____ State _____

Use Delco Radio Service Parts!

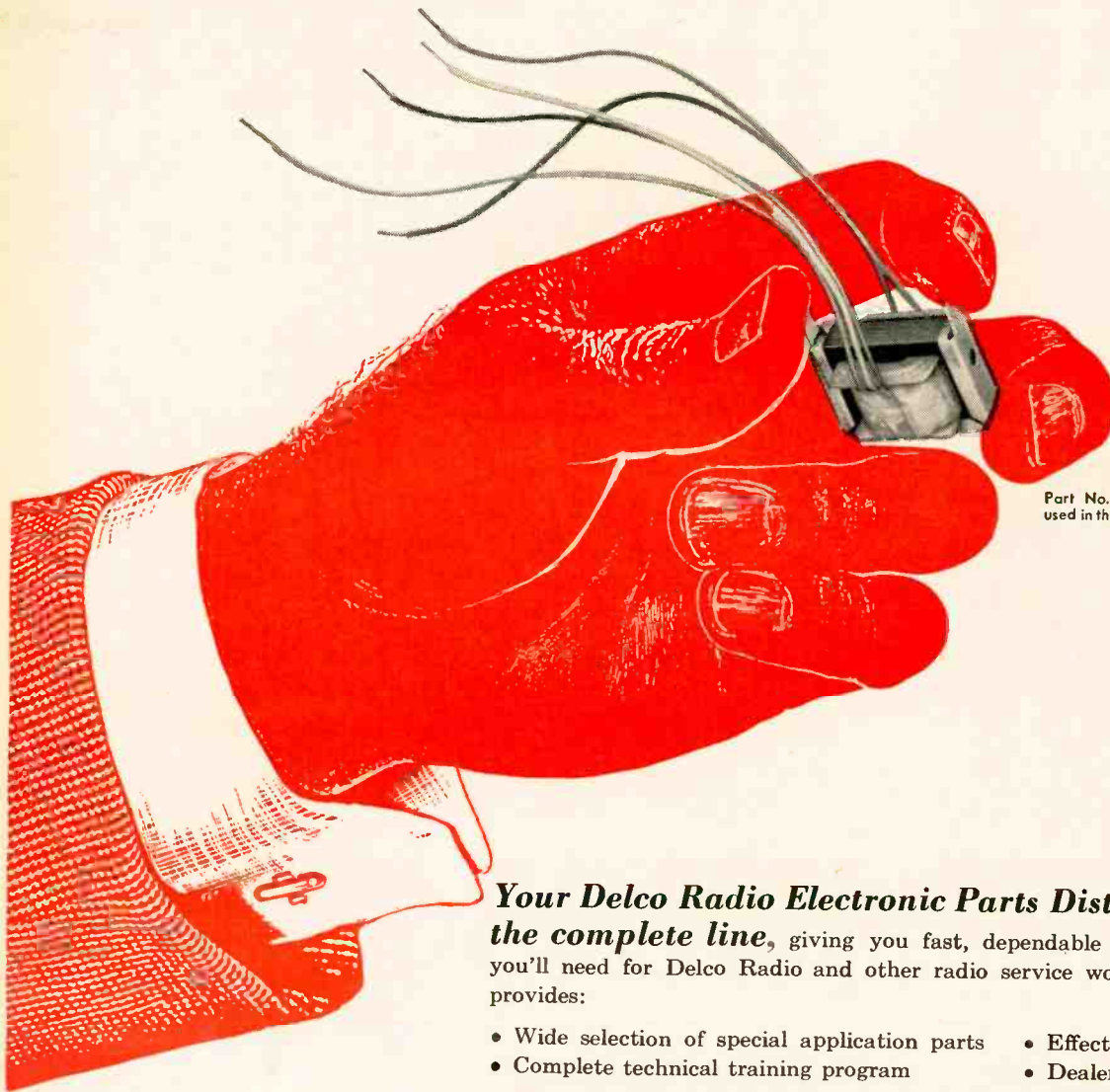

Part No. 7270804—output transformer used in the new Delco Portable Car Radio.

Your Delco Radio Electronic Parts Distributor carries the complete line, giving you fast, dependable service on the items you'll need for Delco Radio and other radio service work. Delco Radio also provides:

- Wide selection of special application parts
- Complete technical training program
- Effective warranty program
- Dealer identification signs







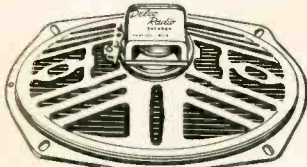
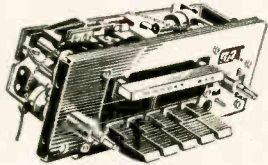

Get the facts today on this truly profitable dealer setup, and grow with General Motors!

Available everywhere through Electronic Distributors associated with . . .



DELCO RADIO

DIVISION OF GENERAL MOTORS, KOKOMO, INDIANA

 <p>SPEAKERS</p>	 <p>TUNER PARTS</p>	 <p>TUBES</p>	 <p>IRON CORES</p>
	 <p>TRANSISTORS</p>	 <p>COILS</p>	 <p>RESISTORS</p>
		 <p>VIBRATORS</p>	 <p>CAPACITORS</p>
			 <p>CONTROLS</p>

RADIO-ELECTRONICS

**STEREO
STEREO
AND
MONAURAL**

the
experts
say...
in HI-FI
the best buys are

EICO®

World-famous
EICO advantages
guarantee your complete satisfaction:

- Advanced engineering • Finest quality components
- "Beginner-Tested," easy step-by-step instructions
- LIFETIME service & calibration guarantee
- IN STOCK — Compare, then take home any EICO equipment—right "off the shelf"—from 1900 neighborhood EICO dealers.



Stereo Preamplifier HF85

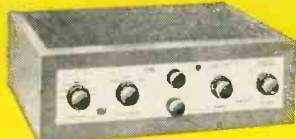

Stereo
Amplifier-Preamp
HF81



Monaural Integrated Amplifiers:
50, 30, 20, and 12-Watt
(use 2 for Stereo)



Monaural Power Amplifiers:
60, 50, 35, 30, 22 and 14-Watt
(use 2 for Stereo)
Stereo Power Amplifier HF86



FM Tuner HFT90
AM Tuner HFT94



Bookshelf
Speaker System
HFS1



Omni-directional
Speaker System HFS2
36" H x 15 1/4" W x 11 1/2" D



Monaural Preamplifiers:
HF65, HF65A
(stack 2 for Stereo)



Over 1 MILLION EICO instruments in use throughout the world.

NEW STEREOPHONIC EQUIPMENT

HF85: Stereo Dual Preamplifier is a complete stereo control system in "low silhouette" design adaptable to any type of installation. Selects, preamplifies, controls any stereo source—tape, discs, broadcasts. Superb variable crossover, feedback tone controls driven by feedback amplifier pairs in each channel. Distortion borders on unmeasurable even at high output levels. Separate lo-level input in each channel for mag. phono, tape head, mike. Separate hi-level inputs for AM & FM tuners & FM Multiplex. One each auxiliary A & B input in each channel. Independent level, bass & treble controls in each channel may be operated together with built-in clutch. Switched-in loudness compensator. Function Selector permits hearing each stereo channel individually, and reversing them; also use of unit for stereo or monophonic play. Full-wave rectifier tube power supply. 5-12AX7/ECC83, 1-6X4. Works with any high-quality stereo power amplifier such as EICO HF86, or any 2 high-quality mono power amplifiers such as EICO HF14, HF22, HF30, HF35, HF50, HF60. "Extreme flexibility . . . a bargain" — HI-FI REVIEW. Kit \$39.95. Wired \$64.95. Includes cover.

HF86: Stereo Dual Power Amplifier for use with HF85 above or any good self-powered stereo preamp. Identical Williamson-type push-pull EL84 power amplifiers, conservatively rated at 14W, may be operated in parallel to deliver 28W for non-stereo use. Either input can be made common for both amplifiers by Service Selector switch. Voltage amplifier & split-load phase inverter circuitry feature EICO-developed 12DW7 audio tube for significantly better performance. Kit \$43.95. Wired \$74.95.

HF81: Stereo Dual Amplifier-Preamplifier selects, amplifies & controls any stereo source — tape, discs, broadcasts—& feeds it thru self-contained dual 14W amplifiers to a pair of speakers. Monophonically: 28 watts for your speakers; complete stereo preamp. Ganged level controls, separate focus (balance) control, independent full-range bass & treble controls for each channel. Identical Williamson-type, push-pull EL84 power amplifiers, excellent output transformers. "Service Selector" switch permits one preamp-control section to drive the internal power amplifiers while other preamp-control section is left free to drive your existing external amplifier. "Excellent" — SATURDAY REVIEW: HI-FI MUSIC AT HOME. "Outstanding quality . . . extremely versatile" — RADIO & TV NEWS LAB-TESTED. Kit \$69.95. Wired \$109.95. Includes cover.

MONO PREAMPLIFIERS (stack 2 for Stereo) HF-65: superb new design. Inputs for tape head, microphone, mag-phono cartridge & hi-level sources. IM distortion 0.04% @ 2V out. Attractive "low silhouette" design. HF65A Kit \$29.95. Wired \$44.95. HF65 (with power supply) Kit \$33.95. Wired \$49.95.

MONO POWER AMPLIFIERS
(use 2 for STEREO)

HF60 (60W), HF50 (50W), HF35 (35W), HF30 (30W), HF22 (22W), HF14 (14W): from Kit \$23.50. Wired \$41.50.

MONO INTEGRATED AMPLIFIERS
(use 2 for STEREO)

HF52 (50W), HF32 (30W), HF20 (20W), HF12 (12W): from Kit \$34.95. Wired \$57.95.

SPEAKER SYSTEMS (use 2 for STEREO)

HF52: Natural bass 30-200 cps via slot-loaded 12-ft. split conical bass horn. Middles & lower highs: front radiation from 8 1/2" edge-damped cone. Distortionless spike-shaped super-tweeter radiates omni-directionally. Flat 45-20,000 cps, useful 30-40,000 cps. 16 ohms. HWD 36", 15 1/4", 11 1/2". "Eminently musical"—Holt, HIGH FIDELITY. "Fine for stereo"—MODERN HI-FI. Completely factory-built: Mahogany or Walnut, \$139.95; Blonde, \$144.95.

HF51: Bookshelf Speaker System, complete with factory-built cabinet. Jensen 8" woofer, matching Jensen compression-driver exponential horn tweeter. Smooth clean bass: crisp extended highs. 70-12,000 cps range. Capacity 25 w. 8 ohms. HWD: 11" x 23" x 9". Wiring time 15 min. Price \$39.95.

FM TUNER HFT90: Surpasses wired tuners up to 3X its cost. For the first time, makes practical even for the novice the building of an FM tuner kit equal to really good factory-wired units. No alignment instruments needed. Pre-wired, pre-aligned temperature-compensated "front end" is drift-free — eliminates need for AFC. Precision "eye-ronic" DM-70 traveling tuning indicator, supplied pre-aligned, contracts at exact center of each FM channel. Pre-aligned IF coils. Sensitivity 6X that of other kit tuners: 1.5 uv for 20 db quieting, 2.5 uv for 30 db quieting, full limiting from 25 uv. IF bandwidth 260 kc at 6 db points. Frequency response uniform 20-20,000 cps ± 1 db. Cathode-follower & Multiplex outputs. Flywheel tuning, automatic gain control, stabilized low limiting threshold for excellent performance from weaker signals, broad-band ratio detector for improved capture ratio & easier tuning, full-wave rectifier & heavy filtering, very low distortion. "One of the best buys you can get in high fidelity kits"—AUDIOCRAFT Kit Report. Kit \$39.95*. Wired \$65.95*. Cover \$3.95. *Less Cover, F.E.T. incl.

NEW AM TUNER HFT94: Matches HF90. Selects "hi-fi" wide (20c — 9kc @ -3 db) or weak-station narrow (20c — 5kc @ -3 db) bandpass. Tuned RF stage for high selectivity & sensitivity, precision "eye-ronic" tuning. Built-in ferrite loop, prealigned RF & IF coils. Sensitivity 3 uv @ 30% mod. for 1.0 V out, 20 db S/N. Very low noise & distortion. High-Q 10 kc whistle filter. Kit \$39.95. Wired \$69.95, incl. Cover & F.E.T.

BEFORE YOU BUY, COMPARE:

You may examine the complete EICO line at any of 1900 neighborhood EICO distributors coast to coast. Compare critically with equipment several times the EICO cost—then you judge. You'll see why the experts recommend EICO, kit or wired, as your best buy.

EICO, 33-00 NORTHERN BLVD., L.I.C. 1, N.Y.
Fill out coupon on other side for FREE CATALOG

Copyright 1958 by Electronic Instr. Co., Inc. 33-00 N. Blvd., L.I.C. 1, N.Y.

Add 5% in the West.

the specs prove it . . .
your **BEST BUY** is

EICO®

for COLOR & Monochrome TV servicing

FREE CATALOG

shows you **HOW TO SAVE 50%**
on 50 models of top quality
professional test equipment.
MAIL COUPON NOW!



NEW!
**TV-FM SWEEP
GENERATOR &
MARKER #368**
KIT \$69⁹⁵ WIRED \$119⁹⁵

Entirely electronic sweep circuit (no mechanical devices) with accurately-biased inductor for excellent linearity. Extremely flat RF output; new AGC circuit automatically adjusts osc. for max. output on each band with min. ampl. variations. Exceptional tuning accuracy: edge-lit hairlines eliminate parallax. Sweep Osc. Range 3-216 mc in 5 fund. bands. Variable Marker Range 2-75 mc in 3 fund. bands; 60-225 mc on harmonic band. 4.5 mc Xtal Marker Osc., xtal supplied. Ext. Marker provision. Sweep Width 0-3 mc lowest max. deviation to 0-30 mc highest max. dev. 2-way blanking. Narrow range phasing. Attenuators: Marker Size, RF Fine, RF Coarse (4-step decade). Cables: output, 'scope horiz., 'scope vertical. Deep-etched satin aluminum panel; rugged grey wrinkle steel cabinet.

**NEW! RF
SIGNAL GENERATOR
#324**
KIT \$26⁹⁵ WIRED \$39⁹⁵



150 kc to 435 mc with ONE generator! Better value than generators selling at 2 or 3 times its cost! Ideal for IF-RF alignment, signal tracing & trouble-shooting of TV, FM, AM sets; marker gen.; 400 cps audio testing; lab. work. 6 fund. ranges: 150-400 kc, 400-1200 kc, 1.2-3.5 mc, 3.5-11 mc, 11-37 mc, 37-145 mc; 1 harmonic band 111-435 mc. Freq. accurate to ±1.5%; 6:1 vernier tuning & excellent spread at most important alignment freqs. Etched tuning dial, plexiglass windows, edge-lit hairlines. Colpitts RF osc. directly plate-modulated by K-follower for improved mod. Variable depth of int. mod. 0-50% by 400 cps Colpitts osc. Variable gain ext. amplifier: only 3.0 v needed for 30% mod. Turret-mounted coils slug-tuned for max. accuracy. Fine & Coarse (3-step) RF attenuators. RF output 100,000 uv; AF sine wave output to 10 v. 50-ohm output Z. 5-way jack-top binding posts for AF in/out; coaxial connector & shielded cable for RF out. 12AU7, 12AV7, selenium rectifier; xmfr-operated. Deep-etched satin aluminum panel; rugged grey wrinkle steel cabinet.

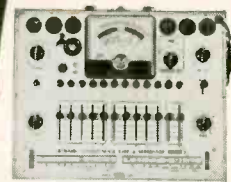

**NEW! DYNAMIC
CONDUCTANCE
TUBE & TRANSISTOR
TESTER #666**
KIT \$69⁹⁵ WIRED \$109⁹⁵

COMPLETE with steel cover and handle.
SPEED, ease, unexcelled accuracy & thoroughness. Tests all receiving tubes (and picture tubes with adapter). Composite indication of Gm, Gp & peak emission. Simultaneous sel of any 1 of 4 combinations of 3 plate voltages, 3 screen voltages, 3 ranges of continuously variable grid voltage (with 5% accurate pot). New series-string voltages: for 600, 450, 300 ma types. Sensitive 200 ua meter. 5 ranges meter sensitivity (1% slants & 5% pot). 10 SIX-position lever switches: freepoint connection of each tube pin. 10 pushbuttons: rapid insert of any tube element in leakage test circuit & speedy sel. of individual sections of multi-section tubes in merit tests. Direct-reading of inter-element leakage in ohms. New gear-driven rollechart. Checks n-p-n & p-n-p transistors: separate meter readings of collector leakage current & Beta using internal dc power supply. Deep-etched satin aluminum panel; rugged grey wrinkle steel cabinet. CRA Adapter \$4.50



**COLOR
and Monochrome
DC to 5 MC LAB & TV
5" OSCILLOSCOPE
#460**
KIT \$79⁹⁵ WIRED \$129⁵⁰

• Features DC Amplifiers!

Flat from DC-4.5 mc, usable to 10 mc. VERT. AMPL.: sens. 25 rms mv/in; input Z 3 megs; direct-coupled & push-pull thruout; K-follower coupling bet. stages; 4-step freq.-compensated attenuator up to 1000:1. SWEEP: perfectly linear 10 cps-100 kc (ext. cap. for range to 1 cps); preset TV V & H positions; auto. sync. ampl. & lim. PLUS: direct or cap. coupling; bal. or unbal. inputs; edge-lit engraved lucite screen; dimmer; filter; bezel fits std photo equip. High intensity trace CRT. 0.06 usec rise time. Push-pull hor. ampl., flat to 400 kc, sens. 0.6 rms mv/in. Built-in volt. calib. Z-axis mod. Sawtooth & 60 cps outputs. Astig. control. Retrace blanking. Phasing control. 5" PUSH-PULL Oscilloscope -425: Kit \$44.95, Wired \$79.95. 7" PUSH-PULL Oscilloscope -470: Kit \$79.95, Wired \$129.50.



**NEW! PEAK-to-PEAK
VTVM #232 & UNI-
PROBE (pat. pend.)**
KIT \$29⁹⁵ WIRED \$49⁹⁵

Half-turn of probe tip selects DC or AC-Ohms.

Uni-Probe - exclusive with EICO - only 1 probe performs all functions!

Latest circuitry, high sensitivity & precision, wide ranges & versatility. Calibration without removing from cabinet. New balanced bridge circuit. High Z input for negligible loading. 4 1/2" meter, can't burn-out circuit. 7 non-skip ranges on every function. 4 functions: +DC Volts, -DC Volts, AC Volts, Ohms. Uniform 3 to 1 scale ratio for extreme wide-range accuracy. Zero center. One zero-adj. for all functions & ranges. 1% precision ceramic multiplier resistors. Measure directly peak-to-peak voltage of complex & sine waves: 0-4, 14, 42, 140, 420, 1400, 4200. DC/RMS sine volts: 0-1.5, 5, 15, 50, 150, 500, 1500 (up to 30,000 v with HVP probe & 250 mc with PRF probe). Ohms: 0.2 ohms to 1000 megs. 12AU7, 6AL5, selenium rectifier; xmfr-operated. Deep-etched satin aluminum panel, rugged grey wrinkle steel cabinet.



**NEW! Transistorized
Power & Bias Supply
#1020**
Kit \$19.95 Wired \$27.95

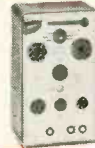

**NEW! Battery-Powered
Filament Continuity
Tester #612**
Kit \$3.95 Wired \$5.95



**Series/Parallel
R-C COMBINATION
BOX #1140**
KIT \$13.95
WIRED \$19.95



TUBE TESTER #625
KIT \$34.95 Wired \$49.95
• tests 600 mil series string type tubes
• illuminated roll-chart

Pix Tube Test Adapter.....\$4.50



**6V & 12V BATTERY
ELIMINATOR
& CHARGER #1050**
KIT \$29.95
WIRED \$38.95
Extra-filtered for transistor equip.
#1060 KIT \$38.95
WIRED \$47.95



**Miniaturized
MULTI-SIGNAL
TRACER #145A**
KIT \$19.95
WIRED \$28.95



**20,000 Ohms/Volt
V-O-M #565**
KIT \$24.95 Wired \$29.95



**1000 Ohms/Volt
V-O-M #536**
KIT \$12.90
Wired \$14.90



**R-C BRIDGE & R-C-L
COMPARATOR #950B**
KIT \$19.95
Wired \$29.95
Reads 0.5 ohms-500 megs,
10 mmdf-5000 mfd,
power factor



VTVM PROBES	KIT	Wired
Peak-to-Peak	\$4.95	\$6.95
RF	\$3.75	\$4.95
High Voltage Probe-1		\$6.95
High Voltage Probe-2		\$4.95
SCOPE PROBES		
Demodulator	\$3.75	\$5.75
Direct	\$2.75	\$3.95
Low Capacity	\$3.75	\$5.75

TURN PAGE
FOR MORE
EICO VALUES

EICO®

Send for
FREE CATALOG
now

Prices 5% higher on West Coast.

33-00 Northern Blvd., Long Island City 1, N.Y.

EICO, 33-00 Northern Blvd.
Long Island City 1, N. Y.

C-5

Show me **HOW TO SAVE 50%** on Test Instruments Hi-Fi Ham Gear. Send me **FREE** Catalog and name of neighborhood dealer.

Name.....
Address.....
City..... Zone..... State.....

THE BUSINESS OF SERVICING

... It Is a Good Business—If You Know the Code ...

SERVICING in this country has grown to large proportions during the last decade. From the latest available figures, its estimated value for 1958 will amount to over \$2,495,700,000. It is quite evident that with the rapid increase of population, as well as new electronic items constantly being brought out, this figure—huge as it is—should easily double in another decade.

The servicing business itself is made up of a variety of interests. There is, first, the large dealer who sells radios, television sets of all kinds, plus appliances. He employs a number of service technicians who do the servicing for all of the dealer's clients. Then there are the large radio and television manufacturers who run their own servicing establishments in various large centers of the country. These, too, employ their own service technicians.

Next we have the independents, self-employed or in partnership, who run their own shops, usually two or three men who go out on call or do the repairs in their shop. Generally this class is fully employed, often working overtime if there is sufficient demand for their labor.

Finally, there is another class of independents, the part-time, self-employed service technician whose name is legion. Often this group is located in the smaller towns, but many are in the big centers, too. Usually the part-time technician has sufficient spare time—4 to 6 hours a week—to try out servicing if he has a talent for the work and wants to give "electronic servicing a whirl." That, incidentally, is how probably most of our future service technicians are graduated. They have to start somewhere, sometime, so part-time work is the logical answer. It does not take much capital to make a start, therefore the risk is not great.

It is also certain that during the next decade, 25,000 new service technicians will be badly needed, and it is equally certain that a large percentage of them will come from the ranks of part-time men.

What are the necessary qualifications of a successful service technician? They are comparatively simple.

1. He must know his electronics business. The more technical knowledge he has, the better.
2. He must give *honest* service if he wants to succeed. This will gain the confidence of his clients.
3. He must be prompt on his calls and keep his promises.
4. He must be neat in appearance and neat in his work—leaving a client's living room messy and in disorder is servicing suicide.
5. He must be pleasant *always*—even under provocation. Most clients know nothing of electronics and can often try one's patience to the limit.
6. He must give a receipt for all moneys collected. And the latter brings us to the most important part of this article, *the business of servicing*.

A goodly percentage of embryo service technicians falls by the wayside because they pay little or no attention to the business end. They do not figure their cost of parts nor their time, and often lose money on jobs that should show a decent profit. Their time, depending on locality and state, should run from \$3 to \$6.95 per hour (Alaska, \$8.50 per hour plus 10c per mile). If the work is to the client's satisfaction and the job is well done, it must be paid for at a decent rate. This elementary rule is so often sidetracked by a new service technician that, if he persists, he develops bad habits and sets precedents difficult to reverse later.

It goes without stressing it too strongly that the new service technician must have *good* and up-to-date tools, test equipment and other servicing musts. *If you can't afford the best—you'll never be successful in this endeavor.*

But there is something far more important than all the above. *It is what the outside world thinks of you*—the indefinable something that gives a man his "standing." Month after month we receive letters—even from established service people—written in longhand on a blank sheet of cheap paper, complaining that the big manufacturers or jobbers, from whom they want to buy, don't ever answer their letters. Or they write for technical information and never receive an answer.

Practically all newcomer technicians picture themselves as business men. *Yet they pen a business communication on junior's blue-ruled scratch pad or schoolpaper and expect an answer.*

They never understand that practically all such missives land in the wastepaper basket—and that's where they belong.

In business, certain rules and codes must be observed religiously. A typewritten letter on a well-designed printed letterhead is the first and most important key to an executive's confidence.* He cannot and will not read hundreds of scribbled scraps. He just hasn't the time. Deciphering all types of handwriting is an arduous chore—he is a *time snob*. So are all busy administrators in most organizations—yes, and editors, too. You cannot expect busy correspondents, who must often answer hundreds of letters a day, to squander their valuable time wrestling with illegible handwriting. Fifty years ago, almost any kind of hieroglyphics was in order, but certainly not today. If you cannot afford a typewriter, rent one or have your letters typed by someone you know.

Moreover, "the man behind the desk" has an uncanny knack for "reading" a dozen facts into the mere appearance of a letter. Even if typewritten on a good letterhead, it can still create an unfavorable atmosphere. It must abide by the basic rules of courtesy and language.

Remember, you are completely judged by your letter; it is your personal introduction.

In our time, we have seen valuable agencies turned down on account of a rag-tag letter. Never underestimate the value of a neat business communication—it is the *open sesame* to what you are after.

The business card you leave with customers is no less important—and see to it that it is clean and not dog-eared. Sloppy card, sloppy work—so judges your client.

Your billhead, too, *must* be printed, not rubber-stamped. The sins that are committed yearly in the US in rubber-stamped letterheads, postal cards, bills and "business cards" would pay the national debts of several good-sized nations, in fortunes lost by so-called business men who were too shortsighted to realize that "you are judged by your printed emissaries."

Incidentally, some of the larger tube manufacturers and other firms will furnish at reasonable cost attractive printed letterheads and other business forms especially created for the service industry. If you are interested, drop us a line. We will supply a complete list of firms who supply such material, plus their addresses.

—H. G.

*See editorials on the same subject in this magazine: "GI Radio Servicemen," November, 1945; "Radio Industry Unfair?" May, 1946; "Servicemen—Wake Up," December, 1946.

RDF

FOR SMALL BOATS

Day and night, radio direction finders guide small-boat owners back to port. Keep their RDF's working, and you will have an easily pleased, satisfied customer

By **ELBERT ROBERSON**



Radiomarine's Golden Guide RDF has ferrite loop antenna.

Sonar RDF has telescopic sense antenna as well as standard loop.

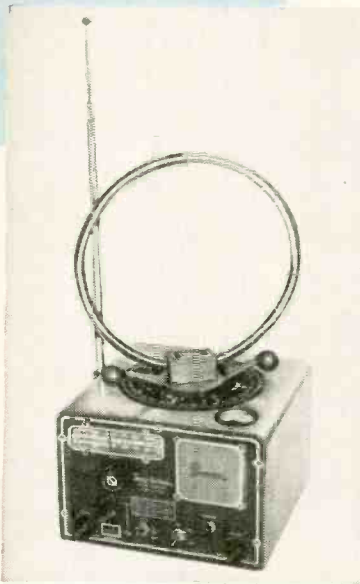

Loop turning control, bearing scale are on front panel of Kaar R238.



Transistor circuitry is used in Raytheon Ranger 354.

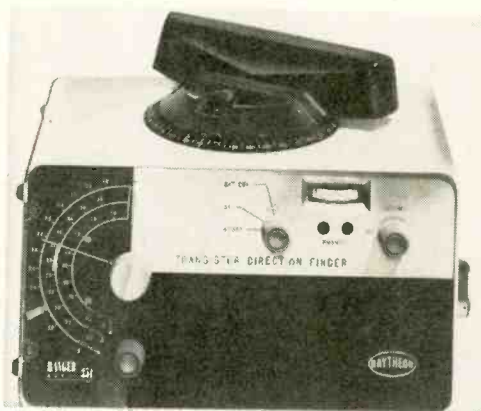

A RECENT US Navy publication soberly states that the radio direction finder has little use on shipboard today and is rapidly being replaced by other devices. This is all very true for Navy 10,000-tonners, sprouting radar antennas like twigs on a tree, and with practically no limitation on cost, weight and power consumption of various sophisticated navigational devices.

But in the small pleasure-boat field, the lowly RDF is becoming increasingly important, and equipment is being tailored down in price, size and power requirements to the point that any boat large enough to carry a person can be equipped with this simple and effective navigational aid.

Over 5,000,000 small boats ply the waters of every part of the nation. Even the residents of bone-dry areas are "in the act," with trailers to haul their boats to the nearest wet spot. A good many of these either have or could be sold an RDF. So look into this field —there may be pieces-of-eight for you in those boats.

General requirements

The small-boat direction finder consists of a radio receiver covering the desired frequency band; a signal transducer, such as a speaker, headset, meter, or combination of these, to indicate the "null" used for bearing determination, and a loop antenna for directivity.

Frequencies useful for small-boat navigation are broken into three bands: the beacon, approximately 150 to 500 kc; the broadcast, from 550 to 1600 kc; and the marine band, 1600 to 5,000 kc. The beacon band is especially useful be-

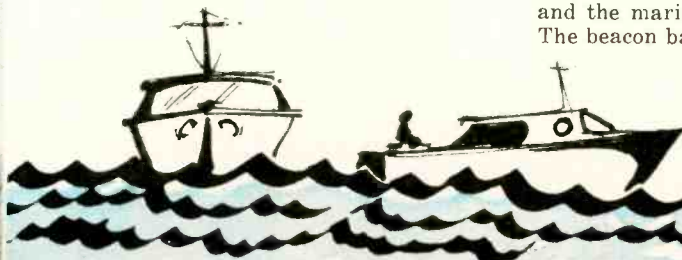

cause, in addition to giving reception of marine beacons and radio stations located at lighthouses and lightships which transmit code signals during foul weather, it lets you take bearings on nearby aircraft range stations which transmit continuously, and you can also listen to their half-hour weather run-down. The broadcast band, of course, is a good source of weather and news, and satisfactory bearings can be taken on many stations with antennas at a known location near the water. Coast Guard and weather information is received on the marine band, and bearings can be taken on nearby radiotelephone-equipped boats, if a rendezvous is desired.

The beacon band is useful for radio bearings day or night, with just a little interference from the sky wave from sunset to sunrise. The broadcast band is reliable during the day but for distances in excess of 10 miles, night bearings are unreliable. On the marine band, short-distance daytime bearings are usable but, from sunset to sunrise, bearing errors are large. To give maximum service and to take advantage of all of the special features of the different frequencies, the RDF receiver is ideally, but not always, designed to give reception on all three bands.

The receiver

Most modern direction finders use a conventional superheterodyne circuit, although there are a few single-banders which have a two- or three-stage rf amplifier, detector and audio amplifier. Generally, receivers have more rf amplification than a comparable home receiver to make up for the low signal input. Because the bearing line is determined by noting antenna positions for maximum and minimum signal points, AVC is not ordinarily used for direction finding, since this feature would tend to obliterate the null. Some receivers, intended for conventional reception as well as navigation, do have AVC, but this is sometimes disabled when the set is used for bearings. Semi-professional models may have a beat-frequency oscillator, for receiving CW signals. Still another refinement is an automatic noise-limiting circuit, which knocks the peaks off engine-ignition pulses and static, and reduces the interference from other pulse type noises.

Indicating transducers

The oldest transducer and, with proper use, the best is the ordinary headset. For convenience, however, most modern RDF's have a built-in speaker. This does away with dangling cords, but allows ambient noise from the engine, wind and sea to mask subtle changes in the signal. Some boat

operators have difficulty in distinguishing the signal null, so RDF's have been built which have a squelch circuit that pops the speaker into absolute silence when the signal drops below a preset level. These circuits are of the type used in mobile equipment for speaker silencing during no-signal periods.

A popular development has been the incorporation of a meter to indicate the null point visually. The meter is actuated by rectified audio signal or carrier current, sometimes with an amplifier stage to increase its sensitivity.

Power sources

Operating power for the larger models is supplied by the boat's batteries, which may be 6, 12, 32 or 110 volts dc. Heaters are connected in the familiar series-string fashion to utilize direct battery voltage, while plate power may come from a dynamotor, vibrator power supply or self-contained B-batteries. Popular compact units operate like portables from self-contained A- and B-batteries. And transistor models have recently come on the scene.

The loop antenna

Bearings are determined by taking advantage of the figure-8 response pattern of a loop antenna feeding the receiver. The loop may be air-wound or a compact ferrite type. Unlike communications, TV or FM directional antennas (which are on the beam when signal strength is maximum), the loop antenna is used for bearings by rotating it until the signal drops out, or nulls.

The reason for this is that the greatest change in signal strength per degree of antenna rotation and, hence, the sharpest indication of the bearing line is found at the null point, which is at right angles to the direction of the loop winding.

This is shown graphically by Fig. 1. Signals arriving from the directions shown around the loop antenna will feed to the receiver a voltage which is proportionate to the length of the direction lines inside the figure-8 pattern. Note that in the 90° sector from A to C, the maximum change is a reduction in voltage to 0.7 (at points A and C) of that obtained at the maximum signal direction, B. The pattern in this sector is too broad to be of any use. On the other hand, in the sector from C to E, the voltage drops abruptly to zero at 90°, giving a very accurate bearing line.

The ideal loop antenna works from the magnetic component of the incoming wave. Current flow occurs when there is a phase difference between the two sides of the loop, as when one side of the loop is closer to the signal source.

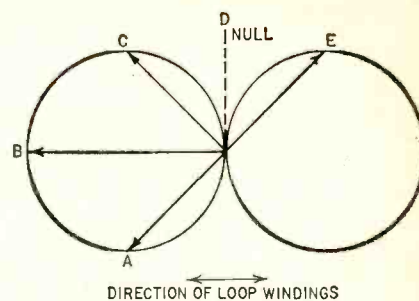

Fig. 1—Figure-8 pattern shows sensitivity of a loop antenna in various directions.

Any factor upsetting the accuracy of this phase difference between the sides of the loop reduces bearing accuracy.

One such factor is the addition of signal due to pickup of the electrostatic component of the incoming waves. Addition of this component to the magnetically induced signal causes one lobe of the pattern to grow and the other to shrink. This squeezes the null points together to one side, so they are no longer 180° apart. The effect is illustrated in Fig. 2. If the amount of electrostatically induced current is one-quarter the level of that from the magnetic field, one lobe is slightly reduced and the other is enlarged. Increasing the electrostatic input to the receiver to one-half results in the second pattern, with greater lobe distortion and null-angle squeezing. When the ratio is one, the minor lobe disappears, and the cardioid unidirectional pattern results, with its minimum rotated 90° from the bearing line of the original.

When electrostatic signal is introduced unintentionally, great errors in bearings obviously result. To prevent accidental pickup, the loop winding is

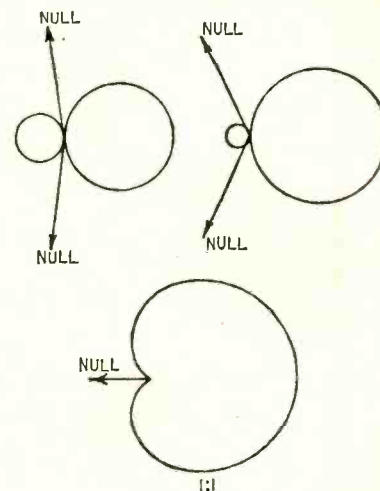

Fig. 2—Electrostatic component of incoming waves can distort the loop antenna's pattern and cause null readings many degrees off.



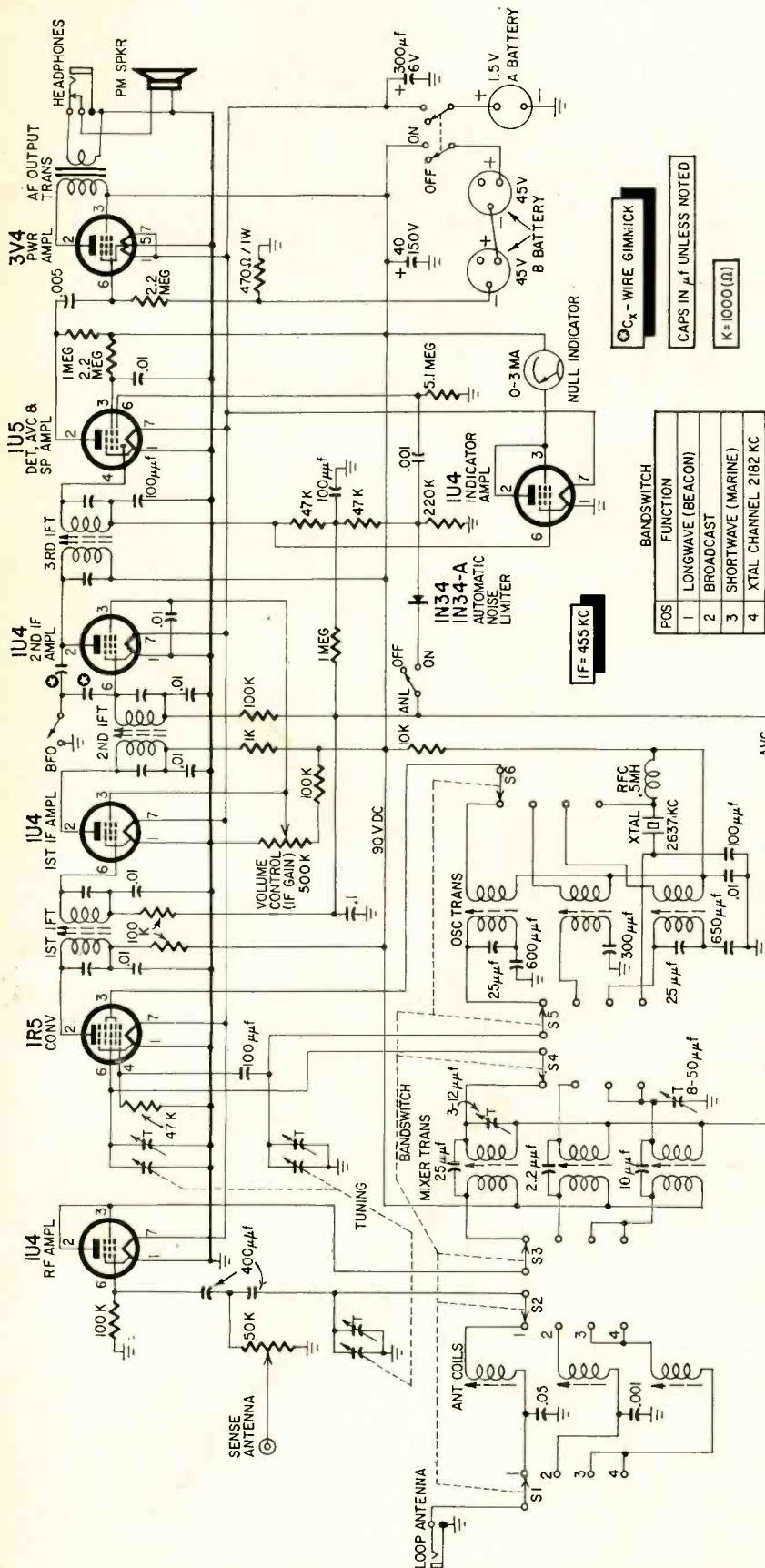

Fig. 3—Circuit of the Sonafinder 4-band RDF.

enclosed in an electrostatic (Faraday) shield—a grounded copper or aluminum housing. The housing is grounded, to arrest passage of the electric field, but it is electrically discontinuous, broken at the top or one side by an insulator, to allow passage of the magnetic field.

Another possible cause of phase distortion is reception of signals from a vertical angle, or sky wave. When a signal arrives in a horizontal path, it strikes both the top and bottom of the loop at the same time, no matter what angle the loop is turned. There being no phase difference between top and bottom, no current flows as a result of this particular interception. However, at night, a reflected signal may strike the top of the loop before the bottom, introducing an additional current in the loop which will interfere with the desired current induced in the loop sides. The result is unavoidable inaccuracy, and the only thing that can be done is to be especially careful not to be fooled by possibly erroneous bearings on frequencies and at hours which might suffer from sky-wave interference.

Sense antenna

Currents out of phase with the loop magnetic current are sometimes put to practical use. Note that the figure-8 pattern would give two bearings on a station—180° apart. Ordinarily, the navigator knows which of the two is correct. However, this may not always be so, and a way to resolve this ambiguity is incorporated in several offshore direction finders.

A short vertical antenna is mounted close alongside the loop to pick up signals from the electrostatic component of the incoming waves. This signal has fixed phase, regardless of direction. When it is added to the receiver input, through a circuit which adjusts its level to a ratio of one with the loop signal, it increases the signal in the direction of one lobe and subtracts in the other. This results in the cardioid pattern, with a null line rotated 90°.

The cardioid pattern is too broad for accurate manual direction finding, but is excellent for pointing out or sensing the general direction of the transmitting station. In a set having this sense feature, a switch connects the vertical antenna when a sense indication is desired. The loop is turned 90° in the direction giving the maximum signal, and an indicating pointer or arrow on the bearing indicator then points out the general direction in which the station lies.

Typical RDF circuitry

An example of typical RDF circuitry is shown in Fig. 3. It is the portable Sonafinder, manufactured by Sonar Radio Corp. The loop is air-wound, the windings housed in tubular metal conduit, one end of which is insulated. The loop plugs into a jack on the top of the cabinet, permitting full rotation, and also has handles and bearing pointer attached. On the cabinet, under the loop, is a calibrated bearing circle on

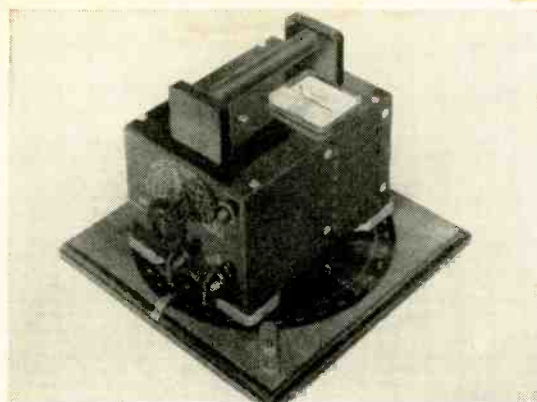

(Above) Roco Radio's RDF has ferrite loop fastened to its case. The entire set is rotated to find null.

(Right) Guest makes this portable unit.

(Above right) Loop attachment converts National 5-band portable for RDF use.



which bearings are read. Alongside is a null meter.

Three separate coils inside the set tune the loop circuit to the three bands, with one gang of a triple-section variable capacitor. A vertical sense antenna is provided, and the signal from this source can be injected to the rf amplifier's grid, along with the loop signal, by opening up the sense-antenna potentiometer.

The converter section is conventional, except for the addition of a crystal in the oscillator section to allow for reception of one preset channel, which may be anywhere in the 2- to 3-mc band, such as the Coast Guard, or the International Distress Frequency, 2182 kc.

For CW reception, a wire gimmick, amounting to a pair of very small capacitors, provides positive feedback between the plate and grid of the second if amplifier. This causes the tube to oscillate at the intermediate frequency, 455 kc, with a resultant heterodyne or beat note. A grounding switch knocks out the gimmick when ordinary AM reception is desired.

Conventional diode detection is used, the signal feeding a two-stage audio amplifier with built-in speaker or phone jack. A diode noise limiter tapped to the detector output applies negative bias to the preceding tubes when static or ignition bursts occur. The rectified detector output also goes to an indicator amplifier tube which operates the null meter.

Installation in the boat

For accuracy as a bearing instru-

ment, the RDF must be carefully installed with the cabinet squared up with the vessel's keel or beams. It should be placed as far as possible from large or encircling masses of metal, such as metal ducts, cables, pipes, etc., which might distort the loop pattern. Sets with built-in speakers must also be kept far enough away from the boat's compass so as not to cause magnetic deviation. And the RDF is most convenient to use when it is installed topside, near the helm. These requirements may call for compromise.

The portable outfits require no electrical installation, being operated from self-contained batteries. Other units must be connected to the boat's electrical system. Some boats have a formal switchboard, and connection can be made to a spare circuit. On others, the wiring is automobile-style, so the power leads are connected to the engine block for a ground, and to the hot terminal on the engine-starter solenoid. In any event, equipment-ground polarity must conform to that on the boat.

Calibration

On many small boats the RDF bearings will be absolutely accurate—that is, the radio bearing on a station will be exactly the same as a sight bearing taken on the transmitting antenna of the station being received. However, nearby metallic masses or wire rigging may cause deviation. So, to be safe, check the calibration before the instrument is used for serious navigation.

To calibrate, it is necessary to take the boat within sight of the antenna

of a station on which it is desired to take radio bearings. This may be a lighthouse with a radio beacon, or a shoreside broadcast station.

Calibration consists simply of taking simultaneous radio and visual bearings on the radio transmitting tower, while the boat is headed on several different courses around the clock. Differences between the two bearings may be zero, or plus or minus a few degrees. Note these differences in tabular form, so the opposite correction can be applied to radio bearings in sectors where there is deviation.

Visual bearings may be taken over the RDF bearing circle if the set is mounted in the clear. Otherwise, a pelorus, or visual bearing aid, must be used. Obtained from surplus stores, a pelorus consists of a sighting tube or equivalent and a degree-calibrated bearing circle. The bearing circles of both the RDF and the pelorus are set so 0° is dead ahead. Then radio bearings should give the same angular figure as a sight bearing taken at the same time.

When it's time to fix one

Servicing direction finders is essentially no different from working on other portable or mobile receivers, and no special techniques are called for. The only slight difference is the mechanical one that either the loop or the entire equipment is mounted so as to rotate 360° for taking the bearings. The rotating means must, of course, be kept clean and lubricated. Some equipment has slip rings and brushes to connect the loop to the receiver input. These should be kept burnished bright, and lightly coated with Lubriplate. The insulator breaking the continuity of the loop shield—the loop housing—must be kept clean, dry and free of paint. In a humid atmosphere, a light coat of silicone grease will help keep moisture out of the insulator.

Compared to conventional radios, a radio direction finder may look out of this world. It really isn't—although it serves very well to keep amateur boatmen here in the world where they belong. So, if you see boating activity in your area, an opportunity for profitable installation and maintenance of easy-to-service equipment may be looking right back at you. END

ABC's of MOBILE RADIO

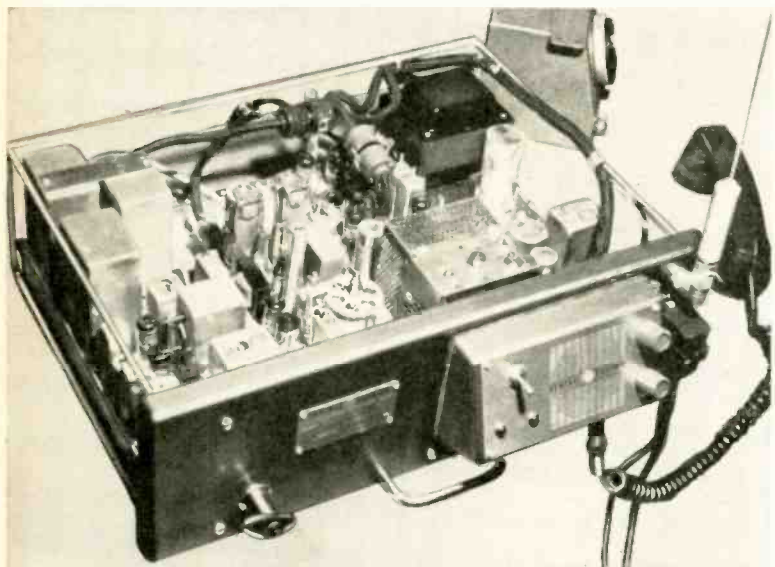

Part IV—Portable equipment, railroad radio, AM operation in the 118-134-mc band and antennas are among this month's topics

By LEO G. SANDS

LAST month we took a look at several types of mobile equipment. Units for 25-54-, 152-162- and 450-70-mc bands were described in detail. Now it is time to continue with a further examination of mobile radio equipment.

A revolutionary kind of portable two-way radio unit developed by General Electric may be carried by a person or used as a base station at a fixed or temporary location. It may also be used on board a vehicle as a mobile unit. The new portable is unique in that it contains the first all-transistor commercial receiver for operation in the 25-54- and 144-174-mc bands. The transmitter has nine tubes and one transistor which functions as a modulation limiter.

The transistors are plug-in types, making replacement easy if it should ever be necessary. Another advantage of plug-in transistors is that they are not subject to heat damage which can occur during soldering.

The low-band (25-54-mc) transmitter delivers 1.25 watts and the high-band (144-174-mc) unit puts out 1 watt. Low-band receivers are rated at 0.5 μ v for 20-db quieting, high-band at 0.8 μ v. Selectivity compares with tube type receivers.

Power is obtained from a 5-day battery pack consisting of a 9-volt and a 6.5-volt mercury cell, two 67.5-volt and two 1.5-volt batteries. A 2-day dry-cell power pack consists of two 67.5-volt, two 7.5-volt and two 1.5-volt batteries. For fixed applications a 117-

G-E's Progress Line mobile unit. Chassis on the left is the receiver, next is a Secode selective calling decoder. The transmitter is next, and the power supply chassis is at the far right.

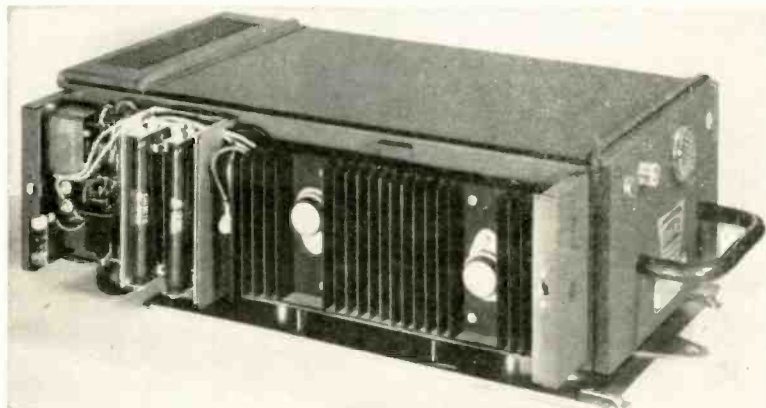

Motorola Stan-Pac railroad radio unit. The transistor power supply is mounted on the side of the unit. Note the finned heat sink.

volt ac power pack is available.

The portable has a built-in loud-speaker fed by up to 300 mw of audio. The unit weighs from 11½ to 13 pounds, depending upon the type of power pack, and is only 12¼ inches long, 4 inches wide and 6¼ inches high.

Railroad radio

Mobile units for use on railroad rolling stock are necessarily a sturdier breed of cat than those used on motor

vehicles where pneumatic tires cushion some of the shock. The vibration and shock encountered in a locomotive or caboose can be of significant proportions.

Railroad radio equipment made by Bendix Radio, Sperry Products and Motorola is sold or leased directly by the manufacturer to railroads. Sometimes servicing is handled by independent service shops.

One of the new railroad radio devel-

opments is Motorola's Stan-Pac, which operates directly from the 64-volt battery commonly used on Diesel-electric locomotives.

Four transistors are used in the power supply in a bridge switching circuit. Two transistors, forming an 8-watt class-B push-pull audio power amplifier for the receiver, are also mounted on the power supply assembly. To offset the wide variation of power supply voltage encountered on locomotives, an automatic voltage regulator keeps the input voltage at a constant 58 (+3 volts) even when power source voltage rises to as much as 85.

The transmitter, which can be tuned to any frequency between 144 and 167 mc, has a minimum rated rf power output of 25 watts. The FM transmitter can be modulated ± 15 kc for wide-band operation or ± 5 kc in split-channel service. The popular 6146 is used as the final power amplifier.

For present 60-kc channel-spacing (wide band) operation, a receiver is used in which selectivity characteristics provide 100-db attenuation of signals ± 30 kc from the desired center operating frequency. Attenuation of 100 db at ± 15 kc is provided in the split-channel model. The wide-band model can be converted to split-channel (narrow-band) operation by a simple field modification.

Shock mounts are used in railroad radio installations to protect the equipment from shock and vibration. Most railroad radio equipment produced today is designed to fit shock mounts conforming with standards established by the Association of American Railroads, permitting interchangeability of various makes.

Other bands

In addition to the 25-54-, 144-148- (Amateur), 152-162-, 162-174- (Government) and 450-470-mc bands, mobile radio equipment is also available for the 118-134-mc Aviation band and the 1.6-8-mc band. Operation on the latter is highly restricted in the United States, although it is popular in foreign countries. Primarily, it is confined to those engaged in mining, construction, lumbering, pipelines and geological surveys as well as to government agencies who require longer-range communications than ordinarily possible at higher frequencies. Equipment is available from only a few sources.

A base-to-mobile communicating range of 50 miles is common. There have been reports of contact between mobile units 200 miles apart and base-to-mobile communication up to 800 miles due to skip transmission at these frequencies.

118-134-mc equipment

Vehicular radio at airports uses frequencies assigned to the aviation radio services. Mobile units communicate with field towers so vehicle drivers can get permission to cross runways and so tower operators can summon emergency



Bendix Radio offers this 24-pound LPI radio with power supplies for operation from 6-, 12-, 24- or 32-volt dc sources as well as 117 volts ac.

and service vehicles. These systems operate in the 118-134-mc band and use AM instead of FM since airport tower radio stations, used for communicating with aircraft, are AM.

Among the few mobile units available for this purpose is the Kaar IMP, which is also produced in types for the 25-54- and 152-162-mc bands as well as between 108 and 134 mc. The IMP units are intended for airport, low-power-industrial (LPI) and other short-range mobile applications.

The IMP is very compact—just over a foot long and weighing only 23 pounds. In this small case are packed three chassis: AM transmitter, AM receiver and universal power supply for operation from 6 or 12 volts dc or 117 volts ac. Power consumption, transmitting or receiving, is only 48 watts. The transmitter has three stages: a 6CB6 crystal oscillator, a 6AK6 frequency multiplier and a 6J6 dual-triode which serves as the push-pull final rf amplifier. The crystal frequency is multiplied 8 times when operating between 108-160 mc and 12 times between 160-174 mc. Power input to the final rf stage is 3 watts, resulting in adequate output for coverage of airports as well as industrial plant areas. The receiver's audio output stage doubles as the transmitter's AM modulator and the first audio stage also serves as the transmit speech amplifier.

The double-conversion superheterodyne receiver has an rf stage ahead of the first mixer which is followed by an if stage tuned to 10.7 mc. The local oscillator uses a crystal tuned to one-third of the operating frequency *plus* 10.7 mc when operating on frequencies between 108-152 mc. When operated above 152 mc, the crystal frequency is one-third the operating frequency *minus* 10.7 mc.

The second mixer uses a separate crystal tuned to 9.2 mc, producing a 1,500-kc if signal which is amplified by another if stage. A series impulse type noise limiter eliminates most of the ignition noise. A rapid-acting ave circuit eliminates flutter.

The squelch circuit (see diagram) is obviously different from the types used in FM receivers. It disables the first

audio amplifier when no signal is being received, thus muting the loudspeaker. The squelch tube (half of a 12AX7) is, in effect, a variable electronic resistor in series with the cathode of the first audio amplifier (half of a 12AX7). When no signal is present, the squelch tube conducts and causes a large voltage drop across R8, biasing the audio amplifier to cutoff. When a 1,500-kc if signal is at the plate of the squelch rectifier (half of a 6AL5), the signal is rectified and a negative voltage, proportional to signal strength, is applied to the grid of the squelch tube, cutting it off and reducing the voltage drop across R8, thus activating the audio amplifier. The squelch threshold is adjusted by R1, a 10,000-ohm variable resistor. R2, whose value is not shown in the schematic, is selected at the factory for optimum performance.

Antennas for mobiles

Vertically polarized antennas are used exclusively in mobile applications because of the complexity of omnidirectional horizontally polarized antennas. Most mobile antennas are quarter-wave vertical whips which use the body of the vehicle as a ground plane. In railroad applications, where overhead restrictions so dictate, shortened antennas of special design are often used.

Obviously, when operating in the 1.6-8-mc band, a quarter-wave whip would be exceedingly long and a base- or center-loaded antenna must be used. The quarter-wave whip for the 25-54-mc band is cut to the proper length and is generally attached to the bumper, cowl or fender of a vehicle, using a flexible mounting. Sometimes, the whip is mounted on the roof of a vehicle but, because of its length, it looks awkward. When mounted on the bumper, some distortion of the radiation pattern occurs because the antenna is not in the center of its ground plane. A quarter-wave whip for the 108-134-, 144-148-, 152-162-, 162-174-mc bands is not awkwardly long. For the 152-162-mc band, it is about 18 inches long and is most often installed at the center of the vehicle's roof. For the 450-470-mc band, the whip is about 6 inches long.

Directional antennas are seldom used

RADIO

on mobile units, except where the vehicles traverse a straight route. Police cars on the New Jersey turnpike, however, use two quarter-wave whips to obtain gain in either a forward or reverse direction. One antenna is switched into use for one direction. For the other direction, the other antenna is activated. By carefully spacing the two antennas, the unused antenna in conjunction with the active antenna forms a two-element, vertically polarized unidirectional array.

For the 450-470-mc band, special antennas are sometimes used which are omnidirectional but provide a small power gain. About 18 inches in length, they look somewhat like a 152-162-mc whip.

The main objection to whip antennas for the 25-54-mc band is awkwardness due to their length—4 to 9 feet, depending upon the part of the band. This has been overcome by the recent development of base-loaded whips only about one-fourth as long. Tele-Beam Industries recently introduced the Magic Wand, a thin wire whip terminating in a tunable loading coil at the base. Field tests have shown these antennas to be as effective as bumper-mounted quarter-wave whips because they can be mounted at the center of a vehicle's roof, thus making better use of the available ground plane.

The communications unit itself serves as the ground plane along with the body of the vehicle when a whip antenna is plugged directly into a radio unit mounted on top of a vehicle such as a fork-lift truck. The antenna is ordinarily connected to the communications unit through a length of 50-ohm coaxial cable, generally RG-58/U. Sometimes lower-loss RG-8/U cable is used. The set end of the cable is terminated in a coaxial connector which mates with the coaxial connector of the communications unit. The center conductor at the other end of the cable is connected directly to the bottom of the whip, which is insulated from the roof of the vehicle or other ground plane. The shield braid is connected to the roof or other ground plane near the

base of the vertical whip. Sometimes, antennas have a coaxial connector which mates with a coaxial connector at the antenna end of the cable.

For special antennas such as those used in railroad applications, the radiating element may be at ground potential, as far as dc is concerned. A matching stub which acts as a dc short is sometimes used.

Things to come

Several mobile radio equipment manufacturers now have built-in as well as outboard transistor power supplies which can be used with existing equipment. These power supplies eliminate vibrators and dynamotors. Some also use transistors in the audio stages, and G-E is already on the scene with an all-transistor receiver. Wider use of transistors is anticipated and it is likely that, within the next decade, tubes will no longer be found in mobile radio equipment.

Because of increasing congestion and growing demand for additional radio channels, the industry is being forced to adopt split-channel operation in many areas. As a result, equipment is being built to meet the higher performance standards. Much of the gear sold today or even during the past 5 years can be readily converted from wide-band to split-channel operation. It is likely that all equipment built in the near future will be designed for split-channel use.

The Army has launched a micro-miniaturization program which will lead to a reduction of electronic equipment size by 10 to 1. Consequently, it is expected that future mobile radio equipment will be considerably more compact and lighter than it is now. It is also likely that there will be a trend toward unitized construction utilizing plug-in assemblies.

This kind of construction, while more expensive initially, can reduce maintenance costs and reduce the time that equipment has to be taken out of service for maintenance. Several years ago, J. A. Parkinson, general superintendent of communications and signals of the Santa Fe railway, suggested that man-

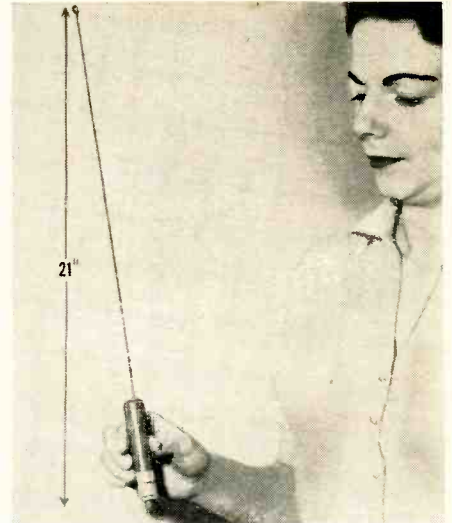

Base-loaded mobile antenna only 21 inches long overall replaces whip antennas 6-8 feet long ordinarily used for 25-50-mc mobile radio systems.

ufacturers consider designing future equipment in which complete sub-assemblies such as the if amplifier, rf section, squelch circuit and audio amplifier would be plug-in modules or strips. When maintenance is required, a spare module could be plugged in and the defective section sent to a repair depot.

To reduce congestion and to eliminate the need for continuous aural monitoring, selective calling is being added to many existing systems and is being stipulated as a requirement for many new ones. Both push-button and dial type selective calling is used. However, the dial type is gaining in popularity because of its almost unlimited capacity and compatibility with telephone techniques.

It is not likely that there will be imminent mass migration to SSB (single sideband) or equipment which will operate at frequencies above 890 mc. While both have been proposed and both have considerable merit, sophisticated users of mobile radio will be reluctant to abandon the present 25-54-, 152-162- and 450-470-mc bands, and narrow-band FM, for these new techniques and wider-open spaces. Eventually, either or both will have to be adopted, but for the next decade, I do not foresee any great departure from existing techniques and frequencies except for making better use of the present radio spectrum.

Summary

Certain specific makes and models of mobile radio equipment have been described here, and some proprietary circuit techniques have been reviewed, for the purpose of providing the reader with kaleidoscopic if not overall view of the art. It is impractical in such limited space to comment on all makes of equipment or to even begin to mention the many novel and noteworthy circuits and techniques which have been developed by all of the manufacturers in the field.

TO BE CONTINUED

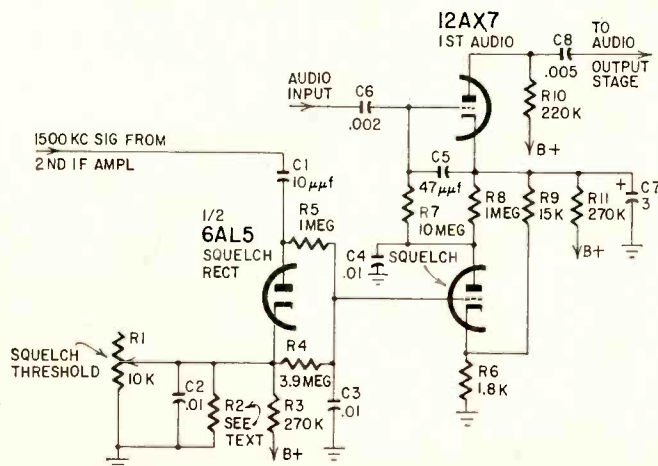

Squelch circuit used in the IMP, a compact piece of AM mobile radio equipment.

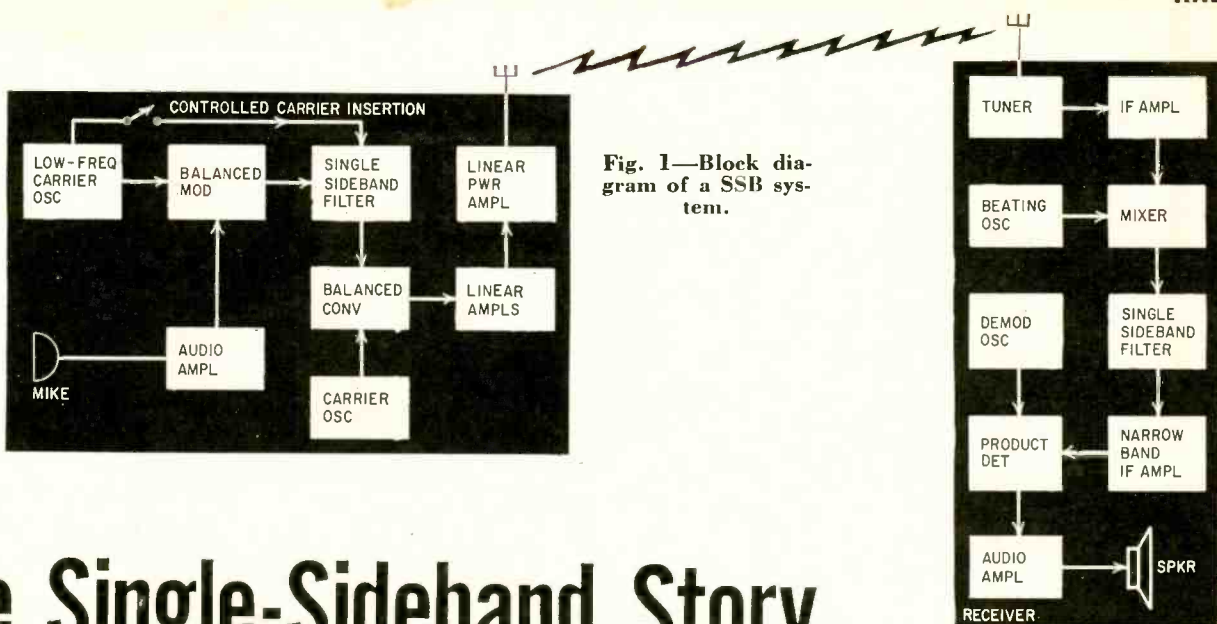

Fig. 1—Block diagram of a SSB system.

The Single-Sideband Story

A commercial SSB convertor.



Part I—Operating principles of a not always understood system of radio transmitting

By EDWARD M. NOLL

USING single sideband solves several communications problems. Its economy, reliability and operational versatility are attracting wide interest.

Single-sideband (SSB) transmission has several significant advantages and favorable performance characteristics. All service technicians, particularly those working in mobile and communications fields, should be bending their ears toward the rising number of SSB signals.

Single sideband now encompasses an impressive slice of the armed services communications systems. Airborne SSB systems have been tried and proven. And increased amateur activity in SSB, as always, is an advance notice of a trend toward commercial use.

In the usual pure SSB system, the carrier and one sideband are removed. Only the remaining sideband is radiated by the transmitter. Some SSB systems, as shown in Fig. 1, include facilities for injecting a controlled level of carrier when desirable. So either a pure SSB signal or a SSB signal with a controlled amount of carrier can be radiated. In the latter arrangement the carrier can be inserted, when necessary, with a level just high enough to permit demodulation by a standard AM receiver. Pure SSB radiation can be

used for strictly SSB communication links.

The obvious feature of SSB is the saving in spectrum space. This is important on amateur bands and crowded communications channels. Less than half the usual space is needed. Only one sideband is radiated and, because of the higher frequency stability required in SSB transmission, the guard bands need not be as wide (see Fig. 2). Thus the assigned channel width can actually be less than half that assigned to a similar AM service.

The improved frequency stability required of SSB is a disadvantage. However, this drawback is more than compensated for by spectrum saving and more reliable performance.

SSB requires less power than regular AM transmission to provide a given coverage. In AM transmission all information to be conveyed is contained in one sideband. The power expended in the carrier and the second sideband serves no useful purpose. In SSB transmission all the power is concentrated in the one transmitted sideband. This is why a 50-70-watt SSB transmitter can provide the same coverage as a standard AM transmitter rated at several hundred watts.

Single-sideband transmission is more reliable under adverse reception condi-

tions. In particular, selective fading (fading of one part of the transmitted spectrum with respect to the remainder, caused by multipath effects) is much less objectionable. Signal-to-noise ratio is improved because of the lower noise content of a narrower-band channel.

Many carrier interference problems are also circumvented. The annoying squeals of interfering carriers can be ruled out with the widespread use of SSB transmitters on crowded channels.

Forming the SSB signal

The first step in forming an SSB signal is to generate a stable carrier. A crystal oscillator or a highly stable

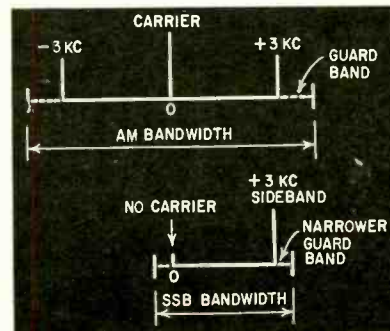

Fig. 2—Bandwidth comparison of SSB transmission and standard AM.

RADIO

vfo does this job. Generally, the carrier is in the 500-kc range or lower.

The next step is to modulate the carrier and, in the modulation process, remove or suppress the carrier itself. A balanced modulator is used for this task. Two typical circuits are shown in Fig. 3.

Fig. 3-a is a balanced arrangement of two triodes connected for a push-pull output. The carrier signal is fed to the two grids in parallel. It is applied via the arm of a balance potentiometer. As the carrier drives the grids in parallel and the plate output is push-pull, the carrier cancels in the output. To insure complete cancellation and removal of the carrier a balance control in the grid circuit is adjusted to correct for slight differences in tube and circuit operation.

The modulating audio signal is ap-

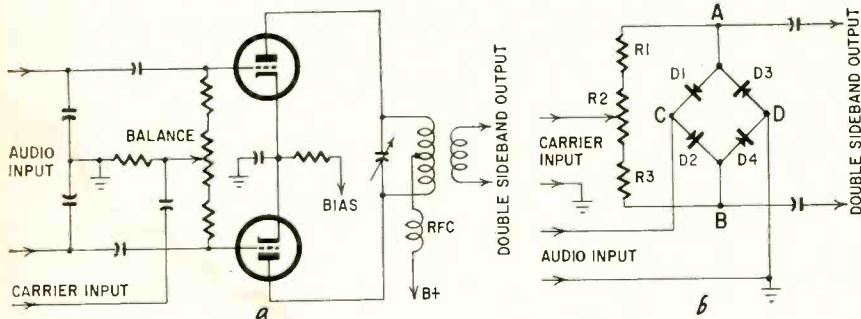

Fig. 3—Two types of balanced modulators. The carrier is canceled in both versions and only the sidebands appear at the output.

plied in push-pull to the grids. The tubes are biased on a nonlinear segment of their characteristics with external bias. As a result, modulation takes place in each tube and sidebands are produced. The modulator is unbalanced to the sideband frequencies and, therefore, upper and lower sidebands are developed in the output. The modulating audio signal does not appear in the output because of the almost zero impedance of the output resonant circuit at the lower audio frequencies. A double-sideband signal with no carrier is developed in the output.

Another type of balanced modulator is shown in Fig. 3-b. It is called a diode ring modulator. Each diode is a modulator with the combination designed so the carrier is cancelled and the sideband frequencies reach the output.

Let us first assume that the carrier alone is present (no modulation). With the carrier swinging positive, points A and B are driven positive with respect to D. There are two current paths with diodes D1 and D4 conducting, drawing equal currents up R3 and down R1. The net difference of potential between points A and B is zero and there is no output. On the opposite alternation of the carrier, diodes D2 and D3 conduct. Again, equal but opposite currents flow through R1 and R3. Net voltage is zero and the carrier components cancel in the output.

When the audio signal is applied, the ring balance is disturbed and unequal currents flow as a function of the modu-

lation. The audio is applied between points C and D of the ring. The bias placed at point C by the audio makes the carrier currents flowing in the ring unequal and sideband signals are developed between points A and B and across the output.

SSB filters

The next step in forming the SSB signal is to chop off one sideband. This is usually done with a sideband filter immediately following the balanced modulator.

There are three major types of sideband filters—L-C, crystal and mechanical. Inductor-capacitor filters are practical in the low-frequency 25-50-kc range. So, if the SSB signal is generated at the low rf range, this type of filter can be used.

At higher frequencies, up to the 500-kc range, crystal or mechanical filters are used. The mechanical filter has become increasingly popular in SSB equipment because of its smaller size, stability and desirable response.

Such a filter (see Fig. 4) consists of a series of half-wavelength mechanical



The Crosby type 51A SSB adapter.

resonators that pass vibrations that occur over their resonant frequency range. Other frequencies are rejected and only the desired sideband is passed on to the next stage.

In operation, a magnetostriction transducer converts the electrical variations of the desired sideband frequencies into like mechanical vibrations. These vibrations alone pass along the half-wavelength resonators and quarter-wave coupling segments. At the output another magnetostriction transducer converts the mechanical vibrations back into electrical changes.

The mechanical filter has passed only the frequency components of the desired sideband. Other frequencies are rejected because they fall outside the vibration range of the mechanical filter.

Amplifying the SSB signal

The next step in processing the SSB signal is to raise its frequency to the assigned channel and to build up its level to the assigned power. The usual form of doubler or frequency multiplier cannot be used because the SSB signal is a modulated one and must be built up with linear converters to prevent distortion. For the same reason, linear amplifiers must be used instead of class-C amplifiers.

A typical SSB converter is shown in Fig. 5. In this linear type of converter, the SSB signal and an inserted or beating carrier are heterodyned. The output is tuned to the sum frequency. Thus the SSB signal has been stepped up in frequency (sum of carrier frequency and SSB input frequency). One or more such converters are used to attain the final operating frequency.

So-called "balanced converters" are

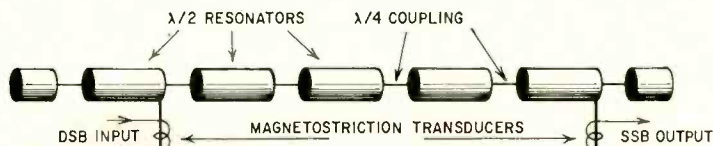

Fig. 4—Mechanical filter. Filter sections vibrate and transmit along their length only the desired sideband frequencies.

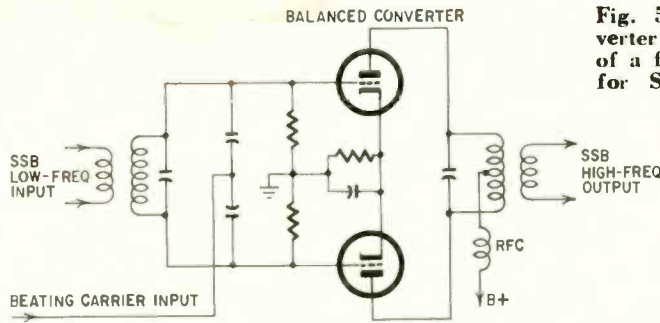

Fig. 5—Balanced converter is used in place of a frequency doubler for SSB transmission.

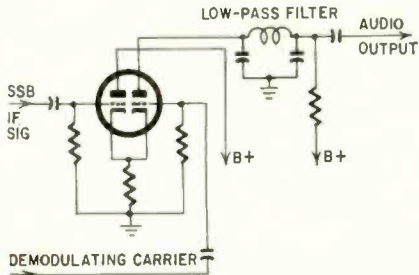

Fig. 6—In an SSB receiver, the product detector takes the place of the standard amplitude detector.

generally used. Such a balanced arrangement keeps the inserted carrier from adding a carrier component to the SSB output signal. In systems designed to add a controlled carrier component, when desirable, a balanced converter circuit can be unbalanced slightly. The degree of unbalance de-

termines how strong a carrier is inserted in the output.

SSB reception

A SSB receiver does not differ greatly from a conventional AM communications receiver. In fact, a conventional communications receiver can be used for SSB demodulation if some way to insert a stable carrier is provided. A bfo can be used if the necessary stability can be provided.

It should be stressed that to get the full advantage of SSB transmission, receivers designed specifically for SSB reception must be used. The rf and if sections of a SSB receiver are more or less conventional, except that bandwidth has been narrowed for the narrower SSB signal. In this way, a higher signal-to-noise ratio is obtained.

SSB receivers often include two or more mixers to beat the SSB signal down to its original low carrier frequency. The stability of the mixer oscillators must be exceptionally good to minimize the introduction of distortion components. A SSB filter is also used at the receiver, offering additional selectivity and interference rejection.

Perhaps the most common form of SSB demodulation is the product detector. An example is shown in Fig. 6. Although regular amplitude detectors can be used after the carrier has been reinserted, better fidelity and noise rejection result when you use demodulators designed for SSB.

The product detector operates as a heterodyning demodulator. Distortion and beat problems of the nonlinear amplitude detector are avoided. In the product detector the incoming SSB signal beats with an inserted carrier whose frequency is identical to the original modulated carrier at the transmitter. The detector's output circuit selects the difference frequency. In this case the original audio variations are the difference frequency. The output circuit is of the low-pass filter type and therefore the carrier and sideband frequencies are filtered out. The inserted carrier generator is crystal-controlled to insure proper stability.

Next month, some typical commercial SSB systems and circuits will be described. TO BE CONTINUED

Modulating Crystal Oscillators

By PAUL S. LEDERER

CRYSTAL oscillators provide accurate and stable frequencies for calibrating receivers, signal generators and similar devices. Transistor crystal oscillators are compact and portable. One such unit is described by I. Queen in "Build a Dual Wide-Band Crystal Oscillator," which appeared in the November, 1956, issue of RADIO-ELECTRONICS.

While experimenting with a short-range remote-control system operating just below the broadcast band, I noted that two-channel operation might be possible with crystals. Surplus crystals with fundamentals from about 370-540 kc. are available at low cost. So I built a crystal-controlled oscillator

using a CK722 p-n-p transistor in a Pierce oscillator circuit. (See "Transistor Low-Cost Frequency Standard," RADIO-ELECTRONICS, November, 1958, page 61.)

However, a communications receiver was not handy (with its built in bfo), and the oscillator's ability as a transmitter could not be checked—an unmodulated carrier cannot readily be picked up by an ordinary receiver.

To get around this problem I tried to find a simple way of modulating the crystal oscillator.

First I tried using the output of a bell transformer (about 13 volts rms) with a 1N34-A germanium diode as a series-connected rectifier to deliver negative half sine waves to the transistor oscillator. This didn't work as the circuit didn't oscillate.

Adding a large electrolytic as a filter made the circuit oscillate but produced practically no modulation. Finally, by experimentally varying the value of capacitance, I got modulated oscillation.

As shown in the schematic, the capacitance used for C was 0.64 μ f. Although the exact value is not critical, varying the capacitance changes the amplitude of the modulated carrier and the percent of modulation. The photos show this very clearly.

The top waveform where 0.24 μ f was used has an amplitude of 6.6 volts

peak to peak, and 60-cycle modulation appears to be almost 100%. The bottom signal, about 30% modulated and measuring 18.5 volts peak to peak, was obtained with 0.64 μ f.

While the modulation is not linear, it is certainly adequate for the purpose. When the modulated oscillator was operated from a 400-cycle source (audio transformer fed by audio generator) with a 0.24- μ f capacitor, 30% modulation and carrier amplitude of about 15 volts peak to peak resulted.

Two precautions must be considered in transistor circuits: Observe proper polarity of the modulator supply—negative-going halfwaves to the collector of p-n-p transistors, positive-going to the collector of n-p-n types. Secondly, the peak voltage of the sine wave must not exceed the peak rating of the transistor. END

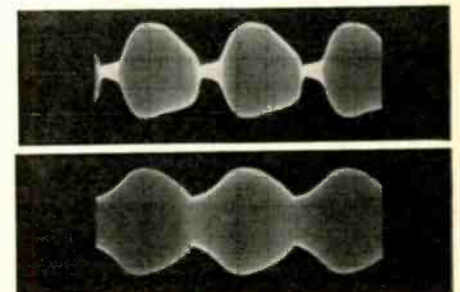
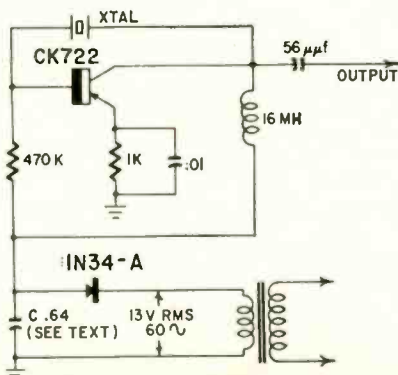

ELECTRONICS on the HIGHWAY

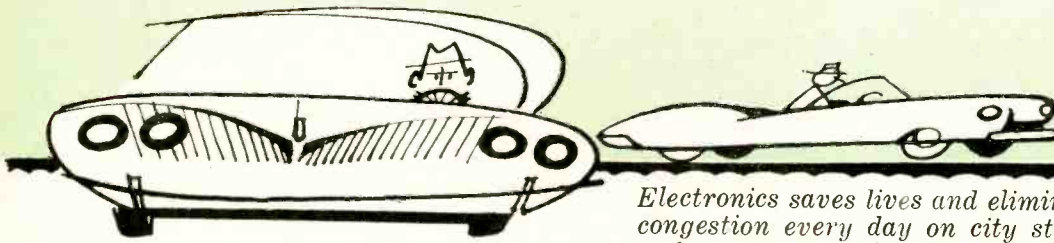

Electronics saves lives and eliminates congestion every day on city streets and country roads. Here's a close look at electronic traffic signal control, police radar, and the proposed TV-controlled highway and radar for your car

By DAVID LACHENBRUCH

HAS electronics already saved your life on the highway? Possibly. If not, it has certainly saved your temper by reducing delay as you drive through cities and congested areas.

The phrase "electronic traffic control" conjures up visions of automatic vehicles speeding along automated highways, as described in previous articles in this series (RADIO-ELECTRONICS, January, 1959, page 34, and April, 1959, page 99). But even though you still hold the steering wheel with your own hands and apply the brakes with your own foot, electronic traffic control devices today are saving lives and expediting vehicle flow in hundreds of cities, on thousands of highways.

In today's form, electronic traffic control devices have two main jobs: to speed you up in the city and slow you down on the highway. You are speeded up by automated traffic-actuated signal lights; slowed down by the ubiquitous speed meter, commonly known as "police radar."

Two other electronic devices which contribute to driving safety and convenience are the two-way police radio and the common garden-variety automobile broadcast receiver, although the latter has never reached its full potential as a safety device.

The first remotely surveyed and controlled highway in the world may be in operation in Detroit within the next year. A combination of closed-circuit TV and remotely operated roadside signs will be used to observe and direct traffic from a central control room.

Traffic signals

The corner traffic light has changed from an electrical version of the policeman's old stop-and-go signals to part of a complex electronic system. Traffic-actuated counter-computers gradually are replacing the clockwork mechanisms which once controlled signal timing, and radio signals are replacing the multi-conductor cables which have been used to link traffic signals.

Although most big cities are switching to electronic signal control, many still

cling to cable interconnection—mainly because the cable is already installed. Philadelphia uses buried multiconductor cable to connect its new million-dollar electronic signal system. A few cities—Chicago is one—use radio to interconnect old-fashioned electromechanical traffic-light systems. Los Angeles and some other cities are gradually swinging into all-electronic systems—electronically controlled signals tied together by radio. New York recently embarked on a long-range program to convert 8,000 intersections to electronically triggered, radio-linked units.

Radio signal interconnection

Radio interconnection is usually preferred to cable for new traffic signal installations because it requires no excavating or stringing of overhead lines. Most traffic-light radio signals are vhf, although one manufacturer (Motorola) is plugging for uhf interconnections because that part of the spectrum, being less crowded, is less prone to interference.

Here's how a typical traffic-light radio linkage (General Electric) is used as a direct replacement for cable:

A standard vhf mobile transmitter is located at the city's central control

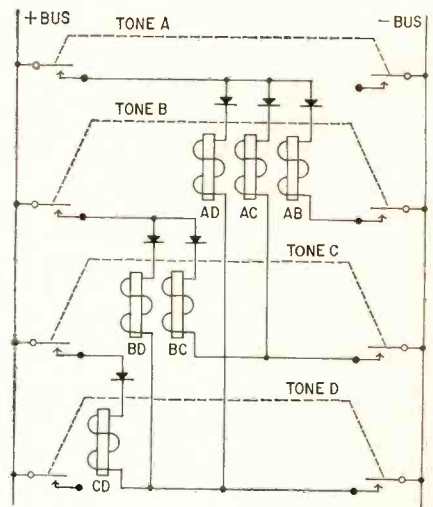
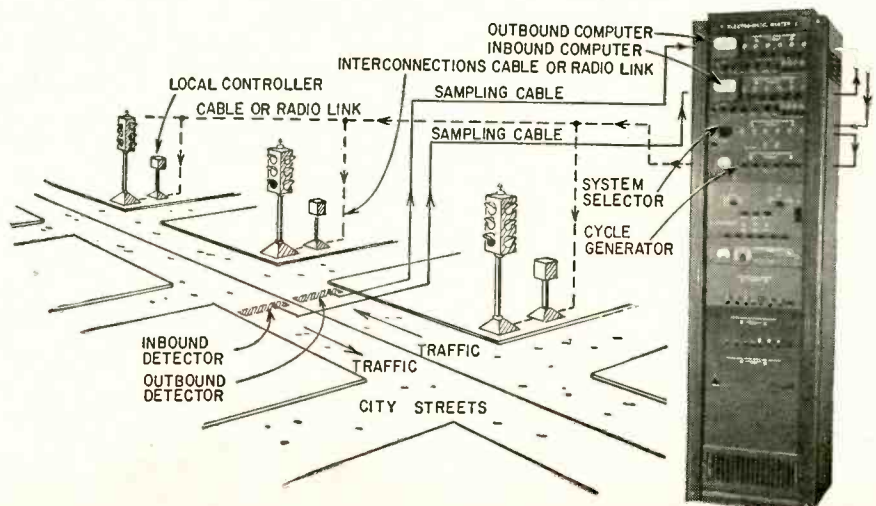

Fig. 1—Part of decoding circuit used at each intersection with radio-linked traffic signals. Each relay responds to a pair of audio tones. Wiring is printed, with two relays mounted on each circuit board.

Fig. 2 (below)—A "traffic-actuated" system for controlling a large group of intersection signals on basis of traffic-density patterns fed to central computers.



headquarters, sending out a carrier which is frequency-modulated with a number of tones at different audio frequencies—as many as six audio tones can be transmitted at the same time.

The transmitter is modulated by a “master tone translator” which receives its instructions from up to six conventional “master controllers”—central stations which control light cycles. One master translator can receive commands in any order and in any quantity representing up to 90 traffic-light functions, store them and send them out in proper time sequence without confusing itself or the units at the intersections.

The key to the system is the combining of audio tones into pairs—any given pair corresponding to a single traffic-light function, such as selection of changing cycle, offset (staggered timing of

different signals so a car can continuously meet green lights as it proceeds at a fixed speed), flashing lights, complete shutdown, etc.

In a box near each traffic light is a receiver and “tone translator” set to respond to various pairs of tones, rejecting as noise tones intended for other traffic signals. The heart of the tone translator is a group of relays, each of which reacts to a specific pair of tones. Thus 5 separate tones, in 2-tone combinations, can trigger 10 traffic-light functions, and 6 tones can take care of 15.

The relays actuated by the tone pairs (Fig. 1) have contacts (not shown) to close circuits supplying the control voltages normally supplied by a cable circuit. These are applied to the “local controller” at the intersection—the

device which actually keys the changing of the lights.

Traffic-actuated signals

Roadside computers are becoming commonplace these days—but few people even realize that they're there. The external appearance of traffic signal systems hasn't changed much, but the introduction of electronics has greatly increased the functions they perform and is credited with reducing traffic deaths and injuries, and speeding intersection traffic as much as 400%.

In the familiar black box alongside the intersection is an analog computer. The pressure-sensitive treadle in the road may have been replaced by a buried magnetic detector or an overhead radar detecting device which transmits a continuous cone-shaped “searchlight” beam at 2455 mc. As a vehicle enters the cone, it causes a Doppler shift in the frequency of the reflected wave, which is noted by the built-in receiver and passed on to the signal controller as “one vehicle” count.

On the basis of vehicle counts on all lanes entering the intersection, the roadside computer establishes the proper signal cycle and the required timing for each part of the cycle for the traffic at the intersection at the time, having been fed the necessary decision-making information by 28 preset adjustment dials.

This “volume-density” type of traffic signal control takes into account the number of cars waiting at a red signal, the volume of traffic passing the green light—and it doesn't neglect that forgotten man, the guy who got caught just as the light changed, as it also considers the amount of time the first car at the red light has been waiting. If the intersection has a pedestrian pushbutton, the traffic-light controller keys a special “walk” interval—except when nobody is waiting to cross.

These systems can be tailored to any intersection conditions—incorporating left- and right-turn arrows; three-, four- and five-way lights—and in each instance the signal pattern changes continually and automatically on the basis of traffic conditions at the moment.

Coordinated systems

A more sophisticated computer arrangement integrates the signals in an entire city or section of a city into a single vehicle-actuated system. One such master control system—the PR Electromatic, made by the Automatic Signal Div. of Eastern Industries Inc.—is in use in Baltimore, Philadelphia, Chattanooga, San Antonio, Waco, Mobile, Houston, Seattle, Denver and many other cities.

When the signals are controlled and coordinated from a central point, traffic samplers or vehicle detectors (pressure, magnetic or radar types) are located at a few strategic points in the city, instead of each intersection (Fig. 2). They count the traffic in each direction and pass this information to a central



Police officer checks speed of passing cars from his stationary vehicle. Speed meter on top of dash indicates passing vehicle is traveling 40 miles an hour, while recorder at right keeps a permanent record of speed.



Traffic engineer observes sections of two Detroit expressways via closed-circuit TV during recent tests.



Overhead radar units make a vehicle count for the automatic adjustment of traffic signals. Closeup of radar unit partially removed from its case is seen in inset.

master controller, which makes all decisions on length of cycle, split (division of time between red and green) and offset of signals to favor the flow of traffic at the moment.

Each master controller consists of a pair of computers (for inbound and outbound traffic), one "system selector" (which compares the traffic counts registered by each computer) and a cycle generator (which passes instructions on to local controllers at the intersections). Baltimore has 8 master units controlling 800 intersections, Philadelphia has 6 for 320.

Los Angeles installed a master system of this kind on an 11-mile 19-signal stretch of Ventura Boulevard. Comparing the 5-month period immediately after the installation with the preceding 5 months, when conventional signals were used, the city fathers reported fatal accidents reduced from 4 to 0, personal injury mishaps from 17 to 10. The average motorists saved 10.1 minutes covering the 11-mile stretch, and sections of the highway were able to handle as much as 265% more traffic in a given period.

Chattanooga cut traffic delay in half, and Philadelphia estimates its new electronic system is resulting in a more than 50% speedup of downtown traffic by raising the average speed from 9-12 to 15-19 miles an hour.

Automatic lane control

An ingenious variation of the coordinated signal system is Eagle Signal Corp.'s lane control system. Used on arteries with three or more lanes, it automatically varies the number of lanes of traffic in each direction, according to the traffic pattern.

Taking a three-lane street as an example, here's how a typical lane control system works:

Each lane is controlled by overhead lights every 250-500 feet. The lights mounted above the outer lanes are fixed

and unchanging—green in the direction of traffic and red in the opposite direction.

Above the center lane are three lights—green, yellow and red—mounted side by side. Traffic sampling detectors in the roadway count vehicles and indicate the direction they travel.

At central headquarters, the traffic count is fed into two computers. A "lane selector" has been preset to cut in automatically when various ratios of inbound-to-outbound traffic have been reached. At this point, the selector generates a signal which is fed to a third electronic control, the transfer unit.

The transfer unit determines the total time required to switch a lane from two-way to one-way traffic. It automatically transmits electronic directions to the overhead control lights.

With traffic roughly equal in both directions, a flashing amber light above the center lane in each direction indicates that cars may use it for passing or driving with caution.

Then, let's say, westbound traffic increases to the point where the ratio of westbound-to-eastbound exceeds the predetermined "changeover ratio." An automatic "lane transfer" cycle begins, lasting for a preset amount of time varying from 1 to 15 minutes. During this period, the flashing amber signal continues for westbound traffic in the center lane, while the center-lane light turns red to eastbound traffic.

After the transfer cycle is complete, the center light turns green in the westbound direction (making two westbound lanes) and remains red to eastbound traffic (leaving one eastbound lane). This is maintained until traffic density changes to another predetermined level.

Emergency signals

Fire engines, police cars and ambulances can stop all traffic in their path by using a relatively simple traffic con-

trol mobile radio. This equipment is marketed in several versions (among them Electronic Protection Inc.'s EL-TEC and Eagle's NATECS).

Uhf is used, principally because the line-of-sight limitations in that band are an asset in cutting down the transmission's range to about a quarter-mile on normal city streets.

NATECS uses a 2475-mc carrier frequency, modulated with a 120-cycle pulse. EL-TEC works on 465 mc, modulated with a "basic control tone" of 800 cycles, plus 1,900 cycles for east-west travel and 3,000 cycles for north-south.

Both units work similarly. When approaching an intersection, the transmitter in the emergency vehicle beams a signal to an antenna atop the traffic light, operating a receiver-relay combination which changes the lights to red in all directions or red in one direction only, depending on the type of system and intersection.

Every one of the electronic traffic-light systems described easily pays for itself in relief of congestion alone, not to mention safety. Then why haven't they spread to every city and town? An official of one of the biggest companies in the traffic signal field makes this interesting observation:

"There happens to be a great need for trained electronic technicians in the municipal field. It is the lack of such personnel that has retarded the purchasing of electronic traffic controls by cities which have long recognized the need for them."

Radar speed meter

The police radar will get you if you don't watch out—but motorists are mighty fortunate that there is such a thing. It's credited with a 77% reduction in traffic accidents in Mississippi, a 50% reduction in traffic deaths in Houston, a 28% reduction in fatalities in Pasadena and similar savings in lives and property elsewhere.

Automatic Signal's Electro-Matic radar speed meter is completely portable—all components fit in a compact case and weigh only 35 pounds. The standard model consists of a transmitter-receiver and an indicator unit. An accessory graphic recorder makes a permanent record of the speed of all passing automobiles on a moving paper tape (Fig. 3).

The speed meter is powered either from a 12-volt auto battery or 117 volts ac. It operates by measuring the Doppler shift in frequency of the wave reflected by the moving automobile. The transmitter is built around lighthouse tubes, with a carrier frequency of 2455 mc (industrial radio band).

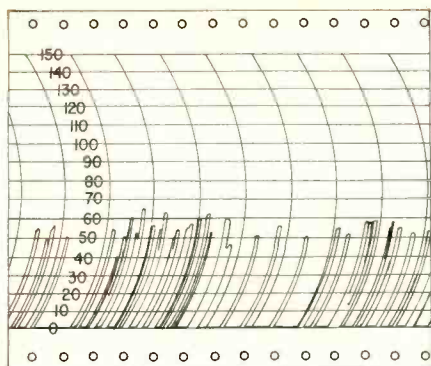

Fig. 3—Graphic record of automobile speeds made by radar speed-meter recorder. Each pip represents one automobile. Double pips indicate one car was passing another.

The receiver picks up the energy reflected from the target and mixes with it a small amount of signal directly from the transmitter. The resultant Doppler beat note is amplified and fed to a frequency meter calibrated directly in miles per hour.

At the 2455-mc transmitter frequency, the frequency shift is 7.31 cycles per mile per hour. Thus a beat note of 438.6 cycles would be read on the meter as 60 miles per hour.

The meter's speed indications are accurate within ± 2 miles per hour up to 100 miles per hour—far more reliable than your car's speedometer.

TV highway patrol

Another method of superhighway surveillance—closed-circuit TV—has been tested on Detroit's elaborate expressway system and has convinced the Department of Streets and Traffic that it may be the best solution to a unique problem which crops up when superhighways are built in areas of extremely heavy traffic.

Detroit's problem: The expressways are too popular.

Although the superhighway system proved to be the safest, speediest way of flushing traffic through the city, the popularity of the expressways revealed a serious flaw: When one car breaks down, it can immobilize 300 to 400 vehicles behind it in 3 or 4 minutes—sometimes causing multi-car front-to-rear crashes and always resulting in time-wasting tie-ups which are difficult to unscramble.

Under the co-sponsorship of the Michigan Bell Telephone Co., Detroit experimented for several months with closed-circuit TV cameras on expressway overpasses. So encouraging were the results of the initial tests that the city's Streets and Traffic Director, Alger F. Malo, concluded: "The key to any successful plan for combatting accidents and congestion on expressways is television."

Detroit now plans a far more extensive TV test, which will, in effect, establish the world's first electronically patrolled and controlled highway.

It will cover an 8-mile section of

Detroit's expressway system. A total of 33 cameras will be used, mounted approximately 1,500 feet apart on towers to be built on existing overpasses, effectively permitting remote observation of every inch of the 8-mile segment.

The cameras, in weatherproof housings equipped with windshield wipers, will be designed for remote focus, pan, tilt and lens change from a central control room.

To make things easier for the control-room operator, there won't be a monitor for each camera. Instead, the principal monitor will use a "sequential scan" system—changing from one camera to the next every 4-6 seconds, giving the operator a view of all sections of the road every 2-3 minutes and capable of following a section of traffic as it moves along the highway. Other monitors will show the picture as "seen" by a selected camera at any time.

Viewing the sequential monitor, the control-room engineer will be able to

spot traffic tie-ups and trace them to their source with minimum delay. Then, using a standby monitor and remote camera control, he can pan in to a close-up of the exact cause of the trouble.

When he has found the location and cause of the bottleneck, he can immediately dispatch a police car, ambulance, fire engine or tow truck to the location of the trouble, speeding aid to the scene by telling the emergency vehicles—by radio—the fastest route to the trouble spot, on the basis of his TV observations of traffic tie-ups.

To keep further traffic from aggravating the congestion, the engineer operates a switch panel which actuates electrically changeable illuminated overhead signs on the expressway and at entrances to it.

For example, he may light a sign saying "Accident Ahead—Exit at Next Ramp," or "Slow to 35 mph." He may also close off entrances around the affected area simply by pushing a button.

END

TRANSISTORS MAKE CARS RUN BETTER

TRANSISTORIZED IGNITION for automobiles, using a power transistor to switch heavy current in the pri-

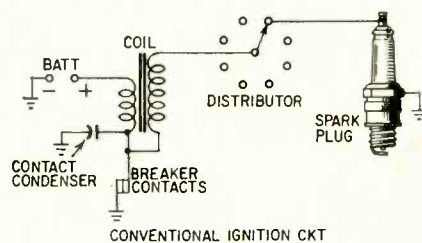

CONVENTIONAL IGNITION CKT

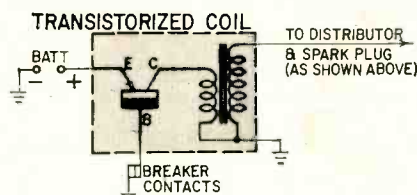

TRANSISTORIZED HIGH-VOLTAGE IGNITION SYSTEM

mary of the ignition setup transformer, has been developed by Electric Auto-Lite Co.

of the transistor, thus timing the firing of the transistor-switched transformer to the engine. The distributor contacts function in their normal manner except that they carry very low current (less than 250 ma instead of 4 or 5 amps!). Through the action of the transistor and improved stepup transformer design made possible by this system, it delivers greatly increased voltage to the spark coil.

The unit mounts in place of the ignition coil which it replaces. It contains the power transistor, heat sink, stepup transformer and associated circuitry. Two primary terminals and a high-voltage secondary terminal appear just as on the conventional ignition coil.

Additional advantages accrue from the improved transformer design and increased dwell time, which raises available transformer output voltage at high speeds. The new system can be installed in any battery ignition system quickly. Initially it will cost about as much as power steering. The company anticipates that it will be available as optional equipment on cars in 1961.

The company showed a package slightly larger than the conventional ignition coil which it replaces. They stated that starting failures and poor starting due to "blued" distributor contacts are greatly reduced, the contacts last much longer due to lower current through the distributor, ignition maintenance and adjustment is reduced, and the ignition "condenser" is eliminated.

Auto-Lite designed the system around a power transistor which switches the heavy current required in the ignition coil primary. The emitter-collector circuit of the transistor carries this current and is triggered by the distributor contacts which are placed in the base

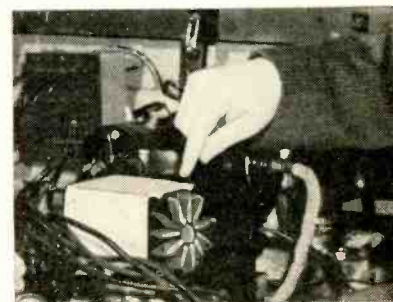

New unit installed on motor has cooling fins, is little bigger than older coil.

ELECTRONICS

Electronic displays of science facts can make classes come alive. In this second of a series—the first appeared in February—photo-cells are used in demonstrations of the properties of light. In demonstrations of electronic resonance, the vtvm and oscilloscope act as indicators



By SOL D. PRENSKY*

WHEN a nonelectrical property is demonstrated, a transducer converts the results into electrical variations which actuate the electronic display instruments. In this article, the properties of light are studied through the transducer action of the photoelectric cell. The electronic equipment works to illustrate (or measure) both electrical and nonelectrical properties.

Over the years we have become familiar with commercial uses of photoelectric cells as a transducer—light striking the cell (or the absence of light) produces an electrical signal. We interrupt a light beam to open a door or start a hand-dryer motor. A more

*Fairleigh Dickinson University, Teaneck, N.J.

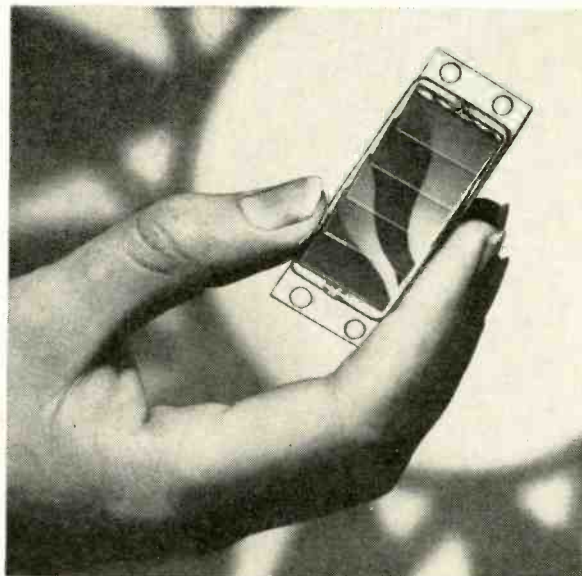

Fig. 2 — Silicon solar module uses five 1 x 2-cm cells. Courtesy International Rectifier.

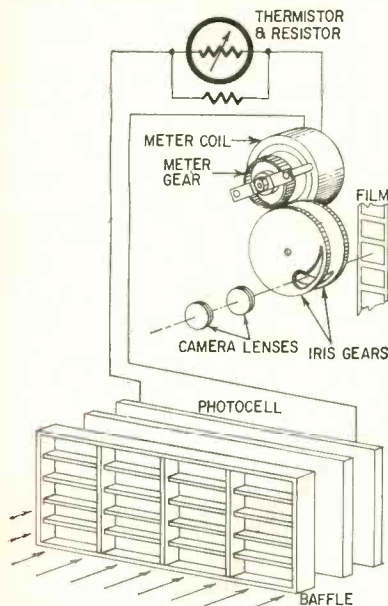

Fig. 1—Selenium photocell arrangement used in self-adjusting movie camera. Current generated by light flows through resistor and thermistor combination and rotates meter coil in proportion to light intensity. This sets the variable lens opening through the two iris gears.

novel example, currently coming into use in self-adjusting electric-eye cameras, is shown in Fig. 1. In this device, the amount of light falling on the photocell sets the camera's lens aperture to its proper opening (f stop), through the gearing arrangement shown. The electrical circuit used is the utmost in simplicity, thanks to the modern version of the photovoltaic cell—a selenium solar battery in this case.

Efficiencies of these remarkably simple solid-state devices (both selenium and the newer silicon versions) have been greatly improved by recent developments, making them much more suitable for use in classroom demonstrations than more complicated devices using phototubes and vacuum-tube amplifiers. The selenium self-generating photocell is convenient to use and is readily available in inexpensive forms. It is interesting to note that silicon solar cells extend the current and power capabilities of the photocell still further. A recently released version of this solar cell, a silicon solar module measuring 10 x 2 cm overall, is illustrated

in Fig. 2. Though more expensive than selenium cells, silicon cells offer great promise in satellite and other special applications because of their ability to convert up to 8% of the radiant energy falling on their surface. (They can supply 100 watts of power per 14 square feet of cell area.) Their response to the spectrum of light also extends further into the infra-red region than does that of the selenium cell.

For most classroom demonstrations of photoelectric action, the less expensive selenium sun battery is amply sensitive and closer in spectral response to the human eye or camera film than the silicon cell. Increased sensitivity can be easily obtained, when needed, by adding a simple transistor amplifier.

Properties of light

To measure illumination or light intensity, connect two leads from a photovoltaic cell to a sensitive dc milliammeter. The simple light-meter connections are shown in Fig. 3. International Rectifier B2M sun-battery cells (or

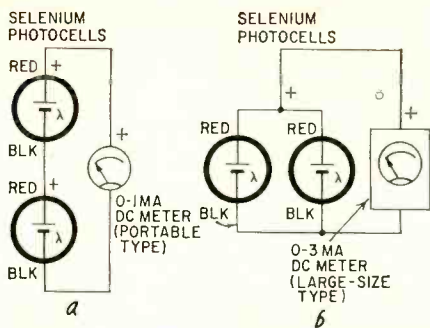

Fig. 3—Arrangement for measuring light intensity, using selenium sun batteries: a—series connection for meters having about 100 ohms resistance; b—parallel connection for large-size meters of lower internal resistance.

equivalent units) are connected to a dc milliammeter to provide a deflection proportional to the strength of illumination. When the meter face is calibrated in terms of illumination (foot-candles), we have a light meter.

For use with large-size demonstration type vtvm's (such as the Sylvania 301¹ or Hickok 209A), the parallel connection of Fig. 3-a works best and delivers an output current of about 1 ma at roughly 100 foot-candles. When using more sensitive portable type multimeters, such as the Triplett VOM630 or Precision VOM120, follow the series cell connection in Fig. 3-b. Here, as shown in the output table, the source impedance of the two cells in series (100 to 120 ohms) offers a better match for the approximately 100-ohm internal resistance of the meter on its 0-1-ma range, and supplies about 0.5 ma. The portable type multimeter also provides a more sensitive full-scale range of 50-60 μ a which can be put to good use when measuring lower light levels, such as room illumination.

The smaller portable type meters (up to 4½ inches) have more sensitive current-measuring ranges (around 50 μ a full scale) compared to the more easily seen large-size meters (generally around 3 ma full scale). The problem of choosing between the two conflicting advantages is one that arises repeatedly in classroom demonstrations. One way to take advantage of the greater sensitivity of the smaller meter is to arrange a system for projecting the reading on a screen. Another way, better from the standpoint of a simple uncluttered demonstration, is to have one student call out the readings to the class. Still another method is presented in a later part of this experiment, where a simple transistor amplifier is used to amplify current readings, so they may be displayed on larger but less-sensitive meters. I prefer the amplifier method as it is then possible to use the larger-size instrument.

Comparing light sources

Two light sources can be compared

¹The Sylvania 301 vtvm (6-inch) includes ma ranges. Though discontinued, quantities still remain to be liquidated. (Terminal Radio Corp., 85 Cortlandt St., New York, N.Y., and several mail-order houses.)

by the circuit arrangement of the photometer, shown in Fig. 4. The two selenium (B2M) photocells are connected back to back (in series opposing) to the indicating zero-center meter. Since current generated by one source opposes current generated by the other, illumination from each source will be equal when the meter is brought to center-zero balance by varying the distance of the unknown source from its photocell. The ratio of the candlepower of the unknown source is then found by applying as usual the inverse-square law.

Relay systems

Light controlled relay systems are greatly simplified by selenium photo-

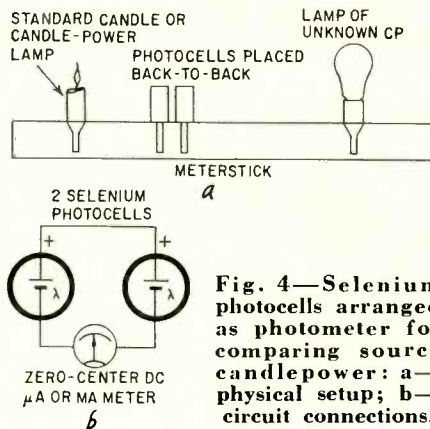

Fig. 4—Selenium photocells arranged as photometer for comparing source candlepower: a—physical setup; b—circuit connections.

cells. The circuit shown in Fig. 5 uses two small B2M cells in an arrangement that would automatically turn on room lights as evening approached, and would also automatically turn the room lights off as the morning became light enough. The current generated by the two cells in series serves as the input to a simple transistor amplifier that has a quiescent collector current of about 0.8 ma through the relay coil, when the photocells are in the dark (simulated by interposing a cardboard to block off the light from the cells). In the dark condition, the relay drops out (Fig. 5-a) and one set of its spdt contacts connects the battery to the white lamp. When ordinary room illumination (simulating the approach of daylight) reaches the cells, the generated current adds to the transistor's base bias, causing the collector current through the relay to increase to about 1.2 ma, exceeding the relay's pull-in requirement. As a result, the other set of contacts lights the red bulb, indicating the switched-over condition. The relay used here (Allen D. Cardwell model BK-7-B) is a very useful one for this type of experiment because its pull-in current is adjustable from about 0.75 to 1.25 ma with corresponding dropout values.

(The BK-7-B has long since been discontinued by the manufacturer and is available only through Relay Sales Inc., Box 186, West Chicago, Ill. and other firms specializing in surplus military electronic equipment and components. It has a 4,500-ohm coil.—Editor)

Output of 2-Cell Arrangement

(see Fig. 3)

Illumination at 100 foot-candles.

Internal resistance approximately 50 to 60 ohms, each cell.

Connection	Meter (load) resistance (ohms)	Source Impedance (ohms)	Current (ma) of Combination
Parallel (large-size meters, 0-3 ma full scale)	30	25 to 30	about 1.0
Series (portable meters, 0-1 ma full scale)	100	100 to 120	about 0.5

The action of the simple transistor amplifier used here illustrates how easily the small current from the photocells can be amplified to produce a much larger current output. The low source impedance of the cells is a good match for the transistor input resistance. When the load impedance (relay or meter) is of the same order as the transistor output resistance, current gains from 10 to 50 are obtained without difficulty. The circuit works well, without complications, with a collector supply of around 3 volts with loads in the neighborhood of a few hundred ohms. (In this case, if the amplifier is used to actuate a meter, the simple components can be mounted on a board fitted directly over the meter ter-

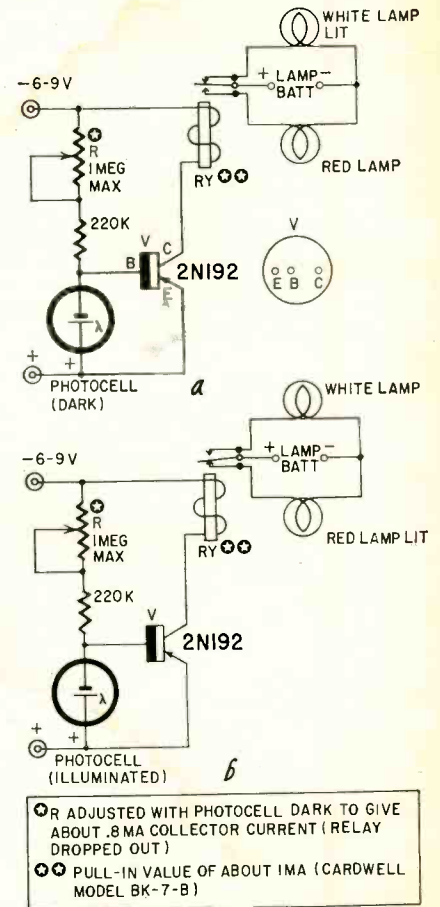

Fig. 5—Sensitive light-controlled relay using transistor amplifier. During the night (photocell dark), relay remains dropped out (a); daylight illuminates photocell, causing relay to close (b).

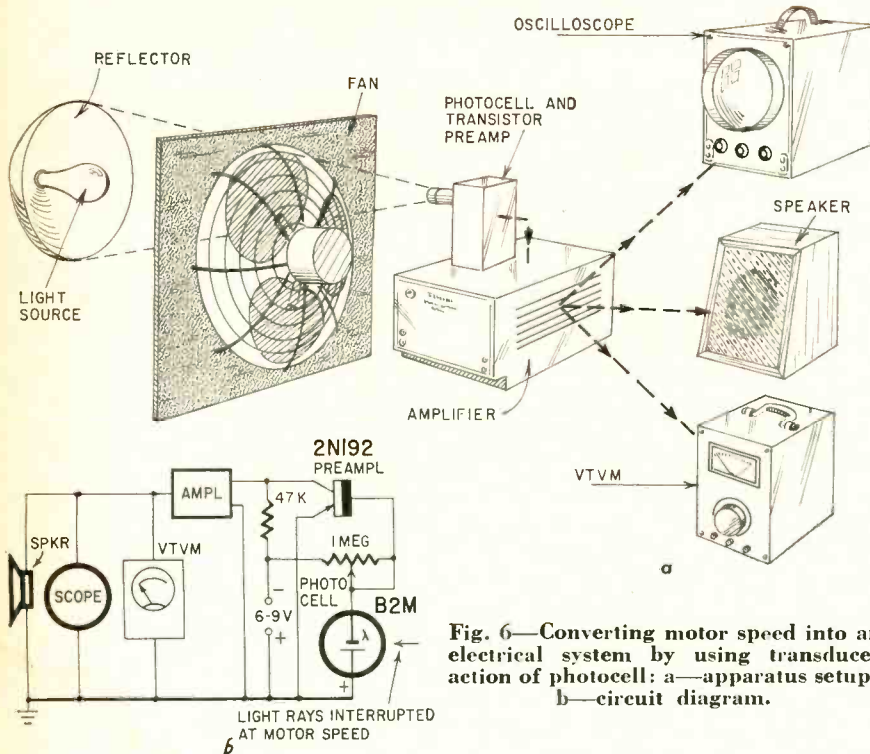

Fig. 6—Converting motor speed into an electrical system by using transducer action of photocell: a—apparatus setup; b—circuit diagram.

minals.) By raising the battery voltage to 9 or 12, resistance loads of a few thousand ohms can be accommodated.

Motor-speed indicator

An indirect use of the photoelectric effect—to give audible indication of motor speed—is shown in Fig. 6. This example illustrates the general action of a photocell as an ac transducer, by forming an ac signal from the variations in the light falling on the cell. Once the variations in the incident light have been converted into an ac signal, it then becomes a simple matter to use the amplified signal, either making it audible in a loudspeaker or displaying it on a scope. Operation of the transistor amplifier in producing amplified voltage variations for this purpose is similar to its previous function as a current amplifier. The main difference lies in the choice of a higher value for the load resistor. As a result, small current changes in the collector circuit produce an output consisting of comparatively large voltage variations, which make up the ac signal output.

Invisible light

All the preceding experiments use the visible portion of the radiation spectrum. This spectrum also includes invisible radiations (ultra-violet and infra-red) on either side of the visible light range. Fig. 7 shows a graph of relative spectral response. It clearly depicts how the eye of a standard observer provides a substantial response only to the visible portion from the short-wave violet end (around 450 millimicrons) to the long-wave red end (around 650 millimicrons), centering in the yellow-green region between. Response of the

photocells covers a much wider range than the eye. In the shorter wavelength or ultra-violet region, the selenium photocell has the better spectral response, making selenium a better detector in the invisible ultra-violet region (down to about 300 millimicrons [$m\mu$]). Conversely silicon photocell response extends well into the infra-red region, making detection of infra-red radiations possible all the way out to approximately $1,100 m\mu$, with a broad peak centering at $800 m\mu$, where eye response is practically nil.

For detecting ultra-violet rays with selenium (B2M) cells, numerous ultra-violet sources and visible light filters are available. A very convenient source is the General Electric Purple-X, a

250-watt bulb (catalog #250A21-60) (available from Hudson Specialties Co., 160 W. 14th St., New York 11, N. Y.). This bulb operates at a high temperature and is intended for intermittent use only (rated for 50-hour life at 115 volts, used 5 minutes on and at least 10 minutes off for cooling). It produces substantial ultra-violet radiation, with only a small amount of visible purplish light which is easily filtered out. It screws into the standard-base socket of a photo-flood reflector. The reflector must have a porcelain socket to handle the heat generated.

Infra-red rays are best detected by silicon solar cells (model S1020, International Rectifier Corp., each individual cell having dimensions of 1×2 cm, or equivalent units). The most convenient sources of infra-red radiation are the reflector type heaters designed to give more heat than light. Filters for infra-red transmission are harder to come by than the ultra-violet ones. However, use can be made of the opposite effect—ordinary transparent materials are opaque to infra-red radiation.

Electrical resonance

The effectiveness of a conventional demonstration of series resonance at 60 cycles can be considerably enhanced by using a large-size high-impedance vtvm and large-screen oscilloscope as the indicating elements. A setup of a commonly used resonance board combined with these indicating instruments is presented in Fig. 8-a.

The resonant point is reached by varying the inductance of coil L, raising or lowering its movable iron core. When its reactance (X_L) equals that of capacitor X_C , the lamp lights, indicating maximum current flow. At this time, a resonant voltage rise appears across C. It will be greater than the input voltage by a factor that is the effective Q of the circuit. With the lamp taken out of the circuit to improve cir-

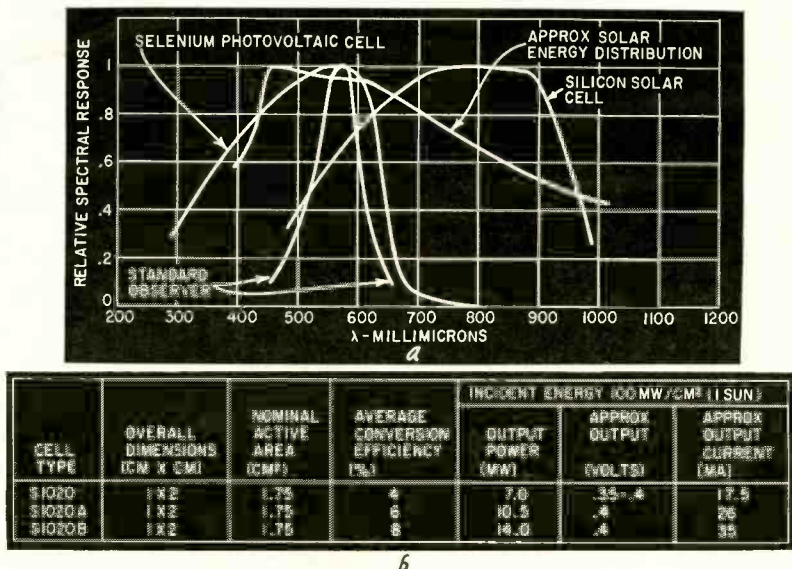

Fig. 7—Silicon solar-cell data: a—relative spectral response of silicon and selenium photocells; b—typical electrical characteristics of silicon solar cells for maximum power transfer. (Ratings are for International Rectifier Corp. units.)

ROAD TO UNIVERSE OPENED

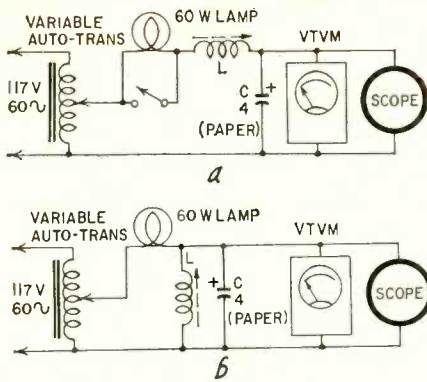

Fig. 8—Electrical resonance: a—series resonance; b—parallel resonance. Both are obtained by raising or lowering movable iron core in inductor L.

cuit Q, and an input of around 100 volts applied to the components as shown, there should be no difficulty in obtaining around 500 volts across C (indicating an effective Q of about 5). When the ordinary dynamometer type of ac voltmeter (with an impedance of 100 ohms per volt or less) is used, the loading action of the voltmeter across capacitor C will often pull the voltage down to so low a value as to hide completely the effect of the resonant voltage rise we are attempting to show. (Caution: Be sure not to exceed the scope's input voltage rating. Also, remove any residual charge on the capacitor after the power plug has been disconnected.)

The new connections of the circuit board to show parallel resonance at 60 cycles are shown in Fig. 8-b. Here, the presence of minimum line current at the resonant condition can also be demonstrated in a more effective manner than usual by taking advantage of the vtm's low-range high-sensitivity capabilities. At the same time, the oscilloscope amplifiers provide sufficient sensitivity to allow the waveforms to be displayed as the voltage drop across the lamp decreases to a minimum and then rises again on the other side of resonance.

About the references

The references listed in the first article are repeated here. An additional one has been added to aid professional workers and others who wish to pursue this investigation. Readers are invited to send comments or suggestions (addressed to the author, in care of RADIO-ELECTRONICS), particularly concerning instances in which electronics has proved its usefulness in the classroom.

Demonstration Experiments in Physics, edited by Dr. R. M. Sutton, McGraw-Hill, 1938.
 S. D. Prenskey, *Experiment Manual for Electronic Demonstration*, Radiolab Publishing, 1946.
First Annual Report of the Physical Science Study Committee (1957-58), Dr. Elbert P. Little, executive director; PSSC, 94 Massachusetts Ave., Cambridge 39, Mass.

Rider and Prenskey: *How to Use Meters*, (2nd edition), J. F. Rider Publisher; scheduled for 1958.

Radio & TV Test Instruments, Gernsback Library No. 49, 1957.

R. P. Turner, *Basic Electronic Test Instruments*, Rinehart Books, 1953.

Terman and Pettit; *Electronic Measurements*, McGraw-Hill, 1952.

John Sasuga, *Photocells and Sun Batteries*, International Rectifier Corp., 1956. END

RADAR contact with Venus, first achieved Feb. 10 and again Feb. 12, 1958, extended the range of radar to 28 million miles, more than 100 times the previous record, giving man his greatest dx. The contact gave us more accurate information on the size of the solar system, and may give us information about the surface of the planet.

The contact was made by scientists of the Massachusetts Institute of Technology Lincoln Laboratory, using equipment never before employed for radio-astronomical purposes and introducing techniques hitherto quite foreign to radio communications.

Most conventional of the apparatus was the high-power radar at Millstone Hill, Westford, Mass. (pictured in this magazine March 1958, page 58). Built for special precision work, it beamed a 265-kw signal in the 300-500-mc range from its 84-foot parabola with extreme accuracy toward Venus. Of all this power, only about a 1/4 watt reached the planet and about a billionth of that arrived at the antenna on the return trip. The signal was so fantastically weak and buried so deep in noise no ordinary means of detection could lift it out. Two special techniques were required to recover the signal.

First step was maser amplification. The maser, first developed by Professor Townes of Columbia (RADIO-ELECTRONICS, June, 1955), adds practically no noise to the signal while amplifying it. A solid-state maser (using a crystal instead of Townes' gas chamber) operating at 2° Kelvin (about -450° F) added as much to the received signal as would a fourfold increase in transmitter power, with ordinary amplification.

Even after maser amplification, the signal was so buried in noise that individual pulses could not be recognized. The scientists turned to the digital computer to "take over virtually all the functions usually performed by radio receiver circuits."

The signal, a train of radar pulses sent at the rate of 30 per second, was recorded for analysis by the computer. Certain pulses were deleted in a controlled but irregular manner to "code" the signal and make identification easier. To increase accuracy, a long sequence was transmitted—a series of



The maser is said to look "like something out of Hades—a big thermos bottle with wires coming out and liquid helium bubbling and fogging over." Here it is withdrawn from its temperature-conditioning chamber. The flat crystal in the frame at the bottom of the rod does the actual amplifying.

8,000 pulses, lasting 4 1/2 minutes, or to within 1/2 minute of the time the first return pulse was expected.

The statistical method of detection used is best explained by the Lincoln Laboratory report: "The known pulse pattern of the transmitted signal was compared to the noisy and irregular fluctuations of the received signal. At each time when a pulse is expected to be present, the received signal should be a tiny bit stronger than it would be in the absence of a pulse. No single pulse makes enough impression to be measurable individually, but the total of thousands of such tiny coincidences is added (or integrated) to give a result that can be observed and measured."

Several months were required for this work. The entire 8,000-point pattern was matched some 600 times, as one pattern was shifted step by step with respect to the other. The result was the curve shown.

The byproducts of this spectacular accomplishment will be as useful in astronomy, missiles and space travel as in radio and electronics. The distance of Venus has been determined within possibly 100 miles. Astronomical methods over the same distance would yield an uncertainty of about 50,000 miles. This greater exactitude will make it possible to plot courses for interplanetary rockets, and may stimulate the launching of one toward Venus next fall. We know also that it is possible to send and receive radio signals over interplanetary space, a necessity for space travel. We have learned something about the mysterious surface of Venus, though so far it is so combined with information on the rotation rate of the planet as to be not immediately useful. END

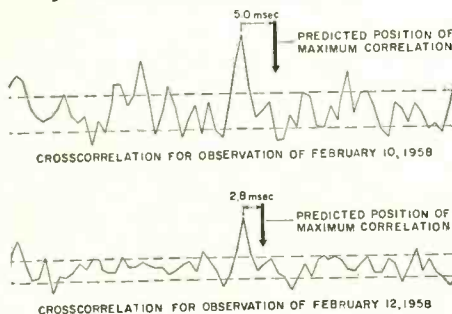

The chart that showed, with less than 1 chance in 10 million of error, that a Venus contact had been made.

WATER is the trigger

Easily built one-transistor rain alarm can be modified to act as a humidity control

By JAMES A. McROBERTS

A SINGLE inexpensive transistor operates this simple rain relay. The remaining parts are few and inexpensive. Power is supplied by a bell transformer, whose bell may be used as an alarm if desired. A slight modification converts the device into a very sensitive humidity relay. (However, the required sensing unit is comparatively expensive.) It can operate an alarm or turn on either humidifying or dehumidifying equipment in damp basements, fur storage vaults, shoe factories, etc. Such industrial applications will require a separate transformer and relay to handle motor starting power and similar control currents which may exceed the ratings of the sensitive relay's contacts.

Circuit description

Fig. 1 is the circuit of the rain alarm unit. Most connections are made to the terminal strip. About 12 volts ac from the bell transformer is supplied to terminals 2 and 3. Diode D1 rectifies this and capacitor C1 takes care of the filtering. Energizing the relay furnishes ac power to the house bell or other device, such as a low-voltage lamp or an auxiliary power relay connected between terminals 1 and 2.

The voltage-divider network R4 and R5 is chosen so about 1.1 ma passes through the relay which pulls in at 1.4 ma. When current is increased due to reduced resistance between terminals 4 and 5 on the terminal strip, the

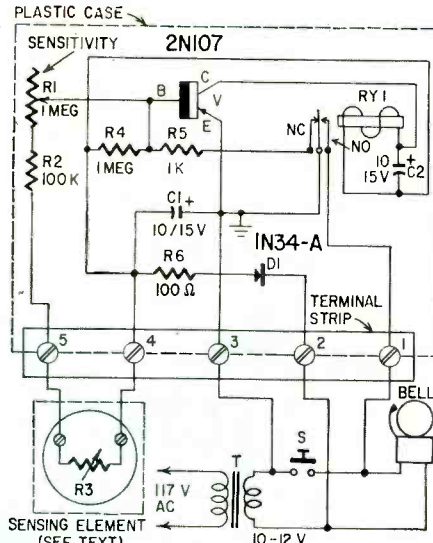

- SENSING ELEMENT (SEE TEXT)**
 R1—pot, 1 megohm, miniature (Lafayette VC-38 or equivalent)
 R2—100,000 ohms
 R3—sensing element (see text)
 R4—1 megohm
 R5—1,000 ohms
 R6—100 ohms
 All resistors 1/2-watt 10%
 C1, 2—10 μ f, 15 volts, miniature electrolytic
 D1—1N34-A
 RY1—5,000-ohm coil, pull-in at 0.25 ma (Lafayette F-260 or equivalent)
 T—bell transformer; primary, 117 volts; secondary, 10-12 volts
 V—2N107 (G-E)
 Terminal strip, 5 screw lugs
 Case, plastic, 3 1/8 x 2 1/8 x 1
 Miscellaneous hardware
 For the humidity alarm an El-Tronics humidity sensing element is required.

Fig. 1—Circuit of the rain alarm or basic unit.

relay closes. Capacitor C2 helps prevent chatter.

R3 is the sensing resistance. It is merely two 6/32 nuts and bolts mounted an inch apart on the plastic case in which the relay is shipped. The plastic case is mounted so that it will be wet by the rain. A single woodscrew holds it to any wood surface while a machine screw or stud will do for metal surfaces. When dry, the resistance between the screw terminals (R3) is nearly infinity. When thoroughly wet, R3 drops to about 10,000 ohms. The sensitivity of R3 in controlling base current is limited by the 1-megohm potentiometer (R1) with a protective 100,000-ohm series resistor (R2). (Do not omit the series resistor or misadjusting pot R1 will burn up the transistor.)

Some readers may wish to adjust the pull-in sensitivity more closely. If so, replace R4 (1 megohm) with a 500,000-ohm pot and a 470,000-ohm series resistor to prevent transistor damage. Reducing the resistance will increase relay coil current.

Humidity sensing and control are taken care of by the modification shown in Fig. 2. The sensing element is mounted above the 6/32 terminal screws by two 2/56 machine screws and nuts (see photos). Since this sensing unit must be used on ac to avoid polarization effects, the circuit differs from Fig. 1.

An additional diode D2, capacitor C3

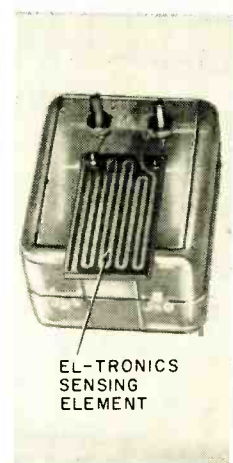
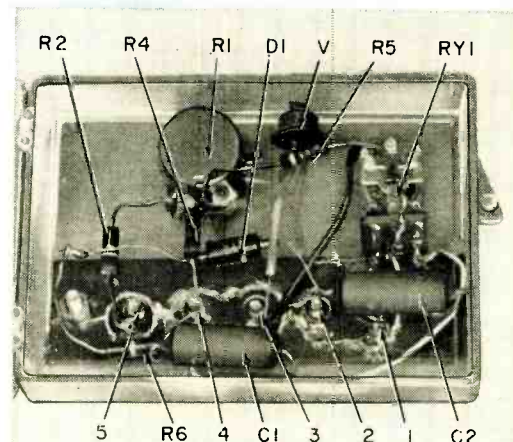
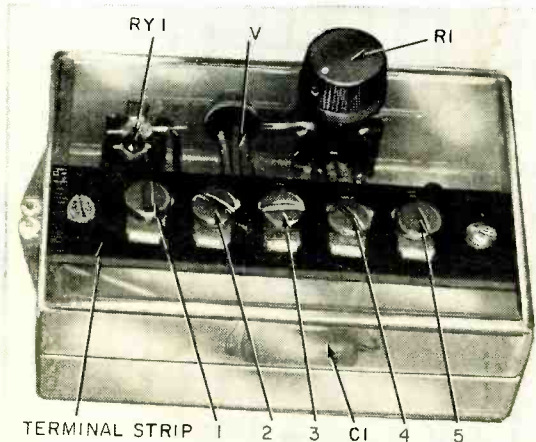

At the left, the basic rain alarm in its plastic case. As shown in the center photo, most parts of the simple unit are con-

needed to the terminal strip and at the right the humidity-sensing element connects across rain-sensor contacts.

and resistor R7 are connected as shown in Fig. 2 to the terminal strip. These components rectify ac to control the transistor's base current. Terminal 5 remains the switch leg but the sensing element's supply is taken from terminal 2 instead of terminal 4. That is, terminals 2 and 5 are the input control switch legs while 1 and 2 remain the output to a bell, light, etc.

Let's put one together

Drill holes for mounting the terminal strip, enlarging them with a file or reamer to the proper size. Drill two holes for mounting the relay but defer mounting it until all connections to it have been soldered. Capacitor C2 is mounted across the coil contacts with its positive lead left long for tacking to the transistor's collector. The transistor is mounted last, with spaghetti over its leads to prevent possible short circuits¹. Use a pair of pliers as a heat sink when soldering (tacking) the leads of the transistor. Take similar precautions while soldering diode and miniature capacitor leads.

The remainder of the work is shown in the photos. A lug under one of the terminal strip's mounting screws is handy as a tie point for the humidity relay version. The unit's plastic case may be mounted with a screw through its rear cover in some convenient location.

Final tests and adjustments

The unit may be tested by connecting a 12-volt transformer to terminals 2 and 3 of the terminal strip and a 12-volt lamp to terminals 1 and 2. A moistened finger across terminals 4 and 5 should trip the relay and light the lamp. The unit's sensitivity is set with pot R1 so a moistened finger will not fire the relay but a very wet plastic surface between the screws on the sensing element's case will trip it.

In the humidity version, blowing on the sensitive element will give the effect of about 90% relative humidity. The amount may be varied by blowing from a greater or lesser distance.

The humidity version may be checked with the proper humidity as shown by a hygrometer. With a more humid atmosphere, the relay will close. Accomplish this artificially by a long single breath on the sensor element.

The preceding hookups presume that too much dampness is not wanted. The opposite is true in places like leather goods stores and factories. Too dry an atmosphere (excessively low relative humidity) will extract the natural moisture too rapidly from leather and cause cracking. The circuit can be modified to work the opposite way, as the partial schematic of Fig. 3 illustrates.

In normal operation for this work, the relay is energized with the moving contact against the NO contact which will drop out with too low a humidity.

¹The transistor's base is internally connected to its shell. Shell must not touch other exposed wiring and contacts.

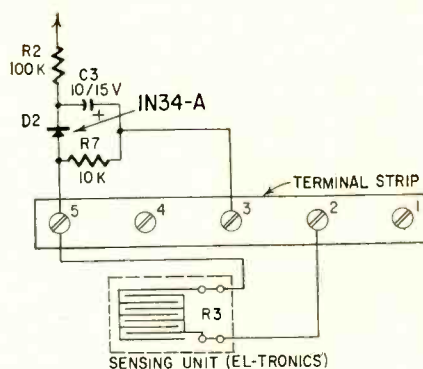

Fig. 2—Modified circuit used for humidity sensing.

As shown, the wire from lug 1 of the terminal strip is rerouted to the NC contact of the relay. It will now turn on a humidifier. Fig. 3 shows an external power relay connected to control large currents that may be needed in such an application.

Resistor R5 is disconnected from the normally closed (NC) relay contact and grounded directly (to B plus). This eliminates the hold action of this resistor, which is not wanted for this application.

Resistor R4 is broken into two parts. One is a 470,000-ohm fixed resistor (R4-a), while the other part is series pot R4-b used to adjust base current. Independent adjustment of base current is desirable in this application.

In operation, the desired humidity is obtained as measured by a hygrometer or other humidity-measuring instrument. The device is hooked up and the new pot (R4-b) is adjusted so the relay pulls in at the desired level. Use a pilot lamp across terminals 1 and 2 to check this action. Allow about 15 minutes to elapse. (The sensing element will reach stability in this time interval.) Then rotate pot R1 until the relay drops out. Reset R4-b to pull in again. Cut out a little of R1's resistance. About a tenth turn backward of R1 is normal for most cases.

A-Bomb Proves Earth's Magnetic Field

LAST fall's Navy-conducted atom bomb tests over the Johnston Islands, and Project Argus showed nuclear detonations at high altitudes produce tremendous flashes of radiation affecting radio frequencies globally. The low-yield atom blasts (kilotons; warheads are usually megatons) were set off 50 to 300 miles up, where there is near-perfect vacuum.

Auroral displays and magnetic storms were created artificially for the first recorded time. One aurora was observed 2,000 miles from the blast which caused it. Much was learned about characteristics of electronic emissions in space, and behavior and intensity of radiation bands which normally surround the earth. These bands are a present obstacle to manned space flight.

No provision for shutting off the alarm has been made. A switch in the power supply lead (either one) will do this. In special applications, the switch may have to cut off the bell or controlled device too. For rain alarm duty, a switch in the lead to the sensor (R3) may be all that is needed.

The sensitive relay's contacts should not break more than about 0.5 ampere intermittently. Less current is permitted for continuous duty. Use a power relay with a 6-volt coil connected across terminals 1 and 2 for heavier loads. The power relay's coil should not take more than 0.25 ampere.

The sensitive relay can be adjusted

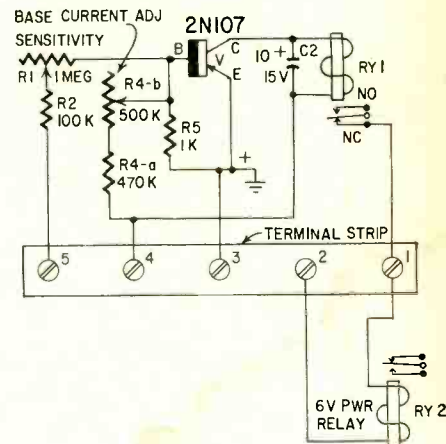

Fig. 3—This circuit reacts to too little humidity.

for a longer hold-in time if required. Simply bend the NO contact to provide a greater spacing. Do not overbend so that the relay fails to release. Ordinarily the spring tension will never require adjustment unless the relay does not pull in with about 7 volts across its coil. If this should happen, bend the clip on the relay body holding the spring until pull-in occurs at 7 volts dc. In checking, be sure the spring seats in its slots on both the armature and the spring clip—the little grooves pointing to the rear. END

Authorities term the tests, involving thousands of men, one of the most important scientific experiments yet conducted. They verified the theory that magnetic lines of force extend from the earth into space, especially at the poles. Data were collected from ion-chamber readings of satellite Explorer IV, which "mapped" the lines of force when going through the bands of electrons activated by the radiation flashes and trapped in magnetic force fields.

It was found that some frequencies, especially around 20 mc, were severely disrupted and even blanked out for hours. Some frequencies everywhere were adversely affected. The project also provided data affecting development of the ballistic missile warning system (BMEWS).

what's

new

?



ENDLESS TAPE-CARTRIDGE player plugs into any stereo disc set, plays up to 2½ hours and continues to play until cartridge is removed from player. Mobius loop (made by giving one tape end a half-turn before connecting the ends) allows both sides of tape to be coated and recorded. Player includes dual transistor pre-amps, feeds any two-channel system. Cartridges available in three sizes, from 5 x 4 up to 8¾ x 7½ inches. Made by Stereophonic Automation Corp., Skokie, Ill.

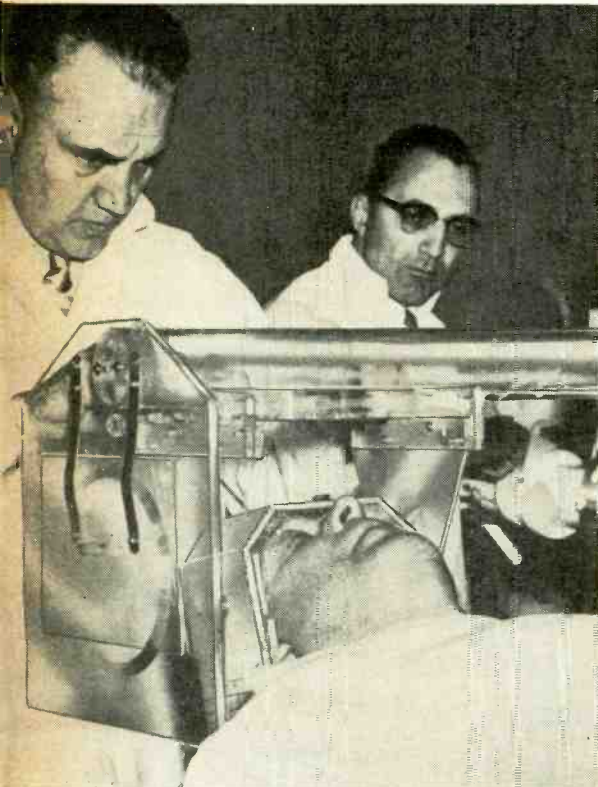

UPI Photo

ATOMIC KNIFE (RADIO-ELECTRONICS March, 1959; page 12) is seen in operation here. Two nerve tracts in the brain of the patient are being severed without an incision, by a powerful beam of protons from a synchrocyclotron. To prevent damage to other parts of the brain, beam direction was shifted 20 times, each projection being only 1/20 of the strength required to do the job. Thus, the full beam was received only at the focal point, where the beams crossed. Prof. Lars Leskell (left) is shown making adjustments. He is assisted by a man identified only as "Professor Einstein of the United States." The actual operation was directed from a distance by television, to reduce radiation hazards to operating personnel.

NEUTRONIC SCALE that can weigh anything from a pocket watch to a freight train is demonstrated here in a working model of the New York Central's nuclear scale. The model will be shown at the US Atomic Energy Commission's nuclear energy exhibit at Tokyo. Gamma rays are emitted from a radioactive source under the track, pass through the car to a scanning bridge directly above. Each car absorbs a certain amount of the rays, according to the density of its contents, and the results—expressed in tons—are shown on the large indicator to which Richard Shackson, New York Central research engineer, is pointing.



UPI Photo

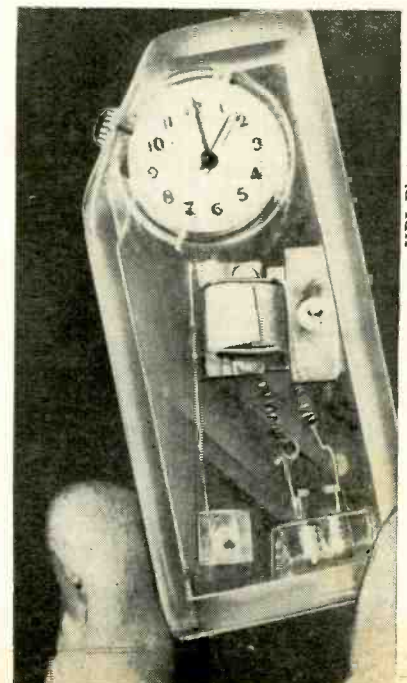

UPI Photo

HEART-BEAT counter, constructed in their spare time by a group of Illinois Bell telephone engineers, supplies valuable diagnostic information to physicians. The device can be worn during ordinary daily activities. Miniature batteries and transistors are used in the pickup device, and the indicator is a discarded wristwatch which advances 1 minute for every 300 heartbeats. Its driving motor is a small relay type device. The engineers are members of an organization called SAVE (Service Activities of Voluntary Engineers) which works with University of Chicago medical researchers.



new DISCS and TAPES

**Reviewed by
Chester Santon
Station WQXR
New York City**

STEREO and MONO

ALTHOUGH stereo discs continue to show improvement, I still include a few mono discs every time I audition a fresh batch of stereo records. It is surprisingly easy to drift away from the top standards of disc reproduction achieved in recent years if listening is confined to stereo.

The inherent fullness and depth of stereo frequently creates the illusion of sweetness throughout the entire range that the finest mono reproduction has today. Yet stereo's distortion average on disc is still higher than mono's average in releases of the past year. If the current rate of progress continues, stereo discs may some day include mono's present distortion figures in their already formidable arsenal.

TCHAIKOVSKY: 1812 Overture
Capriccio Italian
Antal Dorati conducting Minneapolis Symphony Orchestra and University of Minnesota Brass Band

Mercury Stereo Record SR-90054
Here we go again! Mercury's monophonic encounter with the *1812 Overture* is already a legend. The cannon and bells of this second recording will dazzle the newcomer to stereo just as they bowled over the beginner in mono days. The orchestra is picked up at close range at a level that was set for the audio fireworks at the finale. At that distance, the percussion enjoys a solid prominence. The cannon at West Point and the bells of New York's Riverside Church sound at their best when heard individually in the course of the illustrated explanation dealing with the techniques used in making the record.

Love in the Afternoon
The Three Suns

RCA Victor Stereo Tape APS-210 (7-inch; playing time, 15 m:n. \$4.95)
There is plenty of assurance in this reel that RCA can turn out a very good tape these days when it wishes to do so. No wild experiments here with recording level and response curves. The curve used here is really flat all the way out to 12,000 cycles or so. Far too many tapes on the market today peak in the neighborhood of 7 or 8,000 cycles. This fact can be demonstrated with a sharp-cutoff filter. The sound of a tape that comes to a peak at 7,000 will not be altered by cutoff at 10,000 cycles. This new tape by the Three Suns lost some of its smooth highs when filtered at 10,000, indicating the presence of range above that figure. A cello, two violins, a bass guitar and a mandolin have been added to the trio's organ, guitar and accordion. The unusual instrumentation and carefully spaced stereo add up to a very enjoyable quarter hour of entertainment.

España
Ataulfo Argenta conducting London Symphony Orchestra

London FFSS Stereo Record CS-6006
The usual rule of thumb pertaining to catalog number does not apply to this early entry in the London stereo roster. Although one of the first half-dozen releases in their 6000 series, the quality of the sound is on a par with higher-numbered discs. Stereo records still require evaluation on an individual basis. London's *España*, a good mono item, preserves virtually all the original brilliance in the stereo version.

Rimsky-Korsakov's *Capriccio Espanol* and Chabrier's *España Rhapsody* thrive under this treatment.

BEETHOVEN: Piano Concerto No. 4 in G Major
Friedrich Wuehrer, piano
Jonel Perlea conducting Bamberg Symphony Orchestra

Stereo VOX STPL 510.640
The first notes of the orchestra establish the fact that this is a most unusual record. The sound is open and wide-awake. Frequency response comparable to mono discs reveals the liveness of German concert halls. Signal level is up to monophonic standards. Wuehrer's clearly articulated pianism projects into the listening area with gratifying conviction. The secret of the record's impact may lie in the close grouping of the instrumental choirs as well as the proximity of the soloist. They've solved a raft of old problems in this record.

Stereo Stew
Sounds of American Life
Riverside Stereo Record RLP-1117

The best ingredient here is the sound of the whistle on the liner Queen Mary. A blast of this whistle can vibrate a huge ship. If you're launching a stereo system, test the good pickups on the market with this sound. A cartridge with poor compliance won't track these low-frequency excursions with the ease exhibited by the best pickups. Other items on this disc devoted to typical American sounds in stereo include a highly realistic recording of a farm tractor and a Coney Island carousel. The thunderstorm, however, will disappoint those who have heard the best mono recordings.

Music of Guillaume Dufay
Paul Boepple conducting Dessoff Choirs
Vanguard Stereo Disc BGS-5008

Anyone still doubting the value of stereo reproduction would do well to audition these vocal works of the fifteenth century on up-to-date equipment. Oboe, viola, bassoon and cello supplement the vocal line of these vibrant hymns and songs which reflect the period of history when the province of Burgundy, Dufay's birth-



place, included Belgium and the Netherlands. This ranks with the best choral records I've encountered so far in stereo.

Walt Disney's Sleeping Beauty
Original Motion Picture Sound Track
Disneyland Stereo Disc 4018

The orchestral background for this film was miked at the UFA movie studios in Berlin. In all probability, the master recording, 35-mm magnetic film, encompassed the claimed frequency range of 40 to 15,000 cycles. The voices were recorded in Hollywood. This stereo disc shows evidence of severe equalization. The mid-range is emphasized. Orchestral sound is somewhat flatter than that of the voices, and whets the appetite for the day when lush stereo such as this will follow the RIAA curve. The arrangements of excerpts from the familiar ballet score are more treacle than Tchaikovsky.

Concert-Disc Stereo Demo **CSD-2**

The sound of the bouncing ping-pong ball heard in alternate channels at the beginning of this sampler is recorded at the same level for channel balancing. Because the wavefronts are uniform and cleanly recorded, stereophiles still struggling with dissimilar channels may find this test useful for comparing the transient response of present tweeters, amplifiers, etc. At least half the excerpts representing their catalog place Concert-Disc on a firm competitive footing.

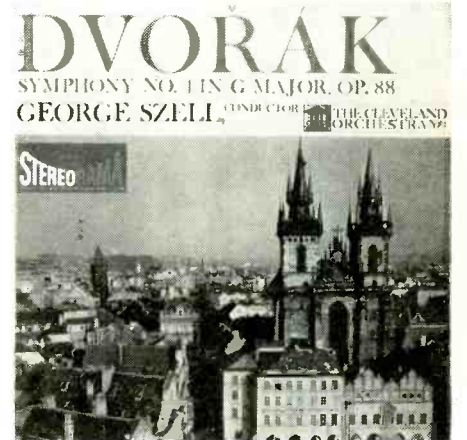

DVORAK: Symphony No. 4 in G Minor
George Szell conducting Cleveland Orchestra
Epic Stereo Record BC-1015

You'll be tempted to consider this the most luxuriant-sounding record ever produced in stereo. Following its acoustical rebuilding last summer, Severance Hall now gives the sound of the Cleveland Orchestra an extra second of reverberation. The difference is especially noticeable in stereo. Some of the more remote and softer details in the orchestral panorama are held aloft for enjoyment on a good system. Dvorak's *Fourth*, his most beguiling symphony, is now a landmark in the evolution of the stereo disc.

Deeds, Not Words
Max Roach New Quintet
Riverside Stereo Record RLP-1122

Start this one with the first band of side 2. Top-flight jazz drummer Max Roach saturates with sound an area about 5 feet wide and several feet in depth. Full-throated stereo lets you hear how busy a good drummer really is during a solo that covers all the resources of his percussion battery. Only the best stereo systems will meet the challenge of this far-ranging drum solo. In the rest of the record, the quintet harbors a tuba that's not afraid of jazz.

BRAHMS: Double Concerto
David Oistrakh, violin and Pierre Fournier, cello
Alceo Galliera conducting Philharmonia Orchestra
Angel Stereo Record S-35353

Angel, in mono, has one of the better up-to-date versions of this noble work. Although sealed at the factory, the stereo pressing that arrived for review had a surface so noisy in spots that normal evaluation was precluded.

Shelley Manne and His Men Play "Peter Gunn"
Stereo Records S-7025

Hank Mancini's music from the popular "Peter Gunn" television series is now available in stereo.
(Continued on page 72)



Why do so
many people buy
HEATHKITS?

*every year more people
buy Heathkits than any other
Electronic Instruments
in kit form!*

Here are a few reasons why...

EASY TO BUILD

Heathkits are engineered for easy kit construction. You need no electronic or kit building experience whatsoever to successfully complete your own kit. Use of printed circuit boards and pre-wired, pre-aligned assemblies cut construction time. Manuals are carefully prepared, employing step-by-step instructions written in simple, non-technical language. Large pictorial diagrams and photographs show you exactly where each part goes.

LASTING QUALITY

Only top quality components go into Heathkits, assuring you of a finished product that is unsurpassed in performance, dependability and endurance. Rigid quality control standards are maintained at the Heath factory to see that each component lives up to its advertised specifications. Heathkits are conservatively rated. No performance claims are made that are not thoroughly proven and tested under the most stringent laboratory conditions.

ADVANCED ENGINEERING

Progress in electronics engineering never stands still at Heath. The latest developments in circuit design and components are exploited by Heath engineers, offering you superior performance at lower costs. New advances in all fields of electronics are carefully watched by Heath engineers to keep abreast of the rapidly growing industry. The modern, up-to-date styling of Heathkits make them a handsome addition to your home or workshop.

WORLD-WIDE REPUTATION

A pioneer in do-it-yourself electronics, Heath Company, over more than a decade, has established public confidence in its products both in the United States and abroad. Today, as the world's largest manufacturer of electronic kits, Heath stands as the leader in its field.

GREATER SAVINGS

Do-it-yourself Heathkits save you up to 1/2 the cost of equivalent ready-made equipment. Direct factory-to-you selling, eliminating middle-man profit, plus the tremendous Heath purchasing power mean even further savings to you. And the convenient Heath Time Payment Plan allows you to use and enjoy your Heathkit NOW, while you pay for it in easy installments.



HEATH COMPANY
Benton Harbor 20, Michigan

 a subsidiary of Daystrom, Inc.

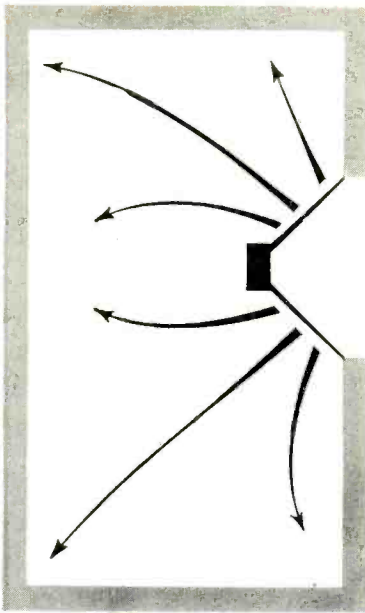

Fig. III-1—If the speaker cone in a box baffle moves inward, compression spreads within the cabinet. The compression also reacts on the cone. The effect is equivalent to increasing the stiffness of the coil-cone supports.

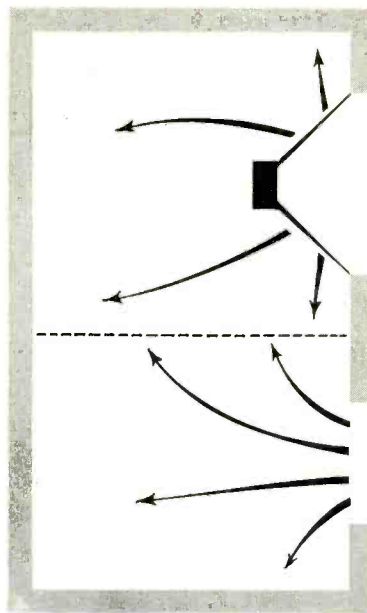

Fig. III-2—At the frequency of the upper peak in the impedance curve, the port and the cone share the enclosure's volume.

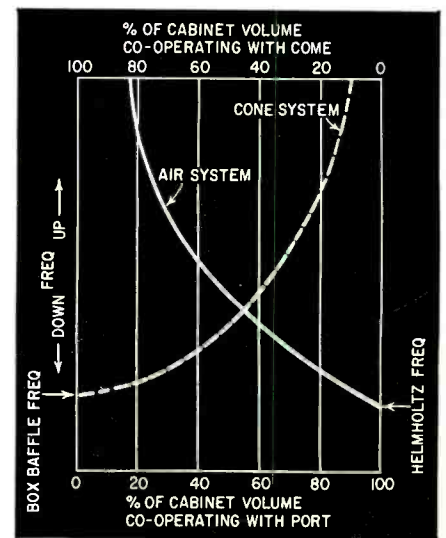

Fig. III-3—Relationship between Helmholtz resonance of the air system and cone resonance, both referred to percent of cabinet volume cooperating with each. The point where the two curves cross indicates the frequency of parallel operation.

increased more and more, these peaks spread farther and farther apart.

Resonant peaks in the reflex

With reflex cabinets, what happens is very similar, though for the single-peak case impracticably large cabinets are usually needed. Therefore, this is rarely encountered. The two peaks in the impedance curve are usually clearly defined, and the smaller the cabinet (the closer the coupling between cone and air cushion) the greater the spacing between the peaks. With cabinets small enough, a spread of as much as two octaves is not unknown!

To say that things have similarities is no substitute for explaining the reasons for their behavior, especially when the comparison is between reflex cabinets and bandpass circuits. To understand and make proper use of the peak-spreading characteristic of reflex cabinets, we will discuss the mechanics concerned in more detail than was done in Part I of this series.

The free-air resonance of a speaker occurs at the frequency at which the mass of the moving parts resonates with the mechanical stiffness of the coil-cone supports.

If the speaker is mounted in a properly closed box baffle, we have the situation shown in Fig. III-1. The arrows show how the air pressure spreads through the cabinet when the air is compressed. The compression reacts with the back of the cone, effectively adding to the stiffness of the coil-cone supports, shifting the resonant frequency above the free-air figure.

Other things being equal, the resonant frequency increases as the square root of the total effective stiffness. For example, if the air-cushion volume hap-

pens to be such that the air stiffness is equal to the coil-cone support stiffness, the resonance frequency goes up half an octave. If the free-air frequency and that in a box baffle of known volume are measured, the mechanical stiffness of the coil-cone supports can be worked out in terms of so many cubic feet of air cushion. From this, the effect of other volumes used with that speaker can be calculated.

The smaller the volume of the air cushion, the stiffer it is. Consequently, the smaller the internal volume of the box baffle, the further up the scale the added stiffness drives the resonant frequency. So long as we deal with box baffles, we have only one main peak, and that is moved up the scale by the added stiffness. A box baffle cannot do anything to move the peak down the scale.

Sharing the air cushion

Suppose a port is cut into the box, converting it into a reflex cabinet. If the cone oscillates now, the resulting air-cushion pressure variations set up an oscillatory air flow at the port. At the frequency of the so-called "parallel" condition at which the upper peak in the impedance curve occurs, the port flow is in phase with the cone motion. The general conditions then are shown in Fig. III-2. The port and cone "share" the volume of the air enclosed within the cabinet.

There are two groups of arrows in Fig. III-2. One is associated with the cone and the other with the port. The dotted line represents an imaginary air boundary between the two "spheres of influence." At the frequency of the upper peak in the impedance curve, there is very little air motion across that boundary but, for such a boundary

to exist, the pressures on both sides must remain in balance, and that demands that they are equal—oscillate in phase at the same frequency.

The air cushion, in effect, behaves as though divided into two parts by that boundary. To the extent that one portion is concerned with flow at the port, the remaining portion, which is concerned with the cone, occupies only part of the volume of the cabinet. Therefore the effective air stiffness is greater than under box-baffle conditions and the parallel resonance is inevitably above the frequency of the box-baffle peak.

Since the port is not operating with all of the air in the cabinet either, the resonance of the air system comprising the port and its portion of the air volume is also higher than the basic Helmholtz resonance.

In Fig. III-3, the solid line shows how the air system resonance would change if the proportion of volume cooperating with the port could be varied. Any change in that proportion automatically affects the remaining volume which cooperates with the cone. The dashed line shows what would happen to the cone resonance. This would go up as the other resonance goes down, and vice versa. Only at the one point where the two lines cross, do the resonant frequencies of the two systems coincide. Only at such a common frequency can the boundary form and the parallel condition be established properly.

Thus nature has her own way of determining the frequency of the upper reflex peak in a specific case. The greater the volume available, the lower the frequency of that peak, but it always falls above the box-baffle frequency for that volume. The requirement that at the upper peak both portions of the air volume must reso-

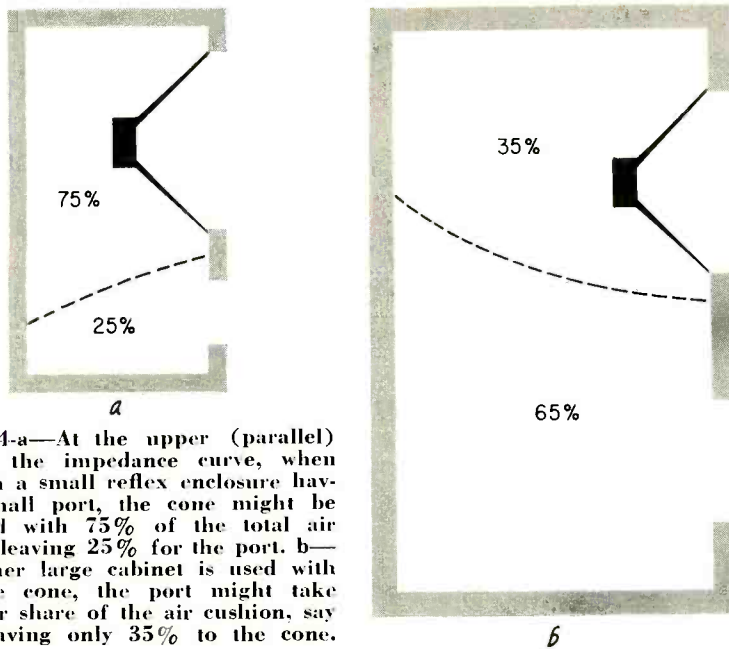

Fig. III-4-a—At the upper (parallel) peak in the impedance curve, when used with a small reflex enclosure having a small port, the cone might be associated with 75% of the total air cushion, leaving 25% for the port. b—If a rather large cabinet is used with the same cone, the port might take the larger share of the air cushion, say 65%, leaving only 35% to the cone.

nate at the same frequency automatically determines the amount of the additional upward displacement at that peak.

By measuring the resonant frequencies of (a) the speaker in free air; (b) the speaker mounted in the cabinet operated as box baffle, and (c) when that cabinet is used reflex, it is possible to calculate in what proportion the air volume is divided between cone and port under practical working conditions.

With a given cone, the proportion varies according to the volume of the cabinet (Fig. III-4). For small cabinets, the coupling to the cone is close. Therefore, the cone is concerned with the major fraction of the air volume.

For large enclosures

On the other hand, with a large cabinet the port is larger and it affects a larger percentage of the total volume. Therefore, the cone's percentage is less. There is very much more to share, however, and so, while the cone is not getting as large a percentage of the total, its share still amounts to a greater volume than before—hence the softer cushion and the lower coupling of the larger cabinets.

The cone's resonance is raised only slightly by the weak action of the loosely coupled air cushion of a large cabinet. Also, because of that loose coupling, the effect of the speaker on the port air system's resonance frequency is slight, and raises it only a little above the natural Helmholtz frequency. Air interaction across the boundary insures that full parallel working occurs only at the frequency where the resonance frequencies of the cone and air systems coincide. And that occurs only a little above the natural frequency of either when a large cabinet is used.

With a small cabinet used as box baffle, the close coupling between cone and air cushion adds very greatly to the effective cone-support stiffness, and

drives the resonance frequency substantially up the scale. When converting to reflex, the port, by taking up part (even if only a small part) of the already small air volume, reduces that available to the cone even more and drives the cone-system resonance up still farther.

The air-system resonance frequency also is considerably above the basic Helmholtz resonance frequency, for the

port air inertia of a small reflex enclosure acts in conjunction with only a small percentage of the total volume. As before, parallel working occurs only at the frequency at which the resonance frequencies of both cone and port air systems coincide. And with small cabinets it is much higher up the scale than with large ones.

There is an inescapable relationship between the cabinet's size and the upward displacement of the upper peak from the free-air and box-baffle positions. The smaller the cabinet, the greater the upward displacement.

So far, we have not found an answer to the question of cabinet size, but we have secured useful information. First, it is theoretically possible to have enclosures that are too big to counteract speaker deficiencies effectively. Secondly, if it is desirable to have the upper peak below a certain frequency, cabinet size must be chosen so the total volume is adequate both for the volume of the portion of the air cushion working with the cone at the peak frequency and for the portion cooperating with the port. Tests with the cabinet used as a box baffle determine the peak position when the whole air cushion operates with the cone. The upper peak when that cabinet is converted to reflex will always be higher up the scale. If it makes the frequency too high, a larger cabinet should be used or the basic speaker altered or replaced by one that has a lower natural resonance frequency. TO BE CONTINUED

3-TUBE HI-FI AMPLIFIER

AN uncomplicated circuit for a 15-watt hi-fi amplifier that you can drive directly with a crystal or ceramic cartridge appears in the RCA specification sheet for their type 7199 tube. In

a full 15 watts at the amplifier's output, with less than 0.5% distortion. Negative feedback (18 db) from the voice-coil winding of the output transformer to the cathode of the voltage

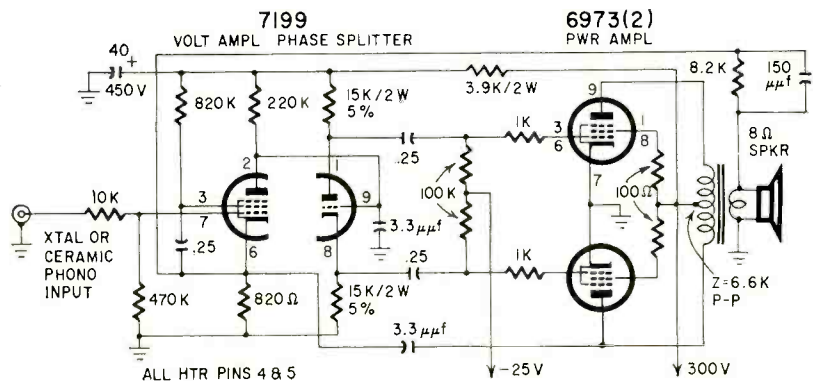

this amplifier, the 7199, a pentode-triode, is used as the voltage amplifier (pentode section) and the phase splitter (triode section). The output stage consists of a pair of push-pull 6973's. All tubes are miniature types.

It takes only 1.2 volts input to get

amplifier makes this possible. Hum and noise are 84 db below 15 watts with the amplifier's input shorted.

The minimum input-signal level required is 100 mv. To use magnetic cartridges add a low-level preamp stage. END



GOLDEN EARS or BATS' EARS?

By GEORGE FLETCHER COOPER

LOOKING through a magazine the other day, I came across an article by what I like to call one of the wide boys. There are, said the author, excellent reasons for making audio amplifiers with flat responses from 10–100,000 cycles. The fine performance of many modern amplifiers is possible because of this extreme bandwidth. Well, there's a queer thing for a man to be saying, thought I. Why would he be writing the likes of that?

I don't believe a word of it.

The only reason why amplifier B is claimed to be flat from 5–150,000 cycles is because amplifier A is claimed to be flat from 10–100,000 cycles.

It is now about 20 years since I first got mixed up with this business which is now called hi-fi. In those days the pace was set by the broadcasters in countries where broadcasting is run by the Government. There are several explanations of this: the engineers were not spending their own money, they were there for life; or maybe the listeners were responsible—there's nothing like paying a tax to make you shout if you don't get what you want. I leave you to choose the answer you like, but the specifications some broadcasters wrote made commercial audio look like the old string telephone.

The last 10 years have seen home equipment catching up with, and passing, the equipment at the source (recording and broadcasting studios). To my mind, the chase after performance figures has gone so far that we are now wasting a great deal of time hunting performance for its own sake. (This view will, I am sure, attract a lot of surplus indignation. Readers who feel strongly about it are at liberty to soak the whole magazine in gasoline and burn it under their television set.)

The purpose of this article is not merely to sling a small piece of mud at someone else; it is to justify the

use of a restricted bandwidth and to explain the special conditions needed to allow it to be used. Let us start out by seeing what we listen to with our hi-fi machinery. The *IT&T Reference Data for Radio Engineers*, third edition, page 526, (fourth edition, page 871); Ghirardi's *Radio Physics Course*, page 16, and other texts show that, if you forget a few keys way down on the left-hand end of the piano, 40 cycles is about the limit for strings and wind instruments. I suppose that there is really no limit to what an organ builder might do. But there is some very interesting work by Helmholtz, showing that if you leave in all the overtones you think you hear the fundamental. I would also point out the equal-loudness contours (*Reference Data for Radio Engineers*, IT&T, third edition, page 532; fourth edition, page 878) which show that, unless the very low frequencies are at pretty high intensity, you don't notice them anyway.

Around 15,000 cycles, too, the ear starts to go on strike. Quite a lot lower, the books say, it loses the idea of pitch. I don't know how true this is, because I've just bought a dog whistle (the physics books call it a Galton whistle) and I can hear the effect of tuning it even though it is up near the limit of my aging ears. Another important factor often overlooked is that the ear acts as a demodulator at frequencies well above the audible. As you know, some multiplex stations put out a 32-kc subcarrier with modulation on it and my guess is that, if you pumped this out loud enough, you would start to hear the modulation—if you didn't go to bed with a splitting head first.

Why exceed 15,000 cycles?

There are probably other reasons why sounds above 15,000 cycles don't matter—things like the way in which they will not go round corners so you must keep your head still to avoid enormous changes in apparent level. I don't

think they matter overmuch, because most practical microphones don't cover these fantastic bandwidths.

According to some people we need 10–100,000-cycle flat-response amplifiers. Here's the viewpoint of a 30–12,000-cycle man

The microphone designer is fighting a constant battle against the conflicting ideas of sensitivity and bandwidth. All microphones depend on moving something in a field of some sort. It may be the movement of a diaphragm carrying a coil in a magnetic field; it may be a combined diaphragm and single-turn coil, the ribbon, or it may be a conducting diaphragm in an electrostatic field. But the air vibrations must shift some sort of mass in a strong linear field. The lower the frequency the bigger the shift, as we know from our loudspeakers.

The microphone designer has another problem, too. Look in your local station's studio or even watch television closely, and you will see that the microphones spend a lot of time being swung through the air on the end of long fishing rods. To the microphones it makes no difference whether the air moves past the ribbon or the ribbon past the air—as soon as there is relative movement it looks like part of a low-frequency sound. Obviously there is no room for the ribbon to bow out an inch or two, even at 1 cycle and, if it did, the intermodulation caused by field nonlinearity would be colossal. The microphone designer puts in wind shields to make sure that the mike does not pick up the very low frequencies.

At the high-frequency end we run slap up against the polar diagram of the microphone. At 13,000 cycles the wavelength in air is just 1 inch. A small microphone diaphragm is starting to have quite a tricky polar diagram. You may feel that, if you are prepared to use two loudspeakers, you can't see why the program originator shouldn't use several microphones. But there is already so much discussion about microphone techniques for orchestral work that twin-channeling

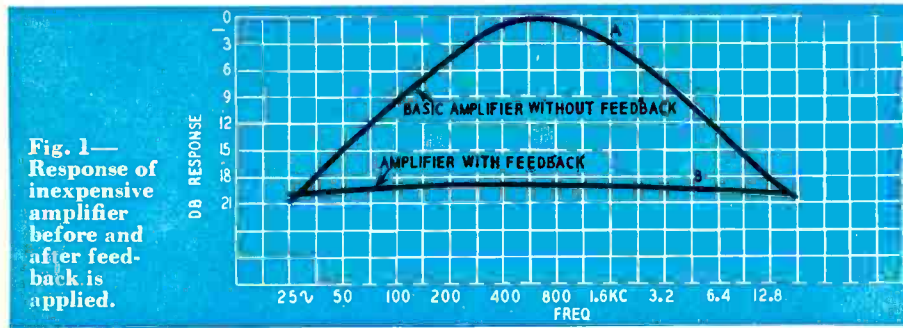

Fig. 1—Response of inexpensive amplifier before and after feedback is applied.

doesn't seem to stand even a chance.

That is part one of the "Watch That Bandwidth" campaign. Now let's look at the loudspeaker for a moment. We connect our bat's ear amplifier to the record player. We have talked ourselves, I hope, into the belief that the disc or tape hasn't had any of these very low frequencies put on to it. If it had, my guess is they'd overload it to an intolerable extent, but, of course, there is the pre-equalization curve. Our old friends Rumble, Mumble and Wow must not be forgotten. Any motor noises in the 1-20-cycle range will swing that loudspeaker cone over a very wide range. The next chance you get, take a look at one of the drive units used to make vibration tests on equipment for aircraft. Whether it's out on the swing or in on the swang, the coil will be well away from the linear field. You will hear only the distortion, though, because you can't hear 10 cycles until it knocks down the cups in the kitchen.

Here comes feedback

That is part two of the "Watch That Bandwidth" campaign. The next step is to see why this wider-than-wide attitude has grown up. Once upon a time there were three small boys called Nyquist, Bode and Black. Even before that, there was Routh, and even earlier James Watt. It was, I suppose, Watt who started it all by tying that lid on the kettle, because his steam engine had a governor and governors are just feedback paths. Anyway, by the time all these small boys had grown up and started writing technical papers, there we were with negative feedback on our hands.

Negative feedback was going to be the answer to all our problems. Twenty years ago, when you built a studio amplifier you built it flat. You used enough iron in the transformers (you used the best iron, too) and you were not mean with the interstage capacitances. Maybe the distortion went up to 1% at full output, but it went up fairly smoothly and frequency responses were pretty good. But with the use of feedback round several stages, including the output transformer, some odd things began to happen.

Suppose you build an amplifier with a nice cheap output transformer which is 15 db down at 50 cycles and at 9,000 cycles. Suppose also that to save any

worry you use nice big coupling capacitors and a low-capacitance structure for the output transformer. You may finish up with a frequency response (curve A) like the one shown in Fig. 1. You will not sell many of these, but it is a very easy matter to put on 18 db of feedback. If you do this, you will get a fairly flat-looking response (curve B). This I have calculated by the methods described in a good little book called *High-Fidelity Circuit Design* (Gernsback Library No. 56). This new frequency response doesn't look too bad, at least by the standards of the old response. Feedback, you might say to yourself, is wonderful.

Take a closer look, however, and things are not so good. At 35 cycles the response is 18 db down (curve A) due to using a cheap output transformer. The output stage is presumably given the optimum load at the center of the band, so that at 35 cycles it has only one-eighth of the optimum load, and what the tubes see is almost pure reactance. To get any power into the load itself the tubes have to deliver 8 times the current swing you'd expect. Distortion will be terrible. Even at 200 cycles the shunt reactance of the transformer is demanding current, current which must be supplied by the tubes in addition to the useful output.

Yes, you may say, but we can tolerate a bit of extra distortion because the feedback will cut it down. At 100 cycles we have 10 db of feedback, so that we can divide the third harmonic of 30 cycles by 3. First of all, in this particular example, it would not just be a question of a small amount of extra distortion. We have already seen that, if we are to do any good by reproducing low frequencies, we must reproduce them at a fairly high level. Otherwise we shall not hear them, and we might as well filter them out and use a cheaper speaker. It follows, then, that distortion will be high. But, as soon as we come to high-distortion situations, we meet a rather odd effect with negative feedback—it doesn't seem to work according to the book.

This is an interesting effect which I should like to discuss in detail in another article. The object of discussing it in full is to be sure that the approximations I am about to make are fair, but here, I'm afraid, you must just take my word for it. Suppose we drive one tube in an amplifier right down to cut-

off with a pure sine-wave signal. At the tip of the sine wave, the tube is cut off and obviously cannot be doing any amplifying. The tube is also producing some distortion and, with the simplifying assumptions we are making, this distortion is all produced during the cutoff time. This is very close indeed to the truth in an amplifier which has a lot of local, stage-by-stage feedback. The distortion is fed back round the loop and starts off through the amplifier in just the right phase to do some cancelling but, when it comes to the tube which is cut off, it cannot get through. And there you are with your distortion nearly cancelled at the tube's grid, but still present at the tube's plate. Another way of looking at it is to say that although the distortion is reduced by a factor of $(1 + A\beta)$, at the critical moment A is zero and the distortion just is not reduced at all.

The simple proof that this discussion is correct can be found by testing any amplifier with and without feedback. Without feedback distortion rises pretty smoothly as the output is increased. With feedback distortion is at first very much less, rises very slowly and then shoots up to join the no-feedback curve when the amplifier is overloaded.

Intermodulation products

We can apply the reasoning to intermodulation, with some rather interesting results. Suppose the typical cheap amplifier of Fig. 1 has a 35-cycle input and a smaller 1,000-cycle input. Intermodulation produces two extra frequencies, 965 and 1,035 cycles. These make the 1,000-cycle note, originating, let us say, in an ocarina, sound very harsh or muddy. But, you say happily, there is lots of feedback around 1,000 cycles so it will not matter. This is a very plausible argument which requires very careful watching. At low levels of distortion or intermodulation I must confess I find it convincing and, until I've done some mathematics, I shall not be sure it is wrong. But going back to our overloaded tube treatment, we see that during the cutoff moment the 1,000-cycle tone is also cut off. To the ear it sounds as though an extra signal consisting of short bursts of 1,000 cycles, in anti-phase with the existing steady 1,000 cycles, had been added. And these are added just at the moment when the signal fed back to clean things up can't get through.

"There's glory for you!" said Humpty-Dumpty. "There's a nice knock-down argument for you!"

"The question is," said Alice, "whether you can make words mean so many different things."

My own guess is that if we work the whole thing out in detail we shall find that there is some truth in both arguments, but that for practical purposes we can regard the second one as being nearer the truth, though on the pessimistic side. All the reasoning applies just as well if we consider the distortion to originate in the output trans-

former, where the high audio currents we are demanding produce a collapse of the inductance in current peaks. Here, indeed, we can see that we virtually short-circuit the output and, at the same time, short-circuit the pickoff for our negative feedback. No wonder it does no good.

Roughly similar reasoning applies if we consider what happens when we apply two high-frequency tones, say 9,000 and 10,000 cycles. If the droop is due to leakage inductance, the impedance rises and we can't get the volts. If it is due to capacitance, the impedance falls and we can't get the current. Either way we are liable to get a very easily heard 1,000-cycle intermodulation tone. Harmonics as such do not really matter, because they can't be heard, but these low intermodulation tones may be more audible than the original tone. So we can't put up with them.

This all boils down to: if you use up the feedback in flattening a poor response, you can't expect it to help you much with your distortion. In the old days when the only figure quoted was the 400-cycle distortion, the amplifier we have been considering looked good. Feedback gave good distortion figures, especially if you concentrated on second and third harmonics. Feedback gave a flat response. When the actual sound was not so good—well, it must be the speaker or the record player or the record or maybe you just weren't used to high quality. That's when we got all those tests to show that most people really liked no bass and no treble.

Intermodulation testing is expensive but, when it started, a lot of people got a shock. They discovered that they had to make the basic amplifier flat over the working band and use the feedback just to cut the distortion. True high fidelity was on its way in. Now if you design an amplifier to be flat down to 30 cycles and then put on 24 db of feedback, you will find that you have finished up with something which is flat down to below 5 cycles. If you design the amplifier by itself to be flat up to 10,000 cycles, adding feedback will probably make it flat up to 100,000 cycles. It looks good to put these figures in a sales pamphlet. One came to me today claiming a flat response to 25,000 cycles (within 1 db) and, if you look through the advertisers' claims, you will find 5-50,000 cycles is not uncommon.

This wide-band response is very useful in the experimental laboratory, and there are customers who buy amplifiers just to get the out-of-audio response. No manufacturer will turn them away unless he has to, so as no audio fan demands a limited response the amplifiers get wider and wider. The man who wants just to listen to the output of his amplifier is being sold something he doesn't need. Worse, it may be doing harm to the quality of his reproduction because any inaudible input will help to overload the amplifier and

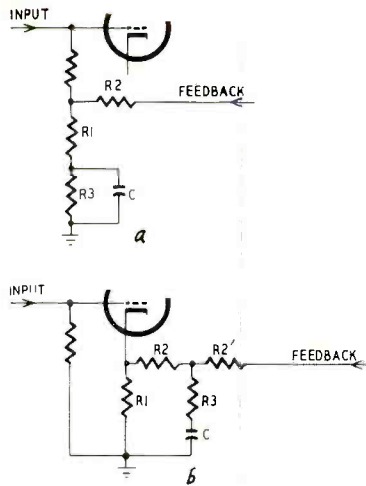

Fig. 2—Two circuits for making an amplifier's overall response drop off at low frequencies.

the speaker system and thus modulate the music he can hear with these out-of-band signals he can't hear. Even though noise power is low, why put out 5-10 times as much as you need, for noise is proportional to bandwidth.

What do we want?

What do we really want? The answer is pretty clear. We want an amplifier with a frequency response which is flat before feedback—say 3 db down at the ends—from 30 cycles to perhaps 15,000 cycles. It would not matter too much if this were pulled down to 12,000 cycles because there is never much power up there. Then we want to add feedback and keep the response pretty flat over this frequency band, but drooping away at both ends. This can be done in either of two ways, or in both. One way is to build some sort of filter network at the beginning or end of the chain, and I don't think very much of it though, if you have a low source impedance to deal with, the input transformer can be made to do this job.

The best way to get the response we want is to build it into the feedback path. We don't want to put out anything much above 15,000 cycles, say. Why not arrange the feedback to increase at higher frequencies, thus forcing the overall response down? This is, indeed, a very good thing to do, because it tends to make the amplifier more stable, in general. It is also a very easy thing to do because, if you are satisfied with a 6-db-per-octave cut, starting 3 db down at what I've called the characteristic frequency elsewhere, it just means putting a small capacitance across the feedback resistor.

It is interesting to do a square-wave test on an amplifier with a variable capacitor across the feedback resistor. Suppose we put in a 1,000-cycle square wave and look at the output. Usually we find a slight ring. But as we increase the capacitance, the ring frequency goes down, and so does the size of the ring until the corners of the square wave are just rounded, with no overshoot at all. That means that the

amplifier is extremely stable. The sort of size we need for the capacitor is easily calculated. It should have a reactance of the same order as the resistance at the 3-db point. For a characteristic frequency of 16,000 cycles, where $\omega = 100,000$, we should need 100 μf for a resistor of 100,000 ohms, or .001 μf for 10,000 ohms. Intermediate values you can work out. Many amplifiers do include a rather smaller capacitance than this, just to prevent the response peaking up in the 30-50,000-cycle region.

The low-frequency end is always more of a problem than the high-frequency end. Everything is so big, and the low frequencies are all mixed up with the standing plate currents. If the feedback is taken to the grid of an earlier stage, things are not too difficult. You have something like Fig. 2-a, to which I have added R3 and C. At the frequency where $1/\omega C$ starts to be comparable with R1, feedback will begin to rise and the overall response starts to droop. If we choose 30 cycles, so $\omega = 200$ and guess R1 as around 10,000 ohms, in a typical circuit we shall find that C is 0.5 μf . This is not too inconvenient a value, I feel. The additional resistor R3 is just to keep the grid tied back to ground and should be about 10 times R1, or more.

When the feedback is to the cathode, life is not so easy. The nice scientific approach is to put an inductance in shunt with the feedback resistor, but I don't think many practical engineers would. The circuit arrangement of Fig. 2-b is probably the simplest, and in this one would make R3 (100 ohms) quite a lot smaller than R1 (1,000 ohms); R2 (2,200 ohms) not much greater than R1, and R2' would fix the overall feedback. The characteristic frequency is where $1/\omega C = R3$ and it is easy to see that this makes C an electrolytic in the 50-100- μf range.

This use of extra feedback at low frequencies also helps to deal with one very-low-frequency problem I have mentioned before. Unless your amplifier is pure class A throughout and is push-pull throughout into the bargain, though bargain is hardly the right word for such a monster, plate currents will vary with the signal amplitude. A perfectly regulated power supply will take care of this, but a practical power supply will apply to the first plate the syllabic frequencies generated in the push-pull output stage. Unless you do something to keep those down, they will be amplified through the rest of the amplifier and your speaker will be huffing and puffing to-and-fro, pushed to one limit of its travel or the other just when it should be reproducing a loud passage. Feedback, however, will do a lot of good in this respect.

I do not doubt that many readers will disagree with my argument. I hope that many others will think about it and, perhaps, be convinced. After all, why should you listen to frequencies you can't hear? END

*Baby's sleeping?
Build this simple unit
to keep a remote ear
over the crib
while you have dinner
or watch TV.
One or more extension
speakers may be used.*

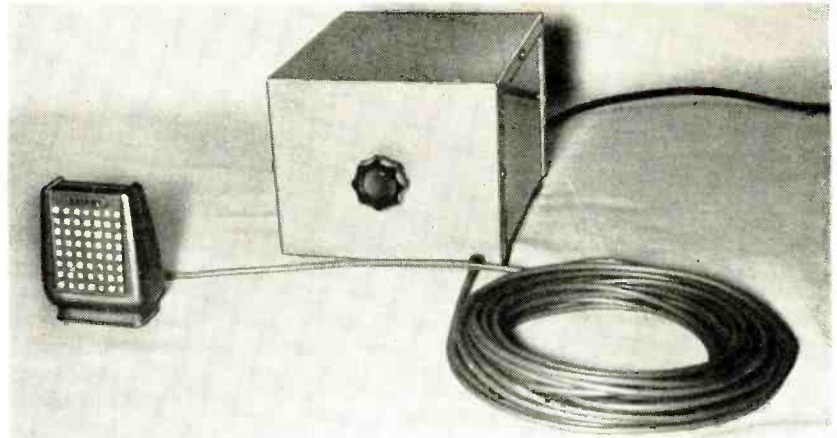

Amplifier in case with microphone.

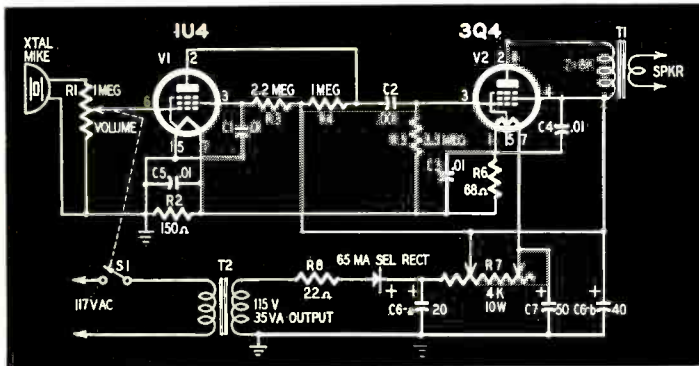

Fig. 1—Schematic diagram of amplifier.

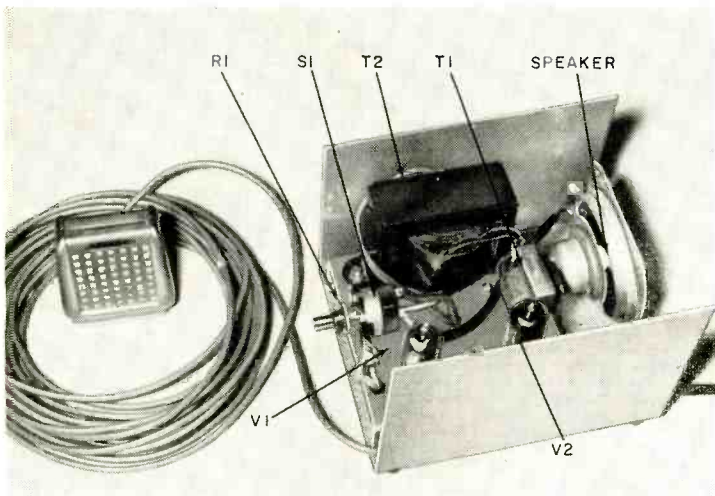
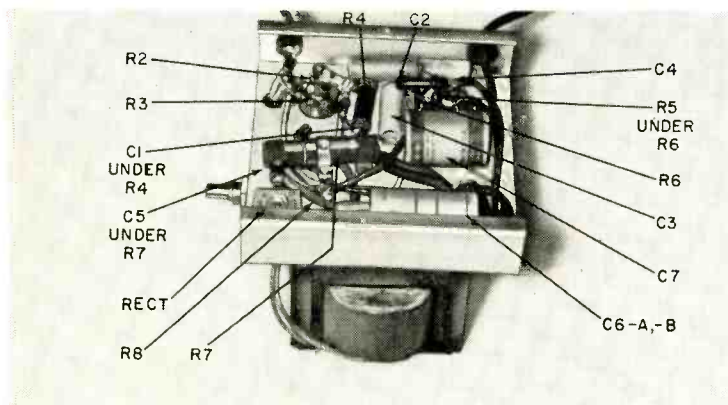
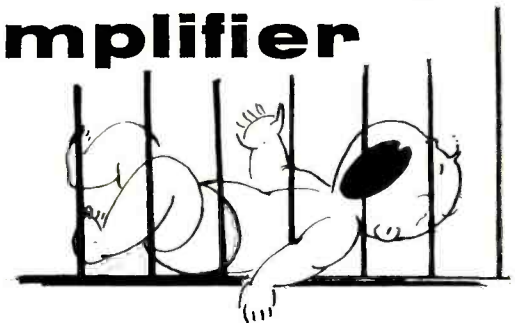

Fig. 2—View inside cabinet, showing layout of major parts.



Underchassis view, indicating component layout.

Baby-Monitoring Amplifier



By JAMES E. PUGH, JR.

THE need for a simple, compact and inexpensive audio amplifier arose when it was realized that we ought to have a means for monitoring the baby at night. The microphone is mounted over the baby's crib and the

Parts List for Fig. 1

- R1—1-megohm pot (IRC type PQ 11-137)
- R2—150 ohms, 1/2 watt
- R3—2.2 megohms, 1/2 watt
- R4—1 megohm, 1/2 watt
- R5—3.3 megohms, 1/2 watt
- R6—68 ohms, 1/2 watt
- R7—4,000 ohms, 10 watts, variable with one extra slider [IRC type I 3/4 AA(ABA)]
- R8—1/2 watt, 22 ohms
- C1, 3, 4, 5—.01 μ f, 400 volts
- C2—.001 μ f, 400 volts
- C6-a, b—20/40 μ f, 150 volts (Sprague TVA 2438)
- C7—50 μ f, 25 volts (Sprague TVA 1206)
- RECT—65-ma selenium rectifier (Federal 1263A)
- V1—1U4
- V2—3Q4 or 3V4
- T1—Output transformer 8,000 ohms to 3.2 ohms (Knight, Allied part No. 62G093 or Merit A-2927, with 1 1/2-inch mounting centers)
- T2—Isolation transformer 115 volts primary, 115 volts secondary, 35 ma (Triad N-51X)
- 3-inch PM speaker, 3-4-ohm voice coil (Jensen 3J6)
- S1—dpst attached to potentiometer (IRC 76-2)
- CHASSIS—1 x 4 x 4 1/2-inch aluminum (ICA 29083)
- CABINET—4 x 5 x 6 inches (Flexmount 29442)
- SOCKETS—(2) 7-pin miniature (Amphenol 147-500)
- MICROPHONE—Crystal
- GROMMETS—Rubber, one 1/4 inch, two 5/16 inch, two 3/8 inch

Audio Servicing Hints

By JOHN A. COMSTOCK

speaker-amplifier cabinet is located in the parents' bedroom near the bed.

The novel feature of this 250-mw amplifier (Fig. 1) is the means of obtaining the filament voltage. As seen from the circuit diagram, the filament voltage is dc and is obtained directly from the dc plate supply through resistor R7. Tubes V1 and V2 are the filament type and connected in series. The bias resistor for V2 (R6) is also connected in series with these filaments. This means that the grid bias voltage for V2 is determined by the sum of the filament current and the total cathode (plate plus screen) current of V2 flowing through R6. In this case the filament current is about 50 ma and the total cathode current of V2 is about 10 ma, giving a bias voltage of about 4 for V2. Since this same current flows through the filament of V1 a shunt resistor R2 will ordinarily be needed across the V1 filament. This shunts the extra current (10 ma), equal to the cathode current of V2, around the filament of V1, reducing the voltage drop across it to about 1.4. Resistor R7 also reduces the B-plus supply voltage to 90 for use on the plates and screens of V1 and V2. Capacitor C8 further filters the filament supply. Otherwise the amplifier is entirely conventional, and should give little trouble to anyone, including the novice.

The tubes, 1U4 and 3Q4 (or 3V4), were selected because of their low filament-current requirements—50 ma at 1.4 and 2.8 volts, respectively. This is one of the important points in the design of this amplifier—low-current filaments to keep the I²R loss in R7 as low as possible. The loss in this case is between 6 and 7 watts, and much more would be excessive. As many, or as few, tubes as desired may be used, provided their filament-current ratings are the same.

The amplifier was designed to give the maximum gain without regard to quality of tone. It is, however, entirely adequate in that respect for most uses.

Construction and wiring

In wiring be sure that all bare wires on the filament terminals are well isolated from the plate and screen terminals because these tubes burn out immediately if high voltage is applied to the filaments.

The 90-volt tap on R7 was made of No. 16 bare wire bent to fit around the resistor. Extra sliders are available at a small cost however, and will be more secure and reliable.

The parts are arranged with the volume control and microphone cord on the front panel (Fig. 2). The speaker is mounted on the back wall of the case. A grille is made by drilling a series of 1/8-inch holes over the area in front of the cone. Four rows across the cone diameter with an in-row spacing of about 1/4 inch will give a neat arrangement and permit the sound to escape easily. Rubber feet are mounted on the bottom half of the case and sev-

eral 1/4-inch holes are drilled in the area under the chassis to provide ventilation.

Adjustment

All wiring can be completed except the B-plus lead from V1 and V2 to the tap on R7, which should be left disconnected temporarily. This is done to prevent high voltage from being applied to the filaments through an accidental short between the plate (or screen) and filament terminals while making preliminary adjustments—also saves tube filaments.

Adjust the filament tap on R7 to about 4,000 ohms and the plate tap to about 2,000. Turn on the 117-volt supply and measure the voltage across pins 1 and 7 of V1 with a dc voltmeter. Next measure the voltage across pins 1 and 5 and 5 and 7 of V2. In the following steps the two sections of the V2 filament are treated as being separate filaments.

With the voltmeter across the pins giving the highest reading (ordinarily this will be across V1) adjust the tap on R7 until the meter reads about 1 volt. Check again for the filament with the highest voltage as it may be different. With the voltmeter across the highest one adjust for 1.3 volts. Check the other two voltages again. They probably will be less than 1.3 volts but should not be less than 1.2. If the variation is greater than this, R2 may need to be changed to a larger or smaller value.

Now connect the B-plus lead to the tap on R7 and adjust for 90 volts. Recheck the filament voltages and readjust if necessary, being very careful not to cause a short between the filament and plate, or screen, terminals with the voltmeter probe. Readjust the 90-volt tap if necessary. The amplifier is now ready to place in the cabinet and use.

Note that if one or two of the three filament voltages are much less than 1.3, it will be necessary to shunt resistors across the highest ones to obtain maximum gain. This will ordinarily be V1 because the cathode current of V2 flows through its filament in addition to the normal filament current. Resistor R2 compensates for this but may need to be a slightly different size because of the variation in filament resistance with different tubes. The value of shunt resistance needed is best found by the "cut-and-try" method because of the difficulty in determining the value of the filament resistances.

First remove R2 and start with about 330 ohms connected across the filament having the second largest voltage. Go to smaller values of resistance until this voltage is close to the smallest voltage. Repeat this step with resistors across the filament having the largest voltage until it is close to the other two. The three voltages should now be nearly equal when adjusted to 1.3 volts. Be careful when making the adjustments—these tubes burn out easy! END

In servicing phonos, it's sometimes advantageous to weight the arm slightly to improve tracking and increase volume. This is easily done with a length of wire solder. Coil up the solder and attach it to the inside of the arm

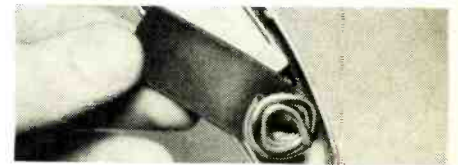

with a strip of electrician's plastic tape or a daub of service cement. The length of the solder, of course, depends on how much weight is needed. This is best determined by experiment or with a stylus pressure gauge.

Cabinet touchup

When filled with touchup shellac or varnish, an empty mucilage bottle makes a handy touchup "pen" for marred speaker and equipment cabinets. Sev-

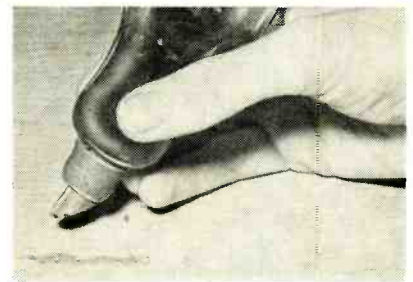

eral of these bottles filled with various shades of shellac or varnish make cabinet touchup fast and efficient. The self-closing rubber tip keeps the bottle's contents from drying out.

Tape-spool dust cover

To keep dust from collecting on the static-charged surfaces of plastic recording tape, I keep a plastic bowl cover over each spool of tape when it's not in

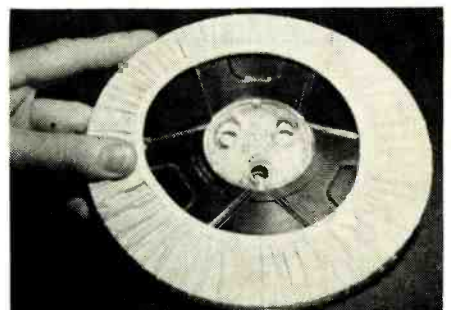

use. The bowl covers are inexpensive and readily available at five and dime stores and in sizes that will fit almost any spool of tape. END

ALL ABOUT THE

REFLEX ENCLOSURE

Part III—Speaker, cabinet and port sizes, and their effects on the enclosure's resonant frequency

By P. G. A. H. VOIGT

In the previous installment we discussed methods for ascertaining the Helmholtz frequency of reflex enclosures, and how the port should be adjusted. We also found that large-area ports had lower air-inertia factors than small ones.

An important question remains. What size cabinet should be selected for a speaker resonating at a specific frequency? The answer involves the details of the loudspeaker concerned.

A speaker with a 5-inch cone might resonate at 80 cycles. This could also apply to a 15-inch cone that would have about nine times the area of the smaller one. Such a difference in area has a profound effect and cannot be disregarded.

For a box baffle, the question of size has a simple answer—"As large as practicable, especially with a big speaker." Now, however, we are no longer concerned with diminishing the effect of the air cushion on the back of the cone to the vanishing point. Instead we are going to drive that air so it will work for us later. Therefore, it must be coupled to the back of the cone. An enormous enclosure which would have made a perfect box baffle provides very little coupling. If the speaker's resonance was objectionable under normal conditions, such an enclosure can do little to remedy matters. **Reflex enclosures can be too large.**

The smaller the enclosure volume, the greater the cushion pressure change for a given cone movement—coupling between cone and air cushion increases as cushion volume is reduced. Alternately, with a given cushion volume, a large cone is more tightly coupled than a small one. Thus, the enclosure volume used with a given cone size depends upon the coupling required. For a specific coupling with different cones, the volume of the air cushion must be greater for a large cone area than for a small one.

The first and very rough rule for reflex cabinets is simply: **A large cabi-**

net with a big cone and a small one with a little cone.

How much coupling

But, how large is large and how small is small? Or, what coupling should be used between cone and air volume? These questions are part of the general compromise, so there is no clear-cut ideal answer. If there is a shortage of space and the finished speaker has to be squeezed into so many inches of the top left-hand part of the bookcase, circumstances have settled quite definitely the question of "optimum" size. When there is free choice, one can make a better decision if the factors involved are understood.

Reflex speaker systems are often compared to bandpass circuits, but the radio engineer designing a bandpass circuit has a simple task. He has only the L, C and R of the driving circuit; the L, C and R of the driven circuit, and the coupling coefficient, just seven variables. And the matter is further simplified because the LC product which determines the frequency of both circuits must be the same, and often has to conform to some standard value.

With reflex cabinets, two frequencies are supposed to be the same, that of the enclosure as a Helmholtz resonator and that of the cone in free air. But suppose we have a medium-size cone and two cabinets, both tuned to the frequency of the cone and, though one enclosure is larger than the other, both could be described as "medium." Which should be used?

We know that coupling between the cone and the larger cabinet is the weaker. As both are correctly tuned, the cabinet with the greater volume (the equivalent of C) will have a lower air-inertia factor port (the equivalent of L)—a port of greater area. When a port that has a low air-inertia factor is used, the inertia barrier between air in the enclosure and air in the room is low too.

The lower the port's inertia barrier,

the faster the transfer of energy from the cabinet to the room (other things being equal of course). Thus, the effectiveness of the equivalent of electrical radiation resistance is greater with the larger port and the air system's Q is lower.

In connection with coupling, it is interesting to note that when enclosure volume is enlarged, the accompanying increase in port area automatically *increases* the coupling to the room. Exactly the reverse happens to the coupling to the cone: it is *reduced* when cabinet volume is increased.

If the designer of an electrical bandpass circuit wants to reduce the coupling, he increases the spacing between two coils. It is easy to do and does not affect anything else.

Reducing coupling between speaker and cabinet of a reflex enclosure requires an increase of air-cushion volume. Since this normally means changing over to a larger cabinet, it is not as easy to effect as altering the spacing between two coils. Also, once done, the equivalent of C has been increased. To keep the tuning frequency correct, the larger cabinet requires a larger port (lower L). The resulting decrease in the inertia barrier increases the coupling to the room, which in turn reduces the Q of the resonant air system.

Thus, we find that a change in coupling between cone and air cushion requires a cabinet of different volume, and results in changes which affect everything else all down the line.

In spite of the great differences between reflex cabinets and bandpass circuits, there are many interesting similarities. In a bandpass circuit, both circuits are tuned initially to the same frequency. If the coupling is loose enough, the mutual effect between them is so small that the resonant frequencies of the two circuits are not changed, and a single resonance peak remains. If the coupling is increased, two humps or peaks appear, one on each side of the original frequency. As the coupling is

TRANSISTOR PORTABLE RADIO KIT

Fun for the whole family, this easy-to-build 6-transistor portable radio is ready to go wherever you go. The modern molded plastic case with pull-out carrying handle and fully enclosed back add beauty and convenience to this splendid kit. Six name-brand (Texas Instrument) transistors are used for good sensitivity and selectivity. The 4" x 6" PM speaker with heavy magnet provides "big set" tone quality. Use of this large speaker and roomy chassis make it unnecessary to crowd components adding greatly to the ease of construction. Transformers are prealigned making the radio ready for use as soon as kit is assembled. A built-in rod-type antenna assures good reception in all locations. Six standard flashlight batteries are used for power, providing extremely long battery life (between 500 and 1,000 hours) and they can be purchased anywhere. Stylish cabinet is two-tone blue molded plastic with gold inlay and measures 9" L. x 7" H. x 3 3/4" D. Shpg. Wt. 6 lbs.

MODEL XR-1L: Identical to XR-1P except in handsome leather case instead of plastic case. Leather carrying strap included. Shpg. Wt. 7 lbs.

LEATHER CASE: Can be purchased separately if desired. Fits all XR-1P and earlier XR-1 chassis. No. 93-1. Shpg. Wt. 3 lbs. **\$6.95.**

HEATHKIT
MODEL XR-1P
\$29⁹⁵



MODEL XR-1L **\$34⁹⁵**

NAVIGATE BY PORTABLE RADIO



HEATHKIT
MODEL DF-2
\$69⁹⁵

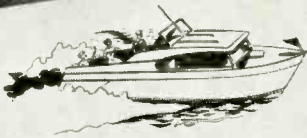

2-BAND TRANSISTOR PORTABLE RADIO DIRECTION FINDER KIT

Enjoy the safety, convenience and entertainment of this self-contained, self-powered, six-transistor superheterodyne radio direction finder. It receives aeronautical and marine beacons as well as standard band broadcasts with startlingly clear tone reproduction over a long range. Covering the beacon band from 200 to 400 kc and broadcast band from 540 to 1620 kc, the DF-2 is designed to take directional "fixes" on both aircraft and marine beacons as well as standard broadcast stations, while providing the entertainment of a high quality transistor portable radio. You are able to receive aircraft weather reports every thirty minutes and constant Coast Guard beacons on the 200 to 400 kc band. A dial light is provided for night operation. Power is supplied by six standard flashlight batteries which will last you up to one year under normal operation. Shpg. Wt. 9 lbs.

POWER CONVERTER KIT

Now you can operate your TV set, radio, razor, and other AC electrical equipment directly from your 12-volt boat or car battery. With the Heathkit Power Converter you can enjoy the convenience of home electricity whether boat cruising or on automobile trips. Two power transistors are employed for years of trouble-free, dependable service. No moving parts to wear out, no tubes to replace. Shpg. Wt. 8 lbs.



MODEL PC-1
\$24⁹⁵

ELECTRONIC IGNITION ANALYZER KIT

Ideal for use on automobiles, boats, aircraft engines, etc., the IA-1 checks ignition systems with the engine in operation (400 to 5,000 RPM). Shows the condition of coil, condenser, points, plugs and ignition wiring. Shows complete engine cycle or just one cylinder at a time. Two test leads are supplied, each 10' long, which will enable you to reach either the breaker points or the spark plug wires. Shpg. Wt. 20 lbs.



MODEL IA-1
\$59⁹⁵

ELECTRONIC TACHOMETER KIT

Useful on inboard and outboard boats, as well as in automobiles, the TI-1 operates directly from the spark impulse of the engine. Use on any spark ignited 2 or 4 cycle engine of any number of cylinders. Completely transistorized, it works with 6, 8, 12, 24 or 32 volt DC systems. Indicates revolutions-per-minute from 0 to 6,000. Calibration control provided for adjusting to engine type. Easy-to-build and easy-to-install. Shpg. Wt. 4 lbs.

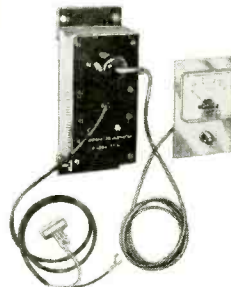

MODEL TI-1
\$25⁹⁵

PROFESSIONAL OSCILLOSCOPE KIT

Everything you could possibly want in an oscilloscope is found in the new Heathkit model OP-1. Featured are DC coupled amplifiers and also DC coupled CR tube un-blanking. The triggered sweep circuit will operate on either internal or external signals and may be either AC or DC coupled. The polarity of the triggering signal may also be selected, and any point on the waveform may be selected for the start of the sweep by using the "triggering level" control. An automatic position is also provided, in which the sweep recurs at 50 cycle rate, but can be driven over a wide range of frequencies with no additional adjustment. Prewired terminal boards are used for rapid, easy assembly of all critical circuits. Power supply is transformer operated utilizing silicon diode rectifiers and is fused for protection. Handsome cabinet features silver anodized front panel with red and black lettering and matching knobs. Shpg. Wt. 34 lbs.

HEATHKIT
MODEL OP-1

\$179⁹⁵



VARIABLE VOLTAGE REGULATED POWER SUPPLY KIT

Invaluable in experimental and design work, the PS-4 eliminates the need for building up a separate power supply for each new circuit tried. It provides a convenient source of variable regulated B+, variable bias voltage and filament voltage for labs and work shops. The PS-4 supplies regulated B+ output continuously variable from 0 to 400 volts DC at up to 100 ma, bias voltage variable from 0 to -100 volts DC at 1 ma, and filament voltage of 6.3 volts AC at 4 amps. Separate panel meters continuously monitors voltage and current output. Rugged, top-rated components used throughout for long, reliable service. Shpg. Wt. 16 lbs.



HEATHKIT
MODEL PS-4

\$54⁹⁵

Your best
dollar value...



HEATH COMPANY • Benton Harbor 20,
Michigan

Subsidiary of Daystrom, Inc.

"EXTRA DUTY" 5" OSCILLOSCOPE KIT

Laboratory quality at utility scope price makes this instrument an unusual value. The Heath patented sweep circuit functions from 10 CPS to better than 500 kc in five steps, giving you five times the usual sweep obtained in other scopes. Vertical frequency response extends from 3 CPS to 5 mc +1.5 db -5 db without extra switching. An automatic sync circuit with self-limiting cathode follower provides excellent linearity and lock-in characteristics. Extremely short retrace time and efficient blanking action are characteristic of this scope. Frequency response of the horizontal amplifier is within ±1 db from 1 CPS to 200 kc. Horizontal sensitivity is 0.3 volts RMS-per-inch. Construction is simplified through the use of two etched metal circuit boards and precut, cabled wiring harness. Complete step-by-step instructions and large pictorial diagrams are supplied for easy assembly. An ideal scope for all service applications as well as in standard or color TV servicing. Shpg. Wt. 22 lbs.



HEATHKIT
MODEL O-12

\$65⁹⁵



HEATHKIT
MODEL TO-1

\$16⁹⁵

TEST OSCILLATOR KIT

Provides the test frequencies most often used by servicemen in repairing and aligning modern broadcast receivers. Five fixed-tuned frequencies (262 kc, 455 kc, 465 kc, 600 kc and 1400 kc) are quickly selected for troubleshooting or alignment of the IF frequency and high and low end of the broadcast band for proper tracking. Shpg. Wt. 4 lbs.



MODEL SG-8 **\$19⁵⁰**

RF SIGNAL GENERATOR KIT

A "must" for any beginning serviceman, this indispensable instrument is used for aligning tuned circuits quickly and tracing signals in faulty RF, IF and audio circuits. Covers 160 kc to 110 mc on fundamentals in five bands and from 110 mc to 220 mc on calibrated harmonics. Coils are pre-wound and calibrated. Complete with output cable and instructions. Shpg. Wt. 8 lbs.



MODEL AG-9A **\$34⁵⁰**

AUDIO SIGNAL GENERATOR KIT

This unique generator uses three rotary switches to select two significant figures and a multiplier to determine audio frequency, allowing return to the exact frequency previously measured when making multiple frequency measurements. Covers 10 CPS to 120 kc with less than .1 of 1% distortion between 20 and 20,000 CPS. Shpg. Wt. 10 lbs.



MODEL TS-4A **\$49⁵⁰**

TV ALIGNMENT GENERATOR KIT

TV service technicians will appreciate the outstanding features found in this sweep generator. Provides essential facilities for aligning FM, monochrome TV or color TV sets. The all-electronic sweep circuit employs a trouble-free controllable inductor which varies frequency by magnetic means. An unusual buy at this low price. Shpg. Wt. 16 lbs.



MODEL CD-1 **\$59⁹⁵**

COLOR BAR AND DOT GENERATOR

The CD-1 combines the two basic color servicing instruments, a color bar and white dot generator in one versatile and portable unit, which has crystal controlled accuracy and stability for steady lock-in patterns. (Requires no external sync leads.) Easy-to-build and easy-to-use. No other generator on the market offers so many features at such a great price saving. Shpg. Wt. 13 lbs.

ETCHED CIRCUIT VTVM KIT

Time proven for dependability, accuracy and overall quality, the V7-A is one of the wisest investments you can make for your electronic workshop or lab. Its multitude of uses will make it one of the most often used instruments in your possession. Use it to measure all operating voltages and potentials such as B+ and AC-DC, or straight AC power supplies, filament voltage, bias voltage, AVC voltage, line voltage, etc. Ideal for measurements in all types of AM, FM and TV circuits. Checks discriminator or detector operation, AVC or AGC performance, while the ohmmeter may be used to measure circuit continuity, circuit resistance, to test out individual components with resistance measurement, or to trace circuit wiring through cables or chassis openings. Front panel controls consist of rotary function switch and a rotary range selector switch, zero-adjust and ohms-adjust controls. Precision 1% resistors are used in the voltage divider circuit for high accuracy and an etched circuit board is employed for most of the circuitry. The circuit board not only simplifies assembly but permits levels of circuit stability not possible with ordinary conventional wiring methods. Shpg. Wt. 7 lbs.



HEATHKIT
MODEL V7-A

\$25⁹⁵



HEATHKIT
MODEL M-1

\$17⁹⁵

HANDITESTER KIT

Ideal for use in portable applications when making tests away from the work bench or as an "extra" meter in the service shop. The combination function range switch simplifies operation. Measures AC or DC voltage from 0 to 10, 30, 300, 1,000 and 5,000 volts. Direct current ranges are 0 to 10 ma and 0 to 100 ma. Ohmmeter ranges are 0 to 3,000 and 0 to 300,000. Top quality, precision components used throughout. Small and compact, take it with you wherever you go. Very popular with home experimenters and electricians. Test leads and 1½ volt size C battery are included with the kit. Shpg. Wt. 3 lbs.



HEATHKIT
MODEL MM-1

\$29⁹⁵

20,000 OHMS/VOLT VOM KIT

Portable and accurate, this kit features a 50 ua 4½" meter and 1% precision multiplier resistors for high accuracy. No external power required. Provides a total of 25 meter ranges on a two-color scale. Sensitivity is 20,000 ohms-per-volt DC and 5,000 ohms-per-volt AC. Measuring ranges are 0-1.5, 5, 50, 150, 500, 1,500 and 5,000 volts AC and DC. Measures direct current in ranges of 0-150 ua, 15 ma, 150 ma, 500 ma and 15 a. Resistance multipliers are X 1, X 100 and X 10,000. Covers -10 db to +65 db. Housed in an attractive bakelite case with plastic carrying handle. Batteries and test leads included. Shpg. Wt. 6 lbs.

TUBE CHECKER KIT

Brand new in every respect, the TC-3 features outstanding performance and ease of operation. Sockets are provided for 4-pin, 5-pin, 6-pin, 7-pin, large, 7-pin miniature, 7-pin sub-miniature, octal, loctal, and 9-pin miniature tubes. Protection against obsolescence is provided by a blank socket to facilitate modification for checking newly added tube types. A 10-lever switch makes it possible to connect any element regardless of the pin numbers involved. A neon bulb indicator shows filament circuit continuity and leakage or shorts between elements. A specially designed spring loaded roll chart mechanism permits the roll chart to run freely throughout its entire length without binding. Thumb wheel drive knobs are provided on both sides of the panel to accommodate the left handed operator. Compact and small in size, the TC-3 is ideally suited for portable applications. Both the roll chart and the meter are illuminated to facilitate use in darkened areas. Shpg. Wt. 12 lbs.

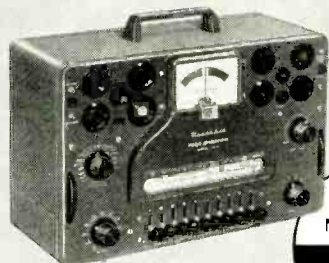

HEATHKIT
MODEL TC-3

\$39⁹⁵

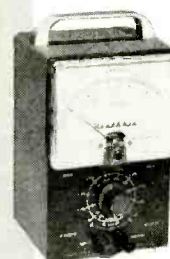

MODEL AV-3

\$29⁹⁵

AUDIO VTVM KIT

This vacuum tube volt meter emphasizes stability, broad frequency response and sensitivity for accurate measurement of critical AC voltages. Features a large 4½" 200 ua meter with increased damping in the meter circuit for stability in low frequency tests. Measures AC from a low value of 1 millivolt to a maximum of 300 volts AC (RMS). Voltage ranges are: 0-.01, .03, .1, .3, 1, 3, 10, 30, 100 and 300 volts. Db ranges cover -52 to +52 db. 1% precision multiplier resistors used for maximum accuracy. Frequency response is essentially flat from 10 CPS to 200 kc. Shpg. Wt. 6 lbs.



MODEL CT-1 **\$7⁹⁵**

IN-CIRCUIT CAPACI-TESTER KIT

This handy kit checks capacitors for "open" or "short" right in the circuit. Detects open capacitors from about 50 mmf, not shunted by an excessive low resistance value. Checks shorted capacitors up to 20 mfd (not shunted by less than 10 ohms). Checks all bypass, blocking and coupling capacitors of the paper, mica or ceramic types. (Does not detect leakage nor check electrolytic condensers.) Electron beam "eye" tube is used for quick indication. A 5-position function switch is featured which controls the power to the instrument and selects the test being made. Easy to build and easy to use. Test leads included Shpg. Wt. 5 lbs.



MODEL BE-5 **\$39⁹⁵**

LOW RIPPLE BATTERY ELIMINATOR KIT

Completely up to date the BE-5 will power all the newest transistor circuits requiring 0 to 12 volts DC, and the new hybrid automobile radios using both transistors and vacuum tubes. An extra low-ripple filter circuit is employed holding AC ripple down to less than .3%. Doubles as a battery charger or marine converter. Shpg. Wt. 21 lbs.

MODEL T-4

\$19⁹⁵



VISUAL-AURAL SIGNAL TRACER KIT

New in every respect the T-4 features a built-in speaker and electron beam "eye" tube for signal indication, and a unique noise locator circuit. Ideal for use in AM, FM and TV circuit investigation. Transformer operated for safety and high efficiency. Complete with test leads and informative construction manual. Shpg. Wt. 5 lbs.



MODEL C-3 **\$19⁵⁰**

CONDENSER CHECKER KIT

Check unknown condenser and resistor values quickly and accurately as well as their operating characteristics with this fine instrument. All values are read directly on a calibrated scale. An electron beam "eye" tube indicates balance and leakage. A valuable addition to any service shop or lab. Shpg. Wt. 7 lbs.



HEATHKIT
MODEL TX-1
\$234⁹⁵

- Built-in cooling fan
- Rotating Slide Rule Dial
- Compact, Stable, VFO
- Provision for SSB Adapter

\$50.00 required on C.O.D. orders. Shipped motor freight unless otherwise specified.

"APACHE" HAM TRANSMITTER KIT

This beautifully styled transmitter has just about everything you could ask for in transmitting facilities. The "Apache" is a high quality transmitter operating with a 150 watt phone input and 180 watt CW input. In addition to CW and phone operation, built-in switch selected circuitry provides for single-sideband transmission through the use of a plug-in external adapter. A completely redesigned, compact and stable VFO provides low drift frequency control necessary for SSB transmission. A slide rule type illuminated rotating VFO dial with full gear drive vernier tuning provides ample bandspread and precise frequency settings. The bandswitch allows quick selection of the amateur bands on 80, 40, 20, 15 and 10 meters (11 m with crystal control). This unit also has adjustable low-level speech clipping and a low distortion modulator stage employing two of the new 6CA7/EL34 tubes in push-pull class AB operation. Time sequence keying is provided for "chirpless" break-in CW operation. The final amplifier is completely shielded for greater TVI protection and transmitter stability. A formed one-piece cabinet with convenient access hatch provides accessibility to tubes and crystal socket. Die-cast aluminum knobs and front panel escutcheons add to the attractive styling of the transmitter. Pi network output coupling matches antenna impedances between 50 and 72 ohms. A "spotting" push button is provided to allow tuning of the transmitter before switching on the final amplifier. This feature also enables the operator to "zero-beat" an incoming frequency without placing the transmitter on the air. Equip your ham shack now for top transmitting enjoyment with this outstanding unit. Shpg. Wt. 110 lbs.

New Styling...
New Features



HEATH COMPANY
Benton Harbor 20, Michigan

 subsidiary of Daystrom, Inc.



HEATHKIT
MODEL SB-10
\$89⁹⁵

SINGLE SIDEBAND ADAPTER KIT

Designed as a compatible plug-in adapter for the model TX-1 it can also be used with transmitters similar to the DX-100 or DX-100-B by making a few simple circuit modifications and still retain the normal AM and CW functions. Easy to operate and tune, the adapter employs the phasing method for generating a single sideband signal, allowing operation entirely on fundamental frequencies. The critical audio phase shift network is supplied, completely pre-assembled and wired in a sealed plug-in unit. Features include single-knob bandswitching for operation on 80, 40, 20, 15 and 10 meters, an easy-to-read panel meter, built-in electronic voice control with anti-trip circuit. Enjoy the advantages of SSB operation by adding this fine kit to your ham shack now. Shpg. Wt. 14 lbs.

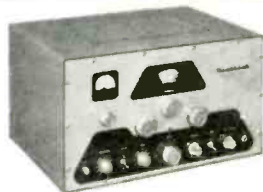

MODEL
DX-100-B
\$189⁵⁰

\$50.00 deposit required on C.O.D. orders. Shipped motor freight unless otherwise specified.

DX-100-B PHONE & CW TRANSMITTER KIT

The same fine performance of the time proven DX-100 is retained in the DX-100-B with improvements in the crystal and loading circuits. The one-piece formed cabinet has convenient access hatch for changing crystals, etc. and the chassis is punched to accept sideband adapter modifications. Features a built-in VFO, modulator and power supply, complete shielding to minimize TVI, and a pi network output coupling to match impedances from 50 to 72 ohms. RF output is in excess of 100 watts on phone and 120 watts on CW. Covers 160 through 10 meters. Single-knob bandswitching and illuminated VFO dial and meter face. RF output stage uses a pair of 6146 tubes in parallel, modulated by a pair of 1625's. Designed for easy assembly. Measures 11 3/8" H. x 19 1/2" W. x 16" D. Shpg. Wt. 107 lbs.



MODEL DX-40 **\$64⁹⁵**

DX-40 PHONE & CW TRANSMITTER KIT

Operates on 80, 40, 20, 15, 11 and 10 meters, using a single 6146 tube in the final for 75 watt plate power input CW, or 60 watts phone. Single-knob bandswitching, pi network output, complete shielding, provision for three crystals and VFO. D'Arsonval movement panel meter. Shpg. Wt. 25 lbs.



MODEL DX-20 **\$35⁹⁵**

DX-20 CW TRANSMITTER KIT

This fine unit covers 80, 40, 20, 15, 11 and 10 meters with single-knob bandswitching. Features a 6DQ6A tube in the final for 50 watt plate power input, pi network output, complete shielding to minimize TVI. Easy to build with complete instructions supplied. Shpg. Wt. 19 lbs.

"MOHAWK" HAM RECEIVER KIT

Designed for ham band operation and for maximum stability and accuracy, the Heathkit "Mohawk" receiver will let you enjoy ham activities to the utmost. This 15-tube receiver features double conversion with IF's at 1682 kc and 50 kc and covers all the amateur frequencies from 160 through 10 meters on seven bands. An extra band is calibrated to cover 6 and 2 meters using a converter. The "Mohawk" is specially designed for single-sideband reception with crystal controlled oscillators for upper and lower sideband selection. A completely pre-assembled, wired and aligned front end coil/bandswitch assembly assures ease of construction and top performance. Many more important features are provided in this outstanding receiver for dependable and effective amateur communications. Ruggedly constructed with well rated components throughout. Shpg. Wt. 66 lbs. Matching accessory speaker kit; optional extra. Model AK-5. \$9.95. Shpg. Wt. 8 lbs.

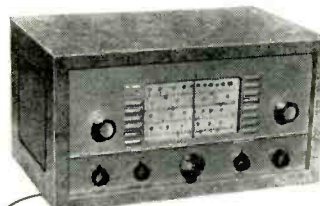

HEATHKIT
MODEL AR-3

\$2995

(LESS CABINET)

ALL-BAND RECEIVER KIT

A fine receiver for the beginning ham or short wave listener. Frequency coverage is from 550 kc to 30 mc in four bands. Features include bandswitch, bandspread tuning, phone-standby-CW switch, antenna trimmer, noise limiter, RF and AF gain controls and head-phone jack. Easy to build. Shpg. Wt. 12 lbs.

- Prewired and Aligned Coil/Bandswitch Assembly
- Crystal Controlled Oscillators for Drift-Free Reception

HEATHKIT
MODEL RX-1

\$27495



MODEL
QF-1

\$995

"Q" MULTIPLIER KIT

Use with any receiver with IF frequency between 450 and 460 kc to add additional selectivity for separating two signals or to reject one signal and eliminate heterodyne. A great help on crowded phone and CW bands. Not for use with AC-DC type receivers. Simple to connect with cable and plugs supplied. Shpg. Wt. 3 lbs.

"SENECA" VHF TRANSMITTER KIT

Brand new in every respect, the model VHF-1 "Seneca" is the latest addition to our line of ham transmitters. This self-contained 6 and 2 meter transmitter features built-in VFO, modulator, and dual power supply. A pair of 6146 tubes are employed in the push-pull final amplifier stage and features up to 120 watts input on phone and 140 watts input on CW in the 6 meter band. Slightly less in the 2 meter band to prolong amplifier tube life. Panel controls allow VFO or crystal control, phone or CW operation on both amateur bands. Four switch-selected crystal positions. Complete RF shielding to minimize TVI. Spotting push-button provided. The VFO slide rule type dial features edge-lighting and vernier tuning. An ideal transmitter for the ham who wants to extend operation into the VHF region. Shpg. Wt. 56 lbs.



HEATHKIT
MODEL VHF-1

\$15995

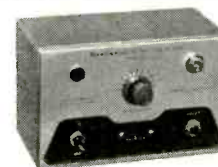

MODEL
CA-1

\$1395

"AUTOMATIC" CONELRAD ALARM KIT

This easy-to-build device gives instant warning and cuts AC power to your transmitter when a monitored station goes "off-the-air". Use with any radio receiver having an AVC circuit. A sensitivity control adjusts to various AVC levels. Incorporates a heavy duty six-ampere relay and manual "reset" button to reactivate the transmitter. Complete instructions provided for connection to receiver. Shpg. Wt. 4 lbs.



MODEL AM-2 **\$1595**

REFLECTED POWER METER KIT

Check the match of your antenna transmission system by measuring the forward and reflected power or standing wave ratio from 1:1 to 6:1. Handles a peak power of well over 1 kilowatt and may be left in antenna feed line. No external power required. 160 through 6 meters. For 50 or 75 ohm lines. Shpg. Wt. 3 lbs.



MODEL B-1 **\$895**

BALUN COIL KIT

Unbalanced coax lines can be matched to balance lines of either 75 or 300 ohms by using this balun coil kit. Use without adjustment from 80 through 10 meters at power up to 200 watts. May be located any distance from transmitter or antenna. Protective cover included. Shpg. Wt. 4 lbs.



MODEL VX-1 **\$2395**

ELECTRONIC VOICE CONTROL KIT

This unique device lets you switch from receiver to transmitter merely by talking into your microphone. Provision is made for receiver and speaker connections and also for a 117 volt antenna relay. Adjustable to all conditions by sensitivity and variable time delay controls provided. Shpg. Wt. 5 lbs.



MODEL VF-1 **\$1950**

VARIABLE FREQUENCY OSCILLATOR KIT

Far below the cost of crystals to obtain the same frequency coverage this VFO covers 160, 80, 40, 20, 15, 11 and 10 meters with three basic oscillator frequencies. Better than 10 volts RF output on fundamentals. Requires only 250 volts DC at 15 to 20 ma, and 6.3 VAC at 0.45 a. Illuminated dial reads direct. Shpg. Wt. 7 lbs.

Beautifully Styled With Plenty of
Room For The Most Complete
Stereo System



MODEL SE-1 (center unit) **\$149⁹⁵** Shpg. Wt. 162 lbs.

MODEL SC-1 (speaker enclosure) **\$39⁹⁵** each Shpg. Wt. 42 lbs.

STEREO EQUIPMENT CABINET KIT

This superbly styled cabinet ensemble is designed to hold your complete home stereo hi-fi system, consisting of a "stereo equipment center" flanked by two individual "stereo wing speaker enclosures". The unit has room for all the components required for stereo sound. Although designed to hold Heathkit stereo components, it is not frozen to this arrangement. The kit is supplied with mounting panels precut to accommodate Heathkits, but interchangeable blank panels are also furnished so you can mount any equipment you may already have. The precut panels accommodate the Heathkit AM-FM tuner (PT-1), stereo preamplifier (SP-1 & 2), and record changer (RP-3). Record changer chassis pulls out easily for convenient loading and unloading. Adequate space is provided for record storage and a pair of matching Heathkit power amplifiers (from 12 to 70 watts). The stereo wing speaker enclosures are open backed, cloth grilled cabinets designed to hold the Heathkit SS-2 or similar speaker systems. The cabinets are available in beautifully grained 3/4" solid core Phillipine mahogany or select birch plywood suitable for the finish of your choice. The matched grain sliding tape deck access door on top pops-up flush when closed. Entire top features a shaped edge. Hardware and trim of brushed-brass and gold finish. Rich toned grille cloth is flecked in gold and black. No woodworking experience required. All parts pre-cut and predrilled for easy assembly. Maximum overall dimensions (all 3 pieces): 82 3/4" W. x 36 1/2" H. x 20" D. Center Cabinet: 47 1/2" W. x 36 1/2" H. x 20" D.

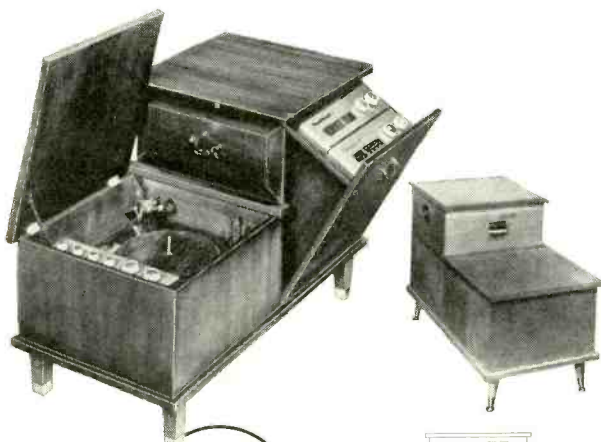

HEATHKIT
MODEL CE-1
\$43⁹⁵
each

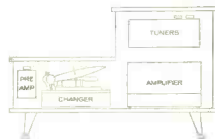

CHAIRSIDE ENCLOSURE KIT

Combine all of your hi-fi equipment into one compact control center and, at the same time add a beautiful piece of furniture to your home. The CE-1 is designed to house AM and FM tuners (BC-1A and FM-3A) and the WA-P2 preamplifier along with the majority of record changers which will fit in the space provided. Changer compartment measures 17 3/4" L. x 16" W. x 9 3/8" D. Adequate space is provided in the rear of the unit to house any of the Heathkit amplifiers designed to operate with the WA-P2. Good ventilation is achieved through properly placed slots in the bottom and back of the enclosure. Overall dimensions are 18" W. x 24"H x 35 1/2" D. All parts are pre-cut and predrilled for easy assembly. The Contemporary cabinet is available in either mahogany or birch, and the Traditional cabinet is available in mahogany suitable for the finish of your choice. Beautiful hardware supplied. Shpg. Wt. 46 lbs.

Plan your own
Hi-Fi System...



HEATH COMPANY • Benton Harbor 20,
Michigan
a subsidiary of Daystrom, Inc.

HEATHKIT
MODEL RP-3
\$64⁹⁵



**HIGH FIDELITY
RECORD CHANGER KIT**

Every outstanding feature you could ask for in a record changer is provided in the Heathkit RP-3, the most advanced changer on the market today. The unique turntable pause during the change cycle saves wear and tear on your records by eliminating the grinding action caused by records dropping on a moving turntable or disk. Record groove and stylus wear are practically eliminated through proper weight distribution and low pivot point friction of the tone arm. Clean mechanical simplicity and precision parts give you turntable performance with the automatic convenience of a record changer. Flutter and wow, a major problem with automatic changers, is held to less than 0.18% RMS. An automatic speed selector position allows intermixing 33 1/3 and 45 RPM records regardless of their sequence. Four speeds provided: 16, 33 1/3, 45 and 78 RPM. Changer is supplied complete with GE VR II cartridge with diamond LP and sapphire 78 stylus, changer base, stylus pressure gauge and 45 RPM spindle. Shpg. Wt. 19 lbs.

"BASIC RANGE" HI-FI SPEAKER SYSTEM KIT

The popularity of this modestly priced speaker system attests to its high fidelity performance. The SS-2 provides an ideal basic speaker for your home hi-fi system. Flexibility of design allows it to be used as a table top model or as an attractive consolette with optional legs. May also be used as a supplementary speaker in more advanced systems or as replacement speaker for TV sets, etc. The specially designed tweeter horn rotates 90 degrees allowing you to use the speaker in an upright position if desired, as in the Heathkit stereo wing speaker enclosures. Total frequency range is from 50 to 12,000 cycles-per-second. An 8" mid-range woofer covers from 50 to 1,600 CPS while a compression-type tweeter with flared horn covers 1,600 to 12,000 CPS. Both speakers are by Jensen. A variable balance control allows level adjustment of the high frequency speaker. Power rating is 25 watts. Constructed of 1/2" veneer-surfaced plywood suitable for light or dark finish. All wood parts are pre-cut and pre-drilled for simple, quick assembly. An added feature of the SS-2 is that, although an outstanding performer in its own right, it may be combined with the SS-1B "range extending" speaker system later to extend the frequency range at the high and low ends of the audio range. Build in just one evening for many years of listening enjoyment. Shpg. Wt. 26 lbs.

ATTRACTIVE BRASS TIP ACCESSORY LEGS convert SS-2 into handsome consolette. 14" legs screw into brackets provided. All hardware included. Shpg. Wt. 3 lbs. No. 91-26. \$4.95.

Assemble it in

Just One Evening



OPTIONAL LEGS
NO. 91-26 \$4.95

DIAMOND STYLUS HI-FI PICKUP CARTRIDGE

MODEL MF-1 \$26.95

Replace your present pickup with the MF-1 and enjoy the fullest fidelity your library of LP's has to offer. Designed to Heath specifications to offer you one of the finest cartridges available today. Nominally flat response from 20 to 20,000 CPS. Shpg. Wt. 1 lb.



"RANGE EXTENDING" HI-FI SPEAKER SYSTEM KIT

Designed exclusively for use with the SS-2, the SS-1B employs a 15" woofer and a super tweeter horn to extend the range of the SS-2 to an overall response of ± 5 db from 35 to 16,000 CPS. When used together the two units form an integrated four-speaker system and are designed to combine into a single piece of attractive furniture. Impedance of the SS-1B is 16 ohms and power rating 35 watts. A control is provided to limit the output of the super tweeter. Constructed of beautiful 3/4" veneer-surfaced plywood suitable for light or dark finish of your choice. All parts are pre-cut and pre-drilled for simple assembly. No woodworking experience required. All hardware included. Shpg. Wt. 80 lbs.

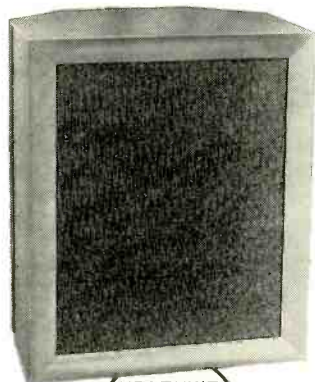

HEATHKIT
MODEL SS-1B

\$99.95

Extended
Frequency Range
for Your SS-2

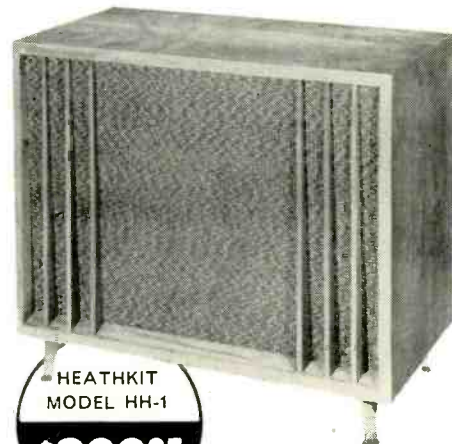

HEATHKIT
MODEL HH-1

\$299.95

"LEGATO" HI-FI SPEAKER SYSTEM KIT

It is difficult to describe in words the performance of this magnificent speaker system. You may never find absolute perfection in reproduced sound, but the Legato comes as close to achieving it as anything yet devised. Perfect balance, precise phasing, and adequate driver design combine to produce the superb quality of reproduction inherent in this instrument. The crisp, clear high frequencies and rich full bass engulf you in a sea of life-like tone. Two 15" Altec Lansing low frequency drivers cover frequencies from 25 to 500 CPS while a specially designed exponential horn with high frequency driver covers 500 to 20,000 CPS. The unique crossover network is built-in making electronic crossovers unnecessary. The Legato emphasizes simplicity of line and form to blend with modern or traditional furnishings. Constructed of 3/4" veneer-surfaced plywood in either African mahogany or white birch suitable for light or dark finishes of your choice. All parts are pre-cut and pre-drilled for easy assembly. Shpg. Wt. 195 lbs.

Easy to buy...

Easy to build

Easy to use...



**HEATH
COMPANY**

Benton Harbor 20,
Michigan

High Fidelity AM
and FM reception
in a Single Set

HEATHKIT
MODEL PT-1
\$89⁹⁵



Professional Stereo-Monaural AM-FM Tuner Kit

Enjoy stereophonic broadcasts as well as outstanding individual AM and FM radio reception with this deluxe 16-tube AM-FM-stereophonic tuner combination. Features include three etched circuit boards for high stability and ease of construction, prewired and prealigned FM front end, built-in AM rod antenna, tuning meter, FM-AFC (automatic frequency control) with on-off switch, and flywheel tuning. A multiplex jack is also provided. AM and FM circuits are tuned individually making it ideal for stereo applications since both AM and FM can be used at the same time. A switch selected tuning meter functions on either AM or FM. Cathode follower outputs with individual level controls are provided for both AM and FM. Other features include variable AM bandwidth, 10 kc whistle filter, tuned-cascade FM front end, FM AGC and amplified AVC for AM. Anywhere from 1 to 4 limiters or IF's assure smooth, non-flutter reception on weak or strong stations alike. The silicon diode power supply is conservatively rated and is fuse-protected assuring long service life. Flywheel tuning combined with new edge-lighted slide-rule dial provide effortless tuning. Use of three printed circuit boards greatly simplifies construction. Vinyl-clad steel cover is black with inlaid gold design. Shpg. Wt. 20 lbs.



MODEL FM-3A
\$26⁹⁵

HIGH FIDELITY FM TUNER KIT

The Heathkit FM-3A Tuner will provide you with years of inexpensive hi-fi enjoyment. Features broadband circuits for full fidelity and better than 10 uv sensitivity for 20 db of quieting. Covers the complete FM band from 88 to 108 mc. Stabilized, temperature-compensated oscillator assures negligible drift after initial warmup. Employs a high gain cascode IF amplifier and has AGC. Power supply is built-in. IF and ratio transformers are prealigned as is the front end tuning unit. Two outputs provided, one fixed, one variable, with extra stage of amplification. Shpg. Wt. 8 lbs.

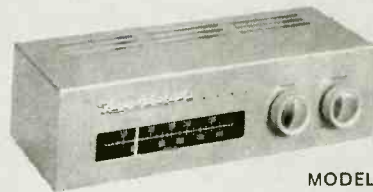

MODEL BC-1A
\$26⁹⁵

HIGH FIDELITY AM TUNER KIT

The BC-1A incorporates many features not usually expected in an AM circuit particularly in this low price range. It features a special detector using crystal diodes and broad band-width IF circuits for low signal distortion. Audio response is ± 1 db from 20 CPS to 9 kc with 5 db of pre-emphasis at 10 kc to compensate for station rolloff. Covers the complete broadcast band from 550 to 1600 kc. Prealigned RF and IF coils eliminate the need for special alignment equipment. Incorporates AVC, two outputs, two antenna inputs and built-in power supply. Shpg. Wt. 9 lbs.



MODEL W-6M **\$109⁹⁵**

**"HEAVY DUTY" 70 WATT
HI FI AMPLIFIER KIT**

Designed for "rugged duty" called for by advanced hi-fi systems and P.A. networks. Silicon diode rectifiers assure long life and heavy duty transformer provides excellent power supply regulation. Variable damping control provides optimum performance with any speaker system. Quick change plug selects 4, 8 and 16 ohm or 70 volt output and the correct feedback resistance. Shpg. Wt. 52 lbs.

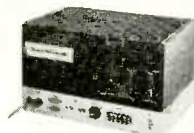

MODEL W-5M **\$59⁷⁵**

**25 WATT HI FI
AMPLIFIER KIT**

Enjoy the distortion-free high fidelity sound from one of the most outstanding hi-fi amplifiers available today. Features include a specially designed Peerless output transformer and KT66 tubes. Frequency response is ± 1 db from 5 to 160,000 CPS at 1 watt and within 2 db 20 to 20,000 CPS at full 25 watts output. Hum and noise are 99 db below 25 watts. Shpg. Wt. 31 lbs.

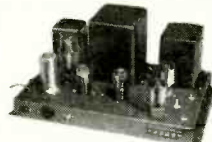

MODEL W-4AM **\$39⁷⁵**

**SINGLE CHASSIS 20 WATT
HI FI AMPLIFIER KIT**

A true Williamson-type high fidelity circuit, the W-4AM features 5881 push-pull output tubes and a special Chicago-Standard output transformer to guarantee you full fidelity at minimum cost. Harmonic distortion is 1.5% and IM distortion is below 2.7% at full 20 watt output. Hum and noise are 95 db below full output. Taps for 4, 8 or 16 ohm speakers. Shpg. Wt. 28 lbs.



MODEL W-3AM **\$49⁷⁵**

**DUAL CHASSIS 20 WATT
HI FI AMPLIFIER KIT**

Another famous Williamson-type high fidelity circuit, the W-3AM features the famous Acrosound TO-300 "ultralinear" output transformer and 5881 tubes. The power supply and main amplifier are on separate chassis for installation flexibility. Harmonic distortion is less than 1% and IM distortion is less than 1.2% at 20 watts. Shpg. Wt. 29 lbs.



HEATHKIT
MODEL SP-2
(STEREO)
\$56⁹⁵

**Monaural-Stereo Preamplifier Kit
(2-Channel Mixer)**

This unique kit allows you to purchase it in the monaural model if desired and then add the second or stereo channel later. The SP-2 features 12 separate inputs, six on each channel, with input level controls. Six dual concentric controls consist of: two 8-position selector switches, two bass, two treble, two volume level and two loudness controls, a scratch filter switch and a 4-position function switch. A separate on-off switch is provided. The function switch provides settings for stereo, 2-channel mix, channel A or B for monaural use. Inputs consist of tape, mike, mag phono and three high-level inputs. NARTB equalization and RIAA, LP, 78 record compensation are provided. A remote balance control is included. Printed circuit boards for easy assembly. Built-in power supply. Shpg. Wt. 15 lbs.



MODEL SP-1 (MONAURAL)
\$37⁹⁵ Shpg. Wt. 13 lbs.

MODEL C-SP-1 (CONVERTS SP-1 TO SP-2)
\$21⁹⁵ Shpg. Wt. 5 lbs.

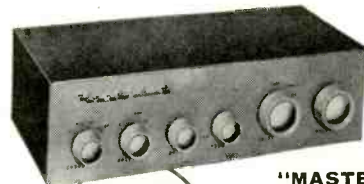

HEATHKIT
MODEL WA-P2
\$19⁷⁵

**"MASTER CONTROL"
PREAMPLIFIER KIT**

Control your hi-fi system with this compact unit. Features 5 switch-selected inputs to accommodate a record changer, tape recorder, AM tuner, FM tuner, TV receiver, microphone, etc., each with level control. Provision also for a tape recorder output. Equalization for records through separate turnover and rolloff switches for LP, RIAA, AES and early 78's. Shpg. Wt. 7 lbs.



MODEL W-7M
\$54⁹⁵

**"EXTRA PERFORMANCE" 55 WATT
HI FI AMPLIFIER KIT**

Enjoy this high fidelity power amplifier at less than a dollar per watt. Full audio output and maximum damping is conservatively rated at 55 watts from 20 CPS to 20 kc with less than 2% total harmonic distortion throughout the entire range. Features famous "bas-bal" circuit, EL-34 output tubes and special 70 volt output. Shpg. Wt. 28 lbs.



MODEL
XO-1
\$18⁹⁵

**ELECTRONIC
CROSSOVER KIT**

This unique instrument separates high and low frequencies and feeds them through 2 amplifiers into separate speakers. Located ahead of the main amplifier, it virtually eliminates IM distortion and matching problems. Note: Not for use with Heathkit Legato speaker system. Shpg. Wt. 6 lbs.



MODEL UA-1
\$21⁹⁵

**"UNIVERSAL" 12 WATT HI FI
AMPLIFIER KIT**

The versatility and economy of this fine kit make it a truly "universal" hi-fi amplifier. An ideal basic amplifier for any hi-fi system or a perfect addition to gear your present hi-fi system to stereo sound. Uses 6BQ5/EL84 push-pull output tubes for less than 2% harmonic distortion throughout the entire audio range. Shpg. Wt. 13 lbs.

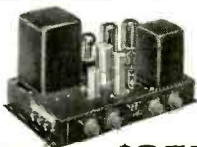

MODEL A-9C **\$35⁵⁰**

**GENERAL-PURPOSE
20 WATT AMPLIFIER KIT**

Designed for home installation as well as for PA requirements, the A-9-C combines a preamplifier, main amplifier and power supply all on one chassis. Four switch-selected inputs are provided as well as separate bass and treble tone controls offering 15 db boost and cut. Detachable front plate allows for custom installation. Shpg. Wt. 23 lbs.



MODEL SW-1 **\$24⁹⁵**

SPEEDWINDER KIT

A real timesaver, the SW-1 leaves your tape recorder free for operation while rewinding tape at the rate of 1200 feet in 40 seconds. Prevents unnecessary wear to the tape and recorder. Handles up to 10 1/2" tape reels. Handles 800' reels of 8 and 16 millimeter film as well. Automatic shutoff prevents whipping at end of rewind. Shpg. Wt. 12 lbs.



NO. 401-6
\$7⁵⁰

12" UTILITY SPEAKER KIT

Replace inferior speakers in radio or TV sets to obtain better tone quality or set up an auxiliary speaker for testing purposes with this convenient, high quality speaker. The speaker will handle up to 12 watts with a frequency response of ±5 db from 50 to 9,000 CPS. Speaker impedance is 8 ohms and has a 6.8 oz. magnet. An outstanding dollar value. Shpg. Wt. 7 lbs.



MODEL TK-1 **\$9⁹⁵**

COMPLETE TOOL SET

These basic tools are all you need to build any Heathkit. The pliers, diagonal side cutters, 2 screwdrivers, and soldering iron are all of top quality case hardened steel for hard duty and long life. Pliers and side cutters are equipped with insulated rubber handles for safety. A good example of just how easy Heathkit building really is. Shpg. Wt. 3 lbs.

HIGH FIDELITY TAPE RECORDER KIT

The model TR-1A tape deck and preamplifier combination provides all the facilities you need for top quality monaural recording/playback with fast forward and rewind functions. $7\frac{1}{2}$ and $3\frac{3}{4}$ IPS tape speeds are selected by changing belt drive. Flutter and wow are held to less than 0.35%. Frequency response at $7\frac{1}{2}$ IPS ± 2.0 db 50-10,000 CPS, at $3\frac{3}{4}$ IPS ± 2.0 db 50-6,500 CPS. Both units may be mounted together or separately affording high flexibility in every application. Features include NARTB playback equalization—separate recording and playback gain controls—cathode follower output and provision for mike or line input. Signal-to-noise ratio is better than 45 db below normal recording level with less than 1% total harmonic distortion. A filament balance control allows adjustment for minimum hum level. Complete instructions provided for easy assembly. Overall dimensions of tape deck and preamp is $15\frac{1}{2}$ " W. x $13\frac{1}{2}$ " H. x 8" D. Shpg. Wt. 24 lbs.



Includes tape deck assembly, preamplifier and roll of tape.

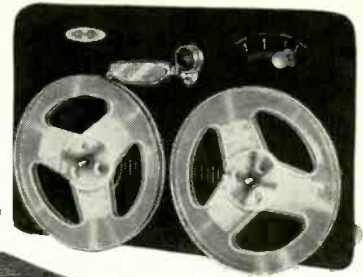

HEATHKIT
TE-1
\$39.95



Tape preamplifier sold separately if desired. Shpg. Wt. 10 lbs.

Many more Heathkits to choose from

hi-fi: Amplifiers—Preamplifiers—Speaker Systems—AM/FM Tuners—Equipment Cabinets—Record Player—Tape Recorder—Electronic Crossover—Stereo Equipment.

test: Oscilloscopes—Voltmeters—RF Signal Generators—AF Generators—Analyzers—Battery Eliminators—Tube Checkers—Condenser Checkers—Computer—Color Bar & Dot Generator—Sweep Generator—Impedance Bridge—Power Supplies—Probe Kits—R/C Decade & Substitution Kits.

ham radio: Transmitters—Receivers—Antenna Accessories—Voice Control—Conelrad Alarm—Variable Frequency Oscillator—SSB Adapter—"Q" Multiplier.

marine: Direction Finders—Marine Converter—Rudder Position Indicator—Fuel Vapor Detector—Charge Indicator—Power Meter.

general: Tool Set—6-Transistor Portable Radio—Radiation Counter—Electronic Timer—Crystal Receiver—Superheterodyne Receiver.

Send for Catalog describing over 100 easy-to-build electronic instruments in kit form. Complete specifications and detailed information on Hi-Fi—Test—Ham and Marine kits.

Save with Heathkits... the quality name in kit form electronics.



**"BOOKSHELF" 12 WATT
AMPLIFIER KIT**

Here are a few of the reasons why this attractive amplifier is such a tremendous dollar value. You get rich, full range, high fidelity sound reproduction with low distortion and noise . . . plus "modern styling". The many features include full range frequency response 20 to 20,000 CPS ± 1 db with less than 2% distortion over this range at full 12 watt output—its own built-in preamplifier with provision for three separate inputs: mag phono, crystal phono, and tuner—RIAA equalization—separate bass and treble tone controls—special hum control—and it's easy-to-build. Complete instructions and pictorial diagrams show where ever part goes. Cabinet shell has smooth leather texture in black with inlaid gold design. Cabinet measures 12½" W. x 8¾" D. x 4¾" H. Output transformer has taps at 4, 8 and 16 ohms to match the speaker of your choice. An ideal unit to convert your present hi-fi system to stereo sound. Shpg. Wt. 15 lbs.

**An Amplifier, Preamplifier
all in one!**



HEATHKIT
EA-2
\$28⁹⁵

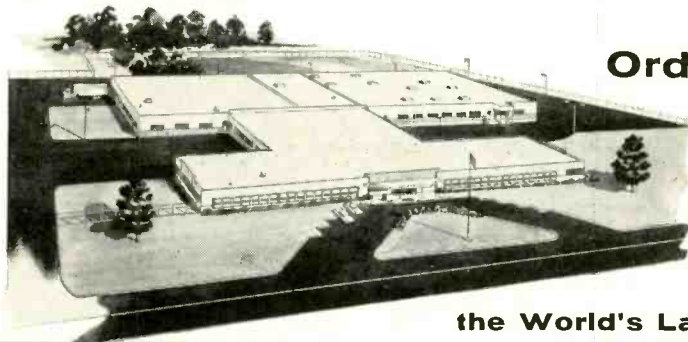

Order direct by mail...

Save ½ or more over equivalent ready-made products by buying direct and assembling them yourself. Heathkit Style, Performance and Quality are unsurpassed!

**the World's Largest Manufacturer
of Electronic Instruments in Kit Form**



HEATH COMPANY BENTON HARBOR 20, MICH.

HE a subsidiary of Daystrom, Inc.

NOTE: all prices and specifications subject to change without notice.

Enclosed find () check () money order. Please ship C.O.D. ()

On Express orders do not include transportation charges—they will be collected by the express agency at time of delivery.

On Parcel Post Orders include postage for weight shown. All prices are NET F.O.B. Benton Harbor, Michigan, and apply to Continental U.S. and Possessions only. 20% Deposit required on all C.O.D. orders.

Name _____
Address _____
City & Zone _____ State _____
(PLEASE PRINT)

SHIP VIA
 Parcel Post
 Express
 Freight
 Best Way

QUANTITY	ITEM	MODEL NO.	PRICE
<input type="checkbox"/> SEND FREE HEATHKIT CATALOG			POSTAGE
			TOTAL

HEATHKITS are also available at your Dealer

see listing on next page

**NOT
JUST
BETTER...**



**For ALL Radio-TV
Replacement Applications**

Naturally you want to supply your customers with the best replacement electrolytic capacitors to insure a satisfactory repair job without costly callbacks. That's exactly what you do when you use only Aerovox AFH twist-prong electrolytics. Aerovox offers you all the latest refinements — 85°C operation, improved hermetic sealing, rugged prongs and terminals (including printed-wiring types), and only high purity aluminum foil construction throughout.

But quality alone is only part of the deal. Aerovox offers you the widest selection of exact-duplicate replacements in the entire industry. Your local Aerovox Distributor stocks every rating you need. Call on him today for all your capacitor requirements and at the same time ask for your free copy of the latest Aerovox catalog.

BUY THEM BY THE KIT...

see the AFH "Stack-a-Lytic" kits (AK-400 and AK-401) at your Aerovox Distributor. A selection of 8 or 16 popular replacement units in a FREE metal storage rack with stacking feature.



**AEROVOX
CORPORATION
DISTRIBUTOR DIVISION
NEW BEDFORD • MASSACHUSETTS**

AUDIO—HIGH FIDELITY

(Continued from page 59)

This is the recorded version to own since Shelley Manne and Victor Feldman are regular members of the band heard in the Gunn series. Fabulous sound.

MAHLER: Symphony No. 2 in C Minor
Hermann Scherchen conducting Vienna Academy Chorus and Vienna State Opera Orchestra
Westminster Stereo Record (2) WST-206

Some of Mahler's more grandiose ideas for the concert hall begin to make sense on records, with the advent of stereo. Many of his effects depend upon a truly fantastic range of orchestral dynamics. These vary from barely audible subterranean comment by the cellos and double basses to the full power of one of the largest instrumental outlays in the symphonic repertoire. Scherchen handles the chorus and orchestra with conviction in full-fledged stereo. Westminster's engineers, to their great credit, have resisted the temptation to pull up the gain even during the passages when the horns are heard offstage.

Music for Bang, Baa-room and Harp
Dick Schory's New Percussion Ensemble
RCA Victor Stereo Record LSP-1866

A wild idea has been carried out with painstaking effort where the Chicago Symphony Orchestra usually plays. A mountain of percussion equipment went to the stage of Chicago's Orchestra Hall. Twelve percussionists participated in these stereo experiments in the use of space. A different mike setup was used for each selection. This disc packs a wallop almost equal to the stereo tape version (RCA CPS-203).

Castle Jazz Band in Stereo
Stereo Records S-7021

It takes a spare-time musician to sound completely spontaneous and unworried in these traditional jazz favorites. Don't count on keeping a straight face when this easy-working West Coast group throws itself into *Tiger Rag*, *Royal Garden Blues*, etc. Stereo permits snug ensemble work yet maintains the identity of each player.

STRAVINSKY: The Firebird (Complete Ballet)
Ernest Ansermet conducting L'Orchestre de la Suisse Romande
London FFSS Stereo Record CS-6017

A few minutes' listening on a top system will convince Firebird fanciers that they have splurged wisely on this one. The complete Ansermet version of this score had no competition in the mono catalog. It should stand apart for years to come in this full-range stereo recording. Lowest and highest strings are accorded equal realism.

Sabicas and Escudero
Montilla Stereo Disc FMS-2005

Flamenco music by guitarists Sabicas and Escudero offers an excellent test of a stereo disc system's transient response. The placement of the two performers is particularly useful. Each guitar occupies its own channel. Sound is very clean throughout the range of the instruments. In addition to the check on transients and channel balance, this record offers another and more subtle test. Heard on two loudspeakers that project a narrow beam of sound, each guitar will appear to issue from its own speaker. On the other hand, two speakers capable of adequate dispersion will place the guitars in their proper places, adjacent to the inner edge of each speaker enclosure.

TCHAIKOWSKY: Symphony No. 6 (Pathétique)
Jean Martinon conducting Vienna Philharmonic Orchestra
London FFSS Stereo Record CS-6052

The enormous activity within a symphony orchestra during the marchlike third movement is very evident in this stereo version of the Tchaikowsky *Sixth*. When the low bass percussion makes its entrance, it does so at the bottom of today's best woofers. The orchestra appears more at home in this music than does the French conductor.

Beat Tropicale
José Bethancourt and His Orchestra
Harry Coon and Richard Campbell, Drums
Concert-Disc (Stereo) CS-33

The famous marimba of José Bethancourt paces the Latin rhythms on side A of this release, but side B will win out with audiophiles who are searching for the unusual. The drum team of Coon and Campbell, with the aid of sound-on-sound recording and a reverb chamber or two, quite frankly, is out to give your sound system a hard time. Their *Savage Drum Fantasy* may

confound quite a few stereo pickups. This record makes no attempt to win the goodwill of the peace-loving resident in the next apartment.



Something For Both Ears
World Pacific Stereo Demonstration Disc HFS-2

This \$2.98 stereo sampler offers some of the high points of the World Pacific lineup of artists who have brought fame to this West Coast jazz label. Tiptop audio work and performers such as Gerry Mulligan, Chico Hamilton, Gil Evans and the Mastersounds should ensure top circulation at this price. The distortion figures audible on the record rate with the lowest available in stereo today. Don't miss this one. It is well worth the price of admission!

HAYDN: Symphony No. 100 in G (Military)
Symphony No. 101 in D (Clock)
Mogens Woldike conducting Vienna State Opera Orchestra
Vanguard Stereo Demonstration Disc SRV-109-SD

Favorites on stereo tape, these well-balanced performances offer even better detail on Vanguard's latest stereo discs. Exceptionally clean cymbal in the important movement of the *Military Symphony*. Both works benefit greatly from the directionality used here.

Plain Vanilla
Larry Fotine and Beale Street Buskers
Bel Canto Stereo Record SR-1001

This last-minute arrival from Bel Canto offers Dixieland music that smashes through to new heights of realism. The undeviating volume level of the crisp material, the obvious superiority of the original tape and the fabulous transfer to stereo disc combine to create a new listening experience. I prefer this disc to the stereo tape version of the same music (Bel Canto STB-38).

Jan Peerce in Las Vegas
Joe Reisman and His Orchestra
RCA Victor Stereo Tape CPS-119
(7-inch; playing time, 25 min. \$8.95)

Furnish your own spotlight and Jan Peerce will sing in your own living room as he did at a Las Vegas night spot. A stereo system with good presence will place his voice several yards in front of the orchestra. Peerce fans probably will find nothing corny in ballads such as *Blue Bird of Happiness*. Most listeners, once they have assumed the mood of a typical Las Vegas visitor, will be stirred by songs such as *Granada*, *Around the World*, *September Song* and the aria *Vesti la Giubba*.

Norrie Paramor's Jet Flight
Capitol Stereo Disc ST-10190

A resourceful English arranger-conductor uses an unusually responsive orchestra to span the music of ten countries. Stereo alone can do justice to the scope of the arrangements which incorporate ingenious and tasteful use of sound effects by the orchestra to heighten the musical atmosphere of the individual countries. A tremendous sound stage is covered with ease by the mike set up. A standout popular item.

Viva España
Manuel Gomez de Arriba conducting Banda de Aviacion Española
Montilla Stereo Disc FMS-2006

The importance of acoustical environment in stereo recording is forcefully demonstrated on this disc. These nine orchestral interludes from the Spanish lyrical theatre are played by a well-

AUDIO—HIGH FIDELITY

trained concert band in a very live hall. The reverberation interval attains maximum sonority without introducing tubbiness. Some overtones are heard in better detail on this wide-range disc than they were on the stereo tape version (FMT-1004).

Note: Records below are 12-inch mono LP's and play back with RIAA curve unless otherwise indicated.

STRAUSS: Death and Transfiguration
Dance of the Seven Veils
Dance Suite After Couperin
 Artur Rodzinski conducting Philharmonic Orchestra

Capitol-EMI G-7147

Artur Rodzinski's last recording sessions were held in EMI's studios. This is the first of three records that will stem from sessions held before his death last November. It documents, in realistic sound, the splendid service to Richard Strauss that Rodzinski could perform with a topflight orchestra. This Capitol release is an important record.

WALTON: Belshazzar's Feast
 Sir Malcolm Sargent conducting Huddersfield Choral Society and Royal Liverpool Philharmonic Orchestra

Capitol-EMI G-7141

If this performance ever appears in stereo, it will be a stunning show. In the meantime, we can only imagine the disposition of the double mixed choir, large orchestra, organ and two brass ensembles—the latter usually placed to right and left of the conductor. Crisp sound that is most vivid in color.

FRANCK: Symphony in D Minor
Symphonic Variations
 Charles Munch conducting Paris Conservatory Orchestra

Richmond B-19022

The previous comment on London's low-numbered stereo discs applies to their mono reissues on the Richmond label. This disc, although high in number, is inferior to the Ansermet recording of Debussy's *La Mer* (Richmond B-19007) reviewed some months ago. The inclusion of the *Symphonic Variations for Piano and Orchestra* would indicate that crowding lowers audio quality even in the lower-priced pressings.

Witches' Brew
 Alexander Gibson conducting New Symphony Orchestra of London

RCA Victor LM-2225

RCA's affiliation with Decca in England provides an opportunity to hear the acoustics of Kingsway Hall, London, on a domestic label other than London. Audiophiles have long been familiar with the remarkable sound of this hall. Its characteristic sonority is heard to good advantage in this collection of music stressing the supernatural. Moussorgsky's *Night on Bare Mountain*, the Liszt *Mephisto Waltz* and Saint-Saens' *Danse Macabre* are both really standout items.

CORELLI: Concerto Grossi, Opus 6 (Complete)
 Jorgen Ernst Hansen conducting Chamber Orchestra of Societas Musica, Copenhagen

Vanguard BG 585/7

This Danish chamber orchestra brings to the music of Corelli a poise and balance all its own. The sound is the sweetest of existing versions. This is another in the series of Vanguard three-record sets offered at the price of two discs, a policy gladly condoned by collectors who are always seeking complete editions of great music.

KHATCHATURIAN: Symphony No. 2
 Nathan Rachlin conducting State Radio Orchestra of U. S. S. R.

M-G-M GC-30002

Until recent years, master tapes imported from Russia were far below the world average in audio. The situation has now improved to the point where records based on Russian tapes merit playback on a wide-range system. M-G-M shows enterprise in making available a recent recording of this colorful Khatchaturian symphony. An earlier disc with the composer conducting (Colosseum 136) does not match this new release. END

Name and address of any manufacturer of records mentioned in this column may be obtained by writing Records, RADIO-ELECTRONICS, 154 West 14 St., New York 11, N.Y.

MAY, 1959

Authorized HEATHKIT Dealers

Convenient "over-the-counter" delivery is now available through any of the Authorized Heathkit Dealers listed below. Although you will find the price of Heathkits slightly higher when buying locally, we're sure you'll agree that this increase is justified. Your dealer absorbs all transportation charges, carries a complete stock of kits for immediate de-

livery, provides demonstration facilities, offers you a reliable source for parts and fast service... and stands ready to counsel or advise you on any problem that might arise.

This new service does not affect your continued privilege to buy directly from Heath Company if you prefer.

NOW READY TO SERVE YOU...

CALIFORNIA

BAKERSFIELD
 Kiesub Corporation
 2615 "F" Street

BERKELEY
 zacKIT Corporation
 2002 University Avenue

CHICO
 Dunlap Radio & TV
 928 Main Street

EL CAJON
 Telrad Electronics
 182 East Main Street

FRESNO
 Dunlap Radio & TV
 2617 Tulare Street

LONG BEACH
 Kierulff & Company
 1501 Magnolia

LOS ANGELES
 Bushnell Sound Corp.
 12024 Wilshire Boulevard

MERCED
 Kierulff & Company
 6303 E. Corsair

MARYSVILLE
 Dunlap Radio & TV
 5th & "J" Street

MERCED
 Dunlap Radio & TV
 234 West 17th Street

MODESTO
 Dunlap Radio & TV
 419 10th Street

NATIONAL CITY
 Telrad Electronics
 639 National

ONTARIO
 Kiesub Corporation
 124 N. Benson

OXNARD
 Kierulff & Company
 508 E. Date Street

PALO ALTO
 Zack Electronics
 654 High Street

SACRAMENTO
 Dunlap Radio & TV
 1800 22nd Street

SAN BERNARDINO
 Kierulff & Company
 390 South Mt. Vernon

SAN DIEGO
 Telrad Electronics
 3453 University Avenue

SAN FRANCISCO
 Zack Electronics
 1422 Market Street

SANTA BARBARA
 zacKIT Corporation
 513 State Street

STOCKTON
 Dunlap Radio & TV
 27 North Grant Street

TARZANA
 Valley Sound Corp.
 18841 Ventura Boulevard

VAN NUYS
 Kierulff & Company
 14511 Delano

VISALIA
 Dunlap Radio & TV
 1725 Mooney Avenue

DELAWARE

WILMINGTON
 Radio Electric Service Co.
 Third & Tainall Streets

FLORIDA

COCOA
 Thurow Distributors, Inc.
 540 St. Johns Street

MIAMI
 Thurow Distributors, Inc.
 1800 Northwest 23rd Street

LOUISIANA

LAFAYETTE
 Sterling Radio Products, Inc.
 1005 Cameron Street

MARYLAND

SALISBURY
 Radio Electric Service Co.
 736 South Salisbury Boulevard

MASSACHUSETTS

BOSTON
 Audionics, Incorporated
 1348 Boylston Street

MICHIGAN

ALLEN PARK
 Volta Electronics
 6716 Park Avenue

DETROIT
 High Fidelity Workshop
 16400 West Seven Mile Road

MINNESOTA

MINNEAPOLIS
 Audio King Company
 913 West Lake Street

NEW JERSEY

ATLANTIC CITY
 Radio Electric Service Co.
 452 North Albany Avenue

CAMDEN
 Radio Electric Service Co.
 513 Cooper Street

MOUNTAINSIDE
 Federated Purchaser, Inc.
 1021 U. S. Route #22

NEWARK
 Federated Purchaser, Inc.
 114 Hudson Street

NEW YORK

BELLEROSE
 Cross Island Electronics, Inc.
 247-40 Jericho Turnpike

BROOKLYN
 Acme Electronics, Incorporated
 59 Willoughby Street

FARMINGDALE
 Gem Elec. Distributors, Inc.
 34 Hempstead Turnpike

FOREST HILLS
 Beam Electronics, Incorporated
 101-10 Queens Boulevard

HICKSVILLE
 Gem Elec. Distributors, Inc.
 236 Broadway

MINEOLA
 Arrow Electronics, Incorporated
 525 Jericho Turnpike

MT. VERNON
 Davis Radio Distributing Co., Inc.
 70 East Third Street

NEW YORK
 Arrow Electronics, Incorporated
 65 Cortlandt Street

HARVEY RADIO COMPANY
 103 West 43rd Street

NO. CAROLINA

CHARLOTTE
 Southeastern Radio Supply Co.
 1200 W. Morehead Street

GREENSBORO
 Southeastern Radio Supply Co.
 404 N. Eugene Street

FAYETTEVILLE
 Southeastern Radio Supply Co.
 525 Gillespie Street

KINSTON
 Southeastern Radio Supply Co.
 408 N. Heritage Street

RALEIGH
 Southeastern Radio Supply Co.
 414 Hillsboro Street

OHIO

CHILLICOTHE
 Buckeye Electronics Dist., Inc.
 565 North High St.

COLUMBUS
 Buckeye Electronics Dist., Inc.
 836-246 East Long Street

DAYTON
 Ham 'N Hi-Fi, Inc.
 826 North Main Street

SREPCO, INC.
 314 Leo Street

HAMILTON
 Srepc, Inc.
 145 Highland Avenue

OHIO

MIDDLETOWN
 Srepc, Inc.
 2104 Brentwood Avenue

NEWARK
 Buckeye Electronics Dist., Inc.
 114 Union Street

PIQUA
 Srepc, Inc.
 R. R. #1, Box 308

SPRINGFIELD
 Standard Radio-Springfield, Inc.
 1300 S. Paris Road

ZANESVILLE
 Buckeye Electronics Dist., Inc.
 120 South Eighth Street

OREGON

PORTLAND
 Eccles Electric Company
 237 Northeast Broadway

SALEM
 Cecil Farnes Company
 440 Church Street, Northeast

PENNSYLVANIA

ALLENTOWN
 Federated Purchaser, Inc.
 1115 Hamilton Street

EASTON
 Federated Purchaser, Inc.
 925 Northampton Street

PHILADELPHIA
 Austin Electronics, Inc.
 1421 Walnut Street

RADIO ELECTRIC SERVICE CO.
 701 Arch Street

RADIO ELECTRIC SERVICE CO.
 3412 Germantown Avenue

RADIO ELECTRIC SERVICE CO.
 5930 Market Street

WILLOW GROVE
 Radio Electric Service Co.
 29 York Road

YORK
 Radio Electric Service Co.
 1114 Roosevelt Extension

RHODE ISLAND

PROVIDENCE
 Audionics, Incorporated
 790 North Main Street

TEXAS

BEAUMONT
 Sterling Radio Products, Inc.
 1160 Laurel Street

BRYAN
 Sterling Radio Products, Inc.
 2615 Texas Avenue

DALLAS
 Hillcrest Records, Inc.
 6309 Hillcrest Avenue

HOUSTON
 Sound Equipment, Incorporated
 2506 Crawford Street

HOUSTON
 Sterling Radio Products, Inc.
 1616 McKinney Avenue

LUFKIN
 Sterling Radio Products, Inc.
 428 Atkinson Street

VIRGINIA

ARLINGTON
 Key Electronics, Inc.
 126 South Wayne Street

WASHINGTON

SEATTLE
 Seattle Radio Supply, Inc.
 2117 Second Avenue

WISCONSIN

MADISON
 Hi-Fi Corner
 401 State Street

SATTERFIELD ELECTRONICS, INC.
 1900 South Park

MILWAUKEE
 Hi-Fi Center
 4236 West Capitol Drive

NETZOW'S
 2630 North Downer Avenue

Careful selection of reliable qualified dealers is a slow process... so please bear with us if your area has not been covered. Thank you.

HEATH COMPANY
 Benton Harbor, Mich.

A Subsidiary of **Daystrom, Inc.**

INDUCED- WAVEFORM ANALYZER SPEEDS SIGNAL TRACING



Inside dope on an instrument that lets you signal-trace a TV set from above the chassis

By **ROBERT F. SCOTT**
TECHNICAL EDITOR

SIGNAL tracing is a speedy and sure-fire method of troubleshooting electronic equipment. But, whether you use a scope, rf-if signal tracer or a pair of phones with a simple detector and blocking capacitor, you invariably have to pull the chassis and, in many instances, expose yourself and the tracer to accidental contact with high voltages. Furthermore, in a complex circuit you may spend a lot of time locating suitable test points. This is not the case when using a waveform analyzer.

A waveform analyzer is a special type of oscilloscope accessory that uses special capacitive pickup probes to make every glass tube and high-level signal lead a potential test point. Thus the technician traces signals and localizes the defective stage in the time required to move the probe from one tube to another. He can spot and eliminate some troubles without even seeing the underside of the chassis.

The signals to be viewed are picked up from the plates of the various stages by special capacitive probes. A large ring-shaped probe slips over octal and GT type octal tubes, and a smaller one fits over 7- and 9-pin miniature tubes. A half-circle probe is used on tubes larger than GT types and on multi-section tubes. The signal is picked up from the desired section by moving the probe around and up and down the envelope. This probe is also used to trace high-level signals through unshielded leads. In addition to speed and convenience, capacitive probes have the

added advantage of providing test and alignment information without loading the circuits.

How the analyzer works

The signal picked up by the probe is fed through the input jack to the INPUT FUNCTION selector switch (S2). See Fig. 1, the schematic of the Win-Tronix model 850 Induced Waveform Analyzer. Position 1 (HIGH-GAIN AUDIO-VIDEO) is used when testing audio, video and low-frequency rf circuits. The incoming signal is fed directly to a high-gain wide-band cascode amplifier using a 6BK7-B. L3 and L4 peak the highs to extend the range and compensate for losses in the scope's high-frequency response.

V2-a amplifies the signal further and feeds it to the output cable (on the rear of the instrument) through a low-impedance gain control and section S2-c of the INPUT FUNCTION switch. The output cable connects to the scope's vertical amplifier input terminal. On this range, the analyzer increases the overall scope gain about 25 times.

When signal-tracing in low-frequency rf, audio and sync circuits, the signal can be heard and analyzed on phones plugged into the jack in the plate circuit of audio amplifier V2-b.

When the function selector is in positions 2 and 3, the signal picked up by the probe is fed to the input of a 12-channel turret type TV tuner. The tuner, shown in block form in Fig. 1, uses a 6BN4 rf amplifier and a 6CG8 mixer and oscillator. It has nine coil strips for TV channels and three spe-

cial coil strips for TV if ranges. The coil set for 3.58 to 4.5 mc is installed in place of the channel 11 coils; the one for 20.5 to 26.6 mc is in position 12 and the set of coils covering 40.5 to 46.5 mc is inserted in position 13. (The TV coil strips for channels 11, 12 and 13 are supplied with the analyzer and may be inserted in place of less desirable channels. Small stickers are supplied to be pasted on the channel-selector knob to identify the positions of the if channel strips.)

When selector S2 is in position 2, the RF-IF BAND selector (corresponding to the channel selector on a TV set) is turned to the same channel as the TV tuner when checking the set's rf circuits or to the corresponding video if channel when tracing signals in the if circuits.

When the RF-IF BAND selector is set to a TV channel or the 41-mc if channel, the signal is amplified by the 6BN4 and heterodyned in the 6CG8 to produce a 21-mc if. The 21-mc output of the tuner is fed to the input grid of amplifier V1 through a broad-band T-network consisting of the mixer plate coil (not shown) and L1 and L2. V1's grid resistor and blocking capacitor C3 provide an optimum time constant for grid-leak detection. The tuner's output is thus detected and then amplified by V1 and V2 and then fed to the scope and phones.

When the RF-IF BAND selector is in the 21-mc position, the oscillator is inoperative and the tuner acts as a straight-through amplifier.

The analyzer's voltage gain through the tuner is around 83 on 41 mc and channels 2-6, 71 at 21 mc and 62 on channels 7-13.

The RF-IF BAND selector is thrown to the 3.58-4.5-mc position when checking signals from a 3.58-mc color-reference oscillator or amplifier or a 4.5-mc sound if amplifier. The tuner then amplifies the signal and converts it to 21 mc. This signal is detected and then amplified by V1 and V2. The analyzer gain is about 40 times in this frequency range. Naturally, a wide-band scope is needed for this application.

When S2 is in either the RF-IF or 3.58-4.5-mc positions, the tuner must be biased down to prevent overloading on strong input signals. The GAIN control is a dual potentiometer with one section as a low-impedance attenuator feeding the output cable and the other section feeding a variable dc bias to the tuner. The two potentiometers are connected so zero bias is applied to the tuner when the control is in the maximum-output position. The analyzer's GAIN control should always be used instead of the scope's vertical gain control when handling high-level signals. Use the scope's vertical attenuator only to avoid having to operate with the GAIN control in the extreme counterclockwise (minimum-output) position.

Throwing S2 to DIRECT SCOPE INPUT connects the analyzer's input and output circuits and bypasses the internal amplifiers and attenuator.

TV signal tracing

Tracing a signal from the antenna to the cathode-ray tube and speaker

of a TV set is simple with the model 850 Induced Waveform Analyzer.

1. Checking the antenna

Set S2 to RF-IF and select an active channel on the analyzer's tuner. Connect one antenna lead to the inside ring, and the other to the outside ring of one of the capacitive probes. Connect the analyzer's output cable to the scope's vertical amplifier, and set the sweep to 30 or 7,875 cycles.

Fig. 2-a shows a typical pattern obtained with a 30-cycle sweep, 2-b a similar signal with a 7,975-cycle sweep. These composite video waveforms may be traced through rf, if and video circuits. Polarity may be reversed in some circuits.

2. The tuner

Remove the shields from the set's rf amplifier and mixer tubes. Slip the smallest probe over the rf amplifier and then the mixer and trace the composite video signal. (Disable the set's age circuit to get a strong easy-to-trace signal.)

3. Video if amplifiers

Set the RF-IF BAND selector to the set's if. With a good signal applied to the set's front end, pick up the if signal from the mixer plate. A signal at this point indicates that the oscillator and mixer are functioning.

As you move the probe tube by tube down the if strip, the signal level should increase with each stage. (In sets with germanium diode video detectors, pick up the signal at that point, with the smallest probe held close to the lead to the detector.)

4. Video detector and amplifiers

Set the scope's sweep to 7,875 cycles, and the analyzer's function selector to HIGH-GAIN AUDIO-VIDEO. Place the probe on the video detector. Compare the scope pattern (video and sync signals of one line) with that in the set's service data or with the typical patterns in Figs. 2-b and 2-c.

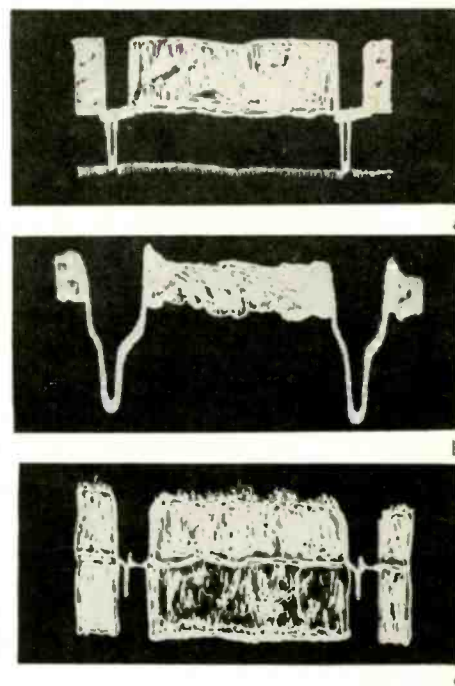

Fig. 2 a-c—Waveforms found at various points in a TV receiver. See text for details.

2-c is typically obtained with a 30-cycle sweep.

Move the probe to each successive video amplifier stage, looking for an increase in amplitude and sync phase reversal each time. (Some older sets use metal video output tubes. Make the pickup by slipping the probe over a loop made in the video output lead to the CRT socket.)

5. Sync circuits

Set the function selector to HIGH-GAIN

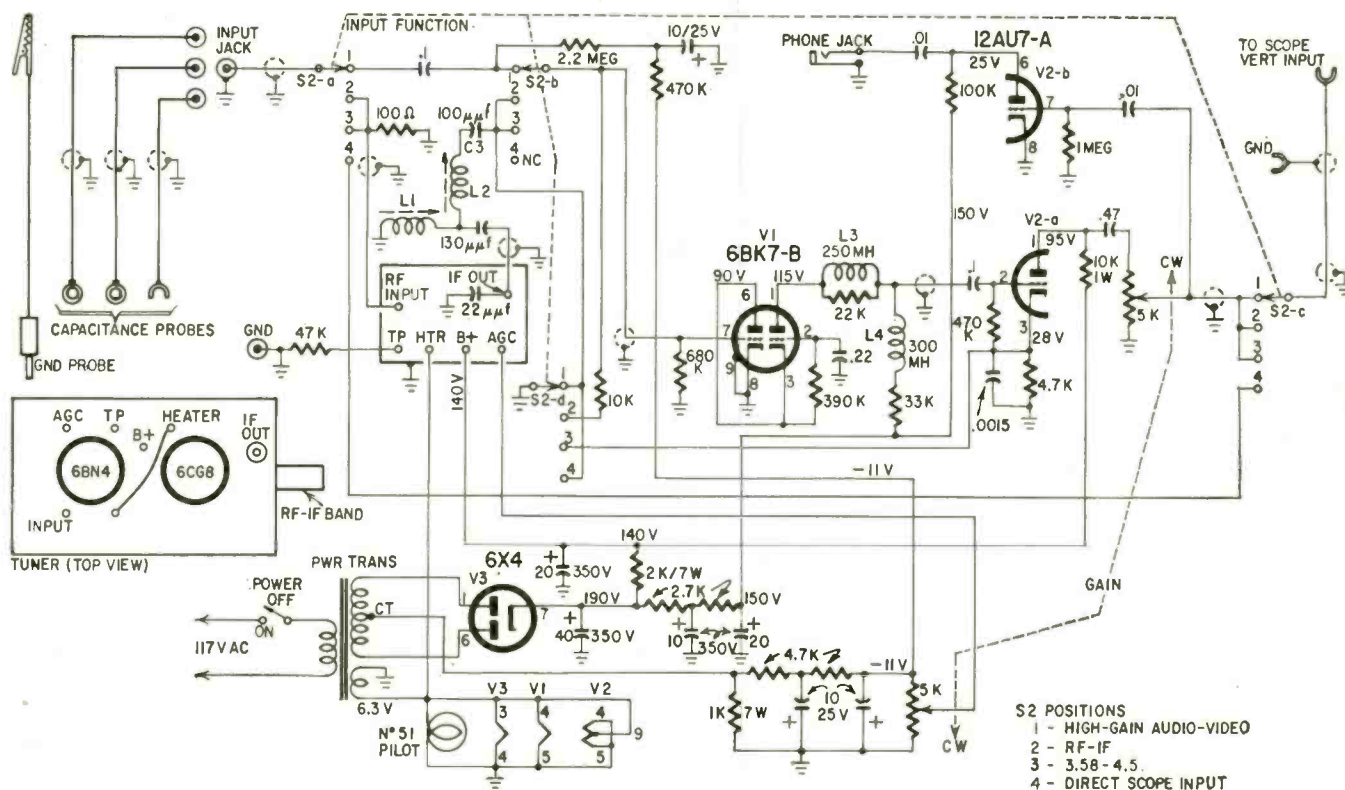
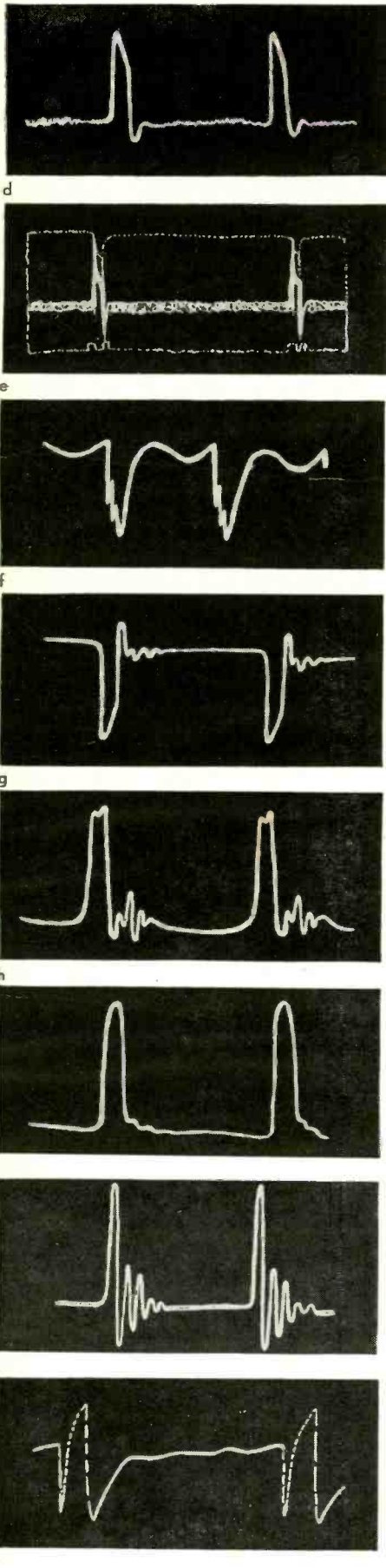

Fig. 1—Circuit of the induced waveform analyzer.

- S2 POSITIONS
 1 - HIGH-GAIN AUDIO-VIDEO
 2 - RF-IF
 3 - 3.58-4.5
 4 - DIRECT SCOPE INPUT



AUDIO-VIDEO, and the scope's sweep to 30 or 60 cycles for vertical and 7,875 or 15,750 cycles for horizontal sync tests. Slipping the probe over the first sync amplifier or separator, compare the waveforms obtained with those in the set's service data. Repeat the operation on successive sync stages. Figs. 2-d and 2-e illustrate typical horizontal and vertical sync waveforms, respectively, at the output of the sync separator with 7,875- and 30-cycle sweeps. (Semiconductor diodes may be used as horizontal phase detectors or afc phase comparators. Use the half-circle probe or the low-capacitance probe in Fig. 3 on the associated leads.)

6. Deflection circuits

Set the analyzer's function selector to DIRECT SCOPE INPUT.

Slip the probe over the horizontal oscillator tube and look for a typical waveform. A Synchroguide oscillator produces a pattern like that in Fig. 2-f and a cathode-coupled multivibrator has waveforms as in Fig. 2-g.

Check waveforms in the horizontal output (Fig. 2-h) and damper circuits (Fig. 2-i) by slipping the probe over the respective tubes.

View the high-voltage pulse by holding the probe about 4 inches from the flyback transformer. The pattern in Fig. 2-j is typical, but amplitude and duration of ringing will vary between sets and with circuit adjustment.

Switch the scope's sweep to 30 cycles—or 60 cycles if waveforms in the manufacturer's service data were taken at this frequency. Fig. 2-k is a typical waveform obtained with the probe over a vertical multivibrator and Fig. 2-l is that present in a vertical blocking oscillator. (In some receivers the vertical oscillator waveforms will resemble those in Figs. 2-k and 2-l only when the vertical output tube is removed or disabled, because the waveform may be affected by circuit loading or feeding back of the output signal.)

Slip the probe over the vertical output stage. A typical waveform is shown in Fig. 2-m.

7. Intercarrier sound system

Set the INPUT FUNCTION and RF-IF BAND selectors to 3.58-4.5 mc, and the 850 and scope gain controls to near maximum. Set the scope's sweep to 30 cycles.

Slip the probe over the first sound if amplifier and plug phones into the phone

jack. The waveform will appear as in Fig. 2-n, and a weak audio signal will be heard in the phones. The modulation on the 4.5-mc sound carrier will be clearly visible when using a wide-band scope.

Move the probe to the second sound if amplifier. Sync and AM noise should be almost completely eliminated. If the stage is a good limiter, the audio signal will remain at about the same level as in the first stage.

When the probe is moved to the sound detector, a modulated rf waveform indicates that the signal is reaching the detector.

Switch the function selector to HIGH-GAIN AUDIO-VIDEO. Audio developed at the detector's output appears as in Fig. 2-o and varies with modulation.

8. Audio amplifiers

Leaving the scope set for 30-cycle sweep and the analyzer set to HIGH-GAIN AUDIO-VIDEO, turn up the set's volume control.

Place the probe over the first af amplifier and then successive audio stages. The pattern (Fig. 2-o) will increase in amplitude and the sound in the phones will get louder.

Make a kink or loop in the hot lead to the speaker's voice coil and slip the small probe over it or bring the half-circle probe close to the hot lug on the speaker. A standard pattern and audio in the phones indicates that audio is getting through to the speaker.

9. Keyed agc amplifiers, color burst keyers, sync noise cancellers and horizontal sync discriminators

The color burst and agc keyers definitely require a 15,750-cycle flyback pulse for proper operation, and the other circuits mentioned may use flyback pulses in some sets.

Set the scope's sweep to 7,875 cycles and the analyzer's INPUT FUNCTION selector to either DIRECT OR HIGH-GAIN AUDIO-VIDEO. Fig. 2-p shows a typical flyback pulse on the color burst and agc keyer tubes. Other circuits may have the flyback pulse passed through shaping circuits, so consult the manufacturer's service data for waveform information.

10. Color-reference oscillator

Set the INPUT FUNCTION and RF-IF BAND selectors to 3.58-4.5 mc. Use a 7,875-cycle scope sweep.

Place the probe over the 3.58-mc oscillator. With a wide-band scope, the waveform will appear as a constant-amplitude

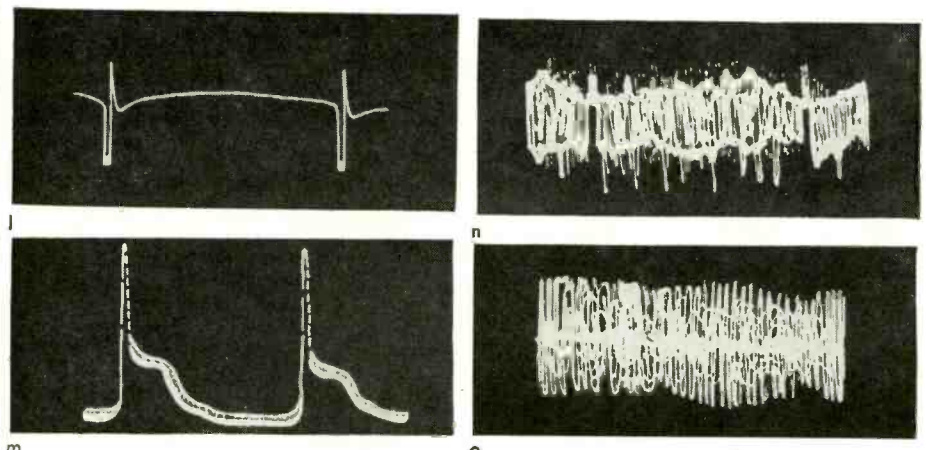

Fig. 2 d-o—Waveforms found at various points in a TV receiver. See text for details.

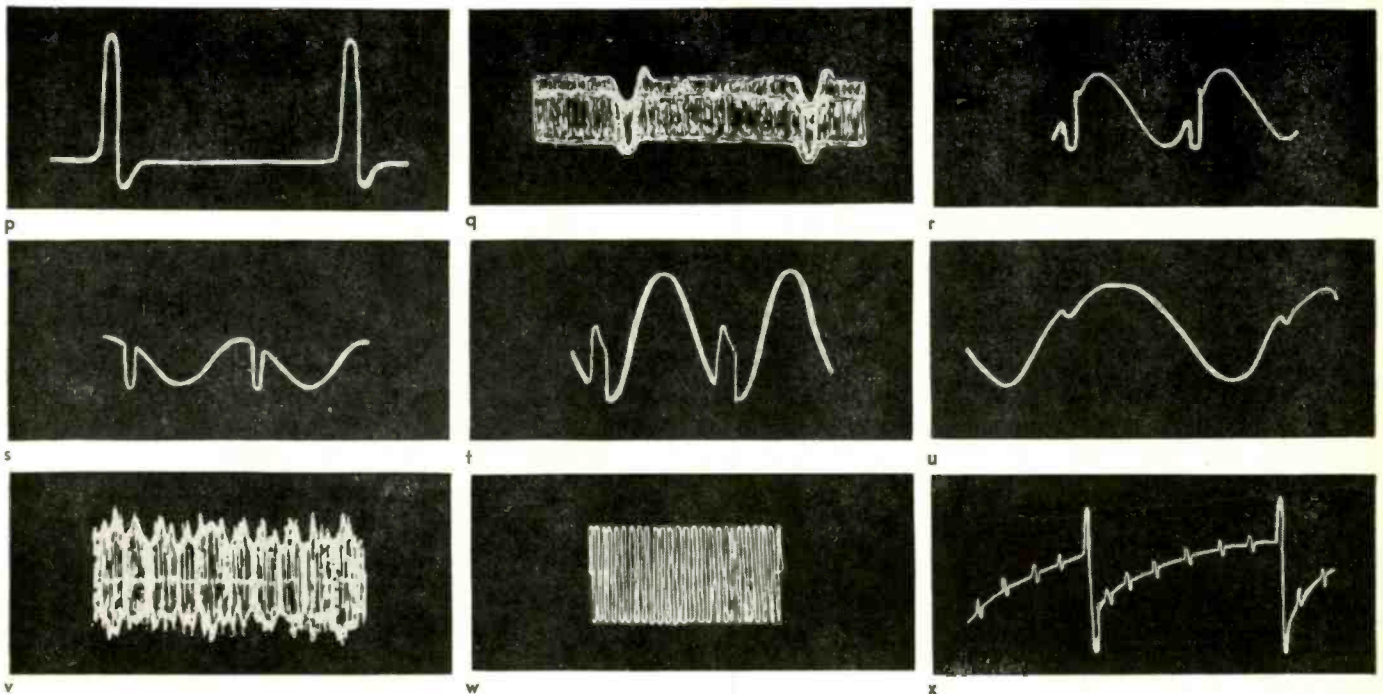

Fig. 2 p-x—Waveforms found at various points in a TV receiver. See text for details.

rf envelope. Stray 15-kc pickup may produce a notch as in Fig. 2-q.

11. Chroma demodulators and amplifiers

A color bar generator should be coupled to the set's antenna posts when checking these circuits, but the scope need not be a wide-band type.

Set the scope to sweep at 7,875 cycles. Throw the function selector to HIGH-GAIN AUDIO-VIDEO. Figs. 2-r, 2-s and 2-t show typical waveforms developed by the R-Y, G-Y and B-Y demodulators and amplifiers, respectively.

12. Dynamic convergence waveforms

Set the scope sweep to 7,875 cycles, and the analyzer's function switch to HIGH-GAIN AUDIO-VIDEO.

Make a kink or loop in each of the hot horizontal tilt or phasing leads to the convergence coils. When the horizontal amplitude is turned up on the set, the resulting patterns should resemble Fig. 2-u.

Other applications

The instrument is equally useful for

troubleshooting and waveform checking in industrial and communications equipment. To signal-trace broadcast radios, for example, set the INPUT FUNCTION selector to HIGH-GAIN AUDIO-VIDEO; tune in a strong station or feed a modulated signal from a generator, and sweep the scope at around 30 cycles. Proceed as indicated for similar circuits in TV. The rf and if signals will resemble Fig. 2-v; the oscillator, 2-w. Audio signals were shown earlier in Fig. 2-o.

A 4.5-kc blocking oscillator type frequency divider driven by a 31.5-kc oscillator in a TV sync generator chain gave the waveform of Fig. 2-x. It shows that the tube is oscillating and correctly counting down by seven.

The usefulness of the 850 increases with circuit complexity and the number of tubes used. If the desired signals do not fall in the range of any of the strips in the tuner, use the HIGH-GAIN AUDIO-VIDEO setting. If signal frequencies are

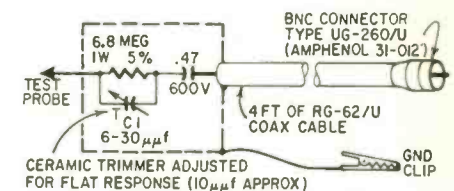

Fig. 3—A low-capacitance isolation probe for use with the induced waveform analyzer. High gain of the model 850 analyzer more than compensates for the probe's attenuation, so it can be used even in circuits with very low signal levels. For optimum probe compensation for frequency response, C1 should be a trimmer capacitor and should be adjusted for best square-wave response through the model 850 with its Input Function set for High-Gain Audio-Video.

very high, it may be necessary to rig a demodulator probe between the analyzer and its loop probe. END

NEXT MONTH

● **The Komplete Kommercial Killer**

Some TV commercials are better than the programs. But some still send you leaping for the volume control—or the on-off switch! Kill the TV sound painlessly by just switching on your chair-side light.

● **Analyze Harmonic Distortion**

This easily constructed distortion analyzer uses transistors—is especially useful for low-level work.

● **Helping the Mute to Speak**

Much has been printed about hearing aids, but little indeed is known of the electronic aid that gives speech back to the person who has lost his voice through an operation. This article illustrates several types of such speech aids and describes their working principles.

the MULTIBIAS BOX

Three independently variable bias voltages are supplied by this valuable instrument for checking color and monochrome TV receivers

By EARL T. HANSEN

WHILE this handy instrument is designed for color TV alignment, it is also very useful in diagnosing and isolating age trouble in monochrome receivers. Alignment procedures for latest color sets require as many as three externally applied bias voltages. A fixed source has frequently been obtained by using batteries. Although this type supply is satisfactory in many ways, the technician often finds that the leads have been shorted and the batteries are dead when needed. If a potentiometer is used to vary the voltage, it has to be disconnected after using. The ac-powered unit described in this article avoids these shortcomings and provides features necessary for repairing the latest receiver circuits.

An age bias supply must be extremely well filtered to avoid introducing hum modulation into the signal. It must be continuously variable over an adequate range (0-20 volts). Internal impedance must be low enough to override other bias sources in the receiver. This unit

meets these three requirements. My first thought was to use a low-voltage transformer, rectifier and

capacitors. However, as higher-voltage components are more readily available and more economical, and the higher

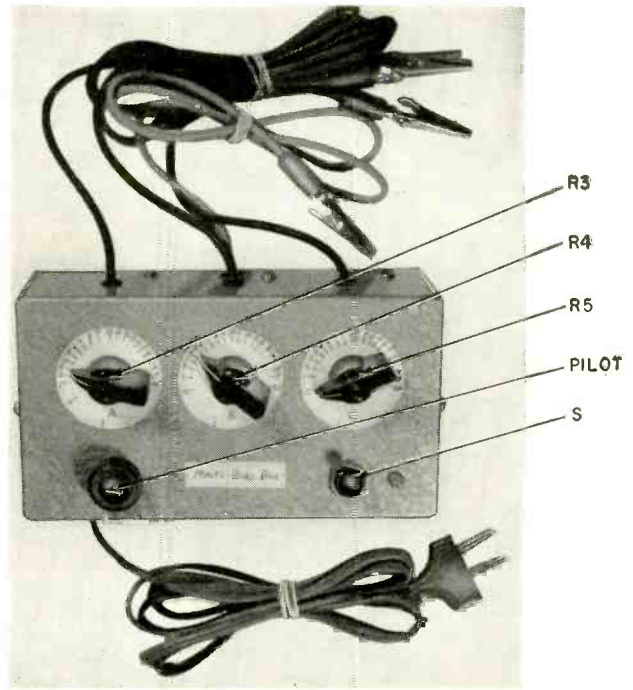

Completed test unit.

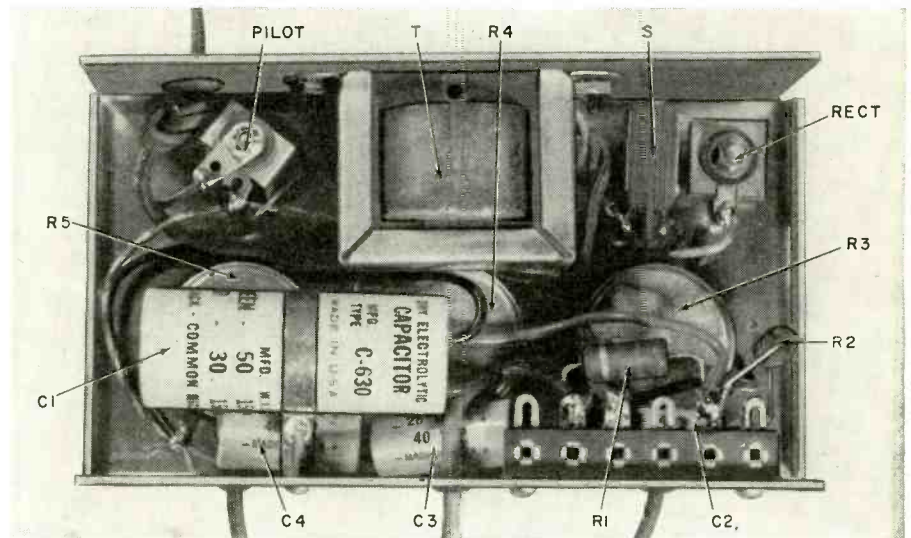

Internal view shows parts layout.

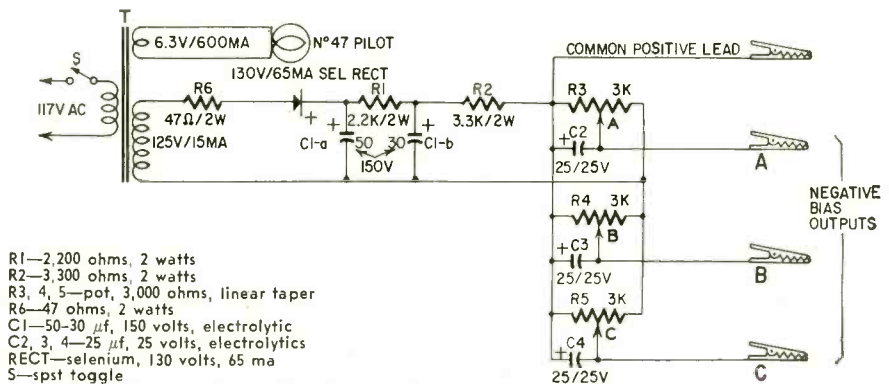

- R1—2,200 ohms, 2 watts
- R2—3,300 ohms, 2 watts
- R3, 4, 5—pot, 3,000 ohms, linear taper
- R6—47 ohms, 2 watts
- C1—50-30 μ f, 150 volts, electrolytic
- C2, 3, 4—25 μ f, 25 volts, electrolytic
- RECT—selenium, 130 volts, 65 ma
- S—spst toggle
- T—power transformer: primary, 117 volts; secondary, 125 volts, 15 ma; 6.3 volts, 600 ma (Stancor PS-R415 or equivalent)
- Case, 2 x 4 x 6 inches
- Pilot-light assembly with No. 47 pilot lamp

- Alligator clips (4)
- Test-lead wire (10 feet)
- Knobs
- Miscellaneous hardware

Circuit of the multibias box.

TEST INSTRUMENTS

voltage is easier to filter, I used the circuit shown in the diagram. Component layout or lead dress is not critical. Each of the three output voltage controls is calibrated after the unit is completed. Paper discs cemented to the box simplify marking.

When using the bias box, the common positive lead is connected to the receiver chassis, or to B-minus if the chassis is floating. The negative leads go to the tuner age and the if age lines. For color receivers, the third goes to the grid return of the chroma bandpass amplifier. This output simulates the ace (automatic chroma control) voltage. The voltage controls are set according to the manufacturer's recommendations, or used to vary the gain of individual sections as desired for alignment procedures.

Another important use for the multi-bias box is trouble diagnosis by substitution. Receiver symptoms caused by improper age voltage are loss of sync, unstable sync, negative picture, no picture, snowy picture and lack of contrast. Symptoms due to poor filtering in the age circuit are vertical jitter, erratic interlace, loss of vertical sync and improper picture shading. Connect the bias box to the tuner and if strip and you can quickly and positively determine whether the age system is at fault. It is not necessary to disconnect the set's age source when making these checks because the relatively low impedance of the bias box allows it to take over.

Occasionally, improper ratio of tuner to if age voltages causes trouble. High tuner bias results in excessive snow. Overloading, white clipping, poor video definition or buzz in the sound will be noted if the tuner voltage is low, especially in a strong-signal area. With the aid of the bias box the ratio can be varied to determine optimum conditions.

One precaution—because of its low internal resistance, the box will allow normal receiver operation with shorted or gassy tubes in the circuit. Therefore, be sure that a bad tube is not the trouble before looking for defects in the receiver's age circuits.

There are times when a voltage, continuously variable from a negative value through zero to a positive value, is desirable; for example, when substituting control voltages in horizontal age circuits, color oscillator age (automatic phase control) circuits, etc. This is easily done with the multibias box. Set the A voltage control for 10 volts. Use the A output as the common lead to the chassis. The common positive is not used in this application. The B and C leads then become sources of a voltage that can be varied from a +10 to a -10 volts. The 10-volt point on the B and C control dials would indicate the zero output voltage points.

The output voltages may also be used in transistor experiments. Needless to say, nothing will be damaged if you forget to turn the unit off, even if the leads short.

END

THE TREASURE CHEST THAT'S NEVER EMPTY

Brings more dollars to C-D distributors

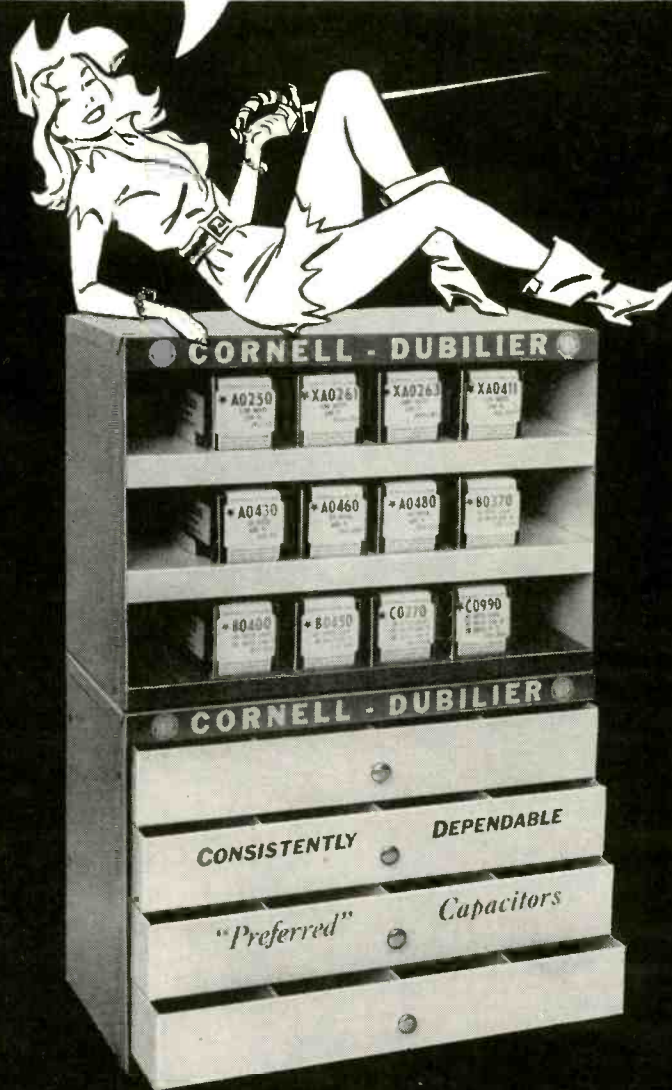

FILLED WITH "GOOD-AS-GOLD" C-D CAPACITORS.

Here's the smart, modern way to keep your working capacitor stock shipshape. Each chest comes with a fast-moving assortment of C-D "Preferred" type twist-prongs, "Blue Beavers," and Mylar Tubulars—buy them and you get the chests FREE. Speed up your work...establish customer confidence with Consistently Dependable C-D capacitors from your own Treasure Chests. See them at your distributor or write for Bulletin to Cornell-Dubilier Electric Corporation, South Plainfield, New Jersey, Dept. RE-5.



Consistently

Dependable

CORNELL-DUBILIER

SERVICE CAPACITORS

build this great new **knight-kit**[®]

A PRODUCT OF ALLIED RADIO

never before such performance...such styling at so low a price...



tremendous value at only

\$44⁵⁰

only \$4.45 down

SAVE UP TO 50%... COMPARABLE IN EVERY WAY TO WIRED AMPLIFIERS COSTING TWICE AS MUCH

Includes two built-in preamplifiers for magnetic cartridges...

Single selector switch for instant choice of desired operation...

Separate bass and treble controls with boost and attenuation...

Concentric volume control adjusts balance on each channel—plus overall volume...

DC on all preamp filaments for hum-free operation...

Dual push-pull output circuitry for smooth, clear high-fidelity output...

knight-kit 20-watt stereo hi-fi amplifier

Newest complete stereo high-fidelity amplifier at an amazing low \$44.50—the most sensational value ever offered in a stereo amplifier kit. It's a pleasure to assemble. It's a truly fine instrument—the worthy heart of the finest stereo hi-fi music system. Ideal for use with newest stereo records or stereo radio broadcasts. Delivers 10 watts per channel into each of two speaker systems for 20 watts of stereo—or 20 watts into one or more speakers for monaural use. Includes two fully integrated built-in preamps to accommodate magnetic cartridges. Single switch selects phono, tuner or auxiliary stereo inputs, plus stereo reverse on each; also switches monaural input to both amplifier channels. Has separate bass and treble controls with both boost and attenuation for complete control of tonal color. Special clutch-type concentric volume control permits individual channel balance adjustment, plus overall volume control. RIAA equalized for stereo discs. Has four pairs of stereo inputs: magnetic cartridge, ceramic cartridge, tuner and auxiliary. With switched AC accessory outlet for added convenience. Response is 20-20,000 cps, ± 1.5 db. Hum and noise, better than 85 db below full output. Distortion less than 1½%. Simple point-to-point wiring for easy assembly—even without previous electronic experience. Custom cabinet attractively finished in French gray; aluminum front panel with ebony trim; 4¼ x 13¼ x 9". With case, tubes, all parts, wires, solder and instructions. Shpg. wt., 27 lbs.

Model Y-773. Knight-Kit 20-Watt Stereo Hi-Fi Amplifier Kit. Net only. \$44⁵⁰

Easy Terms: Only \$4.45 Down

order from **ALLIED RADIO**

the world's largest electronic supply house

stereo hi-fi amplifier

enjoy building the very best

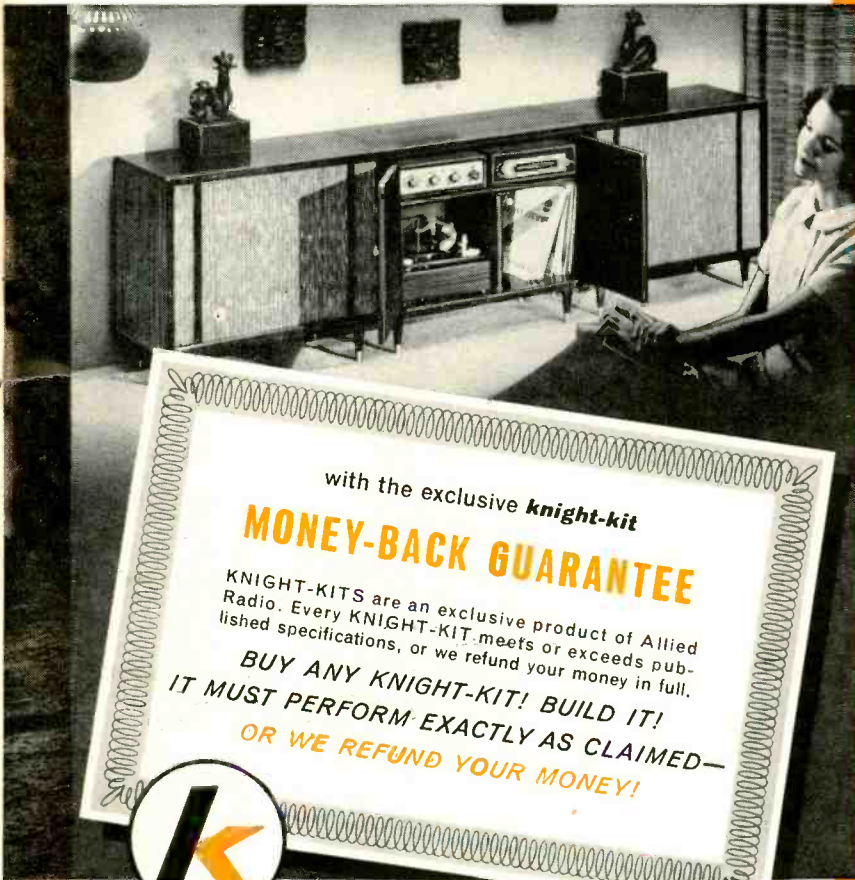

with the exclusive *knight-kit*

MONEY-BACK GUARANTEE

KNIGHT-KITS are an exclusive product of Allied Radio. Every KNIGHT-KIT meets or exceeds published specifications, or we refund your money in full.

BUY ANY KNIGHT-KIT! BUILD IT! IT MUST PERFORM EXACTLY AS CLAIMED—OR WE REFUND YOUR MONEY!



only *knight-kits* have
"CONVENIENCE ENGINEERING"
 for easiest building...no previous electronic experience needed

Exclusive in all Knight-Kits, "convenience engineering" means special attention to every detail: resistors are carded and numbered for ease of selection...all parts and hardware are packaged in clear plastic bags for easy identification...wire is precut, stripped and color-coded to save time. Finally, Knight-Kits are world-famous for their step-by-step instructions and wall-sized picture diagrams — assembly is a marvel of simplicity. Your final reward is proud enjoyment of the superior performance designed into your Knight-Kit.

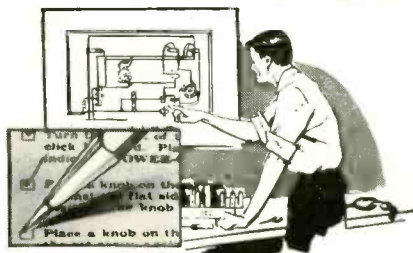
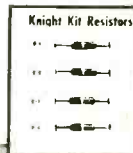

38 years of experience in electronic kit design



see over 50 other fine *knight-kits* in the 1959 Allied Catalog...send for it

FREE

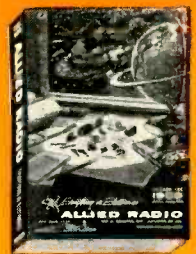

HI-FI KITS

- Stereo Deluxe Preamp
- 60-Watt Stereo Amplifier
- Stereo Control
- 30-Watt Amplifier
- 25-Watt Basic Amplifier
- 18-Watt Amplifier
- 12-Watt Amplifier
- FM-AM Tuner
- FM Tuner
- Hi-Fi Preamp
- Speaker Systems, etc.

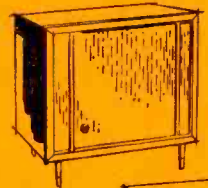

HOBBY KITS

- "Span-Master" 4-Band Receiver
- "Space-Spanner" Receiver
- "Ranger" Radio
- Clock-Radio
- Radio-Intercom
- "Ocean Hopper" Radio
- 5-Transistor Portable
- 2-Transistor Pocket Radio
- 1-Transistor Radio
- Electronic Lab Kits
- Photoelectronic System, and many others

INSTRUMENT KITS

- VTVM
- VOM's
- Tube Checkers
- Oscilloscopes
- RF Signal Generator
- Signal Tracer
- Audio Generator
- Sweep Generator
- Capacity Checker
- R/C Tester
- Transistor Checker
- Flyback Checker
- Battery Eliminator
- Sub Boxes, etc.

AMATEUR KITS

- Communications Receiver
- 50-Watt Transmitter
- Self-Powered VFO
- 100 kc Crystal Calibrator
- RF "Z" Bridge
- Code Practice Oscillator

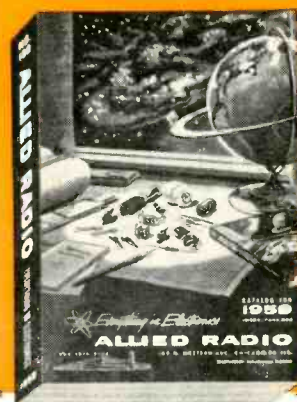

FREE

452-page 1959 ALLIED CATALOG

Send for this value-packed catalog featuring the complete KNIGHT-KIT line, as well as the world's largest stocks of everything in Electronics. Write today for this leading, money-saving Buying Guide.

ALLIED RADIO CORP., Dept. 156-E9
 100 N. Western Ave., Chicago 80, Ill.

- Ship me Model Y-773 20-Watt Stereo Hi-Fi Amplifier. \$_____ enclosed
- Send FREE ALLIED 1959 Catalog.

Name _____

Address _____

City _____ Zone _____ State _____

BRIDGE TYPE

TRANSISTOR CHECKER

Simple bridge circuit checks
transistor leakage, gain, age,
frequency cutoff and
distortion

By LeROY MAHONEY

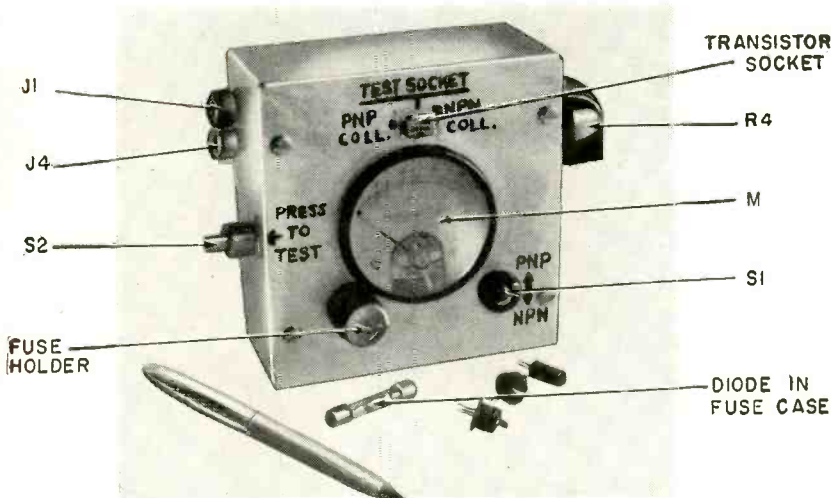

The tester in its small case takes up little room.

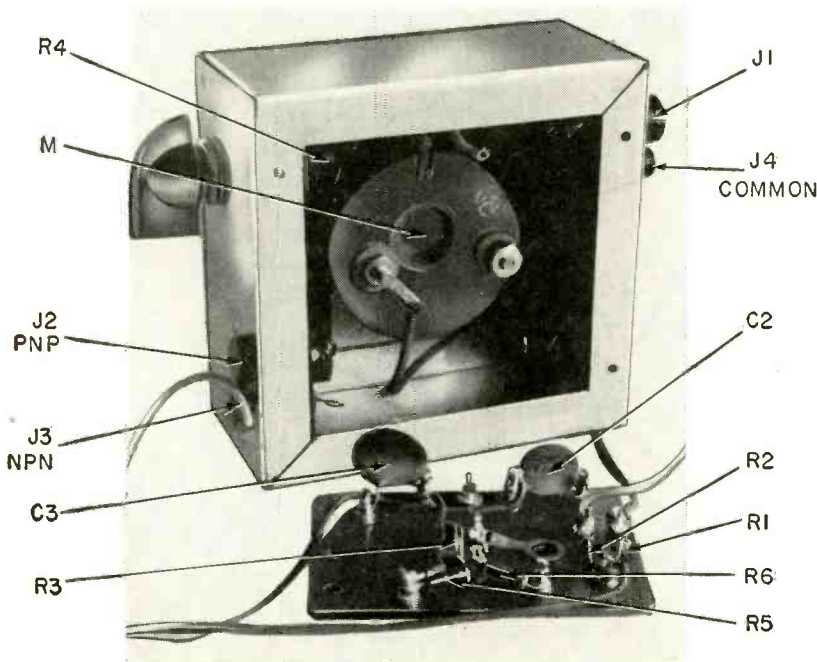

All components not fastened to the case are mounted on a phenolic board.

If transistors were made and used under ideal conditions, there would be little or no necessity to test their usefulness and transistor checkers would be unnecessary. Unfortunately this is not so and a transistor checker is more valuable in servicing transistor equipment than a tube checker is to tube circuits.

If a dozen so-called good transistors are tested, a close average of their characteristics is difficult to determine—at best the limits are broad. Transistors rated to oscillate up to 3 mc may do better, or worse. No parameter minimums are given in transistor manuals although maximums are definitely established. Transistor current gain varies considerably, even when the transistors are from the same production line.

Of course, some variations are the result of manufacturing methods. A surgically clean environment is essential for this operation. Impurities or moisture entering the seal during the assembly process will cause excess current flow between emitter and collector, indicating a resistance lower than the usual 20,000–70,000 ohms. With 4.5 volts applied, this means a current flow of not more than 100 μ a, which is known as leakage current or I_{leak} . It is measured with the base open-circuited to prevent the beta or amplification factor from affecting the measurements.

Leakage current increases with temperature. If an increase in heat is too great or too rapid, the transistor is usually weakened or ruined. Even heat from your fingers will increase the current flow between emitter and collector. Aging of the unit also decreases the resistance between these elements and increases the current flow.

The ratio of change of current flowing in the collector or emitter to the change of current flowing in the base determines the transistor's gain. Base current, of course, is that derived from the input signal or, if the base is coupled to a battery, the bias which is

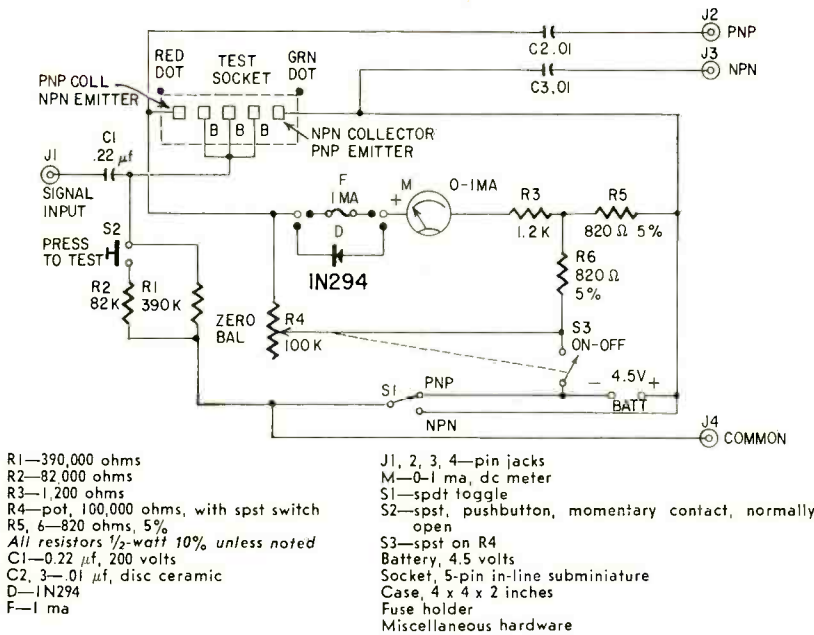

Fig. 1—Circuit of the easy-to-build tester.

either aiding or opposing the signal current.

Fig. 1 is the circuit of the transistor-checker bridge. It uses the resistance between the emitter and collector of the transistor under test as one of the resistance arms. The parts needed to build the unit may be found in almost any junkbox. But even if all parts are purchased, total cost should be under \$6.

The unit is mounted in a 4 x 4 x 2-inch box. The PRESS TO TEST switch is a single-pole, single-throw, spring-return pushbutton. The values of the two precision resistors (R5 and R6) are not critical, but they must be as nearly equal as possible. These resistors form the standard arms of the bridge and, if exactly equal, zero balance of the meter cancels the resistance between the emitter and collector. The ON-OFF switch is ganged to the 100,000-ohm balancing pot. The meter is a 0-1 dc milliammeter. Fig. 2 shows the bridge circuit.

How it works

In the bridge circuit, if the standard arms are equal, current divides through the standard and nonstandard arms. When the nonstandard arms are balanced, current through the meter is zero. Pressing the pushbutton switch increases current flow from the base to the emitter and collector of the transistor under test, which in effect is the same as changing the resistance between collector and emitter, and current flows through the meter. The amount of current is an indication of the transistor's amplification or beta gain.

Immediately you can see that, since a comparison is made between the change of current in the base and the change of current in the collector, the transistor's beta can be obtained:

Beta = $\frac{\text{change of current in collector}}{\text{change of current in the base}}$
If the change in base current is 30 μ a when the button is pressed, and the

change of current flowing in the collector is 500 μ a, beta is then:

$$\beta = 500/30 = 16.666$$

This value is about right for transistors checked for small-signal beta. (Small-signal beta is always a little more than large-signal beta.)

In circuits where the base is grounded and the signal is applied to the emitter, the alpha or gain between the emitter and collector (usually less than 1) is required. Rearranging the beta formula in relation to alpha, $\beta = \alpha / (1 - \alpha)$. To solve for alpha or α :

$$\alpha = \beta / (1 + \beta)$$

In the transistor tested the alpha is:

$$\alpha = 16 / (1 + 16) \text{ or } \alpha = 16/17 = 0.94$$

Transistors used in computers are not required to amplify, but they must oscillate rapidly as electronic switches. In these applications the transistor is generally turned around or the emitter placed in the collector socket. When testing these transistors, the reading may be the same whether the transistor is properly in the socket or reversed. These transistors have little if any value in amplifier circuits.

Using the transistor checker

Unless a manual is handy it is difficult to determine whether a particular transistor is a p-n-p or n-p-n type. With the checker bridge, the type is quickly and easily established. For example, if a p-n-p transistor is inserted in the wrong side of the subminiature five-contact test socket, the reading will be low. Just reverse the transistor in the socket and flip the PNP-NPN switch. The setting that gives the greater reading is correct and the type of transistor is indicated by the switch setting. No damage is caused by manipulations since the battery voltage is well under the breakthrough value. When the transistor is inserted in the proper socket and is receiving the proper voltage polarity, a zero balance can be obtained and when the pushbutton switch is

depressed, maximum reading for the transistor is obtained.

If there is still no balance or indication of current flow, one or more of the transistor's elements are open-circuited. If any element is shorted, there will be a large current flow and no potentiometer adjustment will cause a balance.

To test for a transistor's age, potentiometer R4 is calibrated. Insert various fixed resistors between collector and emitter socket terminals, balance the bridge with each resistor and mark the values on R4's dial. Use resistances from 20,000 to 80,000 ohms. Transistors that attain a balance with less than 20,000 ohms are unsatisfactory since leakage current is excessive and current gain is low. If a transistor has been allowed to overheat and conduct large currents, the same test applies. However, many overheated transistors may still be good. Place them aside to cool and test again in about 15 minutes. If their resistance is still low, discard them.

Dynamic test

This is a most important test for transistors used in if and rf stages. and to conduct it properly a signal generator capable of delivering a good sine wave between 200 and 2,000 kc is needed. If an oscilloscope is not available, a diode must be inserted in the meter circuit.

If a diode is used, encase it in a glass cartridge (fuse case) after withdrawing the fuse element. Using a minimum of heat, solder the diode leads to the metal ends of the cartridge. When dynamic tests are not being conducted, the diode can be slipped out and a low-current fuse with the same type case inserted. Reverse the diode if the meter gives negative readings, first making certain that toggle switch is set for the proper transistor type (n-p-n or p-n-p).

To check for frequency cutoff, insert a transistor in the test socket and balance the bridge. Replace the fuse with the diode (1N294). Connect a signal generator set at the frequency at which the transistor normally operates when in the circuit across the checker's INPUT and COMMON terminals. Slowly increase the generator's output until the meter begins to read. Vary the output frequency a little on either side of the fundamental and watch for lowered

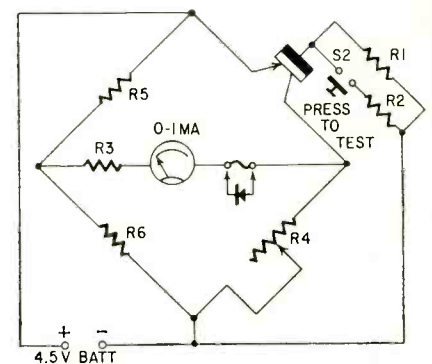

Fig. 2—The important bridge-circuit heart of the versatile instrument set up for a p-n-p transistor.

The Spotlight of Leadership is on...

arkay

KITS and WIRED
• HI-FI STEREO
• TEST EQUIPMENT

TODAY'S BEST QUALITY BUY

The record-breaking sales success of Arkay kits and wired—the greatest in Arkay's 20 year history—is firmly founded on top quality and top value. Acclaimed the finest by professionals and hi-fi enthusiasts who pass the word along... "You get so much more with Arkay!"... advanced engineering • exclusive new features • award-winning styling • matchless performance... at amazing low cost. Prove it to yourself... Ask your dealer!



FM TUNER OF TOMORROW!

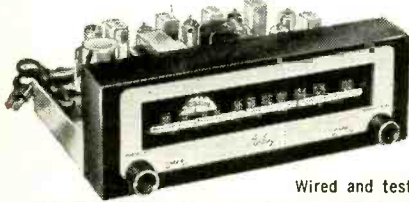

Wired and tested \$59.95, Cover \$4.95 Easy-to-build Kit **\$3995**

ARKAY FM-8 — Designed in the Arkay tradition of highest professional quality at lowest cost. No other kit or wired component

OFFERS ALL THESE ADVANTAGES:

Variable AFC — no drift • tuning meter • silent tuning mute control • "standby" off-on switch • low frequency filter • level control • 3 tuned RF stages • dual limiters • Armstrong FM — Foster Seelye discriminator • hi-level, cathode follower and stereo multiplex output jacks • sensitivity, 1.9 μ V for 20 db quieting • response, 20-20,000 cps \pm 1/2 db • 8 tubes, selenium rectifier.

ARKAY ST-11 AM-FM STEREO TUNER

Separate AM and FM tuning with drift-free stability • variable FM-AFC • 4 μ V for 20 db quieting in FM channel • wide band AM IF's • whistle filter • cathode follower outputs • level controls.

Wired and tested \$74.50 Easy-to-build Kit **\$4995**



ARKAY CS-12 STEREO AMP/PRE-AMP

12 watts of clean power with dual inputs and outputs for excellent stereo reproduction • operates from ceramic or crystal cartridge, tape, tuners, auxiliary equipment • push-pull outputs for each channel.

Easy-to-build Kit **\$3695**

ARKAY SP-6 STEREO CONTROL CENTER

Self-powered sensitive dual pre-amp • reverse position, hi-lo filters, every wanted control. Prices less cover.

Easy-to-build Kit **\$3995**

Wired and tested \$62.95

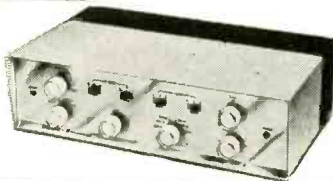

ARKAY SPA-55 STEREO AMP

55 watts stereo-monaural, separate 27 1/2 watt hi-fi amps each channel • "phantom" third channel outputs.

Easy-to-build Kit **\$6495**

Wired and tested \$79.95

NEW! MUSIC MASTERPIECE



ARKAY CS-28 STEREO AMP/PRE-AMP COMPLETE CONTROL CENTER

Full 28 watts stereo or monaural, 60 watts peak • 14 watts each channel • reverse stereo • balance control • two-channel gain control • full range bass and treble controls • IM distortion, 4 to 1 • harmonic distortion, 1% 30-20,000 cps • dual pre-amp 2V output jacks • speaker outputs, 4, 8, 16, 32 ohms • response, 20-20,000 cps • push-pull EL84 Williamson circuit • beauty of design that won Fashion Foundation's coveted Gold Medal! Many other incomparable features.

Wired and tested \$99.95 Easy-to-build Kit **\$6495**

TEST INSTRUMENTS

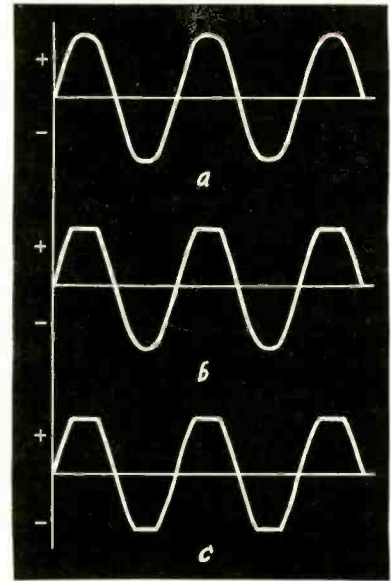

Fig. 3—Waveforms from transistor amplifiers: a—perfect sine wave; b—clipping on positive peaks; c—clipping on positive and negative peaks.

readings on the meter. If the results are satisfactory (the meter reading does not vary), increase the frequency until the meter reads zero. Increase the signal output of the generator until the meter reads again. If no amount of increase causes a reading, the frequency indicated on the signal generator is the upper limit of the transistor. (It is usually somewhat less than the rating given in the manual for the transistor.)

If there is no meter reading, determine if the diode's polarity is right by reversing it in the fuse holder. If there is still no reading, make certain that the diode is good by measuring it with an ohmmeter (the back resistance should be at least about 10 times the forward resistance). If all components are good and the checker meter still does not register, the transistor cannot be used in if or rf circuits, but may be satisfactory for audio use.

When a scope is used, connect the vertical amplifier to either the PNP or NPN outlet and to the COMMON terminal. Use as little gain as possible at the signal generator. The scope provides the only method of determining the type of wave being amplified by the transistor. Fig. 3 shows the types of waves to expect.

Clipped waves (Figs. 3-b and 3-c) result from too much input from the generator for the amount of base bias and, since it is difficult to change the bias of the checker, the input signal is reduced. However, if reducing the signal generator output does not produce a sine wave, the transistor is faulty and will cause distortion if used in if and rf circuits.

When using the scope, better results can be obtained if the input signal is maintained at a constant level. Continually switch the scope terminals to the generator output as the frequency is advanced and increase the input signal when required for best results. END

ARKAY VT-10 6-INCH MULTI-PURPOSE VTVM

Exclusive larger 6-INCH 400 μ A meter movement, edge-lighted, within 2% accuracy • 1% precision multiplier resistors • 7 AC (RMS) and DC ranges • 7 AC (peak-to-peak) ranges • resistance, db, and other essential ranges • 12AU7 for DC ranges, 6A15 for AC • transformer operated selenium rectifier • durable plastic case.

Wired and tested \$47.95 Easy-to-build Kit **\$2595**

ARKAY AV-20 6-INCH AUDIO VTVM PRE-AMPLIFIER

Easy-to-build Kit **\$2995**
Wired and tested \$49.95



ARKAY AW-30 6-INCH DIRECT READING AUDIO WATTMETER

Easy-to-build Kit **\$2995**
Wired and tested \$49.95

ARKAY CA 40 6-INCH DIRECT READING CAPACITY METER

Easy-to-build Kit **\$2995**
Wired and tested \$49.95



ARKAY MT-50 6-INCH 20,000 OHMS PER VOLT METER

Easy-to-build Kit **\$2950**
Wired and tested \$42.95

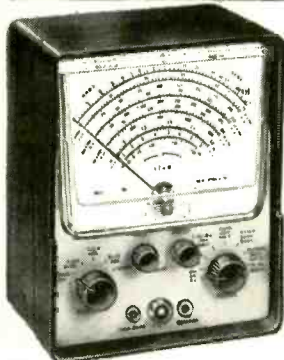

See and hear completely wired Arkay Kits at your dealer. All prices 5% higher west of Mississippi.

FREE! "Let's Talk Stereo"—informative booklet on how and why of Stereo—plus new 16 page ARKAY catalog. Write Dept. RE.

arkay
88-06 Van Wyck Expressway Richmond Hill 18, N.Y.



Freeze that Color Stripe

A color stripe can help you do a quicker and easier color installation job—it even gives you a quick check of the antenna and lead-in

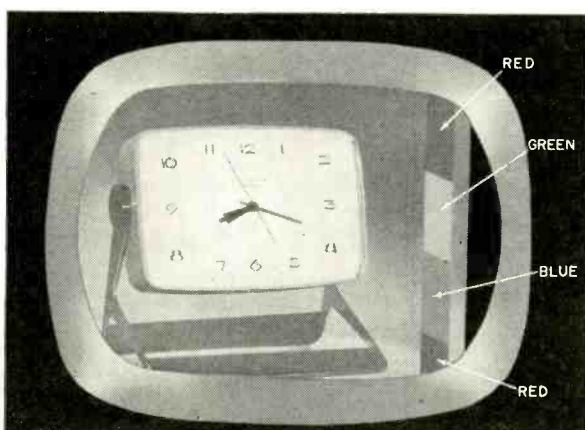

Fig. 1—When out of color sync, the stripe appears as a vertical barber-pole bar.

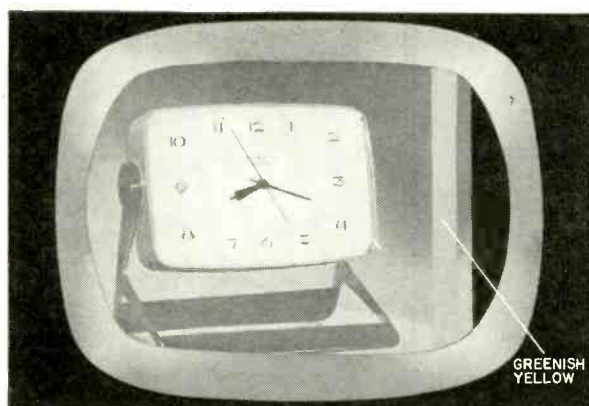

Fig. 2—When locked in color sync, the stripe is colored a uniform greenish-yellow.

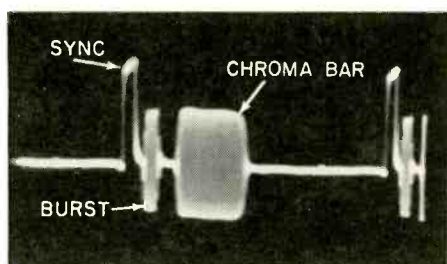

Fig. 3—Burst closely follows sync pulse.

By **ROBERT G. MIDDLETON**
RADIO-ELECTRONICS TELEVISION CONSULTANT

EVERYONE who has ever seen a color TV receiver is familiar with the barber-pole color stripe which shows up at the edge of the picture during black-and-white transmissions from color TV stations. (The stripe is normally hidden by the mask and the picture must be moved to the left, by resetting the horizontal hold control, to bring it into view.) It is characterized by barber-pole spirals of red, green and blue, because the color sync circuits do not lock on the stripe signal (see Fig. 1).

The color stripe is transmitted as a greenish-yellow signal, because this color has low visibility on black-and-white picture-tube screens—only a faint herringbone is visible at close viewing distances. Although the color stripe is a greenish-yellow signal, it appears as a moving red-green-blue barber pole on the screen of a color picture tube because the stripe signal is not locked in color sync with the color receiver's subcarrier oscillator.

However, it is easy to make the color stripe lock in color sync. It is also very useful to be able to do this, because the stripe serves as a practical guide when adjusting the color-phasing control during a color TV receiver installation. So let's see how to stop that color stripe from writhing up and down the screen, and make it lock in color sync like a well-behaved chroma signal (see Fig. 2).

First, let's look at a standard chroma signal, which locks nicely in color sync. Fig. 3 shows such a signal made up of sync, burst and a single chroma bar. Note particularly the location of the burst on the back porch of the sync pulse because this is the heart of the entire matter. The burst closely follows the horizontal sync pulse in time. The burst amplifier in a color TV receiver is designed to pick up the burst just after the sync pulse passes. Except for this brief interval, the burst amplifier is cut off and no signal can pass through into the color sync circuits.

This is made clearer by Fig. 4. The screen grid of the burst amplifier tube is gated by a pulse which arrives just after the horizontal sync pulse. Except for the brief time that this gating pulse is present, no signal can pass. In normal

(Continued on page 88)

Dealer **JOHN G. ALTMeyer** Says...

"Mallory Components are Best

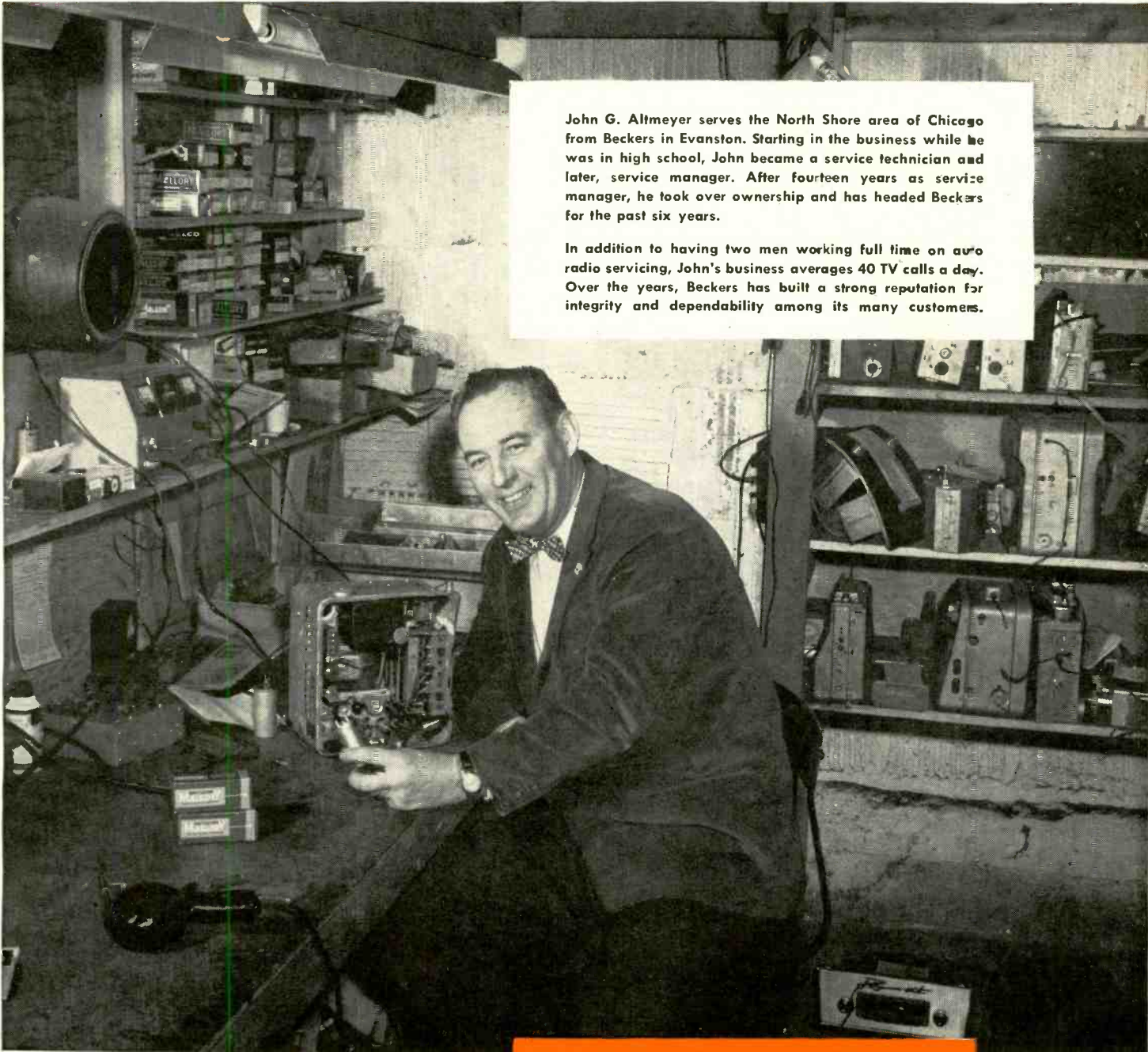

John G. Altmeyer serves the North Shore area of Chicago from Beckers in Evanston. Starting in the business while he was in high school, John became a service technician and later, service manager. After fourteen years as service manager, he took over ownership and has headed Beckers for the past six years.

In addition to having two men working full time on auto radio servicing, John's business averages 40 TV calls a day. Over the years, Beckers has built a strong reputation for integrity and dependability among its many customers.

P. R. MALLORY & CO. Inc.
MALLORY

P. R. MALLORY & CO. Inc., INDIANAPOLIS 6, INDIANA

for Modern Equipment 'Trouble Spots'”

“Modern car radios—for example—need quiet vibrators . . . that’s why we replace with Mallory.

Today’s automobiles are engineered for a quieter, more pleasurable ride. A noisy vibrator in a car radio stands out immediately. Our servicemen use Mallory Vibrators for all replacements. We’ve found that they’re quieter and more dependable. The Mallory buttonless contact design adds to their longer, trouble-free life.”

Whatever component you need for servicing—capacitors, controls, resistors, silicon rectifiers or batteries—you get the highest quality at sensible prices from Mallory. It’s the widest line of parts in the industry . . . and every model is service-engineered to assure you that each job is right the first time, every time.

Stop Callbacks with These Quality Mallory Products...



Gems—5 rugged, moistureproof, Mallory “Gem” tubular capacitors in an easy-to-use dispenser that keeps your stock fresh and clean—easy to find—no more kinks in lead wires. They’re your best bet for outstanding service in buffer, bypass or coupling applications.

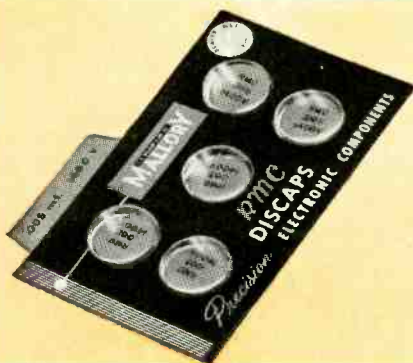

RMC Discaps®—are a product of the world’s largest producer of ceramic disc capacitors. Long the original equipment standard, Mallory RMC Discaps are now available for replacement. They come in a handy 3” x 5” file card package . . . easy to stock, simple to use.

®Trade Mark of Radio Materials Company, a division of P. R. Mallory & Co. Inc.



FP Electrolytics—The Mallory FP—the original 85°C capacitor—now has improved shock-resistant construction and leakproof seal. Its etched cathode construction—standard in all FP’s—assures hum-free performance. High ripple current ratings fit the toughest filter circuits.

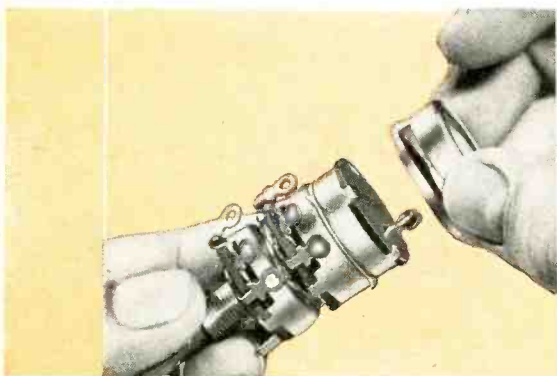

Sta-Loc* Controls—New Sta-Loc design enables your distributor to custom build, in just 30 seconds, over 38,000 combinations—eliminates waiting for out-of-stock controls. You can replace the line switch by itself, without unsoldering control connections.



Gold Label* Vibrators—On critical auto radio servicing, use the Mallory Gold Label Vibrator. It gives longer, trouble-free service life. Mallory Gold Label Vibrators feature Mallory exclusive buttonless contact design.

*Trade Mark

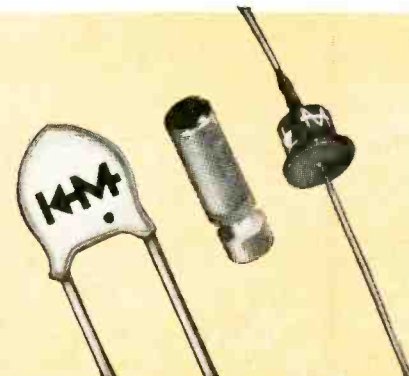

Silicon Rectifiers—New Mallory design gives far longer life, lower forward voltage drop, and reverse leakage current than conventional types . . . exceed the requirements of military humidity tests. In convenient kits for replacement of selenium rectifiers in radio and TV.

Handle any Radio-TV Service Job

EASIER - BETTER - FASTER!

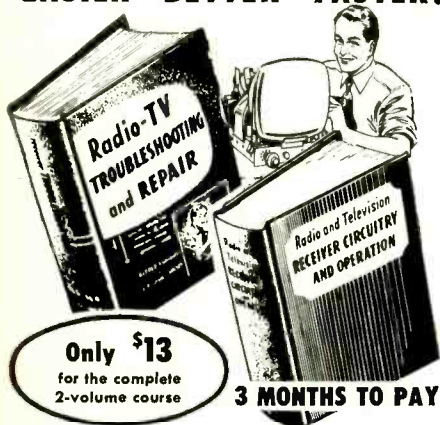

Only \$13
for the complete
2-volume course

3 MONTHS TO PAY

COMPLETE SERVICE TRAINING

... written so you can understand it!

No complicated theory or mathematics! These famous Ghirardi books get right down to brass tacks in showing you how to handle all types of AM, FM, and TV service work by approved professional methods. Almost 1500 pages and over 800 clear illustrations show how to handle every phase of troubleshooting and servicing. Each book is co-authored by A. A. Ghirardi whose manuals have helped train more servicemen than other books or courses of their kind!

1—Radio and Television Receiver TROUBLESHOOTING AND REPAIR

A complete guide to profitable professional methods. For the beginner, it is a comprehensive training course. For the experienced serviceman, it is a quick way to "brush up" on specific jobs, to develop improved techniques or to find fast answers to puzzling service problems. Includes invaluable "step-by-step" service charts. 820 pages, 417 illustrations, price \$7.50 separately.

2—Radio and Television Receiver CIRCUITRY AND OPERATION

This 669-page volume is the ideal guide for servicemen who realize that it pays to know what really makes modern radio-TV receivers "tick" and why. Gives a complete understanding of basic circuits and circuit variations; how to recognize them at a glance; how to eliminate guesswork and useless testing in servicing them. 417 illus. Price separately \$6.75.

Special low price... you save \$1.25

If broken into lessons and sent to you as a "course," you'd regard these two great books as a bargain at \$75 or more!

Under this new offer, you save \$1.25 on the two books—and have the privilege of paying in easy installments while you use them! No lessons to wait for. You learn fast—and right!

STUDY 10 DAYS FREE!

Dept. RE-59, RINEHART & CO., Inc.
232 Madison Ave., New York 16, N. Y.

Send books below for 10-day FREE EXAMINATION. In 10 days I will either remit price indicated (plus postage) or return books postpaid and owe you nothing.

Radio & TV Receiver TROUBLESHOOTING & REPAIR (Price \$7.50 separately)

Radio & TV CIRCUITRY & OPERATION (Price \$6.75)

Check here for MONEY-SAVING COMBINATION OFFER. Save \$1.25. Send both of above big books at special price of only \$13.00 for the two. (Regular price \$14.25... you save \$1.25.) Payable at rate of \$4 plus postage after 10 days if you decide to keep the books and \$9 a month for 3 months until the total of \$13.00 has been paid. SAVE! Send \$13 with order and we pay postage. 10-day return privilege with money refunded.

Name.....

Address.....

City, Zone, State.....

Outside U.S.A.—\$8.00 for TROUBLESHOOTING REPAIR; \$7.85 for CIRCUITRY & OPERATION; \$14.00 for both. Cash only, but money refunded if you return books in 10 days.

TELEVISION



Fig. 4—The color-sync circuits are "open" only for the duration of the burst-amplifier gating pulse.

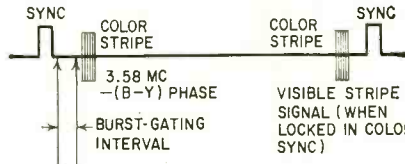

Fig. 5—The 3.58-mc color-stripe signal occurs after burst gate. Complete stripe signal is made up of two bursts, both located in with camera signal.

(Continued from page 85)

operation, the timing of the gate pulse coincides with that of the burst.

The burst amplifier must be gated, because color sync will go haywire if we admit miscellaneous chroma signal instead of or in addition to the burst signal. It is exactly like a black-and-white receiver when the horizontal sync goes haywire because of video in the horizontal phase detector.

Delayed color stripe signal

As in Fig. 5, the color stripe signal occurs later than the standard burst. This delay is intentional, and makes the color stripe appear on the raster where it can be used in service work.

To lock the stripe signal in color sync, we must delay the burst-gating pulse by the same interval as the stripe signal is delayed. Then, the stripe signal can lock the color sync circuits and appear as a greenish-yellow vertical stripe on the picture tube.

How do we delay the burst-gating pulse? By adding capacitance across the gate-delay network as in Fig. 6. When we use more capacitance (.01 μ f usually works out well), a longer charging time is set up and the gating pulse takes a little longer to build up to peak voltage. In this manner, we gate the burst amplifier tube a little later—during the time the stripe signal is present.

Now, the color stripe is no longer a writhing barber pole. It appears as a solid color bar on the screen. We can change the apparent color of the stripe by adjusting the color phasing control, and the proper adjustment for this control is the point that makes the color stripe appear a greenish yellow.

More than one way

Another method of locking the stripe in color sync calls for adding a suitable time delay in the horizontal sync circuit. This is provided in the Admiral color receiver.

A terminal on the rear-chassis apron can be grounded with a test lead to obtain stripe lock. Circuit details are in Fig. 7. Grounding the terminal shunts a .001- μ f capacitor from the sync inverter grid to ground. This delays the horizontal sync pulse in its passage to

the sync discriminator and results in a suitable delay of the burst-gate pulse.

Checks antenna and lead-in

The color stripe provides considerable information:

1. The stripe signal, by its presence, shows that the antenna is capable of supplying a usable color signal.
2. The color phasing control can be adjusted with reference to the stripe.
3. The stripe is an accurate indicator of color phasing, because any phase shift due to antenna or tuner SWR is automatically taken into account.
4. With experience, the installation man can use the stripe as a guide in setting up the color intensity control.

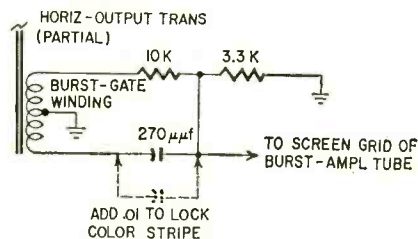

Fig. 6—Increase the value of the charging capacitor in the gate-delay circuit to lock the color-stripe signal.

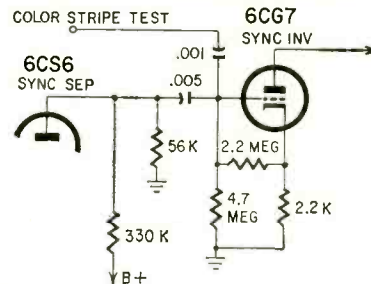

Fig. 7—In Admiral color receivers, the color stripe is locked by grounding the color-stripe test point.

Thus it is evident that a color stripe signal is a more accurate indicator of receiver setup than a color bar generator. When you use a color bar generator, antenna and lead-in characteristics are not considered.

The antenna can cause a shift in hue when it has resonant peaks within the channel passband. This must be compensated for by suitable adjustment of the color phasing control. Any necessary compensating adjustment of the color phasing control remains a question mark if a color bar generator is used instead of a color stripe signal.

If standing waves are present, the lead-in can also cause a shift in hue. Standing waves arise when the antenna and rf tuner do not have a good impedance match to the lead-in. Standing waves also arise when there are kinks in the lead-in and when it is draped over metallic surfaces. Again, a compensating adjustment is required in setting up the color phasing control. A color stripe signal provides an accurate reference for this while a color bar generator does not.

So now that we know how to lock the color stripe, let's use it for what it's worth—and that's quite a bit. END

As the Old
Timer tells
the
Young
Ham,
"There are
tube
changers
and
Tube Changers."



TUBE CHANGING CAN BE PROFITABLE

By JACK DARR



THE Old-Timer came in the back door of the shop, brushing the rain from his jacket. He grinned as he heard loud voices from the shop. The Young Ham and one of his associates were evidently suffering from a difference of opinion, at a pretty high level. He estimated they were running at least 30 db above the background noise. As he came near enough to make out the words, he stopped, and his grizzly eyebrows shot up.

"Aw, that character!" came the Young Ham's voice. "He, he don't know a dipole from a fishin' pole! Why, the Ol'-Timer's forgot more about radio and TV than he'll ever know!" The subject of this praise made a deep bow outside the door, silently agreeing with the speaker. He certainly *had* forgotten a lot about radio and TV, it seemed to him at times. A mumbling reply from inside the shop brought another loud outburst from the loyal Young Ham. "Aww! He's nothin' but a tube changer! He just keeps pluggin' tubes in 'till the thing starts to play, and then leaves 'em all in! If he gets one with a resistor burnt out, he has to wait till that distributor's salesman comes down to help him fix it! He couldn't fix a flat on a bicycle!"

The Old-Timer decided that this had gone on long enough, and whistling loudly he stepped into the shop. "Hi, fellers," he said cheerfully, hanging up his damp jacket. "What's the beef? I could hear you guys arguin' clear out in back!"

"This knucklehead says that bird down the street's a good service technician! Why, he don't know a rectifier socket from the hole in his head!"

"Well, you ain't ever seen him walkin' down the street with a 5U4 stickin' out of his haircut, have you?" inquired the Old-Timer. "Seems like that ought to indicate somethin'. Besides, it ain't proper to talk about the opposition. He's a pretty nice feller. Where you goin', Eddie?"

"I gotta go home," said Eddie, tearing out the door.

"Well anyhow, he's just a tube changer!" said the Young Ham indignantly.

"Now Junior, don't look down on tube changers too much, willya? Seems to me like I've caught you doin' some of it yourself, at times."

"Well," demurred the Young Ham.

Tube Changers and tube changers

"All right, now look," said the Old-Timer, tolerantly. "There's tube-changers and tube changers. Might capitalize one of 'em, if you want to be finicky. There ain't nothin' wrong with tube changin' in itself. Goodness knows I do enough of it m'self!"

"Well, that's different. *You* know what you're doing!"

"I *do*?" said the Old-Timer, raising the eyebrows again. "Gosh, I'm glad to hear that. Most of the time I'll admit to bein' slightly baffled, at least until I get some idea of what's goin' on inside these sets."

"You know what I mean," retorted the Young Ham. "You only change tubes when there's a good reason and so on."

"Well, you might have a point there," said the Old-Timer. "There's tube changers and Tube Changers."

"You just said that," pointed out the Young Ham.

"And I'll say it again, most likely," rejoined the Old-Timer. "Point I was tryin' to make is this. Y'know what causes almost 90% of the troubles in TV sets, don't you? Tubes. Go look at th' job cards if you don't believe me. Dang near all our calls just mean changing one or two bad tubes. Now here's the thing about it. If a technician *knows* his TV sets and their circuits like he should know 'em, he can make the set work again pretty quick by locating the trouble in a certain tube and replacing it. He's got to be able to divide up that TV set into sections—sweep, signal, voltage supplies high and low, and so forth, and be able to pin the trouble down to one given section by carefully observing symptoms *first*. Then, he starts changin' tubes to see if that ain't the trouble. Cause why? He knows that the tubes are most likely to give trouble and he gets them out of the way first. After he changes the tube, if there's any

more trouble, he can spot it pretty quick. But, he goes after the most likely source first. If you get a flat tire on that hot-rod of yours, what's the first thing you look for?" Ignoring the quick answer of "Another tire!" he continued.

"A hole in th' tire—most likely cause, a nail. So, first thing you do, look the tire all over for a nailhead. If there ain't any visible, then you take the tire off and look inside. Same way with TV sets. If you can't find the trouble by changing tubes, then you take it out of the cabinet and look inside for a nail!"

"As much trouble as some of these new sets are to get out of the box, any time we can find the trouble outside it's all right with me," commented the Young Ham.

"That's the truth," agreed the Old-Timer. "Some of 'em seem to have been melted and poured in, by golly! But! like I was sayin', the good TV service tech's got to really know how a TV set works. He's got to know the fundamental circuits and just exactly what each one's supposed to do and how to recognize it when one of 'em ain't! Also, there's a lot of difference between a Tube Changer and a—let's see, y' might call 'em tube pluggers. Guys that just plug in a new tube, get a picture and leave. No, sirree. You've got to check that set thoroughly to see if that's all that was wrong with it and to see if that was *all* of the trouble!"

That ain't foolin' around

"I have noticed you spend a lot of time fooling around with a set after you get it to working," admitted the Young Ham.

"Junior, that ain't foolin' around," said the Old-Timer, sternly. "There's a twofold purpose in that. First place, it makes a bad impression on the customer if you rush in, put in a new tube and rush right out. She gets the impression that maybe you didn't do a very good job. She might be right, too! Second and just as important, you oughta stay long enough to check the
(Continued on page 92)

VACUUM TUBE VOLTMETER

WITH NEW 6" FULL-VIEW METER



Compare it to any peak-to-peak V. T. V. M. made by any other manufacturer at any price!

- Uses new improved SICO printed circuitry.
- Employs a 12AU7 as D.C. amplifier and two 9006's as peak-to-peak voltage rectifiers to assure maximum stability. • Meter is isolated from the measuring circuit by a balanced push-pull amplifier. • Uses selected 1% zero temperature coefficient resistors as multipliers.

AS A DC VOLTMETER: The Model 77 is indispensable in HI-FI Amplifier servicing and a must for Black and White and color TV Receiver servicing where circuit loading cannot be tolerated.

AS AN ELECTRONIC OHMMETER: Because of its wide range of measurement leaky capacitors show up plainly. Because of its sensitivity and low loading, intermittents are easily found, isolated and repaired.

SPECIFICATIONS

• DC VOLTS — 0 to 3/15/75/150/300/750/1,500 volts at 11 megohms input resistance. • AC VOLTS (RMS) — 0 to 3/15/75/150/300/750/1,500 volts. • AC VOLTS (Peak to Peak) — 0 to 8/40/200/400/800/2,000 volts. • ELECTRONIC OHMMETER — 0 to 1,000 ohms/10,000 ohms/100,000 ohms/1 megohm/10 megohms/100 megohms/1,000 megohms. • DECIBELS — 10 db to +18 db, +10 db to +30 db, -30 db to +58 db. All based on 0 db = .006 watts (6 mw) into a 500 ohm line (1.73v). • ZERO CENTER METER — For discriminator alignment with full scale range of 0 to 1.5/7.5/37.5/75/150/375/750 volts at 11 megohms input resistance.

AS AN AC VOLTMETER: Measures RMS value if sine wave, and peak-to-peak value if complex wave. Pedestal voltages that determine the "black" level in TV receivers are easily read.

Comes complete with operating instructions, probe, leads, and streamlined carrying case. Operates on 110-120 volt 60 cycle. Only..

\$42⁵⁰

GENOMETER

7 Signal Generators in One!

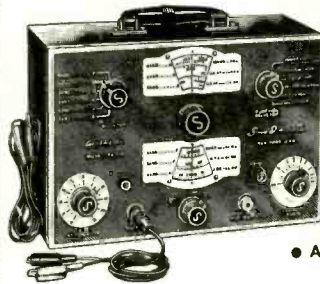

- ✓ R.F. Signal Generator for A.M.
- ✓ R.F. Signal Generator for F.M.
- ✓ Audio Frequency Generator
- ✓ Marker Generator
- ✓ Bar Generator
- ✓ Color Dot Pattern Generator
- ✓ Cross Hatch Generator

This Versatile All-Inclusive GENERATOR Provides ALL the Outputs for Servicing:

- A.M. RADIO • F.M. RADIO • AMPLIFIERS
- BLACK AND WHITE TV • COLOR TV

R. F. SIGNAL GENERATOR: 100 Kilocycles to 60 Megacycles on fundamentals and from 60 Megacycles to 180 Megacycles on powerful harmonics.

VARIABLE AUDIO FREQUENCY GENERATOR: Provides a variable 300 cycle to 20,000 cycle peaked wave audio signal.

MARKER GENERATOR: The following markers are provided: 189 Kc.; 262.5 Kc., 456 Kc., 600 Kc., 1000 Kc., 1400 Kc., 1600 Kc., 2000 Kc., 2500 Kc., 3579 Kc., 4.5 Mc., 5 Mc., 10.7 Mc., (3579 Kc. is the color burst frequency.)

BAR GENERATOR: Pattern consists of 4 to 16 horizontal bars or 7 to 20 vertical bars.

DOT PATTERN GENERATOR (FOR COLOR TV): The Dot Pattern projected on any color TV Receiver tube by the Model TV-50A will enable you to adjust for proper color convergence.

CROSS HATCH GENERATOR: The pattern consists of non-shifting horizontal and vertical lines interlaced to provide a stable cross-hatch effect.

The Model TV-50A comes complete with shielded leads and operating instructions. Only **\$47⁵⁰**

SUPER-METER

WITH NEW 6" FULL-VIEW METER



A Combination
VOLT-OHM MILLIAMMETER
Plus
CAPACITY, REACTANCE, INDUCTANCE, AND DECIBEL MEASUREMENTS
Also Tests
SELENIUM AND SILICON RECTIFIERS, SILICON AND GERMANIUM DIODES.

The model 79 represents 20 years of continuous experience in the design and production of SUPER-METERS, an exclusive SICO development. It includes not only every circuit improvement perfected in 20 years of specialization but, in addition includes those services which are "musts" for properly servicing the ever-increasing number of new components used in all phases of today's elec-

tronic production. For example with the Model 79 SUPER-METER you can measure the quality of selenium and silicon rectifiers and all types of diodes—components which have come into common use only within the past five years, and because this latest SUPER-METER necessarily required extra meter scale, SICO used its new full-view 6-inch meter.

SPECIFICATIONS:

• D.C. VOLTS: 0 to 7.5/15/75/150/750/1,500.
• A.C. VOLTS: 0 to 15/30/150/300/1,500/3,000.
• D.C. CURRENT: 0 to 1.5/15/150 Ma.
• RESISTANCE: 0 to 1,000/100,000 Ohms. 0 to 10 Megohms.
• CAPACITY: .001 to 1 Mfd., 1 to 50 Mfd.
• REACTANCE: 50 to 2,500 Ohms, 2,500 Ohms to 2.5 Megohms.
• INDUCTANCE: 15 to 7 Henries, 7 to 7,000 Henries. • DECIBELS: -6 to +18, +14 to +38, +34 to +58.
Model 79 comes complete with operating instructions, test leads, and streamlined carrying case. Use it on the bench—use it on calls. Only **\$38⁵⁰**

The following components are all tested for QUALITY at appropriate test potentials. Two separate BAD-GOOD scales on the meter are used for direct readings.
• All Electrolytic Condensers from 1 MFD to 1000 MFD.
• All Selenium Rectifiers.
• All Silicon Rectifiers.
• All Germanium Diodes.
• All Silicon Diodes.

ALL PURPOSE BRIDGE

For the first time ever: ONE TESTER PROVIDES ALL THESE SERVICES!

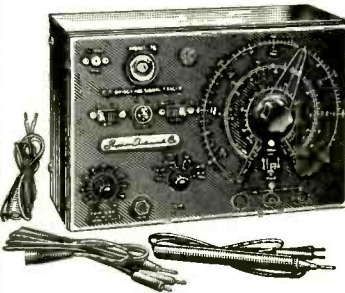

IT'S A CONDENSER BRIDGE with a range of .0001 Microfarad to 1000 Microfarads (Measures power factor and leakage too.)

IT'S A RESISTANCE BRIDGE with a range of 100 ohms to 5 megohms

IT'S A SIGNAL TRACER which will enable you to trace the signal from antenna to speaker of all receivers and to finally pinpoint the exact cause of trouble whether it be a part or circuit defect.

IT'S A TV ANTENNA TESTER The TV Antenna Tester section is used first to determine if a "break" exists in the TV antenna and if a break does exist the specific point (in feet from set) where it is.

SPECIFICATIONS:

CAPACITY BRIDGE SECTION
4 Ranges: .0001 Microfarad to 1000 Microfarads. Will also locate shorts, and leakages up to 20 megohms. Measures the power factor of all condensers from .1 to 1000 Microfarads. (Power factor is the ability of a condenser to retain a charge and thereby filter efficiently.)

RESISTANCE BRIDGE SECTION
2 Ranges: 100 ohms to 5 megohms. Resistance can be measured without disconnecting capacitor connected across it. (Except, of course, when the P. C. combination is part of an R C bank.)

SIGNAL TRACER SECTION
With the use of the R.F. and A.F. Probes included with the Model 76, you can make stage gain measurements, locate signal loss in R.F. and Audio stages, localize faulty stages, locate distortion and hum, etc. Provision has been made for use of phones and meter if desired.

TV ANTENNA TESTER SECTION
Loss of sync., snow and instability are only a few of the faults which may be due to a break in the antenna, so why not check the TV antenna first? 2 Ranges: 2' to 200' for 72 ohm coax and 2' to 250' for 300 ohm ribbon.

Model 76 comes complete with all accessories including R.F. and A.F. Probes; Test Leads and operating instructions. Nothing else to buy. Only **\$26⁹⁵**

INDICATES RADIOACTIVITY IN 3 WAYS!

- 1—BY NEON
- 2—BY PHONE
- 3—BY METER



RCA RADIATION COUNTER

MADE TO SELL FOR \$160⁰⁰—OFFERED FOR ONLY **\$47⁵⁰** NET

(Much less than cost of Manufacture.)

SPECIFICATIONS

Employs the extra sensitive 6306 Bismuth Type Geiger Counter Tube. Sensitivity is .015 Roentgens per hour (1 MR/HR=6600 counts per minute). • Three counting ranges: 0-200/2,000/20,000 counts per minute. • Handy reset button. • Ideal for survey work because the complete unit weighs only 5 1/2 lbs. • Sight and sound indications by neon flashes and headphones. Then when

an indication is obtained you switch to meter reading for exact measurements. • Decontamination easy with damp cloth applied to the weatherproofed aluminum case. • A radioactive specimen is included for instrument checking and experiments. • Included at no extra charge — U. S. Atomic Energy Commission booklet titled "Prospecting with a Counter." • R.C.A. Model WF-11AWB comes complete with self-contained batteries which provide over 200 hours of intermittent operation.

Endless experiments and discoveries in the new exciting field of nuclear energy are made possible when you acquire this finely built and engineered device. In the past, a rugged counter which was suitable for the prospecting of radio-active ores such as uranium, thorium and radium, was unsuitable for laboratory work due to the inability of combining accuracy with ruggedness. Conversely a laboratory counter, while being extremely sensitive, could not withstand use in the field where it would be subjected to abuse and abnormally hard knocks.

In the laboratory where determination of intensity (counts) of a reading are necessary, the WF-11AWB provides sensitivity for surpassing many laboratory counters.

Comes with complete set of batteries, carrying strap, headphone, radio-active specimen and A.E.C. booklet. Only **\$47⁵⁰**

EXAMINE BEFORE YOU BUY!
USE APPROVAL FORM ON NEXT PAGE

SUPERIOR'S NEW MODEL 82A

Multi-Socket Type

TUBE TESTER

TEST ANY TUBE IN 10 SECONDS FLAT!



- 1 Turn the filament selector switch to position specified.
- 2 Insert tube into a numbered socket as designated on our chart (over 600 types included).
- 3 Press down the quality button—

THAT'S ALL! Read emission

quality direct on bad-good meter scale.

SPECIFICATIONS

- Tests over 600 tube types
- Tests OZ4 and other gas-filled tubes
- Employs new 4" meter with sealed air-damping chamber resulting in accurate vibrationless readings
- Use of 22 sockets permits testing all popular tube types and prevents possible obsolescence
- Dual Scale meter permits testing of low current tubes
- 7 and 9 pin straighteners mounted on panel
- All sections of multi-element tubes tested simultaneously
- Ultra-sensitive leakage test circuit will indicate leakage up to 5 megohms

Model 82A comes housed in handsome, portable Saddle-Stitched Texon case. Only **\$36.50**

Production of this Model was delayed a full year pending careful study by Superior's engineering staff of this new method of testing tubes. **Don't let the low price mislead you!** We claim Model 82A will outperform similar looking units which sell for much more—and as proof, we offer to ship it on our examine before you buy policy.

To test any tube, you simply insert it into a numbered socket as designated, turn the filament switch and press down the quality switch—**THAT'S ALL! Read quality on meter.** Inter-element leakage if any indicates automatically.

SUPERIOR'S NEW MODEL TD-55

EMISSION TYPE

TUBE TESTER



THE EXPERIMENTER or PART-TIME SERVICEMAN, who has delayed purchasing a higher priced Tube Tester.
THE PROFESSIONAL SERVICEMAN, who needs an extra Tube Tester for outside calls.
THE TV SERVICE ORGANIZATION, which needs extra Tube Testers for its field men.

Speedy, yet efficient operation is accomplished by:

1. Simplification of all switching and controls.
2. Elimination of old style sockets used for testing obsolete tubes (26, 27, 57, 59, etc.) and providing sockets and circuits for efficiently testing the new Noval and Sub-Minar types.

YOU CAN'T INSERT A TUBE IN WRONG SOCKET
It is impossible to insert the tube in wrong socket when using the new Model TD-55. Separate sockets are used, one for each type of tube base. If the tube fits in the socket it can be tested.

CHECKS FOR SHORTS AND LEAKAGES BETWEEN ALL ELEMENTS—The Model TD-55 provides a super sensitive method of checking for shorts and leakages up to 5 Megohms between any and all of the terminals. Continuity between various sections is individually indicated. This is important, especially in the case of an element terminating at more than one pin. In such cases the element or internal connection often completes a circuit.

"FREE-POINT" ELEMENT SWITCHING SYSTEM—The Model TD-55 incorporates a newly designed element selector switch system which reduces the possibility of obsolescence to an absolute minimum. Any pin may be used as a filament pin and the voltage applied between that pin and any other pin, or even the "top-cap."

ELEMENTAL SWITCHES ARE NUMBERED IN STRICT ACCORDANCE WITH R.M.A. SPECIFICATION—One of the most important improvements, we believe, is the fact that the 4 position fast-action snap switches are all numbered in exact accordance with the standard R.M.A. numbering system. Thus, if the element terminating in pin No. 7 of a tube is under test, button No. 7 is used for that test.

The Model TD-55 comes complete with operating instructions and charts. Housed in rugged steel cabinet. Use it on the bench—use it for field calls. A streamlined carrying case, included at no extra charge, accommodates the tester and book of instructions. **\$26.95**

SUPERIOR'S NEW MODEL TV-12

TRANS-CONDUCTANCE

TUBE TESTER

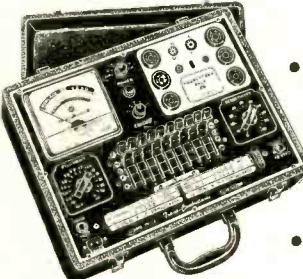

TESTING TUBES

- Employs improved TRANS-CONDUCTANCE circuit. An in-phase signal is impressed on the input section of a tube and the resultant plate current change is measured. This provides the most suitable method of simulating the manner in which tubes actually operate in Radio & TV receivers, amplifiers and other circuits. Amplification factor, plate resistance and cathode emission are all correlated in one meter reading.
- NEW LINE VOLTAGE ADJUSTING SYSTEM. A tapped transformer makes it possible to compensate for line voltage variations to a tolerance of better than 2%.

ALSO TESTS TRANSISTORS!

- SAFETY BUTTON—protects both the tube under test and the instrument meter against damage due to overload or other form of improper switching.
- NEWLY DESIGNED FIVE POSITION LEVER SWITCH ASSEMBLY. Permits application of separate voltages as required for both plate and grid of tube under test, resulting in improved Trans-Conductance circuit.

TESTING TRANSISTORS

A transistor can be safely and adequately tested only under dynamic conditions. The Model TV-12 will test all transistors in that approved manner, and quality is read directly on a special "transistor only" meter scale.

The Model TV-12 will accommodate all transistors including NPN's, PNP's, Photo and Tetrodes, whether made of Germanium or Silicon, either point contact or junction contact types.

Model TV-12 comes housed in handsome rugged portable cabinet and sells for only... **\$72.50**

SUPERIOR'S NEW MODEL 83

C.R.T. TESTER

Tests and Rejuvenates ALL PICTURE TUBES

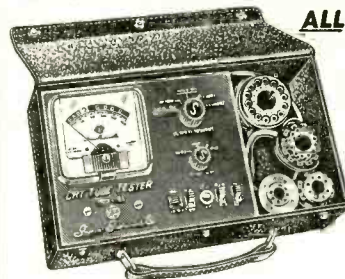

ALL BLACK AND WHITE TUBES

From 50 degree to 110 degree types —from 8" to 30" types.

ALL COLOR TUBES

Test all picture tubes—in the carton—out of the carton—in the set!

- Model 83 is not simply a rebashed black and white C.R.T. Tester with a color adapter added. Model 83 employs a new improved circuit designed specifically to test the older type black and white tubes, the newer type black and white tubes and all color picture tubes.
- Model 83 provides separate filament operating voltages for the older 6.3 types and the newer 8.4 types.
- Model 83 employs a 4" air-damped meter with quality and calibrated scales.
- Model 83 properly tests the red, green and blue sections of color tubes individually—for each section of a color tube contains its own filament, plate, grid and cathode.
- Model 83 will detect tubes which are apparently good but require rejuvenation. Such tubes will provide a picture seemingly good but lacking in proper definition, contrast and focus. To test for such malfunction, you simply press the rej. switch of Model 83. If the tube is weakening, the meter reading will indicate the condition.
- Rejuvenation of picture tubes is not simply a matter of applying a high voltage to the filament. Such voltages improperly applied can strip the cathode of the oxide coating essential for proper emission. The Model 83 applies a selective low voltage uniformly to assure increased life with no danger of cathode damage.

Model 83 comes housed in handsome portable Saddle Stitched Texon case—complete with sockets for all black and white tubes and all color tubes. Only **\$38.50**

SHIPPED ON APPROVAL NO MONEY WITH ORDER — NO C.O.D.

Try any of the instruments on this or the facing page for 10 days before you buy. If completely satisfied then send down payment and pay balance as indicated on coupon. **No Interest or Finance Charges Added!** If not completely satisfied return unit to us, no explanation necessary.

MOSS ELECTRONIC, INC.

Dept. D-597, 3849 Tenth Ave., New York 34, N. Y.

Please send me the units checked on approval. If completely satisfied I will pay on the terms specified with no interest or finance charges added. Otherwise, I will return after a 10 day trial positively cancelling all further obligations.

- | | | |
|---|--|---|
| <input type="checkbox"/> Model 77 Total Price \$42.50
\$12.50 within 10 days. Balance \$6.00 monthly for 5 months. | <input type="checkbox"/> Model TV-50A Total Price \$47.50
\$11.50 within 10 days. Balance \$6.00 monthly for 6 months. | <input type="checkbox"/> Model 79 Total Price \$38.50
\$8.50 within 10 days. Balance \$6.00 monthly for 5 months. |
| <input type="checkbox"/> Model 76 Total Price \$26.95
\$6.95 within 10 days. Balance \$5.00 monthly for 4 months. | <input type="checkbox"/> RCA Radiation Counter Total Price \$47.50
\$11.50 within 10 days. Balance \$6.00 monthly for 6 months. | <input type="checkbox"/> Model 82A Total Price \$36.50
\$6.50 within 10 days. Balance \$6.00 monthly for 5 months. |
| <input type="checkbox"/> Model TD-55 Total Price \$26.95
\$6.95 within 10 days. Balance \$5.00 monthly for 4 months. | <input type="checkbox"/> Model TV-12 Total Price \$72.50
\$22.50 within 10 days. Balance \$10.00 monthly for 5 months. | <input type="checkbox"/> Model 83 Total Price \$38.50
\$8.50 within 10 days. Balance \$6.00 monthly for 5 months. |

Name
Address
City Zone State

All prices net, F.O.B., N. Y. C.

TELEVISION

(Continued from page 89)

set all over, and cook it long enough to see if there's anything that's apt to go wrong right after you leave! There's nothin' worse than havin' to make a callback on a set you fixed yesterday, no matter what's wrong with it! How many dern times have we had to go back, just to make a silly adjustment?"

"Plenty," admitted the Young Ham. "Remember that old lady who said her set wouldn't stop rolling after you fixed it? And all you did was turn the vertical hold control!"

Automatic TV

"Yes, sir," said the Old-Timer. "Don't reckon that old gal will ever learn to run a TV set, but she's one of my best customers, and she actually don't have the faintest idea what all them knobs are for! She can turn it off and on, but that's about all. Just keep her set in as near 'automatic' shape as I can."

"There's no such thing as an automatic TV set, is there?"

"Not by a darn sight there ain't!" said the Old-Timer. "Sometimes I wish there was. But, the way to make money in this business is to do everything possible the best and quickest way. More time you waste, the less you make. That must be why I ain't ever got rich, I reckon. I git along, but to do it, I gotta keep up on all th' shortcuts and that's what tube changing is, mostly. Divide th' set up into sections, like I said. Look it over carefully to see which section seems to be givin' the trouble. Then, start changin' tubes in that section. Way the set acts tells you which section to start lookin' in."

"It's simple, once in a while," said the Young Ham. "Sometimes you can look in and see a tube dead, not even lit up."

"Well, that hadn't oughta count," said the Old-Timer. "That's too simple. Even you could spot one like that! I guess about the simplest complaint would be snow. Where would you look for that?"

"In the tuner! Most likely the rf amplifier."

"Yep. That'd be the first one to try. However, if that didn't clear it up, try the mixer-oscillator. If that don't get it, keep on. I found one the other day with a bad second if amplifier that was makin' snow in the picture. Unlikely, yes, but that's what it was. Next simplest thing, I guess, would be a real good white-out. No picture, no snow, just a good smooth raster. Brightness control works, so you know it ain't the picture tube. Maybe sound, maybe no sound. Well, your trouble's almost gotta be in the 'signal line': rf amplifier, oscillator-mixer or the if's; maybe the video detector or amplifier. Had a couple of sets last month, one almost right after the other. Both of 'em white-outs. First one, I says to myself, that's bound to be a dead video amplifier, so I changed it. Nope.

Changed every dern tube all the way up the line till I got to the rf amplifier. That was the one. Next one, same symptoms. I says, Ah-ha! I know what that is. It's the rf amplifier, so I changed it. Nope. Worked m' way all the way down the line, the other way, till I got to the video amplifier. That was it, that time! So, you never can tell."

"How about that set last week, that wouldn't get the high channels? You said at first that was a bad tuner."

"Thought it was for sure," said the Old-Timer. "It wouldn't even make snow on the highs and I was sure I had a bad tuner. Then I noticed that it was a turret tuner, with individual coils for each channel! Finally changed the rf amplifier, a 6BK7, I think, and here they came booming in! Had another one just like it next day, and it was the mixer-oscillator tube that time! Day after that, same symptoms and derned if it wasn't the first if amplifier! Then, just for a novelty, I got one that had highs but no low channels! Motorola, I think. Yep, same thing; rf amplifier. 6BQ7 that time."

"I know a good simple one," said the Young Ham. "I can diagnose them every time. Bright white line across the screen; no vertical output tube!"

"Yep. Yep with qualifications that is," said the Old-Timer. "If it's a real thin white line, then it's probably the output tube. If the line is maybe a 1/2-inch wide or a little more, then it's likely to be the oscillator itself. It's in the vertical sweep circuit though, and it's usually a tube, though it could be a defective yoke."

Don't change the subject

"Sound troubles are fairly simple aren't they?" asked the Young Ham. "You can tell them right away."

"I'm still talkin' about vertical troubles, young feller," said the Old-Timer. "You changed the vertical output tube in this hypothetical set of yours, but you didn't check the vertical size and linearity! If the dead tube had been weak, the controls may have been set for it and your picture's all out of shape; the people's heads all come to a point, like some I could mention around here!"

"Speak for yourself, John" said the Young Ham. "I remember that just as if it were yesterday and it was." He threw his head back, struck a pose, and recited rapidly, "To check the vertical linearity roll the picture slowly down the screen watching the width of the blanking bar as it passes downward. If it remains the same thickness all the way down the vertical linearity is correct!"

"Kee-rect, turn the record over and change the needle," said the Old-Timer. "How about the vertical hold action? Is it all right?"

"Normal action of the vertical hold control is as follows: the picture will roll downward slowly but will not roll slowly upward. Instead the picture will

snap out rapidly into a fast vertical roll. When rolling the picture downward the blanking bar should snap out of sight at a point not less than one-fourth of the screen diameter from the bottom of the screen period," gabbled the Young Ham, as fast as he could.

"You sound like a 33-rpm record on 45," growled the Old-Timer, "but that's right. Now what if you don't have the proper hold action and your picture won't snap? Wotcha do then, huh?"

"Change a tube?" ventured the Young Ham.

"Fine. Now, which tube? Never mind, I'll tell you. Usually the vertical oscillator. If you can roll the picture up slowly, it means your hold action is weak and you're gonna have trouble with it pretty soon. Might as well go ahead and change it right now and get it over with. Speaking of funny actions, you oughta seen the Bendix I had this morning. Changed a rectifier and horizontal output tube and then checked the vertical hold. That dern picture wouldn't jitter, but it bounced! Wouldn't snap at all, but just bounced up and down three or four times, like it was hung there on a real soft spring! Never did see one do that before! The set had a 6W6 and half a 6SN7 in the vertical oscillator. Changed the 6W6 and she straightened up nicely."

Down to work

The Old-Timer turned to the bench where a 14-inch portable was sitting. "When did this come in?" he asked.

"Man brought it in right after you left," said the Young Ham. "Said it had funny sound and the picture wasn't very good."

"Well lessee," said the Old-Timer, removing the back and attaching a cheater cord. Plugging the cord into the bench wattmeter outlet, he waited for the needle to reach a steady reading. "Hmm, a 100 and—settle down there silly—85 watts looks like. Well, no B-plus shorts anyhow. That's what this model is supposed to draw. Now let's look at it."

The screen showed a trace of snow as the Old-Timer adjusted the brightness and contrast controls. When he connected the shop antenna to it, a picture appeared and a gargling sound came forth. The picture was almost totally blacked out on the lower half of the screen, and a bad bending and weaving was seen at the top. The Old-Timer grinned at the Young Ham. "There's a nice easy diagnosis for you sonny boy. What's that?"

The Young Ham studied the picture, then ventured, "He needs half a new picture tube? No. I know." The Young Ham peered into the set. "One of the tubes in the signal circuit?" he asked.

"Probably right," replied the Old-Timer. "Of course, you see there's a 60-cycle pattern on the screen—only half is blacked out. That almost rules out the possibility of a bad filter condenser which would cause a 120-cycle pattern with two hum-bars instead of

TELEVISION

the one. So we check the tubes in that circuit, beginning with the rf amplifier. In the shop, we might as well use the tube checker. Here, check this," and he handed him the 6BZ7 rf amplifier. The Young Ham set up the tube tester, took a reading and reported, "Checks about half-good, I think. See?"

"No shorts? That ain't the one we're huntin'. Keep on. Set that one aside for a minute. Here, check these," and the Old-Timer removed the if amplifier tubes. Sure enough, the second video if showed a big short. The rest of them tested pretty good, so he put them back in the set. Jotting the date on the chassis by the socket of the tube he had replaced, the Old-Timer turned the set on. Sure enough, the picture came on clear, without the hum-bar.

"Well that's that. But, look at that picture. See anything we might correct there?"

"Looks pretty good to me," said the Young Ham. "Might be a little too much snow, though. Should we try a new rf amplifier in it?"

"Try it and see," said the Old-Timer, handing him a new 6BZ7. The Young Ham plugged the new tube in and, sure enough, the snow disappeared. "There you are," the Old-Timer remarked. "That helped considerable. Now you see you can't tell just exactly by a tube check's readings how a given tube is going to perform in any set. That tube checked pretty good, but she just didn't have the poop to work right. 'Bout the best way is to try a new one and see what it does to the picture."

"Looks pretty good now," said the Young Ham.

"Yep. Believe she'll do. Now, there's a good example of a tube-changin' job for you. We could have done the same thing, almost as fast, by just changin' the tubes one at a time until we got rid of the hum-bar. Then, we could have found that weak rf tube the same way. But, we had to know what we were lookin' for. Now let's go a little farther, just to show you a few of the things you've got to look out for. That snow was one of 'em—that tube would have given trouble in a little while, and chances are we'd have gotten a call-back out of it."

When it comes to agc

"Take agc action, for instance." He turned the set around. "Suppose the complaint is that the picture bends and weaves in the middle and ain't too stable. You try it and, sure enough there's that characteristic agc bend, a big S-shaped buckling over the whole picture. The agc control won't operate just right either. So you change the agc tube itself, first—a 6AU6 in this one. Might be a 6BE6 or a 6CS6 or even a 12AU7. Best way's to try a new tube and see if the set goes back to normal. If it does, leave the new tube in there!"

"'Nother thing you got to watch out for," continued the Old-Timer, "is these dern 'critical' tubes. Agc and sync sep-

arator tubes are about the worst there is, too. I've taken tubes out of a sync-separator socket and put 'em in the tuner. They worked perfectly there and wouldn't work at all in the sync circuits! Say, wait a minute. I think I can show you something. If I didn't throw that tube away, like I should have." He scabbled around in a small box on the end of the bench, coming up with a small tube. "Here it is. Watch this." He plugged the tube into the agc socket of the set. As it warmed up, the set fell out of sync, and finally the screen blacked out completely. The Young Ham stared at it.

"Hey! Looks like it didn't have any high voltage!" he cried. "It's blacked out entirely!"

"Looks like it, doesn't it?" said the Old-Timer. "Look here now," and he turned the brightness up. The screen showed a slight gray, with little flashes and pinpoint of light here and there. "See? It's pretty dark, but you can see those little spots and flashes. Looks kinda like white snow. Actually, the video amplifier's blocked, I think. Never tried to find out exactly, but if you see those little spots and flashes, it's an agc blackout every time. Way to check it, either pull the video amplifier or the agc tube. That should bring the raster back. See?" and he removed the video amplifier. This brought the light back to the screen.

"Boy!" and the Young Ham shook his head. "I never will learn all those symptoms. I'm just too stupid!"

"Naw, you ain't, boy. You ain't stupid, you just act that way!" said the Old-Timer, ducking quickly. "Ohh, me! Has it stopped raining yet?"

"No," replied the Young Ham, peering out the front window. "Still drizzlin' a little."

"Well," said the Old-Timer, striking a theatrical pose and gesturing dramatically, "there comes a time in the affairs of men, which, taken at the flood . . ."

"Leads inevitably to the nearest coffee shop," finished the Young Ham.

END



BOGEN

*the sound way
to better stereo*

IT'S TRUE WHAT THEY SAY ABOUT STEREO

Any stereo set-up—no matter what the cost—is only as good as the quality of the components that go into it. To put it another way, the quality you want can only be supplied by a company with the experience in sound engineering that the manufacture of superior stereo components requires.

Everyone agrees that the making of high-fidelity sound equipment is an extremely technical, highly specialized phase of the electronics industry. And that years of experience are required before a high degree of manufacturing excellence can be achieved. For over twenty-five years, Bogen has been making special sound systems of *proven* excellence for schools, theatres, offices and industrial plants—as well as hi-fi components.

Here is the business end of a typical Bogen school sound system.



Wherever professional sound quality is needed—you'll find Bogen, the sound equipment *made* by professionals. Best of all, the same sound quality that engineers and musicians insist on is yours to supply—and enjoy—with Bogen stereo high-fidelity components.

ILLUSTRATED BOOKLET: 64-page explanation of hi-fi and stereo, "Understanding High Fidelity-Stereo Edition". Enclose 25c. BOGEN-PRESTO CO., Paramus, N.J. A Division of the Siegler Corporation.

BOGEN
HIGH FIDELITY COMPONENTS



SHIPPED ON APPROVAL

IN-CIRCUIT CONDENSER TESTER

Model CT-1

AN ABSOLUTE 'MUST' FOR EVERY SERVICEMAN!

Here is an in-circuit condenser tester that does the whole job. The CT-1 actually steps in and takes over where all other in-circuit condenser testers fail. The ingenious application of a dual bridge principle gives the CT-1 a tremendous range of operation. . . .



Model CT-1 — housed in sturdy hammertone finish steel case complete with test leads
\$34⁵⁰ Net
 SIZE: W-6" H-7" D-3 1/4"

in-circuit checks:

- ✓ Quality of over 80% of all condensers even with circuit shunt resistance present . . . (leakage, shorts, opens, intermittents)
- ✓ Value of all condensers from 200 mmfd. to .5 mfd.
- ✓ Quality of all electrolytic condensers (the ability to hold a charge)
- ✓ Transformer, socket and wiring leakage capacity

out-of-circuit checks:

- ✓ Quality of 100% of all condensers . . . (leakage, shorts, opens and intermittents)
- ✓ Value of all condensers from 50 mmfd. to .5 mfd.
- ✓ Quality of all electrolytic condensers (the ability to hold a charge)
- ✓ High resistance leakage up to 300 megohms
- ✓ New or unknown condensers . . . transformer, socket, component and wiring leakage capacity

SPECIFICATIONS

- Ultra-sensitive 2 tube drift-free circuitry
- Multi-color direct scale precision readings for both quality and value . . . (in-circuit or out of circuit)
- Simultaneous readings of circuit capacity and circuit resistance
- Built-in hi-leakage indicator sensitive to over 300 megohms
- Cannot damage circuit components
- Electronic eye balance indicator for even greater accuracy
- Isolated power line

IN-CIRCUIT RECTIFIER TESTER

Model SRT-1

Checks all power rectifiers in-circuit whether SELENIUM, GERMANIUM, SILICON, etc.

With the growing trend towards compactness, portability and low price, TV manufacturers are resorting more and more to producing series-string TV sets employing selenium, germanium or silicon power rectifiers. Now the need for an in-circuit rectifier tester is greater than ever.

THE SRT-1 CHECKS ALL POWER RECTIFIERS IN-CIRCUIT AND OUT-OF-CIRCUIT WITH 100% EFFECTIVENESS FOR:

- ✓ Quality
- ✓ Fading
- ✓ Shorts
- ✓ Opens
- ✓ Arcing
- ✓ Life Expectancy

SIZE: W-6" H-7" D-3 1/4"

SPECIFICATIONS

- Checks all types of power rectifiers rated from 10 ma. to 500 ma. (selenium, germanium, silicon, etc.) both in-circuit or out-of-circuit.
- Will not blow fuses even when connected to a dead short.
- Large 3" highly accurate multi-color meter . . . sensitive yet rugged.
- Separate meter scales for in-circuit and out-of-circuit tests.
- Cannot damage or over heat rectifier being tested.

SIMPLE TO OPERATE

Just clip SRT-1 test leads across rectifier under test right in the circuit without disconnecting rectifier from circuit. Press test switch and get an instant indication on the easy-to-read three-color meter scales. . . .



Model SRT-1—housed in sturdy hammertone finish steel case complete with test leads
\$29⁵⁰ Net

MINI-CHECK TUBE TESTER

Model MC-1

A Real ECONOMY MULTIPLE SOCKET TUBE TESTER without sacrifice in ACCURACY, SPEED or VERSATILITY

Here is a multiple socket tube tester designed to meet limited budgets. Although low in price it boasts a unique circuitry that enables you to check over 600 tube types — and has a range of operation that far exceeds others in its price class.

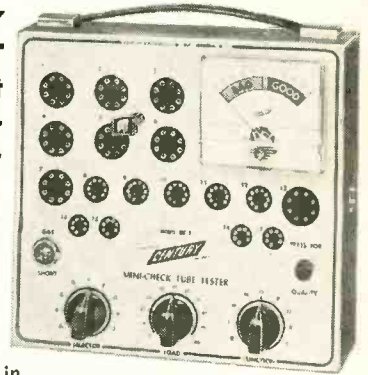

Model MC-1 — housed in sturdy wrinkle finish steel case

\$39⁵⁰ Net

SIZE: W-9" H-8 1/2" D-2 3/4"

SPECIFICATIONS

- Checks emission, inter-element shorts and leakage of over 600 tube types. This covers OZ4s, series-string TV tubes, gas regulators, auto 12 plate volt, hi-fi and foreign tubes
- 3 settings enable a test of any tube in less than 10 seconds
- Employs dynamic cathode emission test principles
- 3 1/2" D'Arsonval type meter — most accurate type available . . . its greater sensitivity means more accuracy . . . its jewel bearing means longer life
- 17 long lasting phosphor bronze tube sockets
- Combination gas and short jewel indicator
- 9 filament positions
- Handy tube chart contained in special back compartment
- New tube listings furnished periodically at no cost
- Detachable line cord

plus these BONUS FEATURES . . . found in no other low price tube tester

- ✓ Checks for cathode to heater shorts
- ✓ Checks for gas content
- ✓ Checks all sections of multiple purpose tubes . . . will pickup tubes with one "Bad" section
- ✓ Line isolated — no shock hazard
- ✓ Variable load control enables you to get accurate results on all tubes
- ✓ Positively cannot become obsolete as new tubes are introduced.

TRANSISTOR TESTER

Model TT-2

AN INEXPENSIVE QUALITY INSTRUMENT DESIGNED FOR ACCURATE AND DEPENDABLE TESTS OF ALL TRANSISTORS AND DIODES QUICKLY AND ACCURATELY

Every day more and more manufacturers are using transistors in home portable and car radios . . . in hearing aids, intercoms, amplifiers, industrial devices, etc. Since transistors can develop excessive leakage, poor gain, shorts or opens, the need for TRANSISTOR TESTER is great.

SPECIFICATIONS

- Checks all transistors, including car radio, power output, triode, tetra-rode and unijunction types for current gain, leakage, opens, shorts, cut-off current
- Checks all diodes for forward to reverse current gain
- All tests can be made even if manufacturers' rated gain is not available
- Tests of less than half a minute required for yet rugged . . . with multi-color scales designed for quick easy readings so small, service life almost equal to shelf life. Battery cannot be drained due to accidental shorting of test leads
- Cannot burn-out its own meter or clips enable tests without entirely removing transistor from circuit
- Long test leads and insulated test leads are identified by E.I.A. color code so that connection to the correct terminal is assured
- Comes complete with replaceable transistor set-up chart that fits into a special rear compartment.

IMPORTANT FEATURE: The TT-2 cannot become obsolete as you to check all new type transistors as they are introduced. New listings will be furnished periodically at no cost.

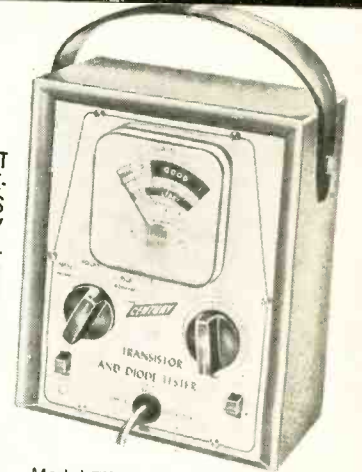

Model TT-2 — housed in sturdy hammertone finish steel case complete with test leads
\$24⁵⁰ Net
 SIZE: W-6" H-7" D-3 1/4"

EASY TO BUY IF SATISFIED
 see order form on facing page

FOR 10 DAY FREE TRIAL

Convince yourself at no risk that CENTURY instruments are indispensable in your every day work. Send for instruments of your choice without obligation . . . try them for 10 days before you buy . . . only then, when satisfied, pay in easy-to-buy monthly installments — without any financing or carrying charges added.

NEW Battery Operated Peak-to-Peak VACUUM TUBE VOLT METER Model VT-1

WITH LARGE EASY-TO-READ 6" METER —

featuring the sensational new MULTI-PROBE * Patent Pending

No extra probes to buy! The versatile MULTI-PROBE does the work of 4 probes

- ① DC Probe ② AC Probe ③ Lo-Cap Probe ④ RF Probe

The VT-1 is a tremendous achievement in test equipment. With its unique MULTI-PROBE it will do all the jobs a V.T.V.M. should do without the expense of buying additional probes. No longer do you have to cart around a maizd of entangled cables, lose time alternating cables or hunting for a misplaced probe. With just a twist of the MULTI-PROBE tip you can set it to do any one of many time-saving jobs. A special holder on side of case keeps MULTI-PROBE firmly in place ready for use.

FUNCTIONS

DC VOLTMETER . . . Will measure D.C. down to 1.5 volts full scale with minimum circuit loading, and give accurate readings of scale divisions as low as .025 volts . . . Will measure low AGC and oscillator bias voltages from .1 volts or less up to 1500 volts with consistent laboratory accuracy on all ranges . . . Zero center provided for all balancing measurements such as discriminator, ratio detector alignment and hi-fi amplifier balancing.

AC VOLTMETER . . . True Peak-to-Peak measurements as low as 3 volts of any wave form including TV sync, deflection voltages, video pulses, distortion in hi-fi amplifiers, AGC and color TV gating pulses . . . Scale divisions are easily read down to .1 volts . . . Measures RMS at 1/20th the circuit loading of a V.O.M. . . . Unlike most other V.T.V.M.'s there is no loss in accuracy on the lowest AC range.

ELECTRONIC OHMMETER . . . Measures from 0 to 1000 megohms . . . Scale divisions are easily read down to .2 ohms . . . Will measure resistance values from .2 ohms to one billion ohms . . . Will detect high resistance leakage in electrolytic and by-pass condensers.

RF and LO-CAP MEASUREMENTS . . . With these extra VT-1 functions you can measure voltages in extremely high-impedance circuits such as sync and AGC pulses, driving saw tooth voltages, color TV gating pulses, mixer output levels, I.F. stage-by-stage gain and detector inputs.

OUTSTANDING FEATURES

- Completely portable — self powered with long life batteries — permits use everywhere
- New advanced pentode amplifier circuit assures amazingly low battery drain
- Large 6" 100-microampere meter, many times more sensitive than meters used in most V.T.V.M.'s
- Laboratory accuracy performance — 2% of full scale on DC, 5% of full scale on AC
- Simplified multi-color easy-to-read 4-scale meter
- No heat operation assures rigid stability and accuracy
- Immune to power line fluctuations
- Amplifier rectifier circuit with frequency compensated attenuator — a feature found only in costly laboratory instruments
- Meter completely isolated — practically burn-out proof
- Hand-crafted circuitry eliminates the service headaches of printed circuitry
- 1% resistors used for permanent accuracy
- Separate RF ground return for low-loss RF measurement
- Micro-ohm type co-axial connector
- Matching cover protects instrument face — snaps on and off instantly.

SPECIFICATIONS

- DC Volts — 0 to 1.5/6/30/150/300/600/1500 volts
- AC Volts (RMS and Peak-to-Peak) — 0 to 3/12/60/300/1200 volts
- Ohms — 0 to a billion ohms, 10 ohms center scale — Rx1/10/100/1K/10K/100K/1M
- RF — Peak reading demodulator supplied for use on all DC ranges
- Zero Center — available on all DC volt ranges with zero at mid-scale
- Decibels — from -10 Db to +10/22/36/50/62 based on the Dbm unit: 0db-1mW in 600 ohms
- Impedance — 11 megohms DC, 1 megohm AC, 10 megohms Lo-Cap
- Input Capacity — 130 mmfd. RMS, 250 mmfd. Peak-to-Peak, 25 mmfd. Lo-Cap



SIZE:
W-7 3/8"
H-9"
D-4 1/4"

Model VT-1 — fully wired and calibrated, housed in hand-some hammertone finish steel case, complete with MULTI-PROBE, and thorough instruction manual covering all the applications in detail. **\$58.50** Net

FAST-CHECK TUBE TESTER Model FC-2

Simply set two controls . . . insert tube . . . and press quality button to test any of over 700 tube types completely, accurately . . . IN JUST SECONDS!

Over 20,000 servicemen are now using the FAST-CHECK in their every day work and are cutting servicing time way down, eliminating unprofitable call-backs and increasing their dollar earnings chose the FAST-CHECK above all other tube testers.

PICTURE TUBE TEST ADAPTER INCLUDED WITH FAST-CHECK
Enables you to check all picture tubes (including the new short-neck 110 degree type) for cathode emission, shorts and life expectancy . . . also to rejuvenate weak picture tubes.

RANGE OF OPERATION

- ✓ Checks quality of over 700 tubes types, employing the time proven dynamic cathode emission test. This covers more than 99% of all tubes in use today, including the newest series-string TV tubes, auto 12 plate-volt tubes, 0Z4s, magic eye tubes, gas regulators, special purpose hi-fi tubes and even foreign tubes.
- ✓ Checks for inter-element shorts and leakage.
- ✓ Checks for gas content.
- ✓ Checks for life-expectancy.

SPECIFICATIONS

- No time consuming multiple switching . . . only two settings are required instead of banks of switches on conventional testers
 - No annoying roll chart checking . . . tube chart listing over 700 tube types is located inside cover. New listings are added without costly roll chart replacement
 - Checks each section of multi-section tubes and if only one section is defective the tube will read "Bad" on the meter scale
 - 41 phosphor bronze beryllium tube sockets never need replacement
 - 7-pin and 9-pin straighteners mounted on panel
 - Large 4 1/2" D'Arsonval type meter is the most sensitive available, yet rugged — fully protected against accidental burn-out
 - Special scale on meter for low current tubes
 - Compensation for line voltage variation
 - 12 filament positions
 - Separate gas and short jewel indicators
 - Line isolated — no shock hazards
 - Long lasting etched aluminum panel.
- NOTE:** The Fast-Check positively cannot become obsolete . . . circuitry is engineered to accommodate all future tube types as they come out. New tube listings are furnished periodically at no cost.

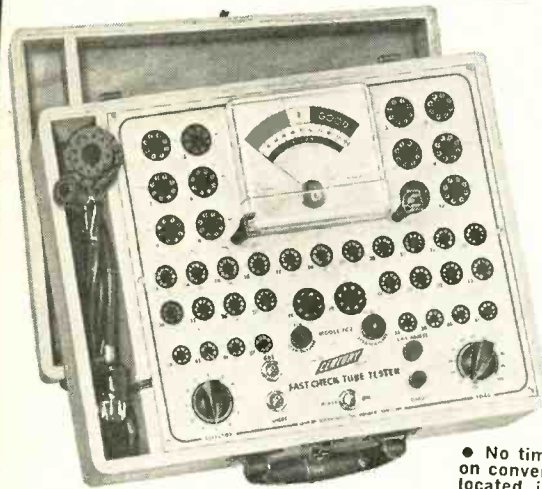

SIZE: W-14 5/8" H-11 1/4" D-4 3/8"

Model FC-2 — housed in hand-rubbed oak carrying case complete with CRT adapter

\$69.50 Net

CONVENIENT TIME PAYMENT PLAN — NO FINANCING CHARGES

ALL CENTURY INSTRUMENTS ARE GUARANTEED FOR ONE FULL YEAR

The extremely low prices are made possible because you are buying direct from the manufacturer.

CENTURY ELECTRONICS CO., INC.

CHECK INSTRUMENTS DESIRED

- | | | |
|--------------------------|--|---------|
| <input type="checkbox"/> | Model CT-1 In-Circuit Condenser Tester | \$34.50 |
| <input type="checkbox"/> | \$9.50 within 10 days. Balance \$5 monthly for 5 months. | |
| <input type="checkbox"/> | Model MC-1 Mini-Check Tube Tester | \$39.50 |
| <input type="checkbox"/> | \$9.50 within 10 days. Balance \$6 monthly for 5 months. | |
| <input type="checkbox"/> | Model SRT-1 In-Circuit Rectifier Tester | \$29.50 |
| <input type="checkbox"/> | \$4.50 within 10 days. Balance \$5 monthly for 5 months. | |
| <input type="checkbox"/> | Model TT-2 Transistor Tester | \$24.50 |
| <input type="checkbox"/> | \$4.50 within 10 days. Balance \$5 monthly for 4 months. | |
| <input type="checkbox"/> | Model VT-1 Battery Vacuum Tube Volt Meter | \$58.50 |
| <input type="checkbox"/> | \$14.50 within 10 days. Balance \$11 monthly for 4 months. | |
| <input type="checkbox"/> | Model FC-2 Fast-Check Tube Tester | \$69.50 |
| <input type="checkbox"/> | \$14.50 within 10 days. Balance \$11 monthly for 5 months. | |
- Prices Net F.O.B. Mineola, N. Y.

111 Roosevelt Avenue, Dept. 105, Mineola, New York

Please rush the instruments checked for a 10 day free trial. If satisfied I agree to pay the down payment within 10 days and the monthly installments as shown. If not completely satisfied I will return the instruments within 10 days and there is no further obligation. It is understood there will be NO INTEREST or FINANCING charges added.

Name Please print clearly

Address

City State

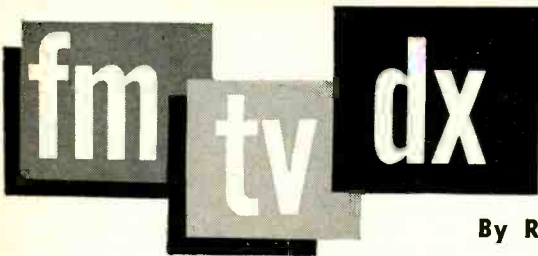

By ROBERT B. COOPER, Jr.

EVERY so often we are reminded that not every FM and TV dx enthusiast is an old hand at the game, and consequently much of the terminology we take for granted in this column is just so much Greek to many readers. This month we shall redefine a few phrases for the new, and old, hands alike.

How, why and when?

How does dx occur, why does it occur and when does it occur? The "when" we try to cover at the end of each column. The "how" and "why" were described in an article appearing in the November, 1957, issue of RADIO-ELECTRONICS entitled "Notes From a TV Dixer's Notebook," which also contains detailed explanations of dxing terms. Another article by this writer appeared in the November, 1958, issue of QST, and dealt with logging high-band (channels 7-13) stations 800-1,600 miles distant by a rare form of sporadic-E skip.

But what about the terms we use in the dx column?

Trops: This is a shortened term for the phrase "tropospheric bending." Trops (or sometimes tropo) is the extension of normal ground-wave coverage of a TV or FM station beyond its normal range by lower-atmosphere (troposphere) weather phenomena. Various boundary lines form in the lower atmosphere (ground level to 20,000 feet), separating regions of hot and cold or moist and dry air. Such boundaries trap FM and TV signals close to the earth and carry them beyond the horizon to distant points. We associate trops conditions with large-scale weather movements across the North American continent.

E Skip (E_s): This is the reflection of low-band TV (and sometimes FM-range) signals from a region in our lower ionosphere, at a height varying from 60-120 miles above the earth's surface, called the E-layer. This layer is composed of various inert gases, plus a thin band of sodium gas and a heavy concentration of hydrogen atoms.

Normally this layer is fairly quiet and radio signals above 10 mc or so pass right through it with little or no rebound. At various unpredictable and fairly unrelated periods (usually between May 1 and Sept. 1), the layer becomes very dense, and low-band TV signals bounce off it as light is reflected from a mirror.

Reception distance varies as the den-

sity and height of the layer fluctuate, but normally 400-500 miles is the range covered. Signals become very strong and often override stations on the same channel as close to you as 25 miles! Reception may last 5 minutes or 5 hours; again, entirely unpredictable.

MS (Meteor Scatter): Under normal conditions, when the E-layer is quiet, meteors (particles of space dust, iron minerals, bits of metallic matter) are swept up by the earth as it flows through space in its path around the sun.

These particles are caught up by the earth's gravitational pull and approach the surface of the earth at a high speed. As they enter the lower E-layer, they begin to encounter a little resistance from the upper atmosphere and consequently become hot, eventually reaching the combustion point, whereupon they disintegrate. The heat given off by their combustion causes the region of the E-layer surrounding the burning particle to become excited, momentarily, while the heat lasts, and for a second or so this small spot in the E-layer forms a mirror, reflecting for a second or two all TV or FM signals passing through that point back to earth at some distant point.

Some experts estimate that tens of billions of such particles are swept up by the earth every day. Thus MS dx is productive on a daily basis, when other forms of dx reception are dead. Because MS dx is weak and short-lived, the ultimate in antennas, receiver sensitivity and stability are required for good results.

Aurora and F2: These two forms of propagation will be explained in the July column.

Central American dx

For some time your editor has suspected that the richest dxing area in the Western Hemisphere exists throughout the Caribbean and Gulf of Mexico region. We received reports from TV dxers on the Yucatan Peninsula in Mexico last spring and summer, who reported dx active on a daily basis on all vhf channels, from stations 700-1,200 miles away.

Now, Walt McNab of Belize, British Honduras (800 miles southeast of Mexico City), notes low-band reception between 1630 and 2230 CST, sometimes with amazing regularity. For instance, he saw KPRC almost daily from Dec.

23 to Jan. 5, for hours at a time. As only low-band action has been noted, we would be inclined to suspect E-skip. However, the great stability of the reception leads us to consider trops.

Mr. William C. Williams in Ciudad Obregon, Sonora, Mexico, has had excellent luck, noting reception "averaging twice weekly" from stations 700-1,300 miles away. All reception has been in the 1700-2100 MST segment. A very interesting "scatter-reception" project over the 340-mile path to Tucson is developing among the local townspeople.

Dx predictions

Meteor showers: Although MS reception is with us daily, occasionally the earth moves through regions of extra high concentrations of space dust particles. During such periods, MS reception is greatly enhanced, with a chance of MS reception even on the vhf high channels (7-13). The table lists the showers during the next forecast period. The "Time Maximum Burst Rate" column, tells when the shower peaks. "Direction" indicates during what hours reception will be best along which radio paths (north-south, Minneapolis, Minn., to Hot Springs, Ark.; east-west, Omaha, Neb., to Portland, Ore.). "Grade" indicates the potential of the shower, from A—very good, to D—only fair.

Trops

In warm weather, general ground-wave coverage increases by 30-75% in most Eastern areas. Dxers along the Great Lakes and throughout the Midwest should be aware of the one or two large-scale annual trops openings which usually show up during late May and June. Watch the high band (7-13) for signs of stations not normally seen, even during the summer. Usually stations to the west and northwest of your location will appear first, followed by stations to the north and south, and finally by stations to the east. Distances up to 800 miles on the high band should be possible. Best hours: 1800 LST (local standard time) to 0200 LST, and 0600-0900 LST.

E-Skip

This is the big summer-time attraction for FM and TV dxers. Any hour of the day, any direction, any of the low-

TABLE OF METEOR SHOWERS

Name	Date	Time (LST) Maximum Burst Rate	Direction	Grade
Aquarids	May 1-6	0830-1000	N-S	A
		0500-0830	E-W	A
Herculids	May 11-24	2130-2300	N-S	C
		0100-0300	N-S	C
Cetids	May 19-21	0730-0900	NW-SE	A
		1100-1230	SW-NE	A
		0900-1100	E-W	A
Pegasids	May 30	0300-0430	N-S	C
		0630-0900	N-S	C
		0800-0930	E-W	C
Scorpiids	June 2-17	0100	NW-SE	B
		2300-2400	E-W	C
		2200	SW-NE	C

Simply by checking
all the tubes in the TV set with

B&K **DYNA-QUIK**

YOU CAN INCREASE YOUR INCOME

FAST AND ACCURATE

- Tests complete set in minutes
- Wins customer's confidence
- Saves costly call-backs
- Sells more tubes on-the-spot
- Avoids substitution testing
- Makes more money every day

\$50*
PER WEEK

***ACTUAL EXPERIENCE SHOWS
TV SERVICEMEN AVERAGE**

**2 extra tube sales
PER CALL**

**5 calls per day in
5 days equal \$50**

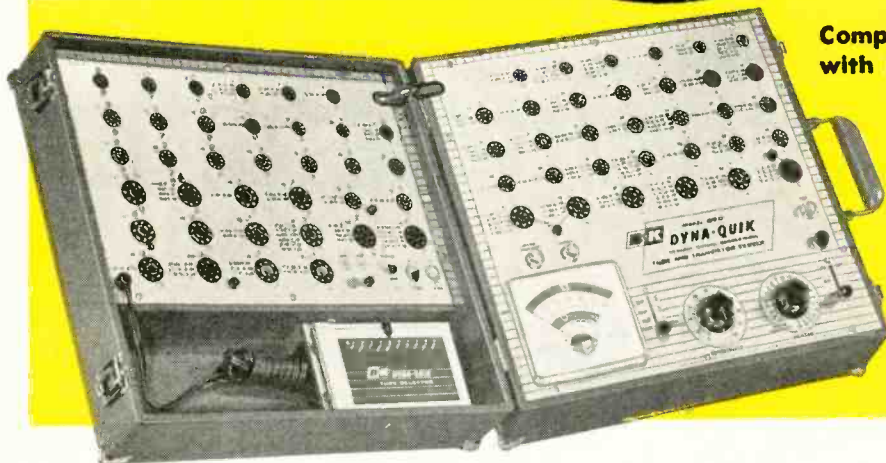

**Completely test each tube
with laboratory accuracy!**

**Model 650
DYNA-QUIK**

*Today's Fastest,
Most Complete Portable*

**TUBE AND
TRANSISTOR
TESTER**



**Professional-type tester
used by more service
technicians every day.**

MEASURE TRUE DYNAMIC MUTUAL CONDUCTANCE

Thousands of technicians are doing a better servicing job and are making more money today with the famous B&K DYNA-QUIK. Completely tests each tube in seconds, with laboratory accuracy, in home or shop. *Measures true dynamic mutual conductance.* Shows tube condition on "Good-Bad" scale and in micromhos. No multiple switching or roll chart. Quickly detects weak, short-life, or inoperative tubes. Shows customer the true condition and life-expectancy of tubes in the set; sells more tube replacements per call. Assures customer satisfaction and protects the service guarantee.

Model 650 Dyna-Quik improves servicing, quickly pays for itself

Checks over 99% of the tubes most widely used in television receivers, plus popular home and portable radio tubes. Tests over 500 tube types. Lists over 125 most commonly used tube types, with settings, on socket panels for maximum operating speed. Complete listing in fast telephone index type selector. Tests each section of multiple tubes separately for Gm, Shorts, Grid Emission, and Life. Tests each tube for Gas Content. Provides instantaneous Heater Continuity check. Includes 16 spare sockets and sufficient filament voltages for future new tube types. Transistor Section checks junction, point contact and barrier transistors, germanium and silicon diodes, selenium and silicon rectifiers.

See Your B&K
Distributor or

Send Now for
Bulletin ST21-E

Net, \$169.95

ANOTHER PROVED MONEY-MAKER



**Deluxe Portable
CRT 400**

**Tests and Repairs
Picture Tubes
Makes New Tube
Sales Easier**

Checks and corrects most TV picture tube troubles in a few minutes, right in the home, without removing tube from set. Restores emission. Checks leakage. Repairs shorts and open circuits. Life Test checks gas content and predicts useful life.
Net, \$59.95

Adapters for Models 400 and 350 CRT's
Model C40 Adapter. For standard 6.3 volt filament 110° tubes and color tubes. Net, \$9.95
Model CR48 Adapter. For the new 110° tubes with 2.34, 2.68 and 8.4 volt filaments. Net, \$4.95



B & K MANUFACTURING CO.
3726 N. Southport Ave. • Chicago 13, Illinois
Canada: Atlas Radio Corp., 50 Wingold, Toronto 10, Ont.
Export: Empire Exporters, 458 Broadway, New York 13, U.S.A.



America's Fastest-Growing Service Capacitor Line...



NEW!

TOBE MYLAR* MOLDED TUBULAR CAPACITORS

- Molded of DuPont Mylar, one of the finest insulation materials ever developed.
- Thermoset Case Construction secures leads and sections firmly to withstand extremes of handling, vibration, shock and soldering temperatures.
- High Insulation Resistance: Average megohm values per unit 10,000 at 25°C. Small capacitance variation with thermal change.
- Temperature Operating Range: -55° to +130°C.
- Moisture Resistant: Exceeds JAN-C-91 requirements.
- Non-Inductive: Extended foil construction insures low resistance connections and low RF impedance.

DESIGNED FOR SERVICE DEALERS

NEW TOBE MYLAR* CAPACITOR KIT

FREE KIT CONTAINS
80 CAPACITORS

ONLY

\$15⁸⁴



Today, order your Tobe Mylar Kit from your Tobe Distributor

Compact, clear-plastic dispenser contains an assortment of 80 Tobe Mylar capacitors in the most popular sizes, ratings and quantities for quick, efficient servicing. Covers over 60 different ratings at 200, 400 and 600 working volts and from .0001 to 1.00 mfd. Dealer pays only for the Tobe Mylar capacitors, kit is free.



TOBE RADIART CAPACITORS

*DuPont trademark

TELEVISION

band channels, are the rules of the E-skip game. Watch for signs of co-channel interference (Venetian-blind effect) on low-band channels not free of interference. The best periods are usually 0700-1000 and 1600-2100 LST, although no hours should be overlooked. Daily patterns of dx every morning from 0800-1030, and nights from 1800-2000 often develop, so watch for signs of repetition in your log. Such patterns seldom last longer than 4 or 5 days running, however, and then a new pattern may begin.

West Coast dxers will find the hours of 1800-2100 PST best for double hop into stations east of the Mississippi. Be especially wary of the period around 1845 PST. Dxers in the EDST time zone should watch for dx from Midwest and Far West stations after their local stations leave the air (0100-0300 EDST) as time-zone differentials can be helpful.

Reporting

This season we are especially interested in all types of FM dx. If you dx the FM band, either regularly or just once in a while, why not get into the regular reporting habit now? It's very easy.

RADIO-ELECTRONICS and the FM-TV Dx column continue to provide dx report forms free to any interested readers. Address a postcard, with the phrase "Dx Forms" and your name and address on the back, to RADIO-ELECTRONICS, FM-TV Dx Column, 154 W. 14 St., New York 11, N. Y. END

AN OLD FRAUD REVIVED

Would you pay \$4.98 to "convert your TV to living true colors in minutes" with a "magnificent converter" developed by "Hanz Koepfel, European inventor"?

With these lavish phrases, advertisements (some of them in reputable newspapers) are reviving an old and thoroughly exposed hoax which dates back to TV's early days. All you have to do is clip out the coupon, send it in with the half sawbuck and you will receive a magnificent sheet of thin transparent plastic, which, when affixed to your TV screen, will give you fascinating color—even on black-and-white shows.

If "true colors" means blue faces, red suits and green feet, the ad is partially true. But not true enough for the New York Better Business Bureau, which clipped the coupon, examined the product and promptly labeled it a "phony." The New York District Attorney's office has seized the advertiser's books and records as a prelude to possible fraud action, and the Federal Government is studying the possibility of postal fraud charges.

So beware a new rash of "cheap color converter" advertisements. The hoax is as transparent as the sheet of colored Cellophane they're hawking. END

TV Service Clinic

conducted by
ROBERT G. MIDDLETON
RADIO-ELECTRONICS TELEVISION CONSULTANT

INTEREST in color TV servicing continues to grow, and a few pointers on color sync appear to be in order. A normal color bar pattern, locked in color sync, is shown in Fig. 1. However, when color sync is lost, each of

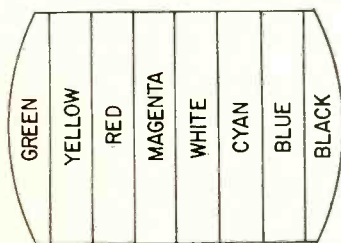

Fig. 1—A normal color bar pattern.

the color bars breaks up and appears as a column of rainbows, as seen in Fig. 2.

The starting point of each rainbow in each bar is different, because each color has a different phase.

Color sync is maintained by the receiver's color sync section. This is an afc circuit (see Fig. 3). In normal operation, when switching from channel to channel, color sync will "pull in" within 1 second. Slow pull-in, or refusal to lock, indicates incorrect adjustment or operation of the color sync section.

If new tubes do not correct the trouble, check the color afc balance control (Fig. 4).

The color subcarrier oscillator will not lock in color sync if the afc balance control is far off correct setting.

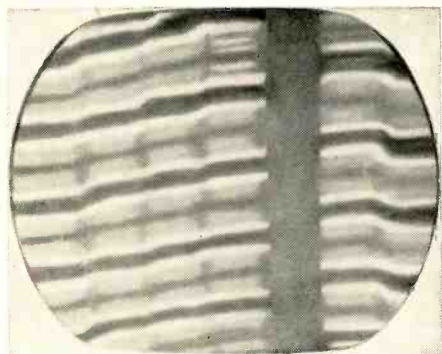

Fig. 2—Color bar pattern which is out of color sync.

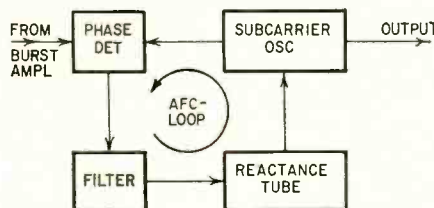

Fig. 3—The color sync system operates as an afc loop.

The weaker the burst signal, the more closely the balance control must be set to lock in color sync.

Normally, there is no voltage between the arm of the balance control and ground. You will observe, however, that this voltage does not stay at zero, but slowly drifts slightly positive and negative. This is caused by normal drift in the circuits. However, a steady large voltage such as 1 or 2 volts shows that trouble is present.

If the balance control cannot be set for zero output (with burst signal present), check the tuning of the subcarrier oscillator, L1 in Fig. 5.

Of course, there are many other

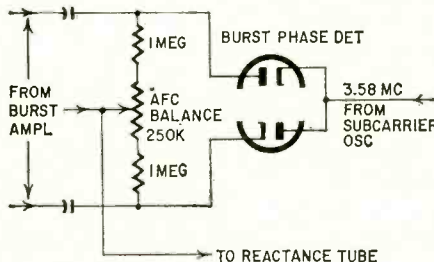

Fig. 4—An unbalanced afc control causes the hues in the picture to change with the chroma signal level.

causes of poor color sync, besides those noted here. However, these are the most important points, which should be checked first in case of trouble.

Picture pulling

A Raytheon 17T18 has developed pulling at the top of the picture on channel 2, and more recently on channel 4. Reception is OK on other channels. The receiver operates on a cable system. Other receivers do not pull when operated from the cable. Please list the possible causes of the trouble.—L. B. S., Missoula, Minn.

This difficulty is probably caused by modulated hum of the incoming signal, plus deterioration of the agc system in the 17T18 chassis. An efficient agc circuit will compensate in part for modulated hum. Look for bad tubes in the cable amplifiers. Also, work over the agc circuit in the receiver chassis and the difficulty should clear up.

Wants larger screen

To convert a G-E 17T2 or a Motorola TS118B from a 17BP4 picture tube to a 21-inch tube, what tube type should be used, and which set do you suggest converting?—J. W., Chicago, Ill.

The 21EP4 is a direct electrical replacement. Of course, some mechanical changes will be required. It would be advisable to size up the mechanical requirements, and choose the chassis to be converted accordingly.

Newer color TV's

Will the newer color TV receivers use a one-gun picture tube, or other features that should be worth waiting for?—J. Di R., Rochester, N. Y.

The most recent color receivers have some minor circuit improvements, but no radical innovations over those now on the market. I would recommend the standard tri-gun receivers as tops in the foreseeable future.

Add video sharpening

How can the video-sharpening circuit shown on page 133 of the November, 1958, issue be added to the video-amplifier output circuit shown in Fig. 6? Would picture quality be improved by adding a dc restorer? How can a dc restorer be connected into the circuit?—K. V., Ontario, Canada

The video-sharpening circuit to which you refer calls for adding a 6BX6 to your chassis. A simpler and equally effective method is to bypass partially

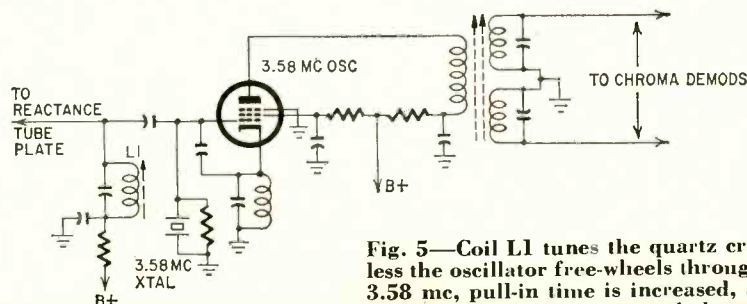

Fig. 5—Coil L1 tunes the quartz crystal. Unless the oscillator free-wheels through or near 3.58 mc, pull-in time is increased, and color sync is poor or lost on weak burst signals.

**"ACCESSORIES ARE MY
PROFIT ITEMS TODAY"**



The volume/profit days of new TV installations are gone forever — today's big market lies in service products.

TV set couplers, antenna couplers, filters — accessories that are easy to sell and install and are good profit items.

The accessories market continues to grow, too: 3,400,000 two set homes at the close of 1957, almost 7,000,000 by the end of 1959!

To help you sell in this market and to acquaint you with the TV accessories available today, AMPHENOL has prepared a color audio-visual film, "TV Accessories." Your AMPHENOL Distributor will be arranging showings during the next few weeks.

We urge you to view this informative film. It will help increase your sales and your profits in today's big market: TV accessories.

AMPHENOL DISTRIBUTOR DIVISION

AMPHENOL-BORG ELECTRONICS CORPORATION
Broadview, Illinois

www.americanradiohistory.com

TELEVISION

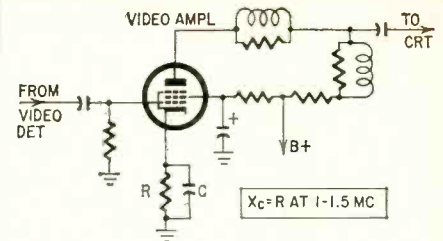

Fig. 6—Partial bypassing of the video amplifier cathode load gives video sharpening.

the video amplifier cathode load, as shown in Fig. 6. Select a capacitor whose reactance equals the cathode resistor at around 1 mc or higher. There are two classes of video-sharpening circuits. The linear class provides high-

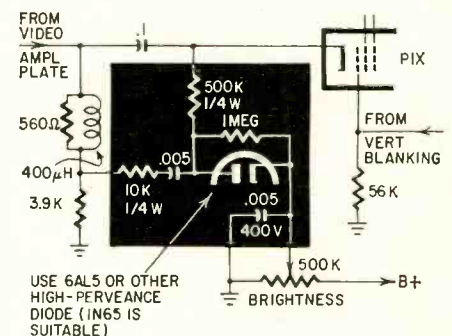

Fig. 3—Adding a dc restorer to a cathode-driven picture tube.

frequency video boost. The nonlinear class accentuates the picture-tube gamma to obtain faster rise time. The pros and cons are extensive, and a matter for personal judgment. A suitable dc restorer circuit is shown in Fig. 7.

Conversion question

Is it practical to replace the 12LP4 in a Bendix model 2020 with a 16RP4? —A. D., Montreal, Quebec

This is not a very practical type of conversion. The 12LP4 is a 52-55° tube, while the 16RP4 is a 90° tube. The time and costs required would greatly outweigh the value of the converted receiver.

Poor contrast

I would like to increase the contrast range on a Bendix 21K3 receiver. Sound bars are visible on channel 2, and frying noises are audible on all channels. What advice could you offer? —S. C., Chicago, Ill.

We would suggest that you first check the front-to-back ratio of the 1N60 picture detector diode. This can cause both low contrast and noisy sound. Also check the 10- μ f charging capacitor in the ratio detector output circuit. This capacitor has a lot to do with noise suppression. Low contrast can also be caused by misalignment, as can the sound bars in the picture. A good sweep and marker generator should be used. Check to see that there is 100 plate and 100 screen volts on the video-amplifier tube. If you find that the rf or if response curves are unstable at low bias,

RADIO-ELECTRONICS

regeneration is at least partially responsible for the difficulties.

Separate pix tube

I have an Admiral 30A1 and an Emerson 24Z5 chassis. What are: (1) limitations on distance between chassis and picture tube; (2) possibilities of using a single cable; (3) best types of leads for the high-voltage line?—E. L. A., Paterson, N. J.

Distance limitations are governed by stray-capacitance loading on the video amplifier output circuit. This causes

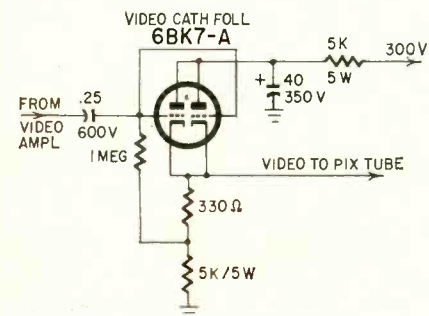

Fig. 8—A cathode follower converts the high-Z video amplifier output to lower impedance, to drive a long video-signal lead, or a coax cable.

fuzzy and blurred pictures. Appreciable extension of the video signal lead requires the use of a cathode follower, as shown in Fig. 8. An extended video signal lead must be coax, to avoid interference from the sweep leads. Coax is suitable for use in a single harness to the picture tube. It would also be advisable to use good high-voltage coax for the high-voltage line.

Cascade-tuner ghost

I installed a Standard Coil cascade tuner in an RCA 630-TS and have a ghost effect. With a pentode tuner, there was a very small ghost, but it is greatly increased by the cascade tuner. What would you suggest?—H. E. A., Romulus, Mich.

The ghost effect you report is due to overshoot and ringing of the video signal. It can be eliminated by proper alignment of the if amplifier. Use a good sweep and marker generator, and align the if circuits for flat-topped response. The video amplifier may also be peaked up somewhat at the high-frequency end. This would add to the ghost effect. Use the sweep and marker generator to check the video-amplifier response. If high video peaking is present, adjust the values of the plate-load resistors and peaking coils to get a flat frequency response.

Frequent tube failure

A Motorola 17T20 receiver is giving trouble. The 25L6 output tube heater burns out frequently. I have replaced tubes and numerous other parts. Would appreciate any tips.—D. W. W., Toledo, Ohio

There are three possibilities: (1) Off tolerances of other heaters in the string could place an abnormally high oper-

ating voltage on the 25L6 heater. This can be checked with a vom. (2) Abnormal warmup characteristics of other heaters could "bug" the 25L6 heater for a few seconds after the receiver is turned on. (3) There may be a heater-cathode breakdown. First make sure that the operating voltage at the 25L6 heater is OK. Heater "bugging" can be eliminated with a Motorola Tube Sentry or a Surgistor. If high ac pulses are causing heater-cathode breakdown, they can be traced with a scope.

Line matching

How can I make a matching transformer from transmission line to convert 450-ohm or 600-ohm line to 300 ohms?—J. C., Galetton, Pa.

There are numerous methods of matching high-frequency impedances with transmission-line sections. Some

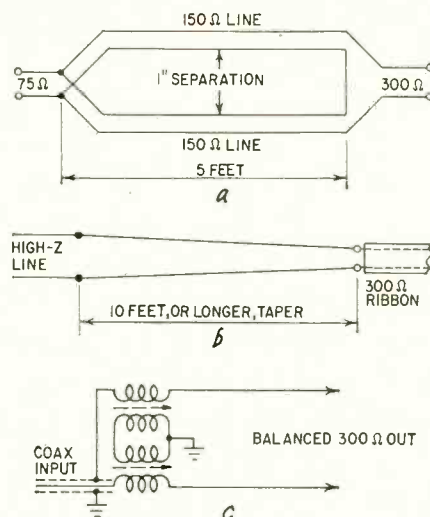

Fig. 9—Broad-band configurations for high-frequency impedance matching: a—series-parallel line transformer; b—tapered line transformer; c—elevator transformer for single-ended input to double-ended output or vice versa.

operate over all the vhf channels satisfactorily (see Fig. 9). Others are suited to single-channel operation, as shown in Fig. 10. Impedance matching is important in fringe reception to conserve as much signal strength as possible. It is also important on long runs to eliminate line ghosts.

630 conversion

What changes are required to convert an RCA 630 to a 16AP4?—L. W. R., Tucson, Ariz.

As an initial conversion, you can try using a 16AP4 directly in place of the 10BP4. Width will be marginal, but can be increased by cutting out the width coil completely. Drive the yoke from the complete secondary winding on the flyback. The width can be further increased by raising the screen voltage on the 6BG6-G somewhat. However, do not reduce the screen resistor below a value which causes the output tube to draw more than rated cathode

current. Brightness may be less than you desire, but this can be increased somewhat by returning the high-voltage filter capacitor to the hot side of the horizontal yoke coils, instead of ground. To increase brightness further use a standard replacement flyback for 16-inch tubes. Be sure that the transformer matches the yoke.

No drive voltage

I have an Admiral 20Y1 in the shop, and replaced the flyback with a Stancor A-8127. I can draw a long spark from the 1X2 cap, but none at its filament. Apparently, there is no drive voltage, but drive appears when the No. 1 lead is disconnected from the flyback. What would cause this trouble?—J. G., Brounland, W. Va.

Since you can draw a spark from the 1X2, ac is being supplied to the tube. On the other hand, the apparent lack of drive voltage indicates that the flyback system "takes off" and that the voltage applied to the 1X2 is not 15,750 cycles. The first thing to do is to recheck the wiring connections carefully. On the basis of the data, it appears that the new flyback has been incorrectly connected.

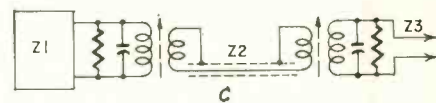
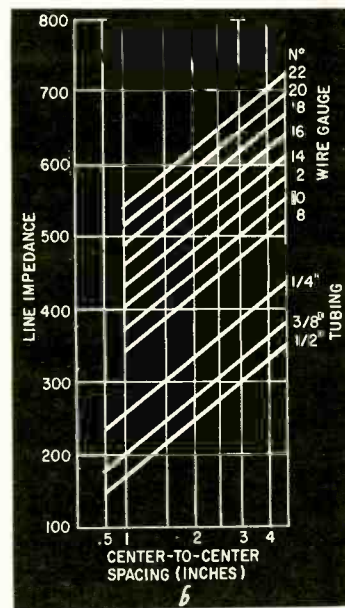
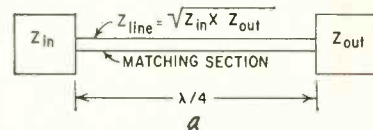

Fig. 10—High-frequency impedance-matching configuration for single-channel operation: a—quarter-wave line matching section; b—spacing of wire or tubing for quarter-wave matching section with desired characteristic impedance; c—transformer matching units (including autotransformer types) are also suitable. Adjustment should be checked with sweep generator and scope.



Only Sylvania has Sarong—

the revolutionary new
receiving tube cathode that
means better service profits

FEWER CALL-BACKS due to intermittents and shorts . . . reduced noise and less arcing . . . these are some of the benefits available to you *now* with this “can’t be copied” Sylvania development.

The Sarong cathode is a completely new development that transforms conventional sprayed cathode coating into a thin uniform film, precision-wrapped and securely bonded, around each cathode sleeve.

Now in use in nearly 1 million receiving tubes, Sylvania Sarong is a field-proven devel-

opment setting new standards of efficiency and quality in electron tube performance.

First tubes to incorporate Sarong are tv tuner types 6BZ7, 6BQ7A, 6BC8 and 6BS8. Eventually Sarong cathodes will be utilized in the full line of Sylvania receiving tubes.

**Here are some of the reasons why
it will pay you to replace with
Sylvania Sarong cathode tubes:**

- Reduced noise . . . uniformity in spacing has resulted in improved noise level up to 0.6 db for TV frequencies.



SYLVANIA

Subsidiary of
GENERAL TELEPHONE & ELECTRONICS



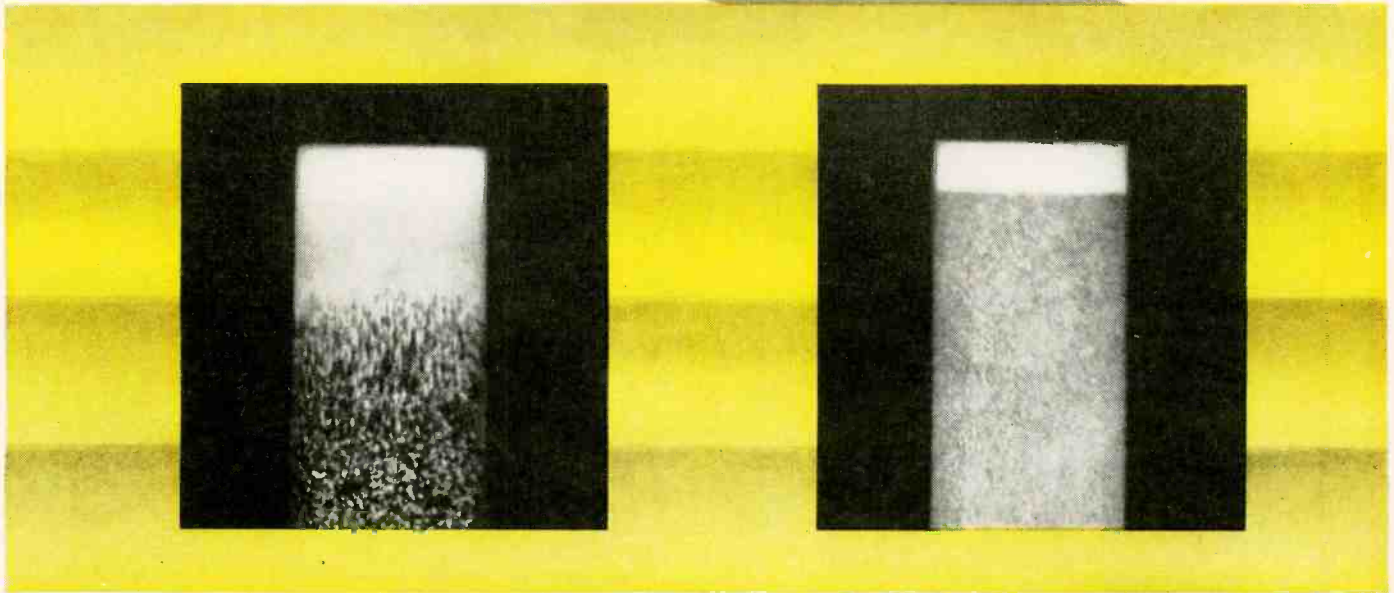

Inherent physical superiority of Sylvania's exclusive Sarong cathode, right, over a conventional cathode, left, is evident in this photomicrograph comparison. The texture,

thickness, sharp coating edges and overall uniformity of Sarong represent major improvements in the heart of the electron tube never before achieved in mass production.

- Less heater-cathode leakage . . . Sarong is flake-resistant and smooth textured. No stray coating particles to stick inside cathode.
- Greater tube ruggedness against shock and vibration because of Sarong's superior coating adhesion.
- Reduced cathode-grid shorts intermittent short circuits, and less arcing due to controlled uniformity of Sarong thickness. Sarong cathode coating is held to thickness tolerances five times closer than conventional sprayed cathode coating.

Sylvania Sarong will help you make better profits through reductions in call-backs. See your Sylvania distributor today for the full story on Sarong — available *only* from Sylvania.

SYLVANIA ELECTRIC PRODUCTS INC.
 1740 Broadway, New York 19, N. Y.
 In Canada: P. O. Box 1190, Station "O," Montreal 9.

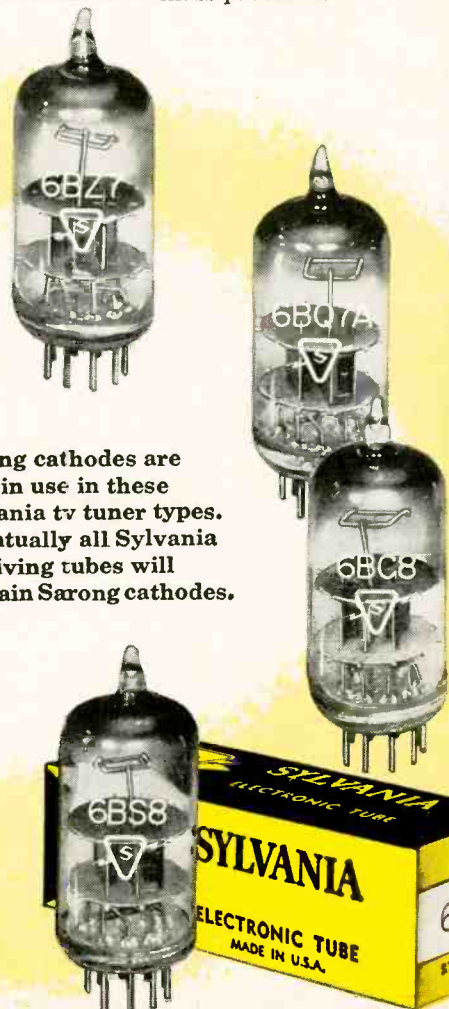

Sarong cathodes are now in use in these Sylvania tv tuner types. Eventually all Sylvania receiving tubes will contain Sarong cathodes.

Technicians —
 look to **Burroughs**
 for your successful future
 in electronics.

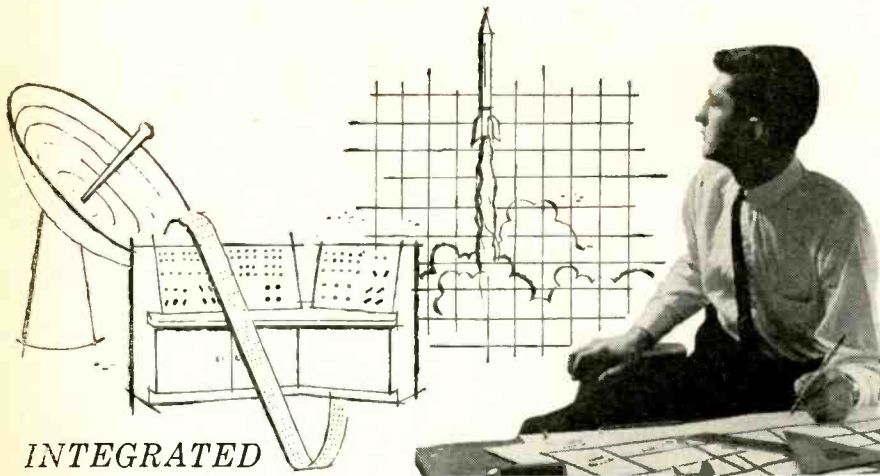

**INTEGRATED
 DATA PROCESSING
 FOR MILITARY
 WEAPONS SYSTEMS**

...at BURROUGHS Military Field Service Division adds up to challenging work on important long range ATLAS and SAGE programs, advancement based on individual performance and a fine career in the field of tomorrow: Digital Computation.

BURROUGHS, consistent with its recognized leadership in equipment, skills and manpower, is providing the answers for complex military weapons systems through automatic suprahuman computation.

Qualified applicants will receive: 1) Formal 16 to 22-week training program in Data Processing Systems. 2) Starting salary commensurate with experience and ability. 3) Full salary while training. 4) Fine fringe benefits including educational assistance in addition to your training program. 5) Current field assignments include West-ern and Midwestern areas, when your training program is concluded.

If you are a graduate of an accredited Technical School and/or have military training in radar or communications equipment, plus at least 2 years' experience in electronics, you are invited to address your inquiries to Mr. A. J. Bellace, Employment Supervisor, Department Y-789, Military Field Service Division, Burroughs Drive, Radnor, Pa. (a suburb of Philadelphia).



Burroughs Corporation
 "NEW DIMENSIONS/in computation for military systems"

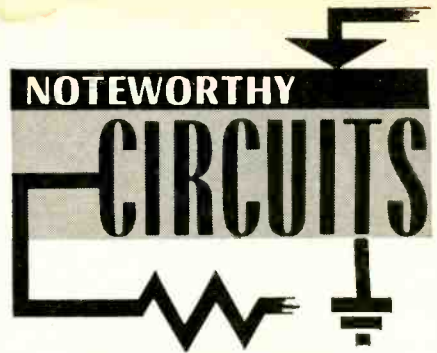

TRANSISTOR PREAMP

This novel but useful transistor pre-amp is ideal for providing more gain and naturally more volume for small one-tube phonographs. The control grid and cathode of a typical unit using a

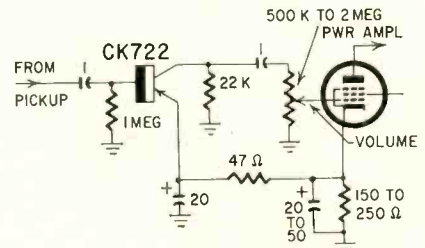

35L6, 25L6 or similar unit is shown in the figure. Power for the transistor stage is obtained from the cathode resistor (well bypassed). Total current is less than 100 μ a. The added gain is approximately 80.—C. O. Reed, W6JFO

**WORKING PHOTOCELL
 CIRCUIT**

This circuit, unlike light-indicating arrangements, is designed to deliver power rather than current. It will easily operate a .005-watt relay coil. Although a 5,000-ohm coil is shown,

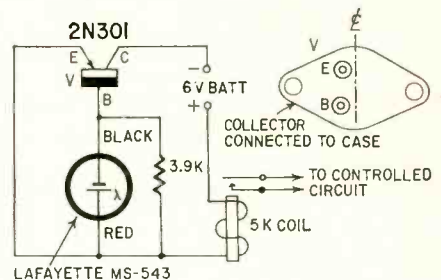

experiments reveal that other coil resistances near this value will also work.

When the photocell is in the dark, current is approximately 0.2 ma—giving enough of a differential to release most relays. The operate current is at least 1.2 ma when the photocell is exposed to a 40-watt lamp at a distance of 5 feet.—I. Queen

**STABILIZE PICTURE
 DIMENSIONS**

Line-voltage variations are bothersome in TV because they show up as a change in picture width and height, and sometimes as defocusing. While line-voltage regulators are a good solution, they are costly and bulky and constitute an additional unit exterior to the TV receiver.

Some recent Grundig receivers have an automatic electronic circuit that

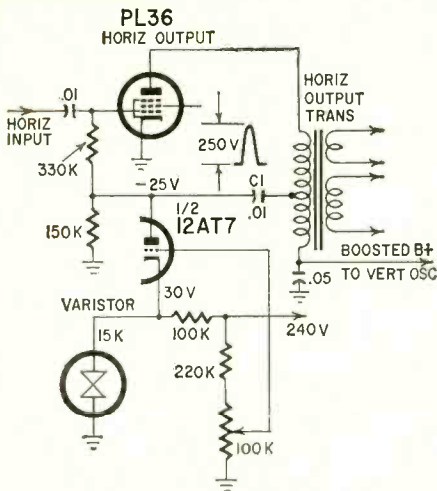

does the same job. The diagram shows that only one extra triode is used, in this case half of a 12AT7.

A tap on the horizontal output transformer provides a positive 250-volt pulse, applied to the plate through capacitor C1. The cathode voltage is stabilized at 30 volts with the help of a varistor.

The grid voltage is obtained through a bridge fed with 240-volt nonstabilized B-plus. When the line voltage changes, the B-plus and the grid voltage follow.

The triode works as a variable level detector. For the nominal line voltage of 117, a negative voltage of -25 appears at the plate. This voltage varies from -20 to -36 for line-voltage variations of ±20%, and is used as a bias for the horizontal output tube.

In this way the power output of the tube is stabilized and neither horizontal amplitude or high voltage varies.

Moreover, the vertical time base is fed from the boosted B-plus produced by the horizontal output stage. Since this boosted voltage is also stabilized, the vertical amplitude is kept constant.

— A. V. J. Martin

TRANSISTOR POWER AMPLIFIER

It is easy to add this simple audio amplifier to a portable radio tuner. When used with a 3-inch (or larger) speaker, volume and tone are adequate for good listening, indoors or out.

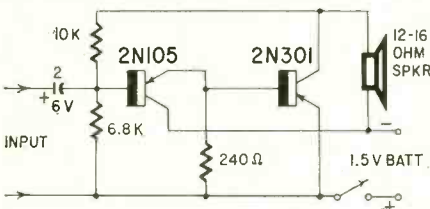

Nearly any tuner can serve as the signal source, since 0.1 volt drives the amplifier to full output.

The main features of this amplifier (see diagram) are its simplicity and economical operation. The power supply is a single size-D flashlight cell. Current drain is approximately 35 ma, so the cell should last about 125 hours.—
I. Queen.

END

General Instrument has the **RIGHT RECTIFIER** for every TV set





Silicon RECTIFIERS



Selenium RECTIFIERS



Don't be fooled by an "all or nothing at all" approach. Selenium and Silicon rectifiers both have a place in today's TV sets . . . and General Instrument supplies the very best!

Radio Receptor "Safe Center" selenium rectifiers have proved their reliability and long life in millions of circuits through the years. When your replacement calls for *selenium* there is no better rectifier.

AUTOMATIC PT5 Silicon rectifiers are the first choice of leading TV set manufacturers switching to silicon in their new models. When replacing or converting to *silicon*, install the PT5 for maximum performance and picture brightness.

Both these outstanding rectifiers are brought to you by GENERAL INSTRUMENT, your finest source of semiconductor components!

General Instrument Distributor Division
RADIO RECEPTOR COMPANY, INC.
Subsidiary of General Instrument Corporation
240 Wythe Avenue, Brooklyn 11, N. Y. EVergreen 8-6000



See us in May in Chicago at the Electronic Parts Distributor Show—Booth 590

NOW THERE ARE 9 RIDER 'PICTURE-BOOK' COURSES

NEW — Heralding the role of Electronics in the space age
BASICS OF MISSILE GUIDANCE & SPACE TECHNIQUES By Marvin Hobbs

Electronics is playing a vital role in the race to achieve mastery of outer space and send manned missiles rocketing to the moon and beyond. You can learn and easily understand the fundamentals of the important electronic areas that will contribute to the conquest of space with this 2 volume picture book course. It is divided into two broad parts. Volume 1 covers the elements of control and guidance. Extensive coverage is given to radio and radar command links, guide beam, doppler and homing methods, fundamentals of gyroscopics, inertial and celestial navigation, computer applications,

and actuators as well as their related components. In the second volume, devoted to radio telemetry and space techniques, testing and telemetering, space exploration by optics and electronics are covered. There is a fascinating coverage of satellite theory and practice, satellite monitoring and tracking, and applications of earth satellites. Navigation in space along with components and power sources for space applications are discussed. #229, 2 vols., soft covers, \$7.80 per set; #229-H, 2 volumes in single cloth bound edition, \$9.00.

BASICS OF DIGITAL COMPUTERS by John S. Murphy. If you have a knowledge of the fundamentals of electronics, you can master the basics of digital computers and understand the details of any specific digital computer with this new 3 volume picture book course. #196, 3 volumes, soft cover set, \$7.50; #196-H, all 3 volumes in single cloth binding, \$8.50.

BASIC PULSES by Irving Gottlieb, P.E. Pulses direct the high speed operation of all types of computers; underlie the function of radar systems; guide industrial operations that require split-second timing for mass production; in fact, the application of pulses recognizes almost no boundaries in the field of electronics. You can learn all about pulses with this one volume picture book training course. #216, \$3.50.

BASIC ELECTRICAL POWER DISTRIBUTION by Anthony J. Pansini, P.E. #187, 2 vols., soft cover set, \$4.80.

BASIC TELEVISION by Alexander Schure, Ph.D. Leading editors, businessmen and educators have declared this to be the clearest presentation of the fundamentals, operation and circuitry of black and white television ever published. #198, 5 volumes, soft cover set, \$10.00; #198-H, 5 vols. in one cloth binding, \$11.50.

BASIC ELECTRICITY by Van Valkenburgh, Nooger & Neville, Inc. #169, 5 volumes, soft cover set, \$10.00; #169-H, 5 vols. in single cloth binding, \$11.50.

BASIC ELECTRONICS by Van Valkenburgh, Nooger & Neville, Inc. #170, 5 volumes, soft cover set, \$10.00; #170-H, 5 vols. in single volume,

BASIC SYNCROS AND SERVOMECHANISMS by Van Valkenburgh, Nooger & Neville, Inc. #180, 2 volumes, soft cover set, \$5.50; #180-H, 2 vols. in single cloth binding, \$6.95.

BASIC PHYSICS by Alexander Efron, Ph.D. #195, 2 vols. in single cloth binding, \$7.60.

5 NEW RIDER BOOKS... EXCITING CODE COURSE

PRINCIPLES OF TRANSISTOR CIRCUITS by S. W. Amos, B.Sc. A remarkably lucid presentation of transistors, the fundamental theory of their operation and how to apply them in circuitry for amplifiers, complete receivers and other equipment. Starting with the basic principles of transistors, semiconductors are clearly defined and explained. The point-contact transistor and junction transistor are covered.

The book covers common base amplifiers, common emitter amplifiers, bias stabilization, small signal amplifiers, large signal amplifiers, and transistor superheterodyne receivers. #241, \$3.90.

LOW FREQUENCY AMPLIFIERS edited by A. Schure, Ph.D. The principles and circuitry involved in the amplification of low frequency electrical circuits is presented in a thorough, easy-to-understand manner. Starting with the principles of amplification such items as the low frequency spectrum, amplifier components, the use of equivalent circuits and grid bias systems are discussed. The fundamental considerations of amplifiers are covered. In the discussion of low frequency voltage amplifiers, tube characteristics are summarized together with the study of voltage gain of pentodes, the use of load lines, and distortion of amplifiers. Single-ended power amplifiers include discussion of the function of a power amplifier, amplifier classifications and the calculation of power output and plate efficiency. Push-pull amplifiers are discussed in detail. Transistor amplifiers are fully explained. #166-30, \$1.80

FUNDAMENTALS OF HIGH FIDELITY by Herman Burstein. How to select the best hi-fi equipment for the money you have to spend—and how to achieve the best performance—are the purposes of this book. The emphasis is not so much on what an amplifier is, rather than on what an amplifier (and the rest of your high fidelity system) should provide, and how you can choose the best equipment to fit your pocketbook. #226, \$2.95.

FUNDAMENTALS OF NUCLEAR ENERGY AND POWER REACTORS by Henry Jacobowitz. After presenting basic concepts in atomic and nuclear physics essential to understanding the operation of nuclear reactors, the book discusses the construction, principles of operation, cost and power output of specific plants. Experimental reactors and the forerunners of the units now under construction are covered. Numerous carefully selected illustrations support the text and show what the various installations actually look like. #218, \$2.95.

FUNDAMENTALS OF RADIO TELEMETRY by Marvin Tepper. Telemetry makes possible the collection of data on which the improvement of existing rockets, missiles and aircraft is based. This exciting book explains its purpose and explores its techniques. Special sections are devoted to missile and satellite telemetry and hardware, and to data recording and processing. Specially prepared illustrations. #225, \$2.95.

learn code faster, easier than ever before— RIDER SOUND-n-SIGHT® CODE COURSE

by Lewis Robins & Reed Harris

- applies REINFORCED LEARNING—a psychological principle proved successful by the Armed Forces.
- uses LP records to teach you to hear signal pattern correctly and identify it—how to transmit.
- uses identification cards to teach you the correct letter associated with each signal pattern.
- uses instruction book to speed your progress. ... plus an imaginary instructor (in complete and novice courses) provides correct answers to speed code learning. Many people have learned to receive 5 words per minute within 9½ hours. Eliminates code plateau barrier!

3 INDIVIDUAL COURSES—THERE'S ONE FOR YOU

COMPLETE COURSE (0-20 words per minute)—Six 10" LP records (192 minutes of recording, 46 recordings), 47 cards, book. #REC-020, \$15.95.

NOVICE COURSE (0-8 words per minute)—Three 10" LP records (96 minutes of recording, 28 recordings), 47 cards, book. #REC-08, \$9.50.

ADVANCED COURSE (9-20 words per minute)—Three 10" LP records (96 minutes of recording, 28 recordings), book. #REC-920, \$8.95.

Records prepared in collaboration with the N. Y. Institute of Technology and mfd. by Decca Records.

Other Rider books that add to amateur radio enjoyment are: Getting Started In Amateur Radio; Building The Amateur Radio Station; Radio Operator's License Q & A Manual (6th edition) How To Read Schematics.

At your jobber or book store,
or order direct, Dept. RE-5



JOHN F. RIDER PUBLISHER, Inc. 116 West 14th Street, New York 11, N. Y.

In Canada: Charles W. Painton, Ltd. 6 Alcina Ave., Toronto, Ontario

TECHNICIANS'

NEWS

ELIMINATES CALLBACKS

TSA Service News, Seattle, Wash., reports this interesting way of preventing callbacks which one shop has found successful.

"... finally pulled the plug... on free callbacks which so often are found unnecessary. In a card handed to each customer on a home call, this shop states that the service fee covers the traveling and technical time of an experienced television technician for one call only... callbacks will be charged at regular call rates... the owner tells your reporter that customer relations have actually improved since the system was introduced.

"In one case, the customer called back several hours after a shop repair delivery, saying the picture had rolled half-way up... instead of demanding a callback, he wanted to know if it was serious and if there was anything he could do. The location of the vertical hold was described to him... he made the adjustment and called back to say thank you and that everything was OK. Had this job been handled prior to introduction of the cards, it would have been a callback 'or else' situation.

"This shop believes that most customer relations problems have developed because we, as service shops, have not taken the time to tell the customer where he stood, or were reluctant to for fear of offending him. If a customer knows what he is getting for his money, this much and no more, he is not apt to seek or demand more than he has paid for. If we are completely honest with our customers, most of them will be honest and fair with us."

WAYNE LEMONS SUGGESTS

"The cries of many technicians hurt by captive service in various large markets have been not only loud but often heart-rending... We have had it suggested that we use selective buying, and many of us (but certainly not all...) are backing the attack through selective buying... [although it] may be morally right but legally wrong, except as an individual endeavor... Perhaps the solution is to buy all our tubes from independent companies who will stamp them with the name TESA. There's nothing wrong with saying, 'Buy only TESA tubes! Don't patronize your competitor!'"—The (Mo.) Raster.

VANCOUVER "EXPOSES"

Some 40% of the service technicians called by reporters of the Vancouver (B. C.) Sun to repair a gimmicked set overcharged, sold unneeded parts or

made false statements about the condition of the television set or the repairs it needed.

The set, previously certified to be in good working order, was made inoperative by replacing the 5U4 with a bad tube. Some 20 technicians were called in. The correct charge for the repair, states the exposé, would have been \$1.92 for the tube plus the service charge (which the *Sun* seems to think should be about \$2). The actual fees ran from \$4.02 (charged by one of the technicians the *Sun* considered honest) to \$27.56, charged by an operator who staged a dramatic show, producing sparks when checking the receiver and taking the set to the shop for 3 days to make "necessary" repairs.

Most shocking thing in the investigation, according to the reporters, "was the tragedy of watching honest men working in unfair competition with their crooked colleagues and struggling against the stigma of dishonesty unjustly stamped upon them." Three of these technicians told the reporters (posing as a young business couple) that they were closing up shop and either going into some other kind of business or moving out of Vancouver.

LICENSE LAWS

Laws proposed for licensing of television technicians in various states are beginning to shape into recognizable patterns with minor variations from state to state. Examining the presently proposed laws for Ohio and New York, and the law now in force in Louisiana, these major points are found.

No one would be allowed to repair television sets unless licensed, except in New York. That state would "certify" technicians and, although anyone would still be allowed to repair receivers, only those who qualify would be allowed to advertise themselves as "Certified Television Technicians." In Louisiana, technicians may qualify for television and radio, or for radio repair only. Radio is not included in the other states.

In each state, the Governor or his agent would appoint a board consisting usually of 3 members (Louisiana, 11), who must have been practicing service technicians for at least 5 years. (New York, 6 years). Indiana board members are required to have 4 years' minimum experience. Regular term for board members is 3 years in each state. (Louisiana, 2 years).

Technicians' fees are \$25 initially, \$10 per year renewal. In Ohio and Louisiana, a lower classification, apprentice technician, has lower fees. Apprentices would be allowed to do service repairs only when a full-grade technician is present. This appears to rule out house calls by unaccompanied apprentices.

Examinations are required in each state, though none is specified for apprentice in Ohio. To become eligible for the examination in New York, a technician would be required to have



BURTON BROWNE/New York



UNION CITY, N.J.

For Checking Miniaturized Equipment, Pyramid's Model RC-1 New Resistance-Capacity-Ratio Bridge Tester. Budget priced . . . outstanding quality instrument . . . the RC-1 saves you both time and money. Precision-engineered, Pyramid's new model RC-1, Resistance-Capacity-Ratio Bridge Tester has a special low voltage bridge and stable vacuum tube amplifier for safe testing low voltage electrolytics such as commonly used in transistorized receivers.

Pyramid's RC-1, Resistance-Capacity-Ratio Bridge Tester is a functionally designed, sturdy, compact, lightweight unit, ideal for use by technicians, servicemen and engineers in radio, television (color as well as black and white), industrial electronics and all related fields.

PYRAMID MODEL RC-1 FEATURES:

- Special 3 volt amplifier for checking low voltage electrolytics used in miniaturized equipment such as transistor radios, etc.
- Capacity Ranges—from 10 mmfd. to 2000 mfd.
- Resistance—from .5 ohms to 200 megohms in 4 ranges.
- Ratio Test—provides quick reactance or resistance ratio between any two capacitors, inductors or resistors—range: .05 to 1 and 20 to 1. It can be used also to determine turns ratio of transformer windings within this range.
- Leakage Tests—handles all types of capacitors at rated voltages between 0 and 500V DC.
- Power Factor—0 to 60% (on capacitors from .1 mfd to 2000 mfd).
- Capacitor Test Voltages—variable between 0 and 500V DC in 17 steps.

PRICE: Dealer Net—\$44.95

For further information about the RC-1 see your Pyramid distributor or write for complete technical data to: Pyramid Electric Company, Union City, N. J. EXPORT: 458 Broadway, N. Y. 13, N. Y. • CANADA: Wm. Cohen, Ltd.—7000 Park Ave., Montreal.



NOW FROM HOWARD W. SAMS

"The AUDIO Cyclopedia"

by HOWARD M. TREMAINE



New! Greatest Reference Work on Audio & Hi-Fi

- 1280 pages
- 3400 topics
- 1600 illustrations
- Up-to-the-minute, including Stereo

SAVE \$300 IF YOU ORDER WITHIN 30 DAYS

Here is the one single book with the most comprehensive coverage of every phase of Audio! Gives you concise, accurate explanations of all subjects in the fields of: basic sound principles, acoustics, recording, reproduction, audio equipment, optical film recording, audio test instruments and measurements, installation techniques, latest stereo information. Over 7 years in preparation—the authoritative, encyclopedic work on Audio—with the unique quick reference system for instant answers to any question. The vital, complete reference book for every audio engineer, technician and serious audiophile. Available for a limited time only at the special pre-publication price of only **\$16.95**

Order today—save \$3.00. Pre-publication price good only until May 31, 1959; thereafter, price will be \$19.95

SPECIAL PRE-PUBLICATION OFFER • SPECIAL \$3.00 SAVINGS

SPECIAL PRE-PUBLICATION OFFER • SPECIAL \$3.00 SAVINGS

SPECIAL PRE-PUBLICATION OFFER

MORE NEW BOOKS from



"ABC's of Transistors"

by George B. Mann

Takes the mystery out of transistors. Explains principles, physical construction, basic circuits, temperature considerations, practical testing and servicing procedures. Written simply and clearly for easy understanding. Invaluable for electronic technicians, students

and hobbyists. 96 pages; 5½ x 8½"; illustrated. An important book for only **\$1.25**



"Marine Electronics Handbook"

Leo G. Sand's comprehensive book describes for boat owners the various types of marine electronic equipment available, what each does and how to perform emergency repairs. For technicians, there is detailed data on circuitry used, as well as installation and maintenance. Special foldouts at back of book include schematics and charts of U.S. shore-based marine transmitter locations. The first and only book on this rapidly developing subject. 264 pages; 5½ x 8½"; illustrated. Only **\$3.95**

HOWARD W. SAMS & CO., INC.

Order from your Sams Distributor today, or mail to Howard W. Sams & Co., Inc., Dept. E-29 2201 E. 46th St., Indianapolis 6, Ind.

Send me the following books:

- "The Audio Cyclopedia" at Special Pre-Publication price of \$16.95 (ACT-1)
 - "ABC's of Transistors" (TRA-1)
 - "Marine Electronics Handbook" (MES-1)
- \$.....enclosed. Send Free Book List

Name.....

Address.....

City..... Zone..... State.....
(outside U.S.A. priced slightly higher)

4,000 hours of service experience, or 2,000 hours and a specified course of school study (4,000 hours based on 40 hours a week is about 2 years). In Louisiana, 2 years' experience is required before taking the examination; in Ohio, 1 year.

In each proposed law is a provision for revoking the license or certification of a technician found, after due hearing, to have "practiced fraud or deceit," been guilty of "unethical practice or conduct," or to have engaged in practices likely to "mislead, deceive or defraud the public, (Ohio)." New York lists "habitual drunkenness" as just cause for revocation.

Final draft of the proposed bill that seeks to license Indiana service technicians would set up a 5-member board of 'practical radio and television repairmen who have been so employed for at least 4 years each.' The members would be appointed by the Governor. Licenses could be revoked for using "misleading advertising," for performing work "in an unskilled manner" or for employing unlicensed personnel. The bill remained in committee throughout the entire session of the legislature, but may be brought up again during the next session.

A bill to license television technicians operating in Kansas is dead, for the time being. Many hearings were held by the State Affairs Committee of the House of Representatives, but the bill was killed in committee after 2 weeks.

CERTIFICATION DISCUSSED

The meeting of Associated Radio-Television Servicemen of New York (ARTSNY) was the scene of a sharp dispute over the proposed bill on certifying television service technicians. Edward Eisen, president of ARTSNY, and Max Liebowitz, Mecca Radio, held that the group should try to get mandatory licensing as soon as possible, rather than accept certification of only those who want to be certified. Robert Larsen, president of ESFETA, who has worked with the Attorney General, said that there will be a bill regulating service technicians "with or without the aid of the service industry." He said that they should work to get a bill that "the serviceman can live with." Larsen said the bill now up would gain respect for the television technician, and raise his standards as well as his income.

RESULTS OF LICENSING

Complaints on television service dropped to less than one-third, in 2½ years of licensing television, the Detroit Better Business Bureau reports. The BBB said it received 1,500 complaints during the 12 months just before licensing started. In 1956, the new law was effective about half the year, and complaints dropped 20%. Next year they went down to 900. In 1958, only 466 complaints regarding television service were received.

Under the new ordinance anyone found guilty of "faulty practice" may

lose his license to operate. The bureau said the law has reduced the number of television repairmen through eliminating fly-by-night operators.—*Indianapolis (Ind.) News.*

LA. LICENSING HEAD SPEAKS

From Harold Yuratich, recently appointed administrator of the Louisiana Radio and Television Technician Board, come these encouraging words:

"The overall picture is good... the law seems to be raising the level of standards, although it is not yet in full operation... most noteworthy is the compliance of the on-the-fence operators to regulations... bringing more realistic figures and equality of operation with shops formerly suffering from their unfair service charges.

"The parts suppliers are also recognizing the effects, and are in most cases cleaning house, preparing in advance to sell only to licensed television people. The attitude of the whole area is to do legitimate business in order to come in under the wire whitewashed and clean for this new kind of TV business in New Orleans... We now have a common goal." *TESA (Cincinnati) News.*

ENCOURAGES CASH-AND-CARRY

The *TSA News* (Seattle, Wash.) says: "Encourage customers to bring in their sets and save the expense of outside service, whether for a simple repair or the more serious that require shop work with its added expense of pickup and reinstallation.

"Technicians work more efficiently if they do not spend a great portion of their time going from job to job on outside service. Working more efficiently and fixing more sets in their working hours would decrease customer costs and make it more profitable for the shop.

"... We should be educating the set owner that he can save a substantial part of his costs if he brought in his own set and picked it up after repair. No shop we know of can truthfully state that it makes money on the service call itself, even at \$6 or \$7 per call. Additional sales of tubes are necessary for the shop to show a profit, and then callbacks can eat up the profits quickly.

"Bringing in his own set relieves the shop of the higher costs of outside service and of the need for callbacks, and enables it to use its skilled manpower to the fullest extent. It will result in better repairs, too, for each set can be observed for those intermittents that are so often missed on a hurried home call..."

IOWA SERVICE TECHS PRESENT THEIR CASE

Officers of the Buena Vista County (Iowa) Television Servicemen's Association (TSA) appeared on the Matter of Opinion program on station KAYL in Storm Lake to discuss the article in *TV Guide* about dishonest and unethi-

cal television repairmen in Washington, D.C. In their discussion they told how television technician's associations are combatting the unscrupulous repairmen who are robbing the public and giving the whole industry a bad name.

Some of the points brought out were how the associations have standardized pricing and credit procedures, have strengthened the warranties on parts and labor for the customer's protection, have discovered just who is dishonest and unethical in their areas and have either caused them to change their methods of operation or have expelled them from the association and have informed the public as to what to expect from unethical operators. — *TSA Beacon*

UNHEARD-OF TUBE TYPES

We have so many types of tubes now complains *TEAM News* (St. Louis, Mo.), that there are even some that do "absolutely nothing, just in case some design engineer wants to build a television set for people who don't like TV. There are memory tubes for computers. We'll bet there are even forgetful tubes! . . . Wouldn't it be great if they could make tubes . . . to perform the following functions?

"6FLIP8, a multigrad mail sorter, separates and destroys all bills, eviction notices and letters of complaint in 50 microseconds or less. Caution! Do not operate at higher than rated voltages or it consumes shirts, neckties and other fabrics.

"3OUT15, a 15-element dead-beat spotter. It warns of the presence of a poor-pay customer and locks the front door before he can enter.

"12HELP7GT, triple-purpose tool retriever, chassis cleaner and flame thrower, for guys who lose tools in dirty chassis or want to have a fire sale.

"7OUCH5, a high-mu attitude inverter. Makes an irate customer happy enough to leave a \$5 tip. You'll have to watch this one as it might make a satisfied customer punch you in the nose.

"1MOVE3, a beam power apartment changer. This converts all your third-floor calls to first-floor calls. Don't use it on a first-floor call or you'll wind up in the second basement!"

OHIO TECHNICIANS FOR BILL

Seventy-five local television technicians attended a meeting in Cincinnati to support passage of the proposed licensing bill in Ohio.

The *ETAT News* (Toledo) carried a page urging technicians in Ohio to contribute \$50 each for support of the proposed bill. It was pointed out that many millions of dollars "leak out of the hand of legitimate service dealers" every year, and that the proposed law would "stop that leak." END



These two speakers
are **BRAND NEW**
and **BRAND NAME**
and the **BRAND NAME** is

QUAM

Here are two new additions to the famous Quam line of replacement speakers. You'll find many uses for both of them, in auto radios and in radio-tv applications. When you use them, you'll enjoy knowing that you're avoiding breakdowns and eliminating callbacks by installing *quality* loudspeakers. Using a brand name product is always your assurance of that . . . especially when the brand name is QUAM.

48A2—Very shallow construction 4" x 8" speaker with 1.4 oz. Alnico V magnet. Used in many 1959 auto radios and in RCA and Sylvania sets. List Price \$6.95

69A1—A low cost 6" x 9" speaker with "high-price" features—full 3/4" voice coil, heavy magnet (1 oz. Alnico V). An exceptional value. List Price \$5.95

ask for QUAM, the quality line for all your speaker needs

QUAM-NICHOLS COMPANY 236 E. Marquette Road, Chicago 37, Illinois

Canada: A.T.R. Armstrong, Ltd., 700 Weston Road, Toronto 9, Ontario
D. Eldon McLennan, Ltd., 1624 W. Third Ave., Vancouver 9, B.C.

**SAVE
TIME
with**

SENCORE

®

New! Improved!

**TRANSISTOR
CHECKER**

America's newest, most popular test instrument

Simple to Operate. Controls are accurately set for each transistor by referring to replaceable set-up chart on rear. Test leads or socket provides for fast hook-up.



MODEL TRC4

\$17.95

DEALER NET

Cannot become obsolete. Approved by leading manufacturers.

NOW CHECKS:

- ★ Transistors for opens, shorts, leakage and current gain. Only tester that tests power transistors as used in car radio outputs.
- ★ Crystal Diodes checks forward to reverse current ratio on all diodes.
- ★ Selenium Rectifiers checks forward and reverse currents.

SERVICE INSTRUMENTS CORPORATION
121 OFFICIAL ROAD, ADDISON, ILLINOIS

See other SENCORE ads in this issue.

"Simplifying Flyback Transformer Servicing"

is the subject of "Stan Cor's Corner"
... a new publication that is

FREE FROM STANCOR

This is the first in a series of publications loaded with service tips to make your job easier. This issue covers such subjects as

- Symptoms due to defective flyback transformers
- Symptoms due to other causes but frequently attributed to defective flyback transformers
- Physically checking the flyback
- Electrically checking the flyback
- Repairing broken flyback leads
- Little known facts about the horizontal output system

Ask your STANCOR distributor for your free copy. It is available only through him.

CHICAGO STANDARD TRANSFORMER CORPORATION
3509 ADDISON STREET • CHICAGO 18, ILLINOIS

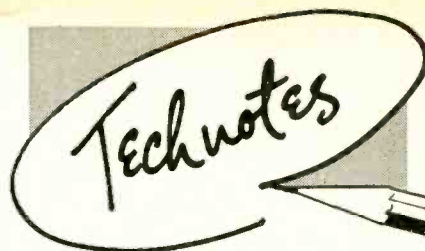

TV ODDITY

Anything can happen around a TV set, and usually does.

Sometimes you can even pick de out of thin air.

Take a dc meter and hold the hot lead near the horizontal output or the picture tube, with the return lead grounded to the chassis.

Without touching any object, the meter lead will often pick up dc out of the air. The pointer will indicate as much as a volt in some receivers.

This is the result of what is called spark-gap rectification in Geiger counters. There is an invisible stream of ac pulse voltage present in the air surrounding the tube.

More of this pulse voltage gets to the meter lead during the peak of the pulse. The result is an effective rectification and conversion of the ac to dc. Hence, the meter deflects and we seem to be picking dc out of thin air.—
R. M. Centerville

ADMIRAL KEYED-AGC SETS

No sound or picture. All tubes were checked and the chassis removed from the cabinet. There was approximately 40 volts of agc at the rf and if tubes, indicating keyed-agc trouble. When the 6AU6 keyer tube was pulled, the sound was OK, but no picture. Finally the 6AC7 video amplifier was changed and everything returned to normal. The 6AC7 checked good in a tube tester, once again proving substitution as the best tube checker.—
Wilbur J. Hantz

HORIZONTAL BAR

The customer complained of a horizontal bar in the picture on channel 5, and intermittent sync pulling. It was an Admiral monochrome receiver using a 23-mc if strip.

This was a toughie which didn't respond to tube changes. Furthermore, no circuit faults were evident in the signal or sync circuits which could produce this effect.

The needed clue appeared when the technician happened to grasp the lead-in between the tuner and the antenna input terminals. The trouble cleared up as long as his hand was in place, but it returned when he let go of the lead.

The section of lead-in was dressed near the if tubes, which made it appear that harmonics from the if or from the picture detector might be picked up by the lead-in, causing the trouble. To check this possibility, the lead-in was run down under the chassis instead of on top.

This did it! The picture cleared up on channel 5 and no more trouble has occurred.—
Robert G. Middleton

SENCORE
CIRCUIT "Fuse Safe"
TESTER

Save Time with SENCORE

Save costly call backs by testing the circuit before replacing fuse, fuse resistor or circuit breaker.

Individual scale for each value fuse resistor—no interpretation, just read in red or green area.

★ Measures line current and up to 1100 watts of power at 115 volts using line cord and socket. ★ Two convenient current ranges—0 to 2 amps and 0 to 10 amps. Test leads clip in place of fuse or fuse resistor. ★ 5 ohm, 10 watt resistor prevents TV circuit damage, simulates operating conditions.



\$8.95 DEALER NET
AC-DC or both as needed for Fuse Resistor Circuits

SENCORE
As Recommended by Leading Manufacturers
SERVICE INSTRUMENTS CORPORATION
121 OFFICIAL ROAD, ADDISON, ILLINOIS

See other SENCORE ads in this issue

RCA KCS68 and KCS81

For optimum performance of the horizontal deflection circuit, it is im-

due to low ac line voltage, more width may be obtained by moving the width

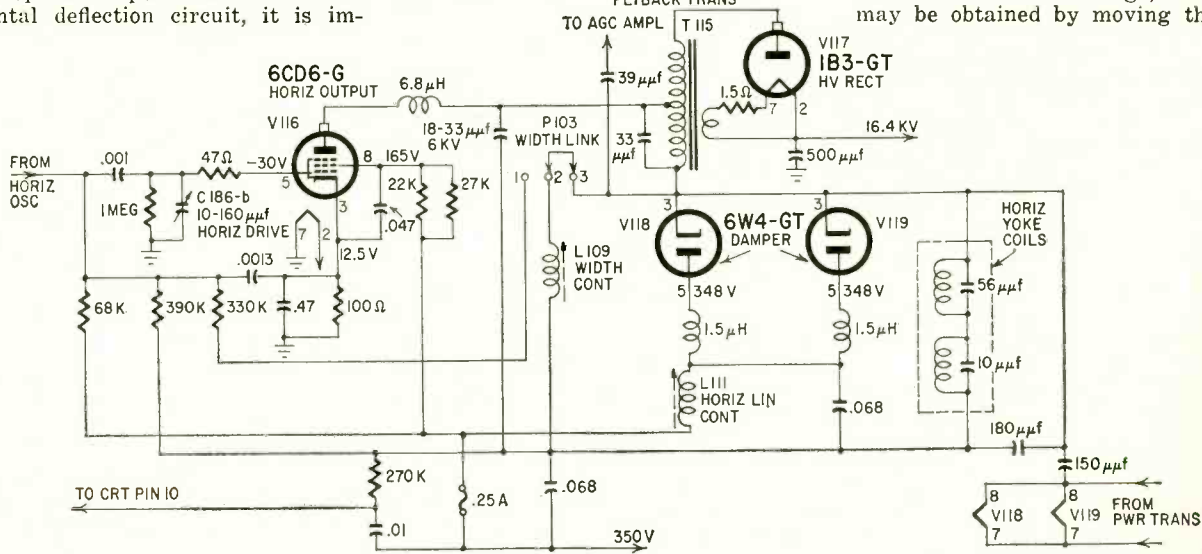

portant that the horizontal drive, horizontal linearity and width controls be adjusted correctly. Incorrect adjustment may cause the flyback transformer to overheat, with arcing and possible damage to it and other components.

3. Adjust horizontal drive trimmer counter clockwise two turns from tight or just before overdrive line appears.

link to the lower position.

To adjust these controls:

4. Insert a 0-500 ma meter in series with the horizontal output tube's cathode resistor and ground. Adjust horizontal linearity control for minimum current (115 to 125 ma).

Sometimes, overheating of the flyback transformer may occur although proper adjustments have been made and the tubes and components are not defective. This condition, then, is probably due to tube and circuit tolerances. A capacitor may be connected as shown in the partial schematic. Any value from 18 to 33 μf, 6,000 volts, may be used.—RCA TV Service Tips

1. Set width link for minimum width. (Short upper and middle connections.)
2. Set width control in maximum counter clockwise position.

5. Adjust width control to obtain sufficient width to fill screen.

If sufficient width cannot be obtained

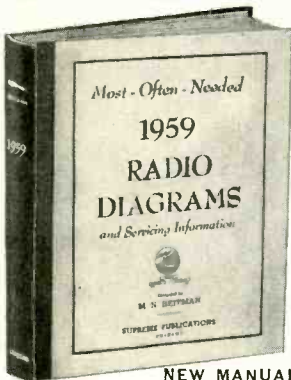

New SUPREME 1959 Radio Manual

Now you can benefit and save money with Supreme amazing scoop of 1959. This one giant volume has all the service data you need on all recent radio sets. A full year of models of all popular makes, home and auto sets, portable radios, stereo, combinations, all included. The full price for this mammoth 1959 manual is only \$2.50, nothing else to buy for a whole year. Other popular Supreme radio service volumes for previous years (mostly at \$2) are described below. Separate TV manuals are listed at right.

SUPREME TELEVISION SERIES

Here is your complete source of TV service data at lowest prices. Supreme manuals at only \$3 each are amazing bargains and defy competition. Each annual manual covers a whole year of models, using original factory material. Include giant double-spread circuits and blueprints, alignment procedure, waveforms, voltage charts, factory revisions, and helpful service hints. Select volumes from list below and send **no-risk coupon**.

- 1959 TV Manual, \$3
- 1958 TV Manual, \$3
- 1957 Early TV, \$3
- 1957 Late TV, \$3
- 1956 TV Manual, \$3
- 1955 Early TV, \$3
- 1955 Late TV, \$3
- 1954 TV Manual, \$3
- 1953 TV Manual, \$3
- 1952 TV Manual, \$3
- 1951 TV Manual, \$3
- 1949 TV Manual, \$3
- 1948 TV Manual, \$3

SUPREME RADIO MANUALS FOR PREVIOUS YEARS

Use Supreme manuals to repair all radios faster, easier; save time and make more money. Here is your lowest-priced service data. Covers all years, from 1926-38 to 1959 models, in 18 volumes. Used by 174,000 shrewd servicemen. Most volumes only \$2 each, see coupon. Average volume 190 large pages, 8½ x 11 inches. Quality printing, easy to use, manual-style binding. Amazing values. Be wise, use these manuals to get all needed diagrams, voltages, alignment facts, and service hints, at the smallest cost. See your jobber or send no-risk trial coupon. →

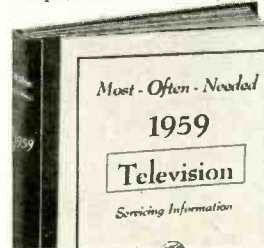

NEW MANUAL
Be prepared to repair quickly all new 1959 radio sets. In this big volume you have easy-to-use, large schematics, needed alignment data, printed circuit views, parts lists, voltage values, information on transistors, hints, location of trimmers, and dial stringing, for almost every 1959 radio. Includes auto radios, stereo, portables, and all types and makes of home sets. Giant in size, 8½ x 11"; manual style, sturdy binding. Price, only **\$2.50**

TELEVISION SERVICING COURSE

Let this new course help you in TV servicing. Amazing bargain, complete only \$3, full price for all lessons. Giant in size, mammoth in scope, topics just like a \$200.00 correspondence course. Lessons on picture faults, circuits, adjustments, short-cuts, UHF, hints, alignment facts, antenna problems, troubleshooting, how to use test equipment, fault-finding hints, picture analysis. Special, only... **\$3**



NO-RISK TRIAL ORDER COUPON

SUPREME PUBLICATIONS, 1760 Balsam Rd., Highland Park, ILL.

Rush today TV manuals checked below and Radio manuals at left. Satisfaction guaranteed.

Most-often-needed 1959 Radio Diagrams, \$2.50
 1957 Radio Manual, \$2.50
 1956 Radio Diagrams, \$2.50
 1955 Radio Manual, only \$2
 1954
 1953
 1952
 1951
 1950
 1949
 1948
 1947
 1946
 1942
 1941
 1940
 1926-1938 Manual, \$2.50
 Radio & TV Master INDEX, 25c

These annual RADIO volumes specially priced at only **\$2.50** each...
 THIS GROUP ONLY **\$2** EACH

Rush today TV manuals checked below and Radio manuals at left. Satisfaction guaranteed.
 New 1959 Television Servicing Manual, only... \$3.
 1958 Television Manual, \$3. Early 1957 TV, \$3.
 Additional 1957 TV, \$3. 1956 TV Manual, \$3.
 Early 1955 TV, \$3. Additional 1955 TV, \$3.
 1954 TV, \$3. 1953 TV, \$3. 1952 TV, \$3.
 1951 Television Manual, \$3. 1949 TV, \$3.
 1948 TV, \$3. 1957-58 RCA TV Manual, \$1.50
 New Television Servicing Course, complete... \$3.

I am enclosing \$..... Send postpaid.
 Send C.O.D. I am enclosing \$..... deposit.

Name:

Address:

Supreme Publications
Sold by All Leading Parts Jobbers

On the Market



MAST CLAMP wraps around pipe. Because of wraparound construction, cannot be tight-

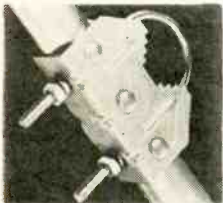

ened enough to crush boom. Clamp shape automatically aligns self to mast.—Winegard Co., Burlington, Iowa.

NO-STRIP ANTENNA CON-

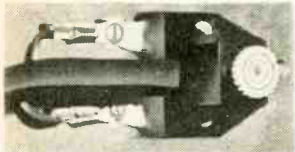

NECTOR for TV sets can be installed in few seconds. Spade lugs of connector fit standard TV set terminals. End of lead-in is inserted and knurled nut tightened, driving sharp contacts through insulation of lead to connect to wires.—**Trio Mfg. Co.**, Griggsville, Ill.

TV COUPLER has "no-strip" feature. *Model A-102* has phosphor bronze washers with sharp serrated edges under terminal

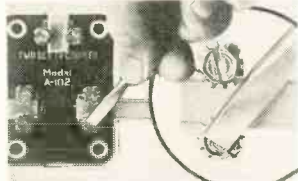

screws. When screws are tightened, washers contact wire through lead-in insulation.—**Blonder-Tongue Labs.**, 9 Alling St., Newark 2, N. J.

BROAD-BAND 6-METER ANTENNA, ring design, matches standard 52-ohm lines such as RG/8U-58U. 2 or 4 units may be stacked. 50.5-mc design center

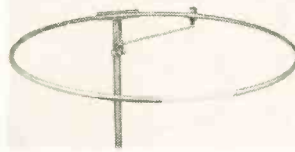

or as specified. Vswr 1.1 at design-center frequency. Diameter 39 inches.—**Hi-Par Products Co.**, Fitchburg, Mass.

ROOFTOP AUTO ANTENNA, *model ASP-177*. Half-wave antenna for 108-177 mc has gain

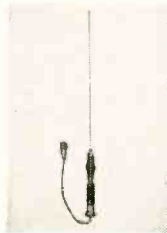

of 3 db over quarter-wave types. Installs through 3/4-inch rooftop hole—solderless type mounting system. 40-inch tapered stainless whip, shock-absorbing spring, 12 feet of cable.—**Antenna Specialists Co.**, 12435 Euclid Ave., Cleveland 6, Ohio.

DC OSCILLOSCOPE KIT *model OR-1* has 5-inch CRT, edge-lighted graticule. De-coupled vertical and horizontal am-



plifiers. Bandwidth dc to 200 kc. Sensitivity 0.1 volt peak to peak per cm. 3-position attenuator frequency-compensated. Sweep frequency 5 cycles to 50 kc. Lower rate available by adding capacitance at external binding posts. Input impedance 3.6 megohms shunted by 28 μ f.—**Heath Co.**, Benton Harbor, Mich.

POWER METER KIT, *model PM-2* is self-contained unit for checking output of ham transmitters, especially mobile rigs. 200- μ a meter. Sensitivity control. May be instantly mounted on any metal surface such as automobile dashboard by swivel and magnet assembly. Has own antenna; may be connected to



The responsibility of being the finest...

A LIFETIME WARRANTY

FLUXVALVE AND T-GUARD ARE TRADEMARKS USED TO DENOTE THE QUALITY OF PICKERING & COMPANY INVENTIONS. 2371 C

Truly the finest stereo pickup ever made... the STANTON Stereo FLUXVALVE is hermetically sealed in lifetime polystyrene with all of the precision that has made Pickering a quality leader in the field of high fidelity for more than a dozen years.

For instance...only the STANTON Stereo FLUXVALVE has the "T-GUARD" stylus assembly—so safe and easy to handle...so obedient and responsive to every musical nuance in the stereo groove.

Only the STANTON Stereo FLUXVALVE has the parallel reproducing element contained in the "T-GUARD"...assuring the proper angle of correspondence between recording and playback styli for maximum Vertical Tracking Accuracy.

And...because of this the STANTON Stereo FLUXVALVE reproduces music with magnificent sound quality...from both stereophonic and monophonic records...with negligible wear on record and stylus.

In plain truth...the STANTON Stereo FLUXVALVE is by far the finest stereo pickup made...backed by a Lifetime Warranty*, assuring you a lifetime of uninterrupted, trouble-free performance—with a quality of reproduction no other pickup can equal.

We suggest you visit your Pickering Dealer soon —drop in and ask for a personal demonstration.

NEWLY REVISED—"IT TAKES TWO TO STEREO"— ADDRESS DEPT. G-59 FOR YOUR FREE COPY.



For those who can hear the difference FINE QUALITY HIGH FIDELITY PRODUCTS BY PICKERING & COMPANY, INC., Plainview, N. Y.

(Excluding wear and tear of the diamond stylus tip and parts of the related moving system in the "T-GUARD" assembly.)

IF YOU MUST SPEND YOUR MONEY

Why not get Something for it? get **QUIETROLE**



IN BOTTLES 2, 4 & 8 oz. Dropper with 2 oz. SPRAY-PACK "CAN"

QUIETROLE

TRADE MARK REG. U.S. PAT. OFF.

Costs little more than the poorest substitutes. Why take less than the BEST...

No Product can match its merit... None can equal its quality... It's the answer to noisy controls and switches

QUIETROLE is the original product of its kind

MFG BY **QUIETROLE Company**

SPARTANBURG, South Carolina

IN CANADA: ACTIVE RADIO and TV DISTRIBUTORS

58 Spadina Ave., Toronto 2B, Ontario

MOST of us are familiar with the age old problem of checking an electrolytic capacitor. We have tried capacitor testers, in-circuit testers and circuit analyzers, only to find that the only real answer to checking any electrolytic accurately is to substitute it with another capacitor. Of course, this presents certain problems; the right value capacitor of the proper operating voltage is usually the one that you installed in the last repair job that you did and you don't have another around the shop for substitution. Then, too, there is always the discharge spark that does little good in creating good-will with your customer, to say nothing of the harm that it can do to the capacitor.

The intermittent electrolytic capacitor is the worst headache, especially where the trouble in the receiver is corrected when another capacitor is connected across it. This we call capacitor healing due to the sudden out-rushing current from the capacitor being paralleled. The ES-102 Electro-Sub is especially made to make substitution easy and is ideal for service shop, laboratory or any other place where design, service or experimenting is taking place.

WHY THE ELECTRO-SUB NOW?

The need for an electrolytic substitution unit has increased recently because of the sharp increase in the use of electrolytic capacitors. Hi-Fi amplifiers, for example, use up to 12 electrolytics. This increased again with the advent of stereo sound. One bad electrolytic will make a thousand dollar Hi-Fi sound like a ten dollar AC-DC radio. Portable TV receivers also use more electrolytic capacitors than conventional TV. The filter capacitors are more critical, especially when the portable uses a fuse resistor.

What Electrolytic Capacitors Will The ES-102 Substitute For?

The ES-102 is especially designed to substitute for all capacitors from 2 MFD to 400 MFD. The actual values selected and some of their uses are shown below.

- 4 MFD... especially handy for transistor radios
- 10 MFD... very handy for adding capacity to see if it will reduce hum
- 20 MFD... popular in many low cost AC-DC radios and TV bypass
- 40 MFD... used in most AC-DC radios and some TV receivers
- 60 MFD... used in many low cost TV receivers
- 80 MFD... used in most TV receivers and higher priced radios
- 100 MFD... used in many TV receivers and low cost Hi-Fi amplifiers
- 150 MFD... very prevalent in Hi-Fi amplifiers
- 225 MFD... used in some Hi-Fi amplifiers
- 350 MFD... used only in very high priced Hi-Fi and special applications. Very handy for design work and for trouble shooting hum.

When substituting for in between values, select the nearest value.

WHAT VOLTAGE CAN BE APPLIED TO THE ES-102?

Any voltage from 2 to 450 volts can be applied to the ES-102 capacitors without capacity change. This is because the capacitors used are special dry electrolytics.

Time-Saver of the MONTH!

by Herb Bowden*

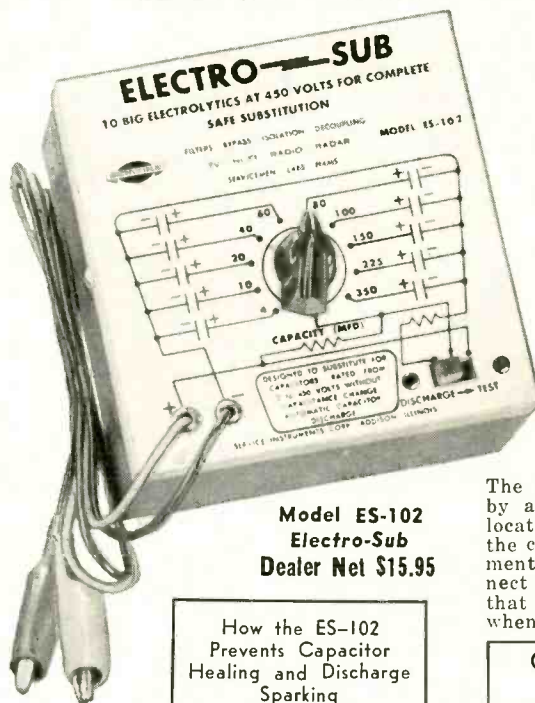

Model ES-102
Electro-Sub
Dealer Net \$15.95

How the ES-102
Prevents Capacitor
Healing and Discharge
Sparking

The ES-102 has a special charge and discharge circuit called a surge protector. This magic device is a development of Sencore and is very unique in operation. The surge protector action is shown in figure 1. Following the action of the surge protector, note the three positions of the switch as it slides from left to right. In position 1, the leads are connected to the circuit under test, but the substitute capacitor is not connected. In position number two, the capacitor is connected to the circuit through the 500 ohm resistor and completes the substitution. The action is in reverse as the surge protector switch is released.

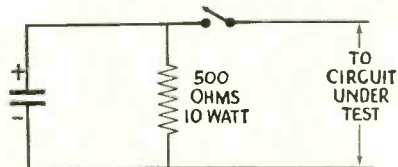

Fig. 1A. Position 1 places resistor across capacitor and only test leads connected to circuit.

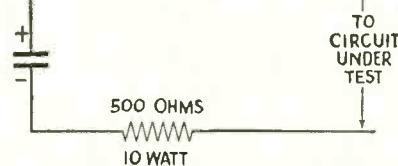

Fig. 1B. Position 2 showing resistor in series with capacitor to "slow down" current in-rush which may heal capacitor being paralleled.

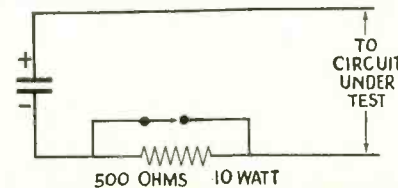

Fig. 1C. Position 3 of surge protector "shorts out" series resistor leaving only electrolytic in circuit.

When it is returned to the extreme left, the 500 ohm resistor discharges the ES-102 capacitor completely within a few seconds. The remaining portion of the ES-102 schematic is screened on the front panel as shown.

Is The Surge Protector Critical In Operation?

It may appear that the surge protector switch must be moved to the right carefully in order to accomplish the connections described. However, this is not the case, as the switch can be compressed as fast as desired and as often as required. The connections and capacitor discharge are automatic.

Can The ES-102 Be Substituted Permanently?

The surge protector switch is returned by an external spring. This spring is located under the front panel. To use the capacitors for engineering or experimental work, you may want to disconnect the spring. Be sure to remember that the surge protector is not operating when the spring is disconnected.

CAN YOU GET A SHOCK FROM THE ES-102?

It is impossible to get a shock from the ES-102 as the test leads are disconnected and the capacitor discharged the instant that the surge protector switch is released. As a matter of fact, you can release the surge protector, disconnect the leads and then touch the leads to your hands without the possibility of shock. This is important, especially where customers or small children may get near your service bench.

DOES THE ROTARY SWITCH ARC WHEN SWITCHING CAPACITORS?

The rotary switch does not arc when switching capacitors because the surge protector switch disconnects the voltage source. This reduces switch wear greatly. One should be careful not to hold the surge protector to the right while changing capacitors.

IS IT NECESSARY TO DISCONNECT THE CAPACITOR BEING CHECKED?

If a capacitor is suspected of being open, you do not need to disconnect it from the circuit. If it is suspected of being shorted, it is necessary to disconnect it while substituting one of the capacitors from the ES-102.

WHERE TO PURCHASE THE ELECTRO-SUB

Over 1000 parts distributors in the United States and Canada carry the complete line of Sencore time savers. These distributors now carry the Electro-Sub in stock. Dealer net is \$15.95 (less than your cost of the electrolytic capacitors).

If, for some reason, your distributor does not carry the Sencore line, please drop us a note at the factory, 121 Official Road, Addison, Illinois. In Canada, please write . . . Active Radio and TV Dist., 58 Spadina Avenue, Toronto 2 B. Look for the colorful Sencore display.

*PRESIDENT SENCORE

[ADVERTISEMENT]

[ADVERTISEMENT]

RADIO and ELECTRONICS TRAINING AT HOME

BUILD 16 RADIO

CIRCUITS with DELUXE

1959 Progressive RADIO "EDU-KIT"®

Reg. U.S. Pat. Off.

PRACTICAL only HOME RADIO COURSE \$22.95



NOW INCLUDES

- ★ 12 RECEIVERS
- ★ TRANSMITTER
- ★ SIGNAL TRACER
- ★ SIGNAL INJECTOR
- ★ CODE OSCILLATOR

- ★ No Knowledge of Radio Necessary
- ★ No Additional Parts or Tools needed
- ★ Excellent Background for TV
- ★ School Inquiries Invited
- ★ Attractively Gift Packed

FREE EXTRAS

- SET OF TOOLS • RADIO & ELECTRONICS TESTER • ELECTRIC SOLDERING IRON • TESTER INSTRUCTION MANUAL • MEMBERSHIP IN RADIO-TV CLUB; CONSULTATION SERVICE • HI-FI GUIDE • QUIZZES • TV BOOK • FCC AMATEUR LICENSE TRAINING • RADIO BOOK • PRINTED CIRCUITRY • PLIERS-CUTTERS • ALIGNMENT TOOL • WRENCH SET • CERTIFICATE OF MERIT • VALUABLE DISCOUNT CARD

WHAT THE "EDU-KIT" OFFERS YOU

The "Edu-Kit" offers you an outstanding PRACTICAL HOME RADIO COURSE at a rock-bottom price. Our kit is designed to train Radio & Electronics Technicians, making use of the most modern methods of home training. You will learn radio theory, construction, servicing, basic Hi-Fi and TV repairs, code, FCC amateur license requirements.

You will learn how to identify radio symbols, how to read and interpret schematics, how to mount and layout radio parts, how to wire and solder, how to operate electronic equipment, how to build radios. Today it is no longer necessary to spend hundreds of dollars for a radio course. You will receive a basic education in radio, worth many times the small price you pay, only \$22.95 complete.

THE KIT FOR EVERYONE

The Progressive Radio "Edu-Kit" was specifically prepared for any person who has a desire to learn Radio. The "Edu-Kit" has been used successfully by young and old in all parts of the world, by many Radio Schools and Clubs in this country and abroad. It is used for training and rehabilitation of Armed Forces Personnel and Veterans throughout the world.

The Progressive Radio "Edu-Kit" requires no instructor. All instructions are included. Every step is carefully explained. You cannot make a mistake.

PROGRESSIVE TEACHING METHOD

The Progressive Radio "Edu-Kit" is the foremost educational radio kit in the world, and is universally accepted as the standard in the field of electronics training. The "Edu-Kit" uses the modern educational principle of "Learn by Doing." Therefore, you will construct radio circuits, perform jobs and conduct experiments to illustrate the principles which you learn.

You begin by examining the various radio parts included in the "Edu-Kit." You then learn the function, theory and wiring of these parts. Then you build a simple radio. With this first set, you will enjoy listening to regular broadcast stations & learn theory, practice testing and troubleshooting. Then you build a more advanced radio, learn more advanced theory and techniques. Gradually, in a progressive manner, and at your own rate, you will find yourself constructing more advanced multi-tube radio circuits, and doing work like a professional Radio Technician.

Included in the "Edu-Kit" are sixteen Receiver, Transmitter, Code Oscillator, Signal Tracer and Signal Injector circuits. These are not unprofessional "breadboard" experiments, but genuine radio circuits, constructed by means of professional wiring and soldering on metal chassis, plus the new method of radio construction known as "Printed Circuitry." These circuits operate on your regular AC or DC house current.

In order to provide a thorough, well-integrated and easily-learned radio course, the "Edu-Kit" includes practical work as well as theory; troubleshooting in addition to construction; training for all, whether your purpose in learning radio be for hobby, business or job; progressively-arranged material, ranging from simple circuits to well-advanced Hi-Fi and TV work. Your studies will be further aided by Quiz materials and our well-known FREE Consultation Service.

THE "EDU-KIT" IS COMPLETE

You will receive all parts and instructions necessary to build 16 different radio and electronics circuits, each guaranteed to operate. Our Kits contain tubes, tube sockets, variable, electrolytic, mica, ceramic and paper dielectric condensers, resistors, tie strips, coils, hardware, tubing, punched metal chassis, Instruction Manuals, hookup wire, solder, etc.

In addition, you receive Printed Circuit materials, including Printed Circuit chassis, special tube sockets, hardware and instructions. You also receive a useful set of tools, a professional electric soldering iron, and a self-powered Dynamic Radio & Electronics Tester. The "Edu-Kit" also includes Code Instructions and the Progressive Code Oscillator, in addition to the F.C.C.-type Questions and Answers for Radio Amateur License training. You will also receive lessons for servicing with the Progressive Signal Tracer and the Progressive Signal Injector, and a High Fidelity Guide and Quiz Book. Everything is yours to keep. "I have repaired several sets for my friends, and made money. The "Edu-Kit" paid for itself. I was ready to spend \$240 for a course, but I found your ad and sent for your Kit."

UNCONDITIONAL MONEY-BACK GUARANTEE

The Progressive Radio "Edu-Kit" has been sold to many thousands of individuals, schools and organizations, public and private, throughout the world. It is recognized internationally as the ideal radio course.

By popular demand the Progressive Radio "Edu-Kit" is now available in Spanish as well as English.

It is understood and agreed that should the Progressive Radio "Edu-Kit" be returned to Progressive "Edu-Kits" Inc., for any reason whatever, the purchase price will be refunded in full, without quibble or question, and without delay.

The high recognition which Progressive "Edu-Kits" Inc., has earned through its many years of service to the public is due to its unconditional insistence upon the maintenance of perfect engineering, the highest instructional standards, and 100% adherence to its Unconditional Money-Back Guarantee. As a result, we do not have a single dissatisfied customer throughout the entire world.

ORDER FROM AD—RECEIVE FREE BONUS RESISTOR AND CONDENSER KITS WORTH \$7.00

- Send "Edu-Kit" Postpaid. I enclose full payment of \$22.95.
- Send "Edu-Kit" C.O.D. I will pay \$22.95 plus postage.
- Send me FREE additional information describing "Edu-Kit."

Name.....

Address.....

Progressive "EDU-KITS" Inc.

1186 Broadway, Dept. 152-G
Hewlett, N. Y.

ON THE MARKET (Continued)

other aerial.—Heath Co., Benton Harbor, Mich.

VOLT-OHM-MILLIAMMETER model 120. Chrome-mirrored



scale reduces parallax errors. Dc polarity-reversing switch. 20,000 ohms/volt dc, 5,000 ohms/volt ac. Low ohms scale, 2 ohms center scale and extended low-current range; 60 microamps.—Precision Apparatus Co., 70-31 84 St., Glendale 27, N. Y.

TUBE ANALYZER model 3444, mutual conductance type. Correct dc potentials applied to tube, 5-ke signal to grid. Low-

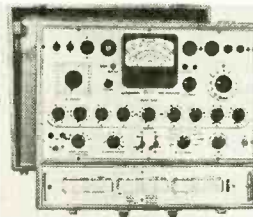

impedance vacuum-tube microammeter reads μ_m directly on 4 ranges from 0-1,000 to 0-30,000 micromhos.—Triplett Electrical Instrument Corp., Bluffton, Ohio.

TRANSISTORIZED BIAS POWER SUPPLY model 1020. Universal power and bias supply for transistor work. .005% ripple at full load. Output 0 to



30 volts continuously variable, metered in 2 ranges, 0-6 and 0-30. Current up to 300 ma at 24-30 volts, 200 ma from 12-24 volts, 150 ma from 0 to 12 volts. Fused. Kit and wired.—EICO, 33-00 Northern Blvd., Long Island City 1, N. Y.

STEREO TUNER model ST350



has physical space for multiplex adapter as well as signal and power connections. Pushbuttons switch AM noise filter, FM-afc control and other functions. FM; sensitivity 0.95 μ v for 20-db quieting; image rejection 40 db; hum down 60 db at 100% modulation; distortion less than 0.1% IM at 30% modulation, 0.5% at 100%, output 0.5 volts for 30% modulation, 1.5 volts, 100%. AM: sensitivity 20 μ v/meter; selectivity 6 db down at 16 kc; image and if rejection, 55 db each; hum 55 db down at 80% modulation.—Harman-Kar-

don, Inc., 520 Main St., Westbury, N. Y.

STEREO AUDIO CONTROL CENTER model 402, 5 inputs for each stereo channel, monitor

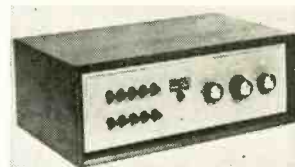

pushbutton, separate loudness controls for each channel which may be operated ganged or separate.—Ampex Audio, Sunnyvale, Calif.

STEREO AMPLIFIER KIT model Stereo 70 includes 2 semi-assembled 35-watt power amplifiers. Output 4 EL34/6CA7's driven by 7199 pentode-triode voltage amplifiers. Dual printed-circuit assembly supplied with small parts factory-wired. Power available from octal sockets for 2 preamps. On-off and mono-stereo switch. 20-20,000 cycles at less than 1% total distortion,



IM .05% at normal levels to 0.5% at rated output.—Dynaco, Inc., 617 N. 41 St., Philadelphia.

STEREO PREAMP-AMPLIFIER, model 245-A. 2-channel unit with 2 complete 20-watt amplifiers and full controls. Automatic shutoff switch allows changer to turn off system after last record. Tone controls adjustable simultaneously or separately. 2 phono inputs for permanent changer and turntable connections. Response, 20-20,000 cycles \pm 1 db. Hum and noise more than 80 db down; sensitiv-



ity for 1 volt at audio jack 2 mv for phono and microphone, 2 mv for tape head. 4-position equalization.—Pilot Radio Corp., 37-08 36 St., Long Island City 1, N. Y.

STEREO HEADPHONES, model SP-3. Frequency response 30 to 15,000 cycles. 3 1/2-inch reproducers in each phone. Rated 4 ohms to go directly across voice coil. Adapters available for



600 and 10,000 ohms.—Koss, Inc., 2227 N. 31 St., Milwaukee.

HIGH-FIDELITY HEADPHONES use liquid-filled cushion. Frequency response flat from 20-12,000 cps, down 4 db at 15 kc. Designed for stereo, separate cords may be paralleled



for mono listening. Impedance 6.4 ohms per phone.—**Sharpe Instruments, Ltd.**, 6080 Yonge St., Willowdale, Ontario, Canada.

EARSETS for transistor radios in 4 models. Shock-resist-



ant Tenite, 15-ohm impedance. Weight 1/6 ounce, less cord.—**Telex, Inc.**, 1633 Eustis St., St. Paul, Minn.

PHONO CHANGER-PLAYER *Dual-1006*, 4-speed operation as automatic disc changer or manual player. Tone arm has plug-in cartridge holders which lock



into place. Stereo-mono switch cancels vertical pickup in mono position. Tracks with 2-gram

stylus pressure.—**United Audio Products, Inc.**, 202 E. 19 St., New York 3, N. Y.

STEREO CARTRIDGE-ARM integrated assembly. *Studio Dynamic*, stereo version, in 12- and

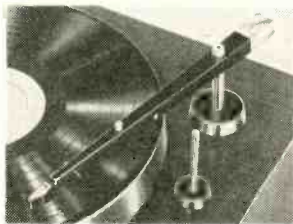

16-inch models. Tracks at 1½ to 2½ grams; channel crosstalk down more than 20 db at 1,000 cycles; output 5 mv each channel; compliance 8×10^{-6} cm/dyne; load impedance 50K.

Purchasers of separate *Stereo Dynamic* cartridge receive certificate for free factory conversion of earlier-model monophonic arm assembly to accept either pickup cartridge as plug-in.—**Shure Bros., Inc.**, 222 Hartrey Ave., Evanston, Ill.

POWER AMPLIFIER, model *HF-41*. Kit or wired. Rated at 14 watts uses EL84's in output,



± 0.1 db 15-100,000 cycles. 20 db feedback. Damping factor 8 or more, 20 cycles to 20kc. Sensitivity 1.25 volts for 14 watts output. Response, 20-60,000 cycles, ± 1.5 db.—**EICO**, 33-00 Northern Blvd., Long Island City 1, N. Y.

SPEAKER LINE designed around new magnetic material *Ticonal-7*. High efficiency. *T-7* series includes two 12-, two 8-inch drivers, several smaller units. Standard EIA mounting holes, 5-way binding posts. Effi-

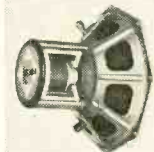

ciencies range from 2.5 to 14%. —**North American Philips Co.**, 230 Duffy Ave., Hicksville, N. Y.

BOOKSHELF SPEAKER has short removable legs for floor



use. Includes 8-inch woofer, crossover network and 3½-inch tweeter. Flat 100 to 13,000 cycles; 24 x 11 x 10½ inches.—**Argo Products Co.**, 301 Main St., Genoa, Ill.



WOOFER SPEAKER, 12-inch model *C-12-RW*. Cone has 2 sections: *flex-edge* for freedom of movement, and heavy body to reduce breakup of middle frequencies. 6-inch spider assembly. 1-inch excursion of voice coil for 4 watts input at 16 cycles. Cutoff at 4,000 cycles.—**Cietron, Inc.**, 1974 E. 61 St., Cleveland 3, Ohio.

SPEAKER ENCLOSURE series *EN-50* for 12-inch drivers. Optional front-panel tweeter



opening with cover plate. 5-cubic-foot distributed-port design; 7 small openings in rear of cabinet. Terminals on rear coded for phasing; leads supplied for connection to driver or crossover.—**General Electric Co.**, West Genesee St., Auburn, N. Y.

SPEAKER CONTROLS. Remote controls, T-pads, in 8- and 16-ohm models. Also available

ALL SERVICE DEALERS LOOK TO DeRO

Restores Em All
SERIES • PARALLEL
CRT BRIGHTENER
One Model for All!
52° 60° 70° 90° and 110°

The Serviceman's Answer To The Multiple Booster "Stock" Problem
The Complete Booster "Kit" In One Compact Unit

- Replaces most types now in use
- Compact
- Guaranteed
- Easily installed

THIS DeRO DISPLAY
A colorful, small space counter display identifies DeRO's quality and engineering—guaranteed satisfaction.

Model RPS—ALL*
List \$1.50

AT ALL LEADING DISTRIBUTORS

THE MAN WHO "KNOWS" LOOKS FOR THIS:
Write for LATEST CATALOG

DeRO Electronics

134 NASSAU ROAD, ROOSEVELT, N. Y.

DEVELOPED AND GUILD-CRAFTED BY PHILIPS OF THE NETHERLANDS

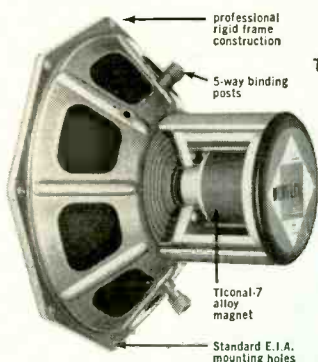

THE NEW LINE OF

Norelco®
T-7 LOUDSPEAKERS

FEATURING NEW **TICONAL VIII®** MAGNETS
(30% MORE POWERFUL THAN ALNICO)

This new line of 5" to 12" loudspeakers is designed to match the quality requirements of the discriminating music lover... at a surprisingly moderate price. The world's greatest buys on the basis of listening quality, the T-7 series incorporates voice coil magnets of Ticonal-7 steel, the most powerful of modern magnet alloys, for maximum efficiency and damping... dual cones for wide frequency response... constant impedance resulting in an extremely straight response curve... longer effective air-gaps and extra high flux density to provide exceptional transient response and to eliminate ringing and overshoot. For further descriptive literature write to the North American Philips Co., Inc., High Fidelity Products Division, Dept. 3E5, 230 Duffy Avenue, Hicksville, Long Island, New York.



A COMPLETE LINE OF SPEAKERS AND ACCOUSTICALLY DESIGNED ENCLOSURES

RESIDENT SCHOOL COURSES

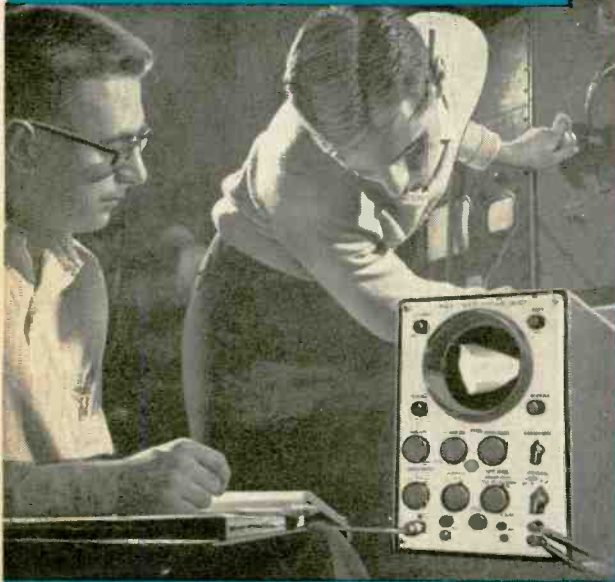

Industry needs Electronic Technicians!

Let RCA train you in Advanced Electronics

This is the college-level training you need to work with professional engineers on research, development or production projects in such fields as: automation, guided missiles, radar, television, computers and other advanced electronic applications.

RCA Institutes Resident School in New York City offers this comprehensive course that prepares you for any field of electronics you may choose. Other courses in TV & General Electronics, Radio & TV Servicing, and Radio Telegraph Operating.

Classes start four times each year. Applications now being accepted. Approved for Veterans.



RCA INSTITUTES, INC.
SCHOOL OF TELEVISION
AND ELECTRONIC TECHNOLOGY
A Service of Radio Corporation of America



RCA INSTITUTES, DEPT. RER-59
350 W. Fourth St., N. Y. 14, N. Y.

Please send me your FREE catalog of Resident School courses in New York.

NAME _____ please print
ADDRESS _____
CITY _____ ZONE _____ STATE _____
For Home Study Courses see ad on opposite page

ON THE MARKET (Continued)



are toroids meeting MIL-T-27 specs for grade-5 class-R units. Operate at 2,500 and 5,000 cycles, delivering square waves. For use with 6-, 12-, or 28-volt input. — **Triad Transformer Corp.**, 4055 Redwood Ave., Venice, Calif.

with phone jack in panel next to control for plugging in headphones. 4 watts continuous or 15 watts peak audio.—**Switchcraft, Inc.**, 5555 N. Elston Ave., Chicago 30, Ill.

WIDE-BAND RF AMPLIFIER for TV and FM. No tuned circuits, cannot drift or be mis-



aligned. Gain 27 db from 54 to 216 mc. Noise figure better than 10 db. 75 or 300 ohm input; output 75 ohms. Self-powered.—**Benco Television Associates, Ltd.**, 27 Taber Rd., Rexdale, Ontario.

RADIO-INTERCOM KIT.



Ranger includes parts for both master and remote station. Two more remotes may be added. Master station has AM receiver and separate volume controls for intercom and radio.—**Allied Radio Corp.**, 100 N. Western Ave., Chicago 80, Ill.

MICROMINIATURE INDICATOR LAMP 0.1 inch long.



use in output of transistor circuits. Lamp has tungsten filament which draws less than 50 ma at 1.5 volts.—**Minitron Components Corp.**, 187 Washington Place, Passaic, N. J.

MINIATURE CERAMIC CAPACITORS rated at 10 volts vary $\pm 7\%$ from 10° to 85°C.



.05 μ f is .385 inch in diameter. Also made in 0.1, 0.2 and 0.47 μ f.—**Centralab Div. of Globe-Union, Inc.**, 900 East Keefe Ave., Milwaukee 1, Wis.

TRANSISTOR POWER TRANSFORMERS, TY series,



PRECISION POTENTIOMETER series 42 in high-temperature version operates up to 446°F. Tolerance $\pm 5\%$ 1 to 100,000 ohms. Linearity $\pm 0.5\%$.

Noise less than 5 microvolts.—**Clarostat Mfg. Co., Inc.**, Dover, N. H.

SUBMINIATURE CAPACITORS, rated at 50 volts for transistor circuitry. *Type MQZF* temperature range -55° to $+85^{\circ}$ C. 0.195 inch dia. x 11/16 inch long. Metallized. .047-8 μ f. *Type AQF* (shown) slightly



larger, range -65° to $+125^{\circ}$ C. .027-2 μ f.—**Astron Corp.**, 225 Grand Ave., East Newark, N. J.

TOUCHUP BRUSH for retouching scratches on TV, radio



and appliance cabinets. *G-C Tipon Touch-Up* comes in 6 shades: walnut, mahogany, blond, gold, appliance white, and black. Use like a marking pencil.—**General Cement Electronics Mfg. Co.** (Div. of Textron Inc.), 400 S. Wyman St., Rockford, Ill.

FLASHLIGHT BATTERY, steel-encased. D cell is leakproof



and corrosion proof. Chrome finish. *Type M 13*.—**Mallory Battery Co.**, 13000 Athens Ave., Cleveland 7, Ohio.

INSULATING-TAPE KIT, No. W-315. 6 rolls of plastic, self-sticking tapes in plastic container. Black, blue, red, green, yellow and transparent in each kit. 1/4 inch wide. 7 feet of tape per roll.—**Olson Radio Warehouse**, 260 S. Forge St., Akron, Ohio. END

All specifications on these pages are from manufacturers' data.

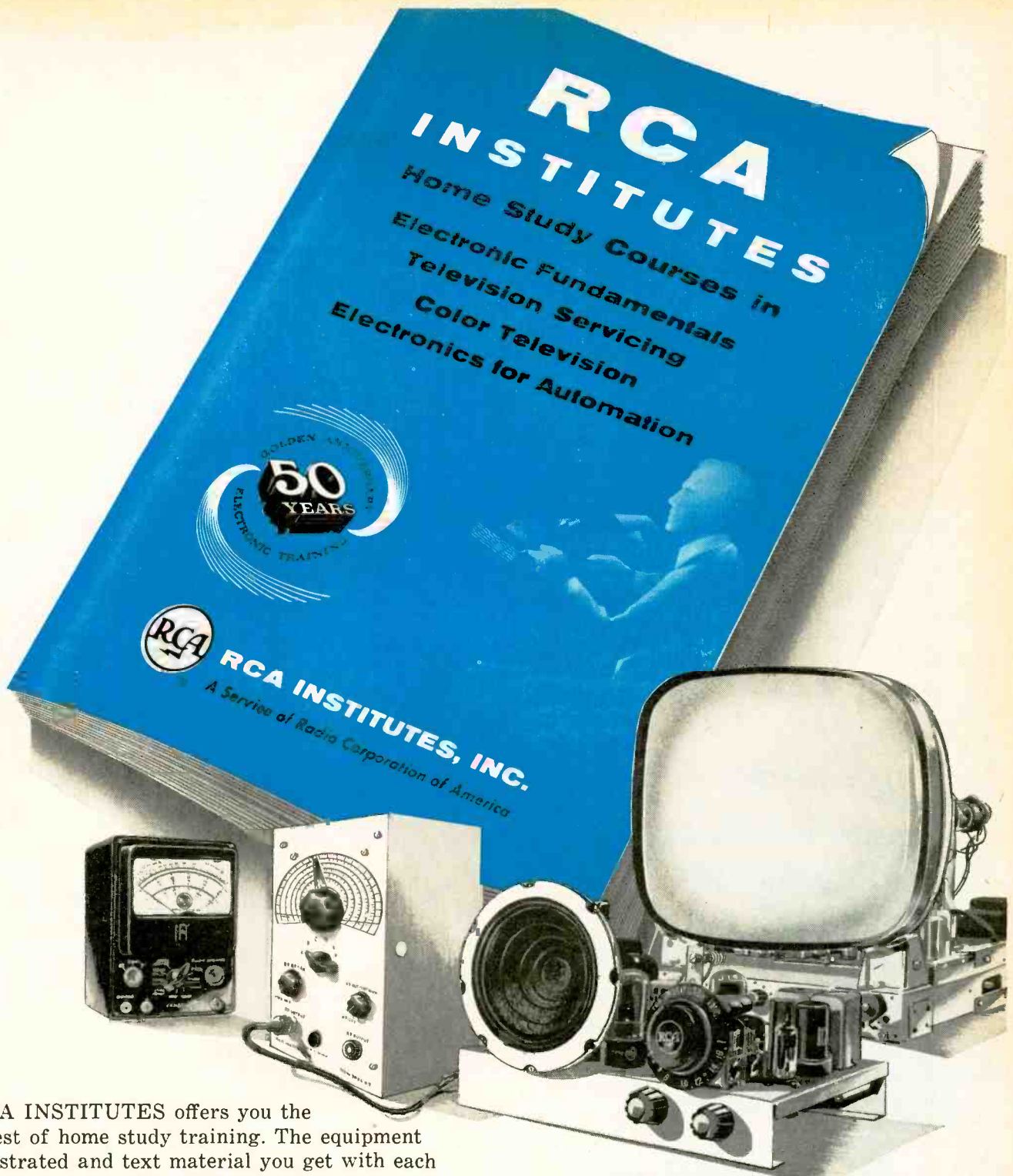

RCA INSTITUTES offers you the finest of home study training. The equipment illustrated and text material you get with each course is yours to keep. Practical work with very first lesson. Courses for the beginner and the advanced student. Pay-as-you-learn. You need pay for only one study group at a time.

**Send for this
FREE Book Now**

FOR RESIDENT SCHOOL COURSES
SEE AD ON OPPOSITE PAGE

RCA INSTITUTES, Inc. Home Study School SRE-59

A Service of Radio Corporation of America
350 West Fourth Street, New York 14, N. Y.
Without obligation, send me FREE 64-page CATALOG on Home Study Courses. No salesman will call.

Name..... please print

Address.....

City..... Zone..... State.....

Korean Vets! Enter discharge date.....

CANADIANS — Take advantage of these same RCA courses at no additional cost. No postage, no customs, no delay. Send coupon to: RCA Victor Company, Ltd., 5001 Cote de Liesse Rd., Montreal 9, Quebec
To save time, paste coupon on postcard.

DON'T SAY "BRIGHTENER"
 SAY

Perma-Power

UNIVERSAL
 TV TUBE BRITENER

Engineered for quality . . .
 and fully guaranteed!

Model C-301 For use in Series
 or Parallel Wired Sets

List Price \$4.45

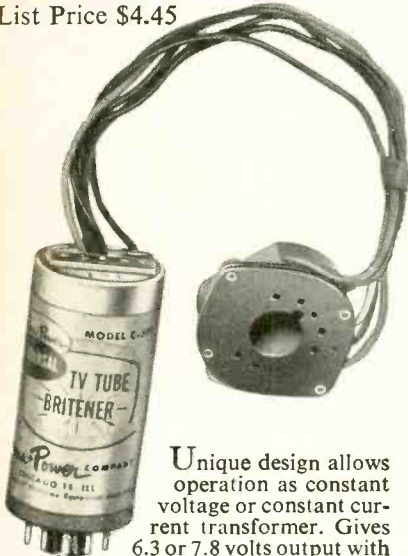

Unique design allows operation as constant voltage or constant current transformer. Gives 6.3 or 7.8 volts output with Isolation on Series or Parallel sets. Works on electrostatic or electro-magnetic focus picture tubes. Relieves Cathode-Filament shorts, without Boost output.

DON'T SAY "BRIGHTENER"
 SAY

Perma-Power

VU-BRITE

Engineered for quality . . .
 and fully guaranteed!

Model C-401 For use in Series Sets
Model C-402 For use in Parallel Sets

List Price \$1.49

The price leader for brightening most sets! Auto-former type transformer increases filament voltage to 7.8 V. Works on electrostatic or electro-magnetic picture tubes.



Don't say "brightener"
 Say **PERMA-POWER**

The Standard of All Comparison
 Available from your parts distributor

PERMA-POWER COMPANY
 3106 N. ELSTON AVE., CHICAGO 18, ILL.

NEW TUBES and SEMI-CONDUCTORS



UNIJUNCTION, drift and diffused-alloy transistors lead this month's parade. Also presented are audio power transistors and a sharp-cutoff pentode. Circuits for using some of the units listed are shown.

2N489, -90, -91, -92, -93, -94

Silicon Unijunction transistors for oscillators, timing circuits, trigger cir-

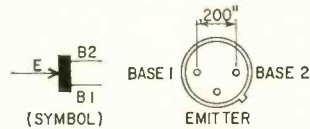

2N489,90,91,92,93,94

cuits and bi-stable circuits where they can serve the purpose of two conventional silicon transistors. The schematic shows how a Unijunction transistor can be used as a relaxation oscillator. High-voltage negative pulses are available across R2, low-voltage positive or negative pulses at low-impedance levels are obtained across a resistor inserted

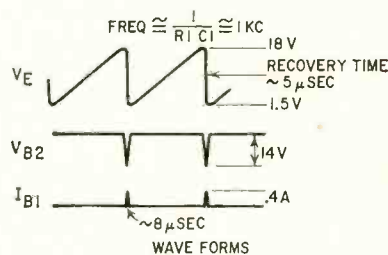
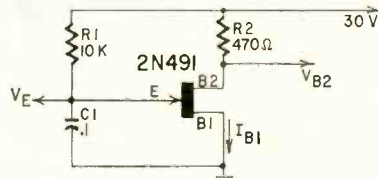

between base 1 and ground or between C1 and ground, respectively.

Maximum ratings of these G-E semi-conductors are:

P_{total} (rms) (mw)	450
I_E (rms) (ma)	70
I_E (peak) (amps)	2 ($T_J = 150^\circ C$)

2N643, -644, -645

P-n-p drift transistors of the germanium alloy type, they are designed for use in high-speed (millimicrosecond duration) nonsaturating switching circuits of electronic computers such as inverters, flip-flops and logic gates

HOW TO MAKE MONEY

Selling Commercial Sound

Here today and here tomorrow — Commercial Sound is a steady-profit 12-months-a-year business of sales, installation and servicing with lots of customers right in your own neighborhood. Take advantage of the Atlas complete line of speakers — manufactured, advertised and supplied directly by Atlas. . . . Speakers for every application, a mike support for every purpose — plus a wide variety of accessories so necessary for a complete professional installation.

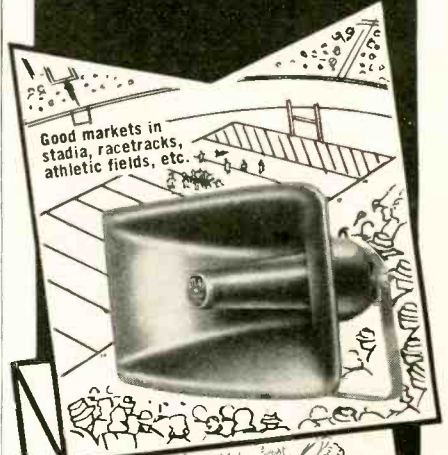

Write for latest catalog and selling aids to help you get profitable commercial sound business.



ATLAS SOUND CORP.

Dept. RE-5
 1449 - 39th St.
 Brooklyn 18, N. Y.

In Canada: Atlas Radio Corp.,
 Toronto, Canada

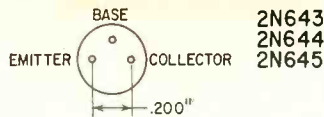

where high gain-bandwidth product and pulse-repetition rates up to 10 mc are primary design requirements. A

V_{1,2,3} (3) 2N643, 2N644, OR 2N645

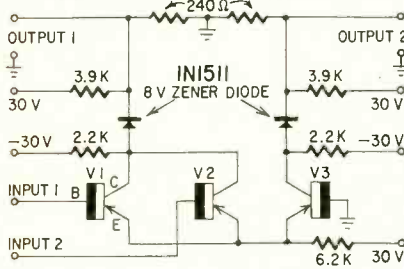

ALL RESISTANCE & VOLTAGE VALUES HAVE 5% TOLERANCE

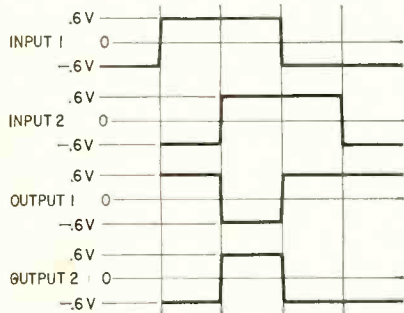

typical gating circuit using these transistors is shown.

Maximum switching-service ratings of these RCA transistors are:

V _{CE}	30
V _{CE}	29 (V _{BE} =1)
V _{EB}	2
I _C (ma)	100
I _E (ma)	100
P _C (mw)	
(at 25°C)	120
(at 55°C)	35
(at 71°C)	10

2N1073, -1073-A, -1073-B

Diffused-alloy power transistors with high-frequency and high-voltage characteristics that make them very suit-

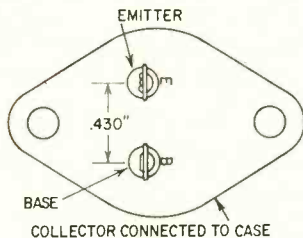

2N1073, 2N1073-A, 2N1073-B

able for use as horizontal output amplifiers for TV or cathode-ray applications. Welded construction with a vacuum-tight seal is featured.

Absolute maximum ratings of these Bendix transistors are:

	2N1073	-1073-A	-1073-B
V _{CE}	40	80	120
V _{CB}	40	80	120
V _{EB}			
I _C (amps)	10	10	10
P _C (watts)	35	35	35
I _E (amps)			

MAIL SHOPPERS EVERYWHERE SAVE DURING LEKTRON'S

KRAZY PRICE DAZE!



OUR USUAL \$1 POLY-PACS®

ONLY **88¢** EACH

BUY ANY 10 POLY-PAKS, PICK 11th FREE!

SAVINGS OF \$3 TO \$35 AND MORE ON EACH PAK!

FREE!
FULL YEAR'S SUBSCRIPTION To Lektron's 24-Pg. "FAMILY SHOPPER"
Electronics • Tools • Jewellery • Novelties • Hi-Fi • Housewares
Write Today!

FREE!

MINI GEIGER COUNTER
Tube. Dozen of radiation, detection uses! 2" long x 1/2" dia. **88c**

S15 MOBILE RELAY
For 6VDC projects. 3 PST silver contacts. Herm. sealed. 1 lb. **88c**

2 P-N-P TRANSISTORS
Popular make! Hundreds of hobby uses! \$5 value. **88c**

8 RCA PLUG-N-JACK
Sets, matched. Most pop. amps. **88c**

JEWELERS' PLIERS
Drop-forged, chrome plated. Precision diagonal or long-nose. **88c**

5 JWLRS SCRWDRVRS
Different sizes. Brass; chrome plated, swivel heads. Reg. \$3.50. **88c**

2 ARI-LOOSTICKS
Adj. 510-1500 kcs. Transistor radios. **88c**

WIRE STRIPPER
Strips, cuts #16 thru #22 hook-up wire. Wt. 1 lb. **88c**

0-60 MINUTE TIMER
For darkroom, lab, shop, kitchen. Loud alarm. 2 lbs. Reg. \$6. **88c**

0-15 VAC MINI-METER
Hundreds of uses! Only 1 1/4" diameter. 1 lb. Reg. \$3.50. **88c**

70 TUB. COND'N'RS
Paper, molded, oil, porcelain. 2.5mf to 1000 V. 2 lbs. **88c**

2 N-P-N TRANSISTORS
Used in many pop. make radios. **88c**

2 TRANSISTOR IF'S
Double-tuned. Only 1/2" square. 456 kcs. **88c**

TEN 3-SECOND TIMER MECHANISMS: precision geared. 2 lbs. **88c**

HOW TO ORDER: Check items wanted. Return entire ad w/check or M.O. including sufficient postage; excess returned. C.O.D. Orders. 25% down; rated, net 30 days. Print name, address. WITH POSTAL ZONE NO., amount money enclosed, in margin. (Canada postage, 48c 1st lb.; 28c ea. add'l lb.)

5" HOBBY SPEAKER
For radios, code osc., intercoms. 2 lbs. **88c**

40 SUB-MINI RESIST'RS
1/4" long. 20 values; 1/2 W to 10 megs. **88c**

15 INSTR. KNOBS
Knurled black bakelite, w/pointer; brass inserts, set-screws. **88c**

5-IN-1 DRILL BIT
Reams, saws, copes, shapes, drills. Hand or power drill. **88c**

15 ROTARY SWITCHES
Assd. gangs. 3 lbs. Reg. \$12. **88c**

30 MOLDED COND'S'RS
Assd. Finest model Wt. 2 lbs. **88c**

100 HALF-WATERS
Assd. value carbon resistors, incl. 10% 5%. Reg. \$12. **88c**

300-FT. HOOKUP WIRE
Tinned, assd. sizes, colors. 2 lbs. **88c**

60 COILS, CHOKES
IF, RF, ant., slug-tuned, too. 3 lbs. **88c**

70 TERMINAL STRIPS
Solder-lug & binding; to 20 terms. **88c**

6-PC. HACKSAW SET
Six assorted blades. 1 lb. **88c**

MINI-RADIO KIT
World's smallest! 2x1x1 Loostick, jacks, diode, etc., w/instruc-tions. 1 lb. Reg. \$3. **88c**

40 HI-Q CONDENSERS
Finest porcelain; NPO's too! 1 lb. **88c**

35 POWER RESISTORS
WW, 5 to 50W, to 10,000 ohms. Vitreous, too! 3 lbs. **88c**

70 ONE-WATERS
Assd. value carbon resistors. **88c**

15 VOLUME CONTROLS
Incl. dials; some w/switch; to 1 meg. **88c**

TV PIC BOOSTER
Parallel, 6-wire. Extends picture tube life. 1 lb. **88c**

8-PC. NUTDRIVER SET
\$3 value! Plastic handle; 3/16" thru 7/16" socket wrenches. **88c**

000-999 COUNTER
By Veeder-Root. For tape recorders, motors. . . hundreds of uses. Wt. 1 lb. **88c**

6 SILICON DIODES
Sylvania 1N22, 1N23. Reg. \$36. **88c**

\$25 SURPRISE PAK!
Larger, varied assortment radio, TV parts. 3 lbs. **88c**

60 PLUGS&RECEPT'LES
Audio, power, line, battery, spkr. 3 lbs. **88c**

8-SCREWDRIVER SET
8 Assd. drivers w/wait rack. Plastic handles. **88c**

40 SUB-MINI C'ND'S'RS
For transistor, printed circuit work. 1 lb. **88c**

8 SUB-MINI SOCKETS
Mica-filled. For transistors, too! **88c**

40-RECORD CADDY
Wrought iron, holds 40 records & albums. 2 lbs. **88c**

70 HI-Q RESISTORS
Insulated, carbon, 10% to 10 megs. 2 lbs. **88c**

HOBBY BENCH VISE
Clamp type. Fits tables, too. Steel. **88c**

SYLVANIA TV MIRROR
10x12" stainless steel. 2 lbs. Reg. \$8. **88c**

100 RADIO PARTS
Wide variety resistors, condensers, pots. 88c forms. 3 lbs. **88c**

5 ROLLS MICRO-WIRE
#24 thru #32; for transistor, sub-mini circuits. 1 lb. **88c**

30 PILOT LITES
Pop. flashlight size; mica base type. **88c**

16-END WRENCH SET
For home & auto. Box & open; 15/64 thru 7/16", 16 sizes. **88c**

"1-POUNDER" HAMMER
Claw; 16-oz. steel, w/14" formed handle. **88c**

100 CERAMIC COND.
Hi-Q discs, tubulars; to .01 mf. 2 lbs. **88c**

40 TUBE SOCKETS
4 to 9-pin; ceramic, mica, shield-based incl. 2 lbs. Reg. \$10. **88c**

10 POLY BOXES
Clear plastic, hinged, w/snap locks. **88c**

40 PRECISION RESIST.
Water-thin; up to 10 meg. Reg. \$17. **88c**

30 DISC CONDENSERS
Wafers; up to 3000 VDC. **88c**

8 GERMANIUM DIODES
Glass-sealed, w/long leads. For all hobby projects. **88c**

1500 PCS. HARDWARE
Nuts, screws, washers, etc. 1 1/2 lbs. **88c**

7 ROLLS WIRE
25-ft. each. #18 thru #22. Assd. stranding, ins., colors. 2 lbs. **88c**

60 CONDENSER SPC'LS
Molded, paper, ceramic, oil, mica, discs. **88c**

75 RESISTOR SPECIAL!
WW, precision, carbon, variable, mini types. 3 lbs. Worth **88c**

15-PC. DRILL SET
1/16 thru 1/4" x 64ths, #22. Assd. stranding, case. Reg. \$3. **88c**

75 MICA CONDENSERS
V. stable. 2 lbs. **88c**

25 VALUES, REG. \$28.
20 ARTISTS' BRUSHES
100% pure bristle; sizes 1-6. **88c**

10 TUBULAR ELECTROS
Assd. paper types, AC, DC. Hobby. 3 lbs. **88c**

4 POWER WOOD BITS
Hi-Q Steel, 9/8, 1/2, 3/4, 1", 5" long. **88c**

60 RADIO-TV KNOBS
Assd. colors, insulation. Some worth \$1. **88c**

10 ELECTROLYTICS
Radio, TV. 10-500mf to 480VDC. **88c**

75-FT. TV TWINLEAD
300 ohm. Hanked, tinned. 3 lbs. **88c**

POSTAGE STAMP MIKE
Crystal, 100 to 8,000 cps. 1 lb. **88c**

4 OUTPUT XFMR'S.
50L6, etc. 3 lbs. **88c**

HEARING AID PHONE
Crystal, w/cord set & plug. **88c**

LEKTRON 131 Everett Ave. CHELSEA 50, MASS.

servicemen everywhere insist on the GENUINE "NO NOISE" big 3 Beware Of Cheap Substitutes!

NO-NOISE NEW RUBBER COAT SPRAY
6 Oz. Spray Can
\$3.25
• Insulates where applied
• Protects indefinitely
• Prevents arcing, shorting, corrosion
• Waterproofs thoroughly
• Non-inflammable
• Contains no plastic
Net To Servicemen

NO-NOISE TUNER-TONIC
With PERMA-FILM
6 Oz. Aerosol Can
\$3.25
• Economical—a little does a lot
• Cleans, lubricates, restores all tuners, including water type.
• Non-toxic, non-inflammable
• Use for TV, radio and FM
Net To Servicemen

NO-NOISE VOLUME CONTROL and CONTACT RESTORER
• Cleans • Protects • Lubricates
NOT A CARBON TET SOLUTION
2 Oz. Bottle 6 Oz. Spray Can
\$1.00 \$2.25
Net To Servicemen Net To Servicemen

ELECTRONIC CHEMICAL CORP. 813 Communipaw Avenue Jersey City 4, N. J.

3

Type SMT SUB-MINIATURE the BEST in ELECTROLYTIC CAPACITOR DESIGN

A complete line of capacitors for all miniaturized transistor circuits.

The best in sub-miniature capacitors for replacement, development and original equipment. Outstanding features include patented construction, hermetically sealed in aluminum cases for long life; low leakage; stable through a wide temperature range and voltages.

Available from leading parts distributors everywhere. Illustrated catalog upon request.

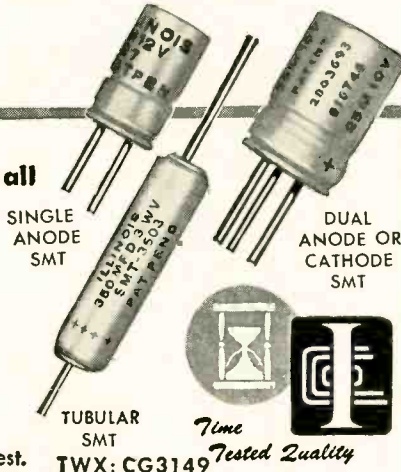

Telephone: EVerglade 4-1300

ILLINOIS

CONDENSER COMPANY

1616 N. Throop Street Chicago 22, Illinois

EXPORT DEPARTMENT, 15 MOORE STREET, NEW YORK CITY, NEW YORK; CABLE, MINTHORNE, NEW YORK.

NEW TUBES & SEMICONDUCTORS (Cont'd)

Minimum electrical characteristics at 25°C

are:
 h_{FE} 20 ($V_{CE}=2, I_C=5$ amps)
 V_{CE} (saturation) 0.75 ($I_C=50$ ma, $R_{SE}=100$ ohms)

New development

Bonded skin-tight cathode coating, trade-marked *Sarong* by Sylvania, is said to result in an "unprecedented control of cathode coating, and insures more stable tube characteristics and longer tube life."

Conventional cathode coatings are a paintlike suspension of carbonates

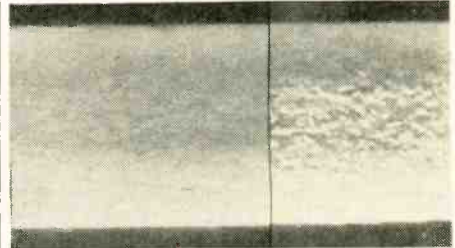

sprayed on the cathodes (right side of photo). With the spraying method, the weight of the material on the cathode may vary by as much as 20% from tube to tube.

The Sarong coating puts the carbonates in the form of a continuous slip or sheet, wrapped around the cathode sleeve (left side of photo), so that every active portion of the cathode surface is covered with a skin-tight bonded film coating of uniform quality and texture.

2N350-A, -351-A, -376-A

Germanium alloy-junction p-n-p audio power transistors, these units are con-

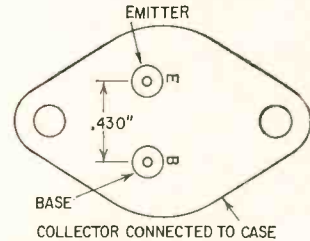

2N350-A, 2N351-A, 2N376-A

trolled for high power gain and low distortion at output levels up to 4 watts class A, 15 watts class B. Power switching characteristics are controlled up to 3, 4 and 5 amps respectively.

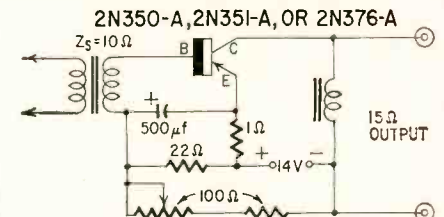

The diagram shows a single-ended class-A audio power amplifier designed around these Motorola units. Performance of the circuit at 1 kc:

	2N350-A	-351-A	-376-A
G_o (power gain) (db)	31	33	35
Distortion (%)	5	5	5
R_{input} (ohms)	10	12	12
R_L (ohms)	15	15	15
I_C (ma)	700	700	700

GET INTO ELECTRONICS TODAY'S TOP OPPORTUNITY FIELD ELECTRICITY - ELECTRONICS TELEVISION RADIO - ELECTRONICS

TRAIN IN THE NEW SHOP-LABS OF
COYNE OLDEST, BEST
 EQUIPPED SCHOOL
 OF ITS KIND IN U.S.

in Chicago—Electronic Center of the World. Prepare for a better job and a successful future in TOP OPPORTUNITY FIELD. Train on real equipment — no advanced education or previous experience needed. Lifetime employment service to graduates. Finance Plan — enroll now, pay most of tuition later. Part time employment help to students. **FREE BOOK**—Mail Coupon or write to address below for Big Free Illustrated Book—"Guide to Careers." Whether you prefer ELECTRICITY, ELECTRONICS, TELEVISION, RADIO, ELECTRONICS OR COMBINED ELECTRONICS TRAINING, this book describes all training offered.

Information comes by mail. No obligation and NO SALESMAN WILL CALL.

B. W. Cooke, Jr., Pres. Founded 1899

COYNE ELECTRICAL SCHOOL

Chartered as an Educational Institution Not for Profit
 1501 W. Congress Pkwy., Chicago 7, Ill., Dept. 59-5A

Coyne Electrical School
 New Coyne Building, Dept. 59-5A
 1501 W. Congress Pkwy., Chicago 7, Ill.
 Send FREE book "Guide to Careers" and details of all training you offer.

Name _____
 Address _____
 City _____
 State _____
 (I understand no Salesman will call)

"It's really just a pizza pie, but of course a **JENSEN NEEDLE** makes *anything* sound better."

Maximum ratings of the transistors are:

BV _{CSO} (breakdown volts)	50
BV _{CES}	40
P _c (watts) (at 70°)	25

6FV6

A sharp-cutoff tetrode in a 7-pin miniature envelope, it is designed for use as an rf amplifier in vhf tuners of television receivers. The 6FV6 has separate pin terminals for the cathode

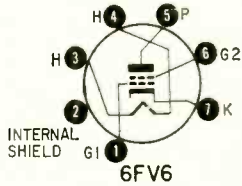

and internal shield. This arrangement lets the designer use an unbypassed cathode resistor to minimize changes in input capacitance and conductance with changes in bias.

Operating characteristics of the RCA 6FV6 as a class A1 amplifier are:

V _p	125
V _{G2}	80
V _{G1}	-1
R _p (K ohms) (approx)	100
g _m (μmhos)	8,000
I _p (ma)	10
I _{G2} (ma)	1.5
V _{G1} (approx) (for 20 μa I _p)	-6

Other types

The 7044, a medium-μ twin triode of the 9-pin miniature type introduced by RCA, is designed for pulse-amplifier, inverter, frequency-divider, cathode-follower and multivibrator circuits.

Pacific Semiconductors has announced a line of n-p-n triple-diffused silicon Mesa transistors for operation as vhf power oscillators and amplifiers. They are types XT-515, -516, -517, -518, -519 and -520. END

50 Years Ago

In Gernsback Publications

HUGO GERNSBACK, Founder

Modern Electrics	1908
Wireless Association of America	1908
Electrical Experimenter	1913
Radio News	1919
Science & Invention	1920
Television	1927
Radio-Craft	1929
Short-Wave Craft	1930
Television News	1931

Some larger libraries still have copies of Modern Electrics on file for interested readers.

- In May, 1909, Modern Electrics**
- Signaling to Mars, by H. Gernsback.
 - Another Novel Detector.
 - Automatic Wireless Transmitter, by Kenneth Richardson.
 - Coil Construction, by C. C. Whittaker.
 - Construction of An Independent Vibrator, by L. Spangenberg.
 - Directive Control of Electric Waves, by M. A. Deviny.
 - Pivotless Hot Wire Ammeter, by A. M. Curtis.
 - Hints for the Wireless Experimenter, by A. C. Austin, Jr.
 - A Potentiometer for Wireless Telegraphy, by S. Fulton Kerr.

Announcing . . . A BRAND-NEW Home Study Program
—Equips you to enter the exciting, new and booming field of

AUTOMATION

and Industrial ELECTRONICS

Engineering Technology

Automation: "Second industrial revolution" . . . latest and most exciting development in our amazing world of electronics. Current needs: 3,000 specialists per year, well-trained in automation and industrial electronics . . . to fill new jobs and draw top pay.

CREI's new complete home study course covers all phases of automation and industrial electronics, including fundamentals of electronic engineering technology and a specialization in: Machine control systems . . . Data processing systems . . . Instrumentation techniques . . . Digital and Analogue Computers . . . Servomechanism systems . . . Telemetry systems . . . Industrial processes.

Leads to jobs like these:

NOW A TELEMETRY TECHNICIAN AT RCA MISSILE TEST PROJECT . . . "On December 31 I will be working for RCA at the Missile Test Project in Florida as a Telemetry Technician. I don't mind telling you that CREI

and your encouragement helped a lot in getting this job."—John S. Trefl, Box 133, Beulah, Mississippi

NOW ASSISTANT CHIEF ENGINEER OF RADAR INSTRUMENTATION STATION . . . "Five years ago I started to work for my present employer as a Radio Repairer and Installer. I also started my CREI course at this time. Three years later I was a supervisory electronic engineer and a year later I was promoted to the position I now hold as assistant chief engineer of a large radar instrumentation station at White Sands Proving Grounds."—Ralph Leo Gagnon, 1255 Gardner Ave., Las Cruces, N. M.

If you have had a high school education, and experience in electronics—and realize the need of high-level technical knowledge to make good in the better electronic jobs — you can qualify for this brand-new CREI Home Study course. Write to Capitol Radio Engineering Institute, Dept. 145-X 3224-16th St., N.W., Wash. 10, D. C.

MAIL THIS COUPON FOR FREE BOOKLET!

CAPITOL RADIO ENGINEERING INSTITUTE

ECPD Accredited Technical Institute Curricula • Founded 1927
Dept. 145-X 3224 - 16th Street, N.W., Washington 10, D. C.

Please send me without cost or obligation your brochure describing your brand-new home study course in Automation and Industrial Electronics Engineering Technology.

Name.....Age.....

Street.....

City.....Zone.....State.....

To obtain fast, immediate service and to avoid delay, it is necessary that the following information be filled in:

Employed By.....

Type of Present Work.....

Education:
Yrs. High School.....

Other.....

Electronics Experience.....

SAVE TIME with



New!

SENCORE Electro-Sub
Check all **ELECTROLYTIC CAPACITORS** in Seconds!

Merely select the electrolytic and substitute it. 10 big electrolytics from 4 to 350 Mfd. to safely substitute in any circuit from 2 to 450 volts.

Model ES-102

ONLY \$15⁹⁵

DEALER NET

Less than you pay for the individual capacitors.

Carry it anywhere—measures only 4 3/4" H x 4 3/4" W x 2 1/4" D

SENCORE

See other SENCORE ads in this issue.

SERVICE INSTRUMENTS CORP. 121 Official Rd. • Addison, Ill.

YOU can make money SERVICING RADIOS

Radio's back—stronger than ever—over 12 million sets sold last year alone! But—they're trickier than ever to service. You've got transistor sets, FM sets, printed circuit sets, foreign sets. Here's a book that tells you how to handle any and all of them quickly—easily—and profitably. Yes, you can make money in the new radio revival. The author lists hundreds of troubles alphabetically, gives you tips on spotting and fixing all kinds of troubles in minutes. Four helpful sections—Receivers, Techniques, Servicing—and a selection of charts for speedy servicing. Here's a book that will double your radio servicing income in no time at all. Get your copy now.

HOW TO GET THIS \$4.60 BOOK FOR ONLY \$3.35

This brand-new book in a new beautifully designed hard-cover edition is sold nationally for \$4.60. But through the G/L TECHNICIANS' BOOK CLUB you can get it and others equally valuable for only \$3.35.

THE G/L TECHNICIANS' BOOK CLUB

has helped thousands of service technicians everywhere

- Learn More
- Do Faster Servicing
- Earn More Money
- Save money on the books they need to get ahead.

Here's how it can help you! This unique club offers deluxe hard-cover editions of today's best practical servicing and theory books by well known authors AT

A DISCOUNT OF 27%! Through mass printing and direct distribution we can offer you these \$4.60 books AT THE WHOLESALE PRICE OF \$3.35—and we pay the postage!

How the Club Works

- To enroll, select the book you want on the coupon below. SEND NO MONEY. Please select only one book! The one you choose will be sent to you on a No-Risk 10-day inspection plan.
- If you like the book keep it and send us your re-

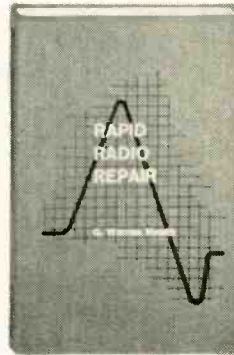

RAPID RADIO REPAIR

By G. Warren Heath
author of Rapid TV Repair
224 pages. Deluxe gold stamped hard cover.

List price \$4.60

mittance. If you don't just send it back.

- A new book is published every three months—you receive your personal copy on the same No-Risk inspection plan as soon as it comes off the press.
- Keep only the books you want—pay only for those you keep.
- You agree to take a minimum of only 4 books—over the whole enrollment period. You may cancel anytime after that. No time limit—no contract to sign.

If you prefer—select any one of these books

Servicing Transistor Radios—By Leonard D'Airo.
Techniques for servicing these tricky sets.

Oscilloscope Techniques—By Alfred Haas.
Photos of hundreds of scope patterns—and their significance.

TV and Radio Tube Troubles—By Sol Heller.
New symptom analysis technique shows you how to track down tube troubles in minutes.

Rapid TV Repair—By G. Warren Heath.
How to get to the heart of tough TV troubles in minutes. Lists hundreds of troubles alphabetically—gives causes, symptoms, cures. No theory—all practical data. Time-saving trouble-shooting charts.

Servicing Color TV—By Robert G. Middleton.
Answers all your questions about chroma circuits, matrix testing, the flyback system, test equipment and much more. Helpful trouble-shooting charts.

TV—It's a Cinch—By E. Aisberg.

All about TV theory from studio to picture tube. Written in breezy conversational style illustrated with hundreds of specially-drawn humorous sketches.

Servicing Record Changers—By Harry Mileaf.
Make extra money servicing changers.

The V.T.V.M.—By Rhys Samuel.
Get more out of this versatile instrument.

Sweep and Marker Generators for Television and Radio—By Robert G. Middleton.
A must for television servicing.

Probes—By Bruno Zucconi and Martin Clifford.
How to use probes for better servicing with today's complex test instruments.

The Oscilloscope—By George Zwick.
Are you getting full use of your 'scope? This book shows you how!

SEND IN THIS COUPON TODAY

GERNSBACK LIBRARY, INC., Dept. 59C
154 West 14th St., New York 11, N.Y.

Enroll me in the G/L TECHNICIANS' BOOK CLUB. Begin my membership with the book checked below. Please check one only.

- | | |
|--|--|
| <input type="checkbox"/> RAPID RADIO REPAIR | <input type="checkbox"/> SERVICING COLOR TV |
| <input type="checkbox"/> SERVICING TRANSISTOR RADIOS | <input type="checkbox"/> TV—IT'S A CINCH |
| <input type="checkbox"/> OSCILLOSCOPE TECHNIQUES | <input type="checkbox"/> THE V.T.V.M. |
| <input type="checkbox"/> TV and RADIO TUBE TROUBLES | <input type="checkbox"/> SWEEP AND MARKER GENERATORS |
| <input type="checkbox"/> RAPID TV REPAIR | <input type="checkbox"/> SERVICING RECORD CHANGERS |
| | <input type="checkbox"/> PROBES |
| | <input type="checkbox"/> THE OSCILLOSCOPE |

Name..... please print

Street.....

City..... Zone..... State.....

**SEND NO MONEY!
MAIL THIS COUPON TODAY!**

You have nothing to lose — everything to gain! Examine the books at our risk.

Stay ahead in servicing—keep up with the new techniques, circuits, devices. New books on timely topics now in preparation.



EXTRA LIFE FOR DEFECTIVE POTS

Defective potentiometers are usually open or very erratic near one end of the resistance strip—ordinarily the low end. This makes them useless as volume controls. But there is still plenty of life in the other end of the strip for experimental work and some construction projects. Simply cut the lug off the defective end and use the other two lugs to obtain a variable resistor.—*J. E. Pugh, Jr.*

PENNY FOR YOUR TAPE

When I take my roll of electrician's tape from my toolkit to wrap some wires, I don't have to search in vain



to find the loose end. I keep a penny under it so it's always easy to find. I don't have to fumble the tape around to get hold of the end either.—*J. C. Alexander*

RCA 7-TR-3 TAPE RECORDER

Under most recording conditions, it is unnecessary to monitor the tape recorder audibly while making a recording. If a recording is being made from a radio or phonograph, the program can be audibly monitored from the loudspeaker of that instrument. If a micro-

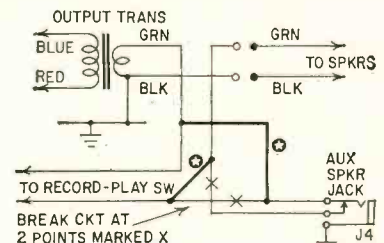

ADD 2 CONNECTIONS SHOWN BY HEAVY LINES
phone recording is being made, acoustic feedback between the loudspeaker and microphone must be avoided.

Where monitoring is necessary and no other provision is available, the AUX SPKR jack of model 7-TR-3 tape recorders may be rewired to permit the use of headphones while recording. Note that using an external speaker with

TV PICTURE TUBES

At Lowest Prices

10BP4	\$ 7.95	17BP4	\$10.95	21AMP4	\$19.95
12LP4	8.95	17GP4	17.00	21ATP4	20.95
14B/CP4	9.95	17GP4	17.60	21AUP4	20.95
16DP4	14.95	17HP4	13.60	21EP4	14.95
16EP4	15.90	17LP4	13.60	21FP4	15.95
16GP4	15.90	17QP4	11.95	21WP4	17.30
16KP4	10.95	17TP4	19.30	21YP4	15.95
16LP4	10.95	19AP4	19.30	21ZP4	14.95
16RP4	10.95	20CP4	13.90	24CP4	23.95
16WP4	15.20	20HP4	17.95	24DP4	26.95
16TP4	10.95	21AP4	22.10	27EP4	39.95
17AVP4	15.20	21ALP4	20.95	27RP4	39.95

1 year warranty

Aluminized Tubes \$5.00 more than above prices. Prices include the return of an acceptable similar tube under vacuum. These tubes are manufactured from reprocessed used glass bulbs. All parts and materials including the electron gun are brand new.

ALL PRICES FOB CHICAGO, ILLINOIS. Deposit required, when old tube is not returned, refundable at time of return. 25% deposit required on COD shipments. Old tubes must be returned prepaid. Tubes shipped Rail Express.

WRITE FOR COMPLETE LIST.

—PICTURE TUBE OUTLET—

3032 Milwaukee Ave., Chicago 18, Ill.
Dickens 2-2048

NEW!

15th Edition

RADIO

Handbook

800 PAGES \$7.50

BUY DIRECT FROM YOUR FAVORITE DEALER

BALANCE YOUR STEREO

UNIQUE INSTRUMENT enables balancing of any ENTIRE stereo record system, INCLUDING PICKUP, for LOUDNESS and TONE. NO electrical CONNECTIONS to make. ANYONE can use it for BETTER STEREO. Performs as stated or money refunded. Send \$2.00. bal. \$6.95 COD or shipped postpaid for \$8.95.

NEWBURY ENGINEERING CO. BOX 144
BRADFORD, N.H.

NEW ALNICO GENERATOR \$4.95!



With 40 ft. of wire and NEW telephone bell (Gov't Surplus). Crank Forward to generate up to 90 volts (will ring bell). Valued at more than \$15.00. All shipments FOB Waymart. Send orders and inquiries to:

SURPLUS SAVING CENTER
Dept. 5-RE, 120 South Street, Waymart, Pa.

Amperex

TUBES

Hi Fi—Transmitting—Spec. Purpose
PHILIPS—VALVO
NORELCO PRODUCTS
ATTRACTIVE PRICES!
ELECTRONIC SUPPLY CORP.
41-08 Greenpoint Ave., Long Island City, N.Y.

TAPE RECORDERS



**HI-FI COMPONENTS
SLEEP LEARN KITS**

MERITAPE UNUSUAL
Low cost, high VALUES
quality recording FREE
tape in boxes or cans. 1959 CATALOG
DRESSNER, 69-02RE 174 St., Flushing 65, N.Y.

TRY THIS ONE (Continued)

this revised connection will change the recording characteristics and lower the recording sensitivity. This may or may not be objectionable.—*RCA Radio and Victrola Service Tips*

TOOLBOX STORAGE KINK

Don't let that unused space in the lid of your toolbox go to waste. Drill a couple of small holes near either end

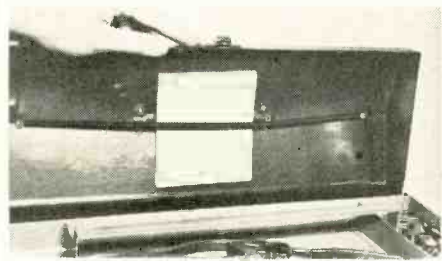

and attach a screen-door spring to the underside. Now you can use this additional space for storing of sandpaper packs, diagrams, service data or other small items.—*John A. Comstock*

INEXPENSIVE BATTERY CONNECTORS

When working with battery-powered equipment, and especially with transistors, flashlight cells provide an excellent voltage source for the experimenter. However, the big problem is how to make connections to the cells since soldering is not recommended.

For the positive terminal connector use a 1/4-inch grid cap (for octal tubes) on C cells and a 3/8-inch grid cap (for glass tubes) on D cells. These grid caps cost only pennies and are just the right size to give a snug fit over the positive terminal of the cell.

For the negative connector cut a strip of .020-inch metal to about 3/16 x 3/4 inch. The lid from an ordinary tin can is just about the right thickness. Smooth the edges with a file and solder it to the negative lead from the equipment. Then slip this strip between the cardboard sleeve and the cell case. The equipment can be turned on now.

These connectors can also be used to connect any number of flashlight cells together, either in series or parallel.—*James E. Pugh, Jr.*

EASILY MADE TEST PRODS

Need a pair of test prods? Here's how you can make them easily from some heavy-gauge insulated solid copper wire plastic tubing. First, select a piece of heavy-gauge insulated solid copper wire and a length of plastic tubing that will

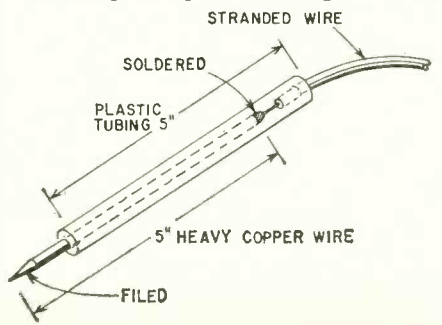

FM ANTENNA

**with New Offset Clamp
Mounts on Same Mast
as TV Antenna**



New Offset Mount
Bright Gold Anodized

New WINEGARD

"Turnstile" GETS 100-MILE FM RECEPTION

Non-directional . . . no rotor needed

With most TV antennas you cannot get good FM reception. That's because TV antennas *REDUCE* FM signal to shut out FM interference on TV. Get clear FM reception up to 100 miles with the sensitive new Winegard "Turnstile" FM antenna. Two antennas give 40% power increase over single antenna. Has unique offset mount—installs quickly on same mast with TV antenna. Perfect 300-ohm impedance. Weatherized—non-corrosive, bright gold anodized finish. Send for free literature.

Powerful FM RECEPTION— 200 MILES PLUS!



New 6 and 12 element directional Winegard YAGI FM antennas. Use single bay or stacked for extra power.

Write today to:

Winegard Co.

3013-5 Scotten, Burlington, Iowa

"TAB" Tubes Tested, Inspected, Boxed

Six Months Guarantee!! No Rejects!

NEW & Used Gov't & Mfgs. Surplus!

Orders \$10 or more, Receiving types only ppd. 48 states

0A2	.80	6B16	.72	12AT6	.59	18S1	1.00
0B2	.72	6BK7	.19	12AT7	.89	11Z6	1.10
0C3	.84	6BL7	1.08	12AU7	.69	4-6SA	10.00
0D1	.80	6BN6	1.08	12AU7	.69	2021	.68
0Z4	.50	6BQ6	1.19	12AX7	.79	3D23	5.00
1A7	1.10	6C4	1.25	6X4	.63	4-6SA	6.75
1B3	.78	6C4	.49	12BA7	.99	4-125	20.00
1B5	.78	6C5	.89	12BD6	.59	4-250	35.00
1S4	.68	6C6	.78	6CB6	.63	4-227	4.00
174	.78	6CD6	1.19	12BF6	.59	4PR60	20.00

Send for Catalog!

1U4	4/81	6H6	.59	12BH7	.99	4X150	7.50
1U5	.80	6J5	.59	12CG6	1.43	5BP1	4.98
1X2A	.88	6J6	.59	12E27	.89	4X500	38.00
3Q4	.88	6K6	.59	12CU6	1.43	5BP1	4.98
3Q5	.88	6K7	.74	12D7	1.29	5BP4	3.98
3S4	.88	6L6	1.19	12G7	.89	35T	4.00
3V4	.99	6S4	.59	12SH7	.89	100T	7.00
5R4	1.25	6S8	.89	12SJ7	.75	250T	20.00
5V4	.50	6SA7	.89	12SK7	.94	388A	4.00
5U4	.80	6SB7	1.19	12SQ7	.96	416A	16.00

Wanted Surplus Electronics from schools & U

5Y3	.59	6SC7	.59	19G6	1.15	4-250	43.00
6B4	.59	6SG7	.79	19T8	1.10	807	1.29
6AC7	.79	6SH7	.69	25BQ6	1.39	808	1.00
6AG7	.89	6SJ7	.89	25L6	.89	25L6	3.00
6AM6	.99	6SK7	.69	25W4	.77	4-400A	4.00
6AK5	.89	6SL7	.89	25Z5	.72	811	3.00
6AL5	.59	6SN7	2/51	25Z6	.75	812	3.00
6AQ5	.69	6SR7	.74	EL34	3.49	813	0.00
6AS7	3.00	6SR7	.79	EL37	2.40	814	2.45
6AT6	.49	6TB	.89	35L6	.59	815	3.95

Wanted Surplus Electronics from schools & U

6AU4	1.29	6U8	.98	35W4	.52	829B	8.00
6AU5	1.19	6V6	1.39	35Y4	.89	832A	7.00
6AU6	.69	6W4	.79	35Z5	.89	866A	1.75
6AX4	.79	6W6	.89	50A5	.89	50A5	1.00
6BA6	.59	6X4	.39	50B5	.69	5879	1.20
6BA7	1.00	6X5	.49	50C5	.69	5881	2.70
6BD6	.89	6V6	.89	KT66	3.29	5842	11.00
6BE6	.59	6V7	.89	KT66	3.29	5842	11.00
6BC8	1.50	12AL5	.59	75	.89	5854	1.00
6BR6	.75	12AC5	.75	80	.59	5824	12.00

TUBES WANTED! WE BUY! SELL & TRADE!

NEW "TEKSEL" SELENIUM RECTIFIERS

FULL WAVE BRIDGE RECTIFIERS. ONE YEAR GTD!

AMP. 18VAC 36VAC 72VAC 144VAC

CONT. 14VDC 28VDC 56VDC 112VDC

1AMP \$ 1.30 2 AMP \$ 2.00 5 AMP \$ 4.90 9 AMP \$ 9.45

2AMP 2.15 3 AMP 3.00 6 AMP 6.25 12 AMP 12.30

3AMP 2.90 4 AMP 4.00 8 AMP 8.60 16 AMP 16.75

6AMP 4.15 8 AMP 5.00 16 AMP 10.75 32 AMP 21.15

10AMP 6.10 12 AMP 7.15 26 AMP 13.30 48 AMP 24.00

15AMP 9.90 19 AMP 12.00 40 AMP 22.00 68 AMP 36.00

24AMP 15.00 29 AMP 19.45 57 AMP 37.50 108 AMP 54.45

NEW SILICON 500MA/100V C/280VAC

/400 p.i.v. Rectifier Mini Sealed \$1.50

\$ 5 for \$6.50, 40 for \$48, 100/\$105.

NEW Selenium Radio & TV Rectifiers! GTD.

65Ma 45c. @ 6 for \$2; 100Ma 50c @ 12/\$5.

200/580; 250Ma 79c @ 10/\$7, 100/\$60; 300Ma

88c @ 10/\$8, 100/\$70; 400Ma \$1.10 @ 10/\$10,

100/\$85; 500Ma \$1.10 @ 10/\$10, 100/\$90.

Orders of \$10 or More, Postpaid 48 states

TRANSISTORIZED "TABSTAT" Kit, or built-in efficiency DC to DC 12VDC

To 450VDC continuous duty power supply 1/2 Output 450VDC

VDC at up to 150MA Up to 70-Watts

80% efficiency; Ripple 0.2%; Low idle current; 15KΩ silicon

rectifiers, oil condensers, oil transf. fused & short circuit proof.

Regulation 1/2% at 20/100% load; Small in size; Light Weight!

Lo-Priced GTD "TABSTAT" TR1245CB built \$35.

Pre-Assembled U-Built Kit TR1245CK ONLY \$30.

For 250V @ 100 mA. T-1225 CB. \$27

KITS! "TAB" THE BEST KITS!

All Kits Contain Most Popular Tubes & Parts

Kit 2 Eng. Parallel Rules

Kit 35 Precision Resistors

Kit 10 Switches

Kit 75 Resistors 1/2 / 1/2W

Kit 150 Carbon Resistors

Kit 25 Panel Lamps

Kit 12 Electrolytic Cond's

Kit 15 Volume Controls

Kit 56 Tube Sockets

Kit 65 Tubular Condensers

Kit 500 Lugs & Eyelets

Kit 10 Bathub Oil Cond's

Kit 5 lbs. Surplus Pkg.

Kit 10 Xmitr Mica Cond.

Kit 10 Xmitr Mica Cond.

Kit 3 Phone Patch Xfms

Kit 4 AN Reflector Lites

Kit 6 Insid Tuning Tools

Kit 6 AN Plugs & cncntrs

Kit 3 Searchlights

Kit Circular Slide Rule

Kit 12 Aight Clip Ass't'd.

Kit 2 Bite Ins 60/2

Kit 5 Pcs. Wrench Set

Kit 5 Sub-Min Tubes

Kit 40 Standoff Insulators

Kit 35 Power Resistors

Kit 8 Xtal Osc-Bianks

Kit 5 Crystal Diodes

Kit 100 Fuses, Assorted

Kit 35 Inductors & Collis

Kit 5 Microswitches

Kit 10 Wheat Lamps

Kit 3 Transistor Xfms

Kit 8 Xtal Osc-Bianks

Kit 4 Assid Rectifiers

Kit 5-UG Connectors

Kit 100 Self-Tap Screws

Kit 8X25 Ft Hookup Wire

Kit 2 Veeder Counters

Kit 2 Searchlights

Kit 6 Pc. Nut Driver Set

Kit High Gain XTAL Mike

Kit Jewelers Screwdriver

Kit 6 ea. Phono Pigs. Jaks

BUY 10 KITS—GET ONE FREE! EACH KIT 99¢

BATTERY CHARGER KIT 1 to 4

Amps. Charges 6 & 12 Volt Batteries.

Kit BCK612 \$6, Built BCK612 \$7.90

BARGAINS—"TAB" FOR BEST BUYS!!!

PANEL 11x12x.062 for Print CKT/Cu. CLAD

IRISH TAPE 1200 HIQTY Gtd. \$2 @ 3/\$5

IRISH "MYLAR" 2400ft/7 Best Qty. \$4.49, 3/512

5" USN-MUMETAL SCOPE SHIELD Reg \$32. \$4

NEW VARIAC50 or equiv 0-135V/7.5 Amp. \$15.30

NEW VARIAC50 or equiv 0-135V/3 Amp. \$10.65

NEW VARIAC50 or equiv 0-135V/1.25 Amp. \$7.25

RF-MTR G.E. 475Ma/50V. Amp Dual T.C. \$4 @ 2/\$7

D.C. METER One Ma/4 Round. \$5 @ 2 for \$8

RF-MTR WESTON Ext/TC 750MA. \$4 @ 2 for \$6

AN-VOLTMETER 0-30 VDC. 1/2 USN. \$3 @ 2 for \$10

XTAL OVEN 115V & Thermostat. \$3 @ 2 for \$5

AUTO VIBRATORS 6 or 12VDC. \$1.49 @ 4 for \$5

5Wv Duty 115V/60Cy Selysins. \$2 for \$9

"MILLER" 2.5Mh/2.565MTR RF Chokes. \$2 for \$9

BC966/3 to 4 Mc's XMTG GOOD CONDITION. \$5.95

AN-ARR 2 RCVR as is-good for parts. \$1.59

RDZ USN 200-400Mc RCVR. No Tubes. \$2.25

LM-7 USN Freq-Mtr 195K to 20Mc Gud. \$72

BC221 Freq-Mtr-Good Cond. \$90

BC312 Rcvr-Good Cond. \$90

BC779 Super-Pro Rcvr Gud Cnd. \$95

ART13 USN Air Multiband Xmitr. \$59

TS34AP W.E. Precision Scope. \$69

NEW DC POWER for TRANSISTORS!!

New low-cost 25 volt one amp filtered

10% ripple Power Supply. Same as

specified in Transistor Manuals. G.E.

WCA, CBS. Ideal for powering trans-

istor circuits, rugged & small in size.

Preassembled kit U-Built B25VIACK

\$10, or assembled B25VIACK \$12.

TERMS: Money Back Guarantee

Our 34th year. \$2 min. order

F.O.B. N.Y.C. Add ship charges

or for C.O.D. 25% Dep. Prices

shown subject to change.

111-GH LIBERTY ST., N.Y. 6, N.Y.

Send 16c PHONE: RECTOR 2-6245 For Catalog

TRY THIS ONE (Continued)

fit snugly over the wire. Cut the wire and tubing into 5-inch lengths. Solder a longer piece (about 3 or 4 feet) of insulated stranded wire to each solid piece for test leads. Next, place some service cement on the solid wires and insert them into the lengths of tubing with 1 inch of the solid wire extending from the business end of each prod. Then cut the insulation from the short extending wire and file the end to a point. Finally, fasten the desired type of clips or connectors to the opposite ends of the test leads and the prods are ready for use.—*Scott Mack*

HIGH-VOLTAGE GLOVES

When I have to reach into the high-voltage circuit of a TV set to remove tubes or discharge capacitors, I find it wise to wear rubber gloves to avoid



getting bitten by the high voltage. When rubber gloves aren't available, I ask the customer to lend me a plastic food bag. Although the bags are only a few thousandths of an inch thick, I find that they can save you from receiving an uncomfortable shock that could prove fatal.—*A. J. Stockton*

TRANSISTOR KINK

Electronic experimenters who use transistors to build one crystal, then tear it down to build another and so on, soon find that their transistors are not built to take that sort of harsh punishment. Excessive heating of the leads while soldering and unsoldering them eventually destroys the inner elements. To prevent this, the experimenter should wire his transistors into the bases of old octal tubes and make them into convenient plug-in units. (Two transistors can be wired into one base.) This arrangement extends the component's life, saves money and is convenient too.—*J. C. Compton* END



"Everyone looks like this."

OPPORTUNITY ADLETS

Rates—50c per word (including name, address and initials). Minimum ad 10 words. Cash must accompany all ads except those placed by accredited agencies. Discount, 10% for 12 consecutive issues. Misleading or objectionable ads not accepted. Copy for July issue must reach us before May 15, 1959.

RADIO-ELECTRONICS.

154 West 14 St., New York 11, N. Y.

INVENTORS—Save! Apply for Patent yourself, New Kit makes it easy. Free "Registration Form". MISS CLAIRIE ARDUN, 806 Wm. Penn Annex, Philadelphia 5, Penna.

HIGH-FIDELITY SPEAKERS REPAIRED. AMPRITE Speaker Service, 70 Vesey St., New York 7, N.Y. BA 7-2580.

CASH PAID! Sell your surplus electronic tubes. Want unused, clean transmitting, special purpose, receiving, TV types, magnetrons, klystrons, broadcast, etc. Also want military & commercial lab test and communications gear. We swap too, for tubes or choice equipment. Send specific details in first letter. For a fair deal write, wire or telephone: BARRY, 512 Broadway, New York 12, N.Y. Walker 5-7000.

RECORDERS, Hi-Fi, Tapes. Free Wholesale Catalogue. CARLSTON, 215-T East 88th St., New York 28, N.Y.

STEREO TAPE RENTALS. For the very best at lowest prices. Write CALIFORNIA TAPED MUSIC ASSN., 763 El Camino Real, Redwood City, Calif.

DISCOUNTS UP TO 50% on Hi-Fi amplifiers, tuners, speakers, tape recorders. Individual quotations only, no catalog. CLASSIFIED HI-FI EXCHANGE, 2375 East 65th Street, Brooklyn 34, N.Y.

CRYSTAL Radio Kit \$1; Preassembled \$1.25; Phone \$1.75; Catalog. CLEARCO CRYSTAL COMPANY, 2966 No. 4th, Milwaukee 12, Wisconsin.

LABORATORY QUALITY equipment and Military Surplus Electronics bought, sold. ENGINEERING ASSOCIATES, 434 Patterson Road, Dayton 9, Ohio.

ALL MAKES OF ELECTRICAL INSTRUMENTS AND TESTING equipment repaired. HAZELTON INSTRUMENT Co., 128 Liberty Street, New York, N.Y.

TV AND RADIO SCHEMATICS. Send model number and \$1 for each TV, 75c for radio. STEVE STECKLER, 1648 Dahill Road, Brooklyn 23, N.Y.

PROFESSIONAL HI-FI REPAIRS. New precision method restores peak performance inexpensively. Laboratory test report included. Bring or ship defective components to BIRNEY ELECTRONICS, 394 East 18th Street, Paterson 4, N.J. Tel. LAmbert 5-1191.

CAMERA Repairmen greatly needed! You can learn manufacturers' service methods at home. In your spare time! Free, big illustrated book tells how! Write today. NATIONAL CAMERA REPAIR SCHOOL, Dept. RE-5, Englewood, Colorado.

PROFESSIONAL Electronic Projects—Organs, Timers, Intercoms, Counters, etc. \$1 each. List Free. PARKS, Box 1665, Lake City Station, Seattle 15, Wash.

TAKE MAGAZINE SUBSCRIPTIONS. Good Profits. Special Offers. CASSELL AGENCY, Boynton Beach 25, Fla.

DIAGRAMS FOR REPAIRING RADIOS \$1. Television \$1. Give make, Model. DALE CO. 319 West 14th St., N. Y.

CIVIL SERVICE JOBS—mechanical, clerical, professional. List \$1. CIVIL SERVICE BULLETIN, 115D Haypath Road, Plainview, N.Y.

DIAGRAMS FOR REPAIRING RADIOS \$1. Television \$2. Give make, Model. DIAGRAM SERVICE, Box 672-RE, Hartford 1, Conn.

U. S. NAVY's new excellent publications: BASIC ELECTRICITY, 684 pages, \$2.25; BASIC ELECTRONICS, 728 pages, \$2.25. Post paid, no C.O.D.'s. FOSTER'S, Box 703, Silver Spring, Maryland.

UNUSUAL VALUES. Hi-Fi components, tapes and tape recorders. Free catalog. RE. STEREO CENTER, 61 W. 35 St., New York 1, N. Y.

SONGPOEMS and LYRICS WANTED! Mail to: TIN PAN ALLEY, INC. 1650 Broadway, New York 19, N. Y.

PATENTS

STEREO SOUND

Patent No. 2,792,449

Allerico Bottini, New York, N. Y.

In this stereo system, sounds are recorded on a time-shared basis. The diagram shows a trinaural setup. The three microphone signals are amplified separately. All amplifiers are normally blocked. Generator A unblocks channel A for

generator is filtered and delivered to channel C, where the sync pulses are superimposed on this channel's audio signal.

A similar arrangement is required for playback. The recorded pulses trigger one of the

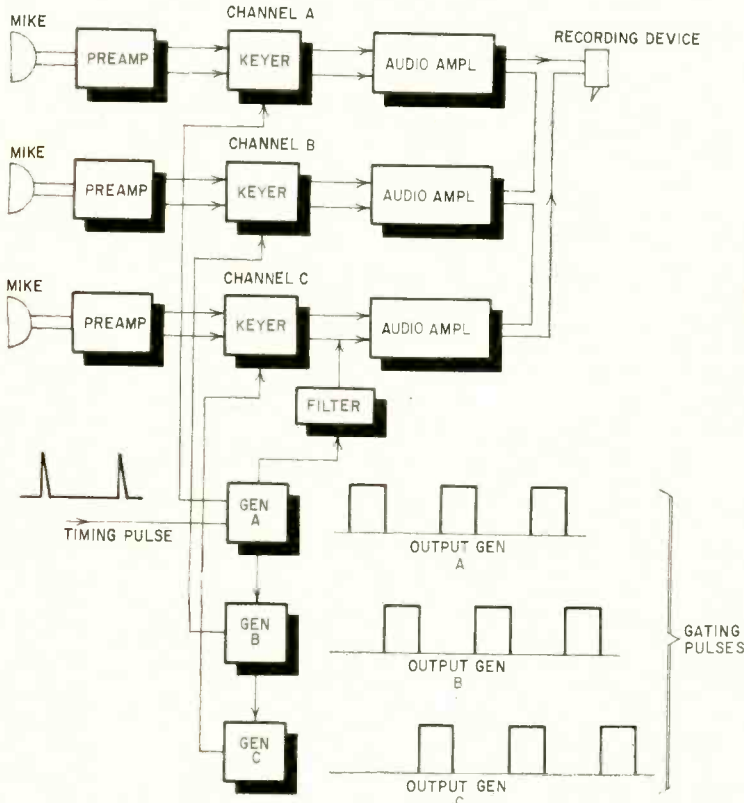

one-third the total time, then B is unblocked by generator B, and so on. Thus all three audio signals can be recorded on a single tape or disc channel like monophonic sound.

An external timing source triggers generator A periodically. Note that the output from this

generators, the others then operating in sequence automatically. The recorded audio is switched and distributed to the proper amplifier channels and speakers. Of course the switching frequency must be high enough so that the listener does not hear interruptions in the audio signal.

IMPROVED AVC

Patent No. 2,848,603

John B. Schultz, Glenolden, Pa. (Assigned to RCA)

This is an example of a slight circuit change that results in considerably improved performance. The avc voltage from a diode in a transistor radio is commonly applied between base and ground of an if stage. Here the dc is connected between base and emitter (points A and

B). Thus the emitter resistor (R) cannot offer degenerative feedback to weaken avc action.

A typical transistor-radio if strip is shown in the diagram. Gain is controlled more effectively when signals are weak, especially below 1,000 μ V per meter.

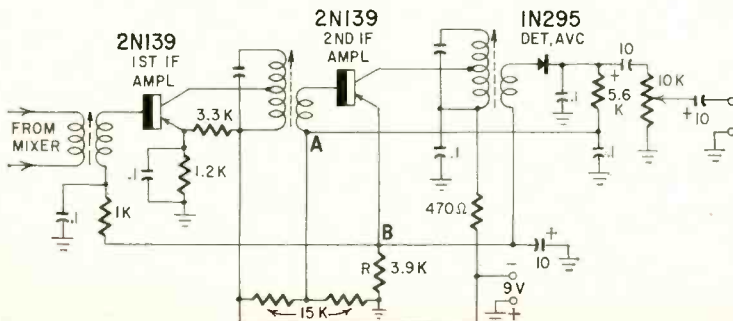

A happier solution is **EMC TEST EQUIPMENT**... finest precision instruments at the lowest possible prices!



Model 102 Volometer

Features a $3\frac{1}{2}$ - 2% accurate—800 microamperes D'Arsonval-type plastic front meter with 3 AC current ranges; and the same zero adjustment for both resistance ranges. Specifications: AC Voltage—5 Ranges: 0 to 12-120-600-1200-3000 volts. DC Voltage—5 Ranges: 0 to 6-60-300-600-3000 volts. AC Current—3 Ranges: 0 to 30-150-600 ma. DC Current—4 Ranges: 0 to 6-30-130 ma. 0 to 1.2 amps. Two Resistance Ranges: 0 to 1000 ohms, 0 to 1 megohms. Model 102, Wt. 1 lb. 5 oz. Size: $3\frac{3}{4}$ x $6\frac{1}{4}$ x 2". \$14.90; Kit, \$12.50.

Model 204 Tube-Battery-Ohm Capacity Tester

Emission tube tester. Completely flexible switching arrangement. Checks batteries under rated load on "reject-good" scale. Checks condenser leakage to 1 meg. Checks resistance up to 4 megs. Checks capacity from .01 to 1 mfd. Model 204P, illustrated. \$55.90. Model CRA, Cathode ray tube adaptor, \$4.50.

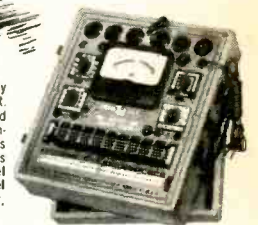

Model 700 RF-AF Crystal Marker TV Bar-Generator

Complete coverage from 18 cycles to 108 megacycles on fundamentals. Bar generator for TV adjustment with a variable number of bars available for horizontal or vertical alignment. Square wave generator to 20 kilocycles. Wien Bridge AF oscillator with sine wave output from 18 cycles to 300 kilocycles. Crystal marker and amplitude control. Individually tuned coils. Constant RF output impedance. Stepped RF attenuator. Variable percentage of modulation. Model 700 \$55.90



Model 205 Tube Tester

Uses standard emission test. Tests all tubes including Noval and subminiatures. Completely flexible switching arrangement. Checks for shorts, leakages and opens. Model 205P, Hand rubbed oak carrying case. \$47.50 (illustrated); Kit, \$36.20. Model CRA, Cathode ray tube adaptor, \$4.50.



Model 104 Volometer

Features a $4\frac{1}{2}$ - 50 microampere meter, with 3 AC current ranges and 3 resistance ranges to 20 megohms. Specifications: DC Voltage: 5 ranges (20,000 ohms per volt). 0 to 6-60-300-600-3000 volts. AC Voltage: 5 ranges (1,000 ohms per volt): 0 to 6-60-300-600-3000 volts. DC Current—3 Ranges: 0 to 30-300 ma. 0 to 3 amps. 3 Resistance Ranges: 0 to 20K, 0 to 200K, 0 to 20 megs. 5 DB Ranges: -4 to +67 DB. Model 104, with carrying strap; Wt. 2 lbs. 5 oz. Size: $5\frac{1}{4}$ x $6\frac{1}{4}$ x $2\frac{1}{4}$ ". \$26.95; Kit, \$19.95. Model HVT, 30,000 volt probe for Model 104, \$7.95.

Yes, tell me more, send me FREE—a detailed catalog of the complete EMC line. RE-59

NAME _____
STREET _____
CITY _____ STATE _____

EMC Electronic Measurements Corp.
625 B'way, New York 12, N. Y.

Ex. Dept. 431 Greenwich St., New York 13, N. Y.

NOW 2 ASSEMBLE-IT-YOURSELF **SAVE HALF NO SPECIAL SKILLS**
Schober ELECTRONIC ORGANS **PAY KIT-BY-KIT**

Now you can afford an electronic organ. Whether you choose the full Concert model or the smaller Consolette, you have an organ equal to any made by the foremost manufacturers. In addition, you save over 1/2 the cost because you assemble it yourself... and you enjoy the thrill of achievement. Too, you purchase each kit only when you are ready for it.



2 different MODELS
2 different SIZES
2 different PRICES

CONCERT MODEL

- ☆ TWO FULL SIZE PIPE-ORGAN MANUALS, 122 KEYS
- ☆ OCCUPIES 3'5" x 4'7" FLOOR SPACE
- ☆ 26 STOPS AND COUPLERS
- ☆ 32 BASS PEDALS
- ☆ ASSEMBLED CONSOLE
- ☆ CONFORMS TO AMERICAN GUILD OF ORGANISTS SPECIFICATIONS FOR PIPE ORGANS
- ☆ COMPLETE STEP-BY-STEP INSTRUCTIONS



CONSOLETTE MODEL

- ☆ OCCUPIES ONLY 2' x 3'2" FLOOR SPACE
- ☆ TWO FULL SIZE PIPE-ORGAN MANUALS, 122 KEYS
- ☆ 22 STOPS — ABOVE-KEYBOARD TABS
- ☆ 13 HEEL-AND-TOE BASS PEDALS
- ☆ 7 FULL OCTAVES OF TONE (DOWN TO 32 CPS)
- ☆ BUILT-IN SPEAKERS OPTIONAL
- ☆ ASSEMBLED CONSOLE
- ☆ COMPLETE STEP-BY-STEP INSTRUCTIONS

10" LP RECORD DEMONSTRATING BOTH MODELS AVAILABLE FOR \$2, REFUNDABLE UPON PURCHASE
FREE NEW 1959 EDITION OF 16 PAGE ILLUSTRATED BOOKLET ON REQUEST

Write Now — See What Fine Instruments You Get At Such Great Savings

The **SCHOBBER ORGAN Corporation** • 2248-B BROADWAY • NEW YORK 24, N.Y.
 SCHOBBER KITS ALL OVER THE WORLD

☆ Designed by Richard H. Dorf.

PATENTS (Continued)

ELECTRONIC CHAUFFEUR

Patent No. 2,847,080

Vladimir K. Zvorykin, Leslie E. Flory and Winthrop S. Pike, Princeton, N. J. (Assigned to RCA)

This electronic brain can take over the tedious job of controlling a car on a busy highway. It automatically steers around stalled cars. When desired, the driver can switch from "automatic" to "manual" to assume full control himself.

A transistor oscillator and associated radiating antenna are mounted along the road at intervals (or blocks) of about 15 feet. Each oscillator is powered by a capacitor which remains uncharged until a car enters that particular block and

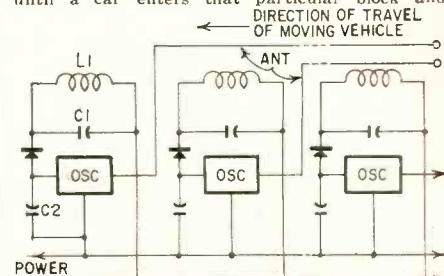

detunes the antenna. For example, C2 (see diagram) is normally uncharged so its oscillator does not function. When a car moves under its antenna it detunes the tank L1, C1. Due to lowered tank impedance, C2 can charge from the high-frequency supply line placed along the road.

Each controlled car contains two sensing coils which receive equal but opposite voltages from the antennas, so long as the car is on course. If it deviates, a voltage energizes a polarized relay to correct the steering.

If a car stalls in any given block, that particular oscillator generates a warning signal as previously explained. This works a mechanical device which steers approaching vehicles from the main road to a passing lane, returning it when the main road is clear.

Other features are explained in the patent.

VOLTAGE REGULATOR

Patent No. 2,828,463

Floyd A. Baker, Baltimore, and Benjamin C. McLeod, Catonsville, Md. (Assigned to Westinghouse Electric Corp., E. Pittsburgh, Pa.)

This device needs no moving parts, tubes or transistors (see Fig. 1). L is a saturating reactor. When the ac input exceeds a predetermined minimum, L saturates and its impedance falls to nearly zero. At this time, R limits the

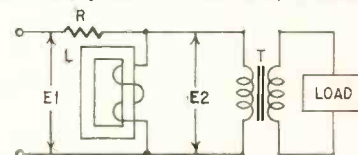

Fig. 1

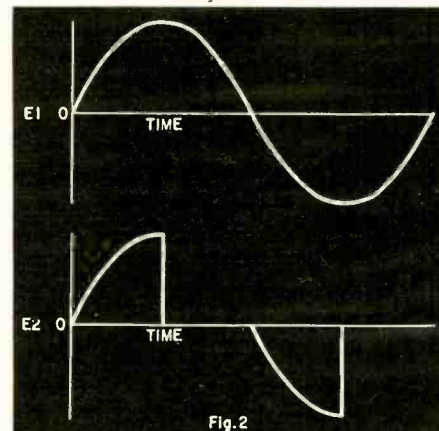



Fig. 2

high current and prevents overloading transformer T.

The waveform curves (Fig. 2) show the input signal (E1) and the output (E2). At saturation the output drops sharply.

When the input rises above its normal average, saturation comes earlier. Conversely, with low input, saturation is delayed. Thus the average output tends to remain constant. T matches and isolates the load. Note that dc in the output cannot affect regulation since T is not a saturating coil. END

THE ARM THAT CONTROLS everything:



ESL Gyro balance

Provides cleaner lows, better highs. Increases stylus and record life. Perfect stylus contact with both sides of record groove regardless of turntable leveling. Approved by the High Fidelity Consumer's Bureau of Standards. Only \$34.95.



FOR LISTENING AT ITS BEST
Electro-Sonic Laboratories, Inc.

Dept E • 35-54 36th St • Long Island City 6, NY

PS: The new *ESL Gyro/jewel* electrodynamic stereo cartridge is years ahead in performance. Only \$64.95.

PUT YOUR OSCILLOSCOPE TO WORK!

Learn to use the handiest service instrument of all!

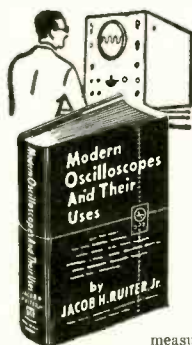

Dust off that oscilloscope of yours! Put it to work fully on the dozens of jobs it can do better than any other service instrument.

Handle jobs twice as fast—and lots more profitably!

This big book, **MODERN OSCILLOSCOPES AND THEIR USES** shows you how... in a way you can really understand. Clearly and simply, it explains exactly where and how to use your scope on all types of AM, FM, and TV service... from troubleshooting to set realigning and everything in between. No fancy theory. You quickly learn how to make connections; how to adjust circuit components; how to set the controls; and how to analyze patterns fast and right! New section even covers quantitative measurements—the slickest method of locating many color TV troubles and aligning sets properly. Has 326 pages and 370 clear pictures illustrating many pattern photos.

Practice from it 10 days... at our risk!

10-DAY FREE EXAMINATION!

Dept. RE-59, RINEHART & CO., Inc.
 232 Madison Ave., New York 16, N. Y.

Send MODERN OSCILLOSCOPES AND THEIR USES for 10-day FREE EXAMINATION. If I decide to keep book, I will then send you \$6.50 plus a few cents postage in full payment. If not, I will return book postpaid and owe you nothing.

Name.....
 Address.....
 City, Zone, State.....

OUTSIDE U.S.A.—Cash with order only. Price \$7.00. Money back if book is returned in 10 days.

ANOTHER GREAT TRIO[®] TV ANTENNA FEATURE

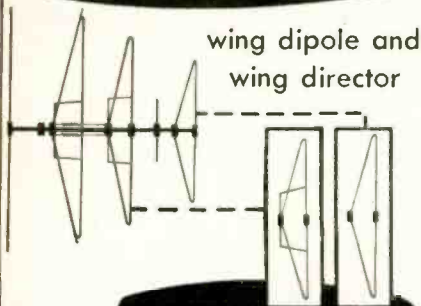

Today's most powerful combination. The Wing Dipole contains 3 active elements on the high, forward Vee to the low band section, plus integrated director. The Wing Director obtains maximum results from the Wing Dipole.

Just one of the features that makes Trio the most advanced TV Antennas in the world. Choose from Trio's complete Zephyr and Color Series Antennas.



BUSINESS and PEOPLE

Cornell-Dubilier Electric Corp., South Plainfield, N. J. is offering distributors a new metal capacitor storage cabinet. Called the C-D Twin Treasure Chests, the combination display-storage cabinets accommodate a generous stock of



Preferred-type twist prong capacitors as well as Blue Beaver electrolytics and PM Mylar tubulars. The chest is free with the purchase of the complete capacitor assortment.

ORRadio Industries, Inc., Opelika, Ala., designed a new convenient package for clubs or individuals who want to maintain correspondence by tape.



The new Irish tape correspondence pack consists of five 3-inch reels in a convenient sleeve wrapper for easy mailing.

Rear Admiral Frederick J. Bell, USN (Ret.), was elected senior vice president — industrial relations, Sylvania Electric Products, New York. He comes to Sylvania from the National Automobile Dealers Association, where he was executive vice president for the past 5 years.



Richard E. Krafve was elected group vice president, commercial, for Raytheon Manufacturing Co., Waltham, Mass., following his resignation as a vice president of Ford Motor Co.

"ONE DOLLAR" buys

As much as \$15 worth — Everything Brand New and sold to you with a money back guarantee.

DEDUCT 10% ON ANY ORDER OF \$10 OR OVER
Plus a **FREE SURPRISE PACKAGE**

- \$15 - "JACKPOT" TELEVISION PARTS. . . . \$1
- 4 - RCA #1U4 TUBES also serves as a 1T4 . . . \$1
- 5 - KENRAD TUBES 128J7 total list price \$16 . . . \$1
- 20 - ASSORTED TUBE SHIELDS best sizes . . . \$1
- 1 - RCA 70° FLYBACK TRANS. # 75240 . . . \$1
- 1 - S11 TODD 60° DEFLECTION YOKE . . . \$1
- 40 - ASST. PRECISION RESISTORS best sizes \$1
- 35 - ASST. DISC CERAMICS best numbers. . . \$1
- 1 - 5" PM SPEAKER ainet #5 magnet. . . . \$1
- 20 - TUBULAR CONDENSERS .05-600v . . . \$1
- 100 - ASSORTED FUSES popular sizes . . . \$1
- 100 - ASST. 1/2 WATT RESISTORS some 50% . . \$1
- 70 - ASSORTED 1 WATT RESISTORS some 50% \$1
- 35 - ASSORTED 2 WATT RESISTORS some 50% \$1
- 50 - ASST. TUBULAR CONDENSERS. . . . \$1
- 10 - 6' ELECTRIC LINE CORDS with plugs . . \$1
- 5 - TV CHEATER CORDS with both plugs . . \$1
- 4 - 50' SPOOLS HOOK-UP WIRE 4 colors . . \$1
- 50 - STRIPS ASST. SPAGHETTI best sizes . . \$1
- 100 - ASST. RUBBER GROMMETS best sizes . \$1
- 100' - TWIN LEAD-IN WIRE 300Ω heavy duty . \$1
- 50' - FLAT 4-CONDUCT. WIRE many purposes . \$1
- 25' - INSULATED SHIELDED WIRE \$1
- 32' - TEST PROD WIRE deluxe (red or black) . \$1
- 1 - S7 INDOOR TV ANTENNA hi-gain 3 section . \$1
- 20 - ASST. TV KNOBS, ESCUTCHEONS, Etc. \$1
- 3 - ASST. TOGGLE SWITCHES spst. dpdt. etc. \$1
- 15 - ASST. ROTARY SWITCHES \$15 worth . . \$1
- 100' - FINEST NYLON DIAL CORD best size . . \$1
- 200 - SELF TAPPING SCREWS # 8 x 1/2" . . . \$1
- 35 - ASST. RADIO KNOBS screw and push-on. \$1
- 100 - KNOB SPRINGS standard size 3/8" x 1/8" . \$1
- 100 - ASSORTED KNOB SET-SCREWS. . . . \$1
- 25 - ASSORTED CLOCK RADIO KNOBS. . . . \$1
- 600 - ASST. H'DWARE screws, nuts, rivets, etc. \$1
- 50 - ASST. SOCKETS oral, novel and miniature . \$1
- 50 - ASST. MICA CONDENSERS some in 50% . . \$1
- 50 - ASST. CERAMIC CONDENSERS " \$1
- 10 - ASST. VOLUME CONTROLS less switch. . . \$1
- 5 - ASST. VOLUME CONTROLS with switch . . \$1
- 100 - VOLUME CONTROL HEX NUTS. . . . \$1
- 20 - ASST. PILOT LIGHTS popular types. . . \$1
- 10 - PILOT LIGHT SKTS. bayonet type, wired . \$1
- 50 - ASST. TERMINAL STRIPS 1, 2, 3, 4 lug . . \$1
- 10 - ASST. RADIO ELECTRO. CONDENSERS. \$1
- 5 - ASST. TV ELECTROLYTIC CONDENSERS. \$1
- 25 - ASST. MICA TRIMMER CONDENSERS. \$1
- 3 - ELECTROLYTIC CONDENSERS 80-450v . . \$1
- 2 - ELECTROLYTIC COND. 40/40 - 450V . . . \$1
- 3 - ELECTROLYTIC COND. 50/30-150v. . . . \$1
- 30 - FP CONDENSER MOUNTING WAFERS. \$1
- 10 - HV TUBULAR CONDENSERS .001-6000V . \$1
- 10 - HV TUBULAR CONDENSERS .005-3000V. \$1
- 35 - MICA COND. 20 - 5mmf & 15-25 mmf . . . \$1
- 35 - MICA COND. 20 - 50 mmf & 15-68 mmf. . . \$1
- 35 - MICA COND. 20 - 100 mmf & 15-270 mmf . \$1
- 35 - MICA COND. 20 - 470 mmf & 15-680 mmf . \$1
- 35 - MICA COND. 20 - 820 mmf & 15-1000 mmf . \$1
- 35 - MICA COND. 20 - 2200 mmf & 15 - 2400 mmf . \$1
- 35 - MICA COND. 20 - 3300 mmf & 15 - 4700 mmf . \$1
- 35 - MICA COND. 20 - 6800 mmf & 15 - 10000 mmf . \$1
- 35 - CERAMIC COND. 20 - 5 mmf & 15-10 mmf . \$1
- 35 - CERAMIC COND. 20 - 25 mmf & 15-47 mmf . \$1
- 35 - CERAMIC COND. 20 - 56 mmf & 15-82 mmf . \$1
- 35 - CERAMIC COND. 20 - 100 mmf & 15-150 mmf . \$1
- 35 - CERAMIC COND. 20 - 270 mmf & 15-470 mmf . \$1
- 35 - CERAMIC COND. 20 - 1000 mmf & 15-1500 mmf . \$1
- 35 - CERAMIC COND. 20 - 2000 mmf & 15-5000 mmf . \$1
- 50 - 100KΩ 1/2 WATT RESISTORS 5% \$1
- 75 - 470KΩ 1/2 WATT RESISTORS 10% \$1
- 10 - ASST. WIRE'ND RES. 5, 10, 20 watt . . . \$1
- 3 - AUDIO OUTPUT TRANS. 50L6 type \$1
- 3 - AUDIO OUTPUT TRANS. 6K6 or 6V6 type. \$1
- 3 - I.F. COIL TRANSFORMERS 456 kc \$1
- 4 - I.F. COIL TRANSFORMERS 10.7 mc FM . . \$1
- 4 - OVAL LOOP ANTENNAS ass't hi-gain types. \$1
- 3 - LOOPSTICK ANT. new ferrite adjustable . . \$1
- 12 - RADIO OSCILLATOR COILS 456 kc . . . \$1
- 3 - 1/2 MEG VOLUME CONTROLS with switch . \$1
- 5 - 50K VOLUME CONTROLS less switch . . . \$1
- 10 - SURE GRIP ALLIGATOR CLIPS. . . . \$1
- 1 - GOLD GRILLE CLOTH 14"x14" or 12"x18" . \$1
- 5 - SETS SPEAKER PLUGS wired \$1
- 10 - SETS PHONO PLUGS and PIN JACKS. \$1
- 2 - \$2.50 SAPPHIRE NEEDLES 10000 playings. \$1
- 5 - DIODE CRYSTALS 2-IN21 2-IN22 1-IN24 \$1
- 3 - DIODE CRYSTALS 1-IN20, 1-IN24, 1-IN28 \$1
- 2 - SELENIUM RECTIFIERS 1-65 ma & 1-150ma \$1
- 15 - ASST. TV COILS sync, peaking, width, etc. \$1
- 5 - TV CRT. SOCKETS with 18" leads \$1
- 1 - LB. SPOOL ROSIN CORE SOLDER 40/60. \$1
- 6 - SPIN TIGHT SOCKET SET 3/16" to 7/16" . \$1
- 3 - TV ALIGNMENT TOOLS assortment #1 . . . \$1
- 3 - TV ALIGNMENT TOOLS assortment #2 . . . \$1
- 2 - ELECTRIC MOTORS 1 1/2 volt. 1001 uses . \$1

HANDY WAY TO ORDER—Simply tear out advertisement and pencil mark items wanted (X in square is sufficient) enclose with money order or check. You will receive a new copy of this ad for re-orders.

ON SMALL ORDERS—Include stamps for postage, excess will be refunded. Larger orders shipped express collect.

BROOKS RADIO & TV CORP.
84 Vesey St., Dept. A, New York 7, N. Y.

SUBSTITUTE PARTS WITH-OUT SOLDERING

Quickly Easily

with

Easily

Has 1001 Uses!

NEW E-Z-Hook "SUB" Connectors

Connect a speaker, or

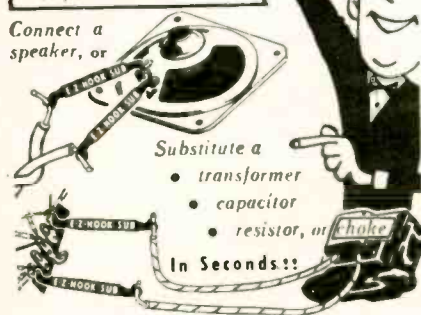

- ★ Makes connections instantly!
- ★ Won't pull off!
- ★ Insures positive contact!

Saves time, money and parts in servicing, experimenting, instructing and production.

E-Z-HOOK SUB

No. 71-1-SUB Only 69¢ ea.

Six Colors! - for Easy Lead Identification

ORDER THROUGH YOUR PARTS DISTRIBUTOR



E-Z-HOOK TEST PRODUCTS
Dept. G-5, 1536 Woodburn Ave.
Covington, Ky.

Canadian Rep: Len Finkler, Ltd., Toronto, Ont.

From the pioneer in ceramics for electronics



Approx. Twice Size

STEREO

the new single ceramic element Stereophonic cartridge

DYNAMIC BALANCING MAKES THE DIFFERENCE

DYNAMIC BALANCING during manufacture provides full stereo reproduction. SINGLE ELEMENT DESIGN offers balanced outputs; excellent separation of 20 db over full audio-frequency range, with equal outputs from both channels. Compatible with stereo and monophonic discs.

SPECIFICATIONS

RESPONSE: 20 to 16,000 cps. OUTPUT VOLTAGE: 0.5 vrms at 1 KC each channel. COMPLIANCE: 3×10^{-6} cm/dyne, vertical & lateral. RECOMMENDED LOAD: 2 megohms. RECOMMENDED TRACKING PRESSURE: 5-6 grams. CHANNEL SEPARATION: 20 db. STYLE: Dual tip; 0.7 mil diamond or sapphire, and 3 mil sapphire. MOUNTING DIMENSIONS: EIA Standard $\frac{7}{16}$ " & $\frac{1}{2}$ " centers.

For additional information, see your Authorized ERIE Distributor

ERIE *Electronics Distributor*
DIVISION
ERIE RESISTOR CORPORATION
MAIN OFFICES: ERIE, PA., U. S. A.

PRINTED CIRCUITS

For Stereo Amplifier as seen in March Radio Electronics.
\$6.50 per set of two
Many other PC's available.
Write your requirements.

ECM Corp.

8160 Orion Avenue Van Nuys, Calif.

DON'T BUY HI-FI

COMPONENTS, TAPE RECORDERS UNTIL YOU GET OUR LOW, LOW QUOTES BY RETURN MAIL. ALL STANDARD BRANDS IN STOCK.
WHOLESALE CATALOG FREE

AUDIO FAIR

1799 First Ave., Dept. RE, New York 28, N.Y.

BUSINESS AND PEOPLE (Continued)

Stewart Edgerton is now vice president and controller of Shure Brothers, Inc., Evanston, Ill. He had been with Ford Motor Co. as controller of the Chicago Parts Depot.



Joseph F. Ferrante was promoted to vice president of Tobe Deutschmann Corp., Norwood, Mass. He has been with the company for 9 years, working on design and construction of special testing devices.



R. Milton Boyce joined Amphenol-Borg Electronics Corp. as director of the newly combined division, consolidating Industrial Products Co. and the Danbury-Knudsen division, Barden, Conn. Previously, Boyce was treasurer of Bard-Parker Co.



Richard J. Mahler was appointed general merchandising manager of Sonotone Corp. Electronic Applications Div., Elmsford, N. Y. Before coming to Sonotone, he was vice president of Ronette Acoustical Corp. in charge of sales, engineering and production.



John F. Rider Publisher, Inc., introduced a new Sound-N-Sight radio code course recently. Reed Harris and Lewis



Robins (left to right), co-authors of the unique course, are shown at the press conference at which it was introduced, along with John F. Rider, Gerald Kass and Leonard Haas of the publishing firm.

Earl F. Broihier (right) joined Heath Co., Benton Harbor, Mich., as assistant advertising manager. He comes to Heath from Grubb & Petersen Advertis-



TELEVISION



AT HEALDS YOU LEARN BY DOING IN MODERN ELECTRONICS LABORATORIES

HEALD ENGINEERING COLLEGE

Established 1863

Van Ness at Post, RE
San Francisco, Calif.

Never before in American history has the need been so great for Trained Engineers and Technicians. No other type of training can compare with actual shop practice you get at Healds under expert instructors.

Bachelor of Science Degree, 27 Months

- Radio-TV Technician including Color TV (12 Months)
- Electronics Technician (12 Months)
- Industrial Electronics Technician (12 Months)
- Electronics Engineering (B.S. Degree)
- Electrical Engineering (B.S. Degree)
- Mechanical Engineering (B.S. Degree)
- Civil Engineering (B.S. Degree)
- Architecture (B.S. Degree)

Heald College ranks FIRST West of the Mississippi in "Who's Who in America"

Approved for Veterans
DAY AND EVENING CLASSES

Write for Catalog and Registration Application.
New Term Starting Soon.

Your Name

Address

City

State

ing Agency, where he had been an account executive. In his new position he will assist Clifford M. Edwards, director of advertising and sales promotion, in the formulation and execution of the kit advertising program of the Heath Co.

Neil Uptegrove joined Tung-Sol Electric Inc., Newark, N. J., as manager of advertising and sales promotion. He had been manager of technical advertising for Allen B. DuMont Laboratories, Inc.



Ken Bell (top left) joined Raytheon Manufacturing Co. as Western regional sales manager of the Semiconductor Div., with headquarters in Los Angeles. He was formerly vice president and industrial sales manager of W. Bert Knight Co., West Coast representative. Charles W. Martel (top right) was promoted to advertising and sales promotion manager of the Semiconductor

Div., Needham Heights, Mass., from manager of technical information serv-

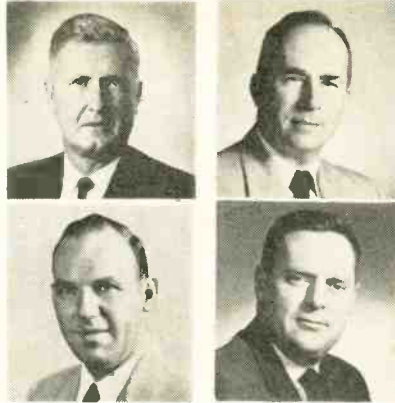

ice. George Loomis (lower left), manufacturing manager of the Receiving Tube Div., Newton, Mass., was promoted to manager. William T. Welsh (lower right), sales manager of the Microwave and Power Tube Div. in Waltham, becomes sales manager of the Equipment and Systems Div. END

LOOK
no further . . . if you're searching for hi-fi savings. Write us your requirements now.
Key Electronics Company
120-A Liberty St., N.Y. 6, N.Y.
EV 4-6071

MAIL ORDER HI-FI
You can now purchase all your HI-FI from one reliable source and be assured of perfect delivery. Carston makes delivery from NY stock on most HI-FI Records and tape within 24 hours. SEND US A LIST OF YOUR HI-FI REQUIREMENTS FOR OUR WHOLESALE QUOTATION and our FREE wholesale catalogue.
CARSTON STUDIOS 215-RD E. 88 St. New York 28, N. Y.

YOU GET SOMETHING EXTRA WITH

TROL AID VOLUME CONTROL & CONTACT CLEANER
TUN O LUBE TUNER CLEANER

Non-inflammable • Non-Toxic
Does NOT contain Carbon-Tet

- CLEANS AND LUBRICATES
- PROVIDES LONGER LASTING PROTECTIVE FILM
- DOES NOT AFFECT ELECTRICAL PROPERTIES NOR HARM INSULATORS

NEW 8 OZ. ECONOMY SIZE . . . \$1.98 DEALER NET
SPECIAL 3 OZ. "CADDY SIZE" . . . 98¢ DEALER NET

Write for Brochure and Guide

CHEMTRONICS inc.
122 MONTGOMERY STREET • BROOKLYN 25, N. Y.

FREE!
"SPRAY AID" AND "WALL MOUNT" WITH EVERY 8 OZ. CAN

SPRAY AID
Remove spray tip by pulling straight up in rotating motion. Replace with Spray Aid.

WALL MOUNT
Screw mount to wall. Slip can edge into position.

SAVE TIME with

SENCORE

SENCORE Handy "36"
R-C-Substitution Unit
"36"—Most Often Needed Components at YOUR Fingertips!
3 Pole, 12 position switch individually selects one of the "36" components for direct substitution.

Contains:
★ 12—1 watt 10% resistors from 10 ohms to 5600 ohms
★ 12—½ watt 10% resistors from 10K ohms to 5.6 megohms
★ 10—600 volt capacitors from 100-mfd. to .5 mfd.
★ 1—10 mfd., 450V Electrolytic ★ 1—40 mfd., 450V Electrolytic
★ For Shop, Lab, or outside service

SENCORE INSTRUMENTS CORPORATION
121 OFFICIAL ROAD, ADDISON, ILLINOIS

Model H-36 ONLY **\$1295** DEALER NET

Completely Isolated Available at all Parts Distributors

TUBE PROBLEM:

An amplifier manufacturer was plagued by noise, microphonics and hum that developed in the high gain stages of his amplifiers. Sonotone engineers were consulted on the problem.

SONOTONE SOLVES IT:

Sonotone engineers discovered that they could correct all three complaints by redesigning just one tube.

RESULTS:

The heater element was changed to a coil heater, eliminating the hum. And rigid controls on the mount structure and processing reduced microphonics and noise. This resulted in the Sonotone reliable type 7025. It's now available for initial equipment and replacement purposes.

Let Sonotone help solve your tube problem, too.

Sonotone U.S. Pat. & Reg. Off.
Electronic Applications Division, Dept. TE-59
ELMSFORD, NEW YORK
Leading makers of fine ceramic cartridges, speakers, microphones, tape heads, electron tubes.
In Canada, contact Atlas Radio Corp., Ltd., Toronto

LEARN TRANSISTOR ELECTRONICS AT HOME!

Prepare now for a profitable career in electronics with this specialized correspondence course on transistors

Learn theory, construction and all important applications of all major types of transistors—Junction, Point Contact, Surface Barrier and many other related types—with this advanced correspondence course specially developed for engineers and experienced technicians now engaged in installation, maintenance and manufacture of electronics equipment.

This field is growing fast... career opportunities are unlimited. Prepare now for a profitable career with this proven home study course developed by experts in this field.

LEARN BY DOING WITH THE COMPLETE TRAINING KIT



Get practical experience, learn faster and easier. Conduct 18 experiments with training kit included. Build Amplifiers, Oscillators, Multivibrators, Pulse Circuits, AM Receivers, as well as Computer Circuits such as "AND," "OR" and "CARRY."

MAIL COUPON TODAY FOR FREE INFORMATION

PHILCO TECHNOLOGICAL CENTER

22nd and Lehigh Ave.
Philadelphia 32, Pa.

TRT-1

Please send free course outline and information on your Transistor Course to:

NAME _____

OCCUPATION _____

ADDRESS _____

CITY _____ ZONE _____

STATE _____

LITERATURE

Any or all of these catalogs, bulletins, or periodicals are available to you on request direct to the manufacturers, whose addresses are listed at the end of each item. Use your letter-head—do not use postcards. To facilitate identification, mention the issue and page of RADIO-ELECTRONICS on which the item appears. UNLESS OTHERWISE STATED, ALL ITEMS ARE GRATIS. ALL LITERATURE OFFERS ARE VOID AFTER SIX MONTHS.

FERRITES, ceramics used for high-frequency devices, are the subject of a paper by Dr. Albers-Schoenberg, researcher in ferrimagnetic materials, and reprinted from the *Journal of the American Ceramic Society*. The four types of ferrites are described, their principal characteristics outlined and their applications and future briefly discussed.—General Ceramics Corp., Crows Mill Rd., Keasbey, N.J.

TEST EQUIPMENT Catalog 38-T lists more than 25 volt-ohm-milliameters and other test instruments. This 8-page 2-color illustrated booklet includes complete specifications and prices, with excellent illustrations.—Triplet Electrical Instrument Co., Bluffton, Ohio.

TRANSISTOR COURSE for home study on basic transistor theory and servicing techniques includes practical experiments. For technicians and engineers, this newly revised course consists of 10 lessons and includes lesson correction and an advisory service. Further information and application blank sent on request in folder PA-276.—CBS-Hytron, Parker St., Newburyport, Mass.

STEREO SPEAKER SYSTEMS and components are listed, described and pictured and their use discussed in a 16-page brochure. Four approaches to stereo speaker setups are investigated and prices are shown.—University Loudspeakers, Inc., 80 So. Kensico Ave., White Plains, N. Y.

SELENIUM PHOTOVOLTAIC CELLS are described in detail along with operation, performance characteristics and applications information in *Bulletin PC-649A*. More than 25 standard cells are discussed.—International Rectifier Corp., 1521 E. Grand Ave., El Segundo, Calif.

CROSS-REFERENCE PARTS catalog for independent service technicians has five sections dealing with components, test equipment, outdoor and indoor parts and accessories, phonograph and audio parts. This 400-page catalog for 1959 includes complete data for the major

IMPROVE

your amplifier 5 ways

with the **Amperex® GZ34/5AR4 RECTIFIER**

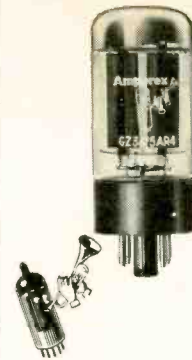

A LOW-IMPEDANCE, INDIRECTLY HEATED, FULL-WAVE RECTIFIER WITH 250 MA OUTPUT CAPACITY

The unique AMPEREX GZ34 replaces without circuit changes, in the majority of amplifier circuits, an entire line of popular, heavy-duty 5-volt rectifiers—5U4G, 5V4G, 5T4, etc.—with the following benefits:

- Better voltage regulation due to lowered power supply impedance;
- Higher power supply output voltage for more power;
- Added filter condenser protection due to reduced surge;
- Cooler operation due to lower voltage drop;
- Protection of costly power output tubes through delayed warm-up.

Ask your Amperex distributor about Amperex voltage amplifier, rectifier and output tubes for hi-fi circuits



Amperex ELECTRONIC CORP.
230 Duffy Avenue
Hicksville, L. I., N. Y.

FREE Information About This

BUSINESS OPPORTUNITY



key to car radio service market

How many car radios have you serviced lately? Most service operators are missing this tremendous market because they have no regular contact with car owners!

This VIS-U-ALL Auto-Radio Service Merchandiser literally moves your shop into the gas stations and garages where car owners must go. It multiplies your sales of parts—booms your repair volume, too. And without increasing your overhead!

Let us tell you how easy it is to increase your net profit by \$50 a week. Write today.

VIS-U-ALL products company
305 Fuller N.E., Grand Rapids 3, Mich.

parts of several thousand television sets of over 80 makers. It also has a visual phono needle finder section.—Philco Accessory Div., A St. and Alleghany Ave., Philadelphia 34, Penna., or Philco distributors.

SOLDERING ALUMINUM is a 22-page manual on soldering methods, fluxes, flames and irons. It gives complete information on various methods including ultrasonic and details the types and properties of various aluminum solders.—Reynolds Metals Co., Box 2346, Richmond 18, Va.

ACCESSORIES for Viking's series 75 and 85 tape recorder line are pictured and described in 4-page bulletin 692. Portable cases, consolettes and racks are included.—Viking of Minneapolis, 9600 Aldrich Ave. So., Minneapolis 20, Minn.

TEST EQUIPMENT and Service Aids describes six instruments useful in on-the-spot servicing. Included are a fly-back circuit and inductance analyzer and an in-circuit current checker for horizontal output servicing. Prices are included.—Seco Manufacturing Co., 5015 Penn Ave., S., Minneapolis, Minn.

EXPERIMENTAL PROJECTS for amateurs, technicians and engineers are described and priced in *Catalog 5-A*. These home projects include circuitry, parts lists and detailed notes for constructing a variety of electronic units such as solo organ, metronome, spot welder, Tesla coil, infra-red radiation counter, moisture meters, and other unusual instruments. Each project is rated for beginners or advanced workers in this large-size 6-page bulletin.—Henry Francis Parks Laboratory, Box 1665, Lake City Station, Seattle 55, Wash.

TANTALUM CAPACITORS and Precision Resistors in special assortments are described in *Bulletin 162*.—Ohmite Mfg. Co., 3670 Howard St., Skokie, Ill.

INDUSTRIAL COMPONENTS, precision potentiometers, power rheostats, switches, capacitors and connectors are listed in this 24-page *Standard Electronic Components catalog*. Many JAN types are included.—Standard Radio-Electrical Products, 86 Franklin St., New York 13, N. Y. END

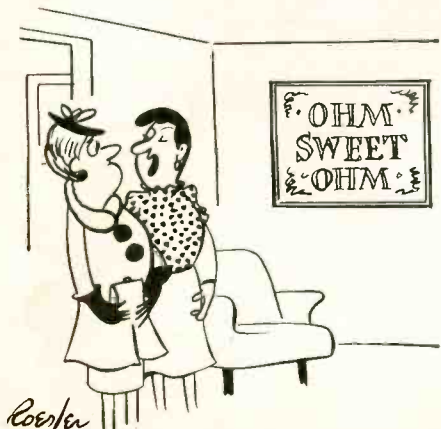

"Charley is in electronics."

\$11.90 Buys You an Acoustic-Designed 12" Bookshelf Enclosure Kit

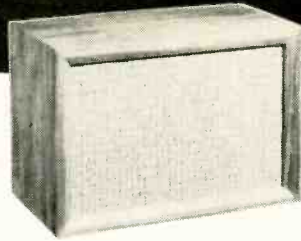

14" H
21" W
11 3/4" D
20 lbs.

For those of you who need an added enclosure for stereo, or an extension speaker system, or just a space-saver that gives you good sound reproduction—at the lowest price available anywhere—you can't miss with this Model One enclosure kit from Homewood Industries. Here's a company that's been building furniture kits for years and knows how to build value into a kit—and still make it easy to do. Here's what \$11.90 buys—

- A bass-reflex baffle that takes a 12" speaker or an 8" speaker.
- A 3/4" plywood enclosure with a four-sided natural veneer finish for horizontal or vertical use.
- A custom-furniture corner design that leaves no end-plys visible.

Price: 11.90 in birch
15.90 in walnut



If the need is for something bigger try the Model Two. Its 4 1/2 feet of baffle area gives you quality reproduction in combination with a 12" speaker. Brass-ferruled legs give it a clean, modern appearance. Meets the highest Homewood standards.

29" H (with legs), 20" W, 12 1/2" D. 25 lbs.
Price: 17.95 in birch

All you need to build is a Hammer-Screwdriver—and 30 minutes! That's how easy it is with a Homewood design.

Satisfaction Guaranteed or your money back in ten days. Send check or money order (no COD's). Freight collect.

HOMEWOOD INDUSTRIES Inc.

26 Court Street, Brooklyn 1, N. Y.

Please send me:

- Model One Bookshelf Enclosure (Birch Walnut)
- Model Two Enclosure Homewood Catalog
- My check or money-order for..... is enclosed.

Name.....
Address.....
City..... Zone..... State.....

Save Time with

SENCORE LEAKAGE CHECKER

Check these outstanding New Features

The LC3 provides all these new improved features in addition to those employed in earlier leakage or "grid circuit" testers. A must for any TV service technician.

- ★ Checks 156 different tube types—more than any other "grid circuit" type checker. Includes UHF and latest type tubes.
- ★ Checks picture tubes without removing tube from cabinet or chassis.

SENCORE

See other SENCORE ads in this issue

- ★ New Roll Chart prevents obsolescence—just dial the tube type and save time. Chart is easily replaced at no extra cost.
- ★ Provides instant filament checks on "Fil-Check" position—no need to carry a second filament checker.
- ★ Capacitor checks simplified.

★ Two spare preheating sockets to cut down testing time.

In stock at your local parts distributor.



Model LC-3
\$2895

DEALER NET
Really Whips
Tough Dogs

SERVICE INSTRUMENTS CORPORATION • 121 Official Road, Addison, Illinois



Service men all across the country agree... there's no other screw driver or nut driver with the built-in comfort of the VACO "comfordome" handle. Makes service work easy! Enjoy the luxury grip of a VACO... the driver that gives plenty of power, yet is always kind to hands. Next time choose a VACO and feel the difference!

Manufactured and Unconditionally Guaranteed by
VACO PRODUCTS CO., 317 E. Ontario Street, Chicago 11, Illinois
In Canada: ATLAS RADIO CORP., Toronto 19, Ont.



NEW L.T.* CHASSIS PUNCHES

REQUIRE

50% LESS EFFORT!

***EXCLUSIVE WALSCO LOW-TORQUE DESIGN THROUGH NEW ELECTRO-COATING!**

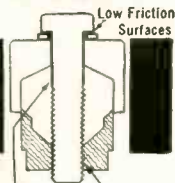

Low Friction Surfaces

New permanent (never wears off) electro-coating process reduces friction, thus lowers torque. New design gives cleaner holes with less effort. Walsco L.T. Chassis Punches REQUIRE NO LUBRICATION, and will give perfect service indefinitely. Join the switch to Walsco for better Chassis Punches.

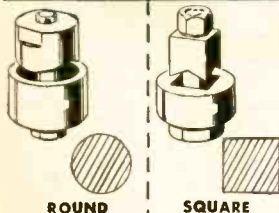

ROUND

SQUARE

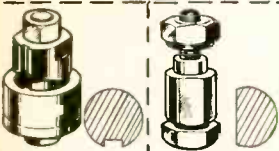

KEYED

"D"

TORQUE WRENCH TEST



Ordinary Punch Torque in Foot Pounds

Walsco "L.T." Punch Torque in Foot Pounds



WRITE TODAY for free literature and wall chart.
ELECTRONICS MFG. CO.
division of Tectron Inc.

Western Plant: Los Angeles 18, California Main Plant: ROCKFORD, ILLINOIS, U.S.A.

HELP THE RESEARCH ATTACK ON CEREBRAL PALSY JOIN THE 53 MINUTE MARCH

Send Contributions To "PALSY" Care Of Local Postmaster

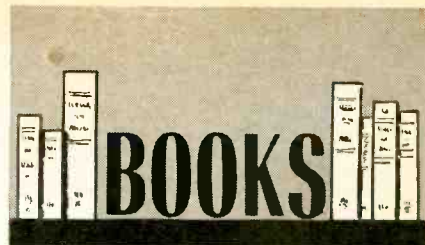

THE HOW AND WHY OF HI-FI AND STEREO, by H. G. Cisin. Harry G. Cisin, Publisher, Amagansett, N. Y. 8 1/2 x 11 in, 40 pp. \$1.

A book for beginning audiophiles and laymen, this easy-to-understand manual is packed with basic information. Mr. Cisin has previously written many manuals and books for amateurs and technicians, and his experience provides a specially lucid exposition here.

He has short sections on each part of the high-fidelity system, and goes into practical detail on stereo systems as well. Included are mechanical details for converting phonographs to stereo with each of three popular ceramic pickups, how to build bass-reflex cabinets and a 60-watt power amplifier using an Acro output transformer. He includes typical prices for each component, a helpful detail often omitted in introductory handbooks.

This book also provides an excellent introduction for service technicians previously unfamiliar with high-fidelity and/or stereo techniques.—CG

JUNCTION TRANSISTOR ELECTRONICS, by Richard B. Hurley. John Wiley & Sons, Inc., 440 Fourth Ave., New York 16, N. Y. 6 x 9 in, 473 pp. \$12.50.

This book is the outgrowth of lectures given to engineers by an authority on transistor circuit design. A mathematical text, it covers both the characteristics of transistors and the circuits of which they are part. Emphasis is on the junction triode but special transistors like the Unijunction and point contact are mentioned.

Basic amplifiers, oscillators, modulators, switches are analyzed in detail. The author reviews briefly Laplace transforms and Boolean algebra as required. Among special features are the many tables of exact and approximate formulas for transistor circuits, design examples worked out with typical numerical values, and the bibliography at the end of chapters.—IQ

ELECTRONIC AVIGATION ENGINEERING, by Peter C. Sandretto. International Telephone & Telegraph Corp., 67 Broad St., New York 4, N.Y. 6 x 9 in, 755 pp. \$9.50 per copy (\$7.60 per copy for 12 or more to one address).

Avigation is the science of conducting aircraft in flight from one point to another. Here an expert describes the equipment used in planes and on the ground. The subject is grouped by zones: long distance, short distance (less than 200 miles), landing, airport zone. The principles and problems of direction finders, position locators and distance measurements are explained. Radar, Loran, Gee, Tacan and many

Amazing New Handbook Takes The "Headache" Out of TV Trouble Shooting

Pin Point TV TROUBLES IN 10 MINUTES



SAVES TIME... ELIMINATES GUESSWORK!

Now, a simple, practical way to accurately spot the cause of trouble in any TV set. FAST! Quick, easy-to-understand tests tell you in which of 5 TV set sections to find the cause of trouble. Fool-proof Check Charts help you locate the exact trouble spot at once, from as many as 700 possibilities. Book fits easily into your tool kit for handy on-the-job use. Over 300 spiral bound fast reference pages with 50 time-saving Check Charts; dozens of easy to understand diagrams and tests; explanations of circuits and designs. The hours and aggravation this amazing handbook can save you on a single servicing job more than pay its low price!

USE IT ON 7 DAYS FREE TRIAL!

Send no money, just the coupon. We'll rush your copy in FREE TRIAL. After 7 days, send only \$3.95 plus postage or return the book and owe nothing. Act NOW!

MAIL COUPON NOW!

Educational Book Publishing Div.
COYNE ELECTRICAL SCHOOL, Dept. 59-T1
1501 W. Congress Pkwy., Chicago 7, Ill.

Rush TV handbook for 7 days FREE TRIAL per offer.

Name.....Age.....

Address.....

City.....Zone.....State.....

Check here if \$3.95 enclosed. We pay postage. 7-day money-back guarantee.

PROFESSIONAL technicians

use *Dave Rice's*

OFFICIAL ORDER BOOKS

for every TV-RADIO

service call



This is the businesslike approach to service record keeping. Triuplicate forms serve as order form, invoice and office record, with spaces for complete information on every job. Separate listings for receiving tubes, pix tube, parts, serial numbers, labor and tax charges, signatures, etc. 75c a book, \$6.50 for dust-proof box of 10. In stock at your distributor.

Write for your free folder describing Dave Rice's OFFICIAL ORDER BOOKS, including an actual size sample copy of the handy order form.

For customer's prices on every replacement part, plus flat rate and hourly service charge data, regional and national, Dave Rice's OFFICIAL PRICING DIGEST, listing over 63,000 items. \$2.50.

ELECTRONIC PUBLISHING CO., INC.
180 N. WACKER DRIVE
CHICAGO 6, ILLINOIS

SCHOOL DIRECTORY

Electronics Engineering Degree in 27 Months

Realize your dream. Become a graduate engineer. Share rewards awaiting college men . . . higher income, rapid advancement. Important firms regularly visit Tri-State College to interview seniors. Approved for veterans.

Electronics or Power Major

Bachelor of Science Degree in 27 Months in Electrical, Mechanical, Civil, Chemical, Aeronautical Engineering. In 36 Months a B.S. in Business Administration (General Business, Accounting, Motor Transport Management majors). For earnest, capable students. Small classes. Enrollment limited. More professional class hours. Mature students. Well-equipped labs. Modest costs. Beautiful campus. Year-round operation.

Enter June, Sept., Jan., Mar. Write J. G. McCarthy, Director Admissions, for Catalog and "Your Career" Book.



TRI-STATE COLLEGE

2459 College Avenue, Angola, Indiana

GET INTO ELECTRONICS

V.T.I. training leads to success as technicians, field engineers, specialists in communications, guided missiles, computers, radar and automation. Basic and advanced courses in theory and laboratory. Assoc. degree in electronics in 28 mos. B.S. in electronic engineering obtainable. ECPD accredited. G.I. approved. Graduates in all branches of electronics with major companies. Start September, February. Dorms, campus. High School graduate or equivalent. Catalog.

VALPARAISO TECHNICAL INSTITUTE

Dept. C Valparaiso, Indiana



ELECTRONICS

PREPARE FOR A GOOD JOB!
BROADCAST ENGINEER
RADIO SERVICING AUTOMATION

TELEVISION SERVICING
BLACK & WHITE—COLOR

APPROVED FOR VETERANS AND SURVIVORS
OF VETERANS
BUILDING AIR CONDITIONED
SEND FOR FREE LITERATURE

BALTIMORE TECHNICAL INSTITUTE
1425 EUTAW PLACE, BALTIMORE 17. MD.

ENGINEERING DEGREES



Option Electronics or Power
Earned through
HOME STUDY
Resident Classes Also Available if Desired
PACIFIC INTERNATIONAL COLLEGE OF ARTS & SCIENCES
Primarily a Correspondence School
5719-M, Santa Monica Blvd., Hollywood 38, Calif.

Be a "key" man. Learn how to send and receive messages in International Morse code. Communicate with operators around the globe. Learn at home quickly through famous Candler System. Used by best operators. Qualify for Amateur or Commercial License. Write for FREE BOOK.

CANDLER SYSTEM CO.
Dpt. 3-E Box 9226, Denver 20, Colo. USA

ELECTRONICS ENGINEERING DEGREE IN 27 MONTHS

Prepare for unlimited opportunities in electronics!

B.S. Engineering degree (27 mo.): Mathematics, Electrical Engineering, TV, advanced Radio Theory and Design. B.E. (36 mo.): Aeronautical, Chemical, Civil, Electrical, Mechanical, Metallurgical Eng. B.S. (36 mo.): Math., Chem., Physics. Also preparatory courses. Earn board. G.I. approved. 20 bldgs., dorms, gym. Enter June, Sept., Dec., March. Catalog. Keeping pace with progress.

INDIANA TECHNICAL COLLEGE
1559 E. Washington Boulevard, Fort Wayne 2, Indiana

ENGINEERING Home Study Courses

COURSES written by world authorities in all branches of engineering. Step-by-step instructions using methods proved successful by thousands of our graduates. One hour each day in your spare time will start you off to higher pay, security, prestige. Check the course you are interested in and we will send you a complete outline of the course with a booklet describing the Institute and our advanced methods of teaching. Send to: Canadian Institute of Science and Technology Ltd., 722 Century Bldg., 412, 5th St. N.W., Wash., D.C.

- | | |
|------------------------------|-------------------|
| Civil Eng. | Electrical Eng. |
| Surveying | Radio |
| Architecture | Electronics |
| Forestry | Television |
| Mining | Aeronautical Eng. |
| Structural | Aircraft Engineer |
| Mechanical Eng. | Navigation |
| Industrial Eng. & Management | General Education |
| Refrigeration | Chemical |
| Heating | Mathematics |
| Drafting | Journalism |
| Plastics | Accounting |

NAME.....

ADDRESS.....

CITY..... STATE.....

Course Interested In.....

Canadians: Send to Canadian Institute of Science & Technology Limited, 722 Garden Bldg., 263 Adelaide St. West, Toronto, Ont.

prepare for your career in

ELECTRICAL ENGINEERING ELECTRONICS COMPUTERS RADIO-TV

At MSOE, you can equip yourself for a career in many exciting, growing fields: **MISSILES RADAR • AUTOMATION RESEARCH • DEVELOPMENT ELECTRICAL POWER AVIONICS • ROCKETRY**

When you graduate from the Milwaukee School of Engineering, you are prepared for a dynamic career as an Electrical Engineer or Engineering Technician. Under a faculty of specialists, you gain a sound technical education in modern, completely equipped laboratories and classrooms. As a result, MSOE graduates are in great demand and highly accepted by industries nationally.

At MSOE you will meet men from all walks of life and all parts of the country — some fresh out of high school or prep school, others in their twenties — veterans and non-veterans.

You can start school in any one of four quarters and begin specializing immediately. Engineering technicians graduate in 2 years with an Associate in Applied Science degree. For a Bachelor of Science degree in Engineering, you attend 4 years. A 3-month preparatory course also is available.



FREE CAREER BOOKLET!
If you're interested in any phase of electronics, radio or television, be sure to look into the programs of study offered by the Milwaukee School of Engineering. Just mail the coupon.

MILWAUKEE SCHOOL OF ENGINEERING

Dept. RE 559, 1025 N. Milwaukee St., Milwaukee, Wisconsin

Please send FREE Career Booklet. I'm interested in Electrical Engineering; Electronics Computers Electrical Power Radio-TV Mechanical Engineering.

PLEASE PRINT

Name..... Age.....

Address.....

City..... Zone..... State.....

I'm eligible for veterans education benefits.

MS-123

BARRY ELECTRONICS CORP.

TUBE HQS.

HAM-TV INDUSTRIAL

HIGHEST QUALITY • TOP BRAND NAMES ONLY BOXED • LOWEST SENSIBLE PRICES • GUARANTEED

0A2	.70	6AK4	1.50	6X5GT	.70	401A	1.50
0A3	.80	6AK5	.75	6X2	1.15	403A	2.40
0B2	.65	6AL5	.65	6Y6G	1.00	403B	2.60
0C3	.70	6AM4	1.90	7B7	5.00	404A	8.00
0D3	.40	6AM8	1.15	8AW8A	1.40	407A	2.95
0Z4	2.00	6AN5	2.00	8A7	1.00	408A	1.75
1A7D7	.90	6AM7	1.20	8C7	.90	417A	8.00
1B3GT	1.00	6AQ5	.65	12A6	.40	420A	6.75
1B85	4.95	6AR6	1.90	12C6	.65	434A	4.00
1S5	.85	6AS7	3.25	12AD6	.75	446A	.50
1S4	.80	6AS8	1.15	12AT6	.70	450-TL	43.00
1U5	.70	6AT6	.50	12AT7	.85	673	11.50
1U4	.50	6AT8	1.15	12AU6	.75	703A	.75
1U5	.75	6AU4GT	1.15	12AU7	.85	717A	.50
1V2	.65	6AU5GT	1.50	12AV7	1.10	723A	B 5.00
1X2	1.20	6AU6	1.20	12C4GT	.95	803	5.00
1Z2	1.30	6AU8	1.20	12AX7	.85	805	3.50
2C39A	9.00	6AV6	.80	12AY7	1.25	806	7.00
2C43	8.00	6AW8	1.25	12BA4	.90	807	1.75
2C51	2.00	6AX4GT	.90	12BA6	.70	807W	1.80
2D21	.65	6AX5GT	1.05	12BE6	.75	809	3.00
2E27	1.75	6B4G	3.00	12C7A	1.01	811	1.50
2E24	1.90	6B6	.60	12BK5	1.20	811A	5.50
2E25	2.50	6B6C	1.80	12BQ6GT	.85	812A	5.50
2E26	3.40	6B6C	.80	12BZ7	1.05	815	3.00
2E30	1.70	6B8C	1.40	12BY7A	1.00	814	2.00
2E35	1.50	6BE6	.75	12BZ7	1.05	815	3.00
2K25	9.95	6BG6G	2.25	12C65	.85	816	2.25
2K26	34.00	6B7	1.50	12CU6	1.55	826	8.00
2K28	30.00	6B7E	.70	12DQ6	1.55	829-B	8.00
2X2	.25	6B7J	1.00	12SA7GT	.95	830-B	.25
3A3	1.25	6B7K	1.20	12S7GT	1.05	831	3.75
3A4	.70	6B8K5	1.10	12SK7G	.95	837	1.00
3A5	.75	6B87A	1.15	12SL7	.75	838	1.00
3AP1	3.50	6B7GT	1.35	12S7GT	.95	839	1.50
3AL5	.65	6B8N4	.85	12SQ7G	.85	872A	1.25
3AU6	.75	6B8N6	1.00	12SR7	.65	879/2X2	.25
3AV6	1.40	6B8T	1.30	12T6GT	1.05	883	1.70
3B4	2.25	6BQ7A	1.35	12W6GT	1.00	885	1.00
3B28	3.50	6B58	1.15	12X4	.60	889RA	75.00
3B6E	.85	6B8U	.80	12Y6	1.20	918	1.85
3B6S	.85	6B8U	.80	12Y7	5.00	954	.10
3BN6	1.00	6BY5G	1.15	19AU4	1.20	955	.20
3BP1	1.50	6BY6	.80	19BG6G	2.25	957	.20
3BU8	.85	6BY8	.90	RY21A	2.00	958-A	.25
3BY6	.85	6BZ6	.80	RX21A	2.00	991/NE16	
3BZ6	.85	6BZ7	1.40	246/3C24	.60	1613	1.50
3C24	3.50	6BZ8	1.60	25A	3.50	1614	2.75
3C86	.85	6C4	.45	25AX4GT	1.05	1616	.60
3C96	.90	6C6	.70	25BK5	1.05	1616	.60
3C96	.85	6C21	10.00	25BK5	1.05	1617	.17
3D23	3.95	6C86	.60	25BQ6GT	1.625	.20	
3D76	.80	6C85	2.75	25C60	1.55	1626	1.50
3E29	6.00	6C6G	2.25	25D6GT	2.00	1635	2.00
3E4	.85	6CF6	.90	2.00	1.60	1654	2.70
3V4	.85	6CG7	.85	25C6G	1.60	1654	2.70
4X150A	7.00	6C8	1.10	25L6GT	.70	1657	.75
4B8	1.40	6C8	1.30	25W4GT	.85	2013	.50
4B7A	1.40	6CM6	.90	25Z5	.65	2014	.50
4B5E	1.35	6C7	.85	F27A	7.50	2050	1.25
4B5B	1.20	6C6	.90	35A5	1.00	2500	4.00
4BZ7	1.40	6C95	.90	35A5	1.00	2500	4.00
4C35	13.50	6C6	1.30	35B5	.90	3516	7.00
5ADP7	7.00	6D6	1.00	15R	3.00	3516	7.00
5AM8	1.15	6DE6	.85	35L6	.85	3528	4.00
5AN8	1.25	6D7E	.85	35T7	1.75	3557	5.00
5AQ5	1.40	6D6	1.30	35T7	1.75	3557	5.00
5A58	1.20	6F4	2.25	35Y4	.80	3559	5.00
5A78	1.15	6F6	.90	35Z5	.65	3588	35.00
5AW4	1.25	6F8	1.25	35A5	1.15	3588	35.00
5B7	1.20	6F8	1.25	35B5	.90	3567	2.50
5BP4	3.00	6H6	1.45	35C5	.75	3568	2.50
5BQ7	1.40	6J4	1.00	35G7	.85	3544	2.95
5C22	18.00	6J2GT	1.35	RKR-72	1.35	3642	1.50
5C68	1.15	6J6	.50	80	.85	3651	1.00
5J1	4.00	6K5GT	.80	81	1.75	3656	3.50
5J6	1.00	6K7	.75	82	1.00	3656	3.50
5LP1	7.00	6K8	1.00	100-T	9.50	3667	75.00
5R4G	1.00	6L6	2.00	117Z3	.85	3670	1.00
5RPIA	12.00	6L5	1.00	120	1.00	3671	1.50
5T4	1.10	6SA7GT	1.05	4X150A	7.00	3691	4.50
5T8	1.20	6S7	1.05	2748	.40	3692	4.00
5U4GB	.75	6S7	1.05	2749	1.00	3693	4.50
5U8	1.15	6SK7GT	.90	307A	.50	3703	1.00
5W4GT	.90	6SL7GT	.90	311A	3.50	3704	1.00
5Y3GT	.40	6SN7GT	.70	320	1.00	3704	1.00
5Z4	1.25	6SN7GTB	.90	339A	5.95	3719	1.00
6A7	1.00	6SQ7GT	.85	350A	2.00	3725	1.00
6A8A	.90	6T4	1.30	350B	1.50	3727	1.50
6AC7	1.45	6T8	1.15	35A	7.00	3736	85.00
6AF4	1.45	6V6GT	.75	357A	15.00	3736	85.00
6AG5	.95	6W4GT	.85	371B	1.00	3749	.85
6AG7	.95	6W6GT	1.00	394A	3.00	3750	1.75
6AG4GT	1.05	6W6GT	1.00	394A	3.00	3751	1.35
6AH6	1.40	6X4	.60	396A	2.00	3751	1.35

AND OTHERS—Cartons and Stockers always in stock—Order or Write

- DPDT TOGGLE SWITCH—New—30¢ ea.
- 4X150A TUBES—Tested—Guaranteed! \$7.00 Each
- 28 V AC or DC BLOWER for 4X150A—Checked/ out of Equip. —\$1.95
- REACTOR-CHOKE—0.02 H. @ 8.5 Amps. D.C. —Lo-Resistance—8% x 6% x 6%. Completely Enclosed. Orig. Cost Approx. \$25.00—Brand New Raytheon —\$7.50
- CHOKE—26 H. @ 95 Ma. New—Rathenon #UX8589 —\$1.00
- SNIPERSCOPE. See in Dark! Attach to rifle, or Use w/o Rifle. Mfd. by American Optical. Model M-3. With orig. 20 X7 power supply and cables. Comes with infra-red light source and filter. Orig. box. Good condition. —\$120.00
- RAYTHEON POWER SUPPLY. Input: 6 volts D.C. Output 117 VAC under load @ 1/2 to 3/4 Amps. A.C. (50 watts plus) new—Original cartoned—heavy duty unit. Best parts. —\$16.95
- TRIMM COMMERCIAL HEADSETS. Highest quality lightweight. Trimm No. 157—double headsets—17,000 ohms impedance. Original Cartons —Unused —\$4.95

Authorized Factory distributors for: ADJUST-A-VOLT, B & W, DRAKE, EIMAC, GELOSIO, GENERAL ELECTRIC, GLASLINE, HONEYWELL, HAMMARLUND, HEXACON, E. F. JOHNSON, NATIONAL CO., NATIONAL ELECTRONICS, PENTA LABS, STACO, TECHNICAL MATERIEL CORP., TOBE, WESTINGHOUSE, VOCALINE and Others. All prices F.O.B. N.Y.C. Specify method of shipment. All merchandise insured and guaranteed for cost of misc. only. Receiving Trade guaranteed 90 days—Special purpose & Xmtg. tubes guaranteed 30 days. If you are a new customer and your order is accompanied by a personal check, allow 7 to 10 days for shipment. If you wish immediate shipment, enclose CERTIFIED CHECK or MONEY ORDER. Send 25¢ for 1959 green sheet. Open Monday to Saturday—come in and browse—we are near Prince St./BMT Station—Spring St./IRT Station. I flight up—20,000 sq. feet of values. Thousands of unadvertised specials. Phone: WALKER 5-7000.

BARRY ELECTRONICS CORP.
512 Broadway, Dept. RE-5, New York 12, N.Y.

BOOKS (Continued)

other systems are analyzed. Block diagrams, schematics and equations help the clearly written text.—IQ

LOUDSPEAKERS (5th edition), by G. A. Briggs. Distributed by British Industrial Corp., Port Washington, N. Y. 5 x 8 1/2 in., 336 pp. \$4.50.

Mr. Briggs is the well-known audio engineer who has designed and manufactured Wharfedale speakers for 25 years. The book begins with an account, tinged with humor, of how he began his career. Thereafter, he describes speaker construction and performance. It is written for non-technical readers who wish to understand the facts of sound quality, stereo, acoustics, etc.

Among the major topics are decibels, cabinet construction, crossovers, feedback, transformers and frequency response. Numerous diagrams and oscillographs show the good and bad effects of resonance, directionality, cabinet size, baffles and speaker quality. The last chapter answers typical questions that have been asked by hi-fi fans.—IQ

ELECTRON-TUBE CIRCUITS, by Samuel Seeley. Second Edition. McGraw-Hill Book Co., Inc., 330 West 42 St., New York 36, N.Y. 6 x 9 in., 695 pp. \$10.50.

This revised edition deals with a wide range of radio and electronic engineering topics. New material appears on transistors, feedback and computers. The author uses detailed mathematical analysis, diagrams, charts and schematics to explain and clarify the theory of basic circuits.

The book is about evenly divided between radio circuits and those utilized for radar, TV, control and instrumentation. Many worked-out examples show how to analyze circuits and apply the formulas. There is mention of basic transistor circuits, but as the book name suggests, tubes receive the major attention throughout.—IQ

BASIC ELECTRICITY FOR COMMUNICATIONS (2d edition), by William H. Timbie. John Wiley & Sons, Inc., 440 Fourth Ave., New York 16, N. Y. 5 1/2 x 8 1/4 in., 527 pp. \$6.25.

This standard text has been revised to include semiconductors, crystals and transistors. As before, it concentrates on basic theory and its applications to communications and industry. It covers Ohm's law, measurements, batteries, magnetism, ac and dc circuits, motors and tubes. Some problems are worked out in detail, many others are left for the student. The appendix contains useful data on wire tables, logarithms, the j operator, etc.—IQ

THE JUNCTION TRANSISTOR, edited by E. Wolfendale. Macmillan Co., 60 Fifth Ave., New York 11, N.Y. 6 x 9 in, 394 pp. \$7.50.

This book has been prepared by a research team of engineers and physicists actively engaged in this field, and the results speak highly for their efforts. Descriptions cover the tran-

sistors themselves, circuit design and applications. Among the chapter topics are equivalent networks, amplification, oscillation, modulation and nonlinear circuits.

Mathematical analyses, charts, schematics and design examples tell the complete story. The chapters include theory along with practical design examples, making the book an excellent guide and reference for engineers, physicists and students.—IQ

CQ YL, by Louisa B. Sando, W5RZJ. Louisa B. Sando, 212 Sombrio Drive, Santa Fe, N.M., 6 x 9 in, 165 pp. \$3.50.

A former member of the staffs of both American amateur magazines, QST and CQ, and the present YL editor of CQ, W5RZJ is thoroughly competent to present the history of women in amateur radio, and does it very competently.

Intended as "a permanent record of the part women have played in amateur radio," photographs have been considered as important as facts—or perhaps considered the most important facts. The book begins with a short glossary for those who may not know what a YL is, then a one-chapter history of the Young Ladies Radio League (YLRL) and a quick survey of its present chapters in photos and text.

The earlier YL operators, from 1915 to 1941, are described in the next three chapters, and then there is a very interesting chapter on YL marine operators. Since there are now no women operators on US ships, it comes as a surprise that women sailed as "Sparks" under the American flag till after World War I—with a second wave of WAC operators on hospital ships in World War II. The last of the American women to leave the sea appears to have been Billie Adels, who operated on the tanker Gulf Banker till 1953.

Following chapters are devoted to YL's and public service, young YL's (8-18 years) and handicapped YL's, with a final photographic chapter showing conventions and hamfests.—FS END



"Your time wasn't wasted after all!"

ADVERTISING INDEX

Radio-Electronics does not assume responsibility for any errors appearing in the index below.

Aerovox Corp.	72
Alliance Manufacturing Co.	12
Allied Radio Corp.	9, 80-81
American Television & Radio Co.	8
Amperex Electronic Corp.	130
Amphenol-Borg Electronics Corp.	100
Arkay Radio Kits Inc.	84
Astatic Corp.	14
Atlas Sound Corp.	118
Audio Fair	128
B & K Manufacturing Co.	97
Barry Electronics Corp.	134
Bell Telephone Labs.	24
Bogen (David) Co., Inc.	93
Brooks Radio & Television Corp.	127
Burroughs Corp.	104
CBS-Hytron	17
Capitol Radio Engineering Institute	19, 121
Carston Studios	120
Centralab Div. of Globe Union	22
Century Electronics Co., Inc.	94-95
Chemtronics Inc.	129
Chicago Standard Transformer Corp.	110
Cleveland Institute of Radio Electronics	11
Colordaptor	135
Cornell-Dubilier Electric Corp.	79
Coryne Electrical School	120, 132
Delco Radio Div. of General Motors Corp.	26
DeRO Electronics	115
Deutschmann (Tope) Corp.	98
DeVry Technical Institute	7
Dressner	123
ECM Corp.	128
Editors & Engineers	123
Electro-Sonic Labs.	126
Electro-Voice Inc.	Inside Front Cover
Electronic Chemical Corp.	119
Electronic Instrument Co. (EICO)	27, 28
Electronic Measurements Corp. (EMC)	125
Electronics Publishing Co., Inc.	132
Electronic Supply Corp.	129
Erie Resistor	128
E-Z Hook Test Products Co.	127
Gernsback Library Inc.	122, 135
Grantham School of Electronics	13
Heald Engineering College	128
Heath Co.	60-71, 73
HomeWood Industries	131
Illinois Condenser Co.	120
Indiana Technical College	135
International Business Machines (IBM)	20-21
International Electronics Corp.	8
Jensen Industries	120
Key Electronics Co.	129
Lafayette Radio	136-137
Lansing (James B.) Sound Inc.	16
Lektron Inc.	119
Mallory (P. R.) & Co., Inc.	86-87
Moss Electronic Inc.	90-91
Mullard Ltd.	8
National Radio Institute	3
National Schools	5
Newbury Engineering Co.	123
North American Philips Co., Inc.	115
Opportunity Adlets	124
Perma-Power Co.	118
Philco Techrep Division	130
Pickering & Co., Inc.	112
Picture Tube Outlet	123
Progressive Edu-Kits Inc.	114
Pyramid Electric Co.	107
Quam-Nichols Co.	109
Quietrol Co., Inc.	112
RCA Electron Tube Division	Back Cover
RCA Institutes	118, 117
Radio Receptor Co., Inc.	105
Radio Shack Corp.	25
Rider (John F.) Publisher Inc.	106
Rinehart & Co., Inc.	88, 126
Sams (Howard W.) & Co., Inc.	15, 108
Schober Orson Co.	126
Service Instruments Corp.	109, 110, 113, 121, 129, 131, 135
Sonotone Corp.	129
Sprague Products Co.	138
Sprayberry Academy of Radio Television	23
Supreme Publications	111
Surplus Saving Center	123
Sylvania Electric Products Inc.	102-103
Tab	124
Trio Manufacturing Co.	127
Tung-Sol Electric Co.	18
United Audio Products	Inside Back Cover
University Loudspeakers Inc.	10
Vaco Products Co.	131
Vis-U-All Products Co.	130
Walsco Electronics Manufacturing Co.	132
Winegard Co.	123

SCHOOL DIRECTORY PAGE 133

Baltimore Technical Institute
 Canadian Institute of Science & Technology
 Candler System Co.
 Indiana Technical College
 Milwaukee School of Engineering
 Pacific International College of Arts & Sciences
 Tri-State College
 Valparaiso Technical Institute
BRANCH ADVERTISING OFFICES: Chicago: 1025 Harlem Ave., Glenview, Ill., Glenview 4-6300. Los Angeles: Harker-Husted-Coughlin, 600 South New Hampshire, Tel. DUmbrik 7-2328. San Francisco: Harker-Husted-Coughlin, 444 Market St., Tel. GARfield 1-2481.
FOREIGN AGENTS: Great Britain: Atlas Publishing and Distributing Co., Ltd., 18 Bride Lane, London E.C. 4.
 Printed in the United States of America

MAKE YOUR HI-FI LOOK AS GOOD AS IT SOUNDS

System sound beautiful but look like a wild night in a spaghetti factory? Here's a book that tells you how to do something about it. Everything you have to know about hi-fi furniture from choosing the right woods, using correct tools to furniture arrangement, and polishing and finishing. Guaranteed to improve domestic relations too. This is a book anyone interested in woodworking—or furniture will want. Get it to make your hi-fi system look better—and sound better.



DESIGNING AND BUILDING
HI-FI FURNITURE

By Jeff Markell

Gernsback Library Book
No. 79

Paper cover edition....\$2.90

See your distributor or use this coupon

OTHER G/L HI-FI BOOKS

- No. 73—Audio Measurements\$2.90
 - No. 71—H. A. Hartley's Audio Design Handbook\$2.90
 - No. 67—Elements of Tape Recorder Circuits\$2.90
 - No. 66—Basic Audio Course.....\$2.75
 - No. 64—Understanding Hi-Fi Circuits.....\$2.90
 - No. 58—Maintaining Hi-Fi Equipment.....\$2.90
 - No. 56—High-Fidelity Circuit Design (Hard cover only).....\$5.95
 - No. 48—High-Fidelity—Design, Construction, Measurements\$1.50
- Paper cover editions, unless otherwise noted.

Gernsback Library, Inc. Dept. 59

154 West 14th Street
New York 11, N. Y.

My remittance for \$_____ is enclosed. Please send me the books checked postpaid

79 Paper cover ed. \$2.90

73 71 67 66 64 58 56 48

Name _____

please print

Street _____

City _____

Zone _____ State _____

BE SURE TO WATCH FOR THE JUNE ISSUE ON SALE MAY 26th.

CONVERT TO COLOR TV

COLORDAPTOR—A simple 10-tube circuit and rotating color wheel converts any-size black-and-white TV, direct view or projection, to receive compatible color TV. **COLORDAPTOR** is simply attached to TV set, does not affect normal operation and can be built from parts experimenters have on hand.

Complete specifications including theory of operation, complete simplified construction plans, schematic and sample color filters

\$1.95

Essential parts kit containing all special parts—coils, delay line, crystal, color filters—

Up to 16" **\$19.95** 17" and **\$20.95** sets—larger—

COLORDAPTOR now COAST-TO-COAST to serve you better and faster.

Colordaptor 335 Melville St., Palo Alto, Calif.
149 Hillside Ave., Berkeley Hgts., N.J.

ENGINEERING

**B. S. DEGREE
IN 27 MONTHS**



Prepare for unlimited opportunities of the Electronic Age! Students study engineering under accelerated program leading to B.S. degree in 27 mo.; or standard 4-yr. program leading to B.E. degree in 36 mo. B.S. degree (36 mo.) in Math., Chem., Physics. Year-round classes. Comprehensive training in electronics, television, advanced radio theory and design, math, nuclear physics and elec. eng. Also prep courses. Low rate. Earn board. G.I. approved. Enter June, Sept., Dec., March. Catalog.

INDIANA TECHNICAL COLLEGE

1759 E. Washington Blvd., Fort Wayne 2, Indiana

Please send me free information on B.S. ENGINEERING DEGREE IN 27 MONTHS as checked.

- Electronics Chemical Aeronautical
- Civil Mechanical Electrical
- B. E. DEGREE IN 36 MO. in: Electrical (Power or Electronics)
- Aeronautical Chemical Electronics
- Civil Mechanical Metallurgical
- B. S. DEGREE IN 36 MO. in: Math. Chem. Physics

Name _____

Address _____

SAVE
TIME
with

SENCORE

Transi-Pak

A "Twin" to the
**SENCORE
TRC4 Transistor
Checker**

See other SENCORE ads in this issue.

A Low Cost TRANSISTOR RADIO BATTERY ELIMINATOR

Here is a complete isolated power supply especially designed to replace batteries during repair time of all transistor radios.

- ★ Supplies up to 24V D.C
- ★ Provides 100ma constant and 200ma on peaks
- ★ Meter indicates either voltage or current
- ★ 1.5 volt biasing tap for Philco and Sylvania Transistor Radios



MODEL PS-103

\$1795

DEALER NET

SERVICE Instruments Corp.
121 Official Road, Addison, Ill.

AT LEADING PARTS DISTRIBUTORS



**LAFAYETTE'S
1959 CATALOG
260 GIANT-SIZE
PAGES
FREE!**

Complete listings of the **NEWEST** in Stereo and Monaural Hi-Fi, Short Wave, Audio, Transistor, and many other Lafayette electronics kits as well as thousands upon thousands of standard brand nationally advertised kits and electronic parts and components are described in **LAFAYETTE'S GIANT NEW 260-PAGE CATALOG**. SEND FOR IT—IT'S FREE! Just fill in coupon below and present it at any Lafayette store, or paste it on a postcard and send it to us. **THAT'S ALL YOU HAVE TO DO** to get your **FREE 1959 LAFAYETTE CATALOG!**

ELECTROSTATIC 3 ELEMENT TWEETER

NEW! "STEREO ANALYST"
Single Needle
VU Balance
Meter



only **11.95**

The Most
Versatile
Instrument
Offered
The Hi-Fi
Enthusiast

- **UNIQUE 2 COIL GALVANOMETER-TYPE PRECISION METER MOVEMENT**
- **7 RANGES OF METER SENSITIVITY**
- **EFFORTLESS BALANCING OF STEREO SYSTEMS**
- **MAY BE USED AS VU METER AND TAPE RECORDER LEVEL INDICATOR**

Solves all stereo balancing problems. Each stereo channel feeds a separate coil through a full-wave bridge rectifier. Balanced signals result in a 0 deflection. 2 slide switches permit individual channel measurements. Metal case, satin gold finish. Size: 4 1/2 x 5 1/2 x 4 1/4". Shpg. Wt., 3 lbs.
TM-66 Stereo Balance Indicator.....Net 11.95

27.50

THE FINEST HI-FI TWEETER AVAILABLE

Leave it to Lafayette to bring you the "hottest" tweeter—the superlative electrostatic 3 element tweeter, rated best regardless of price. This smooth performing tweeter—superior to units costing many times more—improves ANY speaker system, bringing forth the realism and acoustic brilliance of the high frequencies. Simple to connect and use, comes complete with detailed instructions. In mahogany, walnut or blonde finishes with attractive plastic grilles. Size 11 1/2 x 6 x 4 1/2. Shpg. wt., 7 lbs.

- SK-150 Electrostatic 3 Element Tweeter Mahogany Finish
- SK-151 Same in Walnut Finish
- SK-152 Same in Blonde Finish

27.50

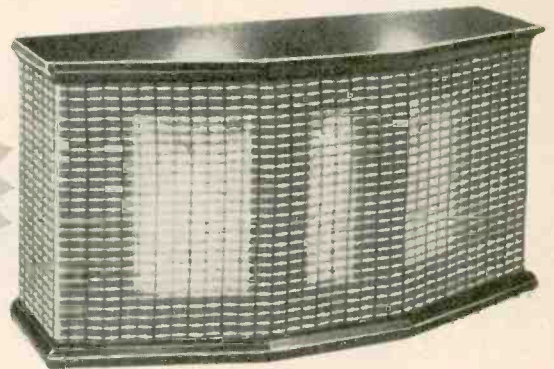

- **BUILT-IN CROSSOVER NETWORK**
5000 Cycle Crossover Frequency
- **WIDE 120° DISPERSION ANGLE**
Achieved by 3 Electrostatic Element Design
- **MEASURABLY IMPROVES ANY SPEAKER SYSTEM**
Superb High Frequency Response from 5000 Cycles to Beyond 25,000 Cycles
- **BUILT-IN AC POWER SUPPLY**
Supplies High Voltage Necessary For True Electrostatic Speaker Operation
- **AVAILABLE IN MAHOGANY, WALNUT OR BLONDE ENCLOSURE**



SHURE M3D
with diamond stylus

SPECIAL MONEY-SAVER COMBINATION



99.50

SAVE 26.60

PK-270

PK-245 hysteresis-synchronous turntable with new Lafayette PK-270 12" professional stereo tone arm plus Shure M3D Dynetic Compatible Stereo Cartridge with .7 mil diamond stylus. Shpg. wt., 19 lbs. Special.....Net 99.50



RC121/II

52.50

SPECIAL SALE! GARRARD RC121/II WITH SHURE M3D DYNETIC STEREO CARTRIDGE WITH DIAMOND STYLUS



SHURE M3D
with diamond stylus

MONEY-SAVER COMBINATION

Garrard latest model RC121/II with Shure model M3D professional Dynetic Compatible Stereo cartridge with .7 mil diamond stylus. Regular 83.15 value. Shpg. wt., 15 lbs.....Net 52.50

GARRARD RC-88

Garrard RC88 and Shure M3D Cartridge..Net 62.50

FREE



CUT
OUT
AND
PASTE
ON
POST
CARD

LAFAYETTE RADIO, Dept. JE-9
P.O. Box 511, Jamaica 31, N. Y.

SEND FOR THE WORLD'S LEADING ELECTRONICS,
RADIO, T.V., INDUSTRIAL, AND HI-FI GUIDE

Send FREE LAFAYETTE Catalog 590

Name

Address

City..... Zone.... State.....

*Lafayette
Radio*
"Everything in
Electronics"

LAFAYETTE Kits Are FUN To Build!

New! Years Ahead!



Use it as a **Binaural-Stereophonic FM-AM tuner**
Use it as a **Dual-Monaural FM-AM tuner**
Use it as a **straight Monaural FM or AM tuner**

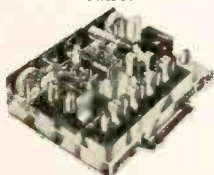

KT-500 IN KIT FORM
74.50
ONLY 7.45 DOWN
7.00 MONTHLY

LAFAYETTE STEREO TUNER KIT

THE MOST FLEXIBLE TUNER EVER DESIGNED

- Multiflex Output for New Stereo FM
- 11 Tubes (including 4 dual-purpose) + Tuning Eye + Selenium rectifier Provide 17 Tube Performance
- 10KC Whistle Filter • Pre-aligned IF's
- Tuned Cascade FM • 12 Tuned Circuits
- Dual Cathode Follower Output
- Separately Tuned FM and AM Sections
- Armstrong Circuit with FM/AFC and AFC Defeat
- Dual Double-Tuned Transformer Coupled Limiters.

More than a year of research, planning and engineering went into the making of the Lafayette Stereo Tuner. Its unique flexibility permits the reception of binaural broadcasting (simultaneous transmission on both FM and AM), the independent operation of both the FM and AM sections at the same time, and the ordinary reception of either FM or AM. The AM and FM sections are separately tuned, each with a separate 3-gang tuning condenser, separate flywheel tuning and separate volume control for proper balancing when used for binaural programs. Simplified accurate knife-edge tuning is provided by magic eye which operates independently on FM and AM. Automatic frequency control "locks in" FM signal permanently. Aside from its unique flexibility, this is, above all else, a quality high-fidelity tuner incorporating features found exclusively in the highest priced tuners.

FM specifications include grounded-grid triode low noise front end with triode mixer, double-tuned dual limiters with Foster-Saeley discriminator, less than 1% harmonic distortion, frequency response 20-20,000 cps \pm 1/2 db, full 200 kc bandwidth and sensitivity of 2 microvolts for 30 db quieting with full limiting at one microvolt. AM specifications include 3 stages of AVC, 10 kc whistle filter, built-in ferrite loop antenna, less than 1% harmonic distortion, sensitivity of 5 microvolts, 8 kc bandwidth and frequency response 20-5000 cps \pm 3 db. The 5 controls of the KT-500 are FM Volume, AM Volume, FM Tuning, AM Tuning and 5-position Function Selector Switch. Tastefully styled with gold-brass escutcheon having dark maroon background plus matching maroon knobs with gold inserts. The Lafayette Stereo Tuner was designed with the builder in mind. Two separate printed circuit boards make construction and wiring simple, even for such a complex unit. Complete kit includes all parts and metal cover, a step-by-step instruction manual, schematic and pictorial diagrams. Size is 13 3/4" W x 10 1/4" D x 4 1/2" H. Shpg. wt., 22 lbs.

KT-500 Net **74.50**
LT-50 Same as above, completely factory wired and tested. Net **124.50**

NEW! LAFAYETTE PROFESSIONAL STEREO MASTER AUDIO CONTROL CENTER

Solves Every Stereo/Monaural Control Problem!

- UNIQUE STEREO & MONAURAL CONTROL FEATURES
- AMAZING NEW BRIDGE CIRCUITRY FOR VARIABLE 3d CHANNEL OUTPUT & CROSS-CHANNEL FEED
- PRECISE "NULL" BALANCING SYSTEM

A REVOLUTIONARY DEVELOPMENT IN STEREO HIGH FIDELITY. Provides such unusual features as a Bridge Control, for variable cross-channel signal feed for elimination of "ping-pong" (exaggerated separation) effects and for 3d channel output volume control for 3-speaker stereo systems; 3d channel output also serves for mixing stereo to produce excellent monaural recordings. Also has full input mixing of monaural program sources, special "null" stereo balancing and calibrating system (better than meters), 24 equalization positions, all-concentric controls, rumble and scratch filters, loudness switch. Clutch type volume controls for balancing or as 1 Master Volume Control. Has channel reverse, electronic phasing, input level controls. Sensitivity 1.78 millivolts for 1 volt out. Dual low-impedance outputs (plate followers), 1300 ohms. Response 10-25,000 cps \pm 0.5 db. Less than .03% IM distortion. Uses 7 new 7025 low-noise dual triodes. Size 14" x 4 1/2" x 10 1/4". Shpg. wt., 16 lbs. Complete with printed circuit board, cage, profusely illustrated instructions, all necessary parts.

LAFAYETTE KT-600 — Stereo Preamp. kit Net **79.50**
LAFAYETTE LA-600—Stereo Preamp. kit, Wired Net **134.50**

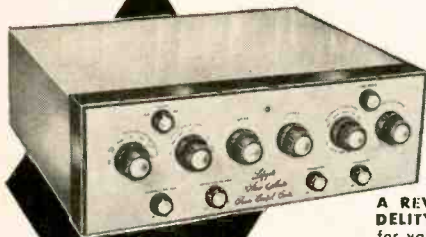

KT-600
79.50

ONLY 7.95 DOWN
8.00 MONTHLY

- RESPONSE 10-25,000 CPS \pm 0.5 DB
- 6 CONCENTRIC FRONT PANEL CONTROLS
- 4 CONCENTRIC REAR PANEL INPUT LEVEL CONTROLS
- 180° ELECTRONIC PHASE REVERSAL

NEW! LAFAYETTE STEREO/MONAURAL BASIC POWER AMPLIFIER KIT

- 36-WATT STEREO AMPLIFIER-18-WATTS EACH CHANNEL
- FOR OPTIONAL USE AS 36-WATT MONAURAL AMPLIFIER
- EMPLOYS 4 NEW PREMIUM-TYPE 7189 OUTPUT TUBES
- 2 PRINTED CIRCUIT BOARDS FOR NEAT, SIMPLIFIED WIRING
- RESPONSE BETTER THAN 35-30,000 CPS \pm 1/2 DB AT 18 WATTS
- LESS THAN 1% HARMONIC OR INTERMODULATION DISTORTION

A superbly-performing basic stereo amplifier, in easy-to-build kit form to save you lots of money and let you get into stereo now at minimum expense! Dual inputs are provided, each with individual volume control, and the unit may be used with a stereo preamplifier, for 2-18 watt stereo channels or, at the risk of a switch, as a fine 36-watt monaural amplifier — or, if desired, it may be used as 2 separate monaural 18-watt amplifiers! **CONTROLS** include 2 input volume controls, channel Reverse switch (AB-BA), Monaural-Stereo switch. **DUAL OUTPUT IMPEDANCES** are: 4, 8, 16 and 32 ohms (permitting parallel (monaural) operation of 2 speaker systems of up to 16 ohms. **INPUT SENSITIVITY** is 0.45 volts per channel for full output. **TUBES** are 2-6AN8, 4-7189; GZ-34 rectifier. **SIZE** 9-3/16" d (10-9/16" with controls) x 5 1/4" h x 13 1/4" w. Supplied complete with perforated metal cage, all necessary parts and detailed instructions. Shpg. wt., 22 lbs.

KT-310 Stereo Power Amplifier Kit Net **47.50**



KT-310
47.50

ONLY 4.75 DOWN—
5.00 MONTHLY

STEREO REMOTE CONTROL CENTER KIT

MODEL KT-315

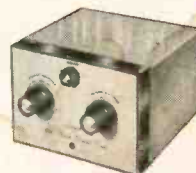

27.50

- TWO LOW NOISE 7025 DUAL-TRIODES
- POSITIVE CONTROL 50 FEET OR MORE
- BRIDGE BALANCING CIRCUIT
- OUTPUT FOR "THIRD CHANNEL"
- CLUTCH-TYPE VOLUME CONTROL

Self-powered electronic adapter with unique features including low-impedance "plate follower" outputs for remote operation of from 50 feet or more from controlled amplifier. Cross-feeding various amounts of audio from each channel eliminates objectionable "hole in the middle" effect. Phase reversal with or without channel reversal. Premium type 7025 dual triodes. Printed circuit board for easy error-free assembly. Complete with cage and simple detailed instruction manual. Size 6 1/4" x 4 1/2" x 7 1/4". Shpg. wt., 7 1/2 lbs.

KT-315 Electronic Stereo Adapter Kit (with cage) Net **27.50**

EXCITING "EXPLOR-AIR" 4 BAND RECEIVER KIT



18.50

- 4 Bands for total coverage:
- 550-1600 Kc broadcast band
- 1.7-5.0 Mc., 5.0-14 Mc., 14-30 Mc. shortwave bands
- Complete band-switching from front panel
- Built-in Big 4" PM Loud-speaker

A complete regenerative shortwave and standard broadcast set covering from 550KC to 30MC. Features include pre-wound coils, isolated chassis and freedom from shock hazard and sensitive circuitry. Perfect for amateurs, students and casual listeners. Simple to build, this kit is complete, including all parts needed and a detailed step-by-step instruction book. Shpg. wt., 8 lbs.

KT-135 EXPLOR-AIR RECEIVER KIT (less cabinet) Net **18.50**
ML-150 Leatherette, covered wooden cabinet for above Net **27.75**

NEW! LAFAYETTE STEREO AMPLIFIER KIT

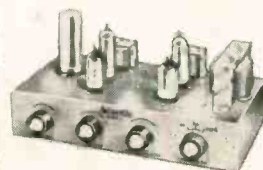

18.95

- GANGED TONE CONTROLS • STEREO-MONAURAL SWITCH • .04 VOLT SENSITIVITY • 4 WATTS STEREO OUTPUT
- ISOLATION TRANSFORMER • SEPARATE VOLUME CONTROLS

Brand new stereo amplifier kit for that extra small stereo hi-fi set, featuring separate volume controls; ganged tone control; stereo, reverse and monaural switch. 40 millivolt sensitivity! Complete kit with tubes, rectifier, all parts and instructions. Only 9 1/2" x 5" x 4 1/2". For 110-120 60 cycle AC. Shpg. wt., 7 lbs.

KT-126 — Complete Kit Net **18.95**

165-08 Liberty Ave. JAMAICA, N. Y. AXtel 1-7000

NEW YORK, N. Y.
100 6th Ave.
WOrth 6-5300

BOSTON, MASS.
110 Federal St.
HUBbard 2-7850

BRONX, N. Y.
542 E. Fordham Rd.
FORDham 7-8813

NEWARK, N. J.
24 Central Ave.
MARket 2-1661

PLAINFIELD, N. J.
139 W. 2nd St.
PLAINfield 6-4718

PLEASE INCLUDE POSTAGE WITH ORDER

NEW DIFILM[®] BLACK BEAUTY[®] MOLDED CAPACITORS

BEAT THE HEAT AND HUMIDITY!

Now Sprague's new DIFILM BLACK BEAUTY MOLDED CAPACITORS have taken the steam out of heat and humidity problems. These capacitors are so good you can *boil 'em* for 24 hours without affecting their performance.

Unlike straight polyester film tubulars, these capacitors operate in a 105°C environment *without derating*.

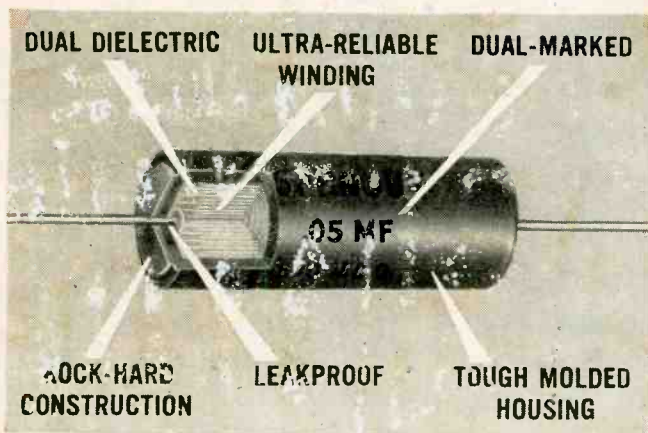

Look for the RED markings on the black case.

And the heart of these new DIFILM capacitors can't be beat. It's a dual dielectric which *combines the best advantages of both Mylar* polyester film and the highest grade of paper dielectric*. A rock-hard solid impregnant fills voids and pinholes in the film.

Talk about *reliability!* . . . these capacitors have it. DIFILM capacitors are actually low cost versions of the Sprague capacitors now being used in every modern military missile. The basic reliability and outstanding performance of missile-type Sprague capacitors are all yours in this outstanding new development. Why take chances when you can get the best—DIFILM BLACK BEAUTY MOLDED TUBULARS . . . at regular prices.

For the complete DIFILM BLACK BEAUTY story, write for Bulletin M-759 to Sprague Products Company, 81 Marshall St., North Adams, Mass.

*DuPont trademark

The major capacitor improvements
come from



SPRAGUE RESEARCH IS CONSTANTLY PRODUCING NEW AND BETTER CAPACITORS FOR YOU

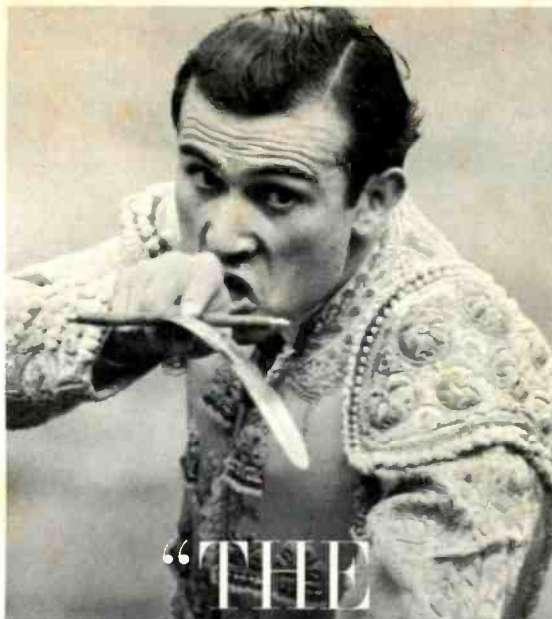

Juan Montero, matador.
From *BULLFIGHT*, by permission of
Simon and Schuster, Publishers.
Copyright © 1958 by Peter Buckley.

“THE
MOMENT
OF
TRUTH”



... for the matador — it comes when he can no longer play at the game of bravery, but must at last face up to the supreme test of his courage and greatness — when he must conquer or be conquered.

... for the turntable or changer — it comes when the stylus descends to the groove of a stereo record, to track as never before required ... vertically as well as laterally, with lighter pressure, greater accuracy, less distortion and far more sensitivity—when the operation must be silent, smooth and flawless to permit the music to emerge with clarity, purity and distinction.

Shorn of pretension and mere

paper claims, every brand, every product of old must now face up to the *new* challenge wrought by stereophonic sound. Regardless of past laurels, it is *today's* performance that counts.

The United Audio DUAL-1006 ... totally new, significantly different ... is the *only* combination professional turntable and deluxe changer created for uncompromised stereo and monophonic reproduction.

We invite you to visit your authorized United Audio dealer ... to submit the DUAL-1006 to the most demanding of tests ... to see and hear it in *its* “moment of truth.”



The DUAL-1006

combination professional turntable / deluxe changer for uncompromised stereo and mono reproduction

Actually tracks and operates automatically or manually with only 2 grams stylus pressure.

Choice of heavy, large diameter turntables* — new laminated concentrically-girded design retains dynamic balance and plano surface.

Rigid equipoise motor suspension principle eliminates vertical rumble.

Built-in direct reading stylus pressure/tracking force gauge.

Totally new design one-piece tone-arm — provides perfect vertical and lateral tracking — no multiple arm resonance or cartridge vertical amplitude distortion.

Truly freefloating tonearm — unique clutch disengagement for complete freedom.

Multiple transmission motor drive uses individual gears for each speed — automatic disengagement makes “flat spot thumping” impossible.

Stereo-mono switch has phase-cancelling feedback circuit to remove vertical noise signal from mono records played with stereo cartridge.

Obsolescence-proof intermix for present or future record sizes.

Elevator action changer spindle safeguards record grooves and centers.

True manual (or automatic) single play — permits setting tonearm on rotating or motionless turntable.

united Audio

PRODUCTS OF DISTINCTION
Desk 2, 202-4 East 19th St., New York 3, N. Y.

Please send full details to:

NAME

ADDRESS

CITY.....ZONE.....STATE.....

*3½ lb. standard; 5¼ lb. optional at small extra cost.

...he's good
because he's using the best...

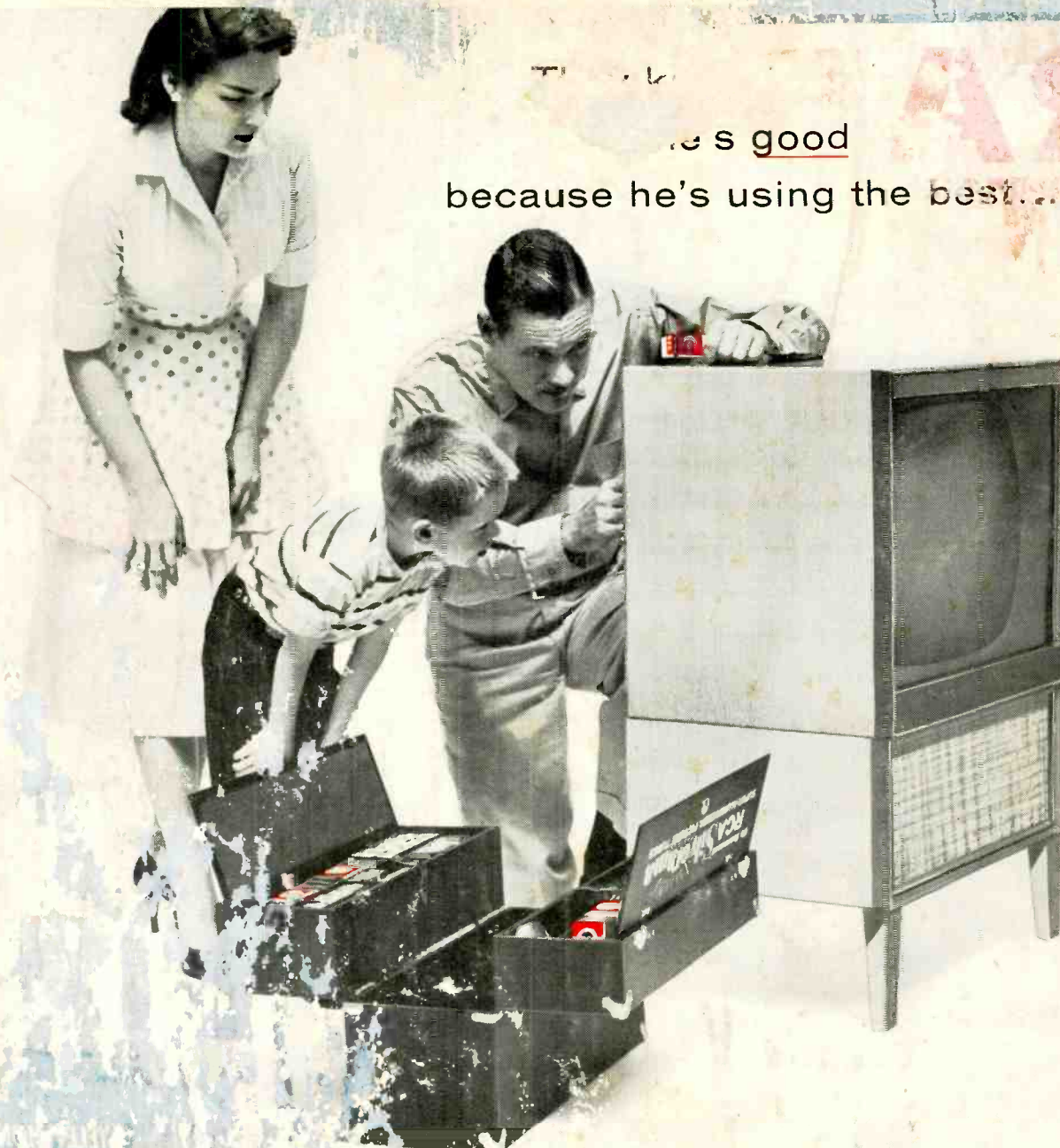

RCA RECEIVING TUBES

Do you ever look behind a TV set very often. But when they do they are usually reassuring to see the familiar red and black RCA Electron Tube Division mark. The one thing the RCA Electron Tube Division electronics and electronic products have done is to establish a name and reputation for themselves. To do this from the confidence of the consumer, they have made over in the past 20 years, "RCA Electron Tubes" a reputation which has earned a stronger position. RCA Electron Tubes are a familiar name. Next time you buy tubes, look for the RCA mark.



RADIO CORPORATION OF AMERICA
Electron Tube Division Harrison, N. J.

