

RADIO — ELECTRONICS

LATEST IN TELEVISION · SERVICING · HIGH FIDELITY

HUGO GERNSBACK, Editor

In this issue:

Oscilloscope Patterns
and
Amplifier Diagnosis

High-Quality Circuits:
Tone Compensation

U.h.f. Television
Antennas

Servicing u.h.f. TV

TV Signal Tracing
Practices and
Problems

Heterodyne Freqmeter
Uses Transistors

Automatic Headlight
Dimmer



30¢

U. S. and
CANADA



Experimental Communication with Light Beams

(See page 4)

Look at the Selling Power of the RCA Radio Battery Package

SMART RCA package design means faster sales, greater inventory turnover for radio dealers and servicemen selling RCA Radio Batteries. This outstanding package styling is another example of the powerful sales appeal of the *Radio Battery for the Radio Trade*.

Call your RCA Battery
Distributor for fast, reliable
service. Stock, sell and
promote RCA Batteries—
*the Radio Battery
for the Radio Trade.*



STEEL-ENCASED (certain types only)

Special steel casings on RCA Battery types VS216, VS236, VS036, VS035, VS084, VS085, and VS086 protect their contents—control bothersome swelling, resist leakage, and damage from shock. This important feature will help you sell more of these RCA Battery types



FAMOUS RCA MONOGRAM

Consumers everywhere recognize RCA as the "greatest name in radio." The RCA trademark stands for experience in the marketing of quality products for radio. It is your assurance of immediate customer acceptance



REPLACEMENT AID

You see, at a glance on the side of the RCA Battery carton, which portable battery types of other manufacturers it will replace. This is another way RCA Batteries help you turn every customer inquiry into a battery sale



REPEAT BUSINESS PROMOTION

Space is provided right on the RCA Battery carton for you to stamp your name and address. In this way you can advertise your own store . . . remind the battery user to come back to you for fresh replacements



SMART DESIGN

RCA Radio Batteries are colorfully styled to catch the customer's eye when displayed in store windows, on counters, in merchandisers, and on shelves. You can use this valuable design in reminding customers to buy RCA Radio Batteries



RADIO CORPORATION of AMERICA
RADIO BATTERIES
HARRISON, N. J.

ADVANCE! Raise your earning power—learn RADIO-TELEVISION-ELECTRONICS by SHOP-METHOD HOME TRAINING

GOOD JOBS AWAIT THE TRAINED RADIO-TV TECHNICIAN

There is a place for *you* in the great Radio-Television-Electronics industry when you are trained as National Schools will train you at home!

Trained technicians are in growing demand at good pay—in manufacturing, broadcasting, television, communications, radar, research laboratories, home Radio-TV service, and other branches of the field. National Schools Master Shop-Method Home Training, with newly added lessons and equipment, trains you in your spare time, right in your own home, for these fascinating opportunities. **OUR METHOD IS PROVED BY THE SUCCESS OF NATIONAL SCHOOLS TRAINED MEN, ALL OVER THE WORLD, SINCE 1905.**

EARN WHILE YOU LEARN

Many National students pay for all or part of their training with spare time earnings. We'll show you how you can do the same! Early in your training, you receive "Spare-time Work" Lessons which will enable you to earn extra money servicing neighbors' and friends' Radio and Television receivers, appliances, etc.

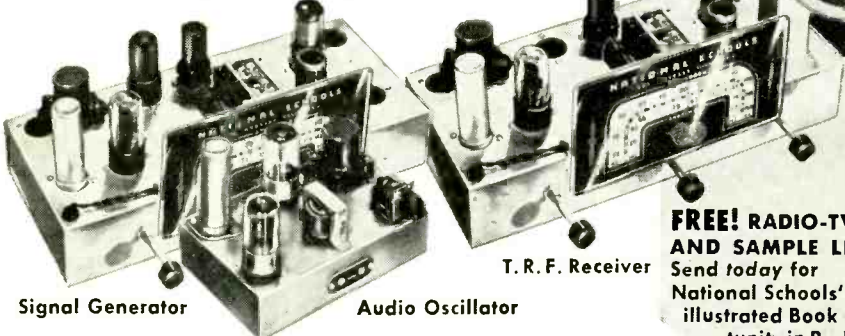

Signal Generator

Audio Oscillator

T. R. F. Receiver

National Schools Training is All-Embracing

National Schools prepares you for your choice of many job opportunities. Thousands of home, portable, and auto radios are being sold daily—more than ever before. Television is sweeping the country, too. Co-axial cables are now bringing Television to more cities, towns, and farms every day! National Schools' *complete* training program qualifies you in all fields. Read this partial list of opportunities for trained technicians:

- Business of Your Own • Broadcasting
- Radio Manufacturing, Sales, Service • Telecasting
- Television Manufacturing, Sales, Service
- Laboratories: Installation, Maintenance of Electronic Equipment
- Electrolysis, Call Systems
- Garages: Auto Radio Sales, Service
- Sound Systems and Telephone Companies, Engineering Firms
- Theatre Sound Systems, Police Radio
- And scores of other good jobs in many related fields.

TELEVISION TRAINING

You get a complete series of up-to-the-minute lessons covering all phases of repairing, servicing and construction. The same lesson texts used by resident students in our modern and complete Television broadcast studios, laboratories and classrooms!



MASTER ALL PHASES!

Get Master Shop-Method Home Training from an Established Practical Resident School with its own Training with its own Training of Successful Experience in Training Ambitious Men.



Shops, Laboratories, Studios — almost 50 Years of Successful Experience in Training Ambitious Men. **We Bring National Schools To You!**

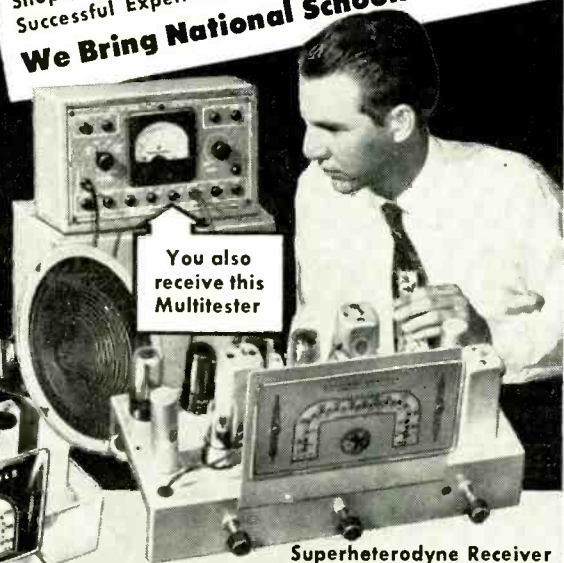

You also receive this Multitester

Superheterodyne Receiver

LEARN BY DOING

You receive and keep all the modern equipment shown above, including tubes and valuable, professional quality Multitester. *No extra charges.*

FREE! RADIO-TV BOOK AND SAMPLE LESSON!

Send today for National Schools' new, illustrated Book of Opportunity in Radio-Television-

This course also offered in Spanish and Portuguese

Electronics, and an actual Sample Lesson. No cost—no obligation. Use the coupon now—we'll answer by return airmail.

APPROVED FOR VETERANS AND NON-VETERANS
Check coupon below

Both Resident and Home Study Courses Offered!

NATIONAL SCHOOLS
LOS ANGELES 37, CALIFORNIA • ESTABLISHED 1905
IN CANADA: 193 E. HASTINGS STREET, VANCOUVER, B.C.



FIND OUT NOW—MAIL COUPON TODAY!

NATIONAL SCHOOLS, Dept. RG-103
4000 South Figueroa Street
Los Angeles 37, California

Mail in envelope or paste on postal card.

Send FREE Radio-TV Electronics book and FREE sample lesson. I understand no salesman will call on me.

NAME _____ AGE _____
ADDRESS _____
CITY _____ ZONE _____ STATE _____

- Check here if released from service less than 4 years ago.
- Check here if interested in Resident Training at Los Angeles.

RADIO - ELECTRONICS

Formerly RADIO-CRAFT • Incorporating SHORT WAVE CRAFT • TELEVISION NEWS • RADIO & TELEVISION*

Hugo Gernsback
Editor and Publisher

M. Harvey Gernsback
Editorial Director

Fred Shunaman
Managing Editor

Robert F. Scott
W2PWG, Technical Editor

Jerome Kass
Associate Editor

I. Queen
Editorial Associate

Matthew Mandl
Television Consultant

Charles A. Phelps
Copy Editor

Angie Pascale
Production Manager

Wm. Lyon McLaughlin
Tech. Illustration Director

Sol Ehrlich
Art Director

Lee Robinson
General Manager

John J. Lamson
Sales Manager

G. Aliquo
Circulation Manager

Adam J. Smith
Director, Newsstand Sales

Robert Fallath
Promotion Manager

 Member
Magazine Publishers
Association



ON THE COVER (See Page 46)
Model Rae George is here shown operating one of Leslie Gould's latest light-beam transmitters, in typical Connecticut terrain.
Color original by Avery Slack

CONTENTS

OCTOBER, 1953

Editorial (Page 33)			
Wanted:—Inertialess Speakers	by Huga Gernsback	33	
Audio—High Fidelity (Pages 34-45)			
Oscilloscope Patterns and Amplifier Diagnosis ..	by Norman H. Crowhurst	34	
High-Quality Audio, Part II (Loud Speakers)	by Richard H. Darf	37	
Extending Amplifier Bandwidth, Part II	by Joseph Marshall	40	
High-Quality Circuits (Tone and Loudness Controls) ..	by John K. Frieborn	42	
Circuit Shorts	by Robert F. Scott	44	
Broadcasting and Communications (Pages 46-47)			
Experimental Communication with Light Beams (Cover Feature)	by Eric Leslie	46	
Television (Pages 48-60)			
TV Signal Tracing	by Scala Radio Co. Engineering Staff	48	
Servicing U.H.F. TV	by Ken Kleidan	51	
Television Service Clinic	Conducted by Matthew Mandl	54	
Television—it's a Cinch	by E. Aisberg	56	
U.H.F. TV Antennas	by Abraham Hyman and James C. Sarayiotis	58	
European TV Station List	by A. V. J. Martin	60	
Servicing—Test Instruments (Pages 61-86)			
Mr. Postal Card has Selling Power	by B. W. Welz	61	
Midget Portables and Their Problems	by Paul Baller	62	
Capacitance and the Ratio Detector	by Cyrus Glickstein	78	
Short Cut Service on A.C.-D.C. Radios	by Fairbanks Tryon	84	
Amateur (Pages 88-94)			
Heterodyne Frequency Meter Uses Pair of Transistors ..	by Rufus P. Turner	88	
Construction (Pages 96-112)			
Inductance Meter Uses Heterodyne Principle		96	
Automatic Headlight Dimmer	by Jack Marley	99	
Phono Oscillator	by James R. Kaness	106	
Versatile Grid Dip Probe	by I. Queen	111	
Electronics (Pages 114-119)			
Charactron Tube has Many Commercial Applications	by S. M. Milanowski	114	
New Design (Pages 120-129)			
Understanding Mechanical Filters	by Leslie L. Burns, Jr.	120	
New Tubes		127	
Departments			
The Radio Manth	18	Technates	140
Radio Business ..	26	Miscellany	143
With the		Radio-Electronic	
Technician	130	Circuits	145
New Devices	132	Try This One	148
New Patents	138	Question Box	152
People	159	Communications	163
Electronic		Literature ..	166
Book Reviews ..	168		



MEMBER Audit Bureau of Circulations

Vol. XXIV, No. 10

RADIO-ELECTRONICS, October 1953, Vol. XXIV, No. 10. Published monthly at Erie Ave., F to G Sts., Philadelphia 32, Pa., Gernsback Publications, Inc. Entered as Second Class in September 27, 1948, at the Post Office at Philadelphia, Pa., under the Act of March 3, 1879.

SUBSCRIPTION RATES: In U. S. and Canada, in U. S. possessions, Mexico, South and Central American countries, \$3.50 for one year; \$6.00 for two years; \$8.00 for three years; single copies 30¢. All other foreign countries \$4.50 a year, \$8.00 for two years; \$11.00 for three years.

EXECUTIVE, EDITORIAL and ADVERTISING OFFICES: 25 West Broadway, New York 7, N. Y. Telephone REctor 2-8630. Gernsback Publications, Inc. Hugo Gernsback, President; M. Harvey Gernsback, Vice-President; G. Aliquo, Secretary.

SUBSCRIPTIONS: Address correspondence to Radio-Electronics, Subscription Dept., Erie Avenue, F to G Sts., Philadelphia 32, Pa., or 25 West Broadway, New York 7, N. Y. When ordering a change please furnish an address stencil impression from a recent wrapper. Allow one month for change of address.

BRANCH ADVERTISING OFFICES: Chicago: 7522 North Sheridan Road, Tel. Rogers Park 4-8000. Los Angeles: Ralph W. Harker, 1127 Wilshire Blvd., Tel. MADison 6-1271. San Francisco: Ralph W. Harker, 582 Market St., Tel. GARfield 1-2481. **FOREIGN AGENTS:** Great Britain: Atlas Publishing and Distributing Co., Ltd., London E.C.4. Australia: McGill's Agency, Melbourne. France: Brentano's, Paris 2e. Belgium: Agence et Messageries de la Presse, Brussels. Holland: Trilectron, Heenstede. Greece: International Book & News Agency, Athens. So Africa: Central News Agency, Ltd., Johannesburg; Capetown: Durban. Natal. Universal Book Agency, Johannesburg. Middle East: Stelmatsky Middle East Agency, Jerusalem. India: Broadway News Centre, Dadar, Bombay #14. Pakistan: Paradise Book Stall, Karachi 3. Copyright 1953 by Gernsback Publications, Inc. Text and illustrations must not be reproduced without permission of copyright owners. **POSTMASTER:** If undeliverable send form 3578 to: RADIO-ELECTRONICS, 25 West Broadway, New York 7, N. Y. *Trademark registered U.S. Patent Office.



ANOTHER D.T.I.

EXCLUSIVE!

Easy-to-learn-from home MOVIES help speed you toward a

PROFITABLE, BRIGHT FUTURE IN

TELEVISION
RADIO • ELECTRONICS

REAL OPPORTUNITY FOR YOU!

You use this 16 mm. Movie Projector and Films at HOME

Thanks to this exclusive D.T.I. home training aid, many important Television-Radio fundamentals quickly become "movie clear." Now you can actually see electrons on the march and other "hidden actions"—a wonderful advantage that's almost like having a teacher in your home.

RIGHT? At Home You Build and Keep this 5-INCH Oscilloscope

... one of the most useful test units in the TV-Electronic field, and almost a "must" for servicing TV sets. No need to buy a costly "scope" when you graduate. This quality, commercial-type unit will serve you for years to come.



LEFT: At Home You Build and Keep A Jewel-Bearing Multi-Meter

... an extremely handy meter. Together with the Oscilloscope, It can also help you "earn while you learn"—servicing in your spare time.



Act now!

MAIL THIS COUPON TODAY. GET THIS EXCITING PUBLICATION.

89 WAYS TO EARN MONEY IN TELEVISION RADIO-ELECTRONICS

RE-10-J

DeFOREST'S TRAINING, INC.,
2533 N. ASHLAND AVENUE,
CHICAGO 14, ILLINOIS

I would like your Opportunity Bulletin showing "89 Ways To Earn Money In Television-Radio-Electronics"; also, complete facts about the training opportunities made possible by your organization.

Name _____ Age _____
Address _____ Apt. _____
City _____ Zone _____ State _____

This great, billion dollar opportunity field now offers you a chance of a lifetime to get started toward a real job or your own profitable business. With the TV station limit now raised from over 100 to 2053, Television in the next several years will be headed for almost every community. Mail coupon today. See how you may prepare to cash in on one of the most active fields of our time.

GET STARTED this Wonderfully Practical Way

You don't have to know the first thing about Television-Radio-Electronics at present. D.T.I. supplies you at home with (a) the knowledge, (b) practical experience and (c) employment service—EVERYTHING YOU NEED to help you get started in Television-Radio-Electronics.

FIRST: You receive well-illustrated lessons.

SECOND: You use visual training movies—a great aid to helping you understand important basic points FASTER . . . EASIER . . . BETTER. D.T.I., alone, brings you this wonderful visual training method at home—the same type the armed forces, colleges and industrial organizations are using with such remarkable results.

THIRD: You get many shipments of parts for setting up your own Home Laboratory—working over 300 construction and test procedures for the practical experience you need. This includes building and keeping a 5-inch commercial-type Oscilloscope, a jewel-bearing Multi-Meter, and a big 21-INCH TV Set. D.T.I. also offers another home training, but without the TV Set.

FOURTH: Upon completing your training, you can then get the fine help of D.T.I.'s effective Employment Service—which has nationwide contacts with many employers of trained Television-Radio-Electronic men.

If preferred, you can get all your training in D.T.I.'s thoroughly equipped electronic training laboratories in Chicago. Get the complete story. We believe what we have for you will really surprise you. MAIL THE COUPON TODAY.



Build and keep this BIG DTI engineered TV set—easily converted to U.H.F.

"ONE OF AMERICA'S FOREMOST TELEVISION TRAINING CENTERS"

— Established 1931 —



MILITARY SERVICE

If subject to military service, the training information we have for you should prove very helpful.

DeFOREST'S TRAINING, INC.

AFFILIATED WITH

DeVRY Technical INSTITUTE

CHICAGO 14, ILLINOIS

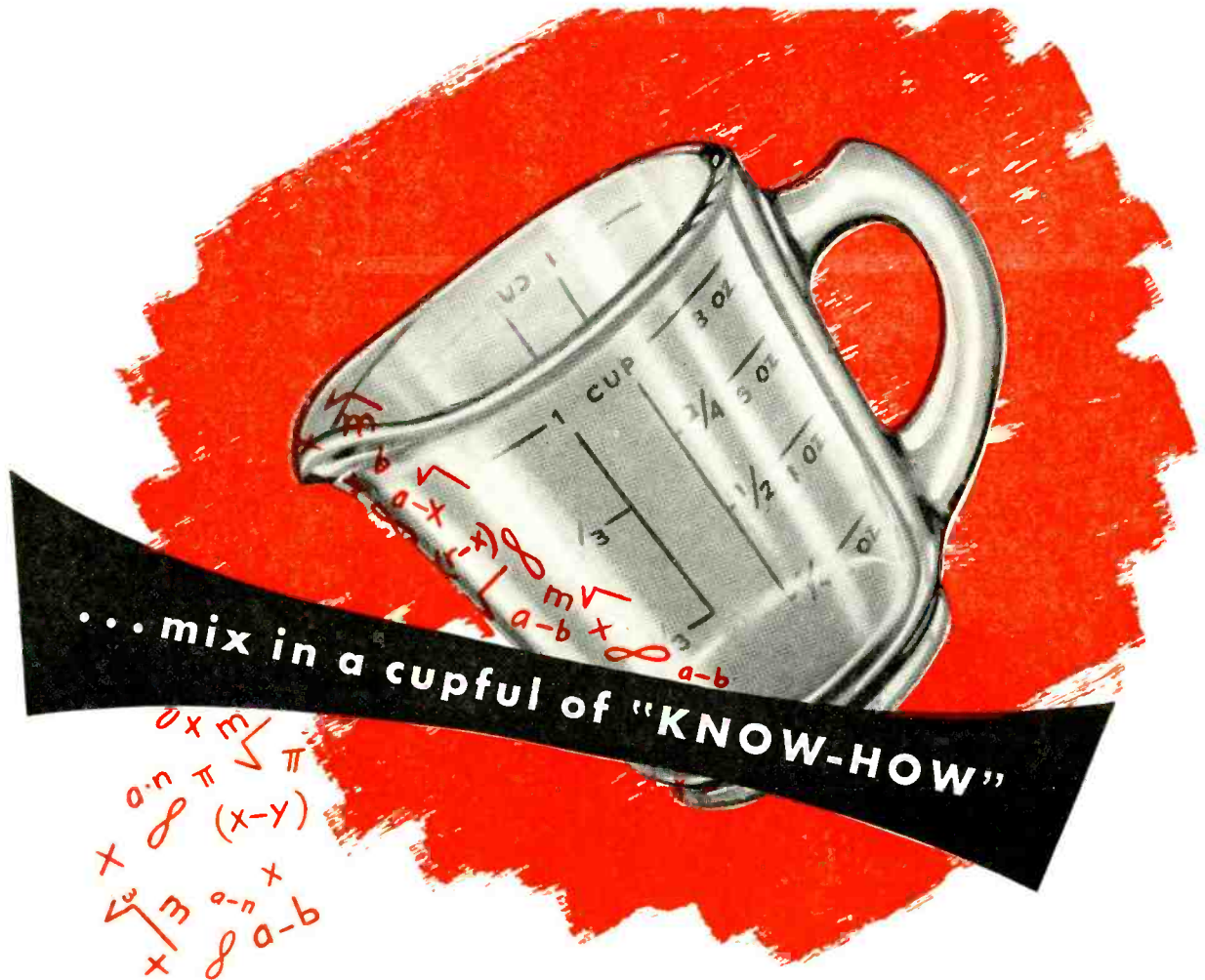

If knowledge came in containers, almost anyone could pioneer in the design and development of Electron Tubes — might even match RAYTHEON'S remarkable record of achievement in the industry.

But the kind of "know-how" that has helped RAYTHEON achieve so many industry-wide firsts, and established Raytheon Tubes as the quality standards of the industry, comes only through years of dedication to a single objective. For *thirty-years* that objective has been to *make the finest Electron Tubes in the world*. And the precious "know-how" accumulated during this period is now being used to maintain RAYTHEON TUBES' leadership in the years to come.

That's why you can use Raytheon Radio and Television Tubes — today and tomorrow — with complete confidence that you are using the finest. Ask your Raytheon Tube Distributor for them.



RIGHT ... FOR SOUND AND SIGHT



RAYTHEON MANUFACTURING COMPANY

Receiving Tube Division
 Newton, Mass., Chicago, Ill., Atlanta, Ga., Los Angeles, Calif.

Excellence in Electronics

RAYTHEON MAKES ALL THESE:

RECEIVING AND PICTURE TUBES • BEARER SUBSTITUTES AND SUBSTITUTION TUBES • CATHODINE RAY AND TRANSFORMER • BULLSEYE TUBES • TELEPHONE TUBES

RADIO-ELECTRONICS

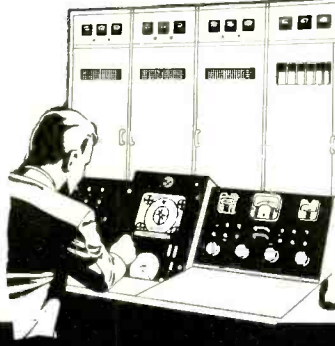

Where Will You Be in **ELECTRONICS** 6 Months from Today?



ADD TECHNICAL TRAINING to your practical experience Get Your FCC License In A Hurry!

Then Use Our Amazingly Effective JOB FINDING SERVICE

Get This Valuable Booklet **FREE**



TELLS HOW—

HERE IS YOUR GUARANTEE

If you fail to pass your Commercial License exam after completing our course, we guarantee to continue your training without additional cost of any kind, until you successfully obtain your Commercial license, provided you first sit for this examination within 90 days after completing our course.

WE GUARANTEE

TO TRAIN AND COACH YOU AT HOME IN SPARE TIME UNTIL YOU GET YOUR FCC LICENSE

If you have had any practical experience—Amateur, Army, Navy, Radio repair, or experimenting.

TELLS HOW—

TV ENGINEERING INCLUDED IN OUR TRAINING & COACHING

Our Amazingly Effective JOB-FINDING SERVICE

Helps CIRE Students Get Better Jobs Here are a few recent examples of Job-Finding results:

GETS AIRLINES JOB

"Due to your Job-Finding Service, I have been getting many offers from all over the country, and I have taken a job with Capital Airlines in Chicago, as a Radio Mechanic." Harry Clare, 4537 S. Drexel Blvd., Chicago, Ill.

GETS FIVE JOB-OFFERS FROM BROADCAST STATIONS

"Your 'Chief Engineer's Bulletin' is a grand way of obtaining employment for your graduates who have obtained their 1st class license. Since my name has been on the list, I have received calls or letters from five stations in the southern states, and am now employed as Transmitter Engineer at WMMT." Elmer Powell, Box 273, Sparta, Tenn.

GETS CIVIL SERVICE JOB

"I have obtained a position at Wright-Patterson Air Force Base, Dayton, Ohio, as Junior Electronic Equipment Repairman. The Employment Application you prepared for me had a lot to do with me landing this desirable position." Charles E. Loomis, 4516 Genesee Ave., Dayton, Ohio.

Your FCC Ticket is recognized in all radio fields as proof of your technical ability.

OURS IS THE ONLY HOME STUDY COURSE WHICH SUPPLIES FCC-TYPE EXAMINATIONS WITH ALL LESSONS AND FINAL TESTS.



GET ALL 3 FREE! MAIL COUPON NOW

TELLS HOW— Employers make JOB OFFERS Like These to Our Graduates Every Month

Letter from nationally-known Airlines, "We would also appreciate if you would place the following additional advertisement in your bulletin—Wanted—Superintendent of Communications . . . Salary \$666.66 per month."
Letter from nationally known manufacturer of high quality AM and FM transmitters, "We are very much in need at the present time of radio-electronics technicians and would appreciate any helpful suggestions that you may be able to offer. Salary up to \$412 per month to start."
These are just a few examples of the job offers that come to our office periodically. Some licensed radioman filled each of these jobs . . . it might have been you!

HERE'S PROOF FCC LICENSES ARE OFTEN SECURED IN A FEW HOURS OF STUDY WITH OUR COACHING AT HOME in Spare Time.

Name and Address	License	Lessons
Lee Worthy 2210 1/2 Wilshire St., Bakersfield, Calif.	2nd Phone	16
Clifford E. Vogl, Box 1016, Dania, Fla.	1st Phone	20
Francis X. Foerch, 39 Beuler Pl., Bergenfield, N. J.	1st Phone	38
S. Sgt. Ben H. Davis, 317 North Roosevelt, Lebanon, Ill.	1st Phone	28
Albert Schell, 110 West 11th St., Escondido, Calif.	2nd Phone	23

CLEVELAND INSTITUTE OF RADIO ELECTRONICS

CARL E. SMITH, E.E., Consulting Engineer, President
Desk RE-57, 4900 Euclid Bldg., Cleveland 3, Ohio

B I want to know how I can get my FCC ticket in a minimum of time. Send me your FREE booklet, "How to Pass FCC License Examinations" (does not cover exams for Amateur License), as well as a sample FCC-type exam and the amazing new booklet, "Money-Making FCC License Information."

Be sure to tell me about your television engineering course.

Name.....
Address.....
City..... Zone..... State.....

Paste on 2-cent postcard or send air mail.

Pre-sold to Millions!



Custom Music Ensemble



G-E DUAL COAXIAL SPEAKER
Model A1-400

New approach to coaxial speaker design—high sensitivity at low cost. Exceptional balance between speakers with G-E Acoustic Balancer. Newly developed Pressure Equalizer . . . a wavefront shaping plug . . . provides smooth tweeter response.

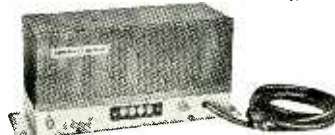

G-E POWER AMPLIFIER
Model A1-300

A medium power, compact amplifier designed to provide needed speaker power. Essential element in the new General Electric "Custom Music" Ensemble. Delivers high-fidelity performance at very low cost.



G-E PREAMPLIFIER-CONTROL UNIT
Model A1-200

Combines functions of equalized pre-amplifier plus adjustable record compensation, program input selection, tone controls and volume control. Matching unit for the "Custom Music" amplifier. Self-powered for use with any installation.



G-E DELUXE TONE ARMS
A1-500 (12") A1-501 (16")

For home or broadcast station use. Compatible with the exceptional quality of G-E cartridges. Calibrated stylus pressure adjustment . . . 4 to 14 grams. They were developed to improve record reproduction in every installation.

G-E SPEAKER ENCLOSURE
Model A1-406 (6 cu. ft.)

Attractive corner or wall cabinet in hand-rubbed blond or mahogany veneers. "Distributed port" design provides full low frequency response. Tonal range with G-E Coaxial Speaker—40 to 15,000 cycles.

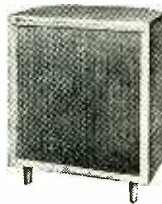

**FOR SUPERIOR PERFORMANCE...
LOW COST...MINIMUM SERVICE...
INSTALLATION ECONOMY!**

● Through the pages of nine top consumer magazines . . . in display rooms . . . on FM broadcasts . . . and at shows millions are discovering —indicating a preference for—the unique features of a G-E Custom Music Ensemble. Here is the single package of *matched high-fidelity equipment* you need to expand your audio business, assure satisfied customers. Get in tune today with the growing popularity of custom audio installations . . . add to your net profit . . . with complete General Electric equipment!

Individual components or the complete ensemble now available! Call a local G-E distributor or write for information.

SEND FOR COMPLETE INFORMATION

General Electric Company, Section 45103
Electronics Park, Syracuse, N. Y.

Please send me specifications and other data on the new G-E Custom Music Ensemble.

NAME.....

ADDRESS.....

CITY.....STATE.....

You can put your confidence in—

GENERAL  ELECTRIC

Get in on the TV boom...

starting today!

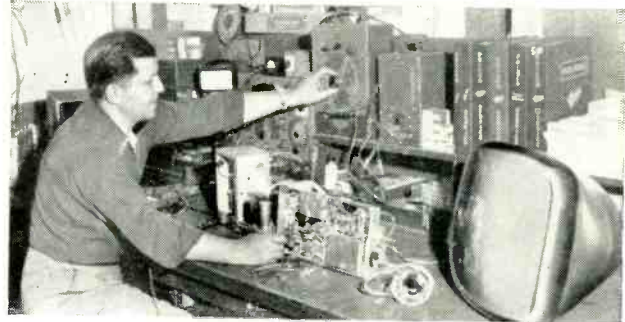
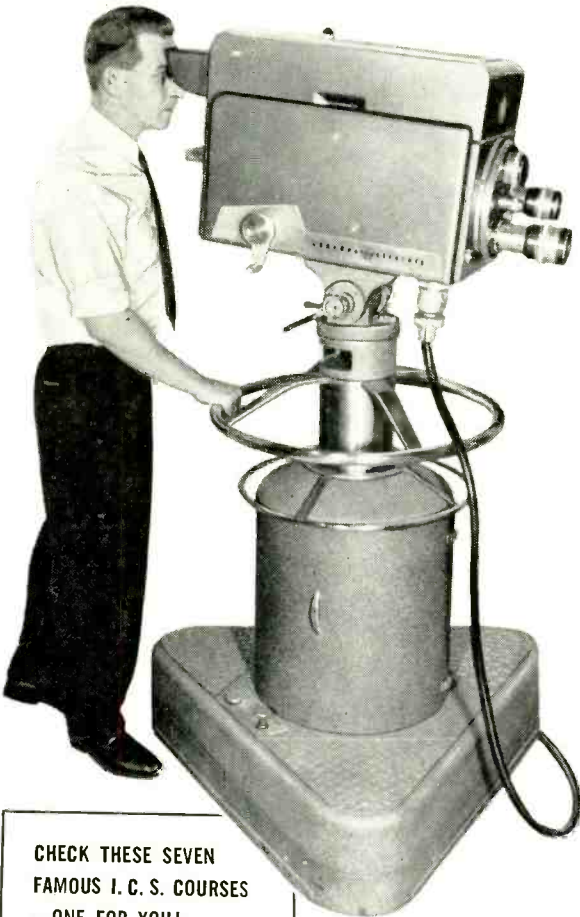

• Prepare now for the new Radio-TV-Electronics boom. Get in on VHF and UHF . . . aviation and mobile radio . . . color TV . . . binaural sound! The International Correspondence Schools can help you!

If you've ever thought about Radio or Television as a career . . . if you have the interest, but not the training . . . if you're waiting for a good time to start . . . NOW'S THE TIME!

No matter what your previous background, I.C.S. can help you. If Radio-TV servicing is your hobby, I.C.S. can make it your own profitable business. If you're interested in the new developments in Electronics, I.C.S. can give you the basic courses of training you need. If you have the job but want faster progress, I.C.S. can qualify you for promotions and pay raises.

I.C.S. training is *success-proved* training. Hundreds of I.C.S. graduates hold top jobs with top firms like R.C.A., G.E., DUMONT, I.T.&T. Hundreds of others have high ratings in military and civil service. Still others have successful businesses of their own.

With I.C.S., you get the rock-bottom basics and theory as well as the all-important bench practice and experimentation. You learn in your spare time—no interference with business or social life. You set your own pace—progress as rapidly as you wish.

Free career guidance: Send today for the two free success books, the 36-page "How to Succeed" and the informative catalog on the course you check below. No obligation. Just mark and mail the coupon. With so much at stake, you owe it to yourself to act—and act fast!

CHECK THESE SEVEN FAMOUS I. C. S. COURSES —ONE FOR YOU!

- PRACTICAL RADIO-TELEVISION ENGINEERING**—Foundation course for radio-television career. Basic principles plus advanced training. Radio, Sound, TV.
- TELEVISION TECHNICIAN**—To qualify you for high-level technical positions in television. Camera, studio, transmitter techniques. Manufacture, sale and installation of TV equipment.
- TELEVISION RECEIVER SERVICING**—Installation, servicing, conversion Dealership. For the man who knows about radio and wants TV training.
- RADIO & TELEVISION SERVICING**—Designed to start you repairing, installing and servicing radio and television receivers soon after starting the course.
- RADIO & TELEVISION SERVICING WITH TRAINING EQUIPMENT**—Same as above but with addition of high-grade radio servicing equipment and tools.
- RADIO OPERATING COURSE**—Special course to help you pass the Government examination for operator's licenses. Code, TV, FM, Radio regulations.
- INDUSTRIAL ELECTRONICS**—Broad, solid background course devoted to the electron tube and to its many applications.

INTERNATIONAL CORRESPONDENCE SCHOOLS



BOX 2880-J, SCRANTON 9, PENNA.

Without cost or obligation, send me "HOW to SUCCEED" and the booklet about the course BEFORE which I have marked X:

- | | | | | |
|---|---|---|---|--|
| <ul style="list-style-type: none"> <input type="checkbox"/> ART <input type="checkbox"/> Commercial Art <input type="checkbox"/> Magazine and Book Illustrating <input type="checkbox"/> Cartooning <input type="checkbox"/> Show Card and Sign Lettering <input type="checkbox"/> Fashion Illustrating <input type="checkbox"/> AUTOMOTIVE <input type="checkbox"/> Automobile, Mechanic <input type="checkbox"/> Auto-Elec. Technician <input type="checkbox"/> Auto Body Rebuilding and Refinishing <input type="checkbox"/> Diesel—Gas Engines <input type="checkbox"/> AVIATION <input type="checkbox"/> Aeronautical Engineering Jr. <input type="checkbox"/> Aircraft Engine Mechanic <input type="checkbox"/> Airplane Drafting <input type="checkbox"/> BUILDING <input type="checkbox"/> Architecture <input type="checkbox"/> Arch. Drafting <input type="checkbox"/> Building Contractor <input type="checkbox"/> Estimating <input type="checkbox"/> Carpenter and Mill Work <input type="checkbox"/> Carpenter Foreman <input type="checkbox"/> Reading Blueprints <input type="checkbox"/> House Planning <input type="checkbox"/> Plumbing | <ul style="list-style-type: none"> <input type="checkbox"/> Heating <input type="checkbox"/> Steam Fitting <input type="checkbox"/> Air Conditioning <input type="checkbox"/> Electrician <input type="checkbox"/> BUSINESS <input type="checkbox"/> Business Administration <input type="checkbox"/> Certified Public Accountant <input type="checkbox"/> Accounting <input type="checkbox"/> Bookkeeping <input type="checkbox"/> Stenography and Typing <input type="checkbox"/> Secretarial <input type="checkbox"/> Federal Tax <input type="checkbox"/> Business Correspondence <input type="checkbox"/> Personnel and Labor Relations <input type="checkbox"/> Advertising <input type="checkbox"/> Retail Business Management <input type="checkbox"/> Managing Small Business <input type="checkbox"/> Sales Management <input type="checkbox"/> Salesmanship <input type="checkbox"/> Traffic Management <input type="checkbox"/> CHEMISTRY <input type="checkbox"/> Chemical Engineering <input type="checkbox"/> Chemistry <input type="checkbox"/> Analytical Chemistry <input type="checkbox"/> Petroleum—Nat'l Gas <input type="checkbox"/> Pulp and Paper Making <input type="checkbox"/> Plastics | <ul style="list-style-type: none"> <input type="checkbox"/> CIVIL, STRUCTURAL ENGINEERING <input type="checkbox"/> Civil Engineering <input type="checkbox"/> Structural Engineering <input type="checkbox"/> Surveying and Mapping <input type="checkbox"/> Structural Drafting <input type="checkbox"/> Highway Engineering <input type="checkbox"/> Reading Blueprints <input type="checkbox"/> Concrete Construction <input type="checkbox"/> Sanitary Engineering <input type="checkbox"/> DRAFTING <input type="checkbox"/> Aircraft Drafting <input type="checkbox"/> Architectural Drafting <input type="checkbox"/> Electrical Drafting <input type="checkbox"/> Mechanical Drafting <input type="checkbox"/> Structural Drafting <input type="checkbox"/> Sheet Metal Drafting <input type="checkbox"/> Mine Surveying and Drafting <input type="checkbox"/> ELECTRICAL <input type="checkbox"/> Electrical Engineering <input type="checkbox"/> Electrician <input type="checkbox"/> Electrical Maintenance <input type="checkbox"/> Electrical Drafting <input type="checkbox"/> Electric Power and Light <input type="checkbox"/> Lineman <input type="checkbox"/> HIGH SCHOOL <input type="checkbox"/> High School Subjects | <ul style="list-style-type: none"> <input type="checkbox"/> College Preparatory <input type="checkbox"/> Mathematics <input type="checkbox"/> Commercial <input type="checkbox"/> Good English <input type="checkbox"/> MECHANICAL AND SHOP <input type="checkbox"/> Mechanical Engineering <input type="checkbox"/> Industrial Engineering <input type="checkbox"/> Industrial Supervision <input type="checkbox"/> Foremanship <input type="checkbox"/> Mechanical Drafting <input type="checkbox"/> Machine Design-Drafting <input type="checkbox"/> Machine Shop Practice <input type="checkbox"/> Tool Design <input type="checkbox"/> Industrial Instrumentation <input type="checkbox"/> Machine Shop Inspection <input type="checkbox"/> Reading Blueprints <input type="checkbox"/> Toolmaking <input type="checkbox"/> Gas—Electric Welding <input type="checkbox"/> Heat Treatment—Metallurgy <input type="checkbox"/> Sheet Metal Work <input type="checkbox"/> Sheet Metal Pattern Drafting <input type="checkbox"/> Refrigeration <input type="checkbox"/> POWER <input type="checkbox"/> Combustion Engineering <input type="checkbox"/> Diesel—Electric <input type="checkbox"/> Electric Light and Power | <ul style="list-style-type: none"> <input type="checkbox"/> Stationary Steam Engineering <input type="checkbox"/> Stationary Fireman <input type="checkbox"/> RADIO, TELEVISION, COMMUNICATIONS <input type="checkbox"/> General Radio <input type="checkbox"/> Radio Operation <input type="checkbox"/> Radio Servicing—FM <input type="checkbox"/> Television <input type="checkbox"/> Electronics <input type="checkbox"/> Telephone Work <input type="checkbox"/> RAILROAD <input type="checkbox"/> Locomotive Engineer <input type="checkbox"/> Cotton Manufacture <input type="checkbox"/> Air-Brakes <input type="checkbox"/> Car Inspector <input type="checkbox"/> Railroad Administration <input type="checkbox"/> TEXTILE <input type="checkbox"/> Textile Engineering <input type="checkbox"/> Woolen Manufacture <input type="checkbox"/> Rayon Manufacture <input type="checkbox"/> Woollen Manufacture <input type="checkbox"/> Loom Fixing <input type="checkbox"/> Finishing and Dyeing <input type="checkbox"/> Textile Designing |
|---|---|---|---|--|

Name _____ Age _____ Home Address _____

City _____ Zone _____ State _____ Working Hours _____ A.M. to _____ P.M.

Occupation _____

Special tuition rates to members of the U. S. Armed Forces. Canadian residents send coupon to International Correspondence Schools Canadian, Ltd., Montreal, Canada.

Versatile!

NEW!

Exclusive!

PHILCO[®] Cross Dot TV Linearity Pattern Generator

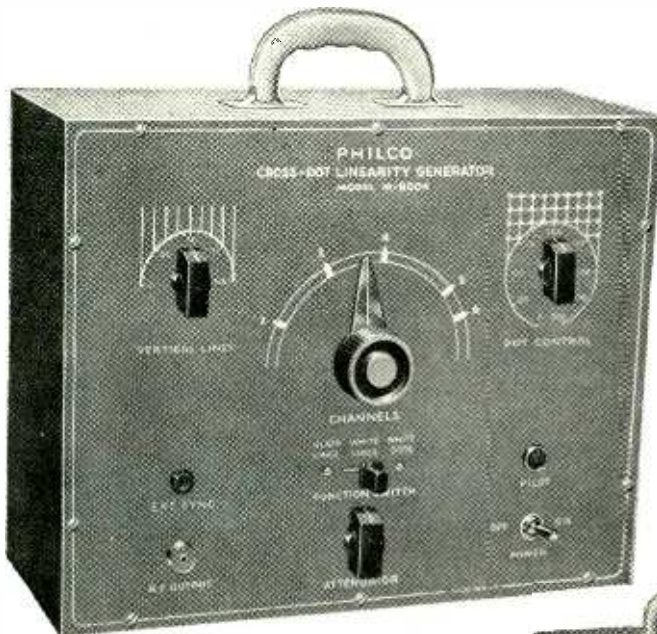

Model G-8004

Specifications: — Self stabilized oscillator • Variable output frequencies • Power consumption approximately 10 watts • Power supply—105-125 Volts, 60 cycles • large easy-to-tune dial • high level output controllable with variable attenuator.

PHILCO
Test Equipment
Specifically Designed for the Serviceman

More Stable Operation at
1/3 the Cost
of Comparable Generators

Again . . . Philco leads the field! For the finest possible linearity adjustments without station pattern, here is the all new *cross dot* linearity pattern generator. This unit not only lets you make TV linearity adjustments more quickly and accurately but also permits precise routine adjustments and trouble shooting with amazing economy of operation . . . Light, rugged, portable, heavy gauge steel case . . . finished in durable gray hammertone . . . See your Philco distributor now or write Philco, Accessory Division, "A" & Allegheny, Philadelphia, Pa.

*Now Yours on New
Special Payment Plan*



Model M-8104—TV Field Strength Meter • Offers more features than any unit at this popular price . . . Super Colorado Tuner for low noise and high gain . . . May be used to check TV boosters, antenna combinations, interfering signals and picture signal strength.



Model 7008—Visual alignment Generator • Combines in one economical unit functions ordinarily found only in a cumbersome collection of costly devices . . . Includes extra sensitive built-in oscilloscope . . . AM, FM, and audio generators. Sweep output flat to within .2 DB/MC.

NO EXPERIENCE NECESSARY!
LEARN TELEVISION AT HOME
IN YOUR SPARE TIME!

L. C. Lane, B.S., M.A.
 President: Radio-Television Training Association
 Executive Director: Pierce School of Radio & Television



VETERANS! CIVILIANS!
PREPARE FOR A BRIGHTER FUTURE
AS A TRAINED TV TECHNICIAN!

Thousands of new jobs in TV are opening up in every state as new stations go on the air. You too can take your place in America's booming TELEVISION and Electronics industries... enjoy the success and happiness you always wanted. Keep your present job while I prepare you *at home* for a life-time career as a trained TV Technician. You "learn-by-doing" with the actual parts and equipment I send you... the same successful methods that have helped hundreds of men—many with no more than grammar school training—master television!

ENOUGH EQUIPMENT TO SET UP YOUR HOME LABORATORY!

As part of your training, I give you ALL the equipment you need to prepare for a BETTER PAY TV job. You build and keep a professional GIANT SCREEN TV RECEIVER complete with big picture tube (designed and engineered to take any size up to 21-inch)... also a Super-Het Radio Receiver, RF Signal Generator, Combination Voltmeter-Ammeter-Ohmmeter, C-W Telephone Transmitter, Public Address System, AC-DC Power Supply. Everything supplied including all tubes.

VETERANS!

MY SCHOOLS FULLY APPROVED TO TRAIN VETERANS UNDER NEW G.I. BILL! If discharged after June 27, 1950 — CHECK COUPON! Also approved for RESIDENT TRAINING in New York City... qualifies you for full subsistence allowance up to \$160 per month.

ADVANCED FM-TV TECHNICIAN TRAINING!

My FM-TV Technician Course can save you months of training if you have previous Armed Forces or civilian radio experience! Train at home with kits of parts, plus equipment to build BIG SCREEN TV RECEIVER, and FREE FCC Coaching Course! ALL FURNISHED AT NO EXTRA COST!

NEW! PRACTICAL TV CAMERAMAN & STUDIO COURSE!



(For men with previous radio & TV training)

I train you at home for an exciting high pay job as the man behind the TV camera. Work for TV stars in TV studios or "on location" at remote pick-ups! Course includes one week of actual work with TV CAMERAS and STUDIO EQUIPMENT at our associate resident school in New York City AT NO EXTRA COST!

FREE FCC COACHING COURSE!

QUALIFIES YOU FOR HIGHER PAY! Given to all my students AT NO EXTRA COST after TV Theory and Practice is completed. Helps you qualify for the TOP JOBS in Radio-TV that demand an FCC License! Full training and preparation at home for your FCC License.

At No Extra Cost! You Get A ROUND TRIP TO NEW YORK CITY
Only RTTA Makes This Amazing Offer!

Yes... FROM ANYWHERE IN THE U.S. OR CANADA — I pay your way to New York and return, PLUS 2 FREE WEEKS of advanced instruction and shop training at the PIERCE SCHOOL OF RADIO & TELEVISION! Available at NO EXTRA COST to all students enrolled for complete Radio-TV Technician Course after home study training is completed.

RADIO-TELEVISION TRAINING ASSOCIATION
 1629 Broadway, Radio City Station, New York City 19, N. Y.
 LICENSED BY THE STATE OF NEW YORK

GOOD SPARE TIME EARNINGS!

Almost from the very start you can earn extra money while learning, repairing Radio-TV sets for friends and neighbors. Many of my students earn up to \$25 a week... pay their entire training from spare time earnings... start their own profitable service business. Act now! Mail coupon and find out for yourself what a TV career can do for you!

MAIL COUPON TODAY!

MY 4 FREE AIDS SHOW YOU HOW AND WHERE TO GET A BETTER PAY JOB IN TELEVISION! See for yourself how my simple, practical methods make success easy.



NO SALESMAN WILL CALL!

Mr. Leonard C. Lane, President
 RADIO-TELEVISION TRAINING ASSOCIATION
 1629 Broadway, New York 19, N. Y. Dept. R-10A

Dear Mr. Lane: Mail me your: NEW FREE BOOK, FREE SAMPLE LESSON, and FREE aids that will show me how I can make BIG MONEY IN TELEVISION. I understand I am under no obligation and no salesman will call.

(PLEASE PRINT PLAINLY)

NAME _____ AGE _____
 ADDRESS _____
 CITY _____ ZONE _____ STATE _____

I AM INTERESTED IN:

- Radio-TV Technician Course
 - FM-TV Course
 - TV Cameraman & Studio Course
- VETERANS!** Check here for Training under NEW G.I. Bill

Revolutionary SUPEROTOR[®]

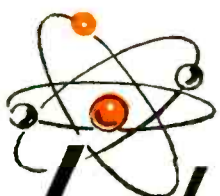

Leader Design gives you

FIVE FIRSTS—Five exclusive sales features

Now! — a new name, and a great new standard of quality and performance in antenna rotators! With FIVE major advances, SUPEROTOR overnight has shot years ahead of the entire field! For the consumer, SUPEROTOR means superb new control and recep-

tion. For the serviceman — a remarkable new ease in servicing. And for the distributor — the "plus" business that comes from handling a unit that wins cheers **all the way down the line**. SUPEROTOR will be available in your area soon. Don't miss it!

5 DYNAMIC NEW ENGINEERING FEATURES . . .

1



QUICK DETACHABLE DRIVE UNIT

Complete drive unit can be replaced in five minutes — by one man, without dismantling antenna. When necessary antenna can be locked in any desired direction with drive unit removed.

A **Leader** First!

2

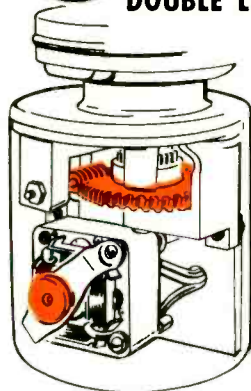

DOUBLE LOCK STOP PREVENTS DRIFT AND COAST

Worm gear lock positively maintains antenna in desired position — no drift. Motor brake prevents transfer of motor inertia to antenna — no coast. Permits smallest increment movement of antenna for precision tuning.

A **Leader** First!

3

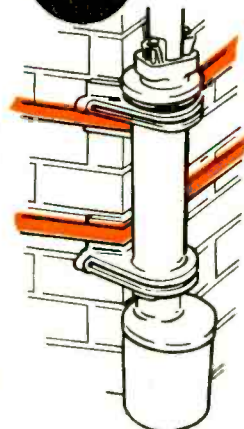

Plus These Other Outstanding Features

- Antenna position readable without rotating antenna
- Operates at upwards of 350 feet from control point
- Dependable high-torque motor
- Wide-span double ball bearing supports



2925 EAST 55TH ST., CLEVELAND 27, OHIO
LEADING THE WAY TO BETTER PRODUCTS

New

Hits TV Industry

Years ahead
of Anything
on the market

BUILT-IN CHIMNEY MOUNT DESIGN

Eliminates need for stub mast assembly. Mounts directly on chimney, and below chimney crown, protecting drive unit from soot and corrosive fumes.

A **Leader** First!

4 STEEL REINFORCED CONSTRUCTION

Entire aluminum rotator housing and antenna supports are maintained with steel. Thus, strength of steel is combined with lightness of aluminum.

A **Leader** First!

5

VP TUNING

Only the Superotor with double lock stop, permits "finger tip" Vernier Precision tuning.

A **Leader** First!

Patent
Applied for

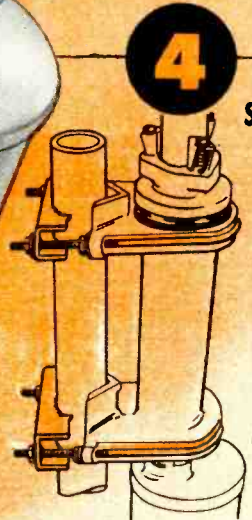
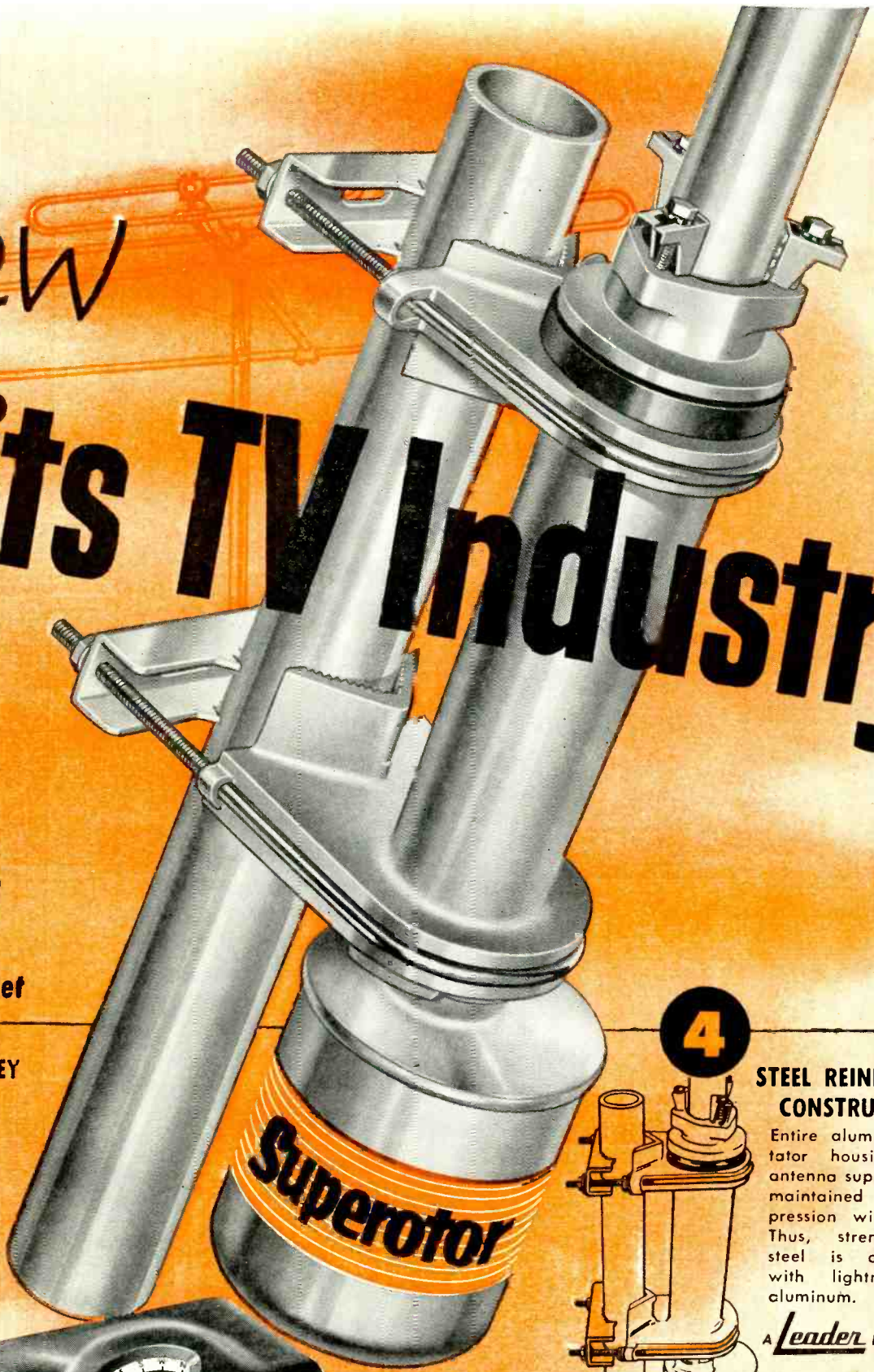

TRIPPLET 630 Volt-Ohm-Mil-Ammeter

"speaks" for itself in any company



TRIPPLET 630 Volt - Ohm - Mil - Ammeter has many significant advantages and features that make it stand distinctly apart from similar instruments in its price class. Actually in components, in engineering, in minutely accurate performance, Triplet 630 closely approaches laboratory standards.

Since the scales of any VOM comprise the means by which it makes its multiple services most valuable, the legibility and easy-read-ability are of prime importance. Triplet engineers have created in Triplet 630 the longest scales available in this size tester. (The upper arc by actual measurement is four and three-eighths inches.)

This long-scale factor accounts for the ease with which precise readings are easily made. Further legibility is gained by use of black and red scale markings. D.C. and D.B. are black and white. A.C. and Ohm markings are red on white. Ohms from one hundred million to one-tenth ohm mark the range of this amazing scale. On low ohms, center scale reading is 4.5 ohms.

The Single Switch

Further indication of the practical skill and engineering "know-how" behind Triplet 630 is the Single Switch. Its simplicity of operation assures no burn-outs thru momentary memory lapses. There is instant switch-

ing to desired circuit thru a single 2½" knob flush with the face panel. The molded switch itself embodies the most advanced engineering practices. Fully enclosed, the silvered contacts are kept permanently clean. Its rugged construction means stronger performance and longer life.

These two factors are but samples of the many ways in which on-the-job needs have been anticipated and provided for in a beautiful streamlined tester. It provides A.D-D.C. Volts, D.C. Micro-amperes, Milli-amperes, Amperes, Ohms, Megohms, Decibel and Out Put readings in a no-short design embodying interior construction with all direct connections; no harness cabling. Its fool-proof unit switch construction houses precision resistors in insulated recesses in direct connection with switch contacts.

Study the following Ranges and descriptions and compare them point by point with *any* similar instrument for conclusive proof that Triplet 630 "speaks" for itself in *any* company.

Ranges

D.C. Volts: 0-3-12-60-300-1200—at 20,000 Ohms/Volt (For Greater Accuracy on TV and other High Resistance Circuits.)
A.C. Volts: 0-3-12-60-300-1200-6000—at 5,000 Ohms/Volt (For Greater Accuracy in Audio and other High Impedance A.C. Circuits.)
Decibels: -30, +4, +16, +30, +44, +56, +70. (For Direct Reading of Output Levels.)
D.C. Microamperes: 0-60—at 250 Millivolts.
D.C. Milliampers: 0-1.2-12-120—at 250 Millivolts.
D.C. Amperes: 0-12—at 250 Millivolts.
***Ohms:** 0-1,000-10,000—(4.4-44 at center scale).
***Megohms:** 0-1-100—(4,400-440,000 center scale).
Output: Condenser in series with A.C. Volt ranges.

**Resistance ranges are compensated for greatest accuracy over wide battery voltage variations. Series Ohmmeter circuits for all ranges to eliminate possibility of battery drain when leaving switch in Ohms position.*

Get a Triplet 630 into your own hands at your distributor.
 U.S.A. Dealer Net \$3950

TRIPPLET ELECTRICAL INSTRUMENT COMPANY
 BLUFFTON, OHIO

TRIPPLET

ANOTHER CBS-HYTRON CTS-RATED* FIRST

***CTS-RATED:** Rated for Continuous Television Service. In TV receivers, five tubes work . . . like transmitting tubes . . . *hard!* You know them: rectifiers, deflection amplifiers, damper diode. Larger-screen sets aggravate the problem. CBS-Hytron recognizes your need for huskier tubes for these sockets. Brand-new designs, not just improved tubes. CTS-Rated 5AW4 already answers your 5U4G low-voltage rectifier problem. Here is your new replacement for the 6BQ6GT: The new CTS-Rated 6CU6. Yes, more CBS-Hytron CTS-Rated tubes are coming. Watch for them.

FORGET: } RUN-AWAY PLATE CURRENT
HIGH-VOLTAGE ARC-OVERS
SHRINKING TV PICTURES

Replace 6BQ6GT with New Work-Horse

CBS-HYTRON 6CU6

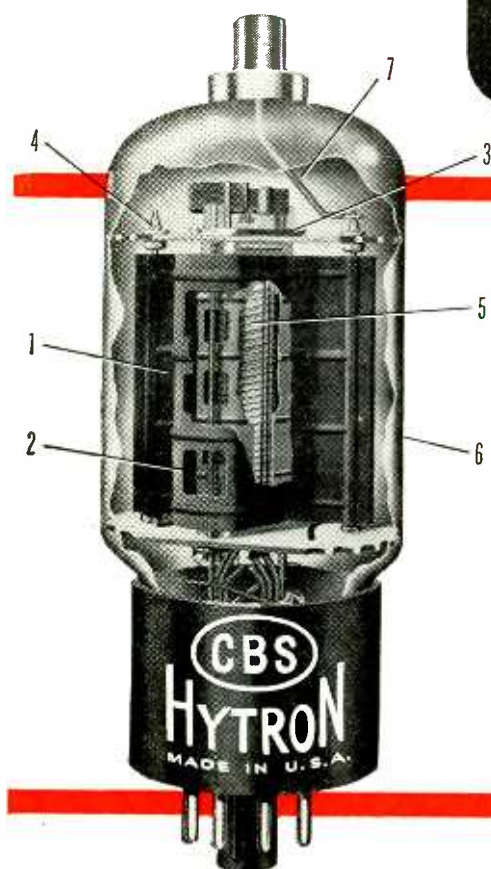
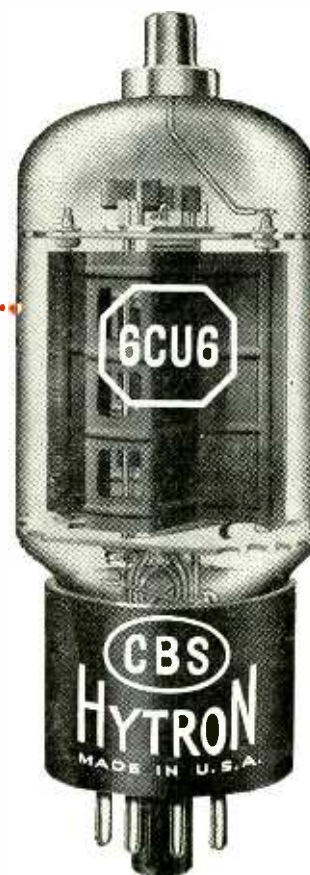

MECHANICAL FEATURES OF 6CU6

1. Heavier-gauge plate with large radiating fins.
2. Vents in beam plates and plate aligned for maximum radiation of heat from grids.
3. Anti-arc rings for uniform distribution of electrostatic field.
4. Anti-arc micro eyelets.
5. Gold-plated control grid to kill primary emission.
6. T-12 transmitting-type bulb.
7. Plate connection: "hard-soldered" and positioned to reduce heat conduction and arcing.

Cut your call-backs by up to 40 per cent with CBS-Hytron 6CU6. It's directly interchangeable with the 6BQ6GT. It's rated the same as the 6BQ6GT. *But* the new CTS-Rated 6CU6 will *live* under 6BQ6GT maximum ratings. How? The 6CU6 has generous *margins of safety* for: plate dissipation . . . plate current . . . high-voltage insulation . . . and high-line protection.

The older 6BQ6GT is a good tube. But remember it was originally designed for 10- and 12-inch TV sets. Today it carries the load in 21-inch sets. Furthermore, it must combat the accumulated dissipation caused by: line-voltage variations . . . faulty receiver adjustment . . . and shifting values of components due to age and overload. Result: the 6BQ6GT may actually be operated well above its maximum ratings in many TV receivers.

In the new CBS-Hytron 6CU6, you have a tube that takes this rough treatment. And continues to ask for more. High voltage and heat meet their match. The weakest link in the TV tube line-up becomes the strongest. And your call-backs plunge downward. Bet you can't wait to try the CTS-Rated 6CU6. We couldn't. It's a honey! Watch for it soon at your CBS-Hytron distributor's.



Manufacturers of
Receiving Tubes Since 1921



CBS-HYTRON Main Office: Danvers, Massachusetts

A Division of Columbia Broadcasting System, Inc.

A

NEW

TWIST

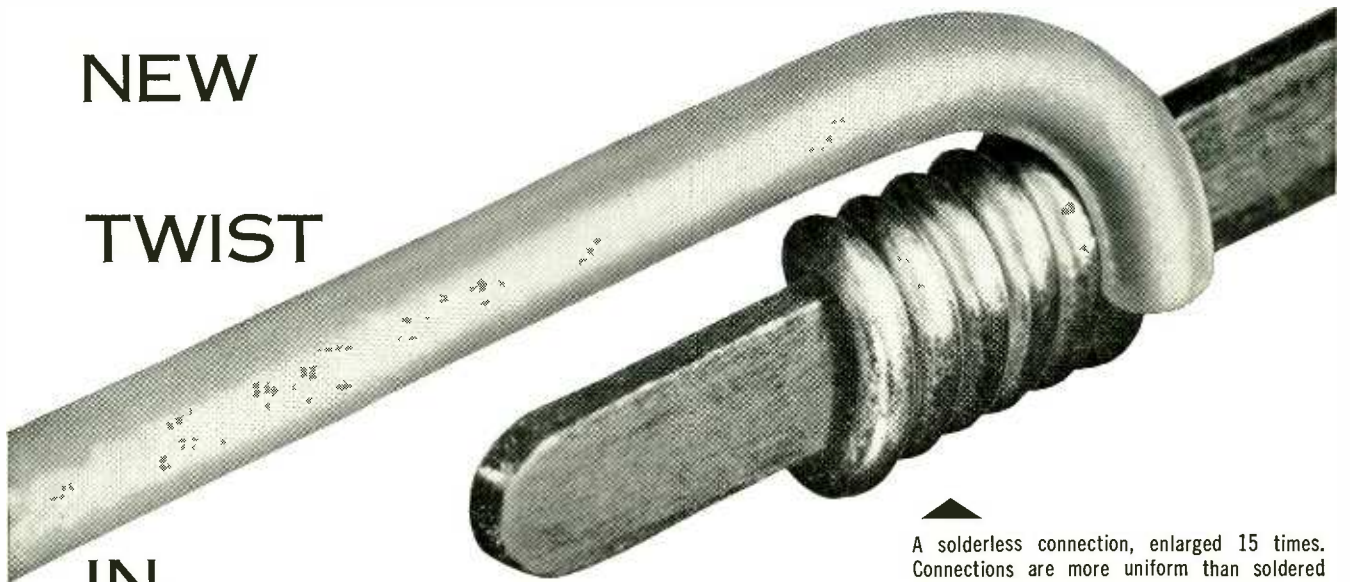

IN

TELEPHONY

A solderless connection, enlarged 15 times. Connections are more uniform than soldered ones and only half as bulky.

For years the accepted way to connect wires to telephone apparatus was with solder. Now, Bell Laboratories engineers have discovered how to make connections faster and better—without solder.

Solder, they reasoned, wouldn't be needed if wire and terminal could be kept tightly pressed together. But, for economy, this had to be done with the wire alone—without complicating screws and springs.

They found the answer in using a properly dimensioned terminal with sharp edges . . . whipping the wire around it under high tension. The terminal bites into the wire, locking it securely into position. Thereafter the squeezed edges maintain a contact pressure of at least 15,000 pounds per square inch—even under vibration that cracks soldered joints.

The new connections can be made in half the time—a big money-saver in the billion connections that Western Electric makes each year for the Bell System. It's another example of the way Bell Telephone Laboratories works continually to keep costs low.

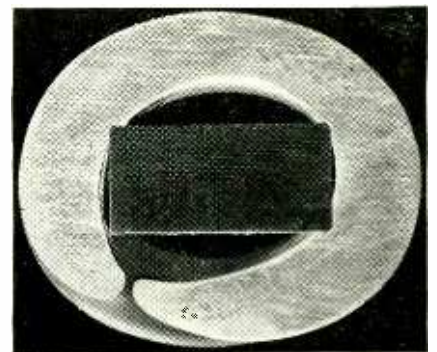

Cross section of solderless connection. Note terminal biting into wire. In a six-turn connection there are at least 20 clean contact areas impervious to moisture and corrosive gases, offering current a low resistance path.

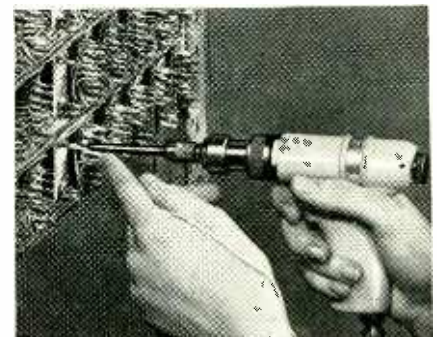

Power tool whips wire on terminal in fraction of a second. There is no heat which could damage miniature components . . . no dropped solder or wire clippings to cause trouble later.

BELL TELEPHONE LABORATORIES

IMPROVING TELEPHONE SERVICE FOR AMERICA PROVIDES
CAREERS FOR CREATIVE MEN IN MECHANICAL ENGINEERING



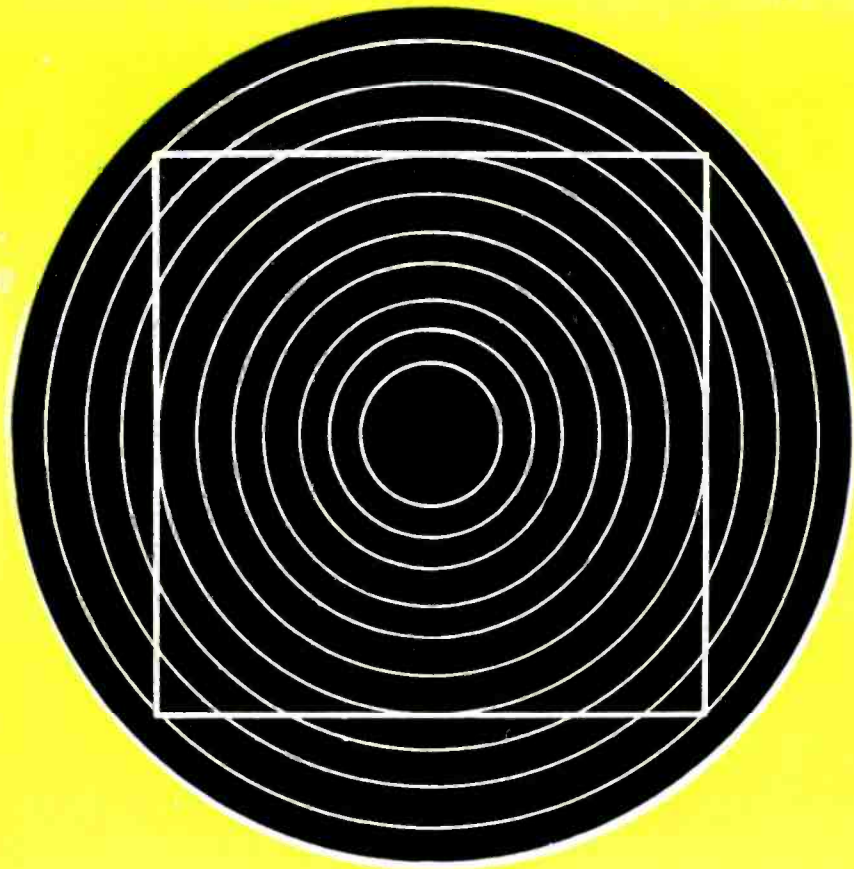

things are NOT as they seem . . .

This is a perfect square within the circle — it is an optical illusion that the sides bend.



Things are not as they seem . . .
These two fuses look alike . . .
But they are not.



This fuse may burn out anywhere along the length of the filament even in the cap—this blown fuse is impossible to detect visually.



This Littelfuse has a controlled blowing point—the filament is plated throughout its length except in the very center—the fuse will always blow here. A blown Littelfuse can be detected immediately—a Littelfuse feature.

Littelfuse holds more design patents on fuses than all other manufacturers combined.

LITTELFUSE

DES PLAINES, ILLINOIS

TOP-SELLING Practical PUBLICATIONS distributed by HOWARD W. SAMS & CO., INC.

COYNE

FAMOUS SHOP-TESTED REFERENCE BOOKS



TV Servicing Cyclopedic. Covers every phase of TV, including color and UHF. Explains theory, servicing, testing, antennas, circuits, converters, etc. 750 p. Order **CTB-1** . . . \$5.95

Practical TV Servicing. How to service by alignment, by picture pattern; how to install antennas; how to handle any TV service problem. Data on color and UHF. 400 pages. Order **CTB-4** . . . \$4.25

Latest Testing Instruments. Covers proper use of all modern TV, radio and electrical testing equipment. Tells short-cuts, analyzes all instruments. 350 p. Order **CTB-3** . . . \$3.25

Television and Radio Handbook. 3000 useful facts on practical radio servicing. Covers most frequently recurring problems; troubleshooting hints. Data on UHF conversion, etc. 375 pages. Order **CTB-5** . . . \$2.75

Industrial Electronics. Practical, simplified information on basic principles and practices of electronics. The ideal book for orientation in the entire field. 468 p. Order **CTB-2** . . . \$3.75

Applied Practical Radio-Television. Complete 5-Volume Library; 1780 pages of latest "know-how" on Radio and TV. Vol. 1, Radio & TV Principles; Vol. 2, Radio, TV and FM Receivers; Vol. 3, Radio & TV Circuits; Vol. 4, Radio & TV Testing Methods; Vol. 5, TV Servicing. 5 Volume Set. Order **CTB-50**. \$15.00

Applied Practical Electricity. 8 Volume Library covering everything on the subject, including home wiring, motors, refrigeration, air conditioning, automotive diesel, etc. 3634 pages in 8 vols. Order set **CTB-180**. . . \$24.00

Electrical Trouble-Shooting. Complete troubleshooting course; also covers refrig., industrial electronics. 626 pages. Order **CTB-101** . . . \$6.95

Electricians Handbook. Code requirements, rules, tables, charts, testing guides; data on motors, currents, etc. 348 pages. Order **CTB-102** . \$2.75

BOYCE

AUTHORITATIVE TV & RADIO HANDBOOKS

Video Handbook. Full data on TV design, construction, production, installation, operation and servicing. 14 complete sections cover the entire field clearly and practically. 892 pages. Order **BB-2** . . . \$5.95

Radio Handbook. 18 sections; clearly explains radio and electronic theory; covers all phases thoroughly, including parts and circuit analyses, Sound, Recording, Testing, Antennas, TV, etc. 890 pages. Order **BB-1** . . . \$4.95



HOWARD W. SAMS & CO., INC.

Order from your Parts Jobber today, or write direct to Howard W. Sams & Co., Inc. 2205 East 46th St., Indianapolis 5, Ind.

\$ enclosed. Send the following books:

Name

Address

City Zone State

PHILIP S. RAND, project engineer at the Remington-Rand Laboratory of Advanced Research at South Norwalk, Connecticut, was recipient of the American Radio Relay League's Merit Award at its presentation on July 12 at the Seventh ARRL National Convention in Houston, Texas. Goodwin L. Dosland, president of the ARRL, the national association of amateur radiomen, presented a plaque to Rand in recognition of his advancement of the welfare of amateur radio through leadership and technical accomplishment in reduction of television interference.



Philip S. Rand receiving special citation.

Rand has done extensive research in the field of television interference elimination for several years from his home in Redding Ridge, Connecticut. He is the compiler and main author of the book, *Television Interference*. Since October, 1952, he has been associated with the ARRL as Technical Consultant. In that capacity he has given demonstrations in a number of cities to familiarize service technicians and amateur radio operators with the causes of television interference and remedies.

THE COMPATIBLE COLOR TV set is no longer just around the corner. The FCC in its tentative adoption of color TV standards as proposed by the National Television System Committee has opened the way for compatible color TV sets to appear in retail stores by next spring, according to statements made by RCA in its petition to the FCC supporting NTSC standards. Objections may come from the three-dimensional color TV advocates, such as Dr. Allen Du Mont and U. A. Sanabria, president of American Television, Inc., Chicago, who said he would oppose the NTSC standards. Already on record in support of the new standards are NTSC itself, an industry-wide committee of engineers and scientists created in 1950; RCA and NBC in a joint petition; Philco; Sylvania Electric Products, Inc.; General Electric; and Motorola. Hazeltine, a research laboratory which has had an important part in color TV, told the FCC it would also support the new standards.

COLOR TELEVISION SETS should be exempted from excise taxes, the RETMA has advised Congress. RETMA

said that it is willing to accept a general manufacturer's excise tax which would cover black-and-white TV sets, and called for repeal of the Federal 10% manufacturer's excise tax on TV sets. Congress was told that color TV sets should get special consideration, in conformance with the tradition of withholding of taxes temporarily from new products and industries. RETMA contended that the imposition of the excise tax on electronic equipment used for commercial and technical purposes was costly and confusing. It was stressed that this tax was contrary to Congressional intent, and legislation should be initiated to remove the tax on parts and components of radio and TV sets other than tubes.

FOURTEEN NEW TV STATIONS on between our last report in this column and August 14. Six of these are v.h.f. stations: KBES-TV (5), Medford, Oregon; KMMT (6), Austin, Minnesota; KMBC-TV and WHB-TV who are to share time of the same channel (9), Kansas City, Missouri; KROC (10), Rochester, Minnesota; and KMO-TV (13), Tacoma, Washington.

The new u.h.f. stations are: WTVP (17), Decatur, Illinois; KFSA-TV (22), Fort Smith, Arkansas; WGVL (23), Greenville, South Carolina; KUSC-TV (28), Los Angeles, California; WETV (47), Macon, Georgia; WKJF-TV (53), Pittsburgh, Pennsylvania; WGLV (57), Easton, Pennsylvania and WTVU (73), Scranton, Pennsylvania.

In addition, WSYR-TV, Syracuse, moved from channel 5 to channel 3; and WROV-TV (27), Roanoke, Virginia, went off the air.

An error in listing a construction permit was made in our August issue. The call given as WMO (Tacoma, Wash.) should be KMO. WJAR-TV (10), Providence, R. I. was incorrectly listed in our July issue as channel 11.

SUBSCRIPTION TV is the answer to the u.h.f. station's problem of economic survival, according to four u.h.f. grantees who asked the FCC to lay down rules, regulations, and standards for a paid TV service.

The four construction permit holders—Home News Publishing Co. (WDHN, channel 47) New Brunswick, N. J.; Pennsylvania Broadcasting Co. (WIP-TV, channel 29) Philadelphia; Stamford-Norwalk TV Corp. (channel 27, no call yet assigned) Stamford, Conn.; and Connecticut Radio Foundation (WELI-TV, channel 59) New Haven, Conn.—believe that the box-office type of TV will make it possible for them to improve programs and thus compete with older v.h.f. stations who have network affiliations.

A survey of their areas, the petitioners state, shows that prospective set owners would be more ready to buy u.h.f. receivers if they could be assured of receiving (for special fees) first-run movies, nonbroadcast sports events, and other features not normally seen by viewers of free TV.

J. E. SMITH
President
National Radio
Institute
Washington, D. C.
40 years of success
training men at
home in spare time.



I Will Train You at Home

For Good Pay Jobs, Success in

RADIO-TELEVISION



Practice Broadcasting with Equipment I Send

As part of my Communications Course I send you kits of parts to build the low-power Broadcasting Transmitter shown at the left. You use it to get practical experience putting a station "on the air," performing procedures demanded of Broadcasting Station Operators. An FCC Commercial Operator's License can be your ticket to a better job and a bright future; my Communications Course gives you the training you need to get your license. Mail card below and see in my book other valuable equipment you build.

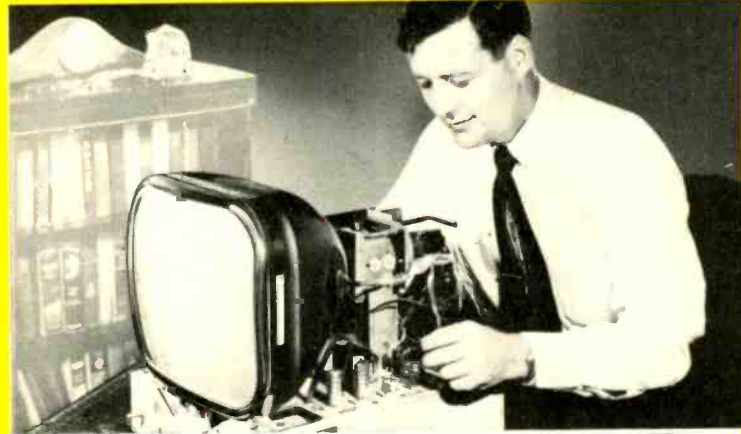

Practice Servicing with Equipment I Send

Nothing takes the place of PRACTICAL EXPERIENCE. That's why NRI training is based on LEARNING BY DOING. You use parts I furnish to build many circuits common to Radio and Television. With my Servicing Course you build a modern Radio (shown at right). You build a Multitester which you use to help fix sets while training. Many students make \$10, \$15 a week extra fixing sets in spare time starting a few months after enrolling. All equipment is yours to keep. Card below will bring book showing other equipment you build.



AVAILABLE TO
VETERANS
UNDER G.I. BILL

**Good Jobs, Good Pay, Success
in Radio-TV! SEE OTHER SIDE**

CUT OUT AND MAIL THIS CARD NOW
Sample Lesson & 64-Page Book
Both FREE

This card entitles you to Actual Lesson on Servicing, shows how you learn Radio-Television at home. You'll also receive my 64-Page Book, "How to Be a Success in Radio-Television." Mail card now!

NO STAMP NEEDED! WE PAY POSTAGE

Mr. J. E. SMITH, President,
National Radio Institute, Washington 9, D. C.

Mail me Lesson and Book, "How to Be a Success in Radio-Television." (No Salesman will call. Please write plainly.)

NAME AGE

ADDRESS

CITY ZONE ... STATE

VETS write in date
of discharge

B C D E F G H

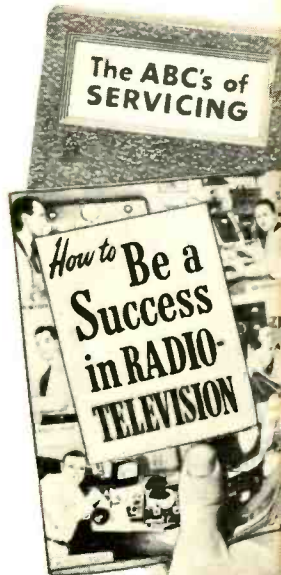

Television is Growing Fast Making New Jobs, Prosperity

More than 25 million homes now have Television sets and thousands more are being sold every week. Well trained men are needed to make, install, service TV sets. About 200 television stations on the air with hundreds more being built. Think of the good job opportunities here for qualified technicians, operators, etc. If you're looking for opportunity get started now learning Radio-Television at home in spare time. Cut out and mail postage free card. J. E. Smith, President, National Radio Institute, Washington, D. C. OUR 40TH YEAR.

Train at Home to Jump Your Pay as a RADIO-TV Technician



**J. E. Smith, President
National Radio Institute**

The men whose messages are published below were not born successful. Not so long ago they were doing exactly as you are now . . . reading my ad! They decided they should **KNOW MORE** . . . so they could **EARN MORE** . . . so they acted! Mail card below now.

Get a Better Job—Be Ready for a Brighter Future in America's Fast Growing Industry

Training PLUS opportunity is the PERFECT COMBINATION for job security, good pay, advancement. When times are good, the trained man makes the BETTER PAY, GETS PROMOTED. When jobs are scarce, the trained man enjoys GREATER SECURITY. NRI training can help assure you and your family more of the better things of life.

Radio-Television is today's opportunity field. Even without Television, Radio is bigger than ever before. Over 3,000 Radio Broadcasting Stations on the air; more than 115 million home and Automobile Radios are in use. Then add Television. Television Broadcast Stations extend from coast to coast now with over 25 million Television sets already in use. There are channels for 1,800 more Television Stations. Use of

Aviation and Police Radio, Micro-Wave Relay, Two-way Radio communication for buses, taxis, trucks, etc. is expanding. New uses for Radio-Television principles coming in Industry, Government, Communications and Homes.

My Training is Up-to-Date You Learn by Practicing

Get the benefit of my 40 years experience training men. My well-illustrated lessons give you the basic principles you must have to assure continued success. Skillfully developed kits of parts I furnish "bring to life" the principles you learn from my lessons. Read more about equipment you get on other side of this page.

Naturally, my training includes Television. I have, over the years, added more and more Television information to my courses. The equipment I furnish students gives experience on circuits common to BOTH Radio and Television.

Find Out About the Tested Way to Better Pay

Read at the right how just a few of my students made out who acted to get the better things of life. Read how NRI students earn \$10, \$15 a week extra fixing Radios in spare time starting soon after enrolling. Read how my graduates start their own businesses. Then take the next step—mail card below.

You take absolutely no risk. I even pay postage. I want to put an Actual Lesson in your hands to prove NRI home training is practical, thorough. I want you to see my 64-page book, "How to Be a Success in Radio-Television" because it tells you about my 40 years of training men and important facts about present and future Radio-Television job opportunities. You can take NRI training for as little as \$5 a month. Many graduates make more than the total cost of my training in two weeks. Mailing postage free card can be an important step in making your future successful. J. E. Smith, President, National Radio Institute, Washington 9, D. C. OUR 40TH YEAR.

I TRAINED THESE MEN



Handicapped but Successful

"I am now Chief Engineer at WHAW. My left hand is off at the wrist. A man can do . . . If he wants to." R. J. Bulley, Weston, W. Va.



\$10 a Week In Spare Time

"Before finishing, I earned as much as \$10 a week in Radio servicing, in my spare time. I recommend NRI." S. J. Petrucci, Miami, Fla.



Control Operator, Station WEAN

"I received my license and worked on ships. Now with WEAN as control operator. NRI course is complete." R. Arnold, Rumford, R. I.



Has Own Radio-Television Shop

"Doing Radio and Television servicing full time. Have my own shop. I owe my success to NRI." Curtis Stath, Fort Madison, Iowa.



Has Growing Business

"Am becoming expert Teletrician as well as Radiotrician. Without your course this would be impossible." P. Brozan, Louisville, Ky.



Got First Job Thru NRI

"My first job was with KDLR. Now Chief Engr. of Radio Equipment for Police and Fire Dept." T. Norton, Hamilton, Ohio.

Find Out What RADIO-TV Offers You



SAMPLE LESSON and 64-PAGE BOOK Both FREE

Cut out and mail postage-free card today!

Start Soon to Make \$10, \$15 a Week Extra Fixing Sets

Keep your job while training. Many NRI students make \$10, \$15 and more a week extra fixing neighbors' Radios in spare time starting a few months after enrolling. I start sending you special booklets that show you how to fix sets the day you enroll. The multimeter you build with parts I furnish helps discover and correct troubles.



Do You Want Your Own Business?

Many NRI trained men start their own successful Radio-Television sales and service business with capital earned fixing Radios in spare time. My book tells how you can be your own boss. Joe Travers, a graduate of mine, in Asbury Park, N. J., writes: "I've come a long way in Radio and Television since graduating. Have my own business on Main Street."



NRI Training Leads to Jobs Like These

BROADCASTING
Chief Technician
Chief Operator
Power Monitor
Recording Operator
Remote Control Operator

SERVICING
Home and Auto Radios
P. A. Systems
Television Receivers
Electronic Controls
FM Radios

IN RADIO PLANTS
Design Assistant
Transmitter Design Technician
Service Manager
Tester
Serviceman
Research Assistant

SHIP AND HARBOR RADIO
Chief Operator
Assistant Operator
Radiotelephone Operator

GOVERNMENT RADIO
Operator in Army, Navy, Marine Corps, Coast Guard
Forestry Service
Dispatcher
Airways Radio Operator

AVIATION RADIO
Plane Radio Operator
Transmitter Technician
Receiver Technician
Airport Transmitter Operator

TELEVISION
Pick-up Operator
Voice Transmitter Operator
Television Technician
Remote Control Operator
Service and Maintenance Technician

POLICE RADIO
Transmitter Operator
Receiver Serviceman

FIRST CLASS
Permit No. 20-R
(Sec. 34.9, P.L. & R.)
Washington, D.C.

BUSINESS REPLY CARD

No Postage Stamp Necessary If Mailed In The United States

POSTAGE WILL BE PAID BY

NATIONAL RADIO INSTITUTE

16th and U Sts., N.W.

Washington 9, D. C.



NEW HOME OF ALLIED RADIO

ultra-modern facilities TO SERVE YOU BEST

FREE!

get your
value-packed
1954
ALLIED
268-PAGE CATALOG

The World's Largest Stocks

- TV and Radio Parts
- Test Instruments
- High-Fidelity Equipment
- Custom TV Chassis
- AM, FM Tuners and Radios
- Recorders and Supplies
- P. A. Systems, Accessories
- Amateur Station Gear
- Builders' Kits, Supplies
- Equipment for Industry

Fastest Service in
Electronic Supply

the only
COMPLETE
catalog for
everything in
TV, Radio and
Industrial
Electronics



Send for it today!

You'll want the *one* complete Buying Guide to *Everything in Electronics*—268 pages packed with the world's largest selection of quality equipment at lowest, money-saving prices. See all the latest releases in custom TV chassis, TV antennas and accessories; AM and FM tuners and radios; *everything* in High-Fidelity custom components; latest P.A. Systems and accessories; recorders and supplies; Amateur receivers, transmitters and station gear; specialized industrial electronic equipment; test instruments; builders' kits; huge listings of parts, tubes, tools, books —your choice of the world's *most complete stocks* of quality equipment. ALLIED gives you *every* buying advantage: speedy shipment, expert personal help, lowest prices, liberal terms, assured satisfaction. Get the 1954 ALLIED Catalog. Keep it handy—and save time and money. Send for your **FREE** copy today.

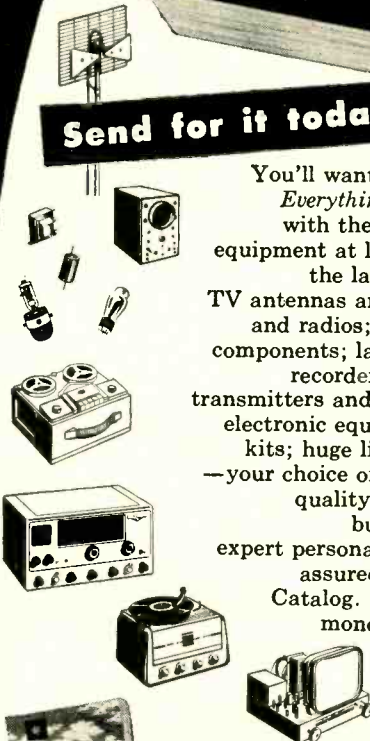

**SAVE ON EVERYTHING
IN ELECTRONICS**

**SEND FOR THE LEADING
ELECTRONIC BUYING GUIDE**

free

ALLIED RADIO
World's Largest Electronic Supply House

EASY-PAY TERMS

Use ALLIED'S liberal Easy Payment Plan—only 10% down, 12 months to pay—no carrying charge if you pay in 60 days. Available on Hi-Fi and P. A. units, recorders, TV chassis, test instruments, Amateur gear, etc.

TV and HI-FI SPECIALISTS

To keep up with developments in High-Fidelity and TV, look to ALLIED. Count on us for *all* the latest releases and largest stocks of equipment in these important fields. If it's anything in High-Fidelity or Television—we have it in stock!

ALLIED RADIO CORP., Dept. 2-K-3
100 N. Western Ave., Chicago 80, Illinois

Send FREE 268-Page 1954 ALLIED Catalog.

Name _____

Address _____

City _____ Zone _____ State _____

You can build a reputation on Tung-Sol® Quality

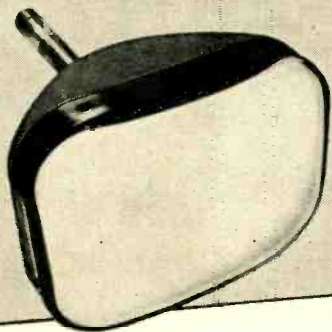

TUNG-SOL makes
All-Glass Sealed Beam Lamps,
Miniature Lamps,
Signal Flashers,
Picture Tubes, Radio, TV,
Special Purpose Electron Tubes,
Semiconductor Products.

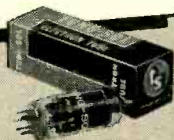

TUNG-SOL ELECTRIC INC.
Newark 4, New Jersey

Sales Offices: Atlanta, Chicago, Columbus, Culver City (Los Angeles), Dallas, Denver, Detroit, Newark, Seattle

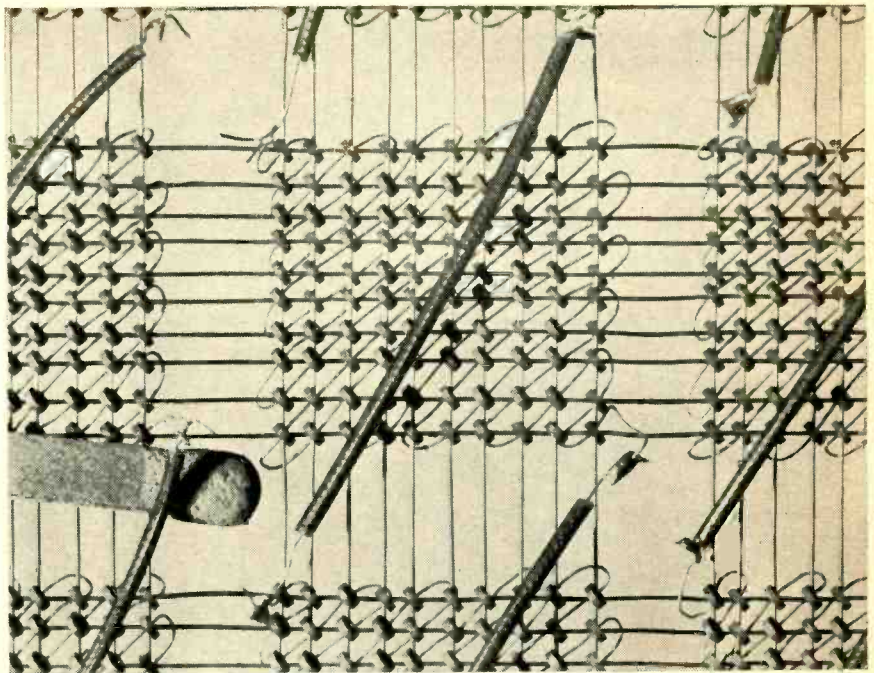

RCA experimental high-speed memory device. Head of match shows relative size.

A NEW MEMORY DEVICE which combines the features of high speed with a potentially huge information storage capacity, was described by Dr. Rajchman of RCA at a symposium on digital computers sponsored by the Argonne National Laboratory. The device consists basically of 10,000 tiny ring-shaped magnets woven on thin wires. The high-speed electronic memory device promises to help solve scientific and economic problems too vast and too complex for the present capabilities of electronic computers. Dr. Rajchman said the new device offers significant advantages for computers of the future because it can memorize a bit of information in a few millionths of a second; it can store 10,000 "bits" of information at any one instant; it potentially has a very high degree of reliability; and it promises to be relatively cheap, as memories for computers go.

BROADCASTING. A bill has been introduced in Congress which would amend the Federal Communications Act by changing a definition in Section 3. The amendment would define broadcasting as a no-charge activity, as it concerns the listener, and would describe subscription television, community-antenna systems, and theater television as common-carrier services.

NATIONAL CONFERENCE on Tube Techniques, sponsored by the Subpanel on Tube Techniques of the Department of Defense will be held on October 13, 14, and 15 at the auditorium of the Western Union Telegraph Co., 60 Hudson St., New York 13, N. Y.

The program will cover all phases of electron tube making techniques, processes, and materials. Pertinent papers are invited. Anyone interested may attend.

FIVE MILLION MORE RADIOS were in use in the United States on January 1, 1953, than on the same date in 1952. Figures released by the four major networks—ABC, CBS, MBS, and NBC—show that the increase brings the total number of sets in working order to well over 110 million. More radios were sold in this country in 1952 than automobiles, refrigerators, TV sets, or other home appliances.

Home radios of course, form the largest group, with about 75 million receivers in nearly 45 million homes. More than 26 million private passenger cars have radios, and about 9 million sets are installed in hotels, restaurants, offices, and other more or less public establishments.

ELECTRONICS has again made the power of its name felt. Radio-Electronics-Television Manufacturers Association is the new name of RTMA. Members of the association (which was simply RMA till several years ago) voted to make the change, and approved a reorganization plan which will expand the board of directors and provide larger representation for new segments of the industry, especially in the advanced electronics field.

AUDIO ENGINEERING Society's annual convention, held in New York City October 14, 15, 16 and 17 in conjunction with the Audio Fair, will have no less than 26 technical papers on technical audio subjects. The papers will deal with such subjects as loudspeakers, audio system design, disc reproduction, new developments, amplifier circuit design, home music systems, and multi-channel sound reproduction. There will be seven morning and afternoon sessions, all of which will be held in the North Ballroom of the Hotel New Yorker. END

START ON THE ROAD TO SUCCESS

Study the RCA

TV Servicing Course

in your spare time

ARE YOU SATISFIED with the position you now hold? Do you feel you're worth more money? Are you pleased with yourself, your work, your associates . . . and your future? What does the next year hold for you . . . and the year after that?

Are you content merely to plod along through the best years of your life . . . or do you want to get into more pleasant work . . . hold a well-paid job . . . perhaps establish your own business?

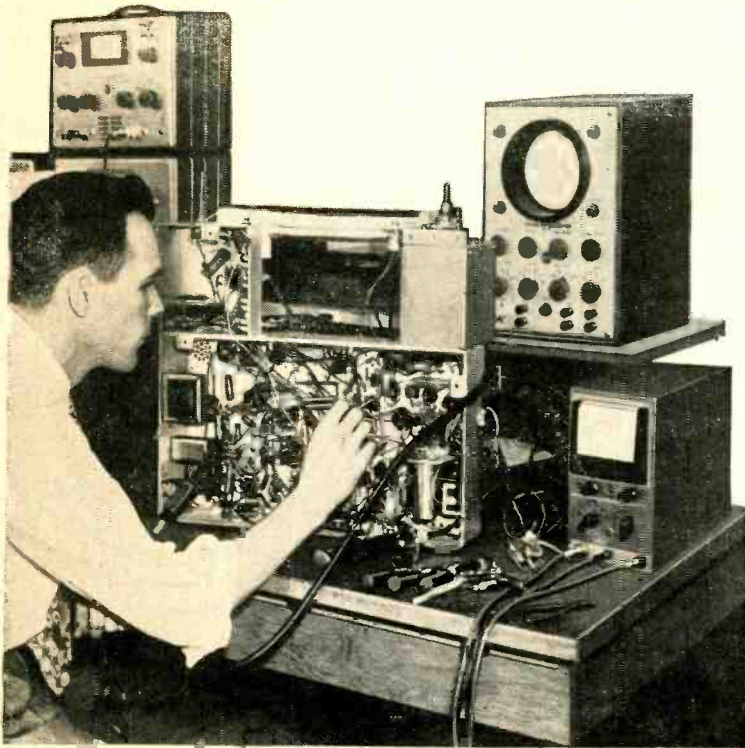

If you are looking for a REAL opportunity . . . If you want to GROW with a GROWING INDUSTRY . . . If you want to grasp the success that should be yours, *then we say to you, study TV Servicing.*

Everyone knows that Television is the fastest growing industry today. Opportunities are going begging for men who have the training and ability to grasp them. Now *is the time to start on the road to success in TV Servicing.*

Study at Home in your spare time

The RCA Institutes Home Study Course in TV Servicing is easy to learn. You progress rapidly, step by step, as you learn the procedure of servicing and trouble-shooting TV receivers and installing TV antennas. Hundreds of pictures and diagrams help you understand the how-it-works information and the how-to-do-it techniques.

A Service of Radio Corporation of America

The RCA Institutes TV Servicing course was written and planned by instructors with years of specialized experience in training men. You get up-to-the-minute information, too, because you study right at the source of the latest developments in Television. Your lessons are carefully examined and accurately graded by competent teachers who are interested in helping YOU to succeed.

RCA Institutes is licensed by the University of the State of New York . . . an affiliate member of the American Society for Engineering Education . . . approved by leading Radio-Television Service Organizations.

It costs so little to gain so much

RCA Institutes makes it easy for you to take advantage of the big opportunities in TV Servicing. The cost of the TV Servicing Home Study Course has been cut to a minimum. You pay for the course on a pay-as-you-learn unit lesson basis. *No other home study course in TV Servicing offers so much for so little cost to you.*

RCA Institutes conducts a resident school in New York City offering day and evening courses in Radio and TV Servicing, Radio Code and Radio Operating, Radio Broadcasting, Advanced Technology. *Write for free catalog on resident courses.*

SEND FOR FREE BOOKLET—Mail the coupon—today. Get complete information on the RCA INSTITUTES Home Study Course in Television Servicing. Booklet gives you a general outline of the course by units. See how this practical home study course trains you quickly, easily. Mail coupon in envelope or paste on postal card.



MAIL COUPON NOW!

RCA INSTITUTES, INC., Home Study Dept. RE1053
350 West Fourth Street, New York 14, N. Y.

Without obligation on my part, please send me copy of booklet "RCA INSTITUTES Home Study Course in TELEVISION SERVICING." (No salesman will call.)

Name _____
(please print)

Address _____

City _____ Zone _____ State _____



RCA INSTITUTES, INC.
A SERVICE OF RADIO CORPORATION OF AMERICA
350 WEST FOURTH STREET, NEW YORK 14, N. Y.



WHY SYLVANIA PRODUCTS MEAN BETTER BUSINESS!

YOU'RE really on board the *better-profit* special when you feature Sylvania Picture Tubes and Receiving Tubes.

Your customers know Sylvania as a pioneer in the development of fine radio and television products. From the very beginning, the name Sylvania has stood for the highest possible quality. And, as the industry has progressed and expanded, Sylvania has taken great care to maintain its recognized leadership.

Now, due to advanced manufacturing techniques and precision testing methods, Sylvania tubes can point to outstanding records, both in long life and fine performance. Today 7 of the 10 leading set manufacturers use Sylvania Picture Tubes and Receiving Tubes.

So, if you want *recognized quality* working on your side . . . *sell Sylvania!* Call your local Sylvania Distributor for the latest fall prices and money-making promotion offers, or write to: Sylvania Electric Products Inc., Dept. 3R-1710, 1740 Broadway, New York 19, N. Y.

SYLVANIA



LIGHTING • RADIO • ELECTRONICS • TELEVISION

**Television keeps telling
about Sylvania quality**

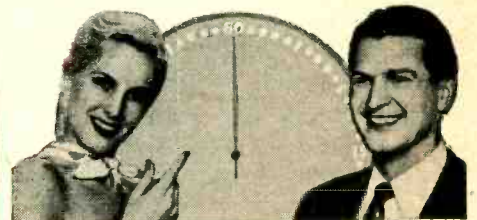

Sylvania's popular nation-wide television show "Beat the Clock" continues to tell millions of your customers week after week, all through the year, about the unbeatable quality of Sylvania products.

In Canada: Sylvania Electric (Canada) Ltd.
University Tower Bldg., St. Catherine Street, Montreal, P. Q.

RADIO-ELECTRONICS

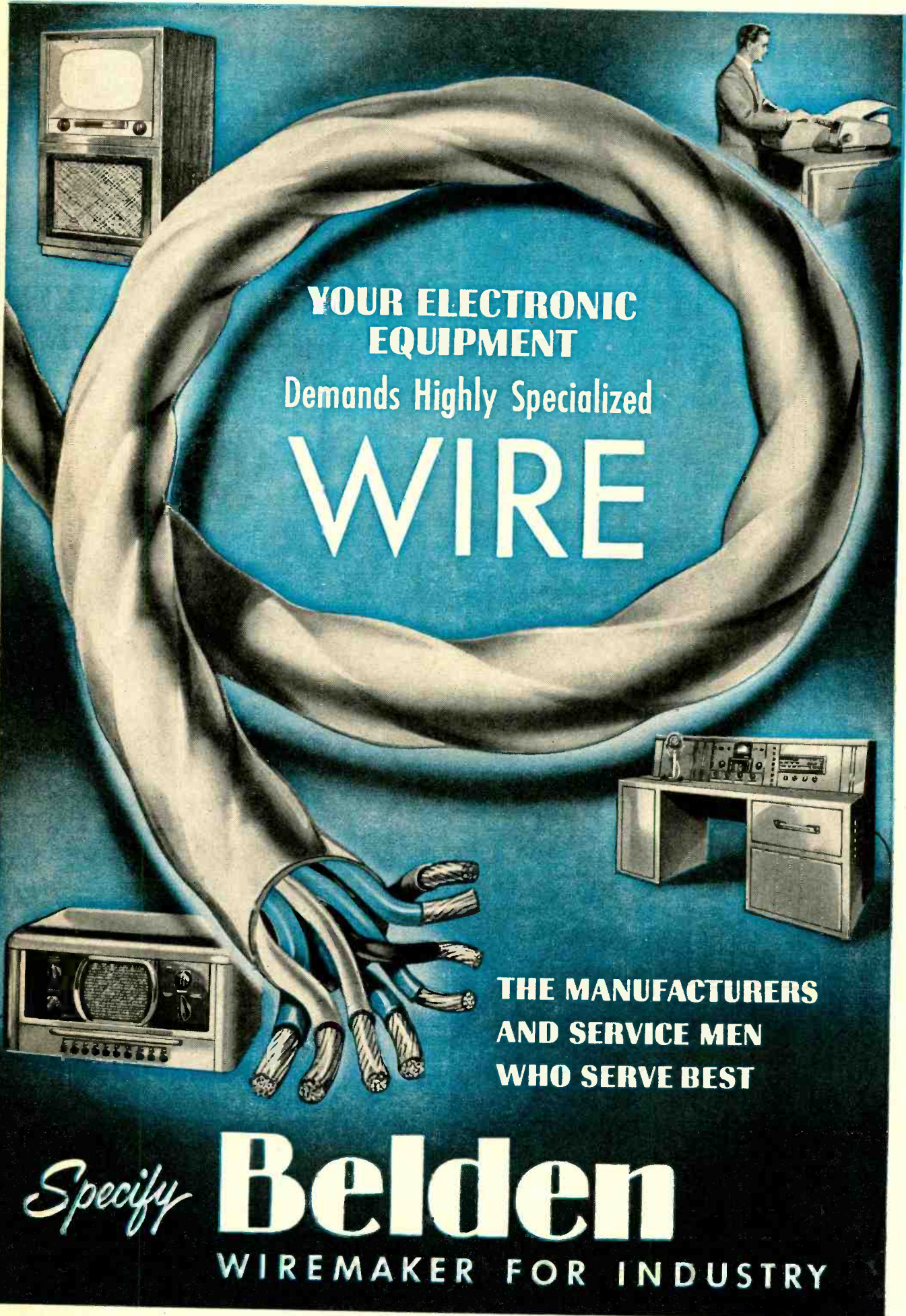

**YOUR ELECTRONIC
EQUIPMENT**
Demands Highly Specialized
WIRE

**THE MANUFACTURERS
AND SERVICE MEN
WHO SERVE BEST**

Specify

Belden

WIREMAKER FOR INDUSTRY

This book will save you
30 Minutes
a day



**FIND TUBE RATINGS,
CONNECTIONS IN SECONDS**

This big new Westinghouse Ready-Guide is a completely new kind of handbook of receiving tube data. Designed to save time for busy servicemen and engineers. Eliminates "squinting" at tiny data listings.

BIG - BOLD - CLEAR

Just 9 tube types are listed on each 8½" x 11" page. Not 30 or 40 tiny type listings as in most condensed data books. Best of all, large clear base diagrams are located on the same page as ratings. Bothersome cross referencing, foot-notes cut to the bone.

COMPLETE, ACCURATE, UP-TO-DATE

This new Westinghouse Ready-Guide lists complete data on receiving tubes which account for more than 98% of tube usage. 48 pages. 385 pictures and diagrams. 342 types listed.

SPECIAL: 3 for \$1.00

This Ready-Guide is being sold at less than cost as an introductory offer only. Price is only 35¢—3 for \$1.00. Order from your nearest RELIATRON Tube Distributor or mail coupon below.

ET-95038

Westinghouse
RELIATRON TUBES TM

Westinghouse Electric Corporation
Electronic Tube Division, Dept. H-210
Box 284, Elmira, N. Y.

.....Enclosed is \$1.00 for 3 copies of
Ready-Guide

.....Enclosed is 35¢ for 1 copy

NAME.....

ADDRESS.....

CITY.....STATE.....

Please Print



BAROMETER of the PARTS INDUSTRY

During August, 87 of the leading manufacturers of Radio-Electronic-Television parts and equipment made changes in their lines. There was a decrease in "change activity" as compared to July.

In price revisions by the number of manufacturers and products affected, the following summary illustrates the comparative trend for the months of July and August.

	No. of Manufacturers	
	July	August
Increased prices	25	32
Decreased prices	21	16

	No. of Products	
	July	August
Increased prices	783	350
Decreased prices	786	65

For a summary of the most active product categories, see the following tables:

Product Group	Increased Prices		Decreased Prices		New Products		Discontinued Products	
	No. of Mfrs.	No. of Products	No. of Mfrs.	No. of Products	No. of Mfrs.	No. of Products	No. of Mfrs.	No. of Products
Antennas & Access.	7	30*	6	24**	18	153	7	63**
Capacitors	0	0	0	0**	1	198**	0	0
Controls & Resistors	1	7*	0	0	2	105**	1	10*
Sound & Audio	13	141**	5	16**	21	114**	17	131*
Test Equipment	3	25*	0	0**	6	21*	3	6**
Transformer	2	134**	1	20**	2	14**	1	1**
Tubes	6	13**	4	5**	10	61*	5	75*
Wire & Cable	0	0**	0	0**	3	6**	1	17

* Increase over July
** Decrease from July

Comment: For the third consecutive month, over-all product activity continues to be heavy. However, the number of manufacturers making changes in their line has decreased slightly since the last reported period.

This data is prepared by the staff of United Catalog Publishers, Inc., 110 Lafayette Street, New York, publishers of Radio's Master, the Official Buying Guide of the Parts Industry.

Merchandising and Promotion

Cornell-Dubilier Electric, South Plainfield, N. J., designed a special display unit for the CDR rotor. Done in full color, the display is adaptable for either window or counter use. Ray T. Leary, jobber sales manager, states that the CDR rotor fits right into the display and may be activated when the customer presses the lever on the control box. At the same time, Cornell-Dubilier and its affiliate, Radiart Corp., Cleveland, announced plans for a greatly accelerated promotion on the CDR rotor at the consumer level beginning early this fall. TV spot announcements, newspaper ads, and promotional kits for distributors will be used.



Simpson Electric Co., Chicago, plans to spend \$250,000 in the next 12 months to promote its line of electrical testing equipment, according to Wallace Carroll, Simpson president.

Raytheon Manufacturing Co., Newton, Mass., had a full-page color ad on its Bonded Electronic Technician program in a recent issue of Life. It was headlined: "Nice Guy With an Underserved Black Eye." The ad pointed out the capable and efficient service TV technicians have been rendering. Raytheon also recently announced a new tube promotion item for service technicians, the Tele Jar-Rotor, which consists of 48 transparent plastic jars for storing transistors, diodes and other small parts placed on a "ferris-wheel" holder.

Vaco Products Co., Chicago, introduced new shelf brackets for mounting



NEW



TIGHTEST SEAL
LOCKS IN PERFORMANCE

TOUGHEST SHELL
LOCKS OUT TROUBLE



ATTRACTIVE YELLOW MOLDED PLASTIC SHELL
Non-flammable. Will not burn or melt under soldering iron or flame.

BONDED SEAL
Positive, heat resistant, non-flammable bond seals leads and shell, locks out humidity.

FIRMLY SECURED LEAD
Can't be pulled out, even under soldering iron heat.

ASTRON BLUE-POINT[†] MOLDED PLASTIC PAPER *Capacitors*

PATENT PENDING

THE NEWEST ADDITION
TO THE **SM**[†] LINE

Yes, the ASTRON BLUE-POINT's *tighter seal* and *tougher shell* give you heat and moisture protection to a degree never before possible—providing a longer life and greater dependability than has ever been achieved in a molded plastic capacitor! BLUE-POINT is a capacitor you can rely on *completely*, under every condition.

BLUE-POINT is suitable for continuous operation at 85°C. The bonded seal uses a special thermo-setting, heat-resistant, non-flammable bonding agent—*positive* protection

against moisture. Solder leads as close to the capacitor as you like—they *won't* pull out! Every BLUE-POINT is clearly marked with voltage and capacitance, bears outside foil identification. Every BLUE-POINT is *tested* and *guaranteed*. Look for the ASTRON BLUE-POINT when you buy capacitors from your jobber, or if he doesn't carry it, send us his name. Insist on ASTRON BLUE-POINT, the capacitor you *know* you can depend on. Order a supply today.

For complete performance characteristics, specifications and listings, write for Bulletin AB-20A

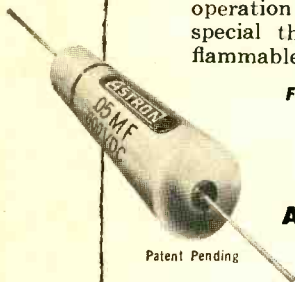

Patent Pending

DEPEND ON—INSIST ON

ASTRON CORPORATION



255 Grant Ave., E. Newark, N. J.

†Trade Mark

Safety Margin capacitors for every radio, television and electronic use.

No dust-catchers



in Merit's line
but complete coverage
where it counts!

Keep inventory at a minimum, profits high with Merit's designed - for - action line. Among the new, quick-turnover items recently added: flybacks  for Motorola replacement, a new series of yokes and TV power transformers. Find Merit's complete line listed in John Rider's Tek-File and Howard Sam's Counter Facts and Photo Facts—Tape Marked* to help you.

And! Be sure to get Merit's new, *really* complete Replacement Guide.  Forty pages of replacement data and schematics, including IF-RF coils, an exclusive Merit feature.

*originated by Merit

M E R I T
Coil & Transformer Corp.
4425 North Clark Street,
Chicago 40, Illinois

its Vari-Board screwdriver display shelf anywhere in the store.

Technical Appliance Corp., Sherburne, N. Y., antenna manufacturer, held another in its series of Taco U.H.F. Television Clinics for service technicians in Buffalo, N. Y. The meeting was co-sponsored by WBUF, channel 17, Buffalo's new u.h.f. station.

Westinghouse Electronic Tube Division, Elmira, N. Y., launched a new premium promotion campaign for its Reliatron tube distributors.

Philco Corp., Philadelphia, has prepared a new 15-minute 16-mm sound movie, "When u.h.f. Comes to Town," for TV dealers and others interested in building enthusiasm for u.h.f.

RMS (Radio Merchandise Sales), New York City, is continuing its forums on TV antenna problems. Martin Bettan, RMS director of sales and engineering, directed the forums which were held in Ft. Smith, Ark., Zanesville, Ohio, and Fort Lauderdale, Fla. A half-hour TV interview was held after each session.

Heppner Manufacturing Co., Round Lake, Ill., is offering a new sample



rack holding 12 ion traps ranging from 25 to 58 gauss. It is available, without charge, to engineers engaged in TV set manufacture.

Walsco Electronics Corp., Los Angeles, Calif., launched a nation-wide promotion campaign for its new u.h.f. converter, the *Imperial*. Point-of-purchase material will be an important factor in the program.

Production and Sales

The RETMA reported the production of 3,834,236 TV sets in the first six months of 1953, a record high for the period. Radio production was 7,266,542.

New Plants and Expansions

Chicago Telephone Supply Corp., has completed a new building which adds about 65,000 sq. ft. to its manufacturing and office space in Elkhart, Ind.

Gates Radio Co., Quincy, Ill., opened a new West Coast office and distributing branch in Los Angeles. Robert Kuhl, who has been in charge of West Coast sales, is office manager.

Herlec Corp., ceramic capacitor manufacturing affiliate of Sprague Electric Co., moved its operations to its new plant in Grafton, Wis.

Hallcrafters, Chicago, has begun construction on a new \$400,000 plant in Toronto, Canada. It is expected to be completed this fall when the company's Canadian subsidiary, Hallcrafters Canada, Ltd., will locate there.

Allied Radio Corp., moved to 100 North Western Ave., Chicago.

Trio Manufacturing Co., completed a new addition to its plant at Griggsville, Ill. Included is 24,000 sq. ft. of manufacturing space and a new laboratory.

International Resistance Co., Philadelphia, is building a new plant in Boone, N. C.

LaPointe Electronics Inc., Rockville, Conn., purchased a 95% interest in Circuitron, Inc., a New Jersey printed-circuit manufacturing corporation. Circuitron operations will be moved to Rockville.

Mosley Electronics, St. Louis, moved all its executive and general offices into new quarters at 8622 St. Charles Rock Road. The company's former quarters are now devoted entirely to packing and shipping operations.

Sylvania Electric Products, Television Picture Tube Division, Seneca Falls, N. Y., is perfecting methods and increasing facilities for the mass production of aluminized picture tubes. At the same time, H. Ward Zimmer, Sylvania president, announced the establishment of an Electronic Defense Laboratory to be located in temporary quarters in Mountain View, Calif.

Teletronics Laboratory, Inc., completed a new engineering building adjacent to its manufacturing plant in Westbury, N. Y.

Westinghouse Electric Corp., purchased the Government-owned plant in Lansdowne, Md., which it had been operating under lease. The plant is used for the large-scale production of electronic equipment for the Armed Forces and more recently, for industrial and commercial customers.

Wincharger Corp., Sioux City, Iowa, a subsidiary of Zenith Radio Corp., is planning for the construction of a new manufacturing plant. It will be located on high ground to keep it safe from flood waters, which caused considerable damage to the Wincharger plant last June.

Business Briefs

... NEDA's counsel, Glenn Catlin, announced that as a result of an application by the association, a reduction in rates on the return of defective picture tubes to manufacturers' salvage or inspection points had been granted by the railroad's Uniform, Official, Illinois, Southern and Western Classification Committee.

... **Sangamo Electric Co.**, capacitor Division, Marion, Ill., provided funds for a research and scholarship program for students majoring in physics at Southern Illinois University.

... **Hughes Aircraft Co.**, Culver City, Calif., is now in full production on hermetically-sealed germanium diodes.

... **Willys Motors, Inc.**, Electronics Division, Toledo, Ohio, has entered the television transmitter field. END

FREE-your Choice of NEW PHONO-CARTRIDGE CARRY-KIT or DISPLAY-DISPENSER



Handy All-Metal
Carry-Kit Holds
6 E-V Cartridges

Complete E-V
Interchangeability
Chart on both sides
makes servicing
positive and easy



PLUS
WINDOW or
DOOR DECAL



PLUS
REVISED SET-MODEL
REPLACEMENT GUIDE



6-Cartridge
Metal
Display
Dispenser
for Wall
or Shelf

10,000,000 PHONOGRAPHS ARE WAITING TO BE SERVICED

Get your share with these E-V aids to sales!

Again E-V gives you a positive profit-maker—and helps make *you* the authority on Phono-Service in your community!

Free of extra cost, from your E-V Distributor, you can get your choice of new Cartridge Carry-Kit or Display Dispenser *plus* professional Decal and up-to-date set-model Replacement Guide, with *every* purchase of *any* 6 E-V Phono Cartridges.

Furthermore, the new E-V high output, high compliance, permanent Ceramic Cartridges revolutionize servicing. They are *not* affected by moisture or heat—can be carried in your service kit or kept on display without fear of deterioration. *And they are directly interchangeable with silent-needle type crystal cartridges that do not use a thumb screw—yet cost no more than crystal.* They are part of the famous E-V Basic 6 Preferred Types that make over 92% of all cartridge replacements.

Take advantage of this offer now! Make money selling cartridge replacements. Cash in on the \$70,000,000 phono-cartridge modernization replacement market.

For a limited
time only.

SEE YOUR E-V
DISTRIBUTOR TODAY

Electro-Voice

BUCHANAN, MICHIGAN

Export: 13 E. 40th St., New York 16, U.S.A., Cable: Arlab

Each E-V Cartridge in
Two-Tone Jewel-like
Golden Yellow Plastic Box



3 New Electrical Advances!

CHANNEL MASTER'S all-new UHF BOW-FLECTOR

model no. 408

The highest gain Bow and Screen antenna ever developed — single or stacked!

to 10 DB
single

to 12½ DB
stacked

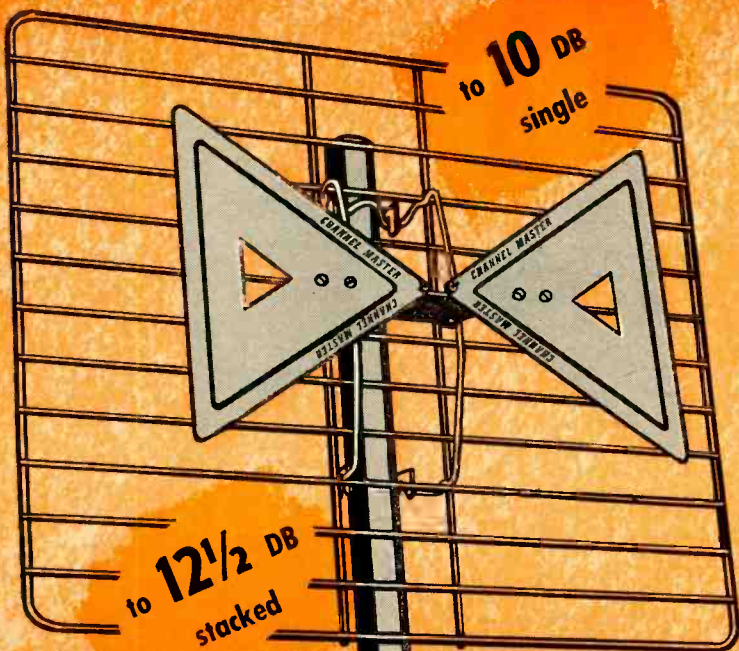

Terrific gain!

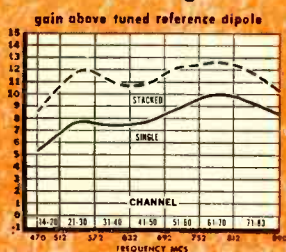

Horizontal Polar Patterns
(Relative Voltage)

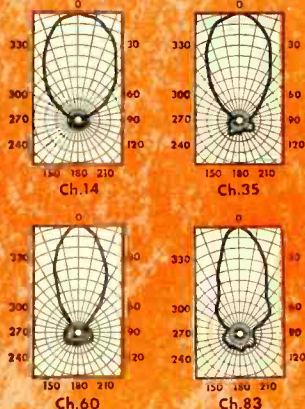

New Mechanical Features

- Deep-embossed "rigidized" aluminum dipoles.
- Snap-in assembly. No U-Bolts.
- High-impact molded insulator.

"Free-Space" terminals that prevent picture dim-out caused by the accumulation of dirt, ice or rainwater between antenna terminals.



1. **Enlarged Reflecting Screen.** 53% more reflecting area — higher, flatter gain level.
2. **Full-Wave Spacing** of stacked antennas. Provides highest stacking gain ever obtained in an antenna of this type.
3. **2-Stage Stacking Transformers** for broad-band impedance match. Delivers high stacking gain over entire UHF band.

Only 20 seconds to install!

Just snap Bow into Screen, then fasten entire assembly to mast with Channel Master's exclusive "SPEED-NUTS." The antenna cannot move, twist, flutter, or vibrate! The light-weight Bow Flector is the most rugged, fastest-installing antenna of its type.



One of 5
Great New
Channel Master
Products
For Fall!

CHANNEL MASTER CORP.

ELLENVILLE, N. Y.



Ask your Channel Master distributor for complete technical literature.

You've never seen a mast like it!

CHANNEL MASTER'S

all-new

STRATO-MATIC

TELESCOPING MAST

for antenna installations
that are

- easier • faster
- safer



Featuring the Amazing "Third Hand!"

— an automatic, removable locking device that actually acts as your "third hand," holds mast sections up when you let go! The Third Hand converts each guy ring, in turn, into a "safety lock." This permits you to raise sections freely, using only one hand. And . . . sections cannot slide down when you let go.

Automatic Mast Extension

The Step-Up Key, inserted through the bottom of the mast tubing, automatically extends each mast section 6 inches. Mast sections are kept partially extended even after mast is placed in vertical position — without using hardware or locking bolts!

World's Finest Mast Protection!

16-Gauge Mastings
**HOT-DIP
GALVANIZED**

Most permanent type of mast corrosion protection available today. Sections are immersed in cauldron of molten zinc, until a thick layer of pure zinc is fused to inner and outer surfaces — so thick it actually adds to the weight of the mast; gives long-term protection!

**ZINC IS
SELF-HEALING!**

When the protective zinc coating is scratched or broken, the surrounding zinc actually goes to work to "heal" the wound. Thus, the base metal is automatically protected against damage due to installation or handling. The only coating with this ability.

18-Gauge Mastings
**HEAVY ZINC
ELECTRO-PLATING**

Heavy layer of bright zinc, exceeding Army-Navy specifications, provides effective long-lasting protection against elements. A chromate dip adds brightness; increases corrosion resistance. The strongest, most durable protection jacket of its type.

One of 5
Great New
Channel Master
Products
For Fall!

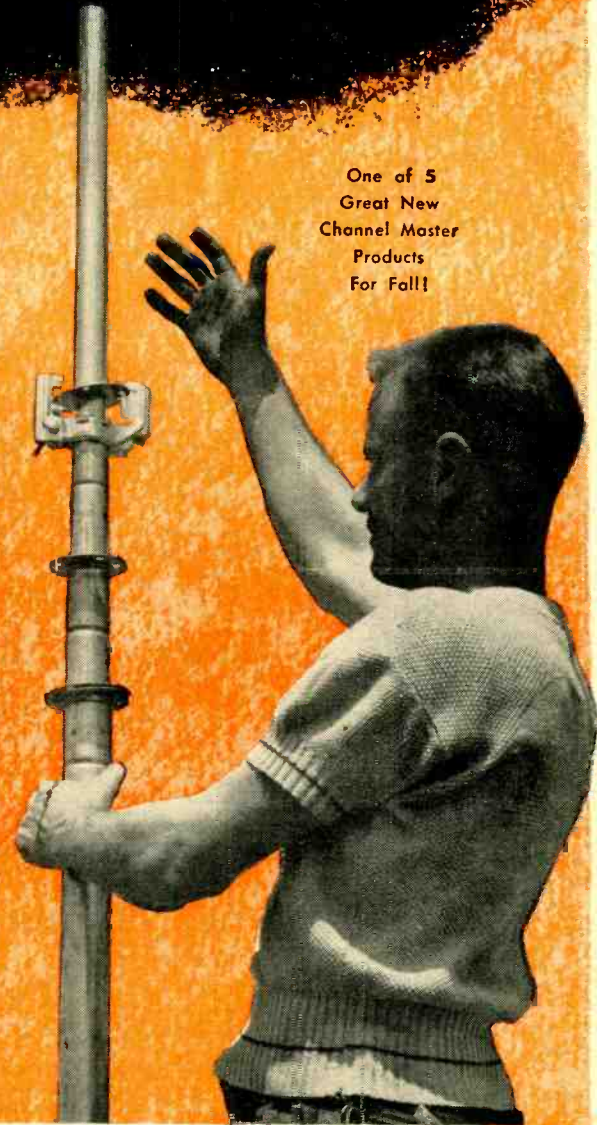

Inter-Locked Sections

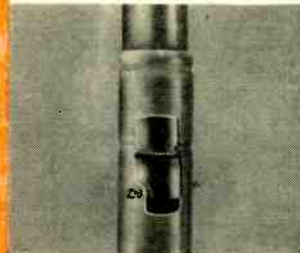

Safety Rings prevent sections from pulling out of each other. Notches in sections engage bolt — no twisting.

No Hidden Holes



Step-Up Key automatically extends mast sections high enough to provide easy access to bolt holes. You don't have to pull up next section to insert bolt!

Model No.	Sections	Lengths	Weights		
			16-Gauge	18-Gauge	
1620	1820	A, B	20'	20 lb.	15 lb.
1630	1830	A, B, C	30'	32 lb.	25 lb.
1640	1840	A, B, C, D	40'	46 lb.	35 lb.
1650	1850	A, B, C, D, E	50'	61 lb.	47 lb.



CHANNEL MASTER CORP. ELLENVILLE, N. Y.

Ask your Channel Master distributor for complete technical literature.

New! 7 INCH PUSH-PULL OSCILLOSCOPE

Only **EICO** Has All These Features:

- VERTICAL FREQ. RESPONSE: flat \pm 2 db 10 cps - 1 mc
- VERTICAL SENS.: .01 volts rms/inch
- HOR. FREQ. RESP.: flat \pm 0 db 10 cps - 200 kc, -4 db at 500 kc
- HOR. SENS.: .3 volts rms/inch
- SWEEP RANGE: 15 cps-100 kc
- 3-STEP FREQ.-COMPENSATED ATTENUATOR eliminates freq. distortion, overloading.
- CATHODE FOLLOWER inputs to both amplifiers
- PUSH-PULL outputs in both amplifiers
- RETURN TRACE BLANKING
- INT. VOLTAGE CALIBRATOR
- V & H TRACE EXPANSION & CENTERING: 1.5X full screen without distortion.
- DIRECT CONNECTION to vert. CRT plates. KIT \$79.95. WIRED \$129.50.
- PHASING CONTROL of internal 60 cps sine wave sweep.
- AT FRONT PANEL: Intensity mod. input; 60 cps, sawtooth outputs.



MODEL 470K

KIT \$79.95. WIRED \$129.50.

FAMOUS EICO AMAZING FEATURE-PACKED ECONOMY-PRICED
425K 5" PUSH-PULL SCOPE KIT \$44.95. WIRED \$79.95.

- AC & DC volts: 0-5, 10, 100, 500, 1000 V (30 KV with HVP-1 probe).
- 5 ohm ranges from .2 ohm to 1000 megohms.
- DC input Z 26 megohms.
- 4 1/2" meter movement in can't-burn-out circuit.
- 1% mult. resistors.



221K VTVM KIT \$25.95. WIRED \$49.95.

HIGH VOLTAGE PROBE \$6.95

- Extends range of VTVMs & voltmeters to 30 KV.



PIX TUBE ADAPTER for Tube Testers \$4.50. Checks TV picture tubes while in set.



625K TUBE TESTER KIT \$34.95. WIRED \$49.95.

- Illum. gear-driven "Speed Rollchart."
- New lever-action switches for individual testing of every element.
- Tests all conventional & TV tubes.

COUNTER CABINET for above: add \$10.00 to Kit or Wired Prices.

- Continuous coverage of all TV & FM freqs. from 500 kc to 228 mc.
- Sweep width variable 0-30 mc.
- Crystal marker oscillator, variable amplitude.



360K SWEEP GEN. KIT \$34.95. WIRED \$49.95.



- Large 7 1/2" meter, can't-burn-out circuit.
- AC/DC volts: 0-5, 10, 100, 500, 1000 (30 KV with HV Probe).
- 5 ohms ranges from .2 ohm to 1000 megohms.
- DC input Z 26 megohms.
- 1% mult. resistors.

214K VTVM KIT \$34.95. WIRED \$54.95.



- Measures & tests all resistors; .5 ohm to 500 megohms.
- Every type condenser, 10 mmf to 5000 mfd.
- 0-500 DC voltage source for capacitor leakage testing.

950A-K R-C BRIDGE & R-C-L COMP. KIT \$19.95. WIRED \$29.95.

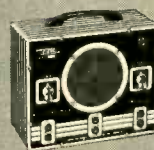

- Audibly signal traces all IF, RF, Video & Audio circuits from ANT to SPKR or CRT in all TV, FM, AM, etc. without switching.
- Germanium crystal diode probe responsive to over 200 mc.
- Integral test speaker.

145K SIG. TRACER KIT \$19.95. WIRED \$28.95.

NOW! ONLY EICO - the largest manufacturer of its kind in the world - gives you **LIFETIME SERVICE & CALIBRATION GUARANTEE*** ... the industry's greatest protection for your test equipment investment!

* at less than our cost of handling (see the EICO Guarantee Card enclosed with each Kit and Instrument).



NEW!

SCOPE VOLTAGE CALIBRATOR KIT 495K KIT \$12.95. WIRED \$17.95

- Sq. wave output at power-line freq. with full-scale readings of 1, 1, 10 or 100 V. peak-to-peak
- Accuracy \pm 5% of full-scale on each range.

NEW!

6V & 12V BATTERY ELIMINATOR KIT 1050K KIT \$29.95. WIRED \$38.95.

- DC output: 0-8 V or 0-16 V.
- Continuous current rating: 10 A at 6 V, 6 A at 12 V.
- Intermittent current rating: 20 A at 6 V, 12 A at 12 V.
- Separate Voltmeter & Ammeter.



NEW!

DECADE CONDENSER BOX KIT 1180K KIT \$14.95. WIRED \$19.95.

- All capacitors precision silver mica, accuracy \pm 1%.
- Range from 100 mmf - 3.111 mfd in steps of 100 mmf.
- Smooth-action positive detent ceramic switches.

Prices 5% higher on West Coast. Specifications and prices subject to change without notice.



536K MULTIMETER KIT \$12.90. WIRED \$14.90.
526K MULTIMETER KIT \$13.90. WIRED \$16.90.

- 1000 Ω /V; 31 ranges
- DC/AC volts: Zero to 1, 5, 10, 50, 100, 500, 5000.
- DC/AC Current: 0-1, 10 ma; 0.1, 1 A.
- Ohms: 0-500, 100 K, 1 meg.



320K SIG. GEN. KIT \$19.95. WIRED \$29.95.
322K SIG. GEN. KIT \$23.95. WIRED \$34.95.

- Complete sine wave coverage, 20-200,000 cps in 4 direct-reading ranges.
- Complete square wave coverage, 60-50,000 cps.
- Cathode follower output circuit.

377K SINE & SQUARE WAVE AUDIO GEN. KIT \$31.95. WIRED \$49.95.



- Resistance values from 0 to 99,999 ohms with 0.5% precision.
- All resistors have 0.5% accuracy.

1171K RES. DECADE BOX KIT \$19.95. WIRED \$24.95.



565K MULTIMETER KIT \$24.95. WIRED \$29.95.

- 20,000 Ω /V; 31 ranges.
- DC/AC/Output volts: 0-2.5, 10, 50, 250, 1000, 5000.
- DC Current: 0-100 ua; 10, 100, 500 ma; 10 A.
- Ohms: 0-2K, 200K, 20 meg.

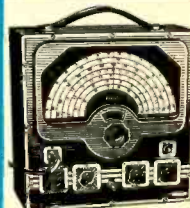

- Covers range of 75 kc to 150 mc.
- 7 calibrated scales: accuracy better than 1%.
- Bandsread vernier tuning.
- 4-step RF shielded output multiplier: constant output Z.

315K DELUXE SIG. GEN. KIT \$39.95. WIRED \$59.95.

555K MULTIMETER KIT \$29.95. WIRED \$34.95.

Write NOW for FREE latest Catalog 10-C

You build EICO Kits in one evening, but... they last a lifetime!

And you SAVE OVER 50%! See the famous EICO line TODAY, in stock at your local jobber.

ELECTRONIC INSTRUMENT CO., Inc., 84 Withers Street, Brooklyn 11, N. Y.



WANTED:—INERTIALESS SPEAKERS

... High-fidelity sound demands new speakers ...

By HUGO GERNSBACK

RADIO-ELECTRONICS, during the past few years, has entered a new cycle in which we turn back the clock, look over past accomplishments, and re-adopt them to our advanced age. Thus, the recent transistor development goes back 40 years to the ancient crystal detector, and by using new techniques enables us in many ways to surpass the most modern vacuum tube.

As we develop new techniques in radio-electronics, we find that we often can go back to older ideas which had never been fully exploited, simply because we did not then have the technical know-how. A very recent transistor improvement also reverts back to the silicon detector; it now makes use of the new refined silicon metal. (The silicon used in our old detectors was the natural nonmetallic element).

When we come to our present-day loudspeakers, we are still using the same principles laid down in 1876 by Alexander Graham Bell. Indeed, today's telephones and loudspeakers use the identical principles. We still use diaphragms or cones, which by vibrating displace air in rhythmic fashion so that we hear the sound.

Present-day speakers were good enough until high-fidelity sound came along. It appears certain now that an entirely new instrumentality is needed. One of the chief faults of the present-day speaker is that it gives rise to *transient distortion*. This is so because the loudspeaker uses a cone and moving coil. These, due to their inherent inertia, keep vibrating after the signal has stopped, thereby creating spurious sounds.

There are other faults in the present-day loudspeakers, the chief of these is that if you wish to cover the entire audio frequency band, you must use more than one speaker. Usually the large speaker covers the lower frequencies, and a tweeter is added for the high notes. Occasionally a third or fourth speaker is added to further divide the band covered by each speaker. What is needed for modern use is an *inertialess speaker* which should cover the entire audio frequency range. No electromagnetic speaker built on Bell's principle satisfies such requirements.

It is possible that new inertialess speakers will evolve in the future by going back to old speakers which were invented over 50 years ago. There is a long list of such loudspeakers. Some of the principles of many of these can be adapted for modern usage. We will give here only the most important ones.

The Molecular Speaker. This speaker was designed by Ader and was also called the iron-wire telephone. It never achieved great prominence, because while it produced articulated sounds, spoken words were not intelligible, probably due to poor construction of early models. No diaphragm or vibrating body is used in the molecular phone. It consists of a one-millimeter thick iron wire stretched under some tension between two unequal sized heavy copper masses. Surrounding the center of the iron wire, there is an electromagnetic wire spool. In operation the iron wire becomes shorter or longer by magnetostriction. Such a molecular motion is microscopic. The sound issues at one end from the smaller copper mass referred to above, to which a dish-shaped heavy wooden or hard rubber disc is attached. The sound comes from this disc.

Several decades ago, a Swiss constructor succeeded in making electric dynamos and motors speak loud and

clearly. This, too—it was claimed—was done by molecular agitation. Thus one could stand in a large room while a one-horsepower motor would give off sound and talk clearly.

The Capacitor or Condenser Loudspeaker which has been brought out again in recent years, has not as yet been perfected. It is today used for tweeters in German extended range receivers. This speaker is not a truly inertialess speaker, but comes close to it.

The Electrothermal Loudspeaker was first demonstrated by W. H. Preece nearly seventy years ago. It translates electric currents into sound by an electrothermal effect. This is accomplished by using a very fine wire which is heated and cooled by the varying audio currents. The wire is in free air and its expansions and contractions create sound in the surrounding air. Delange used this principle in constructing ear phones which seemed to work quite satisfactorily in the heyday of wireless.

Another electrothermal speaker was demonstrated over 60 years ago. This speaker was in fact an electrical incandescent lamp. By using appropriate circuits coupled to the lamp, an ordinary incandescent bulb could be made to give out loud sounds and music. The sounds issued from the outer glass envelope of the lamp, despite the vacuum. The sound conduction was through the stem of the lamp, then on to the glass envelope.

The Ionophone is also in this category, and it is a true inertialess speaker.* It was developed by the French inventor, Sigmund Klein. This speaker actually works by molecular movement and heat. It is in actual production in France. It requires a large horn in its operation.

The Talking Arc Lamp invented by Valdemar Poulsen is in the same category. This is also an electrothermal speaker and was much in vogue at the turn of the century. In this speaker you merely modulated the flaming arc. It was a rather satisfactory loudspeaker in those early days. It was used also in one of the very first radio telephones.

Talking Crystals also go back to the old crystal days, but here we have an entirely different phenomenon. Early experimenters in some cases, instead of using a catwhisker on the crystal—Silicon preferred—employed a razor blade. Now, if the latter was properly adjusted—and this was not easy—you could place your ear near the blade and sounds would issue from it. *Here we have a double action. The detector and the loudspeaker have become a single unit.* This is an attractive idea, and if it were engineered for present-day uses, one can see where we would do away with perhaps quite a good deal of sound distortion. To be sure we would not be using razor blades, but some other means would have to be evolved.

This is exactly the same principle as when a housewife suddenly finds that her pan in which she is frying eggs on the stove mysteriously proceeds to give out music, or when an ordinary cold water faucet starts spouting singing commercials. There are many instances where this has occurred, usually in the close vicinity of a radio transmitter. Strange as it may seem, engineers have never seemed to follow up this clue. We believe the idea to be a worthwhile lead today.

* See RADIO-ELECTRONICS, November 1951

OSCILLOSCOPE PATTERNS and AMPLIFIER DIAGNOSIS

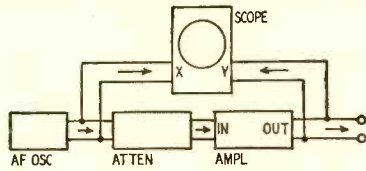

Fig. 1—Simple hookup for diagnosing amplifier with oscilloscope patterns.

MAGAZINE articles and textbooks often describe the use of oscilloscope patterns to detect or assess amplifier distortion. The method, theoretically, is simple. One merely connects the input of the amplifier to the X plates and the output to the Y plates.

As generally presented in the literature, patterns show the effect of *either* distortion or phase shift. In practice, distortion and phase shift frequently come together, so a different pattern is produced.

Fig. 1 shows the general arrangement used for obtaining these patterns. Without doubt, the method itself has advantages over either examining an oscilloscope trace of input and output with an ordinary time-base (with or without electronic switching), or analyzing input and output with a wave analyzer. For both methods, the input should be almost a perfect sine wave.

For this method perfection of waveform is not so important—although the source should be at least ostensibly a sine wave. Compared with the viewing of waveform with an ordinary time-base, small degrees of distortion, particularly lower-order harmonics, are easier to detect and identify.

The use of a wave analyzer identifies precisely the component frequencies produced by distortion, but does not indicate how these component frequencies add up to modify the waveform. To diagnose the cause of the distortion, the actual departure of the waveform from its true shape is more helpful than a detailed analysis of the harmonics introduced.

Phase Shift.

To make the whole matter quite clear, we will start by discussing phase shift patterns when no distortion is present. Fig. 2 shows three families of phase-shift ellipses. In each case zero phase shift is indicated by sloping line which means that the spot traverses to and fro along the same trace. Introduction of phase shift opens the line out into an ellipse, and when 90° is reached, the major and minor axes of the ellipse are horizontal and vertical. Beyond 90° the ellipse would tilt the

opposite way, finishing up with a straight line sloping the opposite way for 180° phase shift.

The three groups of Fig. 2 help clarify the significance of the mathematical properties of various ellipses: In the center group the deflection due to the X and Y plates is equal, so the zero phase shift line is at an angle of 45°, and the 90° phase shift trace is a circle. The left and right groups of patterns show the resulting pictures when the X deflection is less and greater than the Y deflection respectively. It is most convenient for diagnosis to use the equal-deflection pattern shown in the center of Fig. 2 if at all possible. In some instances this may not be easy with the equipment available, so it is necessary to make out a pattern on unequal X and Y deflections. Ellipses

Finding the phase angle

The point where the ellipse crosses the vertical or horizontal center line, measured from the center of the pattern, is the *sine* of the phase-shift angle. (For example, the 30° ellipse crosses the lines at 0.5 the length of the line.) The point on the boundary square of the pattern where the ellipse touches it, measured along that side from the center line, is the *cosine* of the phase shift angle. The cosine is measured as a decimal fraction of the line, and the angle can then easily be found by reference to a simple table of sines and cosines.

It is naturally easier to use the sine reference for angles between zero and 45° and the cosine reference for angles between 45° and 90°, but it is a good idea to measure off both points as a

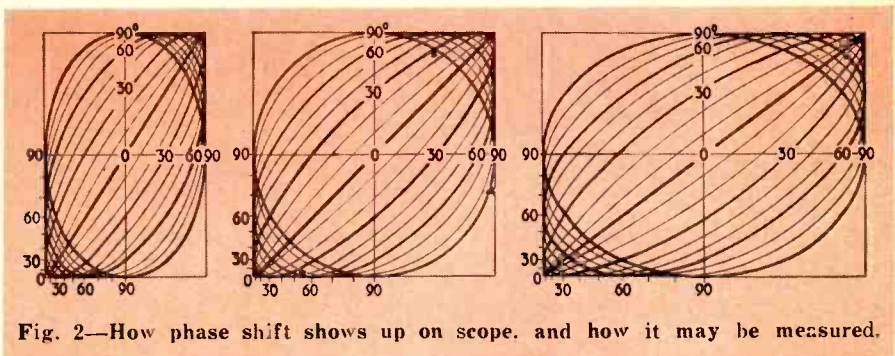

Fig. 2—How phase shift shows up on scope, and how it may be measured.

are shown for 10° intervals of phase shift from zero to 90°, and the 30° and 60° phase-shift ellipses are identified and distinguished from the others by being drawn blacker.

Points by which to deduce the phase shift of any given ellipse are marked on the figure. The best way to measure such an ellipse is to place a transparent cursor with graph ruling in front of the oscilloscope and adjust both deflections so as to fill an even number of squares. This provides a handy reference. Consider half of one side of the square containing the pattern as equal to the unit "one." Using this graphical unit of distance, the location of the points indicated (along the left and bottom edges) is measured from the center or center line of the pattern.

check, particularly where the angle lies between 30° and 60°. It is also a good plan to take an average of all four possible reading points for each value, to eliminate any error due to the ellipse not being quite correctly centered in its boundary square.

Distortion

If the reader has tried to calibrate an oscillator with Lissajou patterns, as described in the author's article in the November, 1952, issue of RADIO-ELECTRONICS, he will have noticed that when the patterns are not quite locked they appear to be moving around. The direction of movement is somewhat subjective; that is, it depends upon the imagination of the viewer at the moment.

The movement could be imagined as

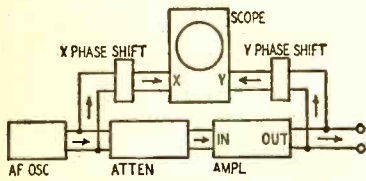

Fig. 3—Setup for injecting phase shift into either X or Y plate feed circuits.

being due to a pattern traced on a transparent cylinder, which is rotated on its axis so the pattern on the far side is viewed as if it were superimposed on the pattern in front. The cylinder could equally well lie on a horizontal or vertical axis, whereupon the movement due to its apparent rotation will appear at right angles. If either of the patterns has a slight distortion, particularly noticeable at one point in the waveform, the direction of the axis of rotation seems to be identified by the movement of this distortion point. For example, if there is a little kink in the 60-cycle waveform due to rectifier pulse current in a power-supply unit connected to the same power line, this kink will maintain a regular position horizontally, moving up and down along a vertical line in the trace, and the kink will appear at all points in the pattern where it crosses this vertical line. This will give the impression that the pattern is moving up and down vertically, or rotating on a cylinder with a horizontal axis. On the other hand, if the output from the oscillator has a similar definite distortion mark, the apparent movement will be the opposite way, the distortion mark traveling along a definite horizontal line in the pattern, as if the rotation were due to the pattern being traced on a cylinder with a vertical axis.

All this is perhaps a little easier to visualize with Lissajou patterns where the frequency applied to the two sets of plates differs. For our purpose the frequency applied to both sets of plates is the same and the pattern does not move because the phase difference re-

mains constant. However, there are ways of making the pattern move by introducing phase shift deliberately, and this can be an aid in recognizing the particular form of distortion.

Fig. 3 shows that deliberate phase shift can be introduced into the signal fed to the X plates or that to the Y plates. For practical purposes it is best to introduce phase shift only into the undistorted signal fed to the X plates, because a phase-shift network will alter the shape of waveform distortion, making it harder to recognize.

Fig. 4 shows the effect of phase shift applied in this way, together with construction lines (representing our imaginary cylinder) to help visualize the movement of the trace as phase shift takes place. The pattern at B shows the trace due to simple distortion with no phase shift. This distortion could be due to grid current or similar action producing clipping. The bent thick line can be regarded as an ellipse viewed edge-on, with the ends bent over, rather like what might happen to the rim of a bicycle wheel if it fell into a slot in the paving and the rider fell off the bike sideways. The thin lines are construction lines to identify the position of the sudden bends, and can be regarded as intersecting circles viewed edge-on.

The pattern shown at A is due to phase shift in the deflection of the X plates, and C shows the effect of phase shift in the deflection of the Y plates only.

The remaining patterns, D, E, and F, show the effect of combined phase shift on both sets of plates, maintaining the same phase shift in the Y-plate deflection as that shown at C, which means that the points on the actual trace will move along horizontal lines as the X shift is varied. To aid in visualizing this, horizontal lines are drawn for the points where the curve suddenly changes, at C, D, E, and F. To allow these points to move on a path similar to a point on the surface of our imaginary vertical cylinder, the original

construction lines, becoming ellipses, move in the peculiar manner indicated at D, E, and F. The arrows on the ellipses indicate an imaginary direction of rotation consistent with the arrows on the thick line showing direction of spot movement. This direction is arbitrary and might easily be in the opposite sense to the one shown.

At D the phase shift in both deflections is in opposite ways, so the resulting pattern is more opened out. At E the two phase shifts are the same way and the same amount, so, if no distortion were present, the straight line, due to the equivalent ellipse being viewed edge-on, would be restored; but the bent-over portions are now moved round so they appear as loops moving away from this straight line. F shows the way the pattern distorts when the X phase shift is in the same direction as the Y shift, but bigger, so as to turn the pattern inside out.

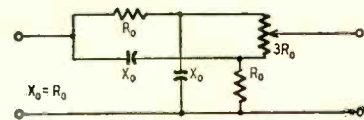

Fig. 5—A simple phase-shift network.

Some of these variations may occur in practical amplifiers. Phase shift may occur before the distortion sets in and further phase shift may be introduced after the point of distortion. If the phase shift is due to the fact that the frequency of the signal is either at the high or low end of the spectrum, it will be progressive, all in the same direction, as the signal goes through the amplifier, before and after the point where distortion occurs, but if viewed from the point of distortion, the earlier phase shift will be in the opposite direction from the shift after that point (the signal on the X plates will be in advance of the point of distortion and that on the Y plates behind it in phase).

So this combination would produce a pattern somewhat like that shown at D in Fig. 4. Phase shift only before or after the distortion point would give an effect similar to the trace shown at A or C respectively of Fig. 4.

To aid in recognizing patterns due to practical amplifier distortion, it may therefore be helpful to inject deliberate phase shift into the signal fed to the X plates. Fig. 5 shows a simple circuit that will give continuous phase shift variation up to about 30° either way from the zero position. The capacitors are marked in terms of their reactance at the frequency for which the network is used. Of course, it can be used only at one frequency, or over a very limited range of frequencies, with any particular set of values, but the arrangement could be modified by switching in different capacitors to provide phase-shift facilities at different preset frequencies. This type of network is used for phase shifting in many test instruments.

Fig. 6 shows the arrangement applied with switching for frequencies of 100, 1,000, and 10,000 cycles. An

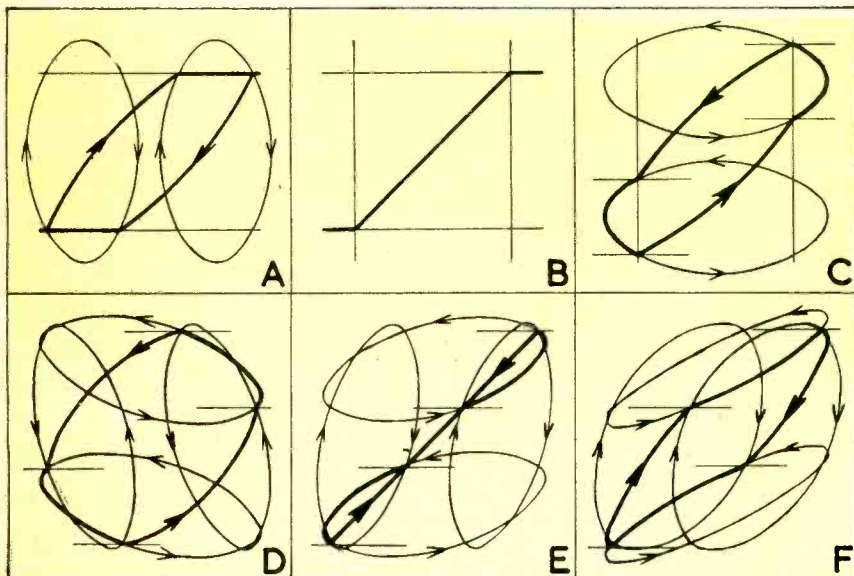

Fig. 4—How a distorted trace's shape varies with phase shifts. See text.

extra switch is provided so the phase shift network can be inserted or removed at will. This enables the frequency applied to the amplifier to be swept through the frequency spectrum without deliberate phase shift, switching over to the phase-shift arrangement at the preset frequencies of 100, 1,000, and 10,000 cycles for more detailed investigation of the pattern at these points.

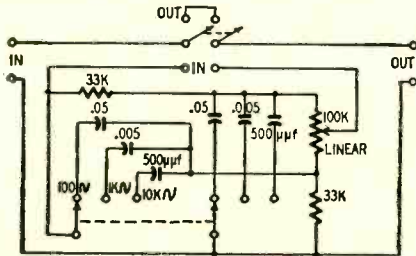

Fig. 6—Three-frequency shift network.

Fig. 7 gives a complete set of prepared patterns for a variety of typical defects in amplifier performance. The pattern for no phase shift is arranged in the second column from the left-hand side for convenience—that for X phase shift only being to the left, and that for Y phase shift only to the right of it. The remaining columns give the effect of equal X and Y phase shift of 30°, the opposite way and the same way. The kind of defect giving rise to the distortion is noted down the left edge of the diagram.

The first four groups of patterns relate to clipping due to grid current or similar action and curvature due to tube characteristics. The former may be due to inadequate grid bias and the latter to too much grid bias. Wrong plate loading can also cause these troubles. Some of the patterns show little difference between the two kinds of distortion. Notice where the X and Y phase shift are the opposite way. Here the difference between the two kinds of pattern is very small, and would be difficult to identify on an actual trace; this means that if some phase shift occurred before distortion, with some more phase shift after it, it would be difficult to determine which of these two kinds of distortion were taking place. Introduction of phase shift in the X plates to neutralize that in the amplifier before distortion occurs would produce a pattern similar to that shown in Fig. 7, in the column "Y phase shift 30°," where the difference between the two forms of distortion is quite clearly identified.

If sufficient phase shift were introduced in the feed to the X plates to offset all the phase shift in the amplifier, the trace would be similar to that in the last column of Fig. 7. Here again the patterns are distinctly different. Probably the easiest point to detect the difference is that where the trace divides: In the pattern due to clipping, the curve splits abruptly, but in the pattern due to curvature it forks apart smoothly.

The next line of patterns illustrates the kind of distortion due to magne-

tizing current in a transformer core. For the previous patterns it would be immaterial which kind of X phase shift were introduced (by itself), because the pattern with no phase shift has a kind of symmetry demonstrated by the fact that the spot retraces its path to produce a single line trace. With this kind of distortion, such symmetry cannot exist, so 30° phase shift produces a different pattern, according to which way the phase is shifted. One direction is indicated in the figure by the solid line, and the opposite kind of phase shift, where it follows a different course, by the dotted line.

Where the phase shift through an amplifier is progressive, as at low frequency, the dotted line pattern would be the one seen, but where a similar phase shift is inserted in the deflection to the X plates, the solid line pattern would be produced. The effect of phase shift after the point of distortion is shown in the "Y shift 30°" column, and

combinations of phase shifts in the remaining two columns.

Another kind of distortion that produces patterns somewhat similar to transformer core distortion in some phases occurs when tubes in class-B operation are badly matched so that one tube cuts off before the other starts to conduct. A variety of patterns for this case is shown in the next line of the figure.

The last line illustrates the kind of pattern produced when high-frequency ringing occurs in the drive transformer of an output stage where positive excursions of the output tube grids are encountered. The ringing is due to shock excitation of an ultrasonic resonant frequency in the drive transformer circuit each time grid current ceases.

A further article will show how the oscilloscope can be used for localizing unexpected factors in the performance of an amplifier. END

DEFECT		X PHASE SHIFT 30°	NO PHASE SHIFT X OR Y	Y PHASE SHIFT 30°	X AND Y PHASE SHIFT 30°	
					OPPOSITE WAY	SAME WAY
CLIPPING DUE TO GRID CURRENT OR SIMILAR ACTION	ASYMMETRICAL					
	SYMMETRICAL					
CURVATURE DUE TO TUBE CHARACTERISTIC	ASYMMETRICAL					
	SYMMETRICAL					
TRANSFORMER MAGNETIZING DISTORTION						
CROSSOVER — BADLY MATCHED CLASS B TUBES						
H.F. RINGING — IN POWER DRIVEN OUTPUT STAGE						

Fig. 7—Common forms of distortion with different phase shift combinations.

HIGH-QUALITY AUDIO

By RICHARD H. DORF*



Fig. 1—Audio room at Terminal Radio Co., NYC, exhibits variety of components.

Part II—Loudspeakers

The loudspeaker is usually the weakest link in a high-fidelity system. A knowledge of loudspeakers makes for a most economical choice

THE INDIVIDUAL who has decided to invest in a custom-made home music system is putting himself in a somewhat different class from those who are satisfied with ordinary department-store combinations. He may be able to find a custom builder and rely wholly on the man's tastes and recommendations, but that procedure is rare. It is much more common to find prospective owners beginning to learn something about audio and electronics so that they can make intelligent purchases of components. Possession then becomes an individual thing as distinguished from the mass-market push-the-button-and-it-goes product.

When a home is to be newly equipped for high-quality audio, the first question is what facilities are desired. Most owners want a phonograph, which consists of a changer or a turntable, arm, and cartridge. Most also desire radio, though not always limited to AM, especially in a city like New York where all major and many minor stations broadcast also on FM. This calls for a tuner. An amplifier is always necessary to convert the voltages from the tuner and phonograph pickup to power, a speaker or speaker system is a necessity.

The most pressing problem is selection of the components. As in any integrated system, the poorest component

determines the quality of the final sound. It is foolish, for instance, to have a first-class three-way speaker system in a big, solid box at a cost of four or five hundred dollars, powered by a \$30 amplifier. The same money would be better spent on a good amplifier, which can greatly improve the performance of an inexpensive speaker. A good speaker will show up all the faults of the poor amplifier. So when a budget figure is arrived at, the money should be apportioned carefully to achieve an integrated system—each component as good as funds will allow, with the money spent for the various components proportionately to do the most good.

Loudspeakers

The impetus of public demand given to designers and manufacturers of high-quality audio equipment has resulted in vast equipment improvements in a short time. Amplifiers have advanced to the point of near perfection in sound quality. All one has to do to get an entirely adequate amplifier is pay for it. Very high-quality turntables and tuners are available. Records today are not perfect, but they are fine; pickups, while far from perfect, are not quality-limiting factors. The one component which limits the performance of the system when the rest of the components are optimum is the loudspeaker.

The basic reason is that it is a power-producing transducer, of which the utmost versatility is required. It must take electrical signals and translate them to movements of air. It must do this over an exceedingly large range of frequencies, (1,000 to 1 if the limits are 20 and 20,000 cycles), and the air movements it creates take in a range of almost 70 decibels between the smallest and largest. In addition, it must create no movements on its own. This is a tall order and is not fulfilled by any speaker system so far developed. The performance of a loudspeaker is greatly affected by its housing and mounting and by the amplifier which drives it.

Since even the finest of loudspeakers fall considerably short of perfection, the best way to place one in a system is to listen to several within your potential price range, know a little about speakers in general, and then make your choice to take advantage of whichever one within your spending range does best. The listening and initial selection can be done in any of the many audio equipment salesrooms throughout the country, most of which are run by electronics jobbers. Fig. 1 shows a portion of the audio room at a New York electronic parts distributor. Most of the items are actually connected to a central distribution panel so that the customer can listen to as many systems as he wishes, each composed

*Audio Consultant, New York City.

of components of his choice and put together in a few seconds at the distribution panel. Unless mail order is the only means, good audio equipment should not be bought without giving an ear to it at a showroom and comparing it to other models. This is especially true of speakers. Since speakers fall short of perfection, each speaker and each system has to a large extent its own sound character. The only way to get satisfaction is to choose the one whose sound suits you.

A loudspeaker is basically nothing more than a reversible d.c. motor. The motor is powered by audio currents from the power stage of an audio amplifier. Its output motion is not rotary but reciprocating—back-and-forth. Its load is the air, and thereby hangs one of the great difficulties of good sound reproduction. Air is compressible, and coupling the moving speaker cone to it becomes more difficult as the cone movement becomes slower. You can see that for yourself, by holding a piece of paper in your hand and moving it so that the area of the paper is opposed by the air. If you move the paper slowly it goes quite easily; the air is gently compressed and moves out of the way. If you move the paper fast, it bends, showing marked air resistance. Similarly in a speaker a fast-moving cone (excited by a high frequency) has no difficulty making the air move. But at low frequencies a cone moves practically no air at all. To make it do so, special provisions are required, such as the use of a large cone (obviously a large piece of paper will move more air at slow speeds), an enclosure so the air cannot readily move out of the way; or some artificial reinforcement such as a bass reflex port in the enclosure.

Speaker structure

The General Electric S-1201-D loudspeaker is a 12-inch unit in the low price range but with surprisingly excellent sound characteristics. It is especially built for home music systems of the more modest type where a single speaker does all the work. Its structure is fairly typical of such units. The working parts of the speaker are shown in the cutaway photo, Fig. 2, and the exploded view, Fig. 3.

The primary parts of the speaker are the magnet and voice coil. The magnet is a cylindrical piece of Alnico V, an alloy of magnetic metal which forms a permanent magnet of exceptionally high field strength. Alnico V is used in practically all good speakers. The more sensitive speakers have magnets of greater size and weight, ranging from a few ounces to 5 pounds or more. The magnet shown weighs 14.5 ounces.

The voice coil is a low-impedance coil mounted on a cylinder of aluminum and placed within the field of the magnet. When current flows through the voice coil the magnetic field set up by the current either aids or opposes the field of the permanent magnet. The excitation for the voice coil is a.c. at audio frequencies. This causes the polarity

of the magnetic field around the voice coil to reverse every half-cycle. As a result the coil moves forward and back at a frequency determined by the audio excitation.

The nature of the voice coil's movement follows the laws of electromagnetic phenomena. In an ideal speaker, the amount of movement for a given excitation frequency, is proportional to the peak value of the a.c. For a given peak value of a.c. the amount of movement is inversely proportional to frequency; there is greater movement at low frequencies than at high frequencies. It might appear at first thought that this would result in bass emphasis, but, like all of Nature's laws, the relationship of air movement, frequency, and ear sensation fit together nicely. The amount of sound sensed at any frequency is a function of the sound power. The power of a movement is proportional to the product of velocity and distance. The same amount of power is expended in moving a bedroom bureau 10 feet at the rate of 50 feet per minute as you would moving it 20 feet at a speed of 25 feet per minute, other things being equal. At low frequencies the voice coil pushes the cone farther but slower—and at the high it does the job faster but not as far.

The voice coil is part of an assembly which includes the spider. The spider is a piece of fabric with corrugations for flexibility. It holds the aluminum coil form in place, when the edge of the circular spider is fastened in place on the frame as shown in Fig. 2. The steel core is fixed in place by the magnet assembly and the voice coil form slips over it so that the coil stays centered and can move only in its axial plane. A felt dust-cap is cemented over the open outer end of the coil form.

The cylindrical magnet is held in place by compression between a dish-shaped front plate of steel, welded to the frame, and a back plate of the same shape which is pressed against the magnet and secured with three bolts. A cover is fitted over the entire magnet assembly and is held in place with a bolt. This prevents dust and stray magnetic metal particles from getting into the assembly and possibly impeding the movement of the voice coil and distorting the magnetic field, resulting in loss of fidelity.

The cone is the element which actually pushes the air. Its inner (small) end is attached to the outer end of the voice coil form and its outer end is cemented to the outer end of the main steel frame of the speaker. Fig. 4, a front view of a speaker, shows that there is a more or less right-angle fold at the outer edge of the cone as well as a couple of accordion pleats. With this provision the body of the cone can move in and out without being greatly restricted by the outer edge fastening. When the voice coil moves back and forth as a result of the changing magnetic field set up around it by the audio current, it pushes the cone in and

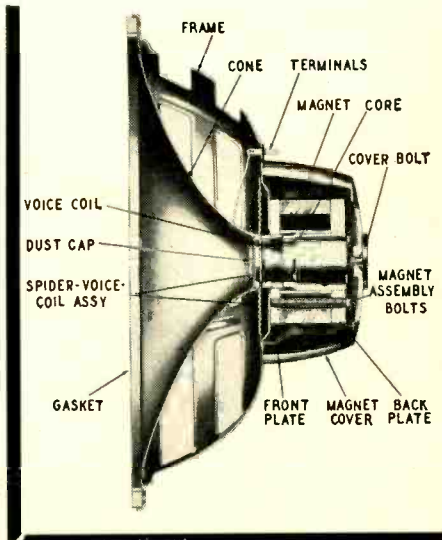

Fig. 2—Cutaway view of modern loudspeaker.

out. The cone, in turn, moves air and sets up sound waves.

Speaker quality factors

The description we have just given illustrates the essentials of speaker construction. Most speakers, big and little, good, bad, and indifferent, are put together in roughly the same way. What, then, makes the differences between speakers?

We have mentioned that the size of the magnet determines the sensitivity of the speaker. This is because the stronger the magnetic fields the greater will be the motor action. It is also possible with a larger magnet to create a more uniform magnetic field over the distance through which the voice coil travels. Any nonuniformity of the field means that the voice coil will fail to move in exact accordance with the audio output of the amplifier, since a given coil current will not produce the same movement at all voice-coil positions. All other things being equal, look for a large magnet when you buy; catalogs rate them in weight.

Electromagnetic speakers once were common. They had no permanent magnet; the field was created by a large coil of wire in the same position as the magnet in present-day speakers. It was excited by direct current either from a special power supply or from the B supply of the set. Electrodynamic speakers are subject to hum from the field supply, and they waste power. Avoid them for high-quality systems.

Voice coils are invariably of low impedance, never higher (except in very special cases) than about 16 ohms. The reason is that higher impedances could be obtained only by more turns. That would increase the weight of the coil and restrict its ability to move quickly in response to high frequencies. It would also, of course, cause overshoots and lags. The nominal a.c. impedance of a voice coil has no relation whatever to the quality of a speaker, but its actual ohmic resistance does.

Ideally the impedance should be pure inductance, since a pure reactance consumes no power. The power fed to the speaker should be used to move air, not to cause heat in the voice coil. Even a small amount of ohmic resistance in a voice coil creates a surprising loss of efficiency.

In a working speaker the mechanical work done by the cone causes the voice coil to draw current from the amplifier. The situation is somewhat analogous to a transformer whose primary draws more current when the load resistance across the secondary is made smaller. It is only the inductive part of the net voice-coil impedance which can make the cone move. The "reflected" resistance of the cone should be the largest part of the voice-coil resistance. (Resistance is defined in this case as the

an ordinary receiver, a department store console or an old-style amplifier, is the audio source, the aluminum ribbon is worth little if anything.

The cone is important because it is the air mover. Its salient features are material, shape, and mounting. Little can be said about cone material because manufacturers choose it without telling the buyer what they have chosen. In general the cone is made of paper and not a very tough paper at that—in fact, when it is not inherently soft and fibrous, it tends to be somewhat brittle. For some unknown reason cones are not usually moistureproofed. So, when handling a speaker, be extremely careful not to let anything touch the cone, back or front, and rest it on a flat surface, face down. I have handled hundreds of speakers and I always treat

what beneficial, since it approximates the beginnings of a small exponential horn, which is the best way to couple the speaker to the air (more on this subject in the next installment).

Another school holds that the cone ought to be as flexible as possible. In a speaker which reproduces all frequencies (not used with a tweeter) the cone tries to move over a large path slowly and over smaller subpaths quickly at the same time. With stiff cones this may cause cone breakup—different parts of the cone moving in different ways and producing air movements with no predictable relationship to the audio input. Some manufacturers prefer to have very flexible cones. They achieve this by *pleating* the cone in the manner of the wide-range University 6200 shown in Fig. 5. The pleating or ac-

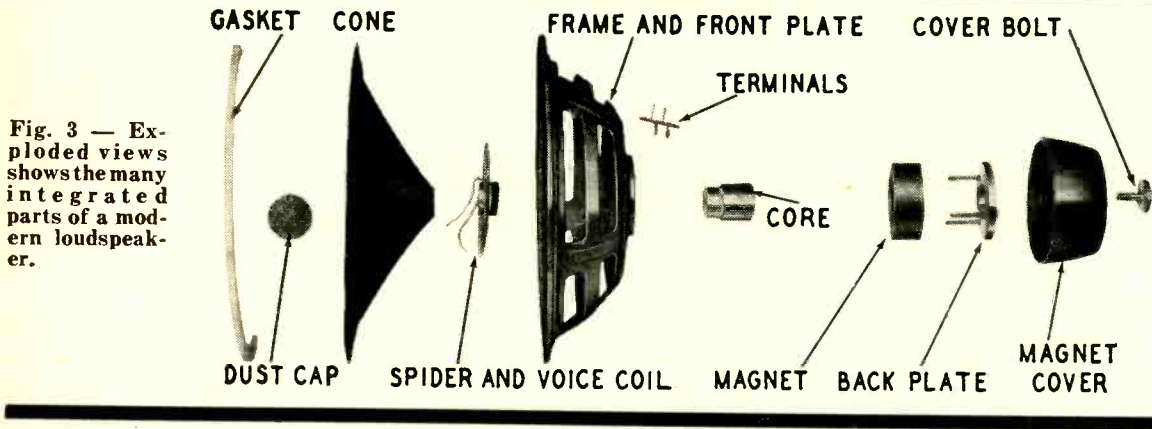

Fig. 3 — Exploded views shows the many integrated parts of a modern loudspeaker.

inclination of the coil to draw current.) Not only does current passing through ohmic resistance of the coil not do any work, but it also contributes to non-linearity of cone movement. We do our best in high-quality amplifiers to provide enough inverse (and sometimes positive current) feedback to make the resistance the speaker sees a low one. When we do this we expect to have the cone moving according to the current, even though the air represents a constantly changing load. But when the voice coil has d.c. resistance the effect is the same as when a series resistor is inserted in a battery circuit.

Ohmic resistance is reduced by using as large-sized a wire as possible without adding too much to the coil's weight. In the most elaborate speakers the voice coil is made of aluminum ribbon wound on the form on edge so that the result looks like a stack of circular cooling fins. The ribbon presents a large area for current flow, which greatly reduces the resistance of the winding. Aluminum is used rather than copper for the sake of smaller mass. Makers of speakers with aluminum-ribbon voice coils usually feel it worth while to advertise the feature, and justifiably so since it makes for a high-quality speaker. Low d.c. resistance in a voice coil, is useful to preserve the regulation advantages of an amplifier with a good amount of negative feedback. If



Fig. 4—Front of speaker. Note right angle fold and accordion pleats at edge.

them gently. While radio-set or public-address speakers can be re-coned by most service technicians, high-quality units require factory repair. Since a new cone is necessary if the old one has even a small rip, hole, or uneven spot from moisture, take care! When mounting speakers in cabinets or on baffles, cut a piece of heavy wire mesh—quarter-inch squares are good—and mount between speaker and panel.

Shapes and mountings of cones differ greatly among manufacturers. In general, cones either have straight sides or are flared. The flare, which can be seen plainly in Fig. 2, seems to be some-

cordion principle to achieve flexibility is commonly used around the outer edge of almost all cones. There is so much variety in effect possible, considering the materials and details of shape and mounting, that a blanket recommendation is impossible. The best procedure is to listen to several speakers and take the one that sounds best.

In the next installment we will talk about enclosures, multispeaker systems, and other facts concerned with getting the most out of the speaker you buy.

END

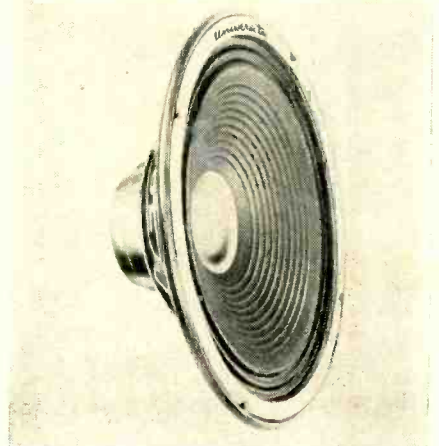

Fig. 5—Loudspeaker using completely pleated cone for maximum flexibility.

Part II—Improving the high-frequency response. The Miller effect, shunt capacitances

extending amplifier BANDWIDTH

By JOSEPH MARSHALL

IN THE first part of this series, we dealt with some of the difficulties in the way of extending the bandwidth of amplifiers and discussed in some detail the problem of extending the bandwidth downward. Having lengthily considered the low end, we now come to the question: What about the highs?

We can take several measures to extend the high-frequency response. It is limited principally by shunt capacitances and the Miller effect. We can start by using miniature tubes in voltage-amplifier and phase-inverter sections. Their capacitances between elements are about half those of the larger tubes. Second, we can design these stages with very low plate loads. Although this results in lower gain and output, it also results in lower losses at high frequencies. Single-ended tubes will deliver enough gain for preamplifier service with plate loads of 50,000 ohms and complementary grid leaks; push-pull tubes can use a higher load. We can improve the h.f. response still further by leaving out the cathode-bypass capacitor and thus producing current feedback. The reduction in gain is not significant at audio frequencies but the improvement in h.f. response definitely is. We can also use, especially with single-ended stages, cathode com-

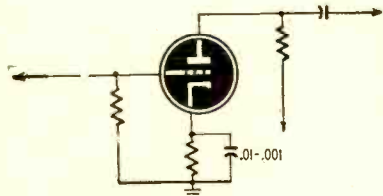

Fig. 1.—A method of h.f. compensation.

pensation as in Fig. 1. This method of operation produces degeneration at lower frequencies but full amplification at the high frequencies. For best results the value of the cathode-bypass capacitor should be adjusted with a square-wave generator and a scope. Values from .01- μ f downward can be tried until maximum flatness is obtained. This method can also be used with push-pull amplifiers (using separate bias resistors) but the same result can be achieved much more simply by inverse feedback.

The greatest villain in the picture as far as h.f. response in triodes is concerned is the feed-through provided by plate-grid capacitance and the Miller effect. The effective capacitance is the product of the actual grid-plate capacitance times the amplification factor of the tube. Thus, if the tube has a gain of 12, and a grid-plate capacitance of 3 μ f, the effective capacitance becomes 36 μ f. The reactance of this capacitance at frequencies higher than 10 kc becomes low enough in relation to the grid resistance to result in considerable attenuation of these frequencies.

There is an extremely simple means of eliminating the Miller effect which should be used more often in high-fidelity design. That means is *neutralization*. Single-ended stages are hard to neutralize at audio frequencies, but push-pull stages are so easily and cheaply neutralized that there is almost no excuse for not including this means of extending the h.f. response.

Voltage amplifiers are cross-neutralized with fixed capacitors approximately equal in value to the grid-plate capacitance of the tubes. If miniature tubes are used, as they should be for reasons which will follow, fixed gimmicks of 1.5 μ f serve for the 12AT7, 12AU7, 12AX7, 12AY7, 6C4, or 6AB4. They are simply wired in from the plate of one tube in a push-pull stage to the grid of the opposite tube in the same stage, as shown in Fig. 2. Fixed capacitors can be used for output tubes in a similar manner; or, for perfect neutralization, ceramic trimmers of the 4-30- μ f type can be wired in and adjusted for complete neutralization. To adjust, simply

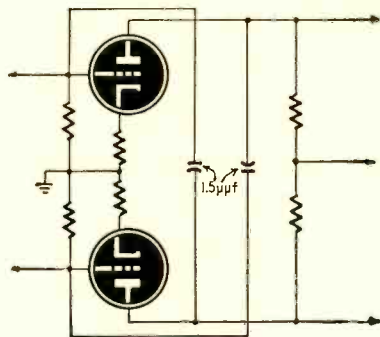

Fig. 2.—Cross-neutralization circuit.

break the filament circuit to the output tubes, feed in a signal, and adjust the capacitors for null or minimum output.

There is another way of neutralizing the grid-plate capacitance of tetrodes used as triodes in output stages. This is by employing the *Ultra-Linear* type of operation or a modified form of it. As indicated in Fig. 3, this form of operation connects the screens to taps on the output transformer. For most effective *Ultra-Linear* operation the screen taps should be about 18% of the impedance of the plate taps. However, ratios as low as 2 to 1, though not providing true *Ultra-Linear* operation, will minimize the Miller effect. The portion of the load between screen and plate isolates them so far as the tube capacitances are concerned and the tube behaves as a hybrid between a triode and a tetrode. The reduction in Miller effect is very similar to that of neutralizing—the high-frequency response is improved.

Optimum *Ultra-Linear* operation requires a special transformer. Many output transformers, however, provide two sets of primary taps—10,000 ohms and 5,000 ohms, or 6,600 ohms and 3,300 ohms, for example. Connecting the screens to the half-impedance taps will affect the power output and distortion characteristics very little, but will flatten the h.f. response.

With neutralization, the remaining h.f. losses are a matter of shunting capacitances only. Once more the use of miniatures helps, especially when neutralization is used. *Neutralization, though eliminating the Miller effect, doubles the output capacitance of the tube.* The output capacitance of miniature tubes is half or less than that of the standard tubes. So, even after neutralization, the miniatures have a better output-capacitance characteristic than the larger tubes.

Lowering the plate and grid loads improves the h.f. response by improving the ratio of load to shunt reactance. Direct coupling also helps, because circuit and stray capacitance is reduced. Feeding a tube from a low-impedance source also minimizes Miller effect. Thus the 12AX7 second section of the cross-coupled inverter described in Part I, last month, being fed by the

very low load of the cathodes of the first section, is affected by the Miller effect only beyond 100 kc. Similarly, in the case of the output tubes direct-coupled to the cathode-follower driver, the Miller effect becomes serious only beyond 50 kc, whereas in the self-bias circuit with a 500,000-ohm grid resistor, it becomes serious shortly after 10 kc. These are approximate frequencies.

Inverse feedback

Use of miniature tubes, neutralization, and the other measures referred to, can extend the response of an amplifier using the direct-coupled front section of Fig. 1 in the September installment and either of the power amplifiers described in this part, to 50 kc or slightly beyond. But this is still about an octave less than the flat response of the best output transformer. One further step can be taken to extend both the low- and the high-frequency response—and that, of course, is inverse feedback.

The conventional amplifier, as exemplified by the Williamson circuit for instance, uses a single feedback loop. Better results can be achieved by using

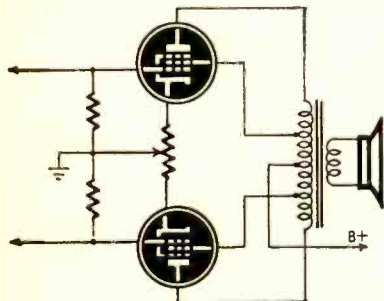

Fig. 3—The Ultra-Linear approach.

two loops. One would be an *internal loop* to flatten the response of the amplifier exclusive of the output transformer, to maintain dynamic and frequency balance, and to cancel part of the distortion. The second would be an *over-all loop* for correcting the response of the output transformer, further reducing distortion, and wiping out any bumps or slopes in the over-all response.

In the virtual direct-coupled amplifier we have been developing here, the internal loop can be very profitably carried from the plates of the output tubes to the cathodes of the voltage amplifier. Because the cathode resistors of the voltage amplifier are 120,000 ohms we can easily keep down the phase shift in the loop, and indeed we can correct the phase shift produced by the single coupling capacitor. For 10% feedback we can use a 1.2-megohm feedback resistor. If we now select a capacitor which gives us the same time-constant as the interstage coupling capacitor-resistor network, we achieve what amounts to neutralization of the interstage coupling capacitance. This is true because the two capacitances produce phase shifts in opposite directions—the interstage capacitor reducing gain, and the feedback capacitor increasing gain at very low frequencies. For exact neutralization the feedback

factor should equal the gain between the interstage capacitor and the output tube plates; and by a coincidence, 10% feedback to a pair of 12AU7s produces a feedback factor of 5 which is almost exactly the voltage gain of the big output triodes, or tetrodes used as triodes. Actually, it is not necessary to neutralize precisely, and even a considerable under- or over-neutralization will be satisfactory in practice. So in the case of the amplifier with self-bias we could use a 0.25- μ f feedback capacitor, yielding an approximate time-constant of 0.25 second, and in the case of the amplifier with fixed bias, a 0.5- μ f capacitor, yielding a time-constant of 0.5 second (Fig. 4). The phase shift in the feedback loops would begin at about the same point, but would go in the opposite direction from the shift caused by the interstage coupling capacitance. The final result would be the extension of the low-frequency response to around 1 cycle in the fixed-bias amplifier, and to 2 cycles in the self-biased amplifier.

With a 12AU7 as the voltage amplifier, 10% feedback will provide 14 db of effective feedback. This is more than enough to extend the high-frequency response at least another octave and probably two octaves. This will make the over-all response from input of the cross-coupled inverter to output-tube plates nearly flat from 1 or 2 cycles to beyond 100,000 cycles. Moreover, since this feedback loop includes the two stages responsible for the largest part of the distortion—the output tubes and the voltage drivers—the 14 db feedback produces an improvement of 5 times in distortion characteristics. Finally, if we match the resistors and capacitors in the feedback loop, we will achieve dynamic and frequency balance. So long as we deliver equal signals to the grids of the 12AU7 voltage amplifier, which we can easily do with the balancing control in the cross-coupled input, the loop will maintain that balance over the dynamic range of the amplifier.

Over-all feedback loop

When we now add an output transformer to the circuit we have just developed we obtain a picture rather different from the one we get when the same transformer is applied to the conventional circuit with its narrow bandwidth. First of all, it is obvious that with so little phase shift in the amplifier proper, the amount of feedback we can introduce from the transformer secondary to the input is limited only by the characteristics of the output transformer itself.

With the best transformers available today, the amount of feedback is actually limited only by the loss in gain we can afford. We have applied as much as 40 db of feedback—in addition to the 14 db of the inner loop—before instability resulted. Actually we need less than 20 db in this loop to correct for phase shifts in the output transformer and decrease the remaining distortion to a negligible level.

The total feedback, as far as the output and driver stages are concerned, would be 30 db or more. This would reduce distortion by a factor of 30 or considerably below 1% at maximum output. 14 db should be sufficient to take care of any remaining imperfections in the response of the best grade of output transformers.

Cheap output transformers

An ordinary public address-type output transformer and about 20 db of over-all feedback in the over-all loop will produce results in this circuit which are about as good or better than those

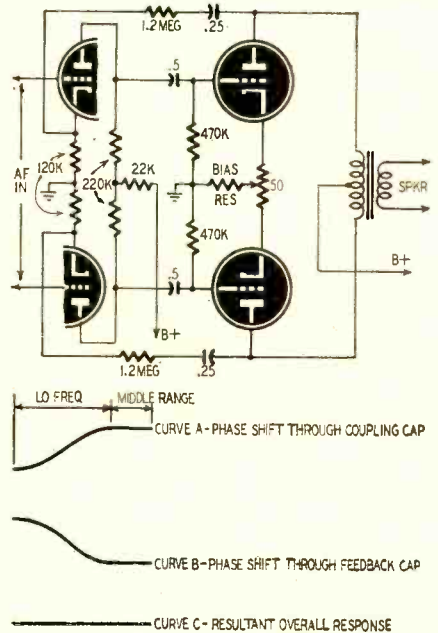

Fig. 4—The phase shift at low frequencies is neutralized in this circuit.

obtained with high-priced transformers attached to conventional narrow-band amplifiers. After all, it doesn't much matter whether the phase shift takes place in the output transformer or in the rest of the amplifier. An amplifier with considerable phase shift in the output transformer but very little in the amplifier itself will have an over-all performance very nearly comparable to that of an amplifier with a wide-range transformer and a narrow-band amplifier. There are other factors, such as core saturation, to be sure; but for many purposes, particularly that of obtaining acceptable high-fidelity reproduction at the lowest cost, an amplifier employing the measures we have discussed here with a public address-type transformer will be practically indistinguishable from the great majority of today's high-grade high-fidelity amplifiers employing high-priced transformers but possessing poor internal bandwidth.

In a very early issue accordingly, we hope to present a practical low-cost version of the *Golden Ear* amplifier, incorporating the various measures discussed in this and previous articles and producing—at a cost of \$25 or less—the reproduction which will compare very favorably with that of \$100 amplifiers.

END

The "goodness" of an amplifier is not shown by its circuit diagram. Circuits have no inherent magic properties, but are merely the tools with which the designer seeks to achieve a certain result, and different designers—provided always that they have the same high standards in view—may achieve the same results by different means.

—D. T. N. Williamson

High-Quality Circuits

Utilization of tone and loudness controls to improve amplifier frequency response.

By JOHN K. FRIEBORN

Tone control

The Bogen model DB20 amplifier uses a tone-control circuit (Fig. 1) which apparently has not yet been used in any

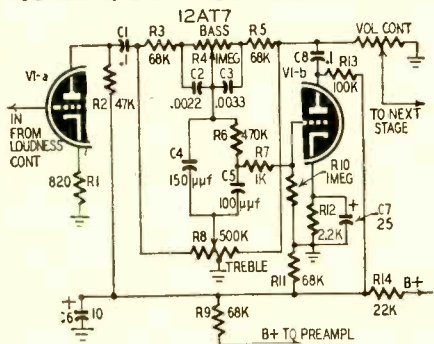

Fig. 1—The Bogen DB20 tone control.

other American amplifier, although it is similar to one published in England. It allows independent bass and treble control, with maximum boost and attenuation as shown in the curves of Fig. 2.

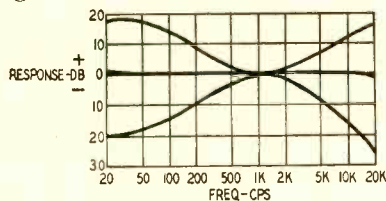

Fig. 2—DB20 control characteristics.

The bass-control section of the circuit includes two signal paths to the grid of VI-b, an input-signal path through R3, C2, and the left-hand section of R4, R6, and R7, and an inverse-feedback path via C8, R5, C3, and the right-hand section of R4. R4 is bypassed for high frequencies by C2 and C3, so

that high frequencies are unaffected by the position of the control. When R4 is divided by the arm into two sections whose resistances are in the same ratio as the reactances of C2 and C3, the same ratio of input signal to feedback signal is obtained at all frequencies and the response is flat. When the arm is moved toward R3, low-frequency incoming signals are attenuated less and feedback signals are attenuated more, so the gain at low frequencies increases. Moving the arm toward R5 has the reverse effects.

The treble-control section consists of an incoming-signal circuit and a feedback circuit, each with two paths. One incoming-signal path, through R3, C2, R6, and R7, has an approximately constant impedance at high frequencies. Through the other path, consisting of the left-hand section of R8 and C5, additional input signal at high frequencies can be bypassed around the first path, thus increasing the gain by an amount which depends upon the position of the arm of R8. The treble attenuation is controlled by the two feedback paths. The first, through C8, R5, C3, R6, and R7, has approximately constant impedance at high frequencies. Through the other path, consisting of the right-hand section of R8 and C5, additional feedback can be obtained and the treble can be attenuated by an amount depending upon the position of the arm of R8. When the arm is opposite the grounded tap on R8, no additional input signal or feedback is obtained and the treble response is flat.

Loudness control

Two recent amplifiers present different solutions to the old problem of tone-

compensated volume control or, as it is now called, loudness control. Both solutions consist of a tone-compensated "loudness control" used in conjunction with an uncompensated volume control. The loudness control used in the remote-

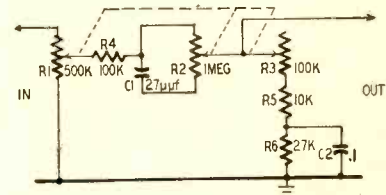

Fig. 3—Loudness control circuit in Stromberg-Carlson AR-25 amplifier.

control unit of the Stromberg-Carlson model AR-425 custom amplifier is a continuously-variable type, as shown in Fig. 3. The three potentiometers are ganged and move together in the direction indicated when the loudness is de-

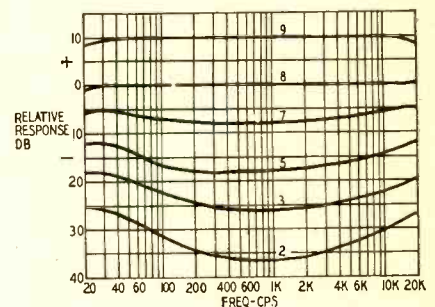

Fig. 4—AR-25 loudness control curves.

creased. The attenuation due to R1 and R2 is increased and the attenuation due to R3 is decreased. C1, shunting R2, provides relative treble boost, and

the circuit consisting of C2 and R6 provides bass boost. This circuit is similar to the IRC loudness control², except for the addition of R6 and a change in the values of the capacitors. The attenuation characteristic for the circuit of Fig. 3 at several settings is given in Fig. 4.

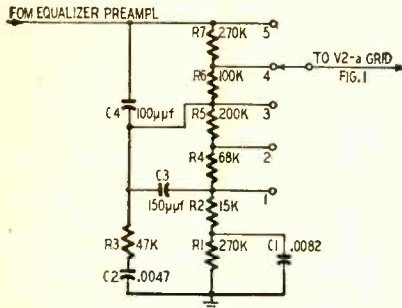

Fig. 5—The loudness control circuit of the Bogen model DB20 amplifier.

The loudness contour selector, as it is called, in the Bogen model DB20 amplifier, is a step-type control. (Fig. 5.) Unlike most previous step-type loudness controls³, this circuit provides treble as well as bass compensation. As the loudness is reduced, the amplitude of treble signal voltages is reduced more than bass, because of the shunting effect of C1 around R1 and C2 and R3 around all the components between step 3 and ground. Hence, there is a relative bass boost. On the other hand, there is also some treble boost, since C3 and C4 bypass high-frequency signals around R4, R5, R6, and R7, which attenuate the lower-frequency signals. The over-all characteristic is shown in Fig. 6.

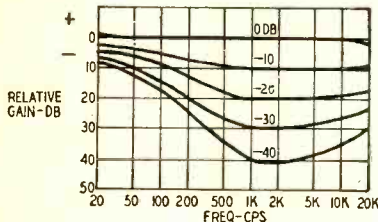

Fig. 6—Frequency characteristics of Bogen DB20 loudness control circuit.

Since there are considerable differences, not only between the actual frequency compensation characteristics of various loudness controls but also between the instructions given by various manufacturers for the use of their controls, it might be useful to sum up briefly the principle involved and a simple method of using any loudness-volume control combination. When any combination of sounds, such as a musical performance, is heard at one volume level and then again at a lower level, if the actual acoustical power of every note is reduced by the same ratio, on the second hearing there will seem to be an extra reduction in the volume of the high-frequency notes and a still greater reduction at low frequencies, compared to frequencies between about 1,000 and 3,000 cycles. If a sound is reproduced at the same loudness level as it originally occurred, no compensation is re-

quired, but if it is reproduced at a lower level, there should be some bass and treble boost.

When a program is to be reproduced at its original loudness level, the loudness control should be set so as to give a flat frequency characteristic and the desired loudness of sound obtained by adjusting the uncompensated volume control. If it is desired to reduce the loudness of the reproduced sound compared to the original, this should be done with the compensated loudness control, leaving the volume control at the previous setting. (If we can properly judge from the published frequency characteristics of loudness controls, their designers assume that no one wishes to reproduce sound at a level higher than natural.)

Even if we do not actually know what the original level of the reproduced sound was, we can set the loudness and volume controls properly. Assuming that we have proper equalization for recording characteristic (in record reproduction) or for transmission characteristic (in FM reception) and that our amplifier is otherwise adjusted for a flat frequency response—if all this is true and the loudness control can be turned up or down with no apparent change in the balance between middle, high, and low frequencies, then the volume control is correctly set. (This, of course, assumes also that the loudness control—and the listener's ears—conform to the Fletcher-Munson average curves.

If the sound is deficient in treble and still more deficient in bass, turn the volume control up and the loudness control down. If there is excessive bass, and perhaps slightly excess treble also, compared to the middle register, turn the volume control down and the loudness control up.

Sideband cutting compensation

A few recent FM-AM tuners do not depend upon bandpass tuned circuits in their AM channels to avoid the loss of high audio frequencies. They simply allow the amplitudes of the various sidebands to be attenuated by various amounts in the r.f. and i.f. tuned circuits and then compensate after the detector with an audio filter.

The idea is not new. It was first suggested in the early 1930's⁴ and analyzed and tested by several engineers around that time. The Robinson

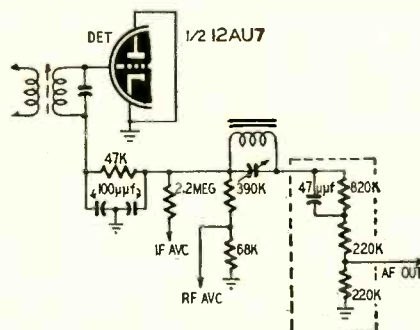

Fig. 7—Sideband compensation circuit, Stromberg-Carlson SR-401 radio tuner.

Stenode, a receiver with a piezo-electric crystal i.f. filter and an audio amplifier having a gain approximately proportional to frequency, was the extreme extension of the idea.

The circuits described in the reference article used series combinations of resistance and inductance as audio amplifier loads. Current practice is to use resistance-capacitance filters between the detector and first audio amplifier. Stromberg-Carlson model SR-401 radio tuner uses the circuit of Fig. 7. Pilot has used a circuit similar to Fig. 8 in several tuners.

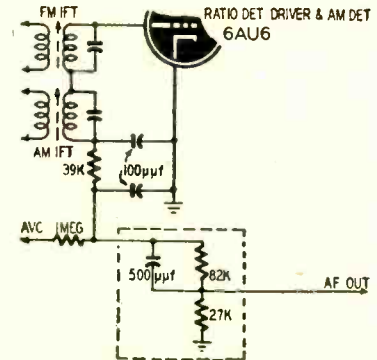

Fig. 8—Sideband compensation circuit in the Pilot model 821 FM-AM tuner.

Various possible defects of the general method were analyzed and disposed of in the article referred to. Presumably Stromberg-Carlson and Pilot find that their particular circuits give satisfactory results.

If the effects of sideband cutting in AM receivers can be counteracted by such a simple method, then why the emphasis all these years on complicated bandpass circuits for high-fidelity receivers?

This article has dealt with interesting circuits and components in current audio equipment. The principles involved and the results achieved are not new in the field of audio design. It is primarily the public interest in high-fidelity equipment that is new; and with this interest the public is willing to pay more to receive this quality. Tone and loudness controls have appeared in a multitude of circuits during the development of radio, but it is only comparatively recently that the more finely engineered circuits have made a widespread appearance. The overall goal is true fidelity of reproduction. What was considered as high fidelity by most manufacturers until recently is now ordinary reproduction. With special compensation networks and high-quality audio components we move continually closer to the ultimate, perfect fidelity.

¹Baxandall, P. J., "Negative feedback tone control—Independent variation of bass and treble without switches," *Wireless World*, October, 1952, p. 402.
²Johnson, E. E., "A continuously variable loudness control," *Audio Engineering*, December, 1950, p. 18.
³Winslow, J., "Full-range loudness control," *Audio Engineering*, February, 1949, p. 24.
⁴Colebrook, F. M., "A note on the theory and practice of tone correction," *Wireless Engineer*, January, 1933, p. 4.

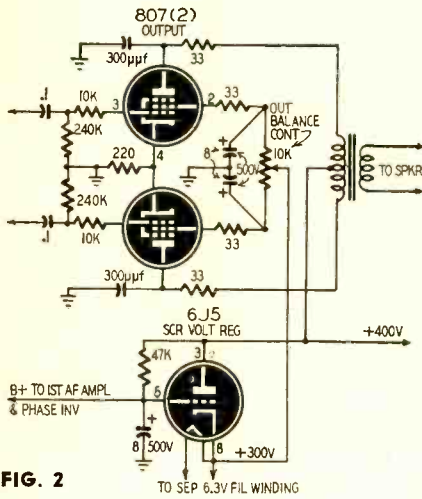

FIG. 2

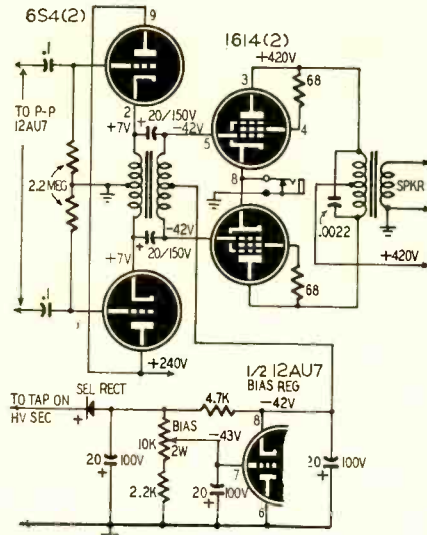

FIG. 3

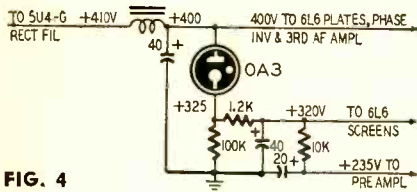

FIG. 4

Fig. 2—Output stage and regulated screen supply in the Hartley amplifier.

Fig. 3—The cathode-follower type driver, Williamson-type output stage, and the grid-bias regulator in the Fisher model 50-A 40-watt amplifier.

Fig. 4—Regulator for 6L6 screen grids.

across T1 or T2. C3 corresponds to the .01- μ f capacitor in series between C1 and C2 and ground. Note that the cold ends of the transformer windings are shown grounded in Fig. 6 while neither is grounded directly in Fig. 5. This does not affect the performance of the actual circuit because the plate and a.v.c. bypass capacitors (C1 and C2 in Fig. 5) effectively ground the lower ends of the windings for the i.f. signal.

Section S1-c of the selector switch varies the response of the audio signal at the output of the cathode follower. In the WIDEBAND position, L1 and C3 form a parallel-tuned 10-kc heterodyne filter which traps out whistles and interference which occurs when adjacent-channel stations are received simultaneously. Throwing the switch to NARROWBAND AM converts the cathode follower output circuit to a modified M-derived filter which begins to cut off at about 5 kc, thus eliminating a lot of the noise and monkey-chatter which may occur in localities where co-channel interference exists. The i.f. circuits are converted to conventional mutual-inductance types by shorting out the .01- μ f capacitor when good selectivity is required.

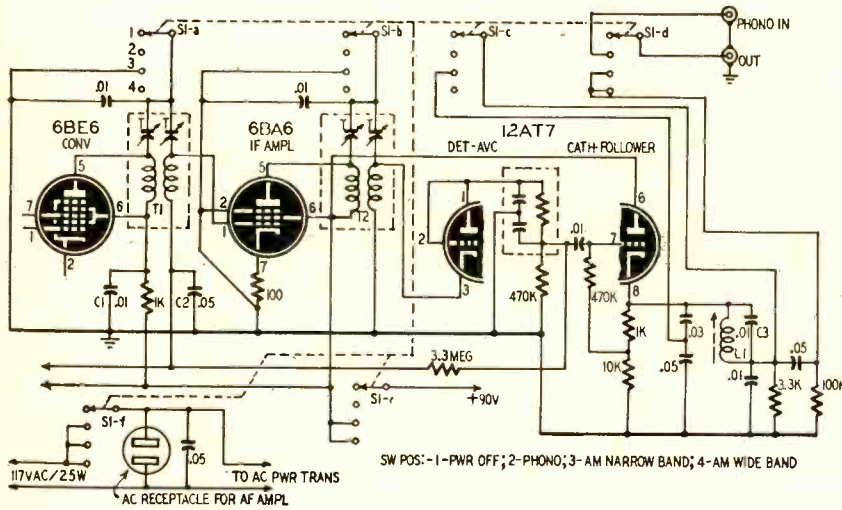

FIG. 5

Fig. 5—Partial schematic of the Bogen model AM-901 high-quality AM tuner.

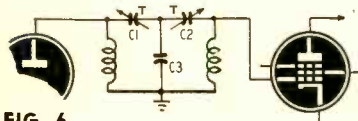

FIG. 6

Fig. 6—Simplified circuit of the overcoupled i.f. stages used in the AM-901.

Fig. 7—Sonocraft's novel tuning eye.

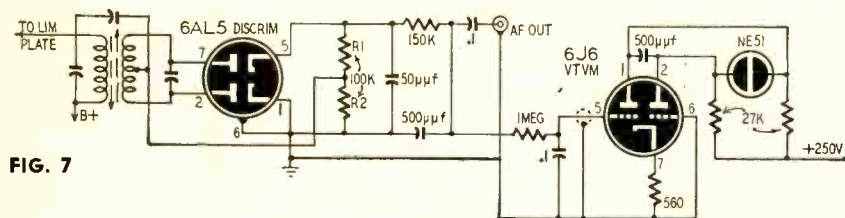

FIG. 7

windings of the i.f. transformers (T1 and T2) are connected to ground through a .01- μ f capacitor. The i.f. transformers are now converted to shunt-capacitance type overcoupled circuits which produce a broad, double-

humped response curve with sharp skirts.

Fig. 6 is the simplified circuits of one of the i.f. transformers when the selector switch is set for broad response. C1 and C2 represent the trimmers

The Blackout tuning indicator

Sonocraft's new FM tuner uses the novel *Blackout* tuning indicator shown in Fig. 7. The 6J6 operates as a bridge-type v.t.v.m. with a NE51 neon lamp connected between the plates in the place of the usual meter. The input of the 6J6 is direct-coupled to the hot cathode of the 6AL5 discriminator in the tuner.

When the tuner is tuned exactly to the carrier frequency, the voltages across discriminator load resistors R1 and R2 are equal with opposite polarities so the net voltage between the discriminator cathodes is zero. When the receiver is detuned, its intermediate frequency shifts above or below the resonant frequency of the discriminator transformer. The voltages across R1 and R2 are now unequal, and the resultant voltage between the cathodes is either negative or positive, depending on the direction of detuning.

Since the most negative electrode of a neon lamp glows when connected across a d.c. source, it can be used as a tuning indicator across the output of a discriminator.

When a d.c. voltage is applied to the input of the 6J6, the plate currents are unbalanced and one plate swings in a negative direction while the other swings positive, depending on the polarity of the input voltage. Since the NE51 is connected between the plates of the 6J6, the most negative electrode glows. Thus, one plate of the neon lamp glows when the set is tuned above the carrier frequency and the other glows when the set is tuned below the carrier. When the set is tuned exactly on the carrier, the d.c. output from the discriminator is zero and neither plate glows.

END

EXPERIMENTAL COMMUNICATION WITH LIGHT BEAMS

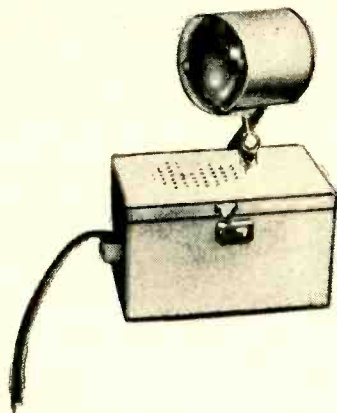

Light-beam communication, free from electrical disturbances, is highly applicable for short-range work

By ERIC LESLIE

THE transmitter on our cover this month is one of two distinct types of light-beam communications devices developed by the Yankee inventor Leslie Gould. (Regular readers will remember his *Prismatone* light-operated organ in the April, 1947, issue, and the *Sonicator* ultrasonic radar printed in August, 1946, as well as earlier items on light-electronic music, FM phonograph pickups, and similar devices.)

The more efficient light modulator, says Gould, is the gate type shown in Fig. 1. It uses the motor of a PM speaker, somewhat in the fashion of earlier light-beam transmitters (RADIO-CRAFT, September, 1934). The difference is in the gate. It consists of two crossed triangular Polaroid wafers, as shown in the figure. The upper one is fixed to a frame built up on the speaker; the lower one is cemented to the voice coil. The cone is removed, the voice coil being held by the spider alone. The two pieces of Polaroid are mounted ahead of a lightproof partition, in the center of which a round hole is cut just behind the crossover point of the two Polaroid strips.

The voice coil of this modulator is attached to the output of an ordinary amplifier. Speech or music makes the lower vane move up and down, and the light-stopping action of the crossed Polaroid pieces modulates the light beam projected through the round hole. (As the lower vane moves up, it reduces the amount of light, and increases it as it moves down.)

While it is the most efficient of the transmitters described here, this equipment requires a complete transmitting apparatus, as indicated by Fig. 2. The light has to be concentrated by special lenses for best results. A range of several hundred feet has been attained in daylight, and would be greatly increased in darkness. The other two modulators are not as efficient, but can be used by placing them ahead of an ordinary car headlight or spotlight, a heliograph mirror, or any other source of strong light.

Two light modulators

One of these modulators uses the

radiating-vane system shown in the cover photo. One set of vanes is fixed; the other can rotate so as to cover or uncover the openings in the first set. See Fig. 3. An iron rod attached at right angles to the shaft runs down past the edge of the assembly and is terminated in a small iron ball (in some models, a rectangular pole-piece) suspended between the poles of a small permanent horseshoe magnet.

A coil of wire is wound around the rod just above the pole-piece, so that current in one direction will make it an N-, and in the other, an S-pole. A thin strip of spring bronze is adjusted with screws as shown in the figure, to center the pole-piece between the magnet poles and prevent it from striking either pole as it is attached and repelled when audio-frequency current passes through the coil. This attraction and repulsion rocks the moving vanes, increasing or decreasing the apertures and therefore the amount of light transmitted.

The other modulator consists of a number of aluminum slats—plus an iron and a bronze one—which form a square frame. The slats are held together by two aluminum rods which pass through holes in their ends, and are spaced on the rods with fiber washers, making slits through which light can pass.

The center slat is of thin phosphor bronze. It extends beyond the sides of the square and is attached to angle-pieces bolted to the outside ring. The whole frame may now swing or pivot around this center. Fig. 4-a is a drawing of the assembly.

The bottom slat is of iron, and is wound with a coil of insulated wire (200 turns of No. 28 enameled in the one shown). About an inch ahead of its edge is placed a small Alnico magnet, as shown in Fig. 4-b. Several holes are drilled in the slat just beyond the magnet poles, confining most of the magnetic field set up by currents through the coil to the area within the field of the permanent magnet.

As alternating audio currents flow through the coil, the slat is alternately attracted and repelled by the magnet, swinging the bottom of the frame in and out (and the top in the opposite

direction). As the angle of the slats change, more or less of the beam of light passes through.

This arrangement has proved more efficient than the rotating one. Signals have been sent with it from a car to a fixed receiving station over a distance of more than 300 feet in daylight.

The receiver

The receiving equipment is simplicity itself. A phototube is mounted in a raintight cylinder, with a simple lens to concentrate the light on it. Its output is connected into any standard phototube amplifier circuit and then goes through a conventional audio amplifier. The first stage of a high-gain amplifier may be hooked up to take the phototube signal directly.

Construction

The original features of all these pieces of equipment are covered by patent applications, so no commercial use may be made of them, as yet. However, the experimenter may wish to imitate the apparatus in one of its forms, either to study light-beam transmission or for his own amusement. He will find construction simple. The modulator units have been built in several sizes and with individual variations. No dimensions or characteristics are particularly critical. Two of the units can be attached ahead of an ordinary automobile headlight and need no further light source. Any good audio amplifier will operate them.

Applications

Equipment of this type might find many uses. They are short-range communications units which require no license and can be used over longer distances than "phono-oscillator" equipment. They are highly directional (though this can be a disadvantage at times.) They can be used in areas where electrical disturbances make radio impractical, or where noise makes a loud-speaker system (straight sound transmission) useless. There are obvious military applications. The equipment is highly interesting to the experimenter, in any event.

END

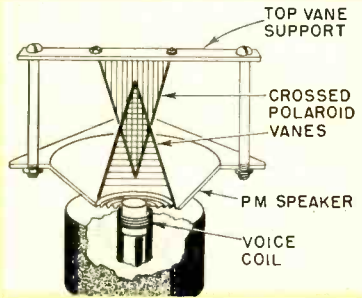
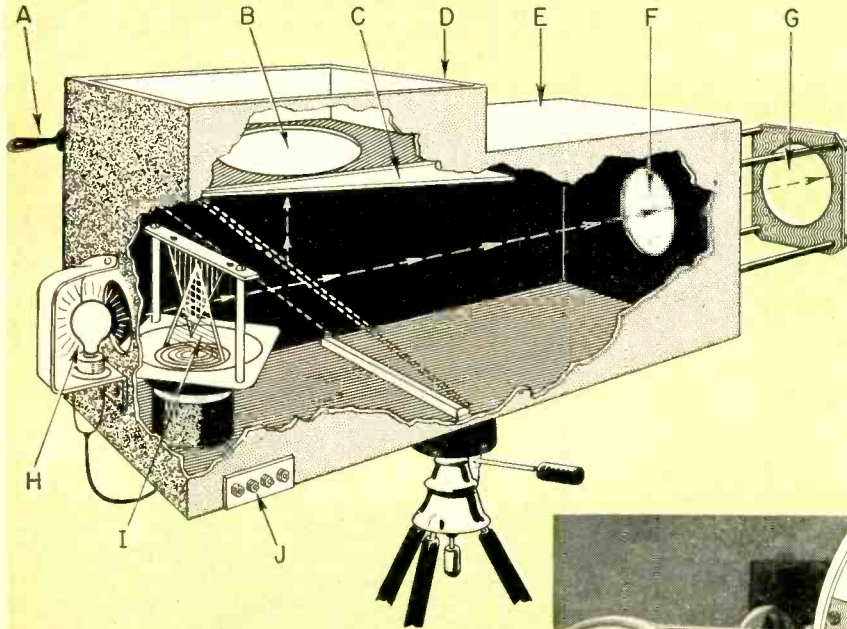

Fig. 1, left—The gate-type modulator. As the voice coil moves the lower vane, it "crosses" a larger or smaller area of the upper one, cutting off light proportionately. Modulation is "negative." Fig. 2, below—The transmitter with light-gate modulator. A is the handle which moves mirror C down into the dotted-line position for sighting an image on ground glass B, or up out of the way for transmitting, D the hood around the ground glass, E the main lightproof case of the instrument, F a 3-inch aperture, G a 4½-inch lens with 20-inch focus, H the lamp in its housing, and I the modulator. A lens system may be made by adding a lens at F and means to vary the distance between it and lens G.



Photograph at right is the shutter-type modulator. It is mounted on the standard transmitter as a convenient light source.

Fig. 3, extreme right—The turning-vane type of light modulator shown on cover.

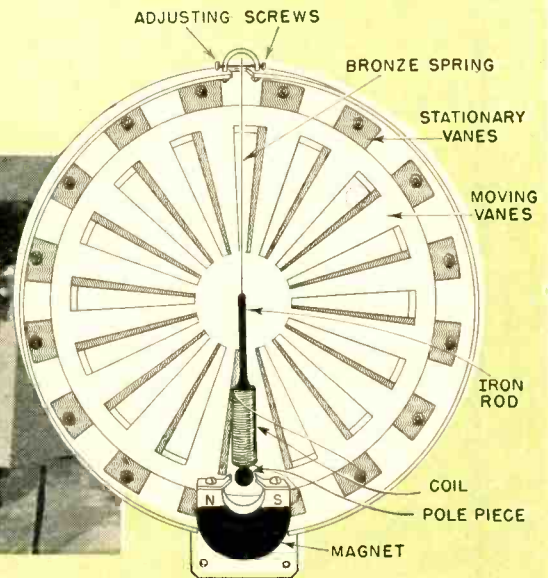
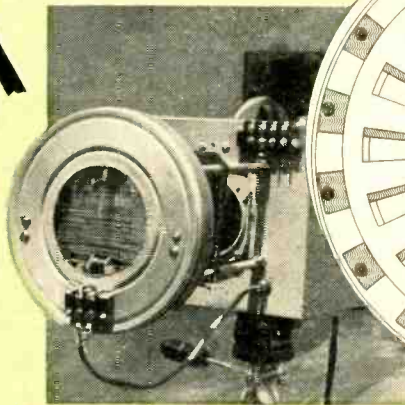
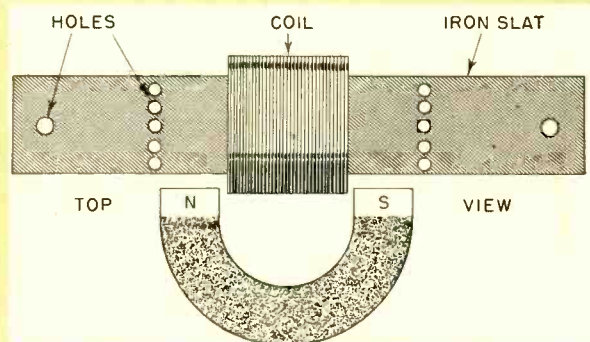
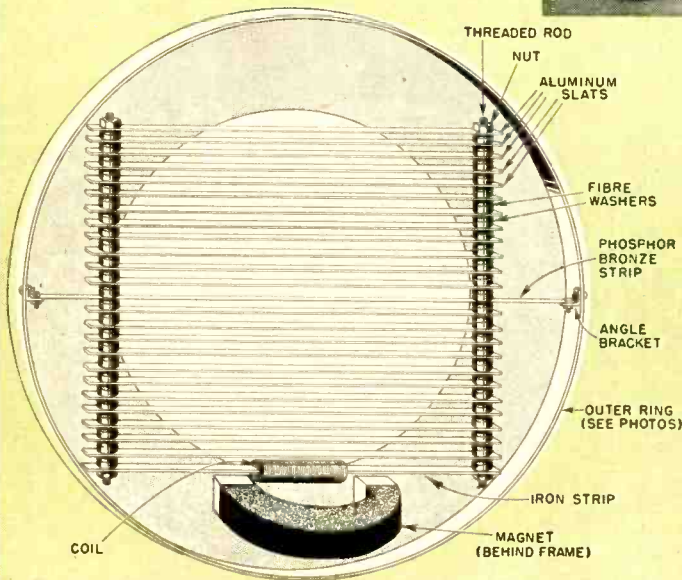

Fig. 4-a, left—Modulator assembly using aluminum slats plus an iron and bronze one. 4-b, below—Detail of the driver slat.



TV SIGNAL TRACING



Fig. 1—Signal tracing with crystal probe shows dead stage as a horizontal line.

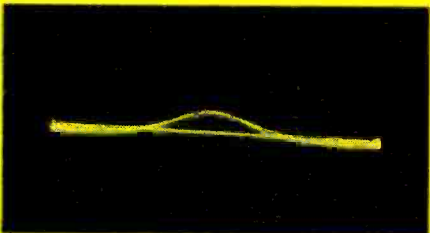

Fig. 2—Gain of 10 through a stage of i.f. Input is shown above, output below.

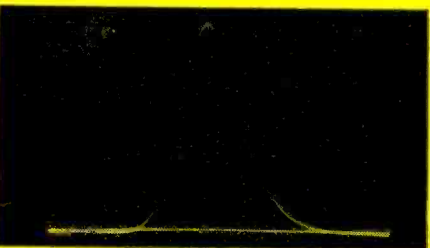

Fig. 3—Example of attenuator resonances and partial rectification of r.f. signal by vertical amplifier of oscilloscope.

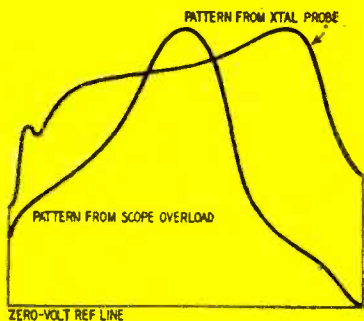

Fig. 4—Patterns obtained from crystal probe and from overloaded oscilloscope.

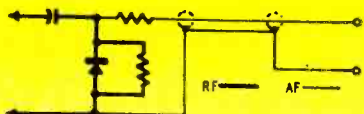

Fig. 5—Diagram of probe signal circuits.

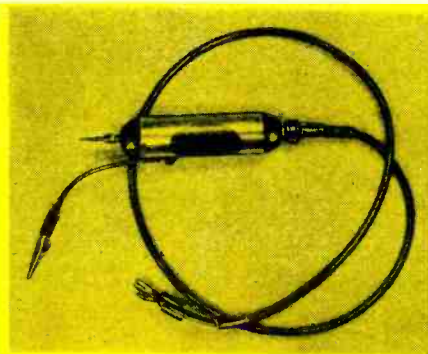

Fig. 6—Probe with moderately long ground lead is unsatisfactory at high frequencies.

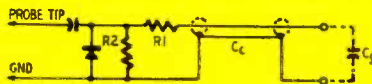

Fig. 7—Probe circuit RC time constants.

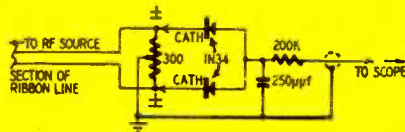

Fig. 8—Schematic of balanced probe.

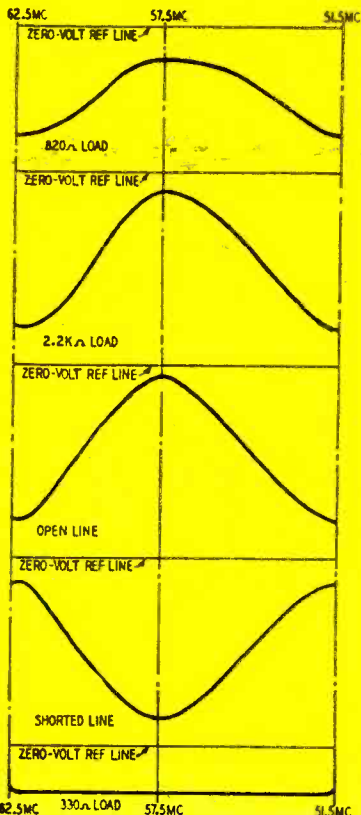

Fig. 9—Margin by which standing wave pattern fails to contact the zero reference line measures the loss in twin lead.

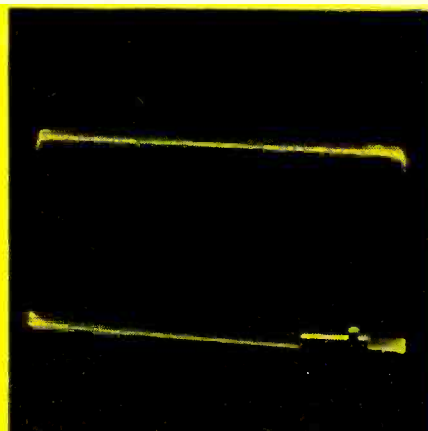

Fig. 10—Crystal probe may rectify signal when testing near local TV station.

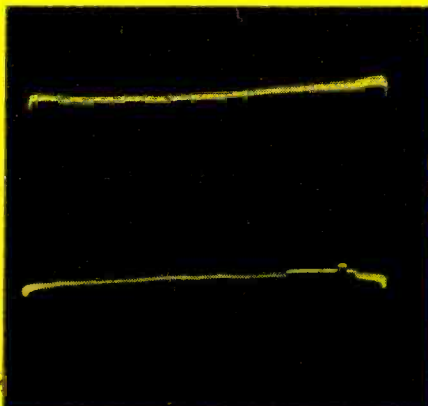

Fig. 11—Curvature of reference line due to 60 cycle pickup in crystal probe.

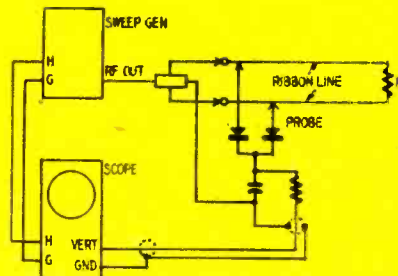

Fig. 12—Horizontal sweep leads shorted. Scope at generator end of line.

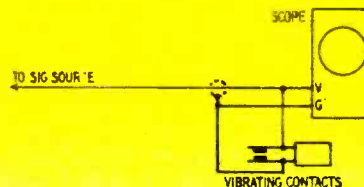

Fig. 13—Vibrating contacts short and un-short the vertical input of scope.

Use of crystal probe gives excellent results in video testing

By Engineering Staff, Scala Radio Co.

MANY technicians find it necessary to use a sweep signal when signal-tracing an i.f. amplifier in a TV receiver, because the available station signal is not strong enough to obtain sufficient vertical deflection on the scope screen when the early stages are under test.

Fig. 1 shows the pattern that is obtained on the scope screen when the i.f. stage under test is dead. A normally operating stage will usually show a gain of approximately 10, as illustrated in Fig. 2.

Technician should take care to keep r.f. voltages out of scope input circuit

Due to unsuitable probes, or to improper modes of testing, the technician is sometimes misled during signal-tracing procedures, due to r.f. voltages entering the scope input circuit. Only demodulated voltages from the probe should be permitted to enter the vertical amplifier of the scope. As shown in Fig. 3, frequency discrimination at r.f. and spurious resonances lead to erratic and unpredictable screen patterns. Partial rectification of the high-frequency voltages which find their way into the vertical amplifier develops a pattern which has no practical value.

When sweep wave envelopes of i.f. signals on the scope screen are viewed by overloading the vertical amplifier with the signal under test, the pattern is highly distorted as compared with the pattern obtained when a suitable crystal probe is used, as illustrated in Fig. 4.

Unnecessary trouble sometime encountered in i.f. signal tracing due to failure to provide good r.f. ground

Suitable ground returns are of great importance in signal-tracing work, and much of the difficulty experienced by beginners is due to this cause alone. Fig. 5 clearly distinguishes between the r.f. and the a.f. circuits which are present in the probe arrangement. The ground lead to the chassis should always be kept very short, and the ground point should be made as near as possible to the signal take-off point in the i.f. amplifier circuit.

This matter is of even greater concern when station frequencies are being tested. It is often necessary to dispense with the short ground lead that is provided with the probe, and to make the ground return directly to the shielded case of the probe.

While a long grounding route would not be of practical concern when a 10-to-1 or a 100-to-1 probe is in use, the long ground route commonly leads to curve distortion, regeneration, or even

oscillation when utilized with a crystal probe in i.f. amplifier signal tracing.

The lengths of the ground leads provided with conventional service probes is shown in Fig. 6. Unless high-frequency r.f. circuits are under test, such ground leads can be used satisfactorily.

Ability of crystal probe to display modulation envelope on scope screen depends on time constant of input cable and the isolating resistor

A crystal probe which is to be used for video-amplifier adjustment as well as for signal tracing must be able to display 60-cycle square-wave modulation on the scope screen without appreciable distortion. As seen in Fig. 7, the limiting factor in the ability of a crystal probe to display a modulation envelope on the scope screen is usually determined by the time-constant of the scope-input circuit, $(C_c + C_s)(R_1 + R_2)$. The total input capacitance $C_c + C_s$ charges through R_1 and discharges through $R_1 + R_2$. Unless this charging and discharging can take place with sufficient rapidity, there will be negative peak clipping of the waveform displayed on the scope screen. R_1 must be large enough to prevent r.f. signal voltage from entering the scope circuits. The time-constant can be reduced by decreasing the value of C_c . The cable capacitance, C_s , is usually much larger than the scope input capacitance C_c . In 1 time-constant interval, the cable can charge up to 63% of the peak value of a square wave, or, having been previously charged, will be able to discharge in 1 time-constant interval to 37% of the peak value of the initial charge.

Balanced crystal probe used to check standing-wave ratio (impedance match) of twin lead to antenna or receiver

A balanced crystal probe, as shown in Fig. 8 (or two single-ended conventional crystal probes), can be used to check a lead-in for flatness or impedance match. Typical patterns and the conditions responsible for the observed standing-wave ratios are shown in Fig. 9. To understand the operation of a doubled-ended probe, note that the two diodes do not conduct simultaneously. As far as the instantaneous lead-in voltages are concerned, when the input signal to one diode is positive, the input signal to the other is negative. These polarities alternate at the carrier frequency, and the diodes conduct alternately.

Standing-wave patterns are sometimes interfered with by TV station signals or 60-cycle hum voltage, as

shown in Figs. 10 and 11. Unless the operator recognizes the source of such distortion, he may be at a loss to interpret the pattern which he has obtained on the scope screen.

In Fig. 8, the scope and the sweep generator are located at opposite ends of the transmission line. That is, the sweep generator is located at the left-hand end of the lead, and the scope is connected (through the crystal probe) at the right-hand end of the lead. In this test, a pair of 150-ohm resistors are connected in series to provide a 300-ohm load with a center-tap. The center-tap is required in this test to provide a d.c. return path for the balanced crystal probe.

If the characteristic impedance of the line is 300 ohms, the 300-ohm load will cause a flat trace to appear on the scope screen, as shown in Fig. 10. If the characteristic impedance of the line is not 300 ohms, the 300-ohm load will cause the trace to depart from flatness. Fig. 9 shows the behavior of a section of 300-ohm ribbon line, when swept with various values of load resistance. The operator will understand that a length of lead 25 or 30 feet long should be used in this test, so that appreciable standing waves can be developed at representative TV signal frequencies. Otherwise, the scope must have very high gain to obtain satisfactory deflection.

Several other practical considerations must be observed. Since the scope and the sweep generator are located at opposite ends of the line which is being tested, there may be a problem of obtaining a horizontal sweep voltage from the generator for the scope. Although some service scopes provide a phasable horizontal sweep voltage which is built into the scope, many service scopes do not have this built-in sweep facility, but rely upon the phasable horizontal sweep voltage which is built into the sweep generator. In that case, test leads are run from the generator to the scope to provide a phasable horizontal sweep voltage.

Since these test leads would have to be 25 or 30 feet long to make a test of a 25- or 30-foot length of lead, other test setups may be found more convenient when using a scope without a built-in horizontal phasable sweep. The probe and scope can be connected at the generator end of the line, if desired, as shown in Fig. 12. In this case, the generator has an r.f. output cable which is terminated in a center-tapped load. This center point is connected to the ground system of the test setup, as shown; the load resistor R then does

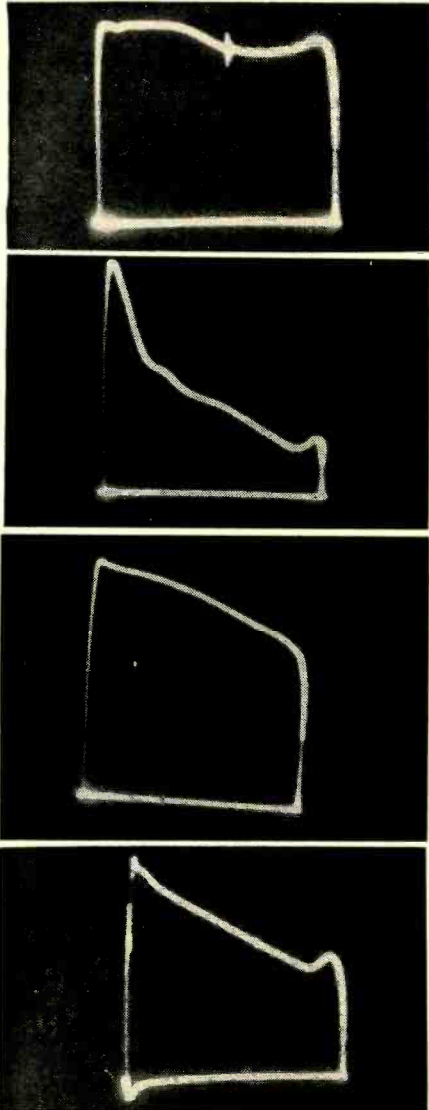

Fig. 14—Result of unsuitable demodulator probe or poor testing conditions.

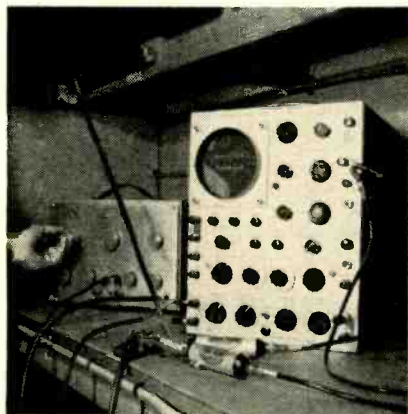

Fig. 15—Testing with dual crystal probes.

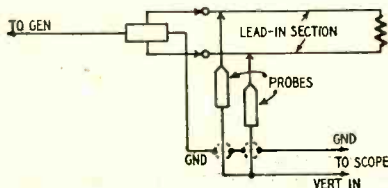

Fig. 16—Diagram of two conventional crystal probes used in balanced tests.

not need to be center-tapped, and the scope is conveniently swept from the generator, as indicated by the leads between them in Fig. 12. This arrangement can be applied conveniently, especially when the load R may represent a remote point such as an antenna, whose match to the lead-in is to be tested.

These tests mean little unless a zero-volt reference line is available in the pattern. There are two ways of obtaining a zero-volt reference line. The most convenient one is to use a sweep generator in which the return trace is converted automatically into a zero-volt reference. This is done by providing a built-in source of square-wave bias to the swept oscillator in the generator. If the technician must use a sweep generator which does not provide a zero-volt reference line in the pattern, any arrangement which rapidly shorts and unshorts the vertical input terminals of the scope will serve the same purpose, as shown in Fig. 13. The rate of vibration should be considerably greater than 60 cycles, but may be any convenient arbitrary rate. The vibrating contacts operate to make the input signal fall to zero many times during the progress of the trace, thus making the zero-volt reference level apparent as a dashed line. The average constructor will usually have little trouble devising a vibrator, if one is needed.

The generator characteristic may be linear or nonlinear. The technician must first determine this characteristic so he can apply a correction, if one is needed. To make the matter clearer, consider the case in which the length of line shown in Fig. 12 is reduced to zero. No effects of standing waves are then apparent in the pattern, because they are absent. The trace should then be reasonably flat, as seen in Fig. 10. Consider, however, the cases shown in Fig. 14, in which the generator characteristics are not entirely flat. Such instances can arise in practice, due to

high harmonics in the generator output combined with probe resonances, for example. In other cases, the fundamental voltage from the generator may vary somewhat. In any case, a correction must be made.

If the technician finds that the display is nonlinear when the lead-in length is reduced to zero, as shown in Fig. 14, the best procedure is to use a grease pencil on the face of the cathode-ray tube. The penciled curve becomes the reference curve, and is the curve that will then be obtained when a section of lead-in under test is properly terminated. Any deviations in waveshape from the shape of this penciled curve indicate that the section of lead-in is improperly terminated.

If it is desired to use a pair of conventional crystal probes, instead of a special balanced probe, the test setup will appear as shown in Fig. 15. Each of the conventional probes is merely substituting for the diodes shown in Fig. 12. The circuit arrangement used in the dual-probe arrangement is shown in Fig. 16.

Standing-wave pattern may not touch zero-volt reference line when termination is a short or an open

In Fig. 9, although the line termination is a short, or an open circuit, the standing-wave pattern seen on the scope screen when a sweep test is made may not quite touch the zero-volt reference line. The standing-wave pattern will touch the zero-volt reference line only if there are no losses in the line. When the test frequency is increased, the line losses increase, and the standing-wave pattern approaches the zero-volt reference line less closely for an open or a shorted termination. The amount by which the pattern fails to reach the zero-volt reference line is a measure of the loss in the line. END

FOLDED DIPOLE TYPE ANTENNAS CAN BE DE-ICED

One of our rural customers had persistent trouble with TV reception each time his TV lead-in became covered with ice. Since this happened too frequently for us to send a technician out to de-ice the transmission line, we made a de-icer for him.

We inserted an a.c. receptacle in series with one side of the 300-ohm lead-in. A plug with its prongs shorted with a jumper is kept in this receptacle to complete the circuit when the antenna is operating properly. See Fig. 1. Note that this method operates only with folded-dipole type antennas.

The instructions we gave were: When reception fades because of ice on the antenna, disconnect the lead-in from the set, remove the shorted plug, and plug in an electric iron in its place; and then poke the lead-in ends into an a.c. receptacle for a few minutes. The current drawn by the iron generates enough heat to melt the ice. The de-

icing circuit is shown in Fig. 2. When the ice has melted, disconnect the iron,

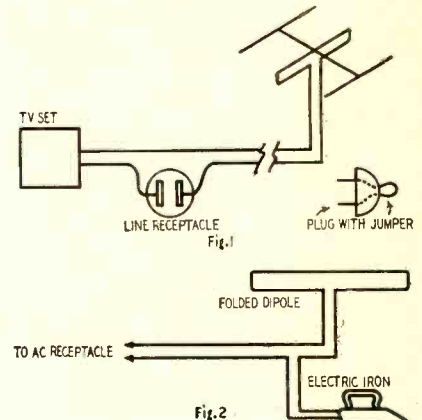

reconnect the lead-in, and return the shorted plug to its normal position.

—Henry Josephs

SERVICING UHF TV

Television is still television. Only tuner undergoes major changes for u.h.f.

BY KEN KLEIDON*

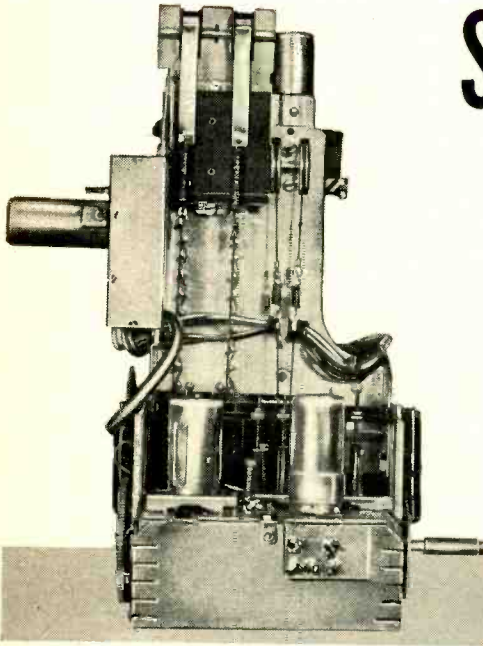

A continuous u.h.f. tuner. It is mounted directly over the v.h.f. tuner.

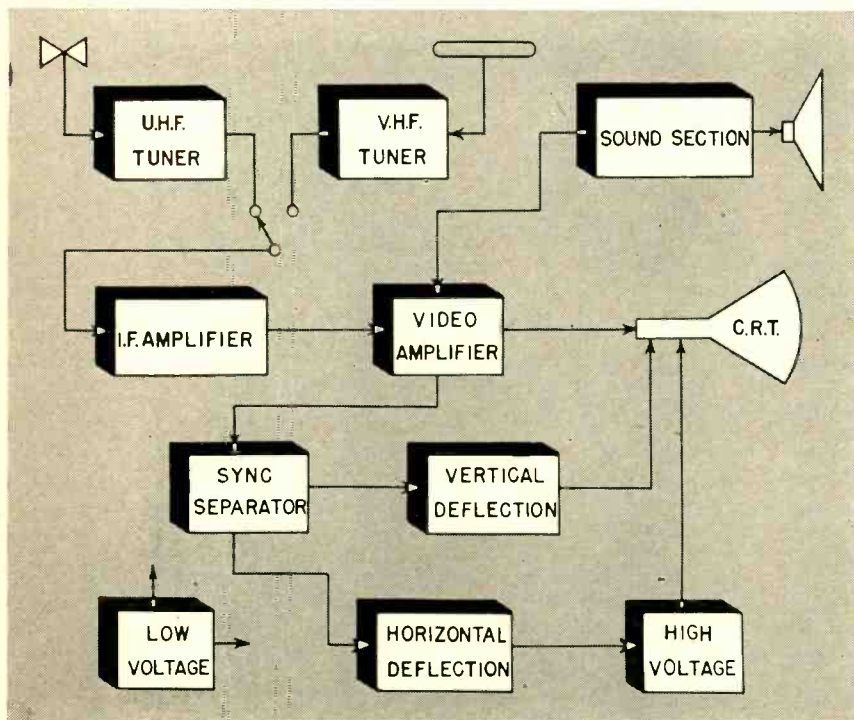

Fig. 1—With the exception of two units, u.h.f. and v.h.f. receivers are identical.

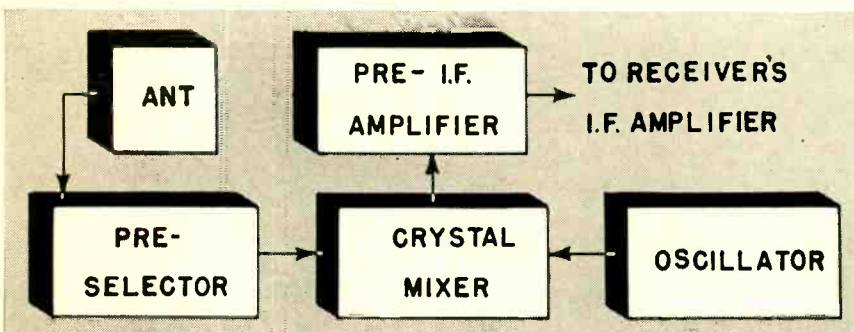

Fig. 2—Breakdown of the component parts of the u.h.f. section of a TV receiver.

SINCE the 70 new television channels have been allocated by the Federal Communications Commission, numerous articles have been published on u.h.f. Many of these articles have confused and in some cases even frightened the average TV technician. U.h.f. is not the monster these publications have led us to believe. It is new and does present different and varied problems not found in v.h.f., but if observed from a practical standpoint, the differences between u.h.f. and v.h.f. are few.

The same transmission standards used for v.h.f. telecasting are also being used for the u.h.f. band. Therefore the only real difference between u.h.f. and v.h.f. is the station's carrier frequency. For this reason, the TV service technician need only observe the different effect caused by the increase in frequency. This increase necessitates new and different tuning methods (u.h.f. strip, converter, or tuner) to receive a u.h.f. station on a v.h.f. receiver. Every u.h.f. television receiver on the market at the present time is nothing more than a v.h.f. receiver with a u.h.f. tuning unit. The majority of circuits in a v.h.f. receiver remain unchanged for reception on u.h.f. Referring to Fig. 1, the low voltage, high voltage, horizontal deflection, vertical deflection, sync separator, video amplifier, sound section, and i.f. amplifier circuits do not change in any way. Even the v.h.f. tuner remains unchanged except for that portion which may be modified to incorporate a u.h.f. tuning device. Because of this, servicing techniques used for v.h.f. will closely parallel u.h.f. servicing.

The function of a u.h.f. tuning device is identical to that of a v.h.f. tuner in that it merely selects and converts the station's sound and picture carriers to an intermediate frequency. Observing the block diagram of Fig. 2, the signal picked up by the antenna is coupled to the preselector which selects the u.h.f. station's sound and picture carriers. The signal is coupled through the preselector to the crystal mixer.

*Raytheon Manufacturing Company, Television and Radio Division, Chicago, Ill.

(Fig. 4) and rotating the r.f. drive pulleys for the sharpest and clearest picture while viewing a u.h.f. program. Complete tracking over the entire u.h.f. band requires accurate test equipment, as well as a detailed alignment procedure (which cannot be presented in this space). Therefore, unless both are available, adjustment of the r.f. tracking screws, oscillator trimmer screw, or shorting bar should not be attempted.

When attempting service of any tuning unit, many technicians fail to explore other circuits or conditions before suspecting the tuning device for trouble. If a "weak picture" condition, as illustrated in Fig. 5, appears on the face of the picture tube, it would be helpful to determine, if possible, if the same condition appears on the v.h.f. frequencies. If the same results are obtained on both u.h.f. and v.h.f., the cause of the trouble will generally be located in either the i.f. amplifier, detector, or video-amplifier circuits. If the condition appears only on u.h.f. and a normal picture is observed on v.h.f., the u.h.f. antenna installation should be checked as the possible source of trouble before suspecting the tuning unit.

If no picture appears, various circuit failures or external conditions may be the cause. As a fast check to localize the possible cause of the trouble, observe the face of the picture tube at both maximum and minimum contrast or picture-control settings. If no appreciable change is noticed between the two control settings, the trouble is usually in the i.f. or video-amplifier circuits. If at the maximum control setting an increase in snow is noticed, the trouble is most likely in the first i.f. amplifier or in the tuning device; it may be due to station failure; the set may be tuned to an off channel; or the

antenna may be disconnected or disabled.

Use of a u.h.f. converter as a method of checking a suspected defective tuning unit may prove very helpful. A u.h.f. converter can easily be substituted for the u.h.f. tuning device, whether it be a tuner, a channel strip, or another converter, to determine if the device is functioning normally. All that is necessary is to connect the u.h.f. antenna transmission line to the terminals provided and connect the output to the v.h.f. antenna terminals of the receiver. If the converter improves picture quality, the u.h.f. tuning device will require servicing.

The design of Raytheon's u.h.f. tuner enables servicing without removing it from the TV chassis. Convenient service check points have been provided, as illustrated in Figs. 3 and 4, for measuring the crystal current, oscillator plate voltage, and oscillator grid current. To determine whether the oscillator is functioning, both the oscillator plate voltage and grid current can be checked. With a voltmeter connected between the point indicated and ground or chassis, a reading of approximately 90 volts should be obtained if there are no defects in the voltage supply source or oscillator plate line. To measure the oscillator grid current, a Simpson model 260 multimeter, or equivalent, in the 100-microampere scale position, should be placed across 22-ohm resistor R2, with the positive meter lead to ground. A reading of 10 to 30 microamperes should be obtained if the oscillator is functioning normally. The crystal current (oscillator injection current) can be measured by placing a meter (type indicated above) on the 100-microampere scale across 22-ohm resistor R10, with the positive lead to ground. A reading of 5 to 40 microamperes

should be obtained if the oscillator and crystal are functioning normally.

When attempting to service a u.h.f. tuning unit, it may prove helpful to keep in mind that when trouble occurs in the oscillator section, the picture will generally disappear and when there is a defect in the r.f. or mixer stage a decrease in signal will usually result. When the oscillator section is suspected, the tube should be substituted, grid current, plate, and filament voltages should be checked, and all components in the circuit should be inspected. When the r.f. or mixer section is suspected, the circuits should be inspected, and tracking, alignment, and crystal current should be checked, and the crystal replaced if necessary. A defective crystal may cause varied effects in the picture and should not be overlooked as a possible source of trouble. Crystals are also the greatest source of noise generated in the majority of tuning units. Noise results in undesirable snow appearing in the picture, and crystal substitution to obtain an increase in picture quality may prove beneficial in some cases. Using an ohmmeter to check a crystal detector will prove to be an unreliable method. Direct substitution is the only positive check. The majority of crystal detectors in present u.h.f. tuning units are soldered into place, and overheating may cause damage. So take care when replacing a crystal. One of the most positive ways to avoid overheating of the crystal, is to hold the crystal with a pair of long nose pliers while soldering. The pliers will absorb most of the heat, preventing damage to the crystal.

Since the primary difference encountered in the u.h.f. receiver lies in the tuner, the service technician should thoroughly familiarize himself with the characteristics of u.h.f. There will be new tubes designed for u.h.f. tuners together with improved components. However, whatever we do the signal will not differ from the basic theory of v.h.f. television receivers. END

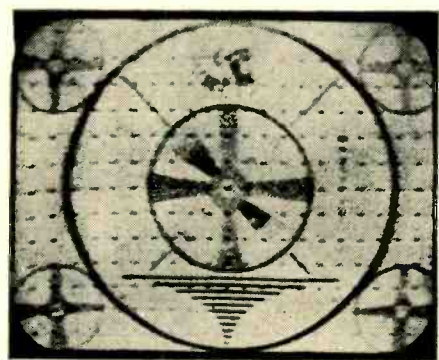
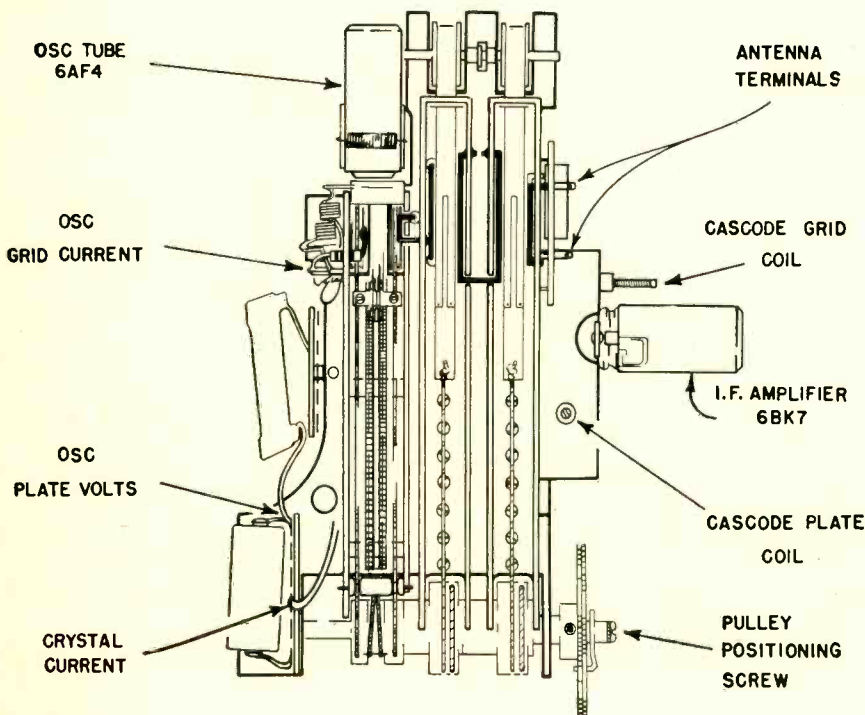

Fig. 4 (Left)—Mechanical detail of the tuner, showing adjustments and check points.

Fig. 5 (Above)—The "weak-picture" condition.



Fig. 1—Picture due to low line supply voltage.

THE large number of new homes built in the past few years have created many line-voltage problems. The power companies are improving their facilities, but the servicing technician will find many areas where the additional evening load drops the line voltage, often to 100 volts or lower. This often results in poor brilliancy, insufficient picture size, and occasionally sync instability because of the change in B voltages which occur. (Rarely these effects may be found in the daytime, as when a room air conditioner is used in an adjacent apartment.)

When a receiver is serviced or installed in the morning or afternoon, the line voltage may be normal. The technician may find that, if he adjusts the picture size to fill the mask at that time, it will shrink during the evening. Sometimes only the top or side of a picture may be affected, depending on the degree of change in sweep amplitude and the idling voltage through the yoke. A change in the latter can cause picture shift as well as general shrinkage.

Fig. 1 shows the appearance of a screen in an area where line voltage dropped to 95. The receiver was adjusted in the afternoon when the line voltage was 115, at which time the controls were set to fill the mask properly. During mornings and afternoons the picture would be perfectly centered and would fill the mask, while during the evening the left and top margins of the picture appeared because of raster shift.

In this particular receiver a readjustment of the controls during the evening when the line voltage was low corrected the condition. The receiver was in an area where only three local stations could be received and signal strength was sufficient to maintain good synchronization. The brilliancy control, however, had to be operated at a higher than normal setting for proper picture illumination.

In weak-signal areas such compensation as adjusting the controls during low line voltage periods rarely solves the problem. Sync instability occurs. This often causes picture pulling and

shifting, with occasional loss of both vertical and horizontal synchronization.

In such instances the only solution is to install a transformer to maintain a constant voltage level or boost an abnormally low voltage. A typical one is the Sola model 7202. It is adequate for most 10- to 16-inch receivers and will maintain the voltage to the receiver constant for wide variations in line voltage.

Other devices which can be used are the *Varitran* units. Type V-O is designed for operating a receiver drawing current up to 2 amperes at 230 watts, and the output voltage is variable from 0 to 130. A 570-watt unit is also available, type V-17.

The transformers described above are fairly expensive, ranging from \$15 to \$35. But they often provide the only means for correcting low line voltages or for preventing picture jitter and pulling during line voltage fluctuations. Where the condition is severe, the power company should be consulted with respect to their plans for improving the service and handling greater loads during peak hours.

Bleached picture

In a Transvision A-4 receiver the light portions of the picture turn white and appear bleached out when the brightness control is advanced. I have checked the control as well as the video i.f., detector, and amplifier tubes as well as resistors and capacitors. I would appreciate any suggestions you have for localizing the trouble. D. F., Welland, Ontario.

You mentioned that the light portions of the picture turn white and appear "bleached out." Since you have checked the parts and tubes of the video detector and amplifier stages, the trouble may be a defective picture tube. A characteristic sign of a defective picture tube is the silvery appearance of white objects when the brilliancy control is advanced.

First, try careful adjustment of the ion trap, to make sure it is positioned for maximum brilliancy. You did not mention whether or not you had sufficient contrast level. This should also be checked. Also make sure the ion trap magnet is not weak and is the

correct type for the tube. If these measures do not help, you could have the tube checked with a picture-tube tester, or try a new one.

Cascade tuner

I have installed a new Standard cascade tuner in an Admiral 30A1. I must turn the volume control up higher than I did before to get the same volume as with the old tuner. I do not believe the picture gain is what it should be, and I get what looks like slight r.f. interference in the picture. I do not have 250 volts as called for on the tuner, having used a 22,000-ohm resistor from the 350-volt line. I get the right voltage drop until I make the connection to the tuner, then the voltage drops to 225. What could cause these troubles? I have connected the tuner directly to the grid of the first picture i.f. amplifier. D. G. Bloomfield, Conn.

These faults you described are probably caused by the fact that the sound take-off coil in the original tuner has not been replaced in the new installation. The Standard Coil Products Company has a replacement coil available, part number XM-752. Refer to page 69 of the January, 1953 issue of RADIO-ELECTRONICS for full information on the use of this coil.

The 225 volts is sufficient, though you can obtain more by reducing the size of the series 22,000-ohm resistor. There is always a drop of voltage when the load is applied.

Sweep angle

I have used an RCA 211D2 yoke in the conversion of a Raytheon C1104M receiver. I have changed the original 12LP4A tube to a 19EP4 rectangular type. I evidently have a mismatch because the left side of the picture is expanded and linearity is poor for both the vertical and horizontal sweep. I have been told that since I am using a 70-degree tube and a 70-degree yoke, I also need a 70-degree transformer. Would this give me a better horizontal match and improve results? Please list the matching transformers for the yoke which I already have. L. T., Cicero, Ill.

The rectangular tubes do have a 70-degree deflection, as your friend told

*Author: Mandl's Television Servicing

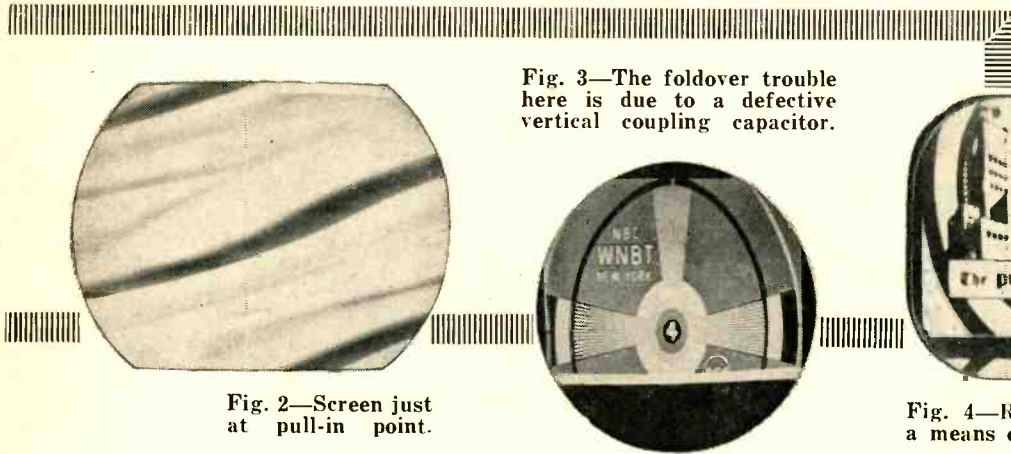

Fig. 2—Screen just at pull-in point.

Fig. 3—The foldover trouble here is due to a defective vertical coupling capacitor.

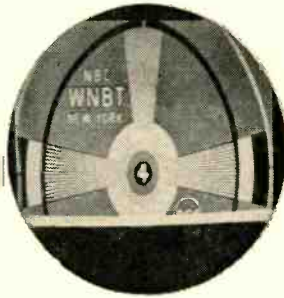

Fig. 4—Rolling the picture slowly as a means of checking vertical linearity.

you. This refers to the angle which the beam must sweep to fill the picture mask properly. When such tubes are used, it is necessary to use a wide-angle yoke and a transformer to match. If this isn't done, poor linearity, insufficient sweep, and other troubles occur.

For the RCA 211D2 yoke, the following represents the matching transformer:

RCA 224T1 (for a 6BQ6 horiz. output tube)	
RCA 230T1	6CD6
RCA 231T1	any
RCA 232T1	any

Definition

I have a few problems on a Bendix model 21K3 receiver. There is not appreciable difference in the picture when the focus control is adjusted and the picture does not seem sharp enough. There is also insufficient range in the contrast control. Another trouble I have is elimination of sync buzz when filmed commercials are on or during certain white portions in a movie. I would appreciate your advice regarding these matters. R. C., Chicago, Illinois

Adjust the focus control and watch the horizontal trace lines closely. If the focus control can give you sharply defined trace lines, the control is all right. If the picture detail is still lacking, tuner tracking and video i.f. alignment may be necessary.

Defects such as open peaking coils or off-value components may exist in the video amplifier sections. If the focus control cannot give a sharp line trace, check the resistive network associated with the focus control, and the focus control itself, for off-values.

Lack of sufficient contrast would indicate defective tubes or components from the tuner through the video i.f. stages to the picture tube. First check the tubes. If they are all right, tuner tracking and alignment will be necessary.

Intercarrier buzz should be at a minimum with proper adjustment of the fine tuning control. In some filmed commercials, however, overmodulation occurs at the transmitter and nothing can be done to eliminate the buzz during such intervals.

Synchroguide check

As a television bench technician I find the most annoying service problem is that of horizontal drift. This is particularly the case with pulse width a.f.c. systems. What are some checks and corrective procedures I can make to save time? J. R., Methuen, Mass.

With the pulse width sync system (Synchroguide), good stability is obtained only if the system is aligned properly according to the instructions given in the service notes for the receiver. Procedures include using a scope to make sure the broad and narrow peaks of the waveform at the junction of the coils are of the same amplitude.

A quick check to see whether or not the circuit requires alignment is to turn the horizontal hold control to the extreme counterclockwise position. Turn the station selector off the channel and back again so that sync is lost. Now turn the hold control slowly clockwise and watch the diagonal bars decrease in number. When only two or three bars are left (see Fig. 2) the picture should pull into sync upon a slight additional advance of the hold control in a clockwise direction. The picture should now remain in sync for about 90 degrees of additional rotation in the clockwise direction. If the sync range of the control is narrow, or if more or less bars are present than mentioned in the above check, the system should be completely realigned.

If drift or instability still persist, try several new tubes (some perform better than others). Finally, check voltages and parts. Some parts in the synchroguide circuit are temperature-compensated, and exact replacements should be used or drift will be worse.

Adjacent-channel interference

In a Mercury receiver there is severe adjacent channel interference between channels 3 and 4, as well as between 5 and 6. Is this an alignment problem or is it caused by a defective component? The receiver is used midway between Dallas (channel 4) and Wichita Falls (channel 3). E. C., Decatur, Texas.

When adjacent channel traps are tuned properly and the receiver is correctly aligned, adjacent-channel inter-

ference should not be present except from a strong local station when a weak distant station is being received. Use your marker, sweep generator, and scope, and check tuner tracking as well as video i.f. alignment. Follow the step-by-step procedures given in the service notes for this receiver and you will be able to minimize this condition.

Oscillator slug

I have on the bench an RCA 241 with low volume on channels 2 and 4 and no sound on channel 7. When the station selector is turned a little past the place where it clicks in, reception is normal.

If the lead shield is removed from the local oscillator tube the volume also returns to normal. I've replaced all tubes in the tuner and sound section, and as well have taken voltage and resistance checks and found them normal. Any help would be appreciated. F. H., Pontiac, Mich.

Turning the station selector slightly beyond normal changes tuning, while removing the oscillator shield alters the capacitance effects on the circuit. Both indicate off-resonance conditions in the local oscillator which can be corrected by adjustments of the local oscillator slug for the stations giving trouble. If this doesn't help, tuner tracking should be checked.

Bottom foldover

In a 1951 Tele-King receiver there is a foldover at the bottom after warmup. Adjustments of the vertical linearity and size controls do not help. What causes this? N. P., New York

This is usually caused by a defective coupling capacitor between the vertical oscillator and the vertical output tube. Linearity is also affected, as shown in Fig. 3. When the defective part has been replaced, readjust the vertical linearity and height controls when a station pattern is on the air, or with a cross-bar generator. A rough check of vertical linearity can be made by misadjusting the vertical hold control slightly until the picture rolls slowly. The blanking bar across the screen should not change in thickness as it reaches the top or bottom of the screen. (See Fig. 4)

END

TELEVISION... it's a cinch

From the original "La Télévision? . . . Mais c'est très simple!" Translated from the French by Fred Shunaman. All North American rights reserved. No extract may be printed without the permission of RADIO-ELECTRONICS and the author.

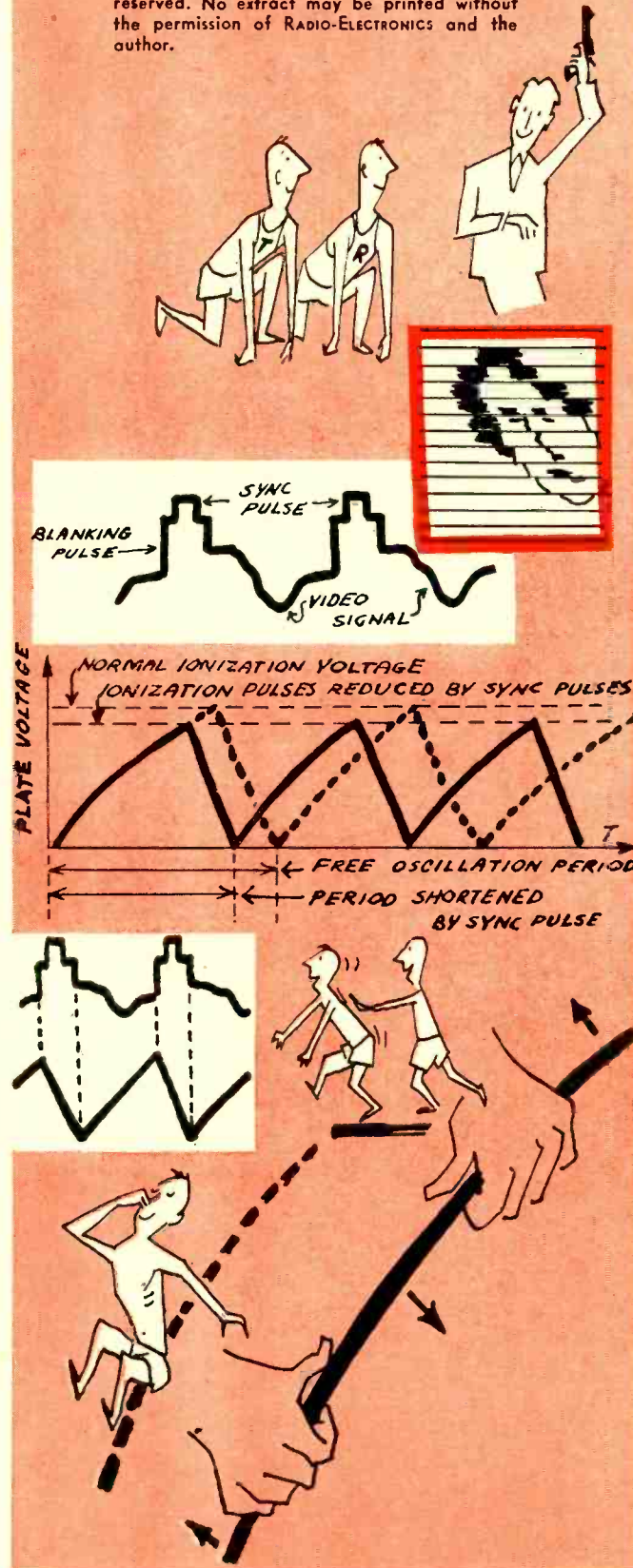

By E. AISBERG

Sixth conversation, second half: Will learns about synchronization.

Hey, you—keep in step!

WILL—And now isn't it about time to take the wraps off that mysterious "synchronization"?

KEN—I think so. You know already that the line and frame sweeps at the receiver have to keep in exact step with those at the transmitter. The beginning of each line (and each frame) have to be *synchronized* rigorously at transmitter and receiver.

WILL—I can see that if they got out of step, you'd get a program something like a piece of music played by an orchestra with every instrument a few seconds behind the one beside it.

KEN—Well, let's not try to develop an optical analogy to your musical program. Actually, the transmitter sends out, along with the video signals, short signals (or pulses) to mark the end of each line, and a longer series of pulses to mark the end of each image.

WILL—And it's these pulses you apply—through capacitor C1—to the thyatron grid? (See last month's installment for figure.)

KEN—Exactly. You have to arrange your circuits so these pulses are *positive* when they reach the grid—so that each one makes the grid *less negative* for a short instant.

WILL—I don't quite see what's going on. Does the tube amplify these pulses?

KEN—No, Will. You're just forgetting the effect of the grid on the anode breakdown voltage.

WILL—Of course! When a positive pulse arrives, the grid becomes less negative, and the ionization voltage drops.

KEN—So the normal period of oscillation of the horizontal oscillator is made just a little *longer* than the time the transmitter takes to make one line (and the vertical oscillator's period a little longer than the time needed to make one field). In other words, the normal frequency is a little lower than the line or image frequency. Then, just before the anode voltage reaches the ionization point, a pulse comes and makes the grid less negative. So the tube discharges prematurely, *triggered* by the synchronizing pulse.

WILL—I think I have it O.K. Say a thyatron has a control ratio of 20 and a grid bias of 15 volts negative. The ionization voltage would then be 300. If the synchronization pulse is 1 volt positive, the ionization voltage will be 280 instead of 300 volts, and the tube will discharge quicker than it would if there were no pulses.

KEN—You have it 100%.

WILL—It wasn't so hard! I had a good example to go by. While I was taking swimming lessons on my vacation, the instructor synchronized the divers.

KEN—Huh??

WILL—When they got out to the end of the board and were ready to jump, most of them would hesitate. Then he'd just expedite them with a firm push on the back. And then they'd make beautiful parabolic curves!

Saturated diodes to pentodes

KEN—Speaking of curves, this business of getting a sawtooth wave by charging and discharging a capacitor is fine, except that the sawtooth we end up with isn't quite linear—it has a curve to it. Now we've got to get back to the job of making that exponential curve as straight as possible.

WILL—Can't we find some method of keeping the current that goes into capacitor C constant? Then the voltage would rise in exact proportion to time, and we'd have a linear sawtooth.

KEN—Maybe you could work out such a scheme. Can you figure out just how you'd limit the current?

WILL—You'd have to replace the charging resistor with something that wouldn't let more than a certain definite amount of current through. How about using a tube—or rather its plate-cathode resistance—for the job?

KEN—That would work, Will. For instance, you could use a diode (preferably a direct-heating type) working at saturation. All the electrons emitted by the filament reach the plate, and so any increase in plate voltage can't increase the current flow. You could regulate the amount of current flow within limits by adjusting the filament voltage.

WILL—But why do you want a direct-heating diode?

KEN—Because a direct heater saturates much more definitely and sharply than an indirectly heated cathode. But if you don't like filament heaters, you can use an ordinary cathode-type pentode.

WILL—Do you work it at saturation, too?

KEN—The term wouldn't be correct, but the result is the same. You know how the plate-voltage/plate-current family of curves of a pentode looks. For any screen voltage, the plate current rises with plate voltage up to a certain point, then changes very little as the plate voltage goes on up. If you work the pentode on that flat part of the curve, it would charge a capacitor at a constant-current rate. Take a look at this schematic. The pentode replaces the charging resistor R. The screen voltage is regulated with a potentiometer P in series with a resistor R4. C3 is a decoupling capacitor.

WILL—These saturated diodes and constant current pentodes remind me of the bed of that old Greek bandit who used to trim off travelers who were too long for it or stretch them out to size if they were shorter than the bed.

The art of using curves

KEN—You're talking about Procrustes. Yes, it is a sort of inflexible way of doing things. As a matter of fact, it's more common to straighten out the curves *afterward*, in the amplifier tube that we need anyway, to bring our sawtooth waves up to the amplitude we want.

WILL—But how can an amplifier linearize a curved sawtooth wave?

KEN—It's easy. We make it distort a little, so it curves them in the opposite direction! Remember, Will, the most important thing in life is to be able to profit not only from the virtues and good points people or things may have, but also from their very faults and vices! What could be worse than a tube with such a crooked characteristic that it actually deforms the voltage it amplifies? But in this case that very fault becomes an advantage.

WILL—In other words, we have an amplifier tube with a curved grid-voltage/plate-current characteristic. And this curvature is exactly opposite to the curve of the sawtooth wave itself. If our sawtooth generator produces a wave that has a curve, all we have to do is feed this curved—or nonlinear—sawtooth into an amplifier that will bend the wave in the opposite direction. The result will be a practically straight sawtooth.

KEN—Here's a little drawing that will show that even better than you can describe it. The curves of the amplifier and those of the sawtooth oscillator may not balance each other exactly, but the compensation is good enough for any practical use.

WILL—Well, now that I've got all that down pretty pat, I suppose the moment has come to tell me that neither thyatron time-bases, constant-current tubes, nor linearizing amplifiers were ever used in television?

KEN—Not quite, Will. All of them have been used at one time or another, and some are still being used. Even if they weren't, I wouldn't have wasted your time, because the thyatron time-base is almost universal in oscilloscopes, and you'll use them a lot if you expect to do much with television receivers. But I must admit that there is a much more common type of time-base, and I can tell you now that it really is used in most TV sets. But we'll have to put that off till our next conversation.

(TO BE CONTINUED)

The illustration contains several key components:

- Schematic:** A circuit diagram showing a pentode tube. The grid is connected to a potentiometer (P) and a resistor (R4). The plate is connected to a resistor (R2) and a capacitor (C). The screen grid is connected to a resistor (R3) and a capacitor (C2). A sync signal is connected to the control grid.
- Graph 1:** A graph of Plate Current (Ip in mA) versus Plate Voltage (Ep in V). The y-axis ranges from 0 to 14 mA, and the x-axis ranges from 0 to 600 V. Multiple curves are shown for different grid voltages (Eg): 0V, -2V, -4V, -6V, -8V, -12V, and -18V. The curves show an initial linear rise followed by a saturation region.
- Diagram 2:** A diagram showing a 'SAWTOOTH GENERATOR' producing a curved sawtooth wave that is fed into a 'LINEARIZING AMPLIFIER', which produces a straight sawtooth wave.
- Graph 3:** A graph showing the 'AMPLIFIER CURVE' (a concave-down curve) and the 'OUTPUT WAVE SHAPE' (a straight sawtooth wave). The input to the amplifier is a curved sawtooth wave. The axes are labeled Ip and Eg.
- Cartoon:** A man is shown in a bed, being stretched or compressed by a mechanism, illustrating the 'Procrustes' analogy.
- Markings:** A large 'X' is drawn over the bottom part of the diagram, and a starburst symbol is present near the man in the bed.

uhf tv ANTENNAS

Current u.h.f. antennas combine the old with the new

By ABRAHAM HYMAN and JAMES C. SARAYIOTES*

BRINGING forth an antenna for television is much like bringing forth a baby into the world.

This brand new baby is bound to be bigger and bouncier than big brother v.h.f. Now that it no longer needs the warmth of the researchers' bassinet, it is casting off its blankets and starting to flex an unusually large pair of biceps for one so young.

Perhaps because they are still so youthful, u.h.f. signals are weaklings. They're quickly absorbed by trees, hills, and buildings. When u.h.f. waves aren't pulled in by obstructions they're bounced hither and thither. What happens then? Multipath signals are produced. These, in turn, hop aimlessly around town until they're lured in by an antenna. And, when multipathers are accepted, they spawn our old black sheep—the ghost.

Very few viewers want ghosts, unless they're watching a TV mish-mash of an old film like "Dracula." [Should they be urban residents, though, they have nothing to fear even if they use the simplest u.h.f. antenna of all—the much-heralded *bowtie*.]

The usefulness of large-area radiators for broad-banding is well known to the art. The triangular dipole is a development of the fundamental dipole for wide coverage in the u.h.f. spectrum.

Very simply constructed of two fan-like, hard-aluminum stampings, they are placed vertex-to-vertex with an included angle of 70°. Element lengths of 16 inches offer maximum gain. This combination results in a peak gain, at 750 mc, of 4 db over a thin dipole. The impedance of the triangular dipole is normally 300 ohms over the u.h.f. band.

A refinement of the simple bowtie dipole antenna is the bowtie backed up by a screen reflector. The change in antenna performance is striking. Gain climbs to well over 8 db at high points in the band, averaging out to about 6 db across the full u.h.f. spectrum. This gain occurs when a single-bay array is used.

Right — Bowtie antenna with corner reflector.

Below — Antenna coupler. Single transmission line can be used for wide range of frequencies.

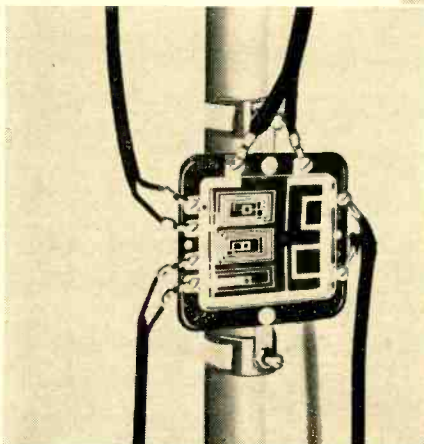

The bowtie reflector may be stacked for improved vertical directivity and an additional 3 db gain. This is important for reducing ground reflections and improving fringe-area operation. The use of wire framing for the reflector along with the U-shaped insulator support minimizes weather effects.

Two other members of the u.h.f. family are the stacked-V and the rhombic. The rhombic can be considered as being two V-antennas in series, resistance-terminated at 470 ohms.

The rhombic antenna has a directional characteristic in the vertical plane. At some angle to the horizontal it has maximum pickup. This angle can be varied to some extent by varying its tilt angle, improving the over-all antenna gain. However, the vertical energy pickup may be out of phase with the horizontal pickup and may result

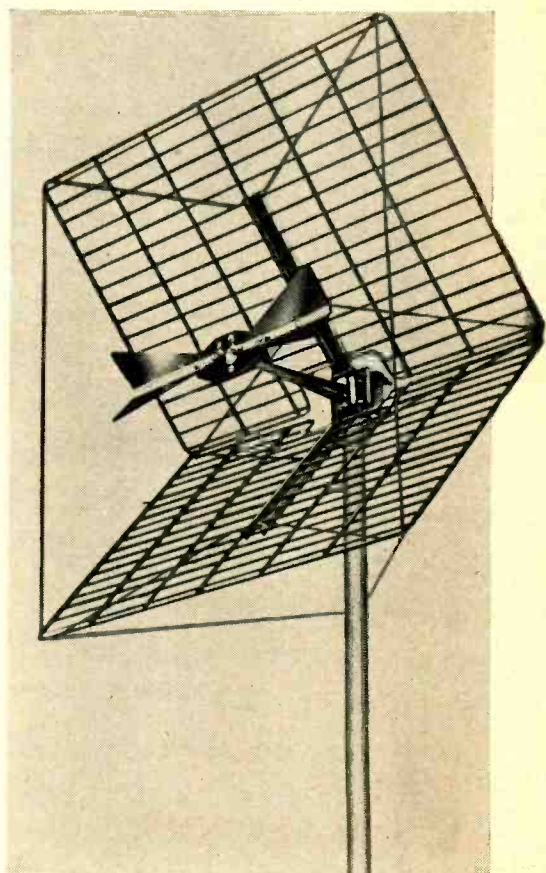

in ghosts. The vertical lobe structure varies radically in phase over the frequency spectrum and leads to further difficulty. The vertical effects may be reduced by stacking, which will give an additional increase in gain.

The longer elements not only lead to mechanical problems but also tend to narrow the horizontal pattern excessively. This subjects the installation to erratic signal variations during strong winds. A compromise value of 3 wavelengths at the low end of the band was used for the design figure. The optimum tilt angle for 3 wavelengths is 55°, which equals a length of 55 inches for each element. For lengths greater than 2 wavelengths the tilt angle is not critical over the band. A frequency range of 2 to 1 is feasible with a rhombic.

The rhombic has a narrow-beam horizontal directivity, and gains up to 9 db as its operating frequency climbs. Its elements have an optimum length of 55 inches and are made of ¼-inch outside-diameter hard-aluminum rods.

Both of these antennas are best put to use in regions where the u.h.f. station will be operating in the upper frequencies, since their highest gain is reached in those strata. Both must be considered broadband jobs, since reception on the lower frequencies is more than adequate and improves when the installation is set in a local area.

The single V is not particularly desirable because of its strong pickup in the vertical plane. On stacking, the V array improves immeasurably as far as vertical polarization is concerned.

* JFD Manufacturing Co., Inc.

Its horizontal directivity is not all that may be desired. As has been found with v.h.f. antennas tested on u.h.f., minor lobes in the horizontal plane are numerous and vary with frequency. On

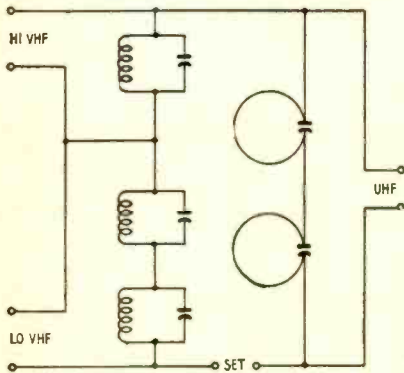
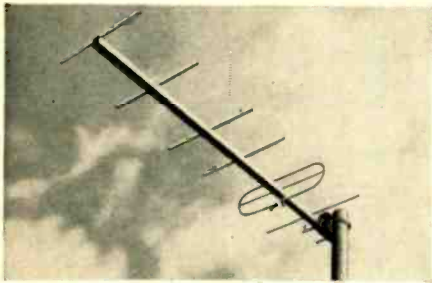

Fig. 1—A simplified coupler circuit for one u.h.f. and two v.h.f. antennas.



Yagi antennas like this receive from six to ten channels on the u.h.f. band.

the high end of the u.h.f. band the lobes are numerous and large enough to make the antenna usable as an omnidirectional job.

Both the rhombic and V antennas have their own particular advantages. The stacked V provides a somewhat higher gain on the lower frequencies of about 6 db and increases fairly well linearly to about 12 db. The rhombic maintains an unvarying impedance over the entire band, making matching with the transmission line remarkably easy.

The opposite of the V antenna as far as lobe structure is concerned is the corner reflector which is most suitable where reflections are caused by objects in the vicinity. Gains of 8 to 12 db can be attained over the band with excellent directivity in both the horizontal and vertical sense.

Two flat reflecting sheets intersecting at an angle form the reflector. Corner angles either greater than or less than 90° can be used, although there are practical disadvantages to angles much smaller than 90°. To reduce the wind resistance of a solid reflector, a grid of closely spaced parallel wires may be used.

In general, the spacing between reflector conductors should be equal to or less than 0.1 wavelength. With a half wavelength driven element the length of the reflector's conductors should be equal to or greater than 0.6 wavelength. If the length is less than .016 wavelength, radiation to the sides and rear tends to increase, and the gain de-

creases. The triangular dipole was adapted for its broadband characteristics. The dipole was bent parallel to the reflectors, minimizing dipole-to-reflector capacitance and reflector shielding of the collector.

The corner reflector does its job well, reaching and sometimes passing 12 db. This high gain is of great significance because increased radiation on higher frequencies, along with transmission line losses, can weaken signal strength if the gain is not high enough or if the installation is not fairly close to the transmitter.

Our old friend, the Yagi antenna, having become famous as a single-channel antenna in v.h.f., might be expected to be just a single-channel worker on u.h.f. too. Don't you believe it! The Yagi pulls in as many as 15 channels on the ultra-highs. The bandwidth covered at the lower end of the spectrum is 6 channels, while the Yagi cut for the highest frequencies will receive channels 74 through 83. Manufacturing firms are turning out u.h.f. Yagis with six extruded aluminum elements. One is a collector, four are directors, and one is a reflector.

The desirability of a combination u.h.f.-v.h.f. antenna based on the old reliable conical, resulted in further improvements on the conical and the u.h.f. triangular dipole. The new dipole for use with the conical has an angle of 35° and is cut to favor the upper portion of the u.h.f. spectrum. The nominal impedance remains 300 ohms over most of the band. However, the actual impedance is higher rather than lower as compared to that of the 70° triangular dipole. Since the power curve falls off at a much slower rate for higher impedance, a gain advantage is obtained over 80% of the u.h.f. band with this design. To permit coupling of the conical with the triangular dipole (or other u.h.f.

antennas), a coupling network was designed to permit connection and use of a single down-lead. It is designed to match a 300-ohm balanced transmission line. High-Q silver-printed circuits minimize any reflections and insertion losses. An improved match is effected with the conical on the low u.h.f. channels, which results in an increase in gain of 2 to 3 db. The schematic Fig. 1 is a simplified version of the network. The antenna coupler consists of a group of tuned circuits. Each circuit—being parallel-resonant—will offer a high impedance to the band of frequencies to which it is tuned, while offering an inductive or capacitive shunt to frequencies below or above its band. The Q of the printed circuits enables the antenna coupler to present a constant impedance of 300 ohms to the transmission line over the low u.h.f., high u.h.f., and v.h.f. bands. Since it is hermetically sealed, the antenna coupler maintains stable circuit constants despite constant exposure to the elements.

This design permits the use of two v.h.f. antennas. Therefore, two v.h.f. Yagis may be tied in with any 300-ohm u.h.f. antenna. A second design makes provision for coupling one v.h.f. antenna over the entire band to the 300-ohm u.h.f. antenna. The printed-circuit technique was chosen over lumped-circuit parameters because it lends itself to uniformity in production. The reduction of undesirable stray and distributed capacitances permits the design of desirable inductances and capacitances over the v.h.f.-u.h.f. range. The proper composition of the silver compound permits the design of the desired Q for proper bandwidth.

Looking down from the rooftops of America, u.h.f. is looking up! Technicians: There will be plenty of ultra-high business, every bit of it new! END

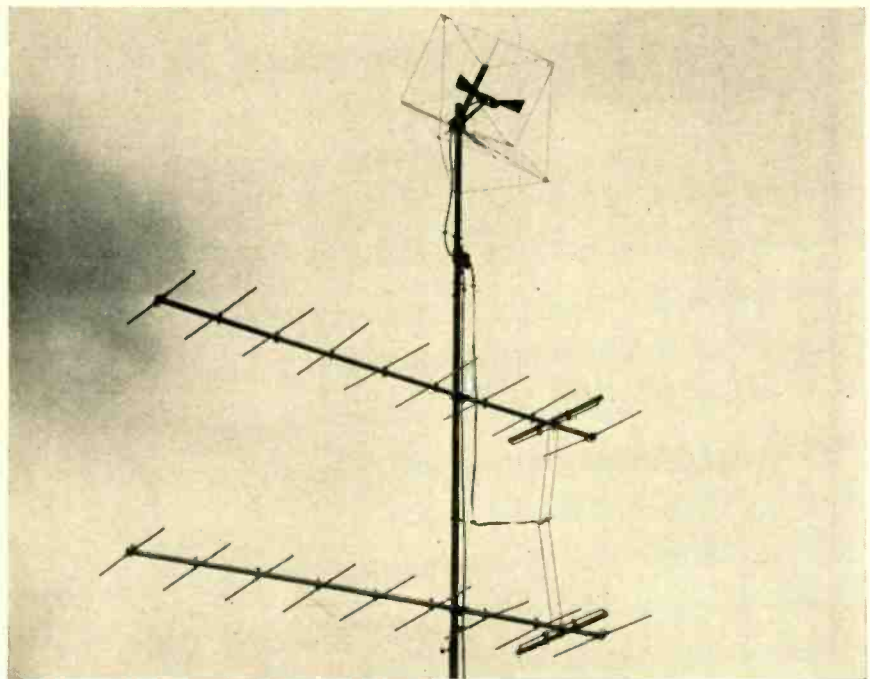

U.h.f. Bowtie with corner reflector and stacked v.h.f. Yagi, using single downlead.

EUROPEAN STATION LIST

By A. V. J. MARTIN

TELEVISION is expanding rapidly in Europe. Regular daily programs of all kinds are broadcast in Great Britain, France, and Germany. These include kinescope recordings and live pickups of plays, concerts, variety programs, sports, and special events.

Very few, if any, stations have the continuous program schedules found in the United States. In general, European TV schedules call for 20 to 40 hours of program per week, with transmissions only during certain hours in the evenings—and, in some cases, in the mornings and afternoons. For example, France has three regular daily transmissions, at 1:00, 6:30, and 8:30 pm. Except for Great Britain (which has regular afternoon and evening programs, plus morning transmissions on Saturdays and Sundays) and Germany, the stations in most other European countries are on irregular or experimental schedules. This applies to Holland, Switzerland, Denmark, and Italy. Very little is known about Russian TV schedules, aside from the fact that at least three stations are on the air.

The standards in use differ widely, according to the country, and four types are in current use.

405 lines. Old low-definition standard used in Great Britain only—25 frames; positive picture modulation; AM sound; vertical polarization.

441 lines. The old Paris transmitter. Now obsolete; will be working till 1958. Except for number of lines, is identical to British standard.

625 lines. So-called "European" standard—25 frames; otherwise identical with the U.S. Standard.

819 lines. High-definition French standard—25 frames; positive picture modulation; AM sound; vertical polarization.

Several instances of exceptionally good dx have been recorded and certified by photographs. For example, the Paris and London programs have been received in Belgium, Holland, and Italy, and Russian telecasts have been picked up in France. *American TV signals were reported seen on one occasion*, but unfortunately this has not been verified, since it lasted for only a few minutes.

Belgium, as yet, has no stations of its own in operation, but plans to establish separate systems with different standards for the French- and Flemish-speaking sections of the country. Receivers in Belgium that are designed for the French 819-line standard have been experiencing severe co-channel interference between Lille and Paris. These stations were assigned the same frequency in the belief that the distance between the two cities—approximately 150 miles—and the "official" service

coverage were enough to prevent any co-channel interference. But many points in Belgium (and France as well) are about the same distance from both cities, and exceptionally good transmission over the flat terrain has created the interference problem. (In the United States the same type of unforeseen co-channel interference was one of the factors that led to the television "freeze" and ensuing changes in several channel assignments.—*Editor*)

The accompanying table lists by countries the European stations now on the air. It includes both sound and picture transmitters, and has been arranged to show the lowest frequency first.

The first column gives the country and the second column gives the actual site of the transmitter. (In many cases this is a suburb of some large city, so the name may not be familiar except to a native.)

The third column gives the transmitter frequency, and the fourth column indicates whether this is the video (V) or sound (S) transmitter. Column five gives the transmitter power when known. (This is *not* the *effective radi-*

ated power, which may be considerably greater through the use of a high-gain antenna system.) The sixth column gives the number of picture lines only, since all European stations have the same 50-field, 25-frame standard.

For picture transmitters, column seven indicates whether single- or double-sideband transmission is used, with D for double-sideband, U for upper-sideband, and L for lower-sideband. The eighth column shows whether positive or negative picture-phase modulation is used. As all picture transmitters are amplitude-modulated, + indicates that an increase in carrier amplitude represents an increase in picture brightness, and a minus sign indicates the opposite. For the sound transmitters this column shows whether the modulation is AM or FM.

The ninth column shows the signal polarization: H for horizontal, and V for vertical.

The only city with two regularly scheduled stations is Paris, with the old 441-line picture transmitter on 46 mc (sound on 42 mc), and the new 819-line picture transmitter on 185.25 mc (sound on 174.1 mc). END

Country	Site	Frequency (mc)	Transmitter	Power (kw)	Lines	Side-band	Modulation	Polarization
DENMARK	Copenhagen	63.25	V	0.1	625	D	—	H
		67.75	S	0.1			FM	H
FRANCE	Lille	174.10	S	0.75			AM	H
		185.25	V	3	819	L	+	H
	Paris	42.00	S	5			AM	V
		46.00	V	30	441	D	+	V
Paris	174.10	S	0.75			AM	H	
	185.25	V	3	819	L	+	H	
GERMANY	Berlin	182.25	V	1	625	U	—	H
		187.75	S	0.25			FM	H
	Hamburg	182.25	V	10	625	U	—	H
		187.75	S	3			FM	H
	Hanover	196.25	V	1	625	U	—	H
		201.75	S	0.25			FM	H
	Cologne	195.25	V	1	625	U	—	H
201.75		S	0.25			FM	H	
Langenberg	182.25	V	10	625	U	—	H	
	187.75	S	3			FM	H	
GREAT BRITAIN	Belfast (Northern Ireland)	41.50	S				AM	V
		45.00	V	0.4	405	L	+	V
	Brighton	53.25	S				AM	V
		56.75	V	0.4	405	L	+	V
	Holme Mass	48.25	S	12			AM	V
		51.75	V	50	405	L	+	V
	Kirk o' Shotts (Scotland)	53.25	S	12			AM	V
		56.75	V	50	405	L	+	V
	London	41.50	S	3			AM	V
		45.00	V	17	405	D	+	V
	Newcastle	63.25	S				AM	V
66.75		V	0.4	405	L	+	V	
Sutton Coldfield	58.25	S	12			AM	V	
	61.75	V	50	405	L	+	V	
Wenvoe	63.25	S	12			AM	V	
	66.75	V	50	405	L	+	V	
THE NETHERLANDS	Eindhoven	47.75	V		625	L	—	H
		53.75	S				FM	H
	Kootwijk	49.00	S				FM	H
62.25		V		625	U	—	H	
Lopik	67.75	S				FM	H	
ITALY	Turin	83.25	V	5	625	U	—	V
		87.75	S	2.5			FM	H
	Milan	201.25	V	5	625	U	—	H
206.75		S	2.5					
SWITZERLAND	Lautanne	62.25	V		625	U	—	H
		67.75	S				FM	H
U.S.S.R.	Kiev	77.25	V		625	U	—	H
		83.75	S				FM	H
	Leningrad	59.25	V		625	U	—	H
		65.75	S				FM	H
	Moscow	49.75	V		625	U	—	H
56.25		S				FM	H	
YUGOSLAVIA	Belgrade	42.50	V	1	625			
		47.00	S	1				

MR. POSTAL CARD

HAS SELLING POWER

Here is an inexpensive salesman who can cover lots of territory fast. Every door is open to him.

By B. W. WELZ



FOR two cents you can buy a salesman at any postoffice who will bring your sales talk right into the customer's home. Your salesman is *Mr. Postal Card*, and he is allowed through anybody's door, rich or poor. He is **BIG BUSINESS** in informal dress.

Don't make the mistake of selling him short because of his puny size. He can say a lot if he is properly handled. If you've never written an ad on a postcard, you'll be surprised at how much you can get on one. *Mr. Postal Card* is an inexpensive operator, too. If you don't want to pay printer's costs, all you need is a typewriter.

He puts your sales talk right under the customer's eyes. He has an unique advantage of his own, too. Ad writers say he can be "individually placed." Since this is what makes him so effective, let's see what it means.

Suppose a shop has a new shipment of 17-inch TV sets. Say the boss has a file of all TV repairs marked with the screen sizes. He goes through the file, picks out the names of those who own 7-, 10-, and 12-inch sets, and he writes an ad on *Mr. Postal Card*, beginning, "Your small-screen TV is worth money on a trade-in . . ."

See how a postal card can be placed—right into the hands of those who would be *most interested* in buying!

Slanting the story

Now, it doesn't make too much difference whether *Mr. Postal Card* is printed in flashy colors or merely typewritten. He is only as effective as his

words. And it's up to the boss to put those words in the right order. If he wished, the boss could get an ad man to write copy for him.

But let's say the boss wants to write his own ad and save money. How does he go about it? First, let's see what he's got to say. He's got some new 17-inch sets he wants people with small-screen sets to buy. Already he's got one of the hardest problems of his ad licked—he's got *something definite to write about*.

The boss knows that to write a good ad *he has to think like a buyer*, not a seller. He doesn't think, "I have some 17-inch sets for sale . . .", but rather, "A small-screen TV is worth money as a trade-in on a new 17-inch set." When he writes the ad he'll be telling people why they want to buy.

With the first sentence down, he warms up to the subject. He describes the sets in his own words, their sensitivity, their fine finish, their super-sharp focus, etc. It's important that he write it smoothly, naturally and plainly—like he was telling the customer right to his face the advantages of buying his product. He searches the manufacturer's literature to get ideas. Because he can say only so much on a postal card, he makes his sales pitch as short and direct as possible.

Other advantages

Besides being individually placed,

Mr. Postal Card can do general heavy work, too. Some stores keep mailing lists handy and send out postal cards regularly, listing new items or telling of monthly sales. This pays off in two ways: Besides boosting sales, it keeps the name of the business in front of those who buy.

Another advantage of postal cards is *follow-up*. If a product moves slowly you can give it a shove with a series of postal cards—a series that doesn't end until the product is sold. Lots of big businesses today owe their rise to persistent follow-ups. Anyone who was ever on their mailing lists will never forget the stream of postal cards he got.

Mr. Postal Card can sell your services, too. Let him tell why people should bring their repairs *to you* instead of to the next guy. Remember to make your best selling point very clear, whatever it is—experience, low cost, reputation—make an impression with it. And remember—*keep the buyer's view in mind*, like the boss did with his TV sets. Convince people that your selling point is an advantage to *them*.

A postal card has lots of other uses. It can announce store openings or enlargements, renew ties with old customers, sell slow-moving appliances, remind past-due accounts, etc.

Once again, write him right: have something to say; say it in your own words, but *with the buyer's benefit in mind*. And next time you plan to sell your services or anything else, get in a good two cents' worth: Let *Mr. Postal Card* do the selling for you. **END**

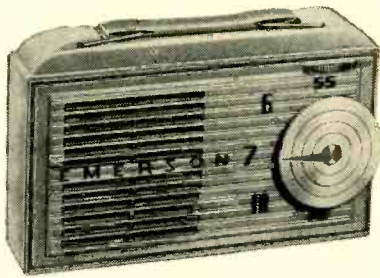

Emerson model 747, the "Pocket Radio."

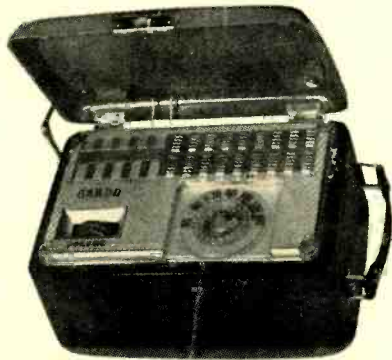

Garod "Starlet," 4 tube superheterodyne

midget portables and their PROBLEMS

The care and feeding of midget receivers. Standard routine makes servicing easy

By PAUL BOLLER

THE standard midget portable has some inherent limitations in sensitivity and tone quality due to its low cost, its compactness, and the materials used in its construction. It's biggest handicap, though, is *service*. The little thing gets the most abuse and the least attention. Only rental PA systems get worse treatment. Here are some of the hazards a midget has to meet:

Rough and improper handling. Few midgets survive more than one season without a cracked cabinet, loose hinges, or a missing handle. Where the set has no lid-operated shutoff, the owner often forgets about the set and leaves it on until the batteries are exhausted.

Corrosion. Few owners realize that a leaky battery is the midget's worst enemy. Corrosion damage is usually permanent. The tuning capacitor is

the most common victim of the leaking chemicals. Steel-sealed A batteries offer some protection against leakage, but this doesn't solve the problem completely.

Elements. A midget is used around the house, in the backyard, at the beach, on trips—under every conceivable physical condition. Near pools and on the beach, it is often splashed, operated by people with water dripping from their bodies. Sand also gets inside. Between water and sand, the set really takes a beating, especially the loudspeaker and the controls. The hot sun heats up black and other dark cabinets to a point where they get soft and distorted. After such an ordeal, the lid often can no longer be shut. In many cases insects crawl inside through the speaker grille and cause rattles

Serviceing midgets is a problem all right. The customer—especially in resorts—wants fast, if not immediate, service. There are at least twenty brands of midgets currently on the market, and it is remarkable how few parts are standardized. Surprisingly few parts are obtainable at local jobbers. Many have to be ordered from the distributor, often from out of town. This makes immediate service almost impossible in some cases.

Most midgets are designed for maximum compactness, and servicing convenience is completely forgotten by the manufacturer. So, to remove a bug that's established itself in front of the speaker cone—a simple matter as the customer thinks—you often have to remove a cabinet, unsolder a loop, then remove some almost inaccessible screws (almost invariably with special heads). All that just to lift off the front panel! The mere pulling of a knob can be a headache when you find out that the genius who serviced the set last glued



Philco personal radio, model 650.

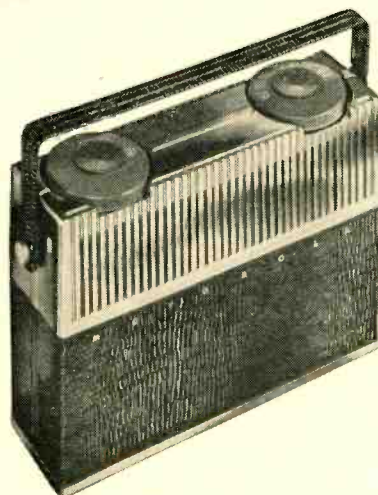

Motorola portable midget receiver.



Motorola model 61L is very compact.

Battery-only sets. Make the same filament-voltage and drop-out tests by using a nearly used-up A battery. A poor oscillator tube or changed oscillator grid resistor will show up in these tests. Abnormal filament voltages across one or more tubes in series hook-ups can stop you in your tracks if you are unfamiliar with the fact that some tubes change their filament resistance as they get old. Try a whole new set of tubes. Naturally there are many other causes of incorrect voltages at the filaments.

Rubber bands tied around microphonic tubes will greatly reduce the tendency to howl.

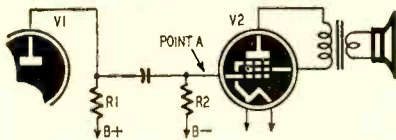

Fig. 2—Audio amplifier check point.

After the set has been on for a while, check the voltage at the grid of the second audio amplifier (point A in Fig. 2). A leaky coupling capacitor can completely upset the bias (measured from grid to filament) because of the high-value grid resistors usually found in midgets. First-audio plate-load resistors range from 470,000 ohms to over 1 megohm, and grid-return resistors in the audio output stage from 1 to 10 megohms. It is clear that even a small leakage will raise havoc in these circuits.

Alignment

Because of the necessarily small antenna, signal pickup is generally poor. This increases the importance of proper

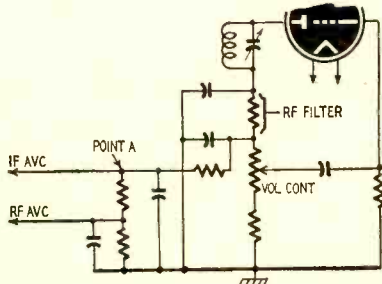

Fig. 3—Point A measures a.v.c. voltage.

alignment. The i.f. alignment can be done before the chassis is installed in the cabinet. Many i.f. slugs and trimmers cannot be reached with any conventional alignment tool, once the chassis is in place. A v.t.v.m. across the a.v.c. bus will give a much better indication of gain variations than will the human ear which has built-in a.v.c. The conventional method of connecting an output meter across the voice coil or the output transformer primary is almost useless, unless a very sensitive meter is used. This is because the a.v.c. has tendency to compensate for any gain increase obtained during alignment, unless the aligning signal is too

weak to produce any a.v.c. voltage. In normal use, the set is seldom tuned to such a weak signal, and a.v.c. bias does influence the response curve of a tuned amplifier. So by tuning the i.f.'s with a nearly normal signal input we do a better job because we have proper response at normal bias. A.v.c. voltages of minus 1.5 to minus 3 volts are normally found at point A in Fig. 3 with a 500-microvolt signal applied to the converter grid. This is about the same reading as you would get when the set is tuned to a local medium-power station. This method of indication has another advantage: It can be silent. No more wide-open volume controls, with earsplitting 80-percent modulation filling the room. An unmodulated signal can be used with just the same effect.

Once the set is back in the cabinet, give it an r.f. alignment. On three-way sets do this with batteries in place (whether or not the customer will purchase a set of batteries) and using battery power. Working with line power will only introduce errors due to the line pickup. Besides, in many sets the capacitance of the batteries affects the loop tuning. Plugged in an outlet a couple of blocks from a 25-kw station, any midget will play—even one that's way out of alignment—but out in the sticks, 60 miles from the nearest 1-kw transmitter—that's real playing. The kind of performance we will try to attain is the kind that advertises.

A good method of signal injection is to couple the r.f. to the set with a loop of about two turns of heavy wire, the loop around six inches in diameter, placed near the receiver. As the oscillator-trimmer setting is not usually affected by the position of the batteries and the antenna loop, special precautions are seldom needed when adjusting it. But the r.f. trimmer is very critical. The ideal way to adjust it is (with the batteries and receiver loop in normal position) through a hole in the cabinet.

Some sets have them. Naturally the ear will have to be used as the output indicator, as it's almost impossible to make connections to the speaker with the cabinet shut. In spite of the handicaps, an accurate adjustment can be made if a weak r.f. signal with low modulation is used. Listen to the hash, rather than to the modulation; it increases as the modulation decreases. Never place a hand or object very close to the receiver loop, nor should the latter be placed on a metal bench top. The r.f. alignment affects tracking, and thus selectivity and gain. All adjustments should be made at the frequencies recommended by the manufacturer.

The oscillator trimmer is usually set at frequencies from 1,500 kc to 1,650 kc; some sets (RCA) have a padder which is set around 600 kc; the r.f. trimmer is generally peaked somewhere from 1,200 kc to 1,550 kc. Going back and forth between these adjustments and rocking the tuning capacitor on the r.f.-trimmer settings will give a very fine job of alignment.

Most of the precautions and practices described become routine after a certain amount of midget work, and many of the above tests take less time than the decision of whether or not to make them. It is good to stop and think, but stoppage because of indecision is non-productive. It is possible to repair and align almost any midget portable (except intermittents) in 30 to 45 minutes, provided replacement parts are at a finger's reach. Any set taking more than an hour of a good technician's time can be considered a bad deal, a lemon. Routine is the most important part in productive and reliable midget service. Routine is possible because midget circuits are more or less conventional and standardized. Only a few different tube types are used, and in a short time one knows most of the base connections. Routine reduces cost by increasing production. END

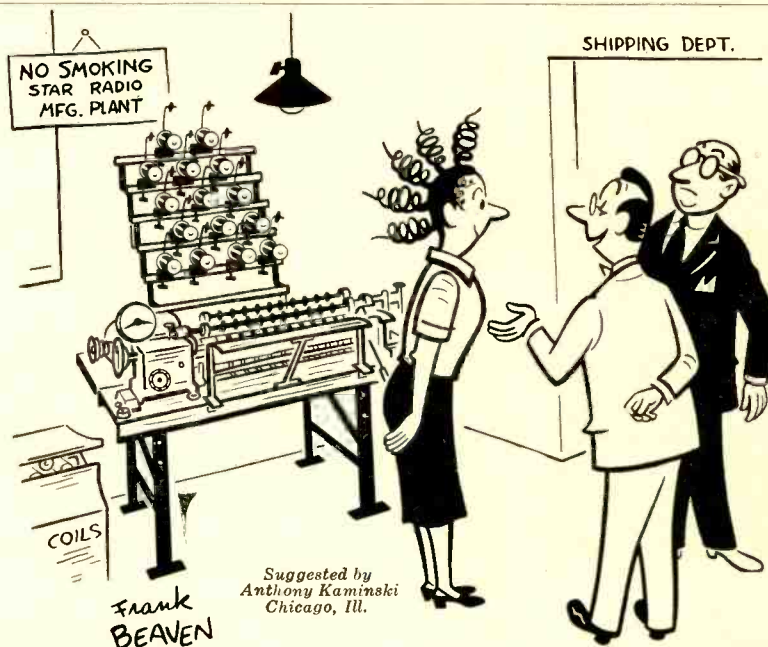

"Miss Spaget, here, is in charge of our Coil Winding Department."



**TRAIN FASTER—TRAIN BETTER—TRAIN EASIER
IN 10 MONTHS—OR LESS—FOR
RADIO-TELEVISION**

Our 21st Year Training Men for Greater Incomes and Security in Radio-Television

**I SEND YOU
18 BIG KITS**

of Radio Television parts and equipment. Much of your training will be actual construction and experimentation . . . the kind of truly PRACTICAL instruction that prepares you for your Radio-Television career.



Frank L. Sprayberry
President
Sprayberry Academy
of Radio

NEW! NO OBLIGATION PLAN

**You Have No Monthly Payment Contract to Sign
Pay For Your Training as You Earn and Learn**

You can get into Radio-Television, today's fastest growing big money opportunity field, in *months* instead of years! My completely new "package unit" training plan prepares you in as little as 10 months or even less! *No monthly payment contract to sign—thus NO RISK to you!* This is America's finest, most complete, practical training—gets you ready to handle any practical job in the booming Radio-Television industry. Start your own profitable Radio-Television shop . . . or accept a good paying job. I have trained hundreds of successful Radio-Television technicians during the past 21 years—and stand ready to train you, even if you have no previous experience! Mail coupon and get all the facts—FREE!

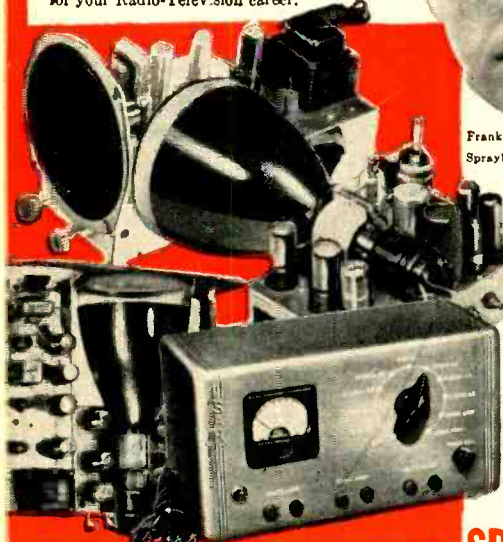

**Valuable Equipment Included
With Training**

The new Sprayberry "package" plan includes many big kits of genuine, professional Radio-Television equipment. You perform over 300 demonstrations, experiments and construction projects. You build a powerful 6-tube 2-band radio set, multi-range test meter, signal generator, signal tracer, many other projects. All equipment and lessons are yours to keep . . . you have practically everything you need to set up your own profitable Radio-Television service shop.

Earn Extra Money While You Learn!

All your 10 months of training is IN YOUR HOME in spare hours. Keep on with your present job and income while learning. With each training "package" unit, you receive extra plans and "Business Builder" ideas for spare time Radio-Television jobs. New television stations everywhere, open vast new opportunities for trained Radio-Television Technicians—and those in training. If you expect to be in the armed forces later, there is no better preparation than practical Sprayberry Radio-Television training.

YOU BUILD the Television set and the powerful superhet radio receiver shown above. IN ADDITION to the other test units shown here (many are not shown because of lack of space). All equipment I send you is YOURS TO KEEP.

**MAIL COUPON
TODAY!
NO OBLIGATION**

SPRAYBERRY ACADEMY OF RADIO 111 NORTH CANAL ST. Dept. 20-B, Chicago 6, Ill.

SPRAYBERRY ACADEMY OF RADIO, Dept. 20-B
111 North Canal St., Chicago 6, Ill.

Please rush to me all information on your 10-MONTH Radio-Television Training Plan. I understand this does not obligate me and that no salesman will call upon me. Be sure to include 3 books FREE.

Name..... Age.....

Address.....

City..... Zone..... State.....

Approved for Veterans under the G. I. Bill

I invite you to get all the facts—
FREE TO YOU 3 BIG
RADIO-TELEVISION BOOKS

I want you to have ALL the facts about my new 10-MONTH Radio-Television Training—without cost! Rush coupon for my three big Radio-Television books: "How to Make Money in Radio-Television" PLUS my new Illustrated Television Bulletin PLUS an actual sample Sprayberry Lesson—ALL FREE. No obligation and no salesman will call. Mail coupon NOW!



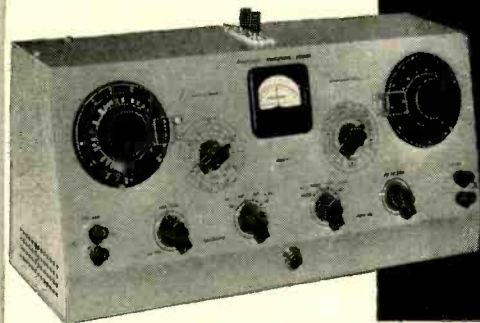

Heathkit IMPEDANCE BRIDGE KIT

MODEL IB-2

\$59⁵⁰

SHIPPING WT.
15 LBS.

Features

- Simpson 100-0-100 microampere meter.
- Completely AC operated.
- Built-in phase shift generator and amplifier.
- Battery type tubes, no warm-up required.
- Newly designed two section CRL dial.
- Single knob D, Q, and DQ functions.
- Special impedance matching transformer.
- New modern cabinet styling.
- ½% precision resistors and silver mica condensers.

Another new, outstanding instrument design so typically characteristic of Heathkit operation in producing high quality instrument kits at the lowest possible price. A new, improved model Impedance Bridge kit featuring modern cabinet styling, with slanted panel for convenience of operation and interpretation of scales at a \$10.00 price reduction over the preceding model. Built-in adjustable phase shift oscillator and amplifier with all tubes of the battery operated type completely eliminates warm-up time. The instrument is entirely AC line operated. No bothersome battery replacements.

The Heathkit IB-2 Impedance Bridge Kit actually represents four instruments in one compact unit. The Wheatstone Bridge for resistance measurements, the Capacity Comparison Bridge for capacity measurements, Maxwell Bridge for low Q, and Hay Bridge for high Q inductance measurements. Read Q, D, DQ all on one dial thereby eliminating possible confusion due to the incorrect dial reference or adjustment. Only one set of instrument terminals nec-

essary for any measurement function. Panel provisions provided for external generator use.

A newly designed two section CRL dial provides ten separate "units" switch settings with an accuracy of .5%. Fractions of units are read on a continuously variable calibrated wire-wound control. A special minimum capacity, shielded, balanced impedance matching transformer between the generator and the bridge. The correct impedance match is automatically switch selected to provide constant load operation of the generator circuit. The instrument uses ½% precision resistors and condensers in all measurement circuits.

The new Heathkit IB-2 provides outstanding design features not found in any other kit instrument. The single low price includes the power supply, generator, and amplifier stages. No need to purchase separate instrument accessories in order to obtain the type of operation desired.

Heathkit AUDIO WATTMETER KIT

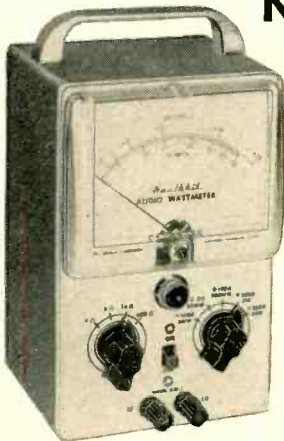

MODEL AW-1

\$29⁵⁰

SHIPPING WT.
6 LBS.

A new Heathkit design for the audio engineer, serious hi fi enthusiast, recording studio, or broadcast station; the Heathkit Audio Wattmeter Kit. This specialized instrument instantly indicates the output level of the equipment under test without requiring the use of external load resistors. All readings are taken directly from the calibrated scales of a 4½" 200 microampere Simpson meter.

The Heathkit Audio Wattmeter features five full scale power measurement ranges from 5 milliwatts up to 50 watts with db ranges of -15 db to +48 db. The instrument has a power measurement rating of 25 watts continuous and 50 watts maximum for intermittent operation. Non-inductive resistance load impedances of 4, 8, 16, and 600 ohms are provided through a panel impedance selector switch. Frequency effect is negligible from 10 cycles to 250 kc. A conventional VTVM circuit utilizes a 12AU7 twin triode tube. The meter bridge circuit uses four germanium diodes for good linearity.

With the Heathkit AW-1 desired information can be obtained instantly and conveniently without bothering with the irksome setups and calculations usually required. Useful for power curve measurements, frequency response checks, monitoring indicator, etc. Convenient calibration directly from 110 volt AC line source. This new instrument will help to supply the answers to your audio operating or power output problems.

Heathkit LABORATORY GENERATOR KIT

MODEL LG-1

\$39⁵⁰

SHIP. WT.
16 LBS.



Another welcome new addition to the popular line of Heathkit instruments, the Heathkit Laboratory Generator. Specifically

designed for flexibility of operation, accuracy and versatility beyond the performance level provided by the conventional service type generator. Frequency coverage of the Colpitts oscillator is 150kc to 30mc in five convenient ranges with provisions for internal or external modulation up to 50%, and .1 volt RF output throughout the frequency range. Panel mounted 200 microampere Simpson meter for RF "set reference level" to provide relative indication of RF output. Individually shielded oscillator and shielded variable and step attenuator provide flexible control of RF output.

The circuit features a 6AF4 high frequency oscillator, a 6AV5 amplifier with grid modulation, 12AU7 400 cycle oscillator and modulator, OB2 voltage regulator tube, and a selenium rectifier for the transformer operated power supply. The smart professional instrument appearance and overall flexibility of operation will prove a decided asset to any industrial or educational laboratory. The Heathkit Laboratory Generator sets a new level of operation, far superior to any instrument in this price classification.

HEATH COMPANY • Benton Harbor 20, Mich.

CHECK THESE *Features*

- ✓ New 5U1 CR tube
- ✓ Re-trace blanking
- ✓ Voltage regulation
- ✓ Extended band width
- ✓ Peak-to-peak calibrating provisions
- ✓ Good square wave response
- ✓ Astigmatism control
- ✓ New heavy duty shielded power transformer

NEW 5" *Heathkit*
**OSCILLOSCOPE
 KIT**

MODEL O-9

\$59⁵⁰SHIPPING
WT. 28 LBS.

Announcing the latest addition to a brilliant series of Heathkit Oscilloscopes, the new Model O-9. This outstanding instrument incorporates all of the features developed and proven in the production of well over 50,000 kits, in addition to a host of many new design features for truly outstanding performance. This new scope features a brand new (no surplus) commercially available 5U1 cathode ray tube for fine focusing, high intensity, and freedom from halation. The 5" CR tube is the standard size for design and industrial laboratories, development engineers, and service men. The only size CR tube offering a wide range of types, colors, phosphors, and persistence. The answer to good oscilloscope performance lies in improved basic design and operating characteristics, and not in the use of larger CR tubes.

VERTICAL AMPLIFIER — New extended band width vertical amplifier with sensitivity of .025 volts per inch, down 3 db at 2 mc, down only 5½ db at 3 mc. Three step vertical input attenuator, quality ceramic variable capacitors for proper input compensation, provisions for calibrated 1 volt peak-to-peak reference, with calibrated screen for direct reading of TV pulses.

HORIZONTAL AMPLIFIER — New input selector switch provides choice of horizontal input, 60 cycle sweep input, line sync, internal sync, and external sync. Expanded horizontal sweep produces sweep width several times the cathode ray tube diameter. New blanking amplifier for complete retrace blanking and new phasing control.

POWER SUPPLY — New high voltage power supply and filtering circuit for really fine hairline focusing. New heavy duty power transformer with adequate operating reserve. Voltage regulated supply for both vertical and horizontal amplifiers for absolutely rock steady traces and complete freedom from bounce and jitter due to line variations.

The acid test of any oscilloscope operation is the ability to reproduce high frequency square waves and the new Heathkit O-9 will faithfully reproduce square waves up to 500 kc. This is the ideal all around, general purpose oscilloscope for educational and industrial use, radio and TV servicing, and any other type of work requiring the instantaneous reproduction and observation of actual wave forms and other electrical phenomena.

Heathkit **LOW CAPACITY
PROBE KIT**

NO. 342

\$3⁵⁰ SHIP. WT.
1 LB.

Oscilloscope investigation of high frequency, high impedance, or broad bandwidth circuits encountered in television work requires the use of a low capacity probe to prevent loss of gain, distortion, or false service information. The Heathkit Low Capacity Probe features a variable capacitor to provide the necessary degree of impedance matching. New probe styling with bright polished aluminum housing and polystyrene probe ends.



NO. 337-B

\$3⁵⁰

SHIP. WT. 1 LB.

Heathkit **SCOPE DEMODULATOR
PROBE KIT**

In applications such as trouble shooting or aligning TV, RF, IF, and video stages, the frequency ranges encountered require demodulation of signals before oscilloscope presentation. The newly-styled Heathkit Demodulator Probe in polished aluminum housing will fulfill this function and readily prove its value as an oscilloscope service accessory. Detailed assembly sheet provided, including instructions for probe operation.

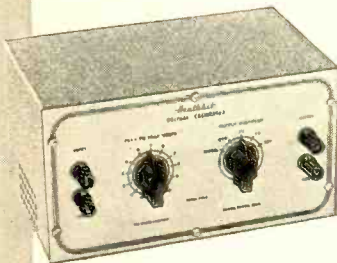
Heathkit **VOLTAGE CALIBRATOR KIT**

MODEL VC-2

\$11⁵⁰SHIPPING WT.
4 LBS.

The Heathkit Voltage Calibrator provides a convenient method of making peak-to-peak voltage measurements with an oscilloscope by establishing a relationship on a comparison basis between the amplitude of an unknown wave shape and the known output of the voltage calibrator. Peak-to-peak voltage values are read directly on the calibrated panel scales. To offset line voltage supply irregularities, the instrument features a voltage regulator tube.

With the Heathkit Voltage Calibrator, it is possible to measure all types of complex wave forms within a voltage range of .01 to 100 volts peak-to-peak. A convenient "signal" position on the panel switch by-passes the calibrator completely and the signal is applied to the oscilloscope input thereby eliminating the necessity for transferring test leads.

Heathkit **ELECTRONIC SWITCH
KIT**

The basic function of the Heathkit S-2 Electronic Switch Kit is to permit simultaneous oscilloscope observation of two separate traces which can be either separated or superimposed for individual study. A typical example would be observation of a signal as it appears at both the input and output stages of an amplifier. It will also serve as a square wave generator over the range of switching frequencies, often providing the necessary wave form response information without incurring the expense of an additional instrument.

Continuously variable switching rates in three ranges from less than 10 cps to over 2,000 cps. Individual controls for each input channel and a positioning control. The five tube transformer operated circuit utilizes two 6SJ7, two 6SN7, and one 6X5 tubes. Buy this kit and enjoy increased versatility of operation from your oscilloscope.



MODEL S-2

\$23⁵⁰

SHIP. WT. 11 LBS.

HEATH COMPANY • Benton Harbor 20, Mich.



Heathkit VACUUM TUBE VOLTMETER KIT

MODEL V-6

\$24⁵⁰

SHIPPING WT. 6 LBS.

The beautiful Heathkit Model V-6 VTVM, the world's largest selling kit instrument, now offers many outstanding new features in addition to retaining all of the refinements developed and proven in the production of over 100,000 VTVM's. This is the basic measuring instrument for every branch of electronics. Easily meets all requirements for accuracy, stability, sensitivity, convenience of ranges, meter readability, and modern styling. It will accurately measure DC voltages, AC voltages, offers tremendous ohmmeter range coverage, and a complete db scale for a total of 35 meter ranges.

New 1½ volt full scale low range provides well over 2¼" of scale length per volt. Upper DC scale limit 1,500 volts. DC ranges 0-1.5, 5, 15, 50, 150, 500, 1,500 volts full scale. AC ranges 0-1.5, 5, 15, 50, 150, 500, 1,500 (1,000 volts maximum). Seven ohm-

meter ranges from .1 ohm to 1,000 megohms. For added convenience a DC polarity reversing switch and a center scale zero adjustment for FM alignment.

The smartly styled, compact, sturdy, formed aluminum cabinet is finished in an attractive gray crackle exterior. The beautiful two-color, durable, infra-red, baked enamel panel further adds to the over-all professional appearance.

Top quality components used throughout. 1% precision resistors — silver contact range and selector switches — selenium rectifier — transformer operated power supply. Individual calibration on both AC and DC for maximum accuracy. DB scale printed in red for easy identification, all other scales a sharp, crisp black for easy reading. A variety of accessory probes shown on this page still add further to over-all instrument usefulness.

Features

- ✓ New 1½ volt full scale low range
- ✓ 1,500 volt upper limit DC range
- ✓ Increased accuracy through 50% greater scale coverage
- ✓ High impedance 11 megohm input
- ✓ Center scale zero adjust
- ✓ Polarity reversal switch
- ✓ 1% precision resistors
- ✓ Clearly marked db scales

Heathkit 30,000 VOLT DC PROBE KIT

For TV service work or any similar application where the measurement of high DC voltage is required, the Heathkit Model 336 High Voltage Probe Kit will prove invaluable. A precision multiplier resistor mounted inside the two-color, sleek, plastic probe body provides a multiplication factor of 100 on the DC ranges of the Heathkit 11 megohm VTVM. The entire kit includes precision resistor, two-color plastic probe, tip connector spring, test lead, phone plug panel connector, and complete assembly instructions.



No. 336

\$4⁵⁰SHIP. WT.
2 LBS.

No. 338-B

Heathkit PEAK-TO-PEAK PROBE KIT

**\$5⁵⁰**

SHIP. WT. 2 LBS.

Now read peak-to-peak voltages on the DC scales of the Heathkit 11 megohm VTVM. Readings can be directly made from the VTVM scale without involved calculations. Measurements over the frequency range of 5 kc to 5 mc. Use this probe to extend the usefulness of your VTVM in radio and TV service work. The Peak-to-Peak Probe Kit features the new polished aluminum housing with two-color polystyrene probe ends. Detailed assembly sheet including instructions for probe operation.

Heathkit RF PROBE KIT

The Heathkit RF Probe used in conjunction with any 11 megohm VTVM will permit RF measurements up to 250 mc, ± 10%. A useful, convenient accessory for those occasions when RF measurements are desired. The RF probe body is housed in the new, smartly-styled polished aluminum probe body featuring two-color polystyrene probe ends and a low capacity flexible shielded test lead. The kit is complete with all necessary material and a detailed assembly sheet as well as instructions for probe operation.



No. 309-B

\$3⁵⁰

SHIP. WT. 2 LBS.

Heathkit AC VACUUM TUBE VOLTMETER KIT

MODEL AV-2

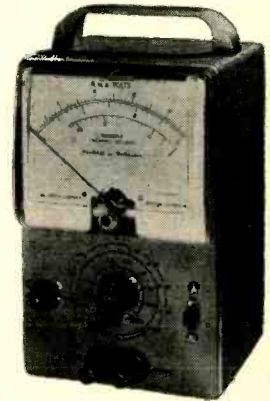
\$29⁵⁰SHIPPING WT.
5 LBS.

The new Heathkit AC VTVM that makes possible those sensitive AC measurements required by laboratories, audio enthusiasts, and experimenters. Especially useful for hum investigation, sensitive null detection, phono pick-up output measure-

ments, making frequency response runs, gain measurements, ripple voltage checks, etc. Low level measurements are easy to make because of the complete voltage coverage of the instrument and the one knob operation.

The large 200 microampere Simpson meter has clearly marked and easy to read meter scales. Ten voltage ranges covering from .01 rms full scale to 300 volts rms full scale, with frequency response ± 1 db from 20 cycles to 50,000 cycles. Instrument input impedance 1 megohm, ten db ranges from -52 db to +52 db. For stability and good linearity characteristics the meter bridge circuit features 4 germanium diodes. Attractive instrument styling, a companion piece for the popular Heathkit VTVM and the new AW-1 Audio Wattmeter.

HEATH COMPANY • Benton Harbor 20, Mich.

CHECK THESE *Features*

- ✓ 20,000 ohms per volt DC sensitivity, 5,000 ohms per volt on AC
- ✓ Polarity reversal switch
- ✓ 1% precision multiplier resistors
- ✓ 50 microampere 4½" Simpson meter
- ✓ Meter ranges for service convenience
- ✓ New resistor ring-switch assembly
- ✓ Total of 35 meter ranges
- ✓ New Modern cabinet styling

NEW *Heathkit* MULTIMETER KIT

MODEL MM-1

\$26⁵⁰

SHIPPING WT. 6 LBS.



The most important Heathkit announcement of the year, the new 20,000 ohms per volt Heathkit Multimeter, Model MM-1. The universal service measuring instrument, accurate, sensitive, portable, and completely independent of AC line supply. Particularly designed for service use incorporating many desirable features for the convenience of the service man. Full 20,000 ohms per volt sensitivity on DC ranges — 5,000 ohms per volt sensitivity on AC — polarity reversal switch, no bothersome transferring of test leads — 1% precision multiplier resistors — large 4½" recessed non-glare 50 microampere Simpson meter — conveniently slanted control panel — recessed safety type banana jacks — standard universally available batteries — rugged practical sized cabinet with plastic carrying handle, and a total of 35 calibrated meter ranges.

RANGES

Voltage ranges selected entirely for service convenience. For example 1½ volt full scale low range for measuring portable radio filament voltages, bias voltages, etc., 150 volt full scale range for AC-DC service work, 500 volt full scale range for conventional transformer operated power supply systems. Complete voltage ranges AC and DC, 0-1.5—5—50—150—500—1,500—5,000 volts. DC current ranges, 0-150 microamperes—15 milliamperes—150 milliamperes—500 milliamperes—15 amperes. Resistance measurements from .2 ohms to 20 meg-

ohms x 1 x 1,000 x 10,000.
DB coverage from -10 db
to +65 db.

CONSTRUCTION

Entirely new design permits assembly, mounting and wiring of precision resistors on a ring-switch assembly unit. The major portion of instrument wiring is completed before mounting the ring-switch assembly to the panel. No calibration procedure is required, all precision resistors readily accessible in event of replacement.

CABINET

Strikingly modern cabinet styling featuring two piece construction, durable black Bakelite cabinet, with easy to read panel designations. Cabinet size 5½" wide x 4" deep x 7½" high. Good cabinet physical stability when operated in vertical position.

The Heathkit MM-1 represents a terrific instrument value for a high quality 20,000 ohms per volt unit using all 1% deposited carbon type precision resistors. Here is quality, performance, functional design, and attractive appearance, all combined in one low priced package.

Heathkit BATTERY TESTER KIT



MODEL BT-1
\$8⁵⁰
SHIP. WT.
2 LBS.

The Heathkit Battery Tester measures all types of dry batteries between 1½ volts and 150 volts under actual load conditions. Readings are made directly on a three color Good-Weak-Replace scale. Operation is extremely simple and merely requires that the test leads be connected to the battery under test. Only one control to adjust in addition to a panel switch for "A" or "B" battery types. The Heathkit Battery Tester features compact assembly, accurate meter movement, and a three deck wire-wound control, all mounted in a portable rugged plastic cabinet. Checks portable radio batteries, hearing aid batteries, lantern batteries, etc.

Heathkit HANDITESTER KIT



MODEL M-1
\$14⁵⁰
SHIPPING WT.
3 LBS.

The Heathkit Model M-1 Handitester readily fulfills major requirements for a compact, portable volt ohm milliammeter. Despite its compact size, the Handitester is packed with every desirable feature required in an instrument of this type. AC or DC voltage ranges full scale, 0-10—30—300—1,000—5,000 volts. Two ohmmeter ranges, 0-3,000 and 0-300,000. Two DC current measurement ranges, 0-10 milliamperes and 0-100 milliamperes. The instrument uses a Simpson 400 microampere meter movement, which is shunted with resistors to provide a uniform 1 milliampere load on both AC and DC ranges. Special type, easily accessible, battery mounting bracket — 1% deposited carbon type precision resistors — hearing aid type ohms adjust control. The Handitester is easily assembled from complete instructions and pictorial diagrams. Necessary test leads are included in the price of this popular kit.

HEATH COMPANY • Benton Harbor 20, Mich.

New *Heathkit* 12 Volt BATTERY ELIMINATOR KIT



MODEL BE-4

\$31⁵⁰SHIPPING WT.
18 LBS.

CHECK THESE *Features*

- ✓ Either 6 or 12 volt operation
- ✓ Continuously variable voltage output
- ✓ Constant ammeter and voltmeter monitoring
- ✓ Automatic overload relay — self-resetting
- ✓ Two 10,000 mf condensers
- ✓ New 18 disc split type heavy duty rectifier unit
- ✓ Fuse protection

Here is the new Heathkit Battery Eliminator necessary for modern, up-to-date operation of your service shop. The Heathkit Model BE-4 furnishes either 6 volts or 12 volts output which can be selected at the flick of a panel switch. Use the BE-4 to service the new 12 volt car radios in addition to the conventional 6 volt radios.

This new Battery Eliminator provides two continuously variable output ranges, 0-8 volts DC at 10 amperes continuously, or 15 amperes maximum intermittent; 0-16 volts DC at 5 amperes continuously or 7.5 amperes maximum intermittent. The output voltage is clean and well filtered as the circuit uses two 10,000 mf condensers. The continuously variable voltage output feature is a definite aid in determining the starting point of vibrators, the voltage operating range of oscillator circuits, etc. Panel mounted meters constantly monitor voltage and cur-

rent output and will quickly indicate the presence of a major circuit fault in the equipment under test. The power transformer primary winding is fuse protected and for additional safety an automatic relay of the self-resetting type is incorporated in the DC output circuit. The heavy duty rectifier is a split type 18 plate magnesium copper sulfide unit used either as a full wave rectifier or voltage doubler according to the position of the panel range switch.

Here is the ideal battery eliminator for all of your service problems and as an additional feature, it can also be used as a battery charger. Another new application for the Heathkit Battery Eliminator is a variable source of DC filament supply in audio development and research. More than adequate variable voltage and current range for normal applications.

Heathkit VIBRATOR TESTER KIT

Your repair time is valuable, and service use of the Heathkit Vibrator Tester will save you many hours of work. This tester will instantly tell you the condition of the vibrator being checked. Checks vibrators for proper starting and the easy to read meter indicates quality of output on a large Bad?-Good scale. The Heathkit VT-1 checks both interrupter and self rectifier types of vibrators. Five different sockets for checking hundreds of vibrator types.

The Heathkit Vibrator Tester operates from any battery eliminator capable of delivering continuously variable voltage from 4 to 6 volts DC at 4 amperes. The new Heathkit Model BE-4 Battery Eliminator would be an ideal source of supply.



MODEL VT-1

\$14⁵⁰SHIPPING WT.
6 LBS.

NEW *Heathkit* VARIABLE VOLTAGE ISOLATION TRANSFORMER KIT

The new Heathkit Isolation Transformer Kit provides line isolation for AC-DC radios (not an auto transformer), thereby eliminating shock hazard, hum problems, alignment difficulties, etc. The output voltage is variable from 90 to 130 volts AC and is constantly monitored by a panel mounted AC volt meter. Use it to increase AC supply voltage in order to induce breakdown of faulty components in circuits thereby saving service time. Use it also to simulate varying line voltage conditions and to determine the line voltage level at which oscillator circuits cease functioning, particularly in three-way portable radios. Rated at 100 watts continuous operation and up to 200 watts maximum intermittent operation. A useful radio and TV service tool.



MODEL IT-1

\$16⁵⁰

SHIP. WT. 9 LBS.

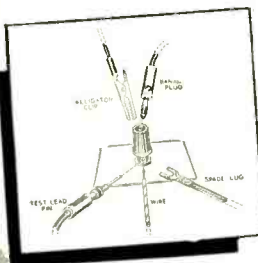

Heathkit BINDING POST

Binding post kit now available so that standardization of all instrument connectors is possible. This new, five-way binding post will accommodate an alligator clip, banana plug, test lead pin, spade lug, or hook-up wire. Sold in units of 20 binding post assemblies. Each assembly includes binding post, flat and shoulder fiber washers, solder lug, and nut. 120 pieces in all. Kit 362, \$4.00.



Heathkit TECHNICAL APPLICATION BULLETINS

An exclusive Heathkit service. Technical application bulletins prepared by recognized instrument authorities outlining various combinations of instrument applications. Available now with 40 four-page illustrated bulletins and an attractive flexible loose-leaf binder. Only \$2.00. (No c.o.d. on this item, please.)

HEATH COMPANY • Benton Harbor 20, Mich.

CHECK THESE *Features*

- ✓ INCREDUCTOR controllable inductor sweep
- ✓ TV and IF sweep deviation 12-30 mc
- ✓ 4 mc- 220 mc continuous frequency coverage
- ✓ Oscillator operation entirely on fundamentals
- ✓ Output in excess of 100,000 microvolts
- ✓ Automatic amplitude circuit
- ✓ Voltage regulation
- ✓ Simplified operation

NEW *Heathkit*
**TV ALIGNMENT
 GENERATOR
 KIT**

MODEL TS-3

\$44.50SHIPPING WEIGHT
18 POUNDS

Proudly announcing an entirely new, advanced model TV and FM Sweep Generator, the Heathkit Model TS-3. This new design provides features and combinations of functions not found in any other service type instrument. Every design consideration has been given to the requirements of the TV service man to provide a flexible, variable sweep source with more than adequate RF output and complete frequency coverage throughout the TV and FM spectrum.

The frequency range of the TS-3 is from 4 mc to 220 mc in four switch selected ranges. All frequency ranges are overlapping for complete coverage. A particularly important feature of the instrument is that the oscillator operates entirely on fundamentals, thereby providing complete freedom from spurious oscillation and parasitics normally encountered in beat frequency type oscillators. This circuitry assures a much higher total RF output level and simplifies attenuation problems.

The new TS-3 features an entirely new principle of sweep operation. Sweep action is entirely electronic with no moving parts or electro-mechanical devices so commonly used. The heart of the sweep system is a newly-developed INCREDUCTOR controllable inductor. With this system, the value of inductance of each oscil-

lator coil is electrically varied with an AC control current, and the inductance variation is achieved by a change in the magnetic state of the core on which the oscillator coils are wound. This system provides a sweep deviation of not less than 12 mc on all TV frequencies, and up to a maximum of 30 mc on TV IF frequencies. The high RF output level throughout the instrument frequency range overcomes the most common complaint of the older type sweep generators. A new, automatic amplitude control circuit maintains the output level flat to ± 2 db throughout the instrument range. For convenience of operation a low impedance 50 ohm output is used.

Operation of the instrument has been simplified through the reduction of panel controls and separate panel terminals provide for external synchronization if desired. The circuit uses a voltage regulator tube to maintain stable instrument operation. A built-in variable oscillator marker further adds to flexibility of instrument operation. Provisions are also made for the use of an external marker, such as your service type signal generator, if desired. Use the Heathkit TS-3 for rapid, accurate TV alignment work, and let it help you solve those time consuming, irksome problems so frequently encountered.

NEW *Heathkit*
SIGNAL GENERATOR KIT

MODEL SG-8

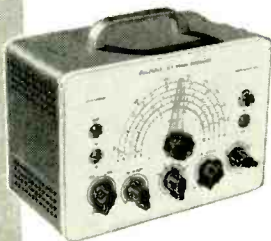
\$19.50SHIPPING WEIGHT
8 POUNDS

Announcing the new Heathkit Model SG-8 service type Signal Generator, incorporating many design features not usually found in an instrument in this price range. The RF output is from 160 kc to 100 mc in five ranges, all on fundamentals, with useful harmonics up to 200 mc. The RF output level is in excess of 100,000 microvolts throughout the frequency range.

The oscillator circuit consists of a 12AT7 twin triode tube. One half is used as a Colpitts oscillator, and the other half as a cathode follower output which acts as a buffer between the oscillator and external load. This circuitry eliminates oscillator frequency shift usually caused by external circuit loading.

All coils are factory wound and adjusted, thereby completely eliminating the need for calibration and the use of additional calibrating equipment. The stable low impedance output features a step and variable attenuator for complete control of RF level. A 6C4 triode acts as a 400 cycle sine wave oscillator and a panel switching system permits a choice of either external or internal modulation.

The transformer operated circuit is easy to assemble, requires no calibration, and meets every service requirement for an adjustable level variable frequency signal source, either modulated or un-modulated.

NEW *Heathkit*
BAR GENERATOR KIT

MODEL BG-1

\$14.50SHIPPING WEIGHT
6 POUNDS

The Heathkit BG-1 Bar Generator represents another welcome addition to the fast growing line of popular Heathkits. The

station transmitted test pattern is rapidly disappearing, and the bar generator is the logical answer to the TV service man's problem in obtaining quick, accurate adjustment information without waiting for test patterns.

The Heathkit BG-1 produces a series of horizontal or vertical bars on a TV screen. Since these bars are equally spaced, they will quickly indicate picture linearity of the receiver under test. Panel switch provides "stand-by position" — "horizontal position" — "vertical position." The oscillator unit utilizes a 12AT7 twin triode for the RF oscillator and video carrier frequencies. A neon relaxation oscillator provides low frequency for vertical linearity tests. The instrument will not only produce bar patterns but will also provide an indication of horizontal and vertical sync circuit stability, as well as overall picture size.

Instrument operation is extremely simple, and merely requires connection to the TV receiver antenna terminal. The unit is transformer operated for safety when used in conjunction with universal or transformerless type TV circuits.

HEATH COMPANY • Benton Harbor 20, Mich.

NEW *Heathkit* TUBE CHECKER KIT

MODEL TC-2

\$29⁵⁰

SHIP. WT. 12 LBS.



The new Model TC-2 Heathkit Tube Checker features many circuit improvements, simplified wiring, new roll chart drive and illumination of roll chart. The instrument is primarily designed for the convenience of the radio and TV service man and will check the operating quality of tubes commonly encountered in this type of work. Test set-up procedure is simplified, rapid, and flexible. Panel sockets accommodate 4, 5, 6, and 7 pin tubes, octal and loctal, 7 and 9 pin miniatures, 5 pin Hytron and a blank socket for new tubes. Built-in neon short indicator, individual three-position lever switch for each tube element, spring return test switch, 14 filament voltage ranges, and line set control to compensate for supply voltage variations, all represent important design features of the TC-2. Results of tube tests are read directly from a large 4½" Simpson three-color meter, calibrated in terms of Bad?-Good. Information that your customer can readily understand. Checks emission, shorted elements, open elements, and continuity.

The use of closer tolerance resistors in critical circuits assures correct test information and eliminates the possibility of inaccurate test interpretation. Improvement has been made in the mechanical roll chart drive system, completely eliminating diagonal running, erratic operation, and backlash. The thumb wheel gear driven action is smooth, positive, and free running. As an additional feature, the roll chart is illuminated for easier reading, particularly when the tube checker is used on radio or TV home service calls.

Wiring procedure has been simplified through the extended use of multi-cable, color coded wires, providing a harness type installation between tube sockets and lever switches. This procedure insures standard assembly and imparts that "factory built" appearance to instrument construction. Completely detailed information is furnished in the new step-by-step construction manual, regarding the set-up procedure for testing of new or unlisted tube types. No delay necessary for release of factory data.

The new Heathkit Tube Checker will prove its value in building service prestige through usefulness—simplified operation—attractive professional appearance. Don't overlook the fact that the kit price represents a savings of \$40.00 to \$50.00 over the price of a comparable commercially built instrument. At this low price, no service man need be without the advantages offered by the Heathkit Tube Checker.

CHECK THESE NEW *Features*

- ✓ Simplified harness wiring
- ✓ Improved, smooth, anti-backlash roll chart action
- ✓ Optional roll chart illumination
- ✓ Individual element switches
- ✓ Portable or counter style cabinet
- ✓ Spare blank socket
- ✓ Contact type pilot light test socket
- ✓ Simplified test set-up procedure
- ✓ Line adjust control
- ✓ 4½" three-color meter

New

HEATHKIT

PORTABLE TUBE CHECKER KIT

MODEL TC-2P

\$34⁵⁰

SHIP. WT. 14 LBS.

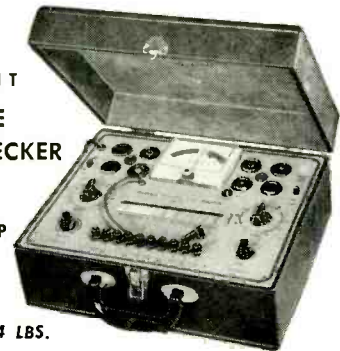

The portable model is supplied with a strikingly attractive two-tone cabinet finished in rich maroon, proxylin impregnated, fabric covering with a contrasting gray on the inside cover. Detachable cover, brass-plated hardware, sturdy plastic handle help to impart a truly professional appearance to the instrument.

PORTABLE TUBE CHECKER CABINET as described above will fit all earlier Heathkit TC-1 Tube Checkers. Shipping weight 7 lbs. Cabinet only, 91-8, \$7.50.



Heathkit TV PICTURE TUBE TEST ADAPTER

No. 355
Ship. Wt. **\$4⁵⁰**
1 Lb.

The Heathkit TV Picture Tube Test Adapter used with the Heathkit Tube Checker will quickly check for emission, shorts, etc., and determine picture tube quality. Consists of standard 12 pin TV tube socket, four feet of cable, octal socket connector, and data sheet.

Heathkit POWER SUPPLY KIT



MODEL PS-2

\$33⁵⁰SHIPPING WT.
17 LBS.

The Heathkit Laboratory Power Supply features continuously variable, regulated voltage output with good stability under wide load variations. A 4½" Simpson plastic enclosed panel mounted meter provides accurate meter output information of voltage or current. All panel terminals completely isolated from the cabinet. Separate 6.3 volt AC supply at 4 amperes for filament requirements. Ripple component exceptionally low, stand-by switch provided to eliminate warm-up time of the five tube circuit.

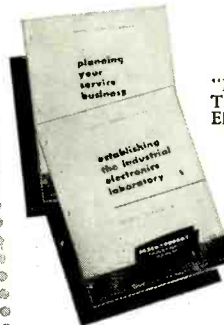

LABORATORY AND SERVICE SHOP BOOKLETS

"Planning Your Service Business" by John T. Frye, and "Establishing the Industrial Electronics Laboratory" by Louis B. Garner, Jr., are booklets available to Heathkit customers at no charge. These booklets, written by nationally recognized authorities, outline the various requirements and considerations for establishing your own service business or for setting up an industrial electronics laboratory. Full attention is given to various details that are frequently overlooked when projects of this nature are undertaken. Just write in to the Heath Company requesting your free copy, or attach a memo to your next order.

HEATH COMPANY • Benton Harbor 20, Mich.

RADIO-ELECTRONICS

CHECK THESE *Features*

- ✓ Visual and aural signal tracing
- ✓ Two channel input
- ✓ High RF sensitivity
- ✓ Unique noise locator circuit
- ✓ Calibrated wattmeter
- ✓ Substitution test speaker
- ✓ Utility amplifier
- ✓ RF, audio probes and test leads included

Heathkit VISUAL-AURAL SIGNAL TRACER

KIT

MODEL T-3

\$23⁵⁰

SHIPPING WEIGHT
10 POUNDS

An entirely new type of signal tracer incorporating a combination of features not found in any other instrument. Designed expressly for the radio and TV service man, particularly for the servicing of AM, FM, and TV circuits. Here in a five tube, transformer operated instrument are all of the useful functions so necessary for speedy, accurate isolation of service difficulty.

This new signal tracer features a special high gain RF input channel, used in conjunction with a newly-designed wide frequency range demodulator probe. High RF sensitivity permits signal tracing at the receiver antenna input. A separate low gain channel and probe available for audio circuit exploration. Both input channels are constantly monitored by an electron ray beam indicator, so that visual as well as aural signal indications may be observed. The instrument can also be used for comparative estimation of gain per stage.

A decidedly unusual feature is a noise localizer circuit in conjunction with the audio probe. With this system, a DC potential is applied to a suspected circuit component and the action of the

voltage in the component can be seen as well as heard. Invaluable for ferreting out noisy or intermittent condensers, noisy resistors, controls, coils, IF and power transformers, etc. A built-in calibrated wattmeter circuit is very useful for a quick preliminary check of the total wattage consumption of the equipment under test. Separate panel terminals provide external use of the speaker or output transformer for substitution purposes. Saves valuable service time by eliminating the necessity for speaker removal on every service job. The terminals also permit the utilization of other shop equipment, such as your oscilloscope or VTVM. The T-3 Signal Tracer can be used as a high gain amplifier for checking tuners, record changers, microphones, phono crystals, etc.

Don't overlook the interesting service possibilities provided through the use of this new instrument and let it work for you by saving time and money. The kit is supplied complete with all tubes, circuit components, demodulator probe, audio probe, and additional test leads.



Heathkit DECADE RESISTANCE KIT

MODEL DR-1 The Decade Resistance Kit provides individual switch selection of resistance values using twenty 1% resistors providing a choice of 1 to 99,999 ohms in 1 ohm steps. Ceramic wafer switches, silver-plated contacts, smooth, positive detent action, baked enamel panel, and handsome, polished birch cabinet.

\$19⁵⁰

SHIP. WT.
4 LBS.

Heathkit DECADE CONDENSER KIT

The Heathkit Decade Condenser Kit features silver mica, precision condensers with a rated accuracy of $\pm 1\%$. Capacity values are arranged in three decades from 100 mmf to .111 mf in steps of 100 mmf. Ceramic wafer switches with silver-plated contacts and smooth detent action. Useful in laboratory work, for circuit development.

MODEL DC-1

\$16⁵⁰

SHIP WT
4 LBS.

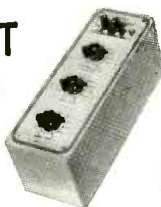

Heathkit RESISTANCE SUBSTITUTION BOX KIT

MODEL RS-1 The Heathkit Resistance Substitution Box provides individual switch selection of any one of 36 RTMA 1 watt 10% standard value resistors, ranging from 15 ohms to 10 megohms. Many applications in circuit development work, and also in radio and TV service work. Ideal for experimentally determining resistance values and for quickly altering circuit operating characteristics. Entire unit housed in attractive Bakelite cabinet, featuring the new universal type Heathkit binding posts to simplify circuit connections.

\$5⁵⁰

SHIP. WT.
2 LBS.



Heathkit CONDENSER CHECKER KIT

MODEL C-3

\$19⁵⁰

SHIPPING WT.
8 POUNDS

Use the Heathkit C-3 Condenser Checker to quickly and accurately measure those unknown condenser and resistor values. All readings are taken directly from the calibrated panel scales without requiring any involved calculation. Capacity measurements in four ranges from .00001 mf to 1,000 mf. Checks paper, mica, ceramic, and electrolytic condensers. A power factor control is available for accurate indication of electrolytic condenser measurements. A leakage test switch with switch selection of five polarizing voltages, 25 volts to 450 volts DC, will indicate condenser operating quality under actual load condition. The spring return leakage test switch automatically discharges the condenser under test and eliminates shock hazard to the operator.

Resistance measurements can be made in the range from 100 ohms to 5 megohms. Here again all values are read directly on the calibrated scale. Increased circuit sensitivity coupled with an electron beam null indicator increases overall instrument usefulness.

For safety of operation the circuit is entirely transformer operated and the instrument is housed in the attractive, newly-styled Heathkit cabinet, featuring rounded corners, and drawn aluminum panel. The outstanding low kit price for this surprisingly accurate instrument includes necessary test leads. Good service shop operation requires the use of this specialized instrument, designed for the express purpose of determining unknown condenser values and operating characteristics.

HEATH COMPANY • Benton Harbor 20, Mich.



Heathkit AMATEUR TRANSMITTER KIT

MODEL AT-1

\$29.50

SHIPPING WEIGHT
16 POUNDS

CHECK THESE NEW Features

- ✓ Single knob band switching
- ✓ Pre-wound coils
- ✓ Metered operation
- ✓ 52 ohm coaxial output
- ✓ Crystal or VFO excitation
- ✓ Built-in power supply
- ✓ Rugged, clean construction

Here is the latest Heathkit addition to the ham radio field, the AT-1 Transmitter Kit, incorporating many desirable design features at the lowest possible dollar-per-watts price. Panel mounted crystal socket, stand-by switch, key click filter, AC line filtering, good shielding, etc. VFO or crystal excitation—up to 35 watts input. Built-in power supply provides 425 volts at 100 ma.

This kit features pre-wound coils, single knob band switching, 52 ohm coaxial output, plug in chassis provisions for VFO or modulator and rugged clean construction. Frequency range 80, 40, 20,

15, 11, and 10 meters. Tube line-up 6AG7 oscillator-multiplier, 6L6 amplifier-doubler, 5U4G rectifier. Physical dimensions 8 1/8" high x 13 1/8" wide x 7" deep.

This amazingly low kit price includes all circuit components, tubes, cabinet, punched chassis, and detailed construction manual. The ideal kit for the novice just breaking into ham radio. It can be used later on as a stand-by rig or an all band exciter for higher powered transmitter.

NEW Heathkit ANTENNA COUPLER KIT

New Heathkit Antenna Coupler, specially designed for the Heathkit AT-1 Transmitter. The Antenna Coupler can be used with any 52 ohm coaxial input—up to 75 watts power. Low pass filter with cut-off frequency of approximately 36 mc — L section tuning network — neon tuning indicator — rugged, compact construction — transmitter type variable condenser, and high Q coil are all outstanding features. The AC-1 has both inductance and capacity tuning for maximum operating versatility. Dimensions 8 1/8" wide x 4 3/8" high x 4 7/8" deep.



MODEL AC-1

\$14.50 SHIP. WT. 3 LBS.

Heathkit ANTENNA IMPEDANCE METER

Use the Heathkit Antenna Impedance Meter for measuring antenna impedance for line matching purposes—adjustment of beam antennas—phone monitor, etc. It will determine antenna resistance at resonance, match transmission line for minimum SWR, determine receiver input impedance, and provide a rough indication of SWR. Precision resistors, germanium diode, 100 micro-ampere Simpson meter. Dial calibrated from 0-500 ohms. Shielded aluminum cabinet. 7" long x 2 1/2" wide x 3 1/4" deep.



MODEL AM-1

\$14.50

SHIP. WT. 3 LBS.

Heathkit COMMUNICATIONS RECEIVER KIT

MODEL AR-2

\$25.50 SHIP. WT. 12 LBS.



Here is the new receiver kit you have repeatedly asked for, the Heathkit Communications Receiver. The perfect companion piece for the AT-1 Transmitter kit. Many outstandingly desirable features have been incorporated in the design of the AR-2; such as, electrical bandspread

for logging and tuning convenience—high gain miniature tubes—IF transformers for high sensitivity and good signal to noise ratio—separate RF gain control with optional automatic volume control or manual volume control, in addition to the conventional audio gain control. Noise limiter—stand-by switch—stable BFO oscillator circuit—headphone jack—transformer operation, etc., all contribute to a high performance standard.

Frequency coverage is continuous from 535 kc to 35 mc in four ranges. For added convenience, various ham bands have been separately identified in respect to their relative placement on the slide rule tuning scale. A chassis mounted, 5 1/2" PM speaker is included with this kit. Tube line up 12BE6 mixer oscillator, 12BA6 IF amplifier, 12AV6 detector AVC audio, 12BA6 BFO oscillator, 12A6 beam power output, 5Y3GT rectifier.

RECEIVER CABINET

Proxilyn impregnated, fabric covered, plywood cabinet with aluminum panel designed expressly for the AR-2 Receiver. Part 91-10, shipping weight 5 lbs., \$4.50.



IMPROVED Heathkit GRID DIP METER KIT

\$19.50 SHIP. WT. 4 LBS.

MODEL GD-1B

The invaluable instrument for service men, hams, and experimenters. Useful in TV service work for alignment of traps, filters, IF stages,

peaking compensation networks, etc. Locates spurious oscillation, provides a relative indication of power in transmitter stages, use it for neutralization, locating parasitics, correcting TVI, measuring C, L, and Q of components, and determining RF circuit resonant frequencies. With oscillator energized, useful for finding resonant frequency of tuned circuits. With the oscillator not energized, the instrument acts as an absorption wave meter. Variable meter sensitivity control, head phone jack, 500 microampere Simpson meter. Continuous frequency coverage from 2 mc. to 250 mc. Pre-wound coil kit and rack, new three prong coil mounting, 6AF4 high frequency triode.

Two additional plug-in coils are available and provide continuous extension of low frequency coverage down to 355 kc. Dial correlation curves included. Shipping weight 1 lb., kit 341, \$3.00.



CHECK THESE *Features*

- ✓ First popular priced Q Meter
- ✓ Reads Q directly on calibrated scale
- ✓ Oscillator supplies RF frequencies of 150 kc to 18 mc
- ✓ Calibrate capacitor with range of 40 mmf to 450 mmf with vernier of ± 3 mmf
- ✓ Measures Q of condensers, RF resistance, and distributed capacity of coils
- ✓ Many applications in design and development work
- ✓ Useful in TV service work for checking deflection yokes, coils, chokes, etc.

Another outstanding example of successful Heathkit engineering effort in producing a Q Meter Kit within the price range of TV service men, schools, laboratories, and experimenters. This Q Meter meets RF design requirements for rapid, accurate measurement of capacity, inductance, and Q at the operating frequency and all indications of value can be read directly on the meter calibrated scales. Oscillator section supplies RF fre-

Heathkit "Q" METER KIT

MODEL QM-1

\$44.50

SHIPPING WT. 14 POUNDS

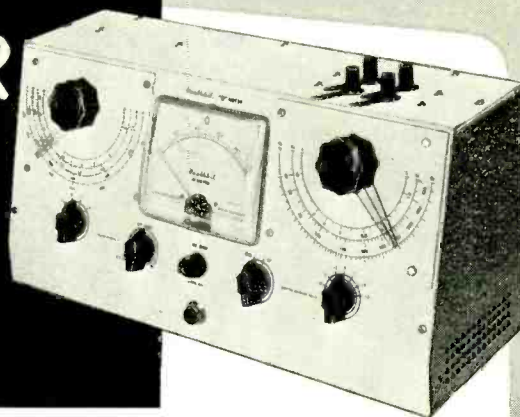

quencies of 150 kc to 18 mc. Calibrate capacitor with range of 40 mmf to 450 mmf, with vernier of ± 3 mmf.

Particularly useful in TV service work for checking peaking coils, wave traps, chokes, deflection coils, width and linearity coils, etc. At this low kit price research laboratory facilities are within the range of service shops, schools, and experimenters.

Heathkit INTERMODULATION ANALYZER KIT

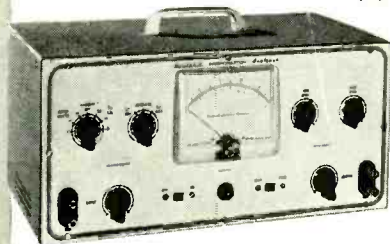

MODEL IM-1

\$39.50SHIPPING WT.
17 POUNDS

The Heathkit IM-1 is an extremely versatile instrument specifically designed for measuring the degree of inter-action between two signals in any portion of an audio chain. It is primarily intended for making tests of audio amplifiers, but may be used in other applications, such as checking microphones, records, recording equipment, phonograph pick-ups, and loud-speakers. High and low test frequency source, intermodulation unit, power supply, and AC vacuum tube volt meter all in one complete instrument. Per cent intermodulation is directly read on the calibrated scales, 50%, 10%, and 3% full scale. Both 4:1 and 1:1 ratios of low to high frequency easily set up. With this instrument the performance level of present equipment, or newly developed equipment can be easily and accurately checked. At this low price, you can now enjoy the benefits of intermodulation analysis for accurate audio interpretation.

Heathkit AUDIO GENERATOR KIT

A Heathkit Audio Generator with frequency coverage from 20 cycles to 1 mc. Response flat ± 1 db from 20 cycles to 400 kc, down 3 db at 600 kc, and down only 8 db at 1 mc. Calibrated, continuously variable, and step attenuator output controls provide convenient reference output level. Distortion is less than .4% from 100 cps through the audible range. The ideal controllable extended frequency sine wave source for audio circuit investigation and development.

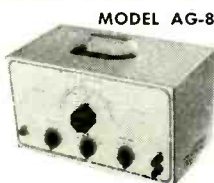

MODEL AG-8

\$29.50

SHIP. WT. 11 LBS.

Heathkit AUDIO OSCILLATOR KIT

Sine or square wave coverage from 20 to 20,000 cycles in three ranges at a controllable output level up to 10 volts. Low distortion, 1% precision resistors in multiplier circuits, high level output across entire frequency range, etc., readily qualify this instrument for audio experimentation and development work. Special circuit design consideration features thermistor operation for good control of linearity.



MODEL AO-1

\$24.50

SHIP. WT. 11 LBS.

Heathkit AUDIO FREQUENCY METER KIT

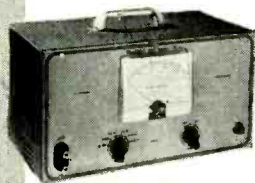

MODEL AF-1

\$34.50

SHIP. WT. 12 LBS.

The Heathkit Audio Frequency Meter provides a simple and convenient means of checking unknown audio frequencies from 10 cycles to 100 kc at any voltage level between 3 and 300 volts rms with any non-critical wave shape. Instrument operation is entirely electronic. Just set the range switch, feed an unknown frequency into the instrument, and read the frequency directly on the calibrated scale of the Simpson 4 $\frac{1}{2}$ " meter.

Heathkit SQUARE WAVE GENERATOR KIT

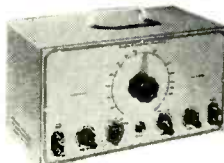

MODEL SQ-1

\$29.50

SHIP. WT. 12 LBS.

The Heathkit Square Wave Generator provides an excellent square wave frequency source with completely variable coverage from 10 cycles to 100 kc. This generator features low output impedance of 600 ohms and the output voltage is continuously variable between 0 and 20 volts, thereby providing the necessary degree of operating flexibility. An invaluable instrument for those specialized circuit investigations requiring a good, stable, variable square wave source.

HEATH COMPANY • Benton Harbor 20, Mich.

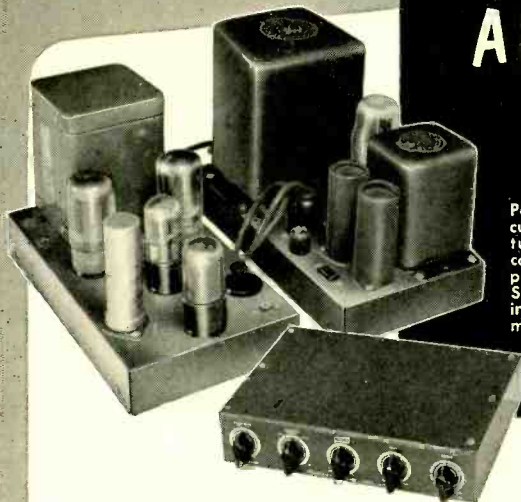

Heathkit WILLIAMSON TYPE AMPLIFIER KIT

MODEL W-2

Particularly designed for custom installations, featuring separate cable connected units for simplicity of installation. Sheet metal work finished in attractive gray hamertone for smart appearance. All control shafts of the adjustable length break-off type.

\$69.⁵⁰

PRICES OF COMBINATIONS

W-2 Amplifier Kit including main amplifier, power supply, and WA-P1 Preamplifier Kit. Shipping Weight 37 lbs. Shipped Express only. **\$69.⁵⁰**

W-2M Amplifier Kit includes main amplifier and power supply. Shipping Weight 29 lbs. Shipped Express only. **\$49.⁷⁵**

WA-P1 Preamplifier Kit only. Shipping Weight 6 lbs. Shipped Express or Parcel Post. **\$19.⁷⁵**

When selecting an amplifier for the heart of your high fidelity audio system, investigate the outstanding advantages offered by the Heathkit Williamson Type Amplifier. Meets every high fidelity audio requirement and makes listening to recorded music a thrilling new experience. This outstanding amplifier is offered with optional output transformer

operation, providing either the conventional triode output circuit or the new extended power circuitry in which the screen supply voltage is obtained from separate transformer primary taps. Frequency response within ± 1 db from 10 cycles to 100 kc. Tube complement — 6SN7 cascade amplifier and phase splitter, 6SN7 push pull driver, two 5881 push pull power amplifiers, one 5V4G cathode type rectifier.

Matching preamplifier available providing three switch selected inputs, correct compensation, and individual bass and treble tone controls. Uses 12AY7 (or 12AX7) preamplifier — 12AU7 tone control amplifier.

Particularly designed for the novice kit builder and requires no specialized knowledge or equipment for successful assembly and operation.

NEW Heathkit 20 WATT High Fidelity AMPLIFIER KIT

MODEL A-9A



\$35.⁵⁰

SHIP. WT. 18 LBS.

A new 20 watt high fidelity amplifier, designed especially for custom audio installations demanding clean reproduction, adequate power, and flexibility to meet individual requirements. Separate treble and bass tone controls provide up to 15 db boost or cut. Four switch selected inputs, each with the necessary compensation for the service desired. Output transformer impedances of 4, 8, and 16 ohms.

Preamplifier, tone control, and phase splitter circuits utilize 9 pin twin triode miniature tubes for low hum and noise level. Two 6L6 push pull power output tubes provide full 20 watts power. Frequency response ± 1 db, 20-20,000 cycles. Total harmonic distortion 1% (at 3 db below rated output). Tube line-up: 12AX7 preamplifier, 12AU7 voltage amplifier and tone control, 12AU7 voltage amplifier and phase splitter, two 6L6 push pull pentode power output, 5U4G rectifier. Truly outstanding amplifier performance coupled with low cost.



MODEL A-7B

\$15.⁵⁰

SHIP. WT. 10 LBS.

Heathkit ECONOMY 6 WATT AMPLIFIER KIT

The new Heathkit Model A-7B Amplifier offers many unusually fine features not normally expected in this low price range. Either of the two input circuits may be individually switch selected for phono or tuner operation. Separate bass and treble tone controls. Output impedances of 4, 8, and 15 ohms. Push pull beam power output stage for balanced reproduction. Excellent voltage gain characteristics, good frequency response, and full 6 watts power output. 12J5 amplifier, 12SL7 second amplifier and phase splitter, two 12A6 beam power output, one 5Y5 GT rectifier.

A-7C incorporates preamplifier stage with special compensated network to provide necessary gain for operation with variable reluctance or low output level phono cartridge. Circuit is properly compensated for microphone operation. \$17.50.

NEW Heathkit BROADCAST BAND RECEIVER KIT

Another new Heathkit for the student, beginner, or hobbyist. If you have ever had the urge to build your own radio receiver, this kit warrants your attention.

New high gain miniature tubes and IF transformers provide excellent sensitivity and good signal to noise ratio. A built-in ferrite core rod type antenna has been provided. A chassis mounted $5\frac{1}{2}$ " PM speaker provides excellent tone and volume. Convenient phono input. Can be operated either as a receiver or tuner. Simplified construction manual outlines circuit theory. Ideal for students. Tube line-up: 12BE6 mixer oscillator, 12BA6 IF amplifier, 12AV6 detector-ABC-first audio, 12A6 beam power output, 5Y3GT rectifier.



MODEL BR-2

\$17.⁵⁰ SHIP. WT. 11 LBS.

CABINET — Proxylin impregnated fabric covered plywood cabinet. Shipping weight 5 lbs. Part number 91-9, \$4.50.

Heathkit FM TUNER KIT

The Heathkit FM-2 Tuner was specifically designed for simplified kit construction. Can be operated through the "phono" portion of your radio or with a separate amplifier. The kit features a pre-assembled and adjusted tuning unit, three double tuned IF transformers, and a discriminator transformer in an 8 tube AC operated circuit. Frequency coverage 88 to 108 mc. Experience the thrill of building your own FM tuner and at the same time enjoy all of the advantages of true FM reception.



MODEL FM-2

\$22.⁵⁰

SHIP. WT. 9 LBS.

Free CATALOG

Write for free catalog containing latest price information, schematics, specifications, and descriptions of all Heathkits.

CAPACITANCE and the RATIO DETECTOR

Understanding circuits through capacitor analysis.

By **CYRUS GLICKSTEIN**

ONE of the handiest tools in analyzing circuits is an exact knowledge of how capacitors work. When a new circuit seems hard to understand, I've usually found I haven't fully analyzed the capacitor action. Once that is completely clear, the over-all circuit operation becomes simple to follow.

Most of the facts on how capacitors work are well known. But every so often a circuit is developed where capacitors act in a way not described in the textbooks. A popular circuit found in many FM and TV receivers bears out this point.

The unbalanced ratio detector is shown in Fig. 1. Very little detailed

is inductively coupled into the secondary and tertiary windings.

At the resting frequency, the voltages across the secondary and the voltage across the third winding (L3) are 90 degrees out of phase. The diodes conduct as usual only when the plates are positive compared to the cathodes. Conduction occurs when the polarity across the secondary is such that the cathode of V1 (top diode) is negative and the plate of V2 (bottom diode) is positive. The diodes therefore do not conduct on the positive half of the incoming signal. Also, the large time-constant of R1-C1 makes this section of the circuit act as a limiter. The peak value of the voltage across the secondary is rectified and developed

across R1-C1.

Specific voltage values will be used to clarify circuit operation. At the resting frequency, assume the peak voltage across each half of the secondary is 5 and the voltage across the third winding (L3) is also 5. Two actions take place: First, the entire secondary—L1 and L2 in series—acts as a generator during the entire negative half-cycle. The total secondary voltage of 10 is across the diodes and R1-C1. The diodes conduct and practically all of the source voltage (10 volts) can be considered across R1-C1, since the voltage drop across the diodes is negligible. This action is shown in Fig. 2.

In addition to this action, a second action is taking place simultaneously during the first quarter-cycle (first half of the negative alternation). One-half of the secondary, L2, is in series with L3 across the bottom diode and C2. The two windings act as out-of-phase generators in series. The voltage polarity is such that current flows through the bottom diode V2 and charges C2 as shown in the simplified circuit of Fig. 3. The rectified voltage across C2 will have the polarity shown—negative with respect to ground—and will be -7 (the vector sum of 5 volts across L2 and 5 volts across L3; the two voltages are 90 degrees out of phase). Now in the next quarter-cycle (second half of the negative alternation), the entire secondary is still across R1-C1 as in Fig. 2. Simultaneously, the polarity across L3 reverses and L3 is now in series with L1. L1 and L3 now act as two out-of-phase generators in series and the voltage polarity is such that current flows through the top diode V1. The current path is through V1, R1-C1, and C2 as shown in Fig. 4. Note that

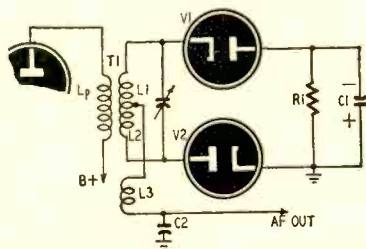

Fig. 1—The unbalanced ratio detector.

analysis of this circuit has appeared in print. Most of the published explanations have not fully described the operation because of an incomplete analysis of capacitor action.

The ratio detector circuit in Fig. 1 acts as a combined limiter and detector for FM sound signals. Transformer T1 is an i.f. transformer with a primary Lp, a secondary which is center-tapped and consists of two equal halves (L1 and L2), and a third or tertiary winding (L3). An i.f. signal from the primary

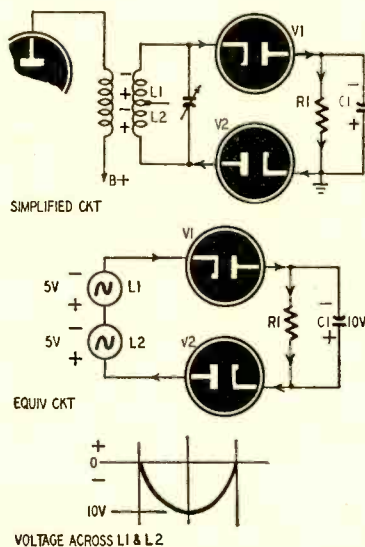
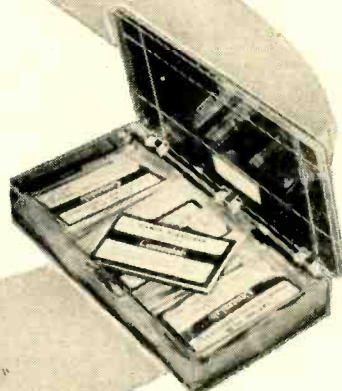

Fig. 2—Simplified and equivalent circuits showing the voltage across R1-C1.

NEW!

4 P.E.C.* KITS

(NO EXTRA CHARGE FOR CABINETS)



PCK-18 18 P.E.C. units. Replace 42 old-style resistors and 52 old-style capacitors. Net - - - - - **\$9.00**



PCK-110 110 P.E.C. units. Replace 255 old-style resistors and 52 old-style capacitors. Net - **\$55.80**

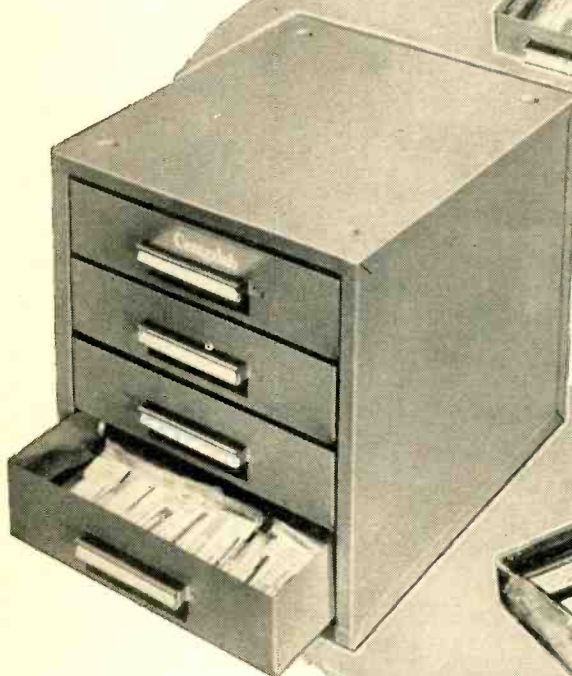

PCK-220 220 P.E.C. units. Replace 525 old-style resistors and 620 old-style capacitors. Net **\$115.80**



PCK-45 45 P.E.C. units. Replace 106 old-style resistors and 133 old-style capacitors. Net - **\$24.00**

Handy P.E.C. Guide No. 2 is included with each kit. Shows part listings, schematics, and test data.

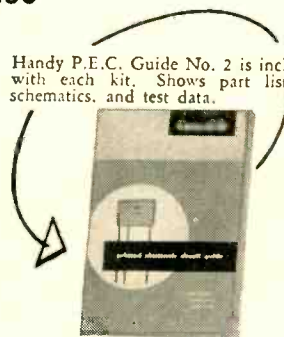

Write for a list of the Centralab distributors in your area who have P.E.C. Kits.

Centralab

A Division of Globe-Union Inc.

922-J E. Keefe Avenue • Milwaukee 1, Wisconsin
In Canada, Box 208, Ajax, Ontario

*Trade Mark — Printed Electronic Circuit

there is 10 volts across R1-C1 and 7 across C2 as a result of the action in the first quarter-cycle. In this second quarter-cycle, therefore, the voltage in C2 is in series-aiding with the voltages across L3 and L1 but this combined total is bucking the voltage across R1-C1. This is illustrated in the simplified schematic of Fig. 5. This means that 7 volts (vector sum of the voltages

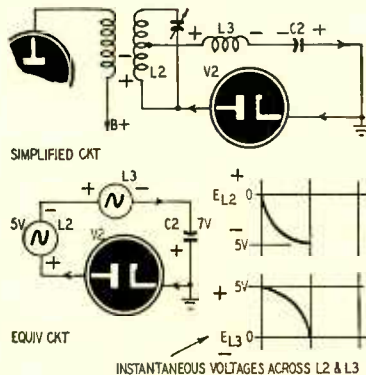

Fig. 3—Peak voltages across L2 and L3 are rectified and developed across C2.

across L1 and L3) plus the 7 volts across C2 (total -14 volts) is bucking the 10 volts across R1-C1. As a result, there is a difference of 4 volts and C2 discharges 4 volts worth. Since it had -7 volts to start with, this leaves -3 volts across C2. As long as the incoming signal remains at the resting frequency, then, the voltage across C2 will be -7 volts on the first quarter-cycle and -3 volts on the next quarter-cycle for each half-cycle when the diodes conduct. The average d-c voltage across C2 is -5 volts. That is, a d.c. meter placed across C2 cannot measure the instantaneous changes at each quarter-cycle but measures the average level of voltage.

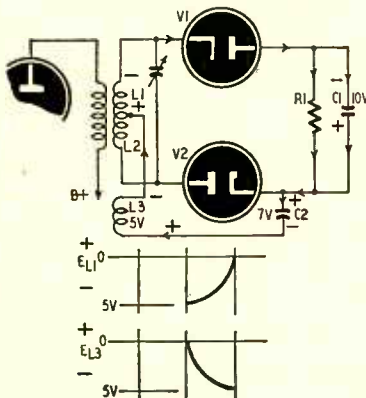

Fig. 4—Diagram showing current flow during second quarter cycle of signal.

It is interesting to note that the average d.c. voltage across C2 (-5 v) is exactly half the voltage across R1-C1 (-10 v). This is true in every ratio detector at the resting frequency. In fact, when aligning a ratio detector, two equal resistors (R2 and R3) in series are temporarily soldered across R1-C1, to divide the voltage in half. A d-c meter is then placed at the junction of the two resistors (Fig. 6) and the top of C2. The secondary circuit of T1 is then tuned, while applying a signal at the

resting frequency, until the meter reads zero—that is, until the voltage across C2 is exactly equal to one-half the voltage across R1-C1.

When the signal frequency deviates to one side of the resting frequency, the following occurs: The rectified vector sum of the voltages across L2 and L3 becomes greater across C2 (let us say 8 volts). C2 therefore charges to this value. On the next quarter-cycle, the vector sum of the voltages across L1 and L3 is less. This value (assume it is 6 volts) is in series with the 8 volts across C2 and bucks the 10 volts of R1-C1. Therefore 14 volts bucks 10 volts and C2 discharges 4 volts or down to -4 volts (subtracting 4 volts from the original 8 leaves 4 volts). The average value across C2 for the two quarter-cycles is -6 volts (Fig. 7-b). Assuming still further deviation, C2 charges up to -9 volts, discharges down to -5 volts, leaving an average now of -7 volts (Fig. 7-c).

When the frequency returns to zero, the charge across C2 goes to -5 volts. With deviation on the other side of the resting frequency, the average voltage across C2 goes to -4 volts then to -3 volts, returning to -4 volts and -5 volts. As a result, a pulsating negative d.c. voltage is produced across C2 which gives 1 cycle of audio for each complete frequency swing of the incoming signal.

One further point on how limiter action is effected in this circuit. Any instantaneous increase of signal voltage across the secondary will not cause C1 to charge up immediately because of the large capacitance of C1. Therefore, even with a noise pulse coming through, R1 and C1 have the same voltage.

To illustrate the action at the resting frequency with figures: Assume R1-C1 have 10 volts across them when an instantaneous noise pulse increases the voltage across the secondary to 14 volts (7 volts across each half) and the voltage across L3 to 7 volts. The vector sum of the two voltages is 10 volts, and C2 charges up to this value. Then the 10 volts across C2 is in series with the 10 volts across L1 and L3 bucking the 10 volts across R1-C1. The difference is 10 volts, so C2 discharges to zero. The average voltage across C2 is $\frac{-10 + 0}{2}$

or -5 volts as before. It is interesting to note that, no matter what values are chosen, and throughout the change of values due to deviation, any instantaneous increase of voltage across the secondary and across L3 will not change the voltage output across C2 compared with the no-noise condition, provided R1-C1 remain at the original voltage value.

A point which is basic to understanding capacitor action is how r.f. and d.c. voltage add together. The voltages across each half of the secondary and across L3 are r.f. voltages. The voltages across R1-C1 and

C2 are rectified r.f., therefore d.c. voltages. It is entirely possible for an r.f. voltage to be in series-aiding (or series-bucking) with a d.c. voltage. It is further possible for a combined r.f. voltage in series-aiding with a d.c. voltage to be applied in opposition to a bucking d.c. voltage. The direction of current flow in the circuit then depends on the difference between the two sets of voltages—on which is larger at a given instant.

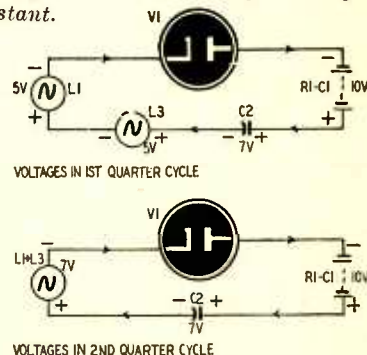

Fig. 5—Simplified circuit of Fig. 4.

Some previous explanations of the action in this circuit are based on the assumption that on one quarter-cycle, C2 (Fig. 1) charges through the lower diode, but on the next quarter-cycle C2 charges equally in the opposite direction through the upper diode. It is maintained that at the resting frequency the voltage across C2 is zero. It is further assumed that C2 can charge equally through the upper diode because

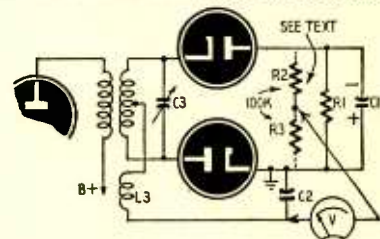

Fig. 6—Aligning ratio detector. Secondary is tuned for zero output on meter. C1 has practically zero impedance for r.f. This explanation is defective on at least three counts. (1) Rectified r.f. is no longer r.f. but d.c.; therefore it is incorrect to state that C1 has zero impedance to r.f., since the diodes rectify the r.f. (2) There is a definite d.c. voltage across R1-C1 which cannot be ignored in the explanation of how voltages are developed across C2. (3) The average d.c. voltage across C2 at the resting frequency is not zero but one-half the voltage across R1-C1. The detailed explanation of the circuit in this article takes each of these points into consideration. END

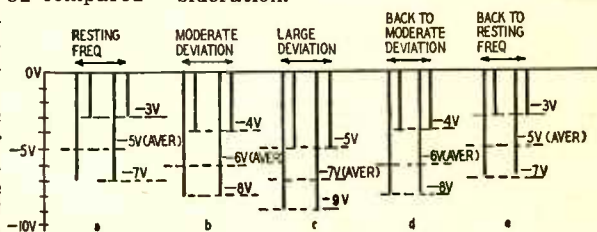

Fig. 7—Voltage across C2 during deviation to one side of resting frequency.



the CDR Rotor

sells faster...sells easier

because.....

The best line of TV Rotors money can buy

It is the complete line of quality rotors, with a model and type to best serve 'most every type application.

TV Spot Campaign

To reach the buying public, an intensive campaign on Television in key markets pre-selling CDR ROTORS for you.

Newspaper Advertisements

Also directed at the consumer, a supporting campaign in key city newspapers exploiting the advantages of the CDR ROTOR.

Moving Displays

It's causing excitement everywhere, this display that is an eye and traffic stopper, a silent salesman for the CDR ROTOR.

Envelope Stuffers

Here's another selling tool that may be mailed directly to your customers, selling them the CDR ROTOR in their home.

Newspaper Mats

A full set of completely prepared advertisements for dealers and distributors to capture extra CDR ROTOR business.

Window Streamers

They let everybody going into and by your-store know that you have the CDR ROTORS, a colorful and eye-catching streamer.

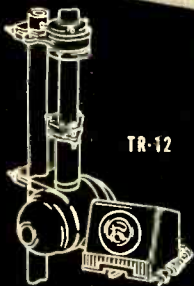

TR-12

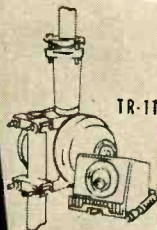

TR-11

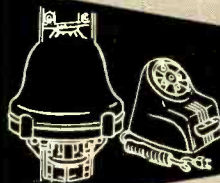

TR-2



THE RADIART CORPORATION
CLEVELAND 13, OHIO



CORNELL-DUBILIER ELEC. CORP.
SOUTH PLAINFIELD, NEW JERSEY

How to pick a TV Radio Electronics

Using known quantities and your engineering mind, you can accurately decide which school is best for YOU

DOES THE SCHOOL OFFER THE COURSES I NEED?

CAPITOL RADIO ENGINEERING INSTITUTE offers up-to-date courses in:

- Introduction to Practical Radio Engineering
- Advanced Practical Radio Engineering
- Specialized Broadcast Radio Engineering
- Specialized Aeronautical Radio Engineering
- Specialized Television Engineering
- Specialized Advanced Mathematics
- Practical Television Engineering
- Television and FM Servicing
- Television Studio Operations

HOW LONG HAS THE SCHOOL BEEN ESTABLISHED?

In 1927, CREI introduced the first home study course in practical radio engineering for the experienced radioman—and since then has successfully trained thousands of professional radiomen all over the world.

WHO INSPIRES THE SCHOOL'S POLICIES AND OPERATION?

Mr. E. H. Rietzke, founder and president of CREI, has been prominently identified with radio and technical education for many years. He was the original Chief Instructor of the Navy's Advanced Radio Materiel School at the Naval Research Laboratory. In 1944 Mr. Rietzke was elected President of the National Council of Technical Schools, of which he is one of the founders. He repre-



sents the proprietary technical schools of the United States on the Technical Institute Sub-Committee of the Engineers' Council for Professional Development. He is past chairman of the Washington Section, Institute of Radio Engineers, and for a number of years represented that body as a delegate to the D.C. Council of Engineering and Architectural Societies. He is a Registered Professional Engineer (DC).

WHAT IS THE BACKGROUND OF THE FACULTY?

Every CREI faculty member has experience and contacts in industry as well as in the educational world. CREI's Vice-President in charge of engineering Albert Preisman was employed by the Wagner Electric Corp.; the New York Edison Co.; he was on the staff at RCA for 13 years; and was senior engineer at Federal Telephone and Radio Corporation. He is a Fellow in the Institute of Radio Engineers.

CREI's chief home study instructor likewise enjoys a rich employment background, having worked with Bendix Radio, among others. And so on down the line.

WHAT TEACHING METHODS ARE USED?

CREI planned home study is an individual method of instruction. You receive continuous attention and assistance to meet your special needs. Upon enrollment, you receive your first set of lessons—each with its own examination, which you send in for correction and comment. Before you complete the first group of lessons, you receive the next set. Thus, you always have a sufficient number of lessons at hand to proceed as quickly as you like. In CREI's plan of "personalized" instruction, you will be assigned to competent instructors, who will guide you through your studies and offer prompt additional explanations. They will recommend steps which will contribute to a more complete understanding of the subject matter and will personally correct and explain errors.

School...

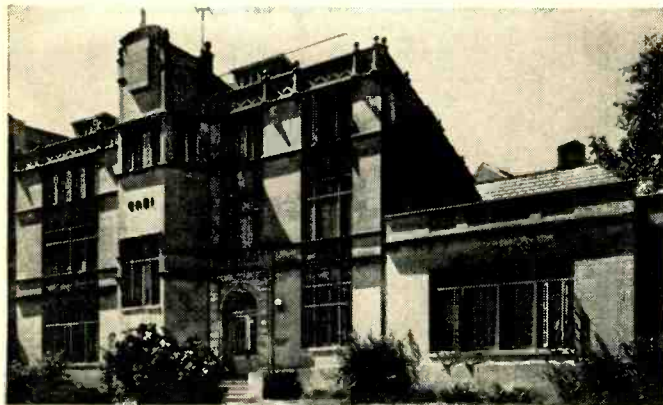

WHAT ARE THE LABORATORY FACILITIES?

CREI residence school is well-equipped with modern radio and television apparatus, with a large variety of laboratory measuring and testing equipment and with parts and supplies for the construction of experimental devices and apparatus. CREI maintains a fully equipped Television Studio and laboratories for experimentation in this important electronic art. In our Ultra-High Frequency laboratory, experimental set-ups are used operating over a wide range of frequencies and circuits to 3,000 megacycles. This extensive lab equipment is at the disposal of our technical staff in preparing the courses—and directing your study.

WHAT TEXTS WILL YOU USE?

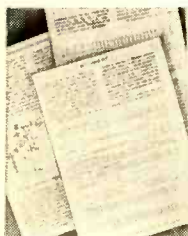

CREI lesson texts are the same as used in the Residence School. Their excellence has been proved by thousands of students. The U.S. Navy during World War II purchased more than 300,000 CREI Home Study Lessons. Every lesson is clear, practical and understandable.

IS THE SCHOOL ACCREDITED, AND IF SO—BY WHOM?

CREI Home Study Courses are accredited by the Engineers' Council for Professional Development. CREI is an approved member of the National Council of Technical Schools.

WHAT IS THE TECHNICAL LEVEL OF THE STUDENTS WHO ENROLL?

In the 26 year history of CREI, 98% of all students were engaged in some phase of radio-electronics at the time of their enrollment.

OCTOBER, 1953

WHAT POSITIONS AND LICENSES WILL YOU BE QUALIFIED TO ACCEPT?

An advanced student of CREI should easily pass the FCC examination. CREI students and graduates are employed in practically every phase of the radio-electronics industry, in positions ranging from technicians to engineers.

DOES THE SCHOOL TEACH WHAT INDUSTRY WANTS AND NEEDS?

CREI technical training is used for training technical staffs in many of the country's great industrial organizations, including United Air Lines; Pan American Airways, Atlantic Division; All-American Cables & Radio, Inc.; Radio Corporation of America, RCA Victor Division; Trans-Canada Air Lines, Canadian Aviation Electronics, Ltd.; Canadian Broadcasting Corporation, Columbia Broadcasting System; Canadian Marconi Company; Machlett Laboratories; The Magnavox Company; Hoffman Radio Corporation and Glenn L. Martin.

WHAT DO EXPERIENCED ELECTRONICS PEOPLE IN YOUR HOME TOWN SAY ABOUT THE SCHOOL?

CREI invites you to ask your local radio engineer, or television engineer—or anyone prominent in tv-radio-electronics about CREI. We will be satisfied with what these experts tell you about CREI. Or if you are on active military duty ask one of your superiors who is a specialist in radio-electronics.

WHAT CLAIMS OR PROMISES DOES THE SCHOOL MAKE?

Like all ethical schools, CREI makes no rash claims or promises of jobs. CREI states frankly there is no high road to success in electronics. Only study and work . . . can bring you to your goals. And a good way to start is by sending in the coupon below. We will send you, free of obligation, our illustrated, valuable booklet, "YOUR FUTURE IN THE NEW WORLD OF ELECTRONICS." In it you will see where the industry is headed and how you can skyrocket up along with the industry by the proper choice of goals, and the best possible selection of schools. Act today. Hear from us immediately. Then make your choice of courses.

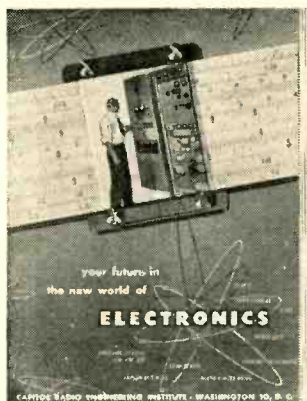

MAIL COUPON FOR FREE BOOKLET

CAPITOL RADIO ENGINEERING INSTITUTE

Dept. 1410, 3224 16th St. N. W., Washington 10, D. C.

Send booklet "Your Future in the New World of Electronics" and course outline.

- CHECK FIELD OF GREATEST INTEREST
- Practical Radio Engineering
 - Broadcast Radio Engineering (AM, FM, TV)
 - Practical Television Engineering
 - TV, FM & Advanced AM Servicing
 - Aeronautical Radio Engineering

Name.....

Street.....

City.....Zone.....State.....

Check Residence School Veteran

Shortcut Service on Radios

By FAIRBANKS TRYON

NO ONE can proceed to fix any radio simply by reading "how-to-do-it" books. But he can learn enough about specific troubles from an article by an experienced technician so that he may service a set that has similar troubles.

I have used this method in tackling a.c.-d.c. sets in my shop for about 15 years. It has saved lots of time—and a lot of radios. Many service technicians make the mistake of plugging in the set before they even look at it. If the filter capacitors are leaky or shorted this is just about the worst thing you can do. Always check for shorts *first!*

When handling a.c.-d.c. sets with tube rectifiers (this *does not* include 3-way portables), make the following tests before plugging in the set or even before taking it out of the cabinet:

1. Set the ohmmeter on its highest range; then short the leads and zero the pointer.

2. Don't plug in the set, but turn the switch *off*, and hook the meter test prods across the prongs of the line plug. See Fig. 1. The meter should read anywhere from several hundred megohms to *infinite resistance*. Anything less than this indicates a short or leak in the line cord, the line-filter capacitor, or the switch. (In many cases carbon granules wear off the volume-control resistance element and get into the switch mechanism.) A high-resistance leak here would not stop the set from operating, but could make it very noisy.

3. If this test shows everything normal, switch the ohmmeter to its 2,000-ohm range (or thereabouts) and turn the set *on*. The meter should now read between 100 and 150 ohms. (If the set has a 110-volt pilot light, this reading may be as low as 50 ohms.) If the meter reads less than 95 ohms, take a look at the pilot light; if it's a 110-volt type remove it and repeat the test.

4. If this test shows an *open circuit*, hold the test prods firmly on the plug prongs and bend the line cord back and forth—especially near the plug, and where the cord enters the chassis. Should the meter kick over when you bend the cord, it means the cord is broken somewhere between the plug and the chassis.

5. If the meter still shows an open circuit, remove one tube at a time and touch the test prods to the tube heater pins. (Check the tube-base diagrams to make sure you get all the heater pins, as there are 3 on some tubes.) No-

reading across any two heater pins indicates the tube is open, and replacing it with a new one may be all you have to do to fix the set.

There is always the possibility that more than one tube is open, or that one is open and another is intermittent. The reading at the line plug will tell. Of course an open reading with all tubes good (and in the right sockets), and the line cord good, would leave only the switch or a series resistor (if there is one in the circuit), which might be open; or a broken connection or cold-solder joint in the heater wiring.

6. Suppose the meter reads about 400 ohms at first; then drops back slowly to 150 or 200. (A 110-volt pilot lamp will fool you here unless you remove it.) This clearly indicates an *intermittent filament* or a high-resistance contact, which is reduced by the voltage of the ohmmeter.

7. I have found that the output tube is the one that's most often intermittent. Test it first, and then the 12SA7, 12SK7, 12SQ7, and 35Z5 (or their equivalents), in that order. The resistance reading across the filament of an intermittent tube will generally be abnormally high at the instant the test is applied. (Good filaments should read 10 to 15 ohms on 12-volt tubes, and 20 to 50 ohms on 35- and 50-volt types.) A reading of 100 to 300 ohms on any tube filament indicates a *probable* intermittent. If the complaint is an intermittent set, or you are in doubt about the results of the resistance test, try the tube in the tube tester. *Bad-* or *weak-tube* indications, and excessive warmup periods before any reading shows on the tester are all indications of an intermittent heater.

8. Any reading of much less than about 100 ohms across the line plug with the switch *on* probably indicates a leak or a short, and the set *should not be plugged in* until the trouble has been cleared and normal reading restored across the plug. Start by removing the rectifier tube from its socket; turn the switch *on*; and, with the meter on its 2,000-ohm range, hook one test prod to the switch side of the line plug and touch the other test prod to the two outside heater contacts of the rectifier socket in turn. One of these positions should read *open*; the other should read the combined series resistance of the remaining tube heaters (between 75 and 120 ohms). Then repeat this test with the power-output tube and

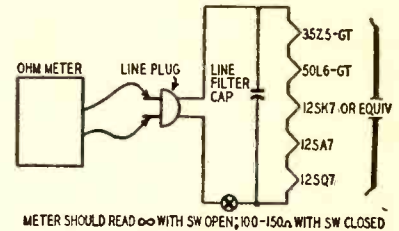

Fig. 1—Checking for shorts in the input circuits of a.c.-d.c. receivers. Proportional readings should be obtained between the individual tube-socket heater terminals and the switch side of the line plug if all is well.

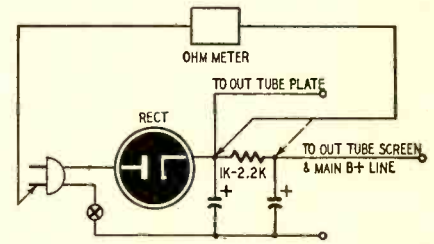

Fig. 2—Isolating leaky or shorted filter and bypass capacitors by comparing resistance readings to switch side of line plug at rectifier cathode terminal and output screen terminal. Lowest reading shows which side of filter resistor defective capacitor is on.

each of the remaining tubes in the heater string.

9. Now set the meter on the 20,000-ohm range and check from the rectifier-socket *cathode* terminal to the switch side of the line plug. Any reading under 20,000 ohms at this point indicates a short or a leak on the B plus line (except that at the instant of contact the meter pointer may kick all the way over and then swing back slowly—this is the initial discharge and slow recharge of the filter capacitors from the ohmmeter battery, and is perfectly normal).

Readings which indicate leakage on this test also include any paper, mica, or ceramic bypass capacitors across the B plus line as well as the electrolytic filters. To isolate the trouble, you will have to pull the chassis and disconnect at least one side of each electrolytic.

(Sometimes it may be possible to isolate the bad capacitor without pulling the chassis. In most a.c.-d.c. sets the B plus for the plate of the output tube is taken directly from the rectifier cathode, while the output screen voltage and the B supply for the other tubes are taken off the end of a 1,000- to 2,200-ohm filter resistor. See Fig. 2. Measure the resistance to the switch from the rectifier cathode terminal and from the output screen terminal. If the first reading is lower, it shows the input filter is the defective unit. If the second reading is lower, it indicates the output filter—or a bypass capacitor—is bad.—*Editor*)

Any technician who tries these tests will find he can restore over 50% of all a.c.-d.c. sets to operating condition by this method. **END**

MONEY BACK GUARANTEED

TO RECEIVE *All* UHF and *All* VHF STATIONS IN *All* DIRECTIONS FOR 60 MILES WITHOUT A ROTORMOTOR OF ANY KIND!!

WORLD'S MOST POWERFUL UHF—VHF TELEVISION ANTENNA

While antenna reception is guaranteed for 60 miles, perfect pictures have been consistently received as far as 160 miles from stations.

All NEW DESIGN FOR '54

- LOW-LOSS SWITCH
- LOW-LOSS PHENOLIC INSULATORS
- USES NEW 4-CONDUCTOR MATCHED IMPEDANCE LINE
- ONLY 10 INCH SPACING BETWEEN ANTENNA BAYS

ONE INSTALLATION ONE ANTENNA
ONE TRANSMISSION LINE

Money Back Guarantee IN ALL LOCATIONS WITH STATIONS IN ALL DIRECTIONS

The new All Channel Model Super 60 is guaranteed to bring in, immediately on installation, every UHF and every VHF station within 60 miles in any direction, giving clearer and sharper pictures than any antenna or combination of antennas with or without rotor motors.

If, immediately on installation, it fails to do this, we agree to refund to the jobber to whom we sold and shipped it, his full purchase price.

BE READY NOW — FOR THE FUTURE

ALL CHANNEL ANTENNA CORP., 70-07 QUEENS BLVD., WOODSIDE 77, NEW YORK

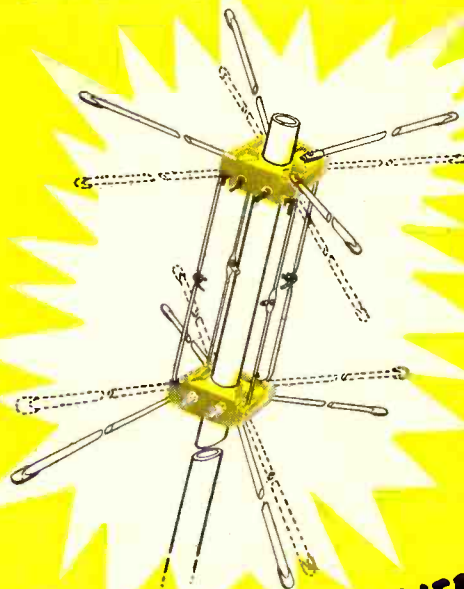

MODEL
**SUPER
60**

**SO NEW! SO DIFFERENT!
IT'S PATENTED!**

2,585,670
2,609,503
2,625,655
2,644,091



The 9 position selector switch electronically rotates the antenna in a stationary position.

LIST PRICE

\$36⁷⁵

SEE YOUR LOCAL
JOBBER

PRICE INCLUDES

Complete stacked array • 4 stacking bars • 9 position switch • Switch-to-set coupler • 3 - 7 1/2" stand offs • Individually boxed in mailable carton



my Radio
and T.V.
REPAIR SECRET?

OHMITE®
DEPENDABLE REPLACEMENTS

Little Devil® COMPOSITION RESISTORS



Tiny, yes... but what dependability, ruggedness, and stability! And they provide an extra margin of safety—being rated at 70C rather than 40C. Completely sealed and insulated by molded plastic, they meet all JAN-R-11 requirements... are available in 1/2, 1, and 2-watt sizes in all RTMA values.

TYPE AB NOISE-FREE POTENTIOMETERS

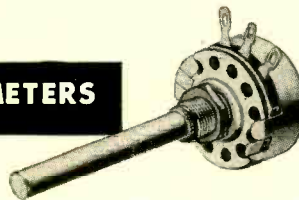

Because the resistance material in these units is solid-molded—not sprayed or painted on—continued use has practically no effect on the resistance. Often, the noise-level decreases with use... and they provide exceptionally long, trouble-free service. Rated at 2 watts, with a good safety factor.

BROWN DEVIL® AND DIVIDOHM® RESISTORS

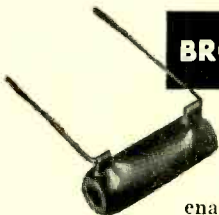

BROWN DEVIL fixed resistors and DIVIDOHM adjustable resistors are favorite vitreous-enameled units! DIVIDOHM resistors are available in 10 to 200-watt sizes; BROWN DEVILS in 5, 10, and 20-watt sizes.

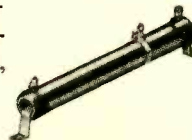

WRITE FOR
STOCK
CATALOG



OHMITE MFG. CO.
3646 W. Howard St., Skokie, Ill.
(Suburb of Chicago)

Be Right With...
OHMITE

RHEOSTATS • RESISTORS • TAP SWITCHES

ATTENUATION PROBLEM

An unusual trouble-shooting problem came up a few years ago during a production run of BA289 band-rejection audio filters for the CAA. These filters had to attenuate a narrow band of frequencies around 1,020 cycles *more than 100 db*, while their insertion loss at all other frequencies had to be held to *less than 10 db*.

The exceptionally steep filter characteristic called for setting each of several adjustable inductors to the right value with a high degree of accuracy.

Physically, the filters were multi-section coil-and-capacitor devices assembled in riveted aluminum-alloy cases. Since the aluminum case was in close proximity to the coils, the pattern of the eddy currents induced in the case had considerable influence on the settings.

After adjusting the filters for the required electrical characteristics, the cases were filled with a molten mixture of beeswax and rosin. Then the cover was put on and fastened with self-tapping screws.

This was the trouble: Tests made on the units after they were filled with wax and sealed showed that they had lost their 100 db attenuation; in fact, most of them had lost as much as 50 to 60 db. After a good deal of study, during which rejected filters were piling up in great quantities, it was definitely established that the hot wax was not causing the coils and capacitors to drift, but that the trouble was caused solely by the *riveted* aluminum-alloy case.

When the hot wax was poured into the box, the rapid heating caused a substantial increase in the contact resistance at the riveted joints. This altered the eddy-current distribution and changed the highly critical inductance values. The tuning in a 100-db device is so sharp that the slightest change in inductance is sufficient to destroy the attenuation characteristics. To obtain an attenuation so great over so narrow a band of frequencies it is necessary to use coils of very high Q. The slightest changes in magnetic fields caused by eddy currents lowered the Q.

The solution to the problem was to replace the *riveted* aluminum box with a drawn, seamless enclosure. This was immune to changes in eddy-current distribution under the heat of the wax, and the filters remained perfectly stable after potting.—*Sidney Wald* END

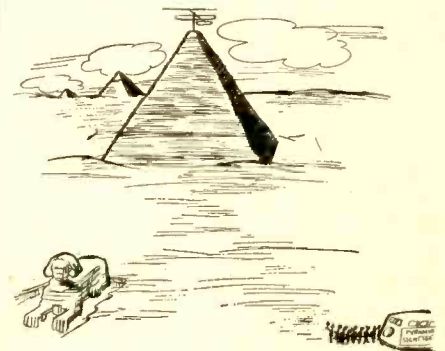

Suggested by Arthur Henrikson, Chicago, Ill.

RADIO-ELECTRONICS

Buy on our radically new

NO INTEREST!! **Time Payment Plan** **NO CARRYING CHARGES!!**



Superior's new
Model 670-A **SUPER METER**

**A COMBINATION VOLT-OHM MILLIAMMETER PLUS
CAPACITY REACTANCE INDUCTANCE AND DECIBEL MEASUREMENTS**

SPECIFICATIONS:

D.C. VOLTS: 0 to 7.5/15/75/150/750/1,500/7,500 Volts
A.C. VOLTS: 0 to 15/30/150/300/1,500/3,000 Volts
OUTPUT VOLTS: 0 to 15/30/150/300/1,500/3,000 Volts
D.C. CURRENT: 0 to 1.5/15/150 Ma. 0 to 1.5/15 Amperes
RESISTANCE: 0 to 1,000/100,000 Ohms 0 to 10 Megohms
CAPACITY: .001 to 1 Mfd. 1 to 50 Mfd. (Quality test for electrolytics)
REACTANCE: 50 to 2,500 Ohms 2,500 Ohms to 2.5 Megohms
INDUCTANCE: .15 to 7 Henrys 7 to 7,000 Henrys
DECIBELS: -6 to +18 +14 to +38 +34 to +58

ADDED FEATURE:

The Model 670-A includes a special **GOOD-BAD** scale for checking the quality of electrolytic condensers at a test potential of 150 Volts.

The Model 670-A comes housed in a rugged, crackle-finished steel cabinet complete with test leads and operating instructions.

\$28⁴⁰
NET



Superior's new
Model TV-11 **TUBE TESTER**

SPECIFICATIONS:

- ★ Tests all tubes including 4, 5, 6, 7, Octal, Lock-in, Peanut, Bantam, Hearing Aid, Thyatron, Miniatures, Sub-miniatures, Novals, Sub-minars, Proximity fuse types, etc.
- ★ Uses the new self-cleaning Lever Action Switches for individual element testing. Because all elements are numbered according to pin-number in the RMA base numbering system, the user can instantly identify which element is under test. Tubes having tapped filaments and tubes with filaments terminating in more than one pin are truly tested with the Model TV-11 as any of the pins may be placed in the neutral position when necessary.
- ★ The Model TV-11 does not use any combination type sockets. Instead individual sockets are used for each type of tube. Thus it is impossible

- to damage a tube by inserting it in the wrong socket.
- ★ Free-moving built-in roll chart provides complete data for all tubes.
- ★ Newly designed Line Voltage Control compensates for variation of any Line Voltage between 105 Volts and 130 Volts.
- ★ **NOISE TEST:** Phono-jack on front panel for plugging in either phones or external amplifier will detect microphonic tubes or noise due to faulty elements and loose internal connections.

The model TV-11 operates on 105-130 Volt 60 Cycles A.C. Comes housed in a beautiful hand-rubbed oak cabinet complete with portable cover

\$47⁵⁰
NET

EXTRA SERVICE—The Model TV-11 may be used as an extremely sensitive Condenser Leakage Checker. A relaxation

type oscillator incorporated in this model will detect leakages even when the frequency is one per minute.

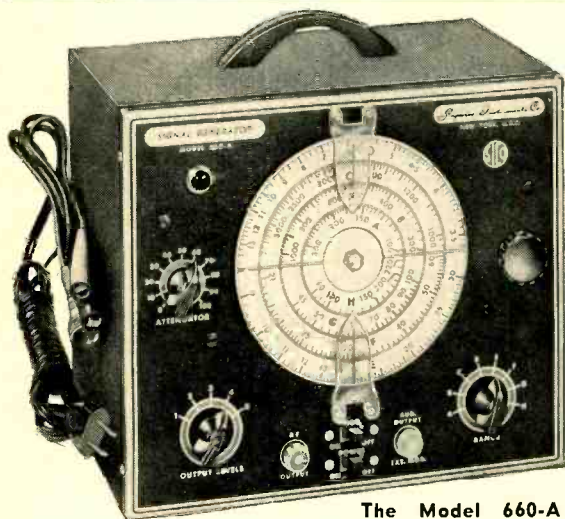

Superior's New Model 660-A AN AC OPERATED
SIGNAL GENERATOR

PROVIDES COMPLETE COVERAGE for AM-FM & TV Alignment

SPECIFICATIONS:

• Generates Radio Frequencies from 100 Kilocycles to 60 Megacycles on fundamentals and from 60 Megacycles to 220 Megacycles on powerful harmonics. • Accuracy and Stability are assured by the use of permeability trimmed Hi-Q coils. • R.F. available separately or modulated by the internal audio oscillator. — Built in 400 cycle sine wave audio oscillator used to modulate the R.F. signal also available separately for audio testing of receivers, amplifiers, hard of hearing aids, etc. • R.F. Oscillator Circuit: A high transconductance hep-

tode is used as an R.F. oscillator, mixer and amplifier. Modulation is effected by electron coupling in the mixer section thus isolating the oscillator from load changes and affording high stability. • A.F. Oscillator Circuit: A high transconductance heptode connected as a high- μ triode is used as an audio oscillator in a High-C Colpitts Circuit. The output (over 1 Volt) is nearly pure sine wave. • Attenuator: A 5 step ladder type of attenuator is used.

Tubes used: 1—6BE6 as R.F. Oscillator, mixer and amplifier. 1—6BE6 as Audio Oscillator. 1—6H6 as Power Rectifier.

The Model 660-A comes complete with coaxial cable test lead and instructions.

\$42⁹⁵
NET

MOSS ELECTRONIC DISTRIBUTING CO., INC.
Dept. B-78, 38 Murray Street, New York 7, N. Y.

Please send me the units checked. I am enclosing the down payment with order and agree to pay the monthly balance as shown. It is understood there will be no carrying interest or any other charges, provided I send my monthly payments when due. It is further understood that should I fail to make payment when due, the full unpaid balance shall become immediately due and payable.

Name.....

Address.....

City..... Zone..... State.....

- MODEL 670-A** Total Price \$28.40 \$7.40 down payment. Balance \$3.50 monthly for 6 months.
- MODEL TV-11** Total Price \$47.50 \$11.50 down payment. Balance \$6.00 monthly for 6 months.
- MODEL 660-A** Total Price \$42.95 \$12.95 down payment. Balance \$5.00 monthly for 6 months.
- I enclose \$..... as down Payment.
- Ship C.O.D. for the down payment.

Heterodyne Frequency Meter uses pair of Transistors

Portable test instruments offer an excellent opportunity for transistors to do their stuff. Small size and light weight make them ideal.

By RUFUS P. TURNER

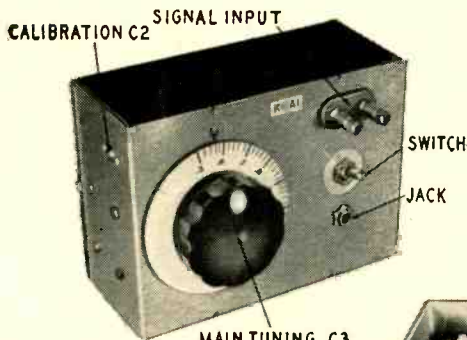

Front view of the transistorized frequency meter in its compact metal case.

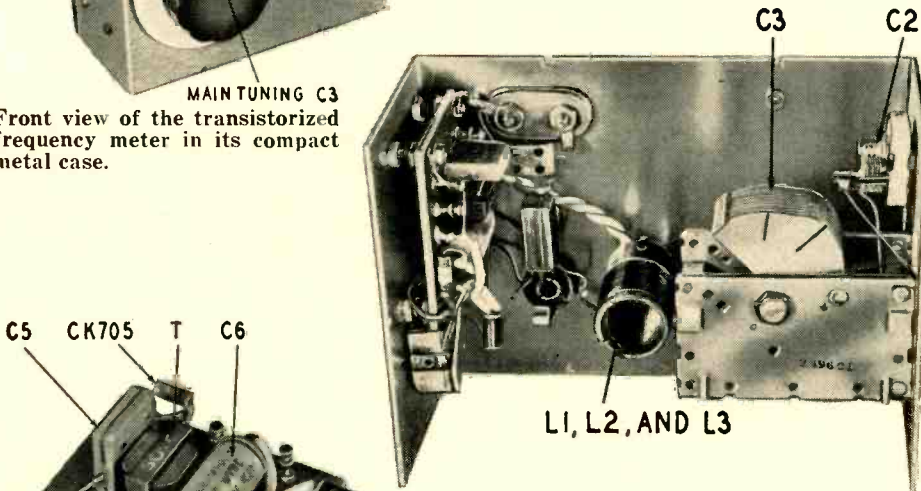

The meter with rear cover removed. All parts are visible except R1, C1, and V1.

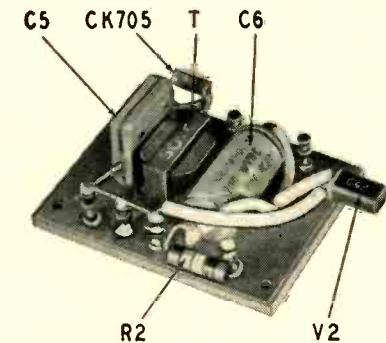

Photograph of the mixer and audio components mounted on a terminal board.

WITHIN its frequency and power limitations, the junction transistor offers interesting possibilities of application in portable test instruments. In our fervor to transistorize amplifiers, receivers, transmitters, and control devices, we should not overlook the heterodyne frequency meter. It is one instrument which can be transistorized readily, and its operation is not handicapped by the limited high-frequency response of the type CK722 transistor now easily obtained.

Battery operation of the heterodyne frequency meter always has been desirable in the interest of complete isolation from power lines, of portability, instant operation, and low heat generation. But battery operation usually has not been feasible because of the cost, weight, and size of the A and B batteries required; comparatively short battery life, especially if the instrument is left running by mistake; and annoying microphonics in battery-type tubes.

A frequency meter using junction transistors has none of those disadvantages and has the following desirable advantages: (1) Complete isolation and portability. (2) Small size. (3) Light weight. (4) Practically zero heat generation. (5) Low-current operation from a single battery. (6) Instant operation. (7) No microphonics. (8) Long battery life with small loss during accidental left-on periods. (9) Infrequent "tube" replacements, since the transistors are believed to have a life of tens of thousands of hours. (10) Ability of the instrument to take rough handling without damage.

The basic instrument

The heterodyne frequency meter is well known to commercial radio operators who use it frequently to measure transmitter carrier frequency. Hams use this instrument supplementarily as a c.w. monitor and receiver calibrator. The heterodyne frequency meter is a common instrument in radio-frequency laboratories where it is used to check the frequency of r.f. oscillators and signal generators and as a comparator.

The block diagram in Fig. 1 shows the basic arrangement of a heterodyne frequency meter. The r.f. oscillator uses

an inherently stable circuit tunable over a single frequency band. Its output is fed into an aperiodic detector or mixer together with the test signal to be measured. The oscillator and test signals (or some harmonics of one or both) produce a beat note which then is amplified by the audio amplifier and monitored with headphones or a visual indicator. The r.f. oscillator is tuned to zero-beat with the signal and the frequency is read off the oscillator dial. The dial may be directly calibrated.

The test-signal frequency may be lower than the fundamental frequency range of the oscillator. Its harmonics then beat with the oscillator. Or the signal frequency may be higher than that of the oscillator, in which case an oscillator harmonic will beat with the signal. In this way, we use the instrument over a wide frequency range extending from f/n to nf , where f is the oscillator fundamental frequency at some suitable setting, and n is a multiplier or divisor representing the most remote useful harmonic or subharmonic which will give a sufficiently strong beat note. Thus, in one commercial heterodyne frequency meter, the oscillator is tunable from 100 to 200 mc, and the useful measurement range (from f/n to nf) is 10 to 2,000 mc. (In this instance, the factor n is 10.)

Transistorized meter

When using a junction transistor in the r.f. oscillator section of a heterodyne frequency meter, the designer is limited by the fact that this type of transistor ordinarily will not oscillate beyond the top of the standard broadcast band. However, by tuning the transistor oscillator from 500 to 1,000 kc., the practical

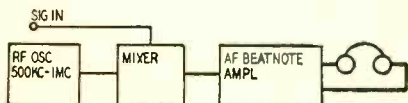

Fig. 1—Block diagram of the meter.

measurement range is found to be 50 kc or less to 30 mc. Response at the high frequencies is dependent to a great extent upon the strength of the test signal.

Fig. 2 shows the complete circuit of the transistorized heterodyne frequency meter. Type CK722 transistors are used in the r.f. oscillator and a.f. amplifier stages, and a CK705 germanium diode is used in the mixer stage. The r.f. oscillator is a high-gain grounded-emitter amplifier provided with inductive feedback through the tickler coil L1. The r.f. output from the oscillator is coupled to the diode mixer circuit through pickup coil L3. Coil L2 is a Miller type 20-A antenna coil (113 turns of No. 32 wire closewound on a 1-inch-diameter form) with the slip-over primary removed. L1 consists of 40 turns of No. 26 enameled wire closewound on top of L2 and wound in the same direction as L2. L3 is 15 turns of insulated hookup wire jumble-wound and cemented inside the form on which L2 is wound. So that the reader may phase these coils properly for oscillation, the tops of L1 and L2 have been labeled X and Y respectively in Fig. 2. X and Y are the beginnings or ends of each coil. It is immaterial which is chosen as long as they correspond.

The test signal is applied to the mixer through coupling capacitor C4. Audio output from the mixer is coupled through transformer T (a UTC type SO-2) to the grounded-emitter a.f. amplifier. Note that the interstage transformer is connected backward to match the low input impedance of transistor V2.

The entire instrument is powered by a miniature 15-volt battery. The 15-volt potential is necessary for high-frequency oscillation because with 1.5 to 10 volts, not all CK722 transistors will operate up to and including the broadcast band. While for size considerations, a hearing-aid-type battery is shown here, a larger-sized battery can be used and may be more desirable, from a life standpoint, to individual builders. Total measured current drain is 440 microamperes d.c. in this instrument, but this may be expected to vary in each direction with individual transistors.

(CONTINUED ON PAGE 90)

Introducing

THE New

PERMOFLUX
Super ROYAL

HIGH Fidelity SPEAKER

The finest speaker ever made by Permoflux . . . retaining all the exceptional features of the famous Royal Line . . . plus new developments in design giving you a performance which is *Virtually Distortionless*. It has *Full Range Response* (to the limits of audibility), and *Superior Damping* with *Maximum Sensitivity*.

This unsurpassed performance is due to exclusive Permoflux features, such as ★ T.S.C. (treated slotted cone) for extended distortionless low frequency response. ★ Latest design in magnetic structure utilizing heavy Alnico 5 ring magnet for maximum flux density.

★ Specially designed single cone radiator for full high and low frequency response, without the phase distortion due to separate speakers for high and low frequencies.

For descriptive literature write to . . .

See and hear the Super Royal at your High Fidelity Dealer

Permoflux CORPORATION
4912 West Grand Avenue, Chicago 39, Illinois
236 S. Verdugo Rd., Glendale 5, California

NOW-GREAT precise TWO OSCILLOSCOPES

(IN KIT OR WIRED FORM)

THE NEWEST, THE ONLY ONE OF ITS KIND!

8½" OSCILLOSCOPE: PRECISE MODEL #308

Now another great Precise Oscilloscope! The only 8½" Oscilloscope on the Commercial Market... in Kit or Wired Form... at an unbelievably low price. Designed to bring you true TV picture clarity and laboratory tested accuracy.

ALL THE OUTSTANDING FEATURES OF THE MODEL 300 as shown below, PLUS:

- ★ INTENSIFIER ANODE
- ★ HI-LOW-NORMAL SYNCH. (A Precise First)
- ★ 8½ INCH TUBE (A Precise First)
- ★ VOLTAGE REGULATION (A Precise First)

"Seeing is Believing"—Go and See! your nearest jobber

308K—kit form..... **\$129.50**

SPECIFICATIONS: PRECISE MODEL 300 OSCILLOSCOPE
VERTICAL — Vertical-flat (3db) DC through 5 megacycles with sensitivity of greater than 10 millivolts push-pull (3.94 Millivolts cm); Constant Resistance; Push-pull input immediately converted to single-ended normal or reverse phase by shorting bar at inputs 1 and 2; Frequency compensated vertical stepping attenuator selects AC or DC inputs; Push-pull DC amplifiers from input through output; Internal electronic mixing through inputs 1 and 2; five-way binding posts.
POSITIONING — Bridge type positioning on vertical and horizontal does not vary tube characteristics.
HORIZONTAL — Frequency compensated stepping attenuator in horizontal amplifier; Push-pull horizontal out.
BLANKING — Internal (return trace blanked), external (return trace not blanked), 60 cycle or 120 cycle Blanking through Blanking amplifier circuit.
SYNCHRONIZATION — External, Internal Positive, Internal Negative, Internal 60 cycle or Internal 120 cycle synchronization.
SWEEP RATE — Driven or non-driven linear sweeps from 1 cycle to 80KC in five ranges (1:10 cycles uses external C circuit); Trigger potentiometer.
MAGNIFIER — Electronic magnifier and magnifier positioner allows any part of a signal to be magnified up to ten times (equivalent to 70 inches of horizontal deflection).
CALIBRATION — Internal square wave calibrator and potentiometer for using oscilloscope at a VTVM on Peak to Peak measurements.
CALIBRATION SCREEN — Edge-illuminated scale and graticule may be turned on or off; filtered screen.
OUTPUTS ON FRONT PANEL — Plus Gate output; Sawtooth output; 60 cycle phasing output; 60 cycle unphased output; Calibration output.
FOCUSING — Astigmatism, focus and intensity control.
CR1 — NEW 7" Tube, normally supplied is medium persistence type 710" (oscilloscope green trace) — high persistence types available at additional cost.
DIRECT — Deflection plates available from rear of cabinet.
INTENSITY MODULATION — Z modulation through modulation amplifier.
GENERAL — Low loss components; Over-designed fused power supply for additional circuitry; Deeply etched aluminum panel; New parts from original manufacturers — (NO SURPLUS); Steel cabinet; 11" x 14" x 17"; complete with instruction book and all components; Accessories: Model 912(MM) Demodulator Probe and Model 960 Capacity Attenuator Probe available at extra cost — Please see specifications on following pages. There are many additional features and circuits in kit form, which may be added to the Model 300. Please write us for descriptive literature.

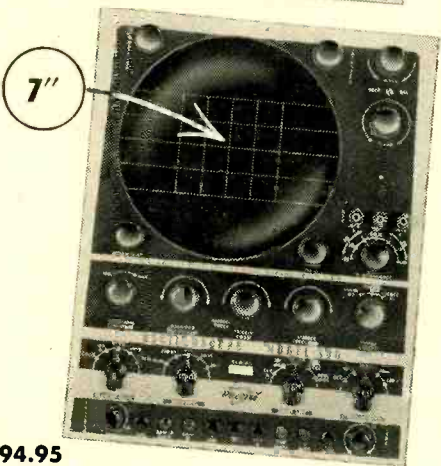
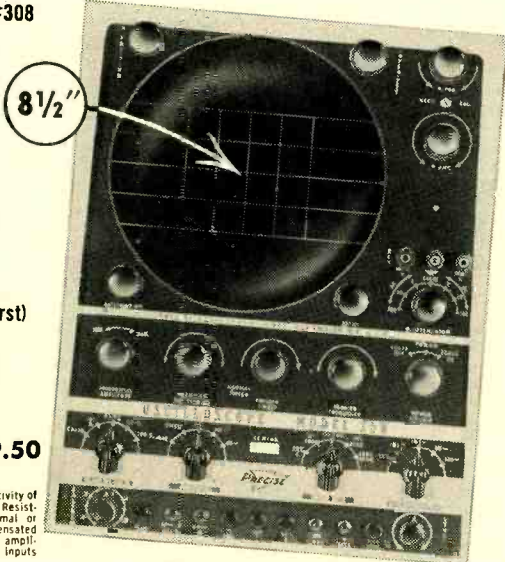

300K—kit form **\$94.95**
 300W—factory wired **\$199.50**

MODEL 960
 10-1 C.A. PROBE
\$5.95

MODEL 912
 RF PROBE
\$4.25

MODEL 635K
 UNIV. AF SINE SQ
 & PULSE GEN
\$33.50

MODEL 468K
 RES. DECADE BOX
\$18.95

MODEL 999
 HI-VOLTAGE PROBE
\$6.98

MODEL 630K
 RF-AF-TV & MARK GEN
\$33.95

MODEL 610K
 RF SIG. GEN.
\$23.95

MODEL 909K
 VAC. TUBE VOLTMETER
\$25.98

MODEL 907K
 DELUXE VAC.
 TUBE VOLTMETER
\$38.98

Prices slightly higher in the West. Prices and specifications subject to change without notice.

PRECISE DEVELOPMENT CORP. Dept. RE 22
 999 LONG BEACH ROAD • OCEANSIDE, L. I., NEW YORK

GENTLEMEN: Without any obligation on my part, kindly send me the following:

PRECISE CATALOG

NAME OF DISTRIBUTOR NEAREST ME

NAME _____

ADDRESS _____

CITY _____ ZONE _____ STATE _____

precise
 DEVELOPMENT CORP.
 OCEANSIDE, NEW YORK

Construction

The photographs show construction details of the heterodyne frequency meter. The entire instrument is built into an aluminum utility box 7 inches long, 5 inches high, and 3 inches deep. Considerable reduction in size is possible by the use of smaller components.

Tuning capacitor C3, calibration trimmer C2, and the r.f. coil assembly are mounted directly to the box (see rear-view photo). The mixer and a.f. amplifier components are mounted between the turret terminals of a Useco 2½ x 2 inch terminal board. Placement of these parts will be seen in the photo of the audio subchassis. Oscillator transistor V1, capacitor C1, and resistor R1 are mounted on a small bakelite terminal strip attached to the front of the main tuning capacitor C3, and are not visible in the rear-view photo.

Base resistors R1 and R2 are the only critical components. Their values vary with individual transistors and must be selected for the particular transistors used. The resistance values given in Fig. 2 worked satisfactorily in the author's instrument and will be good starting values from which to begin tests. Resistor R1 should be selected for lowest collector current which will permit strong oscillation over the entire range of the tuning capacitor. For this test, connect a multirange d.c. milliammeter temporarily in the lead from L1 to the negative terminal of the battery. Note the indicated collector current for each experimental value of R1. To test for oscillation, touch the collector lead of the transistor with the finger. The milliammeter should change reading vigorously. A slight change shows weak oscillation. After each change of R1, make this check at each setting of C3.

To adjust R2, insert a pair of 2,000-3,000-ohm headphones into the jack. Feed in an r.f. test oscillator signal (500 to 1000 kc) at the SIGNAL INPUT terminals, and obtain a beat note by tuning C3. Using this beat note, adjust the value of R2 for loudest undistorted signal. Remove the headphones and plug a d.c. milliammeter into the jack. The current reading ordinarily should not exceed 1 ma. Choose R2 for the lowest current which gives a loud signal with low background noise.

Calibration

The best final calibration will be obtained with a 100-kc frequency standard. However, follow these steps for the initial calibration: (1) Feed a 500-kc signal to the SIGNAL INPUT terminals. (2) Set the main tuning capacitor to its full-capacitance position. (3) Plug headphones into the jack and adjust the CALIBRATION trimmer C2 for zero beat. The C3 dial now may be marked 500 kc at this point. (4) Substitute a 100-kc frequency standard for the signal generator. (5) Reset C2, if necessary, to establish a more accurate zero-beat with the standard. (6) Tune C3 slowly from this setting until another standard frequency point is brought in on zero-beat.

(Continued on page 94)

the METROPOLITAN
VHF Industry Standard
\$4.95 list

the BULLSEYE
Smart, compact,
for all UHF
channels \$4.95 list

the SUPER BULLSEYE
For all VHF & UHF
channels \$6.95 list

**NEW
UHF - VHF
SUPER-BULLSEYE**

SELL MORE TV SETS IN EVERY MARKET

If yours is
sets f
Now,
to he

If *you* could advertise nationally, chances are *you'd* do just what CBS-Hytron

is doing for *you*. *You'd* tell the world in

LIFE

and

The Saturday Evening
POST

Half-page advertisements will appear in LIFE Sept. 28, POST Oct. 3, LIFE Oct. 19, POST Oct. 31, LIFE Nov. 16, and POST Nov. 28. Reaching over 28,583,290 readers!

that *you* promise quality TV and Radio service, parts, and tubes . . . and

at fair charges. And that's just what CBS-Hytron is doing for *you* with

advertisements like these.



You'd identify *your* service repair

These are just some of your *Certified Quality Service* advertisements. They sell *you* . . . and without a lot of sell for CBS-Hytron, although CBS-Hytron gladly pays the bill. Why? Because as we build *public confidence* in *Certified Quality Service*, we build greater faith *in you* and more business *for you* . . . our customers.

shop as the *one* people are reading about in the magazines. *You'd* use this

above all *you'd* use these *Certified* **QUALITY SERVICE** tags.



They tell *your*

This plan goes *all* the way to do the job. When *you* use these *Certified* Quality Service tags you're putting right into your customer's hands convincing *proof* . . . Proof that *Certified* Quality Service means *more* for *your* customer's money.

customer he is getting more for his money when he calls *your* service repair

shop . . . because *you* *Certify* the quality of service, parts, and tubes . . . and

at fair charges. Yes, by using all this material, and more to come, *you*

cash in on *your* big *Certified* **QUALITY SERVICE** advertising campaign.



Get *your* kit.

It contains all the material

Make the most of *your* big *Certified* Quality Service advertising campaign. Be sure you have *all the facts* . . . and *all* the material you need. Get this sales promotion kit, today!

you need to identify *you* as a *Certified* **QUALITY SERVICE** dealer. Ask your

CBS-Hytron distributor for *special deal*. Or use coupon to order direct.

SEE YOUR
CBS-HYTRON
DISTRIBUTOR



Here's the new **SHURE** **SLIM-X**

All-Purpose Crystal MICROPHONE



MODEL 777
List Price \$21.00

MODEL 777s
(with switch)
List Price \$23.00

(Price includes
cradle for mounting
on stand)

Its Versatility and
"Hand-a-Bility" make it
an ideal low-cost
all-purpose microphone

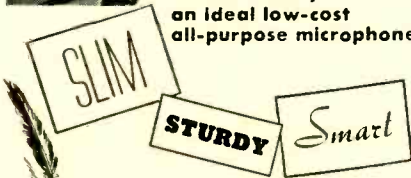

LIGHT! The new "777" Slim-X Microphones are rugged little microphones weighing only 6 ounces! They are designed for good-quality voice and music reproduction. Their versatility and "hand-a-bility" make them ideal for use by lecturers, announcers, instructors, and Hams; for audience participation shows; carnivals; panel and quiz shows; and use with home-recorders. When mounted on either cradle or swivel, the "777" can be removed in a flash (no tools necessary)—simply by lifting it out of the holder. This makes it an ideal "walk-around" hand-held microphone.

TECHNICAL INFORMATION: Smooth frequency response—60 to 10,000 c.p.s.; special-sealed crystal element—for long operating life; high impedance; 7' single-conductor cable, disconnect type. Dimensions: (Microphone only) Length, 4½"; Diameter 1". *Finish:* Rich satin chrome overall.

NOTE: Lavalier cord for suspension of Microphone around neck is included.

ACCESSORIES FOR "777"

MODEL S38 STAND is a heavy die-cast base. Includes metal screw machine stud for connecting microphone adaptor to stand base.

List Price: \$3.30

MODEL A25 SWIVEL ADAPTOR features a long-life, high-quality swivel connector. Is lined with a long-life nylon sleeve—for noise-free and scratch-free insertion and removal of microphone.

List Price: \$5.50



Mark this point 600 kc on the dial. (7) Repeat at each standard spot frequency, marking the dial 700, 800, 900, and 1000 kc accordingly. If the frequency standard is equipped also with a 10-kc multivibrator, 10-kc points may be located and marked between adjacent 100-kc graduations on the dial.

It is advisable to check against a standard-frequency source before be-

through the phones for its collector current. When using a visual zero-beat indicator, such as an oscilloscope or meter, complete the d.c. collector path by connecting a 2,000-ohm resistor in parallel with the jack.

When checking a transmitter (and some oscillators), satisfactory coupling into the frequency meter is obtained by using 1 or 2 feet of stiff wire.

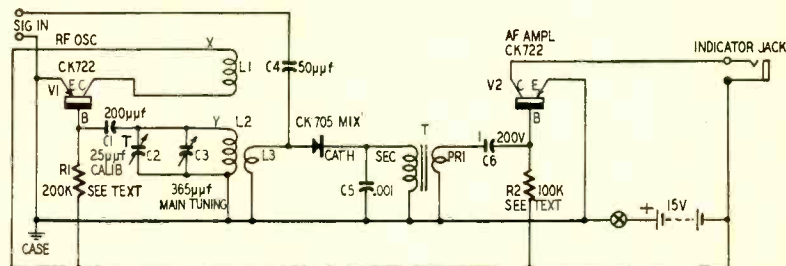

Fig. 2—Circuit of the transistorized 50-kc to 30-mc heterodyne freqmeter.

Materials for frequency meter

Capacitors: 1—25 µuf, air trimmer; 1—365 µuf, single-section tuning capacitor; 1—50, 1—200 µuf, midget mica or ceramic; 1—.001 µf, mica or ceramic; 1—1.0 µf, 200 volts, metalized paper.
Miscellaneous: 2—CK722 transistors; 1—CK705 germanium diode; 1—s.p.s.t. toggle switch; 2—resistors

(see text); 1—3:1 interstage a.f. transformer (U.T.C. type SO-2 or equivalent); 1—J. W. Miller broadcast antenna coil type 20A; 1—miniature 15-volt battery (Burgess U10 or equivalent); 1—aluminum utility box 7 x 5 x 3 inches; 1—insulated open-circuit phone jack; 1—2 x 2½-inch terminal board with 10 posts (USECO or equivalent); 1—tuning dial; hookup wire, hardware.

ginning use of the heterodyne frequency meter at any subsequent time. A single spot check will suffice. A rapid method is to set the dial to 1000 kc (1 mc) and, with the 100-kc standard feeding into the SIGNAL INPUT terminals, adjust trimmer C2, if necessary, to re-establish exact zero-beat. This compensates for any frequency shift due to transistor temperature characteristics or to battery variation.

Application

Always use high-resistance magnetic headphones (minimum 2,000 ohms). Crystal phones will not work, because transistor V2 relies upon the d.c. path

Longer ones may cause interference on nearby broadcast receivers. Ordinarily, such interference is not created because of the low power output of the transistor oscillator stage.

Remember that a relatively low input impedance appears at the SIGNAL INPUT terminals. This is an important factor when the frequency meter is used to calibrate an r.f. oscillator or signal generator connected to those terminals. Usually, the only mischief is the requirement of a stiffer signal from the oscillator under test. But the situation is not much worse than feeding a signal generator into the antenna coil of a receiver. END

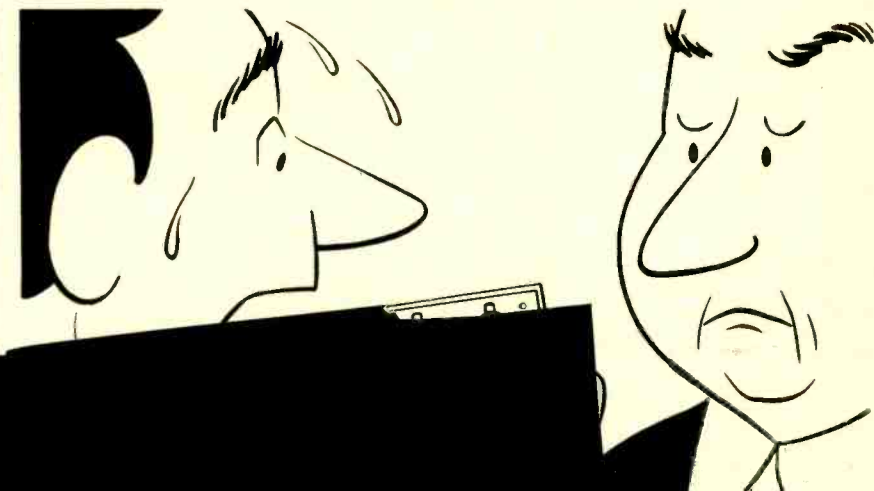

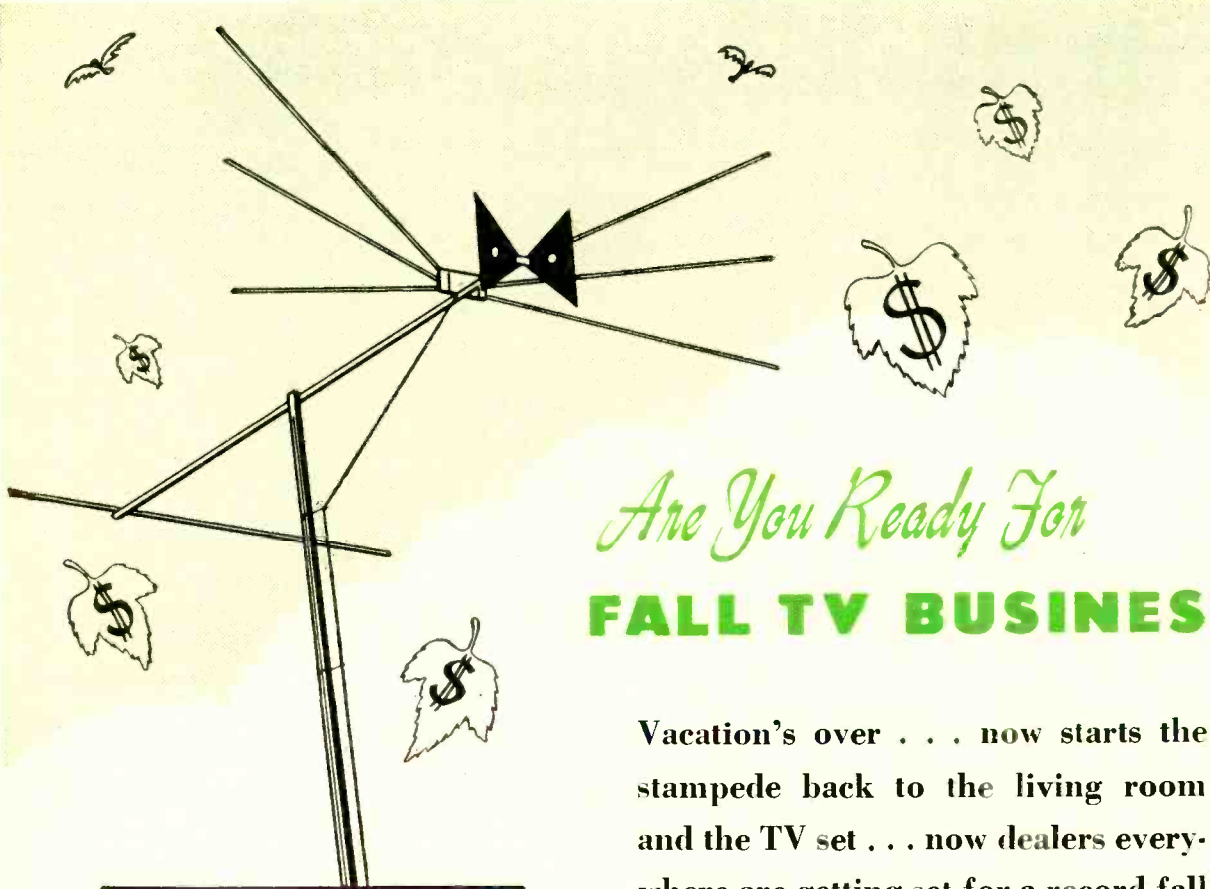

Are You Ready For
FALL TV BUSINESS?

Vacation's over . . . now starts the stampede back to the living room and the TV set . . . now dealers everywhere are getting set for a record fall season!

Don't get caught short. Now's the time to lay in your requirements for SYNKOTE wire and cable. Ask your Plastoid representative to show you the complete SYNKOTE line—now.

SYNKOTE DEPENDABLE TV WIRE
 for every purpose . . . for every purpose

 SYNKOTE FLATLINE (nom. 50 - 100 mil web)	 SYNKOTE PERFORATED (60 mil web)
 SYNKOTE ULTRATUBE	 SYNKOTE OVALTUBE
 SYNKOTE JUMBO (185 mil web)	 SYNKOTE SHIELDED (300 OHM)
 SYNKOTE ROTOR CABLE (Flat; 3, 4, 5 conductor)	 SYNKOTE ROTOR CABLE (round; 4, 5, 8 conductor)
 SYNKOTE COAXIAL (72 ohm Jr. Coax)	 SYNKOTE COAXIAL (RG 11/U and 59/U)

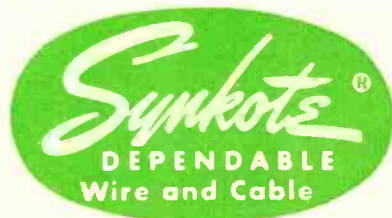

"Manufactured by the mile . . . tested by the inch"

PLASTOID
 Corporation

42-61 24th St., Long Island City, N.Y.

Windsor TUBES

RADIO & TV RECEIVING

TESTED and GUARANTEED for PEAK PERFORMANCE

TO MERIT YOUR CONFIDENCE—to insure your satisfaction—Every tube we ship has been tested in a radio or TV set for **PEAK PERFORMANCE**. Each tube is attractively packaged in individual carton—and, **EACH WINDSOR Tube you buy carries the full RTMA GUARANTEE!**

Type	Each	Type	Each	Type	Each	Type	Each	Type	Each	Type	Each
1A7GT	\$.67	5U4G	\$.44	6BN6	\$.98	6W4GT	\$.50	7L7	\$.85		
1B3GT	\$.69	5V4G	\$.83	6BQ6GT	\$.98	6W6GT	\$.63	7N7	\$.62		
1C6	1.06	5Y3GT	\$.32	6BQ7	\$.92	6X4	\$.37	7Q7	\$.62		
1E7GT	1.09	5Y4G	\$.43	6BZ7	1.05	6X5GT	\$.36	7R7	\$.70		
1H5GT	\$.51	6AB4	\$.51	6C4	\$.41	6Y6G	\$.64	7S7	\$.90		
1L4	\$.63	6AG5	\$.59	6CB6	\$.58	7A4/XXL	\$.57	7V7	\$.92	Type	Each
1L6	\$.66	6AH4	\$.68	6CD6G	2.04	7A5	\$.70	7X6	\$.62	14C7	\$.70
1LA4	\$.82	6AK5	1.05	6E5	\$.72	7A6	\$.57	7Y4	\$.45	14E6	\$.70
1LA6	\$.80	6AL5	\$.44	6F5GT	\$.54	7A7	\$.58	7Z4	\$.50	14F7	\$.85
1LB4	\$.82	6AQ5	\$.51	6J5GT	\$.44	7A8	\$.56	12A76	\$.53	14E7	\$.69
1LC5	\$.80	6AQ6	\$.47	6J6	\$.68	7AD7	1.05	12A77	\$.75	14F8	\$.99
1LC6	\$.80	6AQ7	\$.75	6J7	\$.70	7AF7	\$.63	12AU6	\$.47	14J7	\$.85
1LD5	\$.80	6AR5	\$.42	6K6GT	\$.45	7AG7	\$.65	12AU7	\$.58	14N7	\$.75
1LE3	\$.80	6AS5	\$.55	6K7	\$.70	7AH7	\$.65	12AV6	\$.41	14Q7	\$.62
1LG5	\$.80	6AT6	\$.42	6L6G	\$.88	7AJ7	\$.70	12AV7	\$.87	14R7	\$.85
1LH4	\$.80	6AU6	\$.47	6L6GA	\$.88	7B4	\$.54	12AX4	\$.72	14S7	\$.80
1LN5	\$.80	6AV6	\$.41	6Q7GT	\$.55	7B5	\$.51	12AX7	\$.67	19B6G	1.53
1N5GT	\$.63	6AX4	\$.72	6S4	\$.51	7B6	\$.52	12AY7	2.15	19T8	\$.87
1R5	\$.62	6BA6	\$.50	6S8GT	\$.75	7B7	\$.58	12BA6	\$.50	25BQ6GT	\$.98
1S4	\$.67	6BA7	\$.66	6SA7GT	\$.57	7C4	1.05	12BA7	\$.66	25L6GT	\$.53
1S5	\$.52	6BC5	\$.58	6SD7	\$.63	7C5	\$.56	12BD6	\$.51	25W4GT	\$.53
1T4	\$.62	6BD5GT	\$.98	6S7	\$.55	7C6	\$.50	12BE6	\$.52	25Z6GT	\$.46
1T5GT	\$.78	6BD6	\$.54	6SF5GT	\$.66	7C7	\$.58	12BH7	\$.69	35A5	\$.55
1U4	\$.61	6BE6	\$.51	6SH7GT	\$.52	7E5	\$.85	12SA7GT	\$.57	35B5	\$.53
1U5	\$.51	6BF5	\$.66	6SK7GT	\$.55	7E6	\$.65	12SK7GT	\$.55	35C5	\$.53
1X2A	\$.74	6BF6	\$.43	6SL7GT	\$.68	7E7	\$.85	12SL7GT	\$.67	35L6GT	\$.52
2X2	1.42	6BG6G	1.47	6SN7GT	\$.59	7F7	\$.69	12SN7GT	\$.59	35Z5GT	\$.33
3Q4	\$.66	6BH6	\$.63	6SQ7GT	\$.46	7F8	\$.97	12SQ7GT	\$.46	50A5	\$.55
3Q5GT	\$.72	6BJ6	\$.53	6T8	\$.85	7G7	\$.85	14A7	\$.58	50B5	\$.52
3S4	\$.61	6BK5	\$.76	6U8	\$.86	7H7	\$.61	14AF7	\$.68	50C5	\$.52
3V4	\$.62	6BK7	\$.97	6V3	1.09	7J7	\$.85	14B6	\$.50	50L6GT	\$.52
5R4GY	1.00	6BL7GT	\$.94	6V6GT	\$.51	7K7	\$.85	14C5	\$.85	117Z3	\$.43

WRITE FOR ADDITIONAL TUBE TYPES AND PRICES. We also stock Special Purpose and Transmitting Tubes at similar savings!

25% Deposit with Order. All merchandise F.O.B. NYC. For orders less than \$10. add \$1 handling cost. Deduct 2% if full remittance accompanies order. All merchandise subject to prior sale and price change without notice. Dept. C-10.

Windsor ELECTRONIC TUBE CO.

1515-C SHEEPSHEAD BAY ROAD, BROOKLYN 35, N. Y.

INDUCTANCE METER USES HETERODYNE PRINCIPLE

There are a number of ways of measuring the inductance of a coil. The most common of these are:

1. Shunt the unknown inductance with a capacitor and then use a grid-dip meter to measure the resonant frequency of the combination. Calculate the inductance from the formula for resonance.
2. Use an inductance bridge.
3. Measure the reactance at a known frequency, then calculate the inductance from the reactance formula.

This can be done by connecting the inductance in series with a resistor across a signal generator. The voltage drop across the resistor gives the circuit current. By measuring the voltage drop across L, and knowing the resistance of L, its reactance can be computed.

4. Insert the inductance in the circuit of a L-C oscillator. Measure the operating frequency, then calculate the inductance from the resonance formula.

A novel adaptation of the fourth method uses the heterodyne principle. The unknown inductance is connected in parallel with a standard capacitor in a transitron oscillator. The frequency of the transitron is measured by heterodyning it with the signal from a calibrated signal generator. The inductance of the coil in henries is then calculated from the formula:

$$L = \frac{1}{(6.28 \times f)^2 C}$$

where L is in henries, C in farads, and f in cycles per second.

The circuit of the transitron inductance meter—reprinted from *Radio Constructor* (London, England)—is shown in the diagram. The transitron oscillator V1 may be a 6K7 of any similar r.f. pentode with a separate pin connection for the suppressor grid. A part of the signal from the oscillator V1 is fed through a 10-μf capacitor to the grid of mixer tube V2 which operates as a grid-leak detector. A low-level signal from an accurate signal generator is fed to the grid of V2 through a 50-μf capacitor. The beat note generated by the two r.f. signals is fed to the input of V3, an audio amplifier which drives a pair of headphones used as the null indicator. A null indicates that the frequencies of the internal oscillator and signal generator are the same. Use the inductance formula or a reactance slide-rule to determine the inductance of the coil.

When constructing the unit, be sure to keep the oscillator leads short to minimize stray capacitance and to increase efficiency at high frequencies. To set up the tester, set R3 (the oscillator output control) to maximum, R1 about one-third the way up, and then adjust R2 so the suppressor is slightly negative with respect to the cathode. V1 should now oscillate when a coil is

opportunities

AT

BELL TELEPHONE LABORATORIES

A career for you with one of the nation's leaders in research and development in communications and military electronics.

ELECTRONIC TECHNICIANS DRAFTSMEN
ELECTROMECHANICAL TECHNICIANS

Openings require previous training at high school, armed service school, or technical institute level and in general 2 or more years of applicable industrial or military experience.

Applications particularly invited from those who reside within about 1000 miles of the Laboratories.

Send your name and address for application, telephone collect within 100 miles for information, or visit us Monday through Saturday. Evening interviews arranged.

BELL TELEPHONE LABORATORIES

WHIPPANY, N. J. (Near Morristown)—WHIPPANY 8-1000, Ext. 326
MURRAY HILL, N. J. (Near Summit)—SUMMIT 6-6000, Ext. 3381
NEW YORK, N. Y. 463 West Street—CHELSEA 3-1000, Ext. 1114

You can't keep up with u.h.f. TV without reading the articles in future issues of

RADIO-ELECTRONICS

connected across the test terminals and the selector switch is thrown to position 1.

Connect an external signal generator and tune it through its range until a beat note is heard in the phones. If a beat note is not heard, vary the setting of R2 (and R1 if necessary) until the tester starts to oscillate. After obtaining a beat note, readjust R1 and R2

tance bridge. Measure the internal stray capacitance across the test terminals with the power off, S1 in position 1, and C1 temporarily disconnected from the circuit. Add the measured internal capacitance to the capacitance of C1 and C2 when computing the inductance of the coil. C1 and C2 should be high-stability type capacitors having a tolerance of 2% or better.

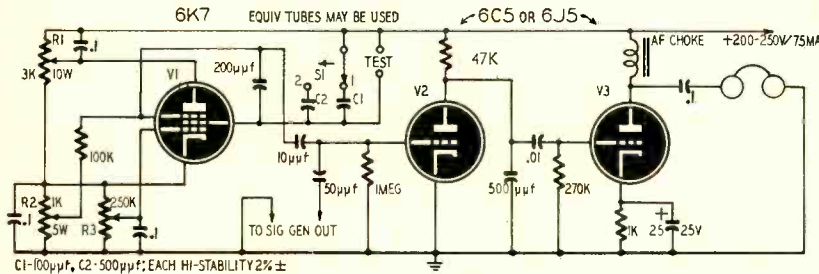

Schematic of inductance meter. 6K7 tube is used in transitor oscillator circuit.

Materials for inductance meter

Resistors: 1—1 megohm, 1—270,000, 1—100,000, 1—47,000, 1—1,000 ohms, 1/2 watt; 1—1,000 ohms, 5 watts with semiadjustable slider, 1—3,000 ohms, 10 watts with semiadjustable slider; 1—250,000 ohms, potentiometer.

Capacitors: 1—10, 1—50, 1—200, 1—500 μ mf mica or ceramic; 1—100, 1—500 μ mf, silver mica with tolerance of 2% or better; 1—.01, 4—0.1 μ f, 400 volts, paper; 1—25 μ f, 25 volts, electrolytic.

Miscellaneous: Tubes (see text), sockets, hardware, hookup wire.

for the strongest signal. Adjust R3 until the signal is barely audible and then repeat the procedure. The sliders of R1 and R2 may now be locked in position.

For extreme accuracy, use a capaci-

The inductance meter is an extremely accurate method of determining L. The inductance being measured is allowed to operate at its natural frequency. The accuracy of the signal generator limits accuracy of the final result.

END

COMPARISON PROVES EICO OFFERS GREATEST V-O-M values!



GET the MOST for your money — Before you buy, see chart below!

World-renowned EICO VOLT-OHM-MILLIAMMETERS

*#536 KIT \$12.90. Wired \$14.90
#526 KIT (with 1% multipliers) only \$13.90. Wired \$16.90.

VERIFY AT YOUR DEALER'S	EICO	Co. A	Co. B	Co. C	Co. D
	\$12.90 up (KIT)	All Over \$24.00			EICO price range
31 ranges?	YES	No	No	No	No
Full-size 3-inch meter?	YES	Yes	Yes	Yes	No
400 μ a sensitivity?	YES	Yes	Yes	Yes	No
Zero to 1 v. range on both AC and DC?	YES	No	No	No	No
5000 v. range on both AC and DC?	YES	Yes	No	Yes	No
AC/DC sens: 1000 Ω /v.?	YES	Yes	Yes	Yes	No
DC and AC Current Ranges?	YES	No	No	No	No
In KIT and Wired Form?	YES	Wired Only	Wired Only	Wired Only	Wired Only
Lowest cost in the Industry?	YES * See Above	No	No	No	No
		All over \$24.00			EICO price range

Write for FREE Catalog MC-10 & name of local dealer. Prices 5% higher on West Coast.

ELECTRONIC INSTRUMENT CO., Inc.
84 WITHERS STREET, BROOKLYN 11, N. Y.

NOW! Famous COYNE SCHOOL Trains You AT HOME For TELEVISION RADIO ELECTRONICS!

KEEP YOUR PRESENT JOB! LEARN IN SPARE TIME!

Now, the famous Coyne School, with a background of over half a century of practical training experience, brings practical HOME TRAINING IN TELEVISION, Radio and Electronics RIGHT TO YOU—Training up to the standards that have made Coyne famous. 100 easy-to-understand lessons take you step-by-step through TV construction and repair, AM and FM Radio testing instruments, circuits, trouble-shooting, servicing, even UHF and COLOR-TV! Practical JOB GUIDES with each lesson show you how to do actual servicing jobs so that early in the course the training can start making money for you.

PRACTICAL TRAINING AT SURPRISINGLY LOW COST!

We don't send you—and charge for—a high sounding list of "put-together" kits and parts that you many never need or use, but that could easily double the cost of the course. You don't need them to master Coyne Home Television Training. You get and pay only for the practical training you need . . . Not an old Radio Course with Television "tacked on". Every lesson deals with practical Television—Up-To-Date Television including the latest in Transistors—all made easy to understand. No radio background or previous experience needed, AND it costs you half of what you would expect to pay.

GET FULL FACTS NOW!

Get in on the ground floor of Television, the booming, big-pay opportunity field of the century. Send coupon for full facts about sensational Coyne Television Home Training—No salesman will call—No cost or obligation.

54th Year



RUSH THIS COUPON NOW!

COYNE SCHOOL, Dept. 73-HT4
500 S. Paulina St., Chicago 12, Ill.

Please send me, without obligation, full facts on your low-cost practical home training in Television.

Name

Address

City..... Zone..... State.....

COYNE SCHOOL TELEVISION HOME TRAINING DIVISION
500 SOUTH PAULINA STREET, DEPT. 73-HT4 CHICAGO 12, ILLINOIS

Valuable 3-way aid for Auto Radio Repair Men!



Once you're on the Delco Radio team you're in line for this three-way help: a reliable source for Delco Radio original equipment and replacement parts and universal replacement parts; a complete and comprehensive Delco Radio Service Manual; monthly issues of "Testing Tips," a bulletin giving the very latest factory information on testing and repairing Delco car radios—even the sensational new "Favorite Station" Signal-Seeking model! To get going with Delco Radio contact your nearest United Motors Electronics Parts Distributor. Don't delay—act today!



DELCO RADIO

DIVISION, GENERAL MOTORS CORPORATION, KOKOMO, INDIANA

A GENERAL MOTORS PRODUCT  A UNITED MOTORS LINE

DISTRIBUTED BY ELECTRONICS WHOLESALERS EVERYWHERE

AUTOMATIC HEADLIGHT DIMMER



Electronic headlight dimmer installed. Oncoming headlights actuate dimmer.

By JACK MARLEY

THE automatic headlight dimmer has always intrigued me, and I decided to build one, planning to use low-cost parts. It cost even less than I had expected, and provided interesting instruction over several pleasant hours.

All parts used were stock items, except the 931-A phototube and the resistor network. The 931-A can be obtained from any radio supplier and the resistor network may either be purchased from a United Metors radio parts distributor or made up of 220,000-ohm 1/2-watt resistors. The network is very compact and costs only \$2.25.

Several tries with other tubes showed me that a multiplier type is the best phototube to use. Another unit built

around an 868 gas phototube lacked sufficient sensitivity. The gas type, being a single-stage unit, does not have sufficient current flow. The 931-A takes a submagnal 11-pin socket. If one isn't available, use an Amphenol 77-MIP11.

The phototube operates with approximately -520 volts on the cathode, which gives ample sensitivity at all times. The tube may be covered with light yellow cellophane as an aid in filtering out moonlight. Care must be taken not to use too many layers or the sensitivity will decrease.

The -520 volts on the phototube cathode and the 220 volts on the 6C4 plate are obtained from separate vibrator power supplies. In building this

(CONTINUED ON PAGE 102)

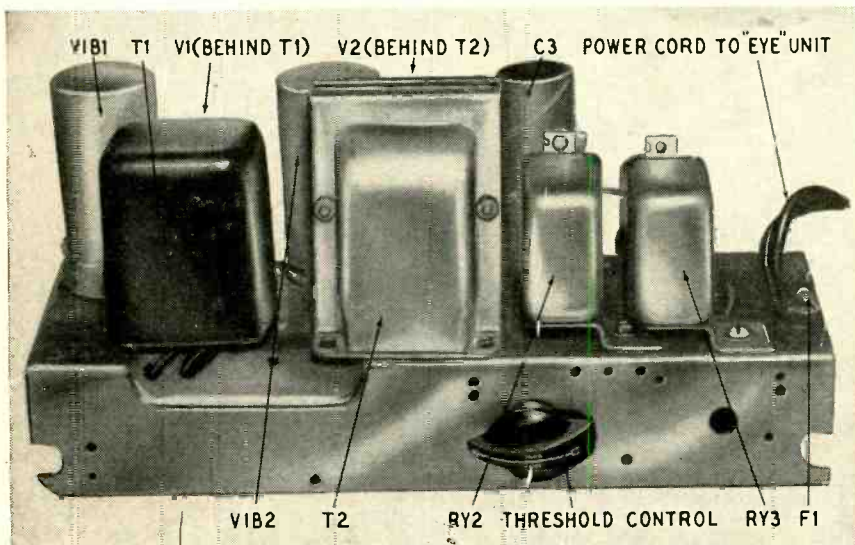

Front view of dimmer. The power cord to the 931-A is located at extreme right.

Here's how to SAVE MONEY ON INSTRUMENTS!

- ✓ . . . how to do faster, better testing with fewer instruments
- ✓ . . . how to increase the usefulness of your present instruments
- ✓ . . . how to choose the right instrument for each job
- ✓ . . . how to understand instrument operating principles
- ✓ . . . how to evaluate instrument readings and put them to practical use



BASIC ELECTRONIC TEST INSTRUMENTS

By RUFUS P. TURNER
254 pages, 171 illus., Price \$4.00

The instrument book written especially for SERVICEMEN • AMATEURS • EXPERIMENTERS

★ Here, at last, is a book that can save you money on instruments and help you use your present instruments lots more efficiently!

Over 60 instruments—from the most modern TV pattern generators to special-purpose bridges—are carefully described. Their uses are fully explained. Valuable work-saving short cuts are outlined.

Included are complete details on simple meters for current and voltage; ohmmeters and V-O-M's; V-T voltmeters; power meters; impedance meters; capacitor checkers; inductance checkers; special-purpose bridges; oscilloscopes (this material alone is worth the entire price of the book to busy servicemen!); r-f test oscillators and signal generators; audio test oscillators; radio frequency and audio frequency measuring devices; audio-amplifier testing devices; r-f signal tracers and tube testers.

Among other things, BASIC ELECTRONIC TEST INSTRUMENTS is a complete training course in the latest instruments including grid-dip oscillators, TV sweep and marker generators; TV linearity pattern generators, square-wave generators and others.

SEE WHAT IT CAN DO!

You are shown new uses for VOM's, scopes, signal generators and other old standbys. You learn how easy it is to extend the range of many old instruments; how power drain measurements can be used for fast TV troubleshooting; how a useful and accurate bridge can be built from a combination of familiar general-purpose instruments; how to calculate shunts and multipliers; how to measure r-f impedance with a simple T-network; how to measure inductance and capacitance with a grid-dip oscillator and scores of other money-saving "tricks".

Read BASIC ELECTRONIC TEST INSTRUMENTS for 10 days at our risk! Send coupon today.

10-DAY FREE EXAMINATION

Dept. RE-103, Rinehart Books, Inc.
Technical Division,
232 Madison Ave., New York 16, N. Y.

Send Turner's BASIC ELECTRONIC TEST INSTRUMENTS for 10-day FREE EXAMINATION. If I decide to keep book, I will then remit \$4.00 plus postage. Otherwise I will return book postpaid promptly and owe you nothing.

Name _____

Address _____

City, Zone, State _____

Employers Name and Address _____

OUTSIDE U.S.A.—Price \$4.50, cash only. Money back if book is returned postpaid in 10 days.

TRIO ZIG ZAG ANTENNAS

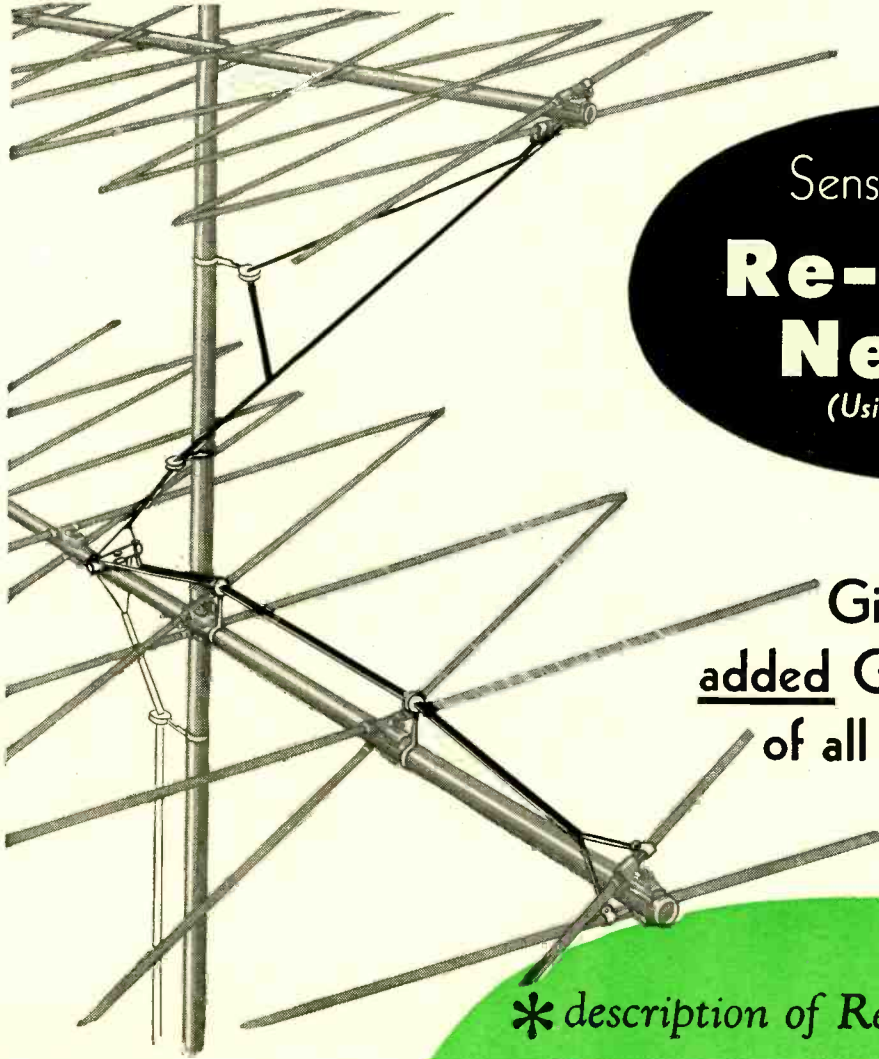

Sensational NEW
**Re-entrant
 Network**
(Using Single Lead-In)

Gives **ZIG ZAG**
added Gain over Best
 of all other Antennas!

* description of Re-entrant Network

As developed by TRIO, the re-entrant network consists of two paralleled quarter wave transformer sections coupled to each antenna. One transformer provides an efficient impedance match throughout the upper channel coverage of the antenna, the other transformer covers the lower channels. The two transformer sections together offer a practically constant impedance termination to the feed-line, which is not affected by coupling a second antenna and its re-entrant network. Rain or shine, no antenna in America can match the performance of the ZIG-ZAG — on any channel!

ANOTHER NEW TRIO PLANT TO SERVE YOU!

A modern, new addition to TRIO's present facilities adds 24,000 sq. ft. of manufacturing space. A new laboratory, not illustrated, has also been added.

TRIO has on hand, or in the process of shipment from the mills, 60 carloads of aluminum to meet increased production schedules.

Despite these facts, we are not sure we will be able to fill all orders. We suggest you order now.

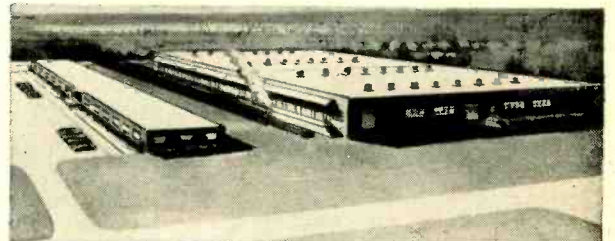

Outperform on ALL Channels!

Gain that is greater by far than that offered by the best of the collinears, conicals and multi-element Yagis, is now offered by famous TRIO ZIG-ZAG antennas!

A sensational new TRIO development — a new re-entrant type impedance matching network — makes possible this tremendous improvement by providing an almost perfect impedance match to the line on every channel!

Unlike isolation filters, the ZIG-ZAG re-entrant network has NO insertion loss!

A single feed-line is used, even when stacking for all-channel operation!

Extensive tests were made in all sections of the country, in every conceivable type of terrain. Results prove that the ZZ12L, ZZ16H combination, with their associated re-entrant networks, provides the finest all VHF channel, single lead-in operation yet obtained.

Current shipments of TRIO ZIG-ZAG antennas include the complete network.

For channels 2 thru 6 or channels 7 thru 13 separately, or combined for channels 2 thru 13, TRIO ZIG-ZAG antennas are the hottest ever designed.

New descriptive literature available.

HIGH GAIN TRIO UHF ANTENNAS

UBT BOW-TIE SERIES

(4-stack, in actual tests, bests all other types)

The popular TRIO 4-stack bow-tie, in actual field tests, outperformed all other types because it takes advantage of the fact that UHF signals are composed of closely spaced layers of different signal strength. Because of its vertical height, the TRIO 4-stack taps one or more of these varying high density layers at all times — offers consistent high gain day in and day out.

TRIO bow-ties offer high forward gain without sacrificing excellent front-to-back ratio and good line

match. Adoption of reflectors using individual horizontal elements eliminates vertically polarized noise pick-up so often encountered with grid, mesh and solid type reflectors.

TRIO bow-ties are also available in 2-stack and single stack models. The 4-stack and two stack come assembled on 4 foot and 3 foot aluminum masts respectively, with phasing harness installed. The single bay model is furnished assembled on a 2 foot aluminum mast.

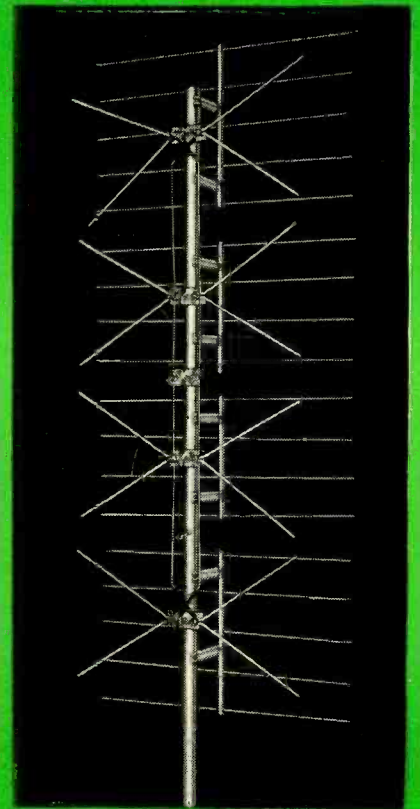

TRIO

Manufacturing Co.
GRIGGSVILLE, ILLINOIS

PERMO PHONOGRAM NEEDLES



PERMO



PHONO



NEEDLES



SEE YOUR JOBBER OR WRITE FOR CATALOG

PERMO, INC. PERMO

6415 Ravenswood, Chicago 26, Illinois

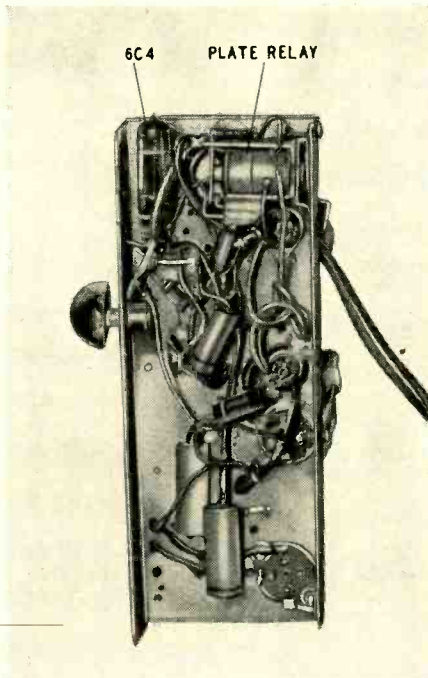

Note horizontal mounting of plate relay.

electronic dimmer, old auto radio transformers were used as an economy measure. All returns are made to the 6-volt bus so that the unit will work with either polarity-type battery system. New vibrators should be used, since a variation in voltage will affect the sensitivity to light. Select the buffers with the aid of a scope to insure long vibrator life. The Radiart vibrator manual lists procedures for checking buffer capacitors. C1 and C2 should be matched to T1 and T2 with an oscilloscope.

The 10,000-ohm s.p.d.t. plate relay used in the 6C4 plate circuit is not too critical. However, it is well to be sure that the relay used can be closed by the 6C4 plate current. The builder should be sure to ground the relay armature.

Ordinary horn relays handle the full headlight current. These may be purchased from any auto-parts store.

The mounting for the main unit and the eye unit may be placed at any convenient location in the car. The plate relay must be horizontal in order to keep car vibrations from affecting it, and the eye unit must be so placed that little extraneous light will strike it.

The phototube itself was mounted in a metal container found in the shop junk box. The container was grounded to eliminate shock.

Operation

The cathode of the multiplier type phototube emits electrons when light strikes it. The resultant current flows through the 6C4 grid resistor, developing a negative voltage at the grid of the 6C4, causing the tube to be cut off. The plate relay is de-energized, which in turn de-energizes the high-beam power relay and energizes the low-beam power relay to dim the lights.

When an oncoming car has passed, or when the car leaves a lighted area, current flow from the 931-A drops to a value which will no longer keep the 6C4 cut off. When this happens the plate relay armature is pulled down and the high-beam power relay is re-energized. The voltage drop across the 6C4 grid resistor was 60, with the 931-A under light. All voltages were measured with a v.t.v.m. The 2-megohm potentiometer is a high-voltage threshold control which is adjusted so that the phototube will just recover to high beam after passing an oncoming car. This control also compensates for bright moonlight nights.

Connecting the unit to the original car wiring as shown in Fig. 1 permits the driver to signal an oncoming car with a flick of the floorboard dimmer switch.

Fig. 2 is the diagram of a hold cir-

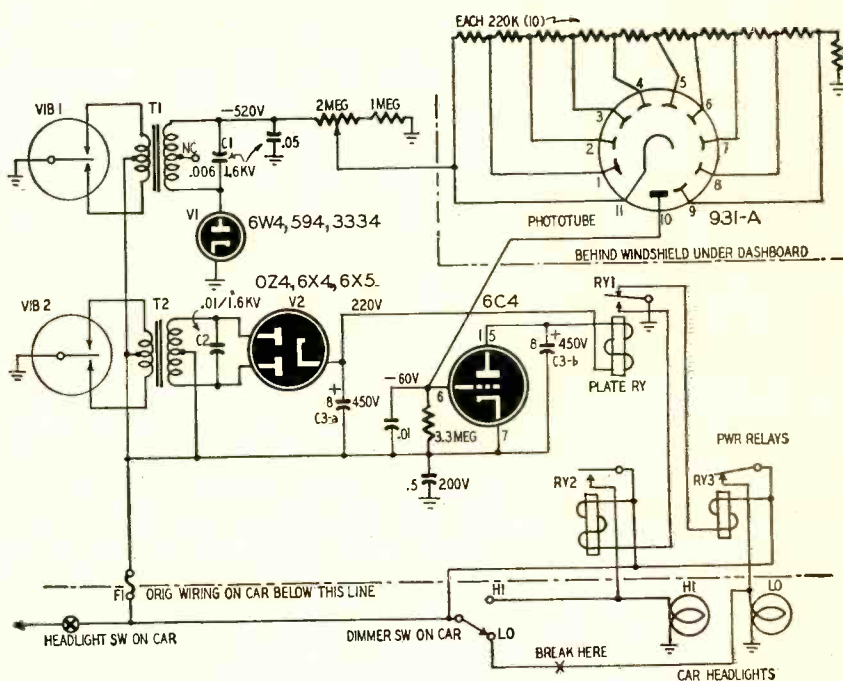

Fig. 1—Schematic of dimmer. The 931-A circuit is mounted on separate chassis.



Presenting

"RECTIFIER RED"

the new product-line color for

Federal MINIATURE SELENIUM RECTIFIERS

FEDERAL—the original miniature—is saying goodbye to gray. The new bloom is "Rectifier Red" . . . a striking color that instantly tells servicemen they're getting the rectifier efficiency and long life that created tens of millions of profit opportunities for radio-TV servicing . . . tells them they're getting the quality that keeps Federal miniatures the best-seller in America's vast and growing rectifier replacement market!

Look for "Rectifier Red" . . . get the performance that clicks . . . the replacement profit that sticks! See your Federal Distributor for Federal miniatures in handy 8-unit kits . . . in quantity lots . . . or in individual packages sold through Federal's self-service rectifier dispenser . . . on hundreds of counters! See your "FTR" Distributor now, or write to Dept. F-763.



"America's first and largest manufacturer of selenium rectifiers"

Federal
Telephone and Radio Company

100 KINGSLAND ROAD, CLIFTON, N. J.

In Canada: Federal Electric Manufacturing Company, Ltd., Montreal, P. Q.
Export Distributors: International Standard Electric Corp., 67 Broad St., N. Y.

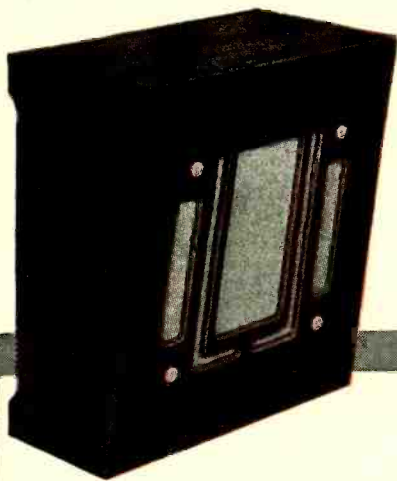

Built to sell!

utone

THE NEW WALL BAFFLE BY UTAH

The new, luxurious looking UTONE wall baffles will complement the interior of any restaurant, church, school, home, club, tavern or factory . . . wherever speaker housing is needed.

The quality and construction of Utone wall baffles is of the finest, the finest woods matched by the fine production skill of Utah—a pioneer and leader in the sound field for over 30 years.

Utone wall baffles are available in three beautiful finishes and four versatile sizes—Genuine Honduras Mahogany—in red or brown finish, handsome limed oak and natural unfinished wood. Models in 6, 8, 10 and 12 inch sizes.

Utone baffles are also available for delivery complete with mounted speakers.

NOTE THESE UTONE QUALITY FEATURES

- *Styled By Master Woodworkers*
- *High Gloss Lacquer Finish*
- *Beautiful Matching Grill Cloth*
- *Free of Vibration and Rattles*
- *Moisture and Water Resistant*
- *All Joints Mortised and Secured With Water Proof Glue*
- *Made from the Finest 5 Ply— $\frac{3}{4}$ and $\frac{1}{2}$ Inch Veneer*

THE NEW UTONE WALL BAFFLES ARE BUILT RIGHT AND PRICED RIGHT TO SELL



Write today for catalog and prices

RADIO PRODUCTS CO., INC.

1250 Washington Street - Huntington, Indiana

cuit later added to the original unit to increase its sensitivity when the lights are on low beam. This keeps them from flicking up and down frequently during twilight hours. By adding another relay as shown, you can now speed the return to high beam by pressing the dimmer switch to high beam and then back to automatic (low) position.

The author has used this unit for approximately four months with success and no component failures. No bugs were encountered in building this unit other than the usual ones you run into in everyday servicing.

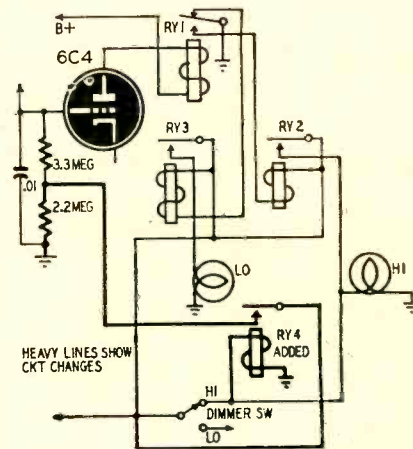

Fig. 2—Additions for more sensitivity.

Materials for electronic dimmer

Resistors: 10—220,000 ohms, 1/4 watt, or use General Motors printed network assembly No. 5943524; 1—3.3 megohm, 1/4 watt; 1—1 megohm, 1/2 watt; 1—2 megohm potentiometer.

Capacitors: (Paper) 2—buffer capacitors, 1,600 volts, matched to power transformers with scope; 1—.01 μ f 600 volts; 1—.05 μ f, 1,600 volts; 1—.05 μ f, 200 volts. (Electrolytic) 1—8-8 μ f, 450 volts.

Miscellaneous: 2—auto radio power transformers; 2—4-prong nonsynchronous vibrators; 1—10,000 ohm s.p.d.t. plate relay; 2—automotive-type horn relays; 1—6W4 or GM 5943334; 1—0Z4 or 6X4 or 6X5; 1—931A multiplier-type phototube; 1—SFE 9 fuse; sockets; wire; assorted hardware.

Building this electronic dimmer gives its constructor valuable experience in and information on the principles of servicing automatic headlight dimmers which may prove to be very useful in their repair as the units become more common. The General Motors *Autronic Eye* is a model now in popular use.

We may see the day when all cars will have an electronic dimmer as standard equipment. END

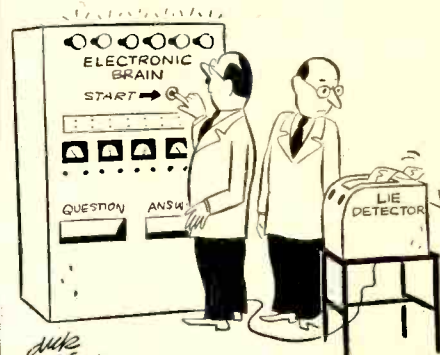

TRAIN AT HOME FOR UHF-TV AND

TELEVISION SERVICING

Learn practical, professional type TV Servicing without leaving your present job. Included are money-making extras such as set conversion, master antenna installation, UHF-TV, field servicing short cuts. You can start earning Television money after first few lessons. You learn to test, trouble shoot and repair all types of TV sets.

HERE'S HOW YOU GET EXPERIENCE!

You train on a large screen, modern TV receiver, furnished with the course and yours to keep! As an optional feature you can get two weeks actual experience with Chicago's largest independent servicing organization. You learn by doing! Age is no barrier. Many students are over 40! ACT NOW! Send for FREE Catalog and SAMPLE LESSON today!

TV COMMUNICATIONS INST.
205 W. Wacker Dr., Dept. RE-22
Chicago 6, Ill.

VETERANS!
T.C.I. is approved for G.I. training. Under Public Law 550. Check coupon.

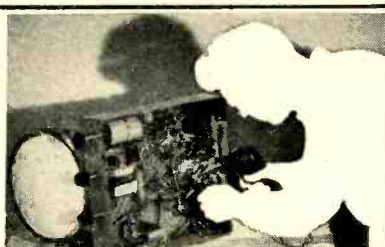

MAIL NOW FOR FREE BOOKLET

MILTON S. KIVER, President
TELEVISION COMMUNICATIONS INST.
205 W. Wacker Dr., Dept. RE-22, Chicago 6, Ill.
Rush FREE Catalog and Sample Lesson. I am not obligated. Salesman will not call.

Name..... Veterans: Check here

Address.....

City..... Zone..... State.....

BEGINNERS check here for Pre-TV Radio Course.

HICKOK

Price
\$129.50

New Television

5" CATHODE RAY RAY Oscilloscope

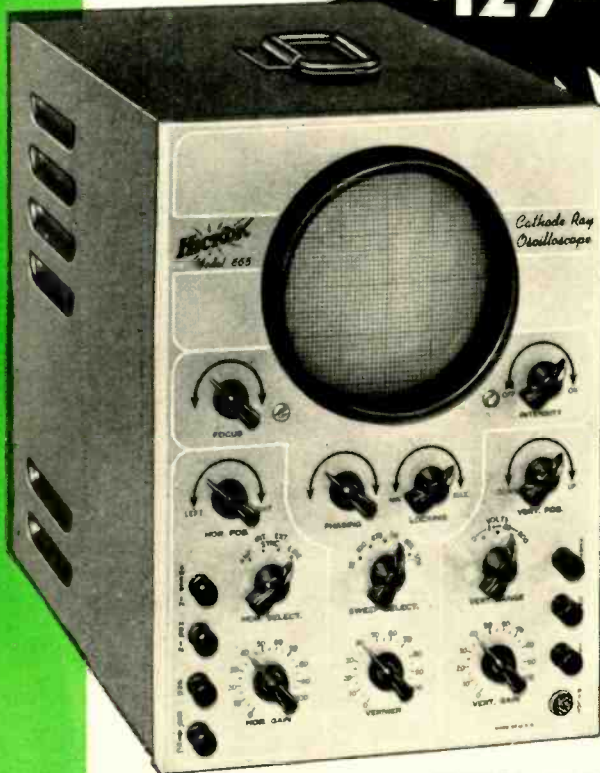

MODEL 665

TUBE Complement

- 1 5UP1 Cathode Ray Tube
- 1 1V2 High Voltage Rectifier
- 1 6X4 Low Rectifier
- 3 12AT7 { (Vert. Cathode — Follower-
1st Amplifier
(Vert. Push-Pull Output
(Horiz. Push-Pull Output
- 1 6AB4 1st Horizontal Amplifier
- 1 6J6 Sweep Circuit Oscillator

This new HICKOK 5" Scope has all the needed characteristics for accurate TV alignment and service work. Designed, built and guaranteed by HICKOK, the Model 665 will perform every function required of it and give long, trouble-free service within the range of its technical characteristics.

Technical SPECIFICATIONS

- Frequency Range: 0.5 cycles to 700KC, down 3 db.
- Accelerating Potential: 1775 Volts (high intensity), provides very sharp focus.
- Square Wave Response: Flat, 60 cps. to 100KC, with less than 1% tilt, less than 2% overshoot.
- Dual Fuse: B+ is fused and the line is fused.
Fused B+ provides protection against transformer damage. This is another HICKOK exclusive feature.
- Amplifier: Push-pull, vertical sensitivity 20 MV RMS per inch.
Horizontal, 30 MV RMS per inch.
Vertical Input Impedance: 15 MMF, 2.2 Megohms.
Horizontal Input Impedance: 52 MMF, 0.1 Megohms.
- Sweep Oscillator Range: 18 cps. to 50KC.
- Withstands shock, vibration, and humidity. CRT is shock-mounted, and external connections to CR Tube are provided.
- Blue hammertex steel case.
- 13" H., 17¼" D., 9½" W. 23 lbs. net.

Write for detailed information or see your HICKOK jobber today.

THE HICKOK ELECTRICAL INSTRUMENT COMPANY
10531 DUPONT AVENUE • CLEVELAND 8, OHIO

NEW! IMPROVED!

Only **ALLIANCE** makes
the fully automatic
rotator....

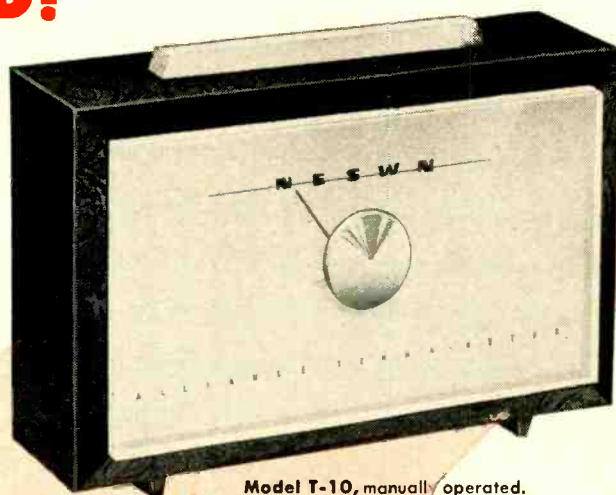

Model T-10, manually operated. Pointer shows right where antenna is aimed. Highly accurate!

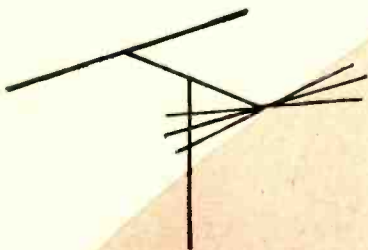

Stay on the beam with

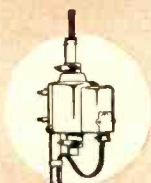

ALLIANCE TENNA-ROTOR

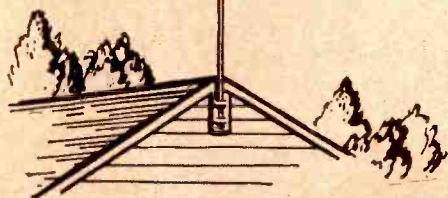

Model U-83, fully automatic. Completely restyled and completely redesigned. Set it and forget it. Only Alliance makes the fully automatic rotator.

Over 1,000,000 satisfied viewers suggest that Alliance is the line for you. Now, completely restyled with new streamlined beauty in appearance. Redesigned inside too, for even better performance, easier installation. Only Alliance has the fully automatic rotator.

And Alliance gives you the pre-sold line . . . this Fall through more powerful advertising than ever . . . on TV . . . in newspapers . . . and in magazines to help you cash in on UHF and VHF. Better get your order in right now for the new model Alliance Tenna-Rotors.

Alliance Manufacturing Co.

ALLIANCE, OHIO

MANUFACTURERS OF TV ANTENNA ROTATORS • PHONOMOTORS
ALLIANCE TV BOOSTERS • UHF CONVERTERS

The #630 TV RECEIVER remains unmatched for quality and performance • RCA designed and developed this set quality-wise *not* price-wise • The original 10" set retailed at \$375.00 • Subsequent TV sets serve to prove the sacrifice of quality for price • What better proof can there be of its superiority than the fact that it is the choice of TV engineers and TV technicians! Herewith we offer you — YOUR BEST BUYS IN TV! All you pay is the price shown • • • Excise taxes have already been paid by us.

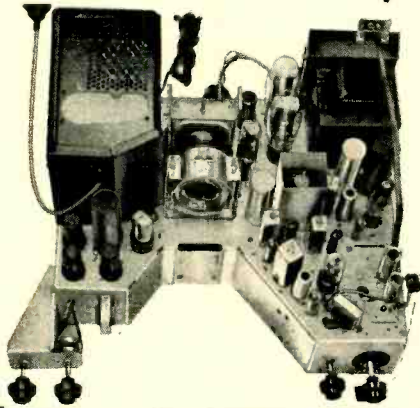

Build your own
SUPER DELUXE
31-TUBE
#630 TV CHASSIS
 With—U. H. F.

With a #630 SUPER DELUXE 31-TUBE TV KIT including your favorite U.H.F. Station. Engineered in strict adherence to the genuine RCA #630 plus added features . . . OPERATES 16" to 24" PICTURE TUBES . . . FULL 4 MC BANDWIDTH . . . CASCADE TUNER . . . COSINE DEFLECTION YOKE . . . LARGER POWER TRANSFORMER . . . KEYED AGC . . . 12" SPEAKER . . . UNIVERSAL MOUNTING BRACKETS . . . CONDENSERS and RESISTORS at rated capacities and tolerances. You receive a COMPLETE SET of PARTS and TUBES, everything needed is included (less wire & solder). All I.F. Coils and Transformers are factory pre-aligned and tuned. You will enjoy building it with "LIFE-SIZE" easy to follow step-by-step ASSEMBLING INSTRUCTIONS" included with each KIT.

NOTHING BETTER AT ANY PRICE!

only... **\$119.44**

Brooks **LIFE-SIZE** *Edition*

#630 TV KIT BUILDER-SET OF INSTRUCTIONS

BUILDING YOUR OWN #630 TV CHASSIS is now simplified with this COMPLETE SET OF BUILDING & WIRING INSTRUCTIONS. Covers all #630's, from the RCA 10" SET to the latest SUPER DE LUXE 31-tube 16" to 24" RECEIVER.

EVERYTHING AT A GLANCE-LAYOUT CHARTS show chassis and components in actual LIFE-SIZE with instructions alongside the illustrations.

GUESSWORK IS ELIMINATED by specially prepared SCHEMATIC DIAGRAMS, LOCATION GUIDANCE, CODE CHARTS, ALIGNMENT PROCEDURE and TOP AND BOTTOM PHOTOGRAPHS OF A COMPLETED CHASSIS (assembled from these instructions) clearly showing placement of each component.

INDISPENSABLE for BUILDING, CONVERTING or TROUBLE SHOOTING any #630 TV SET.

\$2.49

Popular priced at only. Postpaid

SPECIAL #630 TV PACKAGE

- HINTS for BETTER PICTURES on YOUR 630TV
- 630TV DIAGRAM WITH MODIFICATIONS
- ILLUSTRATED TV CONVERSION MANUAL
- PULSE KEYED AGC CIRCUIT DIAGRAM
- RMA RESISTOR & MICA CODE CHARTS

\$1.00

All for only Postpaid

#630 SUPER DELUXE TV CHASSIS With—U. H. F. Licensed under RCA patents

COMPLETE READY TO PLUG IN AND PLAY — Similar in characteristics and features to the TV KIT above . . . Manufactured especially for us by Regal Electronics Corporation . . . No efforts or expense have been spared in workmanship or materials, to make this #630 SUPER DELUXE TV CHASSIS the Best obtainable for fringe areas, clarity and all-around-performance, regardless of price. Customers report reception better than 200 miles . . . Each Set is factory aligned and air-tested . . . All parts carry the RMA three month guarantee . . . Our mass volume of business on this CHASSIS (numbering thousands of pleased customers) now . . . makes it possible for us to reduce the price to

\$157.97
(less CRT)

TWO #630 TV SPECIALS BY TECH-MASTER With—U. H. F.

TECH-MASTER Model C-30 TV CHASSIS, COMPLETE READY TO PLUG IN AND PLAY — The Model C-30 has retained the outstanding characteristics of the RCA-630 circuitry, namely the four-stage, full bandwidth picture IF strip and the three-stage FM sound section . . . In addition, the latest innovations in synchronization and sweep circuits have been incorporated to produce a custom-quality receiver assuring outstanding and trouble free performance . . . **\$149.50**
(less CRT)

TECH-MASTER Gold Medal Series Model 2430-9 TV CHASSIS, COMPLETE READY TO PLUG IN AND PLAY — The last word in TV achievement . . . **90° deflection for perfect operation of all 24" and 27" rectangular and 30" round picture tubes** . . . Ideal for wall or custom-cabinet mounting . . . Detailed technical data mailed on request, however with the knowledge that this CHASSIS is a 30-tube #630 with both TECH-MASTER'S and OUR guarantee, you need not hesitate sending your order in now. . . . special at **\$262.50**
(less CRT)

BROOKS RADIO & TV CORP., 84 Vesey St., Dept. A, New York 7, N.Y. TELEPHONE COrtland 7-2359

CUSTOM-BUILT CABINETS #630 AND ALL OTHER TV SETS — FROM FACTORY TO YOU

5 LEADING STYLES in genuine mahogany or walnut (blond 10% extra). • • • Ready drilled for any #630 TV chassis and cutout for any 14", 16", 17", 19", 20" or 21" picture tube at no extras in price. • • • Also supplied with undrilled knob panel for any other TV set. • • • EVERYTHING NECESSARY for an easy perfect assembly is included. Each cabinet is delivered complete as pictured with mask, safety glass, mounting brackets, backboard, backcup, hardware and assembling instructions. • • • Each cabinet is shipped in an air cushioned carton from FACTORY to YOU.

The VOGUE
Most Popular Table Model.

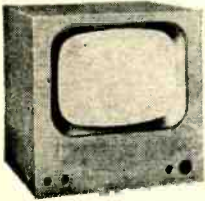

H-25", W-28", D-22"
\$39.89

VOGUE also available for 24" or 27" picture tube
H-31", W-27", D-23"

\$62.54

The MANHATTAN
Style, Quality, Price



H-41", W-25", D-23"
\$59.37

MANHATTAN for 24" or 27" CRT
H-46 1/2", W-27 3/4", D-24" **\$86.22**

The MAYFAIR

Exquisitely modern, with an elegance of simplicity in styling.

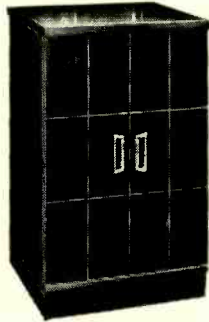

H-40", W-26", D-25"

\$98.56

The PLYMOUTH

Choice of interior Decorators. Truly superb in every detail.



H-40", W-27", D-23"

\$105.48

The TOWN & COUNTRY

Patterned after the popular credenza. Available for all size picture tubes 14" to 27"

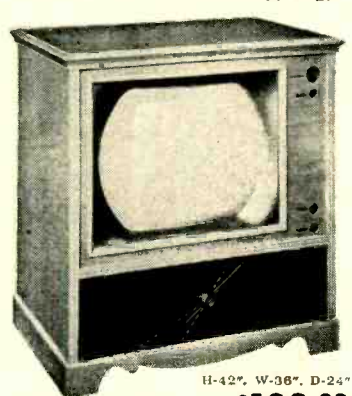

H-42", W-36", D-24"

For 14", 16", 17", 19", 20", 21", 24" or 27" C.R.T.'s **\$109.62**

FINEST STANDARD GUARANTEED PICTURE TUBES

MOST desirable 5 sizes—ALL RECTANGULAR . . . BRAND NEW in Factory Sealed Cartons—With a Full Year Guarantee

17" #17BP4A	\$29.63	20" #20CP4A	\$39.74	21" #21EP4A	\$44.68	24" #24CP4A	\$58.26	27" #27NP4A	\$82.57
-------------	---------	-------------	---------	-------------	---------	-------------	---------	-------------	---------

SPECIAL for SCHOOLS & TECHNICIANS . . . #630 TV KIT under \$100— Top Quality Components suitable for #630 and Many Other TV Sets and Equipment

#630 STANDARD TV KIT

THIS OFFER MAKES TV HISTORY . . . never ever so low a price, never ever such high quality. Quality and improvements in components that will enable the finished chassis to operate 10", 12 1/2" and certain 16" picture tubes . . . This STANDARD KIT consists of a complete set of parts, similar to those used in the famous RCA #630 29-tube chassis, including all tubes, speakers, resistors in correct 5%, 10%, 20% tolerances, the new Cascade Tuner and the Brooks LIFE-SIZE Instructions (less CRT & wire)

only . . . **\$93.78**

#630 PARTS & COMPLETE SETS

TV WIRE & SOLDER KIT, for any set	1.49
VIDEO AND I.F. KIT, 19 items	7.84
VARIABLE CONTROL KIT, 9 controls	5.83
CARBON RESISTOR KIT, 9 resistors	6.98
WIREWOUND RESISTOR KIT, 18 resistors	2.31
BACKET AND SHIELD KIT, 18 items	8.63
ELECTROLYTIC CONDENSER KIT, 6 cond.	7.37
TUBULAR CONDENSER KIT, 38 condensers	4.28
CERAMIC CONDENSER KIT, 28 condensers	3.37
MICA CONDENSER KIT, 11 condensers	1.38
TERMINAL STRIP KIT, set of 30	1.98
COMPLETE SET OF TUBES, 29 tubes	30.31

THE NEW CASCADE TUNER

can now be installed in ANY TV set
"Brooks CASCADE MANUAL"
with Schematics and easy to follow step-by-step instructions.

only **50¢** Postpaid

Modernize a #630 or any TV Set
with a

STANDARD CASCADE TUNER

For better all around performance

Complete with tubes, and Brooks CASCADE MANUAL with step-by-step instructions and all extra parts needed.

\$22.49

STANDARD CASCADE TUNER, incl. tubes	\$22.49
ESUTCHEON PLATE, for tuner69
COMPLETE SET OF KNOBS, incl. decals	1.34
POWER TRANSFORMER, 295ma, 201T6	9.97
VERTICAL OUTPUT TRANS. 204T2	2.69
VERTICAL BLOCKING TRANS. 208T2	1.32
HORIZONTAL OUTPUT TRANS. 211T1	2.47
HORIZONTAL OUTPUT TRANS. 211T5	3.98
FOCUS COIL, 247 ohms, 202D1	2.29
FOCUS COIL, 470 ohms, 202D2	3.42
DEFLECTION YOKE, 60°, 201D1	2.97
DEFLECTION YOKE, Cosine 70° 206D1	3.98
SOUND DISCRIMINATOR TRANS. 203K1	1.12
1st PIX I.F. TRANSFORMER, 202K2	1.08
2nd PIX I.F. TRANSFORMER, 202K3	1.08
1st & 2nd SOUND I.F. TRANS. 201K1	1.02
HORIZONTAL DISCRIM. TRANS. 208T8	1.49
FILTER CHOKE, 62 ohms 202K4	1.47
CATHODE TRAP COIL, 202K4	1.08
WIDTH CONTROL COIL, keyed AGC 1R4AG79
HORIZONTAL LINEARITY COIL, 201R339
3rd & 4th PIX COILS, 204L109
FILAMENT CHOKES, 203L118
VIDEO PEAKING COIL, 203L218
VIDEO PEAKING COIL, 203L318
VIDEO PEAKING COILS, 203L418
ION TRAP BEAM BENDER, double 203D398
ION TRAP BEAM BENDER, single 203D179

VARIABLE CONTROLS

PICTURE & SOUND, 10k ohms 1 meg. & switch	1.14
VERTICAL & HORIZ. 50k ohms 1 meg.	1.04
BRIGHTNESS CONTROL, 50k ohms44
HORIZ. CENTERING, wirewound 20 ohms57
HEIGHT CONTROL, 2.5 megohms48
VERTICAL LINEARITY, 5000 ohms44
VERTICAL CENTERING, wirewound, 20 ohms96
FOCUS CONTROL, wirewound, 1500 ohms98
HORIZONTAL DRIVE, 20k ohms44

PUNCHED CHASSIS PAN, cadmium plated	\$4.87
630-KIT, screws, nuts, rivets, washers	1.69
HI VOLTAGE CAGE ASSEMBLY, complete	3.73
VOLTAGE DIVIDER SHIELD & COVER	1.79
ELECTROLYTIC COND. SUB-CHASSIS94
SOUND DISCRIMINATOR SHIELD19
DEFLECTION YOKE BRACKET29
DEFLECTION YOKE MOUNTING HOOD59
FOCUS COIL BRACKETS set	.49
CATHODE TRAP COIL SHIELD39
CHASSIS MOUNTING BRACKETS, set of 444
BRIG-HITNESS & HOLD CONTROL BRACKET59
WIDTH CONTROL BRACKET16
TUNER SHAFT BRACKET17
*FUSE (.25 amp.) & HOLDER24
HV RECTIFIER, SOCKET ASSEMBLY, single79
*HV RECTIFIER, SOCKET ASSEMBLY, double	1.37
TV 6" LINE CORD, with both plugs29
INTERLOCK SAFETY CONNECTOR (input)17
COMPLETE TERMINAL STRIP KIT, set of 3098
*AGC BRACKET & SOCKET39
MINIATURE WAFER SOCKETS07
MINIATURE MOLDED SOCKETS12
OCTAL WAFER SOCKETS07
CATHODE RAY TUBE SOCKET, 18" leads39
HV KINESCOPE LEAD, with clip39
AUDIO OUTPUT TRANSFORMER (6K6)69
8" PM SPEAKER, heavy alnico #5 magnet	3.97
*12" PM SPEAKER, heavy alnico #5 magnet	6.94

ELECTROLYTIC CONDENSERS — 85°C

40/10/80 mfd — 450/450/150 v	1.37
40/40/10 mfd — 450/450/450 v	1.49
80/50 mfd — 450/50 v	1.49
40/10/10 mfd — 450/450/350 v	1.37
20/80 mfd — 450/350 v	1.49
250/1000 mfd — 10/6 v98

H. V. FILTER CONDENSERS — (Cartwheels)

15kv — 500 mmf67
20kv — 500 mmf79
30kv — 500 mmf	1.49

UNIVERSAL Picture Tube MOUNTING BRACKETS

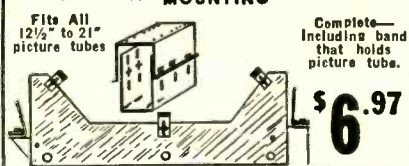

Complete—Including band that holds picture tube.
\$6.97

PULSE KEYED AGC KIT

Finest, most accurate and the easiest Kit to install in a #630 or in any other make TV receiver. Improves performance, and insures a steady picture on all channels.

COMPLETE SET OF PARTS **\$4.59**
Including 6AU6 tube & Instructions

BROOKS RADIO & TV CORP., 84 Vesey St., Dept. A, New York 7, N. Y. TELEPHONE COrtland 7-2359

THE PRICES SPEAK FOR THEMSELVES!

RADIO & TV TUBES

STANDARD TOP KNOWN BRANDS

- At 14¢ each** — 37, 38, 39/44, 77.
- At 39¢ each** — 35Z5, 35W4, 5Y3, 6AL5, 43, 80, 6H6, 6SQ7, 12SJ7, 6FS, 7C5, 7F5.
- At 59¢ each** — 1LD5, 0Z4, 3V4, 5U4, 6AT6, 6K6, 6SA7, 6SK7, 7F7, 117Z3, 45Z5.
- At 69¢ each** — 1H5, 1Q5, 1T4, 1T5, 6C4, 6C5, 6AB4, 6AU6, 6BE6, 12AL5, 12SK7, 12SA7, 50L6, 6BA6, 6AG5, 6CB6, 6SN7, 7A8, 6AB7, 35L6, 50B5, 12SG7, 12AT6, 7V7.
- At 72¢ each** — 1LE3, 1R5, 1S4, 3Q4, 3Q5, 354, 12AT7, 12AU7, 12BE6, 35Y4, 14A7.
- At 98¢ each** — 1A7, 1B3, 1LB4, 5V4, 6AC7, 6AH6, 6AK5, 6J6, 6SH7, 6T8, 6SD7, 7F8, 25A6, 35A5, 50A5, 117Z6.

TUBE CARTONS in Lots of 100

(10% extra discount in lots of 1000)

- SMALL PEANUT** 1"x1"x2 1/8" \$.89
- LARGE PEANUT** 1"x1"x2 3/4" .98
- GT TYPE** 1 1/4"x1 1/4"x3 3/8" 1.06
- SMALL G** 1 1/2"x1 1/2"x4 1/2" 1.39
- LARGE G** 2"x2"x5" 1.59
- EXTRA LARGE** 2 1/4"x2 1/4"x6 1/2" 2.97

A PLAN TO SAVE YOU MONEY

PACKAGE DEALS—Each containing an assortment of the most desirable types and sizes, to enable you to get the most amount of repairs done, with the least investment in parts, at a cost of only 1/3 than if bought separately

Resistor & cond. code charts **FREE** with each order

100 ASSORTED TUBULAR CONDENSERS

All Are Standard Brands & Desirable Sizes **\$4.69**
\$15.00 Value Only

- 100— ASSORTED 1/2 WATT RESISTORS** \$3.97
- 15 — Asst. Radio Electrolytic CONDENSERS** \$4.74
- 15 — Assorted TV Electrolytic CONDENSERS** \$6.88
- 100— ASSORTED MICA CONDENSERS** \$4.99
- 100— ASSORTED CERAMIC CONDENSERS** \$4.99
- 100— ASSORTED 1 WATT RESISTORS** \$5.86
- 100—ASST. PILOT LIGHTS** \$4.83
#44, 46, 47, & 51
- 100— ASSORTED SOCKETS** \$3.92
Octal, Localt & Miniature
- 100— ASSORTED KNOBS** \$3.97
SCREW & PUSH-ON
- 10— VOLUME CONTROLS** \$2.94
ASSORTED, WITH SWITCH
1/4, 1/2, 1, 2 meg. and others
- 10— VOLUME CONTROLS** \$1.94
ASSORTED, LESS SWITCH
1/4, 1/2, 1, 2 meg. and others

BELIEVE IT OR NOT! THIS SUPERHETERODYNE RADIO THAT FITS INTO ANY #630 TV SET OR CAN BE ADAPTED TO ANY TV SET with following features . . . at only \$7.89

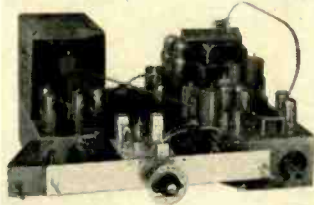

Superb Radio Performance on all AM Radio Stations 540 to 1700 KC. Easily Installed one hole mounting. Equipped with—Automatic Volume Control . . . High Q Loop Antenna . . . Easy to read Dial . . . Automatically shuts off CRT and High Voltage. It uses the amplification of the TV Set, giving you the same grand tone on Radio as you get on TV.

NOW!! Here is the good news . . . The regular selling price is \$24.95. It is yours complete with tubes and instructions for only **\$7.89**

RCA 12" PM SPEAKER
only 120 in stock **\$3.42**
limit 8 to a customer each

50L6 OUTPUT TRANSFORMERS
2000 in stock **29¢**
first come, first served each

5" PM SPEAKER (Alnico #5)
1200 in stock
case of 30 **99¢** each
smaller lots **\$1.14** each

\$5.00 SAPPHIRE PHONE NEEDLE
only a few hundred left **46¢** each

8MFD-450V CONDENSER
made by top mfr.—lists for \$1.35
12000 in stock
26¢ each in lots of 100
29¢ each in smaller lots

Vertical Output TRANSFORMER
Universal Type 10 to 1 Ratio **99¢**
List Price \$6.50
Only 100 in stock slashed to

RCA FLYBACK TRANSFORMER
Famous #218T1, good for **\$3.49**
CRT tubes from 16" to 24"
Schematic included only

1st or 2nd SOUND I.F. TRANS.
Most popular type **59¢**
#202K1 slashed to

G.E. AGC COILS **28¢**
Regular price 97¢ only

HORIZONTAL WIDTH COIL #201R4
HORIZONTAL LINEARITY COIL **5¢**
#201R5 only each

WIRE-WOUND RESISTORS
TV TYPE 5300/2—500 ohms 20/2/2W
Worth 89¢ only **19¢**

CUSTOM-BUILT AUTO RADIOS

Known Mfr. . . . Licensed By RCA
6-TUBE SUPER (8-Tube Performance) Installs easily in 15 minutes. Appearance and tone quality equal to expensive radios supplied by car manufacturers.
FORD · CHEVROLET · PLYMOUTH
DODGE · STUDEBAKER · HUDSON
1948 to 1953 Inclusive List Price \$59.95

Any model complete **\$41.97**
ready to install—Your price

ALSO AVAILABLE IN AUTOMATIC TUNING FOR

FORD 52-53 CHEVROLET 51-52
PLYMOUTH 1953 DODGE 1953
List Price \$79.95

Any model complete **\$55.96**
ready to install—Your price

MISCELLANEOUS ITEMS

- ONE POUND ROSIN CORE SOLDER \$.59
- 100 WATT SOLDERING IRON 1.78
- OUTPUT TRANSFORMER (6K6)52
- UNIVERSAL OUTPUT TRANS. (any tube)89
- OVAL ANTENNA LOOPS29
- VARI-LOOPSTICK ANTENNA57
- 6 FOOT LINE CORD, molded plug16
- VARIABLE CONDENSER, 2 gang, super.59
- I. F. TRANSFORMER, 456 kc49
- I. F. TRANSFORMER, FM 10.7 mc58
- VOLUME CONTROL L/S 1/4, 1/2, 1 or 2 meg24
- VOLUME CONTROL W/S 1/4, 1/2, 1 or 2 meg47
- FAMOUS MAKE CRYSTAL PICKUP 2.44
- CRYSTAL CARTRIDGE, fits most pickups. 1.42
- UNIVERSAL PICKUP, 78, 45, 33 rpm 4.63
- PHONO MOTOR, 78 rpm, complete. 3.18
- PHONO MOTOR, 78, 45, 33 rpm 4.97
- PHONO AMPLIFIER, incl. 3 tubes. 4.87
- TOGGLE SWITCH, DPDT46
- AUTO VIBRATOR, 4 prong type.99
- HYTRON PROBING TWEEZERS35
- HYTRON TUBE PULLER75
- HYTRON SOLDERING AID49
- HYTRON TUBE LIFTER15
- HYTRON PICK-UP STICK05
- HYTRON 7-PIN STRAIGHTENER55
- HYTRON 9-PIN STRAIGHTENER55
- HYTRON AUTO RADIO TOOL24
- SPRAYWAY PLASTIC SPRAY98
- SPRAYWAY ALUMINUM ENAMEL98
- TV HIGH VOLTAGE PROBE49
- TV COLOR ELECTRIC MOTOR 5.68
- TV 10KV-500mmf CONDENSER (Cartwheel)19
- TV BACK CUP, recesses C.R.T.59

be sure of the best



UHF - VHF

television pictures

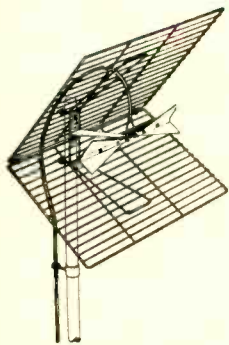

CORNER REFLECTOR

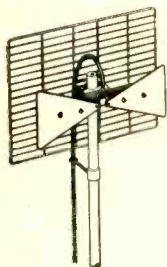

BO-TY

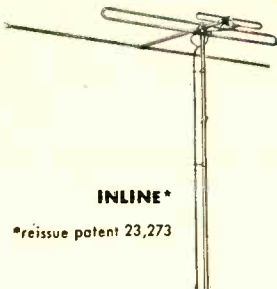

INLINE*

*reissue patent 23,273



YAGI

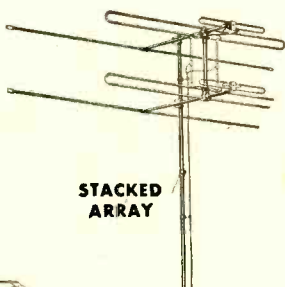

STACKED ARRAY

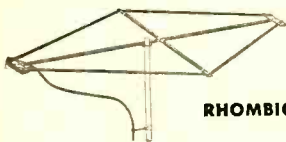

RHOMBIC

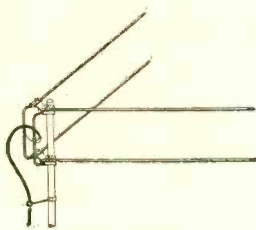

STACKED-V

There is one sure way of guaranteeing that any television set will produce the best picture that it is capable of and that is by installing an AMPHENOL antenna. For only with an AMPHENOL quality antenna installation can the customer be assured of better TV picture quality (the electrical qualities of AMPHENOL antennas are unexcelled) and years of trouble-free service (AMPHENOL antennas are sturdy and rugged; they are designed to perform efficiently for years).

Besides providing complete customer satisfaction in the quality of the antenna installed, the dealer has also the advantage of the completeness of the AMPHENOL antenna and accessories line. AMPHENOL makes a variety of types of both UHF and VHF antennas, as well as the famous AIR-CORE Tubular Twin-Lead and every necessary accessory.

see your **AMPHENOL** distributor

The AMPHENOL film "The UHF/VHF Television Antenna Story" is now available for all dealers to see. By contacting your AMPHENOL distributor you will receive full information on this interesting color presentation of TV signal transmission and comparison of current antenna types. The film is especially valuable in its discussion of the problems of UHF.

the **UHF VHF**
AMPHENOL
 television
 antenna story

A new AMPHENOL aid to dealers is the "TV Antenna Folio", which gives a short version of "The UHF/VHF Television Antenna Story." With Kodachrome illustrations from the film, it is designed not only to help dealers with television problems but to contain, as well, current catalog sheets on AMPHENOL antennas and accessories. Write your AMPHENOL distributor for copies.

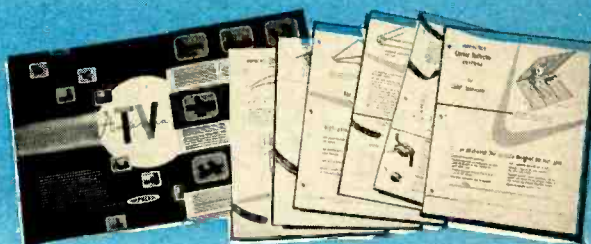

added a metal shelf one-half inch below the top of the box. It holds the sockets for coil L and the 955 tube. The shelf may be mounted either with spacers or brackets.

For high frequencies, a 3/4-inch diameter polystyrene coil is convenient. Be careful in soldering to the pins. More often than not the heat softens the polystyrene and ruins the coil form. I found the following procedure good: Saw the base off an Amphenol type 24 form (no prongs). This form fits neatly

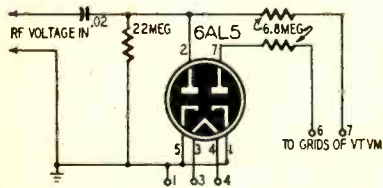

Fig. 3—Voltmeter probe which can be used in conjunction with the probe.

Materials for probe

- Resistors:** 1—9,100, 1—12,000, 1/2 watt.
- Capacitors:** 1—50 μ mf, mica; 1—1,000 μ mf, mica; 1,500 μ mf, ceramic; 1—50 μ mf, variable.
- Miscellaneous:** 1—25-mh r.f. choke; 1—955 tube and socket; 1—4-prong socket (Amphenol 78-54S); 2—coil forms (Amphenol type 24); 2—4-prong plugs (Amphenol 71-4S); 1—metal box 4 x 4 x 2 inches; 1—7-prong socket.

into a 4-prong miniature chassis plug (type 71-4S). The two are cemented together or they may be held together by screws. This makes a plug-in coil form with a bakelite base so there is no soldering problem. The chassis plug mates with Amphenol socket type 78-54S.

Two coils are used with this probe. One has 8 turns occupying about 1/2 inch. This tunes over 10 and 15 meters. The other has 4 turns and oscillates on 6 meters. Other ranges may be determined experimentally; it is difficult to specify exactly at high frequencies.

The grid-dip instrument tunes much more sharply than an absorption meter. A circuit does not have to oscillate to have its frequency measured by the grid-dip method. This offers a decided advantage. Not only must an absorption type meter depend upon an oscillator circuit to operate, but in the process a small amount of power is taken from that circuit. In cases of low-power high-Q circuits, noticeable impedance may be reflected. END



"What's the number of that tube? If the set acts that way again, I won't have to call you!"

**You can't beat
RADELCO
when it comes to
UHF-VHF antennas!**

Sensationally low prices, plus quality construction and exceptionally fine performance make RADELCO the leader in UHF-VHF antennas! Order from your nearest Parts Jobber.

UHF "BO-NANZA"

All metallic construction. No plastic insulators to absorb moisture and weaken signal... an all-weather antenna. Shipped pre-assembled.

LIST \$3.95

Model US-201 List \$3.95. As shown, less mast
Model US-202 List \$8.25. Double Stack with Q-bars.

NEW UHF-VHF "BOW-X" ANTENNA

UHF elements are completely isolated from VHF elements by metallic insulator. Unique construction permits use of single line to set for both UHF and VHF signals. Pre-assembled.

LIST \$8.45

Model US-761 List \$8.45
Single Stack

Model US-762 List \$17.75
Double Stack with Q-bars.

**ALL-CHANNEL
UHF-VHF ANTENNA**

A tried, tested and proved antenna. High gain job, gain increases with increasing frequency. Matches 300-ohm line. Pre-assembled.

LIST \$5.45

Model US-102 List \$5.45
Double Stack, 2 to a carton.

Model US-102 List \$6.25
Double Stack,
1 to a carton.

Model US-104 List \$11.75
Quad Stack with
Q-bars.

RADELCO
MANUFACTURING CO.

7580 GARFIELD BLVD.
CLEVELAND 25, OHIO

FACTS YOU SHOULD KNOW ABOUT UHF CONVERTERS

Many converters on the market today are unsatisfactory in fringe and shadow areas where signal strength is low. Before you install a UHF converter in these areas you should know these facts:

- 1** Signal power loss in the preselector seriously affects picture quality. Most UHF converters use sliding-contact shorted line tuners in the preselector with a fixed power loss of 6 db. The Turner converter uses High Q coaxial cavity tuners with no sliding contacts. Signal power loss is cut to 3 db. The resulting low noise figure keeps picture quality high.
- 2** Oscillator radiation often causes disturbing interference with neighboring sets. In the Turner converter the oscillator tube socket and all associated circuits are inside the coaxial cavity, self-shielded. Removable covers provide a second shield against radiation.
- 3** High amplifier noise figure can further damage picture quality. The Turner converter uses a special broadband amplifier with Cascode circuit. It retains the preselector signal savings without appreciably increasing the noise figure. The Turner amplifier noise figure is only 4 db.

Whether you're selling converters for installations in shadow or fringe areas or putting one in your own home, remember . . . the Turner converter often means the difference between good reception and bad.

EXCLUSIVE TURNER FEATURES

- Higher sensitivity
- Extremely low noise figure
- Exceptional frequency stability
- Double shielding
- Hi-Q silver plated coaxial cavities
- No sliding contacts

OTHER MAJOR TURNER FEATURES

Continuous single-knob tuning. Illuminated slide-rule dial. Smaller size: 8"x6"x6". Use with UHF or combination antennas. Self powered, uses channels 5 or 6. Complete installation instructions for 110-120 volts 50-60 cycles AC. Schematic included.



List price \$49.50

In VHF fringe and shadow areas, the Turner Booster is a superior performer, too.

THE TURNER COMPANY

933 17th St., N.E., Cedar Rapids, Iowa
Export: Ad Auriema, Inc.,
89 Broad St., New York 4, N. Y.
Canada: Canadian Marconi Co.,
Toronto, Ont. & Branches

ELECTRONICS

CHARACTRON TUBE HAS MANY COMMERCIAL APPLICATIONS

By S. M. MILANOWSKI

DESPITE the "human inertia" that often delays the development and use of new inventions for periods of many years, Joseph T. McNaney's *Charactron* tube has found a variety of commercial applications since its development was first announced by Consolidated Vultee Aircraft Corporation at San Diego, Calif., back in 1949. (See RADIO-ELECTRONICS, December, 1949.)

The *Charactron* is a special cathode-ray tube which is distinguished from its predecessors to the extent that it has a beam-forming matrix situated between its electron gun and fluorescent screen. The matrix has a sequence of stencil-like openings with different configurations (for letters, numerals, or other characters), through which the electron beam must pass before it reaches the screen. These apertures alter the cross-sectional shape of the beam so that it forms images of a predetermined character. After leaving the matrix, the beam passes through a second set of deflecting plates which position the image at any desired point on the screen.

Because it can produce as many as 10,000 separate characters in a period of only one second, and these can be positioned on the screen in any arrangement desired, the *Charactron* is a tube of particular importance in the development of equipment for the transmission, storage, reproduction, and interpretation of data requiring the visual use of words, symbols, and statistics. For example:

One version of the *Charactron* is currently being used with electronic computers to convert electronic answer-impulses into visual figures which can be easily read and recorded by engineering personnel.

Charactrons with standard alphabetical and numerical matrices are being used in Xerographic high-speed printing machines. Here their purpose is to reproduce visual images on light-sensitive surfaces, so that words and figures can be permanently developed and transferred to paper. Messages and data thus printed may come directly from a remote transmitter or from an automatic filing system wherein various types of information have been recorded on magnetic tape.

As shown in Fig. 1, the *Charactron* starts with a more or less conventional electron gun and a set of electrostatic deflecting plates called *selectors*. These are followed by the beam-forming matrix and a second deflecting-plate assembly. The latter may be varied in many ways to meet special requirements. The matrix is located about three inches ahead of the gun-selector assembly.

Focusing voltage for the *Charactron*

WANTED

DISTRIBUTORS WHO WILL HELP

the electronic service technician

Advertisements like the one shown here go a long way toward giving the serviceman the community standing he so rightfully deserves.

But obviously he cannot afford to go such a campaign alone. We, you and Sprague, can help. So let's all pitch in—

Order advertising mats and reprints of this advertisement for all your customers . . . who, in turn, can mail it or advertise it in newspapers to their customers.

Sprague's high volume printing makes reprints available at extremely low quantity rates. Write, wire, or phone for complete information.



Get newspaper mats and reprints of this ad free from your distributor, or send 10c to Sprague to cover handling costs.

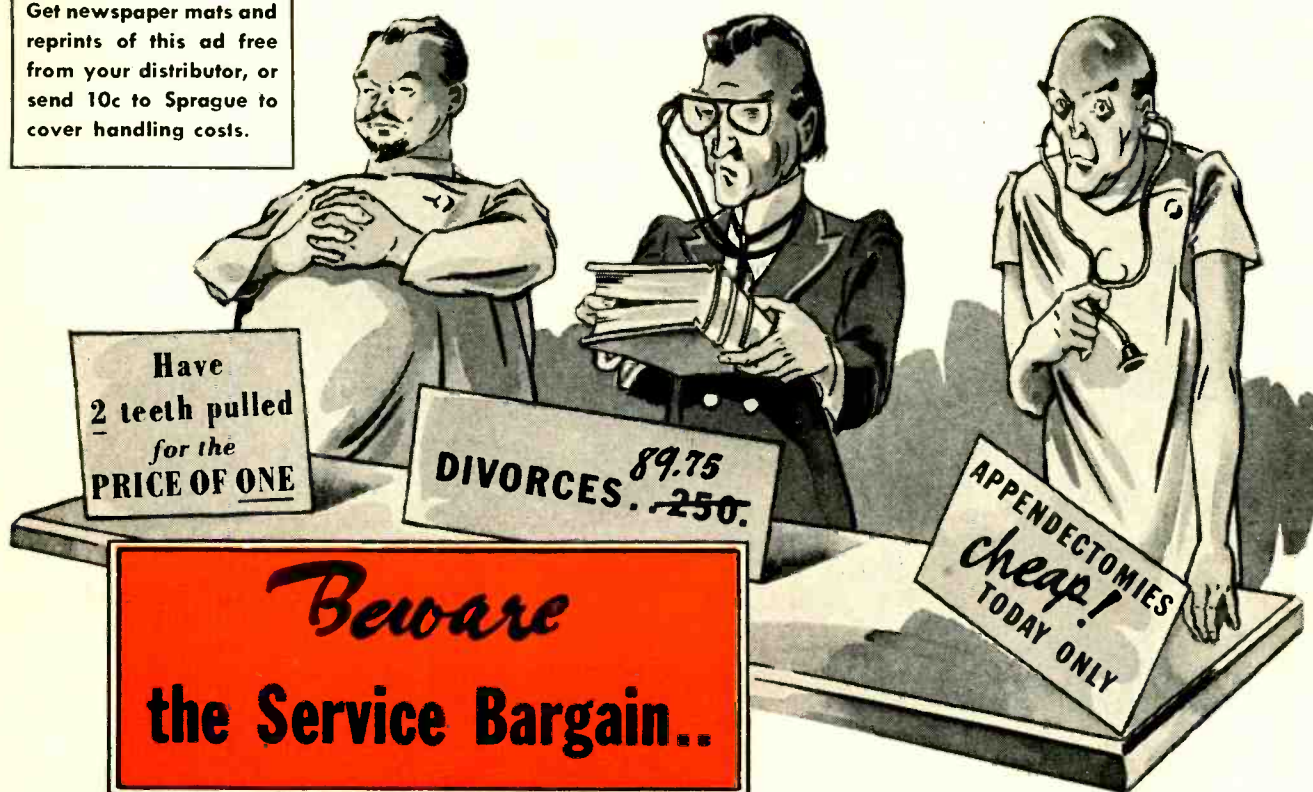

You'll never see your doctor advertise a special sale on appendectomies . . .

You'll never see your lawyer announce cut-rates for divorce cases . . .

You'll never see your dentist hold a "2-for-1" sale on extractions . . .

AND You'll never see the day when you can take your TV set in for a service "bargain" and be sure you're getting a square deal!

"Bargains" in home electronic service are as scarce as the proverbial hen's teeth! Here's why—

The expert service technician, just like other professional people, must undergo years of study and apprenticeship to learn the fundamentals of his skill. And a minimum investment of from \$3000 to \$6000 per shop technician is required for the necessary equipment to test today's highly complex sets. Finally, through manufacturer's training courses and his own technical journals, he must keep up with changes that are developing as fast as they ever did in medicine, law, or dentistry. Those best equipped to apply modern scientific methods are almost certain to be

most economical for you and definitely more satisfactory in the long run.

Unfortunately, as in any business, there will always be a few fly-by-night operators. But patients, clients, and TV set owners who recognize that you get only what you pay for, will never get gypped. "There just ARE no service bargains"...but there is GOOD SERVICE awaiting you at FAIR PRICES!

Harry Nathan
PRESIDENT

SPRAGUE PRODUCTS COMPANY
North Adams, Mass.

SPRAGUE

WORLD'S LARGEST MANUFACTURER OF ELECTRIC CONDENSERS

**SHARPER PICTURE
BETTER *all around*
PERFORMANCE!**

CHANNELS 2 TO 83

**UHF
& VHF** **VU-1**

**RECEPTION *in*
METROPOLITAN AND
PRIMARY AREAS**

**BE "ALL SET" WHEN UHF
COMES TO YOUR CITY!**

- One lead-in wire for all channels.
- Reception up to 50 miles, depending on terrain and power of transmitter.
- Quality construction throughout... double plate dipole holders... heavy cast aluminum mast clamp... heavy gauge aluminum cross arms... 7/16" aluminum tubing for extra strength and long life... micarta insulator... over-all lightweight and partial pre-assembly mean easy assembly and erection.

The "best by test"... according to leading technicians in areas now receiving both UHF and VHF! No matching pads or isolation filters... no coils or condensers which tend to cut down signals and increase cost of installations. K-T engineering has eliminated the "bugs" and the possibilities of frequent service call-backs.

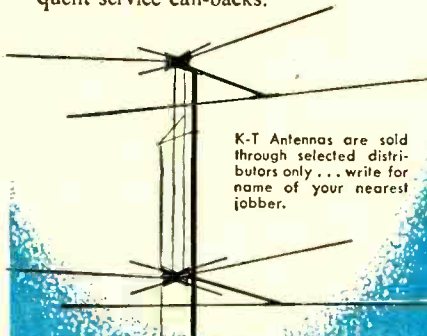

K-T Antennas are sold through selected distributors only... write for name of your nearest jobber.

VU-2

**KAY-TOWNES
ANTENNA CO.
BOX 586, ROME, GA.
THE BEST SET IS ONLY AS
GOOD AS ITS ANTENNA**

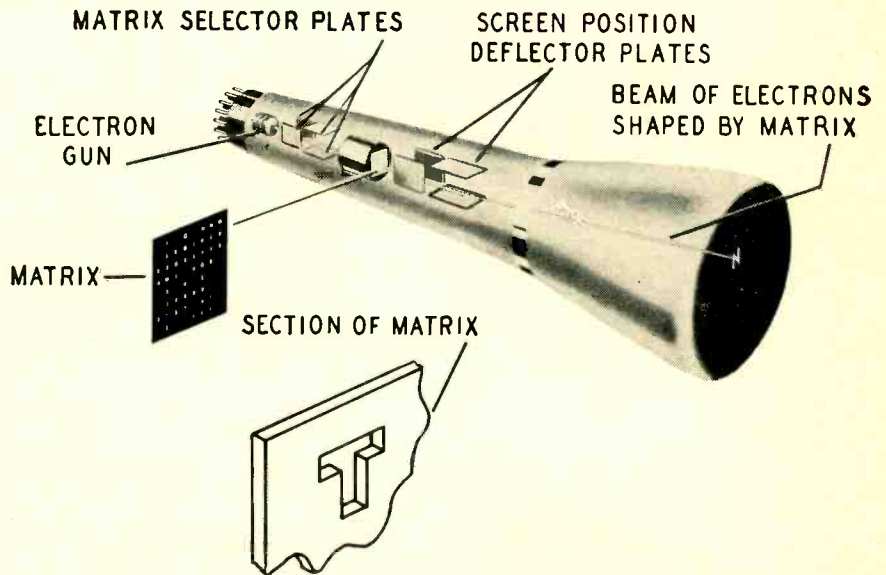

Fig. 1—Elements of the Charactron. Selector plates next to electron gun guide beam through desired opening in matrix, which shapes beam outline to produce letters, numerals, or special symbols on screen. Deflector plates following matrix shift image to any position desired over screen area.

is adjusted so that the undeflected electron beam will produce a relatively large spot of light, since the diameter of the beam must be large enough to cover each matrix aperture. Accelerating voltage adjustments, effective beyond the matrix position in the tube, make it possible to create a screen image of exceptional sharpness with a minimum number of control elements.

Control voltages applied to the selector plates determine which opening in the matrix the beam passes through. When it has been shaped by a matrix opening, the beam may be deflected to an appropriate area of the screen by the second set of electrostatic deflecting plates or electromagnetic forces (or a combination of both), depending on the nature of the images that must

be produced or reproduced. As many as 100 different letters or figures may be provided on the matrix of a single Charactron, and the position of each on the screen is determined by its sequence or the selective voltage with which it is transmitted.

Many different types of viewing screens have been used experimentally in constructing Charactron tubes, but only the phosphor types are now considered satisfactory. P-4 screens are used for direct viewing just as in TV picture tubes, while short-persistence P-11 types are used principally for photographic purposes.

Virtually all types of photographic materials and equipment can be used to reproduce the images that appear on the face of a Charactron; but Xerog-

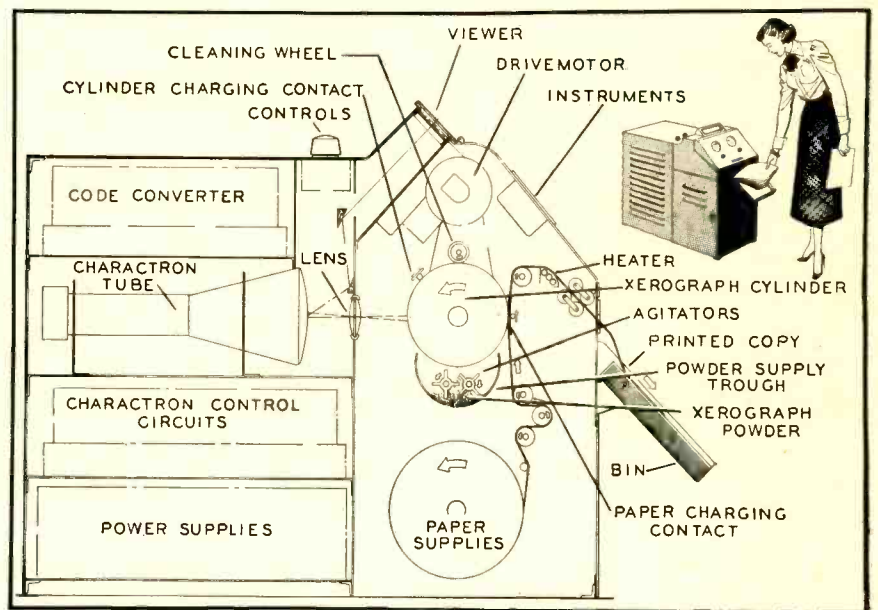

Fig. 2—The Charactron in high-speed Xerographic ("dry") printing transforms coded signals directly into light images of letters, figures, punctuation, etc. These are focused on photosensitive drum, which picks up colored printing powder in direct proportion to degree of exposure. Charged paper picks up powder pattern, which chemicals and heat make into permanent impression.

TUBES & PARTS

Write for our free BARGAIN CATALOG

ALL TUBES are guaranteed for one year... individually boxed. Very BEST BRANDS available for immediate delivery!

024	59c	2A6	89c	6AH6	1.89	6BH6	69c	6R3GT	89	6S07	79c	12AU7	79	12SN7GT	89	26	57	79c	SPECIAL
024G	79	2A7	89	6AK5	89	6B16	69c	6R4GT	59	6S07GT	59c	12AV6	59	12SQ7GT	69c	35A5	89	70L7	1.49
1A5GT	69	2B1	89	6AL5	1.09	6B47	1.19	6R7GT	79	6S17	79c	12AV7	89	12SR7GT	69c	35B5	89	71A	87
1A7GT	69	2C34	79	6A4C	69c	6B16	1.19	6L5G	1.19	6S17G	1.15	12AX4	69	1223	95	35C5	89	71B	87
1B3GT	95	2E5	89	6A4C	81	6B16	1.19	6L6A	1.19	6S17GT	1.15	12AX4	69	1223	95	35C5	89	71C	87
1B5	29	2X2/373	74	6A47	1.19	6B4QGT	1.29	6L6A	1.19	6S17GT	1.15	12AX4	69	1223	95	35C5	89	71D	87
1M5GT	59	3L74	1.25	6A8S	79	6B07	1.29	6L7	1.19	6S17GT	1.15	12AX4	69	1223	95	35C5	89	71E	87
1J6GT	119	304	89	6A74	59	6B27	1.29	6L7	1.19	6S17GT	1.15	12AX4	69	1223	95	35C5	89	71F	87
1L3	1.29	354	89	6A8S	59	6C4	59	6L7	1.19	6S17GT	1.15	12AX4	69	1223	95	35C5	89	71G	87
1L4	1.19	3V4	89	6A8S	59	6C5	59	6L7	1.19	6S17GT	1.15	12AX4	69	1223	95	35C5	89	71H	87
1L6	1.19	5T4	1.09	6A8S	59	6C6	59	6L7	1.19	6S17GT	1.15	12AX4	69	1223	95	35C5	89	71I	87
1L6C	69	5U4G	59	6A8S	59	6C6	59	6L7	1.19	6S17GT	1.15	12AX4	69	1223	95	35C5	89	71J	87
1L6S	1.19	5U4G	59	6A8S	59	6C6	59	6L7	1.19	6S17GT	1.15	12AX4	69	1223	95	35C5	89	71K	87
1L6S	1.19	5U4G	59	6A8S	59	6C6	59	6L7	1.19	6S17GT	1.15	12AX4	69	1223	95	35C5	89	71L	87
1L6S	1.19	5U4G	59	6A8S	59	6C6	59	6L7	1.19	6S17GT	1.15	12AX4	69	1223	95	35C5	89	71M	87
1L6S	1.19	5U4G	59	6A8S	59	6C6	59	6L7	1.19	6S17GT	1.15	12AX4	69	1223	95	35C5	89	71N	87
1L6S	1.19	5U4G	59	6A8S	59	6C6	59	6L7	1.19	6S17GT	1.15	12AX4	69	1223	95	35C5	89	71O	87
1L6S	1.19	5U4G	59	6A8S	59	6C6	59	6L7	1.19	6S17GT	1.15	12AX4	69	1223	95	35C5	89	71P	87
1L6S	1.19	5U4G	59	6A8S	59	6C6	59	6L7	1.19	6S17GT	1.15	12AX4	69	1223	95	35C5	89	71Q	87
1L6S	1.19	5U4G	59	6A8S	59	6C6	59	6L7	1.19	6S17GT	1.15	12AX4	69	1223	95	35C5	89	71R	87
1L6S	1.19	5U4G	59	6A8S	59	6C6	59	6L7	1.19	6S17GT	1.15	12AX4	69	1223	95	35C5	89	71S	87
1L6S	1.19	5U4G	59	6A8S	59	6C6	59	6L7	1.19	6S17GT	1.15	12AX4	69	1223	95	35C5	89	71T	87
1L6S	1.19	5U4G	59	6A8S	59	6C6	59	6L7	1.19	6S17GT	1.15	12AX4	69	1223	95	35C5	89	71U	87
1L6S	1.19	5U4G	59	6A8S	59	6C6	59	6L7	1.19	6S17GT	1.15	12AX4	69	1223	95	35C5	89	71V	87
1L6S	1.19	5U4G	59	6A8S	59	6C6	59	6L7	1.19	6S17GT	1.15	12AX4	69	1223	95	35C5	89	71W	87
1L6S	1.19	5U4G	59	6A8S	59	6C6	59	6L7	1.19	6S17GT	1.15	12AX4	69	1223	95	35C5	89	71X	87
1L6S	1.19	5U4G	59	6A8S	59	6C6	59	6L7	1.19	6S17GT	1.15	12AX4	69	1223	95	35C5	89	71Y	87
1L6S	1.19	5U4G	59	6A8S	59	6C6	59	6L7	1.19	6S17GT	1.15	12AX4	69	1223	95	35C5	89	71Z	87

100 #47 Pilot Lights \$2.95 10 for 39c

on orders of 100 tubes or more, 5% DISCOUNT on orders of 50 to 99 tubes.

FREE \$20 Hot value assortment of Rotor condensers with order of 80 or more tubes.

Picture tube brightener \$1.69 ea.



REGENCY UHF CONVERTER

UNIVERSAL CONVERTERS ALL SETS — the only converter recommended for the 5,000,000 split sound and video TV sets now in use as well as all intercarrier TV sets. **\$37.46**

Bogen UHF Converter... \$31.24



JFD UHF-VHF ANTENNA

Efficient on all channels. Uses conical element and reflector for VHF and "bow-tie" for UHF. Equipped with printed circuit antenna coupler for excellent signal transfer into single transmission line. Easy to install. **\$11.20**

RADAR TYPE TV ANTENNA

For UHF and VHF RECEIVES ALL CHANNELS WE FINALLY DID IT

You ordered so many thousands of these radar type TV Antennas, that the cost has come down through the savings of mass production. WE ARE PASSING THESE SAVINGS ON TO YOU!

The only TV antenna with the money-back guarantee with the new Electronic Dipole Separators. Unbeatable for fringe area and DK at this low, low price we cannot mention manufacturer's name. **\$18.75**

5 ALUMINUM MAST heavy gauge 1 1/2" diam. with interlocking end. Slip two sections together for a ten-footer. **\$1.00** Each

TV Antennas

10 Element conical rugged throughout. **\$3.95** Only

Double bay array, with stacking bars **\$7.75**

4 Bay array, with harness and stacking bars **\$14.95**

6 Element Conical. **\$2.95** Only



JFD BOW TIE REFLECTOR

UHF Antenna Bowtie Reflector Ultra-High Gain

Completely assembled—ready to mount. For all UHF Channels—easy to stack for two or four bay. Single Bay **\$4.50** Two Bay complete **\$7.85**

Inoor UHF antenna \$7.61

Outdoor UHF antenna \$4.77

TELEVISION PICTURE TUBES

SIZE	PRICE	SIZE	PRICE
8 inch	\$17.95	16 inch	\$19.95
9 inch	\$23.00	17 inch	20.95
10 inch	12.95	19 inch	23.95
12 inch	16.95	20 inch	24.95
14 inch	17.95	21 inch	26.95
15 inch	19.95	22 inch	54.95
		27 inch	69.95

ORDER AND WE WILL SHIP FROM STOCK IMMEDIATELY

METAL TUBES \$1.50 extra per tube
Electrostatic Tubes \$1.50 extra per tube

ONE FULL YEAR WARRANTY ON ALL TYPES



consisting of rectangular tube, 70 degree yoke, beautiful mesh flyback transformer and width coil.

17" Conversion Kit, as above, complete... **\$24.95**
20" Conversion Kit, as above, complete... **29.95**
21" Conversion Kit, as above, complete... **31.95**
24" Conversion Kit, as above, complete... **69.95**
27" Conversion Kit, as above, complete... **89.95**

TV CONVERSION KITS

Easily installed

7" tube size, Sweep magnifier, complete push-pull from input through output. Vertical sensitivity better than 10 millivolts. Bandpass — 0 — 3db. 0 to FIVE mc, complete with phasing control, blanking control, intensity mod. and self-measurement peak to peak feature, with DC amplifiers throughout as found only in scopes selling for over \$550.00. Exclusive, easy maintenance feature. **\$94.95**

Model 300
Precise
Oscilloscope

Here is the Buy

RME converter. All UHF channels \$29.63

TV 2-set antenna couplers \$1.17 ea.

Flyback Transformer TV Horizontal output, universal replacement, 14,500 V. \$2.49 ea.

WELLER SOLDERING GUNS

Brand New Models

Model	Watts	Price
WS 100	150	\$8.77
WS 200	275	9.75
WS 300	350	10.73
WS 400	450	11.71

RESISTOR KITS

Insulated 1/2, 1 and 2 watt assortment of most used values, I.R.C. Ohmic, Stackpole, Sprer, etc., 100 for **\$2.95**

300 OHM TWIN LEAD

Quantity	Price
55 Mil. 100 ft.	\$1.59
1,000 ft.	13.95
20 Ga. 40 Mil. 100 ft.	1.89
1,000 ft.	16.95
UHF TUBULAR 300 OHM LINE 1,000 ft.	\$3.50
100 ft.	\$4.95

FILTER CONDENSERS

Service Dealers Net Price Fresh stock.

Value	Price
50 mfd. 25V	.19 ea.
50 mfd. 50V	.39 ea.
3X10 mfd. 150V	.39 ea.
30 20 mfd. 150V	.39 ea.
60 mfd. 150V	.35 ea.
40 40 mfd. 150V	.39 ea.
40 mfd. 150V 20 25V	.39 ea.
80 mfd. 150V	.39 ea.
8 mfd. 450V	.27 ea.
8 mfd. 450V	.29 ea.
10 10 mfd. 450V	.39 ea.
150 25V	.39 ea.
20 mfd. 450V	.44 ea.
80 400V	.44 ea.
36 mfd. 450V	.39 ea.
470 20 25V	.39 ea.

MISCELLANEOUS BUYS

1. F. TRANSFORMER—55c Ea. 20c
PILOT LIGHTS, Type No. 47 10 for 39c; 100 for \$2.95
VOLUME CONTROLS with SWITCH 2" shaft, 1 meg. 1/2 meg. 1/4 meg. 34c
SINGLE ION TRAPS... 19c
DOUBLE ION TRAPS... 29c
OUTPUT TRANSFORMER for 600V... 19c
8-foot LINE CORD UL... 10 for \$1.99
TV INTERLOCK CORDS... ea. 49c

TUBE KITS

BEST BRANDS AT BEST PRICES

3V4, 1T4, 1R5, 1S5, 5Z 19	Value \$8.00	Tube Kit only	\$1.99
354, 1T4, 1S5, 1R5, 1S5	Value \$7.80	4-Tube Kit	\$1.99
1U6, 354, 1S5, 1R5, 1S5	Value \$7.80	All Four Tubes for	\$1.99
11Z3, 1U6, 354, 1R5, 1T4, AC-DC Portable Kit	All for		\$2.49
12AT6, 12BA6, 12BE6, 35W4, 50B5, 5 Tubes for			\$2.95
50LEGT, 35Z5GT, 12SQ7GT, 12SK7, 12SA7G, 5 Tubes for			\$3.22

VTVM PRECISE

Vacuum Tube Volt-Meter, 1% accuracy, resistor ceramic precision resistors; Coax DC connector; FM zero alignment scale; burn-out proof circuit, rugged oversize 4 1/2" meter. Model 909, factory wired \$44.98. 909K—Kit **\$25.98**

Model 300
Precise
Oscilloscope

Here is the Buy

7" tube size, Sweep magnifier, complete push-pull from input through output. Vertical sensitivity better than 10 millivolts. Bandpass — 0 — 3db. 0 to FIVE mc, complete with phasing control, blanking control, intensity mod. and self-measurement peak to peak feature, with DC amplifiers throughout as found only in scopes selling for over \$550.00. Exclusive, easy maintenance feature. **\$94.95**

Model 300
Precise
Oscilloscope

Here is the Buy

Selenium Rectifiers

75 mil.	79c
100 mil.	89c
150 mil.	\$1.32
200 mil.	1.85
250 mil.	2.38
300 mil.	1.94
350 mil.	2.41
400 mil.	2.55
450 mil.	2.91
500 mil.	3.44

P. M. SPEAKERS

12" COAXIAL P.M. SPEAKERS. High Fidelity with Crossover Filter attached. 20 watts; 40-19,000 cps. response; a sham Voice-Coil. ea. **\$12.95**

1 1/2" COAXIAL SPEAKER. 20-17,500 cps. ea. **\$19.95**

Very best quality—NATIONAL BRANDS. Individually Packaged.

3 1/2" ea.	\$1.39
4" ea.	1.59
5" ea.	1.59
6" SPECIAL PRICE	2.19

Telenor TV Wave Trap

For VHF Channels 3 through 13. Clears VHF Disturbance. Interference at 30 db. below to attach. **\$1.75**

All UHF channels... **\$2.75**

TENNAKIT

All-Range Antenna for UHF and VHF. Twin Lead Lighter than UL. 300 Ohm Impedance. 30 db. below to attach. **\$1.75**

Most Popular Antenna for UHF and VHF. **\$1.75**

BY-PASS CONDENSERS

100 Condensers assorted in package. **\$6.95**

Value	Price
.001	6c
.002	6c
.005	6c
.01	6c
.02	6c
.05	6c
.1	6c
.2	6c
.5	6c
1	6c
2	6c
5	6c
10	6c
20	6c
50	6c
100	6c
200	6c
500	6c
1000	6c

NEPCO TV WIRE

Twin Lead Type—300 Ohm. 25 AWG Copperwired Wire for Maximum Strength and Maximum Flexibility. Constant Impedance under all conditions. The "X" Line is an attractive, easy to handle UHF TV lead for maximum signal.

30 Gauge—7 Strand No. 25 AWG Copperwired Wire for Maximum Strength and Maximum Flexibility. Constant Impedance under all conditions. The "X" Line is an attractive, easy to handle UHF TV lead for maximum signal.	100 ft.	\$8.00
1000 ft.	\$47.86	

30 ft. of Stainless Steel Strap with HEAVY ZINC BRACKET dealer's best quality **\$3.00**

Chimney Mount for TV and... **\$1.49 ea.**

70 degree cosine yoke with 4 leads and network **\$2.95 ea.**

All Burgess batteries in stock

Enjoy the new advantages in this
compact high quality, dual speed, portable

tapeMaster

TAPE RECORDER

Completely Self-Contained,
with Push-Pull Supersonic
Bias-Erase Oscillator, Audio
Amplifier, Speaker and Micro-
phone in Carrying Case.



Here in the new Dual Speed Model PT-150 you have today's handiest, quality-built tape recorder at low cost—for home, studio, school or commercial use. New design completely eliminates slippage under all operating conditions. Vibration is reduced to absolute minimum.

Gives you the many fine features of the famous PT-125—plus built-in audio amplifier and speaker, ready to plug in and use anywhere, anytime. Can also be used with separate external audio system.

Recording and playback are remarkably clean, natural and full-toned. Size 12½" x 12" x 9½" high.

Model PT-150 Net \$12450
(Slightly Higher West and South)

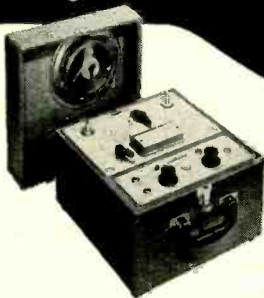

Model PT-150A
(Improved Model PT-125)
Net \$10950

PORTABLE PROFESSIONAL QUALITY DUAL SPEED TAPE RECORDER

Push-pull supersonic bias-erase, less audio amplifier and microphone. Designed for use with your own audio amplifier, radio or radio-phono combination, or with separate external audio system. In attractive sturdy waterproof leatherette carrying case. Size 12½" x 12" x 9½" high. Transport mechanism and preamplifier available without case for custom installation.

Wherever you Are
You Can Enjoy
the TapeMaster



tapeMaster inc.

13 W. HUBBARD ST. • CHICAGO 10, ILL.

Write for
Bulletin 112

Export: Scheel International, Inc.
4237 N. Lincoln Ave., Chicago 18, U.S.A.
Cable: Harscheel

raphy appears to have the greatest advantages in this connection. As it has been developed by the Haloid Company of Rochester, N. Y., Xerography involves:

1. Exposing a photosensitive surface such as selenium to a high-voltage electric field, which builds up a light-sensitive electrostatic charge on it.

2. Exposure of the electrostatically charged photosensitive surface to light, much the same as conventional photographic films are exposed. The light changes the charge at any point on the surface in proportion to its intensity at that point.

3. Development of the exposed surface with multicolored powders, which are attracted to the surface in accordance with the respective intensities of the remaining electrostatic charges.

4. The use of heat, pressure, and adhesives for transferring the powder images to paper and other surfaces.

This is an inexpensive and rapid method of reproducing high-contrast images because the photosensitive printing plates can be recharged and re-used indefinitely.

Fig. 2 shows how a Charactron tube has been used in conjunction with Xerographic equipment for high-speed reproduction of printed matter on paper. Operated at top speed, this setup is capable of decoding numerous types of input signals and translating them directly into words and figures that can be printed continuously in small type at a rate of 20 square inches of paper per second.

In this setup images on the face of the Charactron are focused by the lens on the surface of a selenium-coated cylinder. The section of the cylinder to be exposed is charged with high voltage immediately before exposure to light coming through the lens. The cylinder is rotated by a small motor synchronized with the Charactron control circuits, and exposed surfaces are developed immediately after they pass beyond the range of the lens by means of mechanically agitated powders in a trough beneath the cylinder.

The developed surfaces next come in contact with the chemically treated surfaces of a continuous roll of paper, which is electrically charged to facilitate the final transfer of powder images. A heater unit "fixes" the powder-printed copy, and makes the image permanent. Research is daily opening new fields for use of the Charactron. A field in which it should prove virtually indispensable is that of guided missiles. Data could be telemetered from a guided missile in high-speed flight and photographically recorded by means of the Charactron tube. Needless to say, such flight instrument data would be very difficult to obtain by other means. Fundamentally, the system would operate with the guided missiles signaling to special radio receiving equipment. This signal could then be passed through a commutating system to a Charactron commutator, then to an analog-to-digital converter. From there to a Charactron commutator, then to Charactron control circuits, and finally to the tube. END

NEW JFD "3-in-one" LIGHTNING ARRESTER

No. AT110 with hardware for wall or window sill mounting, \$1.50, list.

No. AT110S with stainless steel strap for pipe mounting, \$1.75 list.

Both feature the patented JFD strain-relief lips which prevent contact washers from ripping the lead-in wires apart!

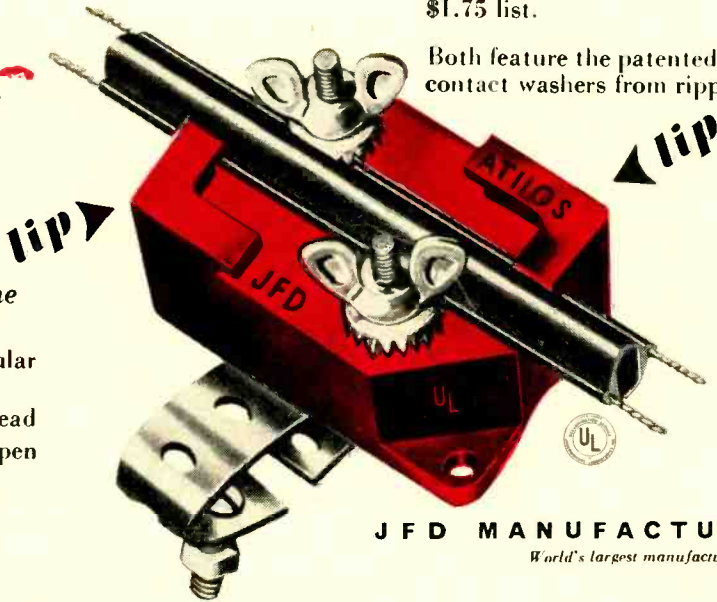

one for all... all for one



1. for UHF or VHF tubular twin lead
2. for VHF flat twin lead
3. for VHF or UHF open wire





Burton brook advertising

JFD MANUFACTURING COMPANY, INC.
World's largest manufacturer of tv antennas and accessories; Brooklyn 4, New York

NO GUESSWORK with JFD LIGHTNING ARRESTERS!

With  you don't just HOPE contact is made, you KNOW it is... you can SEE it!  Lightning Arresters have the patented, strain-relief lips!

 Lightning Arresters are UL approved!
 is the World's largest manufacturer of TV antennas and accessories!

Be sure you get  Lightning Arresters!

the secret is in the LIPS!

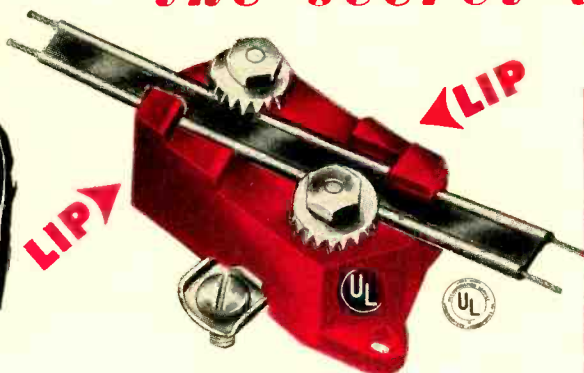

"Little Giant" LIGHTNING ARRESTER

the *only* lightning arresters with the strain relief lips are made by JFD. A patent is its proof!

JFD MANUFACTURING CO., INC. BROOKLYN 4, N.Y.
World's largest manufacturer of TV antennas and accessories

for flat and oval jumbo twin lead
No. AT105 (with hardware for wall or window sill mounting) \$1.25 list
No. AT105S (with stainless steel strap for universal mounting) \$1.50 list

understanding MECHANICAL FILTERS

Superior filtering and selectivity is obtainable by use of mechanical filters

By **LESLIE L. BURNS, JR.**

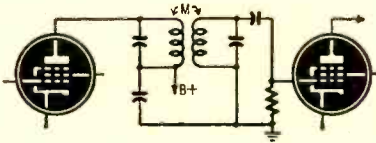

Fig. 1—Conventional i.f. transformer.

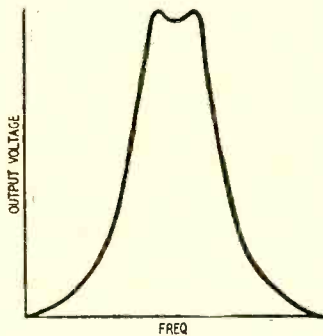

Fig. 2—Typical response curve For Fig. 1.

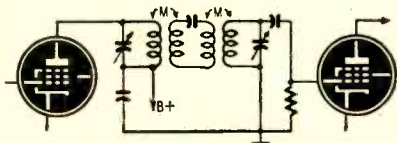

Fig. 3—Coupling with third tuned circuit.

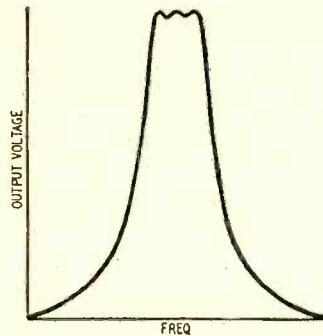

Fig. 4—Typical response curve for Fig. 3.

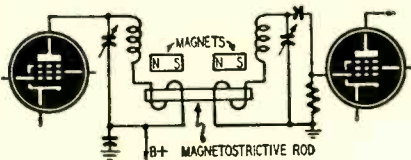

Fig. 5—Mechanical resonator circuit.

OBTAINING adequate selectivity is an always-present problem in radio receiver design. Most receivers get the necessary selectivity by cascading a number of i.f. stages. This method does not result in ideal selectivity; it gives us a rounded selectivity curve with broad skirts. The ideal curve would have a flat top and steep sides.

Special commercial receivers for point-to-point communication sometimes use crystal filters of the type used to a great extent in telephone work. These are expensive and not suitable for use in communications receivers for ordinary use. A new answer to this problem is provided by mechanical filters which are becoming increasingly important in radio communications. Several radio sets manufactured for the Armed Forces have mechanical filters. One company markets such a filter for amateur or experimental use and also sells a communications receiver with this filter installed.

By a mechanical filter we mean a filter that employs mechanically coupled mechanical resonators as distinguished from one that employs mechanical resonators coupled electrically (as in the case in crystal filters). This definition becomes clearer as a mechanical filter is better understood.

These filters make it possible to obtain a lot of filtering in a small space and to maintain the flat top and steep sides so desirable in selectivity considerations. These filters are stable with respect to temperature and humidity. Field maintenance is eliminated, since—once a filter is manufactured—no adjustment is either necessary or possible.

Principles of Operation

The basic idea behind mechanical filters is very simple and can be easily understood. Consider Fig. 1 which shows a conventional i.f. transformer coupling the plate of one i.f. amplifier to the grid of the next i.f. amplifier. The two tuned circuits are coupled by a mutual inductance. The amount of this mutual coupling determines the bandwidth of this particular transformer. Fig. 2 is a typical response curve for this type of circuit. To obtain more selectivity with this arrangement we might put a third tuned circuit between the two already shown, as illustrated by Fig. 3. Fig. 4 illustrates the response from this arrangement. Now we might continue this procedure until we get a response approaching the ideal, which would be a flat-topped curve with steep sides.

These additional electrical circuits would have losses due to the resistance of the coils, and these losses would prevent the selectivity curve from being as steep as might be desired. Also the problem of aligning additional circuits during maintenance operations in the field would be acute. However, these interior electrical circuits can be replaced by permanently tuned mechanical circuits. Fig. 5 shows an arrangement similar to Fig. 3 wherein the middle electrical circuit has been replaced by a single *mechanical resonator*. This mechanical resonator is exactly equivalent to the middle electrical circuit of Fig. 3, with the additional feature of being of very low loss.

Magnetostrictive conversion

The radio-frequency signals must be converted to mechanical vibrations in

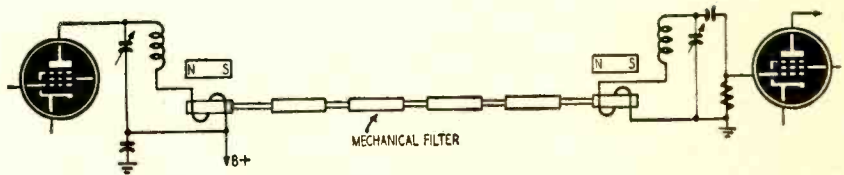

Fig. 6—Multisection magnetostrictive rod filter.

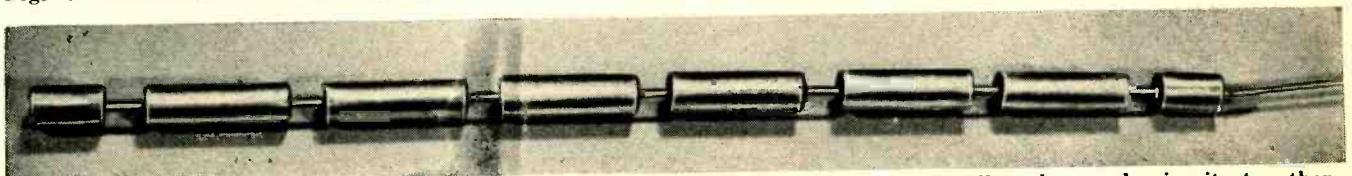

Fig. 7—8-circuit mechanical filter designed for 455 kc with bandwidth of 6 kc. Small necks couple circuits together.

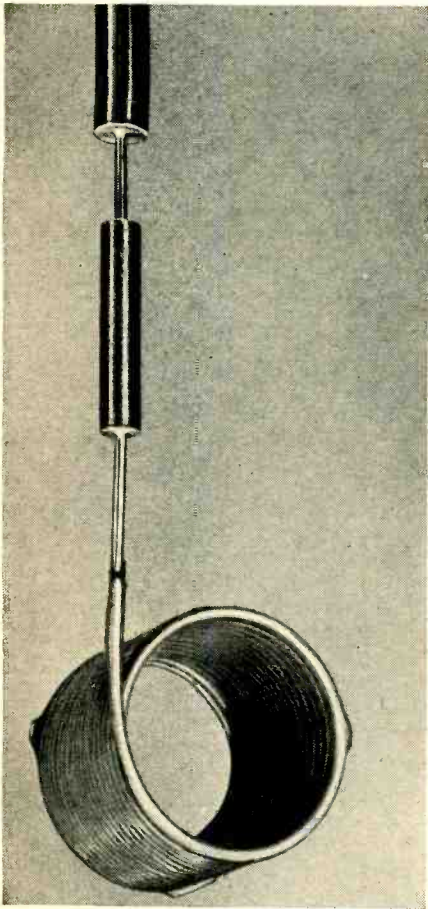

Fig. 8—End circuit has narrow diameter.

an intermediate amplifier so that they may be filtered by a mechanical filter. This is done with the help of a phenomenon known as *magnetostriction*. When certain materials are placed in a magnetic field they expand or contract, depending on the nature of the particular material. Nickel contracts when placed in a magnetic field. Thus a small rod of nickel becomes slightly shorter when magnetized. Now if the magnetic field is made to alternately increase and decrease, the nickel rod will alternately become shorter and longer. If the frequency of the alternating magnetic field coincides with the resonant frequency of the rod, the motion will be relatively large. Efficient electrical-to-mechanical conversion of energy is thus obtained.

Conversely, a rod of nickel that is alternately expanding and contracting generates a magnetic field that can produce a voltage in a coil surrounding the rod. In both cases a permanent magnetic field is supplied to prevent double frequency operation.

With these two effects in mind it is easy to see that the electrical energy is converted to mechanical energy at the filter input coil by magnetostriction; at the output the reverse phenomenon converts the mechanical energy back into electrical energy.

Instead of nickel, most mechanical filters are made of an iron-and-nickel alloy called Ni-span C, which is very stable with respect to temperature.



JACKSON

MODEL CRO-2

Proved by the hundreds in use by TV manufacturers' and dealers' technicians

Judging by ratio of sales to market potential, this laboratory grade 5" oscilloscope is preferred by the great majority of television and electronic technicians. The specifications explain why such is the case.

Specifications

Vertical Amplifier—Push-pull amplifiers provide flat response within 1.5 db from 20 cycles thru 4.5 Mc.

Sensitivity Ranges—The sensitivity ranges are .018, .18, 1.8, .25, 2.5, 25 RMS volts-per-inch.

Horizontal Amplifier—Push-pull with sensitivity of .55 RMS volts-per-inch.

Input Impedances—Vertical 1.5 megohms shunted by 20 mmfd. Direct to plates, balanced 6 megohms shunted by 11 mmfd. Horizontal: 1:1 megohms.

Linear Sweep Oscillator—Saw tooth wave 20 cycles to 50 Kc in 5 steps. 60 cycle sine wave also available as well as provision for using external sweep.

Input Voltage Calibration—Provides a standard voltage against which to measure voltages of signal applied to vertical input.

Vertical Polarity Reversal—For reversing polarity of voltage being checked or for choosing either positive or negative sync. voltages.

Return Trace Blanking—Electronic blanking provides clear, sharp trace to prevent confusion in waveform analysis.

Synchronizing Input Control—to choose among INTERNAL, EXTERNAL, 60 CYCLE, or 120 CYCLE positions.

Intensity Modulation—60 cycle internal or external thru front panel binding posts.

Accessory—Model CR-P Probe for demodulating RF and IF voltages.

Prices: Model CRO-2, Users' Net \$197.50
Model CR-P Probe, Users' Net \$9.95

See your electronics distributor for more information, or write

JACKSON ELECTRICAL INSTRUMENT CO. • DAYTON 2, OHIO

"Service Engineered" Test Equipment
IN CANADA: THE CANADIAN MARCONI CO.

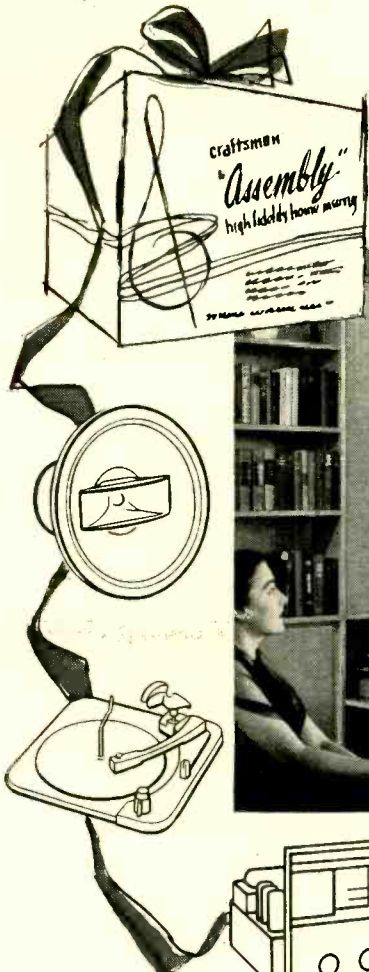

An *Altogether* new idea for music lovers!

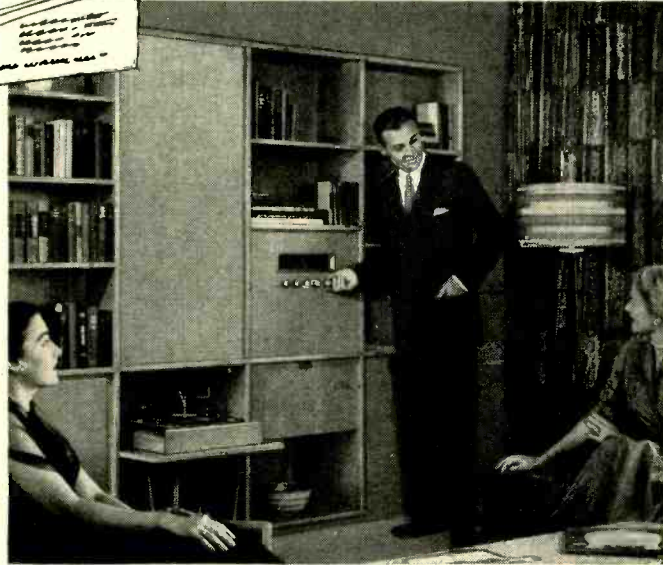

The new craftsmen
"Assembly"
 high fidelity home music system — \$275

DID YOU KNOW that buried away in your own phonograph records there's a treasure of beautiful music you probably have never heard? It's true! Today's High Fidelity recording (and broadcasting) techniques bring you music with a clarity and tonal range never before possible outside the concert hall.

To enjoy this full measure of realism, you need an instrument capable of reproducing all the music without distortion—a High Fidelity home music system.

Now, in one package, the world's most respected name in High Fidelity brings you a complete system of perfectly matched units—the Craftsman "ASSEMBLY."

You get the performance-proved Craftsman FM-AM Tuner and Amplifier

... two new Craftsman speakers coaxially mounted and 3-speed record player with dual sapphire magnetic pick-up... many accessories, too.

The Craftsman "ASSEMBLY" is waiting for your critical ear in the sound rooms of a Radio Parts Supplier near you. Drop in today for a demonstration of distinctly better listening.

Send for this booklet on High Fidelity by DEEMS TAYLOR

Ask your Supplier for a copy of this 24-page booklet by Deems Taylor—or write to us, enclosing 10¢ to cover handling and mailing.



high fidelity by craftsmen® means distinctly better listening

The Radio Craftsmen, Inc., Dept. C-10, 4401 N. Ravenswood Ave., Chicago 40, Illinois

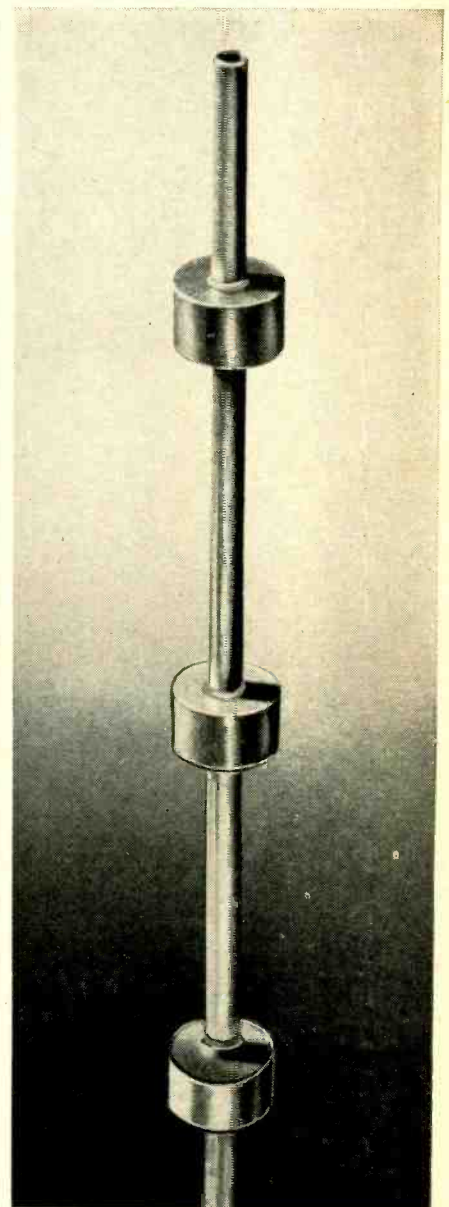

Fig. 9—Heavy slugs couple resonators.

By continuing the process of adding more mechanical circuits we have the arrangement shown in Fig. 6. Here we have six mechanical circuits and two electrical circuits for a total of eight circuits. This arrangement will provide a selectivity curve with a flat top and steep sides suitable for most communications receivers designed for general use.

The bandwidth of this type of arrangement is determined by the relative size of the mechanical resonators to the small coupling necks. The small neck corresponds to weak coupling and produces a narrow band, whereas a larger diameter neck produces a wider band. To keep the functions of a mechanical filter clearly in mind, imagine each resonator—that is, each large portion of the rod—to be a tuned circuit, and imagine each small neck portion to be like a small amount of mutual coupling. Fig. 7 is an enlarged photograph of an 8-circuit mechanical filter designed for 455 kc with a bandwidth of 6 kc. The small necks coupling the mechanical

RCP VTVM

Model 655

READS PEAK-TO-PEAK VOLTAGES DIRECTLY

ACCURATE MEASUREMENT OF COMPLEX WAVESHAPES

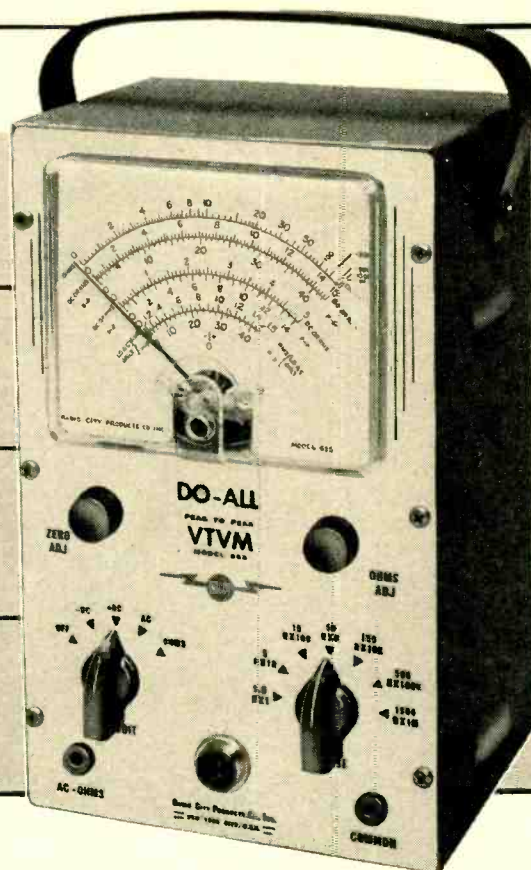
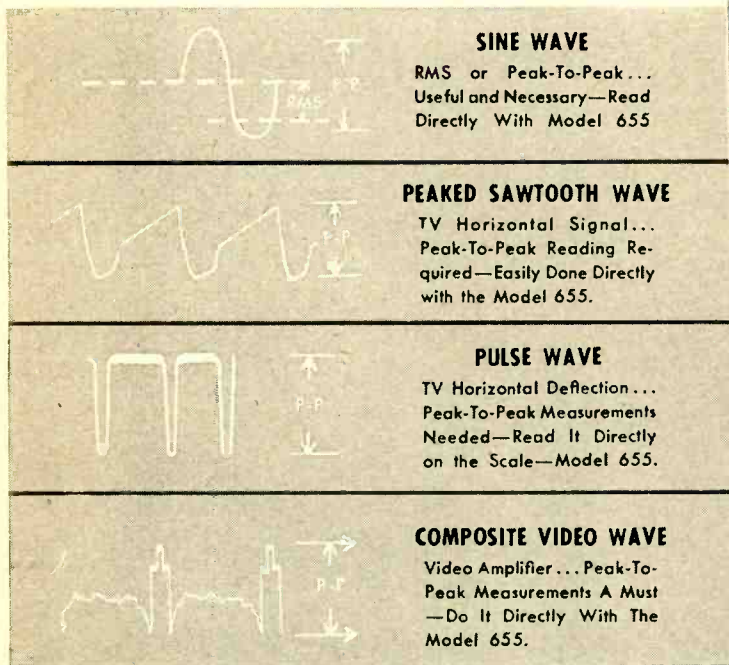

Quickly... Accurately

DO-ALL Model 655.

ONLY \$59.50

... gives a true reading measurement of complex and sinusoidal voltages with necessary peak-to-peak or RMS value read directly, for the analysis of waveforms in video, sync and deflection circuits.

Now TV efficiency is given greater effectiveness because sets can be serviced as the manufacturers say—the peak-to-peak way. The combination of this P. to P. meter and service notes to match, take the guesswork out of service and speed up your service operation.

Versatility of measurement, built into each Model 655, serves a variety of industrial applications in the service of vibrator power supplies, AC generators and all equipment utilizing any type of waveform or DC.

Match the Model 655 with any peak-to-peak VTVM—You will find that comparable performance can only be found

in much higher priced instruments. Of high impedance design, the Model 655 makes use of an electronic balanced push-pull circuit and peak-to-peak rectification. The result is an absence of circuit loading, waveform error or frequency distortion.

This handsome looking unit has a brushed aluminum panel, etched for durability and uses an attractive clear plastic meter. Comes complete with our new "RCP SOLDERLESS TEST LEADS" for operation on 105 to 125 V AC.

FOR TELEVISION SERVICE AND INDUSTRIAL MAINTENANCE

- PEAK-TO-PEAK AC measurements of from .2 V to 4200 V on 7 ranges.
- AC RMS measurements of .1 V to 1500 V on 7 ranges.
- DC measurements of from .02 V to 1500 V on 7 ranges.
- RESISTANCE measurements of from .2 ohms to 1000 Megohms on 7 ranges.

Remember You can do more with a "DO-ALL".

See It at Your Parts Distributor. Write Dept. RE-10 for RCP '53 Catalogue.

RADIO CITY PRODUCTS CO., INC.

152 WEST 25th STREET • NEW YORK 1, N. Y.



YOUR HIGH-PAYING
interesting career in
TELEVISION
starts here!

Complete, Easy-to-Learn
HOME STUDY COURSE
with one of America's
LARGEST schools

There's a place for YOU in the tremendous, billion-dollar Television, Radio & Electronics industry! It's so easy to get started with the famous **CRESCENT SCHOOL** course. Learn at home, in your spare time. Illustrated, simplified lessons and kits to practice on. No previous training needed. Send for **FREE** sample lesson . . . make this day the day you started on your way to a brilliant profitable career!

APPROVED FOR KOREAN VETS

Also Day & Eve. Classes
Trained at Our School



SEND COUPON TODAY!

CRESCENT SCHOOL Dept. E10
500 Pacific Street, Bklyn. 17, N.Y.

Sirs: Rush your **FREE** sample lesson and full details about the **CRESCENT SCHOOL** Course—at no obligation to me!

Home Study Course Residential Course

NAME _____
ADDRESS _____
CITY _____ ZONE _____ STATE _____

SAVE MONEY! SAVE SERVICE CALLS!
CHECK ALL TV, RADIO & PICTURE TUBES
with this **VISULITE TV TUBE CHECKER**

NO TECHNICAL KNOWLEDGE REQUIRED

Simple Instructions Furnished
SAFE—QUICK—FOOLPROOF
Most radio set failures are due to burned out tubes. Just plug tube into socket provided and Neon Lamp indicates this condition instantly. Operates on 110 Volt AC or DC. **PERFORMS 1001 ELECTRICAL CHECKS.** Checks continuity of resistors, appliances, motors or any Electrical device. Sturdily built for long life of trouble shooting. Test Leads Included—Nothing else to buy.

SOLD ON 10-DAY MONEY-BACK GUARANTEE. See it at your distributor today. If he can't supply, order direct from factory. **\$3.95** Postpaid anywhere in the U.S.

Only **\$3.95**
Complete

VISULITE CO., Dept. RE-10, 423 Broome St., N.Y. 13, N.Y.

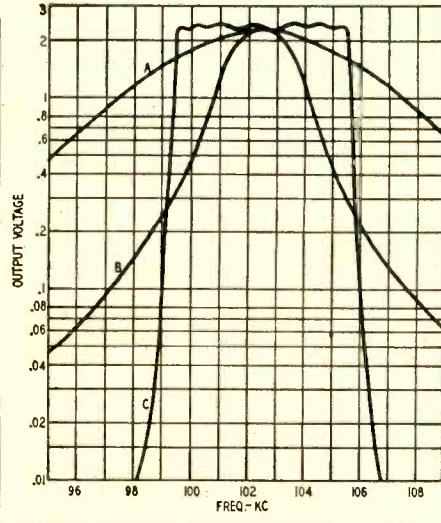

A—SELECTIVITY WITHOUT FILTER; B—SELECTIVITY WITH XTAL FILTER; C—WITH MECHANICAL FILTER

Fig. 10—Selectivity of various filters.

circuits together can be easily seen. The interior resonators of this filter are actually 0.4 inch long.

Further design considerations

The resonant frequency of a magnetostrictive rod is determined by its length. A rod of nickel about 1 inch

long will be resonant at 100 kc. The relation is:

$$\text{Length} = \frac{\text{velocity of sound}}{\text{frequency} \times 2}$$

The velocity of sound is different in different materials. In nickel it is 1.95×10^5 inches per second, while in Ni-span C the velocity is 1.89×10^5 inches per second. Each of the resonators in a mechanical filter is made exactly this length or some multiple of this length so that they all will be resonant at the center frequency of the pass-band. In some designs the interior resonators are made just twice as long as the end resonators, but they are still resonant at the center of the pass-band.

Also, other forms than the rod-shaped resonator can be used in mechanical filters. Disc or spherical resonators can be used. Each of these different shapes has advantages that make it suitable for certain frequencies and bandwidths.

The bandwidth of the simple rod-type filter that has been illustrated is determined by the relative size of the coupling neck to the resonator. The relation is:

$$\frac{\text{bandwidth}}{\text{center freq.}} = \frac{\text{area of neck}}{\text{area of resonator}}$$

where the area is the cross-sectional area of the neck or resonator.

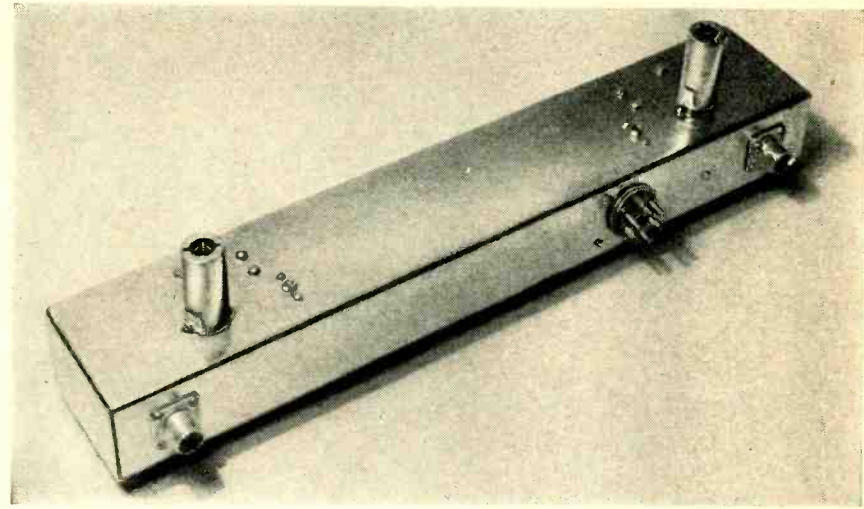

Fig. 11—A top-side view of a typical mounting for a mechanical filter.

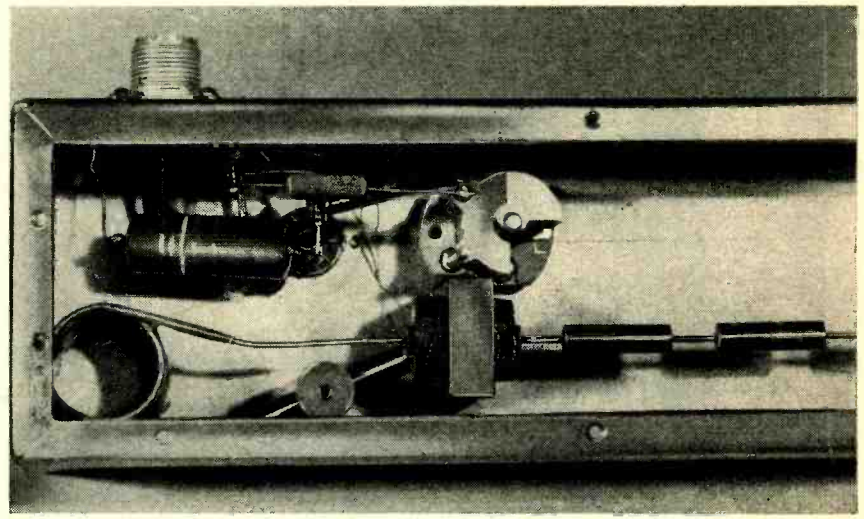
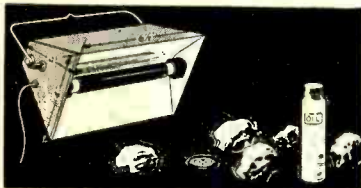

Fig. 12—The drive coil and permanent magnet can be seen in this bottom view.

**BLAK-RAY SELF-FILTERING
ULTRA-VIOLET LAMP**



BLAK-RAY 4-watt lamp, model X-4, complete with U-V tube. This lamp gives long-wave ultra-violet radiation having a wave-length of 3654 to 4000 angstrom units. Some of the substances made to fluoresce visibly when illuminated by U-V light are certain woods, oils, minerals, milkstone, cloth, paints, plastics, yarn, drugs, crayons, etc. This lamp is self-filtering and the invisible U-V rays are harmless to the eyes and skin. Equipped with spectral-finish aluminum reflector. Consumes only 4 watts and can be plugged into any 110 volt 50-60 cycle A.C. outlet. Will give 2000 to 3000 hours of service. It weighs but 1 3/4 lbs. Approved by the Underwriters Laboratories and has a built-in transformer so that it may be safely used for long periods when necessary. Extra U-V tubes are available.

Ship wt. 4 lbs.
ITEM NO. 125
UNUSUAL BUY **\$14.75**

POWERFUL ALL PURPOSE MOTOR



Sturdy shaded pole A.C. induction motor. 15 watts, 3000 rpm. 3"x2"x1 1/4"; 4 mounting studs; 3/8" shaft, 3/16" diameter; 110-120 volts, 50-60 cycles, A.C. only. When geared down, this unit can operate an 18" turntable with a 200 lb. dead weight. Use it for fans, displays, timers and other purposes. Ship wt. 2 lbs.
ITEM NO. 147
UNUSUAL BUY **\$2.45**

WATTHOUR METER

Leading makes—reconditioned. Ideal for trailer parks. 100-110 volts, 60 cycles, 2-wire A.C. 5 amp. Heavy metal case 8 1/2" x 6 1/4" x 5". Easy to install. Ship. wt. 14 lbs.



ITEM NO. 33
NOW ONLY **\$4.50**

WESTERN ELECTRIC BREAST MIKE

Lightweight 1 lb. carbon microphone. Aircraft type. Breastplate mounting, adjustable 2-way swivel. Easily fastened straps. For home broadcasts, communications etc. Complete with 6 foot cord, hard rubber plug. Sheradized plate, non-rusting finish. Ship. wt. 2 lbs.
ITEM NO. 152
NEW LOW PRICE **\$2.25**

AMAZING BLACK LIGHT

250-watt ultra-violet light source. Makes fluorescent articles glow in the dark. Fits any lamp socket. For experimenting, entertaining, unusual lighting effects. Ship. wt. 2 lbs.
ITEM NO. 87
A SAVING AT **\$2.45**

250 POWER TELESCOPE LENS KIT

Make your own high powered 6 ft. telescope! Kit contains 2" diam., 75" focal length, ground and polished objective lens and necessary eye pieces. Magnifies 50x to 250x. Full instructions. Ship. wt. 1 lb.
ITEM NO. 123
YOU SAVE AT **\$2.95**

HUDSON SPECIALTIES CO.
25 West Broadway, Dept. RE-10-53
New York 7, N. Y.

I am enclosing full remittance for items circled below. (Be sure to include shipping charges.)
OR, my deposit of \$..... Ship balance C.O.D.
MINIMUM C.O.D. ORDER \$5.00.
C.O.D. ORDERS ACCEPTED ONLY WITH 20% DEPOSIT
INCLUDE SHIPPING CHARGES.

Circle Items Wanted
87 147 33 152 123 123

Name Please Print Clearly

Address

City Zone State

**LOOKING for the RIGHT
TV REPLACEMENT
TRANSFORMER?**

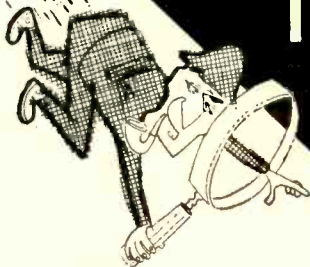

you'll find it in

**STANCOR'S
NEW TV
REPLACEMENT
GUIDE**



Easier to use . . . lists replacements by manufacturer's model and chassis number and also by original part number.

Up-to-date . . . over 5600 models and chassis are covered, including virtually all sets built prior to 1953 as well as most 1953 models.

You'll save time and trouble when you use this valuable Stancor reference. Get it now from your Stancor distributor, or write us directly for your free copy.

FIVE NEW STANCOR EXACT REPLACEMENT FLYBACKS

Many of these units are the result of recommendations of the Stancor Servicemen Advisory Board, composed of the top TV servicemen throughout the country.

PLUS A-8126, Universal vertical blocking-oscillator transformer for all Philco sets, including 1953 models.

Stancor Part No.	Exact Replacement For	No. of Models Using Flyback
A-8137	Hoffman #5035	29
A-8220	Philco #32-8555	24
A-8221	Philco #32-8565	18
A-8222	Philco #32-8533 & #32-8534	38
A-8223	Philco #32-8572	15



CHICAGO STANDARD TRANSFORMER CORPORATION

3592 ELSTON AVENUE • CHICAGO 18, ILLINOIS

EXPORT SALES—Roburn Agencies, Inc., 39 Warren St., New York 7, N. Y.

VTVM

**FACTORY ASSEMBLED AND CALIBRATED
NEW MODEL 940
VACUUM TUBE VOLTMETER**



SPECIFICATIONS:

- 6-AC VOLT RANGES 0-3, 15, 30, 150, 300, 1500. (Frequency response from 25 to 100,000 cycles)
- 6-DC VOLT RANGES 0-3, 15, 30, 150, 300, 1500. (Up to 30,000 volts with accessory probe)
- 5-RESISTANCE RANGES: 1,000-10,000-ohms, 1-Meg, 10 Megohm, 1,000 megohms. (10 megohms center on 1,000 megohm scale)
- DECIBEL RANGES -24 to -1.5, -8 to -15, +12 to +35, +21.5 to +44.5, +32 to +55

FEATURES

- Due to the high input resistance of 16.5 megohms, the circuit under test will not be loaded down.
- All functions and ranges are electronics, therefore no danger of meter being burned out.

The Model 940 comes complete with test leads and operating instructions in a round cornered bakelite case. Factory assembled & calibrated.
10 DAY MONEY BACK GUARANTEE
Write for FREE CATALOGUE

**ALL-MAIL SALES CO., Dept. RE-10
100 PARK PLACE, NEW YORK 7, N. Y.**

\$29.95
NET

ATR

Makes it easy to
DEMONSTRATE
and **TEST**
D. C. apparatus
from A. C. lines



"A" BATTERY ELIMINATORS

**FOR DEMONSTRATING
AND TESTING AUTO RADIOS**

New Models... Designed for Testing D. C. Electrical Apparatus on Regular A. C. Lines. Equipped with Full-Wave Dry Disc Type Rectifier, Assuring Noise-Less, Interference-free Operation and Extreme Long Life and Reliability.

6 VOLT OR 12 VOLT!

6 or 12 volt D. C. combination output available by means of simple toggle switching arrangement, properly safeguarded to prevent accidental switching

ATR

✓ NEW MODELS
✓ NEW DESIGNS
✓ NEW LITERATURE

"A" Battery Eliminators, DC-AC Inverters, Auto Radio Vibrators
See your jobber or write factory

AMERICAN TELEVISION & RADIO CO.

Quality Products Since 1931

SAINT PAUL 1, MINNESOTA-U. S. A.

Mechanical filters, like electrical filters, must be terminated for minimum ripple in the pass-band. Termination of a filter for minimum ripple is analogous to terminating a television transmission line for minimum reflections in the picture. Mechanical resistance in the form of mechanical lossy material is attached to the end resonators. (A mechanical lossy material might for example be a small piece of rubber glued to the end resonator.) Another method of producing the required mechanical resistance is to attach a long piece of wire coated with some lossy material to absorb the vibrations. With this method it is easy to get exactly the proper amount of mechanical resistance since the diameter of the wire determines the amount of the losses. Fig. 8 shows the end portion of a mechanical filter with a coiled lossy line attached.

Sometimes, when the bandwidth of the filter is not too great, no mechanical resistance in the form of lossy material is necessary, since all the resistance needed to properly terminate the filter is provided by the electrical circuit coupled to the end resonator.

Another consideration in mechanical filter design is that, to obtain the flat-test pass-band response, the end resonators must contain half the energy of the interior resonators. This is evident in Fig. 7 where it can be seen that the end resonators are half as long as the others and in Fig. 8 where the end resonator has a smaller diameter than the interior resonators.

The circuits of an electrical filter can be coupled by either a mutual capacitance or a mutual inductance. This is true also of the mechanical case. One form of mechanical filter uses heavy slugs to couple the resonators instead of the small necks as has been previously shown. Fig. 9 illustrates this type of filter. Here the small tubes are the resonators, while the slugs form the couplers. The slugs are about 0.2 inch long, while the interior resonators are about 0.6 inch long. Again on this filter the half-energy end resonators can be seen clearly. A filter of this type is fully equivalent to the

other form shown, and the choice between the two is purely a matter of the ease of fabrication for the frequency desired.

Applications

A typical selectivity curve is illustrated in Fig. 10, which also shows for comparison the curves obtained in a high-quality communications receiver with and without the crystal filter. The crystal filter here referred to is the type usually found in communications receivers and is designed to provide a single sharply peaked response and not a flat-topped response such as is provided by a mechanical filter or a band-pass crystal filter employing several crystals.

The electrical circuit diagram for a mechanical filter is given by Fig. 6. A typical mounting for a mechanical filter is illustrated by Figs. 11 and 12 for a 100-kc filter with a 6-kc band-pass. The drive coil and permanent magnet are evident in the underchassis view. Filters for higher frequencies will have much smaller housings.

The application of mechanical filters to high-quality receivers will increase as improved designs and better fabrication techniques are developed. It seems unlikely that they will ever be used in the cheap table-model broadcast receivers because the selectivity of these receivers is now satisfactory. However, the better-quality broadcast receivers will use mechanical filters. The big field for the application of mechanical filters is in communications receivers and in military equipment where the stringent selectivity requirements cannot be met by any other type of filter.

References

- "Compact Electromechanical Filter," R. Adler, *Electronics*, April, 1947, page 100.
- "Mechanical Filters for Radio Frequencies," W. van B. Roberts and L. L. Burns, Jr. *RCA Review*, September, 1949, page 348.
- "A Bandpass Mechanical Filter for 100 Kc.," Leslie L. Burns, Jr. *RCA Review*, March, 1952, page 34.
- "Mechanical Bandpass Filters for I.F. Ranges," Ben Roberts, *QST*, February, 1953.
- "How to Use Mechanical I.F. Filters," M. L. Doelz and J. C. Hathaway, *Electronics*, March, 1953, page 138.

END

CIRCUIT-SYMBOL STAMPS

Here's an unusually handy gadget for the technician, engineer, or hobbyist who isn't an expert draftsman but who wants to draw neat schematics. It's a set of 12 1 1/4 x 1 1/4-inch clear-plastic blocks engraved with the basic component symbols that make up practically all electronic circuit diagrams. All you have to do is ink them lightly on an ordinary stamp pad and press them on the paper to produce perfect tube diagrams, resistors, or other common circuit elements.

The set has five tube stamps, covering standard types from diode to pentagrid converter; a fixed resistor and a potentiometer; fixed and variable capacitors; a basic inductor stamp which can be repeated and inverted as required for transformers or coupled circuits; a contact-rectifier symbol; and a stamp for headphones. [This latter

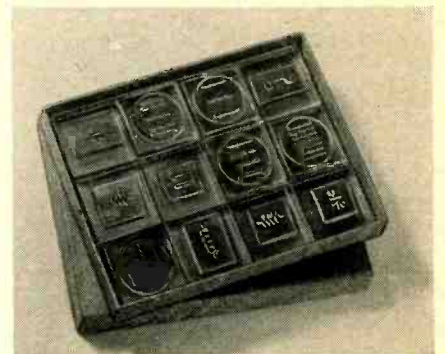

one will probably get relatively little use, and possibly the manufacturer (Precise Measurements Co.) should substitute a more common symbol such as a speaker, line plug, or a transistor.]

END

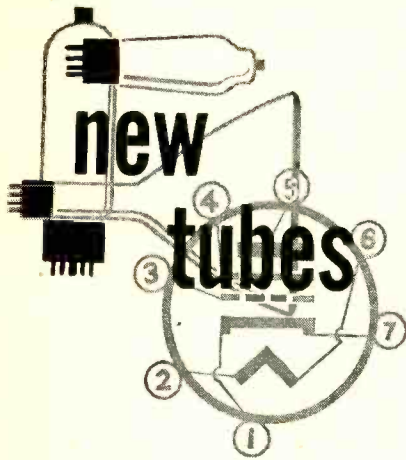

(and Transistors)

THE transistor continues to make news. As mentioned last month, Sylvania Electric Products has developed two new types of point-contact transistors.

One is a tetrode transistor 3N21 that was scheduled to be commercially available about August 15, and the other is a pentode transistor that is expected to become commercially available later this year. Sylvania is the first company to announce that its development work

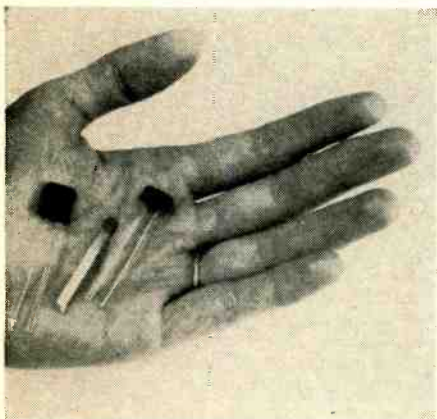

Photo shows compactness of transistors.

in tetrodes and pentodes has progressed to the point of commercial production. Where the triode transistor has two cat-whiskers in contact with the germanium crystal, the tetrode has three wires making contact, and will do the work of two triode transistors in all applications where the two outputs could be paralleled.

The type 3N21 tetrode is designed primarily for use in switching and small signal applications. Recommended small-signal applications include modulation, signal translation apparatus, and audio or low r.f. mixer. The maximum ratings of the 3N21 are: collector voltage d.c. -60; collector dissipation 100 mw; emitter voltage d.c. -50 volts; emitter output (either emitter) 30 mw; ambient temperature 50°C. Voltages are with respect to base.

New Tubes

With virtually simultaneous announcements, General Electric and the Rauland Corp., have heralded

A large graphic featuring a stylized cityscape with various buildings and a car. In the center, the letters 'ATR' are written in a large, bold, white font inside a black oval. Below this, the text 'for A. C. current ANYWHERE!' is written in a bold, black font.



AT NEW LOW COST

\$25⁵⁵ And Up Retail Price

INVERTERS

For Inverting D.C. to A.C. . . . Specially Designed for operating A.C. Radios, Tape Recorders, Wire Recorders, Record Changers, Television Sets, Amplifiers, Address Systems, Radio Test Equipment and most small electrical and electronic devices from D. C. Voltages in Vehicles, Ships, Trains, Planes and in D. C. Districts.

Type	Input DC Volts	A.C. Output 60 Cycles	Output Int.	Wattage Cont.	Consumer Net Price
6-LIF	6	110 volts	40	35	\$25.55
12-LIF	12	110	50	35	25.55
* 6-RSD	6	110	85	75	39.25
*12-RSD	12	110	125	100	39.25
32-RSD	32	110	150	100	39.25
110-RSD	110	110	250	150	39.25
*12T-HSG	12	110	250	200	96.45
110AT-RHE	110	110	325	250	56.95

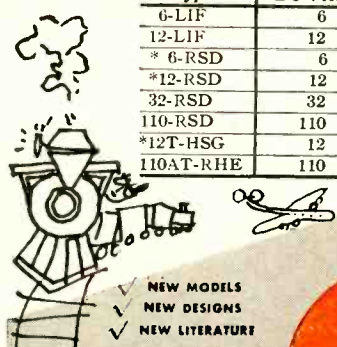

NEW MODELS
NEW DESIGNS
NEW LITERATURE

See your jobber or write factory



There is an ATR model for most any application.
* Available with leather carrying handle at \$1.00 additional—optional.

"A" Battery Eliminators, DC-AC Inverters, Auto Radio Vibrators

AMERICAN TELEVISION & RADIO Co.
Quality Products Since 1931
SAINT PAUL 1, MINNESOTA—U. S. A.

CONCORD PROUDLY PRESENTS

NEW! EICO

7 INCH PUSH-PULL SCOPE

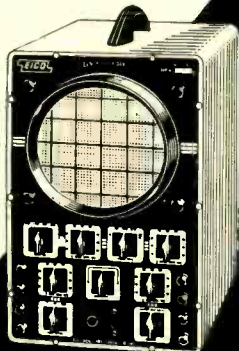
MODEL
470

KIT \$79.95 Factory Wired \$129.50

- VERTICAL FREQ. RESPONSE: flat ± 2 db 10 cps - 1 mc.
- VERTICAL SENS.: .01 volts rms/inch.
- HOR. FREQ. RESP.: flat ± 0 db 10 cps - 200 kc, -4 db at 500 kc.
- HOR. SENS.: 3 volts rms/inch.
- SWEEP RANGE: 15 cps - 100 kc.
- 3-STEP FREQ.-COMPENSATED ATTENUATOR eliminates freq. distortion, overloading.
- CATHODE FOLLOWER inputs to both amplifiers.
- PUSH-PULL outputs in both amplifiers.
- RETURN TRACE BLANKING
- INT. VOLTAGE CALIBRATOR
- V & H TRACE EXPANSION & CENTERING: 1.5X full screen without distortion.
- DIRECT CONNECTION to vert. CRT plates.
- PHASING CONTROL of internal 60 cps sine wave sweep.
- AT FRONT PANEL: intensity mod. input; 60 cps, sawtooth outputs.

Famous EICO amazing value-packed economy-priced 425K 5" Push-Pull Scope KIT \$44.95. Wired \$79.95.



NEW EICO 6V & 12V BATTERY ELIMINATOR & CHARGER

1050K KIT \$29.95. Factory Wired \$38.95.

- DC OUTPUT: 0-8 V or 0-16 V.
- CONTINUOUS CURRENT RATING: 10 A at 6 V, 6 A at 12 V.
- INTERMITTENT CURRENT RATING: 20 A at 6 V, 12 A at 12 V.
- SEPARATE VOLTMETER & AMMETER.

Send for our new 1954 CONCORD CATALOG!

FREE! A complete, comprehensive listing of all your electronic requirements. Bursting with those SPECIAL VALUES that only CONCORD can present.



CONCORD RADIO
54 Vesey Street
New York 7, N. Y.

- Send me at once your new 1954 catalog
- Send complete information and technical data on NEW EICO Model 470
- Please send EICO Model..... Enclosed find \$..... 20% deposit with C.O.D. required. Pre-paid if remittance in full.

Name.....
Street.....
City..... State.....

Concord Radio

54 Vesey Street
New York 7, N. Y.

Phone
DLgby 9-1132

two new 24-inch rectangular glass cathode-ray tubes for television application, the 24CP4 and its aluminized counterpart, the 24CP4A.

The new tubes have a deflection angle of 90 degrees, a major factor in making them shorter than 21-inch glass rectangular tubes. They measure only 21½ inches in over-all length.

The new types are glass, magnetic-focus and magnetic-deflection, direct-view picture tubes. They boast an electron gun which is used with an external single-field ion trap magnet and an external conductive coating that acts as a filter capacitor when grounded. Another feature of the two new types is a gray, filter-glass face-plate to improve contrast in the presence of ambient light.

The aluminized version, the 24CP4A, gives additional light output because of its metal-backed screen.

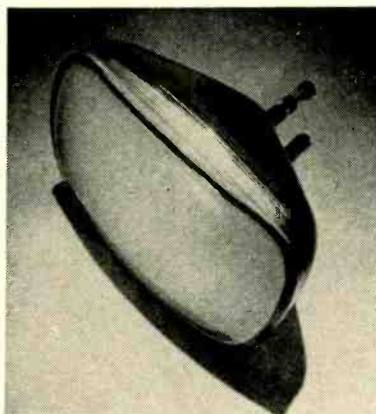

24CP4 has deflection angle of 90 degrees.

Recommended operating conditions for the 24CP4 and 24CP4A:

Anode voltage, 16,000; grid 2 voltage, 300; grid 1 voltage, -33 to -77; focusing coil current, 119 ma; ion trap intensity, 40 gauss. Base-pin connections are for a standard small-shell, 5-pin duodecal socket.

A new RCA electron tube specially engineered to shake off the "shakes" of airborne and mobile electronic communications equipment has been made available. The new type tube, RCA-

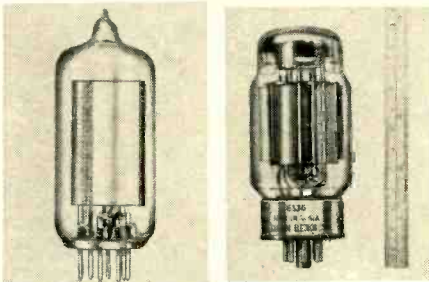

VC-1258 thyratron; 6336 twin power triode.

6101, is designed specifically for use as a class-A amplifier and control tube in applications where dependable equipment performance hinges on the ability of electron tubes to take abnormal shock and vibration.

The 6101 is a medium-mu twin triode which couples the characteristics of the 6J6 with the ability to withstand punishing physical operating conditions.

to the

E. E. or

PHYSICS GRADUATE

with an interest
or experience in

RADAR or

ELECTRONICS

Hughes Research and Development Laboratories, one of the nation's large electronic organizations, are now creating a number of new openings in an important phase of operations.

Here is
what one of
these
positions offers
you

OUR COMPANY

located in Southern California, is presently engaged in the development of advanced radar devices, electronic computers and guided missiles.

THESE NEW POSITIONS

are for men who will serve as technical advisors to the companies and government agencies purchasing Hughes equipment.

YOU WILL BE TRAINED

(at full pay) in our Laboratories for several months until you are thoroughly familiar with the equipment that you will later help the Services to understand and properly employ.

AFTER TRAINING

you may (1) remain with the Laboratories in Southern California in an instruction or administrative capacity, (2) become the Hughes representative at a company where our equipment is being installed, or (3) be the Hughes representative at a military base in this country—or overseas (single men only). Adequate traveling allowances are given, and married men keep their families with them at all times.

YOUR FUTURE

in the expanding electronics field will be enhanced by the all-around experience gained. As the employment of commercial electronic systems increases, you will find this training in the most advanced techniques extremely valuable.

How
to
apply

If you are under 35 years of age
and have an E.E. or Physics
degree and an interest or
experience in radar or electronics,

write
to

HUGHES

RESEARCH AND DEVELOPMENT
LABORATORIES

Scientific and Engineering Staff
Culver City,
Los Angeles County, California

Assurance is required that the relocation of the applicant will not cause the disruption of an urgent military project.

The new tube has a pure tungsten heater to provide long life under frequent on-off switching operations. Additional insulating material has been applied to the heater to give protection against short-circuits between the heater and cathode under conditions of extreme vibration. Base connections are the same as the 6J6.

Chatham Electronics Corp. has announced the production of two new tubes. The first, type 6336, is a high-perveance, high-plate-dissipation twin-power triode for voltage regulation. Used as a series tube, it will pass 150 ma per section at 40 volts d.c. with minimum bias, and the same current at 200 volts d.c. with a grid bias of -60 volts. The tube features a hard glass envelope and an 8-pin butt stem. Pin connections are the same as those of the 6AS7-G. The filament voltage is 6.3, and it draws 5 amp. Forced ventilation is not necessary at ambient room temperature. Mu is 2.7, gm is 11,000 micromhos, Rp is 250 ohms. Its life expectancy is 1,000 hours minimum. The second tube, type VC-1258, is a miniature hydrogen thyratron for pulse generating applications. It is capable of handling peak power up to 10 kw. This tube will fit a standard miniature socket. (See base diagram below.) It is rated at 1,000 peak anode volts, 20 amperes peak anode current, and 40 ma average anode current. Repetition rates in excess of 10,000 pulses per second are possible at reduced ratings.

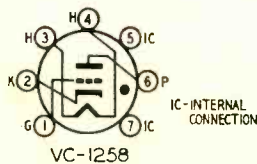

Tube fits standard miniature socket.

The VC-1258 will withstand all shock and vibration tests required of a ruggedized electronic tube.

RCA has announced the production of a tube type 6CF6. The 6CF6 is a sharp-cutoff pentode of the miniature type especially designed for use in gain-controlled video if stages operation at frequencies in the order of 40 mc. It is also well suited for use as an r.f. amplifier in v.h.f. television tuners.

The 6CF6 features controlled plate-current cutoff and very high transconductance (6,200 micromhos) combined with low capacitance values. It is provided with separate base pins for grid No. 3 and the cathode.

The heater operates at 6.3 volts and draws 300 ma. The tube may be mounted in any position. The base is of the small-button miniature 7-pin type. In typical operation, the 6CF6 has a plate voltage of 200, the suppressor grid is connected to the cathode at socket, the screen grid voltage is 150, and the grid bias for a plate current of 35 μ a is -6.5 volts. Except for its sharper cutoff, the 6CF6 is identical to the 6CB6. END

**FASTER
STURDIER
Lower Installed Cost**

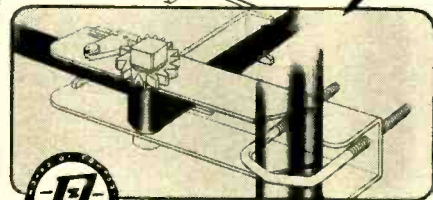

**RADIART SPEE-DEE
CHIMNEY MOUNT**

Model AK 85 The fastest-installed chimney mount ever devised for TV antennas! Rugged in design—simple to install. Simply thread strapping through ratchet, around chimney and back through ratchet—wind up ratchet tight—and the job's done! Heavy gauge, zinc-plated steel with large "U" bolt for up to 1 3/4" O.D. mast and full length galvanized steel strapping.

**THE RADIART CORPORATION
CLEVELAND 13, OHIO**

TeleSound CORPORATION Custom Built TV CABINETS

DIRECT FROM MANUFACTURER TO YOU!

Standard Brand
PIX TUBES—1 YR. GUARANTEE
17" 17B14A \$28.90
20" 20CP14A 38.05
21" 21EP14A 40.25
27" 27GP4 (electro-magnetic) 90.00

WHY PAY MORE! COMPARE! Don't be misled by other offerings similar in appearance to these original TELESOUND creations—but not in quality! Our cabinets are massively constructed, fully reinforced, smartly styled in the modern manner, and offered to you at today's **LOWEST PRICES** for quality cabinets of this type. Prompt Factory-to-you shipments. Buy with confidence! All cabinets illustrated available in Ribbon stripe Mahogany. Add 10% for Blonde Korina. Complete catalog on request.

 Model 200 H 40 1/4", D 22 1/2", W 25 1/4", Wt. 60 lbs. \$46.50	 Model 240 H 25", D 21 1/2", W 25", 50 lbs. \$39.00	 Model 260 H 40 1/2", W 25", D 22", 60 lbs. \$54.50	 Model 300 24" Model: H 31", D 24", W 27" \$56.50 27" Model: H 31", D 24", W 31" \$56.50	 Model 875-D H 43", W 25 1/2", D 23 1/2" \$117.00	 Model 1200 H 35", D 23", W 40" \$127.00	 Model 875 H 42", W 25 1/2", D 23" \$69.50
---	--	--	---	--	---	---

Save Money With TELESOUND "Package Deals"!

Famous VIDEO 530DX TV Chassis, Super-powered, complete with receiving tubes. **OUR LOW PRICE, less picture tube \$139.50**
Order the TeleSound Cabinet you want, combined with Video 530DX chassis, 12" PM Speaker, and your choice of picture tube, at these terrific low prices!

CABINET STYLE	Combined with Video 530DX chassis, 12" PM Speaker, and 17" CRT				
	20" CRT	21" CRT	24" CRT	27" CRT	27" CRT
200	\$208.50	217.25	219.50
240	\$216.00	224.75	227.00
300	\$217.75	226.75	228.75	263.75	326.25*
500	\$201.25	210.25	212.25	263.75	326.25*
875	\$230.25	239.00	241.25	276.25	338.50*
875-D	\$275.25	284.25	286.50	321.25	383.75*
1200	\$284.75	293.75	296.00	330.75	393.25*

FOR OTHER TV CHASSIS. ADD: for Video 630, \$5, Video 630-DX, \$15, Techmaster C-30, \$10; 1930, \$40; 2431-P, \$60. *These models equipped with Video 530-DXC-27 chassis.

TV CHASSIS SPECIAL VALUES!

all less picture tube

VIDEO 630 Super-Deluxe	\$144.50
VIDEO 630-DX Chassis	\$154.50
VIDEO 530DXC-27 for 27" Pix Tube	\$189.50
TECHMASTER C-30 TV Chassis	\$149.50
TECHMASTER 1930 TV Chassis	\$179.50
TECHMASTER 2431-P TV Chassis	\$199.50

Please include 25% deposit with orders, balance C.O.D. All shipments F.O.B. NYC. Prices Subject to change without notice.

TeleSound CORPORATION
"Designers and Manufacturers of Custom TV and Radio Furniture"
421 West 28th Street New York 1, N. Y.
Phone: WI 7-0719

Reliance Specials

SOUND POWER PHONES
Sound Powered Handset
TS-10 TYPE
Uses no batteries or external power source. Ideal for TV installation work, farms, construction projects, connecting outbuildings, etc. Includes 5 ft. cord. **\$18.95**
Pair

SOUND POWERED HEAD & CHEST SET
Navy type M head and chest set. Brand new. For work requiring free use of hands. Heavy duty—consists of headset with 2 phones and chest mike. Includes 20 ft. rubber cord. Each. **\$14.88**

COAXIAL CABLE CONNECTORS

Full line of JAN approved coaxial connectors in stock.



RG-1AC	\$0.42	PL-274	\$1.10	UG-88/U	\$0.90
RG-1AB	.50	PL-275	1.20	UG-89/U	1.10
RG-1BC	.35	SO-239	1.40	UG-102/U	.80
RG-1F	1.10	UG-113/U	1.70	UG-103/U	.68
RG-1H	.12	UG-188/U	1.05	UG-104/U	1.40
RG-1HP	.22	UG-208/U	1.60	UG-105/U	1.50
RG-1J	.73	UG-211/U	.85	UG-106/U	.15
RG-1R	.40	UG-213/U	1.30	UG-107/U	2.75
RG-1R1TY	.65	UG-21C/U	1.05	UG-146/U	2.00
RG-1SP	.45	UG-21D/U	1.45	UG-167/U	3.75
RG-1SPN	.50	UG-22/U	1.30	UG-172/U	.12
RG-1T	1.30	UG-22A/U	1.60	UG-176/U	.12
RG-2AP	1.95	UG-22B/U	1.20	UG-185/U	.95
RG-2J	2.10	UG-23/U	1.50	UG-187/U	1.65
RG-22AP	1.65	UG-23B/U	1.50	UG-203/U	.65
RG-22F	1.40	UG-23C/U	1.10	UG-224/U	1.15
RG-22J	1.40	UG-24/U	1.25	UG-225/U	1.10
RG-22P	.68	UG-27A/U	2.25	UG-281/U	1.10
RG-22SP	2.10	UG-28/U	1.90	UG-285/U	1.10
RG-22T	1.95	UG-28A/U	2.95	UG-273/U	1.45
RG-168	.12	UG-29B/U	1.75	UG-274/U	2.30
RG-185	.12	UG-29C/U	2.30	UG-290/U	.90
CW-123A/U	.45	UG-57B/U	1.85	UG-281/U	.95
M-358	1.30	UG-58/U	.70	UG-308/U	2.65
M-359	.70	UG-59/U	.90	UG-414/U	1.95
M-359A	.65	UG-59A/U	1.90	UG-499/U	1.25
PL-258	.75	UG-83/U	1.75	UG-625/U	1.35
PL-259	.50	UG-87/U	1.40	Quotations on	
PL-259A	.50			All Other Types	

NEW COAXIAL CABLES JAN APPROVED

RG 8/U	Price Per Ft.	RG 58/U	Price Per Ft.
RG 11/U	12 1/2c	RG 77/U	7 1/2c
RG 22/U	19c	RG 82/U	9c

Deduct 20% 500 ft. or more of a type.

RG-8/U Unmarked 100 ft. coil **\$5.95**

SPECIAL FILAMENT TRANSFORMER

SEC. 5V 190A. PRI. 105-125 VAC. 60 cy. 1 Phase .97 KVA. 35 KV. RMS Insulation test. 7"x10"x12"; weight 80 lbs. Ideal for use as arc welder. **ONLY \$29.50**

HARDWARE ASSORTMENT—Five Pounds

Mixed nuts, bolts, washers, pivots, solder lugs, & what not. An experimenter's nightmare. **\$2.00**

GIANT RESISTOR KIT

200 assorted 1/2 W. American made resistors—all insulated. **ONLY \$2.50**

GEAR ASSORTMENT

100 small assorted gears, bushings, & shafts. Most are stainless, or brass. An experimental **\$5.50** treasure.

OIL FILLED CONDENSERS

MFD	VDC	PRICE	MFD	VDC	PRICE
2	400	\$0.55	4	1000	\$1.59
6	400	.85	1	2000	1.30
1	600	.55	1	2000	1.95
2	600	.75	3	2000	2.75
3	600	.95	8	2000	2.95
4	600	1.75	12	2000	8.95
4-1/4	600	2.50	32	2500	15.80
5	600	1.75	1	4000	7.95
6	600	1.85	1	5000	4.88
8	600	1.85	1	6000	9.95
10	600	3.25	1	7000	1.55
50	600	7.95	1	7000	1.79
1	1000	.69	1	8000	6.50
2	1000	.95	1	10KV	29.50
			1	15KV	45.00
			1	16KV	8.95
			1	20KV	19.95
			1	50KV	24.50
			1	50KV	42.50
			1	50KV	85.00
			1	50KV	95.00

FILTER CHOKE — 10 HY
400 MA. 90 OHMS **\$4.88**
3500 VDC. Test
HERMETIC SEALED

Selsyn Motors 50V-50 cy. 3/8" D x 5/8" L. Connect in series for use on 110 V-60 cy. Like new. **Only \$12.95**

TERMS—Cash with Order or 25% Deposit—Balance C.O.D. Net 10 Days to Rated Accounts. All Prices are Net F.O.B. our Warehouse.

RELIANCE MERCHANDIZING CO.

2221 ARCH ST., PHILA. 3, PA.

NATESA'S FOURTH MEET

Fourth annual convention of the National Alliance of Television and Electronic Service Associations will be held at the Morrison Hotel in Chicago, on October 9, 10 and 11, reports Frank J. Moch, national president.

More than one thousand members of the thirty-five affiliated state groups are expected to accompany the seventy delegates, with an additional five hundred persons representing Chicago area companies, John Cecich, convention chairman, estimated.

This year's plans call for both an industry convention and product display and an open forum, to which the public is invited, and where leading authorities on television maintenance and repair will give set owners an opportunity to air their comments on TV repair service.

The Convention entertainment program will be in charge of Phil Levant, with a gala industry banquet scheduled for Saturday night, Oct. 10th. The educational program will feature Donn Mason, nationally known sales training consultant, and Dr. J. H. Hazlehurst, prominent business consultant and psychologist, both of Chicago.

PENNSYLVANIA LICENSE BILL

Paul V. Forte, executive secretary of the Television Contractors Association, has struck out against Pennsylvania House Bill, HR 839, a law to license television technicians, as "an innocuous piece of legislation." He said it will not accomplish the purpose for which it is intended, to protect the service technician and the customer.

Mr. Forte attacked the bill as unsound and asserted that there is no need for television licensing.

One section of the bill says that just complaints would be recognized and investigated. Mr. Forte said that this was a naive statement, and that there are so many complaints about television service that a fantastically large staff would be needed just to read them, much less determine which complaints are just and which are unjust.

PENNSYLVANIA PARLEY

The Federation of Radio Service Men's Associations of Pennsylvania plans to hold an Eastern Conference in Philadelphia in January, 1954, to discuss television-radio servicing and related industry problems. L. J. Helk, spokesman for the FRSMAP, said that representatives of similar servicing organizations from Maine to Florida are expected to attend.

MIDDLETON ILL

Tom Middleton, former active member in the Philadelphia and Pennsylvania service organizations, has suffered a complete breakdown in health. Tom left Philadelphia for Miami some time ago, with the hope that the climate would improve his condition.

Though his health was poor when he arrived in Florida, Tom became an active influence in the Miami service technicians' organization. His wife has

Examine Free

Take your pick of these authoritative books on modern electronic theory and practice . . . and we will send the ones you select for 10 DAYS' FREE EXAMINATION. Just fill in and mail coupon below.

Prentice-Hall Electronic Books

ELECTRONIC FUNDAMENTALS AND APPLICATIONS, by John D. Ryder. Complete, logical, easy-to-follow treatment of (a) physical principles underlying electron tubes, (b) characteristics of vacuum tubes, (c) all basic tube circuits. 806 pages. Price, \$10.00

PULSE TECHNIQUES, by S. Moskowitz, and J. Racker. Covers transient response of linear networks, design of pulse networks, pulse shaping and clamp circuits, pulse generation, measurement and instruments, communication systems and aerial navigation aids. 300 pages. Price \$6.65

ULTRAHIGH FREQUENCY ENGINEERING, by Thomas L. Martin. Theory and technique of ALL the new fields of electronic engineering: Radar, Telemetering, Electronic computing, Facsimile, Television, Blind landing systems, Pulse-time modulation, and the others. 456 pages. Price, \$8.00

INDUSTRIAL ELECTRONIC ENGINEERING, by W. L. Davis and H. R. Weed. Covers industrial timing circuits, servomechanisms, electronic control of motors, radio frequency heating and other important uses of electronics in industry today. 450 pages. Price, \$11.35

RECURRENT ELECTRICAL TRANSIENTS, by L. W. Von Tersch and A. W. Swago. Thorough coverage of the basic concepts of recurrent electrical transients, and their application in television, nuclear instrumentation, radar, computing devices, and industrial controls. 399 pages. Price, \$10.35

ELECTROMAGNETIC WAVES AND RADIATING SYSTEMS, by Edward C. Jordan. Covers entire field of electromagnetic engineering. Includes propagation as well as radiation and transmission. Full treatment of UHF transmission lines, wave guides, antennas, radiation and diffraction, ground-wave and sky-wave propagation. 710 pages. Price, \$10.35

ELEMENTS OF TELEVISION SYSTEMS, by George E. Anner. Complete basic theory, plus current practice, covering: Closed TV systems, Commercial Telecasting Systems, Color TV Systems. 804 pages. Price, \$10.35

BASIC ELECTRICAL MEASUREMENTS, by M. B. Stout. 504 pages. Price, \$8.00

FUNDAMENTALS OF ELECTRICAL ENGINEERING, by Fred A. Pumphrey. 668 pages. Price, \$8.65

CIRCUITS IN ELECTRICAL ENGINEERING, by Charles R. Vail. 560 pages. Price, \$8.70

RADIO SERVICING, by A. Marcus. 775 pages. Price, \$5.95

TELEVISION SERVICING, by Walter H. Buchsbam. Price, \$5.35

MAIL THIS COUPON

Prentice-Hall, Inc., Dept. M-RE-1053
70 Fifth Ave., New York 11, N.Y.

Send me, for 10 DAYS' FREE EXAMINATION, the books indicated below. After ten days' trial, I will either return them without obligation, or remit the price indicated.

Title..... Price, \$.....

Title..... Price, \$.....

Title..... Price, \$.....

Name.....

Address.....

City.....Zone...State.....

there must be a reason that more

QUIETROLE
TRADE MARK REG. U.S. PAT. OFF.

is being **SOLD!***



More Servicemen are finding that only QUIETROLE, the original, non-conductive, non-inflammable Lubri-Cleaner will assure positive quietness to noisy TV and radio controls and switches. It does so much, yet, costs so little.

Carried by leading jobbers everywhere!

manufactured by

QUIETROLE COMPANY
Spartanburg, South Carolina



STOP!

TV INTERFERENCE



Eliminates interference caused by Short Wave... F.M. Hams... Diathermy... Atmospheric disturbances, etc.

With a TELEMATIC Full Range FILTER KIT

SIMPLE — SPEEDY — EFFICIENT

- Eliminates antenna-fed interference!
- Covers full-range both I.F. and R.F. Sharper, steadier picture!
- Fewer service recalls!
- Any filter in kit replaceable separately!

FILTER KIT contains 2 Hi-Pass Filters, 4 WAVE TRAPS covering full range of interference signals. Send for **FREE** Booklet on TV-INTERFERENCE

TELEMATIC
9 SOLEMON ST. BROOKLYN 2, N. Y.

informed us that it will be necessary for him to have complete rest, and that they expected to return to Philadelphia in August. Meanwhile the service technicians of Miami were helping to liquidate his business in that city.

NEW TRADE ASSOCIATION

The formation of the Utah Association of Radio and Television Servicemen has been announced by D. Pieper, general manager. The association was incorporated as a nonprofit, educational unit, with the basic purpose of promoting the welfare, progress, and well-being of the radio and television service industry in the State of Utah.

The aims and objectives of the association include the following: Establishment of suggested minimum rates and charges, assuring all members of fair and equitable returns for work and services performed; protection of the industry through voluntary beneficial policies and regulations; promotion of legislation that is affirmative and responsive to the growth and progress of the industry as a whole; and initiation of a broad, comprehensive public relations campaign, to better acquaint the public with the industry.

PHILLY LAUNCHES CAMPAIGN

The Television Service Dealers Association of Philadelphia have announced a series of 18 newspaper advertisements promoting TSDA's members' facilities. A sum of \$1,200 was voted unanimously by the association to cover the costs of the campaign.

TSDA has set up offices at 6021 Ogontz Avenue, with a central telephone system to channel requests for service to the nearest member shop.

A grievance committee has been appointed to investigate all customer complaints. Industrial and Public Relations Committees have also been set up, with Dave Krantz as chairman of the former and Edward Strychowski of the latter.

THE "SERVICE-SAVER"

A new and unique method of helping television technicians diagnose and repair troubles in a television set was described recently by Carroll W. Hoshour, director of Raytheon Sales Engineering.

The new device, which means "more efficient and economical service" for television set owners, consists of a booklet containing photographs of 40 possible troubles that could occur with a TV set's picture. Each picture is numbered for easy identification. When something goes wrong with the set, the owner calls his service technician and tells him, "My picture looks like number seven, or ten, or twenty-four."

In the Raytheon Service manual that is distributed to all television technicians, there is also a "Service Saver" section that shows the same numbered 40 conditions, and gives schematic diagrams of the circuits and what causes the trouble, plus a complete list of parts and tubes that might be involved. It also contains hints and kinks for quick repair—what to test, and what component might be causing the difficulty.

WORLD'S LARGEST MANUFACTURER OF CUSTOM BUILT TELEVISION

MATTISON

SILVER ROCKET 630 CHASSIS
• with **TUNEABLE** •

BUILT-IN BOOSTER
for Better DX Reception

Featuring **NEW CASCODE TUNER** made for UHF interchangeable tuning strips and **COSINE YOKE**

Tube Complement:
28 tubes
3 rectifiers
1 CRT

32



All Channel Booster

- Broad band single knob control pre-amplifier built in to eliminate long leads which may cause regeneration and attenuation of signal.
- **ONLY THE MATTISON 630 CHASSIS HAS AN ALL CHANNEL TUNEABLE BUILT-IN BOOSTER THAT INCREASES SIGNAL STRENGTH UP TO 10 TIMES. THE SILVER ROCKET WILL OUTPERFORM ANY CHASSIS MADE AND IS PRICED RIGHT TO SELL FAST WITH AN EXTRAORDINARY MARGIN OF PROFIT FOR YOU. ALSO AVAILABLE WITHOUT BOOSTER.**

Available for **IMMEDIATE DELIVERY!**

Silver Rocket for 27" Operation

ANNOUNCING the New **AMBASSADOR** for 1954

The only open face console made in every expensive decorator finish . . . on guaranteed genuine mahogany, walnut, oak and other rare woods!



The AMBASSADOR 21" and 27"
Best Looking . . . Best Value, Too!

Full size console for eye level television. Available in every expensive decorator finish. Featuring removable safety glass. ALL CABINETS MADE IN MATTISON'S OWN CABINET FACTORY.

DEALERS! SERVICE DEALERS! Here is your opportunity to become the "important" TV Dealer in your area for the **FINEST CUSTOM-BUILT LINE OF TV RECEIVERS. FREE!** Write for Mattison's merchandising portfolio explaining the "UNASSEMBLED PLAN" and "\$1,000,000 FLOOR PLAN."



When you buy from Mattison you need only one source of supply! You can buy a Mattison Chassis, a Mattison Cabinet or a complete Mattison TV Set!

Manufactured with integrity

Mattison Television & Radio Corp.
10 West 181st St., Dept. RE, N.Y. 53, N.Y.

"ON TOP OF-THE-STATION RECEPTION" in the FRINGE AREAS

OUT PERFORMS all other VHF Antennas!

BJ-2

These "BIG JACK" Antennas are performing with outstanding success in many areas. Near-station installations of the BJ-1 provide a higher gain and clearer picture on all VHF channels in range. The BJ-2, for fringe area installations, has provided excellent reception where other antennas have failed.

Kay-Townes superior constructions and engineering details plus fringe area "Know-How" make the BIG JACK series the greatest high-gain VHF antennas ever built.

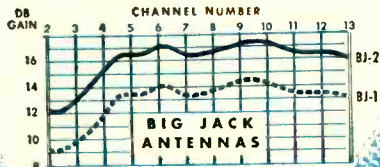
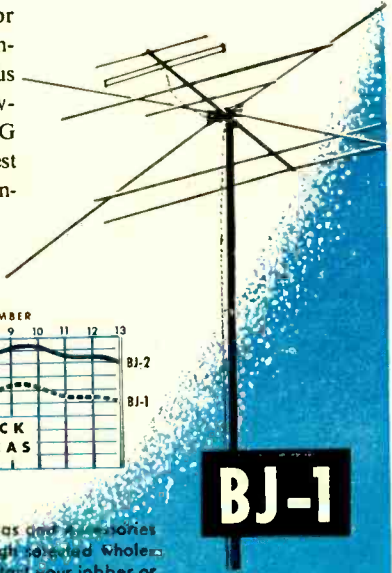

Kay-Townes Antennas and accessories are sold only through selected Wholesale outlets. Contact your jobber or write for name of nearest distributor.

BJ-1

THE BEST SET IS ONLY AS GOOD AS ITS ANTENNA!

KAY-TOWNES ANTENNA CO.
BOX 586, ROME, GA.

NEW DEVICES

ADJUSTABLE ION TRAP

J. W. Miller Co., 5917 S. Main St., Los Angeles, Calif., has developed the new type 6285 single-field adjustable ion trap having a variable gauss range of 32 to 55. The strength of the magnetic

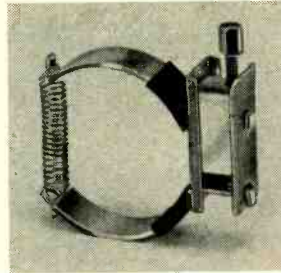

field is varied by turning a small screw which moves a slug back and forth in the field of the ion-trap magnet.

TEST SOCKET ADAPTER

Pomona Electronics Co., 524 W. Fifth Ave., Pomona, Calif., has announced the Peco TVS-1 Duo-Decal test socket adapter. The unit permits operating tests on all circuits going into the television tube socket while the set is in operation.

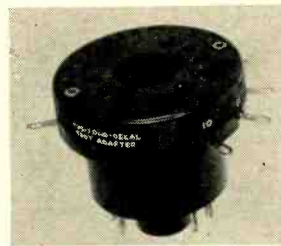

The TVS-1 is inserted between the C-R tube base and its socket to complete the circuit and make all connections accessible to meter test leads. Measurements can be made without tracing circuit wiring to test points below chassis.

AUDIO TRANSFORMERS

Triad Transformer Corp., 4055 Redwood Ave., Venice, Calif., has added the JAF series of miniature audio transformers to their line. For use with transistor or tube amplifying equipment, these magnetically shielded, hermetically sealed units cover the audio-frequency range.

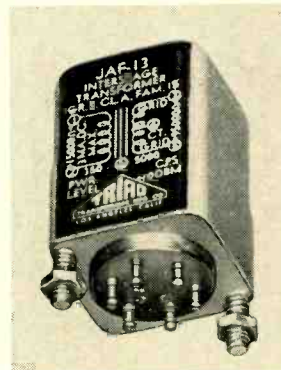

The JAF line is available in standard MIL cases with mounting studs so arranged that transformers may be mounted in closest possible proximity to each other. Information for each transformer is carried on a permanently attached decal.

TV REMOTE CONTROL

Blonder-Tongue Laboratories, Inc., 526-536 North Avenue, Westfield, N. J., is distributing the new RCI remote-control unit for controlling TV boosters, u.h.f. converters, distribution units, and many other remote electrical accessories from a single on-off switch. The control unit consists of the RCI-P

power unit and the RCI-R remote unit. The RCI-P plugs into any 117-volt a.c. outlet and receives the line cord of the TV receiver, audio preamplifier, or other device containing the a.c. line switch. It contains a thermal relay, indicator light, and fuses. The RCI-R, located at the unit to be controlled, is connected to the power unit through a single heavy-duty 300-ohm line. This line carries a.c. to the remote apparatus and serves as a transmission line for TV signals coming

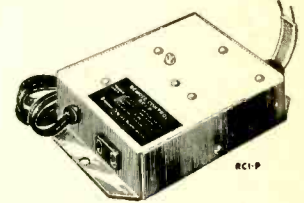

down from the antenna. Both sides of the slave unit are fused to comply with the code of the National Board of Fire Underwriters. Any unit drawing 100 watts at 117 volts can be operated at distances up to 1,000 feet or more with this control system.

UHF CONVERTER

Walsco Electronics Corp., 3225 Exposition Place, Los Angeles, Calif., is introducing the new Walsco Imperial all-channel u.h.f. converter which features the new Turretune tuning system—a turret-type bandspread tuning unit with a double-tuned preselector. The tuned circuits have a constant L-C ratio throughout its range. The oscillator uses a balanced-line circuit for minimum frequency drift. Input terminals are provided for separate



u.h.f. and v.h.f. antennas. The cabinet is available in a wide variety of colors to blend with modern interiors.

VHF YAGI

Technical Appliance Corp., Sherburne, N. Y., has announced a broad-band, triple-driven v.h.f. Yagi for channels 2-6. The antenna consists of three directors and three driven elements, plus reflector. Gain is of the order of 7 db throughout the low band.

Primarily designed for fringe areas receiving two or more low-band channels, the No. 1840 antenna is also recommended for areas in which a channel change is contemplated. This new antenna eliminates the need for

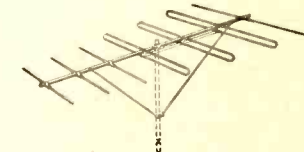

multiantenna installations for low-band reception and the ensuing multi-transmission lines and switching devices otherwise employed.

V.H.F. ANTENNA

Wells & Winegard, Burlington, Iowa has introduced the model CP-1 Clipper v.h.f. antenna for fringe areas. Manufacturer claims high uniform gain and good front-to-back ratio.

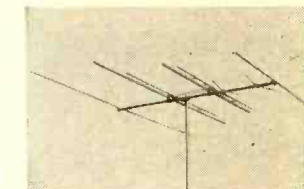

CRYSTAL MICROPHONE

Shure Brothers, Inc., 225 W. Huron St., Chicago 10, Ill., has announced an all-purpose crystal microphone, the model 777. This unit can be used on desk or floor stand, in the hand, or around the neck.



The model 777 has a frequency response of 60-10,000 c.p.s., is 4 1/2-inches long x 1-inch wide, and is finished in chrome.

INDOOR U.H.F. ANTENNA

The Hi-Lo Antenna Corp., 3540 N. Ravenswood Ave., Chicago 13, Ill., has announced their model 303 *Twin Arrow* indoor antenna for u.h.f. The twin arrows may be adjusted for local areas. The upright and crossbar are gold-colored, and the base is of lightweight brown plastic.

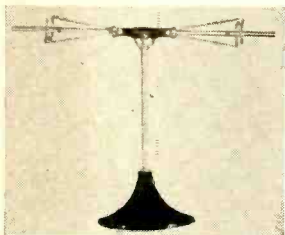

HOME MUSIC ASSEMBLY

Radio Craftsmen, Inc., 4401 N. Ravenswood Ave., Chicago 40, Ill., has announced a home music assembly for the high-fidelity enthusiast.

All the units for a complete home-music system are provided in a single carton, complete with a changer mounting board, all necessary connecting cables, mounting hardware, detailed yet simple connecting instructions, and drawings of typical cabinets, including a horn-loaded corner speaker cabinet.



Included in the assembly, known as the Craftsmen CA1 are the C10 FM-AM tuner, a C400 10-watt amplifier, a 3-speed automatic record changer, and a 12-inch speaker system with a range of 40 to 16,000 c.p.s.

SIGNAL GENERATOR

Hickok Electrical Instrument Co., 10514 Dupont Avenue, Cleveland 8, Ohio, has announced the model 292XAL airline microvolt signal generator, which provides continuous coverage from 125 kc to 165 mc on fundamentals.

The generator covers the aircraft band, including all the necessary intermediate frequencies and covers all radio frequencies with calibrated out-

put. It can be externally modulated from 15 to 10,000 c.p.s., and measures both input and output of units under test.



COLOR CODE UNIT

Centralab, Division of Globe-Union, Inc., 900 E. Keefe Ave., Milwaukee 1, Wis., is producing a color code calculator covering both capacitors and resistors.

The calculator is printed in full color. By setting seven rotating wheels, capacitance or resistance, tolerance, and temperature coefficient can be read directly. The calculator covers RETMA color code specifications on normal- and extended-range tubular ceramic capacitors and radial- or axial-lead resistors.

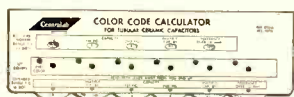

WALL BAFFLES

Utah Radio Products Co., Inc., Huntington, Ind., has announced the Utone line of wall baffles. They are obtainable in 6-, 8-, 10-, and 12-inch sizes in brown, red mahogany, limed oak, and unfinished.

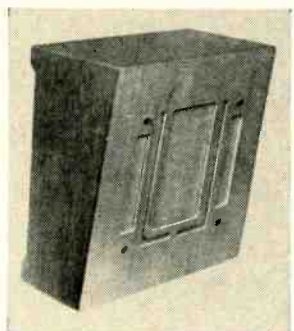

REPLACEMENT UNITS

The Standard Division of the Chicago Standard Transformer Corp., has added five TV replacement components to the Stancor line.

They include a new exact replacement flyback transformer, A-8137, exact duplicate of Hoffman No.5035, used in 25 Hoffman models and chassis, and A-8126, universal Philco replacement vertical blocking oscillator transformer. A-8126 can be used in all Philco TV models and chassis built up to the spring of 1953.

Two width controls, WC-1 and WC-4, and a tapped linearity coil, WC-2, also have been added.

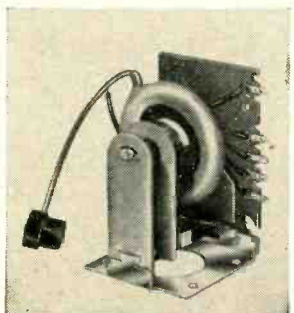

THE *Greatest*
UHF-VHF
ANTENNAS
EVER BUILT!

FAR-REACHING
and PHOTO-CLEAR
RECEPTION!

HIGHER GAIN
on all Channels 2-83

BJU-2

Original, revolutionary design... FIXED IMPEDANCE* Point System provides All-Channel, High-Gain reception with a single transmission line.

Kay-Townes' BJU Antennas are the recognized leaders in the field of low-picture, high-gain, trouble-free UHF-VHF antenna performance! Simplified, but more exacting and effective engineering has resulted in "bug-free" antennas that provide photo-clear reception. One lead-in wire only. No matching pads or isolation filters... no coils or condensers... which tend to cut down signals.

BJU-1

*Pat. Applied For

THE BEST SET IS ONLY AS GOOD AS ITS ANTENNA!

KAY-TOWNES
ANTENNA CO.
BOX 586, ROME, GA.

Compare... prove EMC superiority

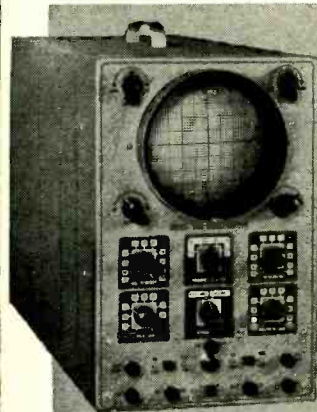

model 600

EMC MODEL 600 SCOPE features the use of a SUP1 new 5 inch scope tube. The 2-stage, push pull, vertical amplifier has a sensitivity of .02 volts per inch and can be used up to 5 megacycles. A two step attenuator input is available. Synchronization is available on either positive or negative phase of input voltage through the vertical amplifier or from an external source. A multi-vibrator type of sweep from 15 cycles to 75 kilocycles is incorporated. Direct connections to scope plate available.

MODEL 600 (completely wired and tested) \$99.50

model 106 VACUUM TUBE VOLTMETER

Check these features
SPECIFICATIONS



All functions completely electronic — meter cannot burn out.
DC VOLTAGE: Input resistance 16.5 megs or 1 1/3 megahms per volt. Ranges 0 to 1.5, 10, 100, 300, 1000 up to 30,000 volts (with accessory probe).
AC VOLTAGE: Input resistance 2 megohms. Ranges 0 to 1.5, 10, 100, 300, 1000, frequency response flat from: 25-100,000 cycles.
OHMS: 1000 — 10,000 — 100,000 — 10 megohms, 1000 megahms.
COMPACT, portable bakelite case measures 4 1/4 x 5 1/4 x 2 3/8"

- MODEL 106 (complete with 1 meg isolating probe) \$35.90
- IN KIT FORM 23.90
- MODEL HVP, 30000 Volt Probe for Model 106 8.75
- MODEL RFP, High Frequency Probe (useful to 300 megacycles) 6.95

— See them at your Jobbers —

EMC

Write Dept. RE-10
for Free Complete
Catalogue of these
and other Instru-
ments.

ELECTRONIC MEASUREMENTS CORPORATION
280 LAFAYETTE STREET • NEW YORK 17, N. Y.

EXPORT DEPARTMENT 136 LIBERTY STREET • NEW YORK 6, N. Y.

U.H.F. ANTENNA

General Antenna Manufacturing Co., 1652 Rockwell Ave., Cleveland 14, Ohio, is producing an outdoor u.h.f. antenna reported effective up to 50 miles, depending on local conditions.

The 500-U has a low vertical radiation angle, low standing wave ratio, and 300-ohm terminal impedance.

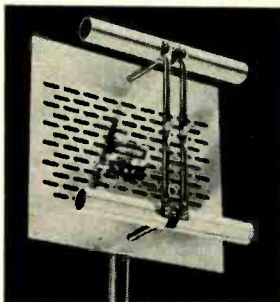

VOLTAGE REGULATOR

Perma-Power Co., 4727 N. Damen Ave., Chicago 25, Ill., has announced a TV voltage regulator, which returns full height and width of picture when it is distorted by low line voltage.



The unit has a 300-watt rating. A selector switch permits boosting or lowering of voltage.

HIGH-FIDELITY SPEAKER

Oxford Electric Corp., 3911 South Michigan Ave., Chicago 15, Ill., has announced a 15-inch speaker, No. HF15LN. The unit has a frequency range of 50 to 10,000 c.p.s., a 14-ounce Alnico V magnet, 25 watts power rating, an input impedance of 8 ohms and a 1/2-inch-diameter voice coil.

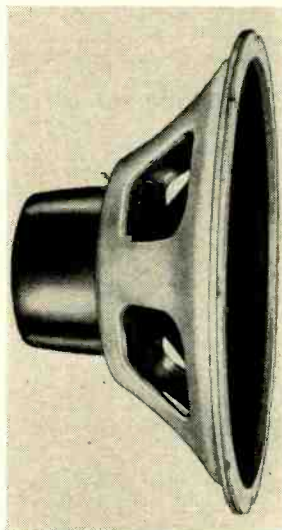

TVI ANALYZER

Tele-Matic Industries, Inc., 1 Joralemon St., Brooklyn 1, N. Y., is producing a TVI analyzer to identify TV interfering signals.

A cross-index scale indicates what wave trap or filter is needed to eliminate interference. The analyzer contains a high-pass and ignition filter

section, an a.c. line filter section, and a full range of calibrated wave traps.

The unit is housed in a compact steel case with carrying handle measuring 5 1/2 x 7-inches, and can be carried in a service technician's kit.



AUDIO ITEMS

RCA Victor Division of RCA, Camden, N. J., has announced three audio equipment items for AM-FM and TV stations. These are the type BA-12A utility amplifier, the LC-6A speaker mechanism and associated wall housing, and a microphone boom stand.

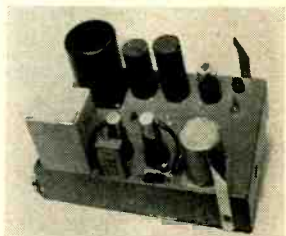

The BA-12A amplifier can serve as a microphone preamplifier, a turntable booster amplifier, a line amplifier, or an isolation amplifier. The 2-stage unit has a frequency response of ± 1 db 30 to 15,000 cycles.

LEARNER'S KIT

Progressive Electronics Co., 497 Union Ave., Brooklyn 11, N. Y., has announced its 1954 *Edu-Kit*, which features a new instruction book and a newly designed tester and manual. Circuits of a signal tracer, code oscillator, receivers and transmitters are included.

NEW CAPACITOR

Cornell-Dubilier Electric Corp., South Plainfield, N. J., has developed a molded tubular capacitor, the *CUB*, for general replacement service.



The unit is molded in mica-base bakelite. The 200- and 400-volt series are impregnated with HT compound, and the 600-volt and up series with Dykanol "C" oil. It is dry-assembly processed and sealed immediately after impregnation.

NEW OSCILLOGRAPH

The Instrument Division, Allen B. DuMont Laboratories, Inc., 760 Bloomfield Ave., Clifton, N. J., has announced that an electrical equivalent of the well-known DuMont-type 304-A cathode-ray oscillograph is now available as a rack-mounted unit. The rack-mounted version is designated as the type 304-AR, and features the same built-in voltage calibration as the type 304-A. The illuminated screen is specially calibrated for reading any portion of the signal directly in volts. The screen is calibrated by a push-button control on the operating panel which applies a standardizing potential to the screen.

The type 304-AR incorporates a flat-faced, tight-tolerance cathode-ray tube, type 5ADP, to increase accuracy of measurement. Voltage-reading range on a 4-inch scale is from 0.10 volt to 1,000 volts, full scale. Frequency response is flat at d.c. and extends to 300 kc, 50% down. END

All specifications given on these pages are from manufacturers' data.

BIG

the V-O-M with the BIG dial

SIMPSON'S NEW MODEL 269 VOLT-OHM-MICROAMMETER!

100,000 OHMS PER VOLT

Never before available commercially a Volt-Ohm-Microammeter with this sensitivity . 7 inch dial in 7 inch case . Read 33 Ranges direct on the dial . The biggest dial in the smallest possible case . It is ideal for voltage measurements in high resistance circuits . May be used in place of Vacuum Tube Volt Meter for many voltage and resistance measurements . Complete with Operator's Manual, pair of test leads with removable alligator clips, 4000 volt DC probe extension . . . only \$88.00

RANGES FOR MODEL 269

DC Voltage

0-1.6 volts	} 100,000 ohms per volt sensitivity
0-8 volts	
0-40 volts	
0-160 volts	
0-400 volts	
0-1600 volts	
0-4000 volts	

AC Voltage

0-3 volts	} 5,000 ohms per volt sensitivity
0-8 volts	
0-40 volts	
0-160 volts	
0-800 volts	

AF Output Voltage

0-3 volts	} 0.1 microfarad internal series capacitor
0-8 volts	
0-40 volts	
0-160 volts	

Volume Level in Decibels

- 12 to +11 decibels	} Zero DB Power Level .001 watt in 600 ohms
- 3.5 to +19.5 decibels	
+10.5 to +33.5 decibels	
+22.5 to +45.5 decibels	

DC Resistance

0-2,000 ohms (18 ohms center)
0-20,000 ohms (180 ohms center)
0-200,000 ohms (1800 ohms center)
0-2 megohms (18,000 ohms center)
0-20 megohms (180,000 ohms center)
0-200 megohms (1.8 megohms center)

DC Current

0-16 microamperes	} 267 millivolts maximum drop
0-160 microamperes	
0-1.6 milliamperes	
0-16 milliamperes	
0-160 milliamperes	
0-1.6 amperes	
0-16 amperes	

ALSO, SIMPSON'S NEW MODEL 262 VOLT-OHM-MILLIAMMETER!

20,000 OHMS PER VOLT SENSITIVITY \$68.00!

SIMPSON ELECTRIC COMPANY 5200 W. Kinzie Street Chicago 44, Illinois ESTebrook 9-1121

In Canada: Bach-Simpson, Ltd., London, Ontario

WANTED

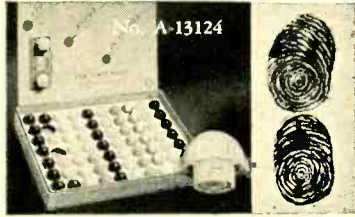

By DEALERS, SERVICEMEN and others.

Suspected of willfully aiding and abetting them in saving time and satisfying customers.

Name . . . **WALDOM'S AUTO KNOB ASSORTMENT**

Description . . . 70 CRONAME tenite knobs in assorted colors. Knobs are 7/8" in diameter and will fit 3/16" flatted shaft. Set screws included. Housed in attractive display box. Answers to No. A-13124

SPECIAL BULLETIN

Knob Assortments answering to above charge and description have been apprehended by your local parts distributor, assisted by Waldom Electronics Inc., 911 N. Lorabee St., Chicago 10, Illinois.

For the very best yet in



- science fiction stories
- articles
- features
- illustrations

READ SCIENCE-FICTION PLUS

December issue on sale October 9

Read the exciting and stimulating stories of science-fiction masters like Harry Bates, Murray Leinster, Eric Frank Russell and many, many others. Ponder over the challenging article "Extra-Terrestrial Communication" by Leslie R. Shepherd. See the finest science illustrations published anywhere, by such top flight artists as Frank R. Paul, Virgil Finlay and Lawrence.

On sale at all better newsstands, 35¢.

BUILD 15 RADIOS ONLY AT HOME \$19⁹⁵

With the New Improved 1954 Progressive Radio "EDU-KIT"

NOW INCLUDES SIGNAL TRACER and CODE OSCILLATOR



- FREE TOOLS WITH KIT
- ABSOLUTELY NO KNOWLEDGE OF RADIO NECESSARY
- NO ADDITIONAL PARTS NEEDED
- EXCELLENT BACKGROUND FOR TV
- 10 DAY MONEY-BACK GUARANTEE

WHAT THE PROGRESSIVE RADIO "EDU-KIT" OFFERS YOU

The Progressive Radio "Edu-Kit" offers you a home study course at a rock bottom price. Our Kit is designed to train Radio Technicians, with the basic facts of Radio Theory and Construction Practice expressed simply and clearly. You will gain a knowledge of basic Radio Principles involved in Radio Reception, Radio Transmission and Audio Amplification.

You will learn how to identify Radio Symbols and Diagrams; how to build radios, using regular radio circuit schematics; how to mount various radio parts; how to wire and solder in a professional manner. You will learn how to operate Receivers, Transmitters, and Audio Amplifiers. You will learn how to service and trouble-shoot radios. You will learn code. You will receive training for F.C.C. license.

In brief, you will receive a basic education in Radio exactly like the kind you would expect to receive in a Radio Course costing several hundreds of dollars.

THE KIT FOR EVERYONE

The Progressive Radio "Edu-Kit" was specifically prepared for any person who has a desire to learn Radio. The Kit has been used successfully by young and old in all parts of the world. It is not necessary that you have even the slightest background in science or radio.

The Progressive Radio "Edu-Kit" is used by many Radio Schools and Clubs in this country and abroad. It is used by the Veterans Administration for Vocational Guidance and Training.

The Progressive Radio "Edu-Kit" requires no instructor. All instructions are included. All parts are individually boxed, and identified by name, photograph and diagram. Every step involved in building these sets is carefully explained. You cannot make a mistake.

PROGRESSIVE TEACHING METHOD

The Progressive Radio "Edu-Kit" comes complete with instructions. These instructions are arranged in a clear, simple and progressive manner. The theory of Radio Reception, Radio Transmission, Audio Amplification and servicing by Signal Tracing is clearly explained. Every part is identified by photograph and diagram. You will learn the function and theory of every part used.

The Progressive Radio "Edu-Kit" uses the principle of "Learn by Doing". Therefore you will build radios to illustrate the principles which you learn. These radios are designed in a modern manner, according to the best principles of present-day educational practice. You begin by building a simple radio. The next set that you build is slightly more advanced. Gradually, in a progressive manner, you will find yourself constructing still more advanced radio sets, and doing work like a professional Radio Technician. Altogether you will build fifteen radios, including Receivers, Transmitters, Amplifiers, Code Oscillator and Signal Tracer. These sets operate on 105-125 V. AC/DC.

THE PROGRESSIVE RADIO "EDU-KIT" IS COMPLETE

You will receive every part necessary to build 15 different radio sets. Our kits contain tubes, tube sockets, chassis, variable condensers, electrolytic condensers, mica condensers, paper condensers, resistors, line cords, selenium rectifiers, tie strips, coils, hardware, tubing, hook-up wire, solder, etc.

Every part that you need is included. These parts are individually packaged, so that you can easily identify every item. Tools are included, as well as an Electrical and Radio Tester. Complete, easy-to-follow instructions are provided.

In addition, the "Edu-Kit" now contains lessons for servicing with the Progressive Signal Tracer, F.C.C. instructions, quizzes. The "Edu-Kit" is a complete radio course, down to the smallest detail.

TROUBLE-SHOOTING LESSONS

Trouble-shooting and servicing are included. You will be taught to recognize and repair troubles. You will build and learn to operate a professional Signal Tracer. You receive an Electrical and Radio Tester, and learn to use it for radio repairs. While you are learning in this practical way, you will be able to do many a repair job for your neighbors and friends, and charge fees which will far exceed the cost of the "Edu-Kit". Here is your opportunity to learn radio quickly and easily, and have others pay for it. Our Consultation Service will help you with any technical problems which you may have.

FREE EXTRAS

- ELECTRICAL AND RADIO TESTER
- ELECTRIC SOLDERING IRON
- BOOK ON TELEVISION
- RADIO TROUBLE-SHOOTING GUIDE
- MEMBERSHIP IN RADIO-TELEVISION CLUB
- CONSULTATION SERVICE
- QUIZZES
- TRAINING FOR F.C.C. LICENSE

Send me the "Edu-Kit" with 10 Day Money-Back Guarantee—include All FREE extras. Send further information.

Check or M.O. enclosed—postage prepaid C.O.D. (U. S. Only)—I will pay postage

NAME _____
ADDRESS _____
Outside U.S.A.—cash orders only; send international M.O. or check on U.S. bank. Postage Prepaid. "Edu-Kit" for 210-250 V. AC/DC \$22.45

PROGRESSIVE ELECTRONICS CO.

497 UNION AVE., Dept. RE-76, Brooklyn 11, N. Y.

100,000 Ohms per Volt sensitivity



Simpson

ALL-CHANNEL UHF CONVERTER



Model BTU-2 Ultraverter

Ultra POWERFUL

Ultra DEPENDABLE

MORE POWER

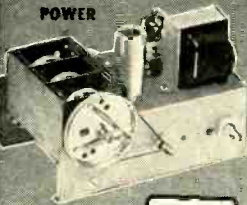

GREATER STABILITY
EASIER TUNING



Employing the newly developed B-T Ultratuner, the B-T Ultraverter, Model BTU-2, provides for reception of all UHF channels on any TV set with quality unmatched by any converter, regardless of price. 'On/off' operation is automatically controlled by the power switch on the TV receiver. Terminals are provided for both VHF and UHF antennas.

Advanced circuit design assures high gain, high stability, and lowest noise performance. A high ratio vernier knob permits easy, accurate tuning on UHF channels from 14 through 83. Tube complement: 6T4/6AF4, 6AB4, and Germanium Diode, 1N72.

\$3995

BLONDER-TONGUE LABORATORIES

Manufacturers of TELEVISION AMPLIFIERS, UHF CONVERTERS, MIXERS, D-DISTRIBUTION UNITS and TV ACCESSORIES WESTFIELD, N. J.

WITH THE *Scala*

SUPER MARKER INJECTOR \$67.50

SAVE UP TO 75% IN TIME

ON ALIGNMENT

SAVES TIME—Marker size determined by instrument setting only. Not affected by characteristics or defects of circuits being aligned. Only one setup for each section (video I.F., sound I.F., detector or tuner) regardless of number of stages.

NOTHING ELSE to buy—can be used with your present marker generator, sweep generator and oscilloscope.

AVAILABLE AT LEADING JOBBERS

SCALA RADIO COMPANY

2814—19th ST., SAN FRANCISCO, 10



STABLE D.C. AMPLIFIER

Patent No. 2,620,406
Robert P. Nelson, Southbridge, Mass.
(Assigned to Philco Corp., Philadelphia, Pa.)

Direct-coupled circuits must be used for amplifying d.c. or very low frequencies, but unfortunately the gain of any circuit that responds to slow signal variations is also affected by even minor fluctuations in supply voltages. These changes in gain can be minimized by using carefully balanced push-pull stages throughout, large amounts of inverse feedback, and closely regulated power supplies, all of which call for very complex circuit arrangements.

This invention is a *single-ended* direct-coupled amplifier that is compensated against the effects of changes in supply voltages. The first two triodes (12AX7) are the d.c. amplifier. The third triode (one half of a 12AU7) draws considerably more plate current than the output section of the 12AX7, and determines the voltage drop across R1.

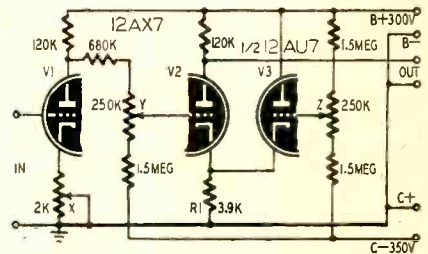

The bias on V2 is the sum of the drop across R1 and the negative voltage from the C supply at the slider of potentiometer Y. If the C supply voltage increases, the grid of V2 goes more negative. At the same time the V3 grid also receives a more negative bias. This reduces the current through R1. At the correct setting of potentiometer Z, the change in V3 current will restore the bias on V2 to normal.

V1 is especially sensitive to changes in the B supply because these variations are amplified by the following stage. Assume an increase in the supply voltage. This increases the V1 cathode current and raises the bias on its grid. The increase in bias *reduces* the cathode current again—but not necessarily to the original level, unless the cathode resistor has a certain critical value. By making the cathode resistor adjustable, a setting can be found that will hold the V1 plate current constant regardless of changes in the B supply voltage.

According to the inventor, circuit adjustments should be made in the following order: First set Y for desired output. Then adjust Z to compensate for drift in the bias supply. Finally, set X to neutralize variations in B voltage.

DELAY CIRCUIT

Patent No. 2,635,185
Robert F. Casey, Pompton Plains, N. J.
(Assigned to Allen B. Du Mont Laboratories, Inc., Clifton, N. J.)

Delay circuits are sometimes troubled by time-jitter. Hum modulation, thermal agitation, voltage drift, and other circuit variations may affect the delay interval and cause erratic operation. The circuit shown here has been engineered to prevent time-jitter. The input signal—a negative pulse—initiates a square-wave output. The wave lasts for a short but definite time. The interval between the leading and trailing edges of the square wave is the desired time delay. It remains constant and under control at all times.

The 2-tube circuit functions as follows:

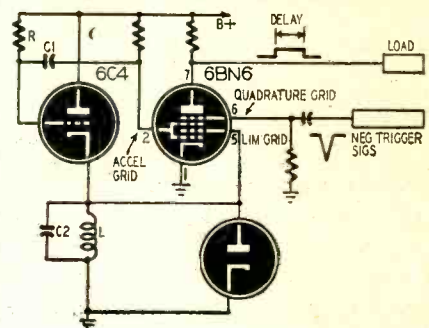

Just Out

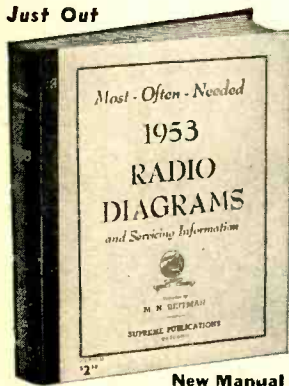

New Supreme 1953 Radio Manual

Now you can benefit and save money with Supreme amazing scoop of 1953. This one giant volume has all the service data you need on all recent radio sets. A full year of models of all popular makes, home and auto sets, portable radios, combinations, changers, all included. The full price for this mammoth 1953 manual is only \$2.50, nothing else to buy for a whole year. Other Supreme radio service volumes for previous years (mostly at \$2), TV, and UHF manuals are described below and at right.



SUPREME RADIO MANUALS FOR PREVIOUS YEARS

Use Supreme manuals to repair all radios faster, easier; save time and make more money. Here is your lowest-priced service data. Covers all years, from 1926-38 to 1953 models, in 13 volumes. Used by 141,000 shrewd servicemen. Most volumes only \$2 each, see coupon. Average volume 192 large pages, 8½x11 inches. Quality printing, manual-style binding. Amazing values. Be wise, use these manuals to get all needed diagrams, parts lists, alignment facts, at the smallest cost. Send no-risk coupon.

SUPREME TELEVISION SERIES

Here is your complete source of TV and UHF service data. These manuals at only \$3, \$2, and \$1.50 each are amazing bargains and defy competition. Each manual covers a whole year of models, using original factory material. Include giant double-spread circuits and blueprints, alignment procedure, voltage charts, test patterns, wave forms, factory revisions, and helpful service hints. Select volumes from list below and send no-risk coupon.



1953 TV, \$3
New giant volume of TV factory data has everything you need on recent sets. 192 pages, 8½ x 11", + double-spread blueprints. Only...\$3
1952 TV Manual, \$3
1951 TV Manual, \$3
1950 TV Manual, \$3
1949 TV Manual, \$3
1948 TV Manual, \$3
1947 FM & TV, \$2
1953 UHF Units \$1.50

New Manual
Learn to repair quickly all new 1953 radio receivers. In this big single volume you have easy-to-use, extra large schematics, needed alignment data, replacement parts lists, voltage values, and information on stage gain, location of trimmers, and dial stringing. For almost every 1953 radio. Giant size, 8½x11", manual style, sturdy binding. Price, only **\$2.50**

RADIO-ELECTRONICS

NEW AMAZING HOME-STUDY COURSE OFFER

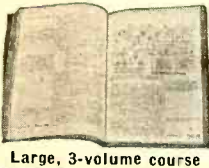

Here is the most amazing bargain in electronic training. For only \$3.95 (full price), you receive a complete course of 53 large lessons. Covers every topic of radio, electronics, with large lessons on TV, FM, audio, etc. As an extra, every page has teacher-comments to guide you and supply additional help. Includes self-testing questions, 427 drawings, pictures, and diagrams. Compares lesson-by-lesson with the best \$200 home-study correspondence course. Price complete, 3-in-1 volume, 53 lessons, only **\$3.95**

Large, 3-volume course

Supreme Publications

Sold by all Leading Radio Jobbers

NO-RISK TRIAL ORDER COUPON

SUPREME PUBLICATIONS, 1760 Balsam, Highland Park, ILL.

Radio Diagram Manuals

- New 1953 Manual, \$2.50
- 1952 Radio
- 1951 Diagrams } EACH
- 1950 Manual } \$2.50
- 1949 Radio
- 1948 & 1947
- 1946
- 1945
- 1944
- 1943
- 1942
- 1941
- 1940
- 1939
- 1926-1938 Manual, \$2.50

PRICED AT ONLY \$2 EACH

Send Radio Manuals checked at left and TV Manuals below. Satisfaction guaranteed or money back.

- Practical Radio & Electronics Course... \$3.95
- 1953 TV Manual, \$3. 1953 UHF Units, \$1.50
- 1952 Television Manual, \$3. 1951 TV, \$3.
- 1950 Television Manual, \$3. 1949 TV, \$3.
- 1948 TV, \$3. 1947 TV & FM, only \$2.

I am enclosing \$..... Send postpaid.
 Send C.O.D. I am enclosing \$..... deposit.

Name:

Address:

1. A negative pulse applied to the quadrature grid of the 6BN6 reduces the plate current very little, but "partition action" increases the accelerator-grid current considerably. The voltage on the accelerator drops and feeds a negative pulse through C1 to the grid of the 6C4.

2. The triode blocks, and the sudden disappearance of cathode current permits C2 to discharge through L. The time required for C2 to discharge depends on the natural resonant frequency of the tank circuit. The discharge places a negative voltage on the limiter grid of the 6BN6.

3. This blocks the gated-beam tube and its plate voltage rises abruptly to the B+ value. This starts the square-wave output. It lasts until the voltage across C2 reverses polarity—that is, becomes positive. The diode now damps out the oscillation and removes the bias from the limiter grid. The 6BN6 conducts, its plate voltage drops to the original value and there is no further output till the next signal pulse arrives.

The delay interval depends only upon the natural resonant frequency of L and C2. It cannot be changed by other components or supply voltages.

FLUORESCENT DISPLAY

Patent No. 2,635,215

Frank M. Shoemaker, Pittsburgh, Pa.

A fluorescent lamp (even one that's burned out) will glow in an r.f. field. This invention

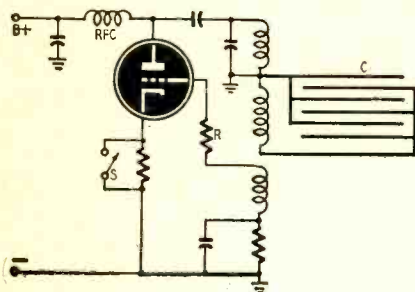

uses this principle for display purposes. Fluorescent tubes are shaped to form characters and are placed in an r.f. field. If the r.f. oscillator is keyed on and off periodically, the characters or letters will blink.

The schematic shows a triode r.f. oscillator tuned to a relatively low frequency, (for example 120 kc) to reduce harmonic interference to broadcasting. Harmonic radiation is reduced still further by inductive coupling between circuits and by designing them for high Q. An anti-parasitic resistor R is connected in the grid lead. The switch S is opened and closed automatically to flash the sign.

The load capacitance C is made up of strips of metal foil. The r.f. field exists between them. The fluorescent characters are placed on shelves where they rest within the field. Unlike a neon sign, these letters are not connected to each other or to any source of voltage, so they may be moved about as required as long as they remain within the r.f. field.

ARC SUPPRESSION

Patent No. 2,637,769

(Assigned to Westinghouse Brake & Signal Co., Ltd., London, England)

When an inductive circuit is interrupted suddenly, the energy stored in the magnetic field induces an e.m.f. which may be many times greater than the original voltage. This induced voltage may force an arc discharge across the opened contacts. Repeated arcs will ruin relay or switch contacts and every effort should be made to avoid them. This patent discloses a simple method to suppress arcing.

Fig. 1 applies to d.c. circuits. L may be the winding of a relay or electromagnet. The rectifier is connected so that it cannot conduct while the switch is closed. When the switch opens, the d.c.-input circuit is broken and a counter-e.m.f. is induced in the winding L. This induced voltage appears across L with the opposite polarity to the original input voltage but in the right polarity for the rectifier to conduct.

If the rectifier alone were connected across L, it would have to be large enough to dissipate all

the energy stored in the winding almost instantly. But by connecting the bias battery in series with the rectifier, L cannot discharge until the induced e.m.f. is greater than the bias voltage. This limits the discharge current through the rectifier, so

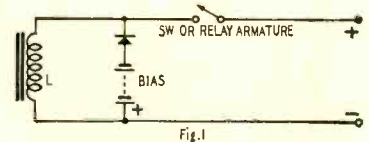

Fig. 1—Rectifier and bias across L.

that a relatively small unit can be used, and the stored energy is dissipated not in the rectifier, but in the battery.

Fig. 2 is a bridge-type arc suppressor for an a.c. circuit. Here the energy represented by the

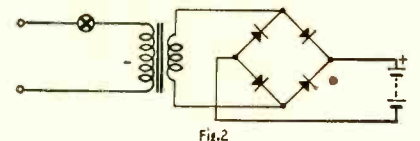

Fig. 2—Bridge rectifier for a.c. circuits.

e.m.f. across L is induced in a secondary winding. As before, the energy is dissipated within the biasing battery, and does not go back into the a.c. circuit.

The voltage induced by a rapidly falling magnetic field, such as that occurring when a circuit is opened, is often dangerous to life, especially in a heavily inductive circuit. For circuits of this type, the rectifiers should be of sufficient size to dissipate the heat created by a large current flow. This is true even in circuits which use a capacitor across the circuit switch to absorb much of the surge. When used in circuits with electric motors, values should be carefully computed. END



**NEW 1954 EDITION TV CONSULTANT
THE TV SERVICEMAN'S SILENT PARTNER**



New, easy-to-use way to solve toughest TV troubles. UHF sect. Includes conversions. Installations and servicing. Modern alignment methods shown by pictures, diagrams and simple directions, tell exactly *what to do* and *how to do it*. Practical pointers on use of all TV Test Instruments. Over 300 pix, raster and sound symptoms. Detailed directions tell *where* and *how* to find faulty parts. Over 135 **RAPID CHECKS**, many using pix tube as trouble locator. 125 illustr. of scope wave forms, diagrams, station patterns show various defects—take mystery out of TV servicing. **NO THEORY—NO MATH—NO FORMULAS**—Just practical service info. covering all types of TV sets.
Only.....\$2

**NEW! Trouble Shooting PIX GUIDE
incl. TV TERMS Explained**

Sec. 1 is a fully illustrated **GUIDE** to oft-recurring pix faults. Causes and cures explained. Copyrighted Trouble Indicating illustrated chart tells where troubles start in typical TV set—illustrations show resulting faulty TV pictures. Sec. 2 explains hundreds of TV terms in non-technical language. **SPEEDS UP TV SERVICING—HELPS YOU DO A BETTER JOB FASTER!**



Only.....\$1

NEW! TV TUBE LOCATOR



Money-Making Time Saver tells which tubes to replace to cure every type of tube trouble. Over 135 such TV troubles listed with clear charts for quickly locating the faulty tubes. Copyrighted **TROUBLE INDICATING TUBE LOCATION GUIDES** for over 3000 most popular models from Admiral to Zenith, 1947 to 1953 models. A storehouse of valuable TV servicing info. priced very low for large volume sales.
Only.....\$1

NEW! TV TROUBLE TRACER

70 Common TV troubles traced to source and cured. Copyrighted trouble indicating tube location guides covering over 500 most popular TV models. Many models different from those shown in **TV TUBE LOCATOR**. Contains over 70 illustrations and tube location guides. Forty most common picture troubles illustrated, with symptoms described, causes given and remedies prescribed.
Only.....50¢



H. G. CISIN, PUBLISHER

Order from your Jobber today, or if not stocked, write to

Harry G. Cisin, Dept. E-22
200 Clinton St., Brooklyn 1, N. Y.

Enclosed find \$.....Send

- TV Consult'nt TV Locator
- TV Pix Guide TV Tracer

Name

Address

CityZone....State.....

CHEVROLET 985793 RADIO

Several of these sets have been brought in with complaints of distortion and intermittent operation. In each case, the fault was traced to the spark plate connection which bypasses the 6SQ7 plate. This section of the spark plate develops a high-resistance to ground and causes the trouble. When we eliminated this connection from the circuit the trouble cleared up with no noticeable effect on reception.—Geo. R. Anglado

DEAD AUTO RADIOS

When servicing dead auto radios, I have a procedure for checking the power supply quickly so I will have more time to track down the trouble if it is in some other part of the set. The circuit of a typical vibrator supply is shown in the diagram. This is the procedure:

1. Check for 6 volts d.c. across the input to the supply. Measure the voltage at a point between the set and the fuse. Low voltage at this point when the 6-volt supply is perfect indicates excessive voltage drop in the supply line. Check the fuse holder for high resistance. If the fuse is blown, check the vibrator and make a resistance check to make sure that there are no

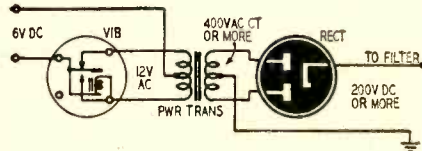

shorts in the transformer or filter.

2. Measure the voltage across the primary of the transformer. There should be 6 volts a.c. across each half and 12 volts a.c. across the full primary. No voltage is a symptom of a defective vibrator.

3. Measure the voltage between the rectifier plates. Average a.c. voltage measurements show 400 volts or more between the plates and 200 volts or more from each plate to ground. No voltage is indicative of a defective transformer. If a buffer capacitor is connected between the rectifier plates, it should be checked for a short or leakage.

4. Measure the voltage between the rectifier cathode and ground. It should be 200 volts d.c. or more. Low voltage is probably caused by a weak or burned-out rectifier tube.

Loss of signal or d.c. voltage at other points in the set may be caused by defective spark plates. Check the schematic for the location of spark plates and check each one for a short.—A. von Zook

RCA KCS66 TV CHASSIS

When the set was first turned on, sound came in normally for a few seconds and then dropped out when the raster appeared. There was no evidence of video modulation on the raster. The a.g.c. bias was normal (about 0) until the raster appeared and then falls to 35 volts negative.

This trouble was caused by an open



17" Table
\$122.68
Pl. \$12.27 Fed. Excise Tax

20" Table
\$134.50
Pl. \$13.45 Fed. Excise Tax

Check these luxury features: Ultra sensitivity, dynamic range control, UHF adaptability, Duo power supply, Acousticclear Sound System... All in a beautiful Mahogany Finish Cabinet.

21" Console
\$164.95
Pl. \$16.50 Fed. Excise Tax

20" Console
\$149.95
Pl. \$15.00 Fed. Excise Tax

ALSO AVAILABLE T.V. CHASSIS

All sets have full 1 yr. factory picture tube warranty, and standard 90 day RTMA parts warranty.

MAIL and Phone orders filled. \$25 deposit. Balance C.O.D., Shipping Charges Add'l.

STEPHEN SALES CORP.

45 Crosby St., N. Y. 12, Phone WO 4-8233

Dealer Inquiries Invited

AUDELS TV-RADIO SERVICE LIBRARY

HERE IS LATE INFORMATION IN A HANDY FORM FOR RADIO & TELEVISION REPAIRMEN, SERVICEMEN & STUDENTS

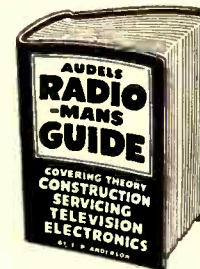

2 VOLS. \$6 COMPLETE \$18. PAY ONLY \$1 MO. IT PAYS TO KNOW!

AUDELS T.V.-RADIO SERVICE LIBRARY presents the important subjects of Modern Radio, Television, Industrial Electronics, F.M. Public Address Systems, Auto, Marine & Aircraft Radio, Phonograph Pick-Ups, etc. Covers Basic Principles—Construction—Installation—Operation—Repairs—Trouble Shooting. Shows How to get Sharp, Clear T.V. Pictures. Install Aerials—How to Test. Explains Color Systems & Methods of Conversion. 1001 Facts—Over 1260 Pages—625 Illustrations—Parts & Diagrams—Valuable for Quick Ready Reference & Home Study. Tells How to Solve T.V. & Radio Troubles—Answers T.V. & Radio Questions.

Get this information for yourself.
7 DAY TEST—ASK TO SEE IT!

MAIL ORDER

AUDELS Publishers, 49 W. 23 St., N.Y. 10
Mail AUDELS T.V. RADIO SERVICE LIBRARY 2 Vols. \$6 on 7 days free trial. If O.K. I will remit \$1 in 7 days and \$1 monthly until \$6 is paid. Otherwise I will return them.

Name _____
Address _____
Occupation _____
Employed by _____ RE



HIGHEST POWERED...

MOST RUGGED

of all rotors

the GREAT, NEW



jeb

ROTOR

model JEB-10

BIGGER MOTOR — (with 3/4" lamination) develops 40 ft. lbs. torque at antenna mast... drives heaviest array!

MOISTURE-TIGHT — completely closed aluminum housing with gasket seal against entrance of atmosphere.

RUST-PROOF thrust bearings... all parts anti-rust finished — lifetime factory lubricated.

POSITIVE ALIGNMENT — gears are locked at both ends of shaft; they're bigger, broader — for smoother rotation.

NO DRIFT — 2000% greater braking surface! Also electric cut-offs for strain-free stop at end of rotor travel!

Package becomes attractive display!

\$44.95
list



CONTROL CASE—just 2 1/2" high; mahogany color; one switch instantly reverses or stops rotor.



jeb

SALES CORPORATION
BROOKLYN 37, NEW YORK



Just a few minutes reading this New Gernsback Library Book

can save you hours of servicing work



128 Pages

\$1.50

Over 100 Illustrations

TV Repair Techniques—No. 50

The most timely, the most needed,
the most valuable low-price book
on TV servicing yet published!

At last, a television servicing book that gets right to the point! No dallying with theory—no harping on obvious or almost impossible troubles. This book assumes you understand theory and know what tubes to check. It goes right to work in analyzing the tricky bugs which are enough to stump the experts. It concentrates on the circuits in which they occur and tells you how to recognize, find and correct them in jig time. It offers you the experience of some of the top technician-writers in the field today. The hints they give you can save you hours of sweating out a tough one. Look over the partial list of contents. Compare the price. Then order your copy today.

A QUICK GLIMPSE OF SOME OF THE CONTENTS

- Unusual TV Troubles
- Servicing Procedure
- TV Signal Tracing
- Servicing TV in the Home
- TV Control Troubles
- High-Voltage Headaches
- Servicing Picture Tube Circuits
- Brightness Troubles
- Correction of Picture Distortion
- Servicing Horizontal Locks
- Curing Intercarrier Buzz
- Vertical Sweep Problems
- Television Interference

Have you read these Gernsback Library Books?

Radio & TV Test Instruments—No. 49

How to build just about every instrument required for modern TV-radio servicing. 128 Pages. **\$1.50**

Radio & TV Hints—No. 47

Over 300 hints, gimmicks and short cuts on radio, TV and Audio. Seven sections. 112 Pages. **\$1.00**

Radio Tube Fundamentals—No. 45

How and why tubes act as they do in modern radio circuits. Written for the service technician. 90 Pages. 74 Illustrations. **\$1.00**

Model Control By Radio—No. 43

Remote control of model planes, boats and trains. Theory and construction details. 112 Pages. 114 Illustrations. **\$1.00**

Public-Address Guide—No. 41

Covers every phase of PA installation and maintenance plus construction details on an all around system. 80 Pages. Illustrated. **75¢**

Practical Disc Recording—No. 39

Covers theory and practical techniques. A full chapter for each important recording component. 96 Pages. Illustrated. **75¢**

Published by Gernsback Publications, Inc.

Publishers of

RADIO-ELECTRONICS

High-Fidelity—Design, Construction, Measurements—No. 48

New 3-way approach on how to get top performance from a high-fidelity system. 128 Pages. **\$1.50**

Television Technotes—No. 46

Cuts routine trouble shooting time. Causes and cures of over 600 specific troubles. 128 Pages. **\$1.50**

Basic Radio Course—No. 44

John T. Frye's classic on fundamentals makes learning theory fun—from Ohm's Law to advanced techniques. 176 Pages. Cloth cover. **\$2.25**

High-Fidelity Techniques—No. 42

One of the best written and most informative books on high-fidelity written at any price. By James R. Langham. 128 Pages. Illustrated. **\$1.00**

See your distributor—or mail this coupon

GERNSBACK PUBLICATIONS, INC., Dept. 103
25 West Broadway
New York 7, N. Y.

Enclosed is my remittance of \$ _____

Please send me the following books postpaid.

- 50 TV REPAIR TECHNIQUES
- 49 48 47 46 45
- 44 43 42 41 39

Name _____

(Please print clearly)

Street _____

City _____ Zone _____ State _____

circuit in resistor R131 (the 2,500-ohm, 10-watt wirewound resistor between the 265- and 143-volt B plus lines). This is a voltage-dropping resistor which supplies reduced B plus voltage to the sync and a.g.c. circuits and holds the cathode of the 6CB6 a.g.c. amplifier at 100 volts positive. The grid of the 6CB6 is supplied with 80 volts positive from another source. When R131 opens, the 6CB6 cathode voltage drops below the grid. This renders the 6CB6 highly conductive to pulses from the horizontal sweep circuit and causes the development of excess a.g.c. bias. Excess bias cuts off the i.f. amplifier and blocks the sound and picture signals.

Replace the resistor to clear up the difficulty.—George DeLaMater

OSCILLATIONS IN PHILCO 645

Squeals and birdies on the high end of the 3-6-mc band are usually caused by oscillations in the 6A7 converter. This can sometimes be eliminated by trying several 6A7's until you find one which does not oscillate.

If the trouble cannot be eliminated by substituting 6A7's, try replacing the 15,000-ohm oscillator plate-dropping resistor (part 72 on the Philco schematic) with a 1-watt resistor of 25,000 to 40,000 ohms. The schematic shows the

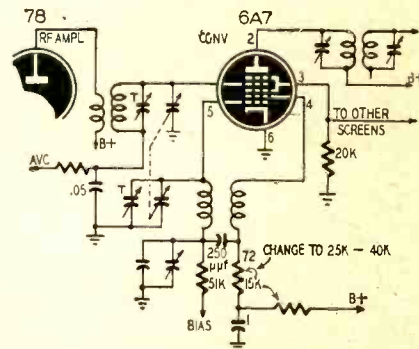

position of this resistor in the circuit. Use the lowest value which results in an oscillator anode voltage of 70 to 85. If the converter performance drops off, increase the capacitance of the oscillator injection gimmick which is mounted on top of the tuning capacitor.

This type of trouble may also occur in other makes and models of old sets when a 6A7 is replaced with a new one.—G. P. Oberto

SEARS, ROEBUCK TV SETS

When one of these sets comes in with no high voltage and no obvious defect in the sweep and high-voltage circuits, take a look at the 1B3-GT high-voltage rectifier. In many instances, you will find that someone has installed a G-E 1B3-GT.

G-E 1B3's will not work in many Sears receivers because pins 1, 2, 3, 5, and 8 are connected internally. The socket is wired so that the high voltage is automatically grounded out when this type of 1B3-GT is used.

Substituting a 1B3 of a different brand will usually eliminate the trouble.—Raymond W. Calvert **END**

tv dx
IN OCTOBER

OCTOBER, like September, will produce very little in the way of ionospheric dx. The early fall is one of the low spots of the year for sporadic-E skip. October will provide interest to the observer who likes to check the effects of weather variations on TV reception. Tropospheric dx will not equal the summertime skip in miles spanned, but it often provides steady or nearly steady signals from far beyond the normal range at this season of the year.

The best tropospheric propagation is usually associated with the changing seasons, so it will have passed its peak in the more northerly parts of the country in September. Below the Mason-Dixon Line, October may be at least as good as its predecessor. Worth watching in the North will be the effect of diminishing foliage, particularly where u.h.f. reception was begun during the green-leaf months. The removing of foliar screening may more than make up for the drop in signal levels that will accompany the arrival of cooler weather in the northern states and Canada, particularly in hilly terrain, or in sites where antennas aim directly into dense growths of deciduous trees.

Dx on u.h.f. continues to lag behind v.h.f., due primarily to the relatively poor performance of the majority of u.h.f. receivers. The summer of 1953 brought numerous instances of communication by amateurs using the 420-mc. band over distances exceeding 300 miles. This was done with power levels that are but a small fraction of those employed in u.h.f. TV transmission on only slightly higher frequencies. The hams have vastly superior receivers and antenna systems, so it seems only a question of time before u.h.f. TV receiving techniques will catch up. When this happens, tropospheric dx of 300 miles or more may be observed on u.h.f.

What the limit of u.h.f. dx will be is anybody's guess, but strong signals on the 420-to-450-mc band exchanged by hams over distances in excess of 400 miles will give some inclination of the possibilities.

CORRECTION

There is a discrepancy between the diagram and the text of the article "Tube-Filament Checker" on page 90 of the June, 1953, issue. The text specifies a 5-ma meter and the diagram specifies 500 ma. The value of 500 milliamperes on the diagram is correct.

We thank Mr. Allan W. Seely, of Danvers, Mass., for calling this to our attention.

STANDARD BRANDS TUBES ALL RADIO & TV TYPES

Standard Warranty ... Bulk Packed or Individually Boxed

1B3GT72	6AC795	6BH665	6SN7GT65	12SN7GT65
1L467	6AH685	6BJ655	6T885	19B6G1.59
1R565	6AK585	6BL7GT1.10	6V6GT55	19T885
1S473	6AL549	6BQ6GT1.05	6W4GT55	25BQ6GT1.10
1S555	6AQ555	6BQ71.05	6W6GT65	25L6GT55
1T465	6AG565	6BK795	6X5GT45	35B565
1U465	6AT645	6C445	12AT645	35C565
1U555	6AU649	6C559	12AT780	35L6GT60
1X2A73	6AV645	6CB660	12AU650	35W445
3Q5GT78	6B4G1.10	6CD6G1.49	12AU765	35Z542
3S465	6BA655	6H655	12BA655	50B565
3V465	6BC565	6J5GT50	12BE657	50C565
5U4G50	6BE655	6J672	12BH775	50L6GT60
5Y3GT45	6BG6G1.59	6K6GT50		

More than 400 types in stock, include all your needs when ordering.

Orders for less than \$10.—add \$1.00 service charge. Terms: 25% with order, balance COD. All prices subject to change without notice. F.O.B. New York City. Mail order division.

TeleVision Materials Corp.
120 LIBERTY ST., NEW YORK 6, N. Y. • COrtlandt 7-4307



TO HELP SELL 'EM THAT
2d TV SET, SELL 'EM A

Vidaire TELE★COUPLER

- For one antenna with two TV sets
- Reduces effects of local oscillator radiation from one TV set to another
- Uses high efficiency transformers
- Filter action reduces interference at IF frequencies
- For most sets, 72 or 300 ohm input
- Sold only through authorized VIDAIRE distributors
- send for catalog B

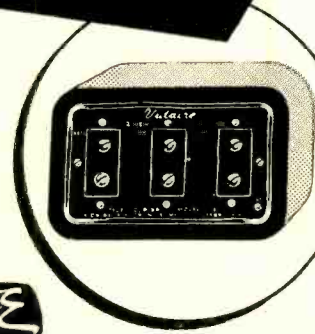

Vidaire ELECTRONICS MFG. CO.



- Manufacturers of:
- TV COLOR EQUIPMENT
 - TV AMPLIFIERS
 - ELECTRONIC DEVICES

Factory: LYNBROOK, N. Y.

Nat'l Sales Office: 6 E. 39th ST., N. Y. 16, N. Y. • Phone No.: LE 2-7372

PHOTOGRAPHS

RADIO-ELECTRONICS can use good photographs of service benches, service shops, high-fidelity audio layouts, and any other interesting and original radio-electronic devices.

We will pay \$6.00 each for good professional photos or equivalent, suitable for reproduction.

Full information on subject photographed will increase their acceptability.

The Editor, RADIO-ELECTRONICS
25 West Broadway, New York 7, N. Y.

**Preferred
for Original
Equipment**

**Proven
for
Replacement**

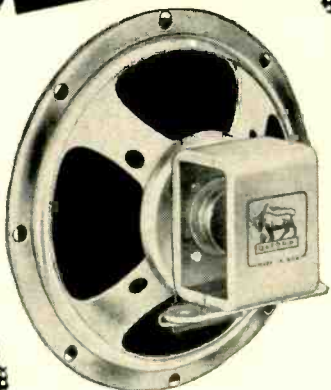
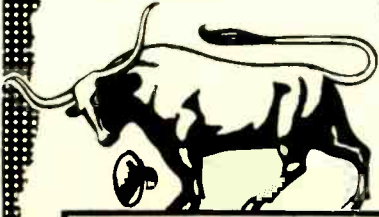
OXFORD

Speakers

There is an application for every Oxford Speaker . . . and an Oxford Speaker for every application.

**OXFORD
ELECTRIC
CORPORATION**

3911 S. Michigan Ave.
Chicago 15, Illinois

EXPORT: ROBURN AGENCIES, NEW YORK CITY
In Canada: Atlas Radio Corp., Ltd.
560 King Street, Toronto, Ontario

**THE FUND REACHES
\$10,807.59**

**HELP -
FREDDIE-WALK
FUND**

Herschel Thomason, radio technician of Magnolia, Arkansas, and father of five-year-old Freddie Thomason, writes the HELP-FREDDIE-WALK FUND as follows:

"... Freddie is really looking forward to getting some arms. Almost every time we sit down to eat, he will tell us that Dr. Kessler is going to make him some



Freddie Thomason and young brother.

hands and that he will be able to feed himself. We are very anxious for next spring to come, for that is when they will start on his arms."

By this time, most of our readers are acquainted with little Freddie, the youngster who was born without arms or legs, and for whom life has meant a series of adjustments such as few of us can comprehend. Quite some time ago, he was fitted with artificial legs at the Kessler Institute for Rehabilitation, West Orange, N. J., and he is now learning to walk by himself. Each step forward is a new accomplishment requiring courage and faith, but these are qualities in which Freddie and his family have never been found lacking.

They and we have been encouraged not only by the welcome contributions to the Fund, but by the many expressions of affection and good will that often accompany donations. Typical of such messages are the following:

Received from Patricia L. Nield, Sec'y-Treasurer of The Sunshine Circle of Sacramento, Calif., along with their donation of \$10.00: "We, The Sunshine Circle, are thankful that this case has been brought to our attention and that we are privileged to help Freddie attain health and happiness . . . We

seek to reach out and give a touch of warmth, so necessary for the well-being of those in need of help. Therefore, along with our gift for Freddie, we send our most sincere and heartfelt thoughts."

And from Frank Gabinowitz, of Long Branch, N. J., comes a donation of \$2.00 accompanied by this note: ". . . It is good to hear that he is making progress at Kessler Institute with his legs . . . Every now and then I'll be only too happy to make a contribution to his progress. I believe in strong legs to work so weak legs can someday walk."

Won't you join our family of friends of Freddie? No donation is too small to receive our sincere thanks and acknowledgement, as well as the heartfelt appreciation of the Thomasons. *Make all checks, money orders, etc., payable to Herschel Thomason.*

Address letters to:
HELP-FREDDIE-WALK FUND
c/o RADIO-ELECTRONICS Magazine
25 West Broadway
New York 7, N. Y.

FAMILY CIRCLE CONTRIBUTIONS

Balance as of July 17, 1953	\$ 602.50
FAMILY CIRCLE Contributions as of August 18, 1953	\$ 602.50
RADIO-ELECTRONICS CONTRIBUTIONS	
Balance as of July 17, 1953	\$10,166.09
Anonymous, New York, N.Y.	1.00
A/IC E. J. Dupuis, Eglin A.F.B., Fla.	20.00
Frank Gabinowitz, Long Branch, N.J.	2.00
G. Leonard, Gouverneur, N.Y.	1.00
Edward J. Schnepf, Forest Hills, N.Y.	5.00
The Sunshine Circle, Sacramento, Calif.	10.00

RADIO-ELECTRONICS Contributions as of August 18, 1953	\$10,205.09
FAMILY CIRCLE Contributions as of August 18, 1953	602.50

TOTAL Contributions as of August 18, 1953 \$10,807.59

Radio Thirty-Five Years Ago
In Gernsback Publications

HUGO GERNSBACK Founder	
Modern Electrics	1908
Wireless Association of America	1908
Electrical Experimenter	1913
Radio News	1919
Science & Invention	1920
Television	1927
Radio-Craft	1929
Short-Wave Craft	1930
Television News	1931

Some of the larger libraries still have copies of ELECTRICAL EXPERIMENTER on file for interested readers.

**OCTOBER 1919
ELECTRICAL EXPERIMENTER**

- "My Inventions—The Art of Telautomatics," by Nikola Tesla.
- "Submarine's Under-water Radio."
- "The Wireless Ukulele."
- "Unique Radiophone Helmet."
- "Government Radio Control—Once More," by H. Gernsback.
- "Radio Problems in Aviation," by Edward Rice Doyle.
- "Efficient Radio Crystal Detector," by Robert F. Gowen, R.E.
- "Can Radio Ignite Balloons?" by Nikola Tesla and others.

END

SENSITIVE CAPACITANCE RELAY CIRCUIT

In the most common types of capacitance relay circuits, the relay tube is controlled by the cathode bias of the oscillator tube. In this circuit described by D. H. Sullivan in *Radio Constructor* (London, England), control bias is ob-

L1, L2, and L3 may be tuned to any convenient frequency as long as it is not too low and is not in the broadcast band. L1 consists of 250 turns of No. 28 wire wound on a 3/8-inch form and tapped 50 turns from the ground end. L2 and L3 are each 200 turns of No. 28 wire wound side-by-side or one over the other on a 3/8-inch form.

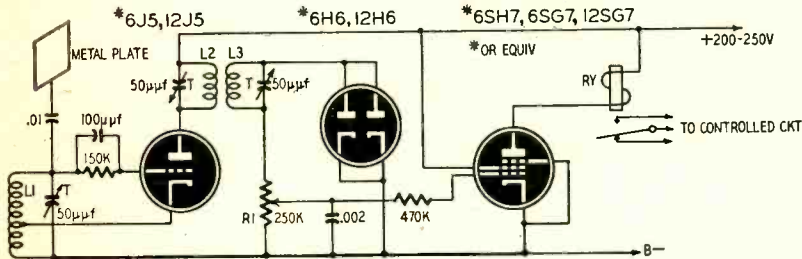

tained from a rectifier coupled to the oscillator plate circuit.

The unit is simple to adjust. Set the sensitivity control R1 so the grid of the relay tube is grounded. Connect a high-resistance voltmeter or v.t.v.m. across R1 and adjust the trimmers across L2 and L3 for maximum indication on the meter. Advance R1 slowly until the relay just opens. When any comparatively large body approaches the metal pickup plate, the added capacitance appears across L1 and causes the oscillator frequency to shift. This reduces the r.f. voltage developed across L2 and L3. The rectified bias voltage across R1 drops and causes the relay to operate.

Materials for capacitance relay

Resistors: 1—470,000, 1—150,000 ohms, 1/2 watt; 1—250,000 ohms potentiometer.
Capacitors: 1—.002, 1—.01 µf, 1—100 µmf mica or ceramic, 3—50-µmf air or ceramic variable trimmers.
Miscellaneous: Chassis, 3/8-inch rod or tubing for coil forms, sockets, tubes; 1—plate-circuit relay with coil resistance of 2,000 ohms or more; hookup wire, and hardware.

PICTURE TUBE CHECKER

TV service technicians have developed various short-cuts for quickly determining whether the more common picture-tube complaints are caused by defects in the kinescope or in the receiver circuits. A recent issue of *Current Flashes* (Stromberg-Carlson TV service bulletin) shows how a 6AF6-G

or similar twin-beam electron-ray tuning indicator can be used to check the voltages at the picture-tube socket. The diagram is shown in Fig. 1-a. The 6AF6-G socket is wired to a plug which fits the picture tube socket.

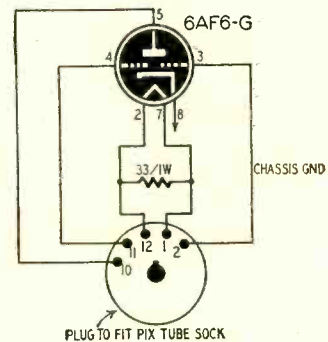

Fig. 1-a—6AF6-G is wired to plug.

The performance of the kinescope and associated receiver circuits can be checked by inserting the checker into the socket on the receiver. Indications are as follows: (1) A glowing heater indicates the presence of heater voltage on the C-R tube socket. (2) A bright green glow on the target indicates the presence of first anode voltage. (3) One of the shadows will have sharp areas as in the lower half of Fig 1-b. A properly functioning brightness control will cause the shadow area to vary as the control is rotated. (4) One-half of the target area will have fuzzy or blurred edges as in the upper

Get This Valuable Book ➔ Just for Examining COYNE'S New 6-Volume Set

FREE



ON 7 DAY FREE TRIAL!



"Applied Practical Radio-Television"

Here's "Know-How" That Makes You Worth More!
 Coyne's great new 6-volume set gives you all the answers to servicing problems—quickly! For basic "know-how" that is easy to understand, you'll find everything you want in volumes 1 to 5 which contain over 5000 practical facts and data. They cover every step from principles to installing, servicing, trouble-shooting and aligning all types of radio and TV sets. So up-to-date it includes COLOR TV and UHF, adaptors and converters. Also covers very latest information on TRANSISTORS.

And then, for speedy on-the-job use, you get volume 6—the famous Coyne TELEVISION CYCLOPEDIA. It answers today's television problems on servicing, alignment, installation and others. In easy-to-find ABC order, cross indexed. Use this 6 volume TV-RADIO LIBRARY free for 7 days; get the valuable Servicing Book ABSOLUTELY FREE!

FREE BOOK—FREE TRIAL COUPON!

COYNE ELECTRICAL & TELEVISION-RADIO SCHOOL, Dept. A3-T1
 500 S. Paulina St., Chicago 12, Ill.

YES! Send 6-volume "Applied Practical Radio-Television" for 7 days FREE TRIAL per your offer. Include TV-Radio Patterns & Diagram Book FREE.

Name..... Age.....
 Address.....
 City..... Zone... State.....
 Where Employed.....
 () Check here if you want library sent COD. You pay postman \$20.95 plus COD postage on delivery. 7-day money-back guarantee.

The
TARZIAN
TUNER
is known
for its
dependability

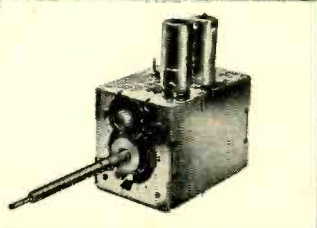

That's why most manufacturers of the best known receivers today are placing their confidence in the TARZIAN TUNER.

Leading manufacturers are specifying the TARZIAN TUNER to be used in the sets they make because they can be SURE of customer satisfaction.

For selectivity . . . stability . . . and reception (especially in fringe areas) the TARZIAN TUNER is recognized as an engineering triumph.

And speaking of triumphs, there's the sensible — all-channel — Tarzian approach to UHF . . . the first with UHF adaptability engineered into a VHF tuner.

 SARKES TARZIAN, Inc., Tuner Division, Bloomington, Indiana

THE NEW TV DYNATRACER



\$4.95

Pad.
or COB & Chgs.

TRACES TV
SIGNALS and
VOLTAGES

LOCATES
DEFECTIVE
COMPONENTS
INSTANTLY

REQUIRES NO
ADDITIONAL
EQUIPMENT

Makes Television
Servicing Easier,
Faster and
More Accurate
—AT LOW COST

Ideal for trouble-shooting television in the field or on the bench. Used under actual operating conditions, will out-perform more expensive testers.

A MUST FOR EVERY ALERT TV TECHNICIAN!
SPECIFICATIONS: The "DYNATRACER" is a self-powered quality instrument designed to trace TV signals through any Video, Sound, Sync, AFC or Vertical and Horizontal Sweep Circuit—will isolate trouble to a stage or component.
ADDED FEATURE: The "DYNATRACER" will also trace voltages and instantly locate open, shorted or intermittent condensers, resistors, coils, speakers, transformers, etc.

COMPLETE INSTRUCTION BOOK ENCLOSED
10-DAY MONEY BACK GUARANTEE
Clip Adv. . . . Write Name and Address in Margin.
Attach \$5.00 Bill, Check or M.O. and Mail to

Century ELECTRONICS CO.

8509-21st Ave., Dept. 106, Brooklyn 14, N. Y.

ANOTHER OUTSTANDING JOBBER

NIDISCO

713 Newark Ave.
Jersey City, N. J.

55 State St.
Hackensack, N. J.

658 Anderson Ave.
Cliffside, N. J.

294 Passaic St.
Passaic, N. J.

126 So. Warren St.
Trenton, N. J.



\$29.95

HAS THE SENSATIONAL NEW

EICO 1050-K 6V & 12V
BATTERY ELIM. KIT
IN STOCK!

Watch for the
NOVEMBER ISSUE
of RADIO-ELECTRONICS
on the newsstands
OCTOBER 28, 1953

half of Fig. 1-b. The blurred edge indicates the presence of video or sync information, or both. A properly operating contrast control causes the shadow area to vary as it is turned.

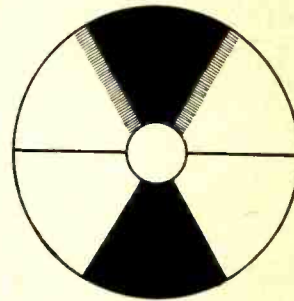
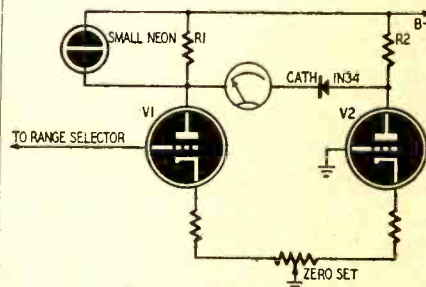

Fig. 1-b—Upper half has blurred edges.

On the Stromberg-Carlson models 24 and 119, the eye will overlap, but this does not prevent the contrast and brightness circuits from being checked as described above. On the model 317 series, the brightness and contrast controls affect the voltage on the cathode of the kinescope so the operation of both of these controls will be observed on the same half of the target.

PROTECTING V.T.V.M.

This circuit shows how a conventional bridge-type v.t.v.m. may be protected against overloading and possible burnouts. Resistor R1, the plate load of V1, is shunted with a small neon lamp. When the input voltage is zero, the voltage across R1 is just below the firing point of the neon lamp. Excessive input to the v.t.v.m. will cause V1 to conduct heavily and the voltage drop



across R1 exceeds the firing voltage of the lamp. The lamp fires and practically short-circuits R1 so the full supply voltage is applied to the plate of V1. Ordinarily, the needle would tend to fly off scale in the reverse direction. However, this does not happen because the most positive voltage is now applied to the cathode of the 1N34 so that it does not pass current through the meter. The neon lamp may be mounted on the front panel of the meter to provide an immediate indication of meter overload.—D. Sachs

OSCILLOSCOPE MODIFICATION

My Eico model 425K scope performed well, but its trace was not as sharp as I desired. The spot was oval instead of round. I incorporated a spot-shape control which improved the trace. A 1-megohm potentiometer is the only component required for the modification. Pin 7 of the 5BP1 is normally

grounded. I lifted it off ground and connected it to the arm of the 1-meg-ohm potentiometer connected between the first B plus lead and ground as shown by the dashed lines in the diagram. I mounted the potentiometer on the chassis, since readjustment is not

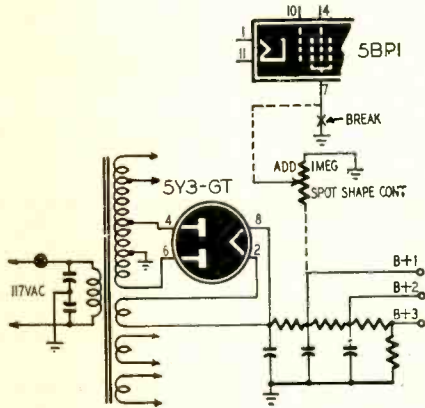

required until the C-R tube is replaced. To adjust the control, turn the vertical and horizontal gain controls fully clockwise. Set the horizontal input switch to EXTERNAL and turn down the brightness to prevent burning the screen. Adjust the spot-shape control to produce a spot which is as round as possible while keeping the spot diameter at minimum with the focus control.—Milton Herman

NOVEL PHONO OSCILLATOR

The phono oscillator shown in the diagram will probably provide better quality than those in which the pickup works directly into one of the grids of a pentode or a multigrid converter tube. Since one half of the tube is used as an audio amplifier and plate modulator, it will provide a greater depth of modulation with less distortion.

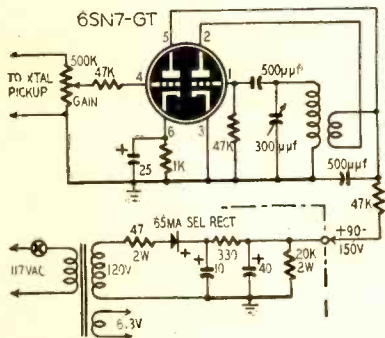

The oscillator uses a standard Hartley-type broadcast oscillator coil tuned by a 300-μF trimmer capacitor. The designer, writing in *Radio-Gen* (New Zealand), claims that the output is sufficient to cover a small home.

Power input should be the lowest value that will provide a usable signal at the receiver. Power-supply requirements are slight. Any supply delivering 90 volts or more at a few milliamperes will suffice. A suitable supply is shown below the main diagram. To vary the output, use a semivariable resistor in place of the bleeder. Connect B plus line from oscillator to the slider on the resistor and vary as desired. END

this protection pays!

RMS LIGHTNING ARRESTORS

ALL Completely UNIVERSAL! for twin, tubular lead and open line
ALL UL APPROVED! for indoor and outdoor
ALL QUICK-MOUNTING!

Available from your local jobber!

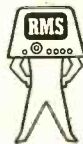

RMS

2016 BRONXDALE AVENUE
NEW YORK 60, N. Y.



Cadillac the finest name in **TUBES** for the lowest price

ALL TYPE
TUBES IN
STOCK FOR
RADIO & TV

Partial Listing of our own CADILLAC Brand Tubes

0A2	\$0.82	6BD6	.45	6SL7GT	.62
0B2	.90	6BE6	.47	6SN7GT	.55
0B3	1.03	6BF5	.55	6SN7BTA	.55
0C3	.80	6BF6	.40	6SQ7GT	.42
0D3	.77	6BG6G	1.49	6T4	1.00
1T4	.58	6BH6	.58	6T8	.78
1U5	.46	6BJ6	.49	6V6GT	.46
3Q4	.62	6BK7	.75	6V6GT	.62
3S4	.58	6BK7A	.75	6W4GT	.46
5U4G	.38	6BQ6G	.93	6W6GT	.57
5V4G	.75	6BQ6GT	.91	6X4	.34
5X4G	.49	6BX7GT	.88	6X5GT	.34
5Y3G	.34	6CZ7	.95	6X8	.77
5Y3GT	.30	6C1	.37	6Y6	.59
5Y4G	.39	6CB6	.64	7A4, XXL	.47
5Z3	.46	6CD6G	1.75	12AL5	.47
6A7	.62	6D4	.50	12A7	.40
6AB4	.46	6E5	.63	12A7	.55
6AG5	.54	6F6GT	.45	12A7	.63
6AH4GT	.62	6H6GT	.49	12BE6	.47
6AJ5	1.95	6J6	.62	12S7GT	.50
6AK5	1.04	6K6GT	.41	12SK7GT	.50
6AL5	.42	6K7GT	.60	12SB7GT	.55
6AQ5	.48	6L6GA	.80	12X1	.35
6AQ6	.42	6S4	.44	25L6GT	.47
6AT6	.38	6SA7GT	.50	25Z1GT	.42
6AU6	.43	6SA7GT	.63	35Z1GT	.31
6AV6	.38	6SJ7GT	.47	50Y3GT	.50
6AX4GT	.50	6SJ7GT	.58	11Z6GT	.68
6BA6	.45	6SK7GT	.50		
6BC5	.55	6SK7GT	.66		

BRANDED
GUARANTEED
INDIVIDUALLY
BOXED

Write for complete listings and our low prices!
Terms: Min. order: \$10, 25% dep. with COD's, F.O.C. New York City

Cadillac ELECTRONICS CORP.
19 West 26th Street, New York 10, N. Y. • MU 6-4164

OSCIL-O-PEN
Extremely convenient test oscillator for all radio servicing; alignment • Small as a pen • Self powered • Range from 700 cycles audio to over 600 megacycles u.h.f. • Output from zero to 125 v. • Low in cost • Used by Signal Corps • Write for information.
GENERAL TEST EQUIPMENT
38 Argyle Ave. Buffalo 9, N. Y.

ENJOY 3 COLOR TELEVISION FILTER SCREEN NOW
Changes dull eye-straining black and white pictures into beautiful color tones. Seconds to attach. No tools used. Helps eliminate glare and snow in fringe areas. Order direct. Send \$1 for screen size up to 16", \$1.25 size 17", \$1.50 size 20", \$1.95 size 21". We pay postage except on C.O.D. orders. Satisfaction guaranteed. Dealers in TV areas needed.
Zingo Products, Johnstown 13, New York

Let me show you how EASY it is to

LEARN TV

the practical way--

ASSEMBLE A
TRANSVISION TV KIT

Pay as You Wire \$ **39**

Down Payment

I WILL HELP YOU to start learning TV the practical way — by assembling a TRANSVISION TV KIT in EASY STAGES. For only \$39 you get PACKAGE #1 (standard first pkg. for all of our kits). This package gives you the BASIC CHASSIS and over 450 TV COMPONENTS with complete Instructions, Drawings, Photos, Service Booklet, and a year's subscription to my "TV and Electronics Notes". When ready, you order the next stage (pkg. #2), etc. Low prices make your complete kit a terrific buy!



FREE CATALOG Shows 6 Great TV Kits:

EXCLUSIVE: Only Transvision TV Kits are adaptable to UHF. Ideal for FRINGE AREAS. No Previous Technical Knowledge required. Write now!

TRANSVISION, INC., Dept. RE10
NEW ROCHELLE, N. Y.

--- MAIL THIS COUPON TODAY ---

Mr. D. Gnessin, Educational Director,
TRANSVISION, INC., NEW ROCHELLE, N. Y. Dept. RE10

I'm enclosing \$ _____ deposit. Send standard kit PACKAGE #1, with all Instruction Material. Balance C.O.D.

Send FREE copy of your new TV Kit Catalog.

Name _____
Address _____
City _____ State _____

Tremendous Opportunities in

COIN TV

and COMMERCIAL TV

TRANSVISION offers the only specially designed line of Coin-Operated and Commercial TV with the

FREEVIEWER* ATTACHMENT

(Pat. Pend.)

This field offers rich rewards to enterprising servicemen or dealers — on part time or full time basis.



*The Electronic Freeviewer is a patented device which makes coin operation really pay off in a big way. Boosts revenue by "sampling" — by giving a short freeview of TV programs to prospective customers. Works like magic in enticing sales.

Get details now.
TRANSVISION, INC.
NEW ROCHELLE, N. Y.

--- MAIL THIS COUPON TODAY ---

TRANSVISION, INC., NEW ROCHELLE, N. Y. Dept. RE10

Rush full details on COIN OPERATED TV.

Name _____
Address _____
City _____ State _____

DEMAGNETIZING GUN

The magnetic field surrounding the tip of a Weller-type gun is useful for demagnetizing wrist watches and pocket watches. A special technique is needed for best results. Turn on the gun and place the watch between the tip electrodes or as nearly so as possible. Then slowly withdraw the watch, taking three or four seconds to get it a foot or two away from the gun (which is left on). Repeat this for each axis of orientation of the watch, and if it happens to be a large one, for each side. Take care to avoid touching plastic crystals with the gun tip while it is hot.

Of course, it is better to take precautions to keep from magnetizing the watches. They should not be brought closer than two or three times the largest dimension to modern magnetic structures, even momentarily. Multimeters, photographic exposure meters, and speakers are among common offenders. Both wrist and pocket watches should be removed before handling large PM speakers, even when speakers are inside their shipping containers.—Gray C. Trembly

ANTENNA COUPLER

You may sometimes want to couple two TV sets to a single antenna for a demonstration or a comparison.

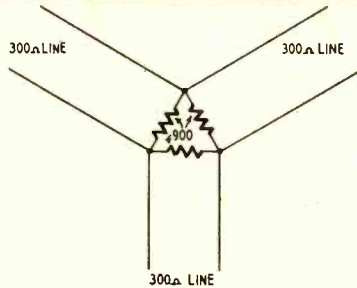
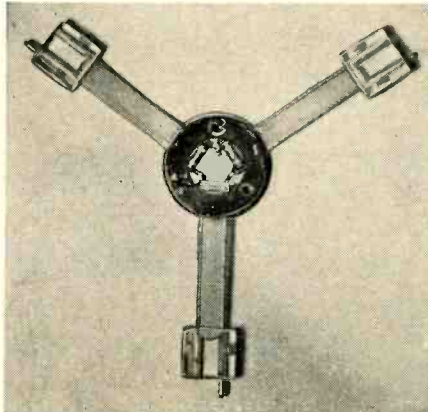

Simply take three 2½-inch lengths of 300-ohm lead and connect them together as shown above, with a 900-ohm, ½-watt carbon resistor (standard 910-ohm units will serve nicely) soldered across each lead at the junction. Then rivet suitable fiber washers together so that the assembly is held between them.

When a 300-ohm TV-antenna lead is connected to any one of the legs and 300-ohm receiver inputs are connected to the other two, each of the receivers and the antenna "look into" 300 ohms. At the same time the signal from the antenna is divided equally.—John T. Frye

WANTED

WE NEED YOUR SURPLUS ELECTRONIC EQUIPMENT

WE PAY TOP \$\$\$ FOR:

- ★ RADIO RECEIVERS
- ★ TRANSMITTERS
- ★ ARC-1
- ★ ARC-3
- ★ ART-13
- ★ CONTROL BOXES
- ★ INDICATORS
- ★ CLAMPS
- ★ PLUGS
- ★ CORDS
- ★ RELAYS
- ★ TELEPHONE MATERIALS
- ★ AN CONNECTORS
- ★ WE BUY ANYTHING!

Write, Wire today! Tell us what you have.

TALLEN CO., Inc., Dept. RE
159 Carlton Ave., Brooklyn 5, N. Y.

EASY TO LEARN CODE

It is easy to learn or increase speed with an Instructograph Code Teacher. Affords the quickest and most practical method yet developed. For beginners or advanced students. Available tapes for beginner's alphabet to typical messages on all subjects. Speed range 5 to 40 WPM. Always ready—no QRM.



ENDORSED BY THOUSANDS!

The Instructograph Code Teacher literally takes the place of an operator-instructor and enables anyone to learn and master code without further assistance. Thousands of successful operators have "acquired the code" with the Instructograph System. Write today for convenient rental and purchase plans.

INSTRUCTOGRAPH COMPANY

4701 Sheridan Rd., Dept. RC, Chicago 40, Ill.

TELEVISION

Big demand for graduates

B.S. DEGREE IN 27 MONTHS in radio including TV engineering—VHF, UHF, AM and FM. Students use over \$100,000 worth of equipment including 2 large commercial type transmitters in new TV lab. Intense specialized course includes strong basis in mathematics, science and advanced design in radio and TV.

Hundreds of young men each year are earning engineering degrees in this recognized institution. Start any quarter. Many earn a major part of expenses in this industrial center. Low tuition. Competent instruction. Thorough, intense practical program.

Also B.S. DEGREE IN 27 MO. in Aeronautical, Chemical, Civil, Electrical and Mechanical Engineering. G.I. Gov't approved. Enter Dec., March, June, Sept. Free catalog. ENROLL NOW.

INDIANA TECHNICAL COLLEGE
17103 E. Washington Blvd., Fort Wayne 2, Indiana

PRES-PROBE CONDENSER TESTER

Finds Intermittent Condensers Instantly



Pres-probe's sliding tip with variable resistance prevents condenser heating. Tests with power on. Requires no adjustment. Stops guesswork. Saves time. Convenient probe size (7½" long). Satisfaction guaranteed.



See Your Dist. or Order Direct

PRES-PROBE CO.

4034 N. Sixth St., Milwaukee 12, Wisc.

SUBSCRIBERS

If you're moving, please don't forget to send us your address as it appears on the copy of the magazine, including the numbers shown beside your name, as well as your new address.

If we receive this information before the 20th of the month, you will continue getting the magazine without interruption.

Your cooperation will be most helpful and greatly appreciated.

FINDING V.H.F.—U.H.F. BANDS

Harmonics from the oscillator of an accurately calibrated communications receiver can be a valuable aid in calibrating other receivers and converters designed for use on v.h.f. and u.h.f. bands. First, you must know the receiver's i.f. and whether its oscillator is on the low or high side of the signal frequency. With these facts, the set's oscillator can be used as an accurate signal generator. If the oscillator is above the signal, add the i.f. to the dial reading to get the oscillator frequency. Subtract the i.f. from the dial reading when the oscillator operates on the low side.

This is how a receiver using a high beat might be used to locate the 220-225-mc band which was opened to technicians: Set the receiver dial to 27.045 mc. Add the i.f. (455 kc in this case) to get the oscillator frequency (27.5 mc). The 8th harmonic (27.5 X 8) is 220 mc, the low end of the band. Similarly, tune the receiver to 27.67 mc to find the high end of the band at 225 mc.

Tune to frequencies between 27.05 and 27.67 mc to establish other points in the band. Although we have used the 8th harmonic in this example, other harmonics may be used to calibrate this and other v.h.f. and u.h.f. bands.

We must emphasize that the equipment to be calibrated must first be roughly calibrated with a grid-dip meter, Lecher wires, or a wavemeter to establish the approximate tuning range before attempting spot calibration with the communications receiver.

No direct connection is needed between the two receivers. Laying two short antennas side-by-side should provide sufficient coupling.—S. H. Beverage, W1MGP

FILAMENT WIRING HINT

In building sets where large filament currents are required, it is often considered necessary to parallel smaller filament transformers to get the required current. However, in such cases it is best to divide the filaments into groups and feed each group from a separate transformer. If the transformers are paralleled and their output voltages are not identical under all load conditions, circulating currents flow through the transformers and cause power wastage and possible transformer overload. You also get the advantage of isolation. Frequently undesirable coupling results from common filament supplies.—Charles Erwin Cohn

HANDY GROUND CLIPS

Someday when your wife isn't around, snitch one of her wave-set clips. They make good clamps to ground chassis during tests. I used a Goody clip which is nearly 4 inches long. It grips a large area of the chassis, thus assuring a good ground. There are holes in the clips, so all you have to do is attach a soldering lug and a length of ground wire.—B. W. Welz



H. D. Suesholtz, General Manager, Transvision, Inc.

Servicemen, Technicians, secure your future —

I WILL START YOU in a WELL-PAYING TV SET BUSINESS

FOR THE AMAZINGLY SMALL INVESTMENT OF ONLY **\$9.95**

Be a TRANSVISION Factory Agent — and make good money full time or part time.

Would you like to increase your income with at least \$5000 a year, or more? Then get on the Transvision Factory Agent band wagon. Here's a golden opportunity to get that extra income you've been dreaming of—without investing in merchandis or overhead.

That's right — I don't tie you up with inventory. ALL YOU NEED is my SALES KIT costing only \$9.95. This kit gives you our 3-Dimensional Illuminated Viewer, Natural-color Slides displaying our complete line of gorgeous TV Sets; also our spiral-bound Salesman's Catalog and price list.

YOU CARRY NO STOCK: With my Sales Kit you sell from our million-dollar inventory. We ship either to you, or direct to your customer, as you wish. **YOU MAKE 2 INCOMES FROM EACH SALE — profit on the set, and a fee for the installation** (we expect all of our Factory Agents to be competent installation-and-service men).

YOU CAN BEAT COMPETITION: Our prices on giant screen TV sets will enable you to meet and best competition at a good profit.

YOU SELL THE FINEST SETS: You sell sets with the incomparable RCA-licensed 630 Chassis — the finest on the market — or the famous fine-quality Transvision A6 Chassis. You have a wider sales range — a greater choice of Table Models, Consoles, Combinations, in screen sizes from 17" to 21". You have a set and a price for every prospect.

SECURE YOUR FUTURE: Don't lose time. Get started making more money now. Fill out and mail the coupon to me — TODAY!



CLINCH SALES in prospect's home with my 3-Dimensional Illuminated Viewer, Natural Color Slides, and Salesman's Catalog.



We offer the LATEST, 31-tube
630 DE LUXE TYPE TV CHASSIS
with High-Fidelity Sound
Mr. licensed under RCA patents
Has Super-Fringe Area Circuit... Redesigned for peak UHF performance... High fidelity push-pull audio (40-13,000 cycles)... 12" Hi-Fidelity Speaker... 31 tubes (28 tubes, cycles)... plus CRT makes 32 tubes... handles 3 rectifier tubes — up to 24" — made with only the finest parts... carries standard RMA Guarantee.
JOBBER INQUIRIES INVITED



BEAUTIFUL, IRRESISTIBLE CABINETRY: This illustration is only suggestive of our vast line of gorgeous TV Sets. Get the SALES KIT. See the Natural-Color Slides. You'll agree that Transvision offers the hottest TV deal in the entire industry!

TRANSVISION, INC.
NEW ROCHELLE, N. Y.
NE 6-6000

RUSH THIS COUPON NOW

Mr. H. D. Suesholtz, Gen. Mgr.
TRANSVISION, INC., NEW ROCHELLE, N. Y. Dept. RE10
 I enclose \$9.95 for your complete FACTORY AGENT'S SALES KIT
 I like the idea but would appreciate more details.

Name _____
Address _____
City _____ State _____

Holds the Screw!
Drives it too!

Unconditionally Guaranteed

Quick-Wedge SCREW-HOLDING SCREWDRIVER

Ask for it at your Dealer
Kedman Co., 233 S. 5 W., Salt Lake City, Utah

UHF and THE KLIPZON CRYSTAL PROBE

SELF HOLDING POINTS.

KLIPZON HIGH FREQUENCY CRYSTAL PROBE
WITH SELF-HOLDING TEST POINT

TYPE C

solves your UHF ... VHF ANTENNA PLACEMENT and ORIENTATION problems

No more roof-top shouting—No phones—No expensive field strength measuring equipment!
Use a KLIPZON Type C PROBE
We show you how. Maximum picture guaranteed in a jiffy! **SAVE TIME AND MONEY**
Many other uses described in FREE 4-page illustrated bulletin.

Ask for KLIPZON Type C at your local distributor; if not stocked, send \$6.95 check or M. O. direct to:

UNITED TECHNICAL LABORATORIES
BOX 425 F • MORRISTOWN, N. J.

Entirely
NEW!

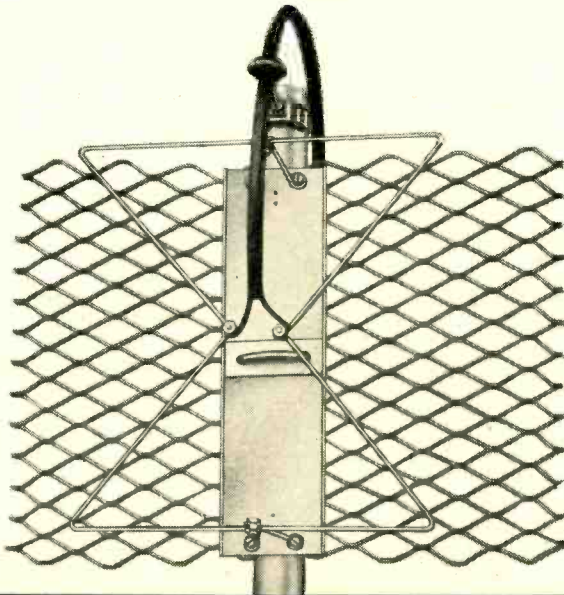

The last word in
UHF TV Antennas—the UW-2

NOW AT NEW LOW PRICES!

UHF TV Antenna MODEL U-4

A superb antenna featuring uniform gain with low vertical radiation. 300 ohm terminal impedance.

A completely balanced broad band antenna covering all channels from 14 to 82 and terminating in 300 ohms with a very low voltage standing wave ratio.

- MINIMUM WIND RESISTANCE
- COMPLETELY FREE OF INSULATORS
- EXCELLENT DIRECTIVITY

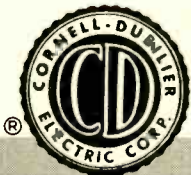

CONSISTENTLY DEPENDABLE

CORNELL-DUBILIER

SOUTH PLAINFIELD, NEW JERSEY



- CAPACITORS
- ANTENNAS
- ROTORS
- VIBRATORS
- CONVERTERS

SPEAKER MATCHING CONTROL

When two 8-ohm speakers are used with an amplifier, one in the cabinet and one at a remote point such as a rumpus room, it is often desirable to energize either one separately or both simultaneously.

For maximum output quality and volume a proper impedance match must be maintained. This is easily done by using a 4-deck, 3-position switch such as a Centralab type 1427. The schematic shows a hookup which can be made in

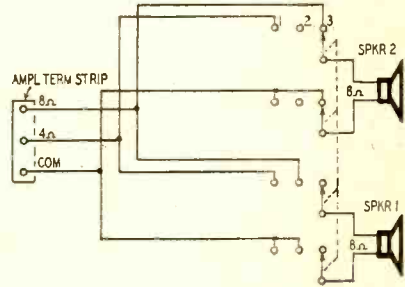

a matter of minutes. Most amplifiers have both 4- and 8-ohm taps. Both of these are used. Placing the switch in position 1 connects speakers 1 and 2 in parallel across the 4-ohm tap. Position 2 connects only speaker 1 to the 8-ohm tap and position 3 connects only speaker 2 to the 8-ohm tap. Thus we have properly matched impedance in all three positions.

This switching circuit can be used with speaker impedances different from those mentioned. The output taps on the amplifier and the speakers used are your guide. Just keep in mind that two 8-ohm speakers in parallel become one 4-ohm unit, and two 16-ohm speakers in parallel become 8-ohms. It's the law of parallel resistances, remember?—This system is of course not limited to 2 speakers. If sufficient power is available, you can hook up as many speakers as you wish. Always be sure that the total impedance of the speakers equals that of the transformer.—

John E. Howlett

MODIFIED CAPACITOR CHECKER

The capacitor checker in the February issue (bottom diagram on page 115) worked fine but I was not satisfied. It had one feature I did not like. Sometimes we want to check a capacitor for its ability to hold a charge. I could not do this with the original checker because the capacitor automatically dis-

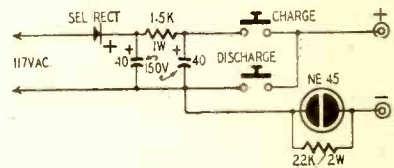

charged when the switch was released. After some experimenting, I came up with a satisfactory circuit. See diagram. Two s.p.s.t push-buttons are used instead of the d.p.d.t. switch in the original model.—*Harold L. Wilkerson*

CORONA RADIO KITS

• Easy Assembly • Excellent Reception

SINGLE BAND SUPER Rocket 115K—Latest superhet circuit for ultimate in sensitive reception and tonal quality. Kit includes all necessary parts, punched chassis, attractive bakelite mahogany cabinet, built-in loop antenna, iron core IP's, big 5" Alnico V spkr.; tubes: 12SK7, 12SA7, 12SQ7, 50L6, 35Z5. Automatic vol. control, beam power out-put. Tunes 540 to 1700 Kc. Simple step-by-step instructions included. Net **\$14.75**

2 BAND AC-DC SUPER Plaza 812K—Excellent sensitivity. Tunes standard Broadcast 535 to 1800 Kc. foreign shortwave 6 to 18 Mc (16.6 to 50 meters). Features iron core IP's, bass-treble tone control, 5" Alnico PM Spkr., phono jack. Handsome bakelite mahogany cabinet, 11 1/2 x 8 x 6 3/4". Tubes: 12SK7, 12SA7, 12SQ7, 50L6, 35Z5. All parts, punched chassis, easy step-by-step instructions included. Net **\$20.75**

3-BAND SUPER Globemaster 814K Complete Kit. Net **\$24.75**
All kits supplied less wire and solder. Please include 25% deposit with C.O.D. Orders. Dept. 6-10

CORONA RADIO & TV CO.
136 LIBERTY ST. NEW YORK 6, N. Y.

WE ARE QUICK & CASH BUYERS

We're looking for surplus inventories of all types of electronic parts—receiving, transmitting and special-purpose Tubes. Anything in the Radio-TV and electronic field.

SMALL or LARGE QUANTITIES—SEND US YOUR LIST

Submit samples where possible, amount of each item and prices:

NAT ADELMAN
168 Washington St., New York 6, N. Y.

Please mention
RADIO-ELECTRONICS
when answering
advertisements

Send for Your
FREE
Copy of the NEW 1954
MIDWEST
TELEVISION and
RADIO Catalog

MIDWEST *Presents*

For 1954 a Completely NEW LINE of
21" and 27" TELEVISION

**CONSOLES
TABLE MODELS**

and
**COMPLETE
CHASSIS**

at
**LOW FACTORY
PRICES**



YOUR CHOICE OF EITHER 12 CHANNEL
VHF or All-Channel VHF-UHF Models

Buy your Television or Radio Direct from the Midwest Factory . . . on
30 DAYS TRIAL . . . Easy Terms . . . and at LOW FACTORY PRICES.
For 34 years Midwest, the world's largest and oldest exclusive Factory-
To-You radio and television manufacturer, has served hundreds of thou-
sands of satisfied customers all over the world.



**EASY TERMS
— • —
30 DAYS
TRIAL**



FACTORY-TO-YOU

Also—Powerful New 1954 World-Ranging
MIDWEST Series 16 RADIOS
In Beautiful Consoles and Complete Chassis



Once again Midwest offers its famous series 16 five band AM-FM radio chassis and the magnificent new Symphony Grand Radio-Phonograph with 3-Speed Automatic Inter-mix Record Player. Also, a complete line of clock radios, table radios, and portables.

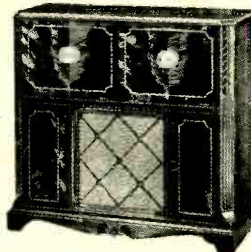

All models available in your choice of mahogany, walnut finish or blond limed oak.

WRITE IN NAME AND ADDRESS (PLEASE PRINT) ON COUPON OR 2c POSTCARD

MIDWEST RADIO & TELEVISION CORP.
Dept. B-38 909 BROADWAY • CINCINNATI 2, OHIO
Please send me your new FREE 1954 Catalog.

NAME _____
ADDRESS _____
CITY _____ ZONE _____ STATE _____

MIDWEST RADIO & TELEVISION CORP.
DEPT. B-38 909 BROADWAY, CINCINNATI 2, OHIO

Compact Design

**GENERAL INDUSTRIES
MODEL SS
3-SPEED (2-POLE)
PHONOMOTOR**

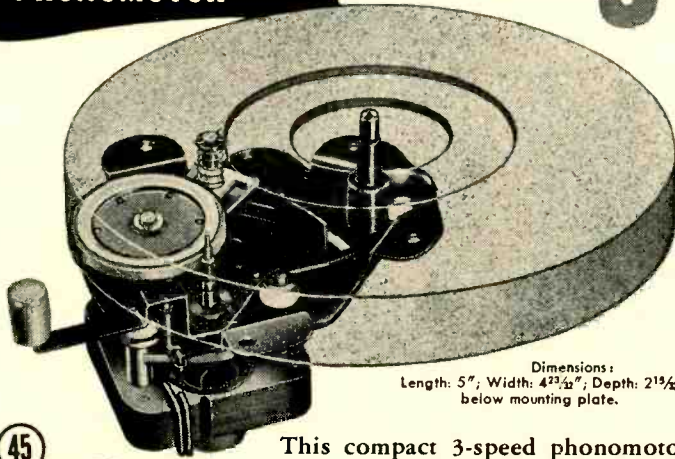

Dimensions:
Length: 5"; Width: 4 3/4"; Depth: 2 1/4"
below mounting plate.

This compact 3-speed phonomotor is ideally suited for both phonographs and combinations in which quality reproduction and limited size are important pre-

requisites. Incorporating General Industries' novel vertical idler shifting principle, the Model SS provides smooth, dependable performance at all three operating speeds. Moving shift lever to "OFF" position automatically disengages idler wheel from motor shaft during non-operating periods.

Specifications and quantity price quotations on the Model SS, or its companion, the Model DSS, with 4-pole motor for high-fidelity reproduction, will be furnished promptly upon request.



THE GENERAL INDUSTRIES CO.
DEPARTMENT ME • ELYRIA, OHIO



VHF and UHF

Broadband Television Antennas

- Proved Best in Gain — Clear Pictures up to 150 miles from Stations!
- Top Performance in Any Weather — No Insulators to Collect Moisture or Dust.
- Rugged Construction—Minimum Wind Resistance—No Joints to Corrode.
- Sold Coast to Coast with a Money-Back Guarantee through Leading Distributors.

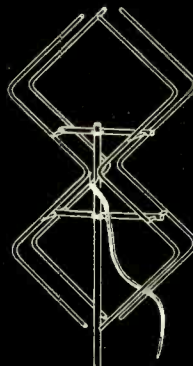

DISTRIBUTORS — Write or wire now to
BEST ELECTRONICS CORPORATION
2254 Colby Avenue, Los Angeles 64, California

**BATTERY
CHARGER-ELIMINATOR**

? Please prepare a diagram of an a.c. operated power supply for charging storage batteries and operating dynamotors requiring 6 to 28 volts d.c. at a maximum of 10 amp.—O. H. M., Brentwood, N. Y.

A. Here is the circuit of a power supply which will do the job for you. Transformers for high-current, low-voltage d.c. supplies are usually special items which are not generally available to the consumer. Of course, a suitable transformer can be obtained on special order but its cost alone is likely to be greater than that of a complete commercial supply having the same ratings. The transformer should have a large number of taps on the primary and secondary windings to permit adjusting the voltage input to the rectifier to the required value for various d.c. loads and voltages.

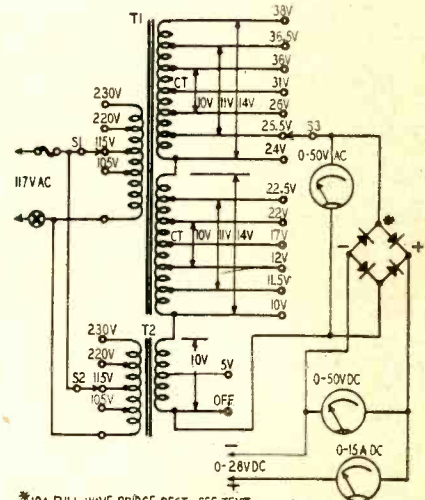

To avoid specifying a transformer which would have to be wound to order, we have designed the supply around 10-amp filament transformers having tapped primaries and secondaries. The secondaries are connected in series aiding. The sum of the secondary voltages should not exceed the maximum input to the rectifier. You can use any number of 10-amp transformers as long as you get the required a.c. voltage out of them. Since some UTC series CG filament transformers have dual multivoltage secondaries and multivoltage primaries, the large number of taps available makes them ideal for obtaining the desired a.c. output. Type CG-124 and CG-126 transformers or close equivalents are recommended for CT and T1 respectively. The positions of S1 and S2 can be changed independently.

You have a choice of copper oxide, magnesium-cupric sulphide, or selenium rectifiers. The maximum a.c. input voltage for each type depends on the make and type. Manufacturers' data gives the maximum a.c. input to each type when working into inductive, resistive, and capacitive loads. The a.c. voltage rises when the rectifier is not

Presenting . . . at most moderate cost . . .

ESPEY

25th Anniversary "Trophy" Models AM-FM CHASSIS • TUNERS • AMPLIFIERS



In commemoration of twenty-five years' experience in the manufacture and development of high-fidelity audio equipment, Espey is proud to present its distinguished "Trophy" models. Renowned for beauty of styling and excellence of performance, the new Espey models are so reasonably priced that for the first time magnificent listening pleasure is within the means of all lovers of fine audio reproduction.

Descriptive literature on the new Espey AM-FM chassis, tuners and amplifiers is now available . . . your inquiry is invited.

SYLVAN A. WOLIN & ASSOCIATES SALES CORP., 409 GRAND AVENUE, ENGLEWOOD, N. J.

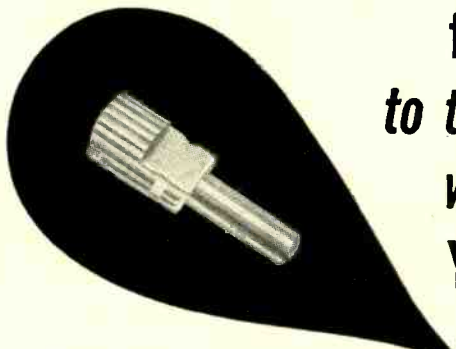

fit the right shaft
to the right
wire-wound control—
YOURSELF!

Immediately, conveniently, correctly, economically.

Just select the Clarostat wire-wound control for your *electrical* needs. Then select any one of 12 Pick-A-Shaft types (or even a high-voltage coupler or nylon shaft) meeting *your shaft needs*. A slight tap joins them together—rigidly, permanently, satisfactorily. Ideal for radio-TV and industrial purposes.

It's another Clarostat *first!* These new Clarostat A43, A58 and A10 wire-wound controls take field-attached shafts. And remember, *only Clarostat* offers 2-, 3- and 4-watt wire-wound controls.

ASK YOUR CLAROSTAT DISTRIBUTOR
for these new Pick-A-Shaft wire-wound controls.
Ask for new catalog—or write us.

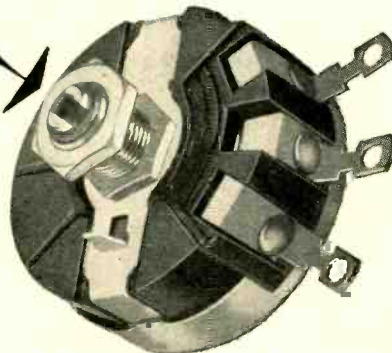

Controls and Resistors

CLAROSTAT MFG. CO., INC., DOVER, NEW HAMPSHIRE

In Canada: Canadian Marconi Co., Ltd., Toronto, Ontario

ATLAS RADIALS

FOR CHURCHES

FOR FACTORIES

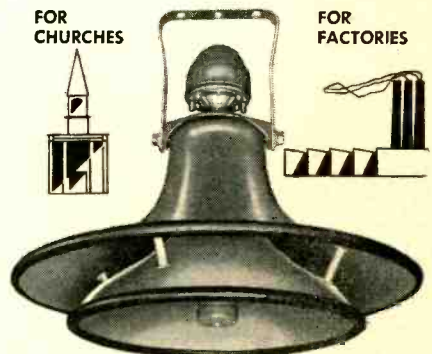

FOR TERMINALS

FOR CARNIVALS

With uniform 360° coverage, non-resonant construction, and 100% storm-proofing, ATLAS Radial Driver Unit Projectors often solve the most difficult sound problems—are excellent for reproduction of speech, chimes and music. For complete details on Radials and the famous ATLAS line of Public Address and Microphone Stand Equipment . . .

WRITE NOW for FREE Catalog 553



1443 39th St., Brooklyn 18, N. Y.
In Canada: Atlas Radio Corp., Ltd., Toronto, Ont.

RADIO-ELECTRONICS

resistor varies the pitch and a 50,000-ohm control varies the headphone volume. The half-wave power transformer T2 isolates the unit from the power line and minimizes the shock hazard. The transformer may be a Stancor type PS8415 or equivalent. Note particularly that the tube heater is connected across the a.c. line rather than across the secondary of T2.

OSCILLATOR SWITCHING

? I am constructing a small signal generator which provides four spot frequencies for checking superhet alignment. The circuit (see Fig. 1) requires

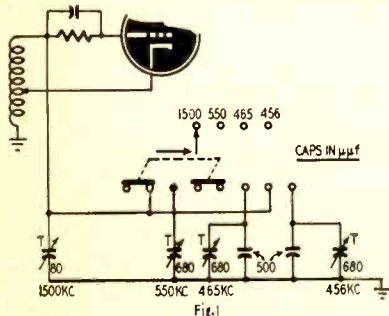

a special slide switch which I cannot obtain. Please modify the circuit so that I can use a switch which is readily available.—J. W. S., Hartford, Conn.

A. The diagram in Fig. 2 shows how the circuit can be wired with a standard

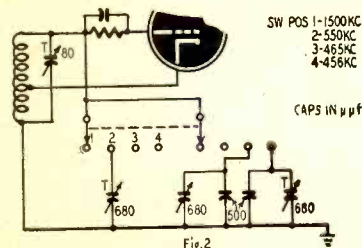

double-pole (two-circuit) rotary switch having four or more positions.

EXTENSION LOUDSPEAKER

? I plan to add an extension speaker and separate volume control to my audio system. Please show how the switch and volume control may be added without disturbing the impedance of the output circuit.—H. W. K., Hagerstown, Md.

A. The diagram shows the circuit you requested. The L-pad and remote speak-

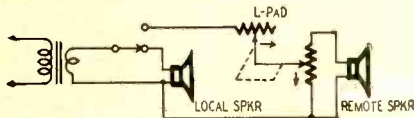

er should have the same impedance as the secondary impedance of the output transformer.

CONICAL ON U.H.F.

? Is it true that conical antennas designed for the regular v.h.f. channels can also be used on u.h.f.? The particular one I have in mind has an "X"

Congratulations! **Hudson**
RADIO & TELEVISION CORP.

Authorized Distributors of
Electronic Equipment and Components,
on the Opening of Their New Salesrooms in
NEWARK, N. J.
at 35 WILLIAM STREET



Everybody in Electronics welcomes the great new HUDSON Salesrooms just opened in the heart of the mighty New Jersey market—to provide the same Huge Stocks, Low Prices, and Superlative Service that have made our two New York Stores the Leading Electronic Supply Centers of the East!

Radio and TV Dealers and Servicemen, Industrial Users of Electronic Equipment and Components, Radio Amateurs, High-Fidelity Enthusiasts... all have come to learn that "HUDSON has EVERYTHING IN ELECTRONICS—at the LOWEST Published Price of Them All!" Visit our Newark Store, you Jersey Area Patrons—see our Huge Stocks and Facilities, meet our Friendly, Helpful People—you'll enjoy the experience!

- SAME DAY SERVICE
- FREE TRUCK DELIVERY IN 25-MILE AREA
- FREE PARKING
- HI-FI STUDIOS

These Nationally Famous Manufacturers of Standard Brand Top Quality Electronic Products and High Fidelity Components, whose Complete Lines are found in ALL THREE Great HUDSON Salesrooms, join in congratulating us on the Opening of the Newark Store:

- | | | | |
|------------------------------|------------------------------|-----------------------------|-------------------------------|
| Acro Products | ClaroStat Mfg. Co., Inc. | Jackson Industries, Inc. | Pyramid Electric Co. |
| Advance Elec. & Relay Co. | Consolidated Wire | Jersey Tech Labs | Quam-Nichols Co. |
| Aerovox Corp. | Continental Carbon, Inc. | Jennings Radio Mfg. Co. | Radio Apparatus Corp. |
| Alpha Wire Corp. | Cornell-Dubilier | Jensen Industries, Inc. | Radio Corp. of America |
| Altec-Lansing Corp. | Dow-Key, Inc. | Jensen Mfg. Co. | Radio Craftsmen, Inc. |
| American Elec. Heater Co. | Drake Electric Works | E. F. Johnson Co. | Raytheon Mfg. Co. |
| Amperex Electronic Corp. | Allen B. Dumont Labs, Inc. | Mathias Klein & Sons | Sangamo Electric Co. |
| Arrow-Hart Hegeman Elec. Co. | Electronics Instrument Corp. | Kraeuter & Co. | Shure Bros., Inc. |
| Arco Electronics | Electro-Voice, Inc. | La Pointe Electronics, Inc. | Simpson Electric Co. |
| Audio Devices, Inc. | Multi Products, Inc. | Littelfuse, Inc. | Herman H. Smith, Inc. |
| Barker & Williamson, Inc. | Erie Resistor Corp. | Livingston Electronic Corp. | Snap-On Drawer Co. |
| Bell Sound Systems, Inc. | Espey Mfg. Co. | P. R. Mallory & Co., Inc. | Sonar Radio Corp. |
| Berlant Associates | Eveready Batteries | Mark Simpson Mfg. Co. | Sprague Products Co. |
| Bliley Electric Co. | Freder Transformer Co., Inc. | Meissner Mfg. | Stanwyk Winding Co. |
| David Bogen Co., Inc. | General Electric Co. | Morrow Radio Mfg. Co. | Stephens Mfg. Corp. |
| British Industries Corp. | General Industries Co. | Mosley Electronics | Switchcraft, Inc. |
| Brook Electronics, Inc. | Gonset Co. | Mueller Electric Co. | Sylvania Electric Products |
| Brush Development Co. | Gordon Specialties Co. | National Co. | Tech-Master Products Co. |
| Burgess Battery Co. | Gray Research & Develop. | Ohmite Mfg. Co. | Triplet Elec. Instruments |
| Cambridge Co. | Guardian Electric Mfg. Co. | Par Metal Products Corp. | Turner Co. |
| Camburn, Inc. | Hallicrafters Co. | Pentron Corp. | Ungar Electric Tools, Inc. |
| Cannon Electric Co. | Hammarlund Mfg. Co. | Perma-Power Co. | United Transformer Corp. |
| Carter Motor Co. | Harvey-Wells Electronics | Pilot Radio Corp. | University Loudspeakers, Inc. |
| Centralab | Hickok Electrical Inst. Co. | Potter-Brumfield Co., Inc. | Vector Electronic Co. |
| Chicago Stand. Transformer | Harvey Hubbell Co. | Precision Apparatus Co. | Walter L. Schott Co. |
| Cinch-Jones Sales | Insuline Corp of America | Precision Electronics, Inc. | Webster-Chicago Corp. |
| Clarkstan Corp. | International Resistance Co. | Premier Metal Products | Weston Elec. Instrument Co. |

One Call for All...



write for complete, new 1954 Giant Hudson Catalog! Dept. R-10

Adjoining Radio City
48 West 48th St., N. Y. 36
Phone: Circle 6-4060

Downtown New York
212 Fulton St., N. Y. 7

NEWARK, N. J.
35 William Street
Phone: Market 4-5151

PAY LESS FOR TUBES ★ INDIVIDUALLY BOXED • FULLY TESTED • EACH TUBE GUARANTEED FOR SIX MONTHS

Type	Price	Type	Price	Type	Price	Type	Price
1B3GT	\$.69	6A55	\$.50	6S4	\$.46	12BA6	\$.45
1N5GT	.46	6AT6	.38	6SA7GT	.52	12BE6	.47
1N5GT	.57	6AU6	.43	6SJ7GT	.47	12BH7	.63
1R5	.56	6AV6	.38	6SK7GT	.50	12SA7GT	.52
1S5	.47	6BA6	.45	6SL7GT	.52	12SK7GT	.50
1T4	.56	6BC5	.53	6SN7GT	.54	12SL7GT	.61
1X2	.67	6BE6	.47	6SO7GT	.42	12SN7GT	.54
303GT	.65	6BG6	1.34	6T8	.78	12SQ7GT	.44
3S4	.55	6BH6	.57	6U8	.85	25BQ6	.89
3V4	.56	6BJ6	.48	6V6GT	.46	25LGT	.48
5U4G	.43	6BL7	.81	6W4GT	.45	25Z6GT	.42
5V4G	.73	6BQ6	.89	6W6GT	.57	3B5	.47
5Y3G	.34	6BQ7	1.10	6X4	.34	35L6GT	.47
5Y3GT	.36	6BZ7	1.10	6X5GT	.33	35W4	.31
6AR4	.46	6C4	.34	12AT6	.78	35Z6GT	.30
6AF4	1.40	6CB6	.53	12AT7	.68	50B5	.47
6AG5	.54	6CD6	1.85	12AU7	.55	50C5	.47
6AK5	.95	6J5GT	.40	12AV6	.38	50L6	.47
6AL5	.49	6J6	.62	12AV7	.80	117Z	.39
6AD5	.46	6K6GT	.41	12AX7	.61	117Z6	.68

Each tube is performance-proven. 25% deposit must accompany all orders. Balance C.O.D. All prices F.O.B., N.Y.C. If remittance is made with order, you can deduct 20% \$1.00 handling charge for orders under \$10.00. Subject to Prior Sale. Importer inquiries invited.

PHILLIPS TUBE COMPANY 2281 1/2 Nostrand Ave. Brooklyn 10, N. Y. C/Overdale 2-8010-1-2

MORE CAPTURE AREA!

Cat. No. 3006
\$16.50 List.

**FOR FINEST
UHF
RECEPTION**

The Taco 4-stacked Bow-Tie
Cat. No. 3006 gives more capture area
for a stronger, clearer signal in the
weakest fringe areas. This UHF array
has been proved as the finest for performance
and dependability in all UHF areas.

Also available:

Model 3031 Single Bow Tie with screen grid reflector \$4.00 List
Model 3032 Dual Bow Tie with screen grid reflector \$7.95 List

Ask your Taco distributor for complete details.

TACO

TECHNICAL APPLIANCE CORPORATION • SHERBURNE, N. Y.

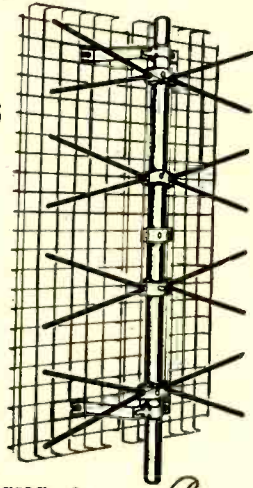

type reflector and the fed element has two short "high-frequency" bars.—E. T., Gaston, Ind.

A. Most present-day television antennas will work on u.h.f. because they act as long-wire antennas on the higher frequencies. Losses are greater, however, and the antenna should be well spaced from tin roofs, shade trees, or other possible reflecting or absorbing surfaces. The transmission line should also be spaced from the mast, rain pipes, and other metal objects by 6 inches or more.

Because of the small dimensions necessary for u.h.f., a more efficient antenna could be used. The corner reflector type, rhombic, collinear, and others are most popular on these frequencies. Because half-wavelength spacings are smaller, multiple stacking

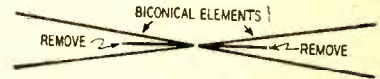

can also be utilized to increase gain.

(Incidentally, research has disclosed that the two small center arms of the biconical you mentioned actually load down the antenna and decrease instead of improve performance on both the high and low channels. Removing them will give you better signal strength.)

COAXIAL LINES

? I got fairly good results using a home-made v.h.f. antenna in conjunction with a 300-ohm ribbon type transmission line. Since installing a commercial antenna plus an RB-59/U coaxial line, results are inferior to those of the old antenna. The new antenna is several feet higher than the old homemade affair. What is causing the poorer reception?—J. C., United, Pa.

A. You are probably getting a mismatch with the coaxial cable at both the antenna and the receiver. A certain amount of mismatching is permissible when the antenna is connected to the transmission line. However, too great a mismatch results in serious loss of signal, and reflections are set up all along the line. Reflections in a transmission line may cause double images to appear on the picture tube screen just as readily as reflected signals at the antenna itself. Besides this, coaxial-cable transmission lines have higher losses than most 300-ohm ribbon types. Coaxial lines are most useful for their self-shielding properties where local noise levels are extremely high and the losses in the coaxial cable can be minimized. Type RG-11/U should be used if possible, for it has lower losses than RG-59/U. The following table gives relative losses per 100-foot length:

Frequency	ribbon	RG-11/U	RG-59/U
100 mc	1.25 db	1.88 db	3.66 db
200 mc	1.82 db	2.85 db	5.50 db

If you install 300-ohm line with the commercial antenna, your reception will probably improve. You should also make sure the new antenna is properly oriented.

END

the

630

IS STILL THE FINEST
TV CHASSIS EVER DESIGNED

...and there is no finer
630 chassis than the
GOLD MEDAL

by **TECH-MASTER**

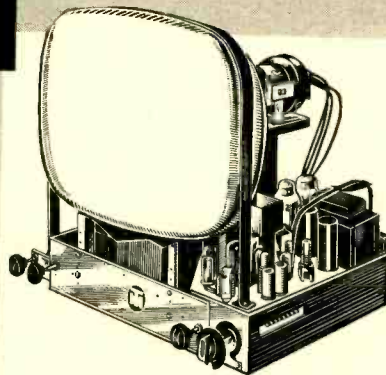

There is a Tech-Master Custom-Designed, custom-built TV Chassis for every requirement where quality and reliability are the predominant factors.

- MODEL 2430: For picture tubes up to 24". Audio connection for optional use of external amplifier.
Net Price..... (Less Kine)..... \$189.50
- MODEL 2431P: Same as 2430, but with true fidelity Push-Pull audio amplifier.
Net Price..... (Less Kine)..... \$199.50
- MODEL 2439: For new 90° kinescopes. (24" rectangular, 27" and 30")
Net Price..... (Less Kine)..... \$262.50

TECH-MASTER TV Chassis

TECH-MASTER TV Kits

TECH-MASTER Audio Equipment



Write for Detailed Data

TECH-MASTER PRODUCTS CO.

445 BROADWAY, NEW YORK 13, N. Y.

Concord Radio presents the world's most powerful UHF-VHF-FM antenna!



MONEY BACK GUARANTEED

TO RECEIVE *All* UHF and *All* VHF STATIONS IN *All* DIRECTIONS FOR 60 MILES WITHOUT A ROTORMOTOR OF ANY KIND!!

While antenna reception is guaranteed for 60 miles, perfect pictures have been consistently received as far as 160 miles from stations.

***All* NEW DESIGN FOR '54**

- LOW-LOSS SWITCH
- LOW-LOSS PHENOLIC INSULATORS
- USES NEW 4-CONDUCTOR MATCHED IMPEDANCE LINE
- ONLY 10 INCH SPACING BETWEEN ANTENNA BAYS

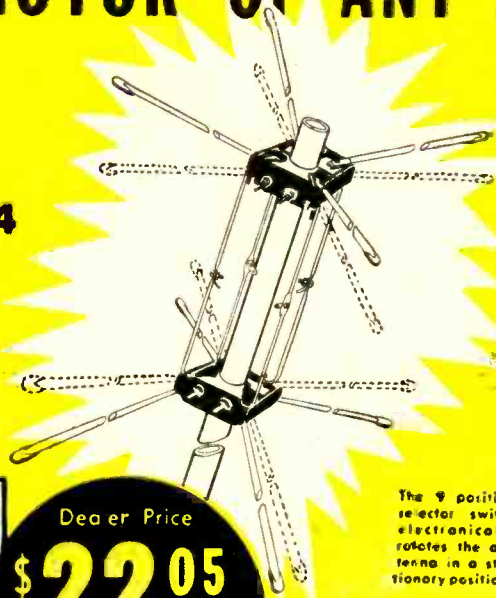

MODEL SUPER 60



The 9 position selector switch electronically rotates the antenna in a stationary position.

NEW! POLYMICALENE 4 CONDUCTOR Matched Impedance TRANSMISSION LINE

Improves Both UHF and VHF Performance of any ALL-CHANNEL Antenna!

100 Ft.	\$8.90
150 Ft.	\$13.90
200 Ft.	\$17.50

Minimum quantity 100 ft.

Dealer Price

\$22.05

LIST PRICE

\$36.75

PRICE INCLUDES
 Complete stacked array • 4 stacking bars • 9 position switch • Switch-to-set coupler • 3 - 7 1/2" stand offs • Individually boxed in mailable carton

Mfg. solely by
ALL CHANNEL ANTENNA CORP.
 New York, N. Y.
 under license Pat. No's 2,585,670,
 2,609,503, 2,625,655. others pending.

WRITE FOR FREE CATALOG
Concord Radio
 54 Vesey Street, New York 7, N. Y. • Digby 9-1132

CONCORD RADIO 54 Vesey Street, New York 7, N. Y.

Please send me.....amount at \$36.75 list price.
 Please send me.....amount at \$22.05 dealer net.
 Dealers order on letterhead.
 Please send me.....feet of 4 conductor Polymicalene

Name _____
 Address _____
 City _____ State _____

Check Enclosed Money Order Enclosed
 C.O.D. enclosed please find 25% of total purchase price... check...
 Money Order. Send Giant New FREE Concord Catalog at once check...
 Please put my name on your "Special Bargain" mailing list.

() Enclosed find \$_____ in full. Send prepaid.

BARGAINS · BARGAINS · BARGAINS

BARGAINS · BARGAINS · BARGAINS

Famous
STEVE-EL
BRANDED

TUBES

All Brand New
Individually Boxed
FAR BELOW WHOLESALE COST!

1A7	50.59	6A55	48	6CD6	1.21	6U6	57	12AX7	69	35L6	48
1B3	43	6A03	37	6F6	43	6UB	37	12AZ7	69	35W4	48
1P5	54	6AT6	37	6J5	37	6V6GT	46	12BA6	46	50B5	48
1R5	56	6AX4	52	6J6	79	6V8	46	12BA7	58	50C5	47
1S5	48	6B8	52	6K6	41	6W4	57	12BE6	46	50	38
1U4	48	6BA6	45	6L6G	89	6W6	57	12SL7	57	117Z3	36
1U5	46	6BC5	58	6S4	44	6X4	37	12SN7	54		
7V4	48	6BC7	86	6SA7	52	6X5	37	14A77	57		
5W4	46	6BE6	48	6SG7	49	7N7	52	14N7	64		
6A5	51	6BG6	1.21	6SK7	43	7K7	62	19T6	78		
6A05	46	6BH6	62	6SL7	52	12A6	48	25B06	77		
6AK5	1.1	6BJ6	53	6SN7	54	12AT6	48	25W4	48		
6AL5	41	6BN6	74	6SQ7	42	12AT7	68	25L6	48		
6AU6	43	6C4	34	6SR7	44	12AU7	65	25Z6	42		
6AV6	37	6CB6	48	6T8	74	12AV6	52	35C5	47		

SPECIAL DISCOUNTS
50%
100%
Asth. 5%
Asth. 10%

INTERCOM SPECIAL



Now you can own an intercom that has a thousand uses at a price you would normally pay for a kit. This intercom comes housed in wooden cabinets completely wired and ready to operate. Outfit consists of one master, one sub station and fifty feet of two wire cable. Ideal for home as baby sitter. Perfect for office or factory. Order now as quantities are limited.
YOUR COST COMPLETE only \$15.95

AC-DC SUPERHET 5 TUBE RADIO KIT

Easy to build. Complete with all parts, plastic cabinet and step by step schematic drawings. Standard broadcast 550 to 1600 K.C. 2 I.F. transformers 455 K.C. Alnicap Speaker. Built in antenna. Slide rule dial. Walnut cabinet.
Only **\$11.89**

STEVE-EL now carries full line of Eico, E.M.C., Pilot, Tech-Master, Pentron, Wen Products, Burgess, Shure, etc. Write for free catalog.

STEVE-EL ELECTRONICS CORP.

Dept. E-10 61 Reade St., New York 7, N. Y. COrtland 7-0086

STAN-BURN ELECTRONICS

* CATHODE RAY TUBE SPECIALS *

ONE YEAR GUARANTEE		STAN-BURN	
STP4	G.E. \$44.95	10BP4	\$11.00
71P4	17.10	14CP4	17.00
10BP4A	19.25	14CP4A	17.00
12CP4A	27.10	15DP4	19.50
12LP4A	21.70	16AP4	21.60
12UP4B	28.25	16FP4	19.60
14CP4	24.50	16GP4	21.60
16AP4A	30.95	16HP4	19.60
16DP4A	28.20	16DP4/HP4A	20.60
16GP4	31.25	16KP4	18.50
16LP4/16RP4	25.20	16MP4	21.60
17BP4A	23.90	16LP4A	21.60
17CP4	23.90	17BP4	18.50
18CP4	38.45	17CP4	21.60
20CP4	32.50	19AP4	23.90
20LP4	37.50	19AP4A	25.90
21CP4A	37.35	20CP4	29.50
24AP4 A	78.50	21EP4	32.50

* ANTENNAE SPECIALS *

RED DOUBLE "V" Antenna	1-5	6 or more
10 ELEMENT CONICAL	2.19	1.98
Dowled Inertial	2.98	2.79
50 elements Low Quick Rig	4.25	3.25
WINDOW CONICAL	4.95	3.75
MASTS 5 FOOT SWEGGED	.79	.69
10 FOOT PLAIN	1.39	1.29
NEPCO MASTS	1.69	1.49
TV WIRE 42 Mill. 55 Mil. 300 OHM		\$9.95 M Ft.
72 OHM COAXIAL		35.00 M Ft.
12" Heavy Slug Speaker		Special \$3.98
CHASSIS 630 REGAL with Cascade Tuner	\$11.00	
OPEN FACE CABINET		42.00

* WIRE RECORDERS IN STOCK *

PENTRON-Model 9T3C-2-speed Tape Recorder	Write for Price.
RADIO CRAFTSMAN Model C400-Hi-Fi Amplifier	Net \$42.90
Model C10-AM-FM Tuner	Net 13.50
Model C500-Williamson Amplifier	Net 99.50

- We also carry MASCO-BOGEN-PILOT, etc. Amplifiers-Pre-Amps, FM Tuners and WEBSTER Tape Recorders.
- 6"x9" PM SPEAKER \$3.98
- 7" PM SPEAKER 3.98
- 7711 G.E. Flyback 1.98
- 705 Yoke 1.98
- 630 Vert. Output Upright 1.98
- 630 Vert. Output Potted 1.29
- 630 Vert. Blocking Osc. Xform. 1.89
- CASCADE TUNERS 19.95
- STANDARD TUNERS 17.95
- DUMONT 21.25mc 14.95

AUTHORIZED DISTRIBUTORS for: General Electric, Kenrad, Tung-Sol, National Union, De Wald, Regal, Automatic and General Motors.

AUTOMATIC CUSTOM-BUILT RADIOS for Plymouth, Ford, Chevrolet and many others, always in stock. We carry a complete stock of HI-FIDELITY and SOUND EQUIPMENT. Send us your requests. We also carry a complete line of popular makes of Radio tubes at 50% discount. Also many other special purpose and transmitting types, and all electronic parts and equipment at lowest prices. Send us a list of your requirements for prompt quotations.

Terms: 20% with order, balance COD. All prices FOR NEW YORK Warehouse. Minimum order \$5.00

Write for our latest price list and Hi-Fi Catalog to Dept. RE-10.

STAN-BURN RADIO and ELECTRONICS CO.

(C.B.S. THEATRE BLDG.)
1697 BROADWAY · NEW YORK 19, N.Y.

RECORDING TAPE (PLASTIC BASE) 40% OFF

WASHINGTON, D. C.: WHERE ELSE WOULD THERE BE MORE MAGNETIC TAPE?

- 1200 ft. plastic tape with plastic reel included. Each reel individually boxed. Choice of nationally famous top quality brands such as: Reeves (SPN-12) 3.20; Webeor (2906) 3.20; Audio (1251) 3.23; Scotch (111-A) 3.25; Irish Professional grade, (211 RP4) 3.30. (LIST PRICE ON ABOVE TAPES ARE 5.50 EA.)
- 10% additional discount to Club Members of:
 - A. Tape-Response International 3488-22 St. San Francisco, Calif. (Fred Goetz, Secretary)
 - B. Voice-response Club 1614 N. Mango Ave., Chicago, Illinois (John Schirmer, Secretary)

New empty plastic reels in boxes for easy labeling 3"-10c; 4"-22c; 5"-24c; 7"-30c each. EMPTY BOXES: 3"-3c; 4"-5c; 5"-5c; 7"-10c.

- We carry new recorders, recording blanks, tape, tape recorders, etc., at large savings. PLEASE INCLUDE SUFFICIENT POSTAGE.

COMMISSIONED ELECTRONICS CO.
2503 Champlain Street, N.W., Washington 9, D.C.

NATIONAL ELECTRONICS' BARGAIN

OF THE YEAR DUE TO A SPECIAL BUY WE MADE.
BUY EARLY—STOCKS LIMITED

Leave it to National Electronics to make a special buy like this. This is the kind of buy you would expect only during the off season, but not in October! Made by one of the leading makers of antennas who wouldn't allow us to use his name because of this low price, these Yagis are engineered to cover three adjacent channels with high average gain, and offer pin-point directivity and a superior signal-to-noise ratio. Single arrays give good pictures in the medium fringe and stacked arrays at 70 miles or better. Look at these prices:

MODEL	SINGLE BAY NET EACH	2-BAY SINGLE BAY NET EACH	4-BAY SINGLE BAY NET EACH	LOTS OF 6 EACH
XY-11-13	\$3.50	\$7.50	\$2.95	\$2.95
XY-9-11	3.50	7.50	2.95	2.95
XY-7-9	3.50	7.50	2.95	2.95
XY-456	6.25	11.95	4.95	4.95
XY-345	6.25	11.95	4.95	4.95
XY-234	6.25	11.95	4.95	4.95

Model numbers indicate channels covered—be sure to specify.

Super-Gain TO ELEMENT TWIN-DRIVEN YAGI

Designed for finest reception in ultra-fringe weak signal areas. TWIN-DRIVEN for Channels 2-6. Uni-Driven for Channels 7-13. Single array produces 11 db gain. Finest construction. Each array includes 10 airplane-type aluminum elements, mast boom, mast clamp and supporting brackets. Pre-assembled for easy installation.

Channel 2	\$21.90	Channel 3 or 4	\$18.90
Channel 5 or 6	16.90	Channel 7 to 13	7.95

(Give exact channel required)

Save With Rocket 35 Foot Mast Kits

Economy mast kit contains 3 self-coupling 10' seamless TRI-COATED 1 1/4" O.D. masts, one 5' mast, 300 feet of 6/20 galvanized steel guy wire, and everything else needed including guy rings, insulators, cable clamps, guy hooks, and swivel mounting base.

35 Foot Mast Kit \$15.95 25 Foot Mast Kit \$11.95

ALL PRICES F.O.B. CLEVELAND, OHIO
Do not remit more than complete purchase price. Pay shipping charges on receipt of goods. 25¢ deposit on all C.O.D. orders, please. Money-back guarantee.
Prices Subject to Change Without Notice

Sensational Powermaster ALL DIRECTIONAL TV ANTENNA

ELECTRONICALLY ROTATES IN ALL DIRECTIONS \$41.50

Especially designed for ultra-fringe areas where signals arrive from several directions. Offers extra high gain over any broad-band antenna. Requires no motors—no electric power. 360° rotation by means of 6-position switch located at set. 48 elements, with 6 matched tie rods. Complete with 6-position Beam Switch, 100' Tubular Low-Loss Tri-X Universal Mast Clamps. Order Model AX-518-10. With 150' lead-in, order AX-518-15.

Model AX-524—same Directional operation as Model AX-518. Provides 2-bays, 21 elements. Complete with 6-position switch, 75' tubular cable, 3 matched stacking bars. \$23.50

BARGAIN in All-Channel CONICALS

3 Hi-gain 2-Ray 16-element arrays including hi-hand adapters and 3 pair Tie Rods \$13.95
Same, less Tie Rods \$12.50
Only 600 Left. Order Early.

SENSATIONAL LOW PRICES ON ACCESSORIES

Mast Steel (Dualcoated 5' crimped) 1 1/4" O.D.	\$1.05
Mast Steel (Dualcoated 10' 1 1/4" O.D.)	1.95
Mast Connectors for 1 1/4" Mast	.59
Chimney Mount complete with struts	1.19
Peak Roof Saddle (will take up to 1 1/2" Mast)	1.59
Lightning Arrestor-TV	.69
Steel Guy Wire—6/20—100' coil	.85
Rocket Twin-lead—7/28 stranded	2c ft.
UIF Tubular Twin-lead Lo-Loss 100' coil	4.95
Mast Stand-off Insulators—3"	1.0
Screw Type stand-off Insulators—3"	.03
Sateo Combination UIF Converter and VHF Booster	
Efficient and a real buy at	\$34.95
Regency VHF TV Booster	
With plenty of gain; designed for new and old front ends	19.50
Alliance ATR Antenna Rotator	
Efficient and dependable—economically priced	20.53
4-conductor motor wire—cut to order	4c ft.

NEW FALL AND WINTER CATALOG AVAILABLE

National Electronics OF CLEVELAND

THE HOUSE OF TV VALUES

210 Delco Building, Cleveland 3, Ohio

\$3.00 FOR CARTOON IDEAS

RADIO-ELECTRONICS prints several radio cartoons every month. Readers are invited to contribute humorous radio ideas which can be used in cartoon form. It is not necessary that you draw a sketch, unless you wish.

Address
RADIO-CARTOONS, RADIO-ELECTRONICS
25 West Broadway, New York 7, N. Y.

FREE!

**THE HOTTEST VALUE-
PACKED BULLETIN
IN THE MAILS!**

Over 153,000 subscribers
buy and save through
**WHOLESALE RADIO'S
F.Y.I.
BULLETIN
EVERYTHING
IN RADIO • TV
HI-FI SOUND**

Write for
New FYI
#202
Just Off
The Press

**WHOLESALE
RADIO PARTS
COMPANY, Inc.**
311 W. Baltimore St.
Bal'imore-T, Md.

COAST ELECTRONICS has the
NEW precise
MODEL 308 K
8 1/2" OSCILLOSCOPE
THE GREATEST OSCILLOSCOPE
FROM COAST TO COAST

ALL THE FEATURES
OF THE FAMOUS
MODEL #300 PLUS:

- ★ INTENSIFIER ANODE
- ★ HI-LOW-NORMAL SYNCH.
(A Precise First)
- ★ 8 1/2 INCH TUBE
(A Precise First)
- ★ VOLTAGE REGULATION
(A Precise First)

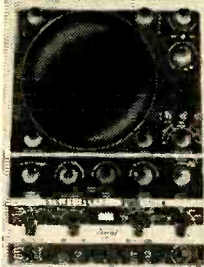

See Precise Ad Page 90

The only 8 1/2" Oscilloscope on the commercial market today. We have this Precise "scope" for you.

NEW 7" Oscilloscope Kit \$ 94.95
LATEST 8 1/2" Oscilloscope Kit..... \$129.50

OTHER PRECISE KITS AVAILABLE:

MODEL 909K—VACUUM TUBE VOLTMETER	\$25.98
MODEL 630KA—RF-AP TV & MARKER GENERATOR (pre-assembled head)	\$38.95
MODEL 610KA—RF SIGNAL GENERATOR (pre-assembled head)	\$28.95
MODEL 635K—UNIV. AF SINE, SQ. & PULSE GEN.	\$33.50

Terms: All merchandise shipped FOB Alhambra, California. Prices slightly higher in the West. Prices and specifications subject to change without notice. Include 20% deposit for C.O.D.'s. WRITE FOR NEW CATALOG—FREE!

COAST ELECTRONICS SUPPLY CO. Dept. P2
527 W. Main Street • Alhambra, Calif.

Send me _____
 Enclosed find \$ _____ deposit. Balance C.O.D.
 Enclosed find \$ _____ in full.
 NAME _____
 ADDRESS _____
 CITY _____ ZONE _____ STATE _____

Les Willberg, president of Leader Electronics, Inc., Cleveland, announced that his firm, which has been producing special industrial switches, would enter into the manufacture and sale of TV equipment for consumer use. Mr. Willberg has been in the electronics field for over 30 years. He was the founder and former president of Radiart Corp.



L. Willberg

Vinton K. Ulrich joined David Bogen Co., New York City, as general sales manager replacing W. Walter Jablon, who resigned as vice-president in charge of sales. Ulrich was formerly renewal sales manager of National Union Radio. Mortimer Sumburg of the Bogen jobber sales staff has been upped to the position of distributor sales manager.



V. K. Ulrich

Edward P. Atcherley was appointed merchandising manager for renewal tube sales of Sylvania Electric Products, New York City. He was formerly regional sales manager for renewal sales in the Midwest district. Sylvania also announced the appointment of W. T. Buschmann to the new position of product sales manager of radio receiving tubes. He was formerly production requirements and service coordinator for the Radio Tube and TV picture Tube Divisions.



E. P. Atcherley

Douglas Carpenter and Jim Hall were appointed chief antenna development engineer and associate antenna test



D. Carpenter



J. Hall

engineer, respectively, for JFD Manufacturing Co., Brooklyn, N. Y. Carpenter was at one time with La Pointe Electronics and Hall with the Civil Aeronautics Administration.

Karl W. Jensen, vice-president of Jensen Industries, Inc., Chicago, was elected chairman of the Electronic Parts & Equipment Manufacturers Association. Theodore Rossmann, general manager of Pentron Corp., Chicago, was elected vice-chairman, and Helen

Heard...
but not Seen

American's

25th year of leadership
in the design and manufacture of quality microphones. Pioneers of the attractive "full-vision" design of quality microphones to be heard but not seen. Enjoy perfect performance... plus... full vision for both artist and audience.

**D 33
BROADCAST
D 22 P.A.**

**DR 330
BROADCAST
DR 332 P.A.**
RIBBON & DYNAMIC
CARDIOID

Write for Free Catalog 46

American
MICROPHONE CO.

370 S. FAIR OAKS AVE., PASADENA 1, CALIF.

EDLIE
says

"Save with confidence"

The Lowest Priced Kits on the Market



LOWEST PRICED SIGNAL GENERATOR, BROADCAST BAND

New simplified circuit provides the following switch tuned, tone modulated frequencies:

1. 455 K.C.—Intermediate I.F. frequency
 2. 1500 K.C.—High frequency of Broadcast Band
 3. 600 K.C.—Low frequency of Broadcast Band
 4. Audio tone—for audio amplifier trouble shooting
 5. An attenuator control is included for adjustment of the output signal strength
- Housed in small black bakelite cabinet size 6"x6"x3 1/2". Can be useful for alignment of all Broadcast Band radio receivers. **Completely Wired. \$7.95**

INTRODUCTORY OFFER
Deduct \$1.00 if ordered with Kit #1 or #2

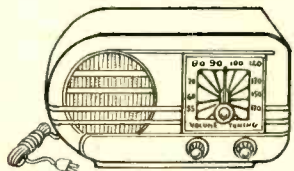

5 TUBE AC-DC SUPERHET KIT

Kit #1—Five Tube superheterodyne kit, A.C.-D.C. contains all components required to construct this latest design, highly sensitive superheterodyne broadcast receiver, complete with black bakelite cabinet (excludes with black wire and solder) **Only \$7.95**
Kit of 5 tubes (12AT6, 12BA6, 12BE6, 35W4 50C5). Only \$3.25.

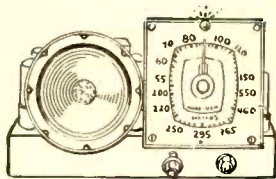

6-TUBE RADIO KIT

Kit #2—A low-priced 6 TUBE KIT designed for high sensitivity, excellent selectivity and good tone quality. Uses 25L6, 25Z6, 6SQ7, 6SA7, 6SK7, 6SK7 in an easily constructed circuit. The 6 Tube Kit is shipped with all parts, including punched chassis, resistors, condensers, coils, sockets, PM Speaker, hardware, etc.

And at a closeout price of **\$6.95** only (less tubes and cabinet)
Matched set of six tubes **\$3.25** for kit

PHONO OSCILLATOR

Not a Kit!

Wireless phono oscillator transmits recording for crystal pickups or voice from carbon mike through radio without wires. Can also be used as an intercomm by using P.M. speaker as mike. Price (excluding tubes) **\$2.95**

With Complete Set of Tubes.... \$3.95

3-TUBE PHONO AMPLIFIER

Not a Kit!

An assembled unit ready for installation using tone and volume control and six feet of rubber **\$2.95** cord (Not including Tubes)

With Complete Set of Tubes \$3.95

Electronic Code Practice Oscillator & Blinker Kit

AC/DC or Battery Operated!

Kit #3—One of the most practical Code Practice Oscillators ever designed, yet one of the simplest to build and operate.

Can be used with any number of headphones. Adjustable Pitch Control—Any type of headphone can be used.

No warmup time—ready to operate instantly.

Simple and safe to operate.

Operates anywhere—with AC or DC power, or from a 90 volt Miniature Battery.

Learn Blinker Code with flashing light.

Blinker can be used as signaling device. International Morse Code included.

Kit \$1.95 Assm. \$2.95 each

Terms: All merchandise shipped F.O.B. New York City, prices are subject to change without notice. Include 20% deposit for C.O.D.'s. **WRITE FOR NEW CATALOG—Free!**

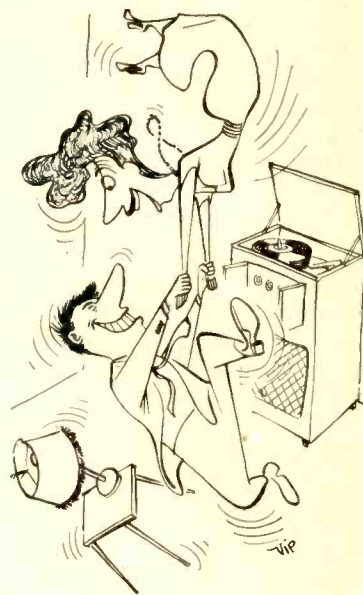

"Dancing's a lot more exciting when we use a JENSEN NEEDLE!"

PLEASE MENTION RADIO-ELECTRONICS when answering advertisements

EDLIE Electronics

154 Greenwich St.
DI 9-3143
New York 6, N. Y.

Regency

UHF

the quarter million dollar converter

CONVERTER MODEL RC-600



\$49.95 list



R. W. Jensen

executive secretary.

Staniland Quam, distributor sales manager of Quam-Nichols Co., Chicago, was re-elected treasurer of the association for her 16th annual term. Kenneth C. Prince was re-named ex-

Edwin A. Freed was named manager of operations of the General Instrument Corp. headquarters plant in Elizabeth, N. J. He was formerly sales manager. Robert L. Klabin, controller of General Instrument, was elected to manage the company's Sickles Division plant at Danielson, Conn. C. F. Sullivan, assistant controller, was named acting controller during Klabin's absence. General Instrument also announced the election of Malcolm C. Hutchison as a director of the company. Hutchison is a former vice-president of Irving Trust Co.



E. A. Freed

Jacob H. Ruitter, Jr. was appointed to the newly created post of public relations manager for the Allen B. Du Mont Laboratories, Clifton, N. J. He was formerly technical advertising manager.

Obituary

Fred R. Ellinger, president of Waldom Electronics, Chicago, and Ellinger Sales Corp., Chicago representative firm, died recently in Chicago after a short illness.

Personnel Notes

... Jerome J. Kahn, founder and president of Standard Transformer Corp. until its recent merger with Chicago Transformer Corp., withdrew from active management in the newly formed Chicago Standard Transformer Corp.

... Robert C. Sprague, chairman of the Board of Sprague Electric Co., North Adams, Mass., was elected a director of the Massachusetts Business Development Corp., a state agency created to attract industry to Massachusetts.

... Harry C. Hagerty, financial vice-president and director of the Metropolitan Life Insurance Co., was elected a director of the Radio Corporation of America.

... Carl E. Smith resigned as vice-president in charge of engineering of United Broadcasting Co., Cleveland, to devote full time to expanding his consulting engineering operation, that of Carl E. Smith Consulting Radio Engineers, Cleveland. He also continues as president of Cleveland Institute of Radio Electronics.

... George A. Hinckley was appointed sales engineer in the Equipment Sales Division of Raytheon Manufacturing Co., Waltham, Mass. He was formerly chief engineer of station WLAW

MONEY-SAVING OFFER

ON THE LATEST AND GREATEST GHIRARDI TV-RADIO SERVICE TRAINING BOOKS

... only \$12 for the 2-book set

10-day FREE examination . . . 4 months to pay

Radio-TV CIRCUITRY AND OPERATION

by Ghirardi and Johnson

688 pages, 417 clear illustrations

Price \$6.50 separately



Radio-TV TROUBLESHOOTING AND REPAIR

by Ghirardi and Johnson

820 big pages, 419 clear illustrations

Price \$6.75 separately

Complete training for FASTER, BETTER SERVICE on any TV or radio ever made!

Ideal for beginners . . . a gold mine of time-saving methods for experienced service men

LEARN CIRCUITS FULLY . . . and watch service "headaches" disappear!

It's a whale of a lot easier to repair ANY television or radio receiver when you know all about its circuits and how and why they work. You locate troubles faster. You work more efficiently. What's more, the basic training you get from Ghirardi's *TV & Radio Receiver CIRCUITRY AND OPERATION* book is just the thing to fit you for dozens of other television-radio-electronic jobs.

Actually, it's simpler than you may think. There are only a few basic circuits used in modern equipment—but each of these has many variations. You learn to know and recognize them instantly. You learn to locate troubles in far less time and with less testing.

MAKES THE TOUGH JOBS EASY!

Here's what this great book on modern circuits covers: 1—Amplitude Modulation; 2—Frequency Modulation; 3—RF Amplifiers and TRF Receivers; 4—AM Superhets; 5—AM Detectors and AVC Systems; 6—Push-button Tuning and AFC Systems; 7—AF Amplifiers; 8—Loudspeakers; 9—Radio Power Supplies; 10—Television Receivers; 11—Phone Pickups and Record Players; 12—Automatic Record Changers; 13—Mechanical Construction of Receivers; etc.

Summaries at the ends of every chapter help you locate the data you want in a jiffy. 417 clear illustrations help make circuits easy to learn.

See for yourself how much this great book can help you—in dozens of ways! Use coupon for 10-day FREE examination.



You can't go wrong!

... on a Ghirardi training book! For years, Ghirardi books have been more widely used in schools, for military training and home study than any others of their kind . . . because they make things so amazingly easy to understand. The two new books described above are this famous author's very latest—up-to-the-minute in every respect!

THE HOW-TO-DO-IT GUIDE to modern service methods

For beginners, Ghirardi's NEW 820-page *Radio & TV TROUBLESHOOTING AND REPAIR* book makes all parts of the work amazingly easy to understand. For experienced servicemen it is the ideal way to "brush up" on specific types of work; to find fast answers to specific problems; or to develop better, faster and more profitable troubleshooting methods.

Modern test methods are fully explained. From quick, visual analyses of common troubles, you proceed to learn all about "static" tests and "dynamic" signal tracing and signal injection techniques. Special problems in hard-to-fix sets are greatly simplified. Step-by-step charts explain professional service procedures almost at a glance.

LEARN MORE—EARN MORE!

Throughout, Ghirardi's *TROUBLESHOOTING AND REPAIR* is a book that paves your way to better-paying service jobs! Receiver alignment is made easier than you might have thought possible. Tuning problems, speaker troubles, components and dozens of other subjects are covered fully.

Every step of television repair work is simplified to the utmost degree! You learn to analyze TV picture patterns accurately, to locate troubles faster—even fading and tracing down "intermittents". Handy summaries with every chapter make the book invaluable for quick reference whenever you are "stumped" by a job.

See for yourself! Use coupon today for 10-day FREE examination of this newest Ghirardi book!

10-DAY EXAMINATION OFFER

Dept. RE-103, Rinehart Books, Inc., Technical Division, 232 Madison Ave., New York 16, N. Y.

Send books indicated for 10-day FREE examination. In 10 days, I will either send you price indicated or return books postpaid and owe nothing.

Radio & TV Receiver CIRCUITRY AND OPERATION Price \$6.50 Radio & TV Receiver TROUBLESHOOTING and REPAIR Price \$6.75

SPECIAL COMBINATION OFFER . . . SAVE \$1.25!

Both Books only \$12 for the two. (Regular price \$13.25—you save \$1.25) Combination offer payable at rate of \$3 after 10 days if you decide to keep books, and \$3 per month thereafter until total of \$12 has been paid.

Name

Address

City, Zone, State

(OUTSIDE U.S.A.—\$7.25 for TROUBLESHOOTING & REPAIR; \$7.00 for CIRCUITRY & OPERATION; \$13.00 for both books. Send cash with order. Money refunded if you return books in 10 days.)

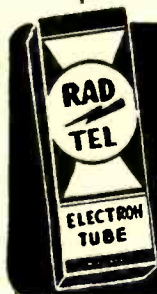

70% to 90% off list! TOP TUBE BUYS

All Tubes Individually Boxed! Same Day Service!
Check this list for Fully 1-Year Guaranteed Tubes.

Type	Price	Type	Price	Type	Price	Type	Price	Type	Price
1A5GT	.30	6AF4	.90	6M6GT	.41	12A8	.61	25BQ6GT	.62
1A7GT	.47	6AG5	.43	6J5GT	.37	12AL5	.37	25L6GT	.39
1B3	.65	6AJ5	.90	6J6	.52	12AT6	.37	26	.45
1B7GT	.30	6AK5	.75	6J7G	.43	12AT7	.56	27	.39
1C5GT	.43	6AL5	.38	6K5	.47	12AUG	.38	32L7	.89
1E7	.29	6AQ5	.39	6M6GT	.37	12AU7	.43	35	.58
1G4GT	.24	6AQ6	.37	6K7	.44	12AV6	.39	35B5	.40
1G6	.30	6AR5	.37	6L6	.64	12AV7	.59	35C5	.39
1H4G	.30	6AS5	.50	6Q7	.45	12AX4	.48	35L6GT	.41
1H5GT	.40	6AT6	.37	6S4	.38	12AX7	.48	35W4	.37
1J6	.24	6AU4	.68	6S8	.53	12BA6	.38	35Z4	.39
1L4	.46	6AU6	.38	6SA7GT	.43	12BA7	.60	35Z5GT	.37
1N5	.46	6AV5	.83	6SD7GT	.41	12BD6	.45	36	.60
1P5	.57	6AV6	.37	6SF5GT	.46	12BE6	.46	41	.42
1Q5	.58	6AX4	.53	6SG7GT	.41	12BF6	.39	42	.42
1R5	.45	6AX6G	.24	6SH7	.73	12BH7	.63	43	.55
1S5	.39	6B4G	.64	6SJ7GT	.41	12BY7	.65	45	.55
1T4	.45	6BA6	.35	6SK7GT	.41	12BZ7	.65	45Z3	.44
1E5	.53	6BA7	.57	6SL7GT	.48	12CB7	.34	45Z5	.45
1U4	.45	6BC5	.44	6SN7GT	.52	12J5GT	.42	50B5	.39
1U5	.39	6BD5GT	.59	6SQ7GT	.37	12J7GT	.34	50C5	.39
1V	.60	6BD6	.45	6SR7GT	.45	12J8	.70	50L6GT	.41
1X2A	.63	6BE6	.39	6SS7	.42	12SA7GT	.44	50Y7	.50
2A3	.70	6BF5	.41	6T8	.56	12SF5	.50	53	.24
2A4G	.24	6BF6	.37	6U4	.60	12SG7GT	.52	56	.24
2W3	.38	6BG6G	1.25	6U5	.44	12SK7GT	.48	57	.58
2X2	1.50	6BM6	.46	6U6	.63	12SL7GT	.47	58	.60
3A4	.45	6BJ6	.39	6UB	.61	12SN7GT	.52	70L7GT	1.09
3E5	.46	6BQ6GT	.59	6V6GT	.39	12SQ7	.44	71A	.60
3Q4	.48	6BQ7	.95	6W4GT	.44	12SR7	.49	76	.44
3Q5GT	.49	6BZ7	.95	6W6GT	.44	12V6GT	.46	77	.57
3S4	.46	6C4	.37	6X4	.37	14J7	.40	78	.47
3V4	.47	6CSGT	.39	6X5GT	.37	14A7	.44	80	.35
5U4G	.50	6C6	.58	6X8	.61	14W7	.30	83V	.68
5W4	.45	6CB6	.44	6Y6G	.48	14H7	.44	85	.59
5Y3G	.32	6CD6G	1.11	7A4	.47	19B6G6	.95	117L7	.99
5Y3GT	.32	6D6	.45	7AF7	.53	19C8	.70	117Z3	.37
5Y4G	.35	6E5	.48	7B4	.44	19T8	.79	807	1.19
5Z3	.46	6F5GT	.39	7C6	.40	19V8	.89	1274	.99
6A7	.59	6F6	.37	7N7	.46	24A	.63	2050	1.85
6A8	.62	6G6G	.52	7X7	.70	25AV5	.83	6113	1.00

NOW! RAD-TEL PARTS AT BIG SAVINGS!

Here's your big opportunity to save as never before on parts you need now. Look at the savings.



NATIONAL TURRET TV BOOSTER
Brand New Factory Boxed
Model TVB-20
\$995

ARMY-NAVY HEADSETS
Individually Boxed Very sensitive Meets both Army and Navy specifications
List \$16 00
\$2.95 each per set

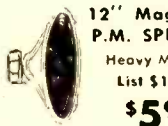

12" Magnavox P.M. SPEAKER
Heavy Magnet
List \$11.50
\$595



5" UTAH AUTO SPEAKER
3-4 Ohm V.C. — 4 Ohm Field
List \$5 05
79c



4 X 6 INCH QUAM P.M. SPEAKER
Lowest Price Oval Speaker
Alnico 5 Field
List Price \$4.75
\$195

RAD-TEL RESISTORS SUPER BUY!
200 TO PKG.

Standard RETMA Coded or Value Printed, Uninsulated, 1/8 Watt, 1 Watt, 2 Watt and some 10 Watt

ASSORTMENT OF 200 for \$139



70° YOKE (Mfg. by Todd)
List \$7 50 **\$195**



RCA TYPE FLYBACK TRANSFORMER
Type 215T1 **95c**



FILTER CONDENSERS KITS* 150 V.
*(10 to a pkg., minimum)
20-20 **\$2.95**
40-40 **\$3.25**
50-30 **\$3.25**

DRY ELECTROLYTIC CAPACITOR
10 MFD 50J WV
600 Peak
Box of ten (10) **\$2.95**

HI-VOLTAGE CERAMIC CONDENSERS
500 mmtd 10 KV **39c** ea.
500 mmtd 15 KV **49c** ea.
500 mmtd 20 KV **49c** ea.

VERTICAL OUTPUT TRANSFORMER
10-1 Ratio RCA Type
List \$4.50
95c

100 INSULATED RESISTORS Box of 100
50 1/2 & 1/2 Watt, 25 1 Watt, 25 2 Watt **\$265**

50 ASSORTED MICAS Box of 50
Regular & Silver Type **\$195**

ANODE CAP **19c**
List \$7.75 each

TERMS A 25% deposit must accompany all orders—balance C.O.D. All shipments F.O.B. Irvington warehouse. Orders under \$10—\$1.00 Handling Charge. Subject to prior sale.

RAD-TEL TUBE CO.

"Integrity Is Our Chief Asset"
Phone: Essex 5-2947 115 Coit Street
Dept. RE-10 Irvington 11, N.J.

... Carolyn Chorlton joined Aerovox Corp., New Bedford, Mass., as a physical chemist in the Research Department. She is a graduate of Seton Hall University and of Smith College.

... Harry Goostein, senior engineer with Clarostat Manufacturing Co., Dover, N. H., was promoted to manager of the Precision Control Division.

... Roy E. Nelson was promoted to the newly created post of manager of semiconductor equipment sales for the RCA Tube Department, Harrison, N. J. He was formerly with the Department's Government Equipment Sales as a sales engineer handling the development and sales of new products.

... Martin W. Krenske joined Edwin I. Guthman Co., Chicago, as assistant sales manager. He was formerly with Standard Transformer Corp.

... Ross H. Reynolds was appointed sales manager for commercial products, Government equipment, marketing in the General Electric Commercial and Government Equipment Department. He was formerly a project manager in the Army Equipment Section of Government Marketing.

... Joseph J. Peterson, formerly with Lee Electric & Manufacturing Co., was named to head the West Coast office of the RETMA Engineering Department. Jean A. Caffiaux, ex-Sylvania, was named assistant to Ralph R. Batcher, RETMA chief engineer, with headquarters in New York City.

... John B. Swan, Jr., Philco Corp., and William L. Fogelson, P. R. Mallory & Co., were reappointed chairman and vice-chairman, respectively, of the RETMA Traffic Committee. Leslie F. Muter, Muter Co., was reappointed chairman of the Annual Awards Committee.

... Robert C. Cheek was promoted to the newly created post of assistant manager of engineering for the Westinghouse Electric Corp. Electronics Division. He was formerly assistant division sales manager.

... Thomas M. Fitzgerald, Jr., joined P. R. Mallory & Co., Inc., as sales manager of the Capacitor Division. He had previously been with Stewart-Warner.

... G. W. Moler was appointed general sales manager of Potter & Brumfield, Princeton, Ind.

... Rufus P. Turner, independent consulting engineer and radio writer, was awarded the honorary degree of Doctor of Science by the College of Engineering of the Golden State University, Hollywood, California. Dr. Turner, who is well known to readers of this magazine for his many articles, was given the degree in recognition of his contributions to radio literature, simplification of test instruments, and popularizing of semiconductor devices.

... Frank W. Mansfield, Sylvania Electric Products, was reappointed chairman of the Industry Statistics Committee of RETMA, and Leslie E. Woods, Raytheon Manufacturing Co., was reappointed chairman of the Association's Industrial Relations Committee. END

HORIZONTAL HARMONICS

Dear Editor:

I have just read, with interest, the letter under the heading "Community TV Troubles" in the May, 1953, issue. This letter brings to mind another radiation problem caused by TV receivers—radiation of harmonics of the horizontal oscillator. This radiation is at its worst in the 55-meter amateur band and is detectable and often objectionable throughout the high-frequency communications bands.

About six months ago a neighbor of mine bought a 1953-model 21-inch TV receiver built by a prominent manufacturer. Harmonic radiation from the receiver's horizontal oscillator almost completely blocked the 80-meter band. A phone signal had to be from 30 to 40 db above S9 to be intelligible.

Why is it that hams are required to keep spurious radiations within the limits of good engineering practice and yet television manufacturers are allowed to produce equipment which radiates high-order harmonics with such terrific field strength?

J. N. PHILLIPS, W4SUF
Anniston, Alabama

REMOTE TOOTHACHE

Dear Editor:

Your editorial, "Radar Hazards," in the August issue of RADIO-ELECTRONICS, was of particular interest to me. It cleared up a mystery which has plagued me since 1943.

While studying 10-centimeter airborne radar gear as part of my training in the R.C.A.F., I noticed that soon after the sets were switched on, I would get a toothache. When the sets were turned off, the toothache would stop. None of the other boys in our group were similarly affected, but then none of them had such a large silver filling as I had. It was inevitable that someone would remark that I had a "resonant cavity." By reading your article, it became evident to me that the heat effect was the cause of my discomfort. In closing, let me say that I'm out to anyone who phones or calls me on the day the postman brings my copy of RADIO-ELECTRONICS.

JACK V. MILTON

Toronto, Ont.

COMMUNITY ANTENNA SYSTEMS

Dear Editor:

I wish to take exception to the conclusions drawn by Mr. E. D. Lucas in his articles on Community Antenna Systems. Unfortunately, his conclusions, as drawn from his own information, do not take into consideration the established facts.

Mr. Lucas, on page 40 of your August issue, recommends the use of broad-band amplifier systems over individual channel-strip amplifier systems despite the fact that to date there are no commercially successful multi-channel broad-band amplifier systems in operation anywhere that compare favorably with individual strip amplifier systems.

ARKAY



RADIO KIT

Model S-5E

5-Tube superhet designed for radio students, includes new 3d dimension instruction book in color. Covers the broadcast Band. Tubes: 12SA7, 12SK7, 12SQ7, 50L6 and 35Z5. Complete with glistening bakelite cabinet.

Walnut or Ivory.

\$14.95 Walnut Net



2 SPEAKER HI-FI AUTOMATIC RECORD PLAYER KIT

Model RC3

Quality 3 speed (V.M.) record changer with new flipover crystal cartridge, quality dual speakers in an acoustically perfected cabinet covered in beautifully designed simulated leather. 4-tube amplifier assures realistic tone. Changer shuts off automatically after last record.

\$59.00 Net



PORTABLE RADIO KIT AC/DC-Batteries

Model 3W10D

3-Way portable for simple construction; including 4" Alnico V permanent speaker, built-in loop antenna, hi-gain coils throughout. Unusual, attractive leatherette cabinet with a semi-airplane dial covering half the cabinet.

\$19.95 Net

Model 2X3W4
Same as above in 2 bands



HI-FI AUDIO AMPLIFIER KIT

Model A10

10 Watt high-fidelity amplifier. Separate tone controls for bass and treble through inverse feedback circuit; 10 watt output or 32 db. less than 3% distortion; frequency response: ± 1 db from 20 to 20,000 cps. Tone controls produce max. bass boost $\neq 8$ db @ 100 cps. Treble controls produce max. treble boost $\neq 10$ db @ 10,000 cps. Hum: 70 db below rated output.

\$21.95 Net



3 BAND AC/DC RADIO KIT

Model P

5-Tube radio with 6" Alnico V dynamic speaker. Highly sensitive receiver including short wave bands. Frequencies: 550-1600KC, 2.3-7MC, 7MC-18. Only finest components used with specially designed tone control circuits. Tubes: 12SA7, 12SK7, 12SQ7, 50L6 and 35Z5. Handsome mottle brown bakelite plastic cabinet.

\$25.75 Net

Write for new catalog of the complete ARKAY line of radio, TV and test equipment kits!

ARKAY

world's finest radio kits

RADIO KITS, INC., 120 Cedar St., N. Y. 6

Build Your Own Interior - Styled Cabinets

KITS

by Cabinart

now available in select 5/8" white pine wood cut to size—takes a beautiful blond or mahogany finish

BASS REFLEX AND EQUIPMENT CABINETS

Ideal housing for hi-fi components. Removable panels make future changes easier. Loudspeaker cabinet acoustically-designed for either 12" or 15" speaker.

Overall dimensions: #80 27.00" (equipment kit)
33 1/2", 23", 16"
Tuner Compartment:
20"H, 21 3/4" W. (inside dimensions) #8112 18.00" (12" speaker)
15 1/4" D
Baffle volume- #8115 18.00" (15" speaker)
6 cubic feet

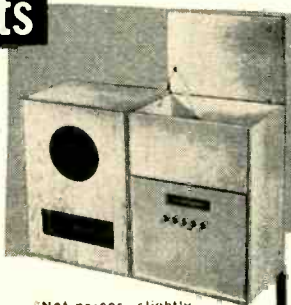

Baffle pre-cut for 12" or 15" speaker, Saran Plastic Acousticcloth, Kimsul Acoustic Insulation, Assembly and finishing instructions, hardware, plastic wood, sandpaper and glue

*Net prices, slightly higher West and South. Sold only thru parts distributors.

Corner Folded Horn Enclosures

Reproduces a quality of bass heretofore only possible through the use of more expensive designs.

#61 (12" speaker) 19.95"
#63 (15" speaker) 23.95"

Write for free catalog and nearest distributor

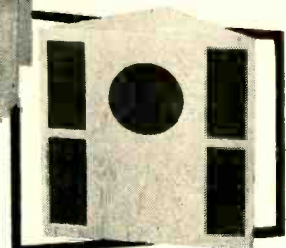

G & H WOOD PRODUCTS COMPANY • 75 NORTH 11th STREET • BROOKLYN 11, N. Y.
Pioneers in radio furniture for high fidelity equipment.

RADIO-ELECTRONICS is paying good rates on acceptance for original and unusual articles on audio, television, FM and AM servicing, as well as articles on industrial electronic equipment and applications. Send for a copy of our Authors' Guide. Address:

THE EDITOR, RADIO-ELECTRONICS
25 West Broadway, New York 7, N. Y.



Prescribed by top mfrs.*

For operating and testing
DC equipment from AC lines



Model B



**FILTERED
DC POWER SUPPLY**

Pat. 2599748

They say: "It's the only one that can withstand continuous high overloads!"

Cooler Operation—Selenium rectifier application and conduction cooling dissipate over 3 times the heat.

Twice the Rectifier Power Rating with EPL Patented Design.
Lowest Cost Per Ampere Output.

Output 6v., 1-20 amps. (35 at peak). 2 units in parallel supply 6v. at 40 amps.

Tests 2 Auto Radios with push-button solenoids at same time;
also motors, instruments, relays, other low voltage devices.

NEW MODEL C-12 services both 12v. and 6v. auto radios.

* Names on request

FREE! New Detailed Literature on America's Only Complete Line!

ELECTRO PRODUCTS LABORATORIES

4501-Rb Ravenswood Avenue Chicago 40, Ill.

Canada: Atlas Radio Corp., Ltd.,
Toronto, Ont.

Brand New- Just Off The Press!

FREE

TO ANY RADIO-TV SERVICEMAN WHO WANTS
A BIGGER INCOME!

- Learn how servicing of mobile equipment has become a million dollar business.
- Learn how smart radio servicemen are cashing in.
- Learn how you can get in on the ground floor, what the profits are, every step you take in this expanding market. This is opportunity knocking at your door. Don't miss out.
- Learn what the latest authentic FCC statistics about growing mobile service needs in this country mean to your future in radio servicing.

There's
**MONEY
FOR YOU**

IN 2-WAY MOBILE
RADIO SERVICING

1st EDITION MARCH 1953

Booklet E

**SERVICING 2-WAY
Mobile Radio Systems
PAYS BIG MONEY**

Let us tell you **FREE!**
How To Cash In...

**WRITE
NOW!**

SEND COUPON FOR FULL INFORMATION
CLEVELAND INSTITUTE OF RADIO ELECTRONICS,
4900 EUCLID AVE. DESK RO-57
CLEVELAND 3, OHIO
(ADDRESS TO DESK NO. TO AVOID DELAY)

I want to know the facts, without obligation, about the profit opportunity in 2-way mobile radio servicing. Rush me your FREE booklet: "There's MONEY FOR YOU IN 2-WAY MOBILE RADIO SERVICING."

NAME _____
ADDRESS _____
CITY _____ STATE _____

PASTE ON A 2 CENT POSTCARD

D If you are owner or manager of a radio-TV service shop check here for Employers' Plan and enclose this coupon with your business card or letterhead.

The use of individual channel-strip amplifiers is a far superior method of solving the problems found in Community Antenna Systems.

In making this statement, consideration has been given to the many inter-related problems inherent in the successful installation and operation of a Community Antenna System. These problems include:

1. *Control of Signal Levels*

With broad-band amplifiers there is no control over individual channels. Even if a broad-band system starts out with individual strips and employs automatic gain control at the antenna site, it is impossible to maintain proper signal level relationships through the miles of cable and the quantity of cascaded broad-band amplifiers that are involved. Cable attenuation is not linear with frequency. Different makes of cable have different temperature variations, which in turn are seldom linear with frequency. In addition, the effects of cable deterioration are not linear.

Thus, the larger the system and the longer it has been installed—the greater the variations; the greater the need for individual control of each channel signal level in order to prevent the twin evils of snow and cross-modulation. Only individual strip amplifiers can do the job properly and keep each channel at the proper level.

2. *Broad-band Systems Use More Equipment*

Broad-band amplifiers cannot be made with the gain or the high output that can be achieved with strip amplifiers. The gains of the broad-bands are generally about 20 db (40 db by stacking two amplifiers together). These amplifiers are spaced about 4 or 5 to a mile (at maximum rated output). To get 20 db, twelve tubes are used; for 40 db, twenty-four tubes are used.

Jerrod "W" strip amplifiers use only five tubes per channel and have gains of 54 db, outputs of 1.0 volt and are spaced 2,600 feet apart (about two to a mile). Because of the higher output, much greater lengths of feeder lines can be run, further reducing the number of amplifiers to cover any given area.

It can be proven by blueprint layout comparisons that in almost every case, strip amplifier systems will use less than ¼ the number of amplifiers that will be needed in broad-band systems.

3. *Less Maintenance with Strip Amplifier Systems*

Because less equipment is used in strip amplifier systems, there will be less maintenance. If one strip goes out in the strip amplifier system, it only affects one channel; when a broad-band amplifier goes out, all channels are gone.

Much is being made of the fact that in "chain" broad-band amplifiers, the failure of a tube does not affect operation because it only

RADIO-ELECTRONICS

changes the gain of an amplifier by 1.5 db. This claim is based on theory, not practice.

- (a) The channel level balance in a system using these amplifiers is often so critical that failure of tubes in this manner definitely does affect operation and can throw the system into either snow or cross-modulation or both.
- (b) A large percentage of 6AK5 tube failures are inter-element shorts. This type of failure stops the entire broad-band system. Furthermore, the vastly greater number of tubes in a broad-band system over a strip amplifier system means that there can be more system-stopping shorts, than the combined total of all tube failures which occur in a strip amplifier system.
- (c) Maintenance becomes more complex. Even if it is assumed that the 1.5 db supposition is true, the failure of a tube leaves the subscriber with a useless connection. These tubes are not easily located, and meanwhile the entire system, all channels, are out of operation.

What is true in both theory and fact is that with individual strip amplifiers it is possible to maintain constant gain, even with tubes that are aging. By applying AGC to at least every third amplifier in a system, as tubes age, the AGC takes control. Periodic preventive maintenance checks catch the weakening tubes and the system does not fail (it does not drop the picture into the snow level; it does not cause cross-modulation). Maintenance is reduced tremendously using strip amplifiers, and the customers have better, more constant pictures.

As for shorts, Jerrold is now using the 5654 Military-Industrial version of 6AK5. This tube is ruggedized and pre-selected. Troubles of all sorts are considerably reduced over the use of 6AK5 tubes. But even if a short does occur, it affects only one channel and not the whole system. Customers still have service on the other channels, and the tube failure is easy to locate.

- 4. *Broad-band Systems Cost More*
 - (a) Initial cost using broad-bands is much higher because of the greater amount of equipment.
 - (b) Operation cost is higher because maintenance is higher.

I think it is important for these facts to be brought to the attention of your readers.

JERROLD ELECTRONICS CORP.
MILTON J. SHAPP
Pres.

Philadelphia, Penna.

OCTOBER, 1953

Why Count Profits in Small Change? WHEN YOU CAN STACK IT IN \$\$\$

Dealers and TV Service Organizations selling DAVIS SUPER-VISION ALL-CHANNEL TELEVISION ANTENNAS do count their PROFITS IN DOLLARS

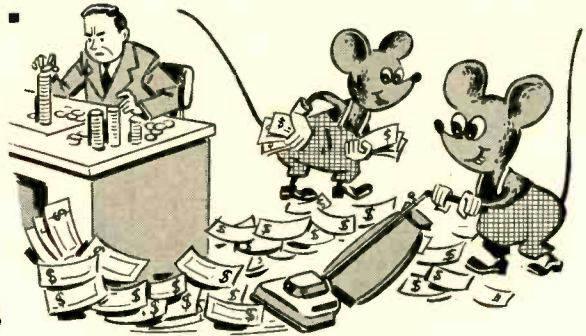

SOLD TO YOU WITH A MONEY-BACK GUARANTEE

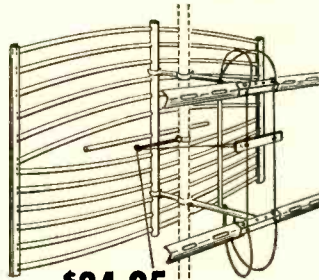

\$34.95

BUILT BY AMERICA'S FASTEST GROWING ANTENNA MANUFACTURER

Copyright 1953



DON'T WAIT! ... Get the "BIG DOLLAR PROFIT FACTS" from our Jobber's Salesman in your area. We will get him in touch with you. USE COUPON.

DAVIS ELECTRONICS 1-42
BOX 1247, Burbank, California

SIRS: RUSH INFORMATION TO ME AS CHECKED:

- Send Complete Information and Technical Data on New SUPER-VISION ANTENNA.
- Send Name and Address of NEAREST JOBBER.

Name _____
Street _____
City _____ State _____

Brand New Set Mfr's SURPLUS TUBES STANDARD BRAND WARRANTY

Bulk Packed in Original Mfr's Nested Cartons or Individually Boxed
Every tube meter and chassis tested for top quality... BRANDED

1B3GT54	6AC771	6BH649	6SN7GT49	12SN7GT49
1L450	6AH664	6B1649	6T864	19B6G61.19
1R549	6AK564	6BL7GT82	6V6GT41	19T864
1S455	6AL537	6BQ6GT79	6W4GT41	25BQ6GT82
1S541	6AQ541	6BQ779	6W6GT31	25L6GT41
1T449	6AG549	6BK771	6X5GT34	35B549
1U449	6AT634	6C434	12AT634	35C549
1U541	6AU637	6C544	12AT760	35L6GT45
1X2A55	6AV634	6C8645	12AU637	35W432
3Q5GT58	6B4G82	6CD6G1.11	12AU749	35Z531
3S449	6BA641	6H641	12BA641	50B549
3V449	6BC549	6J5GT37	12BE641	50C549
5U4G37	6BE641	6J654	12BH756	50L6GT45
5Y3GT34	6BG6G1.19	6K6GT37		

More than 400 types in stock. Include all your needs when ordering.
Orders less than \$10.00—add \$1.00 service charge. Terms: 25% with order, balance C. O. D.
All prices subject to change without notice. F.O.B. New York City. Mail order division.

TRANSAMERICA ELECTRONICS CORP.

120 LIBERTY ST., NEW YORK 6, N. Y. | COrtlandt 7-4307

SERVICE TECHNICIANS

What was your most unusual service case? Not necessarily the most difficult one, but the one you will remember longest, either because of the problem itself or because of other conditions surrounding the job. If the experience was interesting to you, it probably will be to other readers of RADIO-ELECTRONICS. We will pay \$10 for each "My Most Unusual Service Job" item we consider outstanding enough to publish in this magazine. If the item is striking enough or carries sufficient technical information to be worth more than \$10 in our opinion, it will be paid for at our regular space rates. Address your stories to

Unusual Service Job
RADIO-ELECTRONICS

25 West Broadway

New York 7, N. Y.

NOW YOU'LL Really Know How to Use 'Scopes!

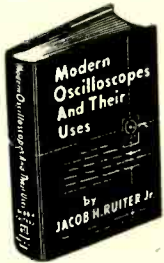

**DON'T LET THE
OSCILLOSCOPE
"STUMP" YOU!**
Learn to use it fully
on all sorts of jobs—
and watch your effi-
ciency and earnings
soar!

MODERN OSCILLOSCOPES AND THEIR USES

BY JACOB H. RUITER, Jr.

of Allen B. DuMont Laboratories, Inc.
326 pages, 370 illustrations, \$6.00

Here at last is a book that makes it easy for you to become expert in the many uses of the greatest, most versatile service instrument of all—the oscilloscope! It contains no involved mathematics. First, the author explains oscilloscopes fully—then gets right down to earth in telling exactly how to use them on AM, FM and TV service work . . . from locating receiver troubles to aligning and adjusting the most complicated circuits.

HOW OSCILLOSCOPES WORK

Expert knowledge of oscilloscopes helps you work faster, far more accurately and more profitably on all sorts of service and laboratory jobs. Basic subjects covered include:

1—Introduction to Oscilloscopes; 2—History of the Oscilloscope; 3—Development of the Cathode Ray Tube; 4—Principles of Cathode Ray Tube Operation; 5—Details of the Modern Cathode Ray Tube; 6—The General-Purpose Oscilloscope; 7—Power-Supply Circuits; 8—Amplifiers, Attenuators and Positioning Circuits; 9—Time-Base Circuits.

HOW TO GET THE MOST OUT OF OSCILLOSCOPES ON ANY JOB

Each operation is carefully explained including the making of connections, adjustment of circuit components, setting the oscilloscope controls and analyzing patterns. About 400 illustrations including dozens of pattern photos make things doubly clear. Here are the specific how-to-do-it subjects covered: 10—Operation; 11—Interpretation of Basic Patterns; 12—Auxiliary Equipment; 13—Typical Applications in Electronics; 14—Servicing A-M Receivers; 15—Servicing F-M Receivers; 16—Television Receiver Servicing; 17—Use of the Radio Transmitter; 18—Using the Oscilloscope in Teaching; 19—Additional Industrial Uses; 20—Photographing Cathode Ray Tube Patterns; (a) Glossary. **Send coupon today!**

READ IT 10 DAYS . . . at our risk!

Dept. RE-103, RINEHART BOOKS, Inc.
Technical Division,
232 Madison Avenue, New York 16, N. Y.

Send MODERN OSCILLOSCOPES AND THEIR USES for 10-DAY FREE EXAMINATION. If book is satisfactory, I will then send you \$6.00 promptly in full payment. If not, I will return book postpaid in good condition and owe you nothing.

Name.....
Address.....
City, Zone, State.....
Employers' Name and Address.....

Price outside U.S.A. \$6.50, cash only.
Money back if you return book within 10 days.

Any or all of these catalogs, bulletins, or periodicals are available to you on request direct to the manufacturers, whose addresses are listed at the end of each item. Use your letterhead—do not use postcards. To facilitate identification, mention the issue and page of RADIO-ELECTRONICS on which the item appears. All literature offers void after six months.

PICTURE TUBE COMPONENTS

Sylvania has issued a 4-page booklet describing tungsten and chemical components for TV picture tubes. Among the components described are screen phosphors, potassium silicate for screen settling, tungsten wire for cathode heaters, and triple carbonate cathode coatings.

Free on request from the Tungsten and Chemical Division, Sylvania Electric Products Inc., Towanda, Pa.

RADIO-TV CERAMICS

Stupakoff's latest 4-page brochure includes photographs and descriptive details on glass-to-metal seals, Steatite and other ceramics, printed circuits and ceramic-metal assemblies. A section is also devoted to the characteristics of Kovar glass-sealing alloy.

Request Bulletin No. 653 from the Stupakoff's & Ceramic Manufacturing Co., Latrobe, Pa.

PICTURE TUBE DATA

Federal's 8-page, 2-color *Picture Tube Data Book* gives interchangeability considerations, basing diagrams, bulb outlines, and dimensions and electrical characteristics of picture tubes of most manufacturers.

Available free on request to the Vacuum Tube Department, Federal Telephone & Radio Corp., 100 Kingsland Rd., Clifton, N.J.

TRANSFORMER CATALOGS

Stancor's 24-page transformer catalog carries complete electrical and physical specifications on almost 500 transformers for radio, TV, hi-fi, amateur, and other electronic applications. Featured are 25 new units, including 13 TV components and 5 transistor transformers, an increased TV section, and an expanded hi-fi section including miniature audio transformers and more detailed information on the Stancor-Williamson amplifier.

The company's 32-page 1953 TV transformer replacement guide lists replacement information on over 5,600 TV models and chassis. It covers 101 brands in alphabetical order, by model and chassis number.

Both available without charge from the Chicago Standard Transformer Corp., Standard Division, Addison & Elston, Chicago 18, Ill.

NON-LINEAR RESISTORS

Bulletin SR-3, *IRC Varistors* (non-linear resistors) gives comprehensive data on voltage-current characteristics, current ratings, temperature characteristics, dimensions, and typical applications. The 6-page booklet is illustrated with charts and graphs.

Free from International Resistance Co., Special Products Div., 401 N. Broad St., Philadelphia 8, Pa.

The Magnemite*



Battery-Operated Spring-Motor Portable Recorder

Field recordings can now be made with equivalent quality and with as little effort as studio console recordings. Smaller than a portable typewriter (11½ x 10 x 8 inches) and weighing 15 lbs. including the dry-cell batteries that last 100 operating hours, the Magnemite* is easily carried and operated anywhere.

Here are truly professional specifications:

- Model 610-SD (7½ ips, 50 to 7500 cycles) meets NARTB standards.
- Model 610-E (15 ips, 50 to 15,000 cycles) meets primary NARTB standards.
- Dynamic range 50 db.
- Flutter ± 0.1%.
- Constant speed governor-controlled.
- Monitoring and playback facilities.

Write for complete technical literature and direct factory prices to Dept. RE:



AMPLIFIER CORP. of AMERICA

398 Broadway, N. Y. 13, N. Y.

*Trade Mark Reg. Pat. Pend.

AMPERITE

Studio Microphones at P.A. Prices

Ideal for
BROADCASTING
RECORDING
PUBLIC ADDRESS

"The ultimate in microphone quality," says Evan Rushing, sound engineer of the Hotel New Yorker.

- Shout right into the new Amperite Microphone—or stand 2 feet away—reproduction is always perfect.
- Not affected by any climatic conditions.
- Guaranteed to withstand severe "knocking around."



Model's
RBLG—20C chms
RBHG—Hi-imp.
List \$42.00



"Kontak" Mikes
Model SKH, list \$12.00
Model KKH, list \$18.00

Special Offer: Write for Special Introductory Offer, and 4-page illustrated folder.

AMPERITE Company, Inc.

561 BROADWAY • NEW YORK 12, N. Y.

Canada: Atlas Radio Corp., Ltd., 560 King St. W., Toronto

KNOB CATALOG

Gee-Lar's 16-page well-illustrated catalog shows and describes hundreds of molded knobs for radio and television equipment. Switches, TV antenna mounts, connectors and other hardware products are also listed.

Ask for Catalog No. 55 from Gee-Lar Mfg. Co., 1330 10th Ave., Rockford, Ill.

A.C. ERASURE

Sound-Talk Bulletin No. 24 discusses a.c. erasure of magnetic tape. The 2-page technical bulletin describes the theory and practice of a.c. erasure, and covers such points as orientation, speed, and number of passes required.

Free from Minnesota Mining and Manufacturing Co., 900 Fauquier St., St. Paul 6, Minn.

LINE AND SLIDE SWITCHES

Stackpole's line and slide switches for radios, TV sets, appliances, small motors, toys, instruments and similar equipment are described in a 16-page bulletin, RC-9B.

Included are specifications, dimensions, and application data for seven new line switches recently developed for use with Stackpole variable composition resistors.

Available on letterhead request to Stackpole Carbon Co., Electronic Components Div., St. Marys, Pa.

SELENIUM RECTIFIER

Westinghouse's new type K Magamp selenium rectifier is described in a new 8-page booklet. Although developed for magnetic amplifier circuits and sensing devices this rectifier may be used wherever improved rectifier characteristics are needed.

The booklet includes the definition of selenium rectifier terms and electrical characteristics; graphs showing reverse current leakage limits and forward current-voltage drop under various conditions.

Request Booklet TD-52-650 from the Westinghouse Electric Corp., Box 2099, Pittsburgh 30, Pa.

ELECTROLYTIC CAPACITORS

Astron has issued a new catalog supplement for its expanded line of twist-prong electrolytic capacitors. Included are catalog numbers, capacitance and voltage ratings, case sizes, and list prices of all standard twist-prong capacitors for radio and TV replacement needs.

Copies of Supplement AC-3A obtainable from Astron Corp., 255 Grant Ave., E. Newark, N. J.

DECIMAL EQUIVALENTS

Meyercoord has printed a time-saving decal showing decimal equivalents in 64ths. Designed for application to slide rules, T-squares, drawing boards, desk tops and other similar equipment, the decal measures 6 x 1 1/4 inches. The figures are printed in sharp black and red type on a white background.

Free on request to the Meyercoord Co., 5323 W. Lake St., Chicago 44, Ill.

OCTOBER, 1953

MOVED TO NEW LARGER QUARTERS
21-26 36th AVE.
LONG ISLAND CITY
NEW YORK
EXeter 2-6000-1-2

SPECIALS

FAMOUS MAKE ANTENNAS

- 10 element conical, 3/8" alum. tub'g, wood dowl'g \$2.70 ea.
- Window conicals \$3.75 ea.
- "V" beam, 3/8" alum. tub'g, wood dowl'g \$3.00 ea.
- Bow Tie, UHF, Matching transfmr \$3.24 ea.
- Indoor antenna, metal base, tip-proof \$1.15 ea.

FAMOUS MAKE TV COMPONENTS

- 5" PM Speaker, Alnico #5 .68 oz. \$ 1.25 ea.
- 500 mmfd-20 KV Aerovox HI-Q Cond.59 ea.
- Lightning Arrestors54 ea.
- 6x9" PM Speaker \$ 3.75 ea.
- Cascade Tuner \$18.50 ea.

PURE POLYETHYLENE WIRE

- 55 MIL-22 GA wire 1000 ft \$12.00
- 100 MIL-20 GA wire 1000 ft \$18.00
- Tubular Twin Lead 1000 ft \$29.65

MINIMUM ORDER \$5.00-ALL MERCHANDISE FULLY GUARANTEED. 25% DEPOSIT WITH ORDER. BAL. COD. FOR NY

5 TUBE AC/DC SUPERHET KIT
Easy to build, schematic, illuminated dial, all parts, walnut plastic cabinet—a REAL BARGAIN \$11.99 ea.

COMPLETE STOCKS OF:

- | | | |
|----------|----------------|----------|
| A.T.R. | IRC | SPRAGUE |
| CINAUDI- | JENSON | STANCOR |
| GRAPH | NEEDLES | STANWYCK |
| DUMONT | JFD | SYLVANIA |
| EICO | LITTLEFUSE | WEBSTER |
| EICOR | PENTRON | ELECTRIC |
| ELECTRO- | RAM | XCELITE |
| VOICE | SARKES-TARZAIN | |
| GENERAL | | |
| CBMENT | | |

SEND FOR OUR FREE BI-WEEKLY TUBE BULLETIN AND LATEST CATALOG RE-8

MANNFRED Electronics Corporation

21-26 36th Ave., Long Island City, N. Y.



FREE GIFT to Rose Co. Customers! . . .

Get a new, Hi-Voltage TV Probe FREE. Trace cause of troubles in hi-voltage section of any TV set, tests CRT's—shockproof, pocket size. FREE with any purchase totaling \$10. or more.

Brand New at Close Out Prices ELECTROLYTIC CONDENSERS

Guaranteed—all highest quality. May be asst. for extra savings.

UHF Bow-Tie Antenna With reflector, hi-gain for all channels. \$3.60 ea. lots of 6 \$3.19 ea.

ROSE Bargain Corner
300 Ohm lead in wire, 55 mil. \$1.75 100 ft. roll—\$13.00 1,000 ft. reel.
300 Ohm—100 mil wire—highest quality. \$2.45 100 ft. roll—\$21.00 1,000 ft. reel.
UHF Tubular lead in wire. \$4.50 100 ft. roll—\$19.75 500 ft. self-dispensing carton.

VARIABLE CONDENSERS
2-Gang super-het. AM Variable Cond. 49c ea. 39c ea. lots of 6 \$1.19 ea.
3-Gang AM-FM Variable Cond. \$1.19 ea. 99c ea. lots of 6 \$5.95 ea.
4-Gang Transmitting Type Variable Cond. used in the BC-342. \$1.95 ea. lots of 6 \$1.45 ea.

May be asst. for quantity prices!
Brand New VOL. CONTROLS
Special purchase of boxed IRC controls, 1 meg., 2 meg., & 2 meg. with 500 K tan. replaceable shaft. 49c ea. Lots of 10 \$3.90 ea.
Switches for above SPST or DPST 10c ea.

MOLDED BY-PASS CONDENSERS
Great Buy—All 600 V. Guaranteed for continuous operation at 85° C. Stock up today at these low-low prices. May be asst.

.001 mfd. \$0.89	10 for \$8.00
.002 mfd.80	10 for 8.00
.003 mfd.99	9.19
.005 mfd.99	9.19
.01 mfd. 1.09	9.95
.02 mfd. 1.09	9.95
.05 mfd. 1.19	10.95
.1 mfd. 1.39	12.75
.25 (400 V.) . . . 2.29	19.51
.5 (200 V.) . . . 2.99	26.90
.01 (1600 V.) . . 2.99	26.90
.006 (1600 V.) . 2.79	24.90
.008 (1600 V.) . 2.99	26.90

500 mm. 20 KV Condensers. \$9c ea. lots of 10 41c ea.
FINEST NYLON CORD PKGE. with Sprng. Med. or Lightweight. 25c ea. lots of 10 19c ea.

25-25V 19c	10 ea. of 10 \$1.70	40x40x20-150V 79c	\$7.20
25-50V 19c	1.70	50x50-150V) 89c	8.10
20-150V 29c	2.60	200-25V) 39c	3.50
40-150V 29c	2.60	8-450V 59c	5.40
20x20-150V 39c	3.50	10-450V 59c	5.40
40x40-150V 45c	3.90	16-450V 69c	6.30
50x30-150V 45c	3.90		
50x50-150V 49c	4.50		

ROSE SPECIALS ON TRANSFORMERS!
Power Transformer
For Williamson Amplifiers, also for 630 TV.
800 V CT - 300 ma
12.6 V CT - 10 A
6.3 V - 4 A
5 V - 3 A
5 V - 3 A
\$5.95 ea. lots of 3 → \$5.49 ea.

OUTPUT TRANSFORMERS BRAND NEW

50L6 49c	20.00
6X8 59c	44c
6X8 59c	52c
50L6 PP. 79c	69c
6X8 PP. 89c	79c
6X8 PP. 89c	79c
6L6 PP. 89c	79c
20 watts \$2.15	\$1.75
Universal Output Trf. 99c	89c
	lots of 3 \$4.39 ea.

The ROSE Co. 76 Vesey Street — Dept. E-10
New York 7, N. Y. CO 7-6195

Terms: Min. Order \$5. Send 25% deposit with COD's. All shipments FOB NYC. prices subject to change without notice.

OPPORTUNITY ADLETS
Rates—45¢ per word (including name, address and initials). Minimum ad 10 words. Cash must accompany all ads except those placed by accredited agencies. Discount, 10% for 12 issues. Misleading or objectionable ads not accepted. Copy for December issue must reach us before October 21, 1953.
Radio-Electronics, 25 W. Broadway, New York 7, N. Y.

SPEAKERS REPAIRED at wholesale prices. Guaranteed workmanship. Fast service. Amprite Speakers Service, 70 Vesey St., New York 7, N. Y.

REPAIR SERVICE—ALL MAKES INSTRUMENTS REPAIRED by factory staff, Simpson, Heath, Triplett, etc. Immediate service. Douglas Instrument Laboratory, 176½ Norfolk Ave., Boston 19, Massachusetts.

TUBES AND EQUIPMENT BOUGHT, SOLD AND EXCHANGED. For a fair deal send details to B. N. Gensler W2LNI, 136 Liberty, N. Y. 6, N. Y.

WE REPAIR ALL MAKES OF ELECTRICAL INSTRUMENTS and testing equipment. Write for free catalogue on new and used instruments at a savings. Hazelton Instrument Co., 128 Liberty Street, New York 6, N. Y.

WANTED: AN/APR-4, other "APR", "TS", "IE", ARC-1, ARC-3, ART-13, BC-348, etc. Microwave Equipment, everything Surplus, Special tubes, Tec Manuals, Lab Quality Equipment, Meters, Fast Action, Fair Treatment, Top Dollar! Littell, Fairhills Box 26, Dayton 9, Ohio.

TRADE-IN TELEVISIONS, WORKING, WHILE THEY LAST. 7" \$30, 10" \$39.95, 12 1/2" \$49.50, also 14-16. W4APL 1420 S. Randolph, Arlington, Virginia.

COAXIAL CABLE: WE ARE REPLACING SINGLE SHIELD coax with double shield in our community system, and have the following used cable for sale: RG11U @ 7¢ and RG59U @ 5¢ per foot. Minimum order 200 feet l.o.b. New Philadelphia, T.V. ANTENNA SYSTEM, 1216 E. High Ave., New Philadelphia, Ohio.

TV FM ANTENNAS ALL TYPES INCLUDING UHF Mounts, accessories. Lowest prices. Wholesale Supply Co., Lunenburg 2, Mass.



Special Offer On This Complete RADIO ENGINEERING LIBRARY

New, Up-To-Date Edition of Famous Library Covers Whole Field of Radio Engineering. Places Latest Facts, Standards, Data Practice, and Theory At Your Fingertips

The five big volumes of the new edition of the Radio Engineering Library now include the very latest facts, standards, data, and practice. This Library will help solve hundreds of problems for designers, researchers, engineers, and students in any field based on radio.

Written by leading radio engineers, these books cover circuit phenomena, networks, tube theory, vacuum tubes, amplification, measurements, etc.—give specialized treatment of all fields of practical design and application. They provide you with a complete and dependable encyclopedia of facts.

- 5 Volumes, 3872 Pages, 2770 Illustrations
- Eastman's FUNDAMENTALS OF VACUUM TUBES, 3rd Edition.
- Terman's RADIO ENGINEERING, 3rd Edition.
- Everitt's COMMUNICATION ENGINEERING, 2nd Edition.
- Hund's HIGH FREQUENCY MEASUREMENTS, 2nd Edition.
- Henney's RADIO ENGINEERING HANDBOOK, 4th Edition.

SEND NO MONEY

Special Low Price—Easy Terms

On this special offer you get this Library for \$37.50, instead of \$43.50. You save \$6 and may pay on easy terms. Mail coupon below to examine the Library FREE for 10 days. No obligation. These books are recognized as standard works; you are bound to need them. So take advantage of this special money-saving offer. Mail coupon at once!

McGraw-Hill Book Co., Dept. RE-10,
327 West 41st St., New York 36, N. Y.

Send for 10 days' FREE trial, the RADIO ENGINEERING LIBRARY. If not satisfied I will return books. Otherwise I will send \$7.50, plus delivery charges, then; and \$6 a month for 5 months. (Reg. price \$43.50, you save \$6).

Name

Home Address

City & State

Employed by.....

We'll Pay Delivery CHARGES if you enclose \$7.50 first payment WITH coupon. Same return privilege for full refund.

(Offer applies to U.S. only.)

TELEVISION AND RADIO REPAIRING, by John Markus. Published by McGraw-Hill Book Company, Inc., New York, N. Y. 6 x 9 inches, 556 pages. Price \$7.95.

This repair manual differs basically from any we have read. It is prepared for persons who know *absolutely nothing* about radio or the use of tools. In simple language and with the aid of clear illustrations, it teaches how to solder, test tubes, read meters, and some of the fundamentals of business. It emphasizes the test, removal and replacement of parts, batteries and tubes. The latter come in for special attention. The author points out that they are responsible for about half of all troubles. This book does not cover trouble-shooting or trouble-localizing as most books do.

Interesting and practical chapters also include pickups and needles, antennas, tuning devices, and service-call suggestions.

The author of this book is highly optimistic. He states that any person who reads the manual becomes qualified to repair 75% of all radio-TV sets. Also, he feels that the life of an independent radioman is a happy one. He notes that the service technician can smoke, relax, listen to music while working, take a day off at will, and even write his own pay-check.

Unlike most books that are purportedly written for the novice, this text very scrupulously maintains an even elementary level. The author defends his position, that of preparing the reader to handle 75% of all service troubles, by very carefully covering the rudiments of day in and day out radio routine. Since the majority of receiver breakdowns are the result of tube failures and obvious defects such as resistors that have burned, the ability to test tubes and check for shorted or open capacitors should enable the beginner to handle most routine problems.

The book is recommended to technician's helpers who want to know something about radio. Radio-TV owners may also find it useful and practical. —IQ

TV TROUBLE TRACER, Volume 2. Published by Harry G. Cisin, 200 Clinton Street, Brooklyn, N. Y. 5 1/2 x 8 1/2 inches, 46 pages. Price 50¢.

This booklet can be helpful to TV owners and can save time for service technicians. It lists 40 typical TV troubles. They include vertical roll, insufficient width, ghosts, foldover, ion spot, etc. Each symptom is followed by probable causes and remedies.

The author has devised a novel time-saving method for localizing troubles due to defective tubes. He lists over 500 different models from more than 40 manufacturers. A tube lineup is given for each model, and each tube is associated with a significant letter, such as H for horizontal, B for brightness, S for sound. Thus if tube trouble is suspected, it is easy to locate the one that is responsible. —IQ

the book that
SAVES TV SERVICE TIME

NEW!
VOL. 4

HOWARD W. SAMS'
"TELEVISION TUBE LOCATION GUIDE"

Latest addition to an invaluable series of Tube Location Guides

FIND THE TROUBLE—REPLACE TUBES WITHOUT REMOVING THE CHASSIS

You've asked for more—and here it is—the fourth volume that brings you right up-to-date! It's the only book that shows the *position and function* of all tubes in hundreds of TV sets. Helps save your servicing time. Often an operational check in the customer's home—looking at the picture and listening to the sound—gives you the clue to the trouble. Most often, a tube failure is the cause. This invaluable Guide makes trouble diagnosis and tube replacement quick and easy, *without removing the chassis!* Each TV model has its own clear, accurate diagram. Fully indexed for quick reference. All new diagrams covering 1951-1952 TV models. Handy pocket size. 192 pages, 5 1/2 x 8 1/2". Pays for itself on the first job!

ORDER TGL-4. Only **\$2.00**



Own the Complete Library

VOL. 3. Used daily by thousands of TV Service Technicians. Shows location and function of all tubes in hundreds of 1950-1951 TV sets. 192 pages. 5 1/2 x 8 1/2".

ORDER TGL-3. Only **\$2.00**

VOL. 2. Gives tube positions and functions in hundreds of 1949-1950 TV sets. Helps solve tube failure troubles in minutes. 208 pages, 5 1/2 x 8 1/2".

ORDER TGL-2. Only **\$2.00**

VOL. 1. Covers hundreds of 1948-1949 TV sets made by 56 mfrs. Not duplicated in other volumes. 208 pages, 5 1/2 x 8 1/2".

ORDER TGL-1. Only **\$1.50**

Carry Them All in Your Tube Caddy

HOWARD W. SAMS & CO., INC.

Order from your Parts Jobber today, or write to HOWARD W. SAMS & CO., INC. 2205 E. 46th St., Indianapolis 5, Ind.

My (check) (money order) for \$..... enclosed. Send the following books:

- TGL-4 (\$2.00) TGL-2 (\$2.00)
 TGL-3 (\$2.00) TGL-1 (\$1.50)

Name.....

Address.....

City.....State.....

BASIC THEORY AND APPLICATION OF ELECTRON TUBES Published by the U. S. Government Printing Office, Washington, D.C. (TM 11-662/TO 16-1-255) 8 x 10 inches, 215 pages. Price \$1.00.

This book will help beginners, students and applicants for radio licenses. It is an orderly presentation of facts relating to tubes of all types. Tube construction, calculation of constants, examples of applications are clearly shown. Large graphs show how to calculate amplification factor, plate resistance and mutual characteristics. The last few chapters cover transmitting and special types. One chapter describes how to use a tube manual effectively.

Each of the 12 chapters is divided into paragraphs which are numbered. This makes it easy to remember or note material which a reader may want to review or remember. Also it is easier to find information in the index.

Each chapter ends with review questions.—IQ

ALIGNMENT TECHNIQUES by Art Liebscher. Published by John F. Rider Publisher, Inc., 480 Canal Street, New York 13, N.Y. 5½ x 8½ inches, 123 pages. Price \$2.10.

This book is devoted entirely to the sweep alignment method of testing and adjusting TV receivers. It discusses markers and illustrates many sweep curves. Separate chapters show how to align video and sound i.f. amplifiers, discriminators and video amplifiers. The author suggests testing the video channel in two steps: square-wave methods for the i.f.; sweep technique for the h.f. He shows how to do this effectively. The last chapter is a brief presentation of u.h.f. alignment. The entire subject is well covered, but there are no schematics or block diagrams to show how test equipment is set up.

The author introduces a novel and efficient method for oscillator alignment. He applies a standard i.f. signal to the first detector along with the local oscillator signal. The beat generates a "supermark" near the carrier frequency. By varying the frequency of the oscillator, the *supermark* will approach the *carrier* marker along the sweep curve. When the oscillator is correctly set, the *supermark* and *carrier* markers will coincide. Alignment is quickly done since the same i.f. may be used on each channel.—IQ

DATA AND CIRCUITS OF MODERN RECEIVING AND AMPLIFYING VALVES (supplement 2) Published by Philips Technical Library. Distributed by Elsevier Press, Inc., 300 Park Ave., New York, N.Y. 6 x 9 inches, 487 pages. Price \$6.50.

Tubes or "valves" give best results when used in appropriate circuits. Therefore circuit information is as important as tube data. This book gives both. All Philips tubes designed between 1945 and 1950 are included. Equivalent American types exist for practically any Philips tube, so the reader may convert and utilize the data.

The tube information includes all necessary average and maximum values, warm-up time for rectifiers, coupling

This new book on Modulation Theory is designed to give both Students and Engineers a broad knowledge of all systems

Modulation is fundamental to any process of communication. Modulation involves change, because the received signal must change in a way that the receiver cannot predict. This book treats all systems on a unified basis and in terms of the new theory. This is made possible by the first eight chapters which contain the pertinent parts of the general philosophy and provide a

framework whereby one system can be compared with another on a rational basis consistent with recent theoretical advance. The last twelve chapters contain theoretical treatments of particular modulation systems, some old and some new. Theory is illustrated by emphasizing the modern theoretical and informational concepts of these particular systems.

MODULATION THEORY

BY HAROLD S. BLACK

Member of the Technical Staff
Bell Telephone Laboratories, Inc.

This book deals with the process by which the message to be conveyed is uniquely specified and unambiguously represented by information-bearing signals that are suitable for transmission over the medium. Included are related processes whereby the message is recovered and delivered to the designated recipient in whatever

form desired, when and where it is wanted. The principles of sampling, quantization, code transmission, and multiplexing are treated analytically. The statistical properties of noise and message material are considered in relation to efficient systems of communication, and it is shown that band width may be conserved by taking advantage of redundancy in the message. This treatment uses mathematics, but is written so that much can be learned even if the mathematics is ignored. Emphasis is placed on the basic consideration of methods to make this book valuable as a text, useful as a reference, and suitable for home study without a teacher.

Judge the Tremendous Scope of this New Book From the Following Brief Outline:

Historical Background • Why Modulate? • The Sampling Principle • Quantization, Code Transmission, and Multiplexing • Efficient Systems of Communication • Speed of Signaling and Channel Capacity • Reduction of Signal Power through The Use of Redundant Codes • Amplitude Modulation • Amplitude Modulators and Demodulators • Amplitude-Modulation Systems • Frequency Modulation • Frequency Modulators and Demodulators • Noise and Interference in FM Systems • Pulse-Modulation Essentials • Pulse-Amplitude Modulation • Pulse Duration Modulation • Pulse-Position Modulation • Pulse-Code Modulation • Mobile Pulse-Modulation Systems.

ABOUT THE AUTHOR

Back in 1925, Mr. Black was placed in charge of groups developing repeaters, regulators, filters, and other circuits for multiplex telephone and telegraph systems. Later he invented the negative feedback amplifier, which in the words of the citation accompanying the Research Corporation Scientific Award (presented to Mr. Black in 1952) "made possible the enormous amplification without distortion upon which rest substantially the structures of multiplex telegraphy, the servomechanism art, the computing art, the entire field of industrial control mechanisms and other important segments of the present electronic industry."

During World War II, Mr. Black was concerned with war developments. He was awarded a certificate of appreciation by the War Department for outstanding assistance in the research, development and production of Radio Set AN/TRC-6. Since the War he has been engaged largely with studies and designs of radio pulse relay systems, and experimental radio receiver using transistors, an experimental verification of the theory of laminated conductors, and new ways to regulate large amounts of distributed amplification considering also different modulation methods. He has received several other honors, and has applied for 68 U. S. Patents and over two hundred foreign applications covering these same inventions which have been filed in 23 foreign countries.

Examine this Great Book FREE

-----MAIL THIS COUPON-----

D. Van Nostrand Company, Inc. Dept. RE-1053
250 Fourth Avenue, New York 3, N. Y.

Please send me a copy of Harold S. Black's MODULATION THEORY. Within ten days I will either return the book or send you \$8.75 plus a few cents postage.

(If you send \$8.75 with this coupon, we will pay the postage. Same return privilege, refund guaranteed.)

Name

Address

City Zone State

between diode plates, microphony, etc. Circuit information includes coil design, recommended schematics (with component values), how to eliminate hum, shielding, etc. Large tube graphs are drawn on each type of tube.

The last 40 pages offer a description of Philips test instruments.—IQ

THE FLIGHT OF THUNDERBOLTS. by F. J. Schonland. Published by Oxford University Press, Amen House, E.C. 4, London, England. 5½ x 8¾ inches, 152 pages. Price \$3.00.

Man has learned how to generate, distribute and utilize electricity, but has made little headway with nature's own brand, lightning. However, much of the hazard of lightning has been minimized. We know how to protect ships, build-

ings and power lines to a great extent. This book gives a full account of our present knowledge of lightning, its causes and effects.

Beginning with early times, the book describes the superstitions and fears connected with thunderbolts. It lists important fires and explosions caused by them. The invention of the lightning rod by Franklin changed all this. The interesting experiments which led up to this invention are given in some detail.

The book describes the safest spots inside a building and out-of-doors when lightning strikes. It details the latest methods for protecting livestock, telephone lines, ships and aircraft. Equipment used to record and investigate lightning is described.—IQ

REAL SALE TUBE WHOLESALE PRICES!

Tube Orders Over \$15.00, with full remittance. Prepaid to you in USA.

Stock up now on these amazing tube values! All tubes are of popular brands and fully guaranteed.

TYPE	NET	TYPE	NET	TYPE	NET
0A2	.70	6AT6	.55	12SL7GT	.55
0A3 VR75	1.05	6AV6	.57	12SN7GT	.70
0B2	.80	6AV6	.49	12SQ7GT	.55
0C3 VR105	.95	6B8	.75	12SR7	.69
0D3 VR150	.95	6BC5	.62	12SX7GT	1.10
0Z4 0Z4A	.55	6BE6	.55	14F7	.75
1A7GT	.77	6B7	.75	21A5	1.20
1AX2	1.05	6BQ6GT	1.13	25BQ6GT	1.00
1B3GT	.80	6BZ7	1.20	25L6GT	.62
8016	.80	6C4	.50	25Z6GT	.59
1B27	12.00	6C6	.50	2B7	1.55
1L4	.50	6F4	3.95	35B5	.55
1L6	.95	6F6	.68	35C5	.55
1N21B	1.95	6F8G	.85	35GT	.60
1N23A	2.05	6F8G	.85	35Z3	.70
1N23B	2.25	6G6	.85	35T	.70
1N34A	.75	6H4	.52	(Eimac)	2.75
1N48	.50	6J4	5.75	35Z5GT	.53
1N54	.75	6J5GT	.50	50A5	.77
1N54A	1.05	6K4	.62	50B5	.55
1N69	.60	6J7M	.75	50C5	.60
1N70	1.25	6K4 (Sylv)	3.00	50L6GT	.65
1N81	1.00	6K4A	3.00	50P7	1.95
1U4	.55	6K6GT	.55	83	1.65
1R4 1299	.59	6K7M	.60	84/6Z4	.65
1X2A	1.75	6L6	.75	117Z6	.98
1Z2	3.25	6L6G	1.10	211 VT4C	.98
2C39A	14.75	6L6GA	1.10	250TH	16.50
2C40	7.95	6L6M	1.50	274A (WE)	3.00
2C51	3.90	6L7	.80	300B (WE)	7.95
2D21	1.20	6N7M	.80	304TH	7.75
2E30 (Hyt)	2.00	6P7	.88	304TL	7.75
2J39	7.95	6Q7GT	.80	310A (WE)	3.95
2J61	39.95	6S7M	.98	407A (WE)	4.50
2J62	39.95	6S7M	.88	408A (WE)	2.50
2K25	2.25	6SD7GT	.80	707A	44.00
723AB	23.95	6S7	.66	717A	.88
2K4	.59	6S7J	.60	725A	4.70
3A4	.44	6S7GT	.80	727B	3.50
3BP11	9.50	(Sylv)	.57	805	3.25
3B7 2291	.39	6SL7GT	.65	807	1.55
3C1	85.00	6SN7GT	.70	811A	3.75
3C23 (GE)	8.65	6V3	.95	812A	3.60
3C24/24G	1.35	6V6GT	.66	816	1.20
3D6 1299	.45	6V6 6T8	.99	829B	7.95
3E29 829B	9.95	6V5 6G5	.75	829B	12.50
3Q5GT	.99	6W4GT	.55	832A	9.95
3S4	.75	6W6GT	.75	861	15.00
3L4	.90	6Y6G	.88	866A	1.20
3V4	.75	6X5GT	.47	(JAN)	1.20
3X2500-				866A (CBS)	1.55
A3	135.00	7AB	.69	869B	65.00
4B24	4.95	7B7	.76	872A	3.75
4B28	.75	7C5	.29	931A	4.75
CE225	.295	7C4	.29	955	.42
4C35	19.95	7C5	.69	958A	.65
4D22	18.50	7D5	.75	958E16	.75
4X150A	29.95	7C30	85.00	958M	1.20
4A00A	35.00	7E5	.39	CK1005	.75
4X500A	85.00	7F7	.99	1622 (WE)	1.95
5C22	39.00	7H7	4.25	1616M	1.95
5D21 (WE)	15.00	7H7	.75	1625	.35
5R4GY	1.20	7J4	.69	1626	.18
5U4	.55	(CBS)	19.95	2050	1.55
5V4G	.95	10BP4A	.80	5516(Hyt)	7.25
5W4	.90	(CBS)	19.95	5528/C6L	11.75
5X4G	.85	12A7	.80	5528	11.75
6AB7	.95	12A7	.80	5528	11.75
6AC7	.80	12AW6	.88	5528	11.75
6AF4	1.34	12AX7	1.90	5654	1.75
6AG5	.70	12AY7	1.90	5655	10.95
6AG7	1.25	12BA6	.60	5670	3.50
6AK5	.60	12BE6	.60	5687	2.95
6AK6	.95	12BE6	.60	5687	2.95
6AJ5	1.30	12BH7	.98	5691	7.60
6AK5	.60	12BY7	1.03	5691	6.25
6AK6	.98	12SA7	.69	5800(Vict)	6.50
6AL5	.50	12SF5	.70	5814	2.20
6AN4	1.50	12SH7	.75	8020	1.98
6AQ5	.55	12SH7	.75	9002	.85
6AS5	1.70	12SJ7	.55	9003	1.25
6AS6	.60	12SK7	.60	9004	.35
6AS7G	3.96	12SK7	.60	9004	.35

Above is a partial listing of our large stock. You may order types not listed at approx. the same savings. Many new special-purpose types in stock.

ODDS & ENDS!

ERCO MARINE TRANSMITTER-RCVR
4 channels, 12 V.D.C. operation FCC approved. New, complete (less xtls) **\$179.50**
Write for details.

BRAND NEW VIBRAPACKS
12 V.D.C. input. 300 V.D.C. @ 125 ma. output. Complete with vibrator. **\$12.95**

TRIMM FEATHERWEIGHT HEADSET
4000 ohms impedance. New orig. boxes. \$ **3.75**

WESTERN ELECTRIC CHOKE
8 hy—300 ma. 65 ohms D.C. Resis. Hermetically sealed in steel cases. **\$4.95**

WESTERN ELECTRIC SWINGING CHOKE
6.5—4.3 hy. @ 200—620 ma. 42 ohms. Hermetically sealed in steel cases. **\$ 6.95**

JENNINGS VACUUM CONDENSER
50 uuf. @ 20 kilovolts **\$ 9.95**

PANADAPTOR—5 INCH SCREEN
Model SB-1, type 200. 100 Kc. sweep. 115 V. 60 cy. Used, good condition. **\$49.50**

BARRY ELECTRONICS CORP.

1368 Liberty Street, N. Y. 6, N. Y. Rector 2-2562

Terms: 25% with order, balance C.O.D. All merchandise guaranteed. F.O.B. N.Y.C.

ADVERTISING INDEX

Adelman, Nat	150
All Channel Antenna Corp.	85
All Mail Sales	125
Alliance Manufacturing Co.	107
Allied Radio Corp.	21
American Microphone Co.	159
American Phenolic Corp.	112
American Television & Radio Co.	126, 127
Amperite Co., Inc.	166
Amplifier Corporation of America	166
Arky Radio Kits, Inc.	163
Astron Corp.	27
Atlas Sound Corp.	154
Audel Publishers	140
Barry Electronics	170
Belden Manufacturing Co.	25
Bell Telephone Labs	16, 96
Best Electronics	152
Bionder-Tongue Labs	138
Brooks Radio & TV Corp.	108, 109, 110
CBS Hytron (Division of Columbia Broadcasting System)	15, 92, 93
Cadillac Electronics Co.	147
Cannon Electric Co.	170
Capitol Radio Engineering Institute	82, 83
Centralab-Div. of Globe Union	79
Century Electronics Co.	146
Channel Master Corp.	30, 31
Chicago Standard Transformer Corp.	125
Cisin, H. G.	140
Clorostat Manufacturing Co., Inc.	154
Cleveland Institute of Radio Electronics	7, 164
Coast Electronics	159
Commissioned Electronics	148
Concord Radio	128, 157
Cornell-Dubilier Electric Corp.	150
Cornish Wire Co.	153
Corona Radio	150
Coyne Electrical & TV Radio School	97, 145, 153
Crescent School	124
Davis Electronics	165
DeForest's Training, Inc.	5
Delco Radio (Div. of General Motors Corp.)	98
Edlie Electronics	160
Electro Products Labs	164
Electro-Voice, Inc.	29
Electronic Instrument Co., Inc.	32, 97
Electronic Measurements Corp.	134
Espey Manufacturing Co., Inc.	150
Federal Telephone & Radio Corp.	103
G & H Wood Products Co.	163
General Electric Co.	8
General Industries Co.	152
General Test Equipment	147
Gernsback Publications, Inc.	142
Heath Co.	66-77 inclusive
Hickok Electrical Instrument Co.	105
Hudson Radio & TV Corp.	155
Hudson Specialties Co.	117
Hughes Research & Development Labs	128
Indiana Technical College	148
Instructograph Co.	148
International Correspondence Schools	9
JFD Manufacturing Co., Inc.	119
Jackson Electrical Instrument Co.	121
Jeb Sales Corp.	141
Jensen Industries	160
Kay-Townes Antenna Co.	116, 132, 133
Kedman Co.	149
Leader Electronics	12, 13
Leotone Radio Corp.	153
Littelfuse, Inc.	17
Mallory and Co., Inc., P. R.	Inside Back Cover
Mannfred Electronics	167
Mattison Television & Radio Corp.	131
McGraw-Hill Book Co.	168
Merit Coil & Transformer Co.	28
Midwest Radio & TV Corp.	151
Moss Electronic Distributing Co.	87
National Electronics of Cleveland	158
National Radio Institute	19, 20
National Schools	3
Nidisco	146
Ohmite Manufacturing Co.	86
Opportunity Adlets	167
Oxford Electric Corp.	144
Permo, Inc.	102
Permoflux Corp.	89
Philco Corp.	10
Phillips Tube Co.	155
Plastoid Corp.	95
Precise Development Corp.	90
Precision Apparatus Co., Inc.	106
Premier Radio TV Supply (Div. Continental Co.)	117
Prentice-Hall, Inc.	130
Pres-Probe Co.	148
Progressive Electronics	135
Quietrol Co.	131
RCA Institutes, Inc.	23
RCA Victor Division (Radio Corporation of America)	Inside Front Cover, Back Cover
Rad-Tel Tube Co.	162
Radelco Manufacturing Co.	113
Radiart Corp.	81, 130
Radio City Products	123
Radio Craftsmen Inc.	122
Radio Merchandise Sales	147

RADIO SCHOOL DIRECTORY PAGE 171

American Electronics Co.
Candler System Co.
Capitol Radio Engineering Institute
Commercial Trades Institute
Indiana Technical College
Indianapolis Electronic School

The **XL** series
—available
through

CANNON PLUGS

radio parts
distributors
and electrical
wholesalers
everywhere

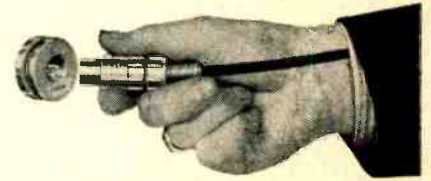

Cannon's famous XL Connector Series for audio applications is available in 14 shell designs through Radio Parts Distributors and Electrical Wholesalers. These lightweight, compact connectors embody many desirable features: adaptable either to cord end or wall mounting applications... convenient latchlock coupling device... cable entry with compression gland and relief spring or integral clamp... tapped metal for insert retaining screw... provision for special grounding contact or grounding to shell. Accessories include dust caps and adapter shunts, receptacles for integral mounting on microphones and other audio components. Watch for the colorful Cannon counter display carton at your Radio Parts Distributor.

NOTE TO JOBBERS AND WHOLESALERS:

Be sure the name "Cannon" is on every plug you buy... it's your customers' guarantee of satisfaction. For complete details send for Bulletin RJC-6.

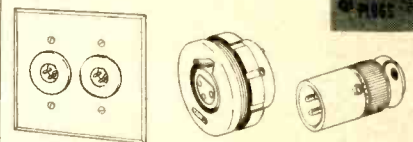

XL Connectors are available in 14 shell designs shown here.

Watch for this Cannon XL counter display carton.

CANNON ELECTRIC

Since 1915



Cannon Electric Co., Los Angeles 31, Cal.

Factories in Los Angeles, Toronto, New Haven. Representatives in principal cities. Address inquiries to Cannon Electric Co., Dept. J-144, Los Angeles 31, California.

Milwaukee School of Engineering
 RCA Institutes, Inc.
 Tri-State College
 Valparaiso Technical Institute
 Western Television Institute

Radio-Television Training Ass'n.	11
Radian Corp.	91
Raytheon Manufacturing Co.	6
Regency Div. (I.D.E.A., Inc.)	160
Reliance Merchandising Co.	130
Rider, Inc., John F.	111
Rinehart Books, Inc.	99, 161, 166
Rose Co.	167
Sams & Co., Inc., Howard W.	22, 168
Sangamo Electric Co.	106
Scala Radio Co.	138
Science Fiction +	135
Shure Bros., Inc.	94
Simpson Electric Co.	136, 137
Sprague Products Co.	114, 115
Sprayberry Academy of Radio	65
Stan-Burn Radio & Electronics	158
Stephen Sales Co.	140
Steve-El Electronics Corp.	158
Supreme Publications	139
Sylvania Electric Products	24
Tab	172
Tallen Co., Inc.	118
Tape Master, Inc.	146
Tarzian, Sarkes, Inc.	156
Tech-Master Products	156
Technical Appliance Co.	156
Telematic Industries Inc.	131
Telesound Corp.	129
Television Communications Institute	140
Television Materials, Inc.	140
Transamerica Electronics	165
Transvision, Inc.	148, 149
Trio Manufacturing Co.	100, 101
Triplett Electrical Instrument Co.	14
Tung-Sol Electric Co.	18
Turner Co., The	114
United Technical Labs	149
Utah Radio Products Co., Inc.	104
Van Nostrand Co., Inc., D.	169
Vidair Television Co.	143
Visulite Co.	124
Waldrom Electronics	135
Westinghouse Electric Corp.	26
Wholesale Radio Parts Co., Inc.	159
Windsor Electric Tube Co.	96
Zingo Products	147

Radio-Electronics does not assume responsibility for any errors appearing in above index.

TOPS in TV TRAINING

WANT to get into TV? Then don't settle for LESS THAN THE BEST. Get FULL FACTS FREE about our highly SUCCESSFUL TV Train-at-Home Plan. We TELL you and SHOW you how to Build your own big TV Set (with parts we supply). Learn how to Install, Repair, Service. Know about Capacitors, Inductors, Pre-amplifiers, Boosters, Resistors, Signals—everything a Top-Flight TV Expert must understand. TWENTY KITS of Parts, Professional Equipment and Tools included. Make a TV Set operate as smoothly as a precision-made watch. Be ready for a Big-Pay TV Job—a Big-Pay TV Job will be ready for YOU. Don't confuse CTI Home-TV-Training with ordinary home-study courses made up of radio lessons with some TV lessons tacked on. The CTI Train-at-Home Plan is MODERN, SPECIALIZED 100% TV INSTRUCTION. Over 24 MILLION TV Sets in use and more thousands sold every week make TV TODAY'S Big BOOMING Opportunity. Get the RIGHT Training—NOW! Then accept a Big-Pay Job—or have a business of your own. Thousands CASHING-IN with our Proved Methods. Send for Big FREE Book, "You Can Succeed in Television."

Commercial Trades Institute, Dept. 727-10, 1400 Greenleaf Ave., Chicago 26, Ill.

Unlimited Opportunities in RADIO ENGINEERING

DEGREE IN 27 MONTHS

Complete Radio Engineering course including telev., U. H. F. and F. M. Bachelor of Science Degree also in Mech., Civil, Elect., Chem., and Aero. Eng.; Bus. Adm., Acct. Extensive campus, modern buildings, well equipped labs. Low cost. Prep courses. Personalized practical instruction. Founded 1884. Placement service. Growing shortage of engineers. Prepare now. Approved for Korean vets. Enter January, March, June, September. Write for catalog.



TRI-STATE COLLEGE

24103 College Ave. ANGOLA, IND.

RADIO-TV ELECTRONICS



CREI graduates in big demand. Approved by Engineers Council for Professional Development. New classes start every month. Free placement service for grads. Courses offered—Radio Engineering (Practical or Broadcast) TV Engineering, TV, FM, AM Servicing. Write for free catalog.

CAPITOL RADIO ENGINEERING INSTITUTE
 Dept. RE, 3224—16th St., N.W., Washington 10, D.C.



RCA INSTITUTES, INC.

A service of Radio Corporation of America
 350 West 4th St., New York 14, N. Y.

OFFERS COURSES IN ALL TECHNICAL PHASES OF RADIO, TELEVISION, ELECTRONICS

Approved for Veterans
 Write Dept. RC-53 for Catalog

GET INTO ELECTRONICS

You can enter this uncrowded, interesting field. Defense expansion, new developments demand trained specialists. Study all phases radio & electronics theory and practice: TV; FM; broadcasting; servicing; aviation, marine, police radio. 18-month course. Graduates in demand by major companies. H.S. or equivalent required. Begin Jan., March, June, Sept. Campus life. Write for catalog.
 VALPARAISO TECHNICAL INSTITUTE
 Dept. C Valparaiso, Ind.



TV REPAIRMEN MAKE TOP MONEY!

In just 39 weeks, you can get complete TV service training! Streamlined course gives you all essentials for a good job as service technician. Graduates in great demand; jobs are plentiful in this growing field. Other courses in electronics, radio operation and maintenance. Day or evening classes; modern equipment. Opportunity for employment in local industry.

Write for Catalog 111 Today

INDIANAPOLIS ELECTRONIC SCHOOL
 312 E. Washington, Indianapolis 4, Ind.

BECOME AN ELECTRICAL ENGINEER



Bachelor of Science Degree in 36 months.

Major in Electronics or Power. Now, prepare for a career in these rapidly expanding fields.

This school will prepare you to become an engineer, technician or service man. Previous military, academic or practical training may be evaluated for advanced credit.

Enter Both Radio and Television

In 12 months you can attain the Radio-Technician's certificate. An added 6 months course qualifies you for the Radio-TV Technician's certificate and the Degree of "Associate in Applied Science." The Technician's course is the first third of the program leading to a Bachelor of Science Degree in Electrical Engineering with a major in Electronics.

Also offered: 12-month Radio-TV service course; 12-month Electronics or Electro Technician Courses; 6-month Electrical Service Course and 3-month refresher and general preparatory classes.

Terms Open Oct., Jan., April, July

Famous for its Concentric Curriculum. Faculty of specialists. 50,000 former students. Annual enrolment from 48 states and 23 overseas countries. Non-profit. 50th year. Courses approved for Veterans. Residence courses only.

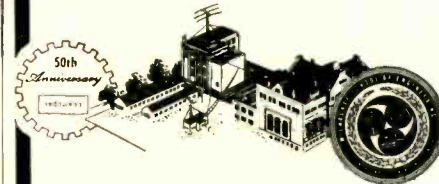

MILWAUKEE SCHOOL OF ENGINEERING

MILWAUKEE SCHOOL OF ENGINEERING
 Dept. RE-1053, 1025 N. Milwaukee
 Milwaukee 1, Wisconsin

Send: Free 45-page "Your Career" booklet describing Electrical Engineering Courses; Booklet on Careers in Radio-TV.

I am interested in _____ name of course

Name _____ Age _____

Address _____

City _____ Zone _____ State _____

If veteran, indicate date of discharge _____

LEARN WITH "AMECO" COURSES
BECOME A RADIO AMATEUR
 Simple, Low Cost, Home-Study Courses prepare you to pass F.C.C. Code and Theory license examinations.
 Write for details and receive free sample F.C.C.-type questions and answers for all amateur examinations.
 FREE →
 AMERICAN ELECTRONICS CO.
 1203 Bryant Ave., (Dept. RE-10), New York 59, N. Y.

GET INTO TV SERVICING
 Send for free 24-page illustrated booklet which tells you how to become a successful TV technician. America's leading TV servicing school offers you a specialized training program that omits non-essential math & design theory. You concentrate on radio & TV servicing only. You get professional training & experience right in our fully-equipped shops & laboratories. Send for this booklet today. Write Dept. E-103. No obligation—no salesman will call.
 Approved for Veterans
WESTERN TELEVISION INSTITUTE
 341 W. 18th St. Los Angeles 15, Calif.

RADIO ENGINEERING IN 27 MONTHS DEGREE
 Intensive, specialized course including strong basis in mathematics and electrical engineering, advanced radio theory and design, television, Modern lab. Low tuition. Self-help opportunities. Also B.S. degree in 27 months in Aeronautical, Chemical, Civil, Electrical, and Mechanical Engineering. GI Gov't approved. Enter December, March, June, September. Catalog.
INDIANA TECHNICAL COLLEGE
 1510 E. Washington Blvd., Fort Wayne 2, Indiana

CODE SENDING SPEED RECEIVING SPEED
 Be a "key" man. Learn how to send and receive messages in code by telegraph and radio. Commerce needs thousands of men for jobs. Good pay, adventure, interesting work. Learn at home quickly through famous Candler System. Qualify for Amateur or Commercial License. Write for FREE BOOK.
CANDLER SYSTEM CO.
 Dept. 3-L, Box 928, Denver 1, Colo., U.S.A.

Depend on Mallory
for
Approved Precision Quality

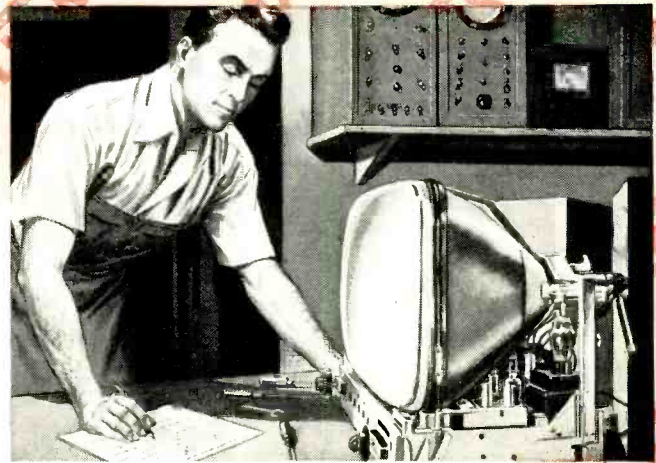

Put **More** Service Life Into All Your Jobs



Whenever Mallory FP Capacitors go into a service job, your customers can be sure of more hours of entertainment . . . you can be sure the job is done right . . . once and for all. For all your service work, you'll get better results with Mallory Capacitors. They are engineered to meet the electrical requirements of any TV or radio set. They'll give performance that is equal to . . . and often better than . . . the original equipment.

What's more, Mallory FP Capacitors are the only fabricated plate capacitors available to the replacement market. You can depend on them to give longer life at higher temperatures and greater ripple currents. They will give trouble-free performance at 185° F. (85° C.).

Any way you look at it, dependable service work builds satisfied customers. The next time you order capacitors, ask for Mallory FP's. They will put an end to call-backs due to capacitor failure . . . yet they cost no more.



For plastic tubular replacements, specify Mallory Plascaps®. Their improved moisture proofing will put an end to shorts. No off-center cartridges . . . leads are permanently secured.

P. R. MALLORY & CO. Inc.
MALLORY

CAPACITORS • CONTROLS • VIBRATORS • SWITCHES • RESISTORS
RECTIFIERS • POWER SUPPLIES • FILTERS • MERCURY BATTERIES

APPROVED PRECISION PRODUCTS

P. R. MALLORY & CO., Inc., INDIANAPOLIS 6, INDIANA

Have you hung up

your shingle?

IT PAYS TO KEEP GOOD COMPANY . . .
and it's good business to advertise the
good company you keep.

Thousands of dealers and servicemen
are using the sales-magic in the RCA name
to instill confidence in their customers.
Identifying *your* name with RCA pays off
in dollars and cents.

And it's so easy to do . . . because RCA's
new Dealer Identification Program pro-
vides you with a handsome "shingle" with
your name on it, that you'll be proud to
display in your shop. When a customer
sees this Dealer Identification Plaque he
knows you are using the best tube products
available.

So, we ask . . . "Have you hung up *your*
shingle yet?" If not, be sure to see your
RCA Tube Distributor today and learn
how *you* can qualify for a Registered
Dealer Plaque at no extra cost.

Unlock the door to bigger profits

Here's *your* key to better business . . . RCA's
dynamic Dealer Identification Program. Ask
your *RCA Tube Distributor* for your copy of the
colorful, 16-page booklet
"A Magic Pass-Key to
Customer Confidence."
It tells you how — for
the first time—you can
become a Registered
Dealer . . . and get
extra sales benefits.

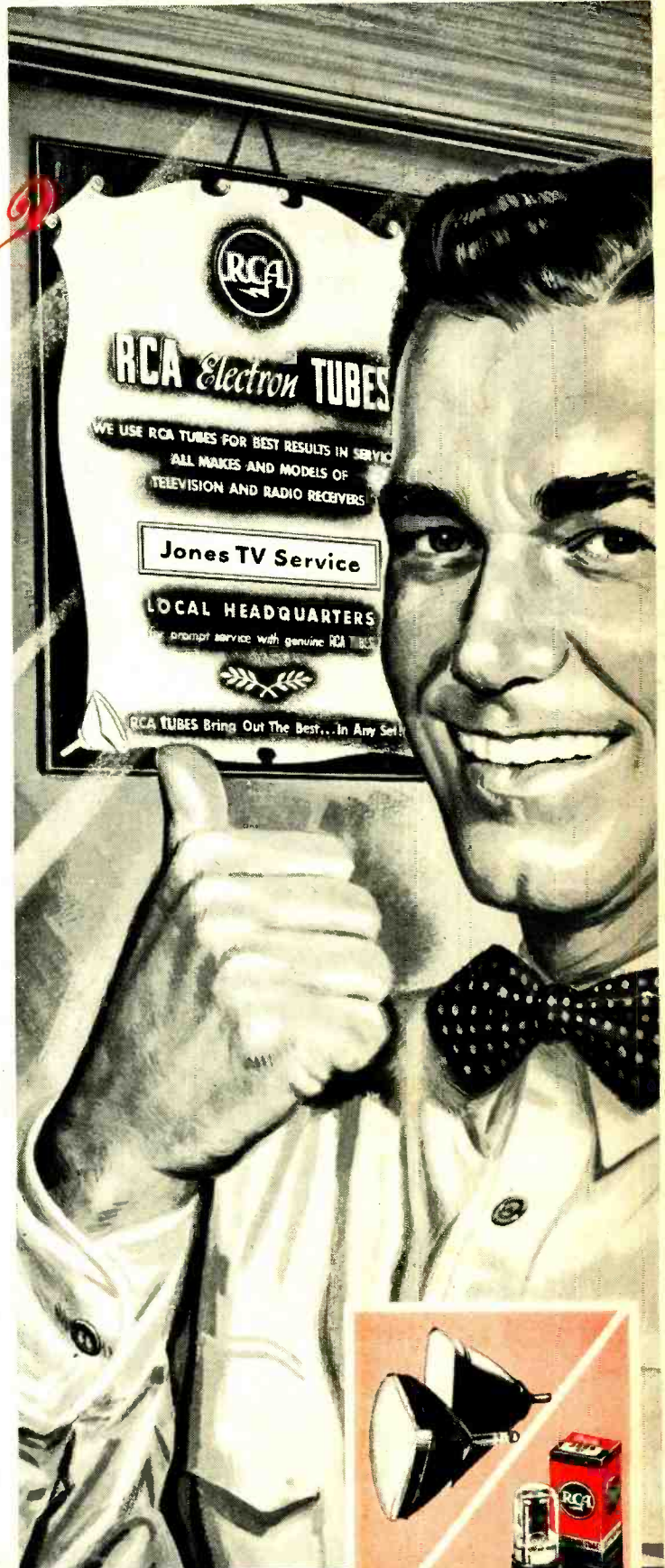

RADIO CORPORATION of AMERICA
ELECTRON TUBES

HARRISON, N. J.