

# RADIO — ELECTRONICS

LATEST IN  
TELEVISION  
SERVICING  
AUDIO

formerly  
**RADIO  
CRAFT**  
HUGO LERNBACK, Editor



SEPT  
1950

30¢

U. S. and  
CANADA

FASTER PICTURE TUBE PRODUCTION — SEE TELEVISION SECTION

[www.americanradiohistory.com](http://www.americanradiohistory.com)



# A Controlled Curve For Better Performance!

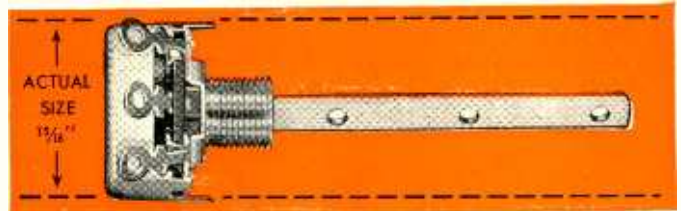
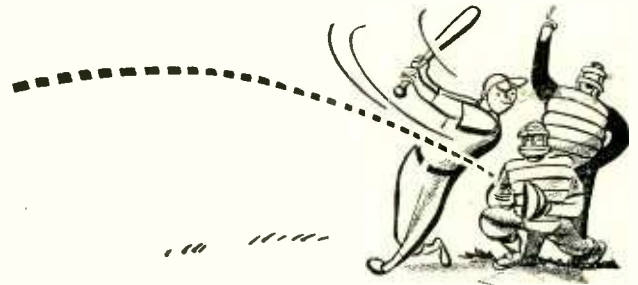

## The Mallory Midgetrol

The resistance taper of the Mallory Midgetrol makes a smooth, controlled curve. No sharp breaks... perfect attenuation. An exclusive Mallory engineered machine automatically forms the taper... removes all chance of human error. Each Mallory Midgetrol element is a duplicate of every other element of the same rating. And each element gives you accurate over-all resistance and ample current-carrying ability.

The Mallory Midgetrol is the answer to your control problems. A  $\frac{15}{16}$ " diameter control with electrical characteristics superior to  $1\frac{1}{8}$ " controls, it lets you standardize on *one* control for all of your replacements!

### WIDER APPLICATION

The small size allows you to service portables, auto radios and small AC-DC receivers requiring  $\frac{15}{16}$ " controls.

### LESS INVENTORY

Electrical characteristics allow you to use the Mallory Midgetrol to replace large as well as small controls. No special shafts required. You carry fewer controls in stock.

### SIMPLER INSTALLATION

The new and unique flat shaft design of the Mallory Midgetrol saves installation time with all types of knobs.

*See your Mallory distributor for this new standard in carbon controls!*

**P. R. MALLORY & CO., Inc.**  
**MALLORY** CAPACITORS... CONTROLS... VIBRATORS...  
 SWITCHES... RESISTORS... RECTIFIERS...  
 VIBRAPACK® POWER SUPPLIES... FILTERS  
\*Reg. U. S. Pat. Off.  
**APPROVED PRECISION PRODUCTS**

**P. R. MALLORY & CO., Inc., INDIANAPOLIS 6, INDIANA**



## You Practice COMMUNICATIONS I Send You Parts To Build This Transmitter

As part of my Communications Course you build this low power broadcasting transmitter, learn how to put a station "on the air," perform procedures demanded of Broadcast Station operators, make many tests.



**NEW**

## You Practice Radio SERVICING On This Modern Radio You Build With Parts I Send

As part of my Servicing Course, I send you the speaker, tubes, chassis, transformer, loop antenna, EVERYTHING you need to build this modern, powerful Radio Receiver! I also send parts to build other Radio circuits, see below. You use for practical experience and to earn EXTRA money in spare time.

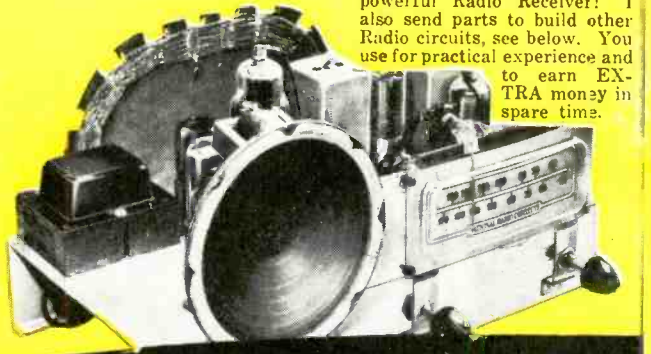

# BE A RADIO-TELEVISION TECHNICIAN

**YOU BUILD** this Tester with parts I send early in my Servicing Course. Helps you fix neighbors' Radios and EARN EXTRA MONEY in spare time.

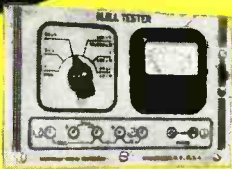

**YOU BUILD** Vacuum Tube Power Pack as part of my Communications Course; get experience with packs of many kinds. Learn how to correct Power Pack troubles.

**YOU BUILD** this A. M. Signal Generator as part of my Servicing Course. It provides amplitude-modulated signals for many tests and experiments.



## Learn Servicing or Communications by Practicing in Spare Time with KITS OF RADIO PARTS I Send



J. E. SMITH, President National Radio Institute

Do you want good pay, a job with a bright future and security? Would you like to have a profitable shop or store of your own? If so, find out how you can realize your ambition in the fast growing, prosperous RADIO-TELEVISION industry. Even without Television, the industry is bigger than ever before. 81 million Home and auto Radios, 2,700 Broadcasting Stations, expanding use of Aviation and Police Radio, Micro-wave Relay, Two-way Radio for buses, taxis, etc., are making opportunities for Servicing and Communications Technicians and FCC-Licensed Operators.

### Television is TODAY'S Good Job Maker

In 1949, almost 3,000,000 TV sets sold. By 1954, 20,000,000 TV sets estimated. 100 TV Stations now operating. Authorities predict 1,000 TV Stations. This means more jobs, good pay for qualified men all over the United States and Canada.

### Many Soon Make \$10 Extra a Week in Spare Time

Keep your job while training. Hundreds of successful RADIO-TELEVISION TECHNICIANS I trained had no previous experience, some only a grammar school education. Learn Radio-Television principles from illustrated lessons. Get PRACTICAL EXPERIENCE—build valuable multimeter—experiment with circuits common to Radio and Television. Keep all equipment. Many students make \$5, \$10 extra a week fixing neighbors' Radios in spare time. SPECIAL BOOKLETS start teaching you the day you enroll.

### Send Now For 2 Books FREE—Mail Coupon

Send now for my FREE DOUBLE OFFER. You get actual Servicing lesson to show you how you learn at home. Also my 64-page book, "How to Be a Success in Radio-Television." Read what my graduates are doing, earning; see equipment you practice with at home. Send coupon in envelope or paste on postal. J. E. SMITH, President, Dept. OJX, National Radio Institute, Washington 9, D.C. Our 37th Year.

## I TRAINED THESE MEN

"I have been operating my own Servicing business. In two years I did \$14,000 worth of business; net profit, \$6,850. Have one full time employee, an N.R.I. Student."—PHILLIP G. BROGAN, Louisville 8, Ky.

"Four years ago, I was a bookkeeper with a hand-to-mouth salary. Now I am a Radio Engineer with a key station of the American Broadcasting Company network."—NORMAN H. WARD, Ridgefield Park, N. J.

"When halfway thru the N.R.I. course, I made \$5 to \$8 a week fixing sets in my spare time. Am now selling and installing Television sets and antennas."—E. J. STREITENBERGER, New Boston, Ohio.

"My first job was operator with KDLR, obtained for me by your Graduate Service Dept. I am now Chief Engineer of Police Radio Station WQOX. I never hesitate to endorse N.R.I."—T. S. NORTON, Hamilton, O.

# Veterans YOU MUST ACT FAST

G. I. Bill gives you valuable training benefits. For each 3 months of training eligibility, you can get a full year of N.R.I. Training. Keep your job while learning. But Act Now! Time is running out!

**HURRY!**

Mail Coupon Now!

## Good for Both—FREE

The ABC's of SERVICING

MR. J. E. SMITH, President, Dept. OJX, National Radio Institute, Washington 9, D. C.

Mail me Sample Lesson and 64-page book about How to Win Success in Radio-Television. Both FREE. (No Salesman will call. Please write plainly.)

Name..... Age.....

Address.....

City..... Zone..... State.....

Check if Veteran Approved for training under G. I. Bill





# RADIO — ELECTRONICS

formerly **RADIO-CRAFT**

MEMBER  
AUDIT BUREAU OF CIRCULATIONS

Hugo Gernsback, Editor-in-Chief

M. Harvey Gernsback, Editorial Director

Fred Shunaman, Managing Editor  
Robert F. Scott, WZPWG, Technical Editor  
Manfred Wentzel, Associate Editor

I. Queen, Editorial Associate  
Angie Pascale, Production Manager  
Wm. Lyon McLaughlin, Tech. Illustration Director

Lee Robinson, General Manager  
John J. Lamson, Sales Manager

G. Aliquo, Circulation Manager  
Robert Fallath, Promotion Manager

Incorporating  
**SHORT WAVE CRAFT\*** **TELEVISION NEWS\***  
**RADIO & TELEVISION**  
\*Trademark registered U. S. Patent Office

## CONTENTS ————— SEPTEMBER, 1950

<b>Editorial (Page 21)</b>			
Emergency Radios.....	by Hugo Gernsback 21		
<b>Television (Pages 22-27)</b>			
Birth of a TV Picture Tube (Cover Feature).....	22		
Installation Problems of Urban TV Receivers.....	by Ira Kamen 24		
Students Demonstrate TV Station.....	by Steve Lamoreaux 25		
Television Service Clinic.....	by Walter H. Buchsbaum 26		
Television DX Reports.....	27		
<b>Electronics (Pages 28-31)</b>			
Radio Electronics in the Home.....	28		
Fieldistor—New Crystal Triode.....	by W. P. Schulz & O. M. Stuetzer 29		
Electron-Tube Steno Writes in Shorthand...by Jean Dreyfus-Graf	30		
<b>Servicing—Test Instruments (Page 32-40)</b>			
Radio Set and Service Review (Polic-Alarm and Monitoradio)	32		
Code of Standards for Radio-TV Service.....	33		
Low-Cost R-C Bridge Features Wide Range.....	by J. W. Korte 34		
Handy Tool Kit.....	by H. Leeper 36		
New Service Plans for TV.....	36		
Plug-in Adapter for Power Check...by Rufus P. Turner, K6AI	37		
Fundamentals of Radio Servicing, Part XIX—Receiver Selectivity	by John T. Frye 38		
Publicity Checklist.....	by Dan Valentine 40		
<b>Audio (Pages 41-48)</b>			
Electronics and Music, Part III.....	by Richard H. Dorf 41		
Jwa Low-Noise Pickups for Home Constructors	by Benjamin F. Meissner 43		
A High-Gain Amplifier.....	by James Rundo 45		
Preamp for Low-Speed Pickups.....	by Robert Hill 48		
<b>Amateur (Pages 50-52)</b>			
Dependable V.F.O. for 80-Meter Band	by Richard L. Parmenter, W1JXF 50		
<b>Construction (Pages 64-67)</b>			
Germanium Crystal Receivers Pick Up European Broadcasts	by Dr. Wm. H. Grace, Jr. 64		
<b>New Design (Pages 70-72)</b>			
Tubes of the Month.....	70		
<b>Departments</b>			
The Radio Month....	10-12	Question Box.....	80
Radio Business .....	14-16	Miscellany .....	82
New Patents.....	56	Technotes .....	89
New Devices.....	68	People .....	91
Radio-Electronic		Communications .....	93
Circuits.....	74	Book Reviews .....	95
Try This One.....	78		

**ON THE COVER:**

Automatically sprayed picture tubes dry under heat lamps at Sylvania's Ottawa, Ohio, plant. More pictures of tube production on page 22. Kodachrome courtesy Sylvania Electric Products.

**RADIO-ELECTRONICS, September 1950, Volume XXI, No. 12.** Published monthly. Publication Office: Erie Ave., E to G Streets, Philadelphia 32, Pa. Entered as second class matter September 27, 1948, at the post office at Philadelphia, Pa., under the Act of March 3, 1879. **SUBSCRIPTION RATES: In U. S. and Canada, 12 U. S. dollars per annum, South and Central American countries, \$3.50; \$6.00 for two years; \$8.00 for three years; single copies 30c. All other foreign countries \$4.50 a year, \$8.00 for two years, \$11.00 for three years.** Allow one month for change of address. When ordering a change please furnish an address stencil impression from a recent wrapper. **RADCRAFT PUBLICATIONS, INC.** Hugo Gernsback, Pres.; M. Harvey Gernsback, Vice-Pres.; G. Aliquo, Sec'y. Contents copyright, 1950, by Radercraft Publications, Inc. Text and illustrations must not be reproduced without permission of copyright owners. **EDITORIAL and ADVERTISING OFFICES, 25 West Broadway, New York 7, N. Y.** Tel. RECTOR 2-9690. **BRANCH ADVERTISING OFFICES:** Chicago: 520 N. Michigan Ave. Telephone Superior 7-1796. Los Angeles: Ralph W. Harker, 1127 Wilshire Blvd., Tel. MA 6-1271. San Francisco: Ralph W. Harker, 582 Market St., Tel. GARfield 1-2481. **FOREIGN AGENTS:** Great Britain: Atlas Publishing and Distributing Co., Ltd., London E.C.1. Australia: McGill's Agency, Melbourne. France: Brentano's, Paris 2e. Holland: Trillectron, Heemstede. Greece: International Book & News Agency, Athens. So. Africa: Central News Agency, Ltd., Johannesburg. Capetown: Durban. Natal: Universal Book Agency, Johannesburg. Middle East: Steimatzky Middle East Agency, Jerusalem. India: Broadway News Centre, Dadar, Bombay #14. K. L. Kannappa Mudaliar, Madras 2. Pakistan: Paradise Book Stall, Karachi #3. **POSTMASTER: If undeliverable send form 3578 to: RADIO-ELECTRONICS, 25 West Broadway, New York 7, N. Y.**

# two rugged wirewounds



## OHMITE

### BROWN DEVIL

Vitreous-Enameled Resistors

Provide the utmost dependability and small size. Easily mounted by 1½" tinned wire leads. Three sizes: 5, 10, and 20 watts. Tolerance ± 10%.

### DIVIDOHM

Adjustable Resistors



Vitreous-enameled resistors, with wire exposed along one side for contact with adjustable lugs. Use for multi-tap resistors or voltage dividers, and for quickly obtaining odd values of resistance.

### NEW OHM'S LAW CALCULATOR

Quickly solves Ohm's Law problems—including parallel resistance. Also has standard slide rule.



25c

**OHMITE MANUFACTURING CO.**  
4895 Flournoy St. Chicago 44, Illinois

Be Right with  
**OHMITE**  
Reg. U. S. Pat. Off.

**RHEOSTATS - RESISTORS - TAP SWITCHES**

RADIO-ELECTRONICS for





Get  
Into

# TELEVISION, RADIO ELECTRONICS

## Master ALL Phases



**YOU RECEIVE THIS  
PROFESSIONAL MULTITESTER  
YOU BUILD ALL THESE AND  
MANY OTHER UNITS WITH  
PARTS WE SEND YOU!**



Signal Generator

Audio  
Oscillator

T.R.F.  
Receiver

You Build This  
Superheterodyne

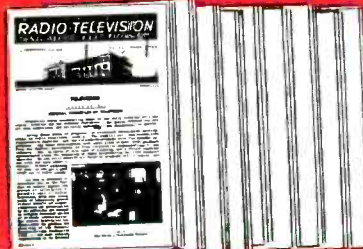

**You Receive a Special Series  
of Modern Lessons in TELE-  
VISION, all a part of your  
course: you master all phases.**

**Get Complete Training. You Receive and Keep All Tubes,  
Equipment, Parts and Lessons. No Extra Charges.**

**GOOD PAY  
and Unlimited Opportunities  
in JOBS LIKE THESE:**

Business of Your Own  
Radio Manufacturing, Sales, Service  
Broadcasting, Telecasting  
Television Manufacturing, Sales, Service  
Laboratories: Installation, Maintenance  
of Electronic Equipment,  
Electrolysis, Call Systems  
Garages: Auto Radio Sales, Service  
Sound Systems and Telephone Com-  
panies; Oil Well and Drilling Com-  
panies; Engineering Firms  
Theatre Sound Systems, Police Radio

**And scores of other good jobs  
in many related fields**

**YOU CONDUCT MANY  
EXPERIMENTS LIKE THESE!**

Checking action of condensers  
Experiments with AF and RF amplifiers  
Experiments with resonance  
Producing beat frequencies  
Calibrating oscillators  
Experiments with diode, grid-bias, grid-  
leak and infinite impedance detectors  
Practical experience in receiver trouble  
shooting  
Application of visual tester in check-  
ing parts and circuits  
Experiments with audio oscillators  
Advanced trouble-shooting  
... and many, many others

**Complete Training by Practical  
Resident Trade School, Est. 1905**

The same highly trained faculty, in-  
struction materials and methods used  
here in our large, modern resident  
school, are adapted to your training  
*in your own home.* Shop Method Home  
Training has been proved by hundreds  
of successful graduates.

**Both Resident and Home Study  
Courses Offered**

**YOU  
LEARN BY  
DOING**

You receive  
special labora-  
tory experi-  
ment lessons  
to show you  
how to build  
with your own  
hands various  
experimental  
units such as  
those shown at  
left, and how  
to conduct  
many tests.

You will find all lessons easy to under-  
stand because they are illustrated  
throughout with clear diagrams and  
step-by-step examples that you work  
out yourself. Every piece of the equip-  
ment and complete lesson material we  
send you is yours to keep and enjoy,  
including the multimeter, experimental  
equipment, all parts of the Superhetero-  
dyne, tube manual, radio dictionary,  
and complete, modern Television texts.  
All parts are standard equipment.

**Shop Method Home Training ...  
Earn While You Learn**

With our practical resident Shop  
Method Home Training, you study in  
your spare time. You receive Spare  
Time Work Lessons, which show you  
how to earn while you learn. Service  
neighbors' radios and TV receivers, ap-  
pliances, etc., for extra money and ex-  
perience. Many National students pay  
all or part of their training with spare  
time earnings!

**DON'T DELAY! The Radio-Television  
Industry needs trained men NOW!**

**APPROVED  
FOR  
VETERANS!  
Check coupon below!**

**For quick action,  
mail coupon  
today and we'll  
rush you full in-  
formation.**

**Free!**

**NEW, ILLUSTRATED  
OPPORTUNITY  
BOOK AND SAMPLE  
LESSON SHOW YOU  
HOW WE TRAIN  
YOU ... SEND FOR  
THEM TODAY! NO  
COST. NO  
OBLIGATION.**

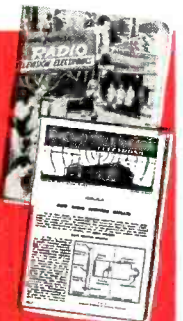

**NATIONAL SCHOOLS**

LOS ANGELES 37, CALIF. • EST. 1905



**FIND OUT NOW ... MAIL COUPON TODAY**

**National Schools, Dept. RE-9  
4000 South Figueroa Street  
Los Angeles 37, California**

Send me your FREE book "Your Future in Radio" and  
the sample lesson of your course. I understand no sales-  
man will call on me.

NAME.....AGE.....

ADDRESS.....

CITY.....ZONE.....STATE.....

Check here if Veteran of World War II

*Mail in envelope  
or paste on  
penny postal.*



# NOW! A FULLY AUTOMATIC ANTENNA ROTATOR BY ALLIANCE

## The New **HIR**

with The Most Accurate Indicator On the Market!

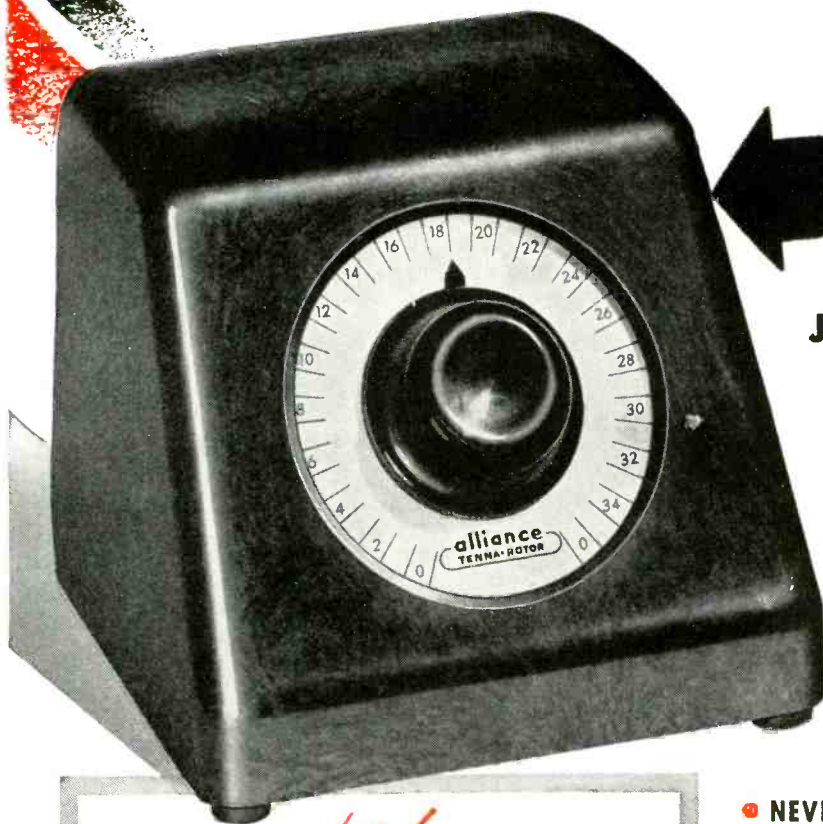

### JUST SET THE POINTER AND FORGET IT!

- **AUTOMATIC** — the new deluxe model HIR Alliance Tenna-Rotor is fully automatic! The antenna turns to any setting on the dial and stops.
- **FASTER INSTALLATION** — the only rotator where no orientation of antenna is required. Has special "Zip" feature—4-conductor cable.

- **NEVER OUT-OF-DATE** — station selector dial is eraseable. May be marked for present or new channels at any time by viewer.

- **MOVING MYSTIC LIGHT** — light moves along dial—shows position while antenna rotates. Pointer indicates antenna direction *at all times!*

*And remember!*

Only ALLIANCE delivers a national TV campaign to five million viewers around 60 stations.

- Has more than 250,000 users
- Comes with special "Zip" feature 4-conductor cable.

The famous Model DIR also available with handy — North — South — East — West indicator. Approved by Underwriters' Laboratories — guaranteed for one year!

**Alliance Manufacturing Co.**  
Alliance, Ohio

Export Department: 401 Broadway, New York, N. Y., U. S. A.

**alliance**  
**TENNA • ROTOR**

(TV ANTENNA ROTATOR)

RADIO-ELECTRONICS for



# Are You Prepared for a Good Paying Job in Television?

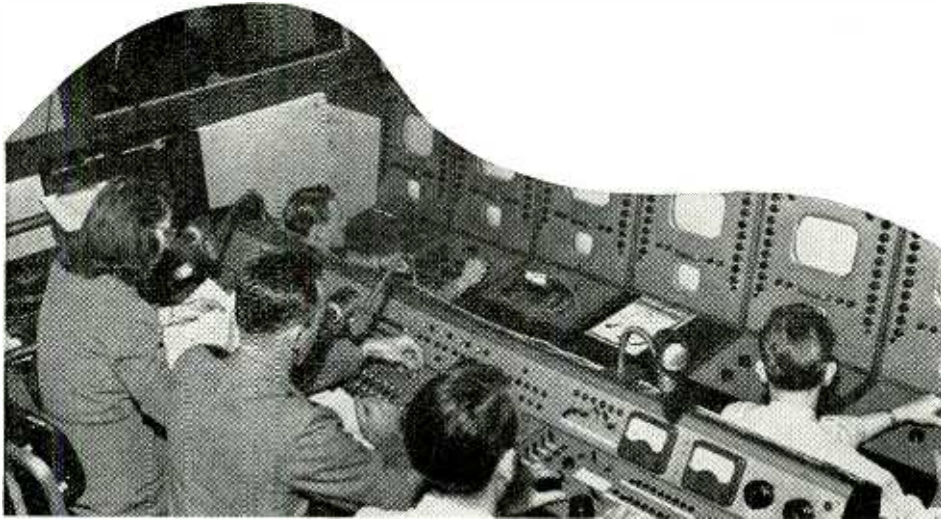

Television technicians are in demand—in stations, factories, research labs; in installation and trouble-shooting jobs. And the opportunities are increasing daily.

**The future belongs to those who prepare for it. This school gives you up-to-date technical training required to help you step ahead!**

By  
**E. H. RIETZKE**  
President CREI

**Y**OUR future success can best be assured by the steps you take today to prepare for it. No field offers a properly qualified young man greater opportunity than Television. But it takes technical training to land the good-paying jobs. Authorities are agreed that the *one sure way* to acquire this training is from a good school.

How can a young man select a "good school?" By its reputation in the industry . . . the professional standing of its faculty . . . the quality of its courses . . . the personalized help it offers . . . the length of time it has been in existence . . . and its accomplishments.

CREI invites investigation and comparison. An accredited technical institute founded in 1927, CREI's home-study graduates today fill important engineering, research, and radio-TV posts throughout the industry. While CREI makes no job promises to its graduates, the CREI Placement Bureau generally has on hand more requests than it can fill. During the war CREI trained thousands of technicians for the Army,

Navy and Coast Guard. Hundreds of thousands of special CREI technical texts were used in the Navy's own training program. Leading industrial firms—RCA Victor, United Air Lines, TWA, Pan American Airways, All-America Cables & Radio, Inc., Sears Roebuck & Co., to name only a few—have CREI group training programs now in operation.

CREI, through home study, offers practical technical training, starting with basic principles, going step-by-step through the more advanced subjects of TV and its related fields. Each student receives continuous attention and assistance to meet his special needs. You learn about Optics; Pulse Techniques; Deflection Circuits; RF, IF, AF and Video Amplifiers; FM;

Receiving Antennas; Power Supplies; Cathode Ray, Iconoscope, Image Orthicon and Projection Tubes; UHF Techniques, TV Test Equipment, etc. **SEND FOR FREE SAMPLE LESSON** and see for yourself how interesting it is to study at home and increase your income. Mail the coupon below and receive "The Orthicon and Image Orthicon." This lesson describes the development, theory and operation of the orthicon and image orthicon TV camera tubes.

**The Three Basic CREI Courses:** Practical Radio Engineering (fundamental course in all phases of radio-electronics); Practical Television Engineering (specialized training for professional radiomen); Television and FM Servicing (streamlined course for men in "top third" of field). *Also available as Residence School Courses.*

## CAPITOL RADIO ENGINEERING INSTITUTE

Dept. 149B, 16th & Park Rd., N. W. Washington 10, D. C.

Gentlemen: Send me FREE SAMPLE LESSON and booklet, "Your Future in the New World of Electronics," together with details of your home study training, CREI self-improvement program and outline of course. I am attaching a brief resume of my experience, education and present position.

Check the Field of Greatest Interest:  PRACTICAL TELEVISION ENGINEERING.  PRACTICAL RADIO ENGINEERING.  TV, FM & ADVANCED AM SERVICING.  AERONAUTICAL RADIO ENGINEERING.  BROADCAST RADIO ENGINEERING (AM, FM, TV).  RADIO-ELECTRONICS IN INDUSTRY.

NAME \_\_\_\_\_ AGE \_\_\_\_\_

ADDRESS \_\_\_\_\_

CITY \_\_\_\_\_ ZONE \_\_\_\_\_ STATE \_\_\_\_\_

Check here—  
 If interested in Residence School only.



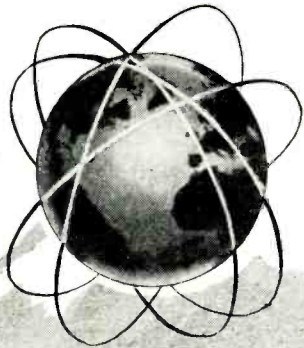

**1** built by the makers of electronic equipment respected throughout the world.

**2** not 3.2 . . . not 3.5 . . . not 3.7 . . . but a full 4.0 mcs. video bandwidth.

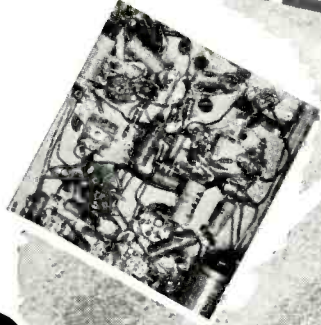
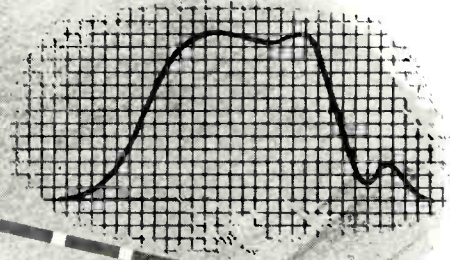

**3** clean-as-a-whistle wiring.

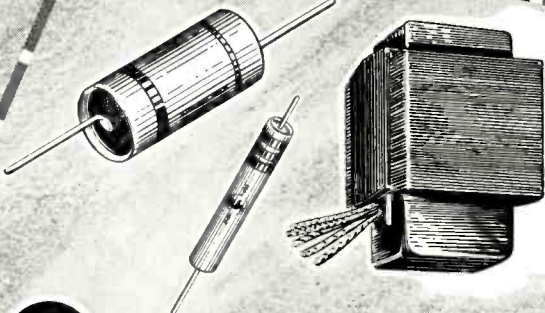

**4** the best components available in the industry.

**4**

*good reasons why* **NATIONAL TELEVISION** *performs while others claim!*



Table model with 16" rectangular, dark-screen tube; built-in Tele-Vane antenna. \$249.95



Console with 16" rectangular, dark-screen tube; built-in Tele-Vane antenna. \$289.95

RADIO-ELECTRONICS for



# HERE'S YOUR BIG CHANCE!

## D.T.I. Can prepare you for a Profitable Future in TELEVISION

### RADIO and ELECTRONICS

NO EXPERIENCE NECESSARY



E. B. DeVry, President DeForest's Training, Inc.



**NOW...BUILD AND KEEP A 16" RECTANGULAR "BLACK" PICTURE TUBE TELEVISION RECEIVER (This is an optional feature...described below)**

## 10 reasons why!

See how DeForest's Training, Inc. can start preparing you now for the opportunities ahead in TELEVISION . . . RADIO . . . ELECTRONICS. We provide practical training in your own home to help you gain the confidence and "know-how" to fit you for a responsible, well-paying job or your own business. D.T.I. trains you rapidly, thoroughly, by using modern instruction methods and equipment. Write today for free facts on how you, too, may get started toward a profitable, exciting career.

### 16 Big Shipments of Parts—Plus Lessons

Here is everything you need to prepare you at home for FASCINATING WORK, GOOD MONEY and a THRILLING FUTURE in one of America's most promising fields. Work over 300 electronic experiments and projects from 16 big shipments of parts. This includes building and keeping all test equipment and radio set shown at left side of page. Modern easy-to-read lessons with handy fold-out diagrams simplifies your entire training.

### You Also Use Home Movies

D.T.I., alone, includes the modern, visual training aid . . . MOVIES to help you learn faster, easier at home. See electrons on the march and other fascinating "hidden action"—a remarkable home training advantage that speeds your progress.

### EMPLOYMENT SERVICE

When you complete your training, our effective Employment Service helps you get started toward a real future in Television-Radio-Electronics.

### Modern Laboratories

If you prefer, you can get ALL your preparation in our new, Chicago training laboratories . . . one of the finest of its kind. Ample instructors . . . modern equipment. Write for details!

1. You profit from our 19 years of "know-how" in preparing men for real opportunities in the Radio-Electronics field—which now includes Television.
2. A faculty of more than 60 skilled residential and 15 extension instructors.
3. You may learn at home or in our new, modern laboratories in Chicago.
4. Home Movies, an exclusive D. T. I. feature, help you learn faster . . . easier at home.
5. You receive many shipments of commercial-type equipment which give you practical "on-the-job" experience in your own home.
6. You build modern-type test equipment which you can regularly use for analyzing, checking and testing purposes.
7. You also get lessons with many illustrations and schematic drawings that make electronic circuits easier to grasp.
8. EFFECTIVE EMPLOYMENT SERVICE is available when you complete your training to help you get started.
9. Consultation Service. After you complete your training, you are privileged to write for additional information to help you with "on-the-job" problems.
10. Build and keep a quality 16-inch rectangular tube Television Receiver. This is an optional feature—available at slight additional cost after completing training described above.

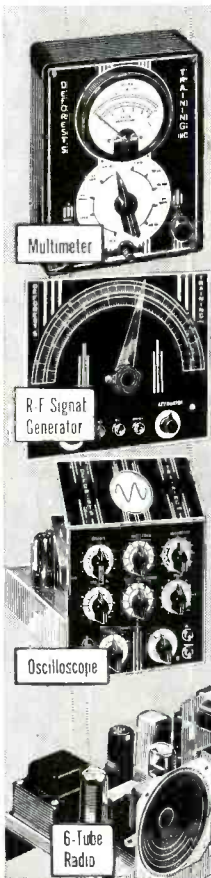
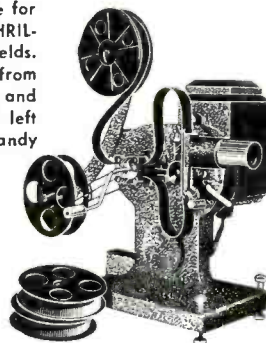

### MAIL THIS OPPORTUNITY COUPON NOW!

Mr. E. B. DeVry, President  
DeForest's Training, Inc.  
2533 N. Ashland Avenue, Dept. RE-G-9  
Chicago 14, Illinois

Please show me how I may get started toward a good job or a business of my own in Television-Radio-Electronics.

Name \_\_\_\_\_ Age \_\_\_\_\_

Address \_\_\_\_\_ Apt. \_\_\_\_\_

City \_\_\_\_\_ Zone \_\_\_\_\_ State \_\_\_\_\_

**DeForest's Training, Inc.**  
CHICAGO 14, ILLINOIS

Associated with the DeVry Corporation  
Builders of Movie & Electronic Equipment



# American Beauty

## ELECTRIC SOLDERING IRONS

are sturdily built for the hard usage of industrial service. Have plug type tips and are constructed on the unit system with each vital part, such as heating element, easily removable and replaceable. In 5 sizes, from 50 watts to 550 watts.

### TEMPERATURE REGULATING STAND

This is a thermostatically controlled device for the regulation of the temperature of an electric soldering iron. When placed on and connected to this stand, iron may be maintained at working temperature or through adjustment on bottom of stand at low or warm temperatures.



For descriptive literature write

**AMERICAN ELECTRICAL  
HEATER COMPANY**  
DETROIT 2, MICH., U. S. A.

**MONUMENT** commemorating the first transatlantic short-wave message will be dedicated at Greenwich, Connecticut, early this fall. Sponsored by the Radio Club of America, the monument carries the inscription:

Near this spot, on December 11, 1921, radio station 1BCG sent to Ardrossan, Scotland, the first message ever to span the Atlantic on short waves. 1BCG, an amateur station, was built and operated by members of The Radio Club of America. Dedicated Greenwich, Connecticut, 1950.

In addition to the monument, bronze medals will be awarded to those who took part in the 1BCG transmission and reception.

**JOHN T. FRYE**, regular contributor to RADIO-ELECTRONICS ("Fundamentals of Radio Servicing") and a number of other radio publications, received an engraved plaque from the Indiana Radio Council as Indiana's outstanding radio amateur of the year.

Mr. Frye already has a citation from the Amateur Radio Relay League for relaying messages during the Ohio River flood between the flood area and Washington, D.C. He works with the emergency disaster committee of the American Red Cross and is a member of the River Forecast Net, a group set up recently by the Weather Bureau of the Department of Commerce to speed communication of data on the rivers of the Ohio watershed.

He was a member of the Army Amateur Radio System (a group connected with the Signal Corps) before the war, and now belongs to the Hoosier Emergency Net.

**READING PENCIL**, developed and improved by Dr. Zworykin of RCA, and which enables a blind person to read ordinary print and typewritten copy, was demonstrated at a recent meeting of the American Association of Instructors for the Blind. When pointed at a letter, the pencil translates the shape of the letter into a distinctive noise which is heard by the blind person through a hearing aid. The average blind person can learn about 190 words which he can read in sentences after about 24 hours of practice. However, changes in typeface are very confusing and require additional practice.

For the nearly blind, an electronic magnifier based on television principles was also demonstrated. An instrument about the size of a flashlight scans the type to be read. The word, magnified 15 times, is transmitted to the screen of an ordinary televiser.

The demonstrators pointed out that these devices still need further development before the average blind person can use them effectively.

**CROSS-COUNTRY VIDEO** will make its debut Jan. 1, 1952. The Federal Communications Commission has authorized the American Telephone and Telegraph Co. to complete the first transcontinental television microwave relay circuit by that date.

Fifty-five microwave relay stations will bridge the last major gap between Omaha and San Francisco in the proposed system. The New York to Chicago portion of the circuit was completed recently. New York, Chicago, St. Louis, and many Eastern cities are already connected by A.T.&T.'s system of underground coaxial cable. The cost of the complete transcontinental microwave system will be about 37 million dollars.

**TELEVISION SETS** owned by students at the Valparaiso Technical Institute must be registered with the school authorities. If a student's grades fall below normal, the school checks the register to see if too much TV is the trouble. If so, he must either send the set home or put it in storage with the school.

**R.F. ENERGY** is used to pasteurize a continuous flow of milk in a device invented by George H. Brown of Princeton, N. J. (U.S. patent No. 2,510,796, assigned to Radio Corporation of America). The milk passes through a high-frequency field which heats the liquid nearly to its boiling point for a fraction of a second to kill the germs. The milk is then sprayed into a vacuum chamber for quick cooling.

**GIANT PICTURE TUBE** with a diameter of 30 inches and more than 536 square inches of picture area is used by Allen B. Du Mont Laboratories in their "Club 30" receiver. The picture tube's 90° deflection angle makes it shorter in length than in diameter, so it can be housed in cabinets of conventional proportions.

The receiver is designed for public places such as schools, hospitals, clubs, hotels, and restaurants. Besides TV it has full-range AM and FM radio and a plug-in attachment for a record player. Production on the model will start this fall.

The Du Mont company has announced they intend to make the 30-inch tube in rectangular as well as round form.

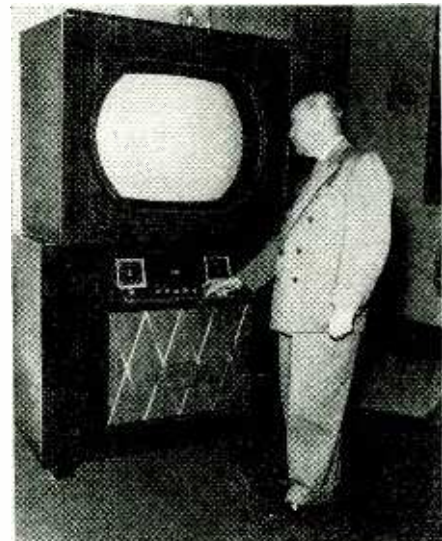

Photo of the 30-inch diameter picture tube in the Du Mont Club 30 receiver.





# Train at Home in Spare Time for and **RADIO TELEVISION**

**I Send You  
18 BIG  
KITS  
OF RADIO-  
TELEVISION  
EQUIPMENT**



**My Famous Training System Prepares You  
Double Quick For a Good Job or Your Own  
Profitable Radio-Television Business**

Radio-Television is now America's greatest opportunity field! Trained men are needed to fill good jobs and handle profitable Radio-Television Service work. I have trained hundreds of men for success in Radio-Television—and I stand ready to Train you too, *even if you have no previous experience.* My training is 100% practical—designed to give you the knowledge and experience you need to make money in Radio-Television in the shortest possible time. I Train you with up-to-the-second revised lessons—PLUS many big kits of Radio-Television equipment. You actually do over 300 demonstrations, experiments and construction projects. In addition, you build a Powerful 6-tube-2-band radio, a multi-range test meter and a complete Television receiver! All equipment is **YOURS TO KEEP.**

**EASY TO MAKE EXTRA MONEY WHILE YOU LEARN**

You do all your training with me **AT HOME** in spare hours. Keep right on with your present job and income while learning—and earn extra cash besides! The day you enroll I begin sending you plans and ideas for doing profitable spare time Radio-TV work. Many of my Sprayberry students pay for their entire training this way! You get priceless experience and many plans for making extra money. You build all your own Radio-TV Test Equipment from parts I send you—nothing else to buy. Just one more reason why I believe I offer the ambitious man the biggest value in top notch Radio-TV Training available anywhere in America today.

**BE READY FOR TOP PAYING RADIO-TELEVISION JOBS**

Radio-Television is growing with amazing speed. More than 2000 Radio broadcasting stations PLUS an additional 102 Television stations are now on the air. Radio sets and TV receivers are being made and sold in record breaking numbers. If you enjoy working with your hands . . . if you like to do interesting and varied work . . . if you really want to make good money and work in an industry that has a future . . . **YOU BELONG IN RADIO-TELEVISION.** But you **MUST** have good Training to "cash in" . . . the kind of training that starts you out with basic fundamentals and carries you right through every circuit and problem of Radio-Television Servicing and Repair. In a word . . . that's Sprayberry Training . . . the course backed by more than 20 years of association with the Radio-Television industry!

**FREE 3 BIG RADIO AND TELEVISION BOOKS**

I want you to have ALL the facts about my complete system of Radio-Television Training! Act now! Rush the coupon for my three big Radio-Television books: "How To Make Money in Radio-Television," PLUS my new illustrated Television bulletin PLUS an actual sample Sprayberry Lesson—all FREE with my compliments. No obligation and no salesman will call on you. Send the coupon in an envelope or paste on back of post card. I will rush all three books at once!

**Sprayberry Academy of  
Radio, Dept. 20-N**  
111 North Canal St., Chicago 6, Ill.

**Mail  
Coupon  
Today!**  
**NO OBLIGATION  
No Salesman  
Will Call**

**VETERANS:** My Radio Training is Approved for Veterans.

**IF YOU ARE EXPERIENCED** in Radio & TV qualify you for Television in 4 to 8 weeks. Rush coupon.

**SPRAYBERRY ACADEMY OF RADIO, Dept. 20-N**  
111 North Canal St., Chicago 6, Ill.

Please rush to me all information on your Radio-Television Training plan. I understand this does not obligate me and that no salesman will call upon me.

Name..... Age.....

Address.....

City..... State.....

Please Check Below About Your Experience  
 Are You Experienced?     No Experience



**FCC DECISION** on new station allocations may bring an end in the very near future to the present TV freeze. At a hearing of the Senate Interstate and Foreign Commerce Committee held this summer, FCC commissioner George E. Sterling said, "If we could come up with an agreement on color television, we could write a decision within 30 days and then proceed with allocations."

The color problem is still vexing the FCC, but Sterling indicated that he believes color is near at hand. This is contrary to the opinion of Allen B. Du Mont and some others in the industry that color as a commercial service is still many years away. Last June the Columbia Broadcasting System requested a delay in any decision until they could demonstrate a new all-electronic color system which they had devised. However, the commission is also under pressure from other industry factions which want a decision as soon as possible.

Also mentioned at the hearing was the proposal to move television into the u.h.f. band. Senator Tobey, New Hampshire Republican, charged the FCC with disregarding the advice of its own engineers when it chose the present v.h.f. band for TV in favor of the u.h.f. band. The Senator pointed out that in 1940 Paul DeMars, then chief engineer for the Yankee Network, warned that tropospheric interference would disrupt TV in the frequencies to which it is now assigned. Sterling denied that the FCC had buried the report, but said that this prediction was based on theoretical calculations and had not enough actual data to merit its being taken seriously.

(Senator Tobey was at a loss for words when, after the meeting, a reporter asked him what the troposphere is. He did not seem to have a clear answer.)

**DOWN MEXICO WAY** television is getting off to a good start with projected opening of station XHTV, Mexico's first TV station (Channel 4). All the equipment at XHTV was built by RCA and shipped to Mexico City from Camden, N.J., last March. It includes a 5-kw transmitter, antenna, and cameras and studio equipment. The station also has a "studio on wheels" that will provide facilities for remote pickup of fiestas, bullfights, news, and other public events. This mobile unit, which completes XHTV's equipment, began the 3,100-mile highway trek from Camden to Mexico City last June. XHTV will be North America's first over-the-border link in what may be an eventual international exchange of TV programs.

Mexico is not alone in the march toward television. Station CMQ, Havana, Cuba, is speeding installation of a 5-kilowatt television transmitter in Havana's radio center, and Sao Paulo, Brazil, saw a preview of the opening of the first TV station in that country this summer. Radio Tupi, as the station is called, is owned and operated by Emissoras Associadas,

Brazil's largest radio network. Equipment for the station, studios and mobile pickups were supplied by RCA. A four-hour demonstration of the equipment over a closed circuit was the highlight of the opening ceremonies of the Museum of Modern Art in Sao Paulo.

**SILVER ANNIVERSARY** of the Chicago section of the Institute of Radio Engineers will be climaxed with a 25 Years of Progress celebration on September 25, 26, and 27 when the Sixth National Electronics Conference will be held at Chicago's Edgewater Beach Hotel.

The Chicago Section of the IRE, formed 25 years ago with a nucleus of

45 members, has grown to a present membership of 1,700, including students and most of the engineers and scientists in Chicago's immense electronic industry. It was in Chicago that Lee De Forest "The Father of Radio" began his experiments with wireless signal receivers that eventually developed into the three-electrode tube.

The National Electronics Conference, sponsored by the IRE, the American Institute of Electrical Engineers, the Illinois Institute of Technology, Northwestern University, and the University of Illinois, will feature radio and TV programs, educational trips, technical meetings, and over 100 exhibits, with "Old Timers Night" as a major event.



Switch Model Illustrated

## THE THRIFTY TURNER TWENTY

Widely popular as an outstanding hand-held crystal microphone value, the Turner *Twenty* is now available in a choice of crystal, dynamic, or carbon circuits. Various switching arrangements provide even more versatility to meet a wide range of applications. All 3 Models are typically Turner—brilliantly engineered and ruggedly constructed for "Sound Performance". The die cast metal case provides stability and ample shielding. The cable is securely anchored and Turner *guarantees* it will not pull out. For top value in the low-cost hand-held microphone field switch to Turner Twenty.

### CRYSTAL

- Model 20X . . . . . \$12.85
- Model S20X With push-to-talk switch having slide lock feature. Switch connected in microphone circuit, normally open. . . \$14.85
- Model SR-20X With push-to-talk switch having slide lock feature. Switch, normally open, connected to two cable conductors independent of microphone circuit for relay control. . . . \$17.85

### DYNAMIC

- Model 20D . . . . . \$16.85
- Model S20D . . . . \$18.85
- Model SR-20D . . . \$21.85

### CARBON

- Model 20R . . . . . \$12.85
- Model S20R . . . . \$14.85
- Model SR-20R . . . \$17.85

Write for Complete Data Sheet

## THE TURNER COMPANY

933 17th Street N. E. Cedar Rapids, Iowa

IN CANADA: Canadian Marconi Co., Montreal P. Q., and Branches

EXPORT: Ad. Auriema, Inc., 89 Broad Street, New York 4, N. Y.



Crystals licensed under patents of the Brush Development Co.

RADIO-ELECTRONICS for

# Become an Electrical Engineer



Major in Electronics



**B.S. Degree in 36 Months**



## Prepare Here for Specific Career-Objectives

Your success in the expanding, fascinating field of Electronics will be influenced materially by the type of educational program you choose.

Important advantages are gained at this Technical Institute and College of Electrical Engineering. For example, you achieve the Technician's occupational certificate upon completion of your first level of study toward a B.S. degree. The *comprehensive* nature of the courses gives you other special advantages in securing positions such as are listed below:

**Major in Electronics  
B. S. Degree**

*(36 successive months of study which include the 12-month Electronic Technician program)*

**Typical job objectives:**

- Design Engineer
- Electronics Research Engineer
- Radio Engineer
- Sound Engineer
- Application Engineer
- Field Engineer
- Patent Attorney (with additional training in law)
- Salesman of Electronic Equipment
- Manufacturing Supervisor
- Communications Engineer
- Industrial Electronics Engineer
- Television Engineer

**Electronic Technician**

*(12 months of objective study which also completes a third of the program leading to the B.S. degree)*

**Typical job objectives:**

- Laboratory Technician
- Electrical Tester (radio mfg.)
- Maintenance and Repair Technician
- Contractor
- Manufacturing Supervisor
- Salesman of Electronic Equipment

**Radio-Television Technician**

*(18 months of study)*

**Typical job objectives:**

- Radio-Television Serviceman
- Audio, Transmitter or Communication Technician.
- Broadcast Operator (upon passing FCC examinations)

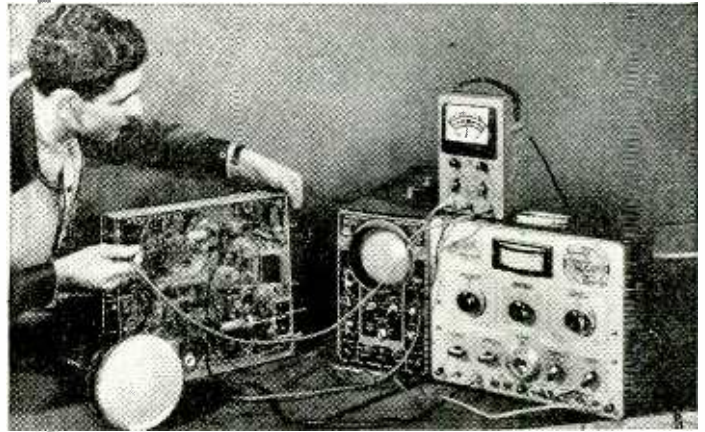

A VALUABLE FEATURE of this educational program is the manner in which LABORATORY experience is woven into *each* successive term to assure a thorough, practical background. You receive electrical practice and technical studies *immediately*. You train with modern equipment such as you will use after graduation.



"HUMAN ENGINEERING" is essential to the full success of tomorrow's technical man. Therefore, courses also include combinations of English, Economics, Engineering Law, Industrial Psychology, Speech and other Humanities.

THIS world-famous course in Electronics presents thorough technical training plus a solid education in the basic sciences, electrical engineering and allied fields. You have an opportunity to save a valuable year by using the option to study the year-round. Thus, you earn your B.S. degree in 36 months.

## MILWAUKEE SCHOOL of ENGINEERING

Technical Institute • College of Electrical Engineering

- The 1,555 students enrolled in this 47-year-old school represent 48 states and 23 countries. Over 35,000 alumni. Terms open Oct., Jan., April, July.
- Military, practical or prior academic training will be evaluated for advanced credit. Preparatory and refresher courses are also available.



Write or send coupon today for the helpful 44-page pictorial bulletin, "Your Career," and the 110-page catalog.

MILWAUKEE SCHOOL OF ENGINEERING  
Dept. RE-950  
1020 N. Broadway, Milwaukee, Wis.

Without obligation send the 44-page "Your Career" bulletin and 110-page catalog.

(Check 6 to 36-month courses which interest you)

- Electrical Engineering:  Electronics  
 Electrical Power  
 Radio-Television  Heating  Refrigeration  
 Air Conditioning  Electricity  Welding

Name ..... Age.....

Address .....

City .....Zone.....State.....

Check if World War II Veteran



Presenting the **NEW**  
**Astatic TV and FM Boosters**  
 Models **BT-1** and **BT-2**

*Astatic* raised tremendously the level of improved TV reception through pre-amplification of signal, when it developed its famous deluxe model AT-1 Booster with exclusive variable gain control and dual tuning. Now Astatic brings another great advancement to the progress of TV enjoyment—with two low-cost boosters that equal, to all practical purposes, the primary function of the highest priced units. Never before has so much quality been incorporated in a booster to sell at so low a price. Why not get the complete details? Write today.

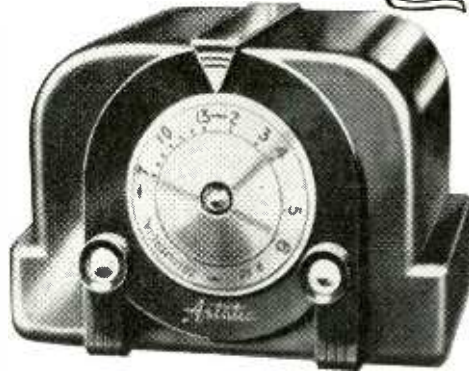

Booster Model **BT-2**  
 List Price **\$32.50**



Booster Model **BT-1**  
 List Price **\$29.95**

**Only ASTATIC offers  
 as complete a choice of  
 BOOSTER MODELS**



Booster  
 Model **AT-1**  
 List Price  
**\$49.50**

Increasing numbers of TV set owners will still want the finest Booster that money can buy—and that means Astatic's deluxe Models AT-1 and AT-1B, with rich furniture finish mahogany or blond wood cabinet, exclusive and variable gain control, dual tuning and powerful four-tube operation.

**LOOK AT THE AMAZING  
 QUALITY FEATURES IN  
 THESE LOW-PRICED  
 BOOSTERS**

- 1 Employ Mallory Inductuner for continuous variable tuning.
- 2 High gain, very uniform on both high and low channels.
- 3 Simplified controls—single tuning knob with continuous tuning through both TV and FM bands.
- 4 Band width adequate over entire range.
- 5 Low noise design and construction.
- 6 No shock hazard to user.
- 7 Off-on switch for easily cutting in and out of circuit.
- 8 Selenium rectifier.
- 9 Use single 6AK5 Tube.
- 10 Provide for either 72 ohm or 300 ohm impedance input and output.
- 11 Model BT-2 has handsome, dark brown plastic cabinet.
- 12 Model BT-1 has metal cabinet in rich mahogany woodgrain finish.
- 13 Large dial face is easy to see in tuning.
- 14 Model BT-2 has recessed pilot light to show when booster is on.

**THE**  
**Astatic**  
**ASTATIC CORPORATION**  
 CONNEAUT, OHIO  
IN CANADA: CANADIAN ASTATIC LTD. TORONTO, ONTARIO

**New Plants and Expansions**

General Electric Corp. will spend over seven million dollars in 1950 to increase production of radio and TV receivers, cabinets and tubes in its plants at Syracuse, Utica, and Buffalo, N. Y.; Tell City, Ind.; and Owensboro, Ky. G-E also announced that new quarters for their industrial research laboratory near Schenectady, N. Y., have been completed. The buildings are flexibly designed to meet the research needs of the future. Philco Corp. has leased 21,500 square feet of additional space in Philadelphia, Pa., for their radar and other government electronics projects. . . . Bendix Radio and Television will quadruple its TV production facilities with the opening of a new building in Baltimore about September 1. . . . Howard W. Sams & Co. has consolidated its four former locations in one new 30,000 square-foot building in Indianapolis, Ind. . . . Alprocco, Inc., has expanded its Kempton, Ind., offices with the construction of 3,000 square feet of additional space. . . . Freed Radio Corp. has contracted a long-term lease for additional manufacturing space in New York City for making Freed Eisemann TV sets. . . . Emerson Radio & Phonograph Corp. has purchased the Musagrund Corp., Brooklyn. This plant manufactures console cabinets and will be operated by the Jefferson-Travis Corp.

The Brunswick Division of Radio & Television, Inc., is building a new TV receiver plant in Brooklyn. When completed, the new plant will produce from 350 to 400 sets a day. . . . Tele-Tone Radio Corp. advised the Securities and Exchange Commission that it has purchased the Rico Television Corp. of Hato Rey, Puerto Rico. . . . Reeves Soundcraft Corp. has announced that it is producing three types of rectangular TV picture tubes at its new Springdale, Conn., plant recently acquired from Remington Rand. . . . The Pentron Corp. has acquired the assets and facilities of Sound, Inc., Chicago. No change in the operation of either company is planned for the present.

**Merchandising News**

Standard Coil Products, Inc., has prepared a striking point-of-sale booster display for dealers and distributors. Obtainable through jobbers, factory representatives, or directly from the com-



pany, it may be used with or without a sample of the standard booster.

RCA's tube division is distributing portable radio batteries in colorful containers which can be converted into

**RADIO-ELECTRONICS for**



# PULL MINIATURES PAINLESSLY!

**WHY STRAIN, fry, and slice your fingers? Why break tubes?** Pull or insert 7-pin miniatures the e-a-s-y way. With economical Hytron Tube Puller. Result of two years' research. Positive grip pulls first time from meanest sockets. Special Neoprene rubber resists heat. Does not harm tube. Adjusts automatically to varying tube diameters. Tube Puller works by suction and friction on top of tube. Removes even tiny 6AK5 and 6AL5 from shielded sockets. Reaches into tightest spots — to pull or insert. Only 75¢! You cannot afford to be without this temper-time-and-money saver. Get your Hytron Tube Pullers from your Hytron jobber today.

**It's Easy!** **TO PULL:** Push Tube Puller onto top of 7-pin miniature. Just enough for firm grip, and without depressing release button at top. Pull straight up and out; no need to bend pins by violent rocking. Hold tube securely in one hand. With other, push release button quickly. Compressed air pops out tube. Or, holding down release button, remove Tube Puller by rocking it. **To insert:** Align arrow on skirt of Tube Puller with keyway of tube. Push tube into Tube Puller. Using arrow as guide, insert tube. Push button quickly to release. Maintain pulling action at peak. Wipe inside of Puller occasionally with clean cloth to remove dirt and grease.



**HYTRON TUBE PULLER**  
75¢ net

## THEY COST PENNIES, BUT SAVE DOLLARS!

**OVER 50,000 SERVICEMEN** know! These Hytron tools pay for themselves again and again. Save time . . . temper . . . dollars — daily. Read what they'll do for you. Write for complete Tool Catalogue. Better still — get these tools from your Hytron jobber today!



**PIN STRAIGHTENERS, 7-Pin and 9-Pin — 55¢ net ea.** You merely press tube gently into Hytron Straightener until button base seats squarely. Presto, pins are straight! Fast . . . safe. Avoiding one broken tube pays for Straightener twice over. Precise, stainless-steel insertion die. Comfortable knurled aluminum holder. For hand, bench, or tube tester use.



**AUTO RADIO TOOL — 24¢ net.** Substitutes for control cables of universal auto radio. Quickly, precisely turns set on/off, tunes, adjusts volume and tone, re-aligns dial. Square also fits splines. Vee fits spade and other key fittings. Minimum backlash. Compact. Bright-zinc plated. Non-rolling large handle for fine adjustments.



**SOLDERING AID — 49¢ net.** Fork tip effortlessly, quickly unwraps "mechanically solid" joints. Straddles wire, grips, unwraps, pulls it free. Guides new wire; holds it firm while soldering. Spade tip reams solder from lug hole; pushes other wires aside. Tips are hardened, twist-proof, insulated, hard-chromed to shed solder. Tool handles like pencil. Reaches tight spots. Has dozens of other uses.



**TUBE LIFTER — 15¢ net.** Lift 'em all the e-a-s-y prybar way: Tubes (GT, G, standard, lock-in, metal). Vibrators and plugs (Jones, Amphenol) — and knobs. A natural for compact auto radios, etc. Slotted end lifts lock-ins, snap-in trimounts . . . easily, safely. Of stainless steel with comfortable rolled edges.



**TUBE TAPPER — 5¢ net.** Handy combination pencil, eraser and tube tapper. Discovers microphonism, shorts, and opens in tubes, etc. Compact, non-metallic, rugged. Doubles in brass for writing orders, etc.





# SAVE

## BATTERY RENEWAL COSTS

# CONVERT

## BATTERY RADIOS TO AC ALL-ELECTRIC

Now is the time to change your dry battery radio into a dependable hum-free AC receiver with an Electro Battery Eliminator. Save money—completely eliminates batteries and high operating costs, uses only 11 watts. Fits most radios, easily slips into battery space.



**Model "P" with Tube Rectifier**

Years of dependable interference-free performance are insured with these Electro Battery Eliminators. Complete filtering provides perfect reception. Operate any 1.4 volt 4, 5 or 6 tube battery radio from 115 volt, 50 to 60 cycle source. On-off switch, standard battery plug and sockets make operation extremely simple. Also available for 220 volt power source.

### Model "S" with Selenium Rectifier

Same as Model "P" except for selenium rectifier. Guaranteed for three years.

**Many Other Models Available  
Unmatched in Quality, Price!**

**SEND FOR FACTS TODAY!**

**ELECTRO PRODUCTS LABORATORIES**  
4507-PS Ravenswood Ave., Chicago 40, Ill.  
Send me FREE literature and name of nearest source.

Name .....

Address .....

City ..... State .....



Pioneer Manufacturers of Battery Eliminators

cardboard circus wagons for the kiddies. An 11-piece kit giving the "circus" promotion extra impact is available to dealers through distributors. The overall promotion is backed by trade and consumer advertising, the TV show "Kukla, Fran and Ollie," and radio's "Screen Directors' Playhouse."

Astatic Corporation is now packaging its phonograph pickup cartridges in sturdy transparent plastic boxes.

The new package permits attractive



display and easy storing. The cartridge and a list of the cartridges it may be used to replace are in the package.

Admiral Corp. has prepared 8-page installation and service manuals which are issued with each TV receiver. Data includes schematic diagram, test voltages, and all installation adjustments the service technician must know. The booklet is designed for the service technician and technically minded TV set owners. Admiral also publishes a non-technical guide for TV owners and a complete service manual which is available from Admiral distributors.

The Town Meetings Committee of the Radio-Television Manufacturers Association announced, through chairman Harry A. Ehle, that the television broadcasting industry has joined with manufacturers and distributors in an educational program to help retailers sell more sets and to make sure set owners are satisfied. It is a noncompetitive program financed by leading TV set manufacturers. The committee also reported progress in organizing the Town Meetings of Television Dealers which are being held in 60 key cities during August, September, and October. Slide films are shown at the meetings to help dealers improve sales, merchandising, management, and service practices.

### Financial Notes

Clarostat Manufacturing Co. sales for the year to June 23 were \$2,392,275 as against \$1,099,391 for the same 1949 period. Earning comparisons were not made as the company wrote off the entire cost of moving the plant from Brooklyn to Dover, N. H., for a net loss in 1949. The company has declared an 8¢ dividend on common stock, announced as the first cash payment since 1946. . . . Allen B. Du Mont Laboratories' sales for the first half of 1950 totalled \$26,000,000 compared with \$18,000,000 for the like 1949 period. Estimated earnings, \$2,700,000 against \$1,780,000 in 1949. . . . Hallicrafters Co. nine months' profit to May 1950 was \$1,110,024 con-

trasted with \$445,565 in 1949. Sales \$19,854,509 against \$12,605,715.

Dividends: Admiral Corp. declared a 25¢ quarterly dividend on common stock. . . . Emerson Radio & Phonograph Corp. paid 25¢ per share on capital stock. . . . Motorola, Inc., 37½¢ quarterly dividend on common stock. . . . Gamble-Skogmo, Inc., 62½¢ on preferred stock. . . . Olympic Radio & Television, Inc., 20¢ on common stock. . . .

### Business Briefs

Zenith Radio Corp. vice president stated that interest in FM radio is definitely reviving in spite of some FM stations closing earlier this year. FCC granted two broadcasters permission to cancel construction permits and delete their FM stations. Four new FM stations were licensed in Jonesboro, Ark.; York, Pa.; Denton, Tex.; and Montgomery, Ala.

Opposition to TV servicing frauds by all branches of the industry crystallized in New York City at a mass meeting where the Better Business Bureau released its new code of practices. The code governs advertising, selling, and servicing of TV sets. In addition to the code, the BBB issued a consumer booklet *Things You Should Know About the Purchase and Servicing of Television Sets*. It is available through dealers or directly from the BBB.

The meeting grew out of the alarming increase of complaints about TV advertising and servicing in this area. Actively supporting this campaign were the distributors of Admiral, RCA, Crosley, DuMont, Emerson, Stromberg-Carlson, Magnavox, Motorola, Philco, Capelhart, Westinghouse, Hallicrafters, and Zenith.

Among the speakers at the meeting were John F. Rider, president of John F. Rider Publisher, Inc., and Robert C. Sprague, president of the RTMA and the Sprague Electric Co. (More details on page 33.)

Service organizations and Better Business Bureaus in other cities are reported drafting similar codes. . . . FCC reports it has received the greatest number of interference complaints in its history in the four years of TV broadcasting. . . . Siatron Corp. has tentative plans to demonstrate a pilot model of its patented Subscriber-Vision which provides special TV programs for a fee. The system requires no telephone connections. . . . Sightmaster Corp. has formed a conversion department which will convert any television set to any required larger screen size. Reports from local service contractors and dealers indicate that conversion may become profitable business. . . . The Radio Parts and Electronic Equipment Shows, Inc., board of directors will meet September 6-8 at the Greenbrier Hotel, White Sulphur Springs, W. Va. New officers will be elected, reports filed, and plans made for the 1951 show. . . . The Audio Engineering Society is sponsoring the nation's second Audio Fair in the Hotel New Yorker, New York City, October 26 to 28. The society will hold its annual convention then.

**SERVICE  
DEALERS!**

**Get this  
valuable  
SYLVANIA  
Socket  
Wrench**

**Kit...NOW**

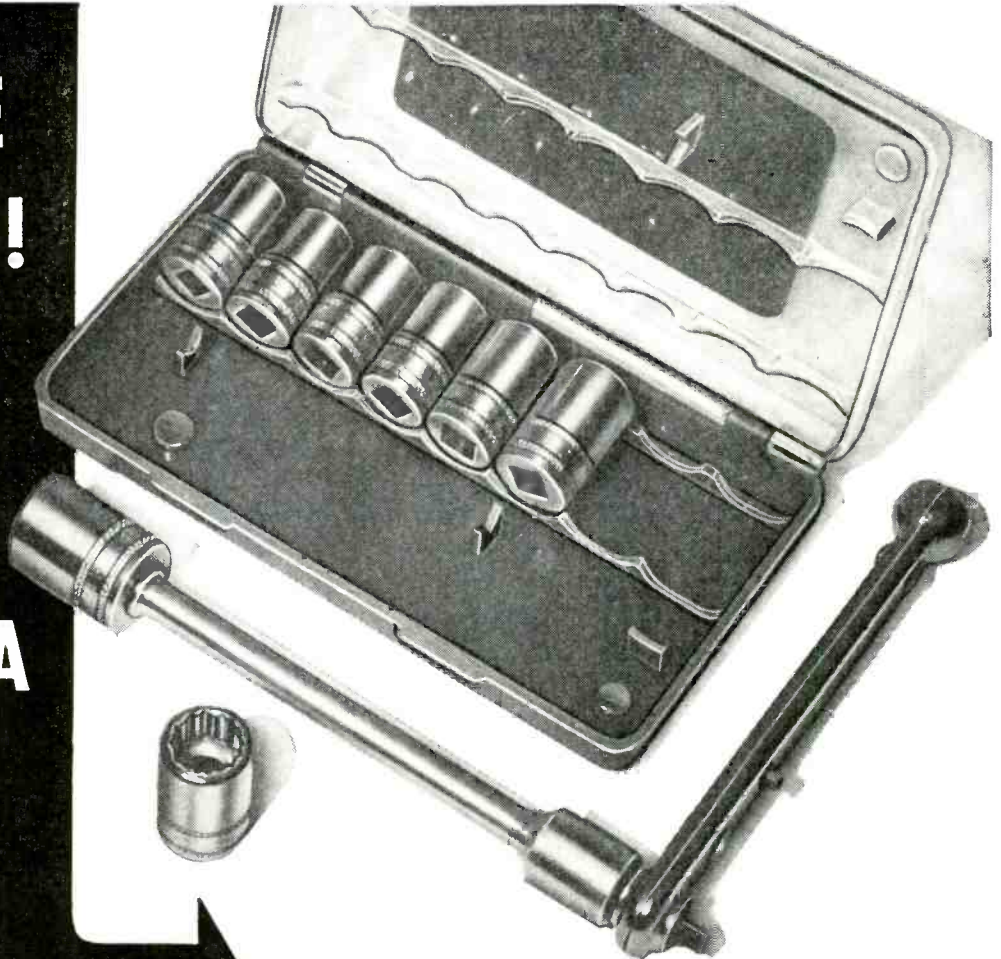

**Specially Priced \$2.50  
to you... only 2<sup>50</sup>—**

**Note these  
outstanding features!**

- 1.** 8 chrome-plated steel interchangeable sockets, 3/16" to 7/16"
- 2.** Either clockwise or counter-clockwise ratchet action . . . finger-tip selector
- 3.** Convenient 4-inch socket extension for hard-to-reach screws and nuts
- 4.** Incorporates offset screwdriver with 2-way ratchet action
- 5.** 3 3/4", easy-to-hold handle, convenient for tight spots
- 6.** Good-looking, plastic case . . . pocket-size

Here's the cleverest and most efficient tool kit you've seen in many a moon!

Eight snug-fitting, interchangeable wrench-heads snap onto a precision-built ratchet handle. You'll find a thousand time-saving uses for this implement around your shop.

In fact, this fine quality tool seemed like such a "natural" for service jobs of all kinds that Sylvania decided to make it available to Service Dealers . . . at a special low price of only \$2.50 complete. And no strings attached . . . nothing else to buy.

Of course, the supply is limited. To make sure you get yours, order now from your Sylvania distributor . . . he has a supply on hand. If your distributor can't supply you, send check or money-order for \$2.50 to Sylvania Electric Products Inc., Dept. R-1009, Emporium, Pa.

**SYLVANIA  ELECTRIC**

RADIO TUBES; TELEVISION PICTURE TUBES; ELECTRONIC PRODUCTS; ELECTRONIC TEST EQUIPMENT; FLUORESCENT LAMPS, FIXTURES, SIGN TUBING, WIRING DEVICES; LIGHT BULBS; PHOTOLAMPS; TELEVISION SETS

SEPTEMBER, 1950



# News that reaches you in less than a second!

**How mobile television vans flash pictures from the field**

**No. 8 in a series outlining high points in television history**

*Photos from the historical collection of RCA*

A fire starts miles away from your home, yet you are on the scene in a jiffy—perhaps as fast as the first hook-and-ladder!

This is television reporting—virtually, by any practical measurement, instantaneous—and making all other methods of news coverage seem slow. Behind it are basic research developments from RCA Laboratories.

“Eyes” of the mobile television vans which gather spot news are supersensitive RCA image orthicon television cameras, which “see” in the dimmest light. This sensitivity, since the light at a news event is usually outside human control, is a definite *must*.

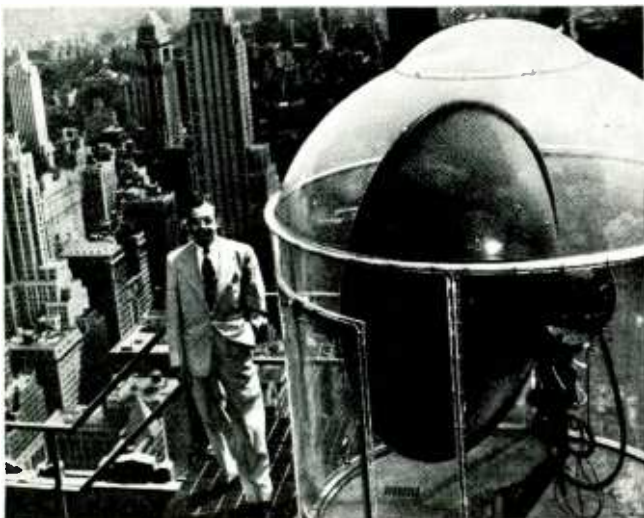

**Bowl-shaped antennas at the parent television station pick up the microwave beam from the remote mobile van.**



**Mobile television van operating “in the field”—note complete camera facilities, and microwave relay apparatus.**

Developed by RCA scientists on principles uncovered by the invention of its parent the *iconoscope*, an image orthicon pick-up tube is essentially three tubes in one. A phototube first converts the visual image into an electron image. This is then “scanned” by the electron beam of a cathode-ray tube—creating a radio signal. An electron multiplier next takes the signal and amplifies its strength for the trip through circuits to the transmitter.

Such compactness is characteristic of every operation inside a mobile television van, and RCA engineers have designed equipment—which might fill entire rooms in a standard studio—to fit the limited space of a truck. Yet every studio facility is present, even monitoring equipment and cameras that can swing quickly from a wide-angle view to a close-up.

Interesting, too, is the technique by which these mobile television vans flash what the camera sees back to the point from which it is telecast. Sharply focussed directional radio beams are used to carry the signal with a minimum loss of power.

More and more, as television spreads across the country, you may expect it to play a larger part in getting news to the public *fast*. And you may expect, from RCA laboratories, developments which will continue to increase the effectiveness of mobile television vans.



**Radio Corporation of America**

WORLD LEADER IN RADIO—FIRST IN TELEVISION

RADIO-ELECTRONICS for



here's what you've been asking for—

# A QUALITY 12-BAND ANTENNA

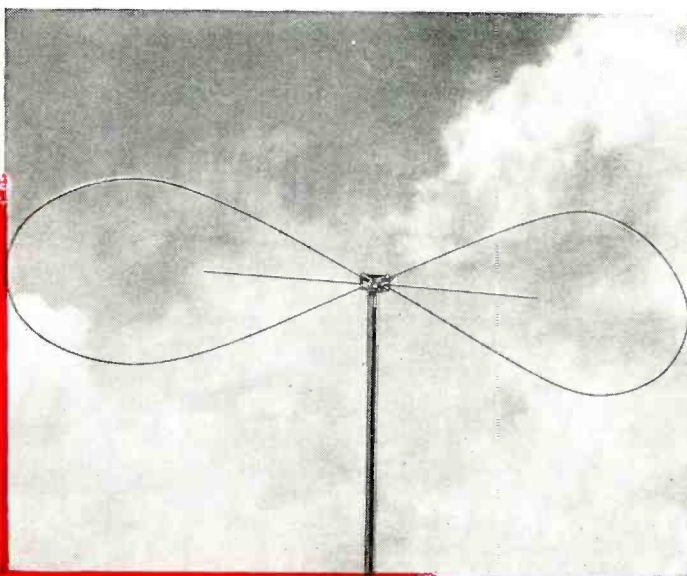

that sells for **\$2<sup>95</sup>** Suggested List

the **ECON-A-RAY**

*Butterfly*

Here is the television antenna you have been asking for — a well-constructed, durable antenna that receives channels 2 through 13 and sells for only \$2.95.

This antenna is for high signal areas only, but in these areas it will perform as well as any antenna on the market today. It eliminates ghost images, gives you strong, sharp pictures on all channels, and receives FM.

You don't have to worry about weather with the Econ-a-Ray Butterfly. It is constructed from Dural, with Polystyrene and stainless steel fittings, to withstand winds up to 75 mph, and is unaffected by snow, rain or any other weather conditions. It cannot corrode.

The Econ-a-Ray Butterfly will give you good television at the lowest cost possible. Ask your dealer for it today, or write for information. Remember, the Butterfly is a primary antenna only.



## CHECK THESE FEATURES:

Constructed from solid Dural — cannot corrode. Wide band, Hi-Lo antenna for all TV channels and FM. Unitized construction — no assembly necessary. Can be used with 72, 150 or 300 ohm impedance line. Integral high channel dipole for greater efficiency. Low loss — bi-directional.

Dural elements solidly mounted in weatherproof polished Polystyrene.

Perfect for low cost, high quality television in strong signal areas.

Tel-a-Ray manufactures a complete line of fine television antennas, including the now famous Model T, which is bringing television to areas as far away from stations as 200 miles. Write for specification sheets.

**WRITE TODAY FOR COMPLETE DETAILS AND THE NAME OF YOUR DEALER**

*Tel-a-Ray*

"FIRST—BECAUSE THEY LAST"

**ENTERPRISES, INC.**

P. O. BOX 332A • HENDERSON, KY.



# Want To Double Your Pay?



## How To Pass **FCC** **COMMERCIAL** **RADIO OPERATOR** **LICENSE** **EXAMINATIONS**

**GET THIS AMAZING NEW BOOKLET FREE!**

**TELLS HOW —**

**WE GUARANTEE**

**TO TRAIN AND COACH YOU AT HOME  
IN SPARE TIME UNTIL YOU GET**

**YOUR FCC LICENSE**

If you have had any practical experience—Amateur, Army, Navy, Radio repair, or experimenting.

**TELLS HOW —**

**Employers make**

**JOB OFFERS Like These  
to Our Graduates Every Month**

Telegram, April 7, 1950 from Chief Engineer, Broadcast Station, Pa. "Immediate opening for engineer-Ambassador, basic salary \$62.50 . . . real future for right man."

Letter, April 14, 1950 from Chief Engineer, Broadcast Station, Montana. "Immediate opening for engineer-Ambassador, basic salary \$62.50 . . . real future for right man."

Letter, January 30, 1950 from Chief Engineer, Broadcast Station, Tenn. "Have openings for operators. If you have men, please have them contact us."

These are just a few examples of the job offers that come to our office periodically. Some licensed radiomen filled each of these jobs . . . it might have been you!

**HERE'S PROOF FCC LICENSES ARE OFTEN SE-  
CURED IN A FEW HOURS OF STUDY WITH OUR  
Coaching AT HOME in Spare Time.**

Name and Address	License	Hrs. of Training
James A. Gram 11 West Main St., Cuba, New York	1st class telephone	34
Ernest K. Hodson Box 1001, Caldwell, Idaho	1st class telephone	71
Howard J. Kischassay Rt. 2, Box 716, El Cajon, California	2nd class telephone	49
Ralph I. Nichols 510 Elm St., Kerrville, Texas	2nd class telephone	34
Elbert L. Risinger P.O. Box 122, Bedias, Texas	1st class telephone	34
Harry R. Rogers R.R. 6, Lafayette, Ind.	2nd class telegraph	50
	2nd class radio phone	

**CLEVELAND INSTITUTE OF RADIO ELECTRONICS**  
Desk RE-21, 4900 Euclid Bldg., Cleveland 3, Ohio  
Approved for Veteran Training Under G.I. Bill

**TELLS HOW —**

**Our Amazingly Effective  
JOB-FINDING SERVICE  
Helps CIRE Students Get Better Jobs**

Here are a few recent examples of Job-Finding results:

**GETS JOB WITH CAA**

"I have had a half dozen or so offers since I mailed some fifty of the two hundred employment applications your school forwarded me. I accepted a position with the Civil Aeronautics Administration as a Maintenance Technician. Thank you very much for the fine cooperation and help your organization has given me in finding a job in the radio field."

Dale E. Young, 122 Robbins St., Owosso, Mich.

**GETS JOB IN PUBLIC UTILITIES**

"I have secured the position of Radio Technician with the Toledo Edison Company. I want to thank you once more. The help you gave me was much more than would ordinarily be expected—both in obtaining my license and in finding employment."

Norman W. Stokes, Jr., Rt. 11, Box 612, Toledo 7, Ohio

**GETS JOB AS DEVELOPMENT ENGINEER**

"I wish to express my thanks for the Applications-For-Employment you recently prepared for me. I received 3 telephone calls and one letter. As a result I am now employed in a development engineering capacity."

K. E. Forsberg, 26 Soley St., Charlestown, Mass.

**GETS JOB IN BROADCASTING**

"I have accepted a position with KWAD. I secured this position through the help of your Job-Finding Service and I had at least six other offers. I am sincerely under obligation to you."

Fred W. Kincaid, Box 241, Wadena, Minn.

**Your FCC Ticket is always recognized in all  
radio fields as proof of your technical ability**

**OURS IS THE ONLY  
HOME STUDY  
COURSE WHICH  
SUPPLIES FCC-  
TYPE EXAMINA-  
TIONS WITH ALL  
LESSONS AND  
FINAL TESTS.**



**Get All 3 FREE**

**MAIL COUPON NOW**

CLEVELAND INSTITUTE OF RADIO ELECTRONICS  
Desk RE-21—4900 Euclid Bldg., Cleveland 3, Ohio  
(Address to Desk No. to avoid delay)

Approved for Veteran Training Under G.I. Bill

I want to know how I can get my FCC ticket in a minimum of time. Send me your FREE booklet, "How to Pass FCC License Examinations" (does not cover exams for Amateur License), as well as a sample FCC-type exam and the valuable new booklet, "Money-Making FCC License Information."

NAME .....

ADDRESS .....

CITY ..... ZONE ..... STATE .....

Veterans check for enrollment information under G. I. Bill.

RADIO-ELECTRONICS for

# Emergency Receivers

. . . *The Atomic Age necessitates better communications* . . .

By HUGO GERNSBACK

It has been a matter of growing concern to us that the radio set industry—now almost completely taken up with the manufacture of television receivers—has done little to bolster radio reception. It is true that those manufacturers still engaged in making radio receivers have brought out new models; but they are the same receivers, slightly modified, we have had with us for well over a decade.

The atomic age requires entirely different radio receivers. It is surprising that the radio set industry has not seen the light.

The major percentage of radio receivers in this country are located in the large cities. There are in the United States over eleven cities with more than 1,000,000 inhabitants each. The total population of these cities—including their metropolitan sections—probably exceeds 30,000,000 today. These large centers and many other vital manufacturing cities are excessively vulnerable to enemy bombing.

In our personal opinion—as stated on this page in our March 1948, issue—no atom bombs are likely to be used either by us or by Russia. Yet we may feel fairly certain that many of our large cities will be bombed by regulation bombs during the next war, if and when it comes. Every military man seems to feel certain that when such wholesale bombing comes it will be devastating—certainly much worse than it was in England and Germany during World War II.

It does not take an expert to foresee that, when our metropolises are being bombed, communication is vital. It is also certain that many radio stations will remain intact and will be able to operate despite all bombings. This was wartime experience in England and Germany. During alert periods and after bombing, radio's importance to morale is incalculable. One thing that a nervous and jittery population demands during such an emergency is quick information. We know from experience in England and Germany that electric lines and electric power plants suffered considerably from heavy raids. Line-operated radio receivers in the affected districts were put out of commission—often for days. Unless the people had battery sets—which in Europe are far more prevalent than in the United States—no radio information could be received.

It is true that in the United States a few manufacturers have made a.c. receivers equipped with self-charging storage batteries. Unfortunately no radio set manufacturers so far has seen fit to call public attention to the important use of such receivers during emergencies and in wartime. One disadvantage is that such storage-battery receivers are as a rule expensive.

To the best of our knowledge, they have never been mass-produced at a price low enough so that every family could afford such a stand-by emergency unit. It is possible today to manufacture such a receiver at not more than 20% of the normal cost of a midget receiver. We would strongly recommend that radio manufacturers look into this important phase immediately.

While the a.c.-d.c.-battery-type receiver may often prove a godsend to a harassed population during times of stress, such a set still leaves much to be desired. Such radios, unfortunately—even the smallest ones—are still cumbersome and are of not much use if you are bombed out and have to take with you some of the more necessary of your remaining possessions.

What is needed even more is an honest-to-goodness pocket-size radio receiver that can be used, not only during emergencies, but in normal times. *In our opinion any receiver that weighs more than one pound is not a personalized portable.*

In England and Germany there were literally millions of bombed out persons who, unless they found immediate shelter with other families were completely bereft of radio information. It is important that radio set manufacturers bestir themselves vigorously to perfect a low-priced, battery-powered pocket receiver, that will not bulk too much in a man's pocket and which will also fit into a woman's handbag.

As we have pointed out many times on this page there is a tremendous market even in peace times for such a receiver which can be taken along on trips and even used when walking in the streets or on a road. There is no longer any technical difficulty in making such a mini-radio today—it can be mass-produced cheaply by using appliqué (printed) circuits. Batteries would not pose a problem—these receivers would have such a high morale and communications value that continued wartime production of batteries for them would certainly be authorized.

As a measure of utility we advance a new note which to the best of our knowledge has never been proposed for a radio receiver. *During emergencies, particularly at night, a handy source of light is badly needed.* It should be no trick at all to design a pocket radio with a powerful electric bulb installed in the top or bottom. The light would of course work like any flashlight simply by pushing a button on the side. The battery which feeds the receiver would be used for the flashlight. This would make a sensible combination and would be particularly desirable during emergencies.



# THE BIRTH OF A TV PICTURE TUBE



Electron gun mounting section of the picture tube plant.



This automatic stem making equipment seals metal leads into a glass wafer. The electron gun is then welded to these leads.

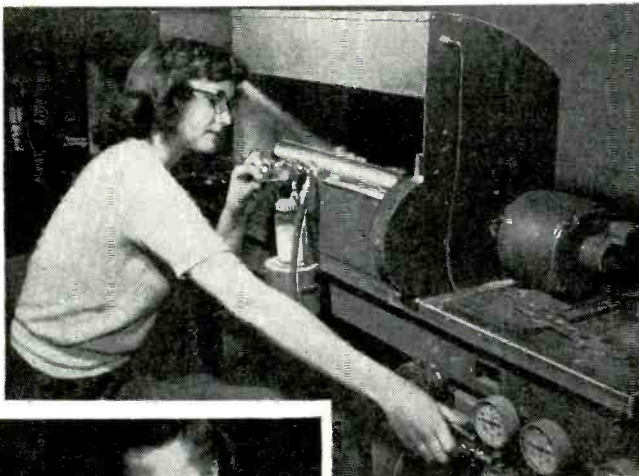

Errissive material is carefully sprayed on the cathodes in the apparatus in the above photo.



The completed electron guns shown in the photo above are being carefully aligned for proper operation. The picture tube bulbs at right are thoroughly washed to prevent contamination of fluorescent material.

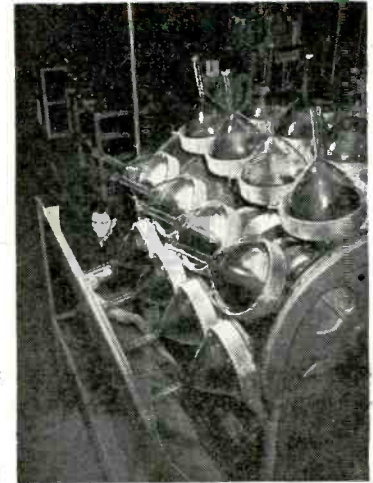

Once the screens are coated, the conveyer above takes them to dry.

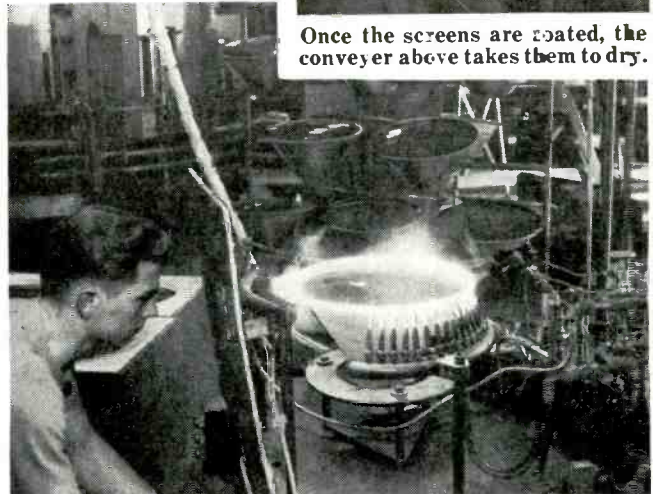

The first step in making a metal television picture tube is sealing the glass faceplate to the tube's metal cone.



The operator above is putting a coat of conductive material on the inside of a large glass picture tube.





After coating and screening, the bulbs go through a high-temperature oven to drive out all organic matter. The operator above takes the bulbs from the conveyer as they emerge from the oven and puts them on the overhead conveyer which takes them on to the next step.

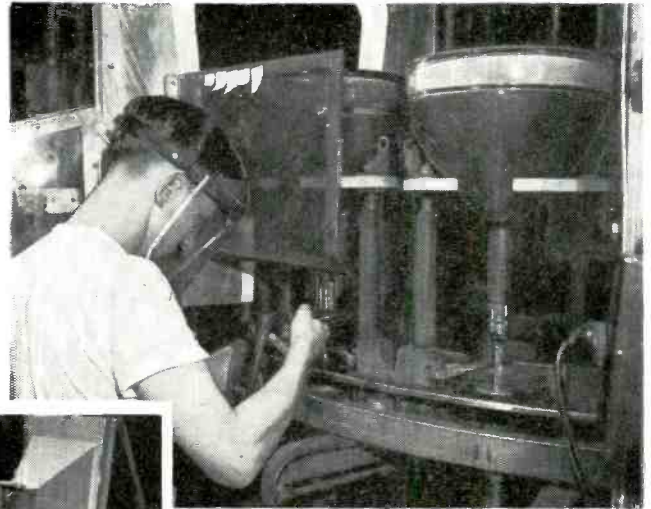

The operator above is sealing the nearly completed picture tube after it has been processed and exhausted. When it is finished, the electrical characteristics of each tube must be checked. The operator in the photo at left puts each tube into a test set where light output, vertical and horizontal scan, focus and many other characteristics are carefully checked with standards.

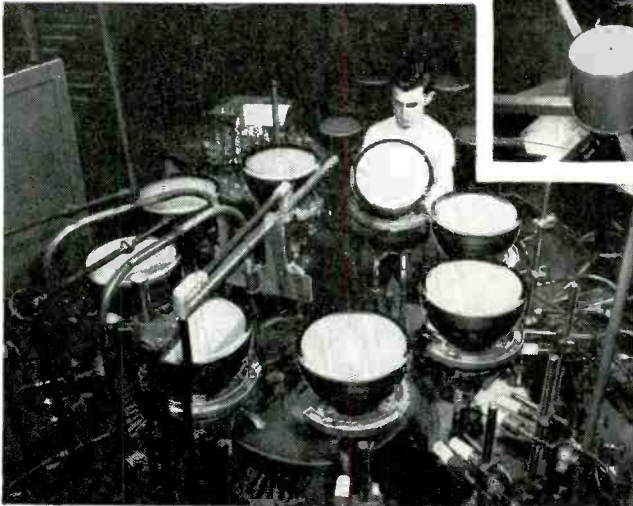

Electron gun mounts and finished glass bulbs are sealed together. The tube is then ready for exhausting and finishing.



Life testing of large TV tubes is a regular practice. These tubes are run day and night under their maximum ratings.

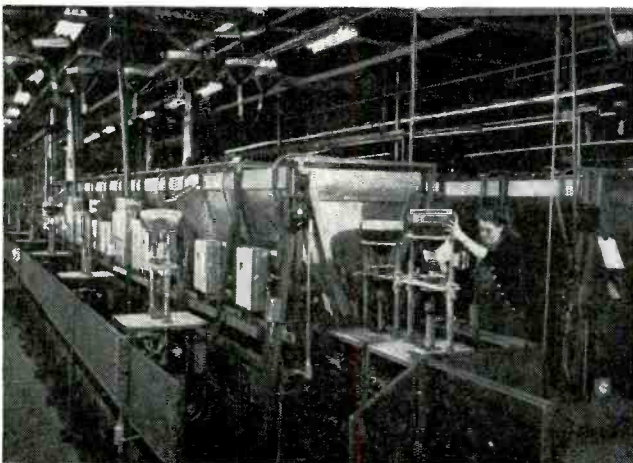

The picture tubes are exhausted, processed, and sealed off in this new equipment designed for high-speed production.  
SEPTEMBER, 1950



Overhead conveyers and other automatic equipment provide a continuous efficient movement of tubes during production.



# Installation Problems of Urban TV Receivers

**A TV installation expert reports on a number of typical problems that are found in crowded metropolitan areas**

By IRA KAMEN

THE wartime slogan "Difficult problems we solve immediately—the impossible take a little longer" represents the standards by which the television consultant in the New York City area must work.

This article is a report of actual problems the author analyzed and solved for various service operations in the greater New York area.

**Problem 1**—Picture on channel 7 had reflections which marred the quality to an objectionable degree. Complete roof surveyed at all practical heights and azimuth bearings.



Fig. 1—A receiving antenna near the transmitter but at a much lower level presented a problem of installation.

**Solution 1**—This location was less than a half mile from the channel 7 transmitting antenna and approximately 750 feet lower than the height of the antenna as indicated in Fig. 1. The antenna survey men said that they held the antenna in the conventional horizontal position while making their rooftop investigation. A new survey was made with a stacked array that was tilted and effectively beamed for channel 7. Fig. 2 shows the antenna in its final position where it selected a ghost-free picture. Fig. 2 shows that with a stacked antenna tilted for direct pickup from channel 7 the signals from the station arrive in phase at the midpoint of the stacked antenna. Reflected signals from the copper flashing of the adjacent roof are first induced into the lower section of the stacked array and then into the upper section so they arrive out of phase at the midpoint of the antenna and tend to cancel or at least are reduced to a low enough level

that they are swamped by the direct signal. The directors on the stacked array make the front-to-side ratio high enough to eliminate side reflections for all practical purposes.

**Problem 2**—Leading ghosts on three TV channels on receivers located near windows facing the three TV transmitters. Location: Macy's department store, fifth floor, New York City.

**Solution 2**—The TV receivers in the store receive their TV signals from an RCA Antenaplex system which provides high-quality TV signals on all six New York channels (Fig. 3). A well-shielded TV receiver connected to television outlets installed near the windows facing the transmitters indicated clean pictures. A TV receiver with insufficient shielding connected to these outlets had leading ghosts on channels 2, 4, and 7. Shielding the receiver front end eliminated the leading ghosts. However it was impractical to shield the receivers on the floor from a sales standpoint, as these receivers are subsequently sold.

In very strong primary signal areas, several thousands microvolts of TV

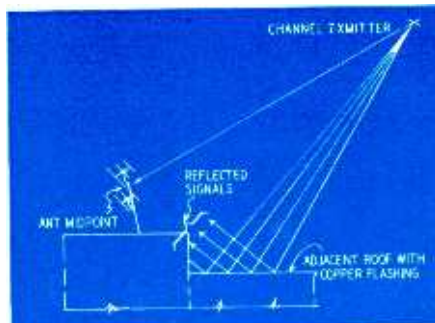

Fig. 2—A stacked Yagi beamed directly at the transmitter antenna helps reduce reflections from an adjacent rooftop.

signal may be induced directly into a receiver front end which has insufficient shielding. This direct signal pickup arrives at the input terminals of the television receiver sooner than the signals which are fed through the coaxial cable of the Antenna system. Since the direct signal arrives first, it

appears on the picture as a leading ghost. The practical solution to this problem was suggested by Morris Gottlieb, a Macy service technician who recommended installing aluminum foil on the wall between the windows and the nearby TV receivers to reject the direct pickup. This aluminum foil shield reduced the direct pickup so it was not visible on a receiver with the most limited shielding (no bottom plate on the front end, input r.f. coil on top

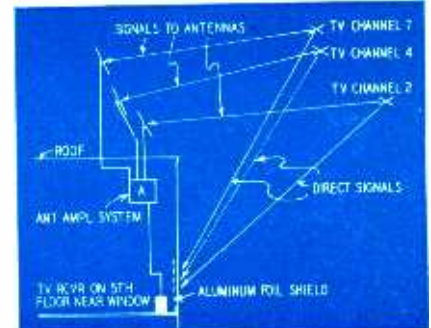

Fig. 3—Direct signals to the receiver may arrive before signals from the antenna and cause leading ghosts if the receiver's shielding is not good enough.

of chassis, 300-ohm input with open twin-lead between the antenna coil and the antenna terminals, etc.).

If direct pickup occurs in an apartment or private home installation within a few miles of the transmitter, there are two solutions. If the direct pickup is only on one channel, install an indoor antenna adjacent to the receiver and connect it to the receiver through an antenna switch. If the direct pickup is on a number of channels, shield the receiver itself. An inexpensive method of shielding the receiver is aluminum foil laid flat under the chassis as a bottom plate or shaped to shield the front end and the r.f. coil from direct pickup. A warning sign that direct pickup is present is a report that better signals are received with an indoor antenna than with an outdoor antenna. Under these circumstances the receiver usually has good pictures with no antenna.

**Problem 3**—Pictures deteriorated

(lacked definition and had ghosts) on channels 4 and 7 in strong primary signal area.

*Solution 3*—This installation was less than a mile from the transmitters



Fig. 4—Circuit for an antenna pad to attenuate a signal that is too strong.

and the service technician had installed an attenuation pad between the antenna and the receiver as shown in Fig. 4 to prevent the receiver from overloading. Reception could not be examined without the pad so a new one with a known quality of resistors was installed and the pictures were excellent. The resistors in the old pad were wire-wound and probably resonated on channels 4 and 7 in such a way that the transmission line was shorted and produced standing waves in the circuit.

There is often no way to determine from an external examination if a resistor is carbon or wire-wound. Use only those resistors with known characteristics in TV pad circuits. Exact pad calculations even with carbon resistors on a steatite form cannot be made because these resistors sometimes change value at least 25 to 35%, but they do make a reasonable match and are satisfactory when adjusted for best results.

*Problem 4*—Combining signals from two antennas located over 200 feet apart into a common coaxial transmission line without impairing the signals

on each antenna.

*Solution 4*—To provide reception on channel 7 for a specific installation a separate antenna was installed for that channel, but the landlord refused to permit another cable to be run down the front of the building. The existing channel-4 antenna had very little channel-7 signal pickup so a Yagi with dipole, director, and reflector was installed to pick up the channel-7 signal in the best location which was 200 feet

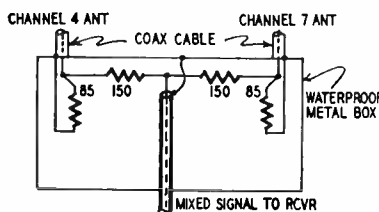

Fig. 5—Hookup for a mixer to combine signals from two different antennas.

from the channel-4 antenna. The channel 7 Yagi had very little channel-4 signal on its terminals.

A separate cable was run to a mixer network, similar to an audio mixer, installed on the roof of the building in a watertight box. This network, shown in Fig. 5, introduces a loss of approximately 12 db which means only one-fourth of the input signal is available at the output of the mixer on each channel. Because of this loss this mixing can be used only if signal strength of more than 5,000 microvolts is available on each channel to be received.

A high-frequency antenna for chan-

nels 7 to 13 can be installed away from the low-frequency antenna and mixed with the signals from the low-frequency elements if a lowpass filter (see Fig. 6) is installed between the low-frequency elements and the mixer network. The lowpass filter traps the high-frequency signals picked up by the low-frequency elements. This filter prevents ghosts caused by the separation of the two antennas which are likely to pick up out-of-phase signals.

In all rooftop mixer network installations, install one antenna at a time and make certain that under no conditions does mixing the signals impair the pictures quality of either antenna.

Often the mixer network can be installed at the receiver input in place of a switch. This is preferable as it eliminates one more step in operating the receiver and the mixer network can be hidden behind the receiver while a switch must be accessible from the front or side of the receiver for easy adjustment.

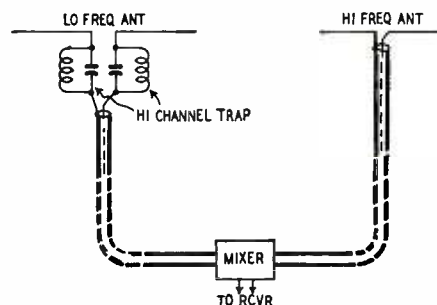

Fig. 6—Circuit showing how to use a lowpass filter to block high-channel signals from the low-channel element.

# STUDENTS DEMONSTRATE TV STATION

By STEVE LAMOREUX

OVER 100 Western radio and TV technicians attended Idaho's first wired television show, held at Idaho State College in Pocatello March 22 through 24. And about 1,500 laymen crowded into the studio.

The college has the only TV station in the state, and it's home-made from war surplus material ("Students Build TV Transmitter," RADIO-ELECTRONICS, May, 1949).

The affair attracted TV men from KDYL in Salt Lake City, Utah; throughout Idaho and Wyoming; and from as far as Los Angeles' KFI. The latter station was represented by Seymour F. Johnson, engineer in charge of TV.

Johnson judged the reception "far better" than the first commercial pictures shown in Los Angeles. "It's remarkable, considering that these students have never seen a TV broadcast," he said.

Definition is 300 lines, roughly about 4 megacycles. Two cameras are operating, both rebuilt from war surplus, except for the image orthicon tubes. One camera uses a 5280 tube, the other a

2P23. Two more, now under construction, will be fitted with 5280's.

The studio has a stage signal system; the control board boasts electronic fading, and has phone connections for four cameras.

Although the aim of the TV course is to produce qualified repair and maintenance men, college heads are eager to use the setup to further education in other fields also. The entire campus is expected to be wired next fall. About 10,000 feet of cable is on hand for the job. Experiments with 600 feet proved successful at the March showing.

Mobile equipment was not ready for the March show, but construction has started and is expected to be completed by the spring of next year.

Visiting engineers were amused when inspecting certain modes of construction. One found fault with the camera dollies: they are mounted on old washing machine casters. Other items not up to par included paint colors, lighting, and safety.

But the course doesn't lack students,

and the faulty items will be remedied by a little time, work, and money.

Next they'll tackle color. They expect to have it by 1952.



A homemade image orthicon camera, one of two at the Idaho State College TV station, being inspected by TV engineer Seymour Johnson, right, of KFI in Los Angeles, and instructor John Walcott.



# Television Service Clinic

Conducted by  
WALTER H. BUCHSBAUM

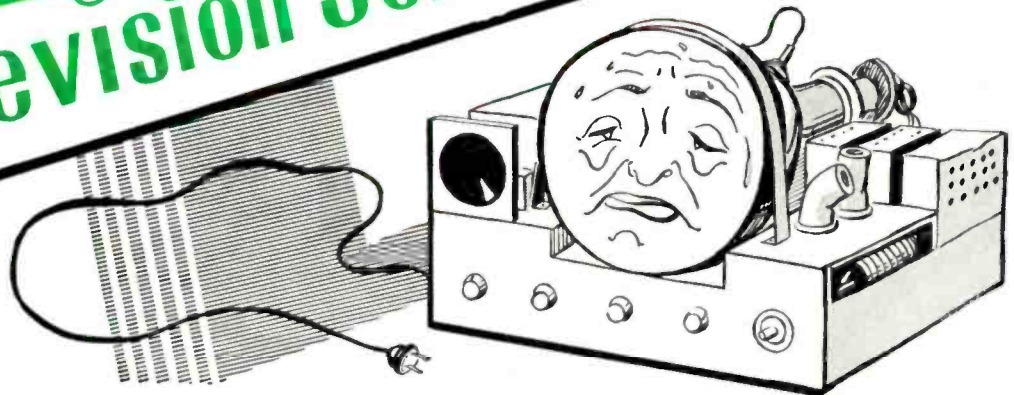

### Narrow picture

My 630 TS receiver, built from a Tech-Master kit, gives good results except that the picture is narrow, having a raster only 8 inches wide on a 12LP4.—J. K., Rochester, N. Y.

The picture may be widened by replacing the flyback transformer with one corresponding to the RCA 211T3. Remove the 6,300-ohm damping resistor and rewire the 6BG6 circuit for the new flyback transformer. If you wish to keep the original RCA 211T1 flyback transformer, replace the 6,300-ohm damping resistor with a 12,000-ohm, 25-watt resistor.

Tech-Master has issued a booklet with special hints for using a 12-inch or larger cathode-ray tube.

### 3-inch conversion

I would like to convert my Pilot television receiver model TV 37 which has a 3-inch tube for a 7-inch tube.—G. W., Corona, L. I.

This cannot be done without an additional high-voltage supply and other major changes which are far too expensive to be worthwhile. A 7-inch tube requires 2,500 to 5,000 volts.

### Modulation hum

All channels have a bad a.c. hum at all volume control settings on a Motorola VT71. The picture is good and changing all the tubes did not help.—J. L. P., Newark, N. J.

This set is an intercarrier type and alignment may be critical. Here are some suggestions. Tune the top and bottom of the ratio detector transformer carefully for minimum hum. Retouch the r.f. oscillator alignment.

If these steps do not help, a complete realignment or filter capacitor check is necessary.

### Post mortem spot

A bright spot about two inches in diameter appears on the picture tube when the set is shut off. The spot then jades out.—F. K., Schenectady, N. Y.

This post mortem spot is not a defect and will not affect the operation

of the set. The appearance of the spot depends on the setting of the brightness control before the set is turned off. To reduce it, turn the brightness control slightly higher than normal before turning off the set.

### Torn picture

Large sections of the picture are torn out and shifted to the right in my Teletone 7-inch table model receiver.—F. L. H., West Hartford, Conn.

This receiver is electrostatically deflected and has a multivibrator as a horizontal sawtooth generator. The multivibrator has no automatic frequency control so that a strong noise pulse tends to tear the picture.

To see if this tearing is due to noise, disconnect the antenna. If the tearing persists check the 6AU6 sync separator for intermittent operation. If replacing this tube does not help, remove the chassis from the cabinet and check the wiring for loose connections or bad solder joints.

If the tearing is due to noise pulses picked up by the antenna, try using a shielded cable for the transmission line.

### Yagi antenna

I would like to increase pickup on channel 5 by using a Yagi type antenna beamed directly toward the transmitter. Please supply data for this antenna.—A. W., Barnesville, Pa.

A Yagi type antenna is shown in Fig. 1. When such an antenna is used in a weak signal area tune the antenna to the video carrier rather than the exact center of each channel. Data for the elements is given in the table. The

distance D in Fig. 1 is in the column under element spacing in the table. The exact element spacing depends on the particular installation and should be adjusted on the spot.

The reflector should be about 9 inches longer than the dipole on channels 2 to 6; 6 inches longer on channels 7 to 9; and 4.5 inches longer on channels 10 to 13.

The director element should be a total of 9 inches shorter than the dipole on channels 2 to 6; 6 inches shorter on channels 7 to 9; and 4.5 inches shorter on channels 10 to 13.

The impedance of this antenna is between 8 and 10 ohms, depending on the spacing of the elements, and it is necessary to match the antenna to the transmission line. The mismatch can be reduced by using a quarter wave stub, the lengths for which are given in the table. No stub is needed to match a 52-ohm line. To match a 75-, 175-, or 300-ohm line, use a section of 52-ohm line.

It is difficult to make a stub which will provide optimum matching between an antenna like this and standard transmission-line impedances. The values given do not produce an ideal match. To step up the impedance of the antenna, place two conductors (having the same diameter as the dipole) in parallel with the dipole so the effect is a three-conductor radiator. This will raise the antenna's impedance nine times. The resulting impedance (72 to 90 ohms) will provide a good match to a 72-ohm line without using a matching stub.

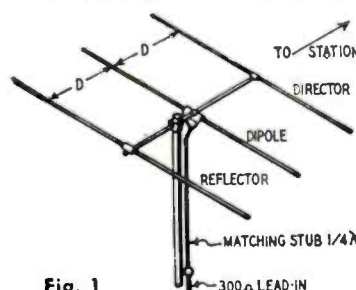

Fig. 1

YAGI ANTENNA DATA				
Chan- nel	Video carrier	Dipole length	Matching stub	Element spacing
2	55.25 mc	100 inches	50 inches	20-30 inches
3	61.25	90	45	18-27
4	67.25	82	41	16.5-24.5
5	77.25	71.5	36	14.5-21.5
6	83.25	66.5	31.75	13.25-20
7	175.25	31	15.5	6.25-9.5
8	181.25	30	15	6-9
9	187.25	29	14.5	5.75-8.75
10	193.25	28	14	5.5-8.5
11	199.25	27	13.5	5.4-8
12	205.25	26	13	5.25-7.75
13	211.25	25.5	12.75	5-7.5

# TELEVISION DX REPORTS

## Summer brings widespread long-distance reception

JUNE was really bustin' out all over, at least on the television frequencies. We've had so many dx reports that, to fit them all in the magazine, we've had to list them in tabular form. Table 1 is a list of all the reports by stations and gives the name of the reporter, the date and approximate time (if reported to us) of the reception, and the

approximate air mileage from transmitter to receiver. Table 2 gives the name of the reporter again, his location, and the type of receiver, booster, and antenna used. Cross reference on these tables gives complete data on each report.

We appreciate these many reports sent in by enthusiastic dx'ers and regret that we cannot include those that

do not give the date of reception as these reports are now being used to study television propagation conditions. When reporting dx—that includes any reception of better than 200 miles—please include the date and time of reception, make and model of the receiver, the type of antenna used, and the make of booster if one is used.

TABLE 1—REPORT OF RECEPTION

STATION	REPORTED BY	TIME RECEIVED	MILE-AGE	STATION	REPORTED BY	TIME RECEIVED	MILE-AGE	STATION	REPORTED BY	TIME RECEIVED	MILE-AGE
KLEE-TV Channel 2 Houston, Tex.	K. D. Anderson	8/11, evening 6/19, 6 pm 6/20, noon 8/23, noon	1,000	WDSU-TV Channel 6 New Orleans, La.	Miss G. Miller	6/18	900	WMBR-TV Channel 4 Jacksonville, Fla.	J. J. Meyer	6/18, 4-6 pm	1,300
	Mrs. A. Shivel	8/23, noon	900		WDTV Channel 3 Pittsburgh, Pa.	K. D. Anderson	6/22		800	WMCT Channel 4 Memphis, Tenn.	K. D. Anderson H. Steward
	K. Peterson	6/23, evening	950	WFBM-TV Channel 6 Indianapolis, Ind.		K. D. Anderson W. A. J. Dean E. Schultz D. Kalman	6/23	550	WNBT Channel 4 New York, N. Y.		K. D. Anderson
	J. L. McCoy	6/21, 6.25 pm	1,000		WNBW Channel 4 Washington, D. C.		R. G. McCurdy, Jr.	6/18, night		950	
	T. C. Shilleman	6/14-6/21	1,000					WOAI-TV Channel 4 San Antonio, Tex.	W. L. Norton	6/19, 4.30- 5.30 pm	900
	C. Miller	6/19	900		WPTZ Channel 3 Philadelphia, Pa.		G. Sandstedt V. Johnson			6/23, 10 am- 1 pm	830 1,180
	W. A. J. Dean	6/18	1,000	WSAZ-TV Channel 5 Huntington, W. Va.		K. D. Anderson		6/22	750		
	J. A. Biggs	6/19-6/19	1,000		WSYR-TV Channel 5 Syracuse, N. Y.		K. D. Anderson K. B. Larkham	6/22 6/16	900 1,100		
	H. Steward	6/19, 6.30- 7.30 pm	1,400	WKY-TV Channel 4 Oklahoma City, Okla.		S. Thayer G. Pigden C. Miller H. Steward D. Shuirman I. L. Lee		6/24 6/22, 1.20 pm 6/19 6/16, 7-9 pm 6/16, night 6/19	950 1,200 650 1,200 800 600		
	H. Gerischer	6/18, 5.15- 7.20 pm	1,400		WLW-C Channel 3 Columbus, O.		V. Johnson	6/19	850	WTCN-TV Channel 4 Minneapolis, Minn.	H. J. Duncan I. L. Lee E. Sander
	Miss G. Miller	6/18	1,300	WLW-T Channel 4 Cincinnati, O.		D. Shuirman		6/19, night	300		
	D. Kalman	6/19, 9.30- 10 pm	1,000		WMAR-TV Channel 2 Baltimore, Md.		K. D. Anderson G. Sandstedt	6/12, 6/22, 6/23	930	WWJ-TV Channel 4 Detroit, Mich.	K. D. Anderson
E. Schultz	6/19, 9 pm	920	WJBC-TV Channel 2 Detroit, Mich.	K. D. Anderson G. Sandstedt V. Johnson		6/19, 2-3 pm 6/20, noon 6/22, noon 6/23, 10 am- 1 pm		600 1,000			
W. L. Norton	6/19, 4.30 pm	750			WJBC-TV Channel 2 Detroit, Mich.	G. Sandstedt V. Johnson	6/19, night	1,000			
J. J. Meyer	6/18, 4-6 pm	980	WBY-TV Channel 2 Greensboro, N. C.	K. D. Anderson T. C. Shilleman			6/21, noon 6/14-6/21	900 820			
G. Pigden	6/22, 1.15 pm	1,300			WJBC-TV Channel 2 Detroit, Mich.	K. D. Anderson	6/19, 2-3 pm 6/20, noon 6/22, noon 6/23, 10 am- 1 pm	500 600 1,000			
C. Miller	6/19	700	WJBC-TV Channel 2 Detroit, Mich.	G. Sandstedt V. Johnson			6/19, night	1,000			
W. L. Norton	6/19, 4.30 pm	700			WJBC-TV Channel 2 Detroit, Mich.	G. Sandstedt V. Johnson	6/19, night	1,000			
A. M. Habernal	6/23	1,300	WJBC-TV Channel 2 Detroit, Mich.	G. Sandstedt V. Johnson			6/19, night	1,000			
K. D. Anderson	6/22, noon	1,000			WJBC-TV Channel 2 Detroit, Mich.	G. Sandstedt V. Johnson	6/19, night	1,000			
K. D. Anderson	6/22, noon	750	WJBC-TV Channel 2 Detroit, Mich.	G. Sandstedt V. Johnson			6/19, night	1,000			
K. D. Anderson	6/11, 7 pm 6/19, 2-3 pm 6/21, 6/22 6/18, 6.30- 9 pm	920			WJBC-TV Channel 2 Detroit, Mich.	G. Sandstedt V. Johnson	6/19, night	1,000			
H. Gerischer	6/18, 4-6 pm 6/16	900 850	WJBC-TV Channel 2 Detroit, Mich.	G. Sandstedt V. Johnson			6/19, night	1,000			
J. J. Meyer	6/18, 4-6 pm	900			WJBC-TV Channel 2 Detroit, Mich.	G. Sandstedt V. Johnson	6/19, night	1,000			
K. B. Larkham	6/16	850	WJBC-TV Channel 2 Detroit, Mich.	G. Sandstedt V. Johnson			6/19, night	1,000			
K. D. Anderson	6/15, noon 6/20, noon 6/23, 10 am- 1 pm	1,000			WJBC-TV Channel 2 Detroit, Mich.	G. Sandstedt V. Johnson	6/19, night	1,000			
G. Sandstedt	6/23, 10 am- 1 pm	1,000	WJBC-TV Channel 2 Detroit, Mich.	G. Sandstedt V. Johnson			6/19, night	1,000			
J. Donnelly	6/24	800			WJBC-TV Channel 2 Detroit, Mich.	G. Sandstedt V. Johnson	6/19, night	1,000			
S. Thayer	6/24	600	WJBC-TV Channel 2 Detroit, Mich.	G. Sandstedt V. Johnson			6/19, night	1,000			
K. B. Larkham	6/16	300			WJBC-TV Channel 2 Detroit, Mich.	G. Sandstedt V. Johnson	6/19, night	1,000			

TABLE 2—RECEIVER DATA

NAME	LOCATION	RECEIVER	BOOST-ER	ANTENNA	NAME	LOCATION	RECEIVER	BOOST-ER	ANTENNA
K. D. Anderson J. A. Biggs W. A. J. Dean	Kerkhoven, Minn. Utica, Ill. Chicago, Ill.	Emerson 647 Hallicrafter Admiral 26X46	Masco Anchor Astatic	Taco Lazy H 2-bay conical Amphenol 2-bay stacked 2-bay conical	J. J. Meyer C. Miller Miss G. Miller W. L. Norton K. Peterson G. Pigden	Benson, Minn. Worthington, Ky. Aima, Wis. Albany, Ind. Rockford, Ill. Madoc, Ontario	Aircastle Sparton Admiral 24A125 Hallicrafter RCA	Jerrold Telekit Bud Anchor	stacked conical Taco stacked array Ward stacked array
J. Donnelly H. J. Duncan H. Gerischer A. M. Habernal V. Johnson D. Kalman K. B. Larkham I. L. Lee J. L. McCoy R. G. McCurdy, Jr.	Lounsbury, N. Y. Dalton, Ga. Slayton, Minn. Kansas City, Mo. Dallas, Texas Akron, Ohio Blackwell, Okla. Henegar, Ala. Milwaukee, Wis. Manhattan, Kan.	Zenith Admiral 24X16 RCA Admiral Admiral Capehart 661P Sentinal TV406 G-E 810 Bendix 235M1	Astatic Regency	folded dipole stacked conical Amphenol 2-bay dipole Amphenol stacked dipole	G. Sandstedt E. Schultz T. C. Shilleman Mrs. A. Shivel D. Shuirman E. Sonder H. Steward S. Thayer	Kansas City, Mo. Racine, Wis. Sturtevant, Wis. Dayton, Ohio Flint, Mich. Milton, Pa. Erie, Pa. New Florence, Pa.	RCA 630 Tele-King Admiral Emerson Radio Craftman Admiral 30A1	Regency Anchor Masco Bud	double-stacked folded dipole circular homemade circular Telrex stacked array Lazy H single dipole



# Radio-Electronics in the Home

## Remote Relay Takes First Prize

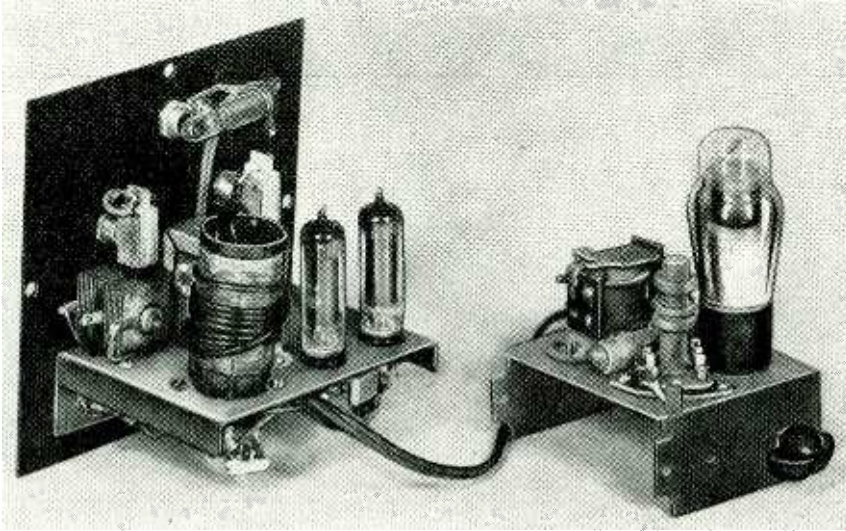

Photo of the transmitter (left) and receiver of the carrier-current relay.

**T**HE low number of entries to the Radio-Electronics in the Home contest has compelled the editors to limit the awards this month to two. Response to the contest might seem to indicate that the Edisonian spirit is lacking in this period, when some people believe too many things have been invented already.

Every reader of RADIO-ELECTRONICS surely has some little job around the house which is disagreeable, time-consuming, or inconvenient. Can it be done by electronics? Try it: if it can, it's worth entering in the contest. The idea itself needn't be new, as past winners show—only its application in the home must in some way be novel.

### FIRST PRIZE

#### Carrier-Current Relay

The first prize went to Edwin Bohr of Chattanooga, Tenn., whose entry is a carrier-current relay. The relay consisting of two units, a transmitter and a receiver, is particularly useful for remote switching in installations where

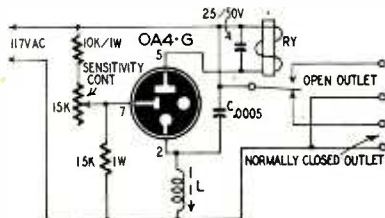

Fig. 1—Schematic of the r.f. switch.

it is not practical to run a length of wire. Switching is reliable up to 500 feet.

Originally the carrier-current-operated switch was built to control a home ventilation fan from a convenient

location by feeding r.f. into the a.c. line whenever operation of the fan was desired. The r.f. triggered an OA4-G cold-cathode gas triode that operated the fan switch. As long as the transmitter fed r.f. into the line the fan remained running. When the r.f. was removed, the fan switch opened and operation ceased.

Later the transmitter was modified so its output could be switched between two frequencies permitting independent operation of two OA4 switches. One switch was used to raise a balanced barn door and the other operated its lowering motor. The two motors were  $\frac{1}{8}$  horsepower each, the door being rather large. A neighbor contemplates using two of these switches to steer an electric lawn mower he now has under construction.

The circuit of the remote control switch is shown in Fig. 1. When the transmitter is tuned to the resonant frequency of the receiver L-C circuit, the potential between the cathode and starter electrode increases, the tube is triggered, and the relay closes. Outlets on the receiver box provide control voltages with the relay either open or closed. Exciting the receiver then turns either on or off any appliance plugged into the receiver switch, depending upon which receptacle is used.

A radio frequency of about 430 kc was chosen for the L-C circuit. L is the secondary of an adjustable-iron-core antenna coil; the adjustable slug is used for tuning. The capacitor C is marked 500  $\mu\text{f}$ ; but if two switches are to be used on different frequencies, it would be well to make C 450  $\mu\text{f}$  for one receiver and 600  $\mu\text{f}$  for the other, allowing them to be tuned further apart. Any number of these OA4-G

switches tuned to the same frequency may be used simultaneously to operate several devices or they may be tuned to different frequencies for independent operation.

The transmitter (Fig. 2) can control two switches separately. Two switches on the front panel, when depressed, supply two different radio frequencies to the a.c. line. The center-tapped transmitter plate coil consists of 120 turns of No. 32 enameled wire close-wound on a  $1\frac{1}{4}$ -inch coil form, and the output coupling coil to the line is eight turns of ordinary plastic hookup wire. The number of output turns is not critical unless the last ounce of power is necessary, in which case the number of turns should be varied for best loading.

### SECOND PRIZE

#### Fire-Intruder Alarm

The second prize for this month was awarded to Edwin M. Macleod of Takoma Park, Md., whose entry is a duplex fire-intruder alarm.

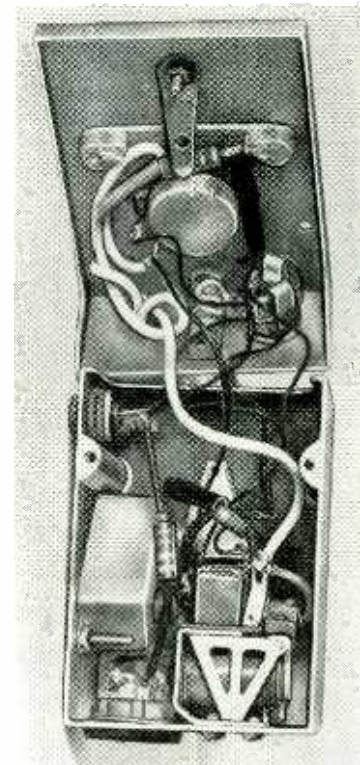

Photo of the fire-intruder alarm unit.

The unit, which appears in Fig. 3, is a gaseous-discharge relay tube that operates an alarm bell when the alarm circuit is broken. For fire warning, the alarm circuit consists of low-melting-point alloy installed in the basement,





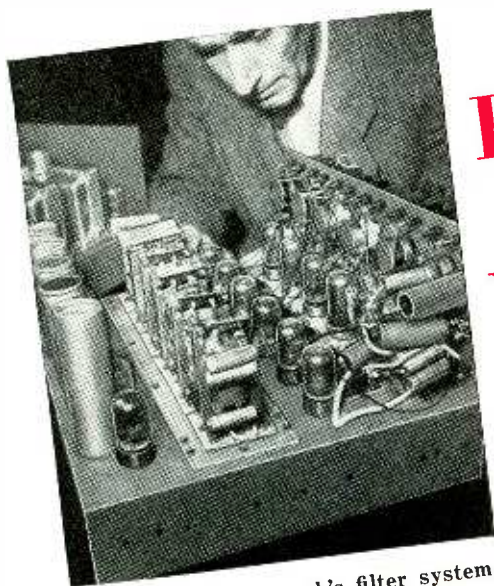

Fig. 1—The Sonograph's filter system.

**T**HE Sonograph is illustrated in Figs. 1 and 2. Its principle is fairly simple. It divides human speech into a number of frequencies by a series of filters (Fig. 1), and the output of each filter is fed to one of the cylindrical solenoids shown in Fig. 2. Magnetic shafts extend into the solenoids. The outside end of each shaft is attached to the pen, which traces a line on the moving cylinder. As each solenoid pulls the pen toward it, the pen traces a line in that direction. The final character drawn is the resultant of all the pulls—all the sounds at different frequencies—passed from the microphone through the filter system to the solenoids.

So far, the Sonograph sounds familiar. All this has been done before—for example in the Bell Laboratories Visible Speech, described in this magazine in January, 1946. But this apparatus introduces a couple of new principles. First, since it is the human voice we want to reproduce, the filters are made to reproduce the frequencies most commonly found in human speech. In an article written for *Bulletin Technique PTT*, a publication of the Swiss postal, telegraph, and telephone administration, I pointed out: "The vocal cords vibrate at a fundamental frequency . . . between 100 and 400 cycles, depending on whether they belong to a deep-voiced man or a sharp-voiced woman. The mouth acts as an orchestra of several resonators, with frequencies around 200, 500, 1,000, 1,500, 2,000 and 3,000 cycles. These are widely separated from each other. "So, our phonetic wave train is like a concert of six principal sinusoidal waves, among which certain ones are re-enforced at will by the speaker." The Sonograph's

# Electron-Tube Steno Writes In Shorthand

By JEAN DREYFUS-GRAF

**T**HE stenographers' enemy is Jean Dreyfus-Graf, sound engineer of Geneva, Switzerland, and inventor of an electronic machine that listens to a speaker's voice and writes down his speech in readable symbols. Dreyfus-Graf also hopes to make one of his machines operate a special typewriter.

six filters are designed to pass these six principal frequencies. This humanizes the instrument, as compared to other types of sound analyzers which simply split the spectrum into slices without reference to the peculiarities of the human voice. Each of the cyl-

inders responds to one of these main frequencies, making the pen follow the voice.

A second new feature of the Sonograph is that it uses only part of the train of waves which makes up any given sound. Sounds can be divided into three parts: an initial increasing portion, a center part almost uniform in strength, and a falling-off part as the sound finishes. By using only the initial rising and the final falling, a sharp "character" like a letter of the alphabet is formed. Specimens of these "letters" are seen in Fig. 3.

So-called "continuous" sounds are really over-and-over repetitions of the

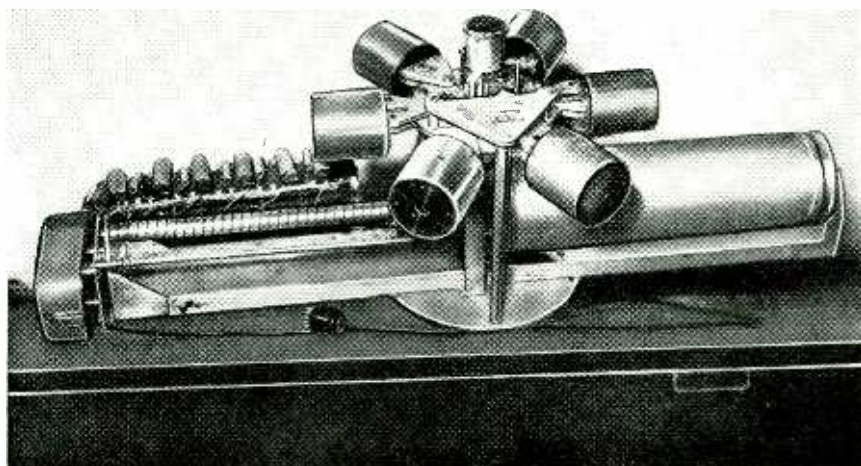

Fig. 2—Photo of the tracing apparatus showing the solenoids mounted on top.

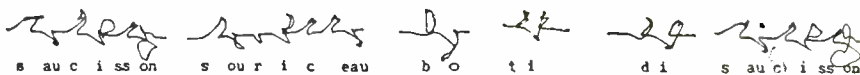

Fig. 3—Some specimens of letters and syllables as written by the Sonograph.



Jean Dreyfus-Graf, the Sonograph's inventor, checks the machine's operation.

same sound elements, as every student of sound who has used an oscillograph knows. Vowel sounds like "o" or "e" appear as a string of similar letters, as do also continuous consonant sounds like "s," "f," and "l." Each element in the continuous sound appears as a separate character.

The system of six selective filters gives us an instrument which pays attention to the human voice and plays down other sounds, making it produce strong signals when actuated by the voice. Selecting only the rising and falling portions of each sound makes the machine produce definite characters of the type people are used to reading, rather than wavy masses of light and shade. These two factors in combination produce a machine which, it is my belief, will be adaptable to practical use as a stenographic instrument.

Of course, the stenographer must learn to read the characters of the

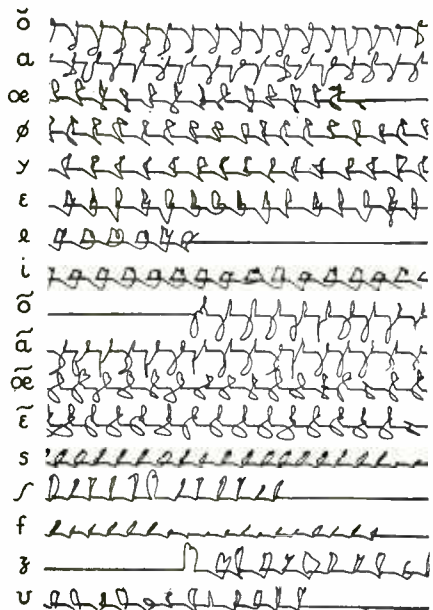

A chart of Sonograph symbols for common speech sounds. Continuous sounds are a series of separate characters.

machine. That should not be harder than learning a shorthand system, and would have the great advantage that the Sono-stenographer could do other work while letters were being dictated.

The Steno-Sonograph, as the machine has been tentatively named, is not yet perfected for general use, though an experimental model has given good results. Meanwhile, a variation now being constructed—the Typo-Sonograph—would make the stenographer unnecessary altogether. Instead of pulling a pen this way and that, the solenoids actuate differential relays in such a way that a typewriter key is depressed for each distinct sound. This system would of course be more useful for languages with a phonetic or near-phonetic alphabet than for English, where one character may represent a half-dozen sounds, and one sound may be represented by several letters or letter combinations.

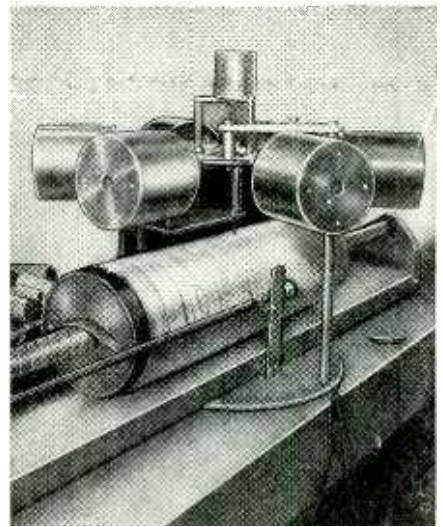

Closeup view of the tracing apparatus.

## ELECTROSTATIC SWITCH

THE feeble energy of a charged comb can be used in this device to operate a relay.

Normally a high resistance is inserted between grid and cathode of a tube to drain away the negative charge which collects on the grid. This drops

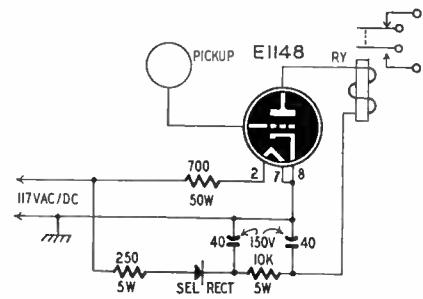

Fig. 1—Electrostatic switch circuit.

the input resistance of the tube to the value of the resistor used, and an appreciable current through the grid return is necessary to get a fair signal voltage at the grid.

If the grid is left floating, and negative signal voltage is applied under proper conditions, the tube will respond even though the voltage is applied through an extremely high resistance such as a layer of air 2 or 3 feet thick.

In Fig. 1, the E1148 (commonly found in the surplus market) is normally conducting, and the plate current of about 4 ma keeps the relay closed. The heater voltage is kept low, about 4.8, to help reduce the grid-cathode conductance. The pickup is a ring of copper wire soldered to the grid cap of the tube. The sensitivity increases with the loop size, but the size is limited by the amount of stray pickup from nearby power lines. It may range from 2 to about 10 inches in diameter.

The tube must be placed as far as possible from the wiring and components. A good plan is to put the parts under the chassis and mount the tube socket on top of a shield can, bolting

this to the top of the chassis. The a.c. line must enter the chassis as far as possible from the tube.

Be sure to connect the ground side of the a.c. line to the chassis or there will be terrific chatter when the pickup loop is mounted.

Leave off the pickup loop for the first tests. Wash the tube well with carbon tetrachloride and wipe it well with paper tissue. Do not handle the glass after this.

Try combing your hair or rub a plastic comb on your clothing and bring it quickly to within a few inches of the tube. The tube should cut off and open the relay. When the grid charge dissipates or the comb is removed, the relay will close. Flicking the grid cap with a brush will charge the tube and the relay will stay open for a few seconds. With the loop in place, sensitivity will be greatly increased and the charged comb will cut the tube off from a distance of 3 feet or so.

A relay requiring up to 12 ma may be used if the heater voltage is increased to 6.3 and the plate supply resistance decreased. A 25-ma relay may be used with the circuit of Fig. 2.

If the device is to be used only as an indicator, the circuit of Fig. 3 is useful. Circuit constants are the same as for Fig. 1. The neon lamp may be a 1/2-watt unit.

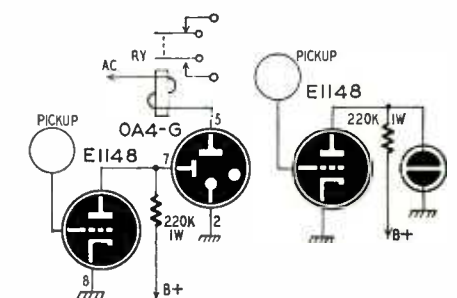
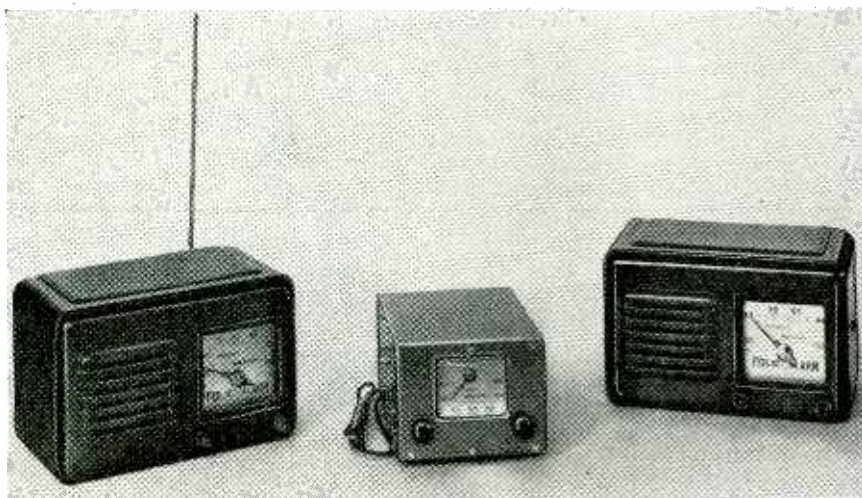

Fig. 2, left—Circuit for 25-ma relay. Fig. 3, right—Hookup for indicator use.



# Radio Set and Service Review



Receivers like these are for commercial, professional, and semi-professional users of the services in the 30-50- and 152-162-megacycle bands.

**W**ITHIN the last five years, the number of users of nonbroadcast radio channels has increased by leaps and bounds. Most of the channel allocations have been in the 30-50- and 152-162-mc bands where the licensee has a choice of using AM or FM telephony. Because of its relative freedom from natural and man-made noises, most stations are designed for FM transmission and reception. Features of FM transmitters and receivers for these bands were described in our June and July, 1950, issues.

Receivers for reception in the 30-50- and 152-162-mc bands are usually expensive sets designed for fixed-frequency operation. Garage operators, volunteer firemen, police agents, newspaper reporters, ambulance services, forest rangers, and many others often need inexpensive receivers designed for monitoring transmissions from fixed and mobile stations.

Four low-cost FM receivers to meet these needs have been developed by the Radio Apparatus Corporation. Polic-Alarm models PR-8 and PR-31

are 5-tube-plus-rectifier FM receivers for the 152-162- and 30-50-mc bands, respectively. Monitoradio models M-101 and M-51 are mobile equivalents of the PR-8 and PR-31, respectively.

In the schematic of the PR-31 (Fig. 1) the antenna is coupled to the antenna coil T1 through a shunt-derived low-pass filter. The converter tube is a 12AT7 with one triode connected as an oscillator and the other as a mixer. This tube is followed by a two-stage, 10.7-mc, i.f. amplifier and a 19T8 ratio detector and first a.f. amplifier. The output and rectifier tubes are 35B5 and 35W4, respectively.

There are minor variations in the circuits of the PR-8 and its low-frequency equivalent, the PR-31. Because of the differences in tuning ranges, the variations are in converter circuit. The front end of the PR-8 is shown in the inset in Fig. 1. An additional bypass capacitor used in the heater string of the PR-8 is connected to the hot side of the 12AT7 heater as shown in broken lines in Fig. 1.

The mobile versions of these receivers are in demand by volunteer firemen,

**Polic-Alarm and Monitoradio are new inexpensive FM receivers designed for use on the 30 to 50- and 152 to 162-megacycle service bands**

foresters, and special police who want to monitor their control and mobile stations while riding in their private cars during off-duty hours. The circuits of the mobile receivers differ from the a.c.-d.c. circuits only in the power supply and selection of tubes for the discriminator and power amplifier. The antenna circuit of the M-101 Monitoradio is almost exactly that of the PR-8. Being designed for use with an 18-inch whip antenna, the 56- $\mu$ f and .005- $\mu$ f capacitors are omitted in the M-101. The coils in these sets are simply U-shaped wires soldered to the tuning capacitors. These may be seen in the left-hand set at the top of the next page and in the top view of the Monitoradio model M-101. The power supply and a.f. output circuits are shown in Fig. 2. An OB2 voltage-regulator tube stabilizes the plate voltage for the 12AT7 converter tube.

The power supply is designed so the set can be operated from 6-volt vehicular storage batteries used in standard automobiles or from the 12-volt batteries used in trucks, small boats, buses, and other special vehicles. Connections for 6-volt operation are shown in the solid lines marked with the letter X. For 12-volt operation, these leads are removed and replaced by leads shown in the broken lines.

Because it is illegal in some localities for an unauthorized person to operate a

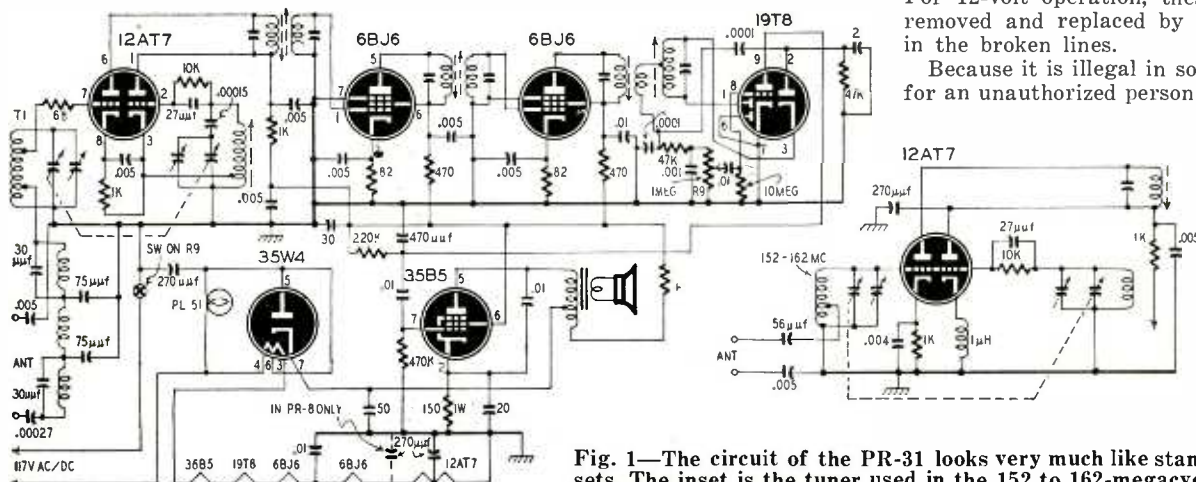
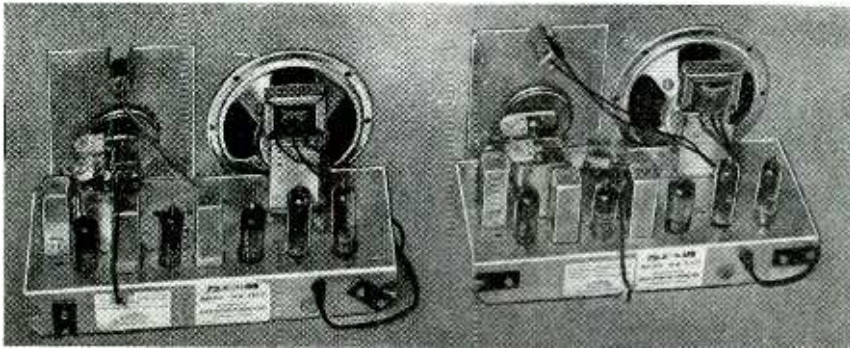

Fig. 1—The circuit of the PR-31 looks very much like standard a.c.-d.c. sets. The inset is the tuner used in the 152 to 162-megacycle receivers.





These sets differ only in the signal circuits. The low-frequency set has conventional type coils, the other has hairpin-type coils on the tuning capacitor gang.

vehicle equipped to receive police radio transmissions, a special muting switch is built into the receiver. This switch, shown connected to one side of the voice coil in Fig. 2, is mounted on the shaft of the tuning control. Its position is adjustable so the speaker is shorted out when the set is tuned to the frequency of a local police station.

**Non-broadcast services**

As of July 1, 1949, most radio services in the 30-50- and 152-162-mc

furnishing communication service for hire between fixed and mobile radio stations on land;

**Industrial Radio Services** covering communications systems operated by manufacturers, constructors, motion-picture companies, forest products, and relay press;

**Public Safety Services** for fire, police, forestry conservation, highway maintenance, and special emergency radio services.

The bands and number of exclusive channels for the most common users of 30-50- and 152-162-mc bands are given in the table. Channels shared with other services are not listed in the table.

**TABLE OF ALLOCATIONS**

SERVICE	30-50-MC CHANNELS	152-162-MC CHANNELS
Railroad Radio	—	41
Taxicabs	—	8
Highway Trucks	7	—
Intercity Bus	16	—
Urban Transit	20	—
Automobile Emergency	1	—
Domestic Public Radio	28	20
Industrial Radio	58	23
Police Radio	96	44
Forestry Conservation	37	6
Highway Maintenance	20	4
Fire	27	14
Maritime Mobile	12	—

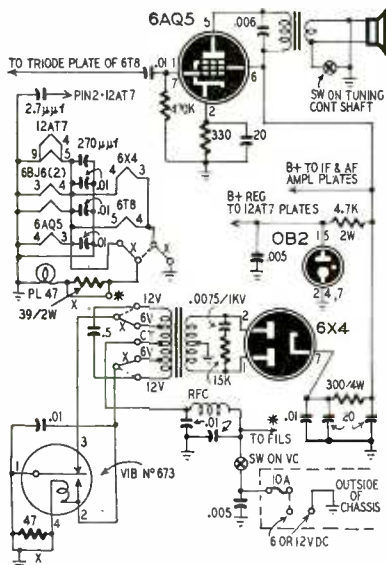
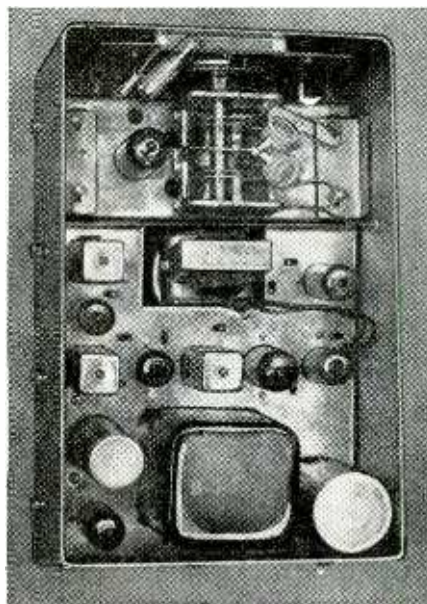

Fig. 2—Power supply and audio output circuits of the Monitorradio model M-101.

bands fall in one of four major categories:

**Land Transportation Radio Service** including taxicab and railroad radio, *Highway Truck Radio Service* for use by persons and organizations regularly operating trucks outside metropolitan areas, *Intercity Bus Radio Service* for common carriers operating on public highways between established city terminals, *Urban Transit Radio Service* for common carriers operating over fixed routes within communities, and *Automobile Emergency Radio Service* used by public garages and organizations or private automobile owners to speed the dispatch of emergency road service;

**Domestic Public Mobile Radio Service,**



Top view of the M-101. Note the hairpin-like coils on the tuning capacitor.

**CODE OF STANDARDS FOR RADIO-TV SERVICE**

A Code of Standards for television dealers and service technicians and a book telling television owners what they should know about the operation and servicing of their sets are the two chief weapons of the Better Business Bureau of New York City in a campaign to stamp out evils in selling and servicing television.

The campaign was initiated at a meeting to which 1,000 television dealers and service organizations had been invited. Representatives of the various groups addressed the meeting. Most applause was given to John Rider, who urged the unqualified adoption of the code as a step in the right direction.

Difficulties between customers and service organizations, according to the BBB, arise because the customer does not receive the service for which he contracts and because he does not always know what to expect from his television receiver.

Part III of the proposed code applies to the advertising, selling, and handling of television service. It prohibits advertising which implies that the service offered is greater than that which is actually included in the contract, forbids the use of such terms as "free" or "gratis" when the offer of an article depends on purchase of other merchandise or services, and provides that no unqualified statement as to the speed of service shall be made. The word "service" is defined in the code, and a number of clauses clarify cost of service (as it varies with tube size, time, etc.), terms of payment, extra charges, availability of service from concerns other than the dealer or a service company designated by him.

An especially interesting clause provides that any concern advertising conversions from small to large tubes must assume responsibility for the performance of the converted set, and for the possible abrogation of the existing service contract.

The television owner is approached by the booklet "Things You Should Know about the Purchase and Servicing of Television Sets" which tells him about good and bad locations, interference, antennas, service contracts and contractors, renewals, and a number of other points. It also points out that it is not necessary to buy a service contract, a fact many television owners seem to be unaware of.

Copies of the booklet are being made available by the Better Business Bureau of New York City at 10 cents each to the general public, and at lower prices to service organizations and dealers for free distribution to their customers. Sample copies of the code will also be sent free to all interested parties. Service technicians will find much food for thought and no small stimulus to action in these two booklets.



# Low-Cost R-C Bridge Features Wide Range



◀ A panel view of the bridge. The dial scale is shown in Fig. 2

EVERY service technician and hobbyist needs equipment to measure wide ranges of capacitance and resistance. The best instruments for this purpose use bridge circuits. This tester includes test features found in higher-priced resistance-capacitance bridges and capacitor leakage testers. Its total cost, about \$25, may be greatly reduced by using surplus parts or components already on hand.

The tester measures capacitance from 10  $\mu\text{f}$  to 700  $\mu\text{f}$  in four ranges; makes leakage tests of oil, paper, and mica capacitors by the relaxation oscillator method and of electrolytics by three ranges of leakage current; measures resistance from 10 ohms to 700 megohms in four ranges; supplies a polarization voltage for testing electrolytic capacitors; and indicates power factor.

The basic circuit is shown in Fig. 1. When the detector indicates a null, the voltage between points 1 and 2 is zero. The voltages across arms A and C are equal, and the voltages across B and D are equal. This can be expressed by the equation:

$$A/B = C/D.$$

A, B, C, and D may be expressed in terms of voltage; or, if A and B are in terms of resistance, C and D may be in terms of capacitive reactance. As capacitance is inversely proportional to reactance, C and D may be expressed in terms of capacitance. The equation can then be used for calibrating the dial.

## Dial calibration

The potentiometer used by the author, a 10,000-ohm, wire-wound, linear-

taper unit with 279° of electrical rotation, is not hard to find in radio parts stores. The dial scale in Fig. 2 is used with the potentiometer to give all the necessary readings. If a potentiometer with a different rotation or taper is used, the builder may calibrate his own dial.

Any point on the dial may be found by using the bridge equation given. Assume that the capacitor at D is 2  $\mu\text{f}$  and the capacitor to be tested at C is 0.5  $\mu\text{f}$ . If the potentiometer is 10,000 ohms, A plus B is 10,000 ohms. From the equation we find that A must equal 8,000 ohms and B 2,000 ohms. If the point of zero rotation is where arm B has zero resistance, then the rotation of the potentiometer is 2,000/10,000 times 279°, or 55.8° at the test point. The points for all the ranges may be calculated the same way.

The complete circuit is shown in Fig. 3. An ordinary electron-ray tube makes a convenient and inexpensive null indicator. A 6E5 or a 2E5 may be used, depending on the filament voltage available, these tubes having a triode section to increase the sensitivity. This also allows maximum sensitivity near the null point and eliminates the need for range switches as voltages larger than the triode's cutoff point have no effect.

The triode section of the tube acts as a grid detector. The a.c. signal across the bridge produces a negative grid voltage. As balance is reached, this voltage decreases and the eye shadow angle opens.

## Power-factor control

The only other continuously variable control (R2, the power factor control) is much easier to calibrate. It indicates deterioration of the dielectric of a

This low-cost, accurate bridge performs as well as many of the commercial types.

By J. W. KORTE

capacitor and shows when an electrolytic is nearing the end of its useful life. Usually a capacitor is rejected if its power-factor reading is greater than 5%. (This actually indicates a 5% drop from a power factor of 1.)

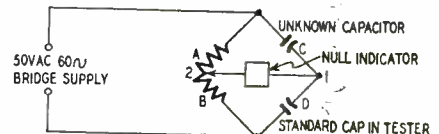

Fig. 1—The capacitance tester is built around this conventional bridge circuit.

If the power-factor reading is greater than zero, the dielectric absorbs some of the charge on the capacitor and the current flow through it has somewhat of a time lag compared with a perfect capacitor. This effect can be simulated by putting a resistance in series with the capacitor. The power-factor control R2 will balance out the dielectric absorption of the capacitor under test. The percentage power factor is indicated for maximum opening of the eye. Table I gives the resistance of this potentiometer for different values of power factor.

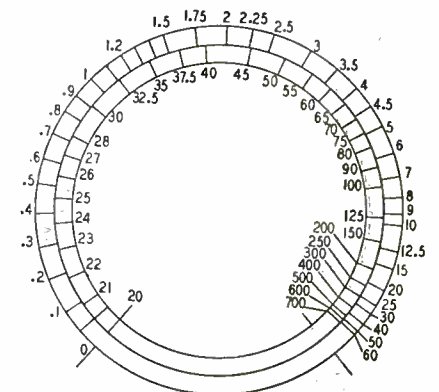

Fig. 2—This dial scale gives all the necessary reading for all four ranges.

The power supply is a conventional halfwave rectifier. A 300-0-300-volt transformer with centertap unused supplies about 800 volts d.c. If voltages other than those shown in Fig. 3 are used, the bleeder resistance should be tapped to supply about 200 volts to the

% Power factor	Resistance of R2 in ohms
0	0
5	66.3
10	133
20	201
30	417
38.3	550
40	578
41.2	600
50	776

electron-ray tube. The 2- $\mu$ f capacitors used by the author were war surplus stock. If the builder cannot find similar units, two 4- $\mu$ f capacitors in series may be used for C4, but C1 should be an oil or paper type.

**Testing leakage**

Leakage tests with this checker are conventional except that additional ranges are used. The neon bulb used as a current indicator for electrolytic capacitors extinguishes on ranges 3 and 4 with leakages of less than 1.4 and 2.5 ma, respectively, and on range 2 it changes from a flash to a glow when the current decreases to 0.2 ma. When electrolytics have been unused for a long time, about 5 minutes should be allowed for the capacitor to form under full test voltage before it is rejected for excess leakage. When used to check oil, paper, and mica capacitors, the relaxation oscillator flashes more slowly for smaller leakages.

The switches used are generally available on the surplus market. S1 is a five-pole, four-position wafer switch with poles 1, 2, and 4 used for resistance, capacitance, and leakage ranges, respectively, while pole 3 is used to switch R3 in the one resistance arm for extended range 4. Pole 5 applies polarizing voltage only on ranges 3 and 4. The three-pole, three-position wafer switch S2 places standard values of resistance and capacitance in the bridge arms and applies polarizing voltages on the capacitance ranges only. S3 is a single-pole, nine-position wafer switch used for the d.c. voltage steps. Table II shows the ranges of S1 for the three settings of S2.

The construction of this tester is neither critical nor complicated. The wiring should be point-to-point to keep stray capacitance as small as possible.

The author used a 6 x 9-inch Masonite panel with a wooden box 5 inches deep. Metal cabinets of similar size are generally available; but if a metal cabinet is used, be careful to keep stray capacitance at a minimum.

High-quality parts with 1% tolerance should be used for C1, C2, C3, R3, R4, R5, and R6. Standard tolerance parts may be used if they are selected with a bridge.

**To test a capacitor**

1. Turn switch S2 to the leakage posi-

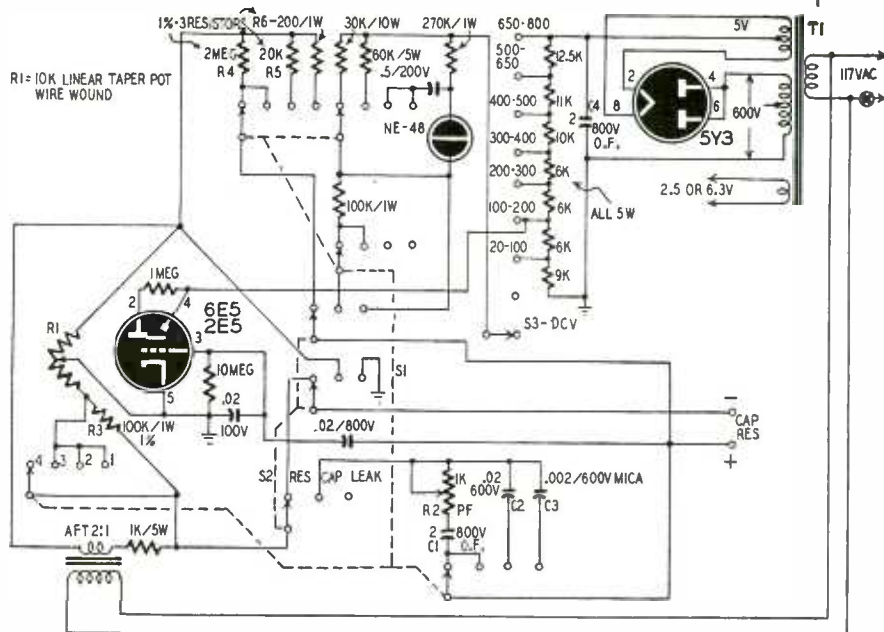

Fig. 3—Circuit of the bridge. The 6E5 triode section acts as a grid detector.

tion, S1 to the range required, S3 to the d.c. voltage rating of the capacitor. 2. Connect the capacitor and note the neon tube indication. If the indication is O.K. according to Table II, proceed with the test.

	1	2	3	4
Res	Rx100 10-5K	Rx10K 1K-500K	Rx1 meg .1-50 meg	Rx 1 meg 20-500 meg
Cap	Cx.0001 10-5,000 $\mu$ muf	Cx.01 .001-0.5 $\mu$ f	Cx1 0.1-50 $\mu$ f	Cx1 20-700 $\mu$ f
Leak	paper under 0.1, 15 sec flash OK	paper over 0.1, 6 sec flash OK	dry elec. ext. at 1.4 ma OK	Wet elec. ext. at 2.5 ma OK

Nos. 1, 2, 3 and 4 refer to S1 setting.

3. Set switch S2 to the capacitance position. S1 to the range required, and, when testing oil, paper, or mica capacitors, S3 to zero voltage. Adjust the main and power-factor controls for maximum opening of the eye tube. If the maximum opening is near the zero end of the dial, switch S1 to the next lower capacitance range; and to the

next higher if the reading is near the high end.

**CAUTION:** D.c. voltages on the test terminals may be high! Always turn S3 to zero volts before handling the capacitor under test.

**To test a resistor**

1. Set S2 to the resistance position and S1 to the range required.
2. Connect the resistor and adjust the main control for a maximum opening of the eye tube. If the eye opens near the zero end of the dial, switch to the next lower range; if it opens near the high end, use the next higher range.

**MATERIALS FOR CAPACITANCE BRIDGE**

**Resistors:** 1—1 megohm, 1/2 watt; 1—100,000, 1—270,000 ohm, 1 watt; 1—1,000, 3—6,000, 1—9,000, 1—10,000, 1—11,000, 1—12,500, 1—60,000 ohm, 5 watt; 1—30,000 ohm, 10 watt; 1—20,000 ohm, 1—2 megohm, 1/2 watt, 1%; 1—200, 1—100,000 ohm, 1 watt, 1%; 1—1,000 ohm, 1—10,000-ohm, wire-wound linear-taper potentiometers.  
**Capacitors:** 1—.0002- $\mu$ f mica; 1—.02- $\mu$ f, 100 volt, 1—.02- $\mu$ f, 600-volt, 1—.02- $\mu$ f, 800-volt paper; 1—0.5- $\mu$ f, 200-volt paper; 2—2- $\mu$ f, 800-volt oil.  
**Transformers:** 1—300-0-300 volt, 5 volt, and 2.5 or 6.3 volt; 1—audio interstage, 2:1 ratio.  
**Miscellaneous:** Tubes, sockets, neon bulb NE48, switches, chassis, hookup wire.

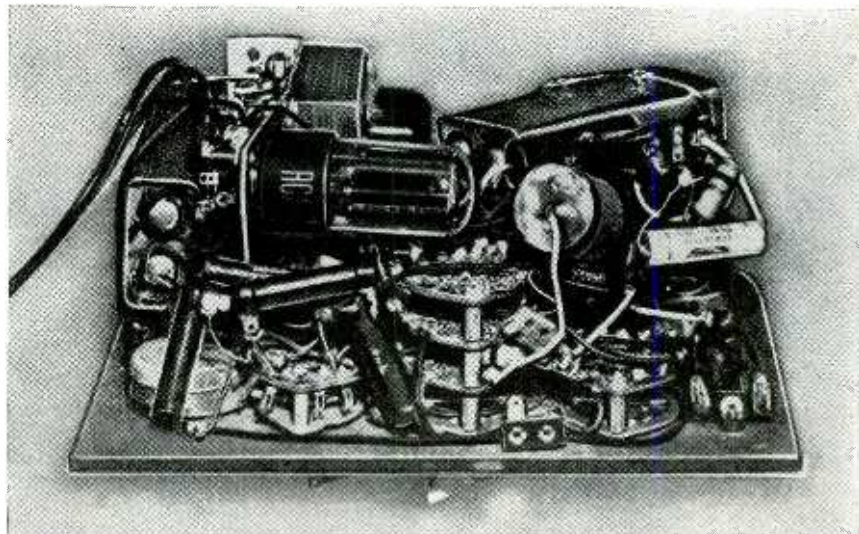

A back-of-the-panel photo. Many of the components are mounted on the switches.



# HANDY TOOL KIT

By H. LEEPER

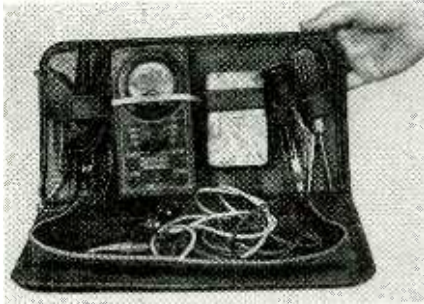

Photo 1. A travel kit case from which the original contents have been removed makes a convenient container for small pieces of test equipment. The kit is easy to carry and is useful for emergency service jobs.

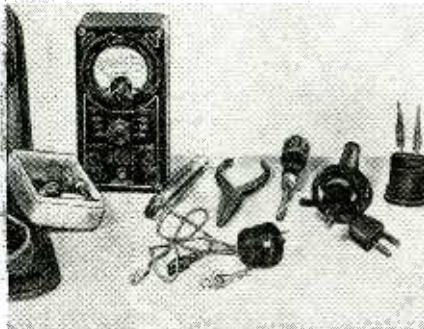

Photo 2. The equipment carried in the case includes a small volt-ohmmeter, a pencil-type soldering iron, small hand tools, a few miscellaneous parts, and an a.c. socket adapted with pin tips.

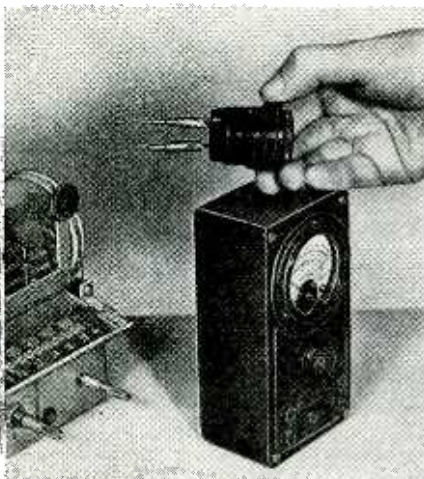

Photo 3. The socket shown in the photo has its regular prongs cut back and pin or phone tips are soldered over the prong ends. The tips are spaced to fit the ohmmeter jacks to speed up certain tests.

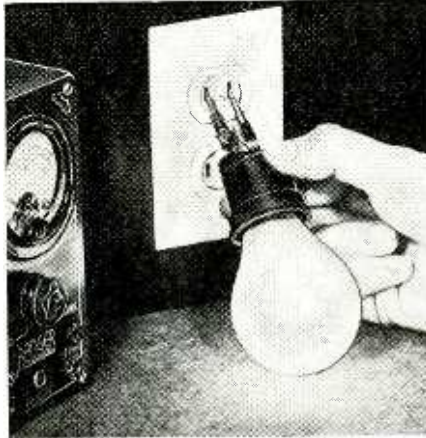

Photo 4. The same socket can be used to test a light bulb. Spread the tips slightly and insert them directly into a wall outlet.

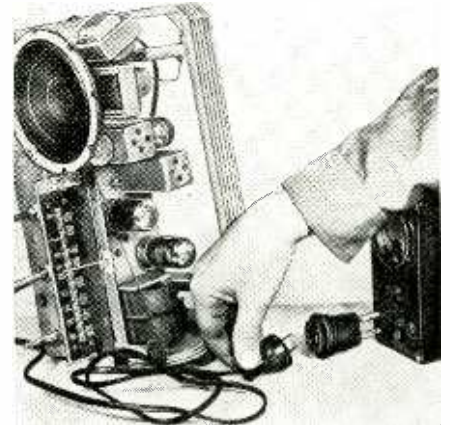

Photo 5. To test the filament circuit of an a.c.-d.c. set, plug the socket into the ohmmeter and the radio's line plug into the socket. Turn the radio switch on.

## New Service Plans for TV

THE television service contract is on the way out. That is what most experts believe. If this is true, it is also true that the contract system will not depart rapidly. Many thousands of television owners have been trained to believe it is the only way to keep their receivers in condition. A large number of service organizations have learned to adapt themselves to the system, and prefer it to the catch-as-catch-can individual job method of doing business.

For the contract has its definite advantages. The customer knows (or believes) he will have his set kept in order for a stated time and a stated sum. Being able to estimate his maintenance costs beforehand, he is more ready to buy a set than he would be if haunted with the possibility of crushingly heavy repair bills.

The contractor receives—in advance—what is supposed to be enough money to handle the servicing and to make a profit. He can estimate roughly the amount of business he will have to prepare for. And he is free from the collection problem. Even on installment-plan service contracts, payments for each month (or other unit of time) is made *in advance*.

Service technicians know exactly how and where the contract system falls short of the above ideals. The disastrous feature of the service contract is that it calls for *unlimited service*. Whether the service company should be called depends only on the judgment

and desires of the customer and the technician must give service till his funds run out, then file with the bankruptcy court.

Another weak feature of the contract is that it often supplies a large sum of money at the beginning of the year to a contractor who may not be enough of a businessman to make it last through the year. A way of doling out the money a month at a time might result in less satisfied customers the first six months of the year, but certainly fewer set owners would be left holding useless contracts from bankrupt service companies.

Several methods have been evolved to reduce the bad effects of the television contract while maintaining some of its advantages. One of the earliest of these was the pay-back plan adopted by Pennsylvania. The customer is given a number of coupons with his contract. He surrenders one to the contractor for each service call made. If any are left at the end of the contract period, he is refunded \$4 for each coupon. In a typical installation the customer might receive five coupons. Thus if he can keep his service calls to four or less, he may make a profit on his transaction. The contractor is not penalized either, for a contract with five \$4 coupons would sell at a price near \$60. This system does not eliminate the "unlimited service" feature, but it does give the customer some incentive to keep down the number of calls.

RADIO-ELECTRONICS for



# Plug-In Adapter For Power Check

By RUFUS P. TURNER

A further advance in the same direction was made by RCA early this year. The new RCA contract calls for installation and unlimited service during the first 90 days. Thereafter the customer pays a fixed rate for each service call. The tubes—including the kinescope—are guaranteed for a year.

The Television Engineering Corporation of Westfield, N. J., has put into effect a plan almost the reverse of Sylvania's. The television contract provides for a low registration fee, which covers installation. A maximum service fee for the year is specified in the contract; it may run from \$30 for a 7-inch table model to \$60 for a large set. Each service call is paid for by the call on a cash basis; if and when the maximum service fee is reached all further calls for the balance of the year are free.

The problem of the contractor who spends all his money during the first part of the year has also been approached. New York's insurance ruling is now famous; a contractor insures himself against the possibility of being unable to complete performance of his contract. Many contractors solve this problem by depositing the year's payment and arranging to have it returned to them in monthly installments.

A New Jersey firm, the Prudential Television Service of Newark, employs a voluntary escrow system in which the contract payment is made directly to the bank instead of the contractor. Prudential's customers—mostly dealers—deposit the contract funds with one of two or three named banks or trust companies, who make the monies available to the service company in monthly installments. Thus company and customer are protected to some extent from premature use of the money.

The insurance approach has been carried to its logical conclusion by another New Jersey firm. Reasoning that if handling second-year contracts is insurance, an insurance company should handle them, the Burlington Fire Insurance Co. of Hackettstown, N. J., has been carrying on an experiment in television service insurance.

Under the plan, the customer takes out a policy. If his set gives trouble, he calls the company (or a service concern designated by the company) for service. The service organization acts as the direct agent of the insurance company, making necessary repairs and reporting directly back to Burlington, who pay for the work on a job basis.

The plan has been tried on a limited scale in a single county, as an experiment. Business is confined entirely to renewal contracts. Definite conclusions cannot be drawn till the end of a working year, but up to the present the plan appears highly successful.

In those areas of the country where the service contract is still dominant, one or another of these plans—or combinations and modification of several—may make that little difference that can turn the contractor's losses into profits.



Photo showing the power check setup.

WITH the simple adapter gadget described in this article the repairman can use his regular a.c.-d.c. voltmeter to measure quickly the watts drawn from the power line by a radio, toaster, or other electrical appliance.

The adapter measuring only 3 inches long, 2 inches wide, and 1½ inch deep, has a line plug, an outlet receptacle, and a pair of jacks for the voltmeter leads. In use, the plug is inserted into a nearby power outlet, the appliance under test is plugged into the outlet receptacle of the adapter, and the voltmeter plugged into the meter jacks. A toggle-type changeover switch in the adapter allows voltage readings to be taken at two points in the circuit, and the wattage is determined from these readings.

Fig. 1 is the complete circuit schematic. Current  $I$  drawn from the power line by the appliance under test must flow through resistor  $R$ . This current flow sets up a voltage drop  $E_1$  equal to  $I \times R$  across the resistor, and this drop is directly proportional to the current. If the voltage drop is measured with a voltmeter, the current through  $R$  may be determined by dividing  $E_1$  (in volts) by  $R$  (in ohms). If the line voltage  $E_2$  also is measured with the voltmeter, the power drawn by the radio or appliance under test may be determined by multiplying  $E_2$  by  $I$ .

These calculations can be eliminated entirely on the job by working out beforehand the wattage corresponding to

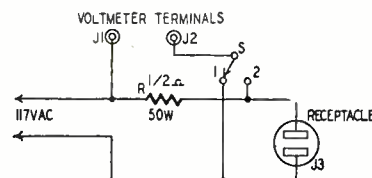

Fig. 1—Schematic of the watts adapter.

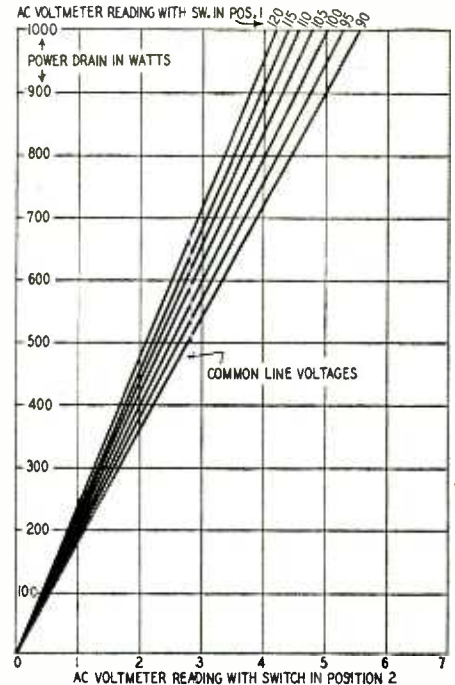
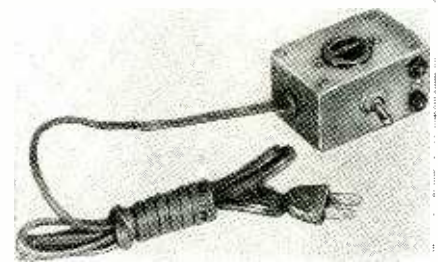

Fig. 2—Calibration curves for adapter.

the voltage drop across  $R$ . This has been done by the author and appears in the table for a line voltage of 115 volts, and in Fig. 2 for common line voltages from 90 to 120 volts.

VOLTS	WATTS	VOLTS	WATTS
0	0	1.6	373
0.1	23	1.7	396
0.2	46	1.8	425
0.3	69	1.9	444
0.4	92	2.0	468
0.5	115	2.1	491
0.6	138	2.2	515
0.7	162	2.3	539
0.8	185	2.4	563
0.9	208	2.5	587
1.0	232	3.0	708
1.1	255	3.5	829
1.2	278	4.0	952
1.3	302	4.5	1080
1.4	325	5.0	1200
1.5	349		

WATTS DRAIN VALUES (115-VOLT LINE)



The watts adapter is a compact unit.



# Fundamentals of Radio Servicing

## Part XIX—Receiver Selectivity

By JOHN T. FRYE

**A** VERY young bird takes a lot of feeding and will swallow practically anything dropped into its gaping mouth. The detector stage described last month is much like this little bird: it requires a lot of signal to keep it going, and it will handle, without discrimination, almost anything fed into it.

But by the time a signal from a broadcast station reaches the receiving antenna it is usually about as strong as high school prom punch; furthermore, two or three dozen broadcast signals may be on the antenna at the

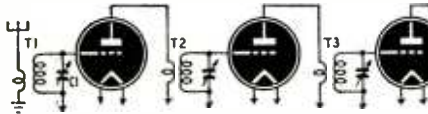

Fig. 1—A skeleton circuit of a tuned radio frequency receiver. Each of the tuned circuits must be adjusted to the frequency of the signal being received.

same time. If all of these signals were dumped into the detector, and if they were strong enough to be detected, a Duke's Mixture of voice, music, and sound effects would come out of the loudspeaker simultaneously.

To avoid such a bedlam, we need a special sort of selective amplifier between the antenna and the detector. Not only must this amplifier be able to build up the strength of received radio-frequency signals as an audio amplifier increases the amplitude of audio signals, but our radio-frequency amplifier must be able to select a particular broadcast signal from among all those present on the antenna and amplify this one signal exclusively, while actually barring the passage of any other than the selected signal from the antenna to the detector.

Fig. 1 reveals a simple way of doing this. It is a skeleton diagram of the basic elements of a tuned radio-frequency amplifier. The antenna circuit is inductively coupled to the grid circuit of the first tube by the air-core radio-frequency transformer T1. The secondary of this transformer is tuned by the variable capacitor C1. The current inductively coupled from the primary of T1 is actually introduced in series with the secondary and the capacitor C1.

A review of the chapter on resonant circuits in the September, 1949, issue of RADIO-ELECTRONICS will show that a series-tuned circuit presents a very low impedance to its resonant frequency and a much higher impedance to all other frequencies. This means that the current in the circuit is much higher at resonance, as is the voltage drop across both the coil and the capacitor. In fact, the drop across either one of these elements is higher than the applied voltage; but at any other frequency than resonance, the voltage appearing across, say the capacitor, is greatly diminished, as shown by the resonance curve of Fig. 2.

This means that the signal voltage applied to the grid of the first tube and the one amplified by that tube will be high *only* for the frequency to which the tuned circuit is resonant. All other signal voltages in the primary will

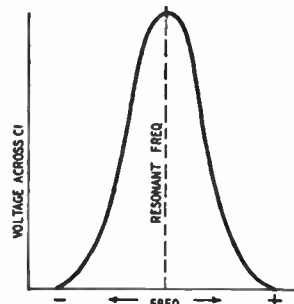

Fig. 2—Frequency response curve of one tuned circuit such as shown in Fig. 1.

either be eliminated from the secondary or be greatly reduced. By varying the capacitance of C1 we can change the frequency to which our circuit is tuned and so select first one and then another broadcast signal to amplify.

### Getting better selectivity

Unfortunately, a single-tuned radio-frequency stage seldom provides either the amplification or the selectivity necessary to receive a weak distant station without interference from a strong local one, especially if the two stations are near each other in frequency. The problem is solved by following the advice Grandma used to give on the subject of keeping warm with petticoats: if one doesn't do the job, use more of 'em! Two or three r.f. amplifier stages

are arranged one after the other as shown in Fig. 1. Thus, each amplifier tube takes up the job of boosting the signal right where the preceding stage left off.

This explains why "cascaded" r.f. stages can be used to get the required amplification, and Fig. 3 shows why the increased number of tuned circuits results in an improvement in selectivity. A band of frequencies of uniform strength is presented to the input of the first r.f. stage. Because of the selective amplification of this stage, the output shows the frequencies 5 kilocycles each side of resonance are only one-half the amplitude of the resonant frequency F. Then, when this amplified signal gets to the next stage, these 5-kilocycles-off-resonance frequencies are again amplified only half as much as the resonant frequency. Thus, since they were only half as strong to begin with, they are reduced to a strength only one-fourth that of the resonant frequency.

All the cascaded r.f. stages must be tuned to exactly the same frequency for most effective action. At first, each variable capacitor was adjusted by a separate dial. This made tuning the receiver too slow and complicated; so the tuning capacitors were "ganged," either by a system of pulleys and belts or by attaching the rotors of the capacitors all to the same shaft.

While this made it possible to keep the various tuned circuits "tracking" fairly close together as the tuning dial was rotated, there were always some discrepancies because it is practically impossible to manufacture identical capacitors and coils in mass production. Even if it were possible, other metal objects near these units would change their characteristics when mounted in a receiver.

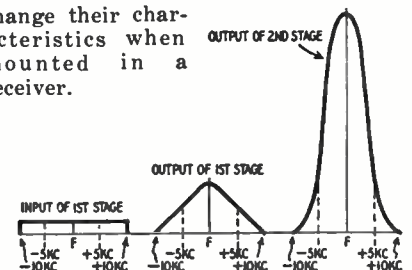

Fig. 3—These curves show how cascaded r.f. stages will increase selectivity.

There are other faults in a tuned radio-frequency amplifier. For one thing, the efficiency of such an amplifier falls off as the frequency goes up and the losses that always accompany a rise in frequency increase. What is more, the selectivity also is variable. At 540 kc an interfering station 10 kc away from the frequency of the desired station has a separation of about 2% of the frequency; but at 1,600 kc, the other end of the broadcast band, this same 10 kc represents little more than one-half of 1%. That means that a tuned radio-frequency amplifier does not do nearly so good a job of separating stations at the high end of the broadcast band as it does at the low. Moreover, a large number of separate variable tuned circuits make a receiver both expensive and bulky.

**The superheterodyne**

A solution to almost all of these problems is to convert any frequency wanted to a single specified low fre-

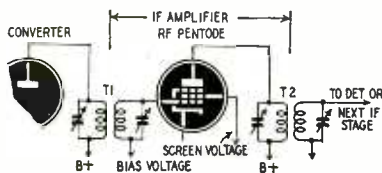

Fig. 4—This is the circuit of a typical intermediate frequency amplifier.

quency and then use a special one-frequency amplifier to do all the amplifying in this one channel. This funneling of all the broadcast frequencies into a single amplifier frequency has many advantages. For one thing, the single frequency can be lower than the lowest broadcast channel, and this low frequency improves both the amplifying efficiency and the selectivity. Since the amplifying is all done at the same frequency, irrespective of the frequency of the broadcast signal being received, this means more uniform selectivity and sensitivity. Bulky and expensive variable tuning capacitors can be replaced with inexpensive and compact semivariable types, and shielding these smaller units is much less of a problem.

The superheterodyne receiver does all this. A single variable-tuned circuit is usually used to lead the desired signal from the antenna into a converter tube. Here the signal is converted to the intermediate frequency—usually in the neighborhood of 455 kilocycles—and then fed into the intermediate-frequency amplifier, which is diagrammed in Fig. 4. At this point, let's not bother our pointed little heads about "how" this frequency-converting trick is accomplished. That will be explained to your complete satisfaction—let us hope—in a subsequent chapter.

You will note that the i.f. amplifier bears some resemblance to the r.f. amplifier; but the difference, as the French deputy said about the differences between the sexes, is important. For one thing, both primary and secondary of the i.f. transformers are tuned. This

gives four tuned circuits for only a single stage of intermediate-frequency amplification. Since we know that tuned circuits are what give an amplifier stage its selectivity, we are not surprised to learn that in most ordinary broadcast receivers a single stage of i.f. provides all the selectivity needed. It provides all the amplification needed, too. The low frequency used, the high efficiency of the transformer, and the high gain of modern radio-frequency pentodes all combine to give us i.f. amplifier stages with gains of 100 and better.

The photo shows how various types of i.f. transformers are constructed. Such transformers consist of two coils, usually mounted some distance apart and provided with screwdriver-adjusting semivariable capacitors for tuning each coil. Ordinarily a metal shield can completely envelope the transformer. Sometimes the coils are tuned by moving pieces of special metal in and out of their fields. In the transformer shown at the lower right of the picture, metal cups of this nature are screwed down over the coils to tune them. In other transformers of this slug-tuned type, slugs of this special metal are screwed in and out of the center of the coils to change their resonant frequencies.

The coupling between the primary and secondary coils—determined by the position and separation of the coils—is of the utmost importance. Fig. 5 shows why. Curve A represents very loose coupling with low current induced in the secondary, a current that peaks sharply at the resonant frequency. As the coupling is tightened, the current increases and the response curve keeps widening out until finally the curve of B is reached. At this critical coupling point, maximum current flows in the

secondary at the resonant frequency. Moving the coils still closer together reduces the current at resonance and increases current at frequencies on either side of the resonant frequency. Curves C and D, respectively, show the progressive double-humping effect of further tightening of the coupling.

This peculiar condition results because, as the coils are moved closer together, the secondary reflects more and more impedance into the primary and this reflected impedance combines with the primary's own impedance to displace the current peaks of the primary to each side of resonance. And because the voltage induced in the secondary is directly related to the current flowing in the primary, similar twin peaks also show up in the secondary response curve.

Obviously if the coupling is too loose, very little signal is transferred from the primary to the secondary. On the other hand, if the coupling is too tight,

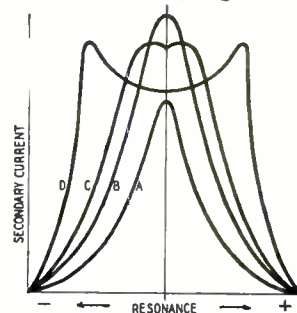
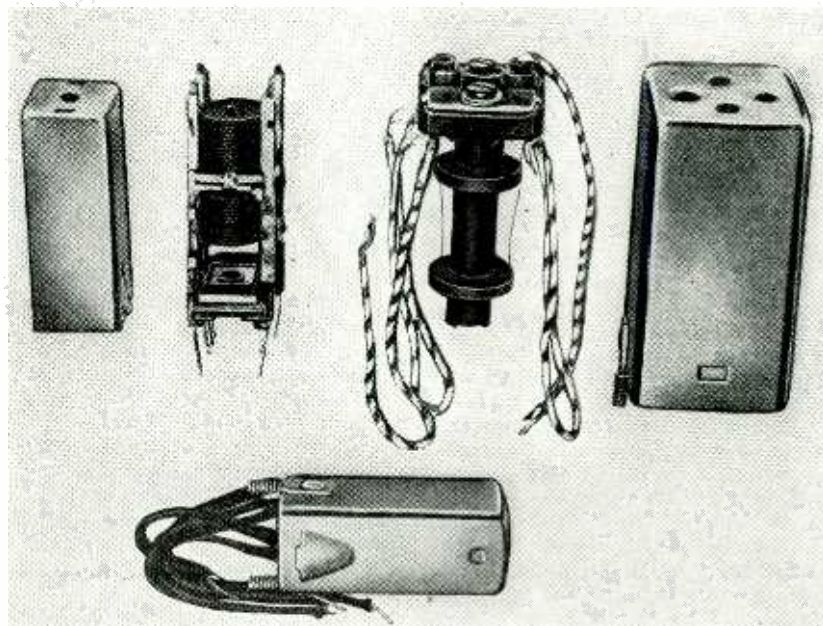

Fig. 5—I.f. transformer bandwidth increases as coupling is increased. Curve A has least coupling, curve D has the most.

the selectivity goes to pot. Critical coupling is ordinarily the best all-around arrangement; however there are cases in which it is necessary to sacrifice maximum signal transfer for



This photo shows three types of i.f. transformers. At right is a trimmer-tuned type; at left is a slug-tuned type; and in the foreground is a midget type.



increased selectivity or deliberately to exceed critical coupling to widen the response curve.

### How much bandwidth?

To understand why the sharpest response curve is not always the most desirable, we must absorb a new fact about the process of modulation: when a radio-frequency carrier is modulated by an audio-frequency note, two new frequencies called "sidebands," are produced, one on either side of the carrier. The frequencies of the sidebands are equal to the carrier frequency *plus* the modulating frequency and the carrier frequency *minus* the modulating frequency. For example, if we have a 1,000-kc carrier modulated with a 1,000-cycle (1-kc) note, the sidebands are at 999 and 1,001 kc. A 5,000-cycle (5-kc) note produces sidebands at 995 and 1,005 kc.

These sidebands must be received without serious distortion or reduction if the modulating information they contain is to come clearly from the speaker. That means that the i.f. amplifying channel must be wide enough to pass them. If only a 1,000-cycle note is used to modulate the carrier, an i.f. amplifier that is 2 kilocycles wide would be sufficient; but when music with high notes up to 5,000 cycles is received, the amplifier must pass a band of frequencies 10 kc wide to avoid distortion.

Various methods are used to widen the response curve of high-fidelity receivers to approach the ideal curve of Fig. 6-a. The curve at 6-b can be achieved by overcoupling, by loading the

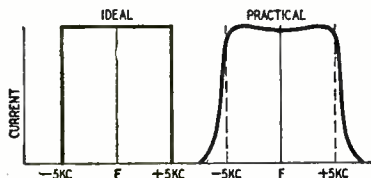

Fig. 6-a, left—An ideal i.f. response curve would have a rectangular shape.

Fig. 6-b, right—Practical curves can be made to resemble the ideal closely.

tuned circuits with resistors, by deliberately resonating the tuned circuits to slightly different frequencies—called "flat-topping"—or by a combination of these methods.

I.f. amplifier troubles, outside of simple misalignment, fall into three broad classes: the stage oscillates; the response cannot be made sharp enough; gain is insufficient. Oscillation usually results from open bypass capacitors in the circuit, from poor shielding between the plate and grid circuits of the tube, or from a defective tube. Broad response results from defects in the windings of the i.f. transformer, such as shorted turns or high resistance, or from the coils having moved too close to each other. Defective windings may also produce low gain, as will windings that have slid too far apart or tuning capacitors that are shorted or defective so that they cannot resonate the associated winding to the proper frequency.

# Publicity Checklist

By DAN VALENTINE

**T**HERE is no magic formula for publicity. It just needs common sense and a little extra effort. Probably no other business needs good, constructive publicity in the newspapers as much as the radio service business.

Adverse publicity over the past decade has caused a lack of public confidence in the radio maintenance field. The best way to regain this all-important public confidence is a program of favorable publicity.

This publicity program is most effective on the local level—when it is directed by *you!*

What is publicity?

When a radio repair shop operator gets his name, the names of his employees, or his firm's name in the *news* columns of the local papers, that's free advertising. To the editors and reporters who write the story, it's news.

Put these two together—free advertising and news—and you have publicity.

"All right," a shop owner will say, "I realize the value of publicity. But how do I get it? I'm a radio repairman, not a reporter. How can I tell what is news and what isn't, what the papers will print and what they won't?"

Having been asked these questions about publicity many times by radio repair shop operators and, having been a working newspaperman for the past decade, I've prepared a publicity checklist outlining some tried and true ways to get—and keep—your name in the newspapers:

**Comment on trade trends.** Never hesitate to comment on the radio repair field. When there are new developments, let the newspapers know. They may quote you in an article—extra publicity for you. Eventually you'll be recognized as the spokesman for the radio repair industry in the area.

**Hobbies and specialties.** Maybe your hobby is collecting antique radio sets. This type of material makes a good newspaper feature. Tell the papers about it. Perhaps one of your employees is a well-known ham who is active in the local disaster group. That's worth a story, too.

**New employees.** Each time you add an employee to the payroll, it's worth a paragraph in the local paper. Type out a few facts about the new worker—name, age, education, where from, position in firm, special training in radio, war record. Send this to the newspapers. These items will probably run only one or two paragraphs, but the name of the firm will be mentioned and the new worker will be officially introduced to the community.

**Building, moving or remodeling.** If you build a new building, add to the

old one, or move to a new location, it's news. Be sure the newspapers have all the facts about the new facilities.

**Trade journal articles.** Has your shop been written up in a trade journal? If it has, let the newspapers know. They'll probably want to reprint part of the article. There is great pride in local business establishments which attract national mention.

**Special window displays.** Never pass up a chance to donate one of your display windows to a worthy cause like the Red Cross, March of Dimes, Boy Scouts, YMCA, etc. It is your duty as a member of the community. It's also good business. If the display is unique, the newspapers will mention it.

**Social affairs.** Do you have an annual dinner dance or banquet for the firm's workers—or a picnic each summer? If you do—and it's good for morale too—it's worth mention in the social pages of the newspaper. Publicity on the social pages is just as good as elsewhere in the paper.

**Anniversaries.** A woman may forget her birthday, but a radio repair shop never. Plan a special celebration—an open house perhaps—to mark each year in business. Stress the occasion in your newspaper ads. It may be worth a short news item, too.

**Special awards.** Radio manufacturers and associations grant special awards in the radio service field. If your firm or one of your workers wins one of these honors, be sure the local papers have all the facts.

**State or national meetings.** If you or one of your workers goes to a national or state meeting of radio technicians, parts show, engineer's meeting or other gathering, let the local papers know.

**Speeches at meetings and conventions.** Are you slated to give a talk before a local, state, or national group of radio technicians? Make an advance copy of your address and leave it at the local newspaper with a release date before you leave town.

**Election to office in trade organization.** If you've been elected to office in a state or national radio group, tell the hometown papers. They'll want to carry the story—and perhaps a picture. Be sure to have an up-to-date picture available at all times.

If you can write these items in newspaper style, you have a better chance to get them into the paper. Study a few short newspaper items and see how it's done, noting especially that in most of them the story is told in the first sentence and elaborated in later ones, so that sentences can be cut from the end without hurting the story. But if you can't write that way, send in the facts! If they're worth while, someone will find time to edit your item.

RADIO-ELECTRONICS 607

# Electronics and Music

## PART III

### Syncing neon tone sources and thyatron generators

THE principal problem in using neon-lamp oscillators as musical tone generators, as discussed in the last article in this series, is that the frequency can be held constant only by adding a synchronizing voltage from another tone source whose frequency is stable. The drawback to that is that with most syncing systems, the sync frequency itself appears in the output of the tone generator being synchronized.

A neon oscillator producing the tone of  $C_{40}$  (Middle C—see frequency chart in the last issue), for instance, synchronized by the injection of a certain amount of  $C_{82}$  an octave above, will show both frequencies in the output.

The use of neon oscillators being very tempting because of their cheapness, the writer tried to eliminate the synchronizing difficulty. The result appears in Fig. 1. No claim of originality is made for the circuit, though its counterpart was not found in any of the hundred or more patents studied.

Three neon-lamp oscillators are shown; they produce the tones  $C_{40}$ ,  $C_{82}$ , and  $C_{64}$ —middle C and the two octaves above it. A synchronizing tone of  $C_{70}$  is provided.

Each oscillator is tuned in the usual way by  $R_3$ , which is comparatively large—1 megohm or so—and  $C_1$ .  $R_4$  is a load resistor of around 10,000 ohms. The sawtooth wave appears across it and is fed to the following stages or keying circuits. The values of  $R_4$  and  $C_2$  (merely a blocking capacitor), as well as the resistance and reactance of

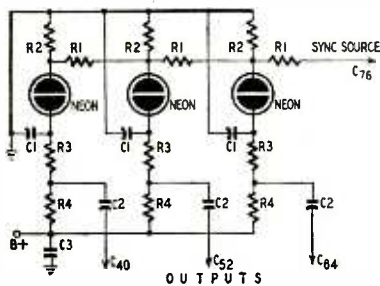
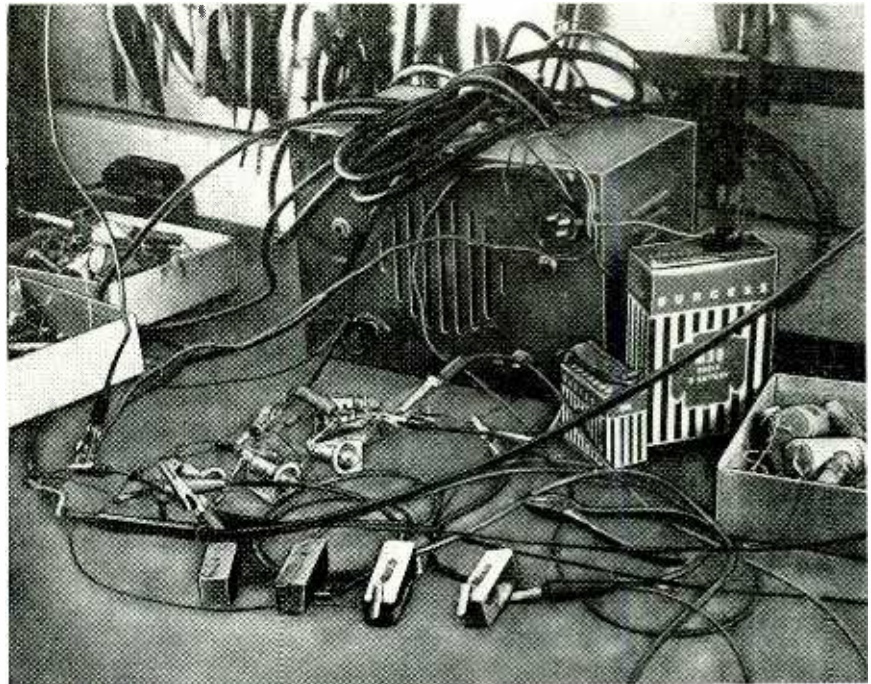

Fig. 1—This method of synchronizing octave strings of neon-lamp oscillators does not permit the synchronizing tone to appear in the audio output signal.



After designing the circuit of Fig. 1 on paper, the author made a haywire assembly job of four sample oscillators. It worked in spite of its crude looks.

the circuit to which the outputs are fed, have some effect on the tuning constants, but if they are not varied too widely during operation, the sync will keep the frequency constant.  $C_3$  is a high-value electrolytic bypass, which prevents coupling between oscillators through the common B-supply. As in all oscillator strings of this type, the impedance of the supply should be extremely low to prevent coupling. Especially at the low-frequency end of the scale, decoupling networks may be used in series with the B-supply to each oscillator, though the writer did not find that necessary.

#### The silent sync

The important component in this circuit is  $R_2$ , across which the sync voltage is fed. The sync source may be the output of any stable tone source whose frequency is twice that of the highest-frequency neon oscillator. As with all gas-tube syncing, best results come when the sync source produces fairly sharp pulses, but a sine wave will do the job almost as well.

The value of  $C_1$  and  $R_3$  are chosen so that the  $C_{64}$  oscillator will produce the correct frequency within a tone or so, without sync. Any exact values given here would not apply for various lamps and B-voltages, but any constructor can find them by experiment in about two minutes.  $R_2$  can have almost any value, as long as it is less than approximately 10% of  $R_3$ , but lower values—10,000 ohms, for example—help in keeping the

sync tone out of the output, though they require a little more sync voltage.

The neon lamp is practically an open circuit when the voltage across it is not

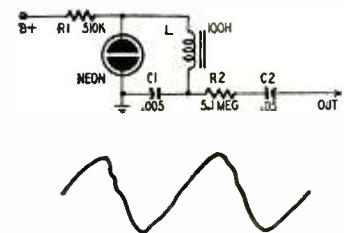

Fig. 2—Many readers will be surprised to see that a nearly sinusoidal wave can be obtained from a neon-lamp oscillator. This is the patented tone circuit.

high enough to ionize the gas. Thus, any sync voltage that appears across  $R_2$  does not reach the  $R_3$ - $R_4$  section of the circuit and the output while the charge on  $C_1$  is building up. When that charge gets near the tube's breakdown voltage, however, a pulse from the sync source provides a little extra voltage and the tube breaks down just when the sync pulse comes. The breakdown, of course, discharges  $C_1$  so that the next sync pulse finds the tube an open circuit and accomplishes nothing. The third sync pulse finds  $C_1$  nearly charged again and again makes the tube break down. And so on.

If the correct values for  $C_1$  and  $R_3$  are used, every other sync pulse "kicks



off" the neon lamp. Those that do not kick it off *are not heard in the output*. As a result only a single frequency appears in the output, equal to one-half that of the sync source.

Any number of consecutive octaves can be synced. The discharge of the  $C_{61}$  neon lamp creates strong pulses across its R2. These are coupled through an R1 to the next lower tube, on which they act as a sync source, and so on down the line. Actually, some amount of all higher octaves appears across each of the lower-frequency R2's; but, because of R1, the predominating frequency is that of the adjacent higher-frequency oscillator. The presence of frequencies several octaves higher

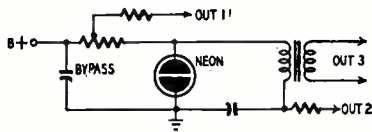

Fig. 3.—Modifying the circuit of Fig. 2 provides three different outputs from a single oscillator, each having a distinctly different quality of tone.

would not impair operation in any case.

Only two adjustments are necessary and they need never be changed. First, each oscillator must be tuned roughly to the correct frequency with C1 and R3 after all connections (including output) have been made, but before R1 is in place. Then, beginning with the path between the main sync source (vacuum-tube oscillator, tuning-fork generator, photoelectric tone wheel, etc.) each R1 should be adjusted in turn. It limits the sync voltage. If too much is applied, the oscillator will lock in at the same frequency or a fifth below the sync. If too little, it will not remain in tune.

After adjusting the R1 between the sync source and the top oscillator, adjust each lower-frequency R1 individually in turn in the same way. Values vary for different neon lamps, frequencies, and B-voltages, but a good tip is to start with a variable resistor of at least 3 megohms, as very little sync voltage is needed. Of course, a full organ range requires 12 strings of oscillators, each similar to that in Fig. 1, and each with as many oscillators as there are octaves in the range.

### Gas-tube sine generator

Ordinarily, the wave-forms obtained from gas-tube relaxation oscillators are either sawtooth (from the capacitor's charge and discharge) or pulsed (from the gas tube's breakdown). It is possible to obtain waves which are almost perfect sines, however, by using an inductor in the circuit.

The inventor of this modification is Dr. Winston E. Kock of Bell Laboratories, who, incidentally is responsible for most of the design of the Baldwin organ, which will be described later in this series. The patent covering the invention is No. 2,046,463, issued in 1936 and assigned to the Baldwin Co., though not used in its organ. Not only

does the inductor produce various waveshapes, but it also has an interesting effect on the frequency stability. This type of oscillator was used to produce vibrato-frequency oscillation in the Thyratone, an instrument designed by the writer, to be described in a later article.

One practical form of the oscillator appears in Fig. 2. R1 and C1 are the usual frequency-controlling elements. If the B-voltage is about 100 volts, the frequency, with the values on the diagram, is somewhere in the vicinity of 100 cycles or less, depending largely on the lamp.

The output is taken across C1. R2 is an isolating resistor and C2 a d.c.-blocking capacitor. In an ordinary neon oscillator, the breakdown of the tube would short the capacitor, which would be connected directly across it. Here, however, a sudden large discharge current through C1 is prevented by L, since an inductance tends to resist sudden changes in current. Instead, C1 is allowed to discharge at a relatively slow rate. The current buildup through an inductor being logarithmic, just as is the voltage buildup across a capacitor, the discharge begins slowly and gradually increases in speed.

During the first part of the oscillation, when the capacitor is charging, the inductor alters the charge curve, rounding it off somewhat. The resulting wave appears in Fig. 2, as drawn by the writer from a scope pattern. It is somewhere between a sine and a triangular wave, with an undulating edge.

### Inductor adds stability

Most relaxation oscillators increase frequency with increased supply voltage. So does the inductive oscillator of Fig. 2—up to a point. After that, increasing voltage has less and less effect on frequency, until a point where varying the voltage has practically no effect at all on frequency. At 200 volts, for example, the circuit of Fig. 2 remains stable at the frequency of middle C, and ordinary supply variations have no appreciable effect. The waveform clears up, too, the undulations disappearing from the leading edge. The frequency, when the supply voltage is high enough to make the oscillator stable, is about the resonant frequency of L and C1.

At least three different waveshapes can be obtained from one of these oscillators, as illustrated in Fig. 3. The sine-wave output can be taken from across the capacitor and a near-sawtooth from a tap on the limiting resistor, both through isolating resistors. If the inductor is made the primary of a transformer, a third output is available from the secondary. All the waveshapes are different and they can be reproduced separately or combined to cause differing tone qualities. The only practical difficulty is to find a transformer whose primary has the correct inductance and a very small ohmic resistance (for reasonably good Q). The writer was unable to find any; possibly

it would have to be made to order. Outputs Nos. 1 and 2 are most practical.

### Thyratron oscillators

The synchronizing difficulty that appears with neon lamps can be avoided entirely by using thyratrons—gas-filled

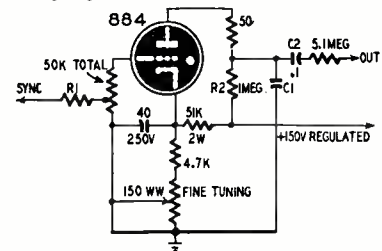

Fig. 4—A thyratron, such as the 884, is more reliable as a relaxation oscillator than a neon lamp but it draws 600 ma filament current. This circuit is used in the author's Thyratone, to be described in a future installment.

triodes such as the 884 and 6Q5.

The circuits are almost exactly the same as those used in time-base oscillators for oscilloscopes. Fig. 4 shows one similar to those used in the writer's Thyratone. The grid is biased by the cathode-resistor arrangement. The 51,000- and 4,700-ohm resistors are a voltage divider across the 150-volt regulated supply. The cathode is around 13 volts positive. The 150-ohm fine-tuning resistor varies the bias to vary the frequency about a half-tone or a little more in either direction. It compensates for the frequency instability caused by the 884's mercury vapor, which changes the breakdown and extinction voltages of the tube somewhat with heat.

The tuning elements are R2 and C1. In a monophonic (single-tone-at-a-time) instrument, it is best to switch in different values for C1 rather than vary R2 for tuning, as the latter varies the voltage output as well as resulting in a kind of chirp—the tone does not come in "on the nose" but slides about a half-tone, making for very sloppy playing. The output is taken through C2, a blocking capacitor, and the 5-megohm isolating resistor.

Synchronizing voltage may be introduced into the grid circuit as shown. The tap on the 50,000-ohm grid resistor and the value of isolating resistor R1 must be chosen by experiment. The amount of sync voltage is rather critical, as with the neon oscillators

Once the 884 has heated for about 10 minutes, its frequency is stable enough to allow its use as a varied- or switched-frequency oscillator for a monophonic instrument. If more than one oscillator is used at a time, however, in an octave-coupled solo instrument or in a polyphonic organ, synchronizing arrangements are essential. The sync frequency should be an octave higher than the oscillator tone, but higher multiples are also permissible, though they make the magnitude of the sync voltage increasingly critical.

The next important type of tone generator is the vacuum or "hard" tube. Circuits for it will be discussed in the next article.

# Two Low-Noise Pickups for Home Constructors

By **BENJAMIN F. MIESSNER**

**D**ESIGN of the pickup needle and its mounting is basically the same for both the r.f. FM or AM capacitance pickup and some commercial magnetic types. This article describes some modifications which can be made to a Clarkstan magnetic pickup to increase its output voltage and reduce its surface noise pickup, and also a capacitance pickup of the type invented by the author. (See RADIO-ELECTRONICS, February 1950, page 50.)

The Clarkstan pickup is especially suitable for modification. It has a tubular magnetic needle supported in the axis of the coil within the bores of a stack of sponge rubber washers which are pressed into the coil spool bore. The top washer having no hole, the needle pivots at this end.

This structure permits the needle tip to vibrate laterally in all directions and it also permits some vertical vibration as forced by the pinch effect. Unfortunately this vertical vibration appears in the output voltage because of the variations in air gap between the top of the needle and the pole faces.

Surface noise of this pickup is lower than some others because of the omnilateral needle vibration, but a central visco elastic pivot would give the needle such a much higher natural vibration frequency it would pick up much less surface noise, and that in a much higher frequency band.

The fundamental frequency of a needle should be much higher than the usual 3,000 to 4,000 c.p.s.—preferably from 10,000 to 15,000 c.p.s. where the noise will be much reduced or not heard at all. In addition, rather strong, if not actual critical, damping should be used to reduce the time constant of any pulse-induced transient vibrations and overhang of resonantly induced vibrations.

## Pickup alterations

The modifications described give the Clarkstan pickup a 20-db increase in signal output which makes it comparable to crystal pickups, a surface noise reduction to about 35 to 40 db below the general signal level (20 db lower than the unmodified pickup), and a fidelity of reproduction that is much better than the original.

Fig. 1 is a detail drawing of the

modified pickup. Both the upper and lower pole edges are filed down to form 90-degree angle tips. This is done on the rear edges of the lower poles and on the front edges of the upper poles.

A new needle is made by rolling a 10-mil thick strip of good magnetic material such as permalvar or permalloy into a tubular form  $\frac{1}{16}$  inch in diameter and  $\frac{1}{16}$  inch longer than the over-all vertical distance between the top faces of the top poles and the bottom faces of the bottom poles.

A single turn of No. 30 copper wire is soldered around this tubular needle, leaving the split at the turn ends aligned with the split in the needle. The jewel tip is cemented in the lower end of the needle.

A washer of soft vinylite, Audiod, or similar visco-elastic material is fastened into the bore of the coil spool with a nonhardening cement. The

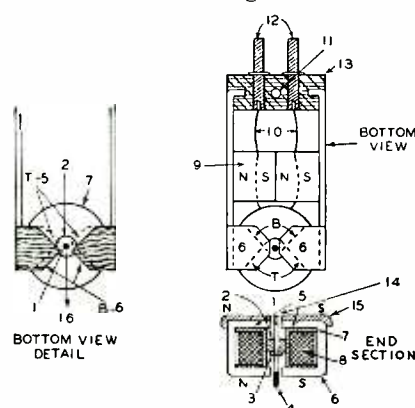

Fig. 1—The modified Clarkstan pickup. The numbered parts are: 1, the tubular needle; 2, visco-elastic pivot; 3, wire ring; 4, jewel tip; 5, top poles; 6, bottom poles; 7, coil spool; 8, coil; 9, Alnico magnets; 10, output leads; 11, tapped hole for case screw; 12, pickup terminals; 13, insulating block; 14, new hole in case top for needle clearance; 15, top side of case; 16, groove motion direction; T, new shape of top poles; B, new shape of bottom poles.

washer is about  $\frac{1}{8}$  to  $\frac{1}{4}$  inch thick, depending on its stiffness, so that when the needle is pushed into it from below, as shown, the copper wire turn prevents further upward slippage, and the compliance for lateral needle deflections is somewhat more than necessary to



Benjamin F. Miessner, a pioneer in radio and electronics, has to his credit more than a hundred American and foreign patents. Some of his most important inventions are the "catwhisker" of crystal detector days, the photoelectric exposure meter, photoelectric crossing alarms, and modulated light beam and heat wave signaling systems. He also did basic work in developing a.c.-operated radio receivers, the superheterodyne circuit, multiplex telephone and telegraph systems, phonograph recording and reproduction, and automatic self-propelled torpedoes. Much of Mr. Miessner's work has been with sound, including speakers, microphones, reproduction of music and electronic music. He holds more than 40 patents in the field of electronic musical instruments alone.

prevent the needle from being attracted by the pole tips into a diagonal, left- or rightward position.

This washer acts as the vertical and lateral compliance for the needle, returning it to its normal mid-position after deflection by the record. The needle can vibrate in all horizontal directions in response both to the groove deflections and to the changes in friction between the groove and the needle. Frictional drag will force both ends of the needle closer into their 90-degree air gaps between the top and bottom poles when the groove modulation amplitude increases. This gives a few db of instantaneous automatic volume expansion and will reduce the surface noise from 10 to 15 db below that of a needle which can vibrate only at right angles to the groove, the needle being able to pass more easily over microscopic irregularities in the groove walls.

Pivot structure of this type also gives vertical compliance as well as



OPENING FOR STYLUS

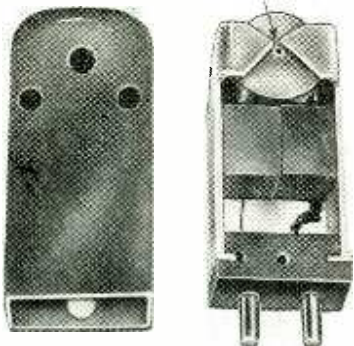

Photo of the modified Clarkstan pickup.

damping for both vertical and lateral motion of the needle. Because the needle extends above and below the magnetic flux fields across the air gaps, any vertical vibration of the needle due to the pinch effect will not be translated.

As a resonant vibrator the needle has a very high resonant frequency, the midpoint pivot reducing its length to half and the bottom end being held in the record groove. The pivot also damps out transient and resonant response at this higher frequency.

The new shape of the pole pieces also increases the sensitivity by concentrating the flux in the immediate region of the pointed pole tips.

### Capacitance pickup

The details of a capacitance pickup are shown in Fig. 2. An important point in the design of such a pickup is that the mass, and therefore the motional reactance of the needle, must be reduced to the lowest possible minimum. A tubular needle obviously accomplishes this object and still provides enough surface area for the capacitance pickup function. Duraluminum or magnesium is the best material. The jewel tip is cemented into one end of the needle with shellac or other thermoplastic material.

The needle is mounted at its upper end in a socket which provides a pivot, a conductive connection, lateral and vertical compliance, and mechanical damping for the vibrations. The socket is made of soft vinylite, Audiod, butyl rubber, or similar viscoelastic material in the shape shown in the figure. A high-speed electric hand drill can be used as a lathe to shape the socket.

A  $\frac{1}{8}$ -inch long spring is wound with 10-mil diameter spring wire and with an internal diameter slightly smaller than the outside diameter of the needle, which should be about  $\frac{1}{16}$  inch. The correct size may be found in a few trials using drill shanks as winding mandrels.

The needle should be turned as it is pushed into the spring so that the turning friction will expand and not contract the spring helix. The fit should be tight to make good contact and prevent slippage under needle pressure on the record, but not so tight that the needle cannot be removed.

The side wall thickness of the viscoelastic plug into which this spring is pressed is such that  $\frac{1}{2}$  to 1 ounce of lateral pressure on the tip deflects the tip about  $\frac{1}{16}$  inch. A straight length of spring wire extends upward through the pivot plug for grounding.

The pickup electrode is made of  $\frac{1}{32}$ -inch brass or copper sheet and should be about  $\frac{3}{16}$ -inch square where it is opposite the needle. Its lateral attachment arm is  $\frac{1}{4}$  inch long and is drilled for a screw.

This plate is mounted on an insulat-

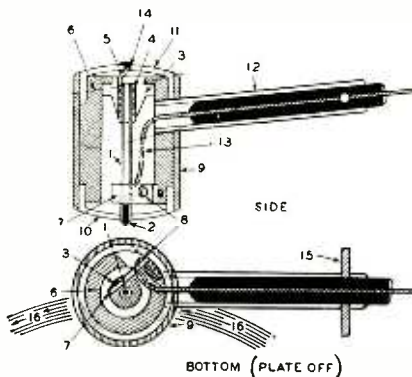

Fig. 2—The Miessner capacitance pickup. The numbered parts are: 1, tubular needle; 2, jewel tip; 3, visco-elastic pivot; 4, contact spring; 5, the spring ground end; 6, polystyrene cylinder; 7, pickup plate; 8, attachment screw for the pickup; 9, shield case; 10, bottom plate; 11, top plate; 12, pivoted end of tone arm; 13, pickup cable; 14, solder hole for spring end; 15, vertical motion pivot; 16, direction of groove.

ing base inside the pickup head so the pickup face is forward of the needle and at an angle of about 45 degrees to the record groove. It may be spaced from the needle after mounting by small bending adjustments. The closer this spacing without vibrating contact when in use, the higher the efficiency.

The details of the tone arm, location

of the oscillator, etc., will be left to the constructor. A nonmicrophonic shielded cable should be used in the tone arm. A tone arm with lateral motion only is best if the vertical motion is obtained by a short pivoted section about 2 inches from the pickup head. This allows the use of a heavy main section of the tone arm without larger needle pressures. It also eliminates the need for counterbalances which give the tone arm so long a time period that the needle pressure on a warped record changes appreciably once per disc revolution. With the hinged pickup head section, only the head contributes to the needle pressure, which should be less than  $\frac{1}{2}$  ounce.

This pickup can be used either as an FM or AM modulator. With AM, much lower frequencies can be used. The most sensitive arrangement is an r.f. capacitance bridge circuit. For this a standard AM receiver will do the entire job of demodulation and reproduction. (See RADIO-ELECTRONICS, February 1950, pages 51 and 52; and October, 1948, page 32, for circuits.—Editor)

### Performance

The curves in Fig. 3 compare the performance of the modified Clarkstan and the capacitance pickup with several standard magnetic units.

The rise in output of the magnetic pickups below 100 c.p.s. is due to the fundamental resonance of the tone arm (Zenith Cobra). The capacitance pickup was used with a tone arm having no resonant frequency within the range of the curves.

All the magnetic units require equalization to compensate for the NAB standard recording characteristics. The capacitance pickup has an ideal characteristic for records made with no frequency compensation so that equalization is unnecessary in either the recorder or reproducer.

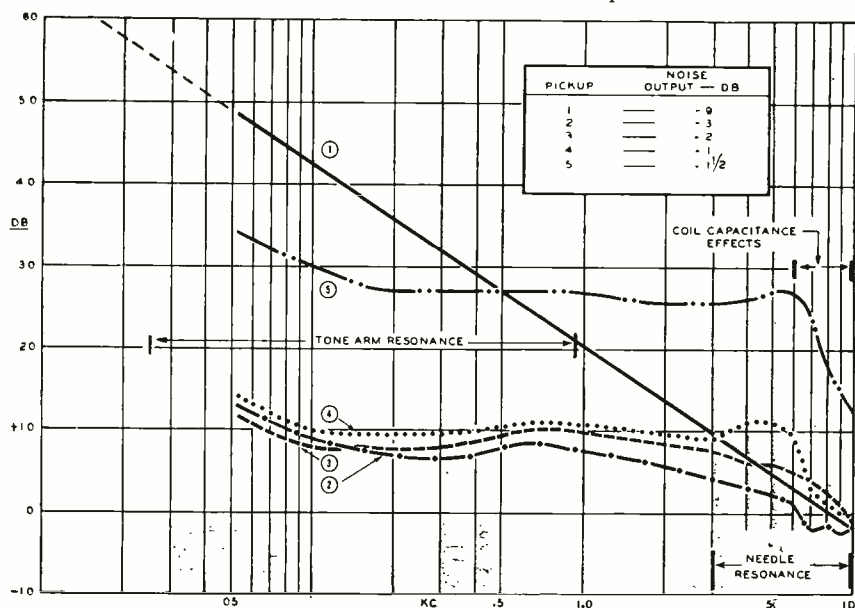

Fig. 3—Comparative pickup frequency characteristics. The curves are for: 1, Miessner capacitance pickup; 2, the Clarkstan magnetic (unmodified); 3, the Pickering magnetic; 4, G-E variable reluctance; 5, the modified Clarkstan magnetic. Noise levels of the pickups are shown in the box at the upper right.



# A High-Gain Amplifier

**B**UILT for use in a dance hall, this amplifier has these important factors: reliability, simplicity, flexibility, and ample power. It has a maximum undistorted (0.5%) output of 30 watts. The input for maximum output is 2.5 millivolts.

Simplicity was desirable because unskilled hands were likely to use the equipment. Flexibility was required so that more than one microphone could be used, and provision had to be made for playing phonograph records.

The amplifier has been operating without trouble three hours a night, five nights a week for two years. The power pack, a separate unit, has been in operation for three and one-half years under the same conditions.

Two novel features in the circuit are the tone control stage and the high-gain phase splitter analysed by E. Jeffery in *Wireless World* (London; August, 1947). Thanks are due the latter for considerable personal assistance.

The input circuit is designed for three dynamic microphones and one crystal pickup, and not two of each as shown in the photograph. Simplicity is the keynote and only one microphone transformer is used, a 50/1 Mumetal-shielded type. Mixing is smooth and silent.

## Tone control circuits

The outputs of the microphone transformer and pickup are applied in parallel between grid and ground of the tone control tube, a 6SJ7 (see Fig.1). Variable negative current feedback is applied to this tube by the cathode resistors and associated networks.

The correct value of grid bias is obtained by returning the 220,000-ohm grid resistor to a tap in the cathode circuit.

When the moving contacts of the two tone control potentiometers are grounded, the impedance between cathode and ground is about 5,400 ohms and is independent of frequency; therefore the negative feedback is also independent of frequency and the gain is constant.

When the moving contact of potentiometer R1 is moved to the other end of its track, the network has an impedance which decreases with rise of frequency—3,500 ohms at 1,000 cycles, and 1,300 ohms at 10,000 cycles (see Fig. 2). The corresponding decrease in the negative feedback with increasing frequency causes the gain to rise and the control to act as a treble boost. Fig. 2 also shows the cathode-ground impedance variations with the frequency, with potentiometer R1 at the half-resistance setting.

By similar reasoning, potentiometer

***This rugged and dependable 30-watt amplifier is built for trouble-free operation***

By **JAMES RUNDO**

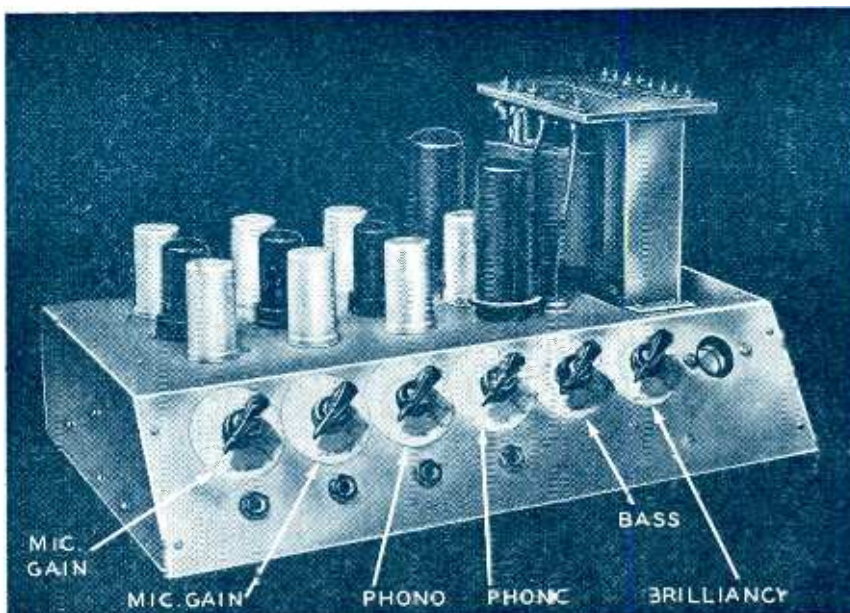

Front view of the high-fidelity amplifier. One of the two phono inputs was later changed to a microphone input. All controls are on the sloping panel.

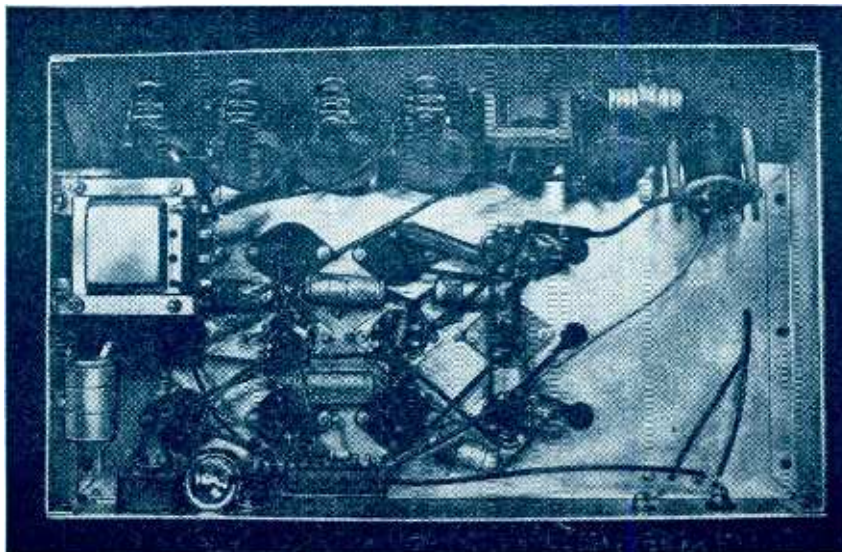

The symmetrical layout under the chassis gives the job a very neat appearance.



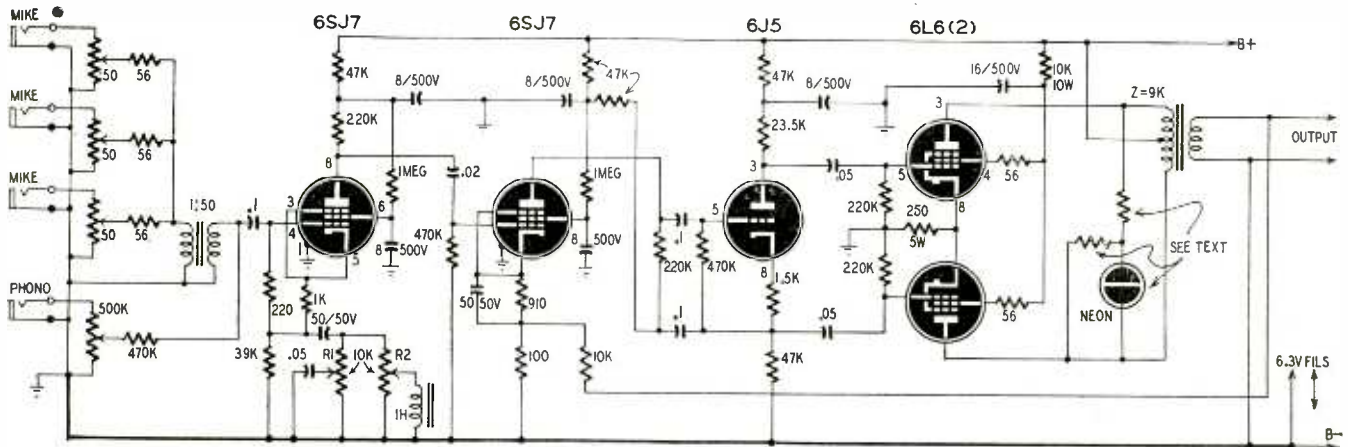

Fig. 1—Schematic of the amplifier. The second 6SJ7 uses the cathode follower's high input impedance as a.c. plate load.

R2 is a bass boost. The 1-henry choke gives the network an impedance of 3,550 ohms at 500 cycles and 1,310 ohms at 50 cycles. Fig. 3 shows the cathode-ground impedance variations with frequency, with both half-resistance and maximum settings of potentiometer R2.

The resonant frequency of the choke and capacitor is 723 cycles; but there is no peak in the response curve at this frequency, even with both controls at maximum, because the tuned circuit is very heavily damped by the parallel resistances.

This tone control circuit, although simple, is extremely satisfactory. The table shows how it increases bass and treble response.

**A novel phase splitter**

The next two stages are considered together. The first is a 6SJ7 operated so the stage gain approaches the amplification factor of the tube. This is achieved by making the plate load of the tube the extremely high impedance of a cathode-follower phase splitter. The operation is best understood by developing the circuit from a conventional cathode-follower phase splitter preceded by a pentode amplifier

whose gain is determined by the values of the late load resistance and the B-supply.

The input impedance of such a cathode-follower is approximately 10 times the impedance between grid and cathode. In the circuit of Fig. 4 this is approximately 2.5 megohms, so that the input impedance of the phase-splitter does not affect the gain of the pentode. However, the maximum value of the plate resistance consistent with a reasonable plate voltage is about 500,000 ohms. This gives a maximum gain of 250 with a 6SJ7 and a plate supply of 300 volts. The gain of the phase splitter being about 0.9, the over-all gain is 225.

The phase splitter of Fig. 4 may be redrawn as in Fig. 5, where C1 and C2 have negligible reactance at the lowest working frequency. The grid-cathode impedance is now 150,000 ohms (R1 being in parallel with the grid resistor), so that the input impedance is 1.5 megohms. If the grid end of R1 is connected to the anode of the preceding pentode and the ground end of R2 is connected to the B-supply, the a.c. conditions of the phase splitter are unchanged and the pentode sees the input impedance of 1.5 megohms as its plate load. The over-all gain is thus increased to about 1,000. The inherent unbalance is negligible if  $R2 = R3 = 2 \times R4$ . Comparison of Figs. 1 and 5 shows that this is the arrangement used. (The constructor may use several methods of obtaining the correct resistance. Possibly the easiest is to use two 47,000-ohm resistors in parallel for R4. The author used old-type 25,000- and 50,000-ohm resistors in his set.—Editor)

**Output stage and B-supply**

The remainder of the circuit is conventional. Two small resistors are included in the screen feeds of the 6L6 output tubes for parasitic suppression and to limit screen dissipation. Considerable negative voltage feedback (about 20 db) is introduced into the cathode of the second 6SJ7 from the secondary of the output transformer. Extensive decoupling is used throughout to prevent positive feedback. Because of its extremely high gain, the

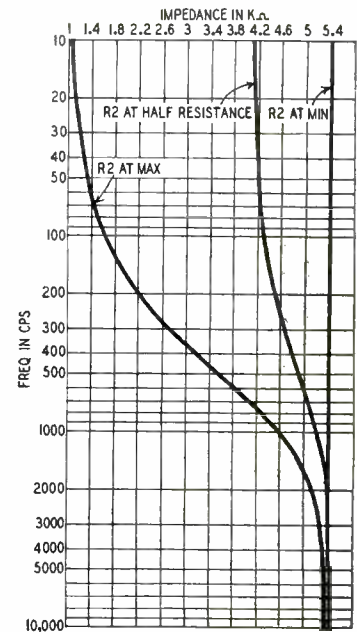
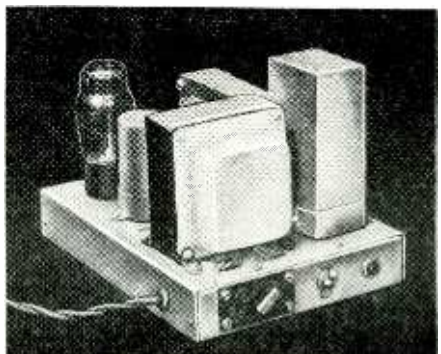

Fig. 3—Impedance variation of bass circuit with treble control at minimum.

amplifier is very sensitive to noise and microphonics in the first tube. The latter noise is eliminated by rubber mounting the tube socket.

The power pack is conventional as seen from the circuit in Fig. 6. The power transformer supplies 350-0-350 volts to a 5Y3 full-wave rectifier, and a 500,000-ohm bleeder is connected across the B-supply to discharge the



The power supply is a separate unit.

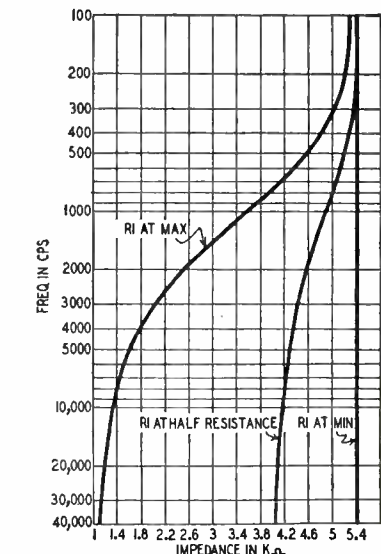

Fig. 2—Impedance variation of treble circuit with bass control at minimum.

# NOW! get your new ALLIED 1951 catalog!

# FREE

## 212 Value-Packed Pages

### THE ONLY COMPLETE CATALOG FOR EVERYTHING IN RADIO, TELEVISION AND INDUSTRIAL ELECTRONICS

### Send For It Today!



**H**ERE'S the only *complete* Buying Guide to *everything* in TV, Radio and Electronics —packed with the world's largest selections of quality equipment at lowest, money-saving prices. See the latest in TV, AM and FM receivers; radio-phonos; new Sound Systems and P.A. equipment; high-fidelity custom sound components; recorders and accessories; full selections of newest Amateur receivers and station gear; test instruments; builders' kits; huge listings of parts, tubes, tools, books—*everything in stock* for immediate shipment.

ALLIED gives you *every* buying advantage: speedy delivery, expert personal help, lowest prices, assured satisfaction, liberal time payment terms. Get the new 1951 ALLIED Catalog. Keep it handy—it will save you time and money. Send today for your **FREE** copy!

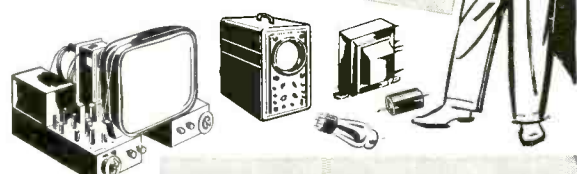
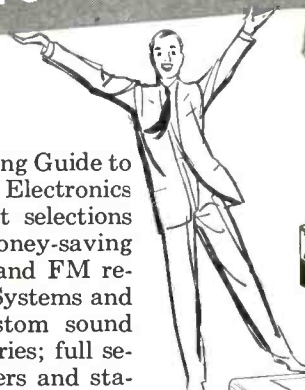

#### WORLD'S LARGEST STOCKS

- Radio Parts Unlimited
- Test Instruments—All Makes
- Television & Home Radios
- P.A. and Hi-Fi Equipment
- Amateur Station Gear
- Supplies for Industry

**QUICK, EXPERT SERVICE**

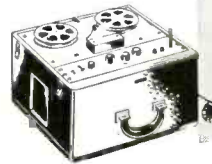

#### ALLIED IS YOUR TELEVISION HEADQUARTERS



To keep up with TV, depend on ALLIED! Count on us for the latest releases and largest stocks of picture tubes, component parts, antennas and accessories—plus the latest in TV tuners and kits. If it's anything in TV—we have it in stock! So remember—for TV—it's ALLIED First!



# ALLIED RADIO

THE WORLD'S LARGEST RADIO SUPPLY HOUSE

Everything in Electronics

WRITE TODAY FOR RADIO'S LEADING BUYING GUIDE

ALLIED RADIO CORP.  
833 W. Jackson Blvd., Dept. 2-J-0  
Chicago 7, Illinois

# FREE

Send FREE 212-page 1951 ALLIED Catalog.

Name.....

Address.....

City.....Zone.....State.....



electrolytic capacitor after switching off.

As shown in the circuit, an output indicator is included in the amplifier. This consists of a neon lamp, with lim-

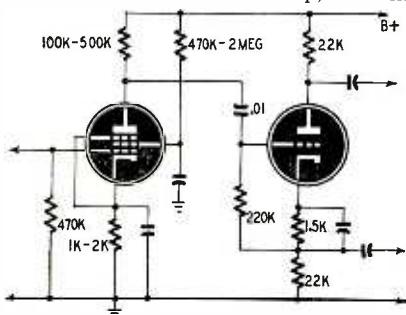

Fig. 4—Conventional cathode follower phase splitter preceded by a pentode.

iting resistors, connected across the primary of the output transformer. The 0.5-watt lamp, a common type of indicator for British standard 230-volt

lines, was uncapped and fitted into the octal base of an old burnt-out tube with Plastic Wood. The values of the limiting resistors were adjusted by trial and error until the indicator is fully lit at 30 watts output.

**Construction hints**

For those readers who contemplate building a similar amplifier, the following constructional notes may be of interest. The chassis of both units are of .064-inch aluminum, and the two chassis measure 15 x 7 x 3 inches and 8 x 6 1/2 x 1 1/2 inches, respectively. The amplifier control panel is set at an angle and the six controls are grouped in a horizontal row, the four input jacks being placed below their respective mixer potentiometers. This, together with a symmetrical layout of the tubes and electrolytic capacitors, gives a neat appearance to the job. Power is carried to the amplifier by a heavy-duty four-wire cable terminated

in a female four-point connector. The speaker output is taken from two insulated binding posts at the rear of the chassis.

While the general layout is not very critical, some precautions must be taken to keep the hum at the lowest possible level because of the amplifier's high gain. One good way to keep hum down is to make all the common ground connections to a single bus bar, then ground the bus bar to the chassis at one point only. This point should be at the input stages or where the signal level is lowest. The heater circuits should be wired with a pair of twisted wires. Do not ground one side of the heaters in the amplifier chassis. The power supply schematic shows one side of the 6.3-volt winding grounded. It is better to ground the centertap of this winding if there is one.

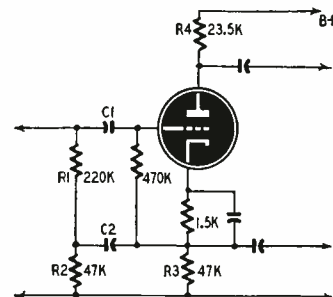

Fig. 5—Re-arrangement of the phase splitter of Fig. 4 for higher gain.

# Preamp for Low-Speed Pickups

By ROBERT HILL

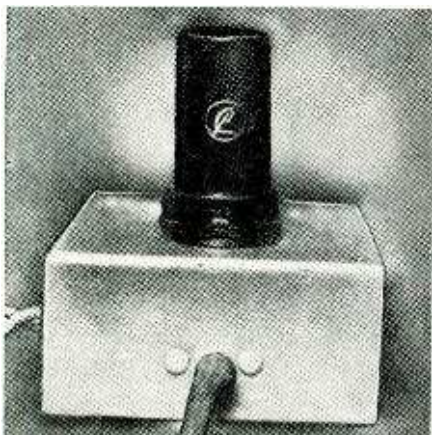

Photo of the tone-compensated preamp.

MANY LP and 45-r.p.m. record players have a low output crystal cartridge which does not give enough output voltage for some radios. Here is a compact preamplifier and tone compensating circuit which will give the needed gain and also provide bass and treble boost.

The filament and B-plus voltages are obtained from the receiver. If the radio is an old one with 2.5-volt heaters, a type 2A6 tube may be used. A 6AT6 can be used instead of the 6SQ7 if min-

ature types are preferred. It is not advisable to use the preamplifier with an a.c.-d.c. set because of the filament connections.

The amplifier output is fed directly to the tone compensating network. For less-high-frequency response, capacitor C1 can be made smaller. An s.p.s.t. switch in series with R1 cuts the bass boost when it is closed. If the bass cut is not great enough, the resistor can be made smaller.

If the 250-300-volt plate supply is not available from the receiver, a lower voltage can be used but the gain of the preamplifier will be lower. In this case it might be advisable to use a duotriode such as the 6SN7 to get additional gain. Use one section of the dual tube as shown in the circuit, and feed the output to the grid of the other section which is hooked up as a straight resistance-coupled amplifier to supply the required gain. Even higher gain can be supplied by using a high-mu duotriode like the 6SL7.

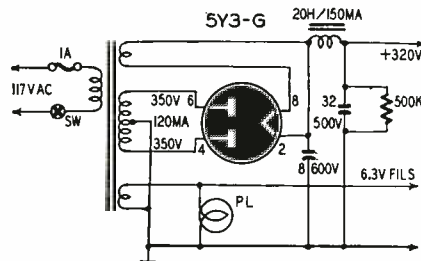
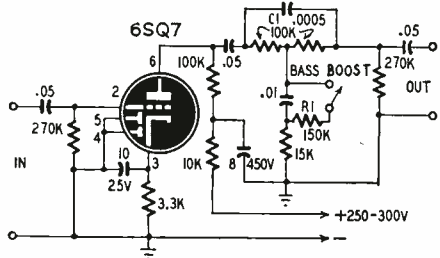
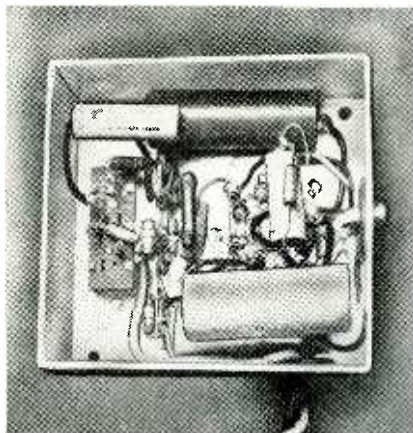

Fig. 6—Power supply for the amplifier.

The photographs show the placement of parts, which is not very critical. All resistors and capacitors have 20% tolerance. The common bias resistor of the 6L6 output tubes largely compensates for any slight mismatch of the resistors in the phase splitter circuit. The 23,500-ohm resistor may be 22,000- and 1,500-ohm units in series. The two 50-μf electrolytic capacitors are mounted with their cans isolated from ground. All coupling, decoupling, and smoothing capacitors are rated at least 500 volts, as the B-supply reaches this value before the output tubes are fully conducting.



Circuit of the one-tube preamplifier.



An under-the-chassis photo of the unit.

**RESPONSE TABLE**

Frequency (cycles)	Min. Treble Min. Bass (response) (db)	Max. Treble Min. Bass (db)	Min. Treble Max. Bass (db)
40	-0.5	0	+10.2
100	0	+0.1	+8.6
200	0	+0.3	+6.6
400	0	+0.8	+4.2
1,000	0	+3.2	+1.3
2,000	0	+5.7	+0.4
4,000	0	+8.0	+0.1
10,000	0	+9.9	0
15,000	+1.0	+11.3	+1.0
20,000	0	+10.6	0
40,000	-0.7	+10.3	-0.7

**GUARANTEE?**

Every unit sold by us is covered by a one year guarantee.

**MONEY BACK?**

Every unit we advertise is offered on a strict "money-back-if-not-satisfied-basis." No ifs—no but's—no may-be's. If you are not completely satisfied after a 10 day trial—return for complete refund. No explanation—you are the sole judge. Plain enough?

THE UNITS OFFERED ON THIS PAGE ARE COMPLETE INSTRUMENTS, NOT KITS! EVERY MODEL IS FACTORY-WIRED, CALIBRATED AND READY TO OPERATE.

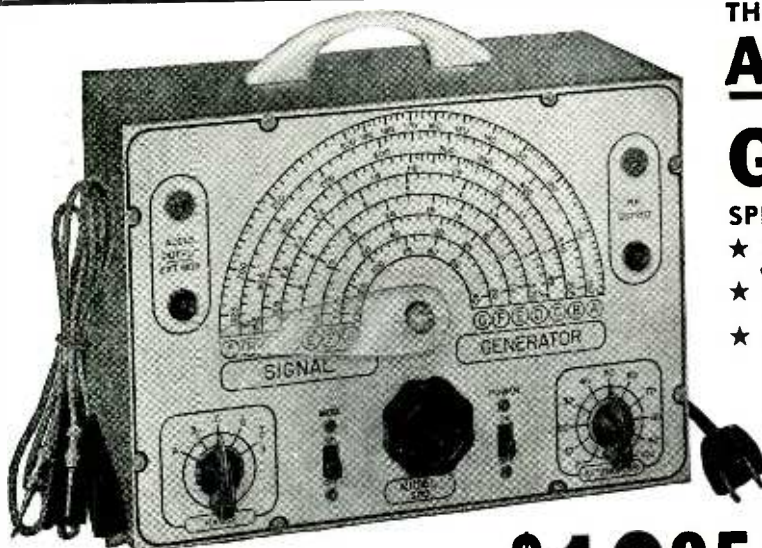

The Model 200 operates on 110 Volts A.C. Comes complete with output cable and operating instructions.

**\$1885**  
NET

**THE NEW MODEL 200  
AM and FM SIGNAL  
GENERATOR**

**SPECIFICATIONS**

- ★ **R.F. FREQUENCY RANGES:** 100 Kilocycles to 150 Megacycles.
- ★ **MODULATING FREQUENCY:** 400 Cycles. May be used for modulating the R.F. signal. Also available separately.
- ★ **ATTENUATION:** The constant impedance attenuator is isolated from the oscillating circuit by the buffer tube. Output impedance of this model is only 100 ohms. This low impedance reduces losses in the output cable.
- ★ **OSCILLATORY CIRCUIT:** Hartley oscillator with cathode follower buffer tube. Frequency stability is assured by modulating the buffer tube.
- ★ **ACCURACY:** Use of High-Q permeability tuned coils adjusted against 1/10th of 1% standards assures an accuracy of 1% on all ranges from 100 Kilocycles to 10 Megacycles and an accuracy of 2% on the higher frequencies.
- ★ **TUBES USED:** 12AU7—One section is used as oscillator and the second is modulated cathode follower. T-2 is used as modulator. 6C4 is used as rectifier.



Superior's new model 670

**SUPER-METER**

A COMBINATION VOLT-OHM MILLIAMMETER PLUS CAPACITY REACTANCE INDUCTANCE AND DECIBEL MEASUREMENTS

**SPECIFICATIONS:**

- D.C. VOLTS: 0 to 7.5/15/75/150/750/1,500/7,500
- A.C. VOLTS: 0 to 15/30/150/300/1,500/3,000
- OUTPUT VOLTS: 0 to 15/30/150/300/1,500/3,000
- D.C. CURRENT: 0 to 1.5/15/150 Ma. 0 to 1.5 Amperes
- RESISTANCE: 0 to 500/100,000 Ohms 0 to 10 Megohms
- CAPACITY: .001 to .2 Mfd. .1 to 4 Mfd. (Quality test for electrolytics)
- REACTANCE: 700 to 27,000 Ohms 13,000 Ohms to 3 Megohms
- INDUCTANCE: 1.75 to 70 Henries 35 to 8,000 Henries
- DECIBELS: -10 to +18 +10 to +38 +30 to +58

**ADDED FEATURE:**

The Model 670 includes a special GOOD-BAD scale for checking the quality of electrolytic condensers at a test potential of 150 Volts.

The Model 670 comes housed in a rugged, crackle-finished steel cabinet complete with test leads and operating instructions. Size 5 1/2" x 7 1/2" x 3".

**\$2840**  
NET



Superior's New Model TV-10

**TUBE TESTER**

**SPECIFICATIONS**

- ★ Tests all tubes including 4, 5, 6, 7, Octal, Lock-in, Peanut, Bantam, Hearing Aid, Thyatron, Miniatures, Sub-Miniatures, Novals, etc. Will also test Pilot Lights.
  - ★ Tests by the well-established emission method for tube quality, directly read on the scale of the meter.
  - ★ Tests for "shorts" and "leakages" up to 5 Megohms.
  - ★ Uses the new self-cleaning Lever Action Switches for individual element testing. Because all elements are numbered according to pin-number in the RMA base numbering system, the user can instantly identify which element is under test. Tubes having tapped filaments and tubes with filaments terminating in more than one pin are truly tested with the Model TV-10 as any of the pins may be placed in the neutral position when necessary.
  - ★ The Model TV-10 does not use any combination type sockets. Instead individual sockets are used for each type of tube. Thus it is impossible to damage a tube by inserting it in the wrong socket.
  - ★ Free-moving built-in roll chart provides complete data for all tubes.
  - ★ Newly designed Line Voltage Control compensates for variation of any line voltage between 105 Volts and 130 Volts.
- The Model TV-10 operates on 105-130 Volt 60 Cycles A.C. Comes housed in a beautiful hand-rubbed oak cabinet complete with portable cover.

**\$3950**  
NET

GENERAL ELECTRONIC DISTRIBUTING CO. DEPT. RC-9, 98 PARK PLACE, NEW YORK 7, N. Y. RC-9

GENTLEMEN: PLEASE RUSH THE MATERIAL LISTED BELOW:

QUANTITY	MODEL	PRICE
TOTAL		

Name \_\_\_\_\_

Address \_\_\_\_\_

City \_\_\_\_\_ Zone \_\_\_\_\_ State \_\_\_\_\_

\$.....  
(Payment in Full Enclosed) (Deposit Enclosed—Ship Balance C.O.D.)



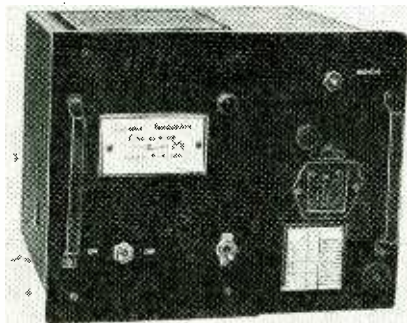

Photo A—Panel view of the v.f.o. that was built in the type CAY tuning unit.

**M**ANY variable-frequency oscillators have been described from time to time. Their popularity is justifiable. If you want to increase your QSO-to-CQ percentage, a v.f.o. in the exciter stage of your transmitter is a must, especially now with the crowded conditions of all bands. The electron-coupled oscillator has enjoyed much popularity with the ham fraternity. The author believes this circuit will be superseded by the Clapp oscillator, two triode versions of which are described here.

The circuit has exceptional stability. In fact, it is so good that the oscillator may be keyed. The resultant tone is T9 and free from chirps and “weepiness.” The great advantage of this stability is that break-in operation is easy, and this is definitely the thing to use when QRM is tough and network schedules are to be kept.

The basic circuit, shown in Fig. 1, is a variation of the familiar Colpitts. Capacitors C1 are fixed micas of high capacitance (.001  $\mu$ f) and the circuit is tuned with the variable C2 in series with the inductance. These capacitors, both C1's and C2, are effectively in series and, since their equivalent capacitance is large compared with the small grid-to-cathode capacitance of the tube, any small changes in these already small values have negligible effect on the generated frequency. This works in practice as well as in theory. A very short warmup period is necessary and, even without regulated voltage on the oscillator plate, the signal is very stable. With this circuit and one isolating stage, the amateur station has a “rubber” crystal for any frequency (within limits) and the signal will stay put.

Two models of the Clapp oscillator are shown in the photos. Both use the same basic circuit shown in Fig. 1, with the variations shown in Figs. 2 and 3. While the layouts used by the author need not be followed strictly, leads in the grid circuit must be short and all wiring must be solid and well soldered.

A good dial with no backlash should be used. Several excellent types have been available on the surplus market. In fact, the dial and the very fine tuning capacitor were the principal

# Dependable V.F.O. for 80-Meter Band

By RICHARD L. PARMENTER, W1JXF

reasons for building the larger model in the Navy tuning unit type CAY. This model is shown in Photo A. If none of these surplus dials are available, use a vernier type which has a blank card for a dial to make the unit direct reading. The tuning capacitor in this unit has a capacitance of about 150  $\mu$ f, but a good standard-make ceramic insulated variable of 140  $\mu$ f may be substituted.

The smaller model of the v.f.o. (Fig. 2 and Photo B) was built into a tuning unit of the military type BC-610 transmitter and has an external power supply. This model was thrown together to try out the circuit, using as many parts of the original unit as possible. The results were so good that we built the larger model, now a permanent fixture in the shack. In experiments with the smaller unit we found that the untuned class-A buffer stage was necessary to prevent pulling of the oscillator frequency. When this stage was tuned, there was a variation of

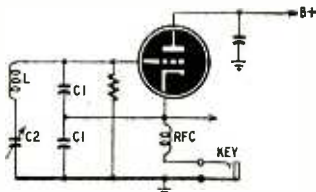

Fig. 1—Basic Clapp oscillator hookup.

oscillator frequency of about 50 cycles as the buffer was tuned through resonance. Since an untuned stage has few parts and no complications of additional tuned circuits are involved, this stage is justifiable.

## Construction

In constructing the larger v.f.o. using the CAY-type tuning unit (for Navy transmitter type GP-7), the first step is to strip the assembly of all components except the oscillator tuning capacitor and dial. (This dial has 800 divisions and for the 3480-to-4050-ke range provides about 1½ divisions per kilocycle. Although not entirely uniform, it is sufficiently so for good accuracy. The dial has a fast action for flexibility in QSY.) The terminal board in the back may be removed or not as the builder sees fit—we removed ours. Detailed layout will not be given since the photos show the arrangement

clearly. In the top view (Photo C) the coil is shown in the upper right with the socket for the oscillator directly on its left. Since the key jack is located on the back panel, this makes for short leads in the oscillator section proper. The socket for the OD3 tube is to the left of the 56 tube and below it are two six-prong sockets, only one of which is used for the 2A5. All other components in this section are wired point-to-point. The monitor switch S1 is mounted on the front panel while the 5,000-ohm dropping resistor for the VR tube is mounted on the back panel as is the coaxial connector for the output lead. The rest of the power supply is built on a small homemade chassis just large enough to hold the rectifier tube, power transformer, and choke. This entire small chassis is put in the left compartment of the tuning unit. The only other component of the power supply is the bleeder resistor which is mounted on the back panel.

On the front panel the monitor switch S1 is at the upper right, the line switch is lower center, and the high-voltage standby switch S2 is at lower left. S2 is not used much and may be omitted if the user intends to key the v.f.o. only. However, if it is necessary to key a crystal oscillator stage and leave the v.f.o. on at all times, it is handy to be able to cut the B-plus to eliminate the v.f.o. signals.

It may seem a bit incongruous to build a modern v.f.o. such as this using war surplus parts and an improved circuit and use the superseded 27 and a 2A5. A good power transformer with a 2½-volt winding and a 5-volt rectifier winding was available as were also tubes which were new. There is no reason why the old tubes should not be used in an outfit like this.

(Continued on page 52)

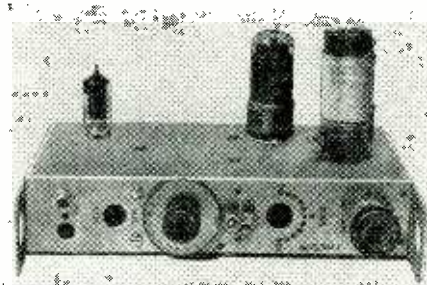

Photo B—This experimental model was built to test the oscillator circuit.

**FEATURE  
FOR  
FEATURE**

**COMPARE  
FOR YOURSELF!**

**and You'll See There Is NO COMPARISON**



**THE RADIART  
TELE-ROTOR**  
is Head and Shoulders  
Above All Others!

**The ONLY Rotator with  
ALL the Important Features**

FEATURES	TELE-ROTOR		Rotator A		Rotator C	Rotator K	Rotator M	Rotator N	Rotator U
	TR-1	TR-2	Type 1	Type 2					
TORQUE FT. LBS.	36	36	5½		4.5	6.75	2.25	4.5	6.00
TORQUE PER POUND OF ROTATOR	3.13	3.13	0.91		0.55	1.08	0.35	0.58	0.96
SIDE THRUST OVERLOAD (FT. LBS.) TO STOP ROTATION	525	525	94		50	83	88	110	160
WEATHER PROOFING	One piece "Water Shed" Dome Housing		Rubber Gasket		Metal Ring	Felt Washers	Rubber Gasket	Rubber Gasket	Rubber Gasket
ELECTRICAL TO MECHANICAL EFFICIENCY TORQUE PER WATTS CONSUMED	72%	58%	16.4%	16.3%	13%	11%	4%	11%	11%
TYPE OF LOAD BEARING	Two 6½ in. dia. Ball Races		Double Sleeve		Sleeve & Ball 2 in. dia. Ball Race	Sleeve	Sleeve	Double Ball Race 1 in. dia. Ball Race	Double Sleeve
MAST CAPACITY	2"	2"	1½"		1½"	2"	1½"	2"	1½"
ALIGNMENT OF ROTATOR SUPPORT MAST AND ANTENNA MAST	In Line	In Line	Off Set		Off Set	Off Set	In Line	Off Set	In Line
MOUNTING VERSATILITY	Mast or Platform		Mast Only		Mast Only	Mast Only	Mast Only	Mast Only	Mast or Side Plate
TYPE OF DIRECTIONAL INDICATION	End of Rotation Light	Dial lights 8 Positions and end	End of Rotation Light	Meter	Meter	Meter	End of Rotation Light	Meter	Meter

**You Can't Beat a RADIART ANTENNA  
on a TELE-ROTOR.... It's TOPS!**



**THE RADIART CORPORATION**  
CLEVELAND 2, OHIO



- ROTATORS
- VIBRATORS
- AUTO AERIALS
- TV ANTENNAS
- POWER SUPPLIES



If the constructor is going to purchase new tubes, a 6C5 and 6F6 with a transformer having a 6.3-volt filament winding are suggested. There will be little or no difference in performance.

Before putting the unit in operation, remove all the tubes except the rectifier and the OD3, insert a milliammeter in the circuit at point X, and adjust the 5,000-ohm potentiometer for a current of about 25 milliamperes.

Calibration of the completed v.f.o. is not difficult. If the coil is wound as specified and with the same values of padding capacitor and capacitors C2 and C3 in Fig. 3, the coverage should run fairly close to what we had. With an all-band receiver it is a simple matter to locate the signal and get check points at 50- or 100-kc intervals. A curve of frequency versus dial reading may be plotted and mounted right over the original on the top cover, using the original markings for dial divisions. By using this curve, intermediate points may be selected and returned to when desired.

The harmonic output of this oscillator is low and there is little danger of confusing fundamentals with second harmonics. The fundamental will be much stronger than any harmonic. When using the station receiver for calibration, allow for discrepancies in the receiver's frequency calibration. Check with the signals from WWV at 2.5 and 5.0 megacycles to make sure your receiver is reasonably right

**Adapting for other bands**

Since we were primarily interested in 80-meter operation and secondarily

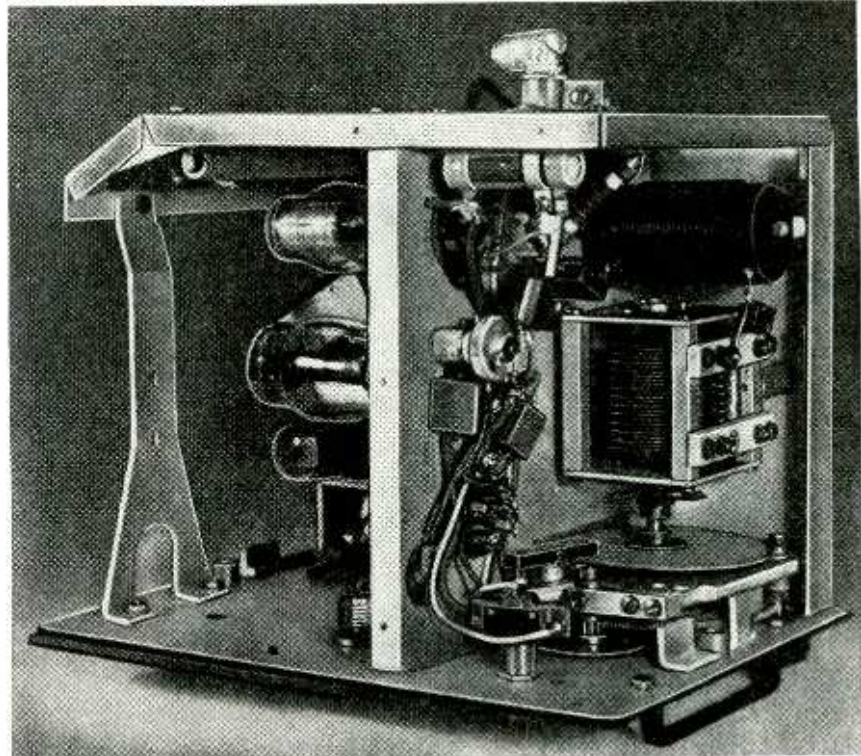

Photo C—Rear view of the larger model showing the tuning section. The power supply is in the compartment at left, the tuning components are at the right.

too far, will cease altogether. This is a characteristic of this circuit and a compromise must be found.

The output of this v.f.o. is sufficient to drive the average crystal stage both on fundamental and for doubling if close coupling is used between the two units. A 3-foot length of coax was used

Now throw the monitor switch back and retouch the tuning of the other stages in the transmitter, if necessary.

If you have never used a v.f.o. before, this unit will be a revelation. Usually when you jump right on the other guy's frequency, he will come back to you. If your station has better than 50-watts output, you will be able to make contact after contact during the evening on 80 meters whereas if you are still rockbound you could probably make only three or four due to the heavy QRM. With this QRM dodger you can move around a few kc and get through the hash without retuning the rest of your rig.

The reset accuracy leaves little to be desired. The author has kept sked after sked on spot frequencies and, when the other fellow was queried about it, he replied that we were right where he expected us to be.

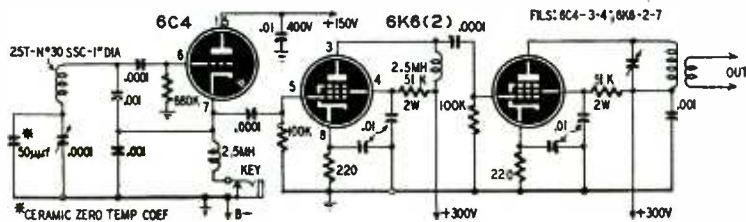

Fig. 2—This circuit, the prototype of the final model, gave excellent results.

40 meters, we did not attempt to obtain frequency coverage to include 11 meters and the higher-frequency bands. The reader may prefer a different range to cover these bands. In this case adjustment of the inductance and the mica padder will be necessary. As in other systems the greater the ratio of tuning capacitor to inductance, the greater the frequency range covered with correspondingly less bandwidth. If more capacitance is added in the capacitor padding the tuning capacitor, less range will be covered by the variable. By juggling the values of padding capacitor and increasing or decreasing the number of turns on the coil, a suitable range of frequencies will be found.

One precaution must be observed. If the total capacitance in the circuit, including the two .001- $\mu$ f capacitors and the tuning capacitor and its padder, becomes too great, the strength of oscillation will decrease and, if carried

in our unit and worked well driving a 6L6 crystal oscillator which excites an 813 in the final. We had no trouble from the 6L6 stage taking off by itself with no crystal in the circuit and no excitation from the v.f.o. This condition may exist, however, and the reader may use various methods of coupling the v.f.o. to the transmitter itself. One suggestion is to use a grounded-grid amplifier to eliminate self-oscillation troubles.

The monitor switch facilitates spotting the transmitting frequency at any point within the frequency range. Set your station receiver on a certain frequency or on the frequency of another station calling CQ. Throw the switch to monitor and this will cut your signal off the air. The signal from the v.f.o. will then be only the weak signal from the oscillator leaking out from the shielded case. In most cases it will be weak enough so that you can still hear the other fellow calling CQ.

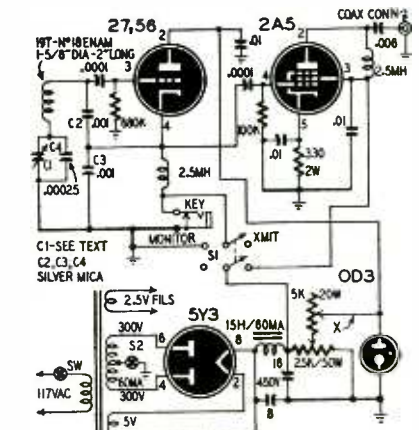
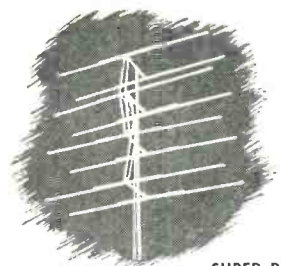
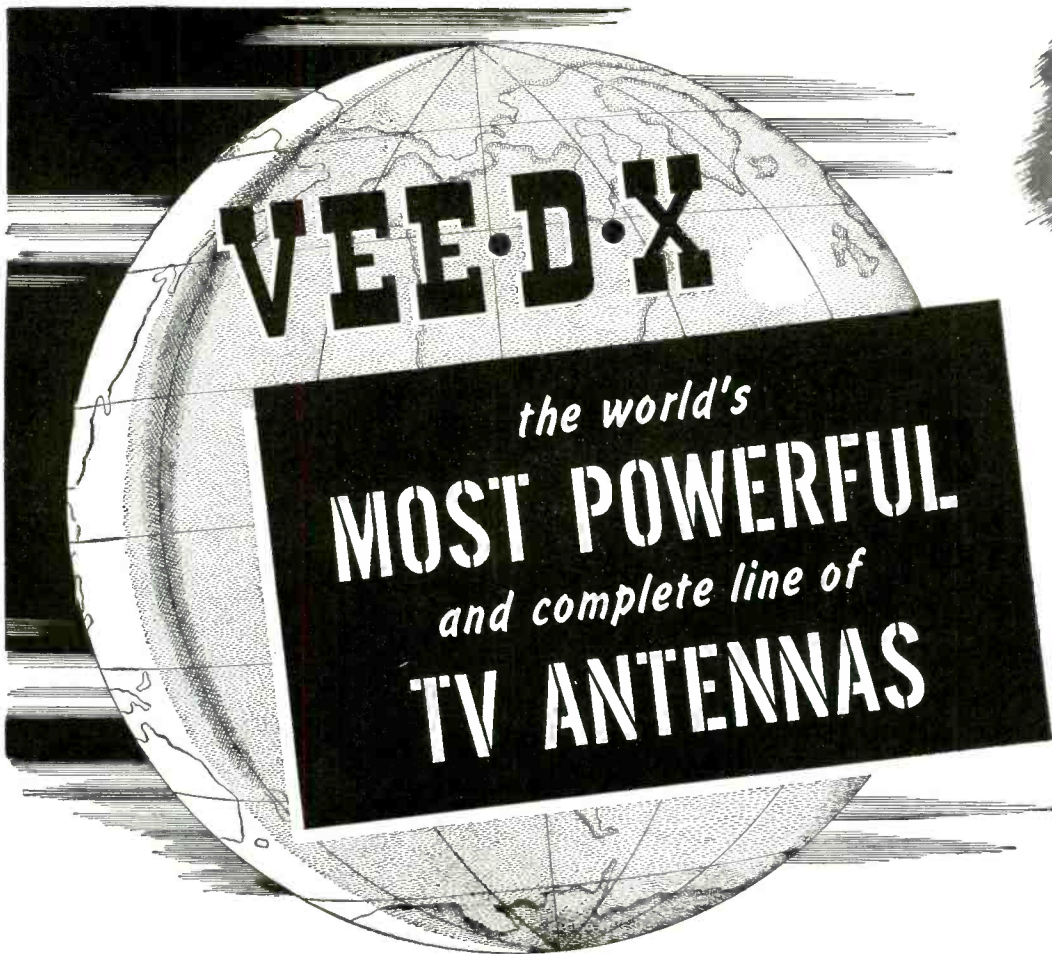
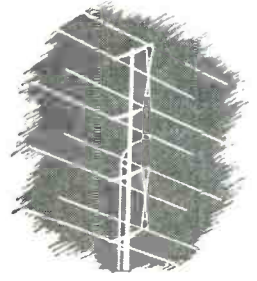

Fig. 3—Circuit of the final model of the v.f.o. complete with power supply.





**SUPER RD-13A**  
Holds every long distance reception record. Eight antennas in one. \$129.50 list.



**CHALLENGER HL SERIES**  
For fringe or near fringe areas . . . high and low channel reception. \$38.95 list.

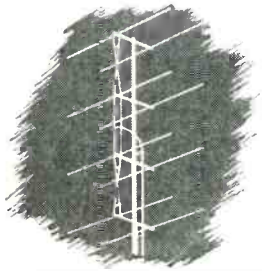

**CA 213 COLINEAR ARRAY**  
The great new pre-assembled all channel 4 bay antenna. Vee-D-X exclusive. Only \$23.75 list (less mast).

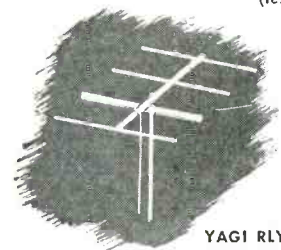

**YAGI RLY SERIES**  
For sensational results on a single channel. Yagis may be stacked for additional gain. \$35.85 list (low channel) \$14.95 list (high channel)

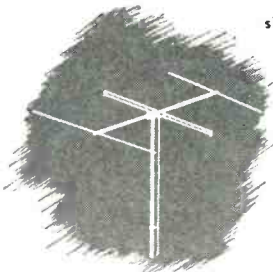

**ECONOMY EC SERIES**  
Economical 3 element beam affords more DB gain per dollar than any other antenna. \$19.75 list (low channel) \$ 8.50 list (high channel)

# for brilliant performance

Yes, true to its name, VEE-D-X means video distance. It's an established fact that the VEE-D-X Super holds every long distance record . . . and it's also fact, proven through extensive tests and letters received from enthusiastic owners, that our low priced arrays are producing powerful, long distance reception never thought possible. You can always count on VEE-D-X for the finest in powerful antennas.

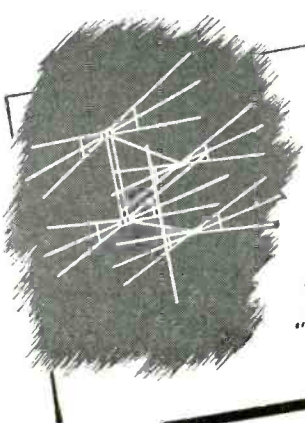

**NEWEST LOW PRICED CONICAL**  
Broad-band conical antenna. Excellent performer on all channels. Available in 1, 2 or 4 bays. Phenolic vibration straps prevent "whistling" in high wind. As low as \$6.95 list.

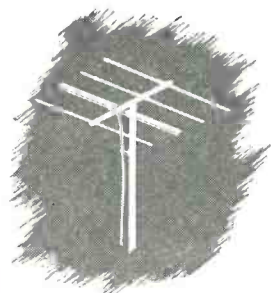

**LOW PRICED PRE-ASSEMBLED YAGI J SERIES**  
Sensational in performance — low in price. Pre-assembled for fast, easy installation. Available in 4 and 5 element, and double stack 3 element. As low as \$7.95 list.

LaPOINTE-PLASCOMOLD CORP. 1  
Unionville, Conn.  
Send me information on the entire line of VEE-D-X antennas and accessories.

Name \_\_\_\_\_  
Company \_\_\_\_\_  
Street \_\_\_\_\_  
City \_\_\_\_\_ Zone \_\_\_\_\_  
County \_\_\_\_\_ State \_\_\_\_\_



# HERE'S YOUR REPLACEMENT

*No Other Control Gives You All These*

**59 IRC CONTROLS WITH AMAZING ADAPTABILITY MEET ALL YOUR NEEDS WITH LESS STOCK**

Compare the amazing adaptability of your IRC Q Control with any other. You'll agree no other control so closely meets all your servicing needs . . . no other gives you so much for your money! Feel its cushioned turn, examine its lustrous finish, study its practical design—ask your Distributor for IRC Q Controls, and you know you're buying the very best.

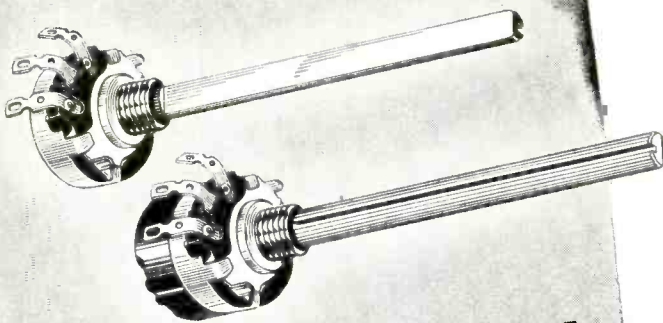

## KNOB MASTER FIXED SHAFT

Standard fixed shaft fits most knobs without alteration or inserts. Flatted, knurled and grooved. 3" length meets TV requirements. Ample cross-section prevents bending.

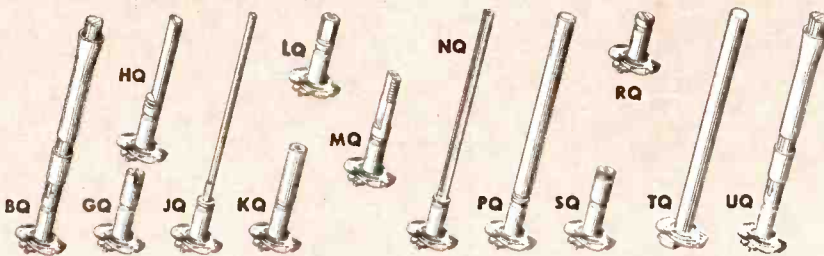

## INTERCHANGEABLE FIXED SHAFTS

Easy replacement of standard shaft with any of 13 special fixed shafts is made possible by exclusive IRC Resilient Retainer Ring. This revolutionary feature provides widest replacement control coverage.

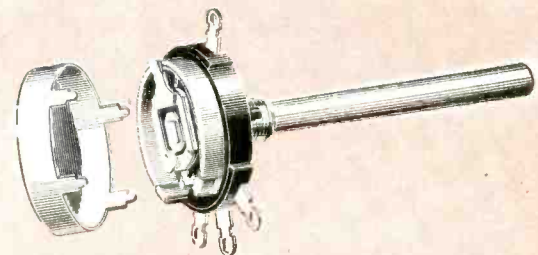

## WIRE WOUND CONTROLS

Dependable 2 watt controls available with center tap for TV centering. Specific TV values now available with Knob Master Shaft to accommodate both knurled and flatted knobs.



# No. 1 CONTROL

*Modern Servicing Features!*

- ★ Fits both flatted and knurled knobs
- ★ Separate switches
- ★ Modern small size
- ★ Fixed shaft convenience with complete shaft interchangeability
- ★ 23 tapped types
- ★ Shorter bushing
- ★ Sparkling appearance
- ★ 1/2 watt rating



**INTERNATIONAL  
RESISTANCE COMPANY**

401 N. BROAD STREET, PHILADELPHIA 8, PA.

*Wherever the Circuit Says* ~~~~

In Canada: International Resistance Co., Ltd., Toronto, Licensee

*Concentrikit*

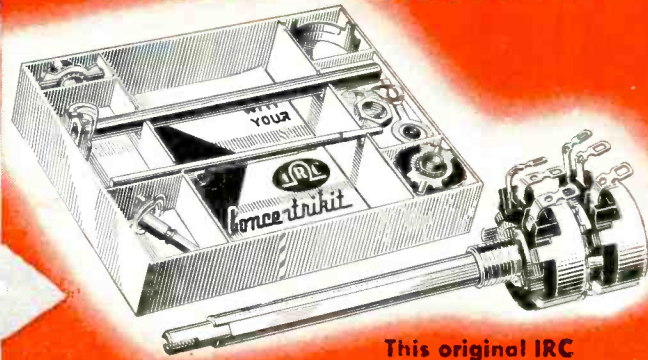

This original IRC feature provides a ready solution to your special control requirements. With this kit of parts you assemble practically any concentric dual control quickly and easily. In a matter of minutes you can prove the advantages of this practical IRC feature.

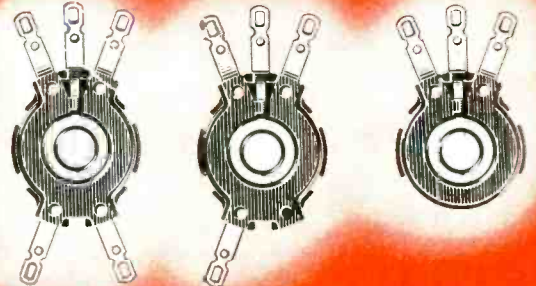

### INTERCHANGEABLE BASE-ELEMENTS

Principally intended for use with Concentrikit, this IRC innovation gives you limitless opportunities for adapting controls to specific requirements. Each unit includes molded base, element, terminals and collector ring—no loose parts. Available in 33 resistance values and a variety of taps.

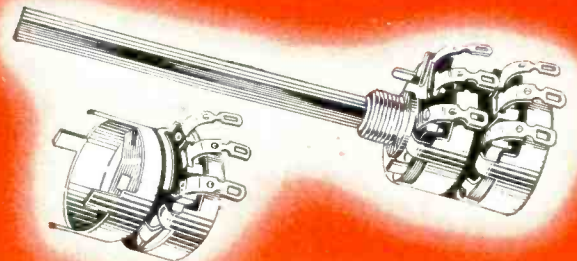

### *Multisections*

For standard deals, IRC Multisections are added to Q Controls like switches. 17 values provide over 11,000,000 variations of dual, triple and quadruple controls; accommodate switches, too!

**INTERNATIONAL RESISTANCE COMPANY**  
417 N. Broad Street, Phila. 8, Pa.

Please send me additional IRC Q Control information checked below:

- Free Catalog Bulletin DC1A  
 Enclosed find 25c in stamps or coin for comprehensive Concentric Dual Replacement Manual

Name \_\_\_\_\_

Company \_\_\_\_\_

Address \_\_\_\_\_



# Specially Designed

for  
**TV**

Technicians

New **OVER/UNDER**  
**WELLER**  
SOLDERING GUN

For ticklish TV soldering, there's no tool like the new 135-watt Weller Gun. Dual spotlights eliminate shadows. Precision balance assures accurate soldering. Long length reaches deep into chassis. 5-second heating saves time and current. Your Weller Gun pays for itself in a few months.



Check This  
Exclusive  
Combination  
of Features

- **5-SECOND HEATING**—No waiting. Saves power.
- **LONGER REACH**—Slides easily into the most complicated set-up. Reaches tight corners.
- **COMPACT DESIGN**—Streamlined and precision balanced for delicate "pin-point" soldering.
- **TRIGGER-SWITCH CONTROL**—Adjusts heat to the job. No need to unplug gun between jobs.
- **OVER/UNDER DESIGN**—Tube construction gives bracing action to tip, and improves visibility.
- **DUAL SOLDERLITE**—Prefocused spotlights completely eliminate shadows—let you see clearly.
- **DUAL HEAT**—Single heat 100 watts; dual heat 100/135 watts; 120 volts, 60 cycles. Handles all light-duty soldering.

See new Model WD-135 at your distributor, or write for bulletin direct.

• **SOLDERING GUIDE.** Get your new copy of "Soldering Tips"—revised, up-to-date and fully illustrated 20-page booklet of practical soldering suggestions. Price 10c at your distributor, or order direct.

**WELLER**  
ELECTRIC CORP.

828 Packer Street, Easton, Pa.

## VOLTAGE DOUBLER

Patent No. 2,493,137

William W. Hansen, Palo Alto, Calif.

(Assigned to United States of America as represented by U. S. Atomic Energy Comm.)

A d.c. potential may be doubled by charging two capacitors in parallel and discharging them in series. However, the required switching arrangement may be complicated, especially if high voltages are involved. In this case, two capacitors are charged in parallel but a simple method is used to reverse the polarity of one of them. They are then discharged in series to double the input voltage.

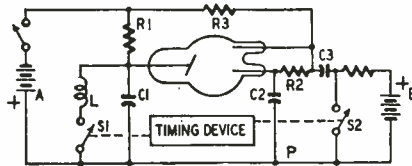

The figure shows the doubler used with an X-ray tube for photographic purposes. The tube contains an anode, a cathode, and an initiator (shown above the cathode). When the voltage between the cathode and initiator exceeds a critical value, an auxiliary discharge takes place between them. This spreads to produce the main discharge between cathode and anode, provided there is sufficient voltage between them.

When A is switched into the circuit, it charges C1 (through R1) and C2 (through R2, R3). In each case the upper plate is negative. C3 is charged by A and B in series.

Because these two capacitor voltages oppose each other across the tube there is no potential difference between cathode and anode. The initiator and the cathode also being at the same potential, the tube cannot fire.

When switch S1 is closed, C1 discharges through L and starts oscillations. One-half cycle later, C1 reverses polarity and the anode-to-cathode potential is now 2A. At this instant, switch 2 is closed automatically due to action of the timing device. Since C2 is charged to A volts and C3 is charged to A + B, a potential difference of B volts exists across initiator and cathode. The auxiliary discharge starts and is followed immediately by the main discharge since the potential difference between anode and cathode is 2A volts.

Each exposure is uniform because the discharge is always started at the same portion of the cycle and the duration is always the same.

The timing device may be any circuit which closes switch S2 a half cycle after switch 1 is closed. The method of operation is not part of his invention. The switches S1 and S2 are shown in the diagram as mechanical switches only for illustration. Actually any other suitable forms of switch may be used such as thyatrons, ignitrons, and series spark gaps.

## INVERTER SYSTEM

Patent No. 2,502,673

Roger D. Rusk, South Hadley, Mass.

(assigned to Induction Heating Corp., N.Y.C.)

Depending upon the resonant frequency of the tank circuit, this efficient inverter has an output between 1 and 20 kc.

When the switch is closed, C2 begins to charge from the d.c. source. Momentarily a high positive voltage is also transmitted through L2 and C1 to the grid of the tube. The thyatron ignites and

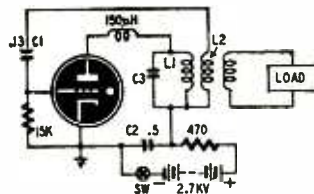

C2 discharges through it into C3. Due to circuit inductance the total plate voltage (of C2 and C3 in series) not only discharges to zero but tends to reverse polarity. The negative plate voltage extinguishes the tube at once. The charge on C3 now sets up oscillations in the tank C3-L1.

At the completion of one cycle, the upper end of L1 swings positive and because of its phasing the upper end of L2 also goes positive. The tube fires again and the cycle repeats. An output coil feeds the a.c. to the load.

## BALANCED MODULATOR

Patent No. 2,499,568

Thomas T. N. Bucher, Moorestown, N. J.

(assigned to Radio Corp. of America)

The conventional balanced modulator needs two tubes and two center-tapped transformers. An audio signal is fed in *push-pull* to the tubes, for example, by means of a center-tapped transformer to the screens. A carrier is fed *in phase* to the control grids. These signals mix in the tube and create sidebands in addition to the original frequencies. The audio is lost because the output circuit is tuned to r.f. The carrier is balanced out because of the push-pull connection of the plates. The output is composed only of sidebands.

This balanced modulator uses only one tube and needs no center-tapped transformers. The carrier is connected across two voltage dividers R1-R2 and R3-R4. The first feeds a portion of the carrier to the grid of V2, the balanced modulator tube. The second divider feeds a portion of the carrier to the V2 cathode. If the dividers are cor-

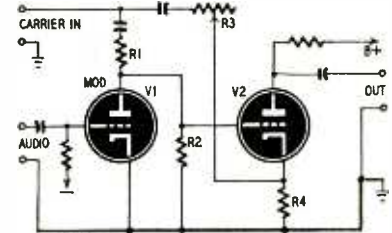

rectly chosen, the grid and cathode signals produce equal (and of course opposite) effects on the plate current. Therefore, the carrier is balanced out.

When audio is fed to the amplifier tube V1, the modulator grid signal is caused to vary and output is present. This contains only sidebands, the carrier still being balanced out.

## CONSTANT-PERMEABILITY CORE

Patent No. 2,498,475

John Q. Adams, Schenectady, N.Y.

(assigned to General Electric Co.)

The usual magnetization curve is S-shaped. Starting from zero, the flux density rises with increasing magnetomotive force (mmf). Finally

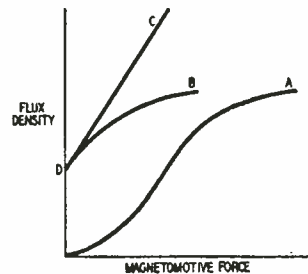
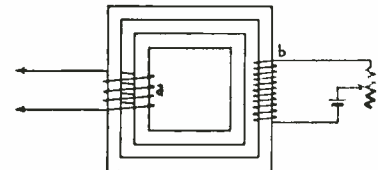

it levels off as it approaches saturation. Such a curve is shown at A. Due to nonlinearity, a coil wound over the core will contain harmonics not originally present. This invention offers a reactor core in which flux density is proportional to mmf and, therefore, permeability remains constant.

Two cores are used. The reactor coil is wound over both of them. A d.c. coil is wound around the outer core. The magnetization curve of the inner core is shown at A. The outer core is magnetically biased by the d.c. winding and its curve appears as at B. With zero mmf (in coil a) the d.c. is adjusted to give a flux density of D. The total flux density is shown by line C which is the sum of curves A and B. C is a constant-permeability line.

In these curves it is assumed that the mmf does not reverse. This requires that the current through A have a large enough d.c. component to prevent current from reversing. If this is not so, a third winding may be wound around both cores and supplied with sufficient d.c. to bias the cores magnetically as required.

*You GET  
THE BEST IN  
Heathkits*

# Heathkits are the Quality Line of TEST INSTRUMENT KITS



### Modern STYLING KITS THAT MATCH

Heathkits are styled in the most modern manner by leading industrial stylists. They add beauty and utility to any laboratory or service bench. There is a complete line of Heathkit instruments allowing a uniformity of appearance.

An attractive service shop builds a feeling of confidence. Many organizations have standardized on Heathkits providing uniform service departments.

There is no waste space or false effort to appear large in Heathkits — space on service benches is limited and the size of Heathkit instruments is kept as small as is consistent with good engineering practice.



### Accuracy ASSURED BY PRECISION PARTS

Wherever required, the finest quality 1% ceramic resistors are supplied. These require no aging and do not shift. No matching of common resistors is required. You find in Heathkit the same quality voltage divider resistors as in the most expensive equipment.

The transformers are designed especially for the Heathkit unit. The scope transformer has two electrostatic shields to prevent interaction of AC fields.

These transformers are built by several of the finest transformer companies in the United States.

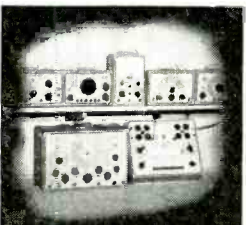

### Used BY LEADING MANUFACTURERS

Leading TV and radio manufacturers use hundreds of Heathkits on the assembly lines. Heathkit scopes are used in the alignment of TV tuners. Impedance bridges are serving every day in the manufacture of transformers. Heathkit VTVM's are built into the production lines and test benches. Many manufacturers assemble Heathkits in quantity for their own use thus keeping purchase cost down.

### Famous HEATHKIT PARTS

- MALLORY FILTER CONDENSERS
- WILKOR PRECISION RESISTORS
- GRIGSBY ALLISON SWITCHES
- ALLEN-BRADLEY RESISTORS
- GENERAL ELECTRIC TUBES
- CHICAGO TRANSFORMER
- CENTRALAB CONTROLS
- SIMPSON METERS
- CINCH SOCKETS

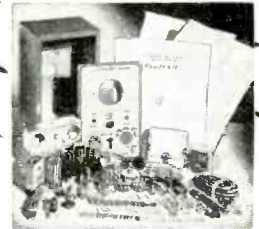

### Complete KITS WITH PARTS THAT FIT...

When you receive your Heathkit, you are assured of every necessary part for the proper operation of the instrument.

Beautiful cabinets, handles, two-color panels, all tubes, test leads where they are a necessary part of the instrument, quality rubber line cords and plugs, rubber feet for each instrument, all scales and dials ready printed and calibrated. Every Heathkit is 110 V 60 Cy. power transformer operated by a husky transformer especially designed for the job. Heathkit chassis are precision punched for ease of assembly. Special engineering for simplicity of assembly is carefully considered.



### Complete INSTRUCTION MANUALS

Heathkit instruction manuals contain complete assembly data arranged in a step-by-step manner. There are pictorials of each phase of the assembly drawn by competent artists with detail allowing the actual identification of parts. Where necessary, a separate section is devoted to the use of the instrument. Actual photos are included to aid in the proper location of wiring.

### Used BY LEADING UNIVERSITIES

Heathkits are found in every leading university from Massachusetts to California. Students learn much more when they actually assemble the instrument they use. Technical schools often include Heathkits in their course and these become the property of the students. High schools, too, find that the purchase of inexpensive Heathkits allows their budget to go much further and provides much more complete laboratories.

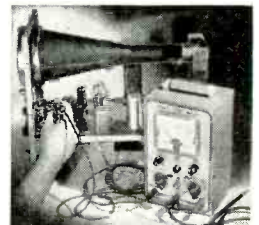

**YOU SAVE BY ORDERING DIRECT FROM MANUFACTURER—USE ORDER BLANK ON LAST PAGE**

EXPORT DEPT.  
13 East 40th St.  
NEW YORK CITY (16)  
CABLE: ARLAB—N.Y.

**The HEATH COMPANY**

**... BENTON HARBOR 20, MICHIGAN**



# 12 Improvements IN NEW 1951

MODEL O-6

PUSH-PULL

## Heathkit OSCILLOSCOPE KIT



Only **\$39<sup>50</sup>**

### New INEXPENSIVE MODEL S-2 ELECTRONIC SWITCH KIT

Twice as much fun with your oscilloscope — observe two traces at once — see both the input and output traces of an amplifier, and amazingly you can control the size and position of each trace separately — superimpose them for comparison or separate for observation — no connections inside scope. All operation electronic, nothing mechanical — ideal for classroom demonstrations — checking for intermittents, etc. Distortion, phase shift and other defects show up instantly. Can be used with any type or make of oscilloscope. So inexpensive you can't afford to be without one.

Has individual gain controls, positioning control and coarse and fine switching rate controls — can also be used as square wave generator over limited range. 110 Volt transformer operated comes complete with tubes, cabinet and all parts. Occupies very little space beside the scope. Better get one. You'll enjoy it immensely. Model S-2. Shipping Wt., 11 lbs.



Only  
**\$19<sup>50</sup>**

- ★ New AC and DC push-pull amplifier.
- ★ New step attenuator frequency compensated input.
- ★ New non frequency discriminating input control.
- ★ New heavy duty power transformer has 68% less magnetic field.
- ★ New filter condenser has separate vertical and horizontal sections.
- ★ New intensity circuit gives greater brilliance.
- ★ Improved amplifiers for better response useful to 2 megacycles.
- ★ High gain amplifiers .04 Volts RMS per inch deflection.
- ★ Improved Allegheny Ludlum magnetic metal CR tube shield.
- ★ New synchronization circuit works with either positive or negative peaks of signal.
- ★ New extended range sweep circuit 15 cycles to over 100,000 cycles.
- ★ Both vertical and horizontal amplifier use push-pull pentodes for maximum gain.

The new 1951 Heathkit Push-Pull Oscilloscope Kit is again the best buy. No other kit offers half the features — check them.

Measure either AC or DC on this new scope — the first oscilloscope under \$100.00 with a DC amplifier.

The vertical amplifier has frequency compensated step attenuator input into a cathode follower stage. The gain control is of the non frequency discriminating type — accurate response at any setting. A push-pull pentode stage feeds the C.R. tube. New type positioning control has wide range for observing any portion of the trace.

The horizontal amplifiers are direct coupled to the C.R. tube and may be used as either AC or DC amplifiers. Separate binding posts are provided for AC or DC.

The multivibrator type sweep generator has new frequency compensation for the high range it covers; 15 cycles to cover 100,000 cycles.

The new model O-6 Scope uses 10 tubes in all — several more than any other. Only Heathkit Scopes have all the features.

New husky heavy duty power transformer has 50% more laminations. It runs cool and has the lowest possible magnetic field. A complete electrostatic shield covers primary and other necessary windings and has lead brought out for proper grounding.

The new filter condenser has separate filters for the vertical and horizontal screen grids and prevents interaction between them.

An improved intensity circuit provides almost double previous brilliance and better intensity modulation.

A new synchronization circuit allows the trace to be synchronized with either the positive or negative pulse, an important feature in observing the complex pulses encountered in television servicing.

The magnetic alloy shield supplied for the C.R. tube is of new design and uses a special metal developed by Allegheny Ludlum for such applications.

The Heathkit scope cabinet is of aluminum alloy for lightness of portability.

The kit is complete, all tubes, cabinet, transformer, controls, grid screen, tube shield, etc. The instruction manual has complete step-by-step assembly and pictorials of every section. Compare it with all others and you will buy a Heathkit. Model O-6. Shipping Wt., 30 lbs.

**YOU SAVE BY ORDERING DIRECT FROM MANUFACTURER — USE ORDER BLANK ON LAST PAGE**

EXPORT DEPT.  
13 East 40th St.  
NEW YORK CITY (16)  
CABLE: ARLAB-N.Y.

**The HEATH COMPANY**

**... BENTON HARBOR 20, MICHIGAN**

RADIO-ELECTRONICS for

New 1951 • • MODEL V-4A

# Heathkit VTVM KIT

HAS EVERY EXPENSIVE *Feature*

- ★ Higher AC input impedance, (greater than 1 megohm at 1000 cycles).
- ★ New AC voltmeter flat within 1 db 20 cycles to 2 megacycles (600 ohm source).
- ★ New accessory probe (extra) extends DC range to 30,000 Volts.
- ★ New high quality Simpson 200 microampere meter.
- ★ New 1/2% voltage divider resistors (finest available).
- ★ 24 Complete ranges.
- ★ Low voltage range 3 Volts full scale (1/5 of scale per volt).
- ★ Crystal probe (extra) extends RF range to 250 megacycles.
- ★ Modern push-pull electronic voltmeter on both AC and DC.
- ★ Completely transformer operated isolated from line for safety.
- ★ Largest scale available on streamline 4 1/2 inch meter.
- ★ Burn-out proof meter circuit.
- ★ Isolated probe for dynamic testing no circuit loading.
- ★ New simplified switches for easy assembly.

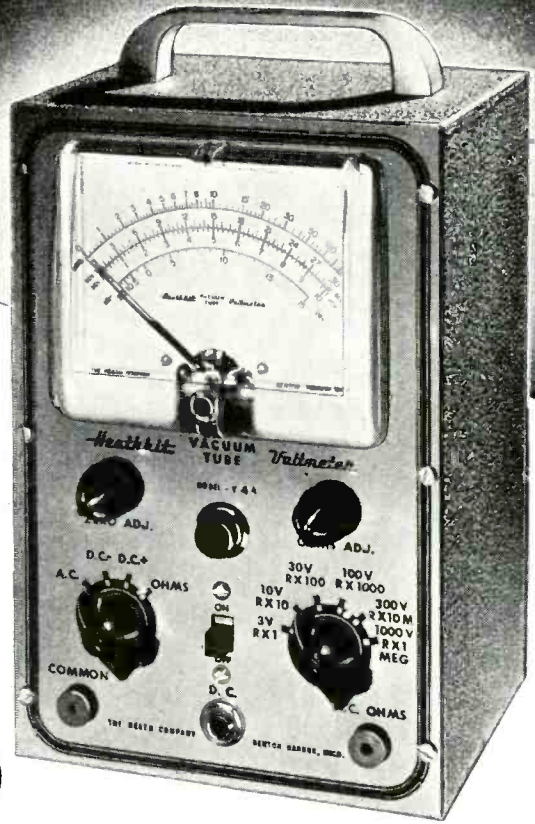

*New*  
**LOW PRICE \$23.50**

The new Heathkit Model V-4A VTVM Kit measures to 30,000 Volts DC and 250 megacycles with accessory probes — think of it, all in one electronic instrument more useful than ever before. The AC voltmeter is so flat and extended in its response it eliminates the need for separate expensive AC VTVM's. + or - db from 20 cycles to 2 megacycles. Meter has decibel ranges for direct reading. New zero center on meter scale for quick FM alignment.

There are six complete ranges for each function. Four functions give total of 24 ranges. The 3 Volt range allows 33 1/3% of the scale for reading one volt as against only 20% of the scale on 5 Volt types.

The ranges decade for quick reading.

New 1/2% ceramic precision are the most accurate commercial resistors available — you find the same make and quality in the finest laboratory equipment selling for thousands of dollars. The entire voltage divider decade uses these 1/2% resistors.

New 200 microampere 4 1/2" streamline meter with Simpson quality movement. Five times as sensitive as commonly used 1 MA meters.

Shatterproof plastic meter face for maximum protection. Both AC and DC voltmeter use push-pull electronic voltmeter circuit with burn-out proof meter circuit.

Electronic ohmmeter circuit measures resistance over the amazing range of 1/10 ohm to one billion ohms all with internal 3 Volt battery. Ohmmeter batteries mount on the chassis in snap-in mounting for easy replacement.

Voltage ranges are full scale 3 Volts, 10 Volts, 30 Volts, 100 Volts, 300 Volts, 1000 Volts. Complete decading coverage without gaps.

The DC probe is isolated for dynamic measurements. Negligible circuit loading. Gets the accurate reading without disturbing the operation of the instrument under test. Kit comes complete, cabinet, transformer, Simpson meter, test leads, complete assembly and instruction manual. Compare it with all others and you will buy a Heathkit. Model V-4A. Shipping Wt., 8 lbs. Note new low price, \$23.50



**New 30,000 VOLT DC  
PROBE KIT**

Beautiful new red and black plastic high voltage probe. Increases input resistance to 1100 megohms, reads 30,000 Volts on 300 Volt range. High input impedance for minimum loading of weak television voltages. Has large plastic insulator rings between handle and point for maximum safety. Comes complete with PL55 type plug.

No. 3366 High Voltage Probe Kit.  
Shipping Wt., 2 pounds.

**\$550**

---



**Heathkit  
RF PROBE KIT**

Crystal diode probe kit extends range to 250 megacycles = 10% comes complete with all parts, crystal, cable and PL55 type plug.

No. 309 RF Probe Kit  
Shipping Wt., 1 lb.

**\$550**

**YOU SAVE BY ORDERING DIRECT FROM MANUFACTURER — USE ORDER BLANK ON LAST PAGE**

EXPORT DEPT.  
13 East 40th St.  
NEW YORK CITY (16)  
CABLE: ARLAB-N.Y.

**The HEATH COMPANY**

**... BENTON HARBOR 20, MICHIGAN**



# NEW Heathkit T.V. ALIGNMENT GENERATOR KIT

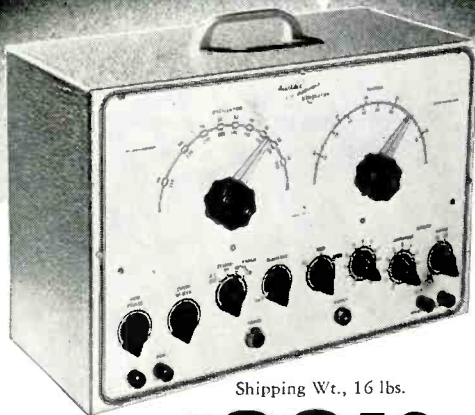

Shipping Wt., 16 lbs.

**\$39.50**

- New 2 band marker 19 to 75 megacycles.
- New simplified circuit for easy calibration and assembly.
- New simplified calibration and assembly.
- Blanking circuit gives reference base line to trace.
- New 2 band built-in marker covers 19 to 75 Mc.
- New dual spider sweep motor for long life.
- New blanking circuit gives base line for better alignment.
- New variable oscillator gives high output fundamentals on high TV-band.
- New variable oscillator gives high output on high band.
- New standby switch keeps instrument ready for instant use.
- New 6 to 1 slow speed drive on both master oscillator and marker tuners.

The new Heathkit TV Alignment Generator incorporates the new developments required for modern TV servicing. An absorption marker circuit covering all possible IF bands and even several of the RF bands. The new blanking circuit provides a base reference line which is invaluable in establishing proper traces. The new sweep motor incorporates dual spiders in the speaker frame assuring better alignment and long life. The mounting of the speaker sweep motor has been simplified for easy alignment.

The variable master oscillator covers 140 to 230 Mc. thus giving high output fundamentals where they are most needed. Low band coverage 2 Mc. to 90 Mc.

A new step attenuator provides excellent control of output.

Planetary 6 to 1 drives on both oscillator and marker provides smooth easy control settings.

A standby position is provided making the instrument always instantly available.

Horizontal sweep voltage with phasing control is provided. No other sweep generator under \$100.00 provides all these features — comes complete with instruction manual. Model TS-2.

## Heathkit CONDENSER CHECKER KIT

Only **\$19.50**

### Features

- Power factor scale.
- Measures resistance.
- Measures leakage.
- Checks paper-mica-electrolytics.
- Bridge type circuit.
- Magic eye indicator.
- 110 V. transformer operated.
- All scales on panel.

Checks all types of condensers over a range of .00001 MFD to 1,000 MFD. All on readable scales that are read direct from the panel. NO CHARTS OR MULTIPLIERS NECESSARY. A condenser checker anyone can read. A leakage test and polarizing voltage for 20 to 500 Volts provided. Measures power factor of electrolytics between 0% and 50%. 110 V. 60 cycle transformer operated complete with rectifier and magic eye tube, cabinet, calibrated panel, test leads and all other parts. Clear detailed instructions for assembly and use. Model C-2. Shipping Wt., 7 lbs.

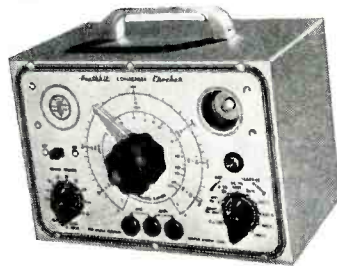

## NEW Heathkit SIGNAL TRACER AND UNIVERSAL TEST SPEAKER KIT

**\$19.50**

### Features

- High sensitivity
- Complete set of speaker impedances
- Tests microphones and PA systems
- Tests both single and push-pull speaker circuits

The popular Heathkit Signal Tracer has now been combined with a universal test speaker at no increase in price. The same high quality tracer follows signal from antenna to speaker — locates intermittents — defective parts quicker — saves valuable service time — gives greater income per service hour. Works equally well on broadcast — FM or TV receivers. The test speaker has assortment of switching ranges to match push-pull or single output impedance. Also test microphones, PA systems — comes complete — cabinet, 110 V. 60 cycle power transformer — tubes, test probe, all parts and detailed instructions for assembly and use. Model T-2. Shipping Wt., 8 lbs.

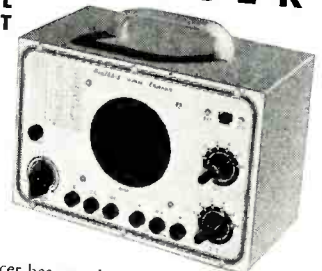

## Heathkit TUBE CHECKER KIT

### Features

Sockets for every modern tube — blank for new types.

Fastest method of testing tubes — saves time — makes more profit.

Rugged counter type birch cabinet.

Test your tubes the modern way — dynamically — the simplest, yet fastest and surest method — your Heathkit has a switch for each tube element and measures that element — no chance for open or shorted elements slipping by, all the advantages of the mutual conductance type without the slow cumbersome time consuming setups.

Your Heathkit Tube Checker has all the features — beautiful 3 color BAD-GOOD meter — complete selection of voltages — roller chart listing hundreds of tubes including the new 9 pin miniatures — finest quality Centralab lever switches for each element — high grade birch counter type cabinet — continuously variable line adjust control — every feature you need to sell tubes properly. The most modern type tube checker with complete protection against obsolescence. The best of parts — rugged oversize 110 V. 60 cycle power transformer — finest of Mallory and Centralab switches and controls, complete set of sockets for all type tubes with blank spare for future types. Fast action brass gear driven roller chart quickly locates the settings for any type tube. Simplified switching cuts necessary testing time to minimum and saves valuable service time. Short and open element check. Simple method allows instant setup of new tube types without waiting for factory data. No matter what the arrangements of tube elements, the Heathkit flexible switching arrangement easily handles it. Order your Heathkit Tube Checker Kit today. See for yourself that Heath again saves you two-thirds and yet retains all the quality — this tube checker will pay for itself in a few weeks — better assemble it now. Complete with instructions — pictorial diagrams — all parts — cabinet — ready to wire up and operate. Model TC-1 Shipping Wt., 12 lbs.

Gear driven roller chart gives instant setup for all types.

Tests each element separately for open or short and quality.

Beautiful 3 color meter — reads good-bad and line set point.

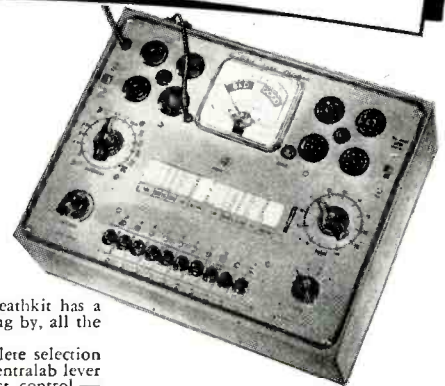

**\$29.50**

**YOU SAVE BY ORDERING DIRECT FROM MANUFACTURER — USE ORDER BLANK ON LAST PAGE**

EXPORT DEPT.  
13 East 40th St.  
NEW YORK CITY (16)  
CABLE: ARLAB-N.Y.

**The HEATH COMPANY**

**... BENTON HARBOR 20, MICHIGAN**

RADIO-ELECTRONICS for

NEW 1951  
*Heathkit*

# SIGNAL GENERATOR KIT

## Features

- Sine wave audio modulation.
- Extended range 160 Kc. to 50 megacycles fundamentals.
- New step attenuator output.
- New miniature HF tubes.
- Transformer operated for safety.
- Calibrated harmonics to 150 megacycles.
- New external modulation switch.
- 5 to 1 vernier tuning for accurate settings.

A completely new Heathkit Signal Generator Kit. Dozens of improvements. The range on fundamentals has been extended to over .50 megacycles; makes this Heathkit ideal as a marker oscillator for T.V. New step attenuator gives controlled outputs from very low values to high output. A continuously variable control is used with each step. New miniature HF tubes are required for the high frequencies covered.

Uses 6C4 master oscillator and 6C4 sine wave audio oscillator. The set is transformer operated and a husky selenium rectifier is used in the power supply. The coils are precision wound and checked for calibration making only one adjustment necessary for all bands.

New sine wave audio oscillator provides internal modulation and is also available for external audio testing. Switch provided allows the oscillator to be modulated by an external audio oscillator for fidelity testing of receivers.

A best buy — think of all the features for less than \$20.00. The entire coil and tuning assembly are assembled on a separate turret for quick assembly — comes complete — all tubes — cabinet — test leads — every part. The instruction manual has step-by-step instructions and pictorials. It's easy and fun to build a Heathkit Model SG-6 Signal Generator. Shipping Wt., 7 lbs.



**\$19.50**

## Heathkit SINE AND SQUARE WAVE AUDIO GENERATOR KIT

Either sine or square wave.  
Stable RC bridge circuit.  
Covers 20 to 20,000 cycles.  
Less than 1% distortion.

Hundreds of Heathkit Audio Generators are used by speaker manufacturers—definite proof of their quality and dependability. The added feature of square wave opens up an entirely new field of amplifier testing. Uses the best of parts, 4 gang condenser, 1% calibrating resistors, metal cased filter condensers, 5 tubes, completely calibrated panel and detailed instruction manual. One of our best and most useful kits. Model G-2. Shipping Wt., 12 lbs.



**\$34.50**

## THE NEW Heathkit HANDITESTER KIT

- Beautiful streamline Bakelite case.
- AC and DC ranges to 5,000 Volts.
- 1% Precision ceramic resistors.
- Convenient thumb type adjust control.
- 400 Microampere meter movement.
- Quality Bradley AC rectifier.
- Multiplying type ohms ranges.
- All the convenient ranges 10-30-300-1,000-5,000 Volts.
- Large quality 3" built-in meter.



**\$13.50**

A precision portable volt-ohm-milliammeter. An ideal instrument for students, radio service, experimenters, hobbyists, electricians, mechanics, etc. Rugged 400 ua meter movement. Twelve complete ranges, precision dividers for accuracy. Easily assembled from complete instructions and pictorial diagrams. An hour of assembly saves one-half the cost. Order today. Model M-1. Shipping Wt., 2 lbs.

## NEW Heathkit BATTERY ELIMINATOR KIT

### Features

- Provides variable DC voltage for all checks.
- Voltmeter for accurate check.
- Locates sticky vibrators-intermittents.
- Has 4000 MFD Mallory filter for ripple-free voltage.

Even the smallest shop can afford the Heathkit Battery Eliminator Kit. A few auto radio repair jobs will pay for it. It's fast for service, the voltage can be lowered to find sticky vibrators or raised to ferret out intermittents. Provides variable DC voltage 5 to 7½ Volts at 10 Amperes continuous or 15 Amperes intermittent. Also serves as storage battery charger. Ideal for all auto radio testing and demonstrating.

A well filtered rugged power supply uses heavy duty selenium rectifier, choke input filter with 4,000 MFD of electrolytic filter for clean DC. 0-15 V. voltmeter indicates output which is variable in eight steps. Easily constructed in a few hours from our instructions and diagrams — better be equipped for all types of service — it means more income. Model BE-2. Shipping Wt., 19 lbs.



**\$22.50**

YOU SAVE BY ORDERING DIRECT FROM MANUFACTURER—USE ORDER BLANK ON LAST PAGE

EXPORT DEPT.  
13 East 40th St.  
NEW YORK CITY (16)  
CABLE: ARLAB—N.Y.

The **HEATH COMPANY**

... BENTON HARBOR 20, MICHIGAN



**New LABORATORY INSTRUMENT KITS**

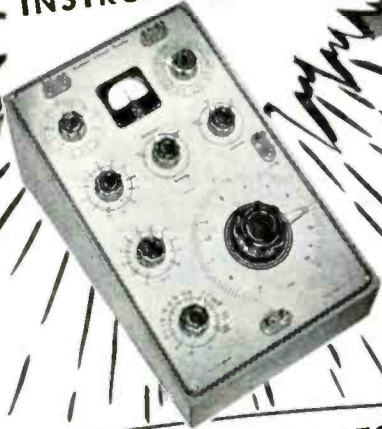

**HUNDREDS OF LABORATORIES USE Heathkit IMPEDANCE BRIDGE as Standard**

**Features**

- Measures inductance 10 microhenries to 100 henries • Measures resistance .01 ohms to 10 megohms • Measures capacitance .00001 MFD to 100 MFD • Measures "Q" and power factor.

Measures inductance from 10 microhenries to 100 henries, capacitance from .00001 MFD to 100 MFD. Resistance from .01 ohms to 10 megohms. Dissipation factor from .001 to 1. "Q" from 1 to 1,000. Ideal for schools, laboratories, service shops, serious experimenters. An impedance bridge for everyone — the most useful instrument of all, which heretofore has been out of the price range of serious experimenters and service shops. Now at the lowest price possible. All highest quality parts. General Radio main calibrated control. General Radio 1,000 cycle hummer. Mallory ceramic switches with 60 degree indexing — 200 microamp type binding posts with standard 3/4" centers. Beautiful birch cabinet. Directly calibrated "Q" and dissipation factor scales. Ready calibrated capacity and inductance standards of Silver Mica, accurate to 1/2 of 1% and with dissipation factors of less than 30 parts in one million. Provisions on panel for external generator and detector. Measure all your unknowns the way laboratories do — with a bridge for accuracy and speed.

**\$69.50**

Internal 6 Volt battery for resistance and hummer operations. Circuit utilizes Wheatstone, Hay and Maxwell circuits for different measurements. Supplied complete with every quality part — all calibrations completed and instruction manual for assembly and use. Deliveries are limited. Model IB-1. Shipping Wt., 15 lbs.

**NEW Heathkit LABORATORY RESISTANCE DECADE KIT**

**Features**



- 1/2% Accuracy
- Birch Cabinet
- Ceramic Switches
- Covers 1 ohm to 99,999 ohms

The new Heathkit Resistance Decade is a handy tool for laboratory, school and service shop. Ideal for test setups, calibrating instruments, bridge measurements, selecting multipliers, etc.

**\$19.50**

Uses the finest Centralab ceramic switches, 1/2% ceramic decade resistors and heavy birch cabinet matching other laboratory equipment. The range is 1 ohm to 99,999 ohms in one ohm steps.

Finest quality throughout to withstand school usage — heavy aluminum panel — laboratory type binding posts — the fine decades are extremely simple to assemble — complete kit. Model RD-1. Shipping Wt., 4 lbs.

**NEW Heathkit LABORATORY POWER SUPPLY KIT**

**Features**

- Supplies 6.3 V. AC at 4.5 Amps.
- Heavy duty construction.
- Handy for schools, labs., and service shops.
- Supplies variable DC 50-300 Volts.
- Shows voltage or current on 3 1/2" meter.



This new Heathkit Variable Power Supply Kit fills hundreds of needs — use it for experimental circuits — no need to build a separate power supply — use it for a test voltage to determine proper coefficients in unknown circuits — calibrate instruments with its variable voltage, etc. This new Heathkit supplies 50 to 300 Volts continuously variable DC together with an AC filament voltage of 6.3 Volts at 4.5 Amperes. A built-in 1 MA 3 1/2" meter has proper shunts to read 0-500 Volts and 0-200 Milliamperes. The circuit uses a 5Y3 rectifier, two 1619 tubes as electronic control 7 1/8" x 13" x 7 1/8". Has instruction manual for assembly and use. Model PS-1. Shipping Wt., 18 lbs.

**\$29.50**

**Heathkit RECEIVER & TUNER KITS for AM and FM**

**TWO HIGH QUALITY Heathkit SUPERHETERODYNE RECEIVER KITS**

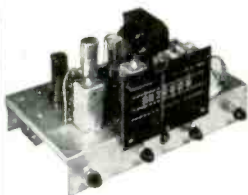

Model BR-1 Broadcast Model Kit covers 550 to 1600 Kc. Shipping Wt., 10 pounds.

**\$19.50**

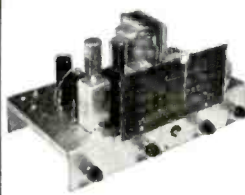

Model AR-1 3 Band Receiver Kit covers 550 Kc. to over 20 Mc. continuous. Extremely high sensitivity. Shipping Wt., 10 lbs.

**\$23.50**

Two new Heathkits. Ideal for schools, replacement of worn out receivers, amateurs and custom installations.

Both are transformer operated quality units. The best of materials are used throughout — six inch calibrated slide rule dial — quality power and output transformers — dual iron core shielded I.F. coils — metal filter condensers and all other parts. The chassis has phono input jack — 110 Volt outlet for phono motor and there is a phono-radio switch on panel. A large metal panel simplifying installation in used console cabinets is included. Comes complete with tubes and instruction manual incorporating pictorials and step-by-step instructions (less speaker and cabinet). The three band model has simple coil turret which is assembled separately for ease of construction.

**TRUE FM FROM Heathkit FM TUNER KIT**

**\$22.50**



The Heathkit FM Tuner Model FM-2 was designed for best possible tonal reproduction. The circuit incorporates the most desirable FM features — true FM — ready wound and adjusted coils — 3 stages of 10.7 Mc. I.F. (including limiter).

Tube lineup: 7E5 oscillator, 6SH7 mixer, two 6SH7 I.F. stages, 6SH7 limiter, two 7CA diodes as discriminator, 6X5 rectifier.

The instrument is transformer operated making it safe for connection to any type receiver or amplifier. The R.F. coils are ready wound — mounted on the tuning condenser and the condenser is adjusted — no R.F. coils to wind or adjust.

A calibrated six inch slide rule dial has vernier drive for easy tuning. The finest parts are provided with all tubes, punched and formed chassis, transformers, condensers and complete instruction manual. Model FM-2. Shipping Wt., 10 lbs.

EXPORT DEPT.  
13 East 40th St.  
NEW YORK CITY (16)  
CABLE: ARLAB-N.Y.

**The HEATH COMPANY**

**... BENTON HARBOR 20, MICHIGAN**

# ENJOY MUSIC AT ITS *Finest* WITH **Heathkit AMPLIFIERS**

## NEW *Heathkit* HIGH FIDELITY 20 WATT **AMPLIFIER KIT**



**\$21.50**

### Features

- Push-pull 6L6's.
- Full 20 Watts output.
- Fully enclosed chassis.
- Provisions for reluctance pickup compensation stage.
- Cased high fidelity output transformer.
- Treble and bass boost controls.
- Full range of output impedances 3.2 ohms to 500 ohms.

The finest amplifier kit we have ever offered — check the features. This inexpensive amplifier compares favorably with instruments costing five times as much. Nothing has been spared to provide the best reproduction — an ideal amplifier for the new Heathkit FM Tuner listed below.

Dual tone controls for control of both treble and bass. Bass control is of the boost type for maximum listening pleasure. Optional preamplifier stage for use with G. E. reluctance pickup or microphone. Uses inverse feedback to give excellent response over entire range. Tube lineup: 6SJ7 preamplifier stage, 6J5 phase splitter stage, two 6L6's in push-pull and 5Y3 rectifier. (6SC7 as optional compensation stage).

Uses highest quality Chicago Transformer Corporation cased output transformer with taps of 3.2, 8, 15, 60 and 500 ohms to match any speaker combination. Power transformer is conservatively rated for continuous operation in sound systems. Tone control gives maximum bass boost of 6 db at 70 cycles. Amplifier has maximum gain of 75 db. Response within 3 db 20 to 20,000 cycles. Shipping Wt., 17 lbs. Complete with all parts, tubes and instruction manual.

Model A-5A Amplifier with preamplifier for G. E. cartridges or microphone **\$23.50**  
12" 20 Watt Speaker, No. 326..... **7.50**

## *Heathkit* ECONOMY 6 WATT PUSH-PULL **AMPLIFIER KIT**



**\$12.50**

No. 301, 12-inch Speaker... **\$6.95**

This new Heathkit Amplifier was designed to give quality reproduction at a very low price. Has two preamp stages, phase inverter stage and push-pull beam power output. Comes complete with six tubes, quality output transformer (to 3-4 ohm voice coil), husky cased power transformer and all other parts. Has tone and volume controls. Instruction manual and all flat + 1 1/2 db from 50 to 15,000 cycles. A quality amplifier kit at new low price. Better build one. Model A-4. Shipping Wt., 7 lbs.

## *Heathkit* RECEIVERS and TUNER CABINETS



**\$4.95**

Order No. 350 for FM tuner.

Blonde birch veneer cabinet for either the receivers or tuner. Modern styling is an asset to any room. 5" speaker fits in end of cabinet when used with receivers. Size 7 x 13 1/2 x 8 1/4 inches. Shipping Wt., 5 lbs. Order No. 345 for either receiver

Metal professional type communications receiver cabinet. Finished in deep grey to fit the panel supplied with Heathkit BR-1 and AR-1 Receivers (panel shown not included with cabinet). 5" speaker mounts in end of cabinet. Gives professional appearance to Heathkit receivers. Size 7 x 14 x 7 3/4 inches. Shipping Wt., 6 lbs.

5" Permoflux Speaker for either cabinet for use with either Heathkit Receiver No. 320 5" Speaker..... **\$2.75**



**\$4.50**

No. 355 Cabinet for receivers only.

# ORDER BLANK

**7c HEATH COMPANY**  
BENTON HARBOR 20,  
MICHIGAN

From \_\_\_\_\_  
\_\_\_\_\_  
\_\_\_\_\_

**SHIP VIA**  
 Parcel Post  
 Express  
 Freight  
 Best Way

(PLEASE PRINT)

Quantity	Item	Price	Quantity	Item	Price
	Heathkit Oscilloscope Kit—Model O-5			Heathkit T.V. Alignment Gen. Kit—TS-2	
	Heathkit VTVM Kit—Model V-4A			Heathkit R.F. Probe Kit—No. 309	
	Heathkit FM Tuner Kit—FM-2			Heathkit H.V. Probe Kit—No. 336	
	Heathkit Broadcast Receiver Kit—Model BR-1			Heathkit R.F. Signal Gen. Kit—Model G-5	
	Heathkit Three Band Receiver Kit—Model AR-1			Heathkit Condenser Checker Kit—Model C-2	
	Heathkit Amplifier Kit—Model A-4			Heathkit Handitester Kit—Model M-1	
	Heathkit Amplifier Kit—Model A-5 (or A-5 A)			Heathkit Variable Power Supply Kit—Model PS-1	
	Heathkit Tube Checker Kit—Model TC-1			Heathkit Resistance Decade Kit—Model RD-1	
	Heathkit Audio Generator Kit—Model G-2			Heathkit Impedance Bridge Kit—Model IB-1	
	Heathkit Battery Eliminator Kit—Model BE-2			Heathkit Signal Tracer Kit—Model T-2	
	Heathkit Electronic Switch Kit—Model S-1				

On Parcel Post Orders, include postage for weight shown and insurance. (We insure all shipments).  
On Express Orders, do not include transportation charges—they will be collected by the Express Agency at time of delivery.

Enclosed find  Check  Money Order for \_\_\_\_\_  
Please ship C.O.D.  Postage enclosed for \_\_\_\_\_ lbs.

EXPORT DEPT.  
13 East 40th St.  
NEW YORK CITY (16)  
CABLE: ARLAB-N.Y.

*The* **HEATH COMPANY**  
... BENTON HARBOR 20, MICHIGAN



**DON'T MISS THIS MARKET**  
**DON'T MISS THESE PROFITS**  
**DON'T MISS**



Complete Set  
**\$39.95**  
 with 50' cable

# Callmaster

Electronic 2-Way Communicator

## RADIO-TV SERVICEMEN and DEALERS

... across the country ... reap quick, easy, and **GENEROUS** profits ... demonstrating, selling Callmaster ... on every service call!

Doctors, dentists, homeowners, garages, clubs, cafes, etc. ... buy Callmaster on one 2½ minute demonstration ... because Callmaster is the right "seller" ... at the right price ... in a wide-open, "ripe" market ... that's right for you ... now!

**CALLMASTER** gets the call for ...

**PERFORMANCE** ... perfect sound fidelity. Even a whisper is received clear and true.

**SIZE** ... compact. 7" x 5½" x 3½". Less space than a telephone.

**APPEARANCE** ... lustrous, mahogany-grained plastic cabinet. Extra-thick, electric-shock-proof. Bakelite control knobs.

**PRECISION BUILT** ... engineered to rigid specifications. All components top quality. No "surplus" parts used in Callmaster!

**INSTALLATION** ... easier to hook-up than standard door-bell system.

**SERVICE** ... durable, rugged Callmaster doesn't have to be "babied". RMA warranty.

**COMPLETE LINE** ... Master and sub-station sets (illus.) Multi sub-stations systems with Selective Masters, de luxe-All-Master systems.

**DEALERS** ... ask your supplier about the Callmaster "Profit Package" ... or write for name of distributor nearest you.

**WM. M. SMITH COMPANY**  
 National Sales Office  
 20 FERGUSON AVE., BROOMALL, PA.

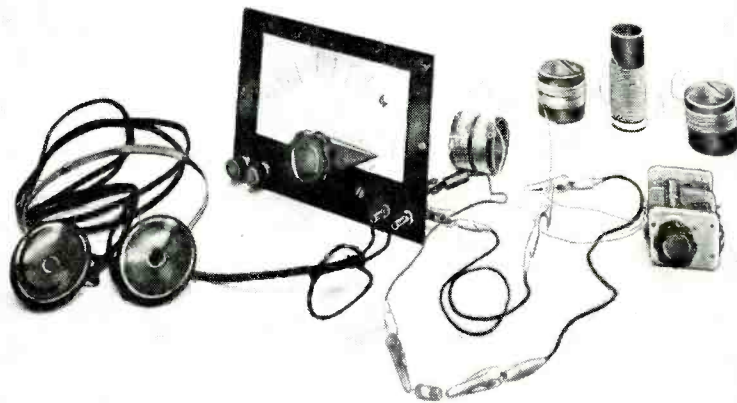

A few coils, two tuning capacitors, headphones, and a germanium crystal are all that you need to build a crystal receiver that is amazingly sensitive.

## Germanium Crystal Receivers Pick Up European Broadcasts

By **DR. WM. H. GRACE, JR.**

**D**URING some experiments with 1N34 and 1N56 germanium diodes, we were surprised by accidental reception of signals from BBC in London. These signals were identified as coming directly from London and were not rebroadcasts of BBC programs from Canada. The tests being conducted were on frequencies much lower than the 25- and 31-meter bands on which BBC programs are broadcast, and the reason for the interference was at first a mystery. By accident we discovered one section of the rectifier circuit had a natural frequency of just about 25 meters and was picking up signals from the London station.

Our location, about 20 miles north of New York, is not especially well situated for shortwave reception. The site is in a shallow valley with rising ground to the eastward, yet the interference from London was checked by newscasts, time announcements, and the chimes of Big Ben, with corresponding time difference.

We decided to put together an experimental tuner using germanium diodes to cover the foreign shortwave bands and investigate further what could be heard with a crystal detector. The only antenna available was one used for broadcast reception and it was not very efficient even for this. It was a single 60-foot length of No. 30 enameled wire below roof level between two sections of an apartment house. About 60 feet of the same wire were used as a lead-in, and the open end of the antenna pointed northeast. The reason for the very small sized wire was to render the antenna "invisible" to a landlord who is very allergic to radio antennas.

The parts, with the exception of the coils, came from the junk box. The coils were simple thin-walled cardboard tubes 1 inch in diameter, dipped in melted parafin wax before winding. All windings were made with No. 24 double cotton-covered wire. Two broad-

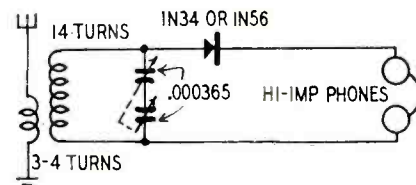

Fig. 1—Though it tunes broadly, this conventional circuit works quite well.

cast two-gang variable capacitors of .000365 µf per section were available, and the sections were connected in series. This reduced the capacitance by half, which was more than ample for the purpose. A crystal diode and a good pair of high-impedance headphones completed the assembly. The latter are a necessity because many of these signals are of modest volume.

We tried several circuits. The first (Fig. 1) is conventional but brought immediate results though tuning rather broadly. Considerable QRM was picked up from WLWO, Cincinnati, which broadcasts Voice of America programs

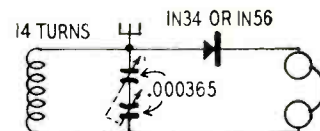

Fig. 2—This hookup is the same as the one in Fig. 1 except that the gain is boosted by a direct antenna connection.

RADIO-ELECTRONICS for

Over 50,000 SERVICEMEN must be right!

# NEW.. **EICO** Instruments and **KITS** give you Laboratory Precision at Lowest Cost!

## VACUUM TUBE VOLTMETER

Versatile top-quality laboratory-precision VTVM for trigger-fast operation and lifetime dependable service.

15 different ranges. Large rugged 4½" meter, can't-burn-out circuit. New zero center for TV & FM discriminator alignment. Electronic AC & DC ranges: 0-5, 10, 100, 500, 1000 v. (30,000 volts and 200 MC with HVP-1 and P-75 probes). Ohmmeter ranges, .2 ohms to 1000 megs. DB scale. New stable double-triode balanced bridge circuit—extreme accuracy. 26 megs DC input impedance. Attractive 3-color etched rubproof panel; rugged steel case. 115 v., 60 cycle AC. 9.7/12 x 6 x 5".

Model 221-K, KIT, only \$23.95

Model 221, factory wired, \$49.95



## New TUBE-TESTER

The brand new professional tube tester and merchandiser EICO Service-Engineered for unbeatable value!

Large 4½" full-vision meter. Tests conventional and TV tubes including 9-pin miniatures. New lever-action switches—tests every tube element. Illuminated "Speedroll Chart." 2 grid caps. Short and open-element tests. Spare socket for new tubes. Protective overload bulb. Electronic rectifier. Handsome 3-color etched rubproof panel; rugged steel case. 115 v., 60 cycle AC. 12½ x 9½ x 4½".

Model 625-K, KIT, only \$29.95

Model 625, factory wired, \$44.95



## 5" PUSH-PULL OSCILLOSCOPE

All-new laboratory-precision scope gives you all the extra sensitivity and response for precise servicing of TV, FM & AM receivers.

Push-pull undistorted vertical and horizontal amplifiers. Boosted sensitivity, .05 to .1 rms volts/inch. Useful to 2.5 MC. TV-type multivibrator sweep circuits, 15 cps—75 KC. Z-axis intensity modulation feature. Dual positioning controls move trace anywhere on screen. Complete with 2-6J5, 3-6SN7, 2-5Y3, 58P1 CRT. Handsome 3-color etched rubproof panel; rugged steel case. 115 v., 60 cycle AC. 8½ x 17 x 13".

Model 425-K, KIT, only \$39.95

Model 425, factory wired, \$69.95



## RF PROBE

Sensitive Germanium crystal probe for signal tracing and measurements to over 200 MC. Extends range of VTVMs and scopes.

Model P-75K KIT, for VTVM; P-76K for Scope; ea. \$3.75

Model P-75 or P-76, factory wired, ea. \$7.50



## HIGH VOLTAGE PROBE

A new professional EICO-engineered MV-probe carefully designed and insulated for extra safety and versatility. Extends range of VTVMs and voltmeters up to 30,000 volts. Lucite head. Large Bushguards. Multi-layer processed handle. Complete with interchangeable ceramic Multiplier to match your instrument.

Model HVP-1, only \$6.95



## New BATTERY ELIMINATOR & CHARGER

The brand new 6-volt power supply EICO Service-Engineered for extra reserve electrical power for all auto radio testing.

Latest-type full wave bridge circuit, extra-heavy-duty 4 stack manganese copper-oxide rectifiers. Latest Variac-type transformer: 0-15 volts output. Continuous operation: 5-8 v., 10 amps; intermittent: 20 amps. 10,000 mfd filter condenser. Rugged meter measures current and voltage output. Double protection: fused primary; automatic reset overload device for secondary. Handsome rugged hammer-tone steel cabinet. 115 v., 60 cycle AC. 10½ x 7¾ x 8¾"

Model 1040-K, KIT, only \$22.50

Model 1040, factory wired, \$29.95

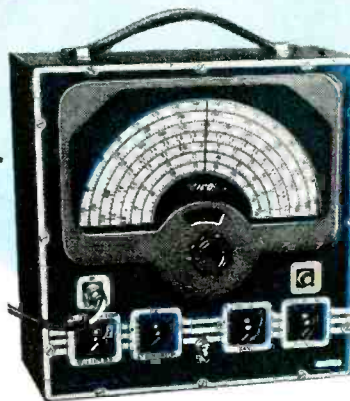

## New Deluxe Kit

### AM-FM-TV SIGNAL GENERATOR

A laboratory-precision generator EICO Service-Engineered with 1% accuracy.

Extremely stable, frequency 75 KC—150 MC in 7 calibrated ranges. Illuminated hairline vernier tuning. VR stabilized line supply. 400-cycle pure sine wave with less than 5% distortion. Tube complement: 6X5, 7F7, 6C4, VR-150. Handsome 3-color etched rubproof panel; rugged steel case. 115 v., 60 cycle AC. 12 x 13 x 7".

Model 315-K, KIT, only \$39.95

Model 315, factory wired, \$59.95

Easy-to-follow step-by-step EICO pictorial & schematic instructions—most explicit & comprehensive in electronics!—supplied with each Kit. Anyone can build the EICO Kits!

See these other EICO Instrument KITS:

Model 320-K Sig Gen KIT, \$19.95

Model 360-K Sweep Gen KIT, \$29.95

Model 145-K Sig Tracer KIT, \$18.95

Model 511-K VOM KIT, \$14.95

## the exclusive EICO Make-Good GUARANTEE

Each EICO Kit and Instrument is doubly guaranteed, by EICO and your jobber to contain only selected quality components. EICO guarantees to replace any component which might become defective in normal use if returned to the factory within 90 days of purchase. EICO guarantees all Kits assembled according to EICO's simplified instructions will operate as specified therein. EICO guarantees service and calibration of every EICO Kit and Instrument at the nominal charge as stated in the instructions.

Be sure to look at the EICO line before you buy any higher-priced equipment from etched rubproof panel to modern engineering design, each EICO Kit and Instrument is cramp-packed with unbelievable value to satisfy the most exacting engineering requirements. YOU be the judge—compare EICO at your local jobber today, and SAVE! Write NOW for free latest Catalog describing the complete EICO line.

**ELECTRONIC INSTRUMENT**  
COMPANY, INC.

276 Newport St., Brooklyn 12, N. Y.

© 1950, Electronic Instrument Co., Inc., Brooklyn, N. Y.





# ..How to STOP GARBLED TV due to poor capacitor retrace

## IN ONE EASY LESSON

You carefully adjust the tuning of a TV receiver. Then—zingo! A few days later, the customer complains about garbled pictures. The set hasn't retraced properly. The difference between its operating temperature and the room temperature has been enough to affect the capacitance stability of the coupling and bypass capacitors and thus upset the critical alignment or synchronization.

Many competitive *molded* tubular capacitors are not sufficiently stable to guard against this annoyance—BUT SPRAGUE TELECAPS MOST CERTAINLY ARE! The reason? These famous molded tubulars are made by an exclusive "dry process", then impregnated under high vacuum. In other words, they're made just like expensive metal-encased oil capacitors. You can use Sprague Telecaps in every TV circuit position. They're as stable as the Rock of Gibraltar—and a sure-fire way to lick capacitor retrace troubles for good! Telecaps have the best temperature coefficient and retrace characteristics of any tubular made.

### SPRAGUE PRODUCTS COMPANY

81 Marshall Street, North Adams, Mass.

(Distributors' Division of the Sprague Electric Company)

# SPRAGUE TELECAP®

PHENOLIC-MOLDED TUBULARS

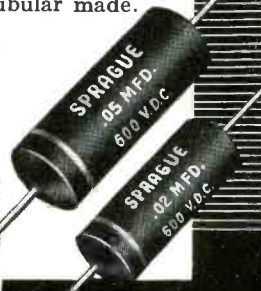

to points outside the U.S.A. Many code, aircraft, and airport ground stations were picked up easily.

Signals appeared louder if the antenna was connected directly as in Fig. 2 or through a series capacitor with no ground connection at all. This circuit tuned even more broadly than the first. In fact, severe interference made station identification difficult with this rig, so the next step was to improve the selectivity by using a double-tuned circuit.

The circuit shown in Fig. 3 gave the best results by far. The coupling between coils was adjusted loosely for best station separation and made a definite improvement without much perceptible reduction in volume. A four-turn primary plus a ground did

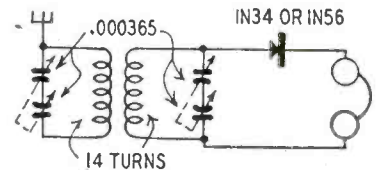

Fig. 3—The double tuning of this hook-up improves selectivity. This circuit was used to pick up European stations.

not better the volume though almost equal results were obtained. Try both ways.

All connections in these experimental tuners were made with clip lead jumpers—obviously poor shortwave practice. Leads should be short, direct, and well soldered for good results as we are dealing with weak currents. Low-loss coils and capacitors will also pay off in better signals.

Many stations, both voice and code, were heard using the circuit of Fig. 3. Several foreign languages were recognized, including Spanish, French, Italian, and Portuguese, but in many cases the stations could not be identified by call letters. The two loudest stations were BBC and a Spanish-speaking station that broadcasts almost endless musical programs plus plugs in Spanish for Duz (jingle and music) and Pepsi Cola.

Swinging or fading is very common and signals disappear for several minutes at a time. Occasionally they are steady for fairly long periods. At times BBC comes in very well with about 90% of the program understandable; but it's unpredictable. Short-wave work on a crystal is very reminiscent of dx hunting during the early days of radio. Sometimes you hear them and sometimes you don't! You need lots of patience and good ears, but it's fun.

Those who are interested in this subject will get much better results with more finished equipment and better antennas. A half or full wave antenna with a tuned primary should increase volume considerably, and such a set might make some new crystal reception records. Why not try some experiments of your own and report results to the editor? Europe can be heard on a crystal receiver—definitely!

# ENGINEERS, TECHNICIANS, HOBBYISTS— Here's the most complete collection of Germanium Diode Applications ever published!

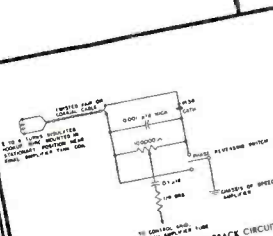

Figure 24. CARRIER OPERATED INVERSE FEEDBACK CIRCUIT  
quality and reducing hum and noise. It is not so easily applied, however, to standard modulated circuits such as grid-modulated screen-modulated cathode modulators and small-lumen amplifiers.  
The carrier current shown in Figure 24 overcomes the difficulty by "sampling" the modulated carrier. The pickup of a modulated carrier is critical and the audio voltage obtained by this process is applied to the control grid of the carrier-operated feedback audio voltage potentiometer enables the operator to adjust the feedback audio voltage to the proper level for best results.

When using this system, it is advisable not to include more than one feedback transformer in the feedback loop. If correlation between the phase response is such to appear positive.  
2.5. PREMODULATION SPEECH CLIPPER. The distortion advantage of speech clipping may be obtained in an existing amplifier by including a modulation clipper unit between the first and second stages of the speech amplifier. Such may be constructed as shown in Figure 25. The original gain control of the amplifier becomes the clipper control. The control is not so convenient as the desired level as shown in Figure 25. A variable potentiometer is connected to the desired level. The DMS should be used to supply the clipper control. A variable potentiometer is connected to the desired level and three capacitors in the clipper control circuit for the circuit.  
The filter, consisting of a choke and three capacitors in the clipper control circuit, is connected to the clipper control. The filter then results in a variable harmonic.

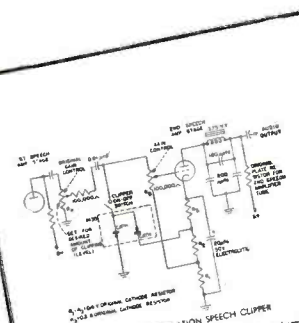

Figure 25. PREMODULATION SPEECH CLIPPER

2.6. LOW-VOLTAGE BIAS SUPPLY. Fixed grid bias voltage for screen and control grids for audio amplifiers may be obtained from the 6.3V AC filament terminals in the amplifier through a crystal rectifier and filter.  
Figure 26 shows a full-wave bridge circuit which makes an excellent bias supply which is compact and requires no attention. The DC output voltage may be varied by changing the resistance value of R<sub>1</sub>, R<sub>2</sub>, or R<sub>3</sub> to decrease the output voltage decrease and vice versa.

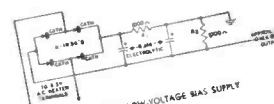

Figure 26. LOW-VOLTAGE BIAS SUPPLY

Here are a few of the 40 applications explained in this booklet:

- Push-pull Crystal Receiver
- Crystal Video Detector
- Carrier-Operated Inverse Feedback Circuit
- Tubeless DC Amplifier
- Sensitive Signal Tracer

Sylvania's new handy-sized book, "40 Uses for Germanium Diodes," presents for the first time all the most important applications of germanium diodes. In it, the engineer and technician will find time-saving devices and simplified circuits. Hams, hobbyists and experimenters will find plans for a host of interesting instruments and gadgets, from crystal receivers to voltage and frequency multipliers.

Simple, clear explanations, plus more than 40 separate diagrams, describe germanium diode applications in receiver and transmitter circuits, instrument construction and electronic "gadgets."

This book is full of new circuit ideas. It will save you time and money. It costs only \$1. Mail the coupon today with your dollar and your copy will be sent you at once.

**S**  
RADIO TUBES; TELEVISION PICTURE TUBES; ELECTRONIC PRODUCTS; ELECTRONIC TEST EQUIPMENT; FLUORESCENT LAMPS; FIXTURES; SIGN TUBING; WIRING DEVICES; LIGHT BULBS; PHOTOLAMPS; TELEVISION SETS

# SYLVANIA ELECTRIC

Sylvania Electric Products Inc.  
Advertising Dept. E-1509  
Emporium, Pa.

Please send me "40 Uses for Germanium Diodes."  
Enclosed is \$1.00.

Name \_\_\_\_\_  
Address \_\_\_\_\_  
City \_\_\_\_\_ Zone \_\_\_\_\_ State \_\_\_\_\_





**"Only three minutes on the job and this Amphenol INLINE Antenna is fully assembled and going up the ladder! I save hours of installation time with Amphenol Quick-up antennas, and even more important, because of the sturdy, durable construction of AMPHENOL antennas, I know I won't be called back to make repairs. For quick, easy handling—and above all, durability, there's nothing like the Amphenol INLINE Antenna."**

**AMPHENOL**

**QUICK-UP  ANTENNAS**

U. S. PAT. NO. 2,474,480

**AMERICAN PHENOLIC CORPORATION**

1830 SO. 54TH AVENUE • CHICAGO 50, ILLINOIS

# New Devices

## ALL-BAND ANTENNA

Tel-a-Ray Enterprises, Inc.  
Henderson, Ky.

This new wideband antenna, called the Butterfly, is designed for both high and low TV bands. It is bidirectional and can be used with 72-, 150-, or 300-ohm transmission lines. The Butterfly is made of solid dural with cast aluminum brackets and stainless steel

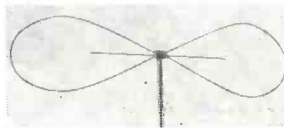

hardware. The insulation block is of polished polystyrene. The antenna comes completely assembled and only needs to be fastened to the mast.

## ISOLATION TRANSFORMER

Standard Transformer Corp.  
Chicago, Ill.

This new isolation testing transformer is rated at 350 watts and is large enough to handle almost any TV or radio receiver on test. It may also be used to correct a high or low line voltage. Three standard receptacles provide output voltages of 105, 115, and 125, with 117 volts a.c. from the line.

## TV FIELD-STRENGTH METER

Approved Electronic Instrument  
New York, N. Y.

Model A-460 field-strength meter can be used to measure television picture signal strength or to check antenna orientation, efficiency of various antenna combinations, local oscillator radiation, and efficiency of TV boost-



ers. The instrument has calibrated full-scale readings from 30 to 20,000 microvolts with a low scale (100 to 20,000  $\mu\text{V}$ ) for metropolitan areas and a high scale (30 to 500  $\mu\text{V}$ ) for fringe areas. The A-460, housed in a heavy-gauge steel cabinet of battleship gray, has 6 tubes and a 1N34 crystal.

## TEST OSCILLOSCOPE

Allen B. Du Mont Laboratories  
Clifton, N. J.

Type 293 cathode-ray oscillograph is designed for impulse testing of high-voltage transformers, insulators, lightning arresters, and other equipment that must withstand high-amplitude surge voltages. The oscillograph can be triggered by a sample of the test impulse and it also contains a pulse generator to trigger external circuits. For accurate quantitative measurements the Y-axis is metered and calibrated and the X-axis is calibrated for time to 0.1% accuracy.

Permanent records can be made with a 35-mm oscillograph-record camera supplied as standard equipment with the type 293. A data card, and color-selective mirror permit simultaneous viewing and recording of waveforms on the oscillograph screen.

## KNURLED CONTROL SHAFT

Clarostat Mfg. Co., Inc.  
Dover, N. H.

The type FKS-1/4-inch finger-tip, knurled and screwdriver-slotted Pick-A-Shaft snaps on any AM or AT control. This shaft is for controls of the rear of a TV receiver chassis or other

controls that require infrequent adjustment. The shaft protrudes only 1/2 inch beyond the control bushing and has a keyed end that slips directly on the control. A slight blow snaps the shaft permanently onto the control.

## TUBE TESTER

Electronic Measurements Corp.  
New York, N. Y.

Designed to test all tubes including the novel and subminiature types by the standard emission method, this new tube tester has individual sockets for each type of tube base and supplies heater voltages from 0.75 to 117. It can also test cold-cathode, electron-ray, voltage regulator, and ballast tubes.

Capacitor leakage can be checked to 1 megohm, resistance to 4 megohms, and capacitance from .01 to 1  $\mu\text{f}$ . The instrument is housed in a hand-rubbed portable oak case with a hinged cover and carrying handle. The built-in roll chart is covered with nonbreakable transparent plastic.

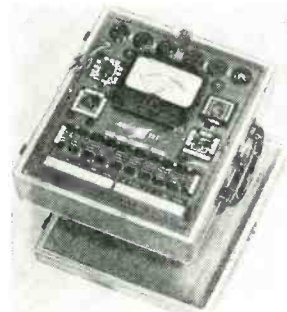

## CONICAL TV ANTENNA

LaPointe-Plascomold Corp.  
Hartford, Conn.

The new VEE-D-X conical is a broadband high-gain antenna for all TV channels. Available with one, two, or four bays, it has universal element brackets allowing a variation of reflector and radiator combinations. The antenna has phenolic vibration straps to prevent yawing and whistling

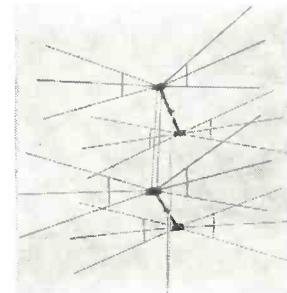

in high winds. Aluminum plugs forced into the joint ends of each element eliminate crystallization and consequent breakage at the bracket joints.

## TV BOOSTER

Electro-Voice, Inc.  
Buchanan, Mich.

The Tune-O-Matic is a high-gain self-tuning booster with four stages of broadband amplification. The bandwidth covers all TV channels so that the booster requires no tuning and may be concealed behind the TV set. The four-stage amplification isolates the local oscillator to reduce re-radiation and interference on nearby receivers.

The booster has four 6J6 tubes, power

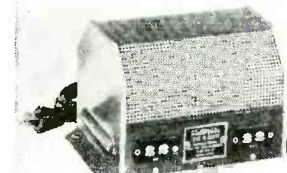

consumption of 20 watts, and both input and output match 150-300-ohm line. Its size is 7 3/4 x 5 1/2 x 4 3/4 inches and it weighs 4 pounds.

RADIO-ELECTRONICS for



**YAGI ANTENNA**

Ward Products Corp.  
Cleveland, Ohio

Designed for weak signal strength areas, this Yagi has a narrow beam width with pinpoint directivity and a high front-to-back ratio to eliminate co-channel interference. A model is supplied for each channel. It has a built-in transformer, to step up impedance. The unit is ruggedly constructed for permanent installation. Mast brackets take up to a 1 3/8-inch mast. Stacking kits for either high or low band are available.

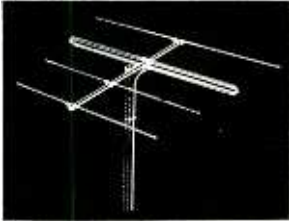

**ISOLATION TRANSFORMER**

Halldarson Co.  
Chicago, Ill.

The output voltage of this isolation transformer, the model N-202, can be varied in 1/2-volt steps with two switch knobs on the front panel. If the line voltage is 117 volts, the output can be

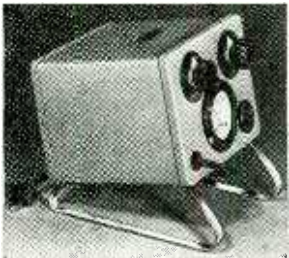

varied from 95 to 145 volts; if the line drops to 90 volts, the output can be varied from 75 to 115 volts. The unit is rated at 500 watts and has a voltmeter to register the output voltage. This transformer weighs only 21 pounds and takes up less than a square foot of bench space. It has steel runners for easy movement over the bench.

**SIGNAL GENERATOR KIT**

Electronic Instrument Co.  
Brooklyn, N. Y.

Eico has announced that its r.f. signal generator, the model 315, is now available in kit form. The new kit, called the model 315-K, has seven calibrated bands covering from 75 kc to 150 mc with better than 1% accuracy. The generator has a VR-tube regulated



power supply to make it independent of line voltage fluctuations and its 4-step r.f. output attenuator is designed for constant output impedance. It has an internal 400-cycle sine wave generator for r.f. modulation or for external audio testing. The tube complement is: 6C4, 7F7, 6X5, and OD3. The kit is supplied with complete pictorial and schematic instructions.

**CAPACITOR TESTER**

Jackson Electrical Instrument Co.  
Dayton, Ohio

The newest addition to the Challenger Line series of test instruments is the Model 112 capacitor tester. It checks all types of capacitors—electrolytic, paper, mica, etc. A new method for leakage tests eliminates flash counting on the electron-ray indicator. It has six test voltages from 20



to 500 volts. The ranges are from 10 µµf to 1,000 µf in four steps and a direct-reading scale measures power factor from 0 to 60%.

**TV ANTENNA**

Radiart Corp.  
Cleveland, Ohio

The Loaded X is an indoor antenna for all channels. It has no adjustments and is rigidly made of polished aluminum and plastic. It is delivered with 11 feet of lead-in.

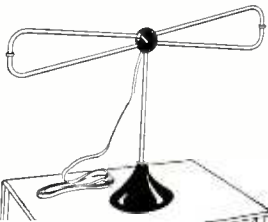

**LOUDSPEAKER**

University Loudspeakers, Inc.  
White Plains, N. Y.

The model 6200 is a 12-inch PM speaker with a frequency response to



over 10,000 c.p.s. and a continuous power rating of 30 watts. It has a W-shaped, 1 1/2-pound Alnico V magnet in a rim-centered assembly which permits easy replacement of the cone and voice coil.

**ANTENNA ROTATOR**

Alliance Manufacturing Co.  
Alliance, Ohio

The model HIR Tenna-Rotor is designed to automatically rotate a TV antenna. The viewer simply sets the



pointer to any desired point on the dial and the antenna automatically rotates to that point and stops. A moving light on the dial shows the antenna position while rotating. The indicator dial may be marked for new channels at any time.

Just published—a world of up-to-date, compressed, essential data in the NEW

**Pender's ELECTRICAL ENGINEERS' HANDBOOK**

Editor-in-Chief, HAROLD PENDER,  
University of Pennsylvania

Fourth Edition  
Volume II—COMMUNICATION-ELECTRONICS

with KNOX McILWAIN,  
Hazeltine Electronics Corporation

Expanded to include current developments, the fourth edition now covers for the first time frequency modulation and pulse techniques in both the communication and radar fields. In addition to the more usual subjects are data on: radio aids to navigation; non-linear electric circuits; radio antennas; electric wave filters; microwave plumbing; transformers with iron cores; single-mesh coupled circuits; electro-mechanical acoustic devices; optics; sound reproduction systems; television; medical applications; and many others.

September 1950 1564 pages \$8.50

Both volumes are part of the Wiley Engineering Handbook Series.

EXAMINE BOOKS FOR 10 DAYS

ON APPROVAL COUPON

JOHN WILEY & SONS, INC., Dept. RE-9  
440 Fourth Ave., New York 16, N. Y.

Please send me, on 10 days' approval, a copy of Pender's ELECTRICAL ENGINEERS' HANDBOOK:

- Vol. I—ELECTRIC POWER @ \$8.50
- Vol. II—COMMUNICATION-ELECTRONICS @ \$8.50

If I decide to keep the book(s) I will remit price plus postage; otherwise I will return the book(s) postpaid.

Name .....

Address .....

City ..... Zone ... State .....

Employed by .....

(Offer not valid outside U.S.)

**Volume I—ELECTRIC POWER**

with

WILLIAM A. DELMAR

Phelps Dodge Copper Products Corporation

400 pages longer, it gives standard data and more material on circuit stability, symmetrical components, electronic and aircraft equipment, heat pumps, servomechanisms, magnets, plastics, and induction and dielectric heating.

1949 1716 pages \$8.50

New "MIGHTY MITES"



**SELENIUM RECTIFIERS**

8J1

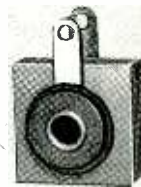

8Y1

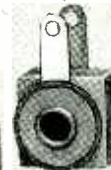

Rectifiers are shown actual size

CHALK UP another First for SELETRON! Here is "mite-size" 8J1, keyed to the requirements of modern electronic circuits . . . A new and smaller 65 mil rectifier with particularly low reverse leakage, built to the following specifications: Input 130 V rms; Max. Peak Inverse Voltage 380 V; Max. D.C. Output Current 65 MA; Plate Size 11/16" square; Stack Thickness 9/16".

. . . And don't forget the 20 Mil "Mite"—No. 8Y1, designed especially for power and bias supply in Radio and Television!

A complete tabulation of all SELETRON miniatures is available. For your copy, write Dept. RS-28.



SELETRON DIVISION  
RADIO RECEPTOR COMPANY, INC.  
Since 1922 in Radio and Electronics

Factory: 64 North 9th St., Brooklyn 11, N. Y. - Sales Department: 251 West 15th St., New York 11, N. Y.



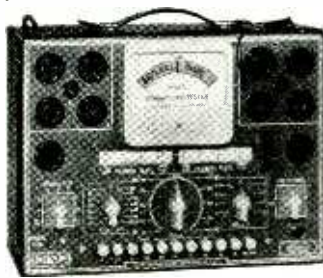

Model 103

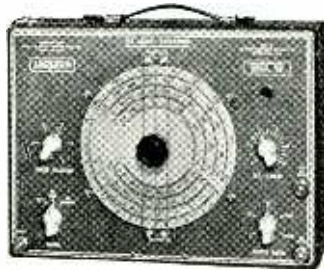

Model 106



Model 109



Model 112

# Now! Low Cost Instruments

with famous **JACKSON** quality

There's no need to take chances on inferior instruments. For now Jackson offers proved quality and time-tried circuits in a new low-cost Challenger line. Made for the small shop, or the shop that needs extra instruments, these new instruments incorporate the same basic Jackson Circuits as used in higher priced instruments. How do we do it? By standardizing case size, and by eliminating the "extras." And, remember, these instruments come to you completely assembled, factory-tested and factory-calibrated at a price little more than you'd pay for a "kit." Look over the specifications. Ask your distributor for a complete demonstration.

only **49<sup>50</sup>** each

**Model 103 Challenger Tube Tester**  
—Uses famous Jackson Dynamic\* principle. Applies separate voltages to each tube element. Features a high voltage power supply to provide plate voltages over 200 volts for more accurate tests. Has large 4" dial. Tests over 700 types. Built-in roll chart. \*TM Reg. U.S. Pat. Office

**Model 109 Challenger Vacuum-Tube Voltmeter**—Provides electronic measurement of both AC and DC voltages. Has 3 megohms sensitivity on 0-4 DC range. Constant input resistance of 12 megohms on all DC ranges. Over 4-million-ohms-per-volt sensitivity on 0-1 AC range. Input resistance 4.4 megohms on all AC ranges. Complete ranges including decibels. High voltage probe available.

**Model 106 Challenger Test Oscillator**  
—Standard AM type for testing AM or FM sets. Fundamentals from 100 KC to 54 MC. Harmonics to 216 MC. Has 400 cycle Audio modulation or may be used as straight RF. Accuracy is 1/2 of 1% on all ranges. And, remember, this is factory-calibrated with the most up-to-date and accurate standards.

**Model 112 Challenger Condenser Tester**—Push-button controlled. Uses Electron Ray Indicator. Shows capacity, leakage, and shorts. Variable power factor. Six test voltages from 20 volts to 500 volts. Ranges from .00001 to 1000 mfd in 4 steps. Very easy to use. Helps you spot bad and doubtful capacitors rapidly.

**Sizes:** All Jackson Challenger instruments furnished in attractive steel cases finished in Challenger Green with Ivory knobs and Meter covers. All measure 13" x 9 1/2" x 5 1/2". Weigh about 11 pounds each.

Look to  
**JACKSON**  
for Quality

Jackson Electrical Instrument Company • Dayton 2, Ohio

## TUBES OF THE MONTH

SYLVANIA has released a number of new tubes, including the 1V2, 6S4, 6AB4, and the 6BD5-GT.

The 1V4 is a small-button, nine-pin miniature, high-voltage, half-wave rectifier for television flyback power supplies using voltage doubler circuits. In typical operation the peak plate pulse voltage (supplied by the scanning system) is 6,000 and the plate current is 0.5 ma. A 500- $\mu$ f load capacitor is used.

The 6S4 is a small-button, nine-pin, miniature, medium-mu triode for use as a vertical deflection amplifier. When used with an adequate power supply, it can drive a 16-inch picture tube at its maximum anode voltage. In typical operation as a deflection amplifier, it has a peak positive pulse output of 800 volts or peak-to-peak sawtooth output of 350 volts. Plate current is 18 ma. As a class-A amplifier the tube has a mutual conductance of 4,500  $\mu$ mhos, an amplification factor of 16, and a plate resistance of 3,600 ohms.

The 6AB4 is a miniature r.f. triode for use in grounded-grid amplifiers at frequencies up to 300 mc. The dynamic characteristics of this tube are the same as one triode section of the type 12AT7.

The 6BD5-GT is a six-pin, octal, beam pentode deflection amplifier for television. It can provide full horizontal deflection for a 50", 12-inch picture tube with 11,000 volts anode supply. In a typical horizontal deflection circuit its voltages are: plate and screen supply, 310; peak positive surge plate voltage, 2,500; peak control grid surge, 50. Curve data of this tube are similar to the type 6L6-G.

Sylvania has also released technical data sheets on the 6BC5 and the 6CB6, both high-frequency pentodes described in the February, 1950, issue. Basing diagrams for these tubes appear below.

(Continued on page 72)



NOTES:-  
IS=INTERNAL SHIELD  
NC=NO CONNECTION IC=INTERNAL CONNECTION.DO NOT USE.



*NOW READY! A Sensational New Line Of*  
**1951 MIDWEST TELEVISION**

*Complete CHASSIS and BEAUTIFUL CONSOLES*  
*Featuring the New MAMMOTH* **19 1/2** Inch *PICTURE TUBE*  
**FACTORY-TO-YOU on**  
**30 DAYS TRIAL**

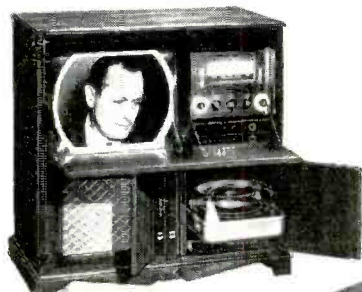

**"VIDEO GRANC"**  
 19 1/2-Inch Picture (225 sq. in. image) Television-Radio-Phonograph Console

**EASY TERMS**



**"CONSTELLATION"**  
 19 1/2" Television Console with BIG 12" Panasonic Speaker

**NOT A KIT!**  
 This is A Completely Assembled Receiver

Never before have you seen such tremendously BIG clear pictures, such luxurious cabinets, such sensation-ally low Factory Prices as Midwest offers in its 31st Anniversary Line of 19 1/2-Inch and 16 1/2-Inch Television receivers. They are available in complete ready-to-use chassis for custom installation in your own cabinet...or in luxurious console cabinets with Television only or in TV-Radio-Phonograph combinations. All are offered on Midwest's famous 30 Days Trial right in your own home.

Plus Powerful New 1951 World-Ranging 5-Band  
**MIDWEST** SERIES 16 **RADIOS**  
 In Beautiful Consoles and Complete Chassis



An entirely new line featuring the powerful Series 16 AM-FM Five-Band Radio Chassis and the magnificent Symphony Grand Radio-Phonograph with 3-Speed Automatic Intermix Record Player.

**EASY TERMS**

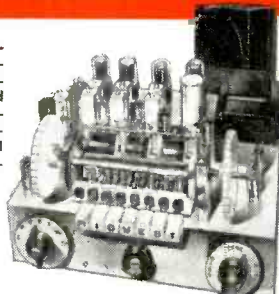

SEND COUPON TODAY  
 For This NEW 1951 4-Color

**FREE** MIDWEST  
 RADIO-TELEVISION  
 CATALOG



WRITE IN NAME AND ADDRESS (PLEASE PRINT) ON COUPON OR 1c POSTCARD

MIDWEST RADIO & TELEVISION CORP.  
 Dept. 38B, 909 BROADWAY • CINCINNATI 2, OHIO  
 Please send me your new FREE 1951 Catalog.

NAME \_\_\_\_\_  
 ADDRESS \_\_\_\_\_  
 CITY \_\_\_\_\_ ZONE \_\_\_\_\_ STATE \_\_\_\_\_

**MIDWEST RADIO & TELEVISION CORP.**  
 DEPT. 38B, 909 BROADWAY, CINCINNATI 2, OHIO



Save Dollars  
WITH THE New  
**LOW COST**  
RCP SIGNAL  
**GENERATOR**

MODEL 705A ONLY

**\$39.95**

Reduced from \$49.95

**FOR FM-AM**

**DOUBLE MODULATION 30% & 80%**

Not one—but two percentages of modulation add greater checking performance to your service tests. All exclusive feature in this low price precision generator. Fully dependable. Excellent for FM alignments.

- Range from 95 kc. to 100 mc.
- Fundamental frequencies in 5 bands, continuously variable
- Accuracy to 2% for broadcast bands—3% for h.f. bands
- Planetary drive condenser with accurate double and tuning indicator
- 5 step ladder attenuator controls voltages from 0 to maximum
- Covers all new FM bands—useful signals can be obtained as high as 150 mc.
- Negligible leakage due to complete shielding
- Complete, ready for the shop. Just plug in any standard 110 V., 60 Cycle A.C. line and go to work
- Grey hammertone case—portable, only 11 lbs.

**AC-DC MULTITESTER**



MODEL 447B

ONLY **\$15.95**

These units are in a class with other makes of testers that sell for considerably more. A 3" square D'Arsonval meter is used, having an accuracy of 2%. Ring type shunt circuits are employed.

**RANGES**

- DC Voltmeter: 0-5-50-250-500-2500 Volts at 1000 Ohm per Volt.
- AC Voltmeter: 0-10-100-500-1000 Volts.
- Output Voltmeter: 0-10-100-500-1000 Volts.
- DC Milliammeter: 0-1-10-100-1000 MA.
- DC Ammeter: 0-1-10 Amperes.
- Ohmmeter: 0-10,000 Ohms—1 Megohm—10 Megohms Ext.
- Decibel Meter: —8 to +55 decibels.

Model 447B—Open face instruments supplied in hardwood case. Size 5" x 8½" x 3". Weight 21 oz. Complete with batteries, ready to operate.

Model 447BP—Same as above, Portable, supplied in oak case with handle, cover and test leads—ready to use. Complete \$19.95

SEE THESE OUTSTANDING BUYS AT YOUR JOBBER TODAY  
WRITE FOR CATALOG 9RE

**RADIO CITY PRODUCTS CO., INC.**

152 West 25th St. New York 1, N. Y.

Five new miniature tubes designed especially for mobile and aircraft service have been added to G-E's production. The tubes are designated the 5749, 5750, 5725, 5726, and 5686. The heater construction of these tubes is designed to withstand many thousand cycles of intermittent operation.

The 5749, a miniature remote-cutoff pentode, is used as an r.f. and i.f. amplifier. The tube has low grid-plate capacitance and under typical operating conditions has a transconductance of 4,400  $\mu$ mhos with a plate current of 11 ma.

The 5750, a miniature pentagrid converter, is used as a combined oscillator and mixer in superheterodyne receivers. It has a conversion transconductance of 475  $\mu$ mhos.

The 5725 is a miniature semiremote-cutoff pentode. It is used in gated and gain-controlled amplifiers, and delay and mixer circuits. The main feature is that the control and suppressor grids can be used as independent control elements.

The 5726, a miniature twin-diode, may be used as an AM-FM detector, a.v.c. rectifier, and low-current power rectifier. The tube has high permeance. Since the heaters for the two diode sections are in series, a heater failure makes both sections inoperative.

The 5686, a miniature pentode power amplifier is used as a class-A audio power amplifier or class-C r.f. power amplifier up to 160 mc. There are multiple leads on the cathode and screen grid to facilitate r.f. bypassing at high frequencies. A useful power output of 5.25 watts at 125 mc or a class-A audio power output of 2.7 watts can be obtained.

Two transistors, two germanium diodes built to joint Army-Navy specifications, and a germanium quad are also announced by G-E.

The transistors, types SX-4A and Z-2, use a metal case with two silver-plated phosphor bronze connecting pins. Each type SX-4A unit is checked for power gain of between 13 and 20 db with 0.1-volt input at 5 kc. Maximum ratings are: emitter d.c. current, 1 ma; collector d.c. current, 2 ma; and emitter r.m.s. signal, 0.3 volt. The Z-2 units are checked for characteristics suitable for trigger circuits.

The two germanium diodes built to JAN specifications are types 1N69 and 1N70. Both feature rugged mechanical construction for either solder or clip-in mounting.

The 1N69 has a continuous reverse working voltage of 60, peak current of 126 ma, average current of 40 ma, surge current of 400 ma, and maximum operating temperature of 70° C.

The 1N70 diode has a continuous working voltage of 100, peak current of 90 ma, average current of 30 ma, surge current of 350 ma, and maximum operating temperature of 70° C.

The G-E quad, type G-9, is a combination of specially selected germanium diodes with matched characteristics. The diodes are hermetically sealed in a compact metal radio tube shell with standard octal base.

**BUFFALO RADIO SUPPLY**

219-221 Genesee St., Dept. RE 9  
Buffalo 3, N. Y.



Latest model fan type conical with reflectors. Better on every channel, but superiority is most terrific on higher channels. A year ago we advertised an antenna that sold for over \$100.00. This antenna is hotter, \$47.50. In lots of 10—\$40.00.  
Order No. 6491.



Full size folded dipole with reflector and mast. Stand-off insulators included. \$4.75 complete. \$40.00 per dozen. Order No. 6430.

Highest quality telescoping folded dipole rooftop type antenna with all the features usually expected in such an antenna, including use as dipole and reflector, and in addition a mounting bracket provided so that the antenna can be installed in any window in two minutes or less. Any slight loss in gain because of the reduction from rooftop height is more than compensated by the ability to orient the antenna instantly by opening the window and adjusting for maximum signal strength. Mounting bar can be installed horizontally or vertically in window frame or even between attic rafters, whichever is most convenient. Your cost \$7.00. With high frequency attachment for channels 7 to 13 \$9.00. Filter type 100% less in dozen lots.



"RT 1711"

RT1711 Brand New 12 Tube, 110 Volt Receiver-oscillator-tiltoscope complete with all tubes and power supply. Has telescoping hood over scope tube, which is equipped with a detachable calibrated screen. Has centering and amplitude controls and two video inputs. A natural for television or radio service. \$39.95

**"DRILLMASTER" ELECTRIC DRILL**

Pistol Grip electric drill, ideal for hobbyists. Complete with sander, buffers, grinding wheels, etc. \$9.95



**LINE FILTERS**—Each unit contains two 4 Mfd. oil filled condensers and a high inductance 50 Amp choke in fully shielded case. Suitable heavy current connectors are provided to attach to the input and output connectors at each end of the filter from your input and output wires. A filter with innumerable uses on oil burners, refrigerators, boats, automobiles and wherever noise is to be suppressed or interference abolished. A \$17.00 value for \$2.98.

**SIGNAL GENERATOR**

Genuine Laboratory-type precision signal generator. Manufactured and sold for \$68.00 each in large quantities during the war by Northeastern Engineering Corp., one of the top manufacturers of electronic equipment for the U.S. Govt. Five fundamental bands starting at 150 KC. Strong harmonics up to 120 MC. Five step ladder attenuator as well as potentiometer output control. Regular 100 cycle audio oscillator using vacuum tube, not a cheap neon sawtooth audio oscillator. Audio output separately available externally. Weight without packing material 16 lbs. which should show what world of difference exists between this signal generator and the ordinary cheap oscillator used by the average serviceman. Complete with fused plug and coaxial output lead. Super Special \$33.75



**COMPRESSED AIR INSTANTLY ANYWHERE**

Portable Air Compressor and storage tank. Ruggedly built of best materials using lifetime lubricated ballbearing on connecting rod and oil impregnated main bearing on shaft. Unusual design forever eliminates valve trouble, the most common fault in air compressors. PATENTED unique air intake system increases efficiency tremendously over other compressors so that air output is much greater than that from larger compressors powered by heavier motors. Will deliver approximately 3500 inches of air per minute at maintained pressure of 30 lbs. or will inflate a 90 lb. truck tire in less than one minute. Comes complete with 100 lb. gauge, although finger-tip adjustment allows setting of output pressure at any value, which will automatically be maintained. Works from any ¼ H. P. motor. Useful for spraying paints or lacquers, disinfectants, insecticides, annealing or brazing with natural gas, inflating tires etc. Price \$14.50. Most popular anywhere in the U.S. Efficient, completely adjustable syphon type spray gun complete with 12 ft. of 100 lb. tested hose available for only \$7.75 with pint container, also prepaid.

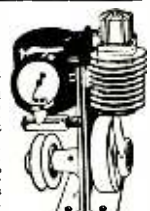

RT1655 Only **\$14.95**

11 tube crystal controlled superheterodyne receiver that covers the FM band. The ultra modern circuit uses the latest types of tubes including 7 miniature 6AJ5's. Beautiful chassis and aluminum cabinet. Tubes and diagram included.



Universal 4 lead broadcast band oscillator coil (can be converted to 3 lead type by addition of jumper). Ten for \$1.00



**WE ARE LOOKING FOR TUBES**

and other surplus. Large or small quantities. Send your list for our bid.



We especially want BC654 and SCR284 components



# Here are great new values from Lafayette on famous **EICO** precision instruments & kits

## 5" PUSH-PULL OSCILLOSCOPE



Model 425-K, KIT, only \$39.95

All-new laboratory-precision scope gives you all the extra sensitivity and response for precise servicing of TV, FM & AM receivers.

Push-pull undistorted vertical and horizontal amplifiers. Boosted sensitivity .05 to .1 rms volts/inch. Useful to 2.5 MC. TV-type multivibrator sweep circuits, 15 cps - 75 KC. Z-axis intensity modulation feature. Dual positioning controls move trace anywhere on screen. Complete with 2-6J5, 3-6SN7, 2-5Y3, 5BP1 CRT. Handsome 3-color etched rubproof panel; rugged steel case. 115 v., 60 cycle AC. 8 1/2 x 17 x 13". Model 425, factory wired, \$69.95

## NEW TUBE-TESTER

The brand new professional tube tester and merchandiser EICO Service-Engineered for unbeatable value!

Large 4 1/2" full-vision meter. Tests conventional and TV tubes including 9-pin miniatures. New lever-action switches—tests every tube element. Illuminated "Speedroll Chart". 2 grid caps. Short and open-element tests. Spare socket for new tubes. Protective overload bulb. Electronic rectifier. Handsome 3-color etched rubproof panel; rugged steel case. 115 v., 60 cycle AC. 12 1/2 x 9 1/2 x 4 1/4"

Model 625, factory wired, \$44.95



Model 625-K, KIT, only \$29.95

## HIGH PRECISION VACUUM TUBE VOLTMETER



Model 221-K, KIT, only \$23.95

Tops in workbench versatility - 15 different ranges! AC and DC ranges: 0/5/10/100/500/1000 volts. Electronic ohmmeter ranges from .2 ohms to 1000 megs in 5 steps. New features include Zero Center for TV discriminator alignment. 26 Meg. DC input impedance. Accurate, 4 1/2" meter cannot burn out. Double triode balanced bridge circuit assures guaranteed performance. Sturdy portable steel case with etched rubproof panel. Will measure up to 30,000 v. and 200 Mc. when used with our HVP-4 or P-75 probes. 110-130 v. AC 50-60 cycle. Size: 9 7/16" x 6" x 5".

Model 221, factory wired, \$49.95

## HIGH VOLTAGE PROBE



A new professional EICO-engineered HV probe carefully designed and insulated for extra safety and versatility. Extends range of VTVMs and voltmeters up to 30,000 volts. Lucite head. Large flashguards. Multi-layer processed handle. Complete with interchangeable ceramic multiplier to match your instrument. Model HVP-1, only \$6.95.

## NEW SIGNAL GENERATOR

For FM, AM alignment and to provide TV marker frequencies. Highly stable Hartley oscillator has range of 150 kc. to 102 mc. with fundamentals to 34 mc. Colpitts audio oscillator supplies pure 400 cycle sine wave voltage for modulation. Vernier Tuning Condenser. Use audio oscillator voltage to test distortion in audio equipment, bridge measurements, etc.



Model 320-K, KIT, only \$19.95  
Model 320, factory wired, \$29.95

Small, handy instrument used a thousand times a day. Large 3" meter, beautifully etched panel. A perfect kit for beginners. Simple to assemble. Ranges: DC - 0/5/50/250/500/2500 volts. AC - 0/10/100/500/1000 volts. Output - 0/10/100/500/1000 v. DC Ma. - 0/1/10. DC Amps. - 0/1/10. Ohmmeter - 0/500/100,000 ohms/0/1 meg. DB meter - 8 to + 55 Db.

Model 511-K, KIT, only \$14.95  
Model 511, factory wired, \$17.95

## VOLT-OHM MILLIAMMETER

Complete Pocket Kit

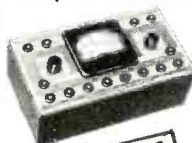

## NEW TV-FM SWEEP SIGNAL GENERATOR



- Crystal marker oscillator with variable amplitude.
- Covers all TV and FM alignment frequencies between 500 kc. and 228 mc.
- Sweepwidth variable from 0-30 mc. with mechanical inductive sweep.
- Extremely wide sweepwidth allows gain comparison of adjacent RF TV Channels.
- Provides for injection of external signal-generator marker.
- Phasing control included.
- Large, easy-to-read dial is directly calibrated in frequencies.
- Vernier Tuning Condenser.
- Comes complete with all tubes (including new, high-frequency miniature types): 6X5GT, 12AU7, two 6C4's. Crystal not included. 10" x 8" x 6 3/4". 5 Mc. Crystals available each \$3.95.

Model 360-K, KIT, only \$29.95  
Model 360, factory wired, \$39.95

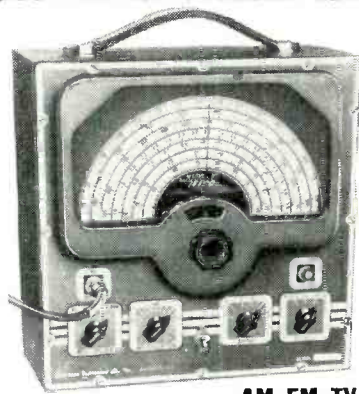

## AM-FM-TV SIGNAL GENERATOR

A laboratory-precision generator EICO Service-Engineered with 1% accuracy.

Extremely stable, frequency 75 KC - 150 MC in 7 calibrated ranges. Illuminated hairline vernier tuning. VR stabilized line supply. 400-cycle pure sine wave with less than 5% distortion. Tube complement: 6X5, 7F7, 6C4, VR-150. Handsome 3-color etched rubproof panel; rugged steel case. 115 v., 60 cycle AC. 12 x 13 x 7".

Model 315-K, KIT, only \$39.95  
Model 315, factory wired, \$59.95

A double-guarantee covers every Eico unit - the manufacturer's and Lafayette's. Send your order now - shipment will be made within 24 hours.

**ORDER NOW!**

# LAFAYETTE RADIO

send all mail orders to New York please.

NEW YORK, N. Y.  
100 SIXTH AVE.  
WAlker 5-8883

NEWARK, N. J.  
24 CENTRAL AVE.  
MARket 2-1661

BOSTON, MASS.  
110 FEDERAL ST.  
HUBbard 2-7850

LAFAYETTE RADIO 100 Sixth Avenue, 13. N. Y. (Radio Wire Television Inc.)

Please send me the following EICO instruments:  
(List Model Number as shown in ad).....

Name.....  
Address.....  
City..... Zone..... State.....



## AUTOMATIC GAIN AND BANDWIDTH FOR VIDEO I.F.

A circuit which automatically adjusts gain and bandwidth to compensate partially for differing signal strengths is featured in the new Philco model 1836 television receiver. As described by Philco's service manager John Pell to the recent Philco Service Managers' Convention in Philadelphia, electronic effects in the i.f. tubes tune circuits in such a way as to increase or decrease the "stagger" of the i.f. section. With circuits widely staggered, bandwidth is wide and gain lower. Tuning them more closely to the same frequency reduces the bandwidth and increases the gain.

A 12- $\mu$ f capacitor between the grid and the unbypassed cathode resistor of the second i.f. produces what Service Manager Pell called a "reverse Miller effect" in which the capacitive react-

ance of the second i.f. grid circuit varies with grid bias. As this capacitance is connected across the inductor in the plate lead of the preceding tube, it varies its resonant frequency from 25.5 mc at high signal levels to 26.6 (the video i.f.) at low signal levels, its effective capacitance being controlled by the grid bias set by the a.g.c. The result is that the response at 26.6 mc varies from 35% at high signal levels to about 80% at low signal levels.

By leaving the cathode resistor out of the third i.f. stage, the tube acts as a small variable capacitive reactance, tuning the 23-mc trap in the plate circuit of the second i.f. down toward 22.1 mc as the a.g.c. voltage decreases. Thus sound as well as the picture response is brought up as signal strength falls off.

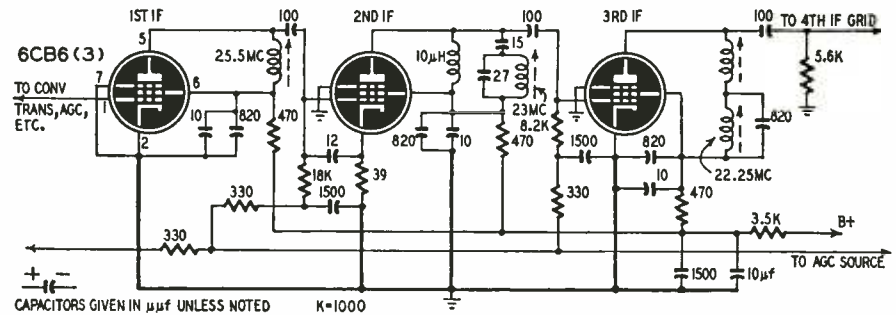

## RECEIVER AS MODULATION CHECKER

Many circuits and gadgets have been developed to enable radio operators to measure percent modulation on their transmitters, but little has been done to enable operators or SWL's to check the modulation on received signals. G8LO described a method of adapting the receiver for checking modulation of received signals in *Short Wave*

tion. The author used a 1½-inch C-R tube which is similar to a 913. Fig. 2 is an experimental circuit which uses a 913. The circuit is arranged so operating voltages can be taken from the receiver. Be sure that adding this tube does not overload the power supply.

The heater and cathode of the 913 being at 100 volts when a 600-volt sup-

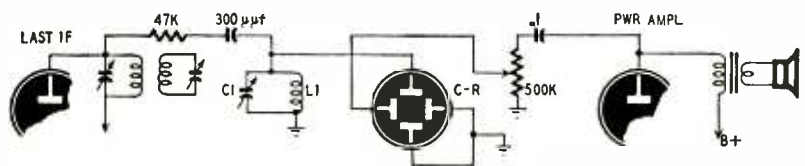

Fig. 1—Basic circuit for C-R tube hookup to check modulation at receiver.

Magazine (London). The basic circuit is shown in Fig. 1.

The plates of a small C-R tube are connected between the plates of the last i.f. and power amplifiers to develop a conventional modulation trapezoid. Tuned circuit C1-L1 tunes to the receiver's i.f. and peaks the r.f. voltage to provide sufficient vertical deflec-

tion. If a separate filament transformer (6.3 volts at 0.6 amp or more) should be used, a separate filament transformer (6.3 volts at 0.6 amp or more) should be used. L1 and C1 may be one winding of an i.f. transformer having the same i.f. as the receiver. Touch up the alignment of the last i.f. transformer after the adapter has been connected. *The shell of the 913 is hot. Watch it.*

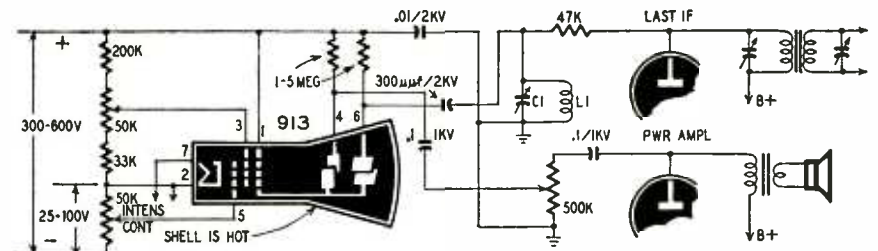

Fig. 2—Circuit for using a 913. The voltages are taken from the receiver.

**NEW!**

**Rectangular  
BLACK TUBE**

**16 in. TELEKIT**

**TELEKIT  
PRICES  
START AT 49.95  
LESS TUBES**

Jobbers: Write for Confidential Price Information

**16 BR Telekit  
\$79.95 Less  
Tubes**

Now you can build your own rectangular black tube TV set! This exciting new Telekit has a big 160 inch screen from a non-glare rectangular black tube. The entire set is engineered for

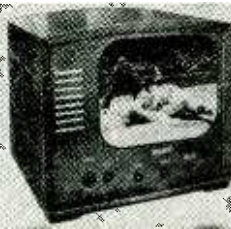

simplicity, and has new 70% deflection, with video tube mounted directly on chassis. Brightness is assured by a 14 KV hi-voltage doubler circuit. The streamlined circuit is easy to assemble. No previous knowledge of TV is required. All you need is pliers, screw driver and soldering iron. The tuning unit and hi-voltage supply are factory wired and assembled for you. A big 54 page illustrated instruction book guides you through easy assembly. Satisfactory performance is guaranteed by our Telekit Factory Service Plan and warranty. Write today for full details.

**12-B Telekit**

**\$69.95**

**8-B Telekit**

**\$49.95**

**Less Tubes**

Here are new low prices on Telekits. Now you can have a fine 8½- or 12½-inch set at a price far below comparable commercial sets costing much more.

Over 30,000 Telekits have been assembled by following the big Telekit instruction book. No previous knowledge of TV is required. Satisfactory results are guaranteed under the Telekit Factory Service Plan. Write for full information.

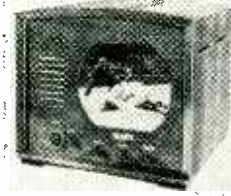

**Telekit**

**Booster**

**\$12.95**

This Telekit Booster will bring in TV signals bright and clear. Especially helpful in fringe areas. Will give brilliant performance with any TV set. NOT A KIT. Completely assembled with tubes.

Write for FREE catalogue listing Telekits, cabinets, tubes, antennas, boosters and television accessories.



**TELEKIT**

**ELECTRO-TECHNICAL INDUSTRIES**  
1432 N. BROAD ST. DEPT. B PHILADELPHIA 21 PA

# TV-RADIO SERVICEMEN

**Here are 2 Big Ways Federal Helps  
You Make More Profits . . . and Keep Them!**

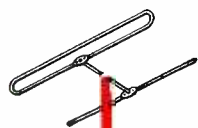

## 1 Lead-in installations and replacements that save "FREE" Service Calls

—IN HIGH AND LOW NOISE LEVEL AREAS

Federal is America's leading manufacturer of solid dielectric coaxial cables!

Federal's K-1046 and K-111—300-ohm lead-in cables—are your answers to the problem of keeping service calls down and TV installation profits UP. K-1046, for low noise level conditions, is insulated with amazingly durable "silver" polyethylene . . . providing 30% more service life . . . plus numerous inherent features. K-111 is tops in noisy areas . . . minimizing noise, snow and ghosts due to transmission line pick-up. Pictures are clearer, brighter, steadier . . . *all the time!*

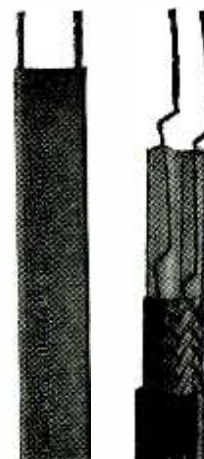

K-1046

K-111

## 2 FEDERAL SELENIUM RECTIFIERS ★ for Replacement in TV and Radio sets

OVER 10,000,000 FEDERAL SELENIUM RECTIFIERS NOW IN SETS OF LEADING MAKERS

For servicemen everywhere this means a new and important replacement market . . . a steadily growing source of extra income!

Be ready for this new profit opportunity by being ready to replace selenium rectifiers with Federal . . . the *original* miniature selenium rectifier. Federal has the industry's *most complete line!*

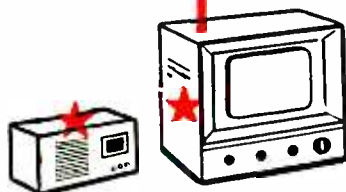

Every year, more and more millions of Federal selenium rectifiers are being installed in AC-DC, portable, table and console radios and TV receivers!

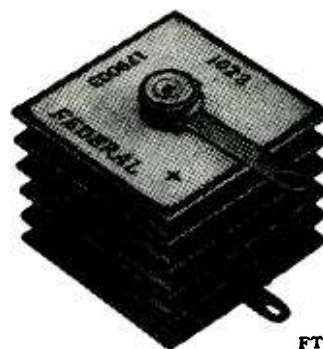

FTR-1023

**Check your stock now—and call your distributor for Federal TV lead-in cables and Federal miniature selenium rectifiers. It pays to install the best!**



**Federal Telephone and Radio Corporation**

SELENIUM and INTELIN DIVISION, 100 Kingsland Road, Clifton, New Jersey  
In Canada: Federal Electric Manufacturing Company, Ltd., Montreal, P. Q.  
Export Distributors: International Standard Electric Corp., 67 Broad St., N.Y.



# BUY NOW! WHILE PRICES ARE LOW-STOCKS COMPLETE



## SPECIAL! CONCORD FM-AM CHASSIS with BUILT-IN PRE-AMP

A terrific value in an AM-FM chassis with built-in pre-amp. Its 10-watt, true fidelity audio system gives better reproduction than many of the highest priced radios. Either you like it or we'll refund your money at any time within 30 days of purchase date. Features include: Pre-amp for GE and other variable reluctance pickups; high and low impedance phono inputs; full range tone control; two cabinet antennas - loop antenna for AM and folded dipole for FM; 10-watt push-pull beam-power audio output; and mike input for PA. Tube complement: 6BA6, 7F8, 7AH7, 7A6, 7F7, 7Q7, 6SH7, 6AT6, 6SC7, (2)7C5, and a 5Y3-GT rectifier. Frequency range: 88-108 mc on FM and 550 to 1700 kc on AM. Operates on 105-125 V, 60 cycle AC only. Chassis size: 9x13x9-1/4". 1-1217J-- Shpg. wt. 25 lbs. **59.50**  
22-19299J Hi-fidelity, heavy duty 12" PM speaker for above .... 5.95

### PRICES SLASHED 68% on FAMOUS MAKE AUTO ANTENNAS

<p><b>Model 4553 - Fig. A.</b> An all purpose 96" 3 section side cowl antenna. Made of triple-chrome-plated brass with bakelite insulators, rattle-proof. Complete with 36" Hi-Q low loss cable which has inner polyethylene insulation with vinylite jacket for protection against oil, carbon, and water. List \$5.45 99-9699J Your Cost, Each.....\$1.98. Lots of Three, Each....<b>1.79</b></p>	<p><b>Model 4566</b> - Same as above except is 65" long. List \$4.45. 99-9698J Your Cost, Each.....\$1.49. Lots of Three, Each....<b>1.39</b></p>
<p><b>Model 4801 - Fig. B.</b> The popular Uni-Mount Antenna. Fits all types of cars - old and new. Mounted under the hood. No drilling of holes in car body. Rustproof, triple-chrome-plated, 60" high. With 36" cable as above. List \$4.45. 99-9694J Your Cost, Each.....\$1.49. Lots of Three, Each....<b>1.39</b></p>	<p><b>Model 4541 - Fig. C.</b> The latest swivel antenna. For convex or flat surfaces of every type car. Triple-chrome-plated, rustproof. Bakelite insulators. 62" high. Has 48" cable as above. List \$5.25 99-9697J Your Cost, Each.....\$1.89. Lots of Three, Each....<b>1.75</b></p>

### FAMOUS CONCORD MUSIC LOVERS AMPLIFIER



LOW-PRICE  
**\$29.50**

Especially designed by Concord engineers to give the newcomer to high-fidelity listening an inexpensive yet good quality unit. The normal rated output of this fine amp is 8 watts (with harmonic distortion of only 2%). Has three inputs: magnetic cartridge, crystal cartridge, and radio tuner; built-in pre-amp for variable reluctance pickup; separate bass and treble tone controls with flat position - bass control gives 10 DB boost, treble gives 12 DB boost and 14 DB attenuation. Frequency response at rated output 40 to 15,000 cps + 1 DB. Tubes: (2)6V6, 6SL7, 6SC7, and 6X5 rectifier. Operates on 117 V, 60 cycle AC. Attractively finished in brown hammerloid. Size: 10-1/2 x 6 x 5-1/4". Complete with tubes.  
2-295J Shpg. wt. 10 lbs. **29.50**

### Tone Arm with Variable Reluctance Pickup

**\$4.45** This tone arm for LP records with the new variable reluctance cartridge lists at \$15.95, but it's yours for a price less than the cost of the cartridge alone. Made by a famous national manufacturer. Plays both 10" and 12" records. Gives wide range response. Lightweight construction, smooth lateral movement, newly designed vertical pivot, and sapphire stylus combine to give long record wear. Easy to install. Complete with 20" flexible cable.  
99-8013J With LP Cartridge and Replaceable Stylus..\$4.45  
99-8014J As above with Standard Cartridge .....\$4.95

### PHOTO ELECTRIC CELL



Just Arrived! Big Shipment of Selenium photo electric cells. Rated at 500 microamperes per lumen. These cells generate one-fourth volt in bright sunlight - batteries are not needed. Can be used in photo exposure meters and in colorimeters having sensitive relays. There are hundreds of other exciting uses for these cells. Stock-up now at our low price.  
99-6810J Each.....**95c**

## FREE

BIG CATALOG  
JAM PACKED WITH VALUES  
Let it be your guide to  
GREATER SAVINGS

GET  
YOUR COPY  
TODAY



## CONCORD RADIO

Mail Order Center and Showroom  
901 W. Jackson Blvd., Chicago 7, Ill.  
Branch Showroom: 265 Peachtree St., Atlanta 3, Ge.

CONCORD RADIO CORP. Dept. J.J-50  
901 W. Jackson Blvd., Chicago 7, Ill.

Enclosed \$.....(Include shipping charge.  
Any excess will be refunded.) Rush me the following equipment:

---

Send FREE latest Catalog & Bargain Bulletin.

Name .....

Address .....

City..... Zone..... State.....

### H.V. METER ADAPTER

Most TV receiver manufacturers warn the service technician not to attempt to measure the pulse voltages on the plates of the horizontal output and high-voltage rectifier tubes. I sometimes find it expedient to do this to check the condition of the high-voltage transformer. For this purpose I use a v.t.v.m. adapter constructed as shown in the diagram.

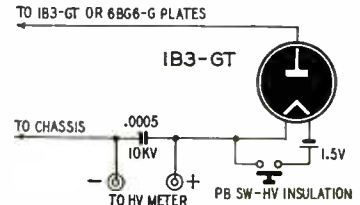

The 1B3-GT, battery, and filter capacitor should be mounted in a wooden or plastic box to prevent leakage. The push-button switch should be insulated for high voltage. The voltmeter should have a sensitivity of at least 20,000 ohms per volt. Its range should be high enough to measure the normal anode voltage on the C-R tube.  
—H. Ackerman

### TO NE 6507, 6F5, 6SJ7, ETC

This tone control is a modification of one which was used in some prewar Airline receivers. I like it so much that I have installed it in several amplifiers and receivers. It consists of separate high- and low-pass filters which work into the grids of the triodes of a 6SL7-GT mixer tube.

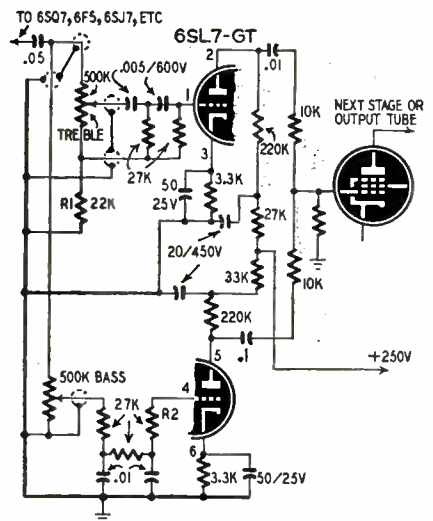

Resistor R1 determines the amount of mid-range frequencies which are passed when the bass and treble controls are turned down. R2 may be as high as 68,000 ohms or may be left out of the circuit entirely. If it is left out, bass notes will override the highs on an average recording. If it is 68,000 ohms, the high will predominate. Values shown for these resistors meet my requirements. Experiment with other values if you wish.

Do not try to leave the 6SL7-GT out of the circuit. It is needed to compensate for losses in the tone-control networks.—James Charles Soukup

*Mounting Bell's new microwave lens in a horn-lens antenna. Other blocks will complete the lens.*

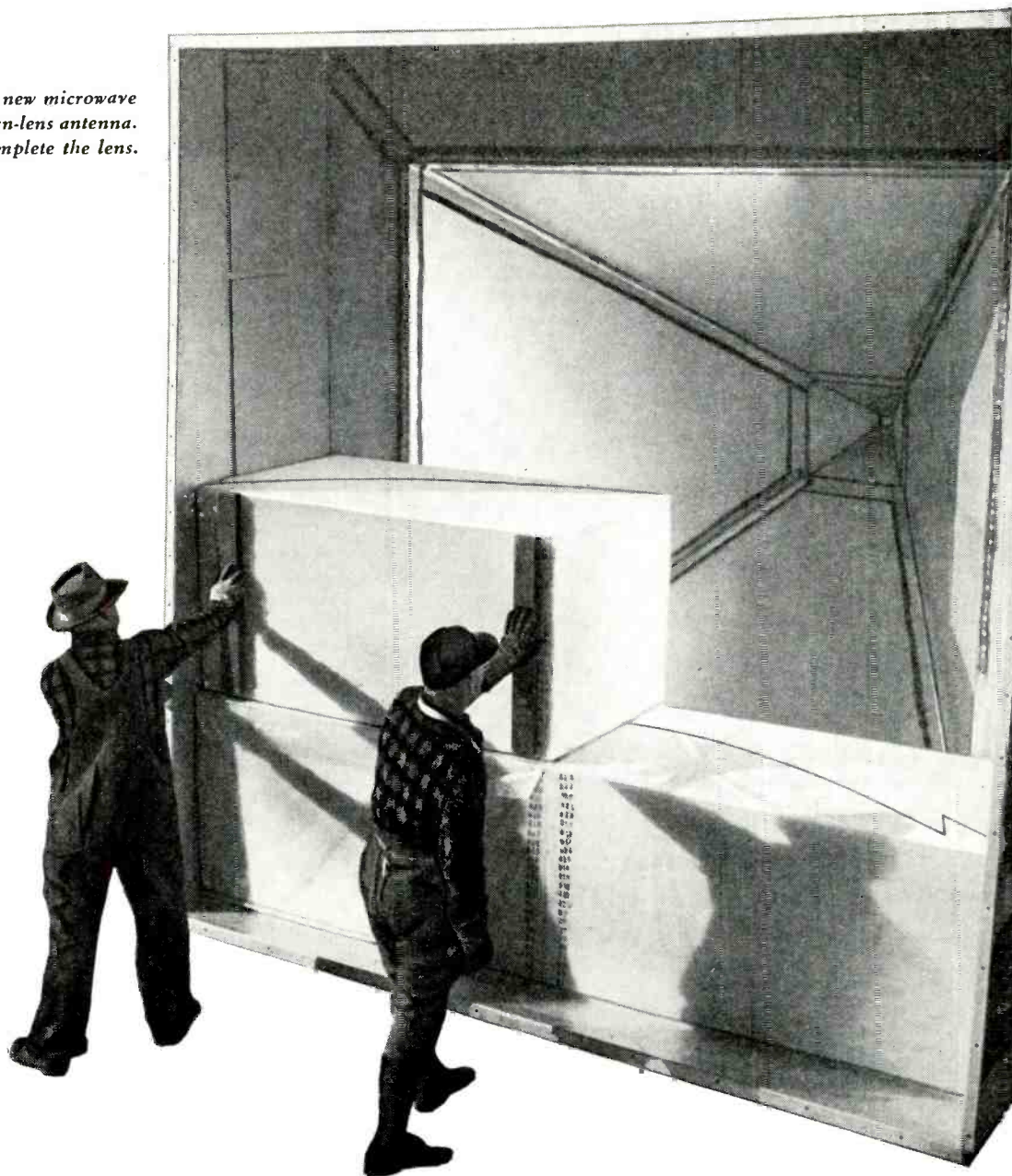

## A focus on better, low-cost telephone service

In the new microwave radio relay system between New York and Chicago, giant lenses shape and aim the wave energy as a searchlight aims a light beam.

Reasoning from the action of molecules in a glass lens which focuses light waves, Bell Laboratories scientists focus a broad band of microwaves by means of an array of metal strips. To support the strips these scientists embedded them in foam plastic which is virtually transparent to microwaves. Rigid and light in weight, the plastic is easily mounted on relay towers.

This unique lens receives waves from a wave guide at the back of the horn. As they pass across the strips, the waves are bent inward, or focused to form a beam like a spotlight. A similar antenna at the next relay station receives the waves and directs them into a wave guide for transmission to amplifiers.

This new lens will help to carry still more television and telephone service over longer distances by microwaves. It's another example of the Bell Telephone Laboratories research which makes your telephone service grow bigger in value while the cost stays low.

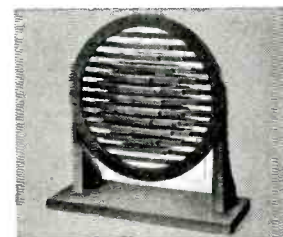

*Laboratory model of the new lens. A similar arrangement of metal strips is concealed in the foam plastic blocks in the large picture.*



# BELL TELEPHONE LABORATORIES

*Working continually to keep your telephone service big in value and low in cost.*

SEPTEMBER, 1950



# SERVICEMEN!

## We'll Prove You'll Save Time & Earn More with PHOTOFACT!

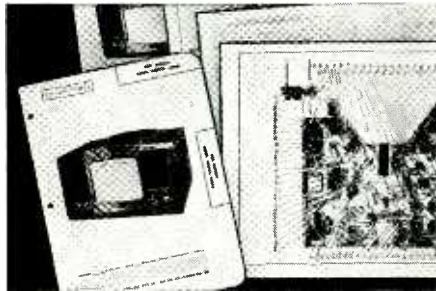

We'll send you absolutely

# FREE

any PHOTOFACT Folder listed in the Photofact Cumulative Index

NOW—learn for yourself—at our expense—how PHOTOFACT makes your service work quicker, easier, more profitable! Examine an actual PHOTOFACT Folder. Use it. You'll learn first-hand why this indispensable service data is used daily by over 35,000 successful service technicians. You'll discover quickly that no other service gives you PHOTOFACT's outstanding advantages: *completeness, accuracy, uniformity and ease-of-use* at the lowest cost to you! PHOTOFACT alone is the only radio service data prepared from laboratory analysis of the actual equipment. Nothing in the field equals PHOTOFACT. Know the facts—get your FREE Folder now. Examine it—use it—compare it—learn why no modern service shop can afford to be without PHOTOFACT!

**NOTE:** This FREE offer is limited to Service Technicians. Attach coupon below to your letterhead and mention the name of your jobber. If you have no letterhead, send coupon to your jobber. Experimenters and others may obtain the Photofact Folder by remitting amount shown below.

HOWARD W. SAMS & CO., INC.  
2201 E. 46th St., Indianapolis 5, Ind.

Send FREE Photofact Cumulative Index

Send Full Easy-Pay Details

I am a Service Technician:

Send FREE Folder for set model.....

I am an Experimenter: Enclosed \$.....

Send Folder for set model.....

TV—\$1.00; Record Changer or Comm. Receiver—75c; AM/FM—50c

Name.....

Address.....

City.....Zone.....State.....

### REPAIRING A.C.-D.C. SETS

If you live in an area where the line voltage is unusually high, a.c.-d.c. sets will probably have frequent tube burn-outs. To reduce trouble from this source replace the output or rectifier tubes with equivalent higher-voltage heater types. A 45Z5-GT can be used, for instance, as a replacement for a 35Z5-GT or a 50L6-GT can be used to replace a 35L6-GT.

If the line voltage is *too low*, reverse the procedure.—*Jacob Dubinsky, W2-LVR*

(Note the tube substitution and the reason for it on a service tag and glue it to the back of the set. This information may prove useful to you and to other technicians who may have to service the receiver in the future.—*Editor*)

### CORD AND ANTENNA REEL

Many radio sets use a hank antenna which must be unrolled when the set is in use. When the set is moved the antenna and line cord always seem to get entangled. To simplify the moving job both antenna and cord are usually rolled up into a ball and shoved into the rear of the set. Straightening out the resulting mess is like trying to unscramble an egg. Try making a rear cover of heavy cardboard or plywood with two small reels cut out as part of the design. The antenna and cord can then be wound up separately and kept apart. The drawing shows how it is done.—*Robert P. Balin*

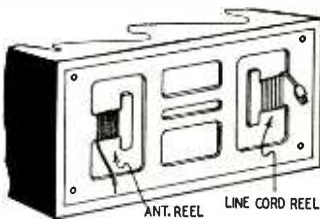

### HANDY DIAL STRINGING TOOLS

A number of gadgets have been devised as aids to dial stringing; however, we find that more than one such instrument is needed for working in close places which cannot be reached with the fingers alone or with the ordinary tools found in a workshop.

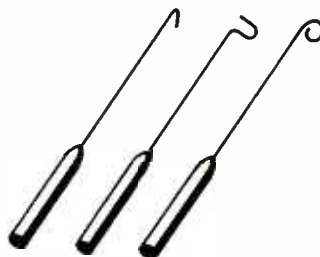

The three instruments shown in the drawings have been evolved by constant usage. Made of stiff wire, bent to shape and fitted into wooden handles, they are just the tools needed during most dial-stringing operations.—*Forrest Rand*



ONE OF AMERICAS GREAT ELECTRONICS STORES

### SMASHING REDUCTION

PHILCO R.F. SIGNAL GENERATOR MODEL 7070

Designed for precision alignment and many other tests. Max. frequency stability, ample output, portable.

6C4 RF osc.—1/2 of 7F8 cathode follower—1/2 of 7F8 audio osc.—6X5GT rect. Six bands of RF from 100 KC to 110 MC. ALL FUNDAMENTAL.

Calibration accurate to within 1% of scale. Complete with shielded output lead and instruction book.

110 V. 60 cycle AC only. 20 lbs.

A \$185.00 value for only **\$39.95**



SCOOP VALUE 5 WATT AUDIO AMPLIFIER

Complete with speaker and 3 tubes. Hi-impedance output for XTAL mike or Phono-Pickup. Volume and tone controls.

5 W. amplif. with 5" speaker ..... **\$8.95**

Same as above with 8" speaker ..... **\$9.95**

### TINIEST V.O.M. IN THE WORLD



NIAGARA exclusively presents the "Universal Baby Tester," measuring 3/8" x 2 1/4" x 1 1/8"!!! Contains a sensitive 0-240 microammeter with the following ranges.

- 0-15 V AC or DC
- 0-150V AC or DC
- 0-100,000 ohms
- 0-750V AC or DC
- 0-150 DC MA.

Ohms adjust and DC-AC-OHMS switch. Includes 1 pair test leads. Will fit into your watch pocket. Fully guaranteed.

Cat. No. N-258 **\$8.95**

SPECIAL



DOES YOUR TV SET DROOP FROM INTERFERENCE BLOOP?

Banish interference with Niagara's Hi-pass filter!

Positive protection against interference from amateur transmitters, diathermy, and all other devices generating radio frequency interference below 40 MCs. Designed for 300 ohm lead-in. No loss in brightness or clarity. Available built up or in easy to assemble kit form. Complete instructions and test report included.

Hi-pass kit ..... **\$1.95**

Wired and tested ..... **\$2.95**

plus 12c postage and handling in USA. Money back if not satisfied.

Niagara Radio Supply Corp. Phone Dlagy 9-1132-3-4 Dept. C70 160 Greenwich Street, New York 6, N. Y.

**RESISTOR WATTAGE CHART**

Economical construction of electronic equipment requires that resistors have a minimum, but adequate, wattage rating. Determining the power dissipated in a resistor is simple, but can be laborious when calculations must be made for each resistor in the circuit.

To avoid future calculations of this kind, I prepared this chart which shows the wattage of resistors when the current through them is known. The current and resistance ranges are 2 to 60 ma and 100 ohms to 1 megohm, respectively. The resistance values are in the left-hand column and the current in milliamperes is across the top. Wattage ratings are found at the intersections of the resistance and current columns. Wattages are adequate and the safety factor runs as high as 20%.

Resistance (ohms)	Current (ma.)										
	2	4	6	9	14	20	28	40	60		
100											
250											
500											
1K											
2.5K											
5K											
10K											
25K											
50K											
100K											
250K											
500K											
1 meg.											

If the resistance is not given on the chart, use the next larger values of resistance and current.—*Kenneth Forsberg*

(The chart is correct for use with

carbon resistors; for wire-wound resistors it will be safer to double the wattage rating shown.—*Editor*)

**HOME MADE FM ANTENNA**

The FM antenna shown in the drawings was constructed from a piece of 2 x 4 hardwood and the lower sections of two telescoping auto antennas. The center of the wooden block is drilled or

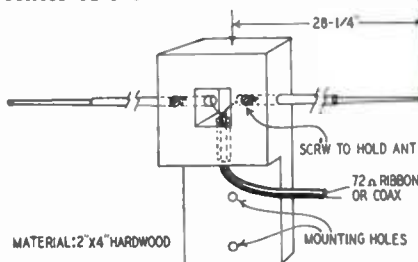

MATERIAL: 2"x4" HARDWOOD

sawed out for connecting the 72-ohm ribbon line or coax. The transmission line can be anchored to the block to prevent strain on the soldered connections at the dipole.—*Ray Lawrence*

**DIAL STRINGING AID**

Use small strips of Scotch tape to hold dial strings on pulleys when restringing elaborate dial drive mechanisms. They will prevent the string from jumping off the pulleys before the tension is applied by the springs.

The tape is also useful in holding the strings in place while the springs are being adjusted for greater tension. This eliminates a complete restringing job.—*Manuel E. Silva*

**AN IMPORTANT NEW PHOTOFAC BOOK!**

for **SOUND TECHNICIANS AUDIO ENGINEERS CUSTOM BUILDERS**

**VOLUME TWO Howard W. Sams' Post-War "AUDIO AMPLIFIERS"**

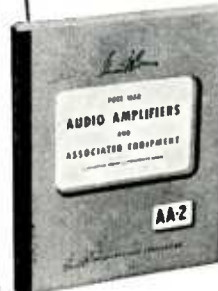

Full Analysis of 104 Important Audio Amplifiers, 12 Popular Tuners and Associated Equipment

Based on Actual Study of the Equipment

**COMPLETE, AUTHORITATIVE DATA**

This new volume continues to fill the large sustained demand for data on Audio Amplifiers and associated equipment. Invaluable to public address and sound technicians, audio engineers, custom installers, BC engineers, and students. Provides a complete, clear, uniform analysis of 104 well-known audio amplifiers and 12 important tuners. Includes detailed circuit and design data based on original laboratory examination of the equipment. All new material, continuing audio equipment coverage begun in Volume 1 (see below). Profusely illustrated with hundreds of photos and diagrams. 368 pages; 8 1/2 x 11"; sturdily bound.

**\$3.95**

ORDER AA-2. Only



**VOLUME ONE Howard W. Sams' Post-War "Audio Amplifiers"**

This is the initial volume covering audio equipment produced after the war, through 1948. Covers 102 audio amplifiers and FM tuners, plus data on important wire and tape recorders. Includes the products of 29 well-known manufacturers. 352 pages; fully illustrated; in sturdy binding,

**\$3.95**

ORDER AA-1. Only

**ORDER BOTH VOLUMES AND OWN A COMPLETE, AUTHORITATIVE SOUND LIBRARY**

**HOWARD W. SAMS & CO., INC.**

Order from your Parts Jobber today, or write direct to HOWARD W. SAMS & CO., INC., 2201 East 46th Street, Indianapolis 5, Ind.

My (check) (money order) for \$..... enclosed. Send the following books:

- AA-2. "Audio Amplifiers." Vol. 2. \$3.95
- AA-1. "Audio Amplifiers." Vol. 1. \$3.95

Name.....  
Address.....  
City.....Zone.....State.....

**BC-1206 RECEIVER**

Setchel Carlson Receiver, 5 Tubes, tunes 200-100 KC. Receives aircraft beam signals; also weather band; also can be used as a Lark Q Ser. Normally operates 24 V. 10". Complete with tubes and instructions for 110 Volt 60 cycle operation. Prices: NEW: \$6.95. **\$5.95**

LIKE NEW Conversion Kit of Parts for 110 Volt operation... **\$3.95**

**BLOWER** 115 Volt 60 cycle Blower, approx. 100 Cubic Ft. Dis. 3/4" Intake, 2" outlet. Motor size: 3 3/4" x 3". 1525 RPM. Complete with mounting bracket. Govt. surplus. Brand New and Boxed. Order **\$7.95**

No. RE-3604

**FAN OR BLOWER MOTOR**—110 Volts, 1550 RPM. Motor size: 3" x 3". Shaft size: 3/16" x 1" **\$3.95**

**AC ELECTRIC MOTOR**—110 V. 60 cycle ball bearing motor, approx. 3500 RPM, 1/25 HP. Shaft size: 3/16" x 1/2". Motor size: 7" x 4". Ideal for models, fans, etc. Converted from Govt. surplus. Only **\$3.00**

**BC-223 TRANSMITTER and SPARE PARTS**

30 Watt Transmitter with crystal or MO control on four pre-selected channels, 2000 to 5250 KC., by use of three plug-in coils. Five Tubes; two 801 & three 4E. With TT-17 Tuning Unit 2000 to 3000 **\$19.95**

OPERATING MANUAL for BC-223... **\$2.00**

SPARE TUBE KIT for BC-223—Contains 5 spare tubes in metal box. Price **\$4.95**

TUNING UNITS: TU-17—2 to 3 MC.; TU-18—3 to 4.5 MC.; TU-25—4.5 to 5.3 MC. NEW: \$3.50 Ea. USED: \$2.50 Ea.

PE-125 VIBRATOR POWER SUPPLY for BC-223 Transmitter. 12/24 Volt Input; output 500 Volt 150 MA. Price **\$9.95**

MOUNTING for PE-125 **1.50**

SPARE VIBRATOR & TUBE KIT. For PE-125—Contains 2 spare tubes, 2 spare vibrators and fuses in metal box. Price **\$4.95**

CABLE only—Transmitter to Power Supply **1.75**

**NEW TRANSFORMERS—CASED—115 V.A.C. 60 CYCLE INPUT:**

OUTPUT: 600-0-600 V.A.C. at 250 MA. 12 V.A.C. at 3 amps; 12 V.A.C. at 3 amps; and 5 V.A.C. at 3 amps. Designed for Army Surplus transmitters. No. RE-108 **\$7.75**

OUTPUT: 250-0-250 V.A.C. at 80 MA. 24 V.A.C. at .6 amps; 6.3 V.A.C. at .6 amps. Designed for Army Surplus receivers. No. RE-109 **\$3.50**

**NEW CHOKE—CASED:** 13 Henries at 250 MA. filter choke, 1500 V. insulation. No. RE-121... **\$4.95**

**TRANSFORMERS—110 Volt 60 cycle Primaries**  
Sec. 12 V. 1 amp...\$1.50 Sec. 24 V. 2 amps...\$2.2  
Sec. 24 V. 1 amp...1.95 Sec. 24 V. .5 amp...1.50  
Sec. 36 V. 2.5 amps 2.95 Sec. 24 V. 4 1/2 amps. 3.95  
Sec. 14-14 or 28 V. 7 1/2 or 15 amps...5.50

Address Dept. RE • Prices F.O.B. • Lima, Ohio • 25% Deposit on C.O.D.'s • Minimum Order \$2.00

**COMMAND RECEIVERS:**

- BC-453—190 to 550 KC. USED: \$11.95 NEW: \$19.95
- BC-454—3 to 6 MC. 5.95 \$7.95
- BC-455—6 to 9.1 MC. 6.95

**COMMAND TRANSMITTERS:**

- BC-457—4 to 5.3 MC. \$5.95 \$8.95
- BC-458—5.3 to 7 MC. 5.95 8.95

**3/4 RPM ANTENNA ROTATOR MOTOR**



High torque, reversible motor—operates directly from 110 Volt 60 cycle by use of condenser. Light weight, quiet running, ruggedly built, positive stop, easily mounted. Normally operates from 110 V. 400 cycle. Complete, with instructions. New: \$4.95

10 MFD 400 Volt Cond. \$1.00; SPST Momentary Switch, 35c; DPDT Momentary Switch, 75c; Resistor, 100 ohm 25 Watt, 50c; 4 Wire Cable, 5c per Ft. COMPLETE KIT OF PARTS: Motor, Cond., SPST Switch, and Resistor **\$5.95**

**WHIP ANTENNA—MAST BASES, INSULATED:**  
MP-132—1" heavy coil spring, 2" insulator. Overall length: 11 1/2". Wt. 2 1/2 lbs. Price **\$3.95**  
MP-22—Spring action direction of bracket. 4" x 6" mounting. Price **\$2.95**

**MAST SECTIONS FOR ABOVE BASES:**  
Tubular steel, copper coated, painted, 3 foot sections. screw-in type, MS-53 can be used to make any length. MS-52-51-50-49 for taper. Any section... 50c Ea. Sections MS-54 or MS-55 (Larger than MS-53) 75c Ea. BAG BG-56 ft/carrying 5 mast sections... **50c**

**BC-645-A TRANSCEIVER 110 VOLT TRANSFORMER AND CHOKE**

15 Tube Transceiver. Ideal for conversion to 460 MC. Citizens Band. Frequency coverage 435 to 500 MC. With conversion instructions—New and Boxed. BC-645-A **\$14.95**

TRANSFORMER for BC-645-A—110 V. 60 cycle input; output 400 V. 150 MA. after filter, 12, 9, and 6 V. A.C. 4 amps and 5 W. 3 amps. No. BE-645... **\$6.95**

CHOKE—15 Hy. 150 MA. No. RE-646... **\$2.95**

PE-101 OYNAMOTOR—13/28 Volt input **\$2.95**

**CAR SHAVER MOTOR**

Use your electric shaver in your car. DYNAMOTOR will supply 110-120 Volt DC approx. 15 Watts from 6 Volt 10C auto battery and will operate most types of AC-10C shavers. Order No. RE-6250. Price—only **\$2.00**

(Use your electric shaver in your car. DYNAMOTOR will supply 110-120 Volt DC approx. 15 Watts from 6 Volt 10C auto battery and will operate most types of AC-10C shavers. Order No. RE-6250. Price—only \$2.00)

**FAIR RADIO SALES 132 SOUTH MAIN ST. LIMA, OHIO**



**SOLVE** your hi-fidelity problems with

# University TWEETERS

WIDEST SELECTION • BEST VALUE • HIGHEST QUALITY

## SINGLE UNIT TWEETERS

**MODELS 4408, 4409—600 CYCLE TWEETERS:** Recommended for highest quality reproduction systems requiring a low crossover frequency. Cobra shaped horn results in perfect wide angle distribution. Frequency response 600 to 15,000 cycles. Model 4408 handles 6 watts and 4409 25 watts.



**MODEL 4407 ADAPTER MOUNTS 4401 TWEETER IN ANY 12" CONE UNIT:** Converts any 12" cone speaker into a wide-range coaxial reproducer in a few minutes. Installation is extremely simple and results in a dual speaker occupying little more space than the original cone speaker. Complete with 4401 tweeter.



**MODEL 4401—2000 CYCLE TWEETER:** An economical 6 watt unit for converting any good 10-15" cone speaker for extended response to 15,000 cycles. Wide Angle horn, compact design and low price bring excellent high fidelity well within the popular price range.



## DUAL TWEETERS



**MODEL 4402, MODEL 4404:** Model 4402 reproduces to 15,000 cycles. Crossover at 2000 cps. Horizontal dispersion 100°, Vertical 50°. Handles 12 watts. Compact design mounts in any radio, phono, or speaker cabinet. Model 4404 incorporates 4402 tweeter in handsome walnut cabinet complete with high-pass filter and high frequency volume control. Any one can install.

## CROSSOVER NETWORKS



**MODEL 4405 HIGH PASS FILTER:** An effective and economical unit for preventing lows reaching the tweeter unit. Contains high frequency control to balance highs and lows. Cutoff frequency 2000 cycles.



**MODEL 4410, 4420 LC CROSSOVER NETWORK:** Genuine LC frequency dividers for segregating highs and lows. Not to be confused with ordinary high-pass filters. Crossover frequencies: Model 4410 600 cycles, Model 4420 2000 cycles. Attenuator controls included and wired.

Write today for illustrated literature—address inquiries to Department D

# University

**LOUDSPEAKERS • INC**

80 SO. KENSICO AV., WHITE PLAINS, N.Y.

## DUO-AMPLIDYNE RECEIVER

? Some years ago I constructed a regenerative receiver called the Duo-Amplidyne from plans which appeared in Short Wave Craft. I do not have the receiver or its diagram. Can you re-print the circuit?—G. R. H., Tyler, Texas.

A. The Duo-Amplidyne is a "hot" receiver which will satisfy the beginner as well as many advanced experimenters and amateurs. Being battery-operated, it is convenient to have on hand as a standby set or for field-day and emergency service.

The type 19 tube has a fairly delicate filament which requires 2 volts at 240 ma. Its octal-based equivalent is the 1J6-G. The 10-ohm rheostat is used to adjust the filament voltage to the required 2 volts. Experienced set constructors may wish to substitute a 1G6-GT, a 1.4-volt, 100-ma, high-mu, twin power triode in which case the filament battery is 1.5 volts and the 10-ohm rheostat eliminated.

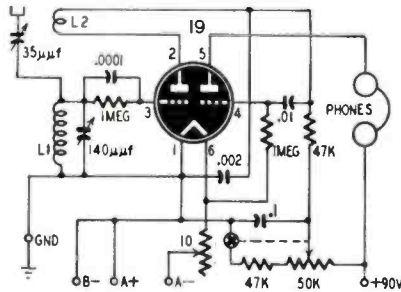

Standard four-prong coil sets can be used or the constructor may wind the coils on 1¼-inch plug-in forms.

Band (Meters)	L1 (Turns)	Wire size (Turns)	L2 (Turns)	Wire size (Turns)
500-350	132	28	34	34
350-200	68	28	28	34
200-80	52	22	15	28
80-40	24	22	7	28
40-20	11	22	6	28
20-10	5	22	4	28

The grid winding L1 for the 500-350 meter coil is bank-wound in two close-wound layers. All ticklers L2 are close-wound approximately ¼ inch below L1. Grid coils for the 350-200 and 200-80 meter coils are close-wound. The others are wound 16, 12, 6 turns per inch for progressively higher frequencies. Experiment with the number of turns on L1 for the desired tuning range and with the number of turns on L2 and the spacing between L1 and L2 for strong oscillations and reliable operation. If the set won't oscillate, try reversing the connections to L2.

## DATA ON CITIZEN'S BAND

? Please print circuits of a compact transceiver and a separate transmitter and receiver for fixed-station use on the citizens' band. We would like to use as much surplus equipment as possible in this project.—R. T. C., Junction City, Kan.

A. The problem of citizens' band transmitters is not one of circuits but

# SAVE \$ \$ \$

## 3 RED HOT SPECIALS

### ANY ITEM 33¢

MIX 'EM UP—SAVE \$ \$ \$

Buy 10-99 Assorted—Deduct 10%

Buy 100 Assorted—Deduct 20%

## MIDGET I. F. TRANSFORMERS

Discounts up to 86%



Midget 456 Kc, 1½" sq. 3" tall, HI-Q ceramic coils. Matched pairs.  
Input - - - - - 72 85G  
Output - - - - - 72 86G



## VOLUME CONTROLS

Discounts to 85%

STANDARD BRANDS complete with attached switch. Ohms-10M-15M-25M-50M-100M-250M-500M-2000M



## CONDENSERS

Discounts to 78%

STANDARD tubulars, type PRS. 2 FAST MOVERS.  
20 MFD-250 VOLT 40 MFD-150 VOLT

## INTERCOM & RADIO

AT A PRICE THAT CAN'T BE BEAT



6 tube superhet—3 tube intercom permits communication between radio-master and up to 4 sub-stations.

WHILE THEY LAST \$29.95

With 1 sub-station and 50 feet of cable  
Extra Sub-Stations \$3.95 each

Original cost \$64.50

## PUSHBACK WIRE



25% below Mill Cost  
1st class, Essex or Lenz. ALL SOLID tinned copper, double cotton serve, waxed finish.

SIZE	COLORS	100 feet	1000 feet	10,000 ft. production reel
22	Black-Brown	.39	\$3.79	\$3.65M
20	White-Blue	.49	4.49	3.95M



## ORDER INSTRUCTIONS

Demand This Seal of Quality

Minimum order—\$2.00. 25% deposit with order required for all C.O.D. shipments. Be sure to include sufficient postage—excess will be refunded. Orders received without postage will be shipped express collect. All prices F.O.B. Detroit.

Quantity and Export Orders Solicited  
**RADIO SUPPLY & ENGINEERING CO., Inc.**  
85 SELDEN AVE. DETROIT 1, MICH.



one of wiring and mechanical construction which will result in a unit which is stable enough to meet the rigid requirements of the band.

This band being intended for use of large numbers of citizens who know little or nothing of radio, it is necessary that the transmitters be particularly stable and the receivers extremely selective and nonradiating to prevent interference and confusion.

At present, the FCC is issuing experimental licenses only to persons having precision laboratory equipment for measuring transmitter characteristics.

No surplus u.h.f. radio equipment has been found to have sufficient frequency stability to meet the requirements of the band. It is extremely unlikely that amateur experimenters and constructors will be able to design such equipment for a number of years.

**HIGH-PASS FILTER FOR TV**

? Please design a high-pass filter for use between my 300-ohm antenna and TV receiver. I want to eliminate interference on channel 2.—H. F., Carlisle, Penna.

A. The diagram shows a high-pass filter which was described in *Sylvania News*. Designed to eliminate all frequencies below 45 mc, it will prevent the fundamental and some low-order harmonics from entering the i.f. system of your receiver through the antenna. It cannot be expected to eliminate signals in the TV bands.

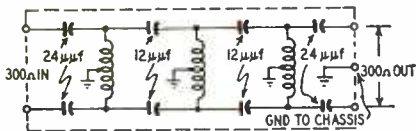

The capacitors should be either ceramics or silver mica. If the values specified are not available, a slight deviation is permissible. The coils are 5½ turns of No. 14 d.c.c. close-wound and center-tapped on a ¾-inch form. Wind them on low-loss forms or make them self-supporting and mount them inside a small metal box so their planes are at right angles to each other. All ground leads should be short.

**300-72 OHMS**

? My TV receiver has a 72-ohm input impedance, and I want to use a 300-ohm antenna. What type of transmission line shall I use?—R.D.E., Upper Darby, Penna.

A. You have a choice of using either 72- or 300-ohm transmission line. If you use 300-ohm line, a quarter-wave section of 150-ohm line should be inserted between the receiver input terminals and the line. For 72-ohm line, the quarter-wave section should be on the antenna end of the transmission line. The matching section or stub should be about 34 inches for a low-band antenna and 14 inches for a high-band antenna. If you have an all-channel antenna or separate antennas on the same transmission line, then the stub should be about 24 inches long.

**WARD**  
PUTS THE ACCENT ON  
*Star Performance*

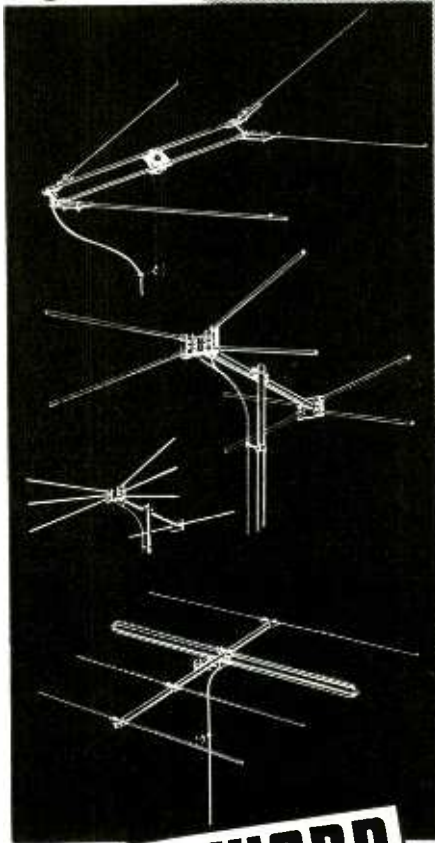

The true measure of antenna performance is in the reception it provides. Ward leadership in engineering and design is your assurance of good TV reception.

**NEW WARD FLYING ARROW:**

An all-band antenna that hits the bulls eye with exceptionally high gain throughout the entire high band. Sharp directivity, maximum energy transfer, fast assembly. Completely preassembled. Stacking kits available for assembling 2 bay arrays. **\$7.95** LIST

**NEW WARD CONICAL:**

High in quality—low in cost. Unique element spacing and angular adjustments eliminated pattern breakup with no falling off of high band response. New molded universal insulator permits any desired element arrangement to suit local conditions and preferences. Stacking kits for 2 single bays and 4 bay arrays.

**NEW WARD YAGI:**

Outstanding in performance for fringe and super-fringe areas. Built-in impedance transformer steps up impedance. Pin point directivity. Very high front to back ratio. No co-channel interference. Minimum standing wave ratio guarantees maximum energy transfer. Plus Ward rugged construction and complete factory preassembly. A model for each channel 2 to 13. Stacking kits for high and low bands.

Write for free catalog pages or call your jobber or distributor now.

**THE WARD PRODUCTS CORP.**  
1523 EAST 45th STREET • CLEVELAND 3, OHIO

*only* **WARD**  
OFFERS  
TV-FM-AUTOMOTIVE  
HOUSE MAST-SPP  
ANTENNAS

**GREYLOCK RADIO TUBE BARGAINS!**

1H5	.59	3Q5GT	.79	6AQ5	.59
1L4	.59	354	.69	6AR5	.59
1NSGT	.59	3V4	.59	6AS5	.59
1Q5GT	.69	6AC5	.49	6AT6	.49
155	.49	6AC7	.89	6BB6	.49
174	.59	6AK5	.89	6BA6	.59
175GT	.59	6AK6	.89	6BA7	.59
3Q4	.59	6AL5	.59	6BE6	.59



**SPEAKER SPECIALS!**  
3", 4", or 5" PM, less output. Alnico 5, each . . . . . 97c  
In cartons of 30, each . . . . . 92c  
6" x 9" Oval PM, Alnico 5, 3.16 oz. magnet, each . . . . . \$2.59

This is only a small fraction of Greylock values. Remember—"Economy Wise Means Greylock Supplies!" 5% off orders of 100 tubes or more. Net F.O.B., N.Y. Write for terrific CR tube prices and Bargain Catalog C-9

**Greylock Electronics Supply Co.**  
115 Liberty Street New York 6, N. Y.

**TWIN-TRAX\* TAPE RECORDERS**

designed... **ENGINEER** in mind

**A COMPLETE SERIES**

of high-fidelity, dependable tape recorders—from transport mechanisms to highly specialized instruments, including the one YOU want. Write today for catalog 5101. Includes ALL technical specifications and direct factory prices.

**AMPLIFIER CORP. of AMERICA**  
398-10 Broadway New York 13, N. Y.

\*Trademark Reg.



These Men are Getting PRACTICAL TRAINING



IN TELEVISION-RADIO ON REAL TELEVISION SETS RADIO RECEIVERS F.M. RECEIVERS IN THE GREAT SHOPS OF COYNE

Big opportunities are waiting for men who know the practical and technical end of Television and Radio. That's what you get at COYNE—besides practical Shop Training in F.M., Electronics and other branches of this giant field.

NOT "HOME STUDY" COURSES All Coyne Training is given in our mammoth Chicago training shops. We do not teach by mail. You train on actual equipment, under friendly instructors.

OLDEST, LARGEST, BEST EQUIPPED SCHOOL OF ITS KIND IN AMERICA Come to the Great Shops of Coyne in Chicago. Established 1899—now in our 51st Year. Fully approved for G.I. training.

MAIL COUPON FOR FREE BOOK

Send today for big new book packed with large pictures taken in Coyne Shops. No obligation. No salesman will call. Get the facts now!

COYNE Electrical & Television-Radio School 500 S. Paulina St., Dept. 60-8H, Chicago 12, Illinois



F. W. COOKE, Pres. COYNE Electrical, & Television-Radio School, 500 S. Paulina Street, Dept. 60-8H, Chicago 12, Ill.

NAME..... ADDRESS..... CITY..... STATE.....

OLD TRICK IN REVERSE

An old trick since the beginning of television has been for self-styled service technicians to call for a receiver to be repaired, remove the set from the owners home, and then abscond, never to be heard from again.

An appliance company man (genuine) called at the home of a Hoboken man to ask how he liked his new TV set. "What set," asked the man, adding that he hadn't been home for several days and didn't like TV anyhow.

An investigation by police revealed that one Richard Vaughan had entered the house while its owner was away, ordered two TV sets worth \$459 from different stores, and hauled them away before the homeowner returned.

CORRECTION

The key figure was left out of the article "Antennas For Fringe Reception" on page 31 of the July issue. The figure shown here is Fig. 1. The dimensions are for a four-element, channel-4 antenna. The drawing in Fig. 1 in the

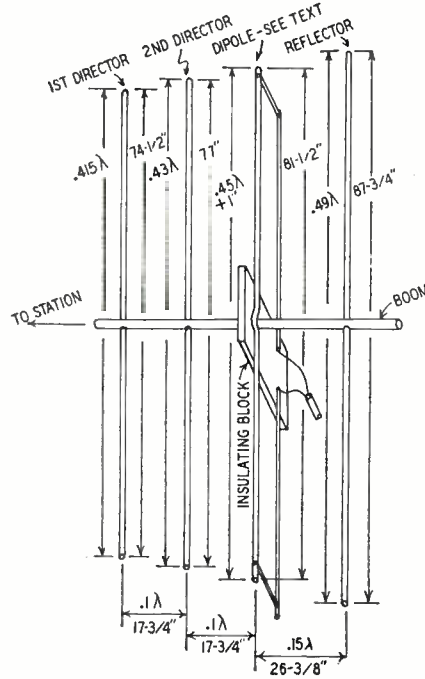

article shows how two of these four-element sections can be stacked 0.475 wavelength apart and matched to a 300-ohm line by making the dipole elements from 3/4- and 5/8-inch tubes spaced 1 3/4 inches on center.

BROADCAST DX

Dx isn't confined only to the short-wave bands. WHSC, a broadcast station in Hartsville, S. C., which operates at 1450 kc with a power of 250 watts, has received three different reports of reception from the vicinity of Dunedin, New Zealand. Two of the receiving antennas were 1,000 feet long and the other was 750 feet. The station uses a .53-wavelength tower.

Leotone Special: Portable DC Ammeter 0-15 Amps. 3 1/2" mirror fan scale. 36" test leads. \$3.95. Dynamic Hand Mike & Headset (B19/Mk II)... \$2.49. T-30V Throat Mike... 39c 6/1.98. CD-508 Cord & Switch for T-30... 49c 6/2.49. Handy Carbon Mike (RS-83)... 5 1/2" cord & plug... .98. T-44A Magnetic Mike... brand new... 69c 3/1.98. 1 1/2" Red Jewel Assy & min. bay. bulb-29c 4/1.00. W-110 Field Wire... rolls approx 2800 ft. Incl. several lengths. Good condition... 5.95. Powerful Alnico 'U' Magnet... 1 3/4"x1 1/4" .98. Wire Record-Playback Head... popular 4 pin Triple-tilt (incl. erase) NOW ONLY... \$6.95. Suicide Socket for wire head... \$0.35. Alnico Erase Magnet for wire or tape... .39. RM-4 Recording Motor (G.I.)... Hvy. duty 115V. AC. 3 3/8" dia. X 2 3/4". Less cable, magnet plate & drive wheel... 4.95. Cabinet & Chassis Foundation... modern plastic; Walnut, Yellow, Orchid or Black. With 8" tube punched chassis. 9"x7"x1 1/2"... 1.49. Cabinet Draw Slides... silent ball-bearing. 1 1/2" x 1 1/2" ext. 1 1/2" x 1 1/2" int. 12 1/2" - \$2.19; Hvy. duty, all-steel 16 1/2" / 12 1/2" - \$2.89; 2 1/2" / 1 3/4" ext. 4.75. 2 1/2" Scope Visor... Hvy. leather. DC rubber... .59. Radio Hardware Treasure... FULL POUND can of Nuts, Screws, Washers, Lugs, etc... .49. Steel Section... MS-53... 39. HS-33 Headsets Lo-imped... 5 ft. cord & PL-55... 1.69. 6V. Buzzer & Key (W.E.)... 1/4" bakelite base... 1.25. 'Luminous Tape'... GLOWS IN DARK. 100 ft. X 3/4"... .49. AN-74A Blade Antenna... SCR-522... .79. PL-259 Co-Ax Plugs... 2 on 4 ft. RG-8 cable... .49. Midget Connector... JK-43 PL-291.2 wire... pair 4 Wire Connector... PL-179 & cable jack... pair High Fidelity Crystal Mike... Hi-imped. Rubber shock-mtd. 1 1/4" O.D. 1/4" deep. Less housing... .98. Aluminum Housing for crystal mike... .15. CK503 AX Sub-Miniature Tubes (Raytheon)... 1.29. Tube Barrels... 90 DA GIAN... 4/1.00. sealed cartons. #24, 27, 39, 41, 42, 77, 78, 84, 85, 89, 9A4, 6DB, 6CS, 6F5, 6G5, 6J5E, 6J7, 6K7, 6S7, 6S7A, 6SD7, 6S7C, 6S7E, 6S7F, 6S7G, 7A7, 7C5, 7H7, 7V7, 12A6, 12SA7, 12SK7 or 35Z3... 2.00. YOUR CHOICE! EACH... .39. 2mf. 50V. Condenser... 2.95. 32mf/450V. Electrolytic... tubular... 39c 3/1.00. 100 Ohm-100 Watt Adjustable Resistor... W.W. .59. 25 Ohm-50 Watt 'Dividom'... 2.95. Power Rheostats... 50W.-4, 50, 300 & 500 ohms 1.29. 25 Watt-350 ohm & knob, cased... .75. 2 1/2" Sq. Panel Meters... 0-50... 1.29. 0-100 AMPS. DC with shunt... .98. Army Gas Mask... universal size, new... .39. Push-Button Station Tabs... covers all U.S... .39. Leather Handies... 6" dbie. sewn & h'dware... .29. 115V. DC G.E. Relay SPST, N.O... 69c 3/1.95. New 'Jumbo Radio Parts Kit'... 17. FULL POUNDS OF COILS, TRANSFORMER, WIRE, SOCKETS, CHASSIS, ETC. Shpg. wt. 21 lbs... 2.95. Moulded Bakelite Condensers... 1.29. .00001 to .2mf., 200-800V. Kit of 50 asstd... 1.98. Knobs... spring, setscrew. Kit of 25 asstd... .98. Wafer Sockets... 4 to 8 pin. Kit of 12 asstd... .25. Wire-Wound Resistors... 5-20W. 15 asstd... .98. Radio Cement & Solvent... 3 oz. each & brush... .69. Min. Order \$2.00. 20% deposit on all COD's. Full remittance with foreign orders. Please add sufficient postage—excess refunded.

OPPORTUNITY AD-LETS

Advertisements in this section cost 25c a word for each insertion. Name, address and initials must be included at the above rate. Cash should accompany all classified advertisements unless placed by an accredited advertising agency. No advertisement for less than ten words accepted. Ten percent discount six issues, twenty percent for twelve issues. Objectionable or misleading advertisements not accepted. Advertisements for October, 1950, issue, must reach us not later than August 24, 1950. Radio-Electronics, 25 W. Broadway, New York 7, N.Y.

MAGAZINES (BACK DATED)—FOREIGN, DOMESTIC. Arts, Books, booklets, subscriptions, pin-ups, Catalog, 10c (refunded). Cicerone's, 86-22 Northern Blvd., Jackson Heights, N. Y.

FREE RECONING PRICE LIST. Guaranteed Work. Hutchison Speaker Service, 4167 Hemphill, Fort Worth, Texas.

LANCASTER, ALLWINE & ROMMEL, 436 BOWEN Building, Washington, D. C. Registered Patent Attorneys. Practice before United States Patent Office. Validity and infringement Investigations and Opinions. Booklet and form "Evidence of Conception" forwarded upon request.

VITOX, for longer storage-battery life. 50c prepaid. LYONART, Trinidad, Colorado.

5D-201 SOLDERING FLUX, 50c up. Parts Distributor or write LYONART, Trinidad, Colorado.

RESISTOR AGENCY WANTED: want to make connections with firm making or selling Resistors. Louis Mairuri, 19 Vinton Street, Providence 0, R. I.

RADIOMEN, SERVICEMEN, BEGINNERS — MAKE more money, easily, quickly, \$250 weekly possible. We show you how. Information free. Merit Products, 216-32L 132nd Avenue, Springfield Gardens 13, New York.

PHONOGRAPH RECORDS CHEAP—Catalogue. Paramount, FF-313 East Market, Wilkes-Barre, Penna.

Five Element TV Yagi Beams. High-Band \$6.75. Low Band \$8.50. Aluminum Tubing, Etc. Willard Radcliff, Postoria, Ohio.

AMATEURS—RADIO AND ELECTRICAL RESEARCH Engineering. Hy Twillmann, R.R. #1, Chesterfield, Mo.

RADIO-ELECTRONICS for



**SERVICE FOR FREDDIE**

Readers are continuing to respond enthusiastically to the appeal for Freddie, the Arkansas radio technician's son who was born without hands or legs. As the photo below shows, Freddie is already able to use his first preliminary pair of legs. Arms will be fitted later, and the artificial limbs will be replaced with more efficient types as Freddie becomes more skilled in operating them.

Contributions from readers for this long and expensive process are pouring in at an accelerating rate.

RADIO-ELECTRONICS is especially gratified that two prominent New Yorkers have asked us for a number of reprints of the original story of "Service to Freddie" appearing in our June, 1950, issue. These reprints were circulated among their own friends in the radio industry with extremely gratifying results.



Freddie tries out his new pair of legs.

RADIO-ELECTRONICS takes great satisfaction in publicly thanking the two gentlemen, Mr. Jules Smith, Vice President of Davega Stores Corporation, famed New York radio chain stores, and Mr. Perry Saftler, well-known radio representative. These two gentlemen were responsible this month for raising \$550.00, which sums are reported below.

Up to the date of July 24, \$2,435 has been collected. No contribution is too large or too small in this campaign to help Freddie. *Make all checks, money orders, etc., payable to Herschel Thomason.* Please address all your letters to:

Help-Freddie-Walk-Fund  
% RADIO-ELECTRONICS  
25 West Broadway  
New York 7, N.Y.

Balance as of June 22 ..... \$1,536.00  
New Contributions ..... 899.01

Admiral Corporation, New York Distributing Division, Inc.—New York, N. Y. \$50.00  
Air King Products Co., Inc.—Brooklyn, N. Y. 25.00  
Harold Don Albright—Clinton, Ohio 2.00  
Anonymous—Modesto, Calif. 1.00

(Continued on page 84)

**HICKOK** *Television*  
**LINEARITY-PATTERN GENERATOR**  
**MODEL 620**

**SERVICE MAN'S INCOME BUILDER...**  
*Provides Stable Pattern for Aligning TV Anytime... Anywhere HOME OR SHOP*

● Here is the instrument for television trouble-shooting that is completely independent of station operation. A new portable instrument especially designed to make TV Warranty Servicing simpler and more profitable.

Now you can prove to any customer in his home, by an electronic instrument that his set is properly aligned. Then, if reception is still faulty, you are able to show the receiver is not at fault. Perhaps a better antenna installation is needed. Model 620 is a compact, portable instrument built to the high HICKOK standard. Technicians who seriously considered dropping warranty servicing now use the 620 and profit by it. Ask any technician who owns one. See your jobber for complete information.

*Features*

- High output to 5,000 microvolts.
- Checks relative receiver sensitivity; horizontal and vertical deflection circuits.
- Permits alignment of linearity, drive, width, height, hold and horizontal AFC controls.
- Connects to receiver antenna.
- Blue hammertex portable steel case.

**THE HICKOK ELECTRICAL INSTRUMENT CO.**  
10531 Dupont Avenue · Cleveland 8, Ohio

Please send me complete details on the new HICKOK 620 Television Linearity Pattern Generator

NAME \_\_\_\_\_  
ADDRESS \_\_\_\_\_  
CITY \_\_\_\_\_ STATE \_\_\_\_\_

**SAVE MONEY—BUILD YOUR OWN SPEED LIGHT EQUIPMENT**  
FOR PROFESSIONAL AND AMATEUR

Easy to follow . . . step-by-step Instructions  
Write for FREE list of complete Kits and Components

**CINEX, INC.**  
Dept. RE-9 165 W. 46th St., N. Y. 19, N. Y.

**TELEVISION RECEIVER—\$1.00**

Complete instructions for building your own television receiver. 16 pages—11"x17" of pictures, pictorial diagrams, clarified schematics. 17"x22" complete schematic diagram & chassis layout. Also booklet of alignment instructions, voltage & resistance tables and trouble-shooting hints.—All for \$1.00.

**CERTIFIED TELEVISION LABORATORIES**  
Dept. C, 5507-13th Ave., Brooklyn 19, N. Y.

**EASY TO LEARN CODE**

It is easy to learn or increase speed with an Instructograph Code Teacher. Affords the quickest and most practical method yet developed. For beginners or advanced students. Available tapes from beginner's alphabet to typical messages on all subjects. Speed range 5 to 30 WPM. Always ready—no QRM.

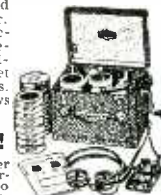

**ENDORSED BY THOUSANDS!**

The Instructograph Code Teacher literally takes the place of an operator-instructor and enables anyone to learn and master code without further assistance. Thousands of successful operators have "acquired the code" with the Instructograph System. Write today for convenient rental and purchase plans.

**INSTRUCTOGRAPH COMPANY**

4701 Sheridan Rd., Dept. RC, Chicago 40, Ill.



**you don't have to be a SLEUTH to know SENCO PRICES are EXTRA LOW**

**BRAND NEW IMMEDIATE DELIVERY**

**TUBES INDIVIDUALLY CARTONED GUARANTEED**

**SPECIAL QUANTITY DISCOUNT OFFER.** Order 25 or More Assorted Tubes and Deduct 5c from the Price of Each Tube.

15¢ Ea.	104	5Y4	524
2C34	10S	523	6B85
1626	2A3	6A6	6B4
E1148	2B7	6AE6	6BF6
	25-45	6A8	6J7
	3B7	6AC5	6Q7
	6A84	6AD7	6W4
999	6AT6	6AL5	6L7
X99	6BA6	6AQ5	6U5
	6BE6	6AR5	6V7
	6B16	6AU6	6V8
	6D7	6B9	7A5
	6F5	6B7	7A9
1240	6G6	6BB	7A7
1245	6H6	6B16	7C5
36	6J5	6C5	7E7
954	6J7	6C7	7F7
955	6K5	6D5	7H7
956	6K7	6E7	7L7
957	6P5	6F6	7M7
	6S5F5	6F8	7Q7
	6S7	6K6	757
	6S87	6K8	7B7
1A3	6H6	6K6	14A7
1V	6V5	6SC7	14Q7
2A6	6X5	6S17	14R7
12AUG		6J7	2A7
2X2	12AF	6V6	2525
6C4	12SF7	7A4	287
6N4	12SJ7	7R6	50L6
6S07	12SR7	7E5	70L7
6S17	12S7	7Y7	R2
6U7	25L6	7Y4	
6X4	31	12AT6	
1248	32L7	12BA6	
1215	34	12BE6	
1217	35Z4	12BF6	
12K7	38	12CF5	
12K8	41	12SG7	
12Q7	43	12SK7	
12S17	46	12SL7	
24A	53	12SN7	
2526	56	12SQ7	
26	58	14R6	
27	80	14H7	
32		1978	
35/51		25A8	
39/44		2804	
57	105	35W4	
76	106	35Y4	
77	106	35Z4	
78	107	35Z5	
78	107	35Z6	
85	107	42	
VR53	107	45Z5	
	109	47	
	1E7	49	
	1F4	50R5	
	1F5	50S5	
	1G4	50Y6	
	1G5	50Y6	
	1G6	71A	
	1H4	71	
	1H6	71	
	1J6	71	
	1L4	89	
	1P5	117Z3	
	1R4	2051	
	1R5		
	100-77		
	100-79		
	155		
	324		
	354		
	3V4		
	4A6		
	4A8		
	1T4		
01A	5W4		
1R5	5Y3		
1T5			

MINIMUM ORDER \$2.50. Send 25% deposit for all C.O.D. shipments. Include sufficient postage; excess will be refunded. Orders without postage will be shipped express collect. All prices F.O.B. New York City

**FREE!**

**NEW 1950 SENCO RECEIVING TUBE BASING DIAGRAM CHART**

Over 230 Basing Diagrams, covering 600 Tube Types. Invaluable to the Service Technician and Amateur. This is Senco's way of saying thank you to old customers and new ones.

**NOTHING TO BUY--FILL IN COUPON--MAIL TODAY!**

NAME .....  
 ADDRESS .....  
 CITY ..... ZONE ..... STATE .....

Radio Men Who Know  
**SAVE AT SENCO**  
 SENCO RADIO, INC., Dept. Y  
 73 West Broadway New York 7, N. Y.

Anonymous—Santa Barbara, Calif.	1.00
Anonymous—Hartford City, Ind.	3.00
Anonymous—Medford, Mass.	1.00
Anonymous—Jackson, Mich.	1.00
Anonymous—Jamaica, N. Y.	1.00
Anonymous—Portland, Oregon	1.00
Artex Poster Co., Inc.—New York, N. Y.	25.00
J. E. B.—Maywood, Ill.	2.00
Mrs. L. B.—Maywood, Ill.	1.00
Milo and Bruce Beam—Richmond, Ind	5.00
Boy Scout Troop Number 43—Weston, Ore.	2.50
Mrs. Cornelia Boland—Springfield, Ohio	5.00
Boston Naval Shipyard, Shop 67 Electronics —South Boston, Mass.	26.50
Joseph Botticella—Hartford, Conn.	2.00
John P. Boyle—Stratford, N. Y.	10.00
Edwin N. Bradley—Sennel, Penzance, Cornwall, England	5.12
Pat Butrico—New York, N. Y.	3.00
California Radio & Electronics Co.—Hollywood, Calif	20.00
Edward and Anne Campbell—New York, N. Y.	20.00
R. Chang—Honolulu, T. H.	3.00
Jack Christie—Winnipeg, Man., Canada	8.94
John Conry—Hillside, N. J.	2.00
A. Crusen—Los Angeles, Calif.	5.00
Dynamic Electronics—New York, N. Y.	10.00
Walter Endel—New York, N. Y.	10.00
Espey Mfg. Co., Inc.—New York, N. Y.	50.00
W. C. Farley—Columbus, Ohio	1.20
Joseph P. Ferraro—Yonkers, N.Y.	2.00
Garod Radio Corporation—Brooklyn, N. Y.	50.00
Michael Gorski—Chicago, Ill.	1.00
Mr. Jesse Green—Springfield, Ohio	1.00
J. Greer—New York, N. Y.	1.00
Ronald Gronsky—Utica, N. Y.	2.00
Larry E. Gubb—Philadelphia, Pa.	10.00
Bobby Gurney—Middleboro, Mass.	2.50
J. J. Harris—Long Island City, N. Y.	25.00
Helen & Jim—Ottawa, Ont., Canada	1.00
Mr. & Mrs. Donald Hill and Family—Jonesville, Mich.	5.00
Hodges Radio and Television—Marion, Ohio	5.00
Charles and Harriett Hornblower—North Hollywood, Calif.	5.00
C. A. Hurray, Jr.—Pittsburgh, Pa.	5.00
Ben Jones—St. Louis, Mo.	2.00
Gerald O. Kaye—Queens Village, N. Y.	25.00
B. A. Keefe—San Antonio, Texas	2.00
T. A. Kennally Philco Corp.—Philadelphia, Pa.	25.00
George J. Klein—New York, N. Y.	5.00
Korty Radio Service—Lexington, Ill.	2.00
Joseph Kubica—Bridgeport, Conn.	2.00
Emil Kurzys—Chicago, Ill.	5.00
M. L.—New York, N. Y.	1.00
Jack Lainfiesta—San Francisco, Calif.	1.00
Harry Lefkowitz, Cortland Co.—New York, N. Y.	20.00
Mr. & Mrs. David Lenn—Baltimore, Md.	2.00
E. Lipfert—St. Albans, N. Y.	1.00
W. McG.—Alameda, Calif.	10.00
Ray B. McKelvey—Florence, Ala.	2.50
Renville McManis—New York, N. Y.	5.00
Machinery Sales & Equipment—Cincinnati, Ohio	5.00
James G. Maddex—Oildale, Calif.	2.50
M. E. Mendelson, M. E. Mendelson, Inc.—New York, N. Y.	5.00
Raymond Mercier—Goose Bay, Labrador, Canada	5.00
Dwight W. Moore—McKees Rocks, Pa.	2.00
Mortimer and Bertha Mosher—South Norwalk, Conn.	2.00
Motorola—New York, Inc.—New York, N.Y.	50.00
William Muessig, Jr.—Aurora, Oregon	1.00
Mr. & Mrs. Herbert Myers—Los Angeles, Calif.	5.00
Dave Ormont, Newark Electric Company—New York, N.Y.	10.00
John M. Otter—Philadelphia, Pa.	25.00
Packerene Radio & Sound Service—Latrobe, Pa.	5.00
José Guzmán Paz—Mayaguez, P.R.	1.00
Perkins Radio & Television Service—Elwood, Ill.	5.00
Vance Philipps—Santa Barbara, Calif	5.00
Post Mfg. Co.—New York, N. Y.	10.00
Radio & Television Division at McKim Technical Institute, Inc.—Akron, Ohio	30.00
Ramm's Radio Shop—Tallahassee, Fla.	2.00
Ivor J. Ranney—Highway Highland, Calif.	1.00
William R. Redlin—Jamaica, N.Y.	2.00
Charles Rogers—New York, N.Y.	25.00
C. A. Ruderman, Davega Stores Corp.—New York, N.Y.	10.00
Lee S. Rynder—Toledo, Ohio	2.00
Louis Sack—New York, N.Y.	10.00
Mortimer Salzman—South Orange, N. J.	10.00
John F. Schwartz, Jr.—Pittsburgh, Pa.	10.00
M. Silver—Brooklyn, N.Y.	25.00
Jules M. Smith—New York, N.Y.	10.00
Harry Stein—New York, N. Y.	10.00
Robert M. Stein—Woodmere, N.Y.	5.00
H. A. Stokes—Fort Worth, Texas	25.00
Sammy Strong—Auburn, Ill.	1.00
John P. Stupu—Bartlesville, Okla.	25.00
Teldisco, Inc.—East Orange, N. J.	10.00
Timas Square Stores Corp.—New York, N.Y.	10.00
C. E. Walter—Pittsburgh, Pa.	10.00
Fred C. Westlager—Pittsburgh, Pa.	2.00
E. A. Wildermuth, Inc.—Brooklyn, N. Y.	25.00

**TERRIFIC VALUES for SMART BUYERS!**

**BUBBLE SEXTANT 12.95** COMPLETE

Terrific value for boat owners! Actually worth \$100 or more! Has illuminated averaging disc for nighttime use. Complete with carrying case, recording discs, flash light with rheostat for using sextant at night, 2X telescope for faint stars, and Allen wrench. **Hurry! Only a few left!**

**ARMY AIRCRAFT RECEIVER—BC-946-B**

Covers 520 Kc to 1500 Kc Broadcast Band. 6 Tubes: 3—12SK7, 1—12SR7, 1—12A6, 1—12K8. Designed for dynamotor operation; can be easily converted to 110 volt or 32 volt use. Two IF Stages. Three-gang tuning con. BRAND NEW, in sealed carton, with tubes and instruction manual, less **\$29.50**

**SMASH VALUES IN RADIO RECEIVERS**

Model	Used	New
BC-453 RCVR.	...	\$21.95
BC-454 RCVR.	\$4.95	7.95
BC-455 RCVR.	6.95	9.95
BC-456 MOD.	1.95	3.45
BC-457 XMTR.	6.95	8.95
BC-458 XMTR.	6.95	8.95
BC-459 XMTR.	...	23.95
BC-676	14.95	24.95

**BC-645 XMTR RECEIVER 15 Tubes 435 To 500 MC**

The electronic equipment that saved many lives in the war. Set can be modified to use for 2-way communication, voice or code, on following bands: ham band 420-450 mc, citizens radio 460-470 mc, fixed and mobile 450-460 mc, television experimental 470-500 mc. 15 tubes (tubes alone worth more than sale price!): 4—7F7, 4—7H7, 2—7E6, 2—6F6, 2—955 and 1—WE316A. Now covers 460 to 490 mc. Brand new BC-645 with tubes, less power supply in factory carton. Shipping weight 25 lbs.

**\$16.95 each**

**PE-101C DYNAMOTOR for above BC-645 \$2.95**

**UHF ANTENNA ASSY, for above BC-645 \$2.45**

**WILLARD 2-VOLT STORAGE BATTERY 20 Ampere-Hours**

Exact replacement for GE Model LB-530 portables—brand new. 5" high, 3 3/4" wide, 3" deep. **\$1.95**

**7-PRONG 2-VOLT VIBRATOR for portables and farm sets. Replacement for GE LB530 \$1.65**

**WILLARD MIDGET 6-Volt 3 Amp-Hr. Storage Battery. Transparent plastic case. New \$2.65**

**DELCO 24 Volt 17 Amp-Hr. Storage Battery, Brand New, very special... \$17.95**

**1-QUART Battery Electrolyte for all above, enough for 2 Two-Volt Cells... \$1.25**

**EE-B ARMY FIELD PHONES, complete with finger, used, good as new!... each \$12.95**

**THYRATRON FG-105 G.E. Mercury Rectifier, individually boxed, brand new... \$11.95**

Please include 25% Deposit with order—Balance C.O.D. MINIMUM ORDER \$3.00. All Shipments F.O.B. Our Warehouse N.Y.C.

**G & G RADIO PARTS SERVICE**  
 53 VESEY STREET - NEW YORK 7, N.Y.



**BROADCAST AUTHORIZATIONS FIND TEXAS AGAIN IN LEAD**

Texas has more authorized broadcast stations than any other state in the country. As of June, 1950, the Lone Star State had a total of 222 AM, FM and TV authorizations; California was second with 219.

Texas and California topped the AM list with 183 and 143 such authorizations, respectively, and Pennsylvania was third with 111.

Pennsylvania had the most FM authorizations—67, commercial and educational—followed by 65 for California, 62 for New York, and 51 each for Illinois and Ohio. Commercial FM authorizations showed 63 for Pennsylvania, 58 for California, and 56 for New York state. In the noncommercial educational FM field, California had 7 such authorizations, and Indiana, New York, Ohio and Wisconsin 6 each.

The television list was led by New York, Ohio, and California, in that order with 13, 12, and 11 TV stations.

Cities with 10 or more broadcast stations, including noncommercial educational, totaled 36. In number of AM, FM and TV stations collectively, New York led with 35, with Chicago's 34 a close second.

New York had the most commercial FM outlets—14; Chicago was second with 13. Eight cities had more FM (commercial and educational) than AM grants (New York, San Francisco, Washington, Baltimore, Pittsburgh, De-

troit, Columbus, and Madison), and two cities had as many FM as AM grants (Boston and Dallas).

Chicago led with 16 AM stations, followed by New York with 14, Los Angeles 13, and 10 each for Philadelphia, Minneapolis-St. Paul, Portland, and New Orleans.

Los Angeles headed the TV list with 7 such stations; New York 6, and 4 each for Chicago and Washington, D.C.

**TELEVISION INVADES TELEPHONE PRIVACY**

Radio-telephone conversations are never certain to be private, but television is likely to make them even less so. It was reported recently that a lady in Connecticut received a call from her father from the Merchants Limited, a deluxe train that runs between Boston and New York. The conversation was about family matters, including some remarks about when the lady's husband was leaving for California.

The lady had no sooner hung up when the telephone rang again and a man, a complete stranger, asked if she would join him for dinner while her husband was away. He said he had heard her conversation on his television receiver and got her number when the operator repeated it.

The Connecticut lady complained to the New Haven Railroad, who blamed the eavesdropping on the poor construction and lack of wave traps in some TV receivers.

**AMPERITE**  
Studio Microphones  
at P.A. Prices



**Ideal for BROADCASTING RECORDING PUBLIC ADDRESS**

"The ultimate in microphone quality," says Evan Rushing, sound engineer of the Hotel New Yorker.

- Shout right into the new Amperite Microphone—or stand 2 feet away—reproduction is always perfect.
- Not affected by any climatic conditions.
- Guaranteed to withstand severe "knocking around."

Models  
RBLG—200 ohms  
RBHG—Hi-imp.  
List \$42.00



"Kontak" Mikes  
Model SKH, list \$12.00  
Model KKH, list \$18.00

**Special Offer:** Write for Special Introductory Offer and 4-page illustrated folder.

**AMPERITE Company, Inc.**  
561 BROADWAY • NEW YORK 12, N. Y.  
Canada: Atlas Radio Corp., Ltd., 560 King St. W., Toronto

**Get This Valuable Book** Just for Examining COYNE'S New 5-Volume Set

**FREE** *"Applied Practical Radio-Television"*



**ON 7 DAYS FREE TRIAL!**



Yes, you get this great big, brand new book, "150 New Radio-Television Diagrams Explained", absolutely FREE! Gives you complete wiring circuits and diagrams on the latest Radio and Television Sets. Easy-to-read, large 8½ x 11" pages, with full instructions on how to read and use the diagrams. This book is a "must" in every Radio and Television service-man's repair kit. You get this valuable book as a FREE Gift just for asking to see Coyne's great new 5-Book set, "Applied Practical Radio-Television"!

**Here's "Know How" that Makes You Worth More!**

Coyne's new "Applied Practical Radio-Television" is written for men who want to get ahead fast in big pay TELEVISION and RADIO work . . . men who know that a practical working knowledge helps bring top earnings. Over 1500 pages, 5000 subjects, of the latest Radio and Television "know how"—with 1000 crystal-clear illustrations and diagrams. COMPLETE SECTION ON COLOR TV AND UHF! How to install, service, align, balance ALL radio and TV sets . . . how to use testing instruments . . . latest data on UHF adapters and converters, and much MORE. Step-by-step photographs "break down" equipment to show you what makes it "tick". Fully indexed for ready reference on the job or to study at home. Up-to-the-minute, complete, easy to understand!

**SEND NO MONEY!** Just mail coupon. We'll send you 5-volume set on 7 DAYS FREE TRIAL. With it we'll include the book on 150 Radio-TV Diagrams. If you keep set, pay \$3 in 7 days and \$3 per month until \$16.50 plus postage is paid. (Cash price, \$15.00.) Return the set alone and you OWE NOTHING. Either way, the book of Diagrams is yours to keep. Coupon is just a request to see Set free and get FREE BOOK. Offer limited. Act NOW!

**FREE BOOK—FREE TRIAL COUPON!**

**COYNE Electrical and Television—Radio School**  
500 S. Paulina St., Dept. 90-T1, Chicago 12, Ill.

YES! Rush "Applied Practical Radio-Television" for 7 days FREE TRIAL per your offer. Include my gift of 150 Radio-Television Diagrams Book FREE!

Name ..... Age .....

Address .....

Town ..... Zone ..... State .....

Where employed .....

**COYNE** ELECTRICAL & TELEVISION-RADIO SCHOOL  
500 S. Paulina St., Dept. 90-T1, Chicago 12, Ill.





Venetian  
Blind Effect  
and  
Audio Chatter

New TRIO "CONTROLLED PATTERN" TV Antenna System completely eliminates co-channel interference even when caused by a signal TWENTY-FIVE TIMES STRONGER than that of desired station.

This amazing system provides up to 17 db. forward gain making possible Extreme Fringe Area TV Reception.

Consisting of two high gain yagis, offset stacked for exact vertical angles, and the remarkable "PHASITRON" (patent applied for) the Model 604 "Controlled Pattern" TV Antenna System enables you to actually Tune Out interfering stations thus providing TV reception where never before possible.

Available for each present TV channel. Write for illustrated folder.

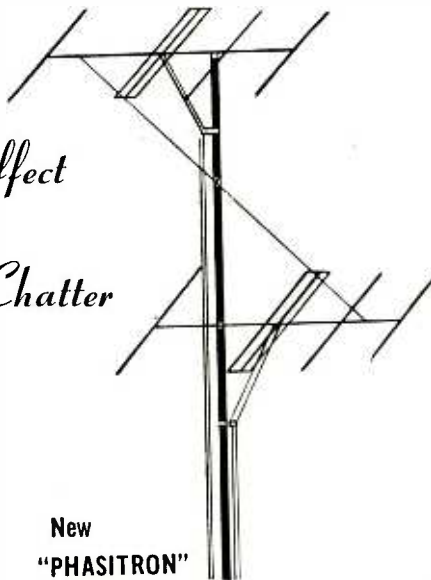

New  
"PHASITRON"



A NOTE TO R-E AUTHORS:  
AVOID HOT CHASSIS JOBS

The following excerpts from a recent letter will be interesting to all writers and prospective writers of construction articles, and may be read with profit by constructors and experimenters as well:

"After looking over your article (and your equipment) we have decided that it is not usable under our present policy of avoiding hot chassis jobs.

"We do not condemn all a.c.-d.c. equipment, of course. Many excellent transformerless jobs are manufactured. But the manufacturer can protect his stuff with plastic cabinets, whereas home-constructed equipment is more likely than not to be used right out 'in the open.' Thus safe construction is more important in home-built equipment than in most commercial products.

"We now require that all a.c.-d.c. equipment be hooked up with a negative bus isolated from chassis (or connected to chassis with the approved capacitor-resistor combination between negative bus and chassis. The capacitor should be not larger than .05  $\mu$ f and the parallel resistor not smaller than 470,000 ohms). We have deviated from this at times—in the case of some especially interesting circuits, a few pieces of apparatus in which possibility of danger is remote, and, in a few cases, through sheer oversight—but our objective is to print only SAFE constructional circuits in the magazine."

The above does not mean that any of our circuits (or any other circuits) are fool-proof. It is always possible to get into a "safe" circuit in such a way as to get across dangerous voltages. Remember, the prosaic 117 volts still hold the record for killing more people than all other voltages combined.

Radio Thirty-Five Years Ago  
In Gernsback Publications

HUGO GERNSBACK  
Founder

Modern Electrics.....	1908
Electrical Experimenter.....	1913
Radio News.....	1919
Science & Invention.....	1920
Television.....	1927
Radio-Craft.....	1929
Short-Wave Craft.....	1930
Television News.....	1931
Wireless Association of America.....	1938

Some of the larger libraries still have copies of ELECTRICAL EXPERIMENTER on file for interested readers.

ELECTRICAL EXPERIMENTER  
SEPTEMBER 1916

- New Light Weight Radio Sets for Aeroplanes
- A Conical Variable Condenser Motorcycle Radiophone
- High Tension Condenser Switch, by Ernest Oke
- An Ultraudion Hook-Up, by L. M. Westcott, U.S.N.
- Adjustable Head Band for Phones
- Building a 110-ft. Iron Pipe Radio Mast, by Samuel Cohen
- Making Selenium Cells, by Homer Vanderbilt
- Frequency Meters, by Milton B. Sleeper

RADIO-ELECTRONICS for



**TRIO MANUFACTURING COMPANY**  
GRIGGSVILLE, ILLINOIS

**\* VOLOMETERS**  
\*Reg. Trade Mark for Volt-Ohm-Milliammeter

**MODEL 102**  
(1000 ohms per volt meter)  
• 3" SQUARE METER  
• 3 AC CURRENT RANGES (0-30/150/600 ma.)  
• Same zero adjustment for both resistance ranges (0-1000 ohms, 0-1 meg-ohms)  
• 5 DC & 5 AC Voltage Ranges to 3,000 Volts. Also 4 I.C. Current Ranges. **\$13.90**



**MODEL 104**  
(20,000 ohms per volt meter)  
• 4 1/2" SQUARE METER (50 micro-amperes—alnico magnet)  
• Includes carrying strap  
• 5 DC Voltage Ranges at 20,000 ohms/volt to 3,000 V.; 5 AC Voltage Ranges to 3,000 V. 3 Resistance Ranges to 20 megs. Also 3 A.C. & D.C. Current Ranges **\$24.95** & 5 DB Ranges.



Export Dept., 303 W. 42nd St., N.Y.C.  
Write Dept. B-9 for Free Catalog

Gives More Measurement Value per Dollar!

**EMC ELECTRONIC MEASUREMENTS CORP.**  
423 BROOME STREET, NEW YORK 13, N. Y.

*Arkay*  
Fine Quality  
Radio  
and  
Test Equipment  
*Kits*  
at popular prices!  
- 19 -  
Different Models!

ask your dealer for catalog or write direct to us!

*Arkay*  
By: RADIO KITS, INC.  
120 Cedar St., New York 6, N. Y.

**ELECTRONIC LITERATURE**

Any or all of these catalogs, bulletins, and periodicals are available to you if you write to us on your letterhead (do not use postcards) and request them by number. Send coin or stamps where cash is required. We will forward the request to the manufacturers, who in turn will send the literature directly to you. This offer void after six months.

**S-1—TELEVISION EQUIPMENT**

Form No. 2J6384 is a 12-page booklet by RCA giving equipment specifications of u.h.f. television transmitter type TTU 1A and antenna type TFU-20A.—*Gratis to interested parties*

**S-2—TAPE RECORDER**

Form No. 2J6434 is an 8-page booklet describing RCA magnetic tape recorder type RT-11A, a professional unit designed specifically for broadcast service.—*Gratis to interested parties*

**S-3—ATOMIC CHART**

More than 1,000 kinds of atoms are shown in the Chart of the Nuclides issued by G-E. The 26 x 50-inch chart shows each of the 96 elements with all their isotopes, giving the composition of each and information about radioactivity.—*Gratis*

**S-4—TRANSFORMER CATALOG**

The Crest Transformer Company has a new 12-page catalog describing their line of transformers and chokes. Included are audio, power, plate, and television transformers.—*Gratis*

**S-5—MINIATURE TUBE GUIDE**

The fourth edition of Hytron's Reference Guide for Miniature Tubes lists 132 miniatures of all makes. The guide has 70 basing diagrams and lists similar larger prototypes.—*Gratis*

**S-6—TEST EQUIPMENT**

Model 301—A Coil Checker and Model 299 R.F. Signal Generator are described in two bulletins released by the Clough-Brengle Co. Complete specifications for the instruments are given.—*Gratis*

**S-7—TIMING MOTORS**

A full line of electrical timing motors is described with photographs, dimensional drawings, circuit diagrams, and ratings in an 8-page catalog of the Haydon Manufacturing Co. Among the motors listed is a new series designed for very slow output speeds in a minimum of space.—*Gratis*

**S-8—CONNECTORS**

Plug-ins, chassis connectors, mechanical locking devices, special connectors, and tube sockets are described in a bulletin released by the Alden Products Company.—*Gratis*

**S-9—LOUDSPEAKERS**

Radio and television replacement speakers, both PM and electrodynamic, are described in catalog 127M released by Cleveland Electronics, Inc.—*Gratis*

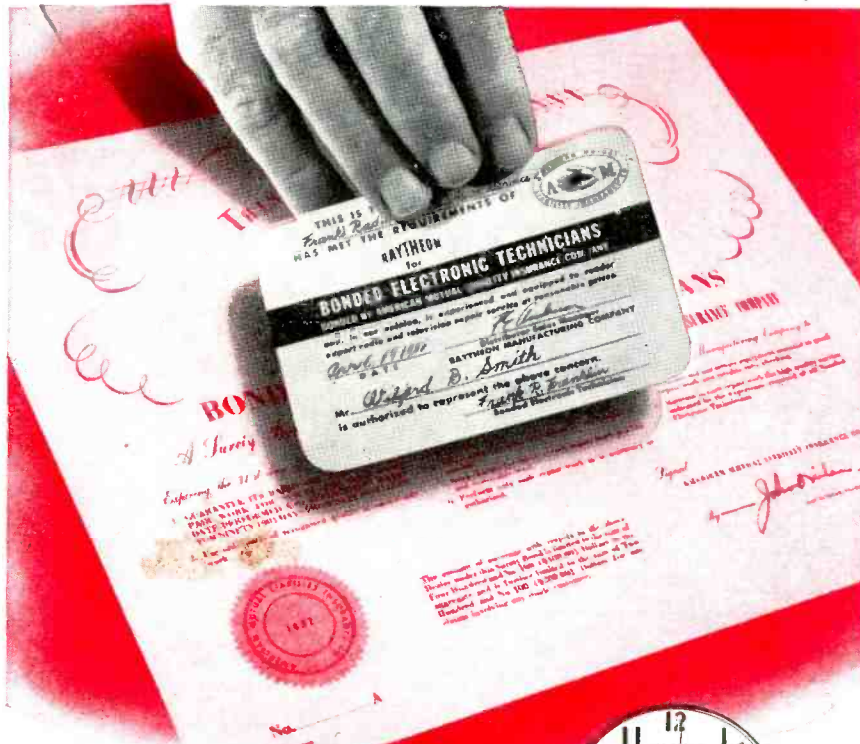

*Your Pass to*  
**TELEVISION AND RADIO SERVICE**  
*Prosperity*

Identification as a RAYTHEON Bonded ELECTRONIC TECHNICIAN means money in the bank for you! It means better business and more of it for you because set owners know they can trust Service Dealers displaying the Raytheon Bonded Certificate, backed by a guarantee bond of the hundred million dollar American Mutual Liability Insurance Co.

This valuable Raytheon Bonded Service Guarantee is yours at no cost, if you qualify. We foot the bill because the Bond is Raytheon's Investment in Your Future!

Ask your Raytheon Distributor to show you how you can profit from becoming a RAYTHEON Bonded Electronic Technician.



**ASK YOUR RAYTHEON DISTRIBUTOR ABOUT THIS WONDERFUL NEW ILLUMINATED TEST PATTERN CLOCK!**

It's a beauty. Big, 15" face... Telechron motored... red metal sweep second hand... lamp illuminated dial... a constant reminder to your customers of your expert Radio and Television Service and of the high quality of

**RAYTHEON RADIO AND TELEVISION TUBES**  
*Right... for Sound and Sight*

**RAYTHEON**  
*Excellence in Electronics*  
Raytheon Manufacturing Company  
Receiving Tube Division  
Newton, Mass., Chicago, Ill., Atlanta, Ga., Los Angeles, Calif.  
(RADIO AND TELEVISION) RECEIVING TUBES, CATHODE RAY TUBES, SPECIAL PURPOSE TUBES, SUBMINIATURE TUBES, MICROWAVE TUBES  
COPYRIGHT 1950

**BUILD 15 RADIOS...Only \$14.75**

- ABSOLUTELY NO KNOWLEDGE OF RADIO NECESSARY
- NO ADDITIONAL PARTS NEEDED
- EXCELLENT BACKGROUND FOR TELEVISION

The PROGRESSIVE RADIO EDU-KIT will help you, if you want an EDUCATIONAL AND INTERESTING HOBBY, or if you want to get into a WELL-PAYING BUSINESS, or if you want to INCREASE YOUR KNOWLEDGE OF RADIO.

Absolutely no knowledge of radio is necessary. The PROGRESSIVE RADIO EDU-KIT is the product of many years of teaching and engineering experience. The detailed instructions and quizzes are clearly written and illustrated, so that they can be understood by anyone between the ages of 12 and 80.

The PROGRESSIVE RADIO EDU-KIT is not merely a collection of radio parts accompanied by a radio diagram. IT IS PRACTICALLY A RADIO COURSE, offered at a mere fraction of its real value. You will be taught to build radios in a progressive manner. First, you will build a very simple 1-tube receiver. The next set is a little more advanced. Gradually you will find yourself constructing elaborate radio sets, and doing work like a professional radio technician. Every part is illustrated. EVERY STEP INVOLVED IN BUILDING THESE SETS HAS BEEN CAREFULLY PLANNED. YOU CANNOT MAKE A MISTAKE.

Each of the 15 radios you will build operates on 110-120 volts, AC or DC. These sets have been designed to teach you the PRINCIPLES OF RADIO. Therefore, you will build a variety of circuits. The PROGRESSIVE RADIO EDU-KIT IS EXCELLENT FOR LEARNING THE PRINCIPLES OF RECEIVER, TRANSMITTER, AND AMPLIFIER DESIGN. It is used in many Radio Schools and Colleges in U.S.A. and abroad. It is used by the Veterans Administration for veteran training.

Quizzes are provided as part of the PROGRESSIVE RADIO EDU-KIT. They will be corrected by our staff at no extra cost.

**FREE 1950 EXTRAS:**

- ELECTRICAL AND RADIO TESTER
- SCREWDRIVER
- BOOK ON TELEVISION
- GENEROUS HANK OF WIRE
- ELECTRIC SOLDERING IRON
- ALIGNMENT TOOL
- SPOOL OF ROSIN CORE SOLDER
- MEMBERSHIP IN RADIO-TV CLUB

ORDER YOUR PROGRESSIVE RADIO KIT TODAY, OR SEND FOR FREE "KIT CATALOG" POSTAGE PREPAID BY CASH ORDERS. O.O.D. ORDERS ACCEPTED IN U.S.A.

**PROGRESSIVE ELECTRONICS CO., 497 Union Ave., Dept. RE-39, Brooklyn 11, New York**



For  
profitable  
TV  
servicing

## Use STANCOR EXACT DUPLICATE TRANSFORMERS

Every call-back you make means lost time and profits. Why take a chance with transformers that "almost fit?" You're sure of a good job and a satisfied customer when you use Stancor *Exact Duplicate* transformers for TV servicing. These units meet the exact specifications, electrically and physically, of the original components. Representative types are listed below.

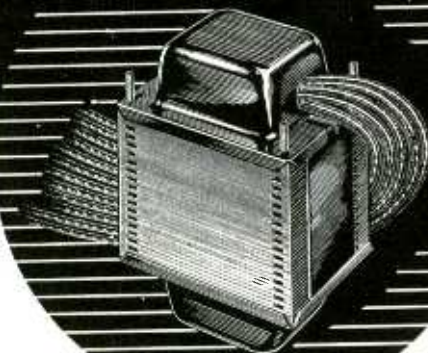

**JUST PUBLISHED**—Ask your Stancor Distributor or write for your free copy of the **New STANCOR TV CATALOG and REPLACEMENT GUIDE**.

Also available is the **New STANCOR CATALOG OF TRANSFORMERS** for radio, sound and other electronic applications.



**STANDARD TRANSFORMER CORPORATION**

3592 ELSTON AVENUE • CHICAGO 18, ILLINOIS

**Vertical Blocking - Oscillator Transformer.** Stancor Part Number A-8121. Exact duplicate of RCA type 208T2. For generation of 60 cps required to drive grids of vertical discharge tubes.

**Plate and Filament Transformer.** Stancor Part Number P-8156. Exact duplicate of RCA type 201T6 used in model 630TS receiver.

**Deflection Yoke.** Stancor Part Number DY-1. Exact duplicate of RCA type 201D1. For use with direct viewing kinescopes such as 7DP4 and 10BP4.

**Focus Coil.** Stancor Part Number FC-10. Exact Duplicate of RCA type 202D1. For use with magnetically focused kinescopes such as RCA type 10BP4.

**Horizontal Deflection Output and HV Transformer.** Stancor Part Number A-8117. Exact duplicate of RCA type 211T1. For use with direct viewing kinescopes, such as types 7DP4 and 10BP4.

For complete specifications and prices of these and other Stancor TV replacement components, see your Stancor distributor or write for Television Catalog 337.

### TECHNICIANS' GROUP HITS JOBBER PRICE PRACTICES

A resolution regarding merchandising practices was among the more important pieces of business passed at the regular meeting of ESFETA (Empire State Federation of Electronic Technicians' Associations) held at Bayville, Long Island, June 25th. The resolution reads:

"Resolved: The policy of radio jobbers and distributors to sell to retail customers at wholesale prices is objectionable.

This practice deprives technicians of their contact with a potential customer and consequently a loss of their legitimate income.

The member organizations of ESFETA, representing some 3,000 radio and television technicians of New York State, recommend to the members of NEDA that this practice be eliminated to the betterment of relations of all groups of the radio and TV industry."

Though hampered by a late start, a number of important discussions and actions were given attention. Presentations of Certificates of Appreciation were made to those individuals and firms who had assisted the Federation in its 1949-50 Television Lecture Course. Representatives of a number of these manufacturers and publishers were present to receive the awards.

Delegates from the Central New York, Endicott, Kingston, Long Island, New York City, Rochester, Southern Tier (Binghamton) and Westchester associations were present at the meeting.

### GERMANIUM PHOTOCELL

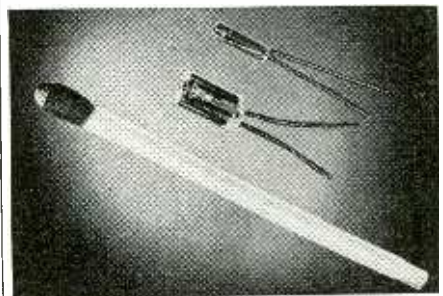

Tiny germanium photoelectric cells thinner than a match stick and less than an inch long are a product of Sylvania Electric's laboratories. The experimental models shown in the photo consist of a tiny piece of germanium in contact with a fine wire whisker sealed in a solid piece of transparent plastic that allows light to reach the contact point. The sensitivity of such a unit is 0.1 ma change in current per lumen of light near the infrared region. No plans have been made for quantity production.

### PARIS EXPOSITION

A radio and television exposition is scheduled to be held in Paris from October 5 to 15 at the Esplanade des Invalides. The show, sponsored by the National Syndicate of Radioelectric Industries, will include a series of demonstrations and broadcasts by Television Francaise.

### NEW CONDENSER TESTER

**Finds Intermittent  
Condensers Instantly**

Pres-probe's sliding tip with variable resistance prevents condenser heating. Tests with power on. Requires no adjustment. Stops guesswork. Saves time. Convenient probe size (7 1/8" long). Satisfaction guaranteed.

See Your Dist. or Order Direct

**PRES-PROBE CO.**

2326 N. THIRD ST., MILWAUKEE 12, WIS.

### PEN-OSCIL-LITE

Extremely convenient test oscillator for all radio servicing; alignment • Small as a pen • Self powered • Range from 700 cycles audio to over 600 megacycles u.h.f. • Output from zero to 125 v. • Low in cost • Used by Signal Corps • Write for information.

**GENERAL TEST EQUIPMENT**  
38 Argyle Ave. Buffalo 9, N. Y.

### \$10,000 REWARD

Earn the government bonus by locating radium with a  
**P.R.I. GEIGER COUNTER**

The most sensitive portable Geiger Counter made.

Weight only 2 lbs. Battery lasts a year. Prospecting hook included free. Priced from \$39.50 complete.  
**PRECISION RADIATION INSTRUMENTS, INC.**  
5478-R Wilshire Blvd. Los Angeles 36, Calif.  
Dea. or Inquiries Invited

# EVERYONE IN RADIO NEEDS—

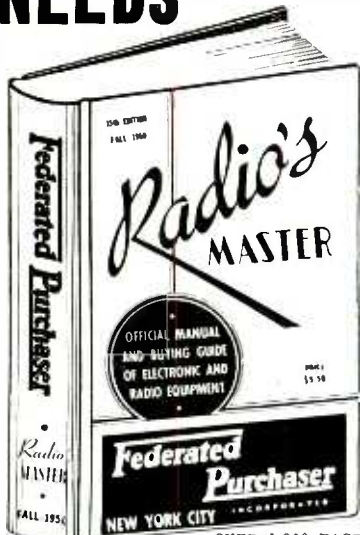

OVER 1,200 PAGES  
FIFTEENTH EDITION PUBLISHER'S  
NOW READY PRICE \$5.50  
THOUSANDS OF ILLUSTRATIONS,  
SPECIFICATIONS, AND PRICES.  
CROSS-INDEXED FOR EASY HANDLING.  
PERMANENTLY BOUND WITH HARD COVER.

**Radio's Only Complete  
REFERENCE BOOK  
AND  
BUYING GUIDE**  
For Radio and Electronic  
Parts and Equipment

**HERE'S HOW TO GET IT  
FREE FROM  
FEDERATED**

We will send RADIO'S MASTER free of charge upon request with your order for Electronic Merchandise.

OR  
USE THIS COUPON

FEDERATED PURCHASER INCORPORATED  
66 DEY ST., NEW YORK 7, N. Y.

Send a copy of RADIO'S MASTER, post-paid. Check for \$1.65 enclosed, which will be refunded with our initial order for Electronic Merchandise.

NAME \_\_\_\_\_  
COMPANY \_\_\_\_\_  
ADDRESS \_\_\_\_\_



NEW YORK CITY: 66 Dey Street  
NEWARK, N. J.: 114 Hudson St.  
ALLENTOWN, PA.: 1115 Hamilton St.  
EASTON, PA.: 701 Northampton St.

### HALLICRAFTERS T-54 AND 505

These sets have push-button tuners which are constructed so it is almost impossible to get directly at the contacts to clean them when they become noisy. I have solved the problem by turning the chassis on one end and using an atomizer to spray front and rear of the contacts with Contactene or carbontet. I work each button vigorously as I come to it. Allow the switch assembly to dry thoroughly before aligning the front end.—*Fred Rodey*

### SUPERIOR 670 MULTIMETER

This instrument has two 0.5- $\mu$ f, 120-volt tubular capacitors as filters. In localities like mine, where the line voltage may rise to 120 volts or higher, these capacitors may break down and ruin the 12H6 tube.

Replacing these capacitors with 400-volt units will prevent troubles of this kind.—*Lester Brunner, Jr.*

### INTERMITTENTS IN A.C.-D.C. SETS

Intermittents in a.c.-d.c. midgets are frequently caused by unshielded coils or cart wheel i.f.'s. The thin leads between the coils and terminals often break because of excessive vibration, or too much tension. The break is hard to locate when the wires are held together by flux or insulation. A break of this type is evidenced by erratic operation when the set is jarred.—*DeLoss Tanner*

### EMERSON MODEL 511

If this set is dead and you cannot locate the trouble, disconnect the voice coil leads and make a continuity test across them. I ran across two of these sets which had open voice coils.—*Raymond E. Terry*

### MIRROR-TONE A.C.-D.C. SETS

When the 35W4 rectifier tube is dead, do not replace it before checking the plate bypass capacitor—usually .02  $\mu$ f at 150 volts—between ground and the plate (pin 5) of the 50B5. Rectifier tubes will continue to burn out if this capacitor is open. Needless to say, the damage can be even more serious if the capacitor is shorted.—*Wm. Gamboney*

### TIPS TO TV CONSTRUCTORS

Constructors, experimenters, and service technicians often run into trouble on sets having slug-tuned coils. The slotted screw which adjusts the core is either so tight that the slot breaks or it is located in a place where it is difficult to get at to make adjustments. I solve this problem by screwing a nut onto the top of the screw and soldering it in place. This allows me to use an insulated wrench or neutralizing tool instead of a screwdriver.

TV experimenters who don't care to pay the high price for a new 6BG6-G can replace this tube with a surplus 807 and a homemade adapter fashioned from an octal base and a five-prong socket. I have found that an 807 often performs better than a 6BG6-G in horizontal output circuits.—*Jacob Dubinsky, W2LVR*

# EVERYTHING IN TELEVISION!

—Now at  
your  
fingertips,  
for quick,  
easy  
reference...



## THE VIDEO HANDBOOK

### THE COMPLETE TELEVISION MANUAL

by MORTON G. SCHERAGA, *Television Research Consultant, Allan B. Du Mont Labs.* and JOSEPH J. ROCHE, *Editor, Radio and Television Maintenance.*

Now in one volume—all the essential know-how of television! All the up-to-the-minute information on television is arranged for quick reference—in easy-to-understand language.

The VIDEO HANDBOOK gives you practical answers to all your questions on television. This best-selling TV encyclopedia tells you . . .

- How Television Works
- How to Plan and Engineer Television
- How to Troubleshoot and Repair Television
- How to Select and Install a Television Antenna
- How to Produce a Television Show, Technical Aspects
- How to Build an Operating Television Receiver
- How to Select a Television Receiver

The VIDEO HANDBOOK contains thousands of vital facts—covering everything you need to know for working in Television. Every important point discussed is visualized in diagram or photographs (over 860 illustrations).

More than 900 pages . . . handsomely bound in durable Fabrikoid. Only \$5.95

### SEND NO MONEY

You must see this book to appreciate it! 20,000 copies now working for practical Television men! Mail coupon for YOUR copy TODAY.

### —10-DAY FREE EXAMINATION COUPON—

BOYCE-ROCHE BOOK CO.  
Montclair 2, New Jersey

Please send me The VIDEO HANDBOOK for 10-day examination. If I decide to keep it, I will send you \$5.95 plus postage; otherwise I will return the book postpaid. (We pay postage if you send \$5.95 with this coupon; same return privilege.)

Name \_\_\_\_\_  
Address \_\_\_\_\_  
City \_\_\_\_\_ Zone \_\_\_\_\_ State \_\_\_\_\_  
Employed by \_\_\_\_\_  
(This offer applies to U.S. only.)



# FIRST TV OFFER EVER MADE ON THE 630 (10" to 19") BASIC TELEVISION PARTS KIT FOR \$39<sup>49</sup>

(If you purchased each part separately at list price it would total over \$100)

- PUNCHED & DRILLED CHASSIS PAN
- BRACKET & SHIELD KIT (18 items)
- VIDEO & I.F. KIT (19 items)
- POWER TRANSFORMER #201T6
- VERTICAL OUTPUT TRANSFORMER
- VERTICAL BLOCKING TRANSFORMER
- FLYBACK TRANS. #211T1 or #211T5
- FOCUS COIL, #202D1 or #202D2
- DEFLECTION YOKE, 60° or 70°

ALL FOR ONLY  
**\$39<sup>49</sup>**  
INCLUDING  
CIRCUIT DIAGRAM

## CONVERT ANY 10" TV SET TO A LIFE-LIKE 16" RECEIVER

With a new DELUXE VOLTAGE DOUBLER KIT—scientific . . . accurate . . . eliminates guess work. Anyone with even a limited knowledge of TV can follow the simple step by step instructions and produce a perfect conversion in one hour.

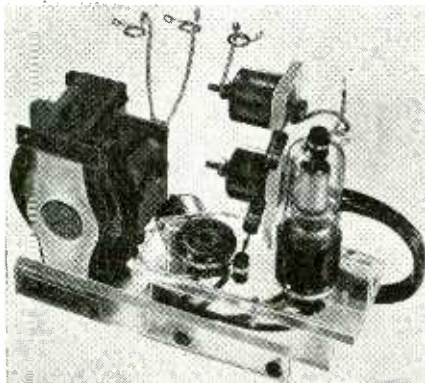

### ASSEMBLED KIT FOR THE 630 CHASSIS

- Sub-Assembly (illustrated)
- Flyback Transformer #211T5
- Rectifier Tube #1B3
- Resistors & Condensers
- Set of Mounting Brackets

**15<sup>98</sup>**

### UNASSEMBLED KIT FOR ANY TV CHASSIS

(SAME SET OF COMPONENTS AS LISTED ABOVE)

Electrically the circuit remains the same. Unassembled form allows for modifications in mounting and wiring.

**13<sup>98</sup>**

ILLUSTRATED CONVERSION MANUAL SUPPLIED WITH EACH KIT

Add \$3.85 for plastic sleeve and ring.  
Add \$3.98 for 70° deflection yoke.

BROOKS RADIO & TELEVISION CORP. 84 Vesey St., Dept. A New York 7, N. Y.

### SENTINEL 401, 402, 406, AND 411

Glass breakage and premature failure of the 6AR5 a.f. output tube are common in these models. The shield over this tube fits very snugly. It is used solely to prevent the tube from dropping out of its socket during shipment. If there are any minute flaws in the glass envelope, the tube will break because of expansion caused by heat. Do NOT reinstall the shield when replacing the 6AR5 tubes.—Sentinel Service Dept.

### MOTOROLA VT-171

Capacitors begin to break down after several months of operation in these sets. This trouble is caused by the intense heat which melts the wax in the capacitors. Replace the capacitors with molded or high-temperature types, then drill ventilating holes in the bottom of the cabinet, in the chassis bottom cover plate, and in the top of the chassis.—Harry Ashby

### TV IN NOISY LOCATIONS

Interference is likely to be picked up on 300-ohm ribbon TV lead-ins when used in noisy locations. If the TV receiver has a tapped input coil for use with 72-ohm antennas, try using two 72-ohm coaxial cables. The inner conductors connect to the ends of the coil and the shields to the center tap.—Ray Dirba

(Federal's 300-ohm shielded line will do the job just as well and much more cheaply.—Editor)

### SAVING A- AND B-BATTERIES

A great many dry batteries have exposed terminals of the snap-on, binding post, or clip types. Before storing these batteries or carrying them in the tool box, cover the terminals with a strip of Scotch tape. This prevents the battery from being shorted if both terminals should contact a metallic object. The tape can be removed when the battery is put in service.—Charles Erwin Cohn

### PHILCO C-1908

If this set plays O.K. at normal volume but distorts when the volume is turned up full, check the output transformer. Voltages on the plates of the 7C5's are equal at low and normal volume levels. There is a small variation at full output. A new output transformer will cure the trouble.

This type of trouble is usually hard to spot because voltage measurements are seldom made with the volume control wide open.—C. A. Phillips

## PICTURE TUBE BARGAINS

10" (10BP4) Leading Standard Brand, Factory Sealed Original Cartons, Brand new and perfect—90 day guarantee . . . \$17.95  
12½" (12LP4) Slight surface imperfection—can't be seen when in use—90 day guarantee against mechanical and electrical defects; sent you on a five day money-back guarantee if dissatisfied.  
White . . . \$15.95 Black . . . \$17.95  
All prices FOB, N.Y. Subject to prior sale  
20% Deposit (Check or Money Order), Bal. sent C.O.D. Rated Companies—Send Purchase Order  
**SOLO ELECTRONIC SALES CORP.**  
168 Washington St. New York 6, N.Y.  
Phone: Worth 2-1042-3

RADIO-ELECTRONICS for

## Seein's Believin'



Actual photo of interference with no filter.

Same TV screen with Drake Filter in antenna lead-in.



### THE R. L. DRAKE High Pass Television Filter

protects the R.F. and I.F. bandpass of the TV set from strong radio frequency interference generated by:

- Amateur Radio Transmitters
- Shortwave Broadcast Stations
- X-ray and Diathermy
- Industrial R. F. Heating
- Auto Ignition and Motors
- Neon Lights, Appliances, etc.

Two models available—TV-300-50HP for 300-Ohm Twin Lead and TV-72-50HP for Small 72-Ohm Coax.

**\$5<sup>95</sup>**  
LIST

Discounts to dealers, servicemen and amateurs

Drake Filters are sold by all leading distributors. Try one today.

Many dealers include one with each installation.

**THE R. L. DRAKE CO.**  
11 Longworth St., Dayton 2, Ohio

## SHOOTS TROUBLE FASTER! MAKES MORE MONEY FOR YOU ON THE JOB OR AT SERVICE BENCH



PRICE \$9.95

at distributor or post-paid, direct. No C.O.D.'s, please. Ohioans add 3% State Sales Tax.

## Signalette

### MULTI-FREQUENCY GENERATOR

In radio service work, time means money. Locate trouble faster, handle a much greater volume of work with the SIGNALETTE. As a trouble shooting tool, SIGNALETTE has no equal. Merely plug in any AC or DC line, start at speaker end of circuit and trace back, stage by stage, listening in set's speaker. Generates RF, IF and AUDIO Frequencies. 2500 cycles to 20 Megacycles. Also used for checks on Sensitivity, Gain, Peaking, Shielding, Tube testing, Wt. 13 oz. Fits pocket or tool kit. Satisfaction, or your money back. See at your distributor or order direct.

## Clippard INSTRUMENT LABORATORY, INC.

DEPT. B, 1125 BANK STREET CINCINNATI 14, OHIO  
Qualified Jobbers write, wire for details.

**AUTOMATIC M-90 AUTO RADIO**



- Six Tube Superheterodyne • Three Gang Condenser • Powerful, Long-Distance Reception • Fits All Cars, Easy Installation
- Mounting Brackets Included Net **\$27.97**
- 6 Tube model M90 ..... **\$27.97**
- 5 Tube model X50 ..... **\$24.36**

Approx. shipping weight either unit (11) eleven pounds.

**MAIL US YOUR ORDERS**

All orders filled within 24 hours. Illustrated parts list on request. Standard Brand tubes 50% off list

**Bill Sutton's** Wholesale Electronics  
Fifth at Commerce Fort Worth, Texas

**HERE IS A TERRIFIC VALUE!**

**3 TUBE PHONO AMPLIFIER**



- Designed for use with all types of records—2 1/2 watt output—Completely wired and with full range tone control. ONLY \$2.39
- LOTS OF TUBES. 2.19
- SET OF TUBES FOR ABOVE.....\$1.35
- 50L6 output trans. for above......35
- 4" PM Speaker......99
- 5" PM Speaker.....1.15
- 6" PM Speaker.....1.55
- 12" PM Speaker.....4.85
- Hi-Volt Phono Pickup with Hardware.....1.95
- Med. Volt Phono Pickup & Hardware.....1.69
- Hi-Volt Phono Crystal.....1.79
- Med. Volt Phono Crystal.....1.59
- 78 RPM Phono Motors & Turntable.....2.49
- 33 1/2 RPM Phono Motors & TT.....3.89
- 3 Speed Phono Motors & TT (33 1/2, 45, 78 RPM).....4.95
- 3 Speed Pickup with Hardware.....5.25

We carry a complete line of Receiving Tubes, Resistors, Condensers, TV Parts and Radio Parts. Write Dept. RE-9 for free descriptive literature. All prices F.O.B. New York. 25% deposit required on all orders. Min. order \$5.00.

**THE ROSE COMPANY** 98 Park Place  
New York 7, N. Y. (Corner Greenwich St.)

**EVERY RADIOMAN Can Use These SERVICE HINTS!**

**Valuable Manual Yours—FREE!**

Every page of "How to Simplify Radio Repairs" is packed with on-the-bench, practical ideas. Contains photos, charts, diagrams—no fluff—no vague theory. In plain every-day language it gives you priceless suggestions—new servicing ideas—you'll use and benefit from the experience of experts. Partial list of contents: How to Localize Trouble; How to Service Amplifiers; How to Test for Distortion; How to Test Audio Circuits; How to Test Speakers; How to Find Faults in Oscillators; How to Test Radio Parts—and it's all yours—FREE! No obligation.

**FEILER** SEND COUPON OR PENNY POSTCARD FOR YOUR FREE COPY TODAY!

**FEILER ENGINEERING CO. Dept. 9RCS**  
1601 S. Federal St., Chicago 16, Illinois

Please RUSH my FREE copy of "How to Simplify Radio Repairs."

Name .....

Address .....

City..... Zone... State.....

George R. Sommers has been appointed general sales manager of the SYLVANIA radio and television picture tube divisions. Mr. Sommers joined Sylvania in 1940 as manager of the Capitol division.



Sommers

He succeeds C. W. Shaw who was made assistant to the vice president in charge of the company's sales.

Arthur A. Brandt and Walter M. Skillman were named sales manager and marketing services manager, respectively, of GENERAL ELECTRIC's receiver division. Harrison Van Aken was named its assistant manager.



Sprague

Robert C. Sprague, president of the SPRAGUE ELECTRIC Co., was elected president and chairman of the Board of Directors of the RADIO-TELEVISION MANUFACTURERS ASSOCIATION.

James D. Secrest, director of public relations and staff assistant of the RMA parts division, was elected secretary and general manager, effective August 1.

Three new committee chairmen were appointed: Dr. Allen B. Du Mont, president of ALLEN B. DU MONT LABORATORIES, INC., chairman of the excise tax committee; John W. Craig, vice president and general manager of the CROSLY DIVISION, AVCO MFG. Co., chairman of the industrial relations committee, and Harry A. Ehle, vice president of INTERNATIONAL RESISTANCE Co., chairman of the town meetings committee.

Ernest Keller, vice president and sales manager of ANCHOR RADIO CORP., was appointed chairman of the TV Booster Committee at the annual meeting of the Amplifier and Sound Equipment Division of the RMA.

Members of the association voted approval of reorganization plans and a change of name to the RADIO-TELEVISION MANUFACTURERS ASSOCIATION.

William Hatton and Frank B. Powers were elected vice presidents of the FEDERAL TELEPHONE and RADIO CORP. Both men have had extensive backgrounds in communications and manufacturing engineering.

Walter Albert Buck has been elected vice president and general manager of the RCA Victor Division of the RADIO CORPORATION OF AMERICA.

Mr. Buck was operating vice president of the RCA Victor Division since 1949. He was previously president of Radiomarine Corp. of America, which he joined after retiring as rear admiral from the U.S. Navy.

**FOR BETTER TOWERS AT LOWER COST! Ask about AERO**

**• COST LESS**

Because Aero Towers are aircraft-designed, lower manufacturing costs offer you a lower price. Lower weight and lower shipping costs are passed on as savings to you.

**• LAST LONGER**

Coated INSIDE and OUT. DIP-COATED process keeps Aero Towers Bright and new. Rust resistant. Will not brown.

**• EASY TO CLIMB AND SERVICE**

Strong electric aircraft welds at EACH joint (not just one or two) prevents sway. Provides sturdy, safe, ladder-like cross members.

**• QUICKER TO INSTALL**

Aircraft precision tolerances assure accurate fit of components. Light and easy to erect. Strong durability assures customer satisfaction.

Jobber Territories Open  
Dealers—Write for FREE booklet



**AERO TOWER DIVISION**  
Knepper Aircraft Service  
1018 Linden Street  
Allentown, Pa.

**A. C. SHANEY'S NEW BOOKLET**

**ELEMENTS of SINGLE and DUAL TRACK TAPE RECORDING and 1001 APPLICATIONS**



ONLY \$1.00 by A.C. Shaney POSTPAID

96 pages, crammed with facts of vital importance to recording technicians, experimenters, recordists! Contains over 100 illustrations, circuit diagrams, parts lists, construction hints, elementary and advanced theory and design. Much valuable data, NOW IN PRINT FOR THE FIRST TIME! Order your copy today!

**AMPLIFIER CORP. of AMERICA**  
398-10 Broadway, New York 13, N. Y.

To: Amplifier Corp. of America  
398-10 Broadway, N. Y. C.

Rush.....copies of A. C. Shaney's Book "Elements" I enclose herewith \$..... @ \$1 per copy.

Rush free literature on your complete tape recorder line.

NAME .....

ADDRESS .....

CITY..... STATE .....

If the biscuits get burned, you can blame it on television. Several gas ranges with built-in 7-inch television screens were on display in Los Angeles at a recent furniture show.



### OUTSTANDING - TV - VALUES

**MODEL # 300**  
Full dipole complete with reflector and high frequency adapter. Covers 13 channels. All alum. construction. Less mast. Shpg. wt. 7 lbs. Price **\$4.10**

**MODEL # 200-D**  
Stacked array. Consists of 2 complete conicals and connecting bars. Very rigid construction. Covers all 13 channels. Matches 300 Ohm or 72 Ohm. Center impedance 150 Ohm. Ideal for low signal areas. Outstanding buy. Shpg. wt. 12 lbs. Less mast. **SENSA-\$7.75**  
**TIONAL OFFER at...**

**MODEL 200-S**  
Single array. Same construction as above. Shpg. wt. 7 lbs. Price, less mast. **\$3.50**

**MODEL # 500**  
All-band folded dipole antenna. Ideal for rotator use. Maximum gain on any channel. Alum. construction. Less Mast. Shpg. wt. 8 lbs. Price **\$4.25**

**MODEL # Y-100**  
5 element Yagi Hi-Gain beam designed specifically for fringe area use. All alum. construction. Cut to specific channels. Shpg. wt. 4 lbs. Channel #7. **\$3.75** Channel #9. **\$3.50** Channel #13. **\$3.25**. The prices are less mast. **"Y" type antenna. Price \$3.75**

**ANTENNA ACCESSORIES**

WM-100 3" Wall Bracket	98
WM-100 15" Wall Bracket	\$2.75
1-ft. 1 1/4" OD Steel Mast. Plated	\$1.50
1-ft. 1 1/4" OD Alum. Mast.	\$1.25
4-ft. 1" OD Alum. Mast.	1.65
3 1/2" 300-ohm stand-off insulators (fit coax cable)	\$2.50 per 100 \$19.50 per 500 \$19.50 per 1000
"U" Bolt Assemblies—ideal for most couplings	12 for \$1.50 50 for \$5.00
Best Quality 300-ohm twin lead	100—\$2.25 1000—\$11.00
High Quality 72-ohm Coax Cable	100—\$2.95 500—\$13.75
Folded Dipole Hi-Frequency Adapters	1.25
Conical Hi-Frequency Adapters	1.50
Straight Dipole Hi-Frequency Adapters	1.25

**TERMS:** All shipments F.O.B. Newark, New Jersey. 25% deposit with orders. Balance C.O.D. Minimum order \$2.00. Include ample postage.

**EAST COAST ELECTRONICS**  
40 St. Francis Street Newark, N. J. New Jersey

Brig. Gen. Tom C. Rives, USAF (retired), was appointed to the staff of the commercial equipment division of the General Electric electronics department.



Browning

ment exercises of Cornell College, Mt. Vernon, Ia. John L. Busey was elected a vice president of G-E and placed in charge of marketing policy. Ben Farmer was named sales manager of the RAULAND CORPORATION.

Percy L. Spencer, vice president in charge of the power tube division of RAYTHEON MANUFACTURING Co., was awarded an honorary degree of Doctor of Science by the University of Massachusetts.



Spencer

Robert A. Elliot fills the newly created post of jobber sales manager at STANDARD COIL PRODUCTS Co., Inc. Richard A. Malmberg named renewal sales manager by HYTRON RADIO & ELECTRONICS CORP. Arthur W. Stewart appointed chief engineer of CLIPPARD INSTRUMENT LABORATORY, INC. Gilbert E. Gustafson, vice president in charge of engineering at ZENITH RADIO CORP., received an honorary degree in electrical engineering from Stevens Institute of Technology. L. M. Sandwick joined SCOTT RADIO LABORATORIES, INC., as merchandise manager. Dr. Allen B. Du Mont, Leonard Cramer, Paul Raibourn, Bernard Goodwin, Arthur Israel, Jr., and Irving Singer were re-elected officers of ALLEN B. DU MONT LABORATORIES, INC. Mel Byron was appointed chief engineer of the ELECTRONIC INSTRUMENT Co., Inc. Earl L. Olson joined JENSEN INDUSTRIES, INC., as chief engineer.

Louis Silver was appointed executive vice president and Milton R. Benjamin national sales manager of MAJESTIC RADIO & TELEVISION, INC. Richard G. Leitner resigned from LEAR, INC., to take the position of chief engineer with U. S. ELECTRONICS CORP. John Cashman, president of RADIO CRAFTSMEN, INC., was named a director of the Radio Parts & Electronic Equipment Shows by the Association of Electronic Parts and Equipment Manufacturers. Edward C. Bonia named to direct sales of the contract division of JOHN MECK INDUSTRIES. John H. Clough resigned as board chairman of the GENERAL ELECTRIC X-RAY CORP. to become president of the FAIRCHILD CAMERA AND INSTRUMENT CORP. Roy W. Chestnut of the technical staff of the BELL TELEPHONE LABORATORIES died at the age of 58. Mr. Chestnut held patents on circuits in carrier, radio, and submarine telephone.

### ALMO SPOTLIGHT SPECIAL

#### SENSATIONAL BARGAINS TV PICTURE TUBES

While They Last!

All Standard Brands

71P4	7 inch	\$12.95
10BP4	10 inch	\$17.95
12LP4A	12 inch	\$18.95
	Black	
14DP4	14 inch	\$26.50
	Black	

Write for FREE Broadcaster 10% Cash With Orders

### ALMO RADIO CO.

509 ARCH STREET • Philadelphia  
6205 MARKET STREET • West Phila.  
6th & ORANGE STS. • Wilmington  
4401 VENTNOR AVE. • Atlantic City

### QUICK, EASY WAY TO READ TUBULAR CAPACITOR CODING

Having trouble deciphering the color coding on tubular molded capacitors in new TV and Radio sets? There's no need to consult complicated wall charts or tables!

The Sprague Capacitor Indicator gives you the needed data in a jiffy. Just flick the dials to the color bands and read the capacitance, tolerance, and voltage directly.

This slick plastic service help fits your pocket. Always on hand, it saves time and avoids mistakes... and it's only 15c. Ask for one at your Sprague distributor today!

**SPRAGUE PRODUCTS COMPANY**  
Distributors' Division of the Sprague Electric Co.  
NORTH ADAMS, MASS.

### TUBES

Guaranteed, Brand New, Individual Cartons! DEDUCT 5c FROM THE PRICE OF EACH TUBE WHEN ORDERING ANY 20!

30¢ ea.	30	6K8	58¢ ea.	1A6
	47	6P5		1B5
1G4	76	6Q7	02A	1C6
39B7	77	6SC7	1F3	1D7
12A8	78	6SG7	1F5	1D7
39/44	80	6X5	1G6	1H6
	85	6Z5	1L5	1G7
47¢ ea.	89	7A4	1LD5	2A4
	2051	7A5	1LE3	6A3
1R5		7A7	1N5	6B5
1S5		7AG7	1N5	6AC7
1U5		7C5	1P5	6B7
2X2	1T4	7E5	1Q5	6B8
6AL5	1U4	7E6	1T5	6C8
6AR5	6AG7	7F6	2A6	6D8
6AT6	6J7	7F7	2A7	6F8
6AU6	65A7	7H7	2B7	6F8
6BA6	125A7	7H7	2B7	6F8
6BE6	125K7	7L7	3L4	6J8
6C4	125Q7	7Q7	3Q5	6T7
6F6	25W4	7Z4	6A6	12A7
6H6	25Z6	12A8	6L5	12C8
6J5	35Z5	25F5	6R7	19
6K5	43	12K8	6E7	32
6K6	XXB/3C6	12QR7	7E7	32L7
6R7	49¢ ea.	14A7	7J7	34
6SA7		14B7	7K7	50A5
6SM7	1A5	14B8	7L7	50Z6
6SK7	1C5	14C5	7V7	FM-1000
6SL7	1M4	14E7	125G7	
6SQ7	1LH6	14H7	14F8	1A4
6V5GT	1Q5	20Z7	14I7	1B4
6V6	1V	21A7	14J7	1C4
6W4	2A3	25	14K7	1D8
6X4	2A5	35 51	14W7	6E5
6Y6G	5U4G	35W4	14X7	6E7
7Y4	5Y4G	38	31	6E7
12B8B	5Z3	42	31L6	81
12SH7	6A6	45Z5	48	99¢ ea.
12S17	6AG5	56	50B5	6L6
12SN7	6AV6	57	50L6	70L7
12SR7	6CB6	57	50L6	117L7/M7
26	6J6	117Z3	79	
27	6K7	WR50	69¢ ea.	117P7

**SPEAKERS**  
Swedgal's Lower Prices

3 1/2" P.M. .68 oz.	\$.95	5.8
4" P.M. .68 oz.	1.05	9.9
4" P.M. 1 oz.	1.10	10.4
4" x 6" P.M. 1 oz.	1.49	
5" P.M. .68 oz.	.92	.89
5" P.M. 1 oz.	.98	.93
5" P.M. 1.47 oz.	1.10	1.04
6" P.M. 1 oz.	1.40	1.32
6" P.M. 1.47 oz.	1.50	1.42
10" P.M. 8.8 oz.	3.69	3.59
12" P.M. 4.64 oz.	4.59	4.25

**ALNICO V MAGNETS**  
Lots of

10K	10K
25K	250K
50K	350K
500K	500K
1 meg.	2 megs.
34¢ ea.	
10 for \$3.00	

**ELECTROLYTIC TUBULAR CONDENSERS**  
Fresh Stock! with mounting strap, CD. Type EDL.

20x20-150 V.	
40x40-150 V.	
50x30-150 V.	
39¢ each	
Any Assortment 10 for \$3.80	

**VOLUME CONTROLS**  
Std. Brands with switch & long shaft!

10K	10K
25K	250K
50K	350K
500K	500K
1 meg.	2 megs.
34¢ ea.	
10 for \$3.00	

**OUTPUT TRANSFORMERS** ea.

3Q5	200...34c
6V6	200...34c
6L6	200...34c
6V6 P.P.	49c
50L6 P.P.	38c
6V6 P.P. 15 Watts.	
Sec. Taps 4, 8, 15, 25	
1/2" X 3/4" . . . . .	89¢ ea.
Shielded.	

**PAPER TUBULAR CONDENSERS**

mfd.	Volts	Ea.
.25	@ 200	.4c
.05	@ 200	.4c
.015	@ 400	.5c
.02	@ 400	.5c
.01	@ 800	.5c

**WICAS**  
200 MMF./00002 MFD., 500 V. size: 1/2" X 3/4" . . . . . 5c ea.  
Minimum Order: \$2.50. 25% deposit, balance C.O.D. All prices F.O.B. New York, N. Y.

### WANTED TO BUY

Large and small quantities of new or used electronic government or manufacturers' surplus tubes and equipment. Highest prices paid. State quantity, condition and best price in first letter.

Box No. F-2 c/o Radio-Electronics  
25 West Broadway  
New York 7, N. Y.

**NEW VACUUM TUBE VOLTMETER** Best instrument buy of the year!  
AC and DC ranges; Kit Form 0-5/10/100/500/1000 volts. Ohmmeter from 2 ohms to 1000 megs. Zero center scale for TV. **\$22.95**  
Has 0-1 ma.; full input imp. 2% accuracy; big 4 1/2" meter; 28 meg. input imped.; Dimen. 1 1/2" x 3" x 6" overall. **Fact. Assembl. \$48.95**

**FEILER ENGINEERING CO. Dept. 9RC5V**  
1601 S. Federal St. Chicago 16, Ill.



**ORGAN CHOIR EFFECTS**

Dear Editor:

It is indeed a pleasure to see the first of a series of well-written articles on "Electronics and Music" by Richard H. Dorf in your July number.

The implication of one statement will bear correction. This refers to the choir effect.

Both the Wurlitzer and the Minshall-Estey organs (licensed under the writer's patents) have excellent choir effects because their various ensembles are mixtures of distinct tonal qualities generated by completely different ranks of reeds. Wurlitzer's larger organs have as many as five different ranks of reeds totaling 292 in all, each rank giving different tonal qualities.

When these are mixed together, they produce true choir effects because the individual reeds are separately tuned so there can be no fixed phase relationship between the partials of the mixture of reed tones.

Only one other electronic organ on the market produces true choir effects. This is the Allen, which has separate ranks of vacuum-tube generators used like separate ranks of pipes in pipe organs.

None of the other electronic organs which use but one set of vacuum-tube generators can produce choir effects, because the separate voices are all taken from one set of generators and all like numbered partials of the same fundamental tone are exactly the same.

For example: if a singer's voice were passed through three different filter circuits to alter the tone quality, and then recombined and reproduced, we would not have a true ensemble of three singers. It would simply be one voice with a tone quality differing from the singer's own quality. This is what occurs in electronic organs having only one set of generators.

BENJAMIN F. MIESSNER  
Miessner Inventions, Inc.

Morristown, N.J.

**INDEX TO CORRECTIONS**

This is an index to correction notes and additional information on articles which have appeared in 1950 issues of RADIO-ELECTRONICS.

REVAMPING A 630-TYPE TV SET, page 39 of the January issue. Correction on page 78 of the February issue.

A DELUXE TELEVISER, January through July issues. Corrections on pages 27 and 82 of the March issue and page 31 of July.

TEST EQUIPMENT FOR TELEVISION, page 28 of the February issue. Correction on page 82 of the March issue.

AMPLIFIER HAS UNUSUAL CIRCUITS, page 37 of the March issue. Correction, page 102 of the May issue.

POWER PACK DESIGN, page 44 of February. Correction on page 102 of the May issue.

A TEN-TUBE FM RECEIVER FOR ONLY \$10, page 30 of the March issue. Correction on page 87 of the June issue.

SEPTEMBER, 1950

# When Equipment Counts...



If you've ever hooked a really big one, then you know that only the best equipment will stand the strain and bring him in.

Likewise only Thomas — a name well known for superior cathode-ray tubes — brings in every exciting minute of the top television shows in complete detail, and with no fuzziness or failure at a crucial moment.

Nationally famous television receivers are represented by Thomas where their performance and quality are most critically judged — in the picture tube. These manufacturers insist on the 'best' — they specify Thomas!

For service and conversion markets also, new Thomas rectangulars are now available in several sizes. Write for data sheets.

**THOMAS ELECTRONICS, Inc.**

118 Ninth Street

Passaic, New Jersey



## WHERE RADIOMEN MEET, EAT and SLEEP

Visit the  
FAMOUS  
FIESTA  
LOUNGE  
Renowned for  
Fine Food

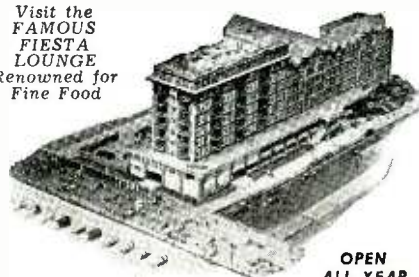

# HOTEL STRAND

Atlantic City's Hotel of Distinction

The Ideal Hotel for Rest and Relaxation • Beautiful Rooms • Salt Water Baths • Glass enclosed Sun Porches • Open Sun Decks atop • Delightful Cuisine • Garage on premises. • Moderate Rate Schedule.

OPEN  
ALL YEAR

Exclusive Pennsylvania Ave. and Boardwalk



# RADIO SCHOOL DIRECTORY



## RADIO COURSES

Preparatory Mathematics, Service, Broadcast, Television, Marine Operating, Aeronautical, Frequency Modulation, Radar.

Classes now forming for the Fall term beginning Oct. 1st  
Entrance exam, Sept. 25th

**Veterans. Literature.**

**COMMERCIAL RADIO INSTITUTE**  
(Founded 1920)  
38 West Biddle Street, Baltimore 1, Md.

## LEARN DAY and EVENING CLASSES TELEVISION

**ELECTRONICS-RADIO**  
Modern Laboratory Instruction in

- SERVICING
- BROADCAST OPERATING
- ELECTRONIC and TV ENGINEERING

**G.I. APPROVED**

WRITE FOR CATALOG

**ELECTRONICS INSTITUTE, Inc.**  
21 HENRY, DETROIT 1, MICH.

## HAVE YOU A JOB FOR A TRAINED TECHNICIAN?

We have a number of alert young men who have completed intensive training in Radio and Television Repairing. They learned their trades thoroughly by working on actual equipment under personal, expert supervision. If you need a trained man, we invite you to write for an outline of our course, and for a prospectus of the graduate. No fees, of course. Address:

Placement Manager, Dept. P108-9

**COMMERCIAL TRADES INSTITUTE**  
1400 Greenleaf Chicago 26

## TELEVISION

Laboratory and theoretical instruction under the guidance of experts, covering all technical phases of Radio, Frequency Modulation and Television. Prepares for opportunities in Broadcasting, Industry or Own Business.

MORNING, AFTERNOON or EVENING SESSIONS. Licensed by N. Y. State. Free Placement Service. APPROVED FOR VETERANS.

ENROLL NOW FOR NEW CLASSES  
Apply Daily 9-9; Sat. 9-2  
VISIT, WRITE or PHONE

## RADIO-TELEVISION INSTITUTE

Pioneers in Television Training Since 1938  
480 Lexington Ave., N. Y. 17 (46th St.)  
PLaza 8-5665 2 blocks from Grand Central

## Your Future in RADIO-TV

Your future in radio-TV begins *right now*, with proper training. The Don Martin School of Radio Arts, established in 1937, offers the training you want . . . for every type of job in Radio-TV—script writer, announcer, disk jockey, newscaster, technician. Free job placement service for graduates. Day and night classes. . . . Write for our FREE booklet, "YOUR FUTURE IN RADIO." Approved for veterans.

**Don Martin School of Radio Arts**  
1655 No. Cherokee, Hollywood 28, Calif. HUdson 23281

## Build Your Career! Become an Electrical Engineer

☆ Major in Electronics or Power  
☆ B. S. Degree in 36 Months



World-famous courses in Radio-Television, Electronics and Electrical Power. 6 to 24-month technical courses. 35,000 former students. Write for free pictorial booklet, "Your Career," and 110-page catalog. State if World War II vet. See full-page advertisement in this issue. Page 18.

**MILWAUKEE SCHOOL OF ENGINEERING**  
Dept. RE-950 N. Broadway, Milwaukee, Wis.

## TELEVISION

PREPARE FOR A GOOD JOB!  
COMMERCIAL OPERATOR (CODE)  
RADIO SERVICEMAN

TELEVISION SERVICING  
BROADCAST ENGINEER

V. A. Furnishes Books and Tools  
SEND FOR FREE LITERATURE

**BALTIMORE TECHNICAL INSTITUTE**  
1425 Eutaw Place, Dept. C, Baltimore 17, Md.



## RADIO ENGINEERING

FM—Television—Broadcast

Police Radio, Marine Radio, Radio Servicing, Aviation Radio and Ultra High mobile applications. Thorough training in all branches of Radio and Electronics. Modern laboratories and equipment. Old established school. Ample housing facilities. 7 acre campus. Small classes, enrollments limited. Our graduates are in demand. Write for catalog.

Approved for Veterans

**VALPARAISO TECHNICAL INSTITUTE**  
Dept. C VALPARAISO, INDIANA

## Learn TELEVISION RADIO—ELECTRONICS

3 BIG RADIO-TV BOOKS FREE!

Prepare for own business or a good paying job. Radio Training Approved for Veterans.

SEE OUR LARGE AD ON PAGE 11

Sprayberry  
Academy of Radio  
Dept. 20-N, 111 N. Canal St., Chicago 6, Ill.

## AUDIO ENGINEERING SCHOOL

Practical engineering training in Audio fundamentals, Disc, Film, Magnetic Recording, and Audio frequency measurements. Studio training simulates Broadcast, Motion Picture, Television, and Commercial Recording work. Approved for Veterans

**HOLLYWOOD SOUND INSTITUTE, Inc.**  
1040-E North Kenmore, Hollywood 27, Calif.  
Correspondence Courses Available  
Specify if Veteran or Non-Veteran.

## RADIO and TELEVISION

Over 30 years N.E. Radio Training Center. Train for all types FCC operators' licenses. Also Radio and Television servicing. FM-AM broadcasting transmitters at school. Send for Catalog R.

**MASS. RADIO SCHOOL**  
271 Huntington Avenue Boston 15, Mass.  
Lic. by Comm. Mass. Dept. Educ.



## RADIO and TELEVISION

Thorough Training in All Technical Phases

APPROVED FOR VETERANS

DAYS—EVENINGS WEEKLY RATES  
FREE PLACEMENT SERVICE FOR GRADUATES  
For Free Catalog Write Dept. RC-50

**RCA INSTITUTES, Inc.**  
A Service of Radio Corporation of America  
350 WEST 4TH STREET NEW YORK 14, N. Y.

## ELECTRICAL TRAINING

Intensive 32 weeks' residence course in fundamentals of industrial electrical engineering, including radio, electronics. Prepares for technician, engineering aides. Approved for veteran training. 57th year. Enter November 6. Catalog.

**BLISS ELECTRICAL SCHOOL**  
7549 TAKOMA AVENUE  
WASHINGTON 12, D. C.



## RADIO COURSES

- RADIO OPERATING • CODE
- RADIO SERVICING • ELECTRONICS
- F.M. TELEVISION
- REFRIGERATION SERVICING

Write for Catalog TE

**YMCA TRADE & TECH. SCHOOL** 229 W. 66 St., N. Y. 23  
ENdicut 2-8117

## AUDIO (SOUND) ENGINEERING HOME STUDY TRAINING

Practical, easy-to-understand lessons, written by competent Audio Engineers and Educators; prepare you for a better job and a great future in the Television, Radio, Motion Picture, and Recording Industries.

Write today for details—Learn while you earn!!

**HOLLYWOOD TECHNICAL INSTITUTE**  
Div. RE  
4928 Santa Monica Blvd. Hollywood 27, California

## TV ELECTROMAGNETIC SERVICING COURSE

Practical Shop and Laboratory Training of Largest Resident TV School in the East!  
Also RADIO SERVICE & REPAIR, F-M & TELEVISION Preparation for F. C. C. LICENSE EXAMS

★ Approved for Veterans ★

**DELEHANTY SCHOOL of TELEVISION**  
105A EAST 13th STREET • NEW YORK 3, N. Y.

## RADIO ENGINEERING!

Complete Radio Engineering course incl. Telev., U.H.F., and F.M. B.S. Degree Courses also in Civil, Elect., Mech., Chem., and Aero. Eng.; Bus. Adm., Acct. Visit campus, see well equipped labs. Low cost. Prep. courses. Personalized instruction. Grads successful. Founded 1884. Enter Sept., Jan., March, June. Write for Catalog.

**DEGREE IN 27 MONTHS**

**TRI-STATE COLLEGE** 2490 College Ave., ANGOLA INDIANA

## RADIO ENGINEERING DEGREE IN 27 MONTHS

Intensive, specialized course including strong basis in mathematics and electrical engineering, advanced radio theory and design, television. Modern lab. Low tuition. Self-help opportunities. Also 27-month courses in Aeronautical, Chemical, Civil, Electrical, and Mechanical Engineering. Approved for G.I.'s. Enter Sept., Dec., March, June. Catalogue.

**INDIANA TECHNICAL COLLEGE**  
159 E. Washington Blvd., Fort. Wayne 2, Indiana

## CODE SENDING SPEED RECEIVING SPEED

Be a "key" man. Learn how to send and receive messages in code by telegraph and radio. Commerce needs thousands of men for jobs. Good pay, adventure, interesting work. Learn at home quickly through famous Candler System. Qualify for Amateur or Commercial License. Write for FREE BOOK.

**CANDLER SYSTEM CO.**  
Dept. 3-K, Box 928, Denver 1, Colo., U.S.A.

RADIO-ELECTRONICS for



**RADIO ENGINEERING HANDBOOK, Fourth Edition**, edited by Keith Henney. Published by McGraw-Hill Book Co., New York. 6 1/4 x 9 1/4 inches, 1197 pages. Price \$10.

Prepared by a staff of 25 specialists, this handbook contains carefully selected material covering the vast field of radio communication in a very concise way. The new edition has been brought up to date with such subjects as cavity magnetrons, radar and loran, sequential scanning, crystal converters, TV allocations, disc seal tubes, lobe switching, and many others. An interesting first chapter discusses the theoretical basis on which the science of communication is founded. This feature is not usually found in handbooks of this type.—*MW*

**ELECTROMAGNETIC THEORY**, by Oliver Heaviside. Published by Dover Publications, Inc., New York. 9 x 12 inches, 386 pages. Price \$7.50.

This 1950 edition of one of the classics of scientific literature is published this year to celebrate the centennial of the author's birth. Originally published at a time when experimental verification was impossible, Heaviside's works were at first rejected by his contemporaries. It was not until his theories were acknowledged by Hertz himself that they were acclaimed the world over. Today his *Electromagnetic Theory* is more in demand than many modern works on the same subject. This is due not only to the importance of the theory itself, but also to the brilliant style and pointed irony of its author.—*MW*

**SATURATING CORE DEVICES**, by Leonard R. Crow. Published by The Scientific Book Publishing Co., Vincennes, Ind. 5 1/2 x 6 3/4 inches, 373 pages. Price \$4.20.

Written for students who have not the mathematical background for more advanced books and as a refresher for experienced engineers, this book describes and illustrates the basic circuits of saturating core devices.

Discussed from a steady-state a.c. viewpoint are peaking transformers, voltage regulators, frequency multipliers, flux gates, servomechanisms, magnetic amplifiers, and relays. The book concludes with a bibliography of text and handbooks and magazine articles on the subjects covered by the author.—*RFS*

**ELECTRIC AND MAGNETIC FIELDS**, by Stephen A. Atwood. Published by John Wiley & Sons, New York. 6 1/4 x 9 1/4 inches, 475 pages. Price \$5.50.

Written as a text for engineering students, this book offers the fundamental concepts, formulas, terminology, units used in electric and magnetic field study. To develop the subject more clearly, the book is divided in four parts: the electric field, the magnetic field, the ferromagnetic field, and combined electric and magnetic fields. A knowledge of calculus is assumed.—*MW*

SEPTEMBER, 1950

# Telrex CONICAL-V-BEAMS\*

*memo* **These 3 basic facts prove TELREX SUPERIORITY!**

- 1** Since the advent of Telrex "Conical-V-Beams" into the field of TV reception, no antenna to date has been able to outperform them except on paper.
- 2** 90% of all Television Antennas being produced today are genuine Telrex "Conical-V-Beams" or imitations thereof.
- 3** Performance counts! It takes more than extravagant claims to produce results. That's why Telrex delivers the goods when others fail.

**THERE'S NO PRACTICAL SUBSTITUTE FOR SOUND DESIGN, THOROUGH ENGINEERING, QUALITY MATERIALS!**

Ounce for ounce, dollar for dollar, Telrex laboratories have designed and produced more worthwhile, service-tested antennas designed for application and long service life. There's no substitute for Telrex. Install one on your next TV installation. You'll see and hear the difference!

**OUTSTANDING ... FOR DESIGN WORKMANSHIP PERFORMANCE QUALITY...**

**TRULY AMERICA'S STANDARD OF COMPARISON!**

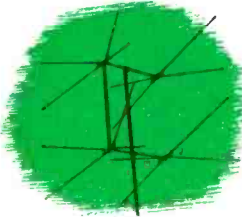

CONICAL-V-BEAMS\*



CLOVER-V-BEAMS\*

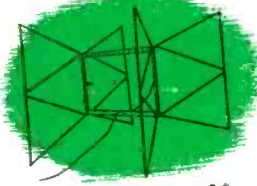

ATTIC-V-BEAMS\*

SEE THEM ALL AT THE SHOW!

Don't fail to see us at the Radio Parts Distributors Convention (NEDA SHOW) BOOTH 126, Cleveland Auditorium, Cleveland, Ohio.

Copyright 1950 Patents Pending

**REGISTERED TRADEMARK**



**CONICAL-V-BEAMS\***

Be sure it's a "CONICAL-V-BEAM"  
—Look for the TELREX\* Trademark

AMERICA'S STANDARD OF COMPARISON

ASBURY PARK 9, N. J.

THE SKILL TO DESIGN  
THE FACILITIES TO PRODUCE  
THE ABILITY TO DELIVER

Over 43,000 Technicians Have Learned

## HOW TO GET THE MOST OUT OF BASIC TEST EQUIPMENT

Why Not You, Too?

**SERVICING by SIGNAL SUBSTITUTION**

A BEST SELLER FOR OVER 9 YEARS! (NEW, UP-TO-DATE, 11TH EDITION)

The Simple, Modern, Dynamic Speed Approach To Receiver Adjustment and Alignment Problems, AM-FM-TV.

- Nothing complex to learn
- Universal — non-obsolete
- No extra equipment to purchase
- Employs Only Basic Test Equipment

only 40¢

100 pages. Invaluable information that will help you re-double the value of your basic test equipment.

Ask for "S.S.S." at your local Radio Parts Jobber or order direct from factory.

PRECISION APPARATUS COMPANY, INC. • 92-27 Horace Harding Blvd., Elmhurst 4, N. Y.



# NEWS FLASH!

## PLATT HAS 'EM ALL AT LESS!!

Visit Our Retail Store at 489 Broome St., N.Y.C.

**SPECIAL OFFER!** ALL THREE KITS LISTED BELOW FOR **\$3.59 ONLY**

**20 POUNDS OF ASSORTED RADIO PARTS**  
Transformers, Chokes, Wire, Condensers, Knobs, Sockets, Switches, Dynamotor. **\$2.39 ONLY**

**100 ASSORTED RESISTORS**  
Non-insulated, various ohmages and wattages. **SPECIAL 97c**

**KIT OF 15 CONDENSERS**  
Bathtubs and Electrolytics. **NOW 98c**

### HEADSETS—Excellent Buys!

HIS-33 with cord and plug, used, good condition ..... \$0.79  
HIS-25—Brand New with ear pads 2.75  
HIS-33—Brand New with ear pads, cord and PL54 plug. .... 2.75

TI-37A—1200 ohms with dual plugs ..... \$2.95  
BC-1206 Beacon Receiver ..... \$ 7.95  
BC-348 Receiver—NEW ..... 165.00  
BC-224 Receiver—Excellent Condition ..... 135.00  
BC-342 Receiver—Excellent Condition ..... 135.00  
BC-221 Frequency Meter—Excellent Condition ..... 79.50  
SCR-691 and SCR-284, Complete, New Conditioned, Prices Sent Upon Request.  
MX-26C Compass Receiver, NEW ..... 29.50  
433G Compass Receiver—Excellent Condition ..... 39.50  
ARNT Compass Receiver—Excellent Condition ..... 49.50  
APN 9—Tested and Guaranteed ..... 239.00

**SENSATIONAL SAVING!**

**FIELD TELEPHONES**

Army surplus, completely reconditioned and electrically tested. Guaranteed. **LIKE NEW. Only \$10.95**



**DYNAMOTORS**

Dynamotor for DY-12 Power Supply for ART-13 ..... Only \$7.95  
Type DM-33-A, in. 28 V. out. 540 VDC, 250 mills ..... BRAND NEW (Excellent—Used) 1.25  
Type DM-53-A, 24 V. in. 220 V., 80 MA out. AND NEW ..... 1.95  
INVERTER—PE-206, 28 V. in. 80 V. at 500 VA, 800 cy. out. .... BRAND NEW (Used—Excellent Condition) 8.95

**274-N COMMAND EQUIPMENT**

**Sensational Buys!**

	USED	BRAND NEW
BC-442 ..... 3 Receiver	\$ 1.85	\$ 2.75
BC-450, 3 Receiver Remote Control .....	.89	1.95
BC-453 .....	12.95	21.95
BC-454 .....	4.95	6.95
BC-455 .....	6.95	8.95
BC-456 .....	1.95	2.95
BC-457 .....	5.95	7.95
BC-458 .....	5.95	24.95
BC-459 .....	14.95	24.95
3 Receiver Rack .....	1.95	
2 Transmitter Rack .....	1.50	



**BC-223 TRANSMITTER**

30 Watt Transmitter with crystal or MO control on four pre-selected channels, 2000 to 5250 KC, by use of three plug-in coils, Five Tubes: 2—801 & 3—46. With TT-17-18-25 Tuning Units, Tubes and mount included. Specially Priced **\$21.95** BRAND NEW, Only

**MINIMUM ORDER \$2.00**

Immediate Delivery—Send 25% deposit on C.O.D. orders. All shipments F.O.B. N.Y.C. (N.Y.C. residents add sales tax to your remittance.)

**PLATT ELECTRONICS CORP.**  
Dept. B, 489 Broome St., N. Y. 13, N. Y.  
PHONES: RE 2-8177 and WO 4-2915

## ADVERTISING INDEX

Aero Towers and Rotator Div. ....	91
Alliance Manufacturing Company .....	6
Allied Radio Corporation .....	47
Almo Radio Company .....	92
American Electrical Heater Company .....	10
American Phenolic Corporation .....	68
Amperite Company .....	85
Amplifier Corporation of America .....	81, 91
Approved Electronic Instrument Corp. ....	96
Arkey .....	86
Astatic Corporation .....	14
Bell Telephone Laboratories, Inc. ....	77
Boyce-Roche Book Company .....	64
Brooks Radio Dist. Corporation .....	90
Buffalo Radio Supply .....	72
Capitol Radio Engineering Institute .....	7
Certified Television Laboratories .....	83
Cinex, Incorporated .....	83
Cleveland Institute of Radio Electronics .....	20
Clippard Instrument Lab., Inc. ....	90
Communications Equipment Company .....	96
Concord Radio Corporation .....	76
Coyne Electrical School .....	82, 85
DeForest's Training, Incorporated .....	9
Drake Company, R. L. ....	92
East Coast Electronics .....	90
Electro Products Laboratories .....	16
Electro-Technical Industries .....	74
Electronic Instrument Company .....	65
Electronic Manufacturing Company .....	96
Electronic Measurements Company .....	86
Fair Radio Sales .....	79
Federal Telephone and Radio Corporation .....	75
Federated Purchaser .....	89
Feiler Engineering Company .....	91, 92
G & G Radio Parts Service .....	84
General Electronic Dist. Company .....	49
General Test Equipment Company .....	88
Greylock Electronic Supply .....	81
Heath Company .....	57, 58, 59, 60, 61, 62, 63
Hickok Electric Instrument Company .....	83
Hotel Strand .....	93
Hytron Radio & Electronics Corporation .....	15
Industrial Development Engineers Associates	
Inside Back Cover	
Instructograph Company .....	83
International Resistance Company .....	54, 55
Jackson Electrical Instrument Company .....	70
Lafayette Radio Corporation .....	73
La Pointe-Plascomold Corporation .....	53
Leotone Radio Corporation .....	82
Mallory & Company, Inc., P. R. .... Inside Front Cover	
Midwest Radio and Tel. Corporation .....	71
Milwaukee School of Engineering .....	13
National Company .....	8
National Radio Institute .....	3
National Schools .....	5
Niagara Radio Supply Co. ....	78
Opnhite Manufacturing Company .....	4
Opportunity Adlets .....	82
Platt Electronics .....	96
Precision Apparatus Company .....	95
Precision Radiation Instrument Inc. ....	88
Pres-Probe Company .....	88
Progressive Electronics Company .....	87

## RADIO SCHOOL DIRECTORY

(Page 94)

Baltimore Technical Institute	
Bliss Electrical School	
Candler System Company	
Commercial Radio Institute	
Commercial Trades Institute	
Delehanty Institute	
Electronics Institute, Inc.	
Hollywood Sound Institute	
Hollywood Technical Institute	
Indiana Technical College	
Martin School of Radio Arts, Don	
Massachusetts Radio School	
Milwaukee School of Engineering	
RCA Institutes	
Radio Television Institute	
Sprayberry Academy of Radio	
Tri-State College	
Valparaiso Technical Institute	
YMCA Trade & Technical Schools	

RCA Victor Division (Radio Corporation of America)	Back Cover
Radio Corporation of America .....	18
Radiart Corp. ....	51
Radio City Products Co., Inc. ....	72
Radio Dealers Supply Co. ....	97
Radio Receptor Company, Incorporated .....	69
Radio Supply & Engineering Company .....	80
Raytheon Manufacturing Company .....	87
Rider, John F., Publisher .....	97
Rose Company, The .....	91
Sams & Company, Incorporated, Howard W. ....	78, 79
Senco Radio, Incorporated .....	84
Solo Electronics Sales Company .....	90
Smith Co., Wm. N. ....	89
Sprague Products Company .....	66, 92
Sprayberry Academy of Radio .....	11

**ARC/5 Xmtrs VFO Drivers**  
40 Watts Output

3-4 Mc ..... \$6.95

Used Good Cond.

Superhet Recvrs W/Dyn  
Can be converted to 110v60cy.  
190-550 Kc ..... \$5.95  
3-6 Mc ..... 4.95

Used Good Cond.



**BC-605 INTERPHONE AMPLIFIER**  
Easily converted to an ideal inter-Communications set for office-home or factory. Original. New w/conversion Diagram ..... \$4.49



**SPECIAL CHOKES**  
10HY250MA \$3.25  
20HY300MA 6.49  
6 HY 150 MA .99  
25 HY 75 MA 1.25  
8.5HY125MA 1.29  
11.5HY90MA 1.39  
5 HY 150 MA 1.45  
Dual 7 & 41  
HY 20 M 1.39  
10HY450 MA 11.95  
5 HY 200 MA 1.29  
10HY500 MA 12.95  
Many others. Write.

**SPECIAL XFMRs.**  
115V. 60 CY.  
36V/3.5 A for Rect. etc. .... \$2.75  
24V/1.5A for ARC 5, etc. .... 1.95  
2300v/4Ma.  
2.5 2A ..... 5.79  
1080Vct/55Ma.  
2x6.3 1.2A ..... 4.49  
720Vct/220Ma, 6.4/  
8.7A 6.4 6.5v 3A.  
1.25 3A ..... \$2.95



**ARR2 Homing Rec.**  
Tunes 234-258 MC  
Contains 4-6AK5.  
6-9001  
1-12A6.  
IDEAL For  
2-600  
Mtr. Conv.  
As is Fair  
Cond. .... \$4.95



**BC 223 XMITR**  
30 Watt Transmitter with crystal oscillator control on four pre-selected channels—also master oscillator. Frequency coverage 2000 KC. to 5250 KC, by use of three plug-in coils. Five tube operation. 801 oscillator, 801 power amplifier, two 46 modulators, and one 46 speech amplifier. Price with TU-17 Tuning Unit, 2000 to 3000 KC. .... \$32.95



**GIBSON GIRL**  
The Emergency Radio Transmitter. Sends S O S signals automatically on 500KC. 150-mile range. No batteries required. Has hand-driven generator, tubes, wire. New. It's only ..... \$3.49



**T.V. Transformer, 7" or 9" scope.**  
3000V/5MA, 720vct/200MA, 6.4/  
8.7A, 6.4/6A, 5/3A, 1.25 3A,  
115V 60 cy input. Price ..... \$3.95

*Rated Concerns Send P.O.*

Send M.O. or CHK. Mdse. Guardt. Shpg. Charges Sent C.O.D. Price F.O.B. N.Y.C. Phone Di. 9-4124

**COMMUNICATIONS EQUIPMENT CO.**  
131 Liberty St., Dept. C9 New York City 7, N. Y.

**it's terrific!**

**Approved**

**MODEL A-470 TELEVISION LINEARITY PATTERN GENERATOR**

... CRYSTAL CONTROLLED ANYWHERE... ANYTIME

**ONLY \$99.50**

Model A-470 is the latest test instrument available to the television service engineer to assist in the proper adjustment and installation of TV receivers, when no station pattern is on the air.

It is housed in a heavy gauge steel cabinet, battle-tested gray finish. 7 Standard brand tubes and 1N34 crystal including 1 special oscillator crystal for high stability. Operating instructions output cable diagram and maintenance card. Shipping weight 25 lbs. Size D-8" X H-10" X W-12"

**JOBBERs:** Write for our new 1951 Edition 16-page Catalogue and Jobber net prices.

**APPROVED ELECTRONIC INST. CORP.**  
142 Liberty St., New York 6, N. Y.

Standard Transformer Corporation .....	88
Sutton's Wholesale Electronics, Bill .....	91
Swedgal Radio, Incorporated .....	92
Sylvania Electric Products .....	17, 67
Tel-A-Ray Enterprises, Incorporated .....	19
Telrex, Inc. ....	95
Thomas Electronics .....	93
Trio Manufacturing Company .....	86
Turner Company .....	12
University Loudspeakers, Inc. ....	80
Ward Products .....	81
Weller Manufacturing Company .....	56
Wells Sales Co. ....	78
Wiley & Sons, John .....	69



\*\*\*\*\*

**NOW! NEW LOW PRICE**

**REMOTE CONTROL TV**

CHASSIS OR COMPLETED UNITS

**16"—19"—20" TUBE**

Custom chassis completely factory wired and aligned. 35 tubes, less C.R.T., including P.P. Amplifier, Variable Impedance Output, Continuous or Turret Tuning, and Synchrolock.

Write for detailed, illustrated circular EEB

Dealer and Jobber Territories Available

**ELECTRONIC MANUFACTURING CO.**  
196 BOWERY NEW YORK, N. Y.

\*\*\*\*\*

*Buy—*  
**TROUBLEPROOF TELEVISION**  
**THE 630 TV WILL WORK WHERE OTHERS FAIL!**

Own the Television Set preferred by more Radio and Television Engineers than any other TV set ever made!

**THE ADVANCED CLASSIC 630 TV CHASSIS**

With the latest 1950 improvements the 630 TV will out-perform all other makes in every way. The 30 plus tube circuit should not be compared to the cheaply designed 24 tube sets now being sold.

- **Greater Brilliance**  
Assured by the new 14-16 KV power supply.
- **Flicker-Free Reception**  
Assured by the new Keyed AGC circuit—no fading or tearing of the picture due to airplanes, noise, or other interference.
- **Greater Sensitivity**  
Assured by the new Standard Tuner, which has a pentode RF amplifier and acts like a built-in High Gain Television Booster on all channels! The advanced 630 chassis will operate where most other sets fail, giving good performance in fringe Areas, and in noisy or weak locations.
- **Larger—Clearer Pictures—for 16" or 19" tubes**  
Assured by advanced circuits. Sufficient drive is available to easily accommodate a 19" tube.
- **Trouble-Free Performance**  
Assured by use of the finest materials such as molded condensers, overrated resistors, RCA designed coils and transformers, etc.
- **RMA Guarantee**  
Free replacement of defective parts or tubes within 90 day period. Picture tube guaranteed fully for an entire year at no extra charge!

PRICE COMPLETE **\$149.50**  
 LESS PICTURE TUBE.

**EXTRA CLEAR PICTURE TUBES**  
**Standard Brands**

ONE YEAR GUARANTEE	PRICE
Glass 16" Black Face (round)	\$39.50
Glass 16" Regular (round)	39.50
Glass 16" Rectangular (black)	39.50

**DE LUXE TELEVISION CABINETS**

Beautifully designed to match the 630 chassis without any cutting or drilling. Solidly constructed like the finest furniture with a satiny piano finish. Shipped complete with mask and protective glass window.

16" Table Model—Mahogany or Walnut	Price <b>\$40.20</b>
16" Console—Mahogany or Walnut	Price <b>\$42.20</b>

**5 TUBE AC/DC SUPERHET KIT**

Beautiful Catalin cabinet with complete parts and instructions to quickly and easily make up a sensitive 5 tube AC/DC superheterodyne broadcast radio. Plenty of volume with good tone quality is assured by the beam power output stage and the PM Dynamic speaker.

All material including tubes are furnished for less than half the cost of the built up radio. Nothing else to buy. Tubes used are, 1-12SA7, 1-12SK7, 1-12SQ7, 1-50L6, 1-35Z5. Fully sensitive built-in loop included. Price **\$8.45**

**3 WAY PORTABLE KIT**

5 Tubes plus rectifier provides high sensitivity and excellent tone, even in remote areas. Beautiful 2-tone, brown leatherette covered cabinet with plastic front grillwork and slide-ratio dial. Light and compact—operates from 110 Volts AC/DC or batteries. Superheterodyne circuit—built in loop. Tubes used: 1-1R5; 2-1T4; 1-1S5; 1-354, plus rectifier. Complete with all parts and diagrams, less tubes and batteries. Extra for set of 5 matched tubes. \$3.75. Price **\$13.75**

Satisfaction guaranteed on all merchandise.  
 All prices F.O.B. New York City  
 WRITE FOR FREE CATALOG C9

**RADIO DEALERS SUPPLY CO.**  
 154 Greenwich St. New York 6, N. Y.

**40 USES FOR GERMANIUM DIODES**, compiled and published by the Electronics Division, Sylvania Electric Products Inc., New York, N.Y. 6 x 9 inches, 48 pages. Price \$1.00.

A compilation of circuits and descriptive text covering germanium diode applications from simple crystal receivers to carrier-shift meters. Ten of the circuits describe applications in radio and television receivers, six in radio transmitters and amplifiers, and 24 in instruments and supervisory circuits.

**RADIO AERIALS**, by E. B. Moullin. Published by Oxford University Press, London. 6½ x 9½ inches, 514 pages. Price \$8.00.

Another of the *International Monographs on Radio* edited by Sir Edward Appleton and Henry G. Booker, this book contains a comprehensive analysis of antenna theory, mainly in terms of Bessel functions. A knowledge of higher mathematics is assumed.

**TELEVISION AND F-M RECEIVER SERVICING**, by Milton S. Kiver. Published by D. Van Nostrand Co., New York, N. Y. 8½ x 11 inches, 248 pages. Price \$3.25.

The first two chapters deal with antennas (operation and installation) and with installing the television receiver. A chapter on television test equipment follows, then eight chapters on television servicing, including a chapter on intercarrier receivers.

There are four chapters on FM, including one on commercial FM receiver circuits and one on FM set alignment.

**GUIDE TO BROADCASTING STATIONS**, fifth edition, compiled by *Wireless World*, published by Iliffe & Sons, Ltd., London, England. 4 x 5½ inches, 88 pages. Price 1 shilling and sixpence.

Listing all the long—and medium-wave broadcast stations of Europe as well as short-wave stations of the world, this new edition now includes a list of the new frequency allocations of European long- and medium-wave broadcast stations under the Copenhagen plan.

**SHORT-WAVE RADIO AND THE IONOSPHERE**, by T. W. Bennington. Published for *Wireless World* by Iliffe & Sons, Ltd., London, England. Distributed in the United States by the British Book Centre, Inc., New York, N. Y. 5½ x 8¼ inches, 138 pages. Price \$2.40.

Written for the beginner, this book explains clearly what the ionosphere is and how it influences long distance radio transmission. The reader learns how it is measured and how it varies. Radio noise, ionospheric storms, and other effects are discussed, enabling the reader to make intelligent use of radio propagation predictions and to understand why they occasionally fail.

A chapter is devoted to amateur transmission on the high frequencies, pointing out differences between professional and amateur objectives in communication and showing how the amateur may achieve phenomenal results through use of maximum usable frequencies, sporadic "E" transmission, and other effects.

**TV INSTALLATION TECHNIQUES**

BY SAMUEL L. MARSHALL

Eliminate the nuisance of unnecessary return service calls. Be sure when you make an antenna installation that it will remain intact. It will mean lower costs, higher profits, and savings in valuable time. All these can be achieved in your TV installation activities by using this completely practical "how to do" book.

Every man who is actively engaged in the specialized field of TV installations, or the man who contemplates entering it, needs this book because of its dollar-making, time-saving contents. It is the only book which will give every installer of an antenna system the information pertaining to antennas, transmission lines, receiver adjustments, physical elements, and above all, the mechanical requirements—all vital information that every installer must have. This book also contains the municipal regulations governing the installation of TV antennas and masts for all of the major cities and areas the United States.

Be sure that you know all of the factors of a good installation, from the top-most element of the antenna, to the ground connection on the receiver terminal board. Order your copy today by filling out and sending in the coupon below!

**CONTENTS**

- 1—Nature of Television; 2—Radio Propagation; 3—Basic Antenna Principles; 4—Transmission Lines and Special Antenna Systems; 5—Materials and Methods Used in Installations; 6—High Mast and Tower Installations; 7—Problems Arising in Television Installations; 8—Receiver Adjustments and Service in the Home; 9—Municipal Regulations; Appendix.

**NOW AVAILABLE**

262 Illustrations      Cloth Bound  
 336 Pages              8¾" x 5½" \$3.60

**— MAIL THIS COUPON NOW —**

**JOHN F. RIDER PUBLISHER, INC.**  
 480 Canal St., New York 13, N. Y.

Enclosed you will find \$3.60. Please send me TV INSTALLATION TECHNIQUES. It is understood I may return book in 10 days if unsatisfactory and you guarantee a full refund.

Name.....  
 Address.....  
 City.....  
 Zone.....State.....

- Check enclosed  
 Money order enclosed

RE



# Latest WELLS Tube Price List

Many Types Are Now Scarce At These Low Prices. Check your requirements at once for your own protection. All tubes are standard

brand, new in original cartons, and guaranteed by Wells. Order directly from this ad or through your local Parts Jobber.

TYPE.	PRICE EA.	TYPE.	PRICE EA.	TYPE.	PRICE EA.	TYPE.	PRICE EA.	TYPE.	PRICE EA.	TYPE.	PRICE EA.
OA4G	.95	5AP1	3.75	7B4	.55	RK60/1641	.65	HY615	.35	866A	1.30
EL-C1A	3.95	EL-C5B	4.25	7B8	.60	VT62 BRITISH	1.00	WL632A	8.75	869	19.75
1A3	.60	5BP1	2.45	7C4/1203A	.35	HY65	3.25	700	17.95	869B	27.25
1A5GT	.65	5BP4	3.99	7C5	.60	66B4	.90	700B	17.95	872A	2.45
C1B/3C31	3.75	5CP1	2.45	7C7	.60	VT67/30	.58	700C	17.95	874	.90
1B4P	1.05	5D21	22.50	7E5/1201	.60	70L7	1.05	700D	17.95	876	.40
1B21A/GL471A	2.55	5FP7	1.75	7E6	.55	CEQ72	1.45	701A	3.00	878	1.75
1B22	3.40	5GP1	2.98	7F7	.60	CRP72	.95	702A	2.60	879/2X2	.45
1B23	7.50	5H-4 BALLAST	.45	7H7	.60	CYN72	1.65	703A/368AS	3.60	902	3.75
1B27	7.75	5HP4	4.75	7L7	.65	RKR72	.90	704A	1.05	931A	3.95
1B32/532A	1.85	5J23	13.00	7Y4	.50	RKR73	1.23	705A/8021	1.00	954	.30
1B42	6.75	5J29	13.45	9-3 BALLAST	.45	76	.40	706AY	17.50	955	.45
1B48	9.90	5U4G	.75	10	.50	77	.45	707A	12.95	957	.35
EL-1C	4.85	5W4	.76	10 ACORN	.55	78	.45	707B	14.45	958A	.35
1C5GT	.65	6-4 BALLAST	.35	10/VT25A	.53	VR78	.65	708A	3.45	967/FG17.	3.75
1C6	.75	6-7 BALLAST	.35	10E/146	1.00	.80	.45	709A	4.75	991/NE16	.24
1C7G	.85	6A3	.80	10T1 BALLAST	.50	FG81A	3.95	710A/8011	1.25	1005	.30
1D8GT	.90	6A6	.65	10Y/VT25	.45	83V	.90	713A	1.45	1007	4.50
1E7GT	.95	6AB7/1853	.95	12A6	.25	89	.42	714AY	3.55	CK1089	3.90
1G6	.65	6AC7/1852	.90	12A6GT	.25	89Y	.40	715B	6.55	CK1090	2.65
1L4	.50	6AF6G	1.10	12AH7GT	1.10	VR90	.95	717A	.60	1148	.35
1LC6	.75	6AG5	1.20	12BD6	.65	VT90 BRITISH	2.55	721A	2.60	1201	.45
1LN5	.80	6AH6	1.00	12C8	.40	VR92	.40	722A/287A	9.50	1203	.45
1P24	1.75	6AK5	1.20	12F5GT	.55	FG95/DG1295	9.95	723AB	14.95	1203A	.65
1Q5GT	.85	6AK6	.80	12H6	.35	VT98/REL5	14.95	724A	3.85	1236	1.75
1R4	.55	6AL5	.85	12J5GT	.35	100R	1.05	724B	3.85	1294/1R4	.55
1S5	.60	6AQ6	.65	12J7GT	.59	101/837	1.65	725A	6.85	DG1295	9.95
1T4	.65	6AU6	.63	12K8	.59	102F	3.55	726A	4.95	1299/3D6	.45
2A7	.70	6AV6	.65	12SA7GT	.62	FG105	9.75	726B	13.50	1299A	.60
2B7	.70	6B4G	.90	12SF7	.50	VU111S	.45	730A	9.95	1613	.55
2B22/GL559	1.75	6B7	.75	12SG7	.55	114B	.80	801	.40	1616	.75
2C22/7193	.35	6B8	.65	12SH7	.40	121A	2.55	801A	.65	1619	.35
2C26	.30	6B8G	.75	12S17	.60	122A	2.65	803	3.40	1624	1.25
2C26A	.40	6BA6	.65	12SK7	.55	VT127 BRITISH	.35	804	6.90	1625	.35
2C34	.40	6C4	.40	12SL7GT	.55	VT127A	2.95	805	5.75	1626	.35
2C40	5.25	6C5	.55	12SN7GT	.59	VR150	.48	808	1.65	1629	.35
2C44	1.25	6C6	.65	12SR7	.50	VT158	14.95	809	2.65	1630	2.75
2E22	1.10	6C8G	.70	12X825 2A.TUNG1	.45	FG172	19.25	811	2.35	1638	.65
2J21	10.45	6C21	19.10	13-4 BALLAST	.35	205B	1.35	812	2.95	1641/RK60	.65
2J21A	10.45	6D6	.50	14B6	.75	211/VT4C	.40	813	8.95	1642	.55
2J22	9.65	6F5	.65	14Q7	.55	215A/VT5	.28	814	2.60	1852/6AC7	.90
2J26	8.45	6F6	.60	15E	1.40	221A	1.75	815	2.35	1853/6AB7	.95
2J27	12.95	5F6G	.60	15R	.70	227A	2.90	826	.75	1960	.85
2J31	9.95	5F8G	.85	16X879 2A.TUNG1	.35	231D	1.20	830B	3.95	1961/532A	1.85
2J32	12.85	6G6G	.85	FG17/967	3.25	RX233A	1.95	832	6.50	1984	1.75
2J33	18.95	6H6	.45	19	.85	257A	3.00	832A	7.95	2051	.75
2J34	17.50	3H16 BALLAST	.45	20-4 BALLAST	.45	268A	2.95	834	5.75	UX6653	1.20
2J37	13.85	6J5	.45	REL-21	2.10	274B	2.65	835/38111A	1.00	7193	.35
2J38	9.95	6J5GT	.45	21-2 BALLAST	.45	282B	5.25	836	1.45	8011	2.55
2J48	19.95	6J6	.85	23D4 BALLAST	.45	287A/722A	9.50	837	2.25	8012	2.75
2J61	24.50	5J7	.65	RK24	1.55	304TH	3.70	838	3.10	8013	1.25
2K25/723A/B	14.95	6J8G	.95	24A	.40	304TL	1.95	841	.40	8020	2.10
2X2	.45	6K6GT	.55	VT25A/10	.45	307A/RK75	3.60	842	2.75	8025	6.75
2Y3G	1.20	6K7	.65	25Z5	.65	316A	.45	843	.40	9001	.45
3-16 BALLAST	.45	6K7G	.65	25Z6GT	.52	327A	2.50	851	39.00	9002	.40
3A4	.35	6L6	1.10	26	.55	350B	1.85	852	6.10	9003	.45
3A4/47	.45	6L7	.75	27	.55	354C	14.95	860	7.55	9004	.55
3B7/1291	.40	6N7	.85	28D7	.40	356B	4.95	864	.40	9006	.30
3B22	2.35	6N7GT	.85	30/VT67	.58	368AS/703A	3.75	865	1.85	38111A/835	1.00
3B24	1.75	6Q7	.55	30	.40	371A	.80				
3BP1	3.45	6R7	.75	33	.70	371B	.80				
EL-3C	3.95	6R7G	.75	34	.33	388A	2.95				
3C21	4.85	6R7GT	.55	RK34/2C34	.35	393A	3.60				
3C24/24G	.45	6S7G	.85	35/51	.55	394A	3.60				
3C31/C1B	3.75	6SA7GT	.55	35W4	.45	395A	4.85				
3CP1/S1	1.95	6SC7GT	.65	35Y4	.50	MX408U BALLAST	.30				
3D6/1299	.30	6SF5GT	.65	36	.55	417A	14.25				
3D21A	.95	6SG7	.65	37	.35	434A	2.85				
3DP1	3.75	6SH7	.40	38	.35	446A	1.15				
3FP7	1.85	6SH7GT	.40	39/44	.30	446B	1.75				
3FP7A	2.25	6SK7GT	.50	43	.50	GL451	1.90				
3GP1	4.95	6SL7GT	.60	45SPEC. 7V. FIL.	.28	GL471A	2.75				
3H-1-7 BALLAST	.45	6SQ7	.55	46	.65	SS501	3.00				
3HP7	3.45	6SR7GT	.55	EF50	.45	527	12.85				
3Q5	.65	6U7G	.55	50B5	.65	WL530	2.75				
3Q5GT	.65	6V6GT	.75	50L6GT	.54	WL531	1.75				
3S4	.60	6X5GT	.73	VT52/45SPEC.	.28	WL532	1.65				
GA4	2.00	7-7-11 BALLAST	.35	56	.70	532A/1B32	1.85				
REL-5	14.95	7A4/XXL	.55	57	.45	GL559	2.10				
VT5/215A	.40	7A7	.56	58	.50	KU610	6.90				

PHOTO. TUBES.	
917/CE11V-C.	\$2.10
918/CE1C.	1.45
920/CE21D.	2.40
922/CE22C.	1.20
923/CE23C.	1.10
927/CE25.	1.25
930/CE30C.	1.20
SPECIAL TUBES.	
4B24/CE22A.	3.25
4B25/CE221.	7.85
4B26/CE226.	1.90
4B27/CE201A.	2.45
4B28/CE225.	2.40
4B35/CE212B.	7.65



Huge Display at Our LaSalle Street Show Rooms

320 N. LA SALLE ST. DEPT. Y, CHICAGO 10, ILL.



NO WONDER *Regency*  
**TV IS THE LARGEST SELLING  
 SIGNAL BOOSTER!**

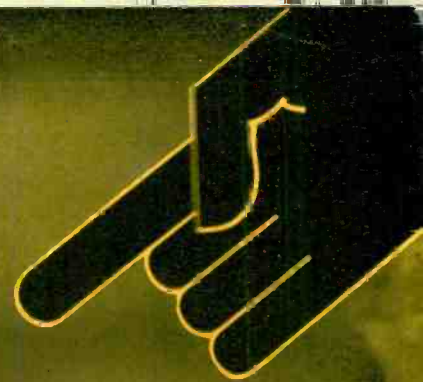

... it wins all  
 performance tests!  
 ... is also  
 lowest priced!

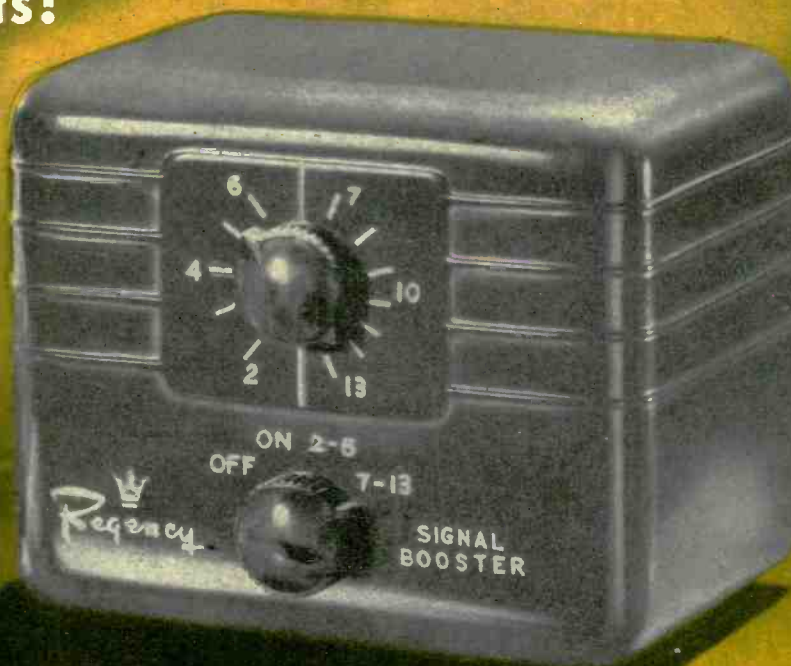

THE DB 400  
**\$29.95**  
 LIST

**REGENCY FEATURES:**

- Single-knob tuning control.
- Off-on switch controls the TV set.
- Easy installation. TV set plugs into the booster—booster plugs into wall outlet!
- The use of Contra-Wound Bifilar Coils with push-pull triode design gives a balanced circuit.
- Electrical symmetry makes possible balanced-bridge neutralization which insures stability and eliminates self-oscillations.
- No external impedance matching devices required.



**REGENCY FEATURES:**

- A handsome plastic cabinet design in mahogany or blonde; created to please the most discriminating interior decorator.
- Wide bandwidth assures equal enjoyment of both video and audio on all 12 channels.
- Underwriters'  Approved.

  
 Division, I.D.E.A., INC.  
 55 N. New Jersey St., Indianapolis 4, Indiana



THE QUALITY OF RCA TUBES IS UNQUESTIONED



## RCA for *Deflection Tubes* ... with dependability

Each standard by which you judge a tube in service is considered in establishing the design requirements of RCA tubes. Dependable performance of deflection circuits starts with *dependable* tubes. For example.

RCA-designed driver tubes, such as the 6SN7-GT and 12AU7—as well as the RCA-6K6-GT and RCA-6AQ5 vertical-deflection tubes—are exceptionally low in microphonics. They are built for *dependable* performance.

RCA-designed horizontal deflection tubes, such as the 6BG6-G, easily withstand peak plate voltages of 5000 volts, and as readily meet peak emission demands on the cathode. They, too, are built for *dependable* performance.

For these reasons, RCA tubes offer *dependability* beyond the average. With fewer service failures and fewer costly call-backs, there is, then, an additional hidden profit in every RCA tube and kinescope you sell.

*Always keep in touch with your RCA Tube Distributor*



**RADIO CORPORATION of AMERICA**  
ELECTRON TUBES  
HARRISON, N. J.