

RADIO — ELECTRONICS

SAP RELAY
P 50

LATEST IN TELEVISION SERVICING AUDIO

formerly

**RADIO
CRAFT**

HUGO GRANSBACH, Editor



AUG

1950

30¢

U. S. and
CANADA

530-MC. U.H.F. SATELLITE TELEVISION STATION—SEE TELEVISION SECTION

NOW... see how you score on the

RCA BATTERY

"Get the Facts" Quiz



The battery for the Radio Trade!

Try yourself out on these leading questions about RCA Radio Batteries. You'll profit by the answers whether you get a

high score or not...because these are the facts about RCA Radio Batteries every dealer and serviceman should know.

Official Questions and Answers from the \$10,000 RCA Battery "Get the Facts" Contest (Ended July 10, 1950)

1. *Of all the radio battery brands sold—which brand is recognized as "The Battery for the Radio Trade"?*

(Answer) RCA.

2. *Why is RCA recognized as "The Battery for the Radio Trade"?*

(Answer) Because RCA sells its batteries to Radio Dealers and Servicemen through Radio-Electronics Distributors.

3. *What sales advantage does RCA's Battery distribution give retailers?*

(Answer) Virtually no RCA Battery competition from non-radio outlets.

4. *How complete is RCA's line of Radio Batteries in terms of consumer needs?*

(Answer) RCA's line covers 99% of today's radio battery demand.



5. *What is the most outstanding Battery in RCA's line?*

(Answer) The RCA-VS036—flashlight-size "A" battery.

6. *Why is the RCA-VS036 an outstanding battery?*

(Answer) Because it contains a Special Radio Mix—is completely Sealed-in-Steel—top, bottom, and sides.

7. *What important advantages does the RCA-VS036 offer retailers?*

(Answer) Sealed-in-Steel construction eliminates shelf-life problems—the battery stays fresh until used.

8. *Why will customers prefer the RCA-VS036?*

(Answer) It's virtually leakproof and, in radio operation, gives more operating hours than competitive flashlight-type batteries.

9. *Is the RCA-VS036 good for Flashlight use?*

(Answer) Yes. It exceeds the U. S. Bureau of Standards Household Flashlight Cell Capacity requirements by nearly 50%.



10. *What RCA "Exclusive" helps you sell the RCA-VS036?*

(Answer) The "Carry Kit" merchandiser—a "carry-away" container that sells batteries like soda pop—eight at a time!

11. *What is your assurance of top quality in RCA Batteries?*

(Answer) Only the finest materials and skilled workmanship go into RCA Batteries. Every cell is aged and individually tested.

12. *How has it been proved that RCA Batteries give extra listening hours?*

(Answer) Exacting laboratory performance tests show that RCA Batteries exceed the average of competitive brands.

13. *What steps are taken to safeguard the quality standard of RCA Batteries?*

(Answer) Constant research, product development, and the continued application of latest production techniques.

14. *Are radio set manufacturers recommending RCA Batteries for their Portables?*

(Answer) Yes—in ever-increasing numbers!

15. *What specialized knowledge does RCA bring to Radio Battery retailers?*

(Answer) RCA—World Leader in Radio—is closer to radio-battery market requirements than any other battery supplier. Such knowledge assures dealers availability of the right types—at the right time—backed by proved radio trade sales programs.

16. *What selling aids does RCA provide?*

(Answer) All types of displays and merchandisers, together with technical literature—the most complete line in the industry—all geared for radio trade use.

17. *What are some RCA "Firsts" in battery sales promotion?*

(Answer) The RCA "Carry Kit," Toy Shipping Container, Basic Sales Aid Kit, and, Radio-gear Sales Aids!

18. *What is your guarantee of high consumer acceptance of RCA Batteries?*

(Answer) Today, as always, the RCA Trade Mark is your assurance of immediate customer acceptance. Consumers everywhere recognize RCA as "the Greatest Name in Radio."

19. *What can radio dealers and servicemen do to prove to themselves that they can sell more RCA Batteries than any other brand?*

(Answer) Starting now—sell RCA Batteries. Watch your business grow!

See your RCA Battery Distributor for fast, reliable service.



RADIO CORPORATION of AMERICA

RADIO BATTERIES

HARRISON, N. J.

NEW



I'LL TRAIN YOU FOR YOUR FCC LICENSE

A Federal Communications Commission Commercial Operator's License puts you in line for a good job in Radio or Television Broadcasting, Police, Marine, Aviation, Two-way, Mobile or Micro-wave Relay Radio. Mail coupon below for 64-page book FREE. It will give you complete facts about my NEW Communications course.



YOU BUILD THIS TRANSMITTER

with parts I send. With this Transmitter you practice how to put a station "on the air." You perform procedures demanded of Broadcast Station Operators, conduct many experiments, make many practical tests.

LEARN COMMUNICATIONS by PRACTICING at Home in Spare Time

with MANY KITS of RADIO EQUIPMENT I SEND



MY COURSE INCLUDES TELEVISION

Course Is New! Different!

Mail coupon now for facts about my NEW, intensely practical course in Radio-Television Communications. Let me send you FREE book. Read outlines of 78 lesson texts written by leaders in Communications and edited for you by my practical staff. See the nine big Kits of Parts I send that "bring to life" theory you learn. Read about the Transmitter you build and operate, about the Electronic Multitester you get. All equipment yours to keep. My NEW course covers Theory thoroughly and you get Practical Experience building units like those shown at the left. It's backed by N. R. I.—the world's oldest and largest home study Radio-Television school.

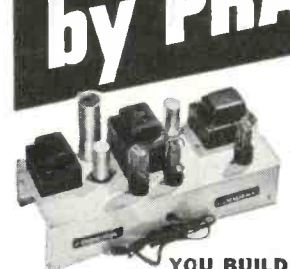

YOU BUILD this Transmitter Power Supply used in the basic experiments in RF and AF amplifiers, frequency multipliers, buffers, etc.



YOU MEASURE current, voltage (AC, DC and RF), resistance and impedance in circuits with Electronic Multitester you build. Shows how basic transmitter circuits behave; needed to maintain station operation.

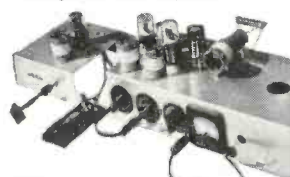

YOU PRACTICE setting up code, amplitude and frequency modulation circuits (put voice, music, etc., on "carrier signals" you produce). You learn how to get best performance.

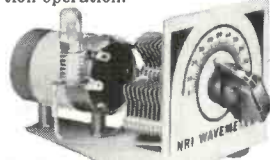

YOU BUILD this Wavemeter and use it to determine frequency of operation, make other tests on transmitter currents.

Ever think HOW FAST Radio-Television Communications is changing, developing, growing? Have you considered what this amazing progress can mean to you?

Look at these facts. In 1946 only 6,000 Television sets were sold. In 1949 almost 3,000,000. By 1954, 20,000,000 Television sets will be in use, according to estimates. 100 Television Stations are operating in 35 states. Authorities predict there will be over 1,000 Television Stations. This rapid growth means new jobs, more jobs, good pay for qualified men all over the U. S. and Canada. Then add development of FM, Two-way Radio, Police, Marine, Aviation and Micro-wave, Relay Radio! Think what all this means! New jobs, more jobs for beginners! Better jobs, better pay for experienced men!

Are you a beginner who wants steady work in this growing field? My NEW course can help you get an FCC License and prepare for the job you want. Are you a man with some training in Radio or Radar, or a Licensed Operator? My NEW course modernizes, increases the value of your knowledge and experience!

Servicing Training Also Offered by N. R. I.

If you prefer a good-pay job in Radio-Television Servicing, or your own money-making Radio-Television Sales and Service Shop, I'll train you at home. My famous Servicing Course also includes many Kits of Radio Parts. You use them to get PRACTICAL EXPERIENCE with circuits common to Radio and Television. I also show you how to make \$5, \$10 a week or more EXTRA MONEY fixing neighbors' Radios while training. Full information in my 64-page book. . . . Mail coupon.

Mail Coupon For Book FREE

Send today! See what my NEW course is like. Find out how I get you ready for a brighter future, better earnings, more security in Radio-Television. Send coupon now in envelope or paste on a postal. NO OBLIGATION. NO SALESMAN WILL CALL! My book, sent to you FREE, tells the full story. J. E. SMITH, President, Dept. OHX, National Radio Institute, Washington 9, D. C.

VETERANS HURRY! To get this valuable training under G. I. Bill. Time is Running out. MAIL COUPON NOW!

I TRAINED THESE MEN

"N.R.I. has been my stepping stone from a few hundred to over \$4,000 a year as a Radio Engineer."—ALTON B. MICHAELS, Trenton, Georgia.

"Am Broadcast Engineer at WLPM. Your NEW Communications course shows the kind of equipment we use."—J. BANGLEY, JR., Suffolk, Virginia.

"I am employed by WKBO as transmitter operator. Have more than doubled salary since starting in Radio full time!"—A. HERR, New Cumberland, Penna.

"4 years ago, I was a book-keeper with hand-to-mouth salary. Am now Radio Engineer with ABC network."—N. H. WARD, Ridgefield Park, N. J.

MAIL NOW-BOOK FREE

MR. J. E. SMITH, President, Dept. OHX, National Radio Institute, Washington 9, D. C. Mail me your 64-page Book about Radio and Television Communications opportunities and training. (No salesman will call. Please write plainly.)

Name..... Age.....
 Address.....
 City..... Zone..... State.....
 Check if Veteran Approved Under G. I. Bill

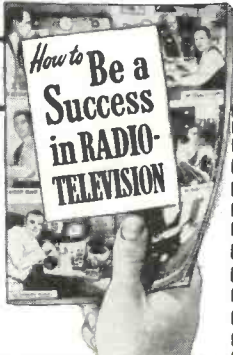

RADIO — ELECTRONICS

formerly RADIO-CRAFT

MEMBER
AUDIT BUREAU OF CIRCULATIONS

Hugo Gernsback, Editor-in-Chief
M. Harvey Gernsback, Editorial Director

Fred Shunaman, Managing Editor
Robert F. Scott, W2PWC, Technical Editor
Manfred Wentzel, Associate Editor

Incorporating
SHORT WAVE CRAFT* TELEVISION NEWS*
RADIO & TELEVISION
*Trademark registered U. S. Patent Office

J. Queen, Editorial Associate
Angie Pascale, Production Manager
Wm. Lyon McLaughlin, Tech. Illustration Director

Lee Robinson, General Manager
John J. Lamson, Sales Manager

G. Aliquo, Circulation Manager
Robert Fallath, Promotion Manager

CONTENTS — AUGUST, 1950

Editorial (Page 19)			
Television Problems.....	by Hugo Gernsback 19		
Television (Pages 20-26)			
Low-Voltage Supplies with No Transformers.....	by H. G. Cisin 20		
Practical Methods for Trouble-Free Antenna Erection	by H. Winfield Secor 22		
D.C. Restorer Circuit Reduces TV Eye Strain	by Robert L. Donaldson 24		
Novel High-Voltage Test Probe.....	by Walter H. Buchsbaum 25		
530-Mc. U.H.F. Satellite Television Station.....	26		
Servicing—Test Instruments (Pages 27-35)			
Fundamentals of Radio Servicing, Part XVIII.....	by John T. Frye 27		
Check That Advertising.....	Dan Valentine 29		
Radio Set and Service Review (RCA WO-57A) by Robert F. Scott	30		
Ayrton Shunt Protects Meter Movement.....	by I. Queen 32		
Midget Signal Generator is Hum Modulated..	by Lyman Greenlee 33		
Making Humless B-Supplies.....	by James R. Langham 34		
Electronics (Pages 36-37)			
An Electronic Therapy Mochine	by Irving Gottlieb 36		
Audio (Pages 38-43)			
Sound Level Indicator Imitates Ear Response..	by John W. Straede 38		
Square Wave Analysis for Audio Amplifiers, Part II	by Eugene J. Thompson 40		
Electronics and Music, Part II.....	by Richard H. Dorf 42		
Amateur (Pages 44-46)			
Modulating the BC-221 Freqmeter....	by W. S. Kemper, W4KOF 44		
A Compact 75-Meter Rig.....	by Ernest J. Schultz 45		
Construction (Pages 47-50)			
High Accuracy Timer for Short Intervals.....	by R. L. Parmenter 47		
Capacitance Relay Operates Display.....	by W. G. Eslick 50		
New Design (Page 58)			
Review of New Tubes.....	58		
Departments			
The Radio Month.....	10	Try This One.....	64
Radio Business.....	14	Question Box.....	66
New Devices.....	54	Miscellany.....	68
Association News.....	56	Technotes.....	72
New Patents.....	60	People.....	74
Radio-Electronic Circuits	62	Communications.....	76
Book Reviews.....	79		

ON THE COVER: NBC's experimental ultra-high-frequency television station KC2XAK at Bridgeport, Conn. Engineer Vic Bary is at the controls and technician John Piorek logging the dials.
Kodachrome by Avery Slack.

RADIO-ELECTRONICS, August, 1950, Volume XXI, No. 11. Published monthly. Publication Office: Erie Ave., F to G Streets, Philadelphia 32, Pa. Entered as second class matter September 27, 1948, at the post office at Philadelphia, Pa., under the Act of March 3, 1879. SUBSCRIPTION RATES: In U. S. and Canada, in U. S. possessions, Mexico, South and Central American countries, \$3.50; \$6.00 for two years; \$8.00 for three years; single copies 30c. All other foreign countries \$4.50 a year, \$8.00 for two years, \$11.00 for three years. Allow one month for change of address. When ordering a change please furnish an address stencil impression from a recent wrapper. RADCRAFT PUBLICATIONS, INC. Hugo Gernsback, Pres.; M. Harvey Gernsback, Vice-Pres.; G. Aliquo, Sec'y. Contents copyright, 1950, by RADCRAFT Publications, Inc. Text and illustrations must not be reproduced without permission of copyright owners.
EDITORIAL and ADVERTISING OFFICES, 25 West Broadway, New York 7, N. Y. Tel. REctor 2-9690.
BRANCH ADVERTISING OFFICES: Chicago: 520 N. Michigan Ave. Telephone SUPERior 7-1796. Los Angeles: Ralph W. Barker, 1127 Wilshire Blvd., Tel. MA 6-1271. San Francisco: Ralph W. Barker, 582 Market St., Tel. GARfield 1-2481. FOREIGN AGENTS: Great Britain: Atlas Publishing and Distributing Co., Ltd., London E.C.4. Australia: McGill's Agency, Melbourne. France: Brentano's, Paris 2e. Holland: Trilectron, Heemstede. Greece: International Book & News Agency, Athens. So. Africa: Central News Agency, Ltd., Johannesburg; Capetown: Durban, Natal. Universal Book Agency, Johannesburg. Middle East: Stelmatsky Middle East Agency, Jerusalem. India: Broadway News Centre, Dadar, Bombay #14. K. L. Kannappa Mudalliar, Madras 2, Pakistan: Paradise Book Stall, Karachi 3. POSTMASTER: If undeliverable send form 3578 to: RADIO-ELECTRONICS, 25 West Broadway, New York 7, N. Y.

Terrific FOR TELE-CIRCUITS!

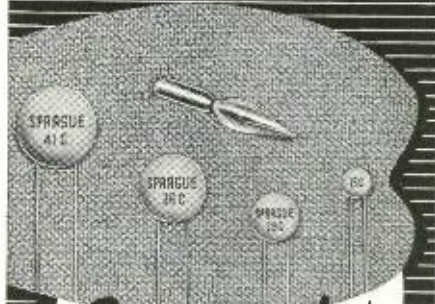

Cera-mite* CAPACITORS

ARE
THE *First* COMPLETE
DISC CERAMIC LINE

DEVELOPED especially for the television industry, Sprague Cera-mite Capacitors fill the bill for the alert service technician!

Temperature-compensating, general-use, and high-K bypass types fit every type of circuit application. The low self-inductance feature of the flat plate with uni-directional lead design gives better high frequency performance than the older tubular ceramics which they replace. And they're ideal as mica capacitor replacements, too!

Tiny and dependable, every Cera-mite is rated at 1000 volts test, 500 wvdc, and for operation at 185°F.

Cera-mites are clearly stamped with capacitance—no confusing color coding.

Stock up at your Sprague distributor without delay!

Write for Cera-mite Bulletin

*Trademark

SPRAGUE PRODUCTS COMPANY

Distributors: Division of the Sprague Electric Co.
81 Marshall St., North Adams, Mass.



Get Into

TELEVISION, RADIO ELECTRONICS

Master ALL Phases

Get Complete Training. You Receive and Keep All Tubes, Equipment, Parts and Lessons. No Extra Charges.

GOOD PAY and Unlimited Opportunities in JOBS LIKE THESE:

Business of Your Own
Radio Manufacturing, Sales, Service
Broadcasting, Telecasting
Television Manufacturing, Sales, Service
Laboratories: Installation, Maintenance of Electronic Equipment, Electrolysis, Call Systems
Garages: Auto Radio Sales, Service
Sound Systems and Telephone Companies; Oil Well and Drilling Companies; Engineering Firms
Theatre Sound Systems, Police Radio

And scores of other good jobs in many related fields

YOU CONDUCT MANY EXPERIMENTS LIKE THESE!

Checking action of condensers
Experiments with AF and RF amplifiers
Experiments with resonance
Producing beat frequencies
Calibrating oscillators
Experiments with diode, grid-bias, grid-leak and infinite impedance detectors
Practical experience in receiver trouble shooting
Application of visual tester in checking parts and circuits
Experiments with audio oscillators
Advanced trouble-shooting
... and many, many others

Complete Training by Practical Resident Trade School, Est. 1905

The same highly trained faculty, instruction materials and methods used here in our large, modern resident school, are adapted to your training in your own home. Shop Method Home Training has been proved by hundreds of successful graduates.

Both Resident and Home Study Courses Offered

YOU LEARN BY DOING

You receive special laboratory experiment lessons to show you how to build with your own hands various experimental units such as those shown at left, and how to conduct many tests.

You will find all lessons easy to understand because they are illustrated throughout with clear diagrams and step-by-step examples that you work out yourself. Every piece of the equipment and complete lesson material we send you is yours to keep and enjoy, including the multitester, experimental equipment, all parts of the Superheterodyne, tube manual, radio dictionary, and complete, modern Television texts. All parts are standard equipment.

Shop Method Home Training . . . Earn While You Learn

With our practical resident Shop Method Home Training, you study in your spare time. You receive Spare Time Work Lessons, which show you how to earn while you learn. Service neighbors' radios and TV receivers, appliances, etc., for extra money and experience. Many National students pay all or part of their training with spare time earnings!

DON'T DELAY! The Radio-Television Industry needs trained men NOW!

APPROVED FOR VETERANS!

Check coupon below!

For quick action, mail coupon today and we'll rush you full information.

Free!

NEW, ILLUSTRATED OPPORTUNITY BOOK AND SAMPLE LESSON SHOW YOU HOW WE TRAIN YOU . . . SEND FOR THEM TODAY! NO COST. NO OBLIGATION.



YOU RECEIVE THIS PROFESSIONAL MULTITESTER YOU BUILD ALL THESE AND MANY OTHER UNITS WITH PARTS WE SEND YOU!

Signal Generator



Audio Oscillator

T.R.F. Receiver

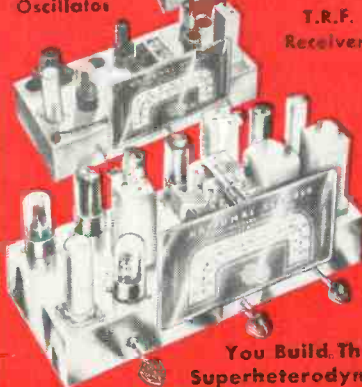

You Build This Superheterodyne

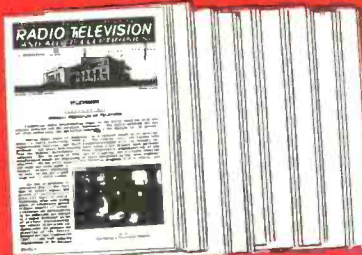

You Receive a Special Series of Modern Lessons in TELEVISION, all a part of your course: you master all phases.

NATIONAL SCHOOLS

LOS ANGELES 37, CALIF. • EST. 1905



FIND OUT NOW . . . MAIL COUPON TODAY

National Schools, Dept. RE-8
4000 South Figueroa Street
Los Angeles 37, California

Mail in envelope or paste on penny postal.

Send me your FREE book "Your Future in Radio" and the sample lesson of your course. I understand no salesman will call on me.

NAME _____ AGE _____

ADDRESS _____

CITY _____ ZONE _____ STATE _____

Check here if Veteran of World War II



Can You See Your Future in TV?

CREI Practical Training Shows You the Way to Greater Earnings in TELEVISION & FM SERVICING!

TODAY THE CATHODE RAY TUBE can be the crystal ball that forecasts your future. Is the picture clear and bright—or is it fuzzy and out of focus?

Are you going to learn *now* how to install and service all types of TV and FM receivers? There can be no doubt that TV is the important field for greater earnings: 83 stations on the air (many more authorized); two million new sets in 1949; twelve million predicted by 1953; practically every area in the nation soon to be in range of a TV station. Technicians with specialized TV-FM training will inevitably have the inside track installing and maintaining all these sets.

CREI offers just the specialized training you need. It's a streamlined course for the top third of the men in the field—thorough and complete. It gives practical answers to the technical problems you run into

while servicing today's intricate TV and FM equipment. It is up to date, constantly revised to cover new developments as they are adopted by the industry.

Start your training now and apply your knowledge immediately. The profitable work, passed up yesterday because it was over your head, can be yours tomorrow. Make this year the turning point in your TV career! Write today for complete FREE information. The cost is popular, the terms easy.

SAMPLE LESSON FREE! "Television & FM Trouble Shooting" devoted to live, "dollar - and - cents", practical practice based on day-to-day servicing problems. Read this interesting lesson! See for yourself how CREI training can help you. Mail coupon for sample lesson, free booklet and details.

THE THREE BASIC CREI COURSES:

- ★ **PRACTICAL RADIO ENGINEERING**
Fundamental course in all phases of radio-electronics
 - ★ **PRACTICAL TELEVISION ENGINEERING**
Specialized training for professional radiomen
 - ★ **TELEVISION AND FM SERVICING**
Streamlined course for men in "top-third" of field
- ALSO AVAILABLE IN RESIDENCE SCHOOL COURSES**

CAPITOL RADIO ENGINEERING INSTITUTE

An Accredited Technical Institute Founded in 1927

Dept. 148-B, 16th Street & Park Road, N. W.
Washington 10, D. C.

Branch Office:
San Francisco (2) 760 Market St.



**FREE BOOKLET
plus
SAMPLE LESSON**

CAPITOL RADIO ENGINEERING INSTITUTE

Dept. 148B, 16th & Park Rd., N. W. Washington 10, D. C.

Gentlemen: Send me FREE SAMPLE LESSON and complete details of the TV and FM Servicing home study course. Also send brochure that explains the CREI self-improvement program and gives complete details and outline of course. I am attaching a brief resume of my experience, education and present position.

- Check the Field of Greatest Interest
- TV, FM & ADVANCED AM SERVICING
 - PRACTICAL TELEVISION ENGINEERING
 - PRACTICAL RADIO ENGINEERING
 - AERONAUTICAL RADIO ENGINEERING
 - BROADCAST RADIO ENGINEERING (AM, FM, TV)
 - RADIO-ELECTRONICS IN INDUSTRY

NAME _____ AGE _____

ADDRESS _____

CITY _____ ZONE _____ STATE _____

IF RESIDENCE SCHOOL PREFERRED, CHECK HERE.

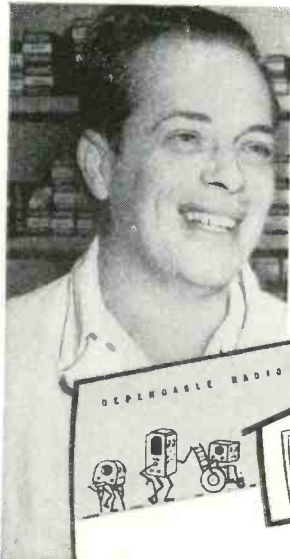

**"We doubled our
store space...
increased our staff"**

DEPENDABLE RADIO SERVICE BY CAREFULLY TRAINED EXPERTS

BETTER RADIO INC.
136 W. Park Avenue
ELMHURST, ILLINOIS
Elmhurst 3228

April 28, 1950

Sylvania Electric Products Inc.
Advertising Department
Emporium, Pa.

Gentlemen:

During January, February and March, I sent 12,000 postal cards to each occupant of three suburban towns, Elmhurst, Villa Park, Lombard and countryside. I had a local letter service handle addressing and mailing at a cost of only 1/3¢ per card.

Business began to pour in soon after the first mailing. In January, it was up 33%, February 35% and March up 45% compared to service business in similar months in 1949. Yes, service business increased an average of 38% the first three months of this year, over last.

Due to the increased business we've had as a result of your campaign mailings, we have doubled our store space, increased our service staff from two to six bench positions, and added an outside staff for antenna installations.

Just thought you would like to know! Thanks for your help in the rapid growth of "Better Radio".

Cordially,
Howard J. Hitzeman
Howard J. Hitzeman
President
BETTER RADIO INC.

Read this remarkable record!

**Now let this SYLVANIA DEALER
CAMPAIGN boost your business!**

The above letter is actual proof of how Sylvania's Service Dealer Campaigns step up sales.

Now the new fall campaign is ready for you. It's tied in with the advertising your customers will be seeing in the Saturday Evening Post, Life, Look, Collier's and Radio and Television Best. It's sure-fire, powerful and complete... from colorful window and counter displays to bright, business-pulling postal cards... even radio spot announcements and ad mats.

All yours ALL FREE... you pay only the postage (1¢ for each card). So don't delay, mail the coupon TODAY!

RADIO TUBES; TELEVISION PICTURE TUBES; ELECTRONIC PRODUCTS; ELECTRONIC TEST EQUIPMENT; FLUORESCENT LAMPS, FIXTURES, SIGN TUBING, WIRING DEVICES; LIGHT BULBS; PHOTOLAMPS; TELEVISION SETS

**SYLVANIA
ELECTRIC**

"Ran out of..."
"I was watching an international beauty contest when suddenly..."

Call Us for expert radio and TV service at reasonable prices...
Let old... Let old...
We use and recommend SYLVANIA RADIO AND TELEVISION TUBES

DISPLAYS

"I was watching an international beauty contest when suddenly..." **We repair**
"On one of our radio sets, both the set and tube were..." **You'll like our expert radio service and fair prices**
WE USE AND RECOMMEND SYLVANIA RADIO AND TELEVISION TUBES

WINDOW STREAMERS

POSTAL CARDS
"How does your radio sound?"
"I was watching an international beauty contest when suddenly..."
DEALER'S IMPRINT

RADIO SPOTS
Spot Radio Announcements
FOR SYLVANIA RADIO SERVICE DEALERS

AD MATS
"Let us put your television set in top shape for Christmas"
"The gift of your radio is sure the next best thing to a television!"
DEALER'S IMPRINT

Sylvania Electric Products Inc.
Dept. R-1008, Emporium, Pa.

Send full details about Sylvania's Fall Advertising Campaign for Radio-TV Service Dealers.

Name _____

Company _____

Street _____

City _____ Zone _____ State _____

RADIO-ELECTRONICS for

HERE'S YOUR BIG CHANCE!



D.T.I. Can prepare you for a Profitable Future in TELEVISION

RADIO and ELECTRONICS

NO EXPERIENCE NECESSARY



E. B. De Vry, President DeForest's Training, Inc.

NOW...BUILD AND KEEP A 16" RECTANGULAR "BLACK" PICTURE TUBE TELEVISION RECEIVER (This is an optional feature...described below)

10 reasons why!

See how DeForest's Training, Inc. can start preparing you now for the opportunities ahead in TELEVISION . . . RADIO . . . ELECTRONICS. We provide practical training in your own home to help you gain the confidence and "know-how" to fit you for a responsible, well-paying job or your own business. D.T.I. trains you rapidly, thoroughly, by using modern instruction methods and equipment. Write today for free facts on how you, too, may get started toward a profitable, exciting career.

16 Big Shipments of Parts—Plus Lessons

Here is everything you need to prepare you at home for FASCINATING WORK, GOOD MONEY and a THRILLING FUTURE in one of America's most promising fields. Work over 300 electronic experiments and projects from 16 big shipments of parts. This includes building and keeping all test equipment and radio set shown at left side of page. Modern easy-to-read lessons with handy fold-out diagrams simplifies your entire training.

You Also Use Home Movies

D.T.I., alone, includes the modern, visual training aid . . . MOVIES to help you learn faster, easier at home. See electrons on the march and other fascinating "hidden action"—a remarkable home training advantage that speeds your progress.

EMPLOYMENT SERVICE

When you complete your training, our effective Employment Service helps you get started toward a real future in Television-Radio-Electronics.

Modern Laboratories

If you prefer, you can get ALL your preparation in our new, Chicago training laboratories . . . one of the finest of its kind. Ample instructors . . . modern equipment. Write for details!

1. You profit from our 19 years of "Know-how" in preparing men for real opportunities in the Radio-Electronics field—which now includes Television.
2. A faculty of more than 60 skilled residential and 15 extension instructors.
3. You may learn at home or in our new, modern laboratories in Chicago.
4. Home Movies, an exclusive D. T. I. feature, help you learn faster . . . easier at home.
5. You receive many shipments of commercial-type equipment which give you practical "on-the-job" experience in your own home.
6. You build modern-type test equipment which you can regularly use for analyzing, checking and testing purposes.
7. You also get lessons with many illustrations and schematic drawings that make electronic circuits easier to grasp.
8. EFFECTIVE EMPLOYMENT SERVICE is available when you complete your training to help you get started.
9. Consultation Service. After you complete your training, you are privileged to write for additional information to help you with "on-the-job" problems.
10. Build and keep a quality 16-inch rectangular tube Television Receiver. This is an optional feature—available at slight additional cost after completing training described above.

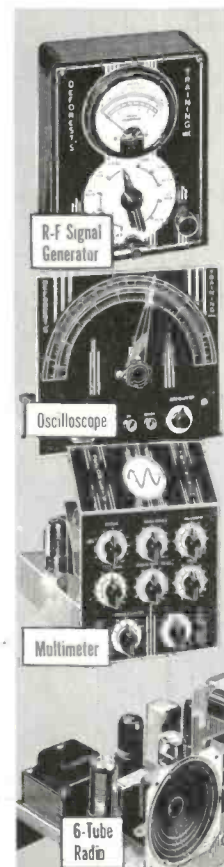
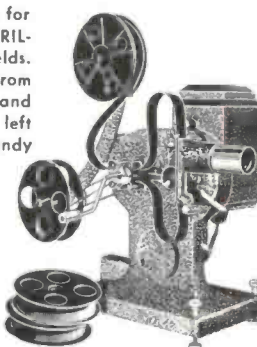

MAIL THIS OPPORTUNITY COUPON NOW!

Mr. E. B. De Vry, President
DeForest's Training, Inc.
2533 N. Ashland Avenue, Dept. RE-G-8
Chicago 14, Illinois

Please show me how I may get started toward a good job or a business of my own in Television-Radio-Electronics.

Name _____ Age _____
Address _____ Apt. _____
City _____ Zone _____ State _____

DeForest's Training, Inc.

CHICAGO 14, ILLINOIS

Associated with the De Vry Corporation
Builders of Movie & Electronic Equipment

ANNOUNCING

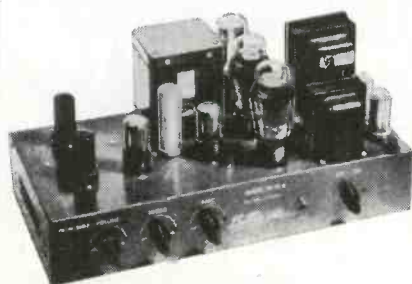

2 NEW MODELS

Of Sun Radio's Famous All-Triode Amplifier

The renowned Sun Amplifier Model CR-10 is now offered in three models, the two new ones featuring the famous Peerless transformers. New models are approved by Consumers' Research, original designers. Here's more good news -- for the first time in many months this much wanted amplifier is available for immediate delivery on all models. And prices are scheduled to go up September 1st, so better buy yours now . . .

CR-10, standard model, as engineered to original design by CONSUMERS' RESEARCH OF WASHINGTON, N. J.

Kit \$42.50
Lab wired, tested, ready to use . . \$69.50

CR-10-P uses Peerless transformers throughout, including output transformer designed especially for this amplifier. Improved low frequency response adds "presence" to reproduction.

Kit \$45.95
Lab wired, tested, ready to use . . \$74.50

CR-10-Q using Peerless transformers throughout, features famous Peerless S-240-Q Output Transformer for real presence effect. Note these specs:

Frequency Response ± 1 db, 20-20,000 cps.
Less than 2% Harmonic Distortion at 10W output.

Source impedance at 4 ohm tap is 1.3 ohms -- this provides excellent damping of loudspeakers.

Delivers full power within 1db from 40 to 10,000 cycles.

Output transformer vacuum impregnated, moisture resistant.

Output impedances available for any load 2 ohms to 16 ohms. (500 ohms available on special order at no extra cost).

Transformer has split windings interleaved with secondary, making for extremely high efficiency and low losses.

Kit \$54.95
Lab wired, tested, ready to use . . \$84.00

Sold Exclusively by Sun Radio, N. Y.

Sun Radio
& ELECTRONICS CO. INC.
122-C DUANE ST. • NEW YORK 7, N.Y.
2 Blocks North of Chambers St.
BARCLAY 7-1840

MAIL ORDERS FILLED PROMPTLY

BANKING BY TELEVISION is carried on at the Glyn Mills Bank in London. A customer may go into the London office of the bank, and at a moment's notice, see his balance sheet projected on a television screen. In addition, an officer of the bank may view at his desk any document kept in the vaults. All the bank's records are kept in a secure place about twelve miles out of town where they were moved during the war for safekeeping.

The remote location of the bank's files made this television system necessary. Besides permitting safe storage of documents in the present vaults, this system will actually cut down expenses by reducing costly filing space in London.

STEREOTELEVISION with three-dimensional pictures has been developed both by RCA and by the Argonne National Laboratory in cooperation with Du Mont. The two systems are very similar, both using a twin lens arrangement with the lenses separated about the same distance as between the human eyes.

The RCA system uses two vidicons (RADIO-ELECTRONICS, May, 1950) side-by-side in the camera and two kinescopes at the receiver. The Du Mont camera has only one camera tube and the images are placed side-by-side in the space normally occupied by one image. The Du Mont receiver requires only one ordinary picture tube.

In both cases, complementary polaroid filters are placed in front of the two adjacent images and the observer wears a pair of polarized spectacles so that he sees the right-eye image only with his right eye and the left-eye image with his left eye.

The RCA receiver has the two kine-

scopes mounted at right angles and the two images are superposed by a semireflecting mirror; while in the Du Mont set the observer has glass prisms in front of his eyes with which he can adjust the two pictures into a single image.

The stereoscopic television is intended for use in watching and remote control of industrial processes which might be dangerous to an observer and in other applications where a two-dimensional picture is inadequate.

ELECTRONIC BANKING has been introduced at the County Trust Company's eighteen branches in Westchester County, N. Y., to speed the processing of checks. Individual customers receive pre-punched checks with their account numbers and these are used in the ordinary way. When the check is presented for payment it is handled entirely by mechanical and electronic machines that can "read" the checks.

SAFETY MEASURES for electronic methods and equipment are increasingly necessary according to a safety panel of the American Institute of Electrical Engineers at Pasadena, California.

In the last ten years nearly 5,000 workers were seriously injured and 380 were killed by electrical accidents in California alone. Most of these resulted from the inexperience of novice electricians and attempts to put equipment to the wrong use.

All electronic equipment designed for use by non-technical personnel such as radios, sound gear, television, X-ray and other medical and dental equipment must have safety built in by manufacturers.



Carl A. Hermanson of the Argonne National Laboratory performs remote control operations which he observes with Du Mont three-dimensional stereotelevision.

RADIO-ELECTRONICS for

FASTEST COMPUTER, recently put into operation, was developed for the Air Force by the National Bureau of Standards. The new electronic brain will be used to handle the astronomic calculations of the military budget. It is called the SEAC (Bureau of Standards Eastern Automatic Computer).

While the Bureau of Standards made no direct comparison with other electronic computers, it called the SEAC "the first automatically sequenced, super-speed computer to be put into useful operation." It can multiply or divide 11-digit numbers in 250 microseconds and add or subtract 11-digit numbers 1,100 times a second.

An input-output unit, a memory unit, a control unit, and an arithmetic unit comprise the four main sections of the SEAC. It can make comparisons of numbers and make limited decisions based on these comparisons and also store intermediate results.

Coded pulses can be fed to the calculator at the rate of 1,000,000 per second to instruct it. It then takes over the calculations, checks its own mistakes, and divulges the answer when it has computed the problem to a predetermined accuracy. A typical operation of the SEAC is to set up mathematical tables for each aircraft in the Air Force in relation to the material needed to keep it operating. Estimated budget requirements for each of these aircraft on any of 200 possible budget levels are supplied within minutes.

SHIPBOARD RADAR RULES governing the license requirements for marine radar operators have been issued by the FCC. The new regulations which will go into effect in January 1951 specify that only licensed radio officers may make repairs, adjustments, tests, or perform maintenance and servicing duties on radar units in normal use as navigational instruments.

Deck officers may operate the radar unit and replace fuses and *receiving-type* tubes, but only holders of first or second class radiotelephone or radiotelegraph licenses may perform the technical functions until the new rules go in effect. Special FCC examinations, in "Element Eight", are being given covering the theory and practice of installation, servicing, and maintenance of marine navigational radar. Radio officers must get a special endorsement on their licenses by passing this examination before they can qualify as radar officers.

WINDOW SHOPPING has become a reality at New York's Lewis and Conger department store. A coin-operated microphone installed on the outside of a display window is connected to a tape recording machine inside the window. The window shopper can order any items in the window simply by depositing 25¢ in the microphone and giving his order verbally. The following morning the orders are

transcribed and delivered to the customer with a refund of the 25¢ deposit. The device operates 24 hours a day. Similar devices have been installed in several other cities.



Window shopping is now a literal term.

The "Tell-it-to", as the window shopper is called, is a development of the L. A. Darling Company of Bronson, Michigan. The recording apparatus is manufactured by the Wilcox-Gay Radio Corporation of Charlotte, Michigan.

BIG MONEY IN RADIO and TELEVISION NOW!

See **COYNE'S Brand New 7 Volume Set APPLIED PRACTICAL RADIO-TELEVISION** **FREE!**



A BRAND NEW Set of books written for men who want to "go places" in TELEVISION and RADIO... men who know how a PRACTICAL working knowledge helps to get the BIG MONEY. Over 2500 pages of the latest Radio and Television "know how"; easy to understand with hundreds of crystal-clear illustrations. It's ALL here! EVEN COLOR TELEVISION AND UHF. How to install, service, align, balance ALL radio and TV sets... how to use new and old testing instruments for TV service... latest data on adapters, converters and MORE. Complete volume on Electronics and handy Radiomen's Handbook included. You name it and COYNE'S GOT IT, in this amazing new money-making 7-Volume Radio-Television Library.

**PRACTICAL!
CLEAR!
COMPLETE!**

7 fact-packed volumes — 1400 illustrations and diagrams with step-by-step photographs which "break down" the equipment to show what makes it "tick." Up-to-the-minute, complete, easy to follow.

Color Television Is Here!

Set contains most complete section ever published on Color Television and UHF, adapters and converters. FULLY ILLUSTRATED AND PRINTED IN 4 COLORS.

Act Now and Get FREE Book

Now you can see these new Coyne books for 7 days without cost and get Coyne's book of 150 Radio and Television Diagrams FREE. It's free just for examining the new 7-Volume Set. Full details of this sensational Coyne "prove it" offer are given below. Mail the coupon at once.

SEND COUPON—SEE SET FREE FOR 7 DAYS

You must SEE these new books to know how easy it is to prepare for the big jobs in radio and television. Here's our special offer:—we'll send the complete 7-volume set for your 7-Day FREE Examination. And with it, we'll include our valuable, new guide for all radiomen, "150 New Radio-Television Diagrams Explained," absolutely FREE! If you keep the 7-volume Set all you pay is \$3.00 within 7 days after the books arrive and \$3.00 per month until \$23.50 plus postage is paid — or you can pay \$22.00 cash. If you don't want the set, return it and you OWE NOTHING. But either way you keep "The Radio and Television Diagrams Book" as a gift. That book is ABSOLUTELY FREE.

SEND NO MONEY Coupon is just a request to see Set free and get FREE BOOK. Offer limited—act now.

COYNE Electrical and Radio-Television School
500 S. Paulina St., Dept. 80-T8, Chicago 12, Ill.

Mail This Coupon NOW

Educational Book Publishing Division
COYNE ELECTRICAL & RADIO-TELEVISION SCHOOL
500 S. Paulina St., Dept. 80-T8, Chicago 12, Ill.

O.K. Send me postpaid, your new 7-volume set, "Applied Practical Radio-Television", on 7 days Free Trial per your offer. Be sure to include as a gift the book of 150 Radio-Television Diagrams absolutely FREE.

NAME _____ Age _____
ADDRESS _____
TOWN _____ ZONE _____ STATE _____
Where employed _____

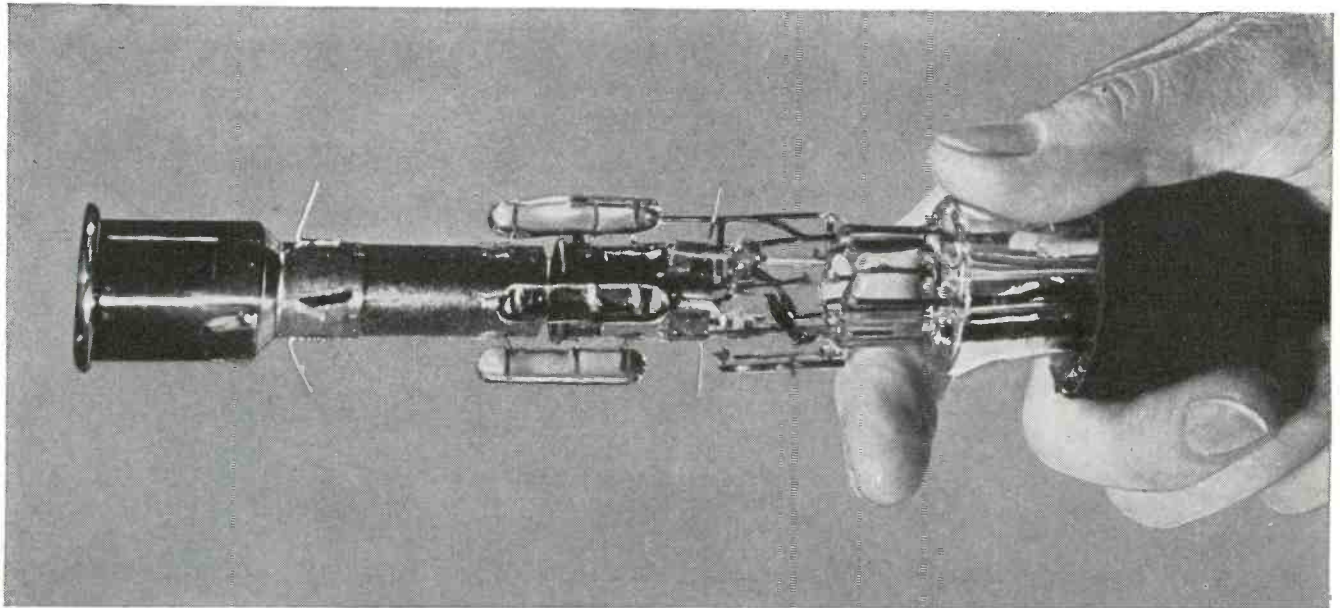

Electron gun which generates the pencil-like beam or "brush," of electrons that paints the television picture on the kinescope's luminescent face.

Wonderful peacetime "gun" shoots electrons

**How a pencil-thin electron stream
"paints" television pictures on TV screens**

No. 7 in a series outlining high
points in television history

Photos from the historical collection of RCA

● Though television now is familiar to millions, few know what makes pictures on the screens of home receivers. And little wonder! This, to most laymen, is a highly complex operation.

Many factors are involved, but in home receivers the kinescope tube—developed by Dr. V. K. Zworykin of RCA Laboratories—is undoubtedly most important. The face of this tube is the receiver's "screen." On it, an amazing electron gun paints pictures in motion.

Inserted inside the kinescope—in a vacuum 10 times more perfect than you'll find in any standard radio tube—this electron gun is machined and assembled with watchmaker precision . . . to 1/1000th of an inch. Such care is necessary to assure that the electron stream, emitted by an electrically heated surface, is under perfect control—compressed into a tiny beam, in perfect

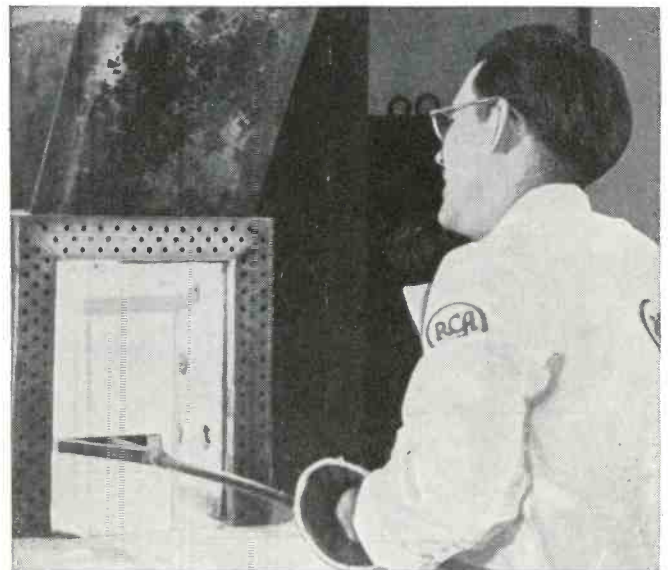

After this white-hot block of luminescent material is taken from the furnace, it will be spread on the face of a kinescope to form the screen for television pictures.

synchronization with the electron beam in a distant television camera.

In obedience to a signal originating in the camera controls—then telecast and received in your home—this electron beam moves back and forth across the luminescent screen of the kinescope . . . to paint areas of light and shade. In turn, your eye automatically "combines" these areas, and sees a picture!

One of the miracles of all this is that, although the electron beam moves across the face of the kinescope 525 times in a *thirtieth of a second*—not a single mechanical moving part is involved! Thus there is no chance, in a kinescope, of any mechanical failure.



Radio Corporation of America

WORLD LEADER IN RADIO—FIRST IN TELEVISION

RADIO-ELECTRONICS

FOLLOW THE LEADERS

BUY WISE...

BUY THE ORIGINALS...

BUY **HYTRON** TV FIRSTS



DUMONT

Emerson



Magnavox



Westinghouse

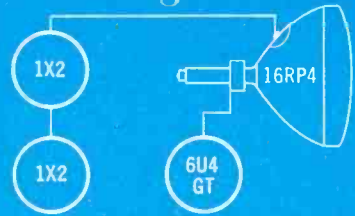

Admiral

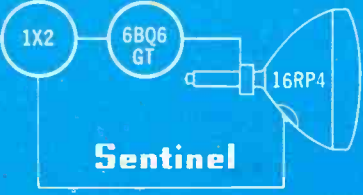
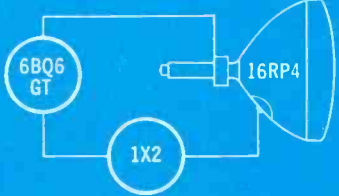

OLYMPIC

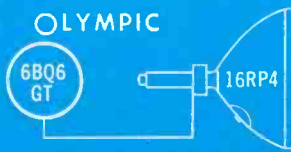

BENDIX

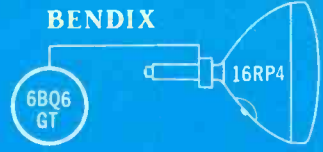

CROSBY

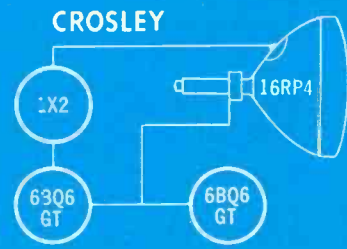

TRAV-LER

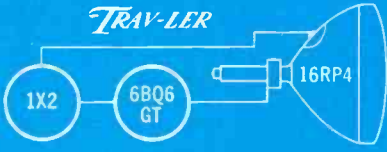

PHILCO



STROMBERG-CARLSON

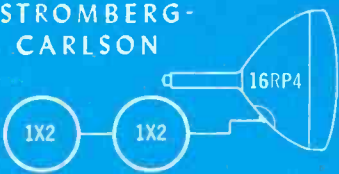

hallicrafters



Packard-Bell



Hoffman

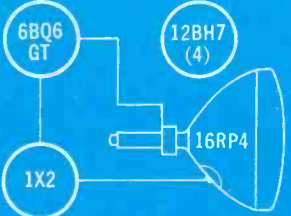
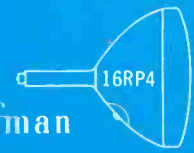

air-king

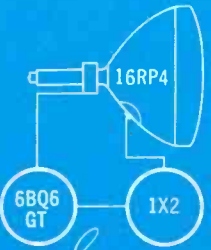

Sparton



National



Motorola

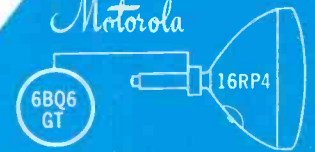

Ask for the original Hytron TV firsts: Hytron 1X2 compact, high-voltage TV rectifier. Hytron 6BQ6GT, 25BQ6GT extra-performance deflection amplifiers. Hytron 6U4GT high-perveance damping diode. Hytron 12BH7 twin-triode sweep amplifier with superior efficiency, Hytron 16RP4 original rectangular TV picture tube.



MAIN OFFICE: SALEM, MASSACHUSETTS

THERE'S A Trio TV Antenna for every installation problem WHAT'S YOURS . . .

. . . GO-CHANNEL INTERFERENCE AND EXTREME FRINGE AREA RECEPTION?

TRIO'S "PHASITRON CONTROLLED PATTERN" TV Antenna System Eliminates Venetian Blind Effect and Audio Chatter! Up to 17 db FORWARD GAIN!

Amazing new TV antenna system consists of two high gain yagis offset stacked for exact vertical angles plus the Remarkable "PHASITRON" (Pat. applied for) that actually *Tunes Out* Venetian Blind Effect and Audio Chatter even when caused by a signal TWENTY-FIVE TIMES STRONGER than that of the desired station! No. 604 "Controlled Pattern" Antenna System complete with Phasitron, 6' mast, Cross Arm, Hardware. Less transmission line. Available for each present TV channel. Please specify.

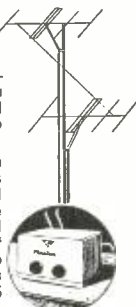

. . . ECONOMY?

Low Cost—High Quality Yagis For Single Channel Reception. Available For Each TV Channel. Please Specify.

No. 203 L.T.L.M. Three Element Single Bay. 6½ db. Gain.

No. 223 L.T.L.M. Two 3-Element Bays Stacked. 8½ db. Gain.

No. 204 L.T.L.M. Four Element Single Bay. 9 db. Gain.

. . . JUST ONE TV STATION?

No. 310 T.V. Low Frequency Broadbanded Folded Dipole with Reflector. With 5' Mast and 60' 300 ohm Transmission Line.

No. 310 L.T. Same as above, less Transmission Line.

. . . FRINGE AREA?

Yagi With Double Dipole. 10 db. Forward Gain on Optimum Channel! 25 db. Front-To-Back Ratio! Easily Stacked For More Gain!

No. 304—2-6 L.T. Low Channel Yagi, less transmission line.

No. 304—2-6 T.V. Low Channel Yagi with 60' 300 ohm transmission line.

No. 304—7-13 L.T.L.M. High Channel Antenna Bay Only.

No. 304—7-13 L.T. High Channel Antenna with 6' Mast, Hardware, less transmission line.

Order By Channel Number Following Model No. 304

. . . LANDLORD?

All Channel TV Antenna For Attic Installation. Suitable for metropolitan areas with sufficient signal strength. Install in attic on rafters, floor joists or attic floor.

No. 305 T.V. All Channel Attic Antenna with 2' Mast and 60' 300 ohm Transmission Line plus Hardware.

No. 305 L. T. Same As Above, less transmission line.

. . . FM ANTENNAS?

TRIO also manufactures a complete line of High Quality FM Antennas. For additional information on all TRIO TV and FM Antennas write for illustrated folders.

TRIO MANUFACTURING CO.
GRIGGSVILLE, ILLINOIS

Merchandising News

Ward Products Corp. of Cleveland offers as a new sales aid a display rack for store counters which illustrates Ward's national advertising. The easel



stands 18 inches high and 15 inches wide. Ad replacements will be sent to dealers several times a year.

General Electric Co. has recently issued a series of "Tele-Clues" designed to aid service technicians in localizing circuit troubles in TV sets. A series of photos shows pictures produced on the TV screen when various components are defective.

The Tele-Clues are available without charge through G-E and Ken-Rad distributors. They are inserted in the bi-monthly publication, "Techni-talk" published by the tube division of G-E.

Jensen Industries, Inc., has developed a new replacement needle package for phonograph dealers and service technicians. Called the "Jensen No. 5 Dealer Pack," the combination consists of a



balanced assortment of 26 different needles individually packaged in a plastic box. The assortment will take care of the majority of requests for new needles.

The Television Contractors Association, Philadelphia, has begun distribution of 20,000 copies of its new *Television Service Guide Book*. Ten chapters describe how television works, how to select a receiver, how to get the best reception, and how to reduce service calls. It is intended for prospective or

present TV set owners. The book will be distributed after an installation or upon request.

The Chicago Parts Distributors Show management reported more than 2,000 distributor personnel of over 800 companies packed the 168 booths and 134 display rooms. An estimated 8,000 persons attended the show at the Hotel Stevens from May 22 to 25.

The sixth annual Pacific Electronic Exhibit, a joint meeting of the IRE and the West Coast Electronic Manufacturers Association, will be held September 13-15 at Long Beach, Cal.

The National Electronics Distributors Association (NEDA) will hold their first National Convention and Show in the Cleveland Public Auditorium from August 29 to 31. RADIO-ELECTRONICS will have a booth at both the Pacific and Cleveland shows.

New Plants and Expansions

RCA-Victor expansion plans include the purchase of a large new building at Harrison, N. J., to provide 126,000 square feet of additional space for electron tube manufacturing facilities. Increased production facilities for radio and television manufacture are also planned. A new radio set factory will be erected in Canonsburg, Pa., and the Bloomington, Ind., plant will step up TV production by several hundred percent. Radio and phonograph manufacturing will be transferred from Bloomington to Canonsburg and added TV facilities will be installed at Bloomington. . . Sylvania Electric Products, Inc., has begun construction on a new \$1,500,000 radio tube plant in Shawnee, Okla. When completed, about the first of the year, the plant will produce more than a million radio tubes per month. Sylvania has also temporarily reopened its Altoona, Pa., radio tube plant. . . Crest Transformer Corp. has taken over an entire new building in Chicago. This new plant more than doubles the company's previous factory facilities. . . The Square Root Manufacturing Corp. has purchased a 30,000-square-foot building on its 3-acre site in Yonkers, N.Y. The company will now produce a new projection TV kit, a complete line of capacitors and flyback transformers in addition to its indoor and built-in TV antennas. . . Hy-Lite Antennae has moved its plant and general offices to larger quarters in New York City. . . Aerovox Corp. has rented 200,000 square feet in the Nonquitt Mill, New Bedford, Mass. The company hopes to add 800 additional employees by fall as part of its expanded production program. . . RMA reported that TV production by members in April equalled the peak levels established in March with 420,026 sets manufactured. Home radio production hit 648,352 sets and auto radio production 234,354—a slight increase over the March rate. Of the 648,352 home radios produced, 78,008 included FM reception facilities. In April 498,624 cathode-ray tubes were sold to TV manufacturers. Of these

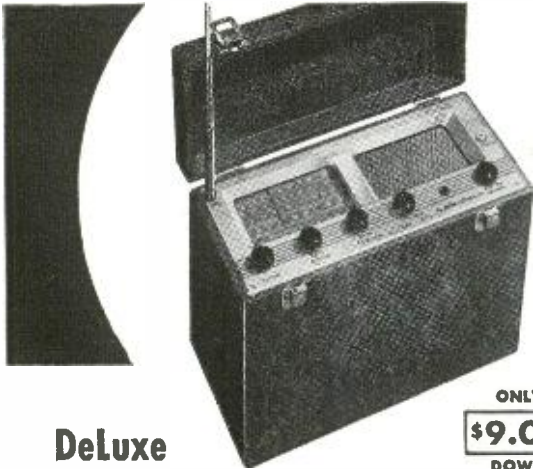

**DeLuxe
S-72 All-Wave Portable**

ONLY
\$9.00
DOWN

The DeLuxe portable! Covers 4 bands: 540-1600 kc, 1500-4400 kc, 4.3-13 mc, and 12-31 mc. Has built-in loop for standard broadcast and 61" whip for short wave. Automatic Noise Limiter; sensitivity control; AVC; BFO: main and fine tuning controls; tone control; phone jack. Brown leatherette-covered cabinet, 14 x 12 1/4 x 7 1/4". For 105-125 volts DC, or 60 cycles AC, or self-contained battery. Complete with tubes, less battery. Shpg. wt., 16 lbs. **\$89.95**

- 97-505. S-72 Portable. Only
- \$9.00 down, \$7.15 monthly for 12 months*
- S-72L. Portable. As above, but with 175-400 kc long-wave band in place of 12-31 mc band.
- 97-507. Only **\$99.95**
- \$10.00 down, \$7.95 monthly for 12 months*
- 80-585. Battery Pack. Only **\$3.85**



ONLY
\$7.00
DOWN

S-53A Communications Receiver

It's a super-value! It's sensitive, powerful, completely dependable! Tunes 5 bands, ranging from 540 kc to 54 1/2 mc—includes 6 Amateur bands, Police, Aircraft and other services, as well as standard broadcast. Features include: slide-rail dial; electrical bandspread; latest series type noise limiter circuit; voltage-stabilized oscillator; iron-core IF'S; tone control; built-in PM dynamic speaker. Handsomely housed in rich satin-black and satin-chrome trim steel cabinet. Complete with 7 tubes and rectifier. **\$69.95**

- 97-573. S-53A Receiver. Only
- \$7.00 down, \$5.66 monthly for 12 months*

**it's ALLIED for
hallicrafters!**



ONLY **\$17.95** DOWN

SX-71 Communications Receiver

A top-performing communications receiver at amazingly moderate cost! Covers five full bands: 538-1650 kc; 1600-4800 kc; 4.6-13.5 mc; 12.5-35 mc; 46-56 mc. Features double conversion superhet circuit, high image rejection, razor-sharp selectivity, extremely high sensitivity. Includes: full electrical bandspread; tuned RF stage, 3-step crystal filter; built-in NBFM adapter; automatic noise limiter; calibrated "S" meter; BFO pitch; tone control; extra-wide-vision dials; 3-watt communications-peaked audio; temperature compensation; universal antenna input. In satin-black steel cabinet; 18 1/2 x 7 3/8 x 12". Complete with 11 tubes, rectifier and regulator. For 105-125 volts, 50-60 cycles. Shpg. wt., 33 lbs. **\$179.50**

- 97-506. SX-71, less speaker. Only
- \$17.95 down, \$14.27 monthly for 12 months*
- 97-787. R-46 matching speaker. 19 lbs. **\$16.95**

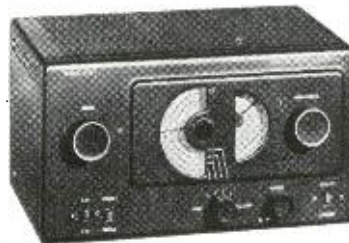

**Popular S-38B
Super-Value
All-Wave Receiver**

The all-star, all-wave value that amazes even the experts. Covers 4 full wave bands, continuous range from 540 kc to 32 mc. Features: full electrical bandspread; Band Selector; Voice-Code switch; Speaker-headphones switch; Standby-receive switch, latest PM speaker. In handsome furniture-steel cabinet, 12 3/4 x 7 3/8 x 7 1/4". Complete with all tubes. For 105-125 volts DC, or 40-60 cycles AC. Shpg. wt., 15 lbs. **\$39.95**

- 97-508. Model S-38B Receiver. Only

NEW ALLIED SUPPLEMENT

Send for ALLIED'S latest Supplement! Packed with new TV releases, recorders, Hi-Fi Music and P. A. Systems, new electronic developments—plus hundreds of big values. Write today for your copy of the FREE ALLIED Catalog Supplement.

ALLIED RADIO

ALLIED RADIO CORP.,
833 W. Jackson Blvd., Chicago, 7, Ill., Dept. 2-H-O

- Send FREE ALLIED Catalog Supplement
- Enter order for Hallicrafters Model
- Enclosed \$ Full Payment
- Part Payment (Bal. C.O.D.)
- Send Time Payment details and order blank.

Name

Address

City Zone State

Anyone
**Can build a
HEATHKIT**

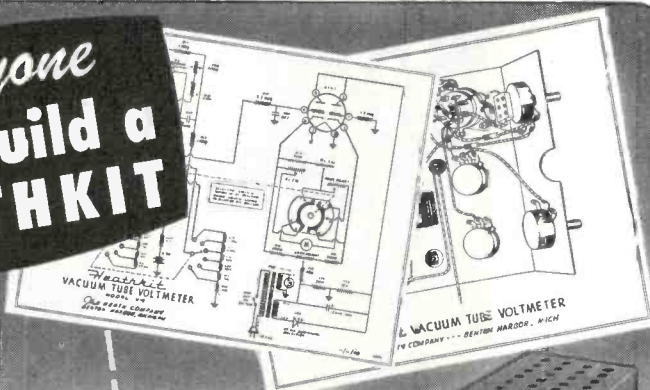

Heathkit
**SIGNAL
TRACER KIT**
\$19.50



Heathkit
**VACUUM TUBE
VOLT METER KIT**
\$24.50



Heathkit
TUBE CHECKER KIT
\$29.50



Heathkit
**BATTERY
ELIMINATOR KIT**
\$22.50



Heathkit
**CONDENSER
CHECKER KIT** \$19.50

Heathkits are beautiful factory engineered quality service instruments supplied unassembled. The builder not only saves the assembly labor cost but learns a great deal about the construction and features of the instrument. This knowledge aids materially in the use and maintenance of the equipment. Heathkits are ideal for and used by leading universities and schools throughout the United States. Each kit is complete with cabinet, 110V 60 cycle transformer (except Handitester), all tubes, coils assembled and calibrated, panel all ready printed, chassis all punched, formed and plated, every part supplied. Each kit is provided with detailed instruction manual for assembly and use. Heathkits provide the perfect solution to the problem of affording complete service equipment on a limited budget. The basic three instruments — an Oscilloscope, Vacuum Tube Voltmeter, and Signal Generator can be purchased in Heathkits for \$83.50, about the cost of a factory-built TVM alone. Write for complete catalog.



Heathkit
**AUDIO GEN.
KIT \$34.50**



Heathkit
**ELECTRONIC
SWITCH KIT**
\$34.50

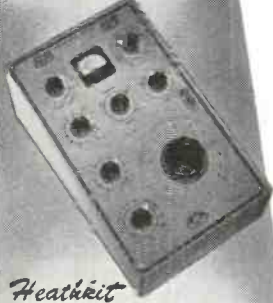

Heathkit
**IMPEDANCE
BRIDGE KIT** \$69.50

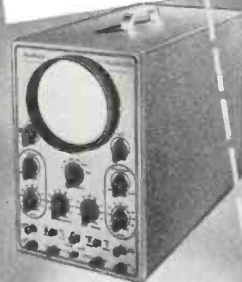

Heathkit
**5" OSCILLOSCOPE
KIT**
\$39.50



Heathkit
**TELEVISION
GEN. KIT . . .**
\$39.50



Heathkit
**R. F. SIGNAL
GEN. KIT . . .**
\$19.50



Heathkit
**HANDITESTER
KIT \$13.50**

HEATH COMPANY
BENTON HARBOR 20,
MICHIGAN

EXPORT DEPT. 13 E. 40th ST., NEW YORK 16, N.Y. . . . CABLE ARLAB - N.Y.

51% were 14 inches or larger and 99% were 12 inches or larger. The RMA stated that total receiver manufacture reported by members for the first four months of 1950 was 1,647,956 TV receivers, 2,373,012 home radios, and 900,646 auto radios. . . . Hoffman Radio Corp. is now occupying its new Plant No. 5 in Los Angeles.

Financial Notes

Sylvania Electric Products declared a 35¢ dividend on common stock and \$1 on preferred.

Sprague Electric Co. announced a 20% boost in its dividend rate. Latest quarterly dividend is 30¢ on common stock.

Cornell-Dubilier Electric Corp. declared dividends of 20¢ per share on common stock and \$1.31¼ on preferred.

General Electric Co. announced a 60¢ dividend payable July 25.

Hazeltine Corp. issued a 25¢ dividend on common stock.

Noblitt-Sparks Industries Inc. paid a 50% stock dividend—one share for each two held—and a 50¢ cash dividend on common stock.

Stewart-Warner Corp. announced a 25¢ quarterly dividend on common stock.

Philco Corp.'s regular quarterly dividends amounted to 50¢ per share on common stock and 93¾¢ on preferred.

Stromberg-Carlson Co. paid a quarterly dividend of 50¢ on preferred stock.

Emerson Radio & Phonograph Corp. stockholders voted an increase in the authorized number of capital shares from 1,000,000 to 3,000,000. This increases outstanding shares from 879,805 to 1,759,610 and leaves 1,240,390 authorized but unissued shares.

Business Briefs

Astron Corp., East Newark, N. J., which makes metallized paper capacitors, will introduce a complete line of electrolytics and molded paper capacitors. . . . Remington Rand, Inc., has sold the television picture tube division of its advanced research laboratory to the Reeves Soundcraft Corp. . . . Motorola, Inc., has transferred a record \$1,654,120.03 to its Employees' Savings and Profit Sharing Fund. . . . Television Engineering Corp., a Westfield, N. J., service contractor, announced a new pay-as-you-go television service contract plan by which the set owner pays \$5 for a one-year registration and then for service only as needed—not to exceed a fixed sum. . . . JFD Manufacturing Co., Inc., has established new terms of payment for its distributors. . . . R. C. Sprague, chairman of the RMA Town Meetings Committee, announced the appointment of committees to supervise the production of four sound slide films to step up radio and TV dealers' management and sales methods. Films will be shown in 60 cities from coast to coast during August and September under the sponsorship of at least 16 radio and TV manufacturers and their local distributors. . . . An estimated 40,000 to 50,000 TV receivers will be produced in Canada in 1950, according to RCA Victor, Montreal.

Become an Electrical Engineer



Major in Electronics



B.S. Degree in 36 Months



Prepare Here for Specific Career-Objectives

Your success in the expanding, fascinating field of Electronics will be influenced materially by the type of educational program you choose.

Important advantages are gained at this Technical Institute and College of Electrical Engineering. For example, you achieve the Technician's occupational certificate upon completion of your first level of study toward a B.S. degree. The comprehensive nature of the courses gives you other special advantages in securing positions such as are listed below:

Major in Electronics
B. S. Degree
(36 successive months of study which include the 12-month Electronic Technician program)

Typical job objectives:
Design Engineer
Electronics Research Engineer
Radio Engineer
Sound Engineer
Application Engineer
Field Engineer
Patent Attorney (with additional training in law)
Salesman of Electronic Equipment
Manufacturing Supervisor
Communications Engineer
Industrial Electronics Engineer
Television Engineer

Electronic Technician
(12 months of objective study which also completes a third of the program leading to the B.S. degree)

Typical job objectives:
Laboratory Technician
Electrical Tester (radio mfg.)
Maintenance and Repair Technician
Contractor
Manufacturing Supervisor
Salesman of Electronic Equipment

Radio-Television Technician
(18 months of study)

Typical job objectives:
Radio-Television Serviceman
Audio, Transmitter or Communication Technician.
Broadcast Operator (upon passing FCC examinations)



A VALUABLE FEATURE of this educational program is the manner in which LABORATORY experience is woven into each successive term to assure a thorough, practical background. You receive electrical practice and technical studies immediately. You train with modern equipment such as you will use after graduation.

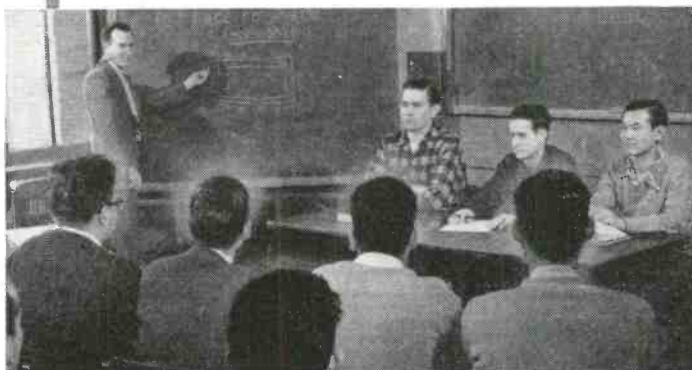

"HUMAN ENGINEERING" is essential to the full success of tomorrow's technical man. Therefore, courses also include combinations of English, Economics, Engineering Law, Industrial Psychology, Speech and other Humanities.

THIS world-famous course in Electronics presents thorough technical training plus a solid education in the basic sciences, electrical engineering and allied fields. You have an opportunity to save a valuable year by using the option to study the year-round. Thus, you earn your B.S. degree in 36 months.

MILWAUKEE SCHOOL of ENGINEERING

Technical Institute • College of Electrical Engineering

- The 1,555 students enrolled in this 47-year-old school represent 48 states and 23 countries. Over 35,000 alumni. Terms open Oct., Jan., April, July.
- Military, practical or prior academic training will be evaluated for advanced credit. Preparatory and refresher courses are also available.



Write or send coupon today for the helpful 44-page pictorial bulletin, "Your Career," and the 110-page catalog.

MILWAUKEE SCHOOL OF ENGINEERING
Dept. RE-850
1020 N. Broadway, Milwaukee, Wis.

Without obligation send the 44-page "Your Career" bulletin and 110-page catalog.

(Check 6 to 36-month courses which interest you)

Electrical Engineering: Electronics
 Electrical Power
 Radio-Television Heating Refrigeration
 Air Conditioning Electricity Welding

Name Age.....

Address

City Zone..... State.....

Check if World War II Veteran

Six Months from Today Which will YOU hold?

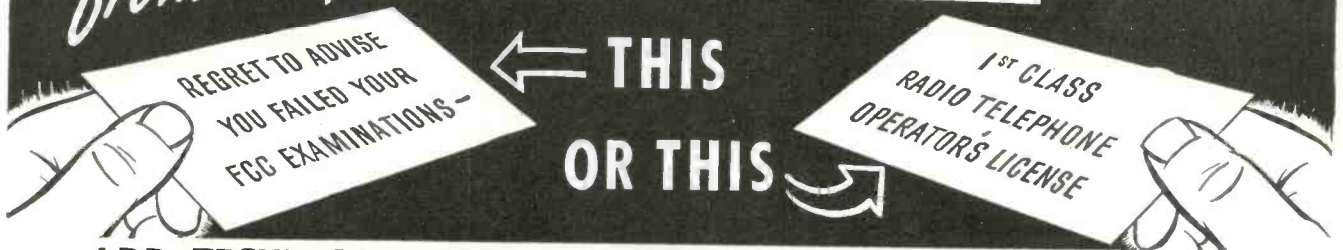

ADD TECHNICAL TRAINING TO YOUR PRACTICAL EXPERIENCE

GET YOUR FCC LICENSE IN A HURRY!

THEN—Use Our Amazingly Effective JOB-FINDING Service.

Get this Valuable Booklet **FREE**



TELLS HOW —

WE GUARANTEE
TO TRAIN AND COACH YOU AT HOME
IN SPARE TIME UNTIL YOU GET
YOUR FCC LICENSE

If you have had any practical experience—Amateur, Army, Navy, Radio repair, or experimenting.

TELLS HOW —

Employers make
JOB OFFERS Like These
to Our Graduates Every Month

Telegram, April 7, 1950 from Chief Engineer, Broadcast Station, Pa. "Immediate opening for engineer. Automobile and First Phone a must. If graduate available please forward name and address."

Letter, April 14, 1950 from Chief Engineer, Broadcast Station, Montana. "Immediate opening for Engineer-Announcer, basic salary \$62.50 . . . real future for right man."

Letter, January 30, 1950 from Chief Engineer, Broadcast Station, Tenn. "Have openings for operators. If you have men, please have them contact us."

These are just a few examples of the job offers that come to our office periodically. Some licensed radiomen filled each of these jobs . . . it might have been you!

HERE'S PROOF FCC LICENSES ARE OFTEN SECURED IN A FEW HOURS OF STUDY With OUR Coaching AT HOME in Spare Time.

Name and Address	License	Hrs. of Training
James A. Gram 11 West Main St., Cuba, New York	1st class, telephone	34
Ernest K. Hodson Box 1001, Caldwell, Idaho	1st class, telephone	71
Howard J. Kischassey Rt. 2, Box 736, El Cajon, California	2nd class, telephone	49
Ralph I. Nichols 510 Elm St., Kerrville, Texas	1st class, telephone	34
Eibert L. Risinger P.O. Box 122, Bedias, Texas	1st class, telephone	34
Harry R. Rogers R.R. 6, Lafayette, Ind.	2nd class, telegraph	50
	2nd class, telephone	

CLEVELAND INSTITUTE OF RADIO ELECTRONICS
Desk RE-20, 4900 Euclid Bldg., Cleveland 3, Ohio
Approved for Veteran Training Under G.I. Bill

TELLS HOW —

Our Amazingly Effective
JOB-FINDING SERVICE
Helps CIRE Students Get Better Jobs

Here are a few recent examples of Job-Finding results:

GETS JOB WITH CAA

"I have had a half dozen or so offers since I mailed some fifty of the two hundred employment applications your school forwarded me. I accepted a position with the Civil Aeronautics Administration as a Maintenance Technician. Thank you very much for the fine cooperation and help your organization has given me in finding a job in the radio field."

Dale E. Young, 122 Robbins St., Owosso, Mich.

GETS JOB IN PUBLIC UTILITIES

"I have secured the position of Radio Technician with the Toledo Edison Company. I want to thank you once more. The help you gave me was much more than would ordinarily be expected—both in obtaining my license and in finding employment."

Norman W. Stokes, Jr., Rt. 11, Box 612, Toledo 7, Ohio

GETS JOB AS DEVELOPMENT ENGINEER

"I wish to express my thanks for the Applications-For-Employment you recently prepared for me. I received 3 telephone calls and one letter. As a result I am now employed in a development engineering capacity."

K. E. Forsberg, 26 Soley St., Charlestown, Mass.

GETS JOB IN BROADCASTING

"I have accepted a position with KWAD. I secured this position through the help of your Job-Finding Service and I had at least six other offers. I am sincerely under obligation to you."

Fred W. Kincaid, Box 241, Wadena, Minn.

Your FCC Ticket is always recognized in all radio fields as proof of your technical ability

OURS IS THE ONLY HOME STUDY COURSE WHICH SUPPLIES FCC-TYPE EXAMINATIONS WITH ALL LESSONS AND FINAL TESTS.



Get All 3 FREE
MAIL COUPON NOW

CLEVELAND INSTITUTE OF RADIO ELECTRONICS
Desk RE-20—4900 Euclid Bldg., Cleveland 3, Ohio
(Address to Desk No. to avoid delay)
Approved For Veteran Training Under G.I. Bill

I want to know how I can get my FCC ticket in a minimum of time. Send me your **FREE** booklet, "How to Pass FCC License Examinations" (does not cover exams for Amateur License), as well as a sample FCC-type exam and the valuable new booklet, "Money-Making FCC License Information."

NAME _____
ADDRESS _____
CITY _____ ZONE _____ STATE _____

Veterans check for enrollment information under G. I. Bill

RADIO-ELECTRONICS for

Television Problems

. . . *The rapid growth of television constantly brings new problems* . . .

By HUGO GERNSBACH

THE rapidly growing television art is and will continue in constant flux for a number of years to come. In the meanwhile, new problems constantly occur; these must be solved to keep abreast with television and the constant pressure and demand by the public.

One of the bad problems in our larger cities and suburbs is the inter-receiver interference between neighboring sets. Each television receiver is a miniature transmitter in itself and if aerials or sets are close together and if several receivers are on simultaneously, interference can take place. For example, the frequency of the local oscillator in some receivers tuned to Channel 2 is located squarely on Channel 5. All neighboring receivers tuned to Channel 5 will thus suffer interference. This interference manifests itself in various annoying patterns on the screens of all the receivers thus affected. The condition often becomes so annoying that it is almost impossible to follow the action on the screen. At times such interference is so strong that everything is completely blurred. Because the non-technical public does not know where the interference originates many people jump to the conclusion that there is something wrong with the receiver itself. The upshot is a call to the service technician. Thousands of such calls are made routinely nowadays. This makes inter-receiver interference a serious problem to the servicing industry, which finds it difficult—often impossible—to eliminate the trouble.

We have noted as many as 26 television antennas on a single apartment house roof. Some of these antennas are so close together that they almost touch. It also follows that the closer the aerials approach to each other, the greater the interference. Furthermore some receivers will cause interference over several hundred yards.

Inter-receiver interference also exists even if there is no roof aerial, when only indoor antennas are used. There are also many instances where television sets are close together as in apartment houses (as well as in other houses), where there may be a television set on one floor with another set on the floor above or below, or one on the opposite side of a wall on the same floor. Very often the separation of the sets is only six to ten feet or even less—in other words close enough to cause inter-receiver interference.

Some set manufacturers are belatedly waking up to this situation and improving their product. Several new front-end units which will be incorporated in next fall's sets have greatly reduced oscillator radiation. And it is only fair to say that not all present-day sets cause interference of this type. The problem has also been under serious consideration by the FCC.

In the meanwhile, what is needed is some reasonable-priced interference eliminator that will do the work and do it satisfactorily.

If such a device can be manufactured at a sufficiently low price it might become standard practice to install one when a new set is installed, at least until such time that non-radiating TV receivers are on the market.

Such a device would certainly greatly help the serv-

icing industry. It would save untold thousands of dollars on useless calls, which service technicians have to make today.

How close are we to overseas and international television? The normal range of our present-day television transmitters is about 50 miles. The only long distance transmission means of today is by television networks, as is well-known.

But other means are in the offing. Early last June Brig. General David Sarnoff, Chairman of the Board of the Radio Corporation of America, when he was awarded the Grand Medal of the *Association des Ingenieurs-Docteurs de France* for his war and peace services, made the following significant announcement:

"International television is not far off. The scientific principles for linking the hemispheres by television already are known. The continued growth of this new art will some day make it possible to see as well as hear around the world.

"When this time comes, New York will look in on Paris and Paris will look in on New York. In fact, the peoples of all nations—large and small—will be able to see and hear each other directly and to understand each other better."

Coming from such a high informed source, we must listen respectfully and take it for granted that long distance television indeed is not far off.

It is reasonable to suppose that the radio-controlled television robot airplane, which the writer first projected in the November 1924 issue of the *EXPERIMENTER* magazine will then also become a reality, particularly for military use. While practical today, its range is limited to the horizon, but with long distance television such a plane could be conducted safely over thousands of miles because its dispatchers could watch the plane as it flies over strange territory. For war purposes, without any human being on board, such a plane would have tremendous military advantages.

Another pressing problem today is that our television sets are "one sided." Unlike radio (where you can sit in any part of the room and listen to your set) a television receiver can be watched from one direction only. Four- or six-way television which would permit the receiver to be placed in the center of the room where onlookers could see it *from every point of the compass* so far has not materialized, although it is technically feasible today. The writer projected such a receiver in the August 1935 issue of *RADIO-CRAFT*.

Today—with a projection television tube mounted vertically instead of horizontally and using a simple optical system of mirrors and lenses—it should be possible to construct a television receiver with four or six screens mounted vertically on top of the receiver. The single television cathode-ray tube would serve the multiple screens in such a way that all screens would carry the same image. Then, instead of grouping the viewers in one direction only, the television audience could enjoy the program seated anywhere in the room.

The cost of doing this should not come too high. The public will welcome such a TV receiver once it is introduced.

Low-Voltage Supplies With No Transformers

Cost and weight reduction make the transformerless low-voltage supplies increasingly popular in modern television receivers

By H. G. CISIN

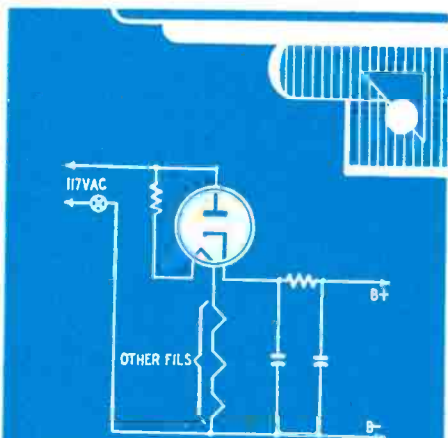

Fig. 1—The basic transformerless power supply as used in a.c.-d.c. receivers.

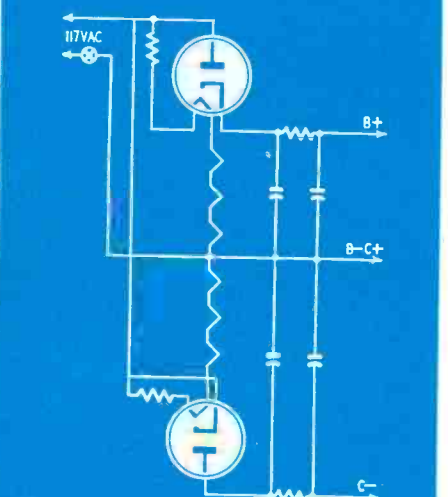

Fig. 2—An additional supply, with tube reversed, supplies a negative voltage.

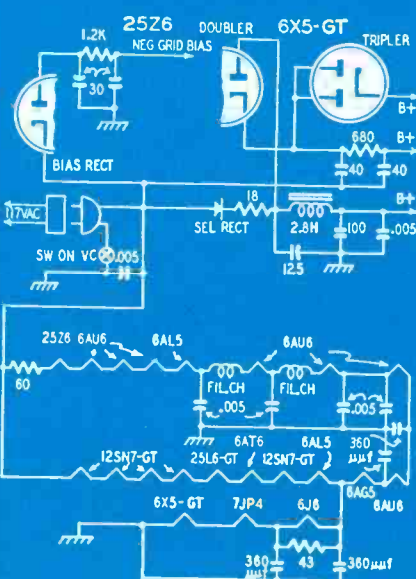

Fig. 3—This Teletone TV149 power supply is typical of the transformerless type.

ELIMINATION of the low-voltage power supply transformer permits considerable reduction in the cost of a television receiver. Hence designers have been investigating the possibilities of transformerless low-voltage supplies. Several manufacturers have used power supplies of this type, not only to reduce costs, but also to obtain lighter and more compact receivers.

The working principle of the transformerless power supply is illustrated in Fig. 1. Invented by the writer in 1932 (U.S. Patent 2,086,256), this circuit since that time has been used in millions of a.c.-d.c. midget radio sets. It consists of a half-wave rectifier with its anode connected to one side of the source and its cathode connected to the input of a filter. This unit provides rectified and filtered d.c. suitable for operating vacuum tubes. Tube heaters in this circuit are connected in series across the unfiltered a.c. source.

This basic circuit has been applied with only slight modifications to a number of low-voltage power supply circuits in television receivers. Some such circuits use cascade voltage doubling and, in some cases, voltage tripling, obtained by additional rectifiers and electrolytic capacitors.

One of the problems of the transformerless power supply circuit is obtaining a suitable negative bias supply. If a power supply transformer is used, it is a simple matter to connect a tapped resistance between the center tap of the transformer and ground to provide bias potentials.

A method of providing negative bias in a television transformerless circuit was patented by the writer several years ago (U.S. Patent 2,317,178). Fig. 2 shows how this is done. Two supplies like that of Fig. 1 are used back-to-back with a common B-minus and C-plus lead, but the positions of the

anode and cathode of the bias supply are reversed. Since electrons can flow only from cathode to anode, the current in the bias supply is opposite in direction to that in the B-supply and the bias voltage is negative rather than positive.

A common ground, one a.c. plug, and one off-on switch is needed. This is then a transformerless power supply which provides d.c. plate and screen voltages as well as negative grid bias voltages.

The commercial application of Fig. 2 is shown in Fig. 3, the low-voltage power supply of the Teletone model TV 149 television receiver. In this receiver, one of the diodes of a 25Z6 is used as the bias rectifier. One of the B-plus potentials is obtained from the portion of the circuit which uses a selenium rectifier. A higher B-plus voltage is supplied by using the other half of the 25Z6 as a doubler. Still higher potentials are obtained by using a 6X5GT/G as a tripler.

The heaters are connected in series in two parallel branches, except that total heater current flows through the heaters of the 6X5GT, 7JP4, and 6J6. Since the 6J6 draws less heater current than the other two, a 43-ohm shunt must be connected in parallel with it. One of the series branches has a 60-ohm voltage dropping resistor. Low-pass filters in the heater circuits of television receivers are used to keep high frequencies from entering the receiver via the power supply. The r.f. chokes generally have an inductance of a few microhenries.

Sets which use this type of supply range all the way from the Pilot TV-37 which has electrostatic deflection and a 3-inch picture tube to the General Electric 805-821 series which has electromagnetic deflection and a 12-inch tube.

Fig. 4 shows a typical low-voltage

transformerless power supply, as used in the General Electric models. This circuit has selenium rectifiers instead of the more conventional vacuum-tube rectifiers. Cascade voltage doubling is used.

Note that the bar of the symbol denoting the selenium rectifier is the cathode, while the black triangle represents the anode. The plus sign on the symbol represents the plus sign on the rectifier case.

When the a.c. polarity is such that current flows from cathode to anode in rectifier 2, the two parallel 150- μ f capacitors charge with the polarity indicated. When the a.c. polarity reverses, these capacitors discharge through rectifier 1 and the load to provide 250 volts at the output of rectifier 1 under normal load conditions.

The voltage at the output of the filter is 200 volts, further reductions being obtained either by series resistors or voltage dividers. The tap between the two series filter capacitors supplies bias for the C-R and voltage for a video amplifier plate. It is a tap on a "bleeder" formed by circuits in the receiver.

The tube heaters are arranged in series with suitable limiting resistors and r.f. chokes. The series strings are connected in two parallel branches combined at one end to permit total current to pass through the 12KP4 tube.

The Motorola models VT71, VT73, and VT73A use a low-voltage power supply similar in most respects to the General Electric design. The Silver-tone model 8130 also has selenium rectifiers in a voltage doubler arrangement, but this circuit differs in the connections of the vacuum-tube heaters. Only three tubes are connected in the conventional transformerless series arrangement, the other heaters being energized by a special filament transformer having two separate 6.3-volt windings.

The Stewart-Warner AVC1, AVC2, and AVT1 television receivers are of the a.c.-d.c. transformerless type. They use selenium rectifiers for a.c. operation and a polarizing relay for removing the rectifiers from the circuit when the set is plugged into a d.c. source. Truetone model D2985 television set is also an a.c.-d.c. receiver with a ballast tube and selenium rectifiers. Truetone's D1990 and D2987 and Raytheon's A-100X24, etc., are similar in design to the Stewart-Warner models, using a

polarized relay for a.c.-d.c. operation. The entire circuit diagrams of these Stewart-Warner, Truetone, and Raytheon sets resemble each other closely.

Emerson models 571, 606, 611, 612, 619, 620, 624, and 627 are of the low-voltage transformerless power supply type. These are available either with selenium rectifiers or with 25Z6 vacuum-tube rectifiers. Fig. 5 shows the low-voltage power supply of the models with selenium rectifiers. Voltage doubling is used both for the B-plus supply and the negative grid bias supply. This requires four selenium rectifiers. A filament transformer is used for supplying the heater current to the tubes in this receiver.

This circuit makes novel use of a ballast tube for shunting the 10-ohm protective resistors and the 75-ohm filter resistors with resistances of equal value. Unusual current surges will cause the ballast resistors to open instead of damaging more expensive components such as the selenium rectifiers or electrolytic capacitors. The ballast tube is relatively inexpensive and readily replaced. When one of these Emerson units stops working completely, the ballast tube is the first place to look for trouble.

Fig. 6 is a diagram of the same Emerson models' low-voltage power supply, except that 25Z6 rectifier tubes have been substituted for the selenium rectifiers. Voltage doubling is used as in the previously described circuit. In the branch which supplies the B-plus potentials, three diodes are connected in parallel to supply sufficient rectified current, which in this case is about 0.215 amp. In the negative grid bias branch, two diodes are paralleled since this branch supplies only 0.136 amp. The ballast tube and the filament transformer are used in the same way as in the sets using selenium rectifiers and have not been redrawn in Fig. 6.

One of the most recent trends in television is to supply large-screen picture tubes which require accelerating potentials up to 25 or 30 kilovolts. In the early days of television such high voltages meant bigger and more costly power transformers. Since the development of the r.f. oscillator-rectifier high-voltage supplies, horizontal flyback supplies, and pulse-type high-voltage systems, combined with doublers and triplers, voltages in excess of 30 kilovolts may be obtained at lower cost than was formerly required to get 3 or 4 kilovolts.

Such transformerless supplies, both high and low voltage, have been an important factor in reducing costs not only because they eliminate the relatively expensive iron-core transformer, but also reduce the size of the cabinet required to house the set.

Merely eliminating such components as resistors, coils, sockets, etc. does not in itself mean reduced costs because these items, when purchased in quantity, are insignificant when compared to the cost of cabinet, picture tube, labor, and overhead. It is more important that the circuit be made simpler to reduce labor cost not only for assembling and wiring, but also for testing, alignment, and troubleshooting; and smaller to reduce the cost of expensive cabinets. Competition is so intense in the television receiver field that manufacturers are making every possible effort to reduce production costs.

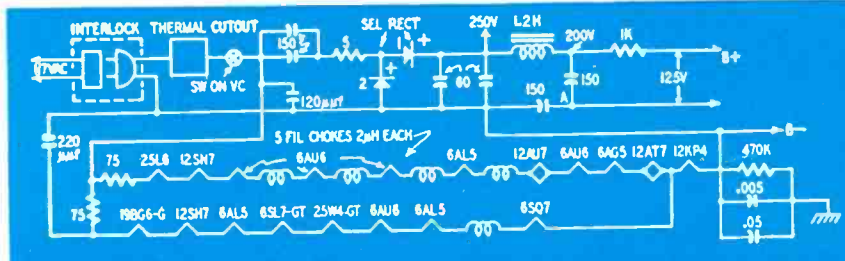

Fig. 4—Selenium rectifiers are used in a number of television receivers. This cascade voltage doubling circuit is typical of several General Electric models.

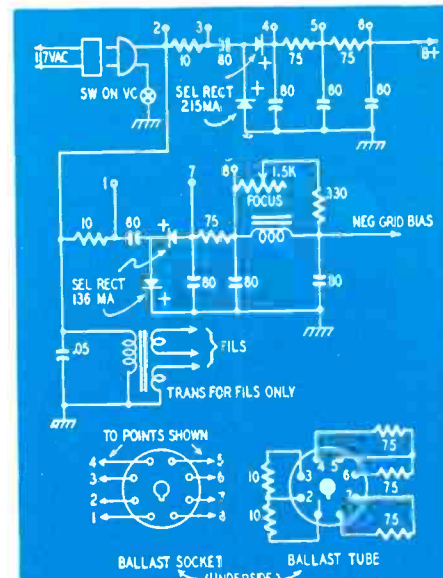

Fig. 5—The Emerson low-voltage supply. The ballast tube is a safety device.

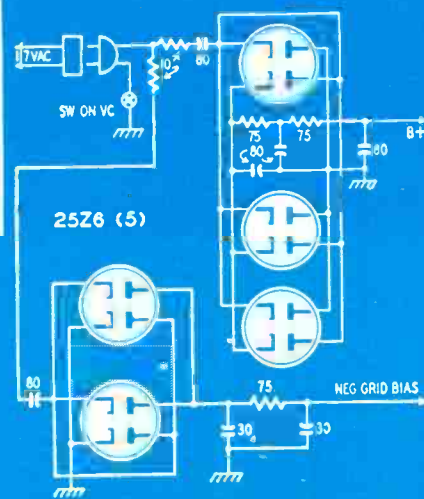
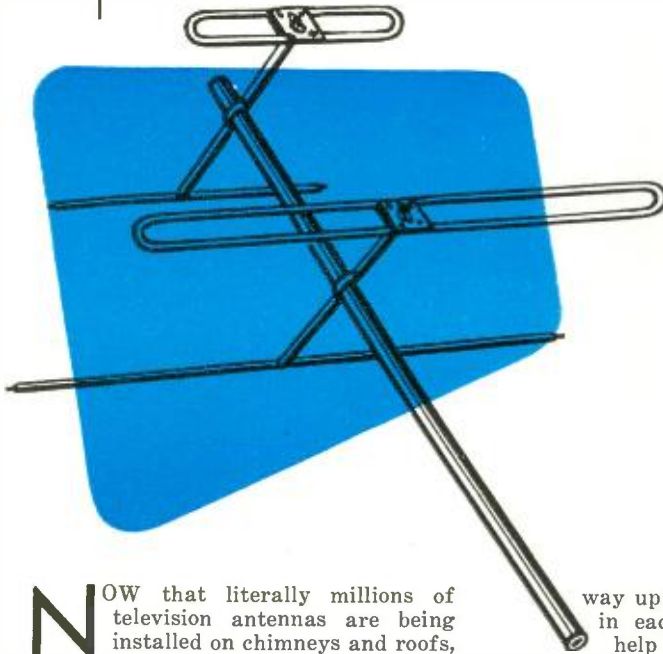

Fig. 6—This Emerson power supply uses tubes rather than selenium rectifiers.

Practical Methods For Trouble-Free Antenna Erection

By H. WINFIELD SECOR



NOW that literally millions of television antennas are being installed on chimneys and roofs, the practical problems of erecting these antennas properly have become important. Fig. 1 shows three common methods of installing rooftop antennas. Two major troubles of the average TV set owner—whether he has installed his own antenna or had it erected by the local service technician—are severe swaying of antenna and mast in high winds, and an annoying hum caused by the wind vibrating the tubular members of the antenna. Many TV antennas are fastened to chimneys, with or without guy wires to prevent their swaying in the wind. If the mast is over 10 feet high, it is advisable to install guy cables. The guy cables ($\frac{1}{8}$ -inch diameter stranded steel or other cable may be used for low masts, although $\frac{1}{4}$ -inch cable is preferable) are best anchored by clamps about two-thirds of the way up the mast.

If the mast is 20 feet or more in height, two sets of guy cables should be installed, anchoring the first set about $\frac{1}{3}$ and the second set $\frac{2}{3}$ of the

way up the mast. Turnbuckles in each cable are useful to help tighten them.

Much of the humming noise heard when these TV antennas vibrate in a high wind will be reduced by proper guying, not to mention the reduced strain on the mounting clamps and the chimney or other support on which the antenna mast is mounted. We have seen many relatively high TV masts anchored on a small brick chimney *with no guys at all!* How long it will take to rip the mast loose, tear bricks out of the chimney, or even bring the whole chimney down during a strong blow is anybody's guess. This is not only a menace to the chimney or roof, but there is also the danger that a falling brick, or the antenna itself, may injure someone.

Many TV installations work fine for the first six months or so and then suddenly develop trouble. A recent case of this kind where the image was jumping badly was traced to a sloppy antenna installation. Strong winds had loosened the antenna elements and the lead connections. When the elements were tightened, reception cleared up

and the image was steady again. Part of the trouble here was due to the lack of guy cables to hold the mast steady.

Another cause of trouble is the use of iron or plated iron screws and nuts on the antenna to fasten the ribbon lead terminals in place. Brass screws and nuts are best, and it is a good idea to cover the connections with tape to protect them from the weather.

If the mast is to rest on the roof install it on a substantial metal or wooden base support to protect the

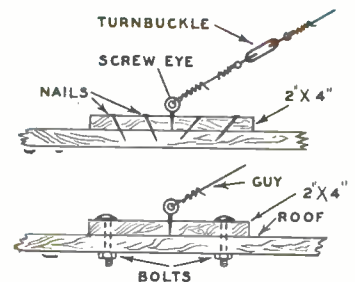

Fig. 2—Fasten guys firmly to the roof.

roof. For best results ground the mast. When guy cables are used, their lower ends can be anchored to pieces of 2 x 4-inch joists, fitted with large screw-eyes, as shown in Fig. 2. Nail the

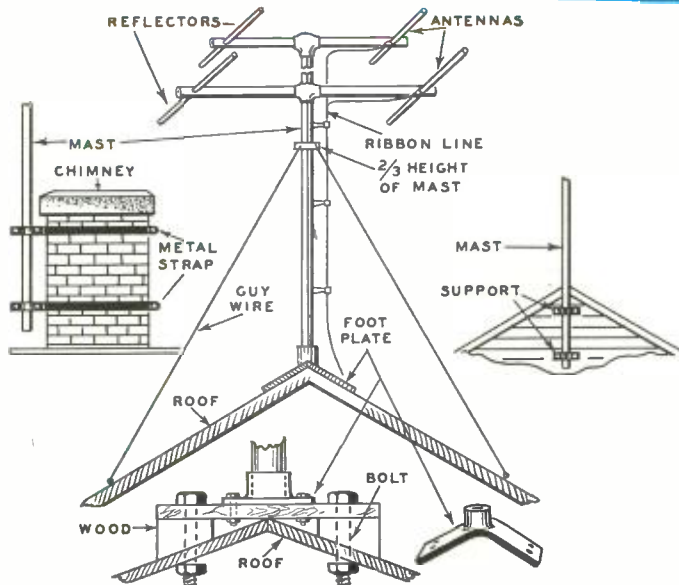

Fig. 1—Three common ways of mounting TV antennas on a rooftop.

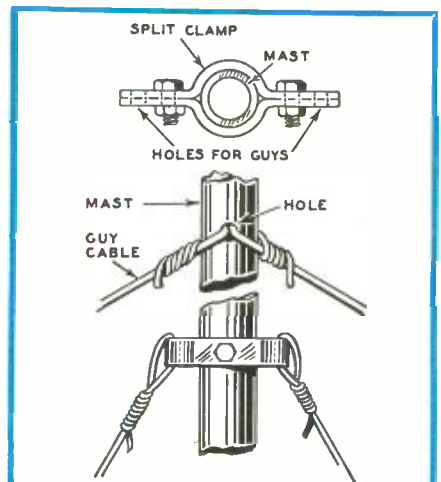

Fig. 3—How to secure the guys to mast.

pieces of joist near the outer edge of the roof to prevent leaks later. Sometimes it is possible to drill holes through the overhanging rafters,

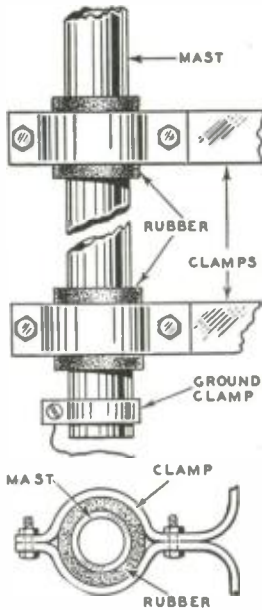

Fig. 4—Annoying hum is eliminated by mounting the mast in rubber supports.

through which the guy cables can be anchored. The guys must be securely attached to the mast. Ways of doing this are suggested in Fig. 3.

One of the most annoying troubles with TV antennas is a loud humming when the wind is high. The first step to reduce this humming is to guy the mast properly. Next the ends of the tubular members of the antenna should be plugged or capped so that the wind blowing through (or across) the tubes will not cause them to act as "whistles" or resonant tubes, which vibrate at a startling rate. The tubular mast also

must be plugged or capped at top and bottom to eliminate this whistle or singing effect. Filling the tubes with sawdust or even sand helps in stubborn cases.

Further, the base of the mast may have to be mounted in thick rubber to prevent the vibrations from being transmitted down the chimney. In one case the humming was so strong that even the steam and water pipes vibrated every time the wind was strong. The noise even interfered with the family's sleep. The trouble was finally solved by mounting the base of the mast in thick rubber liners placed inside the supporting clamps. (See Fig. 4.) The rubber may be placed inside the clamping straps fastened around the chimney or other support if preferred.

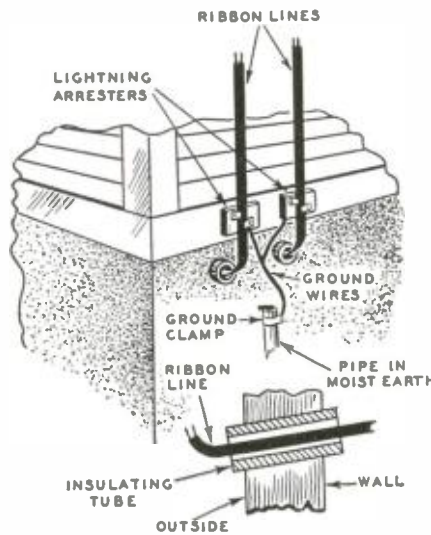

Fig. 6—Use an insulating tube to pass the ribbon line through an outer wall.

Twin-leads are often left free to flap about in the wind. This is another source of trouble. The twin-lead should be fastened in insulators made for the purpose and anchored down along the house wall and the antenna mast as well. Where separate twin-leads are used for the high-low-frequency antennas, separate the leads at least 5 to 6 inches.

Fig. 5 shows a few suggestions for installing lead-in wires.

Where the twin-lead passes through a wall an insulating tube should be used as indicated in Fig. 6. It is preferable to mount lightning arresters outside the building and run a ground wire (no smaller than No. 10 copper wire—it may be bare wire) to a piece of pipe driven into moist earth or to the nearest water pipe. If lightning arresters are mounted inside the building, they should be placed just inside the wall where the lead wires enter and the shortest possible ground wire used to connect the arresters to the nearest water pipe.

In some installations long runs of twin lead have been placed parallel to steam or water pipes, with twin lead close to the pipe. This is undesirable as

it may change the impedance of the lead wire. In no case should the ribbon lead be closer than 6 to 8 inches to a metal pipe (including rain gutters and conductor pipes).

Most of our observations have been made about 30 miles from New York City. At this distance, a high antenna is usually considered essential but we found that an indoor antenna (even one located on the first floor of the house) gave excellent results. Another compromise which has worked very well in several cases is to place the TV antenna in the attic. This eliminates wind troubles and makes it more accessible for experiments such as changing its direction with respect to the transmitting station. Some TV owners have "fished" the twin-lead down through the wall as shown in Fig. 7. Make sure you are not running between or beside metal lath. Once the best position of the antenna has been determined, the tubular elements may be fastened to the under side of the roof rafters. With suitable insulators no mast is necessary.

While a high, outdoor TV antenna is still best in most cases, it will pay to do a little experimenting with an indoor or attic antenna. An indoor antenna in an attic may not be very effective if the roof covering is metal; the writer's experience has been with roofs covered with wooden or slate-surfaced shingles.

If your roof is of these materials, you may be agreeably surprised to find that for your location the indoor antenna will give comparable results to an outdoor antenna. An indoor antenna with telescopic arms can be purchased at a nominal price. A little experimenting with one or two of these is better than a theoretical study of the pros and cons of indoor antennas. "The proof of the pudding is in the eating."

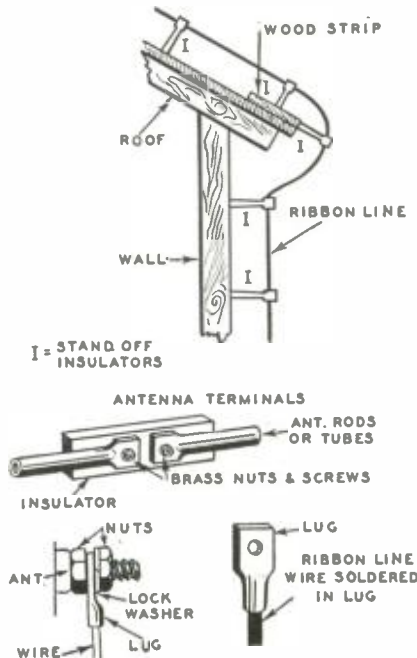

Fig. 5—Hints on installing lead-ins

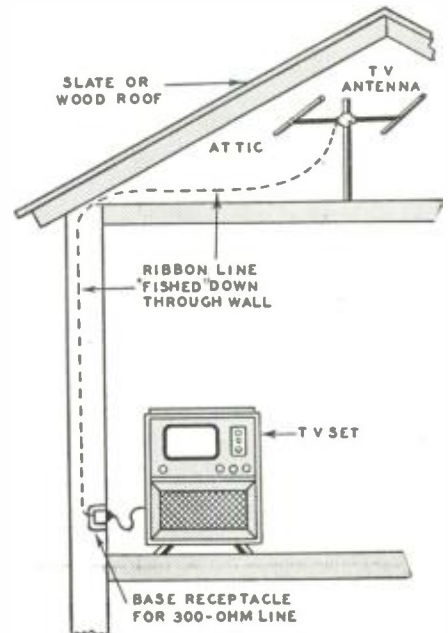

Fig. 7—With an indoor antenna, the lead-in can be fished through the wall.

D. C. Restorer Circuit Reduces TV Eye Strain

By ROBERT L. DONALDSON

A LARGE number of present and would-be television set owners have declared that "it tires my eyes to watch television for more than a short time," and "the pictures seem to jump." Their usual solution to both problems has been: "Keep the lights on in the room and it won't tire the eyes."

In running down these complaints, it became evident that what was really complained of was the usual intermittent change in average brightness of the screen from second to second and scene to scene. A few checks made with simple light-measuring equipment disclosed that, during an average telecast, the total light output from the screen varied from second to second so much so that the ratio of total light output between extremely light scenes and dark scenes was greater than 20 to 1. To make matters worse, the light output dropped to zero when no scene was being presented and during tuning.

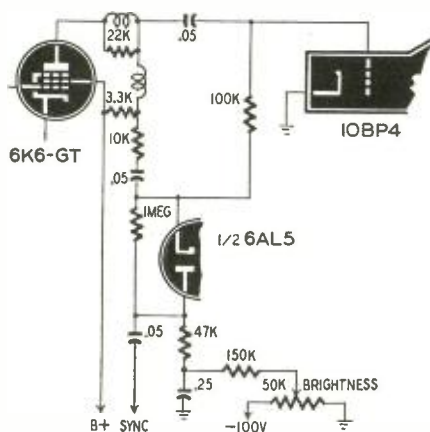

Fig. 1—Combination d.c. restorer and sync clipper as used in many TV sets.

This extreme variation in light intensity forces the iris of the viewer's eye to dilate and contract continually to counteract these variations. That is the source of the eye strain. Any doctor will verify the fact that flickering or intermittent light tires the eye very rapidly.

The common practice of leaving other lights on in the room is an attempt to wash out such extreme variations by having a constant, high light level entering the eye from other sources.

It results in less eye strain, but excessive ambient light makes the picture look weak and washed out. The blacks in the picture lose all detail, because the black presented cannot be any blacker than an unlighted screen.

Motion-picture practice has always been to darken the theater to allow a good dynamic light range on the screen, but to control the average brightness of the scenes carefully so that a fairly constant total amount of light is presented to the eyes of the audience. Movie makers and exhibitors have found out through the years that it pays to be kind to their viewers' eyes. Television receiver practice should take a leaf out of the book of movie experience.

The entire blame for this unsatisfactory performance can be laid to the d.c.-restorer circuit used in almost all television sets. The author proposes certain circuit changes to correct the condition.

Usual circuit

Many sets use the combination d.c. restorer and sync clipper diagrammed in Fig. 1. Assuming no video input to the picture-tube grid, the grid is biased negative by the brightness control to such a point that its screen current is just cut off. This bias value may be regarded as black. Since the video output polarity is positive—voltage increases in a positive direction when a white portion of the picture is being scanned—the grid is brought above cut-off to allow a flow of screen current, producing light. The sync pulses are negative in relation to the steady-state voltage, and thus are blacker than black. This relation of white, black, and blacker-than-black can be seen from the waveform of one line.

Now consider the action of the diode in the circuit. This is placed in shunt with the video load, and in series with the picture-tube grid return. It rectifies the video output and develops on its cathode a positive d.c. voltage derived from the a.c. average value of the video signal. The d.c. voltage is averaged out by the storage action of the capacitor and is applied in series with the fixed bias to the grid of the picture tube. This raises the picture-tube grid to such a positive point that the varia-

tions in voltage of the video signal are depicted on the screen as various shades of gray and the scanning retrace lines become visible.

To counteract this, the fixed bias is reset more negative by the brightness control. Thus, unless a strong video signal is present, the screen is completely black. A strong video signal containing much white is pushed even more positive by the average d.c. voltage, making the whites whiter, the blacks grayer, and the sync pulses visible. A weak video signal containing mostly dark grays and blacks cannot develop much d.c. voltage, so the whole scene is reproduced much darker than average. The sync pulses are not seen in the latter condition, but neither is there any detail visible in any darker portions of the picture, because both of these values are now more negative than the threshold black point. To present a more normal-looking picture, the operator must readjust the brightness control. That means more attention and knob twiddling during the telecast.

Time constants of the circuit are important. Time for charge of the capacitor is approximately $.05 \times .057 = 2,850$ microseconds, or about 45 lines of the picture, so that the circuit will react only to the large objects in the picture or the over-all background. This is satisfactory. Time for discharge is approximately $.05 \times (.01 + 1.0 + .047 + .150 + .01)$ or $.05 \times 1.2 = 60,000$ microseconds, or approximately two complete frames. Here is a reason for the complaint that pictures seem to jump. The long time constant permits nearly two complete frames of a new shot to be seen before the d.c. restorer acts to adjust to its new level. Thus there is a short flicker effect at the beginning of every camera shot that differs in average light intensity from the preceding one.

The modification

The d.c.-restorer circuit proposed by the author, diagrammed in Fig. 2, has only one basic difference from the circuit described above. The diode is reversed in polarity so that a *negative*

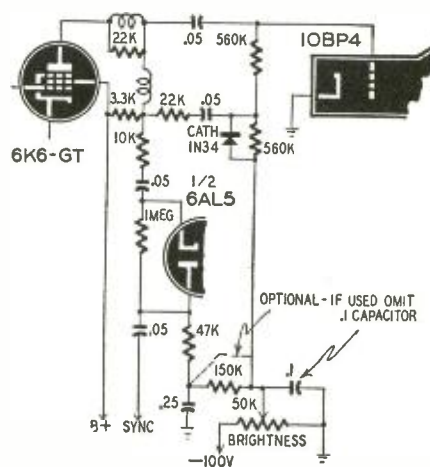

Fig. 2—This d.c. restorer keeps the average picture brightness constant.

voltage is developed in series with the picture tube grid. Examine the action now. The manual brightness control is set to such a point that the average scene is correctly reproduced, that is, dark portions of the picture just hit black, sync pulses and retrace lines are below black and thus invisible, and the whites of the picture attain normal brilliance.

Now suppose a very strong video signal comes through, representing a picture containing much white. The d.c. voltage developed by the diode is now more negative in value, tending to bring the average brightness down to the normal level, preventing the whites from "burning up." Sync pulses are pushed still further negative, and are thus still invisible.

The third condition, of a scene containing mostly dark objects and background with few whites, results in a weak video signal with an average value not much above the sync-pedestal level. Under this condition only a small negative voltage is developed by the diode and the average brightness of the scene is brought up to more nearly normal. In an extremely dark picture, this results in the retrace lines becoming slightly visible, but not objectionably so.

The fourth condition is with no video output, such as is obtained between camera scenes, when no picture is being transmitted, or on a dead channel. This results in no developed negative diode voltage, and the scanning raster and retrace lines are fully visible, showing the operator just what he has during tuning operations and providing the same over-all illumination obtained when there is a picture. As soon as any video signal is obtained it is immediately visible, no matter how weak or mistuned.

Time constants of the revised circuit are changed somewhat from the original. Time constant for charge is $.05 \times .022 = 1,100$ microseconds or approximately 20 lines, so that the circuit is responsive to the effect of any object of importance in the picture, as well as the background. Time for discharge is $.05 \times (.56 + .022)$ or $.05 \times 0.582 = 29,100$ microseconds, slightly less than one complete frame. This is highly desirable since it limits exposure of an uncorrected scene to less than 1/30 second and little or no flicker effect is apparent to the eye. In other words, the reaction of the circuit to brightness changes is fast enough to make its action not apparent to the observer. Scenes change smoothly without any observable difference in average brightness. In actual operation, the new circuit works so well that it is almost never necessary to vary the brightness control from its normal setting, all scenes and conditions being brought to the same average brightness.

Installation

Installing the new circuit in most receivers is not just a matter of revers-

ing the connections to the diode, because that would also reverse the polarity of the sync pulses usually taken off the plate of the same diode and would result in no sync operation. The solution, where the same diode is used as a combination d.c. restorer and sync clipper, is to use a separate diode for each function by installing a 1N34 crystal for the restorer. In the RCA-type circuit, the easiest way is to leave the 6AL5 connected as is, but move the picture-tube grid return over to

the 1N34, as shown. Transference of the circuit to other receivers will be apparent, if it is remembered that the 1N34 must be so wired that it will develop a negative voltage from rectification of the video output. This voltage must be placed in series with the picture-tube grid return. Where a peaking coil is used in the plate circuit of the video output tube, the takeoff point for the crystal must be below the peaking coil, to prevent additional capacitance to ground.

Novel High-Voltage Test Probe

By WALTER H. BUCHSBAUM

A NODE voltages of 8 to 15 kilovolts on modern television picture tubes present somewhat of a problem to the service technician when he has to measure them. The usual method is to use a high-voltage probe with a standard voltmeter or estimate the voltage by drawing an arc.

Fig. 1 shows a novel device which has the features of both these methods. When the two round balls receive opposite charges and are close enough together, a discharge takes place through the air separating them. The critical distance for discharge depends on the potential. For given atmospheric conditions, the relation between voltage and distance is linear and the gap indicates the voltage.

To measure high voltage, the two balls are first separated so that the micrometer-type scale reads higher than the rated voltage to be measured. The tip of the device is applied to the voltage under test, and the top is screwed in. When the separation between the two balls reaches the critical

is calibrated in steps of 5,000 volts, and one complete revolution of the cap is equivalent to 5,000 volts. The cap is further divided into steps of 250 volts.

The device is sold under the name Seg-Hy-Volter. It is small, inexpensive,

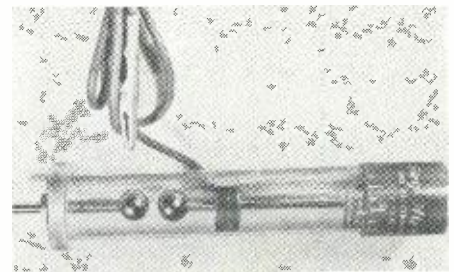

Fig. 1—Closeup of the novel Hy-Volter.

and easy to use. The technician handy with tools can make one himself.

Fig. 2 shows the disassembled unit. The two balls are machined brass and are each $\frac{1}{2}$ inch in diameter. The disc which holds the upper ball bolt is also brass. The metal parts are chrome

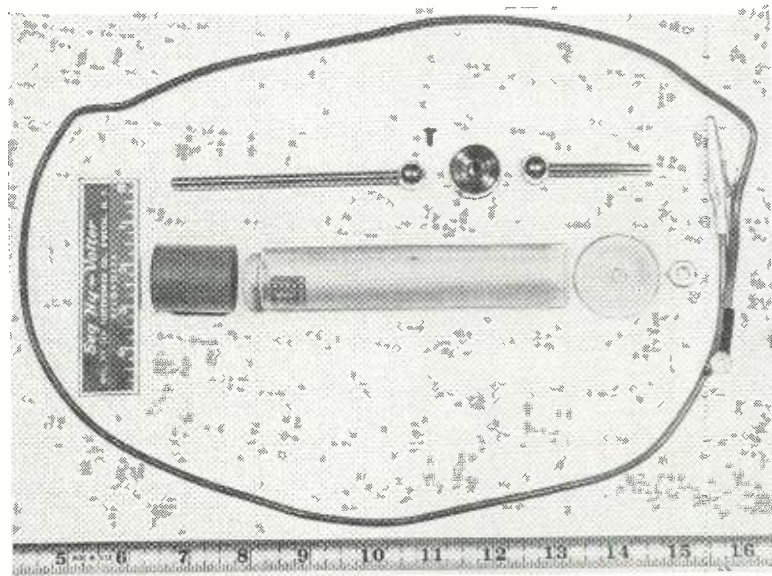

Fig. 2—A few simple parts are all that is needed for the high-voltage probe.

finished, and the balls have an extra smooth surface. discharge distance, a blueish purple glow becomes visible and a hissing noise is heard. The correct voltage can then be read directly on the scale.

The vertical scale on the glass tube

is finished, and the balls have an extra smooth surface.

If one full turn of the top cap is to be equivalent to 5,000 volts, the screw pitch must be 16.7 turns per inch.

530-MC U. H. F.

Satellite Television Station

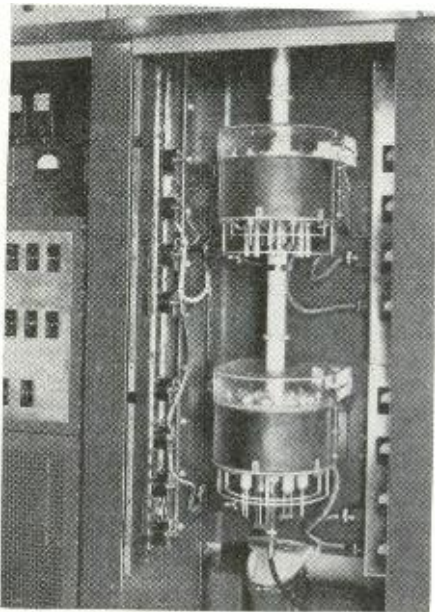

Photo of a pair of the u.h.f. tetrodes showing the ring-type cavity resonators.

KC2XAK, the world's first ultra-high-frequency television station operating on regular program schedules, is now on the air in the 480-920-mc u.h.f. television band. The station is a satellite, operated by the National Broadcasting Company, and rebroadcasts the programs of WNBT, New York City, from a hill between Bridgeport and Stratford, Connecticut.

The new station started operation at full power (1 kilowatt) early in the year, and at the beginning of June was operating on a regular five-day weekly schedule from 9 a.m. to WNBT's signoff.

The tower shown on the cover is 250 feet high to the top of the "stovepipe" mast. Both the antennas for receiving the signals from New York, 55 miles distant, and for retransmitting them at u.h.f., are on it. The transmitter is installed in the building at the foot of the tower.

Originally the satellite station picked up the signals from WNBT on its regular frequency (channel 4) and rebroadcast them. This was not entirely satisfactory, and a relay on 2,000 mc was arranged.

Signals beamed on 2,000 mc from the

KC2XAK's u.h.f. transmission tests may answer TV's economic problems

Empire State Building are received on the small parabola on KC2XAK's 210-foot tower. (The larger parabola was used to receive the channel 4 transmissions.) The signals are fed into the u.h.f. transmitter and radiated on channel 24 (529-535 mc) from the 40-foot slot antenna at the top of the tower.

The radiating elements of the antenna are slots cut in the 10-inch diameter tube. They are a half wavelength long and are separated a half wavelength from each other. A special coaxial feed system provides power and phase balance between the upper and lower halves of the antenna array. The resulting pattern is perfectly circular with practically all the energy radiated horizontally.

The transmitter itself—shown in the insert in the cover—is believed to be the first commercial-type u.h.f. transmitter. TV transmitters have been operated in the u.h.f. band before, but they were special rigs which seldom long outlived the test or demonstration for which they were thrown together. In contrast, this new job is a prototype for a commercial model which can be duplicated on order for any u.h.f. station when such stations can go on the air.

Designated the TTU-1A, the transmitter contains a number of units identical with those of RCA's v.h.f. transmitter TT-500B, plus a tripler stage to increase the frequency to the required 530 mc, a 1-kilowatt power amplifier stage, and a video amplifier stage which grid-modulates the power amplifier. Identical triplers and final amplifiers are used for the sound and picture carriers. Each uses eight 4X150A u.h.f. power tetrodes in special ring-type resonant cavity circuits.

The audience is small but enthusiastic. There are about 100 receivers scattered in carefully selected locations throughout the area, from 1 to 23 miles away from the station, with a few at much greater distances. Approximately

half these receivers are specially constructed, the other half are u.h.f. converters attached to standard television receivers. No notable difference has been recorded in the performance of the two types, though of course the self-contained special receiver is more convenient from the set-owner's point of view. One of the results of the KC2XAK project has been to show that converters are practical.

While the transmission range is not yet fully determined (determination of u.h.f. transmission ranges was one of the chief reasons for the project, and is still under study) the 500-microvolt contour will lie at a radius of approximately 6 to 8 miles from the station. Satisfactory pictures have been received at considerably greater distances than that, of course. Within a radius of 10 miles, 84% of the viewers report good or excellent results and, within a radius of 23 miles, the same results are obtained at 65% of the receivers.

Satellite station operation has been considered by many the answer to television's economic problems. By greatly increasing the television audience it may solve the problems of expensive television programs for the big networks while at the same time making television possible for the small community which could not support an independent station. The country's first regular u.h.f. station will answer many questions about satellite station operation, as well as a number of questions about the operation of independent u.h.f. television transmitters.

The results of KC2XAK's transmission tests may even help to hasten the end of the present freeze on TV station allocations. Two important problems now facing the FCC are providing TV outlets to as many communities as possible and eliminating co-channel and adjacent-channel interference. If this station proves successful, the FCC may find the satellite-type station one of the answers to its problems.

Fundamentals of Radio Servicing

Part XVIII—Demodulating the R.F.

By JOHN T. FRYE

IT WOULD be nice if we could simply attach our audio amplifier to a receiving antenna and sit back and listen to a radio program rolling in loud and clear. Unfortunately, it is not that simple. Before our radio signal can be handled by an audio amplifier, it must go through a process called "detection" or, more accurately, "demodulation."

You cannot explain the word "divorce" to a man who does not know the meaning of "marriage"; and, by the same token, before *demodulation* can be understood, one must first know a little something about *modulation*.

Modulation is the process by which the audio-frequency currents produced by a microphone are joined to the radio-frequency carrier currents generated by the transmitter. This truly is a marriage of convenience. The audio-frequency electromagnetic waves cannot travel through air for more than a few feet at most. Radio-frequency waves, on the other hand, can hop through the ether with the greatest of ease, but the ear will not respond to their rapid vibrations of hundreds of thousands of cycles per second. The obvious solution to the problem of transporting audio-frequency waves through space is simply to arrange some method by which they can ride piggy-back on earth-girdling radio-frequency waves from the transmitter to the receiver. Once they have arrived at their destination, the two can be separated again and the audio-frequency currents used to drive our speaker. The gadget that does the separating is called a *detector* or *demodulator*.

The audio current modulates the radio-frequency carrier in much the same way that you can "modulate" the stream of water issuing from the nozzle of a garden hose by applying varying pressure to a kink in that hose. The audio voltage exerts a kind of "valving" action on the carrier that causes the amplitude of that carrier to vary exactly in step with the audio voltage.

Fig. 1 shows graphically how the modulating audio voltage influences the carrier. The line represents the way the voltage changes with time, as explained in previous lessons. At 1-a we have an unmodulated carrier showing the cycles of radio-frequency current.

For a station in the middle of the broadcast band, there would be about 1,000,000 per second. Fig. 1-b shows a complex audio-frequency wave consist-

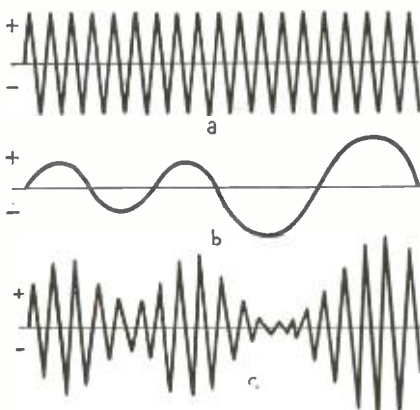

Fig. 1—The r.f. carrier represented by a is modulated by a.f. signal b to form the amplitude-modulated signal c.

ing of various audio frequencies of different intensities. At 1-c we show the carrier wave "envelope" that results when the audio wave modulates that carrier. Note that when the audio signal is zero, our carrier is of normal amplitude. As the audio signal increases in a positive direction, the carrier amplitude increases just as does the amount of water issuing from the hose when you relaxed your pressure on the kink. As the modulating voltage increases in a negative direction, the amplitude of the carrier is greatly reduced, just as the water flow is reduced to a trickle when you clamp

down on the hose.

This modulated carrier is the signal our radio set receives. You will notice that the frequency of the actual carrier remains unchanged. Only its amplitude changes. Under modulation the carrier develops a series of bulges and notches like the neck of an ostrich swallowing different-sized oranges. If the modulating voltage swings are strong, the bulges and accompanying dips are large; if this voltage is weak, the variations are barely perceptible. Also, if the modulating frequency is high, many of these bulges in amplitude appear in a short space of time; if low, only a few appear.

There is one marked difference between the audio voltage and the modulated carrier envelope produced by this voltage: the audio voltage appears first on one side of the zero line and then on the other so that its force is exerted first in one direction and then in the opposite; but our modulated



Fig. 2—Hookup of a simple crystal set.

carrier expands and contracts simultaneously and similarly both above and below the center line (because a half-cycle of a.f. modulates many cycles of r.f.). That means that the equal and opposite voltages tend to cancel each other. The effect is about the same as if you held a strip of rubber in the center while someone pulled on the two ends with equal pressure. As far as you

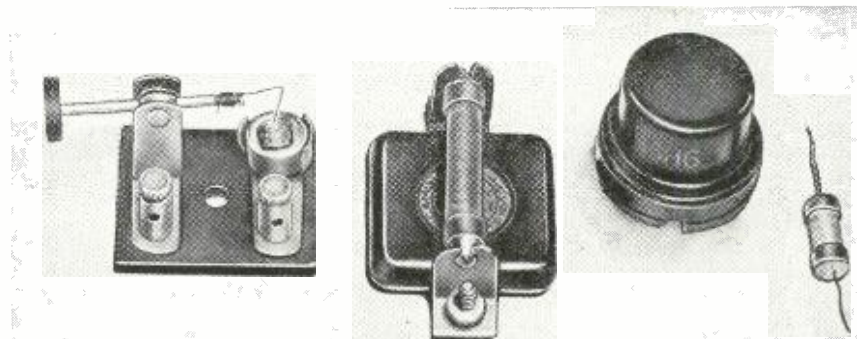

Detector history—crystal to crystal. Left to right—old catwhisker detector; a grid capacitor with leak; 6H6 diode detector tube, germanium crystal diode.

could tell by the feel at the point you were holding, nothing would be happening.

Demodulating the signal

If we are to recover our audio voltage from this modulated carrier, we must find a way of changing this "two-way stretch" back into a one-way stretch. The method of doing this is simple: split the carrier in two right down the center and use half of it. Since the top and bottom halves are identical, either will contain all of the information needed about the original modulating voltage.

This "splitting" is not hard if we remember that the top-and-bottom graph is just an engineer's way of

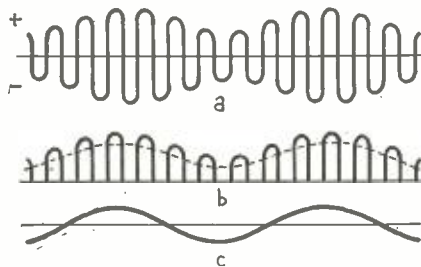

Fig. 3—In the detection process the modulated carrier a is cut in half, b, and the high frequency is filtered out to leave the original audio signal c.

saying that the current in the circuit flows one way half the time and the other way the other half. So what must be done is to *rectify* the r.f. current. That leaves us with a pulsating direct current; actually one with two sets of pulsations—those of the r.f. and those of the a.f. (See Part XIII, March, 1950.)

We filter this pulsating current just enough to smooth out the r.f. peaks but not enough to bother the a.f. changes caused by the modulating voltage. (Look at the March article again.) Since the lowest radio frequency used in broadcasting is over 500,000 cycles per second and the highest audio frequency that can be heard somewhere around 15,000 cycles, that is easy.

Then we are left with a current whose pulsations reproduce those of the current which originally modulated the r.f. signal.

Fig. 2 is a diagram of one of the earliest practical methods of detection. The crystal detector (indicated by XTAL) consists of a piece of galena (a common ore of lead) contacted by the sharp point of a phosphor-bronze wire called a *catwhisker*. It is a peculiarity of this tiny contact that it will allow current to flow easily from the catwhisker to the galena but presents a very high resistance to the flow of current from the galena to the catwhisker.

In our diagram the radio signal is picked up by the antenna and inductively transferred to the tuned circuit L1-C1. The alternating radio-frequency voltage across this circuit is

applied to the headphones *through* the crystal detector. Remembering that the crystal will allow current to flow in only one direction, we can easily see how half of our radio signal will be cut off as shown in Fig. 3.

At Fig. 3-a is the modulated carrier. This envelope is altered as shown in Fig. 3-b by the crystal's refusal to pass pulses of current going in one direction. Only the pulses going *up* from the zero line are allowed to pass through. These pulses of current work together to charge capacitor C2 with a varying voltage as indicated by the dotted line of Fig. 3-b. This capacitor discharges this varying voltage through the earphones.

Since the charge of C2 is made up of the average of the voltage pulses contributed by the expanding and contracting carrier, the voltage on this capacitor looks like Fig. 3-c. This voltage wave is a faithful reproduction of the original audio voltage that modulated the carrier. C2 and the coils in the headphone make up our r.f. filter.

Catwhisker crystal detectors are seldom used these days. They are too hard to adjust and to keep in adjustment. The efficiency of the detector action is critically dependent upon the pressure of the catwhisker on the crystal and also varies greatly from one spot on the crystal surface to another. Furthermore, the crystal detector does not handle either extremely weak or extremely strong signals very well. It has been superseded by the vacuum-tube diode type of detector diagrammed in Fig. 4.

The diode detector

Although this circuit looks much more complicated, it functions just as did the crystal detector. The signal

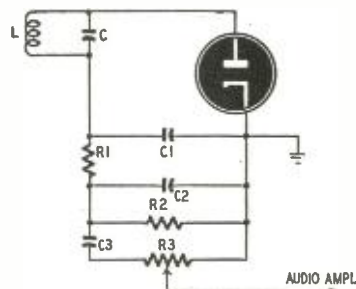

Fig. 4—The vacuum-tube diode detector is commonly used in radio receivers.

voltage appears across the tuned circuit L-C just as before, and the alternating r.f. voltage appears between the plate and cathode of the vacuum tube. While the plate is positive, as it is every half-cycle of r.f. voltage, electrons flow from the cathode to the plate. The more positive the plate swings, the more electrons it attracts. This means that when the carrier is expanding and the positive pulses of r.f. energy are increasing in amplitude, an increasing number of electrons go to the plate. When the carrier is decreasing and each pulse of voltage is weaker than the one just before it, the total electron flow decreases. The elec-

trons actually flow in spurts as dictated by the evenly spaced positive pulses of r.f. voltage, but these spurts are blended together by the filter C1-R1-C2 (see next paragraph) to produce a continuous flow that follows faithfully the variations in the amplitude of the modulated carrier.

The electrons return to the cathode through L and resistors R1 and R2. Resistor R1, together with capacitors C1 and C2, act as a filter to smooth out the "spurdy" nature of the current delivered from the diode plate. The capacitors are large enough to offer a very low resistance bypassing action to the high-frequency variations resulting from the rectification of the individual r.f. pulses, but not large enough to have any material effect on the comparatively low-frequency variations resulting from demodulating the carrier envelope.

When this current, varying in accordance with the original audio voltage, flows through R2, it causes a voltage to appear across the resistor that is an exact reproduction of the original audio signal. Passing through capacitor C3, this voltage also appears across R3, the volume control. The slider on this control permits any fraction of the total audio voltage to be selected and passed along to the audio amplifier.

The grid leak detector

While the diode detector is much like the crystal detector in its "check-valve" action, it was not the immediate successor of the crystal detector. The grid leak detector actually supplanted the galena and catwhisker combination. Fig. 5 is a diagram of a triode grid leak detector.

If you think of the grid as taking the place of the diode plate, you can see that the input portion of this circuit is really quite similar to that of our diode detector. The resistor across which the audio voltage develops has been moved to the grid leg of the input coil, and a capacitor is placed across this resistor so that the r.f. voltage can still be applied between the grid and the cathode; but we still have a condition in which the electrons will flow to the grid, just as they did to the diode plate, when that element is made positive by the half-cycle swings of r.f. voltage. The electron current to the grid, and consequently the voltage across resistor R—which is called the "grid leak"—varies in accordance with the amplitude of the modulated carrier.

The resistance value of the grid leak is sufficiently high (usually 2 to 10 megohms) so that the electrons attracted to the grid during the positive half-cycles of the r.f. carrier do not

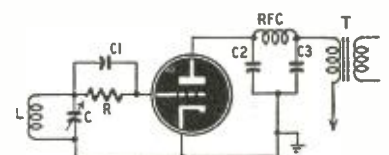

Fig. 5—The grid leak detector is highly sensitive but distorts strong signals.

have time to leak off during the negative half-cycles; but it is at the same time small enough so that the negative voltage on the grid can go up and down in unison with the changes in amplitude of the modulated carrier. This leaves only the audio signal on the grid.

Now stop thinking of our grid as a diode plate and look upon the tube as an ordinary amplifier. On the grid we have a varying voltage that exactly reproduces the audio voltage originally impressed on the carrier. The triode amplifies this audio voltage in the normal manner, and we have an amplified audio voltage across the primary of transformer T that leads into the audio amplifier. C2 and C3, together with the radio-frequency choke RFC, remove any trace of the radio-frequency ripple that might get through to the plate of the triode.

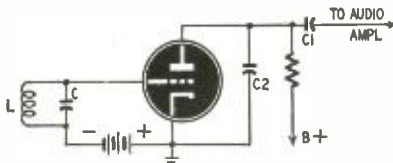

Fig. 6—This detector looks like an amplifier but it is biased at cutoff.

The grid leak detector is very sensitive because it combines the functions of detection and amplification. A pentode can be used in place of the triode to obtain still greater sensitivity. One big drawback of the grid leak detector is that, if it is made very sensitive to weak signals by the proper selection of values for the grid leak and the grid capacitor, it will distort strong signals badly.

The power detector

The "power detector" of Fig. 6 will handle very strong signals without distortion. It looks like and is an ordinary amplifier circuit except that the bias is set so the tube is working very near the plate current cutoff portion of the curve, as is shown in Fig. 7. Bias batteries are generally not used in practical circuits. For description of other types of bias see *Vacuum-tube Grid Bias* by H. B. Davis in the May issue of RADIO-ELECTRONICS.

Since the plate current is practically zero with no signal on the grid, the negative swings of the r.f. voltage impressed on the grid have no effect on the plate current (it can't go below zero) but the positive half-cycles cause pulses of r.f. current to flow in the plate circuit as shown. These positive pulses of current increase or decrease in step with the amplitude of the voltage pulses on the grid. The charging and discharging action of capacitor C2 blends these separate pulses together into a varying current that rises and falls in step with the outline of the modulated carrier, as is shown by the dotted line. What we really have here is a combination of rectification (only the positive half-cycles of voltage affect the plate current) plus amplification. Since the grid bias is very negative, extremely large signals can

be handled without overloading the detector.

This completes the types of detectors that have been used to receive amplitude-modulated radio signals. Each rightfully has enjoyed its day in the sun. The crystal detector had one decided advantage: it was entirely self-sufficient. No filament or plate batteries were needed to help it do its job.

The grid leak detector was much more sensitive—in fact, it is still the most sensitive of all detectors—but it could reproduce faithfully the audio portion only of weak signals. When the signal grew strong, the sensitive grid leak detector was over-loaded and caused distortion in the signal.

The power detector can handle much larger signals without introducing distortion, and it is between the diode and the grid leak detector as far as sensitivity is concerned. What is more, since it causes no rectified current to flow through the tuned input circuit, it does not "load" this circuit and so reduce its sharpness of tuning. All other detectors mentioned do have this effect.

With the introduction of the pentode amplifier tube sensitivity in a detector became of little importance. R.f. amplifiers could easily build up a weak signal to almost any value before it was presented to the detector. That is why the diode, in spite of its low sensitivity, became the most popular detector. It is unbeatable in its ability to handle any strength of signal without introducing distortion. What is more, it can do its job of detecting and, at the same time, produce other useful byproducts, such as automatic volume control voltage which will be discussed in the next chapter.

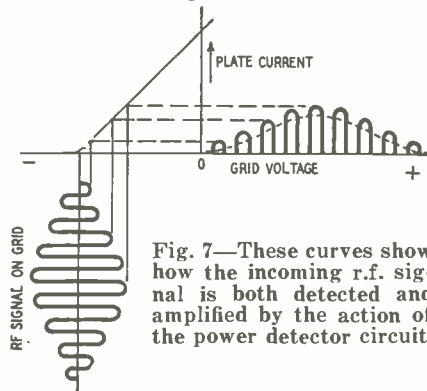

Fig. 7—These curves show how the incoming r.f. signal is both detected and amplified by the action of the power detector circuit.

Quite recently a new form of crystal detector has become popular. This is the tiny germanium crystal diode seen in the photograph. The catwhisker in this unit is sealed in permanent optimum adjustment, and it will handle much more current than would the old galena job. That frees it of the two main drawbacks of its ancestor.

Thus, once more we see demonstrated that amazing and oft-repeated cycle wherein one generation of radio engineers banishes a particular gadget to the electronic attic, and then the next generation hauls the item out of the garret, dusts it off, makes a few changes, and puts it back into use until something better comes along!

CHECK THAT ADVERTISING!

IT'S time to start making out that advertising budget on a scientific, businesslike basis, using actual results as a guidepost.

With business in the radio repair field due to become more competitive in the next months, advertising will play an increasingly important part.

Naturally, any radio repairman wants to spend his hard-earned dollar for advertising that will do the most good.

Sad to say, however, the majority of businessmen in the radio maintenance field shoot in the dark when it comes to advertising. They dole out those precious dollars in a hit or miss fashion, and more often than not, they miss!

In other words, they have no plan. A good advertising program needs a workable, business-producing plan, and it's simple to work out an effective program.

The thing to do is check your present customers.

Conduct a survey of your own right in your shop for the next week or two to help you find just where your advertising dollars bring the most returns. Your customers will be glad to help you—and they'll be able to tell just how to budget to do the most good.

Ask your customers when they come in just how it happened that they visited your radio repair shop in the first place.

Better yet, prepare some small mimeographed sheets explaining that you are trying to test the pulling power of your present advertising program, and hand one to each customer over a period of a week or 10 days.

The card could read something like this:

"I brought my radio for repair to the.....store because I noticed:

- Newspaper advertising ().
- Radio program ().
- Window display ().
- Friend recommended ().
- Billboard sign ().
- Ad in phone book ().
- Handbill ().
- Business card ().
- Roadside sign ().
- Neon sign in front ().
- Just happened to be passing ().

Other reasons (leave a space big enough for them).

You can probably think of some more categories, but the above is the general idea.

National companies, who spend millions of dollars annually for advertising, send crews to all parts of the nation to check their advertising program. You can do your own checking right in your own shop—and it won't cost a cent. Just a little added effort is all that is needed.

After you spotcheck your customers for a few days and compile the results, you'll have a better than fair idea where your advertising dollar can do the most good.—Don Valentine

Radio Set and Service Review

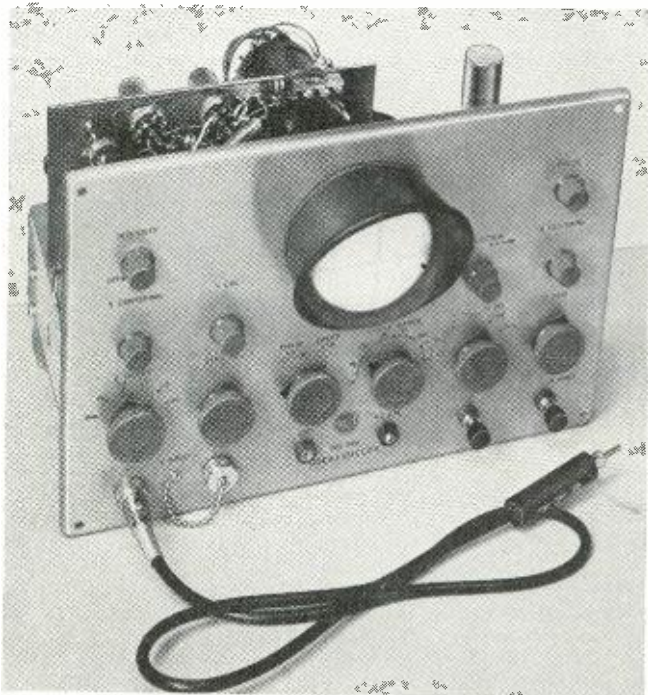

A front view of the new oscilloscope (out of its case). Its blue finish matches other RCA TV test equipment.

THE type WO-57A 3-inch television service oscilloscope is the latest addition to RCA's line of specialized TV test equipment. Although its design makes it particularly suitable for TV servicing, it is versatile enough to permit its use in all phases of radio servicing. Its size, 13½ inches wide, 10 inches high, and 7½ inches deep; and weight, 18 pounds, make it a truly portable instrument. Its blue hammertex case and chrome panel match the WR-39A television calibrator, WR-59A sweep generator, and similar equipment in the RCA test equipment line for TV servicing.

Features which are particularly useful to the TV service technician are:

A two-stage direct-coupled, vertical amplifier having response flat within plus or minus 1.2 db from d.c. to 500 kc, 3.5 db at 1 mc, and useful beyond 2 mc.

Linear sweep generator having fixed 30- and 7,875-cycle positions for viewing sync pulses and sweep oscillator waveforms. These positions make it unnecessary for the operator to adjust coarse and fine sweep controls each time he goes from a horizontal to vertical deflection circuits while servicing a TV receiver. The oscillator will sync equally well on positive or negative pulses being fed into the vertical amplifier and on externally applied sync signals.

Internal 60-cycle phase-controlled sweep.

Separate vertical input terminals, one for a.c. and the other for d.c. Combined a.c. and d.c. voltages can be

applied to the input terminals.

A calibrated screen or grid marked in tenths of an inch for making voltage measurements.

A 1-volt peak-to-peak calibrating voltage source.

A voltage-calibrated and frequency-compensated, step-type vertical attenuator.

The circuit

The complete circuit of the WR-57A is shown in the large schematic. The signals to be observed or measured are fed into the vertical amplifier through a.c. or d.c. input jacks and the frequency-compensated attenuator, V RANGE. Fig. 1 is a diagram of a conventional potentiometer-type gain or volume control. Capacitors C1 and C2 represent the stray capacitances between the arm and the grounded and hot ends of the control. The values of these capacitances are constant and fairly low so that they act as a capacitive voltage divider in parallel with the variable-resistance control. Therefore, the high-frequency components of the input signal will be handled by the fixed capacitive divider and the low-frequency by the variable resistive voltage divider. Consequently, the attenuation of the high- and low-frequency components of the input signal will not be equal and serious frequency distortion will develop in the gain control.

A simplified version of a compensated attenuator is shown in Fig. 2. Here the resistive elements are fixed. Stray capacitances C1 and C2 are

A new 3-inch oscilloscope designed for TV servicing

By ROBERT F. SCOTT

shunted by fixed capacitors C3 and C4 which are much larger. The values of the resistors and fixed capacitors are selected to give the desired attenuation with a linear voltage distribution over a wide frequency range. C3 is usually made variable so the network can be adjusted for different values of stray capacitance in otherwise identical set-ups.

The attenuator feeds into a push-pull, direct-coupled amplifier which is rather unusual in its design. The input signal is fed into the control grid of V1. The control grid of V2 is grounded.

At low frequencies, the 1800- μ f capacitor C12, between the cathodes of V1 and V2, is effectively an open circuit and no signal appears in any part of V2. This tube serves only to balance the current and voltage distribution in the circuit. The signal is amplified by V1 and direct-coupled to the control grid of V3. The grid of V4 is effectively grounded for a.c. so this tube operates as a grounded-grid amplifier being fed from the cathode resistor R25 which it shares with V3. V3 appears as a cathode-follower when viewed from V4, and V4 looks like a grounded-grid amplifier to V3.

At high frequencies, C12 has a low impedance and effectively couples the cathodes of V1 and V2 together. Its control grid being grounded, and having a high-frequency signal applied to its cathode, V2 operates as a grounded-grid amplifier and sees V1 as a cathode-follower. Thus, phase inversion takes place in the first stage at high frequencies and in the second at low frequencies. Because V2 operates only at high frequencies, the high-frequency gain is twice that of low frequencies. C15 compensates for high-frequency

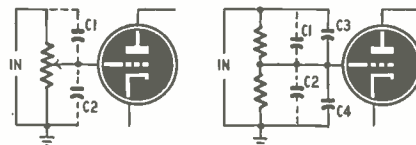

Fig. 1, left—Conventional gain control. Fig. 2—Compensated attenuator circuit.

losses caused by stray capacitance. The vertical deflection plates of the 3MP1 C-R tube are direct-coupled to the plates of V3 and V4.

The deflection sensitivity of the vertical amplifier in r.m.s. volts per inch is .03 with the direct cable and 0.3 with the low-capacitance WG-214 probe. Its input resistance and capacitance are 1 megohm shunted by 90 μf with the direct cable, and 1 megohm shunted by 14 μf with the low-capacitance probe.

The horizontal deflection circuit is simpler than the vertical. It has an uncompensated potentiometer-type gain control (H GAIN) and a single 12AX7 amplifier and phase inverter. A part of the signal from the amplifier is fed to the grid of the phase inverter section through an R-C network. The deflection sensitivity of the horizontal amplifier is 0.6 volt r.m.s. per inch. Its input resistance and capacitance is 1 megohm shunted by 33 μf .

The sweep generator is a Potter-type cathode-coupled multivibrator using a 6J6. Its frequency is adjustable from 15 to 30,000 cycles in five ranges. A SWEEP VER (vernier) R38B varies the

frequency of the oscillator within the ranges set by the SWEEP RANGE switch. Two additional positions on the switch provide fixed 30- and 7,875-cycle sweeps for observing sync and blanking pulses and oscillator waveforms in the vertical and horizontal circuits of TV receivers. Screwdriver-adjust controls are provided on the back panel to permit setting the fixed sweeps to their proper frequencies.

The power supply is similar to those found in most scopes of this size. A full-wave rectifier supplies B-voltage for the amplifiers, oscillator, and second anode of the 3MP1. Approximately 500 volts negative is developed by the half-wave rectifier and applied directly to the control grid and to the cathode and anode No. 1 through a voltage divider.

Controls

Intensity, centering, gain, sweep, phase, focus, deflection, and calibrating controls are on the front panel. Con-

trols for setting the TV horizontal and vertical sweep frequencies, vertical balance, second-anode voltage, astigmatism are on the rear of the chassis. The first three can be adjusted with screwdrivers through holes in the rear cover. The cover must be removed to reach the others.

The H and V CENTERING controls are variable resistors in the cathodes of their respective amplifiers. Moving these controls causes the bias on the push-pull tubes to vary in opposite directions, thus causing the plate voltages and the position of the beam to move along its horizontal or vertical axis.

The DEFLECTION switch reverses the direction of the trace so it is possible to make the trace being observed have the same time-versus-frequency direction as the set manufacturers' service note illustrations. This switch reverses the connection between the horizontal deflection plates and the horizontal amplifier. The sweep direction is conven-

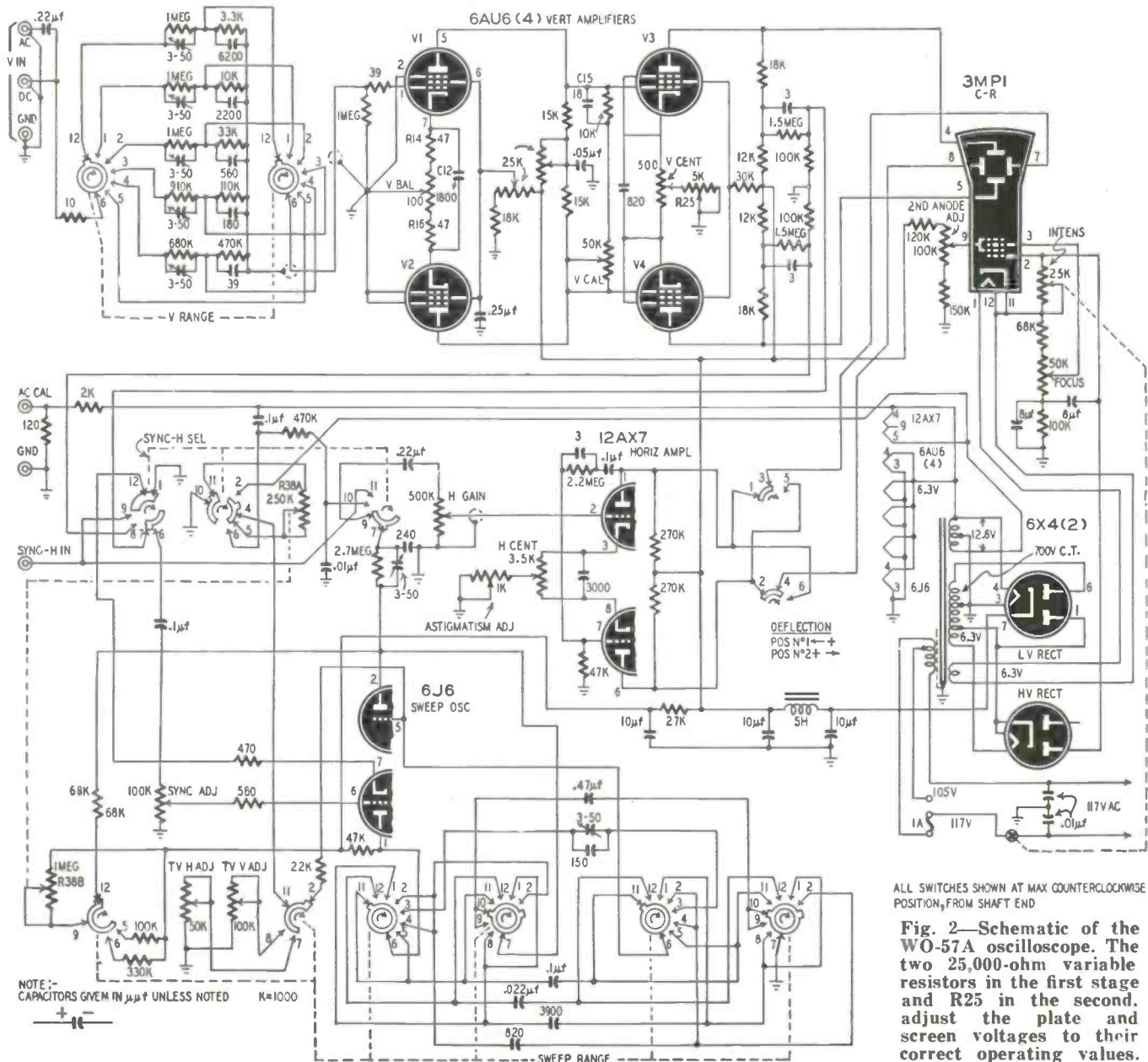
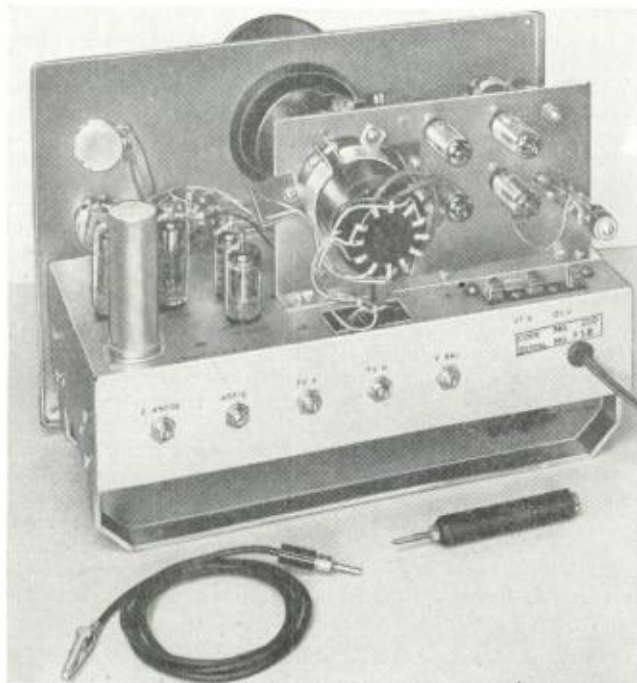

Fig. 2—Schematic of the WO-57A oscilloscope. The two 25,000-ohm variable resistors in the first stage and R25 in the second, adjust the plate and screen voltages to their correct operating values.



tional — left-to-right—when the plate of the input section of the 12AX7 connects to pin 8 of the 3MP1.

On electrostatic C-R tubes, it is important that the potential on the deflection plates be approximately equal to the potential on the second anode. If the potentials are not nearly equal, focusing will vary as the beam

sweeps across the tube. The ASTIGMATISM ADJUST control varies the bias on the 12AX7, thereby changing its plate voltage and the voltage on the deflection plates.

The oscillator can be synchronized with negative or positive pulses on the incoming signal or on external sync pulses. R38B is the sweep vernier. The C-R tube can be driven directly from an internal 60-cycle source or from a signal being applied to the horizontal amplifier. When the beam is driven from the 60-cycle source, R38A is the PHASE ADJ control which permits superimposing the forward and backward traces during circuit alignment. Characteristics of the horizontal deflection circuit with the exception of frequency and width are controlled by the SYNC-H SEL control. Negative or positive sync pulses are taken from the outputs of V4 or V3, respectively.

A rear view of the new oscilloscope. While designed for TV applications, it can be used for other phases of servicing and testing.

The v CAL (vertical calibration) control is a vernier gain control for the vertical amplifier. Its purpose is to vary the load impedance of V1 and V2 without disturbing the d.c. balance of the circuit. If it is adjusted for exactly 1 inch peak-to-peak deflection when the direct probe is touched to the AC CAL terminal and the vertical range switch is on 1.0, input voltages can be read directly. In this case, 1 volt input will produce a 1-inch deflection.

The vertical attenuator and the calibrated scale can be used to measure other voltages. The vertical attenuator (v RANGE) is calibrated in steps of .01, 0.3, 1.0, 3.0, 10, and 30. A.c. or d.c., and combined a.c. and d.c. voltages can be read on the scale. The a.c. input terminal has a 0.22-μf capacitor between it and the attenuator, the d.c. input terminal has not.

The INTENSITY and FOCUS controls vary the brightness and sharpness of the trace by varying the potential between the cathode and control grid and between the first anode (pin 3) and the cathode, respectively. The vertical balance (v BAL) control is a variable resistor common to the cathodes of V1 and V2 and connected between the individual cathode resistors R14 and R16. It adjusts the linearity of the vertical input stage so the trace will not move up or down as the vertical calibrator is rotated.

The scope which we tested was just off the production line and had not been pre-aged, therefore it was necessary to let it run for approximately 32 hours before it would stabilize itself within a 15 or 20-minute warmup period. The initial drift does not greatly affect the performance of the scope for most servicing applications; however, there was some nonlinearity in the vertical amplifier. Voltage measurements cannot be made until the scope has reached operating temperature. Disregarding the inconvenience of the long warmup during the first week of operation, we feel that the unusual features of this will make it a useful and treasured addition to any radio-TV service bench.

Ayrton Shunt Protects Meter Movement

MANY technicians prefer to build their own multimeters. Milliampere meters are often designed around a 200- or 500-μa movement with individual shunts calculated from the formula

$$S = \frac{M}{N-1}$$

where M is the meter resistance, S the shunt resistor, and N the meter multiplier. When several shunts are used, the circuit looks like Fig. 1.



Fig. 1, left—A shunt for each range. Fig. 2, right—The Ayrton or ring shunt.

The Ayrton, or ring shunt, is not as widely used by home constructors, although it is generally found in lab and industrial equipment. It consists of a resistor across the meter (Fig. 2) with a switch to tap off a portion through which the total current flows. Sometimes the taps are brought out as terminals or binding posts, and the switch is eliminated.

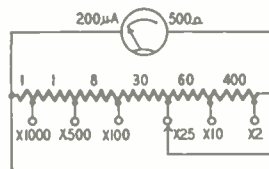

Fig. 3—Ring shunt with typical values.

One of the advantages of an Ayrton shunt is greater meter safety. If the switch in Fig. 1 should become defective, the full current is apt to flow through the meter with probable damage to it. This cannot happen in Fig. 2.

If a contact should develop an open or a high-resistance, no current flows through the meter. Either a shorting or nonshorting switch may be used here without danger.

Another advantage of the Ayrton shunt is the constant damping across the meter. Most technicians know that deflection becomes sluggish when the meter is shunted by a low resistance. This happens in Fig. 1 when N is large. The total resistance across the meter in Fig. 2 is constant, regardless of range chosen.

The tapped sections of Fig. 2 are easily calculated from the formula

$$S = \frac{M + T}{N}$$

Here T is the total shunt and S is the resistance between the common terminal and the desired tap. Another advantage is now evident. Usually N is 10, 50, 100, etc. Therefore in Fig. 1 we must divide the meter resistance by 9, 49, 99, respectively. The formula just given generally gives more convenient values. Assume for example that shunts are to be designed for a 200-μa meter with internal resistance of 500 ohms. The table below gives the correct values for both types of shunt.

N	Imax	S (Fig. 1)	S (Fig. 2)
2	400 μa	500	500
10	2 ma	500/9	100
25	5 ma	500/24	40
100	20 ma	500/99	10
500	100 ma	500/499	2
1000	200 ma	500/999	1

Note that the Ayrton shunt values are inversely proportional to N and need not be recalculated each time from the formula.

The Ayrton shunt circuit appears in Fig. 3.—I. Queen

Midget Signal Generator is Hum Modulated

An easy-to-build 1-tube generator that covers the needs of broadcast receivers

By LYMAN E. GREENLEE

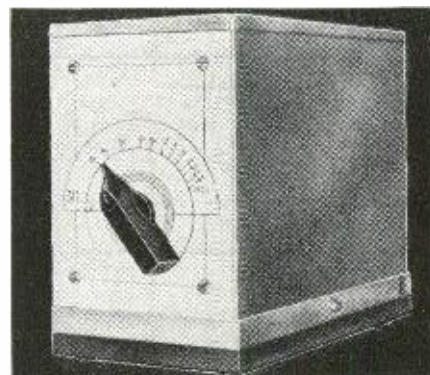

The signal calibrator is built into a shield can. It covers all frequencies needed for broadcast receiver alignment.

THIS simple hum-modulated signal generator can be thrown together in a couple of hours and, if carefully calibrated, will take the place of an expensive piece of test equipment. It is particularly useful in locating stations when setting up push-button controls on new radios. Fig. 1 is the circuit diagram.

A 50L6 tube is used as a triode in a conventional Hartley circuit. The oscillator coil may be wound by hand on a 1-inch cardboard or Bakelite tube with No. 30 enameled wire. Wind 100 turns and bring out a tap for the cathode; then wind 40 more turns and finish with a coat of coil dope to hold the winding in place. The assembly is virtually self-explanatory from the photographs and wiring diagram. The two-gang t.r.f. capacitor (the two sections in parallel) can be salvaged from a junked midget radio. Frequency coverage is from about 400 to 1,800 or 2,000 kc which is adequate for servicing household radios covering the broadcast band and having a 455-kc i.f. This includes almost everything made in recent years except FM and short-wave sets.

The assembly shown in the photos was made in an old shield can, but the parts can be mounted on a board if no case is available. No attenuator is provided as there is sufficient radiation to couple to the radio under test and the input can be controlled by moving the oscillator away from the set. Since the signal generator is used mainly for station finding or testing, an accurate attenuator is not needed.

To avoid a hot chassis, the tuning capacitor is insulated from the shield can and the capacitor shaft is connected to the tuning knob with an insulating coupler. For best stability, the can itself should be grounded to earth.

The 50L6 tube is operated at a reduced filament voltage of approximately 30 and this is also used as the plate voltage. This makes the oscillator stable with adequate output for service work, but it may be a little slow in warming up. The signal is hum-modulated. An unmodulated signal could be obtained by using d.c. for the plate supply, either from a small B-battery or a selenium rectifier in series with the power lines.

The instrument may be calibrated by using a radio set having a dial reading in kilocycles. Tune in a station and listen for the announcement to identify its frequency (a list of broadcast stations and their operating frequencies will be a help) then tune the signal calibrator to the station and mark the frequency on a paper scale. Repeat the process until a sufficient number of

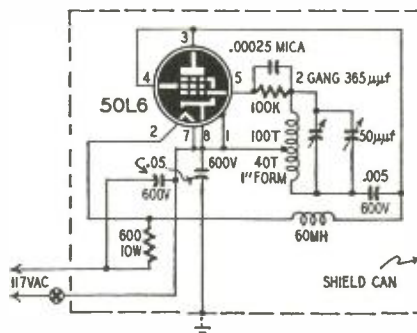

Fig. 1—Hookup of the 1-tube oscillator.

points have been located. It is usually convenient to locate the i.f.'s of 455, 465, etc., and the r.f.'s of 600, 700, 800, to 1700 or 1800 kc. Points between the 100-kc calibrations can be located or estimated and a reasonably accurate dial prepared. The paper dial can be inked in and covered with a piece of cel-

luloid to prevent the numbers from rubbing off. The i.f.'s can be located by listening for their harmonics at 900, 910, 930 kc. Divide the dial reading on the radio set by 2 to get the fundamental or i.f. frequency.

To set up push-buttons, tune the signal calibrator to the frequency of the station wanted on the pushbutton and it will be easy to identify the oscillator signal when the trimmers are adjusted. This method saves a lot time and requires no direct connection to the radio. Plug both the radio and signal generator into the same outlet. Maximum range is about 30 feet under normal conditions, which is short enough to prevent interference with other radio sets and is within FCC regulations. Do not connect the oscillator to an antenna of any kind as radiation will then be excessive.

MATERIALS FOR SIGNAL CALIBRATOR

Resistors: 1—100,000 ohm, 1/2 watt; 1—600 ohm, 10 watt.

Capacitors: 1—.00025 μ f mica; 1—.005, 1—.05, 1—.01 μ f, 600 volt, paper; 1—.000365 μ f, 2-gang variable; 1—50 μ f trimmer.

Miscellaneous: 1—1-inch diameter coil form; 1—60 mh r.f. choke; tube, socket, hookup wire.

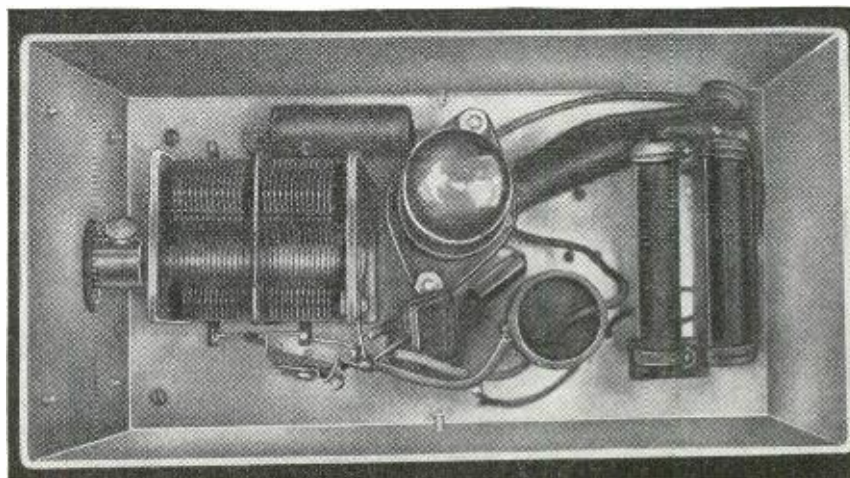

The small metal case allows ample room for all of the parts with no crowding.

An Electronic Therapy Machine

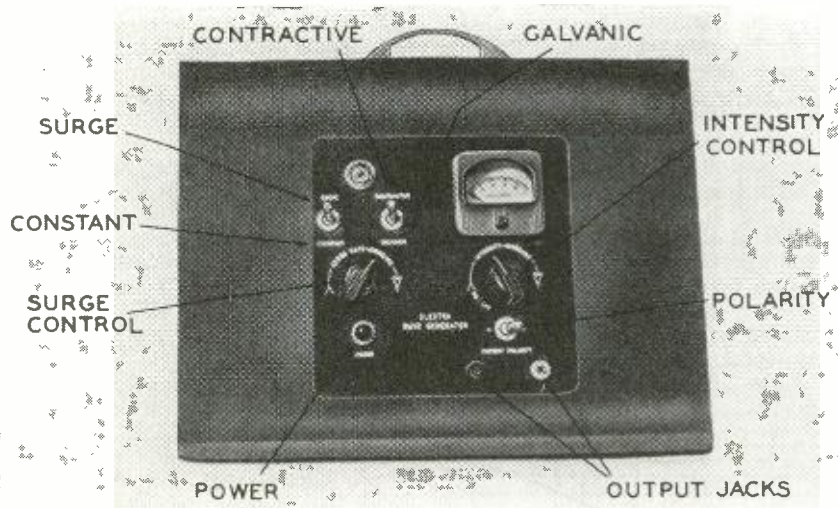

A simple and dependable device that will produce soothing facial massages

By IRVING GOTTLIEB

← A front view of the electronic therapy machine showing controls on the panel.

↓ Rear view with the top cover removed.

ELECTRICAL impulses are commonly used to produce involuntary muscular contraction. Many beneficial physiological results have been ascribed to such treatments although not all of these will survive authoritative medical scrutiny. In such afflictions as polio and some forms of arthritis, it is often desirable to induce activity in the affected muscles. Many beauty parlors now feature a so-called "electric facial massage." This treatment may not be medical therapy in the accepted sense, but the quality of the apparatus should be on a par with that intended for more serious medical work.

In the electric facial, two electrodes are applied to the various nerve motor points on the face. An alternating potential, usually a low audio-frequency pulse of several to perhaps a dozen cycles per minute, is delivered to the electrodes by the machine. This is claimed to provide relief from tenseness and to induce relaxation in muscles which have been unduly contracted by the tempo of modern living.

The circuit of Fig. 1 was designed to eliminate some of the deficiencies found in existing equipment. In much apparatus presently being marketed, mechanical or thermomechanical means are used to pulsate the voltage. Failures in the switching mechanisms and the corrosion and pitting of the contact points reduce the reliability of such equipment. Trouble from this source is more frequent than tube failure in the cheaper machines. The pulsing can, of course, be done electronically. The author, after servicing many machines, is in favor of eliminating all mechanical motion to make the machines more reliable.

Another shortcoming of many such machines is the difficulty of applying

two electrodes to the patient's face and simultaneously adjusting the amplitude control on the panel to the proper level. This is a very important procedure. The correct amplitude is usually determined experimentally by advancing the amplitude control a bit at a time and alternately asking the patient if there is any feeling of discomfort. The operator also watches for the first visual evidence of stimulation.

This procedure is not entirely satisfactory. If the voltage is too high, the patient will get an unpleasant shock. Second, it requires a little time for the electrolytic resistance between skin and electrode to become stabilized. Therefore, when the operator must repeatedly put down the electrodes to

readjust the amplitude control on the machine, considerable experimentation is sometimes necessary—to the discomfort and annoyance of the patient. This situation is aggravated because the neuromuscular system does not immediately decide upon the most pleasant amount of excitation.

Third, the sensitivity to electrical stimulus varies with different nerve motor points. What may be a tolerable or pleasant stimulation at one position of electrode application may be painful half an inch away. This makes it highly desirable for the operator to have means of reducing and increasing the intensity of the stimulus quickly and smoothly.

Furthermore, for an extensive range

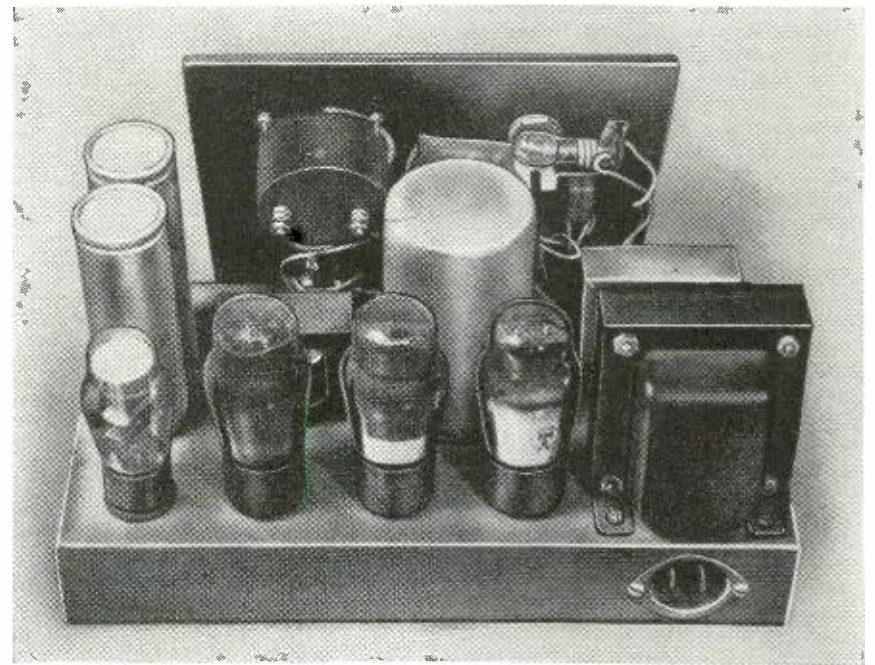

of stimulus intensity, pain results more from too rapid a change in intensity than from the level of the intensity itself. Consequently, the electrodes must not be applied or removed abruptly when the amplitude is above the threshold of initial response.

Because of these considerations, an auxiliary amplitude control was installed directly in the handle of one of the electrodes. The series variable resistor used for this purpose is mounted so the operator can manipulate it with her fingers as she applies the electrode to the patient's face. This amplitude control provides sufficient variation of electrode potential so the main control on the panel of the machine can be set permanently at some nominal position. The electrodes make contact with the skin through small felt pads about 5/8 inch in diameter. These pads are made conductive by soaking them in an electrolyte such as a solution of bicarbonate of soda.

The machine delivers either 500-cycle alternating current or direct current. In the terminology used in electrotherapy work, a periodic alternating potential is called a "contractive mode." Similarly, a direct potential is known as the "galvanic mode." Pulsing of the electrical stimulus is called "surging." This machine enables either of the modes to be surged or to be applied at a constant level. There are, therefore, four combinations of electrical stimulus available. The galvanic mode is used to drive the ions of certain pharmaceutical preparations into the tissues.

The circuit is basically a blocked-grid audio oscillator followed by a class-A amplifier and a rectifier for the galvanic mode. The R-C combination R4-C3 is a feedback link which sustains the duration of the pulses or surges generated by the 6F6 blocked-grid oscillator. Without this feedback network, the pulses are sharp and very short in duration compared to the time between successive pulses. The feedback makes the surge periods approximately equal to the quiescent periods. This holds for the range of surging frequency provided, which is from 5 to 40 surges per second.

The control which varies surge frequency and the switch which selects either surge or constant-level operation is in the grid circuit of the 6F6 oscillator. R1 and C1 are the conventional grid leak and grid capacitor, respectively. R2 and C2 in the grid circuit vary the R-C time constant of this part of the circuit. R2 varies the frequency of the surges of 500-cycle oscillations developed by the 6F6 tube. The switch S1 determines whether the 6F6 will operate as a blocked-grid or constant-output oscillator. When S1 is in the SURGE (open) position, the oscillations are pulsed at a frequency determined by R1-C1 and R2-C2.

When S1 is in the CONSTANT position (closed), an additional resistor R3 is shunted across the grid-leak network. Although the basic circuit is not changed, the blocked-grid oscillator

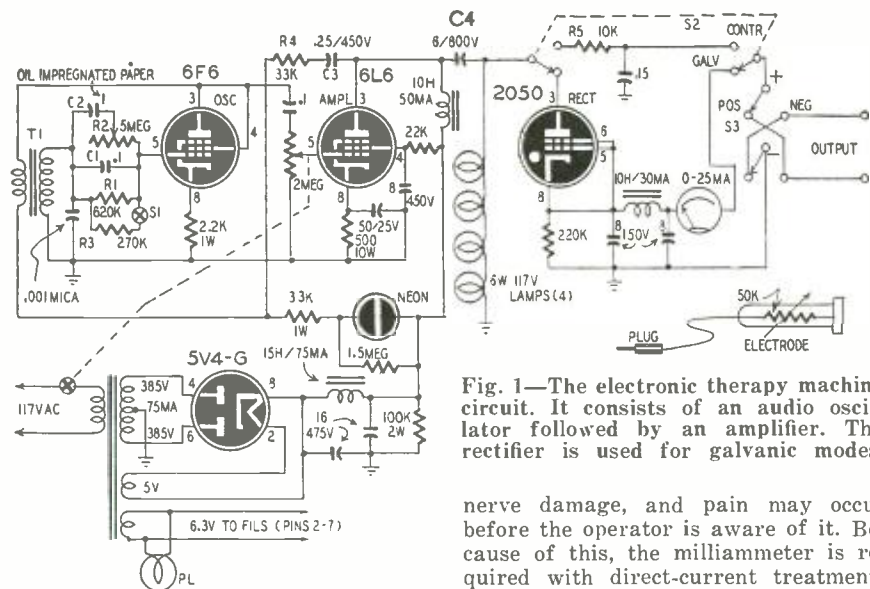

Fig. 1—The electronic therapy machine circuit. It consists of an audio oscillator followed by an amplifier. The rectifier is used for galvanic modes.

will not pulse when the grid-leak resistance is too low because the reduced time constant of the grid circuit allows the charge on C1 to leak off fast enough that it cannot become sufficiently negative to block the grid. The circuit then acts as a constant-output oscillator.

When S1 is in the SURGE position, the panel-mounted neon bulb blinks at the surge rate. When S1 is in the CONSTANT position, this bulb glows with a steady light.

The four series-connected, 6-watt bulbs give the leading edge of the surges a gradual rise because of the change in resistance of the lamp filaments. When the output of the 6L6 amplifier is impressed across these lamps immediately after the blocked-grid oscillator has burst into oscillation, the cold resistance of the filaments is comparatively low and a large amount of the audio energy is dissipated. As the filament temperatures rise, their resistance increases and more power is delivered to the output terminals. Thus, even though the oscillator bursts into oscillation abruptly, the output of the amplifier becomes maximum at a much slower rate.

The feedback network R4-C3, not only prolongs the duration of the oscillation pulses, but also delays the decay of the pulse. As a result, both the rise and fall of the audio-frequency energy pulses are gradual enough to avoid the sensation of electric shock caused by too high a rate of change of the stimulus.

When S2 is in the GALVANIC position, the output of the 6L6 is rectified by the 2050 thyratron which functions as a half-wave rectifier. The output of the rectifier is filtered by a conventional capacitor input.

No metering provision is made for the contractive mode. Electrical stimulus of a nerve motor point causes muscular contraction if alternating current is used and the frequency is not too low nor too high. Direct current causes no such contraction if the rate of change of the stimulus is not too high, and burning of the skin tissue,

nerve damage, and pain may occur before the operator is aware of it. Because of this, the milliammeter is required with direct-current treatments so the correct milliamperage "dose" prescribed for the particular treatment is given. With alternating current, the operator merely watches for muscular contraction. If this is obtained gradually and carefully, the muscles will be exercised rhythmically with a soothing sensation. There will be no feeling of electric shock.

The patient is isolated from the high-voltage d.c. by capacitor C4 and

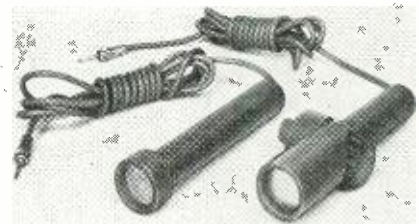

Photo of the two electrodes. One has a built-in potentiometer for easy control.

the 10,000-ohm resistor R5. This capacitor must be of such quality and voltage rating that the probability of dielectric failure is negligible. In this case an 800-volt transmitting type is used. Any other safety precautions which might occur to the experimenter should be used.

The laws concerning the commercial use of this kind of apparatus vary in different states. In most cases, the operator must show evidence of formal training in therapy or nursing. However, many of the beauty operator schools provide the necessary training and meet the legal qualifications of most states.

MATERIALS FOR THERAPY MACHINE

- Resistors: 1—10,000, 1—33,000, 1—220,000, 1—270,000, 1—620,000 ohm, 1—1.5 megohms, 1/2 watt; 1—2,200, 1—33,000, ohm, 1 watt; 1—100,000 ohm, 2 watt; 1—500 ohm, 10 watt, wire-wound; 1—50,000 ohm, 1—2, 1—5 megohm potentiometers.
- Capacitors: 1—.001, 2—.01 uf mica; 1—.015, 1—1 uf, 600 volt, paper; 1—6 uf, 800 volt, oil-impregnated paper; 1—8, uf, 450 volt, 2—8 uf, 150 volt, 2—16 uf, 475 volt, 1—50 uf, 25 volt, electrolytic.
- Transformers: 1—385-0-385 volt, 75 ma, 5 volt, 6.3 volt; 1—audio interstage, 3:1 ratio; 1—15 henry, 75 ma, 1—10 henry, 50 ma, 1—10 henry, 30 ma, chokes.
- Miscellaneous: 4—6-watt, 120-volt lamps; 1—1/2-watt neon lamp; 1—0-25-ma d.c. meter; tubes, chassis, switches, sockets, hookup wire.



The phon meter, complete. Most constructors will use standard microphone plug.

THE noise of whirring machinery and pounding punch presses can annoy factory workers, decreasing their efficiency. Traffic noises may produce unfortunate effects, and noises in many other locations may affect people and processes more or less profoundly.

Measurements of these noises are becoming more important every day as methods for increasing production efficiency and comfort advance. It might appear that the matter is simple—just set up a microphone and amplifier with an output meter. The difficulty is that the microphone and amplifier would function more or less linearly, while the human ear does not. The problem is to make the meter readings indicate as closely as possible, not the absolute level of the noise, but its apparent loudness as the ear hears it.

The response of the ear to changes in volume level is neither linear nor logarithmic, nor does it follow any other straight-line function. The closest approximation, however, is logarithmic, which is the reason for the use of the decibel as the measure of sound-level change.

To complicate matters further, the ear does not respond in the same way to all frequencies. The graph of Fig. 1

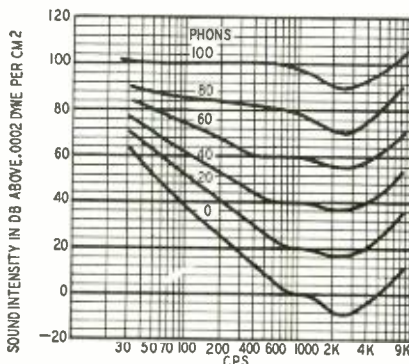

Fig. 1—Equal-loudness curves show how the ear's response varies with intensity.

presents the well known Fletcher-Munson curves, which show the required relative levels of sound at various frequencies for a sensation of equal loudness.

The unit of apparent loudness is the

* Lecturer in electronics and electro-acoustics, Melbourne Technical College, Australia.

Sound Level Indicator Imitates Ear Response

By JOHN W. STRAEDE*

phon. It takes into account the ear's frequency response and the ear's change in frequency response with changes in intensity. It tells how many decibels a sound is above the threshold of hearing.

The level in phons of any sound is the same as the number of db above .0002 dyne per square centimeter of a 1,000-cycle tone which sounds exactly as loud to the average listener as the sound being measured. When the curves of Fig. 1 are being used, the level in phons of a measured sound pressure is the same as the label on the curve in which that pressure at that frequency can be found.

These curves represent the loudness level of pure tones and cannot be applied to sounds containing a spectrum of frequencies such as the noise level in a room. But they do indicate the ear's response to different sound levels.

TABLE I

TABLE OF PHONS

Threshold of audibility	0
Cat purring	20
Quiet countryside	30
Rainfall on roof	40
Quiet conversation	50
Small chamber orchestra	60
Loud speech	70
Symphony orchestra	80
Rivet hammer	100
Unmuffled aircraft engine	110
Threshold of pain	130

Table I lists a number of typical noise sources with the usual noise level in phons for each. The table should enable the newcomer to the phon to orient himself and gain a little familiarity with the orders of the numbers.

Meter characteristics

A meter designed to measure sound level in phons must have two characteristics that make it comparable to the human ear. First, its frequency response must approximate the curves shown in Fig. 1. Second, the frequency response must change with the sound level, becoming flatter as the level rises, according to Fig. 1. Fig. 2, for example, shows two curves that would be required at two different levels. While their shapes are the same in general, one attenuates from 200 cycles and the other from 400. The dotted lines show the crossings of the asymp-

tores, at which points the turnovers are considered to take place. Of course, a compromise is necessary to avoid great complications in the circuits.

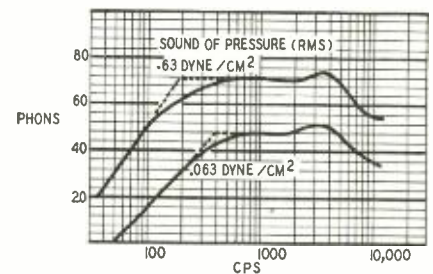

Fig. 2—These curves complement two in Fig. 1. They are ideal for noise meter.

The easiest compromise in practice is simply to reduce the highest and lowest frequencies. That can be done very readily by reducing the value of a coupling capacitor and using another capacitor to bypass highs. The circuit and its response are given in Fig. 3. Notice that this curve is within a decibel or two of the upper curve in Fig. 2 at every point. Fig. 3 corresponds roughly to the 60-phon curve of Fig. 1, which, as can be seen in Table I, is at about the middle of the sound range usually measured.

A practical meter

The instrument described here does not have high accuracy. It is intended for use primarily by the radio service technician, amplifier enthusiast, public-address specialist, advanced architect, designer of sound insulation systems, and automobile engineers.

The basic design is a three-stage voltage amplifier followed by a diode-type vacuum-tube voltmeter. The complete circuit is shown in Fig. 4.

Although the 6SF7 is a 6.3-volt tube, it is fed from a 5-volt filament winding to keep the cathode of the diode fairly cool. If the cathode were extremely hot, the excess emission of electrons would produce a false reading on the meter. It is not necessary to reduce the voltage below about 5¼ volts in most cases—sometimes the full 6.3 volts can be used, but many power transformers have a 5-volt winding.

Sound levels are continually varying and the meter must be highly damped; otherwise each tap or scratch will cause a large flicker of the needle and read-

ing the meter will be impossible. A large capacitor (1,000 μf) is connected directly across the meter and another of lower capacitance (24 μf) but higher voltage rating is shunted across part of the diode load. Both of these damping capacitors must have *very low leakage* or there will be a big drop in sensitivity.

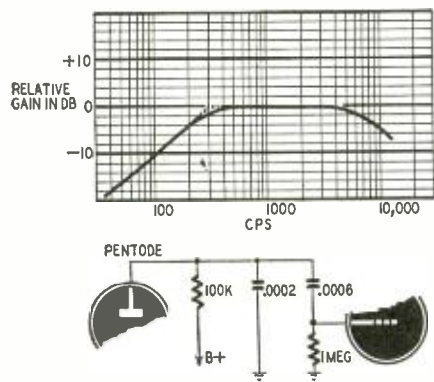

Fig. 3—This simply realized response is produced by the circuit diagrammed above.

The amplifier should have reasonably good logarithmic characteristics to keep the "phons" scale from being too cramped at the low end. This is achieved partly by the use of a number of ranges and partly by the use of grid-leak bias for the first two tubes, particularly for the second one. The gain of a grid-leak-biased pentode varies in a surprising way with the signal level. As the signal level rises from zero to a low value (usually provided by hum, stray r.f., and tube noise), the gain rises very rapidly to a maximum. As the signal increases, the gain decreases so that the circuit is more sensitive to small signals than large.

The range control consists of a voltage divider, the resistors of which are rather critical, preferably less than 2½% tolerance.

The markings on the range control carry, not the usual factors or multiplication signs, but those of addition. At the sensitive position, labeled as SCALE on the panel, the effective range of the meter is 40 to 60 phons, which occupies the central two-thirds of the scale. At the other positions the range control reduces the gain by factors of $\sqrt{10}$, 10, $10^{1.5}$, 10^2 , etc., and so the corresponding markings on the front are +10, +20, +30, +40 etc. Highest range being +50, the loudest sound that can be measured is 110 phons (actually 113 at extreme end of scale). A range of 40 to 110 phons covers whispers to boiler riveting.

Slightly greater accuracy on the higher ranges can be achieved by inserting between resistor R (Fig. 4) and the chassis a 3,000-ohm resistor shunted by a 0.25- μf capacitor. This helps to match the ear's increase in low-frequency response at high levels.

The diode load resistance is adjustable in value, providing a measure of sensitivity control. It is not intended to act as a compensating device for

variation in values, but rather as an initial adjustment before calibration so that the lowest range (40 to 60 phons) fits nicely on the meter scale with a little clear space at each end. When adjusting the 0.1-megohm potentiometer, a position of maximum sensitivity will be found and the sensitivity should be reduced (slightly) to the required value by increasing the resistance rather than reducing it. If you are interested solely in a *relative* calibration, the potentiometer could be replaced by a fixed resistor of about 25,000 ohms.

High voltage for the three tubes comes from a conventional power pack using a 6X5-GT rectifier and a simple R-C filter. Anode voltages are not critical, and the secondary of the transformer can deliver anything from 550 to 750 volts. In the particular instrument illustrated in the photographs the rectified voltage was 315. Further smoothing is provided for the first two tubes by the decoupling net-

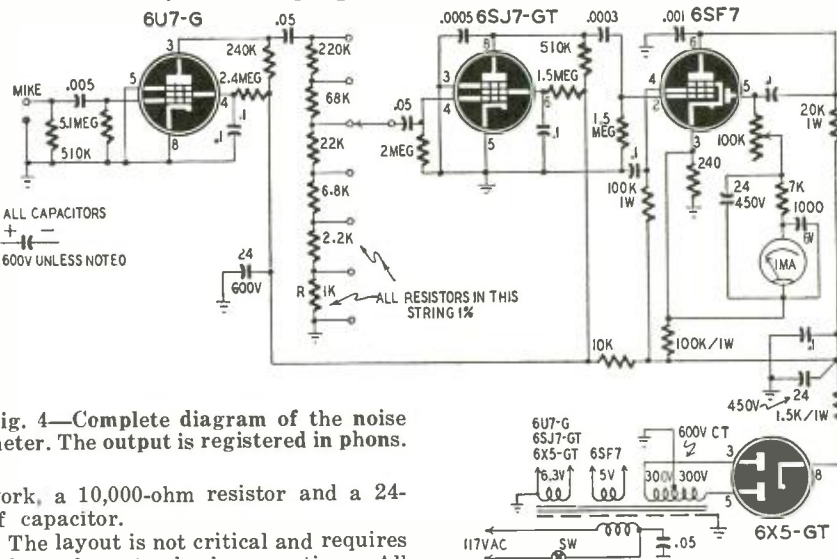

Fig. 4—Complete diagram of the noise meter. The output is registered in phons.

work, a 10,000-ohm resistor and a 24- μf capacitor.

The layout is not critical and requires only a few standard precautions. All components normally grounded to the chassis are separated by fiber insulating washers, and a ground buss of bare copper wire connects them all together and to the chassis at one point only—as close as possible to the cathode lug of the first tube. This keeps down hum level and should be adopted in all amplifiers, test equipment, and the like.

Sensitivity is adjusted by means of a screwdriver fitting into a slot hack-sawed in the shaft of the 0.1-megohm potentiometer, which is mounted underneath and partly to one side of the meter. A tube socket is used for the microphone input.

Calibration

Absolute calibration of the instrument can be performed only if you have access to a calibrated microphone or an acoustics laboratory, but a relative calibration (differing from a true calibration by a *constant* number of phons, probably only a few) can be performed quite readily by using a good-quality a.c. voltmeter. The circuit is shown in Fig 5.

Set the first 1,000-ohm potentiometer to give a reading of 1.5 volts. Then adjust the second potentiometer to make the noise meter read about three-quarters of full scale on any convenient range—preferably one of the middle ranges. Mark the position of the needle on the scale. Now, keeping the second potentiometer fixed, reduce the voltage with the first potentiometer to 0.47 volt and again mark the needle position. The first marking should be labeled 60 phons and the second 50 phons. Following are a series of voltages and corresponding phons: voltages, 1.5, 1.2, 0.94, 0.75, 0.6, 0.47, 0.27, and 0.15; phons, 60, 58, 56, 54, 52, 50, 45, and 40.

The most reliable part of the scale will be that between 50 and 60.

The microphone must be nondirectional—including upward and downward. It must be pressure-operated because the response of a velocity-operated microphone varies with its distance from the source. Fortunately,

the requirement is easily met, as many nondirectional pressure microphones are available. A crystal of the sound-cell type is ideal except that its response varies with temperature. Probably the best bet is a moving-coil or dynamic microphone.

Electronics amateurs suffering from talkative wives can educate said wives

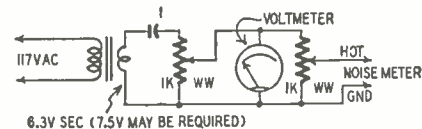

Fig. 5—With this auxiliary circuit the meter is given a relative calibration.

to refrain from talking by connecting a sensitivity relay in place of the meter. Any time the noise level rises above a certain value, the relay closes a circuit setting the phonograph playing some suitable record.

Teachers may find a similar use in class control, the phonograph being replaced by a 500-volt supply and contacts on the seat of every desk!

Square Wave Analysis For Audio Amplifiers

Part II—Circuits for square wave generators and more uses for them

By EUGENE J. THOMPSON

AN ideal square wave is the algebraic sum of a fundamental frequency and all its harmonics. (In practice, harmonics up to about the thirty-first are enough for a good square wave.) Therefore, the action of an electronic circuit on all of these frequencies can be observed, *simultaneously*, by passing a square wave through the circuit. This makes it unnecessary to study the effect on each frequency individually, as was formerly the practice. The result is a great saving of time and work. In the preceding article, the square wave method for checking the frequency response of an audio amplifier from 500 to 15,000 cycles, in one operation, was described.

Approximations of square waves can be produced with clipper networks similar to those used for timing, control and trigger voltages and for wave-shaping in radar, television, and other pulse transmission systems.

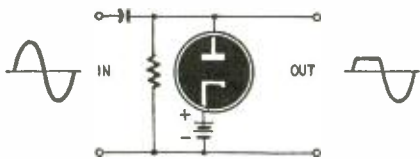

Fig. 1—Simple parallel diode clipper.

Fig. 1 shows a simple parallel diode clipping circuit. The diode is biased so that it will not conduct until a predetermined positive voltage is applied to the plate. As the input voltage rises from its zero value, the diode remains an open circuit until the voltage is high enough to make it conduct. As soon as

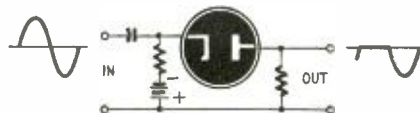

Fig. 2—Series diode clipping circuit.

the diode conducts, it is effectively a short circuit compared to the other circuit components, and the further rise in input voltage does not show up at the output.

A series diode clipping circuit is shown in Fig. 2. In this case, the diode is biased so that it conducts and is a

short circuit until the input voltage rises high enough to make it stop conducting. When this happens, there is no current in the load resistance, and again the top of the sine wave is clipped off. In either of these circuits, the bottom of the sine wave signal could be clipped off just as well by reversing the diode connections and the bias.

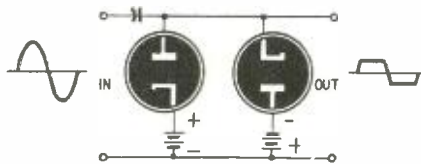

Fig. 3—Two diodes will clip both peaks.

By using two diodes, both the top and the bottom of the sine wave can be clipped. Fig. 3 shows the diodes in a parallel arrangement; in Fig. 4 the diodes are in series. In each of these circuits, the clipping action is the same as with the single diode.

Fig. 5 shows a triode used as a clipper. The sine wave input must be large enough to drive the triode to saturation on the positive half cycle and to drive it to cutoff on the negative half cycle so that both peaks of the sine wave will be clipped. The load resistance of the triode must be large enough so the saturation current will not exceed the tube's current rating.

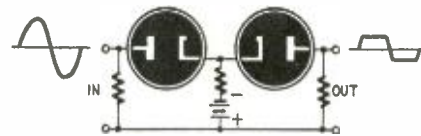

Fig. 4—Two diodes in a series clipper.

With any of these circuits, an ideal square wave can be approximated better by amplifying the clipped wave and clipping it again so that the sides of the square wave will be only the steepest part of the sine wave.

Better square waves can be obtained with the generator in Fig. 6. This is a type of relaxation oscillator known as a free-running multivibrator and is used for generating control and trigger voltages in radar and television equipment. It is a two-stage, resistance-

capacitance-coupled amplifier with regenerative feedback. The output of each of the 6J5's is capacitance-coupled to the grid of the opposite tube. As the

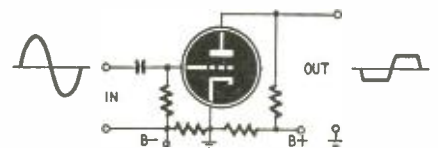

Fig. 5—Clipper circuit using a triode.

signal applied to the input of an R-C-coupled amplifier is reversed in phase at the output, it is of the right polarity to reinforce the signal applied to the grid of the opposite tube. The oscillations are produced by the regenerative switching action resulting from one tube conducting while the opposite tube is nonconducting. The output signal is then passed through a cathode follower which isolates the multivibrator from the following stage, a class-A amplifier. This circuit is the one used in the Du Mont type 185-A electronic switch and square wave generator.

The frequency response of any circuit depends upon its constants. A given combination of R and C will pass a certain range of frequencies and no others. The problem is to determine if a certain circuit will pass the required frequencies. Because square waves are a composite of a wide range of frequencies, this often can be done in one operation.

A square wave is square because it consists of a fundamental and all its harmonics *in definite phase and amplitude relation to each other*. Any circuit which changes the phase relation or the amplitude of any of the components will distort the square wave. Only when the circuit passes all the frequencies of the square wave without attenuation or relative phase shift can the output be undistorted. This is the principle of square wave analysis.

In this relatively brief treatment, not all the possible uses of square wave technique can be discussed. The applications which follow have been selected to suggest other uses to the reader in his own particular field of interest and experience. The only equipment re-

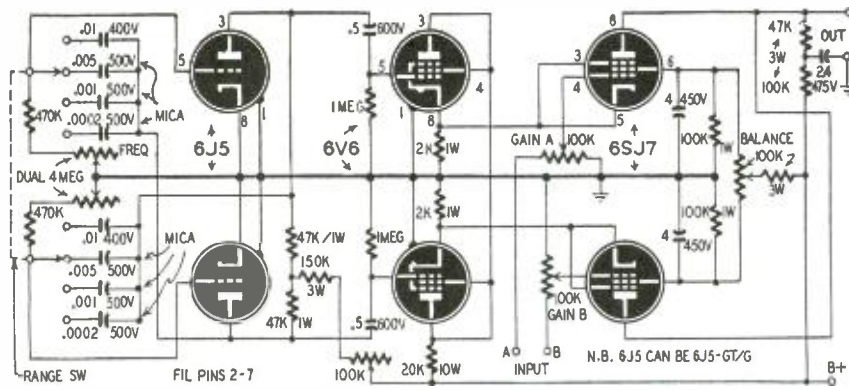

Fig. 6—This multivibrator-controlled circuit will produce good square waves.

quired is a square wave generator and an oscilloscope, having a frequency response that will pass the fundamental and all the desired harmonics of the square wave without attenuation or relative phase shift. The square wave

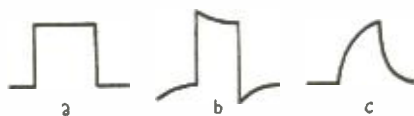

Fig. 7—Three types of pattern: b and c show low- and high-frequency losses.

generator is connected to the input of the circuit under test, and the oscilloscope to the output.

As in any procedure using cathode-ray oscilloscopes, some skill is necessary to interpret the patterns, but this is readily acquired with a little experience. In general, three major types of patterns are seen (see Fig. 7). These represent: (a) no attenuation or relative phase shift, (b) a loss of low-frequency response, and (c) a loss of high-frequency response.

Square wave analysis can be used for signal tracing public address systems and the audio amplifier sections of receivers. The usual stage-by-stage test procedure is used. If a stage is dead because of an open coupling capacitor or a shorted bypass capacitor, or for some other reason, there will be no output from the stage on the oscilloscope. If the grid bias is incorrect, the square wave output for that stage

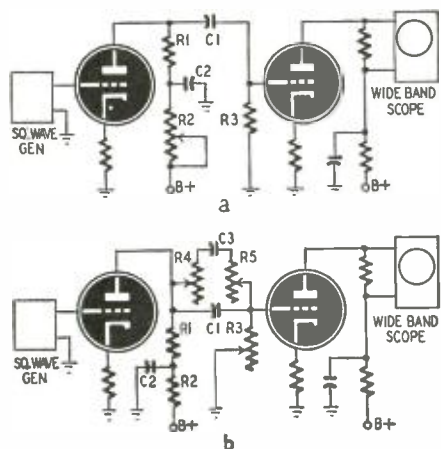

Fig. 8—Two ways to use square waves for adjusting video amplifier response.

will be distorted. The same is true if the frequency response is not good.

Video amplifiers can be serviced in the same way. In addition to this, their low-frequency characteristics sometimes need adjustment. Fig. 8 is a typical video amplifier circuit.

If the R-C constants C1 and R3 change in value, they may introduce phase distortion in the lower frequencies. The phase distortion can be reduced by substituting a variable resistor for R2 and trying different values for C2 and adjusting them until the oscilloscope trace approaches the square wave shape as nearly as possible. This is illustrated in Fig. 8-a.

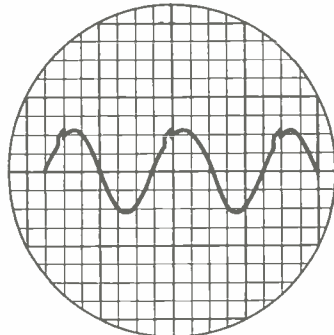

Fig. 9—A scope pattern showing square wave pips superimposed on sine wave.

A more satisfactory procedure (Fig. 8-b) employs the combination of R4, R5, and C3. C3 is selected to have a small reactance compared to the sum of R4 and R5 at the lowest frequency to be passed. If the values of these components are adjusted until the output has a square shape, they will compensate for variations which exist in the other circuit constants and reduce the relative phase shift. When the circuit has been properly adjusted by either of the above methods, the values of the variable capacitors and resistors are measured and fixed components substituted for them.

An accurate square wave generator can be used to check the calibration of audio-frequency oscillators. The outputs of both instruments are applied to the vertical plates of the oscilloscope and the a.f. oscillator is tuned to a number of different frequency settings. At each setting, the horizontal sweep of the oscilloscope is adjusted to get

several complete a.f. cycles on the screen. The frequency of the square wave generator is then tuned until the little square wave "pips" stand still on the sine waves (see Fig. 9). If the readings of the sine wave generator and the square wave generator agree, the calibration of the former is correct.

The above procedures are also useful for checking receivers and the modulator stages of transmitters, frequency

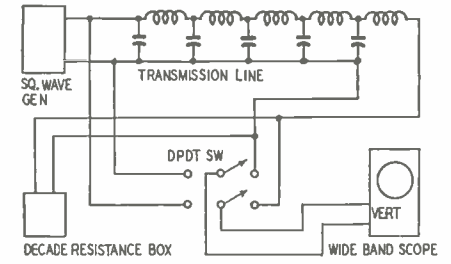

Fig. 10—Setup for impedance matching.

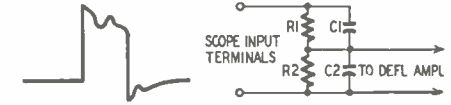

Fig. 11, left—Reflection distort wave. Fig. 12, right—An attenuator circuit.

calibration, etc. The correct terminal impedance of transmission lines also can be found by square wave analysis.

Fig. 10 represents a typical transmission line. If the terminal resistance is incorrect, the reflections within the line will distort the waveshape as shown in Fig. 11. The stepping up of the voltage because of these reflections is quite pronounced. The correct terminal impedance can be found by varying the resistance of the decade box until a square wave is obtained. After this, the oscilloscope should be connected to the input of the line to check for reflections.

Fig. 12 is a schematic diagram of an attenuator network employed in some types of oscilloscopes to limit the input voltage. If the values of the components are set so that the ratio $R1/R2$ is equal to $C2/C1$, the attenuator will have a flat frequency response. Stray capacitance and slight variations in the values of C1 and C2 will cause amplitude distortion.

To remedy this by the square wave method, the fundamental frequency of the square wave is selected a little above the frequency at which $XC1 = R1$, to obtain the full effect of the capacitive reactance for all harmonics. If the output waveshape indicates that the low frequencies are being attenuated, the ratio $C2/C1$ is too small; and if the high frequencies are being attenuated, the ratio is too large. Compensation can be made by substituting a number of capacitors for either C1 or C2 until the output is a square wave.

In addition to the above applications, the square wave generator and oscilloscope have numerous other uses. Square wave generators can be used as electronic switches to permit the simultaneous viewing of two or more different electrical phenomena which are to be compared.

Electronics and Music

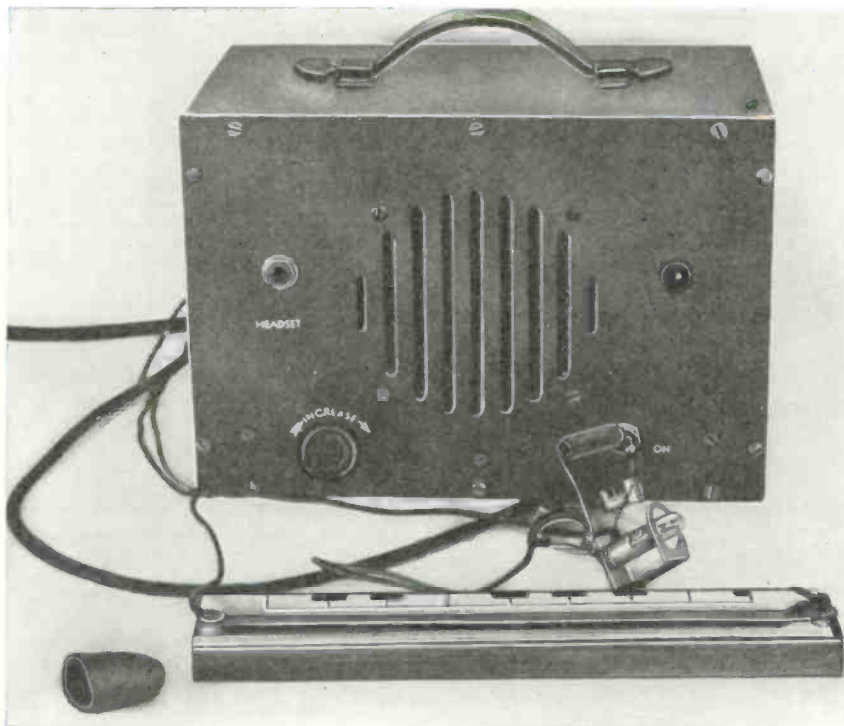

PART II

Some theory of musical scales and the simple tone generator

By
RICHARD H. DORF

Experimental unit built by the author after Fig. 3. The long resistor is made with lead pencil and the piano-key drawing is a guide for fingering. The rubber fingertip insulates the player.

THE designer and experimenter with electronic music has lots of room in which his imagination and ingenuity can run around. He need not be bound by what has been done before, but he will almost always get inspiration and assistance from a knowledge of the best of the many systems tried and used in the past. For that reason, this article and following ones present a number of designs and circuits in commercial musical instruments and in an exhaustive survey of U.S. patents, as well as some that are original or partly so with the writer.

The tempered scale

The most important basic interval between tones, the *octave*, is common to all musical scales—it is the starting point and initial building block. The

octave of any note has a frequency equal to twice that of the note itself; it is, in other words, the note's second harmonic. It is important because the human ear senses a kind of identity between any note and its octave, a feeling that the note is being repeated at a higher pitch.

The most familiar system of music in the western world uses the so-called tempered scale consisting of 12 tones, with the interval between adjacent tones equal as far as the ear can detect. Since the ear's response to frequency (as well as volume) is logarithmic, the frequency difference between adjacent tones is progressively greater as pitch increases.

The piano keyboard drawing in the tempered-scale frequency chart in Fig. 1 can be used to illustrate the tone

structure of music. The white keys are always identified by letters A through G. The keys in this chart are also numbered from 1 to 88. Middle C is key No. 40. The major scale consists of seven notes plus an eighth which is the octave of the first.

Beginning at middle C, we can play a C-major scale by pressing in turn each of the white keys—Nos. 40 through 52. Key No. 52 is the octave of key No. 40. Additional octaves of C are Nos. 64, 76, and 88. The notes in each octave are known by the same letters as those in other octaves.

Notice that the frequency intervals between adjacent notes of the major scale are not constant. To begin with, most are not adjacent to each other because black keys are interposed. The black keys are known as *accidentals*

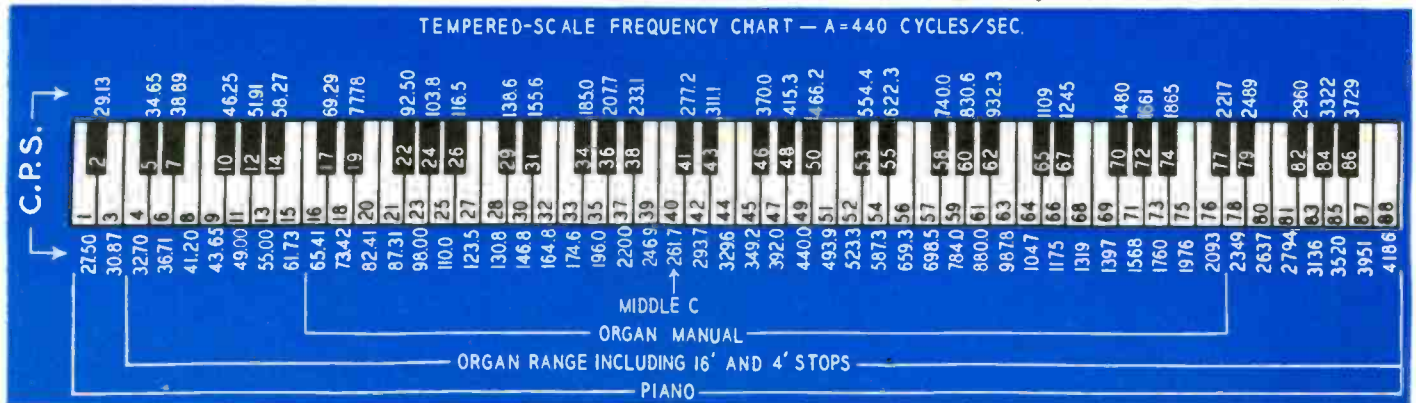

Fig. 1—Drawing of a piano keyboard showing the tempered scale. The frequency of each note in cycles per second is given.

(appropriate because they do not occur in the scale itself but are used for a sort of embellishment). Each accidental may be identified in two ways: it is the *sharp* of the white key below it and the *flat* of the white key above it. Thus, note No. 41 may be called either C-sharp or D-flat. The interval between any key and its next adjacent one, black or white, is a *half-tone*. Since two halves make a whole, the interval between two notes with one key between them is a whole tone. Example: C to D is a whole tone; E to F is a half-tone.

Other terms that will be used in these articles also refer to intervals. We already have the half-tone and the whole tone. Next is the *third*. That is the interval between one note of the scale and, not the next, but the second higher one—between, for instance, C and E in the C-major scale, or between F and B. There are also fourths, fifths, sixths, and sevenths. In each case, the number is an ordinal, not a fraction, and refers to the third, fourth, etc., note from the starting point, counting the starting note as the first. These numbers refer only to notes in the scale, not to accidentals. Thus, a seventh, with C as the bottom note, has B as the top one in the key of C, but B-flat is the seventh of C in the key of F, since, as we illustrated, B-flat is part of the F-major scale, and B-natural is not.

Neon-lamp oscillators

Probably the most truly electronic method of tone generation is the use of space-discharge tubes—hard and soft electron tubes—in which nothing moves except electrons and perhaps ions. Of these, the simplest types are gas-tube relaxation oscillators.

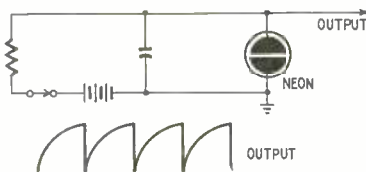

Fig. 2.—The basic relaxation oscillator and sawtooth waveform it produces.

The basic circuit is shown in Fig. 2, using a neon lamp. When the switch is closed, the capacitor starts charging. The lamp cannot ionize or fire until the voltage across the capacitor is above its breakdown point. The rush of electrons from one capacitor plate to the other passes through the resistor, the voltage drop across which reduces the voltage available to charge the capacitor. As the capacitor continues to charge, however, the electron flow diminishes and the drop across the resistor becomes smaller until finally the capacitor is fully charged to the voltage of the battery.

In practice, the capacitor is never allowed to charge fully. When the charge reaches the breakdown voltage of the neon lamp, the neon ionizes suddenly and the lamp becomes a fairly low resistance. This near-short across the capacitor quickly discharges it.

There being now little or no voltage across the lamp and capacitor, the lamp deionizes and the capacitor once more starts to charge. The cycle is repeated indefinitely, its time per cycle (and thus its frequency) depending on the battery voltage, the resistance, the capacitor, and the striking and extinction voltages of the lamp. Output may be taken across the lamp or across any part or all of the resistor. The output wave is a sawtooth like that shown in Fig. 2.

The frequency of a neon-lamp relaxation oscillator is not stable. Even if all components and voltages are held constant, the discharge may not always take place between the same points along the two electrodes in the lamp. The gas is somewhat temperature-

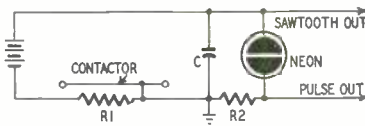

Fig. 3—A simple monophonic instrument requiring only an amplifier and loudspeaker to complete it. Contactor is pressed by finger to determine pitch.

sensitive, too, and the replacement problem is important, since no two "identical" lamps ever oscillate at the same frequency.

The Trautonium

A single neon lamp has been used in a solo instrument with continuously variable frequency by (among others) the German inventor, Friedrich Trautwein, in his Trautonium and similar instruments. The basic idea appears in Fig. 3. The circuit is standard except that R2 has been added as an output load. Its value is a fraction of that of the main tuning resistor R1. A sawtooth wave is obtained from across the lamp and a pulsed output, the result of the periodic neon-lamp discharges, from across R2.

R1 may be a long coil of resistance wire or a long composition element like those used in potentiometers. The contactor is a strip of flexible conducting material suspended slightly above R1 and topped with a nonconducting (insulating) layer. The player presses his finger on the contactor at any point to short out part of R1 and change the frequency.

Typical values for R1 and C with a 1/25-watt neon lamp experimented with by the writer are 1 megohm and .005 µf. R2 may be anywhere from 1,000 to about 100,000 ohms. The lower values are safer because the following circuits will affect the tuning less, but of course more amplification is necessary.

The circuit to which the sawtooth output goes must have a very high impedance or a high resistor (and usually a blocking capacitor) must be inserted in series with the output.

Feeding the two outputs to different amplifiers and mixing the results gives various tone qualities. The actual Trautonium circuit is more complex and will appear in another article.

Synchronized oscillators

Neon-lamp oscillators can be used in a complete organ if they are synchronized by a stable source of frequency.

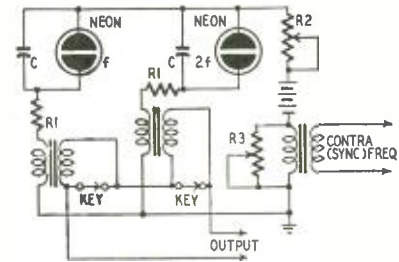

Fig. 4—One method of synchronizing a set of octavely-related neon generators.

For a full scale, this requires 12 such sources, one for each of the notes in the top octave, which may be vacuum-tube oscillators, tuning forks, or any other stable devices. Each source synchronizes one note in each lower octave. A typical way of doing this appears in a patent issued to Nicholas Langer, who is probably the most prolific worker with gas-tube oscillators for music use. The idea is shown in Fig. 4.

Two neon oscillators are shown, one tuned roughly to the desired frequency and the other to about twice that frequency or an octave higher. There would be one oscillator in this string for each note and one for each of its octaves which appear in the organ; for example, six if the note were C, on a 61-note instrument. The neon lamps are fixed-tuned by resistors R1 and capacitors C. Across the common resistor R2 appears a small part of the variations in current caused by each oscillator. This is a synchronizing voltage, which locks all the oscillators together in octave relationship. R2, which should have a maximum value of about 10,000 ohms when 1-megohm resistors R1 are used to tune the oscillators, is varied so that locking is obtained with a minimum of resistance in the circuit.

R3 is across the secondary of a transformer which is fed by a primary sync source—a tuning fork or vacuum-tube oscillator of high stability with a frequency equal to or one octave above the highest note wanted. By adjusting R3, enough primary sync signal is brought in to lock all the oscillators to it.

Output is taken through the transformers associated with each oscillator. The primaries are in series with the lamps and the secondaries are in series with each other. Each secondary is normally shorted. When a key is pressed, the short is removed and the desired tone goes through to the output. The output transformers should have fairly low-impedance primaries to avoid effects on oscillator frequency and somewhat higher-impedance secondaries to minimize disturbances fed back from other circuits. Ordinary 3-to-1 audios do the job very well.

Another system for syncing neon lamps will be found in the article "Simple Electronic Organ" in the January, 1947, issue of this magazine. Additional gas-tube tone generators will be discussed in the next article.

Modulating the BC-221 Freqmeter

By W. S. KEMPER, W4KOF

IT IS relatively simple to add modulation to those BC-221 frequency meters which do not have this feature. A BC-221-F was modified as shown in the diagram. Almost all models can be converted by following the outlines of this article and the diagram. Some are easier to modify than others because of the parts layout.

Remove the a.f. amplifier socket and replace it with an octal socket which will be used for a 6SN7 modulator and amplifier. This is not difficult in the model F because the a.f. socket is out in the clear. Break the B-plus lead to the plate and screen grid of the variable oscillator and insert the primary of a 3-to-1 interstage transformer. Connect the secondary to cathode and grid of one half of the 6SN7 with a 47,000-ohm resistor and .01- μ f capacitor in the grid lead. Replace one of the phone jacks with a s.p.s.t. toggle switch connected between B-plus and the modulator plate. This switch turns the modulation on and off. These modifications are shown in the diagram.

The modulation transformer is not critical. The cheaper it is, the better it appears to work in this circuit. Remove laminations from its core until the oscillator tunes to 400 cycles. The transformer may be mounted on the back of the panel along one side.

Connect the remaining half of the 6SN7 as an a.f. amplifier. If you plan to use batteries, ground the amplifier cathode to the hot heater lead as in the original circuit. If you use an a.c. supply, connect the cathode to ground through a 3,300-ohm resistor.

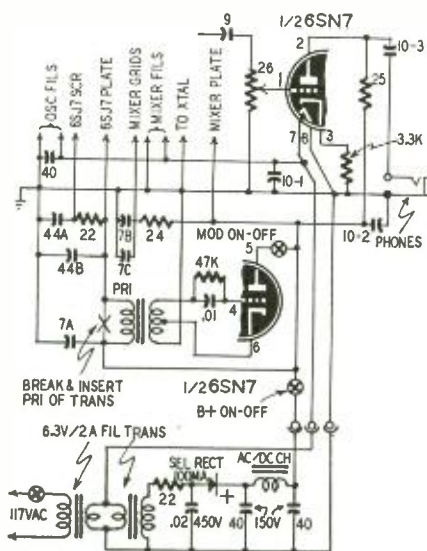

The modulation unit and power supply.

The power supply consists of a selenium rectifier in a half-wave circuit. Two 6-volt filament transformers are connected back-to-back to isolate the B-minus lead from the a.c. line. Heaters are supplied by the secondary of the transformer next to the line. Because the BC-221 was designed to hold calibration over a comparatively wide range of battery voltages, a regulated supply is not a necessity. Voltage regulator tubes such as the OB2 and OC3 may be included as refinements.

Some components in the diagram have values and others have reference numbers, reference numbers indicating components which appear in the original schematic. Add only those components which have values. Locate all components by comparing the diagram with the original schematic. BC-221 diagrams will be found in technical manual TM 11-300 which may be obtained from the Superintendent of Documents, Washington 25, D. C.

Some models have a crystal corrector—reference number 3-3 or 50—connected in parallel with the crystal to set it to exactly 1 mc. In some models, this variable capacitor is adjusted by passing an aligning tool through the hole behind the name plate on the panel. On others, the chassis must be removed from the case.

Turn on the meter and let it warm up for 15 to 30 minutes. Set the control to CRYSTAL or XTAL ONLY, then adjust the corrector until the crystal zero beats exactly with WWV. We find it easier to make this adjustment while WWV is modulated because it is easier for the ear to detect a change of a few cycles in an audio note than a difference of a few cycles at 5 or 10 mc. A 1N34 and milliammeter can be used as a zero-beat indicator.

Notes on the BC-221

Do not rotate the dial of the BC-221 through the black (uncalibrated) area as this will upset the delicate bearings and throw the calibration off so the instrument must be recalibrated to restore its original accuracy.

Some BC-221 and LM-type frequency meters are available without calibration books and crystals. If these are in operating condition, they can be used. Recalibration is a simple but fairly lengthy process.

The original crystal is enclosed in a shell which resembles a metal tube. Any reliable 1-mc crystal can be used to replace it. However, it may be necessary to modify the crystal socket. The low band of the BC-221 covers

from 125 to 250 kc on fundamentals and the high band from 2,000 to 4,000 kc. The 125-250 kc range can be calibrated roughly by tuning in its harmonics on the broadcast band. Beating the harmonics against broadcast carriers will provide several good points from which to start calibration.

Zero-beat the crystal against WWV, and use the beats between the crystal harmonics and the variable oscillator for closer calibration of the dial. Use the same method to locate beat points in the high band.

A 10-kc multivibrator is useful in calibrating between crystal check points. Adjust the multivibrator to exactly 10 kc, then loosely couple its output to the antenna of the BC-221. Select a point where the crystal and multivibrator signals are zero-beat. Turn off the crystal and leave the multivibrator running. Note the dial setting. Tune higher or lower until another 10-kc beat is heard. Record the exact number of divisions between the 10-kc beats. Divide the number of divisions by 10 to determine the number of kilocycles per dial division.

Check both bands and enter the frequencies and dial settings on a calibration chart or in a book. Check the settings and beat points several times.

TUNING AN SSSC SIGNAL

Have you ever heard an amateur phone signal which sounded one moment like a phonograph playing at half speed and like the same record at twice normal speed the next? Was the S meter waving like crazy? If so, you were listening to one of the ever-increasing number of SSSC (single-sideband, suppressed-carrier) transmitters. Because the signal seemed so distorted, you probably wondered how anyone could read it. It's really simple.

Your first step is to forget everything you have learned about tuning your receiver. Tune in the station for maximum deflection on the meter. Turn the r.f. gain all the way off and the a.f. gain full on. Turn off the a.v.c. Increase the r.f. gain until the signal is just audible. Turn on the b.f.o. and adjust its pitch so the speech sounds natural. Advance the r.f. gain for desired volume. It will probably take a transmission or so to get the hang of it; but when you do, you won't have any more trouble. Remember: A.v.c. off. Maximum a.f. Minimum r.f. B.f.o. on. Tune with pitch control.

Operating the set with maximum a.f. and minimum r.f. gain prevents overloading.

A Compact 75-Meter Rig

A portable phone-c.w. station made from surplus gear

By ERNEST J. SCHULTZ

WITH the supply of ARC-5 equipment still plentiful, it is a simple matter to assemble a complete portable phone-c.w. station with little effort. This article describes an assembly making a compact 75-meter phone-c.w. station and also a unit which vastly improves the utility of the command receiver as a communications receiver.

A glance at the surplus ads showed a scarcity of the 274-N transmitters covering the 3-4 megacycle range, indicated by the higher prices now being asked for these units. However, the supply of the BC-457-A's covering the 4-5.3 mc spectrum still seems plentiful and their cost is moderate. With no further incentive, a 457 unit was acquired together with a 3-4 mc matching receiver, a readily available item.

Conversion of the transmitter to cover the required range was just a matter of adding three turns of solid hookup wire close wound to both the oscillator and amplifier coils and realigning the slugs and trimmers in both circuits. The transmitter alignment is a simple process. The oscillator adjustment is merely a formality as the transmitter dial is discarded and the selection of dial position in regard to frequency is arbitrary. (In this case 3.5 mc was made to fall at 4.1 mc on the old dial.)

The amplifier is aligned by inserting a millimeter in the plate lead and tuning the slug for minimum current at 3.5 mc and the trimmer for minimum at 4.0 mc. The 4.6 mc crystal check point is still retained and is found near the high frequency limit of the dial.

Adding an i.f. stage

The receiver was usable as obtained but the performance was unsatisfactory on the congested 75-meter band. It seemed to receive at least half the band at one setting of the dial. It was necessary to supplement the receiver to give a higher degree of selectivity and adequate loudspeaker volume.

An outboard chassis was made of a piece of thin aluminum sheet bent to a U to fit in the space formerly occupied by the dynamotor. The device contains a 12BE6 converter and a 12AT6 diode-triode (Fig. 1). A fixed 960-kc oscillat-

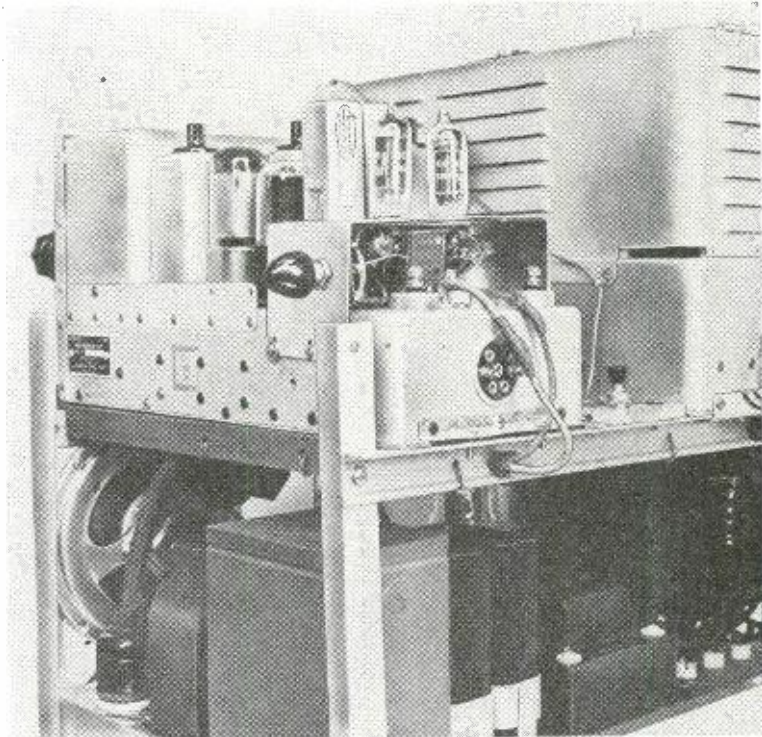

Rear view shows the outboard i.f. unit on the receiver chassis.

tor—using a broadcast oscillator coil in the converter reduces the 1415 kc i.f. frequency to 455 kc. The 455 kc signal is passed through two 455 kc i.f. transformers in tandem loosely coupled by a 3- μ f capacitor. The 455 kc signal is detected by the 12AT6 diodes and the audio is fed through a volume control to the triode section which is R-C coupled back to the 12A6 output tube in the receiver. A.v.c. voltage is taken from the 12AT6 diode load and fed back to the grids of the r.f. and i.f. stages in the receiver, providing a further refinement.

Bandspread was added to the re-

ceiver by removing all but two rotor plates from each section of the tuning capacitor and winding an additional 10 to 15 turns on the coils. (The serrated rotor plate and its adjacent neighbor are left intact.)

Alignment of the receiver was facilitated by drilling out the rivets holding the r.f. coil shield cans to the mounting bracket to give access to the slugs. The receiver is aligned in the conventional manner, the slugs being adjusted at the low end of the band and the trimmers at the high end. With these modifications and additions the performance is comparable or superior to some of the

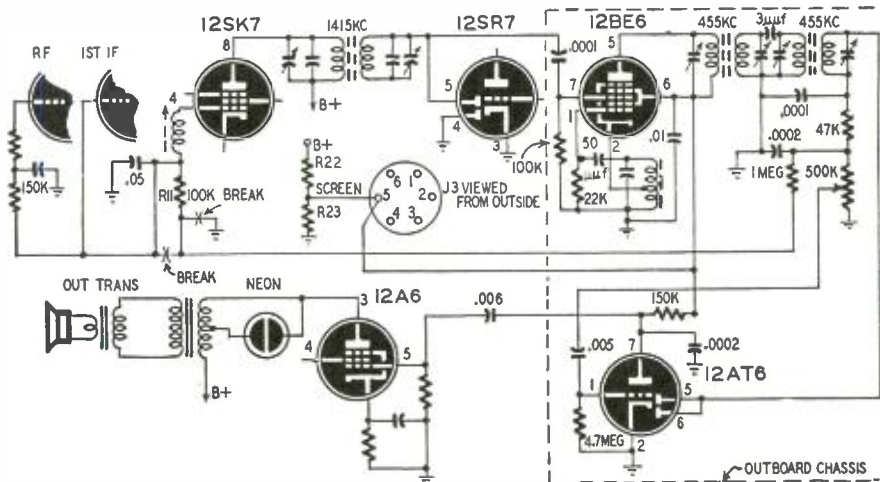
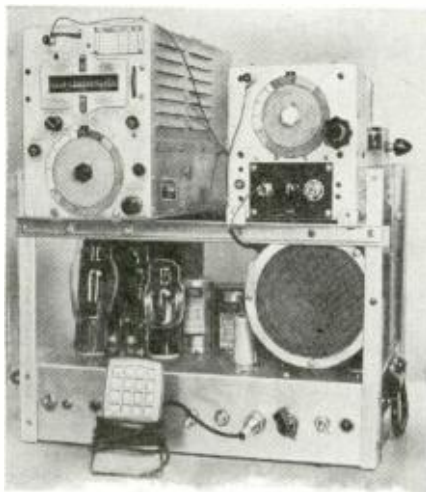

Fig. 1—Circuit of the outboard i.f. stage showing hookup to the receiver.



Front view of the complete unit. The frame is made of aluminum angle stock.

communications receivers in the moderate price class.

The original dials were discarded after using them as templates for the new ones. The replacement dials were made out of flat aluminum with white poster board glued to the surface. The frequencies were inked in with india ink and were colored with different shades of transparent oil paints to indicate band edges as well as c.w. and phone regions.

The oil colors were those normally used for coloring photographs. These colors are easy to apply with a small wad of cotton on a toothpick and if errors or changes are made, they can be removed with a solution supplied with the oil colors. To make the job permanent, clear lacquer or varnish is applied over the colors after allowing

several days for drying. An ample supply of colors for a great number of dials is available at very low cost in a "sampler" kit available in all photography supply stores.

This method of dial construction is particularly suited to those ARC-5 owners who use their sets as multi-band v.f.o.'s and have to stop to multiply mentally each time they change frequency. A dial plate with concentric scales indicating the frequency in use on each band can be made to replace the original.

Two power supplies are used (See Fig. 2). The lower voltage supply powers the receiver when receiving and the speech amplifier, oscillator plate, and amplifier screens when transmitting c.w. The larger power supply furnishes voltage to the amplifier plate when on c.w. and powers the modulator tube plus the amplifier plate and screen when transmitting on phone. A push-button applies voltage to the oscillator plate so that the signal can be spotted when receiving, and a monitor switch allows the receiver to operate independent of the T-R switch if the signal is to be monitored when transmitting.

Three relays are used in the unit. One (RY-1) switches the antenna from the transmitter to the receiver, another (RY-2) does the job of changing from transmit to receive and a third (RY-3) is used for keying. The relay coils may be any type available to the constructor. In our case a low-current 50-watt bias winding on the large power transformer was put to use with a selenium rectifier and an R-C filter to supply 24 volts for the antenna and T-R relays. The keying relay is a 6.3-volt a.c. relay and operates from one of the filament windings.

The heaters in both the transmitter and receiver are connected in parallel and are supplied from two 6.3-volt windings on the large transformer connected in series. The speech amplifier and modulator tube filaments are supplied from the 6.3-volt winding on the small power transformer.

The modulator circuit

The speech amplifier and modulator are conventional in design. The coupling components and the microphone load were chosen to favor the middle of the audio range, thereby avoiding loss of modulator power in useless low frequencies. This pays dividends in another way, as low frequency motor-boating sometimes occurring in high gain speech amplifiers along with hum is eliminated before it starts. This does not impair the quality of speech, all reports being "excellent", "crisp", etc.

The single 6L6-G Heising modulator is run somewhat above its ratings with 400 volts on the plate and 300 volts on the screen, but no coloring of either element has shown up in service. The plate input to the transmitter varies somewhat with different types of antennas, but is about 30 to 40 watts. The 6L6 under the conditions in this setup furnishes adequate audio power to modulate the 1625's sufficiently. While it doesn't have enough power to modulate 120 percent and create a lot of unwanted splatter, no reports have been received of too little audio on the signal.

The antenna loading coil in the transmitter would not do a job on long antennas. A 350- μ f fixed mica transmitting capacitor connected between the antenna terminal and ground makes good loading possible with end fed antennas from 66 to 400 feet long. An external ground makes no apparent difference in signal reports so its use is optional but desirable for safety.

The power supplies and modulator are mounted on a 3 x 10 x 14-inch chassis and the receiver and transmitter are supported on a "skeleton like" platform made of 3/4 x 1/2 x 1/16-inch aluminum angle stock secured to the chassis. The height of the receiver and transmitter above the lower chassis is adjusted so that the power supply and modulator tubes can be replaced without removing the transmitter or receiver. Trunk handles screwed to the ends of the chassis provide easy hand-holds for carrying.

It is not necessary to sell anyone on what can be done with low-powered transmitters, so a list of stations contacted and reports obtained seems superfluous. Many hours have been spent on enjoyable phone and c.w. QSO's both far and near. The portable is a dandy to stow into the car trunk and bring along when you are visiting friends in that cliff dwelling in the Bronx or spending a couple of weeks at some vacation spot. The only accessories are a mike and a key, a piece of wire for an antenna, and last but not least, power.

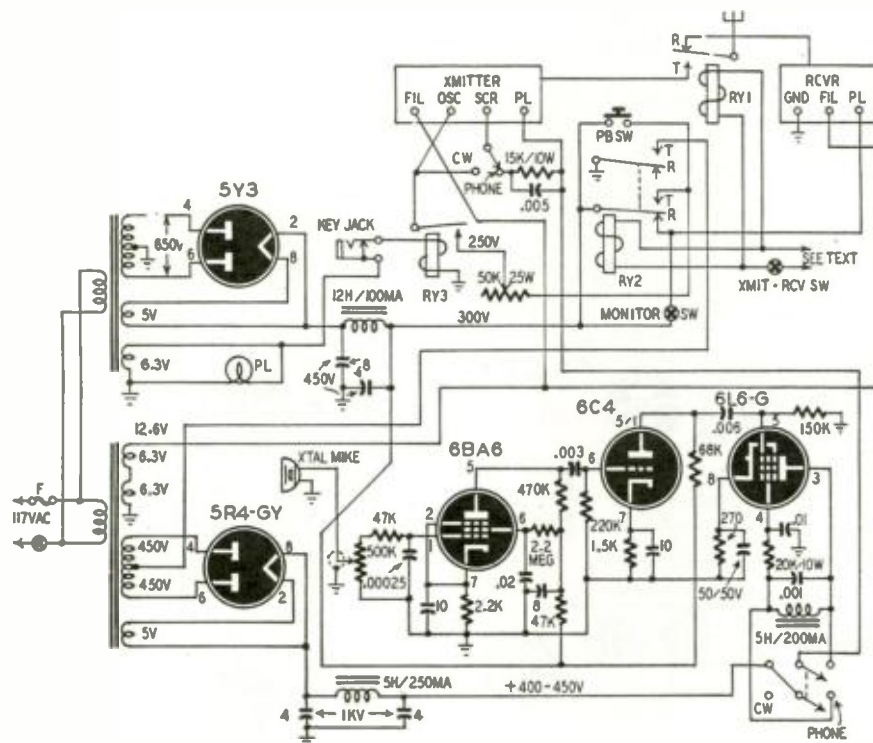
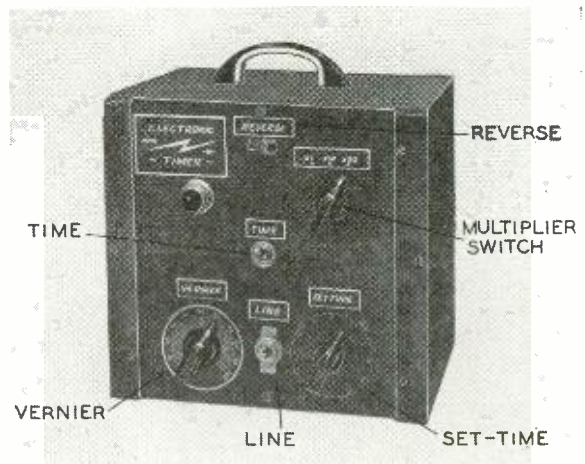

Fig. 2—The schematic of the modulator power supply and control system unit.

High-Accuracy Timer For Short Intervals

This versatile all-electronic timer has many uses in both shop and home

By R. L. PARMENTER



This utility timer is a compact unit ideal for photographic work as well as many other home uses.

ACCURATE short-interval timing is necessary for spot welders, punch presses, plating, heat-treating, and many other industrial uses. Around the house and workshop an electronic-type timer is often more useful than clockwork mechanisms. For very short intervals (less than a second) timers are preferable to mechanical devices because the general accuracy is better and they have greater reset accuracy. This last feature is important in photographic work—printing and color work especially. Such a timer has many uses around the kitchen. Why have burnt toast in the morning when an electronic timer is available?

Almost all electronic timers operate on the same principle. A vacuum tube is generally used to operate a relay. A negative charge on the grid of the tube cuts off the plate current under normal conditions. When a timing switch is closed, a circuit is completed so that this negative charge gradually leaks off until the tube conducts. The plate current is used to operate a relay which in turn controls an external circuit.

This circuit is frequently varied by adding components to provide for controls and sometimes an additional tube is used as a diode rectifier to provide the d.c. biasing potential for the control tube.

How the timer works

A simplified circuit of the timer described in this article is shown in Fig. 1. The single tube is a thyatron, type 2050, 2021, or 2051. The 2050 has been on surplus market lists at reasonable prices. The basic circuit is simple and, since it is practically bug-free, will operate dependably.

No power supply is used. A filament transformer (not shown) provides 6.3 volts for the heater. The a.c. line voltage is applied to the circuit so that, with the timing switch open, the plate of the tube is at one polarity at the same instant the grid is at the other. By grid rectification, the grid of the

tube has a negative voltage high enough to cut off plate current flow. When the timing switch is closed, the grid return is completed, and the negative potential stored by C leaks off through R1 to the cathode, gradually allowing the grid to become more positive until the tube ionizes and conducts. A heavy plate current flows under these conditions (75 ma maximum for a 2051 and 100 ma for a 2050 or 2021), which is sufficient to operate relays having a wide range of resistances.

While the exact resistance of the relay is not critical, if the resistance of the particular unit used is too far from 2,000 to 2,500 ohms, it is well to insert a series limiting resistor if the relay

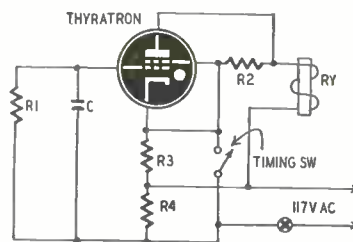

Fig. 1—A basic circuit of the timer.

resistance is too low or, if too high, a parallel resistor, to provide an anode load resistance of approximately 2,000 ohms. If other types of thyatron are used, the relay resistance must be large enough to keep the plate current of the tube within its rated value.

The complete timer

The complete circuit is shown in Fig. 2. A few more components have been added for better coverage of time and greater versatility. The single capacitor in the grid circuit has been replaced with three capacitors and a switch so it is possible to use the basic range or to multiply it by 10 or 50. This is especially useful when checking very short intervals because the average builder generally has no equipment for measuring fractions of a second. By calibrating the middle range $\times 10$, when the

multiplier switch is thrown to $\times 1$, the original intervals will be divided by 10. Since the basic range capacitor is .05 μf , by switching we arrive at .5 μf for the $\times 10$ range and 2.5 μf for the $\times 50$ range.

The main TIME SET control is an 11-point rotary switch with ten 500,000-ohm, $\frac{1}{4}$ -watt resistors soldered to the terminals. (The 510,000-ohm preferred values may be used with only a slight change in the time interval.) This method of determining the interval gives a better degree of reset accuracy than the alternative of using a high-resistance potentiometer which would be difficult to reset at a specific value. A $\frac{1}{2}$ -megohm potentiometer in series with the string of resistors is a vernier adjustment. Although this potentiometer is on the front panel, it would be preferable in most cases to make this a screwdriver adjustment behind the front panel.

A terminal board was installed to simplify connections for different uses. The TIME switch is mounted on the panel but leads are brought out to terminals 3 and 4 to permit connection of a remote, momentary type switch in parallel or in series with it. Likewise, one set of relay contacts are brought out to terminals 5, 6, and 7 with the moving contact connected to terminal 6. This is for the same purpose. The TIME switch can be connected in series with one pair of relay contacts for such functions as repeat cycle, etc.

The other set of relay contacts is connected to the a.c. line through a single-pole double-throw REVERSE switch and an a.c. outlet. This switch connects the outlet to the line either at the start of a cycle or at the end of a cycle. Other arrangements will suggest themselves to the builder as the need arises.

Construction details

The construction of this timer is not difficult. No exact layout of parts need be followed, no shielding is necessary, and, if it is for one specific use only, some of the parts may be omitted. The

photos may serve as a guide for the builder.

The size of the cabinet is approximately 6½ x 7 x 5 inches, allowing ample room for the components. Masonite is used for the panel and sub-base, and light wood and plywood for the cabinet. A fairly tight cover on the back of the box keeps dust and dirt from the relay contacts. Little or no ventilation is required as there is negligible heat even during continuous use. A couple of small vent-holes may be left, one at the top and one at the bottom, for circulation.

Considerable space may be saved if the unit is for limited use. For instance, if the timer is only for photographic work, the terminal board, the multiplier switch, and the reverse switch may be eliminated. The relay could be a more common s.p.s.t. The author has included all the extras so that other arrangements can be tried.

The range of time intervals covered with the components shown in the circuit diagram is from instantaneous to a maximum of about 1 minute and 25 seconds. The table indicates the different settings used to obtain a fairly wide range of time intervals. These were obtained with the vernier adjustment set at zero (maximum resistance). The intervals can be made shorter with the vernier if desired. Four representative intervals are given for the X50 to illustrate the multiplication factor.

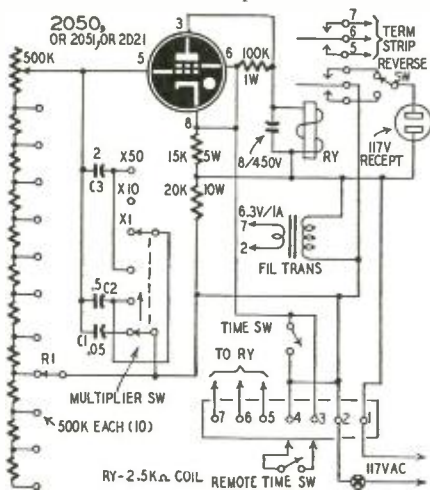

Fig. 2—Complete diagram of the timer. It does not need its own power supply.

(There is a slight error in the X50 intervals as compared to the X10 intervals because the 2-µf capacitor was somewhat under its capacitance rating.)

Adjusting the intervals

If other time intervals are desired, the values of C1, C2, and C3 and R1 can be changed. For smaller intervals, the total resistance of R1 and the capacitances could be made smaller; they should be made larger for longer time intervals. It would be convenient to make the time intervals as close to one second as possible for some applications. A little cut and try may be neces-



For safety's sake, both panel and sub-base of the unit are made of Masonite.

sary to adjust the interval to the desired value.

In selecting capacitors C1, C2, and C3 use a capacitance bridge if possible to get capacitances as nearly as possible exact multiples of one another. This makes calibration easier. The same applies in selecting resistors for the SET TIME unit. The response of the circuit is not linear, but it will be nearly so if you make the resistor values equal. If less vernier action is required, the potentiometer may be as little as 75,000 ohms and still retain some control.

This electronic timer is an interesting project for the beginner as well as a functional device for industrial uses

or applications around the home and workshop. For example, put two or more of these units in series so that one will trigger the next and also cut the previous one off and you have an unlimited number of possible combinations. If you have a fair imagination, you can picture the electronic control of a complicated winding machine—perhaps such as is used in fabricating paper capacitors. Many other uses also suggest themselves.

INTERVAL TABLE		
Set Time	X10 (Secs.)	X50 (Secs.)
1	3½	15
2	5	24
3	7	
4	8½	
5	10	45
6	12	
7	14	
8	15½	
9	17	
10	18	85

MATERIALS FOR UTILITY TIMER

Resistors: 10—500,000 ohm, ¼ watt; 1—100,000 ohm, 1 watt; 1—15,000 ohm, 5 watt; 1—20,000 ohm, 10 watt; 1—500,000-ohm potentiometer.
 Capacitors: 1—.05, 1—.05, 1—2 µf, 400 volt paper; 1—8-µf, 450-volt electrolytic.
 Miscellaneous: 1—2,500-ohm, d.p.d.t. relay; 1—6.3-volt, 1-amp transformer; terminal board; tube; socket; chassis; a.c. receptacle; switches; hookup wire.

INFINITE IMPEDANCE TEST PROBE

Voltage measurements of high-impedance high-voltage sources may be in error when ordinary measuring equipment is used because an additional current drain of even a few microamperes may reduce the output voltage appreciably. The ideal voltage measurement would take no current from the source.

A voltmeter that does this must have an infinite input impedance. One such device, shown in Fig. 1, consists of a high-voltage probe containing a high-voltage capacitor and a low-voltage capacitor and switch which are applied across the terminals of any ordinary vacuum-tube voltmeter. When the probe is applied to the high-voltage source, the high-voltage capacitor is charged. The charge is then transferred to the low-voltage capacitor, and this charge is measured directly by the v.t.v.m. on a low-voltage scale. The switch is used to discharge the low-voltage capacitor.

The capacitance of the high-voltage capacitor is 1/1,000 that of the low voltage capacitor. Thus the voltage transferred to the low-voltage capacitor is 1/1,000 that picked up by the high-voltage capacitor. A voltage of 10,000 volts would give a full-scale reading on the 10-volt scale of the v.t.v.m.

Millivac Instruments is producing this device. Their model, the PR6-NL,

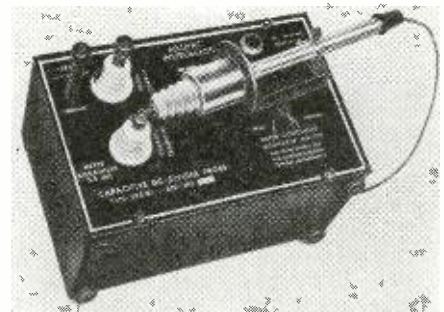

Photo of the high-voltage test unit.

measures up to 30,000 volts. In addition, the probe can be used with other Millivac equipment to measure extremely small values of direct current.

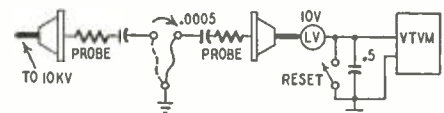
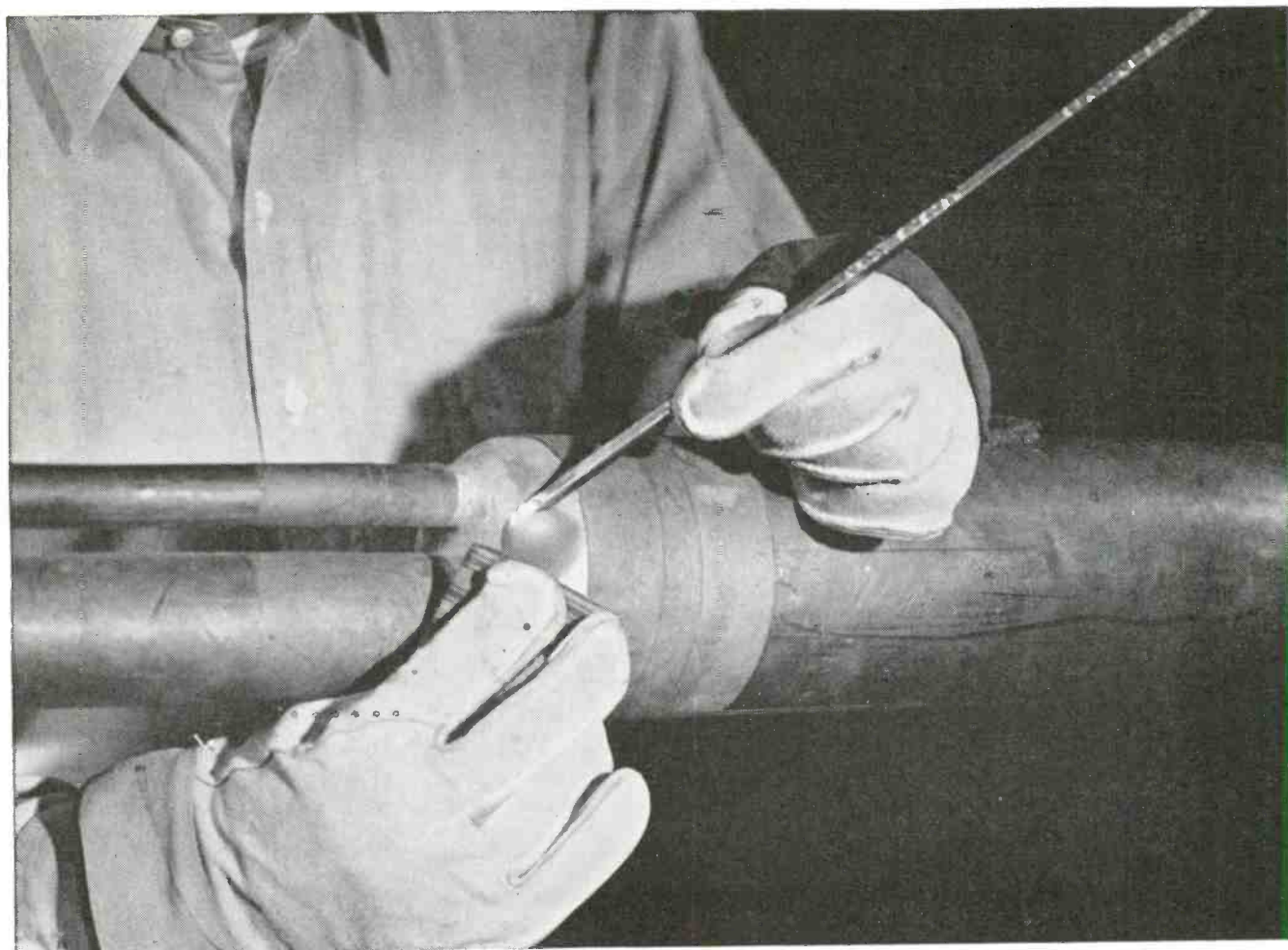

Fig. 1—A high-voltage charge is transferred from the high- to the low-voltage capacitor and measured with v.t.v.m.

For best possible accuracy the two capacitors must have extremely low leakage. The accuracy of the instrument then depends only on the tolerance of the capacitors and the accuracy of the v.t.v.m.



*He seals out
trouble...*

**TO KEEP THE COST
OF YOUR TELEPHONE
SERVICE DOWN**

To make cable joints tight and strong, splicers formerly used lots of solder. Then, Bell Telephone Laboratories developed a new technique for making better joints with much less solder. This saves one million pounds of solder a year — helps keep the price of your telephone service low.

Two kinds of solder are now used. One makes the splice strong; the other seals it. First, the splicer builds up a joint with a solder of lead and tin, which flows easily under his wiping cloth. To seal the joint, he applies a light coating of low-melting-point solder, composed of lead, tin and bismuth. On contact with the still hot joint, it flows into and seals every pore.

Cable-sealing solder is only one of 30 low-melting-point alloys which Bell metallurgists have developed for special uses — in fuse wires, for example, and in the solder connecting hair-like wires to piezoelectric crystals for electric wave filters.

Continuing research with a substance seemingly as commonplace as solder demonstrates again how Bell scientists help keep your telephone service the world's best.

BELL TELEPHONE LABORATORIES



• WORKING CONTINUALLY TO KEEP YOUR TELEPHONE
SERVICE BIG IN VALUE AND LOW IN COST

Capacitance Relay Operates Display

By W. G. ESLICK

THIS circuit will operate a device in a store window when a hand is held near a metal plate on the window, but it can be used as well as an alarm or for many other purposes.

L1-L2 tunes to 456 kc or to 227 kc with no difference in operation. I used an oscillator coil from a midget aircraft beacon radio that tuned from 200 to 430 kc with 135-kc i.f.'s. The coil can be made from an r.f. choke. Tune the signal in on a broadcast receiver and notice if there is a harmonic of 456 kc (or thereabouts, just so the i.f. transformer tunes to the oscillator).

The neon bulb across the control R1 is a midget taken from a fuse. The voltage across R1, measured with a 20,000-ohm-per-volt meter, is 165 volts d.c. The neon bulb indicates if the oscillator is tuned to the correct frequency. A voltmeter could be used but the built-in neon bulb is simpler. The relay was taken from a two-tube marker receiver and is very sensitive.

C1 must be made a smaller value if the circuit is hooked to a large object which pulls the oscillator out of oscillation. The relay can be made to close or open, depending on the setting of R1.

Set R1 so the relay is open, but on the verge of closing. When a hand is held near the metal plate hooked to C1, the relay should close. If R2 is set so the relay just closes, then the added hand capacitance will open the relay.

When the oscillator is tuned to the frequency (or one-half the frequency) of the i.f. transformer, the r.f. voltage is applied to the plate of the 12H6. This voltage is rectified and applied as cutoff or near cutoff bias on the 12A6. When the oscillator is detuned, the bias is removed and the 12A6 plate current operates the relay. The i.f. transformer must be peaked sharply to have the slightest change in oscillator frequency operate the relay.

Do not use a tuned circuit that requires a large value of padder capacitance to reach 456 kc because a small change in capacitance will not detune the oscillator sufficiently to operate the relay. Sensitivity depends on the setting of R1 and the sharpness of the i.f. transformer. Use a voltmeter across R1 to adjust the i.f. transformer.

The circuit can be hooked up with an isolating resistor and capacitor between the common ground and chassis, as shown, to avoid a hot chassis. If this is not satisfactory, a little experimentation may be necessary to get the circuit operating properly.

MATERIALS FOR CAPACITANCE RELAY

Resistors: 1—620, 1—150,000, 2—470,000 ohm, 1/2 watt; 1—300 ohm, 10 watt; 1—250,000-ohm potentiometer.

Capacitors: 1—.0001, 1—.001, 1—.002 μ f mica; 1—.05 μ f, 600 volt; 1—20 μ f, 450 volt; 2—50- μ f trimmers; 1—100- μ f variable.

Miscellaneous: neon bulb (midget), 1-to-5 ma relay, 456-kc i.f. transformer, oscillator coil, tubes, sockets, chassis, hookup wire, switch.

Continuing

\$1,200.00 PRIZE CONTEST RADIO-ELECTRONICS IN THE HOME

Entries for the August contest hit a new summer low. Of the few ideas submitted, practically all were electrical rather than electronic, and therefore did not fall within the scope of this contest.

The only entry which appears to fulfill the conditions is that of Simon Wrynn, 79-18 Elks Road, Elmhurst, N. Y., who sends us a description of a radio nurse. Since his entry meets the requirements of the rules, and since no better idea has been submitted, Mr. Wrynn

was awarded the \$50 first prize.

Unfortunately, the radio nurse idea he submits resembles too closely those embodied in a number of articles and radio-electronic circuits previously printed in this magazine to justify present publication, and will therefore not be printed.

There is still money to be made by working out really good ideas for radio-electronics in the home. If your idea amounts to a full-dress article, regular space rates will be paid in addition to the prize money.

FIRST PRIZE	\$50
SECOND PRIZE	\$25
THIRD PRIZE	\$15
FOURTH PRIZE	\$10

Please Note the Following Rules

1. This is a monthly cash Prize Contest for the best idea submitted during the month for a practical new radio-electronic application in the home.

2. The highest prizes will go to those contestants who have *actually built* the devices they describe and who submit photographs to prove it. Lesser prizes may be given for "ideas" not reduced to practice and for entries unaccompanied by photographs.

Entries of constructed devices must be accompanied by photographs, full description, and complete circuit diagrams.

3. Ideas for new devices which have not actually been built must be stated in complete detail and accompanied by complete diagrams, drawings, and all other possible descriptive material.

4. All the descriptions and photographs of the prize-winning devices or ideas will become the property of RADIO-ELECTRONICS, which will publish a descriptive article on each device or application. The prize winners will be paid regular rates for their articles, in addition to the prize money. Entries not winning prizes will be returned.

5. If two or more entries submit-

ted during the same month are judged to be of equal worth, identical prize awards will be made for both entries. Devices which have been awarded prizes in previous contests will not be considered unless they show marked improvement on earlier entries.

6. All entries will be judged by the Board of Editors of RADIO-ELECTRONICS. Prizes will be awarded in accordance with novelty, general importance of the application or device, smallness of cost involved in building it, and practicability. The decisions of the Board of Editors of RADIO-ELECTRONICS will be final.

7. Excluded from this contest are RADIO-ELECTRONICS employees and their relatives.

8. The fifth monthly contest closes August 31 at midnight, Eastern Standard Time. All entries post-marked not later than August 31 will be judged in the fifth month's contest. Address all entries to "Contest Editor, RADIO-ELECTRONICS, 25 West Broadway, New York 7, N. Y."

9. Announcement of the third monthly prize award will be made in the September issue of RADIO-ELECTRONICS. The third month's prizes will be paid on the publication date of the September issue.

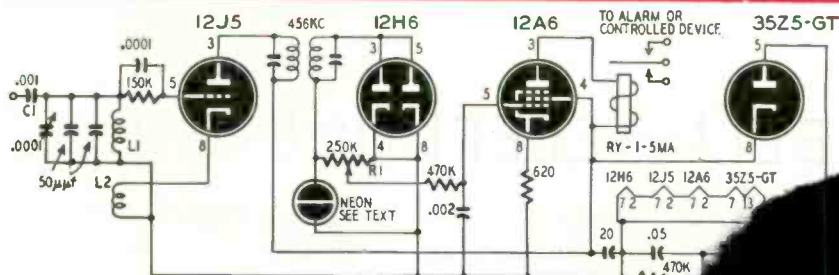

RADIO-EL

here's what you've been asking for—

A QUALITY 12-BAND ANTENNA

that sells for **\$2⁹⁵** Suggested List

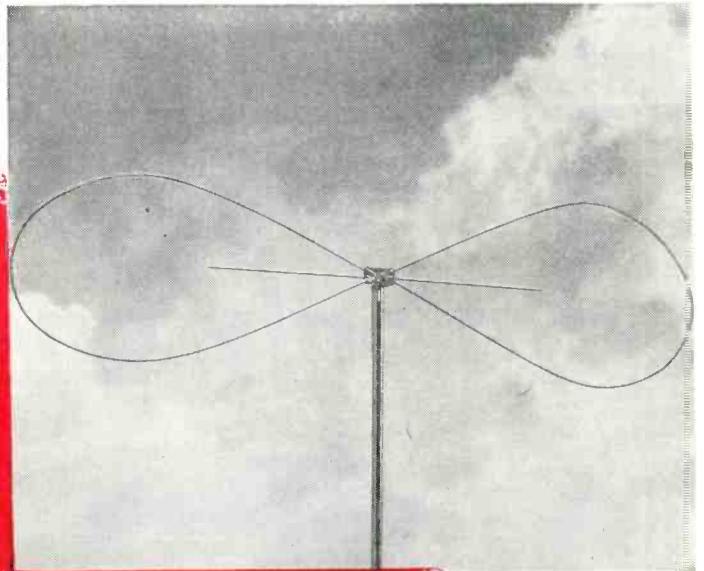

the ECON-A-RAY

Butterfly

Here is the television antenna you have been asking for — a well-constructed, durable antenna that receives channels 2 through 13 and sells for only \$2.95.

This antenna is for high signal areas only, but in these areas it will perform as well as any antenna on the market today. It eliminates ghost images, gives you strong, sharp pictures on all channels, and receives FM.

You don't have to worry about weather with the Econ-a-Ray Butterfly. It is constructed from Dural, with Polystyrene and stainless steel fittings, to withstand winds up to 75 mph, and is unaffected by snow, rain or any other weather conditions. It cannot corrode.

The Econ-a-Ray Butterfly will give you good television at the lowest cost possible. Ask your dealer for it today, or write for information. Remember, the Butterfly is a primary antenna only.



CHECK THESE FEATURES:

Constructed from solid Dural — cannot corrode. Wide band, Hi-Lo antenna for all TV channels and FM. Unitized construction — no assembly necessary. Can be used with 72, 150 or 300 ohm impedance line. Integral high channel dipole for greater efficiency. Low loss — bi-directional. Dural elements solidly mounted in weatherproof polished Polystyrene.

Perfect for low cost, high quality television in strong signal areas.

Tel-a-Ray manufactures a complete line of fine television antennas, including the now famous Model T, which is bringing television to areas as far away from stations as 200 miles. Write for specification sheets.

WRITE TODAY FOR COMPLETE DETAILS AND THE NAME OF YOUR DEALER

Tel-a-Ray

RST—BECAUSE THEY LAST"

ENTERPRISES, INC.

P. O. BOX 332A • HENDERSON, KY.

ACCURATE ALIGNMENT

of any TV Set

with only one instrument

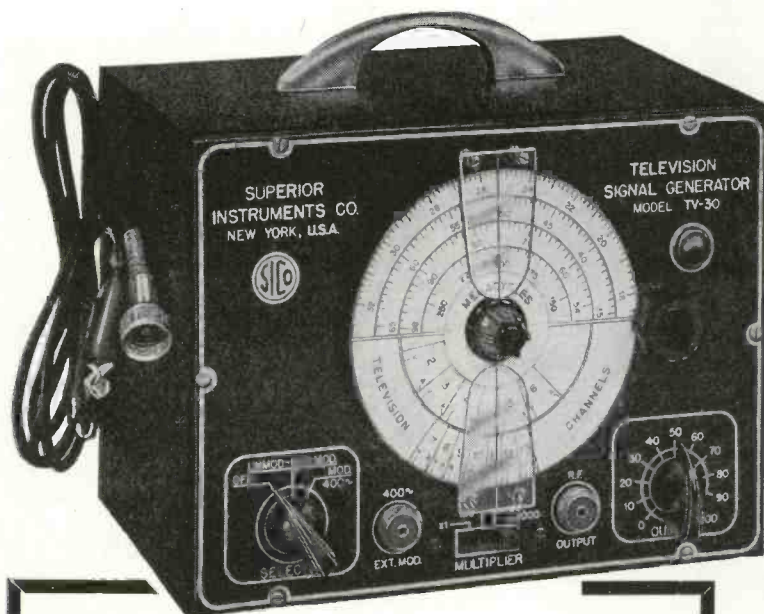

FEATURES

- Built-in modulator may be used to modulate the R.F. Frequency; also to localize the cause of trouble in the audio circuits of T.V. Receivers.
- Double shielding of oscillatory circuit assures stability and reduces radiation to absolute minimum.
- Provision made for external modulation by A.F. or R.F. source to provide frequency modulation.
- All I.F. frequencies and 2 to 13 channel frequencies are calibrated direct in Megacycles on the Vernier dial. Markers for the Video and Audio carriers within their respective channels are also calibrated on the dial.
- Linear calibrations throughout are achieved by the use of a Straight Line Frequency Variable Condenser together with a permeability trimmed coil.
- Stability assured by cathode follower buffer tube and double shielding of component parts.

SPECIFICATIONS

Frequency Range: 4 Bands—No switching
 18—32 Mc. 35—65 Mc. 54—98 Mc. 150—250 Mc.
 Audio Modulating Frequency: 400 cycles (Sine Wave)
 Attenuator: 4 position, ladder type with constant impedance control for fine adjustment.
 Tubes Used:

- { 6C4 as Cathode follower and modulated buffer.
- { 6C4 as R.F. Oscillator.
- { 6SN7 as Audio Oscillator and power rectifier.

Model TV-30 comes complete with shielded co-axial lead and all operating instructions.

Measures 6" x 7" x 9". Shipping Weight 10 lbs.

Manufactured by Superior Instruments Co. under license agreement with Western Electric.

The New Model TV-30
**TELEVISION
 SIGNAL
 GENERATOR**

only

\$29.95
 NET

Aligns Television I.F. and Front Ends Without the Use of an Oscilloscope or TV Sweep Generator

Save \$150

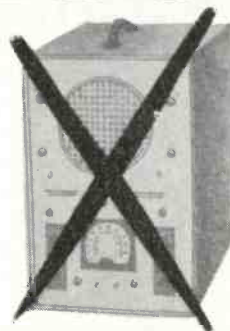
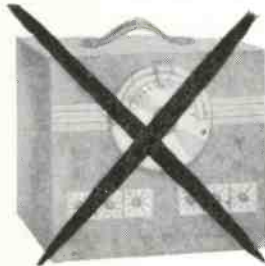

TV SWEEP GENERATOR \$80 **Approx.** OSCILLOSCOPE \$100 **Approx.**

An investment of \$29.95 for the TV-30 saves you \$150. And besides the huge sum of money saved, you also save time. The TV-30 does a three-instrument test in a fraction of the time.

--- TO ORDER—USE RUSH ORDER FORM ON NEXT PAGE ---

GENERAL ELECTRONIC DISTRIBUTING CO.

98 PARK PLACE
 DEPT. RC-8
 NEW YORK 7, N. Y.

GUARANTEE?

Every unit sold by us is covered by a one year guarantee.

MONEY BACK?

Every unit we advertise is offered on a strict "money-back-if-not-satisfied-basis." No ifs—no buts—no may-be's. If you are not completely satisfied after a 10 day trial—return for complete refund. No explanation—you are the sole judge. Plain enough?

THE UNITS OFFERED ON THIS PAGE ARE COMPLETE INSTRUMENTS, NOT KITS! EVERY MODEL IS FACTORY-WIRED, CALIBRATED AND READY TO OPERATE.



The Model 200 operates on 110 Volts A.C. Comes complete with output cable and operating instructions.

\$1885
NET

THE NEW MODEL 200

AM and FM SIGNAL GENERATOR

SPECIFICATIONS

- ★ **R.F. FREQUENCY RANGES:** 100 Kilocycles to 150 Megacycles.
- ★ **MODULATING FREQUENCY:** 400 Cycles. May be used for modulating the R.F. signal. Also available separately.
- ★ **ATTENUATION:** The constant impedance attenuator is isolated from the oscillating circuit by the buffer tube. Output impedance of this model is only 100 ohms. This low impedance reduces losses in the output cable.
- ★ **OSCILLATORY CIRCUIT:** Hartley oscillator with cathode follower buffer tube. Frequency stability is assured by modulating the buffer tube.
- ★ **ACCURACY:** Use of High-Q permeability tuned coils adjusted against 1/10th of 1% standards assures an accuracy of 1% on all ranges from 100 Kilocycles to 10 Megacycles and an accuracy of 2% on the higher frequencies.
- ★ **TUBES USED:** 12AU7—One section is used as oscillator and the second is modulated cathode follower. T-2 is used as modulator. 6C4 is used as rectifier.

Superior's new model 770

AN ACCURATE POCKET-SIZE

VOLT-OHM MILLIAMMETER

(SENSITIVITY: 1000 OHMS PER VOLT)



FEATURES: Compact—measures 3 1/8" x 5 7/8" x 2 1/4". Uses latest design 2% accurate 1 Mil D'Arsonval type meter. Same zero adjustment holds for both resistance ranges. It is not necessary to readjust when switching from one resistance range to another. This is an important time-saving feature never before included in a V.O.M. in this price range. Housed in round-cornered, molded case. Beautiful black etched panel. Depressed letters filled with permanent white, insures long-life even with constant use.

SPECIFICATIONS: 6 A.C. VOLTAGE RANGES: 0—15/30/150/300/1500/3000 VOLTS. 6 D.C. VOLTAGE RANGES: 0—7.5/15/75/150/750/1500 VOLTS. 4 D.C. CURRENT RANGES: 0—1.5/15/150 MA. 0—1.5 AMPS. 2 RESISTANCE RANGES: 0—500 OHMS. 0—1 MEGOHM.

The Model 770 comes complete with self-contained batteries, test leads and all operating instructions.

\$1390
NET

SUPERIOR'S NEW MODEL TV-10

TUBE TESTER

SPECIFICATIONS

- ★ Tests all tubes including 4, 5, 6, 7, Octal, Lock-in, Peanut, Bantam, Hearing Aid, Thyatron, Miniatures, Sub-Miniatures, Novals, etc. Will also test Pilot Lights.
- ★ Tests by the well-established emission method for tube quality, directly read on the scale of the meter.
- ★ Tests for "shorts" and "leakages" up to 5 Megohms.
- ★ Uses the new self-cleaning Lever Action Switches for individual element testing. Because all elements are numbered according to pin-number in the RMA base numbering system, the user can instantly identify which element is under test. Tubes having tapped filaments and tubes with filaments terminating in more than one pin are truly tested with the Model TV-10 as any of the pins may be placed in the neutral position when necessary.
- ★ The Model TV-10 does not use any combination type sockets. Instead individual sockets are used for each type of tube. Thus it is impossible to damage a tube by inserting it in the wrong socket.
- ★ Free-moving built-in roll chart provides complete data for all tubes.
- ★ Newly designed Line Voltage Control compensates for variation of any line voltage between 105 Volts and 130 Volts.

The Model TV-10 operates on 105-130 Volt 60 Cycles A.C. Comes housed in a beautiful hand-rubbed oak cabinet complete with portable cover.

\$3950
NET



GENERAL ELECTRONIC DISTRIBUTING CO. DEPT. RC-8, 98 PARK PLACE, NEW YORK, N. Y.

RC-8

GENTLEMEN: PLEASE RUSH THE MATERIAL LISTED BELOW:

QUANTITY	MODEL	PRICE	
TOTAL			

Name _____

Address _____

City _____ Zone _____ State _____

\$.....

\$..... (Deposit Enclosed—Ship Balance C.O.D.)

(Payment in Full Enclosed)

FUSE HOLDER

Littelfuse Corp.
Chicago, Ill.

The Snap-On TV fuse holder is a fiber attachment which slips on the leads of blown pigtail fuses to eliminate the usual difficulties of replacing such



fuses. The pigtails of the old fuse and the fuse holder become permanent attachments in the set. Each time a new fuse is needed, it can be slipped into the holder.

TV OSCILLOSCOPE

Sylvania Electric Products Inc.
New York, N. Y.

The new type 400 oscilloscope, with 7-inch type 7JPI green-screen cathode-ray tube, has a vertical sensitivity of 10 millivolts per inch and a vertical response useful up to 4 mc.



Other features include: four-position frequency-compensated attenuator for uniform frequency response at any gain setting, vernier gain control, low internal hum level, internal 60-cycle sine-wave sweep which eliminates one set of leads during TV alignment operations, wide-range phasing control, internal hard tube sweep circuit, control for synchronizing to either positive or negative signal, good vertical bounce and return characteristics, and rapid return trace.

The oscilloscope also has linear sweeps ranging from 10 cycles to 50 kc; 5-megohm, 26- μ f input impedance; cathode-follower input circuit; switching for direct connection to deflection plates; panel connection for intensity or Z-axis modulation; built-in, 60-cycle voltage source; and low-parallax, cross-lined screen.

OSCILLOSCOPE

Triplett Electrical Instrument Co.
Bluffton, Ohio

The Triplett model 3440 5-inch oscilloscope for TV and general use has a pattern-reversing switch, a calibrated



meter for peak-to-peak voltage measurements, high vertical sensitivity of .009 r.m.s. volt per inch, a return trace eliminator, a telescoping light shield, linear sweep voltages up to 60 kc, and wide frequency range—20 cycles to over 1 mc. A demodulator probe is also available for signal tracing.

LOW-LOSS LEAD-IN

Gonset Company
Burbank, Cal.

Using polystyrene spacers to minimize dielectric losses and 1-inch spacing to minimize line pick-up and radiation losses, Gonset Line has only 0.5-db loss per 100 feet at 200 mc and the losses do not increase appreciably under unfavorable weather conditions or aging. Its impedance is 300 ohms. Gonset Line is particularly well adapted for fringe areas, coastal installations and where long runs of lead

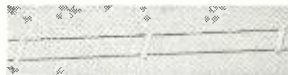

line are required. The low attenuation permits runs in some cases as long as 2,000 feet, to bring TV reception to locations previously unable to get satisfactory reception.

ANTENNA ROTATOR

U. S. Devices
Plainfield, N. J.

Available in two models, the 501 with an end-of-rotation light and the 502 with a directional indicator which rotates 370° both clockwise and counterclockwise, this combination antenna rotator and control box can handle any TV antenna or stacked array.

The rotator has an aluminum main casting, a heavy-duty tandem motor, a magnetic brake release, ball thrust bearings, and insulated strain relief.



It can accommodate antenna masts from 3/4 to 1 1/2 inches in diameter.

TV ANTENNA

Twin-Yex Mfg. Co.
Philadelphia, Pa.

The Skyliner Add-A-Bay antenna is basically a single bay conical with a high signal-to-noise ratio. It has four



extra rod mounts to permit stub addition and rearrangement of elements to provide combinations for any signal strength area.

Preassembled of aluminum and cadmium-plated steel, the antenna matches 72-, 150-, and 300-ohm transmission lines.

TUBE TESTER KIT

Electronic Instrument Co.
Brooklyn, N. Y.

Conventional receiving and TV tubes including 4, 5, 6, large and small 7, octal, loctal, noval, Hytron, VR, and electron-ray tubes as well as pilot light

lamps can be tested with Eico model 625K tube tester kit. A blank spare socket is provided for future new tubes. Two grid caps are provided for convenience, and a protective bulb indi-

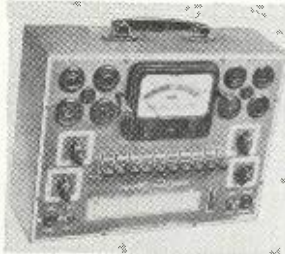

cates transformer overload and acts as a fuse. An illuminated, gear-driven speedroll chart is provided for setting up any tube type.

The kit is supplied with step-by-step instructions and schematic and pictorial diagrams. The tester, also available factory-wired, has dimensions of 12 1/2 x 9 3/4 x 4 inches.

LOUDSPEAKER

Permoflux Corp.
Chicago, Ill.

When properly baffled, this 8-inch blue-cone Royal Eight compares in performance with a 12-inch speaker. The baffle designed for it occupies only half the space of an equally effective baffle for a 12-inch speaker. The Royal Eight is designed for low cost, high-fidelity audio reproduction in the home.

This new speaker introduces a campaign to promote the 8-inch speaker as the ideal size for home use.

**NEW V.T.V.M.**

Radio City Products Co.
New York, N. Y.

An electronic balanced bridge type push-pull circuit with an input impedance of 25 megohms is found in the model 654 v.t.v.m. It makes both a.c. and d.c. measurements and has a discriminator alignment scale with a zero center.



Its ranges are: 0.2 ohm to 1,000 megohms in five ranges; 0.5-25-100-250-1,000 volts on both a.c. and d.c.; -20 to 16, -6 to 30, 6 to 42, 14 to 50, and 26 to 62 db. The unit comes complete with isolation probe and leads. Its size is 10 x 6 x 5 inches.

AUDIO AMPLIFIERS

Sun Radio & Electronics Co.
New York, N.Y.

Two new audio amplifiers, the CR-10-P and the CR-10-Q, have been added to Sun Radio's line of all-triode audio amplifiers.

The new CR-10-P uses Peerless transformers throughout, including an output transformer of special design for this amplifier. Increased quality of low

frequencies increases the "presence effect".

The new CR-10-Q also uses Peerless transformers throughout, and has an output transformer with frequency response of ± 1 db from 20 to 20,000 cycles and less than 2% harmonic distortion at low output. Full power is delivered within 1 db from 40 to 10,000 cycles.

TAPE RECORDER

Allied Radio Corp.
Chicago, Ill.

The new Knight tape recorder plays a full hour on a 1,200-foot reel. Recording speed is 7 1/2 inches per second, and rewind speed is 20 times as fast. The recorder has a simplified tape threading mechanism and only one control for the tape transport mechanism with three positions: RECORD-PLAY; OFF, and REWIND.



Other features include a switch to mute the loudspeaker when recording from a microphone and a constant-speed capstan drive. Recording level is indicated by a neon bulb.

TV PROJECTOR

Snaider Television Corp.
Brooklyn, N. Y.

This new product may be attached to any type of TV receiver regardless of picture tube size to produce a projected picture up to 6 x 8 feet.

The projector works on the same principle as a movie projector and uses an RCA 5TP4 projection tube and an F1.9 lens which may be focused to any picture size. Sync. and sweep circuits are independent of the master set.

D.C. TO A.C. INVERTERS

American Television & Radio Co.
St. Paul, Minn.

A new line of ATR d.c. to a.c. inverters includes three different types. The low power inverters are for operating small a.c. motors, radios, and other electrical devices of approximately 35 watts consumption. They operate from 6-, 12-, 24-, 32-, 110-, or 22-volt d.c. lines.

The radio inverters will operate a.c. radios, PA. systems, TV sets, and other devices using from 75 to 150 watts. Industrial inverters having the same power capacity are available for loads having power factors as low as 60%.

These inverters all have plug-in vibrators and an output of 110 volts a.c.

ATR also has a new A-battery eliminator for testing auto radios and similar equipment. It operates on 105 to 125



volts a.c. and has a rated output of 18 amperes on 6 volts or 9 amperes on 12 volts. The eliminators have full-wave dry-disc selenium rectifiers.

TV ANTENNA

JFD Manufacturing Co.
Brooklyn, N. Y.

A built-in lightning arrester is featured in the D-Xer conical antennas TA160, TA161, and TA162. The arrester is molded directly in the dipole Bakelite insulator and accommodates any type of lead-in and is completely waterproof.

NOW READY! A Sensational New Line Of 1951 MIDWEST TELEVISION

**CONSOLES and
COMPLETE CHASSIS**

Featuring the NEW MAMMOTH

**19½-Inch
BLACK PICTURE TUBE
At Low Factory Prices**



**DIRECT
FROM
FACTORY
TO YOU**



Never before have you seen such tremendously BIG clear pictures, such luxurious cabinets, such sensationally low Factory Prices as Midwest offers in its 31st Anniversary Line of 19½" and 16½" TV Consoles, TV - Radio - Phono Combinations, and complete TV Chassis.

"VIDEO GRAND"
19½" Television-Radio-Phonograph Console

"CONSTELLATION"
19½" Television Console

Check these features: Mammoth 19½-Inch Picture Tube (225 sq. in. image); Synchronized sound and picture; Simplified One-Knob Tuning; Big 12" Panasonic Speaker; Video-Sonic Tuner; and scores of other features.

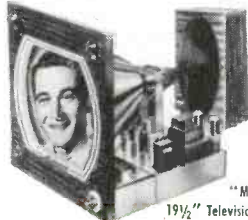

"MIDWEST"
19½" Television Chassis and Speaker



Factory Authorized Service Available in Television Areas

Plus Powerful New 1951 World-Ranging 5-Band
MIDWEST SERIES 16 RADIOS

In Beautiful Consoles and Complete Chassis

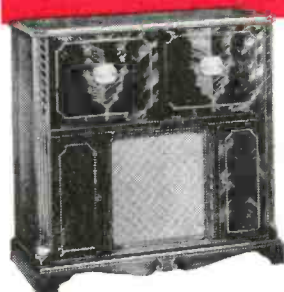

An entirely new line featuring the powerful Series 16 AM-FM Five-Band Radio Chassis and the magnificent Symphony Grand Radio-Phonograph with 3-Speed Automatic Intermix Record Player.

**EASY
TERMS**

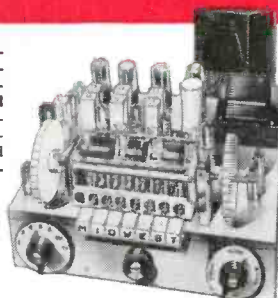

\$44⁹⁵ Will Put This Luxurious
New 1951

**MIDWEST "VIDEO GRAND"
19½-Inch TELEVISION**

with AM-FM RADIO and 3-Speed
Automatic Intermix Phonograph

In Your Own Home on

30 DAYS TRIAL

You Must Be Satisfied or Your
MONEY BACK

SEND COUPON TODAY
For This NEW 1951 4-Color

FREE MIDWEST
RADIO-
TELEVISION
CATALOG



WRITE IN NAME AND ADDRESS (PLEASE
PRINT) ON COUPON OR 1c POSTCARD

MIDWEST RADIO & TELEVISION CORP.
Dept. 38 A., 909 BROADWAY • CINCINNATI 2, OHIO

Please send me your new FREE 1951 Catalog.

NAME _____

ADDRESS _____

CITY _____

ZONE _____

STATE _____

MIDWEST RADIO & TELEVISION CORP.

DEPT. 38-A, 909 BROADWAY, CINCINNATI 2, OHIO

YOUR NEW STANCOR CATALOGS

are ready!

CATALOG OF TRANSFORMERS FOR RADIO, SOUND AND OTHER ELECTRONIC USES.

Here's a "must" for every user of transformers—serviceman, ham, experimenter, engineer. Detailed listings of more than 400 Stancor part numbers. Includes accurate electrical and physical specs, dimensions, prices, illustrations. Complete and up-to-date. Handy charts and easy-to-use indexes help to make this new Stancor catalog the book you'll want to find the part you need.

TELEVISION CATALOG AND REPLACEMENT GUIDE.

The sixth edition of the popular Stancor TV Replacement Guide (50,000 copies printed to date). Now combined in a big, 30-page book with a complete catalog of all Stancor TV components. Original part numbers, with Stancor replacements, are listed for more than 600 TV receiver and chassis models made by 64 manufacturers. Every Stancor component recommended in the guide is listed in the catalog section with complete specs, dimensions and prices. Gives you one convenient source of information. Makes your job quicker and easier.

And remember, when you buy a Stancor transformer, you get a quality product used by the country's biggest set makers as original equipment. Stancor transformers have to be good! See your Stancor distributor today for your free copies of these books. If he is out of stock, we'll be glad to send you copies. Write Standard Transformer Corporation, 3592 Elston Avenue, Chicago 18, Illinois.

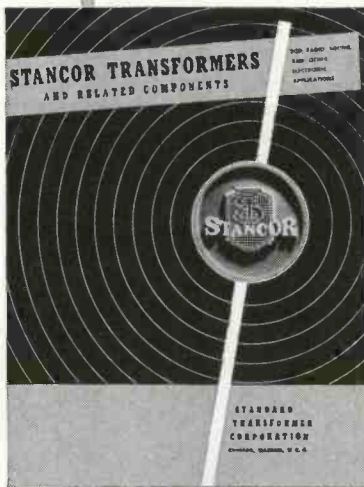

*Most Complete
Line in
the Industry*

PROTEST LICENSE BILL

More than 1,000 New York City radio service technicians crowded the auditorium of the Central Commercial High School to protest the proposed licensing bill recently introduced into the City Council. The bill, introduced by Councilman Chas. Keegan, would require a \$500 license fee from each service shop, and provide that no shop with a staff of less than three persons or less than 500 square feet of floor space would be permitted to service television receivers. Every organization (no matter how large or small) must employ one person who has been certified by the Commissioner of Licenses as a qualified television technician.

Among those speaking against the proposed bill were L. B. Calamaras, representing the National Electronic Distributors' Association, Tim Alexander, Motorola service chief, who spoke for the servicing committee of the Radio Manufacturers' Association, and John F. Rider, who besides speaking for himself brought messages of opposition from the New York district head of the American Legion and from Bruno-New York, distributor of RCA radios and televisers.

Numerous speakers from the floor joined in denouncing the bill, and the forum continued till well after eleven o'clock. Chief point made was that it would not prevent or reduce the two evils it complained of: poor and unskilled workmanship, and the loss of sums of money paid in advance for yearly service contracts. On the contrary, it would tend to drive out of business the smaller independent service shop which as a rule does not do contract work.

A number of speakers agreed that some measure of protection should be provided for purchasers of service contracts, but that licensing was not the correct approach; in fact the bill made no direct provision for protecting the customer, merely providing that financial statements be filed with the license commissioner annually (at a fee of \$25) with interim statements to be demanded at his discretion as often as he would require. (These interim statements would be accompanied with a fee of only \$10.)

The meeting was held under the auspices of the Associated Radio-Television Technicians Association of New York City, John F. Rider Publisher, the local section of the National Electronic Distributors Association, and the district organization of the American Legion.

TEXAS HAMS TO MEET

The twentieth Annual West Gulf Division Convention (ARRL) will be held in San Antonio, Texas, at the Gunter Hotel, August 18, 19 and 20 under the sponsorship of the San Antonio Radio Club. Features include choice of pre-registration prizes, a hidden transmitter hunt, and special prizes and entertainment for the ladies, including a visit to the historic Alamo.

RADIO-ELECTRONICS for



POLIC FM ALARM

RADIO APPARATUS CORPORATION
310 FOUNTAIN SQUARE THEATRE BLDG.
INDIANAPOLIS 3, INDIANA

*Get
EMERGENCY BAND
CALLS At Home!*

• Many fans spend hundreds of happy hours listening to city and state police calls on their Polic-Alarm radios. . . . Polic-Alarm Model PR-31 is a quality radio which will give years of trouble-free service on the 30-50 mc. band. Can be used on either AC or DC current of 115 volts.

Besides police calls, the 30-50 mc. band also is used by fire departments, ambulances, border patrol, forestry, maritime, railroads, bus lines, and other services. Enjoy the thrill of listening to these vital messages at home. Model PR-31 (illustrated) **\$44.95**

Polic-Alarm Model PR-8 is available for 152-162 mc. band reception. **\$39.95**
Price, complete

PRSMA TO HOLD RADIO-TV SHOW

Second annual radio, television, and electronics exhibit sponsored by the Philadelphia Radio Service Men's Association will be held at the Broadwood Hotel, Philadelphia, from September 25 to 27. Sessions will start at 7 pm on the 25th and will run from 10 am to 10 pm the next two days.

Purpose of the exhibit, according to Dave Krantz, show committee chairman, is to acquaint service technicians, dealers, and other interested groups with the latest developments in electronics. Leading manufacturers and others have engaged booths, and a program of educational lectures is being worked out. The first evening of the show will feature addresses by key industrial figures and civic officials, after which the trade displays in the main ballroom of the Broadwood Hotel will open.

The educational program, which was arranged by a panel of trade per-

sonalities including Lewis Winner and Fred Shunaman, editors, Sanford Cowan and John Rider, radio publishers, and Stanley Myers, John Zagury, Dave Krantz and Harry Bortnick representing PRSMA, will differ considerably in presentation and subject matter from earlier forums and lecture series. Separate sessions will be held for dealers, service technicians, and students, and the subjects will deal with matters of immediate present and future interest to the groups addressed. Among the subjects tentatively chosen are: "Problems of u.h.f.," "Radio vs TV," "Phone-vision," and for the student, "Where Do You Go from School."

It is expected that displays will be exhibited by the Signal Corps, the Armed Forces and the Bell Telephone System and that color television will be demonstrated by different manufacturers. An attendance of more than 8,000 is expected.

TISA ADOPTS CODE OF ETHICS

Attempts by the Television Installation Service Association of America to enlist the aid of television manufacturers and distributors in a campaign to clean up service abuses have so far been unsuccessful. At a meeting of service representatives from Chicago, Toledo, Detroit, Philadelphia, and other cities a code of ethics designed to raise service standards and guarantee good workmanship was adopted unanimous-

ly, but representatives of manufacturers and distributors declined to go on record.

Frank J. Moch, president of TISA, said, "evidently the industry is not yet ready to cooperate to straighten out the mess of TV service overcharges and incompetent service. However, we in the service contracting field will go ahead anyhow and set up an organization to fight these excesses."

WCAU-TV PLANS SERVICE FORUMS

Station WCAU-TV of Philadelphia has invited service organizations and others to present the case of the service technician and the television viewer in open forum discussions. One such program was scheduled (at the time of writing) for late June, and others may follow if response shows that the audience is interested.

The organizations taking part are the Philadelphia Radio Service Men's Association, the Federation of Radio

Servicemen's Associations of Pennsylvania, the Philadelphia Television Contractors Association and the Philadelphia Better Business Bureau. They will discuss such questions as "How much can the television owner expect from his receiver? When should the service technician be called? What can the service technician do and what can he not do? How much truth is there in the current 'television racketeering' rumors?"

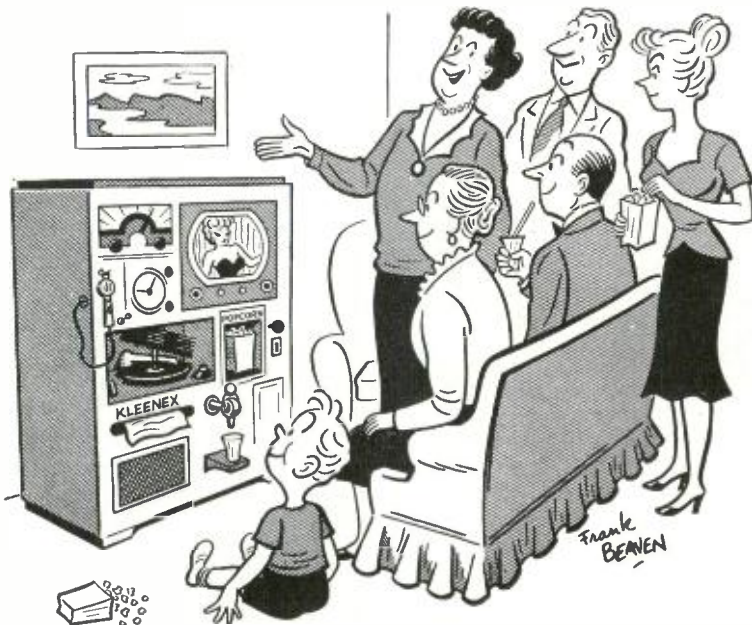

"Herbert just told them to send up the best they had—"

FREE WITH PHOTOFACT!



"Bonus" TV Supplements

Preliminary Service Data on Hundreds of Television Models for Your IMMEDIATE USE . . .

AT NO EXTRA COST!

TV set owners are calling for service within days—even hours—after installation. That's why you, the TV Technician, must have your service data *right now!* And *right now*, PHOTOFACT brings you the "rush" preliminary TV service data you need for *immediate use* to keep you going at full speed. FREE with the purchase of PHOTOFACT Folder Sets No. 91 and No. 93, you receive with each a separate 64-page Supplement containing preliminary data (in *advance* of regular PHOTOFACT coverage) on over 100 popular TV models. Place your standing order for PHOTOFACT today—it's the only way to get *without delay* the TV service data you must have *right now!*

Buy PHOTOFACT Folder Set No. 91 and get **FREE TV SUPPLEMENT NO. 91A:** Covers 114 important Television Receiver models, produced by 11 leading TV manufacturers.

Buy PHOTOFACT Folder Set No. 93 and get **FREE TV SUPPLEMENT NO. 93A:** Covers more than 100 leading Television Receiver models, produced by 17 TV manufacturers.

BUY BOTH! GET THE DATA YOU WANT NOW ON HUNDREDS OF TV MODELS

PHOTOFACT Set Nos. 91 and 93 are going fast—order today to avoid disappointment

HOWARD W. SAMS & CO., INC.

Order from your Parts Jobber today or write direct to HOWARD W. SAMS & CO., INC., 2201 East 46th Street, Indianapolis 5, Ind.

My (check) (money order) for \$_____ enclosed. Send me the following:

- Photofact Set No. 91 and Supp. 91A. \$1.50
- Photofact Set No. 93 and Supp. 93A. \$1.50

Name _____

Address _____

City _____ Zone _____ State _____



DO BOTH WITH

New 250-watt WELLER GUN



You'll save on tools and time with the new Weller Soldering Gun WD-250. Whether the job is rugged or delicate, your Weller Gun does it with the same ease and efficiency. Chisel-shaped RIGID-TIP provides more soldering area for faster heat transfer. New "over-and-under" terminal design gives bracing action to tip. Your Weller Gun is light-weight and compact, gets into the tightest spots.

Weller Guns actually pay for themselves in a few months. Fast 5-second heating saves time on every job. Trigger-switch control saves power—no need to unplug gun between jobs. Prefocused spotlight and longer length mean easy soldering, even when the job's buried deep. No other soldering tool gives you so many time-and-money-saving features. Order your new 250-watt Weller Gun from your distributor today, or write for bulletin direct.

SOLDERING GUIDE Get your copy of "SOLDERING TIPS"—new fully illustrated 20 page booklet of practical soldering suggestions. Price 10c at your distributor's or order direct.



WELLER
MANUFACTURING COMPANY
828 Packer Street, Easton, Pa.

REVIEW OF NEW TUBES

AS IN recent months, most of the new tubes for this month are designed for television applications.

Hytron has announced the type 1X2A half-wave high-voltage rectifier for picture tube anode supply. This miniature filamentary type tube is similar to the 1X2 but has somewhat higher ratings. In typical operation as flyback pulse rectifier the filament potential is 1.25 volts; d.c. output potential is 14 kv; and output current is 175 microamperes.

Another new Hytron tube is the type 12BH7, a double triode having semi-high perveance. One section of the tube can be used as a vertical deflection amplifier for picture tubes having high deflection angle. In typical class-A operation its amplification factor is 21; and transconductance is 6,200 μ mhos. It can supply a sweep height of 10½ inches on a 16-inch picture tube.

Sylvania's type 6BF7 is identical to the type 6BG7 described last month except for its mounting. The 6BF7 has tinned leads for wiring directly into the circuit, while the 6BG7 has short leads for use with an 8-pin sub-miniature socket.

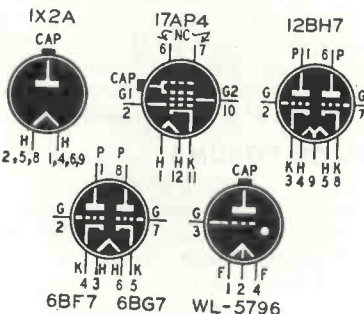

A twin triode, the 6SN7-GTA, is being produced by General Electric. The principal difference between this tube and the 6SN7-GT is its increased maximum ratings to make it suitable for a combined vertical oscillator and vertical deflection amplifier for television receivers. Maximum plate dissipation is 5 watts, maximum plate voltage is 500 volts, and maximum heater-cathode voltage is 200 volts.

A 17-inch rectangular picture tube, the 17AP4, is announced by Du Mont. The tube has a 150-square-inch picture size and features a single-magnet beam bender in its bent-gun construction. Its anode voltage is 12,000 volts; grid No. 2 voltage, 300 volts; focus coil current, 115 ma, and grid No. 1 circuit resistance, 1.5 megohms max.

A grid-controlled inert-gas rectifier by Westinghouse, the type WL-5796 thyatron, is designed for industrial control and ignitor firing service. For general control service maximum cathode current is 20 amps peak and 1.6 amps average. For ignitor firing service, maximum cathode current peak is 30 amps and average is .5 amps. For both uses the maximum negative control-grid voltage is 250 volts before conduction and 10 volts after.

NEW!

Rectangular
BLACK TUBE

16in. TELEKIT

TELEKIT
PRICES
START AT **49.95**
LESS TUBES

Jobbers: Write for Confidential Price Information

16 BR Telekit
\$79.95 Less
Tubes



Now you can build your own rectangular black tube TV set! This exciting new Telekit has a big 16 inch screen from a non-glare rectangular black tube. The entire set is engineered for simplicity, and has new 70% deflection, with video tube mounted directly on chassis. Brightness is assured by a 14 KV hi-voltage doubler circuit. The streamlined circuit is easy to assemble. No previous knowledge of TV is required. All you need is pliers, screw driver and soldering iron. The tuning unit and hi-voltage supply are factory wired and assembled for you. A big 54 page illustrated instruction book guides you through easy assembly. Satisfactory performance is guaranteed by our Telekit Factory Service Plan and warranty. Write today for full details.

12-B Telekit
\$69.95

8-B Telekit
\$49.95

Less Tubes
Here are new low prices on Telekits. Now you can have a fine 8½- or 12½-inch set at a price far below comparable commercial sets costing much more.



Over 30,000 Telekits have been assembled by following the big Telekit instruction book. No previous knowledge of TV is required. Satisfactory results are guaranteed under the Telekit Factory Service Plan. Write for full information.

**Telekit
Booster**
\$12.95



This Telekit Booster will bring in TV signals bright and clear. Especially helpful in fringe areas. Will give brilliant performance with any TV set. NOT A KIT. Completely assembled with tubes. Write for FREE catalogue listing Telekits, cabinets, tubes, antennas, boosters and television accessories.

TELEKIT

ELECTRO-TECHNICAL INDUSTRIES
1432 N. BROAD ST. DEPT. B PHILADELPHIA 21 PA.

Over 50,000 SERVICEMEN must be right!

NEW... **EICO** Instruments and **KITS** give you Laboratory Precision at Lowest Cost!

VACUUM TUBE VOLTMETER

Versatile top-quality laboratory-precision VTVM for trigger-fast operation and lifetime dependable service.

15 different ranges. Large rugged 4½" meter, can't-burn-out circuit. New zero center for TV & FM discriminator alignment. Electronic AC & DC ranges: 0-5, 10, 100, 500, 1000 v. (30,000 volts and 200 MC with HVP-1 and P-75 probes). Ohmmeter ranges, .2 ohms to 1000 megs. DB scale. New stable double-triode balanced bridge circuit—extreme accuracy. 26 megs DC input impedance. Attractive 3-color etched rubproof panel; rugged steel case. 115 v., 60 cycle AC. 9-7/12 x 6 x 5".

Model 221-K, KIT, only \$23.95

Model 221, factory wired, \$49.95



New TUBE-TESTER

The brand new professional tube tester and merchandiser EICO Service-Engineered for unbeatable value!

Large 4½" full-vision meter. Tests conventional and TV tubes including 9-pin miniatures. New lever-action switches—tests every tube element. Illuminated "Speedroll Chart." 2 grid caps. Short and open-element tests. Spare socket for new tubes. Protective overload bulb. Electronic rectifier. Handsome 3-color etched rubproof panel; rugged steel case. 115 v., 60 cycle AC. 12½ x 9½ x 4½".

Model 625-K, KIT, only \$29.95

Model 625, factory wired, \$44.95



5" PUSH-PULL OSCILLOSCOPE

All-new laboratory-precision scope gives you all the extra sensitivity and response for precise servicing of TV, FM & AM receivers.

Push-pull undistorted vertical and horizontal amplifiers. Boosted sensitivity, .05 to .1 rms volts/inch. Useful to 2.5 MC. TV-type multivibrator sweep circuits, 15 cps—75 KC. Z-axis intensity modulation feature. Dual positioning controls move trace anywhere on screen. Complete with 2-6J5, 3-6SN7, 2-5Y3, 58P1 CRT. Handsome 3-color etched rubproof panel; rugged steel case. 115 v., 60 cycle AC. 8½ x 17 x 13".

Model 425-K, KIT, only \$39.95

Model 425, factory wired, \$69.95

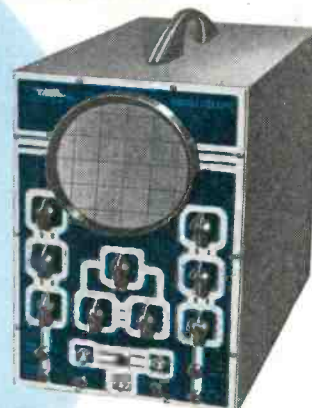

RF PROBE

Sensitive Germanium crystal probe for signal tracing and measurements to over 200 MC. Extends range of VTVMs and scopes.

Model P-75K KIT, for VTVM; P-76K for Scope; ea. \$3.75

Model P-75 or P-76, factory wired, ea. \$7.50



HIGH VOLTAGE PROBE

A new professional EICO-engineered HV probe carefully designed and insulated for extra safety and versatility. Extends range of VTVMs and voltmeters up to 30,000 volts. Lucite head. Large flashguards. Multi-layer processed handle. Complete with interchangeable ceramic Multiplier to match your instrument.

Model HVP-1, only \$6.95



New BATTERY ELIMINATOR & CHARGER



Model 1040-K, KIT, only \$22.50

Model 1040, factory wired, \$29.95

The brand new 6-volt power supply EICO Service-Engineered for extra reserve electrical power for all auto radio testing.

Latest-type full wave bridge circuit, extra-heavy-duty 4 stack manganese copper-oxide rectifiers. Latest Variact-type transformer: 0.15 volts output. Continuous operation: 5-8 v., 10 amps; intermittent: 20 amps, 10,000 mfd filter condenser. Rugged meter measures current and voltage output. Double protection: fused primary; automatic reset overload device for secondary. Handsome rugged hammerstone steel cabinet. 115 v., 60 cycle AC. 10½ x 7¾ x 8¾".



New Deluxe Kit

AM-FM-TV SIGNAL GENERATOR

A laboratory-precision generator EICO Service-Engineered with 1% accuracy.

Extremely stable, frequency 75 KC—150 MC in 7 calibrated ranges. Illuminated hairline vernier tuning. VR stabilized line supply. 400-cycle pure sine wave with less than 5% distortion. Tube complement: 6X5, 7F7, 6C4, VR-150. Handsome 3-color etched rubproof panel; rugged steel case. 115 v., 60 cycle AC. 12 x 13 x 7".

Model 315-K, KIT, only \$39.95

Model 315, factory wired, \$59.95

Easy-to-follow step-by-step EICO pictorial & schematic instructions—most explicit & comprehensive in electronics!—supplied with each Kit. Anyone can build the EICO Kits!

See these other EICO Instrument KITS:
Model 320-K Sig Gen KIT, \$19.95
Model 360-K Sweep Gen KIT, \$29.95
Model 145-K Sig Tracer KIT, \$18.95
Model 511-K VOM KIT, \$14.95

the exclusive EICO Make-Good GUARANTEE

Each EICO Kit and Instrument is doubly guaranteed, by EICO and your jobber to contain only selected quality components. EICO guarantees to replace any component which might become defective in normal use. If returned to the factory within 90 days of purchase, EICO guarantees all Kits assembled according to EICO's simplified instructions will operate as specified therein. EICO guarantees service and calibration of every EICO Kit and Instrument at the nominal charge as stated in the instructions.

Be sure to look at the EICO line before you buy any higher-priced equipment! From etched rubproof panel to modern engineering design, each EICO Kit and Instrument is crisscrossed with unbelievable value to satisfy the most exacting engineering requirements. YOU be the judge—compare EICO at your local jobber today, and SAVE! Write NOW for free latest Catalog C describing the complete EICO line.

*Prices 5% higher on West Coast

**ELECTRONIC INSTRUMENT
COMPANY, INC.**

276 Newport St., Brooklyn 12, N. Y.

© 1950, Electronic Instrument Co., Inc., Brooklyn, N. Y.

DON'T MISS THIS MARKET
DON'T MISS THESE PROFITS
DON'T MISS



Complete Set
 \$39.95
 with 50' cable

Callmaster

**ELECTRONIC
 2-WAY COMMUNICATOR**

Right now, the moderate-price Communicator market is wide open . . . offers tremendous activity . . . continuing, excellent profits to merchandisers who promote it . . . with the **right** product, at the **right** price!

Callmaster meets every requirement of this rich market . . . it's **right**, it's **ready**, to help you get your share.

PRICE . . . \$39.95 complete set (above) . . . ready to connect . . . no "extras."

PERFORMANCE . . . perfect sound fidelity . . . even a whisper is received clear and true.

PROFIT . . . generous profit margin . . . quantity discounts.

SIZE . . . compact . . . 7"x5 1/2"x3 1/2" . . . less desk space than "phone."

APPEARANCE . . . lustrous, mahogany-grain plastic cabinet . . . extra-thick, electric-shock proof. Bakelite control knobs.

PRECISION BUILT . . . engineered to rigid specifications. All components high quality. No "surplus" materials used.

INSTALLATION . . . easier to hook-up than standard door-bell system.

SERVICE . . . durable, rugged . . . doesn't have to be "babied." RMA warranty.

COMPLETE LINE . . . Master and sub-station sets. Selective Masters for multi-sub-station operation. All-Master systems.

DEALERSHIPS . . . available.

DISTRIBUTORSHIPS . . . some still open.

WRITE TODAY . . . on company letterhead, for complete information.

WM. M. SMITH COMPANY
 National Sales Office
 20 FERGUSON AVE., BROOMALL, PA.

VERTICAL INDICATOR

Patent No. 2,497,607

Donald L. Herr, New York City
 (assigned to Control Instrument Co., Inc.,
 Brooklyn, N.Y.)

This instrument may be used aboard ship, submarine, airplane, etc. to indicate the exact vertical direction, regardless of tilt or motion of the vehicle. The apparatus is simpler than a gyroscope which is often used for this purpose.

A pendulum P is used in the gimbal arrangement shown fixed to a base S. The two perpendicular axes AA and BB are free to move, therefore P (which is fixed to BB) is free to swing in any direction whatsoever. As P swings it causes motion of either AA, BB or both.

a position of equilibrium, there will be an a.c. component superimposed over the d.c.

The output of each potentiometer is averaged out by an integrating network and then amplified. Since a pendulum swings over equal arcs on either side of equilibrium, the amplified voltages are the same whether P is stationary or whether it oscillates. These voltages will depend only upon the average angle which exists between the pendulum rod R and the base rod C. Each output may be measured by a separate d.c. meter calibrated in

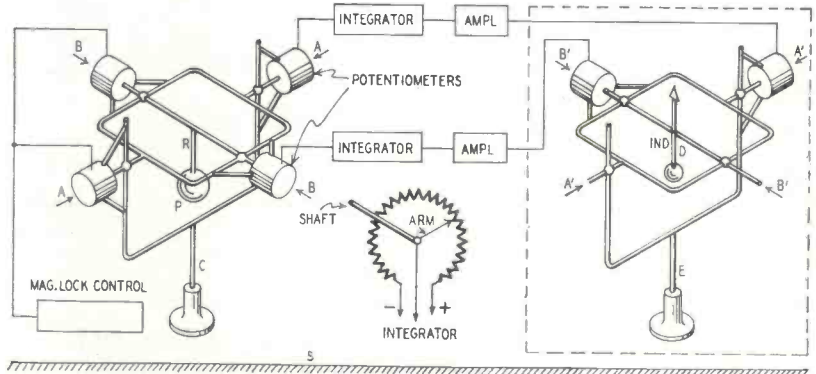

Both AA and BB control a linear potentiometer at one end and each has a magnetic lock at the other ends. The lock prevents excessive shaft displacement due to sudden shock or acceleration. The potentiometers are shown in the insert. As the shaft (either AA or BB) moves, it carries the center arm over a corresponding arc. Each potentiometer has its own d.c. input. At any particular instant the output from each potentiometer depends upon the position of the corresponding shaft. For example, if the shaft oscillates about

terms of angular displacement of each shaft. A more complicated arrangement is to use a second gimbal as shown within the dotted lines. This one is fixed to an extension of the base S. Each of its axes is controlled by the amplified voltages so that each undergoes the same angular displacement as the corresponding axes of the first gimbal. Instead of a pendulum, however, an indicator IND is used. The angle between R and C will be the same as that between D and E, therefore IND will always indicate true vertical.

BRIDGE COMPENSATOR

Patent No. 2,494,499

Henry T. Wilhelm, Long Island City, N. Y.
 (assigned to Bell Tel. Labs, Inc.)

One difficulty in designing a precision bridge is overcoming stray capacitance. This is especially troublesome across large capacitors. Fig. 1 shows a typical Maxwell bridge for measuring inductance and series resistance. R2 is usually large compared with R1. G1 and C1 are the standard conductance and capacitance, respectively. The unknown inductance L_x and its series resistance R_x are calculated from the bridge constants by the equations:

$$R_x = R_1 \times R_2 \times G_1$$

$$L_x = R_1 \times R_2 \times C_1$$

The stray capacitance C_s across R2 often leads to appreciable error. A novel and effective method of compensation is shown in Fig. 2a. A neutralizing capacitor C2 is connected between point B and a tap point E on resistor R2. It is well known

that the Y network, Fig. 2a may be transformed into an equivalent delta as in Fig. 2b. Of the 3 impedances shown in Fig. 2b, BD is across the a.c. source and cannot affect the bridge. AB comes out to be a small capacitance so it may be neglected in comparison with the relatively large C1 shunting it. The remaining arm AD becomes an almost pure conductance when C2 and point E are properly chosen.

The inventor shows that this occurs when C2 is made approximately equal to

$$\frac{K^2 C_1}{K - 1}$$

where $K = \frac{G_3}{G_2}$. For example, if E is the mid-point of G2, K = 2. Therefore C2 should be 4 (C₁) to balance out the stray capacitance C_s.

For exact balance C2 should be slightly variable. Alternatively, a small variable capacitance may be connected between tap E and ground for exact compensation.

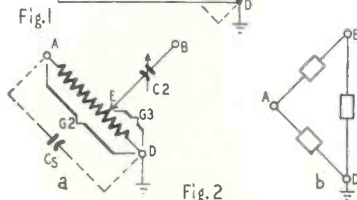
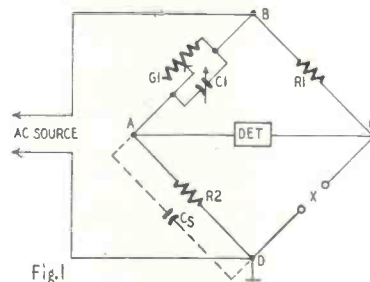

CABLE IMPEDANCE MEASUREMENT

Patent No. 2,490,827

Fred A. Muller, Newark, N. J.
 (assigned to Federal Tel. & Radio Corp.)

The impedance of a parallel line or coaxial cable is quickly determined with this instrument. The principle is illustrated in Fig. 1 An r.f. voltage is connected across a bridge which has 2 fixed arms R1 and R2. The third arm is P, a length of transmission line terminated in variable resistor R3. The fourth arm is another variable resistor R4. These two resistors are equal and are ganged.

When R4 equals the impedance of TL, the resistance across P is equal to R4. Therefore the bridge is balanced and the detector D indicates

null. This circuit is simple enough but the problem is to design a satisfactory R3 and R4. Each of these must remain purely resistive at high frequencies, say up to 100 mc and they must be adaptable to gradual variation and ganging.

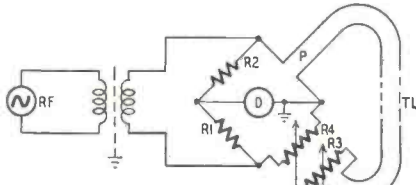

Fig. 1—The circuit of the r.f. bridge is conventional

R3 and R4 are each made up as in Fig. 2. The primary and secondary circuits are resonated at the desired frequency by adjusting the capacitors.

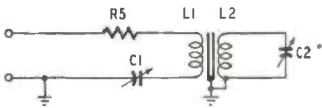

Fig. 2—R3 and R4 are tuned circuits.

The impedance becomes a pure resistance, determined by the value of R5 plus whatever resistance is reflected into the primary by the coupled circuit. The resistance increases as the coupling is increased.

Actual construction of the resistance may follow that shown in Fig. 3. L2 (and its capacitor C2) is made to slide along a track as the knob

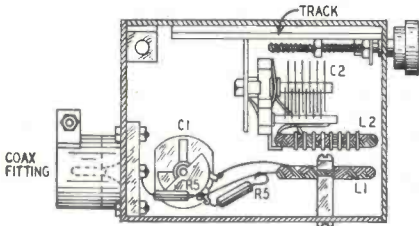

Fig. 3—Mechanical details of R3-R4.

is rotated. This controls coupling between the coils and therefore the resistance. By means of gears and a chain drive the same knob controls a similar arrangement in an adjacent shield box.

To use the equipment, the calibrated dial is adjusted until the bridge is balanced. Then the cable impedance is read off directly from the dial.

AUTOMATIC FIRE ALARM

Patent No. 2,507,359

Paul B. Weisz, Swarthmore, Pa.

(assigned one-half to Herbert Friedman, Arlington, Va.)

An open flame is detected in this device by a special, quick-acting phototube that does not depend upon direct heat radiation. The phototube P is a form of Geiger tube. It has an anode wire near a flat quartz window and a curved metal cathode. An atmosphere of argon with .2% butane mixture has been found sensitive and self-quenching.

The cathode emits electrons when deep ultra-

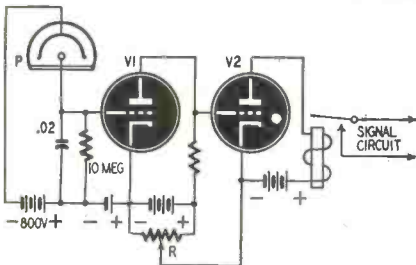

violet light falls upon it. Sensitivity is restricted to radiation below 3,000 Angstrom units, which is much lower than radiation from most artificial lights or from sunlight which has been filtered through glass. Electrons are attracted to the wire anode which is connected to a B-supply through a large resistor. About 10⁻⁸ amperes flow through this resistor, producing a drop of 0.1 volt.

The voltage to V1 is amplified to ignite thyatron V2. This closes the relay contacts to an external circuit containing an alarm. R controls the thyatron bias.

Workshop

PATENT PENDING

DUBL-VEE

TV ANTENNA

UNMATCHED STRENGTH

with minimum Wind Resistance

Recent structural refinements give the WORKSHOP Double-Vee a sinewy ruggedness unmatched by other TV antennas. Coupled with the inherent strength of heavy gauge aluminum elements, the strong, new supports and fittings recently added provide a corrosion-resistant assembly equal to the toughest wind and weather conditions.

MODEL VV
Write for Bulletin D

THE WORKSHOP ASSOCIATES, Inc.
135 CRESCENT ROAD, NEEDHAM 94, MASS.

Clearer Pictures—higher gain brings in stronger signal — especially on higher channels

Clearer Pictures — narrow beam cuts down multi-path ghosts

Clearer Pictures—better impedance match on all channels maintains high signal strength

Clearer Pictures — true horizontal polarization—no out-of-phase ghosts

Clearer Pictures—no parasitic elements — all driven

Clearer Pictures—designed by the pioneers in the antenna industry

\$10.95 LIST

Model 2VV Double-Stack \$21.90 List

Specialists in High Frequency Antennas

EVERYTHING IN TELEVISION!

—Now at your fingertips, for quick, easy reference...



THE VIDEO HANDBOOK

THE COMPLETE TELEVISION MANUAL

by MORTON G. SCHERAGA, Television Research Consultant, Allan B. Du Mont Labs. and JOSEPH J. ROCHE, Editor, Radio and Television Maintenance.

Now in one volume—all the essential know-how of television! All the up-to-the-minute information on television is arranged for quick reference—in easy-to-understand language.

The VIDEO HANDBOOK gives you practical answers to all your questions on television. This best-selling TV encyclopedia tells you . . .

- How Television Works
- How to Plan and Engineer Television
- How to Troubleshoot and Repair Television
- How to Select and Install a Television Antenna
- How to Produce a Television Show, Technical Aspects
- How to Build an Operating Television Receiver
- How to Select a Television Receiver

The VIDEO HANDBOOK contains thousands of vital facts—covering everything you need to know for working in Television. Every important point discussed is visualized in diagram or photographs (over 860 illustrations).

More than 900 pages . . . handsomely bound in durable Fabrikoid. Only \$5.95

SEND NO MONEY

You must see this book to appreciate it! 20,000 copies now working for practical Television men! Mail coupon for YOUR copy TODAY.

10-DAY FREE EXAMINATION COUPON—BOYCE-ROCHE BOOK CO. Montclair 2, New Jersey

Please send me The VIDEO HANDBOOK for 10-day examination. If I decide to keep it, I will send you \$5.95 plus postage; otherwise I will return the book postpaid. (We pay postage if you send \$5.95 with this coupon; same return privilege.)

Name
 Address
 City Zone State
 Employed by
 (This offer applies to U.S. only.)

CALIBRATED BALANCE ATTENUATOR

Balanced attenuators are used in telephone lines, between stages of audio and broadcast equipment, and between signal generators and bridges and other equipment. Though such units are highly useful and have many applications, they are often too expensive for

resistors are used, the actual values may vary above and below the indicated values by factors determined by the tolerances. Therefore, it is recommended that 5% resistors be used whenever possible. Check the components on a bridge or ohmmeter and

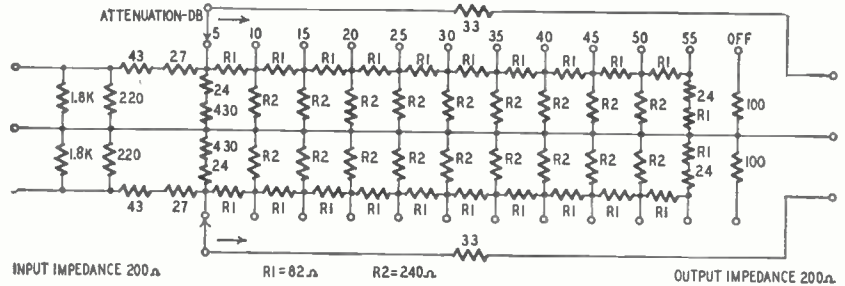

the average experimenter or service technician. A balanced attenuator providing up to 55 decibels attenuation in steps of 5 db in a 200-ohm line was described in *Wireless World* (London). The circuit shown has an insertion loss of 5 db. Although preferred-value

match them in pairs. Matched pairs should be used in corresponding sections of the series and shunt elements. If one of the pairs is low, the pairs immediately before and following it should be high so the calibration error is not cumulative.

HIGH-SENSITIVITY VOLTMETER

An a.c. voltmeter having sensitivity of 100,000 ohms per volt is described here through courtesy of Cornell-Dubilier Electric Corp.

The circuit is shown in Fig. 1 and the probe in Fig. 2. The meter, a Marion model 53RN 10-0-10 d.c. microammeter, has a resistance of 2,000 ohms which with the 50,000-ohm isolating resistor is subtracted from the calculated multiplier values for all except the 1,000-volt range. The multipliers are mounted on two 3 1/4 x 1 1/2-inch strips of 1/16-inch Bakelite. Resistors for the

low ranges are on one strip and those for the 1-kv range are on the other. They should be selected to have the exact values shown on the diagram. An accurate ohmmeter or a bridge will prove useful in selecting the resistors.

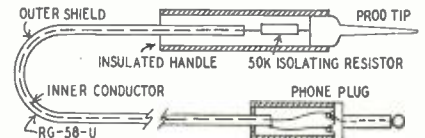

Fig. 2—The test probe is well shielded.

(Surplus precision resistors are available from some dealers. Use them if they are available.)

The meter reads up-scale when positive voltages are applied to the probe. It can be read to 25 mv.

Other voltage ranges may be added or substituted for those on the diagram. Two or more resistors must be connected in series to make multipliers for each range. For 2.5 volts use 180,000 and 18,000 ohms; 5 volts, 470,000, 22,000, 2,700, and 100 ohms; 25 volts—2.4 megs, 91,000, 2,700, and 1,100 ohms; 50 volts—4.7 megs, 220,000, 27,000, and 1,000 ohms; 250 volts—12 megs, 12 megs, 910,000, 27,000, 10,000, and 1,000 ohms; 500 volts—22 megs, 22 megs, 4.7 megs, 910,000, 150,000, 27,000, 10,000, and 1,000 ohms. All the resistors may be 1/2-watt carbons.

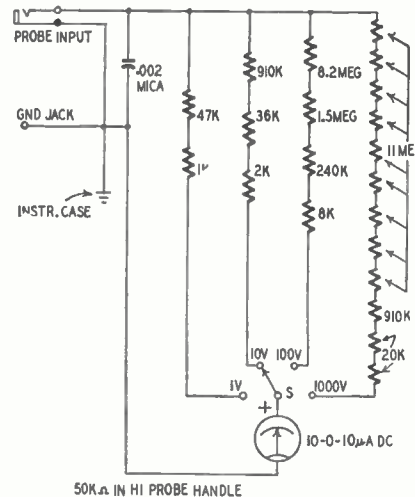

Fig. 1—Circuit of the a.c. voltmeter.

BASS-TREBLE TONE CONTROL

This circuit has a single control which attenuates highs or lows depending on its setting. A typical application of this circuit is shown.

Maximum high-frequency attenuation takes place when the arm of the control is close to C1. The control has no effect when the arm is at midpoint.

Turning the arm to the end nearer to C2 removes the highs from the feedback network which consists of R1 and R2 thus permitting the feedback voltage to attenuate the lows.

If this tone control is used between two voltage amplifier stages, the feedback network must be adjusted to ac-

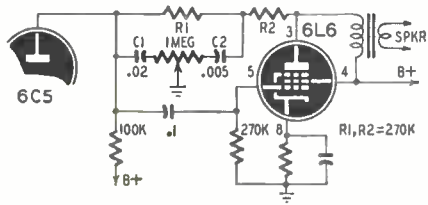

count for the higher gain.

Values of R1 and R2 may be varied to suit the circuit as long as R1 and R2 are equal.—V. Woychoski

HEADPHONE CONNECTION

I find this circuit to be an effective method of connecting magnetic phones to receivers, recorders, audio amplifiers, etc. Phones can be connected in parallel with a high-impedance circuit but they are likely to reduce its gain and alter its frequency response. Secondly, phones cannot be added to or removed from the circuit without affecting it.

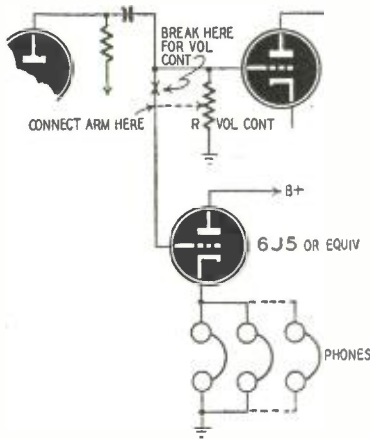

The system shown uses a cathode-follower as the connecting link between the amplifier and phones. It does not load the amplifier or affect its response, nor does it require complex switching arrangements for adding or removing phones from the circuit. Furthermore, connecting extra phones does not affect the volume of those already in the circuit. Certainly the addition of a single tube and socket is worthwhile in high-quality equipment.

A separate volume control for the phones can be made by replacing grid resistor R with a volume control and connecting the grid of the cathode-follower to its arm.—Charles Erwin Cohn

THE GREATEST SHOWS ON EARTH!

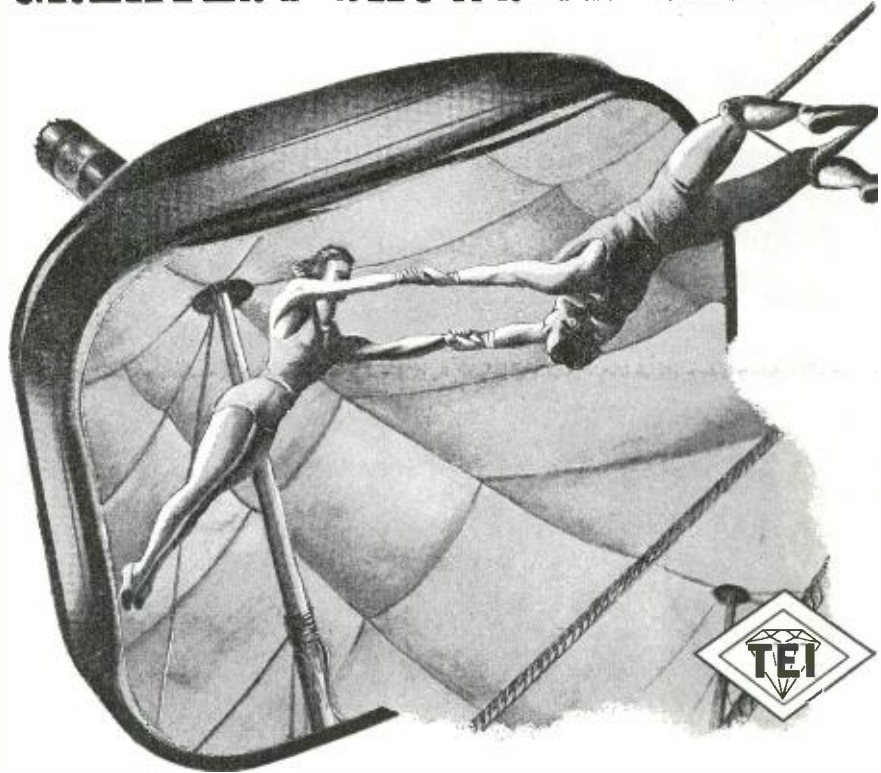

...perfectly reproduced by THOMAS tubes!

Behind the effortless Big Top performances are years of intensive training, a heavy investment in special equipment, and a constant search for ways of improvement. Likewise, behind the flawless performance of Thomas tubes are a highly trained engineering staff, the most modern equipment (much of it specially designed), and a continual research program aimed at producing an ever better picture tube. So when you buy a Thomas tube you are getting a "star performer" in every sense of the word. Insist on the BEST — Specify Thomas television tubes!

THOMAS ELECTRONICS, Inc.
 118 Ninth Street Passaic, New Jersey

 * **NOW! NEW LOW PRICE** *
 * **REMOTE CONTROL TV** *
 * CHASSIS OR COMPLETED UNITS *
 * **16"—19"—20" TUBE** *
 * Custom chassis completely factory wired and *
 * aligned. 35 tubes, less C.R.T., including P.P. *
 * Amplifier, Variable Impedance Output, Continu- *
 * ous or Turret Tuning, and Synchrolock. *
 * Write for detailed, illustrated circular EEB *
 * Dealer and Jobber Territories Available *
 * **ELECTRONIC MANUFACTURING CO.** *
 * 196 BOWERY NEW YORK, N. Y. *

Over 43,000 Technicians Have Learned
HOW TO GET THE MOST OUT OF BASIC TEST EQUIPMENT
 Why Not You, Too?
SERVICING by SIGNAL SUBSTITUTION
 A BEST SELLER FOR OVER 9 YEARS! (NEW, UP-TO-DATE, 11TH EDITION)
 The Simple, Modern, Dynamic Speed Approach To Re-
 ceiver Adjustment and Alignment Problems, AM-FM-TV.
 ● Nothing complex to learn ● Universal — non-absolutescent
 ● No extra equipment to purchase ● Employs Only Basic Test Equipment
only 40¢
 100 pages. Invaluable information that will help you re-double the value of your basic test equipment.
 Ask for "S.S.S." at your local Radio Parts Jobber or order direct from factory.
 PRECISION APPARATUS COMPANY, INC. • 92-27 Horace Harding Blvd., Elmhurst 4, N. Y.

NOW!

THE NEW RCP

Tube Tester KIT

Only \$25.95



MODEL 322 AK

Now you can get in KIT FORM the best professional test equipment made by RCP—precision equipment at the lowest prices ever. Each KIT contains simple step by step instructions.

CHECK THESE FEATURES

- This tube tester has provisions for checking individual sections of multi-purpose tubes as well as miniature and subminiature receiving tubes.
- Convenient Jack is provided for head-phone noise test to check noisy swinging, or high resistance internal tube connections.
- Neon lamp for rapid short and leakage tests between elements.
- Compact, sturdy construction.
- Operates on 100-130 volt, 50/60 cycle A.C. power supply.

Open-face in new hammer-tone grey finish steel cabinet with sloping panel. Size 5 1/4" x 12 3/8" x 8"; Weight 11 lbs.

AC-DC MULTITESTER



MODEL 447BK ONLY \$12.75

NOW in KIT FORM, these units are in a class with other makes of testers that sell for considerably more. A 3" square D'Arsonval meter is used, having an accuracy of 2%. Ring type shunts are employed.

RANGES

- DC Voltmeter: 0.5-50-250-500-2500 Volts at 1000 Ohm per Volt.
- AC Voltmeter: 0-10-100-500-1000 Volts.
- Output Voltmeter: 0-10-100-500-1000 Volts.
- DC Milliammeter: 0-1-10-100-1000 MA.
- DC Ammeter: 0-1-10 Amperes.
- Ohmmeter: 0-10,000 Ohms—1 Megohm—10 Megohms Ext.
- Decibel Meter: —8 to +55 decibels.

Model 447BK—Open face instruments, supplied in hardwood case. Size 5" x 8 1/2" x 3". Weight 21 oz. Complete with batteries, ready to operate.

Send for Bulletin No. 8RE
BUY IT AT YOUR LOCAL DEALER

RADIO CITY PRODUCTS CO., INC.

152 West 25th St. New York 1, N. Y.

CONVERTER TUBES AS AMPLIFIERS

Converter tubes which are no longer useful or serviceable as such, can often be used as voltage amplifiers in experimental circuits. The control grids of the oscillator and mixer sections are

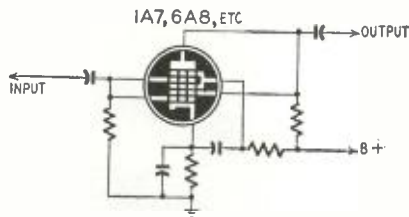

paralleled as are the mixer plate and the oscillator anode. The circuit shows how a typical converter can be connected as an amplifier. The screen and cathode dropping resistors and bypass capacitors may or may not be needed. —Charles Erwin Cohn

SPEAKER INSTALLATION KINK

A number of home, portable, and auto radios have the speakers mounted some distance from the chassis and are connected to it through flexible leads connected at both ends. The speaker leads must be unsoldered or the speaker removed from its mounting whenever the chassis is pulled.

I have made a practice of soldering a phono jack firmly to one of the voice coil terminals on the speaker frame and replacing the speaker leads with shielded wire and a phone plug whenever a set of this type comes in for repairs or a replacement speaker.

The cost of this modification is absorbed in a saving of labor during future jobs on the set. —W. H. Gibson

UNUSUAL SCOPE APPLICATIONS

If your scope has a ruled grid in front of the C-R tube, you can use it for comparing the strength of permanent magnets, or as an electro-scope.

If a negatively charged body is brought close to the ruled plate while the horizontal sweep is on, the trace will open in the center. The separation will depend on the settings of the intensity and focus controls and on the potential of the charged body. For best results, keep the intensity control turned down and bring the charged body to the exact center of the screen. If the plate becomes charged, run up the intensity control for a moment and then return it to its original position.

To compare the strength of permanent magnets, turn on the horizontal sweep and adjust the focus and intensity controls to the desired level. Place the horseshoe magnet against the plate with its sides parallel to the face of the tube. The pole faces should be just under the horizontal center line and on the vertical center line. The beam should be deflected upward; if not, turn the magnet over. The distance through which the beam is deflected is a measure of the magnet's strength. —Walter J. Woitowetch

Leotone

New "Jumbo Radio Parts Kit" . . . 17 FULL POUNDS of new dismantled Coils, Sockets, Wire, Transformer, Resistors, Condensers, Hardware, etc. 2.95

Hi-Frequency Buzzer . . . 3V adjustable 1.69
P-23 Headsets . . . 5 ft. cord & PL-55 1.29
Rubber Phone Cushions . . . pair 29c
500-ohm Transformers 4/1.00
Midget Mike—Speaker Unit! . . . 1 1/2"x9/16" 59
Use as Dynamic Mike, Phone, Pillow Spkr. 59
OPDT Anti-Capacity Switch 39c
.05-600V. Oil Condensers 12/1.00
2830 Kc. IF's (SCR-274) Plug-in 39c
GE Xmt'r Socket . . . 50W. for 11A, etc. 8/2.50
Needle Contact Binding Post. Plated 12c
Bircher Tube Clamps . . . #926B 9c
Screw Jack Ass'y (Leak #501B) with 25:1 Rt. 1.95
Angle gear box. Extends from 3/8" to 1/4" 1.95
Midget Selsyns (Bendix AY-38D) ca. 1.95
3/8" Glossy Black Linen Bakelite . . . 7"x7" 1.10
10"x10" 2.19
12"x12" 2.98

"Polystyrene" Rod & Tubing . . . 1/2" lengths
Rod: (O.D.) 1/4"—9c; 3/8"—19c; 1/2"—34c; 5/8"—53c; 3/4"—76c; 7/8"—105c; 1"—139c
Tubing: 1/4"—9c; 3/8"—12c; 1/2"—16c; 3/4"—25c; 1"—34c; 1 1/2"—1.49; 2"—1.98
Aluminum Panels (.0317) . . . 7"x10"—45c; 7"x12"—55c; 7"x14"—59c; 7"x18"—69c; 11 1/2"x18"—98c.

Radio Hardware Treasure . . FULL POUND CAN of Nuts, Screws, Washers, Lugs, etc. 49
Auto Suppressors . . . Universal elbow 8c
Grille Cloth . . . Ivory, Tan, Wine, 9" sq. 6/1.00
BC-606 Control Box . . brand new 69
BC-347C Interphone Amplifier with tube 2.49
SCR-511 Tech. Manual (incl. PE-137) 75
Freq. Meter Tech. Manual, TS-173. 58pp. 25
R-8-48NA Schematic 25
Phono Motor . . . 117V, 25 cycle. Less TT & mtr. 2.49

Cabinet Lid Tube Cartons (prices per 100)
Support Miniature (1" sq.x2 1/2")
holds satany angle to 98c
angle to 1.25
t i q u e um (1 1/2" sq.x4 3/4")
ish ea. 49c
2.35

Hearing Aid Amplifier Chassis (2 tube) MAKE
A REAL VEST POCKET RADIO adding simple
tube. WITH SCHEMATIC for 2 or 3 TUBE SET.
Less tubes, case 2.49
Hearing Aid tubes for Amplifier, set of 2 2.49
Radio Service Cement . . . 8 oz. bottle & brush 79
Solvent-Thinner for above, 8 oz. bottle 59
TU-17A Tuning Unit (BC-223) 2.49
High Fidelity Crystal Mike . . . Hi-imped. Rubber shock-mtd. 1 1/2" O.D. 1/4" deep. Less housing 98
Aluminum Housing for crystal mike 15
Amber Jewel Assembly . . . D.C. bayonet base 39
F. Selenium Rect. . . 18V. AC. 60ma. 5/8"x3 1/4" 98
RG-13/U CO-AX . . . 74 ohm. 20 ft. lgh. 2 conns. 98
120" Whip Antenna . . . 3 sects. & spring base 1.98
W-10 Field Wire . . . rolls 150-350 ft. only. 1/2" dia. 25
Octal Sockets . . . Moulded 1 1/2" saddle. 7c
Knob Kit . . . Spring, set screw, 25 asstd. 98
Wafer Sockets . . . 4 to 8 pin. 15 asstd. 98
Wire-Wound Resistors . . . 5-20W. 15 asstd. 98
Experimental Tubes . . . for Test, Research, Filament tested. 20 asstd. receiving types 1.00
Speaker Cones . . . 4" to 12" moulded & free-edge. 1.98
Less voice coils. Kit of 12 asstd. 2.49
Spiders, V.C. forms, Rings, Felt, Chamois Leather, Shims, Cement & Instructions. 2.49

ESPECIAL LOW PRICE! "COKE & PEET" KITS FOR \$3.95
Min. Order \$2.00 . . . 20% deposit on all COD's
Please add sufficient postage—excess refunded
Full remittance with foreign orders

LEOTONE RADIO CO.
67 Day Street,
New York 7, N. Y.

The Book that takes Drudgery out of Mathematics

Only \$1 postpaid

SOLVES EVERYDAY PROBLEMS HELPS YOU GET AHEAD IN LIFE

How many times have you lost money because of a mistake in figuring? Do you know how to figure quickly and correctly? Can you figure discounts, interest rates, taxes and all the other calculations you meet up with in your daily life?

Are you having trouble qualifying for Civil Service Exams or Armed Services Promotions, because you're not up on mathematics?

Here is the book that gives you a good background in mathematics; that takes all the irritation and drudgery out of it. You don't need to be scared of mathematics, because here's the subject explained without frills, without useless computations. Here's the book for men in radio jobs; for business men; technicians and craftsmen, explaining and answering everyday mathematic problems in easy-to-understand words and illustrations.

Yes, it's the key to a simple understanding of mathematics. It's a real home-study course in mathematics for the man who's alert to its importance in the world today.

ELEMENTARY MATHEMATICS
EASY — SIMPLIFIED — PRACTICAL

CONTENTS OF BOOK

- CHAPTER I. Arithmetic—Addition—Subtraction—Multiplication—Division
- CHAPTER II. Factoring and Cancellation—Fractions—Decimals—Percentage—Ratio—and Proportion.
- CHAPTER III. The Metric System
- CHAPTER IV. How to Measure Surfaces and Capacities (Geometry).
- CHAPTER V. Powers and Involvement—Roots and Evolution.
- CHAPTER VI. Mathematics for the Radio Technician—Thermometer conversions—Graphs or Curve Plotting—Logarithms—Use of the Slide Rule
- CHAPTER VII. Special Mathematics for the Radio Technician.
- CHAPTER VIII. Commercial Calculations—Interests—Discounts—Short Cut Arithmetic.
- CHAPTER IX. Weights and Measures—Useful Tables.

Send Stamps, Cash or Money Order.

Send Today for Your Copy of This Indispensable Book. It Can Be Carried Readily in Your Pocket.

TECHNIFAX
520 N. Michigan Ave. Chicago 11, Ill.

(Size 8 x 9 in.)

SAVING SOLDERING IRONS

I have found a way to prevent soldering iron tips from corroding and pitting when the iron is left on for long periods.

Dissolve one ounce of potassium silver cyanide in a pint of water in a small plating tank or crock. Using the copper tip as the cathode and any silver object such as an old knife or fork as the anode, deposit a fairly heavy coating of silver on the tip. I use the circuit shown and allow the current to flow over night. This will not discharge the average battery because the current quickly tapers from a 300-ma rate to approximately 5 ma steady state.

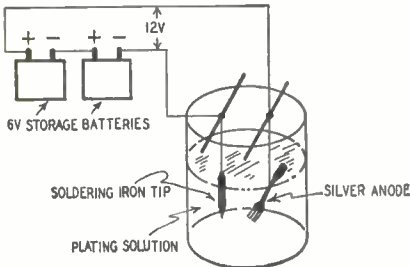

One tip has been in service for at least 25 hours per week for several months without pitting or corroding. A quick wipe with a clean cloth removes any residue which may form on the iron. It has not been necessary to re-tin the iron since its initial tinning immediately after the plating.—*Arnold E. Margolis*

(TAKE CARE! Cyanides are DEADLY POISONS and must be handled carefully. All operations should be carried out in a well-ventilated room or out of doors. Use rubber gloves in handling the solution and plating equipment. WASH the tank, anode, and work in running water.—Editor)

PILOT LIGHT TESTER

The tester shown in the diagram does away with the tedious process of juggling test leads when testing pilot lamps with an ohmmeter. I used a 1.5-ma meter, 1,000-ohm resistor, and a 1.5-volt flashlight battery. Other meters can be used by selecting a battery and resistor which will cause the meter to read full scale when the lamp socket is shorted. A good lamp will cause the meter to deflect to nearly full scale.

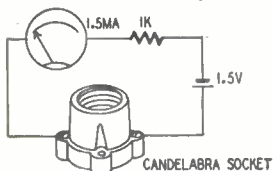

Separate screw and bayonet sockets can be wired in parallel or you can use a candelabra socket of the type used for 117-volt pilot and Christmas tree lamps. This type of socket will take screw- and bayonet-type pilot lamps.—*W. H. Leitch*

MICROPHONE COVER

Unused microphones are easily damaged by dust or dampness. Protect them with a double layer of Reynolds Wrap or similar metal foil.—*Freda Scott*

YOU ASKED FOR IT...

here it is!

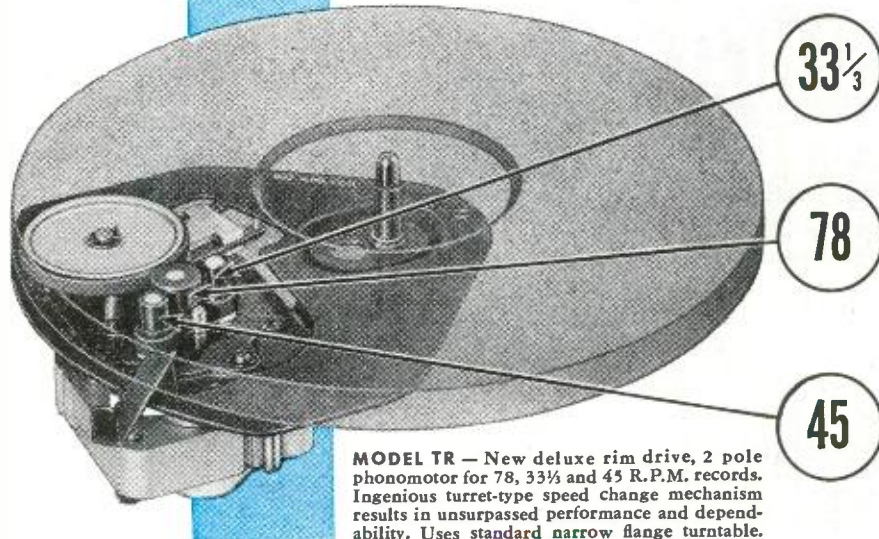

MODEL TR — New deluxe rim drive, 2 pole phonomotor for 78, 33 1/3 and 45 R.P.M. records. Ingenious turret-type speed change mechanism results in unsurpassed performance and dependability. Uses standard narrow flange turntable.

General Industries' *New* Deluxe 3-SPEED PHONOMOTOR

Now . . . in answer to the tremendous demand for a manual version of the popular GI turret model 3-speed record changer motor, General Industries presents the *new* Model TR. Truly the last word in compact 3-speed phonomotors, the Model TR is designed for use in the finest phonographs and radio-combinations.

In addition to the Model TR, General Industries will continue to offer the ever-popular Model TS, 3-speed neoprene belt-driven model for both manual and record-changer use.

Today, as always, General Industries leads the field with the *only* complete line of phonomotors for every record-playing requirement. Write, wire or phone for the latest General Industries catalog containing specifications and description of the full GI *Smooth Power* lineup.



The GENERAL INDUSTRIES Co.

DEPARTMENT C • ELYRIA, OHIO

BUILD 15 RADIOS...Only \$14.75

- ABSOLUTELY NO KNOWLEDGE OF RADIO NECESSARY
- NO ADDITIONAL PARTS NEEDED
- EXCELLENT BACKGROUND FOR TELEVISION

The PROGRESSIVE RADIO EDU-KIT will help you, if you want an EDUCATIONAL AND INTERESTING HOBBY, or if you want to get into a WELL-PAYING BUSINESS, or if you want to INCREASE YOUR KNOWLEDGE OF RADIO.

Absolutely no knowledge of radio is necessary. The PROGRESSIVE RADIO EDU-KIT is the product of many years of teaching and engineering experience. The detailed instructions and quizzes are clearly written and illustrated, so that they can be understood by anyone between the ages of 12 and 90.

The PROGRESSIVE RADIO EDU-KIT is not merely a collection of radio parts accompanied by a radio diagram. IT IS PRACTICALLY A RADIO COURSE, offered at a mere fraction of its real value. You will be taught to build radios in a progressive manner. First, you will build a very simple 1-tube receiver. The next set is a little more advanced. Gradually you will find yourself constructing elaborate radio sets, and doing work like a professional radio technician. Every part is illustrated. EVERY STEP INVOLVED IN BUILDING THESE SETS HAS BEEN CAREFULLY PLANNED. YOU CANNOT MAKE A MISTAKE.

Each of the 15 radios you will build operates on 110-120 volts, AC or DC. These sets have been designed to teach you the PRINCIPLES OF RADIO. Therefore, you will build a mere fraction of its real value. RADIO EDU-KIT is EXCELLENT FOR LEARNING THE PRINCIPLES OF RECEIVER, TRANSMITTER, AND AMPLIFIER DESIGN. It is used in many Radio Schools and Colleges in U.S.A. and abroad. It is used by the Veterans Administration for veteran training.

Quizzes are provided as part of the PROGRESSIVE RADIO EDU-KIT. They will be corrected by our staff at no extra cost.

FREE 1950 EXTRAS:

- ELECTRICAL AND RADIO TESTER
- SCREWDRIVER
- BOOK ON TELEVISION
- GENEROUS HANK OF WIRE



- ELECTRIC SOLDERING IRON
- ALIGNMENT TOOL
- SPOOL OF ROSIN CORE SOLDER
- MEMBERSHIP IN RADIO-TV CLUB

ORDER YOUR PROGRESSIVE RADIO KIT TODAY, OR SEND FOR FREE "KIT-KATALOG" POSTAGE PREPAID ON CASH ORDERS. C.O.D. ORDERS ACCEPTED IN U.S.A.

PROGRESSIVE ELECTRONICS CO., 497 Union Ave., Dept. RE-38, Brooklyn 11, New York

you don't have to be
scotch
to know
SENCO
PRICES
are EXTRA LOW

BRAND NEW IMMEDIATE DELIVERY TUBES INDIVIDUALLY CARTONED GUARANTEED

SPECIAL QUANTITY DISCOUNT OFFER. Order 25 or More Assorted Tubes and Deduct 5c from the Price of Each Tube.

15¢ Ea.	1U4 1U5 2A5 2B7 2S-45 3B7	5Y4 5Z3 6AG 6AE6 6AB 6AC5 6AD7 6AL5 6AQ5 6AR5 6AU6 6B6 6B7 6F5 6G6 6H6 6J5 6J7 6K5 6K7 6P5 6P6 6P7 6SF7 6SS7 6SR7 6V5 6X5	5Z4 6AB5 6B4 6BF6 6I8 6J8 6W4 6SL7 6U5 6V7 6Y6 7A5 7A6 7A7 7C5 7E7 7F7 7H7 7L7 7N7 7O7 7S7 7V7 14A7 14Q7 14R7 22 25Z5 35L6 50L6 70L7 82
19¢ Ea.	V99 X99	6K6 6K8 6L5 6SC7 6SJ7 6T7 6V6 7A4 7B6 7E5 7K7 7L7 7N7 7O7 7S7 7V7 14A7 14Q7 14R7 22 25Z5 35L6 50L6 70L7 82	69¢ Ea.
29¢ Ea.	12A6 12F5 36 955 956 957	12A6G 12F5 36 955 956 957	11A4 11A6 11B4 11C5 11C6 11D5 11E3 11N5 2A3 6A3 6A7 6AB7 6AG5 6BQ6 6CB6 6E5 6F6 6G6 7A7 7AG7 12A7 12AU7 12AX7 35A5 55 117Z6
39¢ Ea.	1A3 1V 2A6 2A7 2X2 6C4 6N4 6SD7 6SH7 6U7 6X4 12A8 12J5 12J7 12K7 12K8 12Q7 12SH7 24A 25Z6 26 32 35/51 39/44 57 76 77 78 79 85 VR53	12A6G 12F5 36 955 956 957	89¢ Ea.
Ballast Tubes	VR53	VR53	99¢ Ea.
45¢ Ea.	6K49B 6K55B 6KV51DJ K428 K49B L42B L42D L49B L49C 100-77 100-79 FD Type A	104 105 106 1H4 1H6 1J6 1L4 1P5 1R4 1R5 1S4 1S5 304 354 4A6 5T4 5W4 5Y3	59¢ Ea.

MINIMUM ORDER \$2.50. Send 25% deposit for all C.O.D. shipments. Include sufficient postage, excess will be refunded. Orders without postage will be shipped express collect. All prices F.O.B. New York City.

FREE!

NEW 1950 SENCO RECEIVING TUBE BASING DIAGRAM CHART

Over 230 Basing Diagrams, covering 600 Tube Types. Invaluable to the Service Technician and Amateur. This is Senco's way of saying thank you to old customers and new ones.

NOTHING TO BUY--FILL IN COUPON--MAIL TODAY!

NAME

ADDRESS

CITY..... ZONE..... STATE.....

Radio Men Who Know
SAVE AT SENCO
SENCO RADIO, INC., Dept. X
73 West Broadway New York 7, N. Y.

D.C.-OPERATED BOOSTER AMPLIFIER

? Please print a diagram of a booster amplifier delivering approximately 10 watts when operated from a 115-volt d.c. source. The input will be 1 watt into 500 ohms, and the output

1,000-ohm load to the plates of the tubes when connected across the 50-ohm tap. If you have several 16-ohm speakers, then two of them can be connected in parallel across a 24-ohm tap.

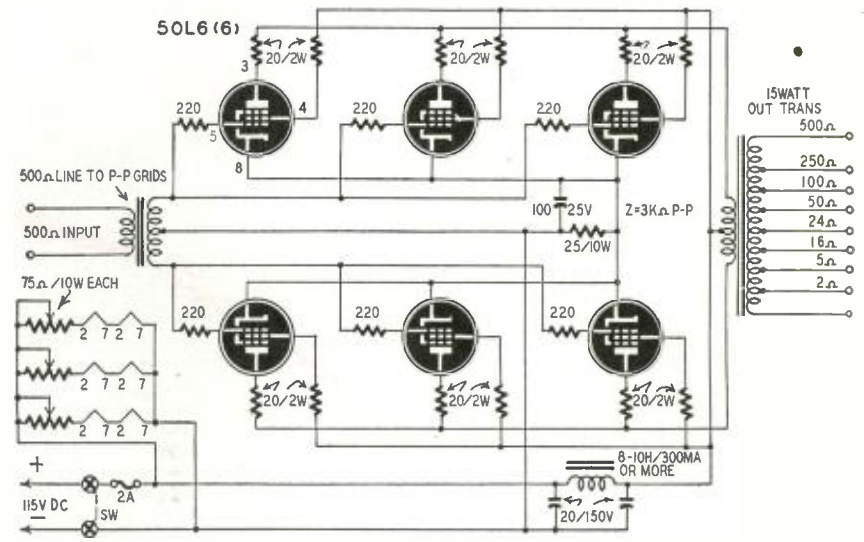

impedance should be 16 ohms. Can I use six 50L6's in push-pull parallel?—R.G.F., Hemlock, Texas

Similarly, three can be connected in parallel across a 16-ohm tap or in series across a 150-ohm tap.

A. This amplifier should meet your specifications. The plate-to-plate load impedance is in the order of 1,000 ohms. It being hard to find a suitable output transformer with a primary impedance this low, a standard 15-watt output transformer with a 3,000-ohm center tapped primary and multitap secondary is specified.

The input transformer should be designed to couple a 500-ohm line to push-pull grids and be rated at 1 watt or more.

Heaters in each pair of tubes are connected in series with a dropping resistor. The resistor should be adjusted for a 50-volt drop across the heater in each tube. All grounds should be insulated from the chassis to avoid shock hazard. Allow air to circulate to keep the tubes and resistors cool.

A 16-ohm speaker or two series-connected 8-ohm speakers will reflect a

SIMPLE SUPERHET USES FEW TUBES

? Please prepare a diagram of an a.c. superhet receiver using a 6SA7, 6SQ7, 6K6-GT, and a power supply. This set is to be used for local reception, and I do not believe that I'll need a separate i.f. stage.—J. E. G., Winter Garden, Fla.

trimmers. If space permits, select a large size transformer rather than a midget. Having only one i.f. and one r.f. transformer, the selectivity of the set will suffer in strong-signal areas. The tuning capacitor should have 365 µmf per section. The oscillator coil should be designed for use with a 6SA7 or similar tube. The oscillator padder capacitor will probably be 350 or 400 µmf; however, follow the coil manufacturer's instructions for best results.

A. The circuit has been prepared to your specifications. We recommend that you use a high-gain i.f. transformer. The best bet is to purchase one having powdered-iron cores and ceramic or air

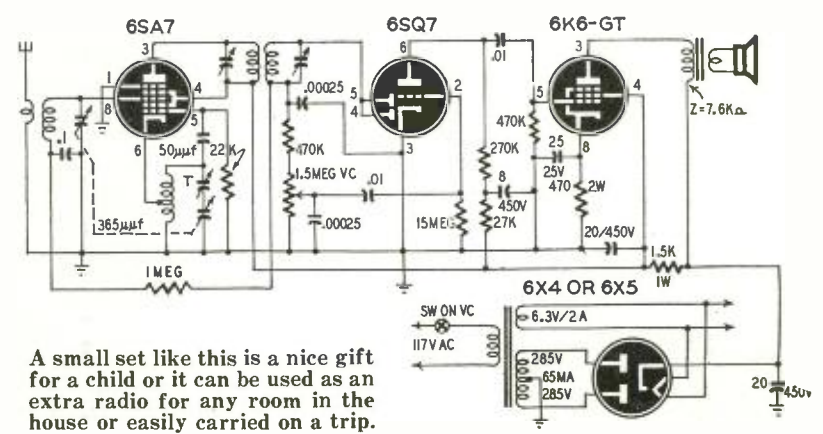

A small set like this is a nice gift for a child or it can be used as an extra radio for any room in the house or easily carried on a trip.

DIODE DETECTORS

? Why must the diode load resistor of a diode detector have a high value?
—C. W. B., Washington, D.C.

A. The diagram shows the basic diode detector circuit. Each positive half of the input cycles produces a positive voltage pulse across the diode load resistor R and filter capacitor C in parallel. C charges to a value equal to the peak signal voltage minus the drop

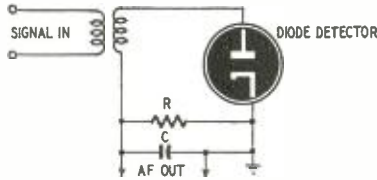

across the diode. R must be much larger than the reactance of C at the signal frequency, yet must be considerably smaller than the reactance of C at audio frequencies. Therefore, if C is too large, or R too low, high frequency response will suffer.

The efficiency of the diode detector depends directly on the ratio of the load resistance to the diode plate resistance, so the load resistance should be made as large as the a.f. and r.f. frequencies will allow for best efficiency.

The tuned circuit feeding the diode may be considered as being paralleled by a resistance equal to approximately $\frac{1}{2} R^2$. Therefore, R should be as high as practical to keep the power (E^2/R) absorbed by the detector low.

SHORTWAVE CONVERTER

? Please design a converter to cover 18 to 31 mc when used with an a.c. receiver tuned to 550 kc. If you can design the converter to tune over a wider range while using standard components, please do so.—A. E., Forest Hills, N. Y.

A. If you use Miller type E-727-A and E-727-C coils or their equivalents in the antenna and oscillator circuits, respectively, the tuning range of the converter will be approximately 13 to 36

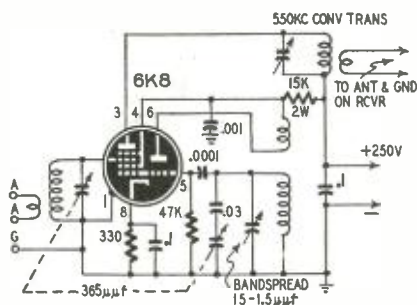

mc. The oscillator coil is designed for use with a 456-kc i.f. and no oscillator padder is used. However, if the converter must work into the equivalent of a 550-kc i.f. system a padder will probably be necessary. A .03-µf capacitor is shown. It may be necessary to experiment with the size of this capacitor to insure tracking. A 15-µf capacitor is across the oscillator tuning capacitor for bandsread.

AUGUST, 1950

TRANSVISION 19" KIT

\$104⁰⁰
less C.R. Tube*

Finest Quality

ANYONE can easily assemble the famous Transvision Kit. No technical knowledge or instruments required. Instruction sheet is simple (each part is packaged and numbered). ALL IFS are wired and pre-tuned. NOTE: Kit comes complete with all parts except picture tube.

COMPLETE LINE: TV only ("A" line). Also TV-and-FM Radio ("D" line). 12½", 16", 19". Choice of tuners includes famous DuMont Inputuner.

*PICTURE TUBES—16" and 19"

*Ask for our NEW LOW PRICES!

WIRED TV CHASSIS

Completely Wired and Aligned

Transvision "A" Chassis (TV only) comes completely wired, aligned and operating. Especially designed for fringe area reception. 23 tubes, AFC, AGC. Wired-in phono plug. Picture tube and speaker not included. Transvision "D" Chassis (TV-and-FM Radio) has famous DuMont Inputuner.

PRICES: 16" TV Chassis ("A" line) ... net \$115.00*
19" TV Chassis ("A" line) ... net 122.00*

* Picture tube and speaker are extra.

All prices are F.O.B. New Rochelle, N. Y. . . . Texas and West Coast slightly higher.

TRANSVISION, INC., Dept. RE, NEW ROCHELLE, N. Y.

Branches: Calif., 8572 Santa Monica Blvd., Los Angeles; 3471 California St., San Francisco . . . Dela., 4 E. 15th St., Wilmington . . . Ill., 4834 S. Ashland Ave., Chicago . . . Md., 1912 N. Charles St., Baltimore . . . Mass., 39 Tremont St., Boston . . . N. J., 601 Broad St., Newark . . . N. Y., 1425 Edw. L. Grant H'way, Bronx; 167-01 Hillside Ave., Jamaica, L. I.; 622 N. Salina St., Syracuse . . . Ohio, 2001 Euclid Ave., Cleveland; 54 E. Long St., Columbus . . . Penna., 235 N. Broad St., Philadelphia; 620 Grant St., Pittsburgh . . . Texas, 700 Commerce St., Dallas.

ALSO ASK YOUR RADIO PARTS JOBBER! Representatives: Apply now for available territories.

Write for Folders on Complete TRANSVISION Line

NEW! Low Cost High-Efficiency

"CLOVER-V-BEAM"

For Indoor or Outdoor Installations

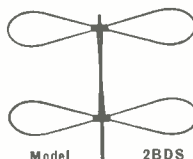

Better Primary and Secondary Area Reception.

See Your Telrex Distributor or Write:

TELREX, INC.

DEPT. 5 ASBURY PARK, N. J.

SIX TUBE SUPER

Three Gang Condenser

\$33.30
NET
Crowe Panel
Kit Included



Panel kit to fit most all makes (Please specify make of car and year model). New up-to-date latest priced Catalog available to dealers.

Bill Sutton's

Wholesale Electronics

5th at Commerce Fort Worth, Tex.

MOST POPULAR RADIO & TV TUBES
STANDARD BRANDS . . . AT LOW PRICES

0Z4	.55	6X5GT	.49
1A5GT	.69	7A6	.79
1A7GT	.69	7A7	.79
1B3GT	.98	7A8	.86
1H5GT	.69	7AG7	.89
1LA4	.58	7B5	.79
1LA6	.69	7B6	.79
1LB4	.69	7B7	.86
1LC5	.69	7B8	.79
1LC6	.69	7C5	.69
1LD5	.69	7C6	.86
1LE3	.79	7C7	.79
1LH4	.69	7E7	.69
1LNS	.69	7F8	.98
1N5GT	.69	7Q7	.69
1Q5GT	.69	7Y4	.79
1R5	.69	12A6	.39
1S4	.69	12A8GT	.89
1S5	.69	12AH7GT	.98
1T4	.69	12AL5	.89
1T5GT	.74	12AT6	.54
1U4	.72	12AT7	1.37
1U5	.69	12AU6	.97
1X2	1.29	12AU7	1.17
3A8GT	1.97	12AV6	.69
3Q4	.79	12AX7	1.17
3Q5GT	.79	12BA6	.54
3S4	.79	12BE6	.54
3V4	.79	12J5GT	.59
5T4	.98	12K7GT	.74
5U4G	.69	12Q7GT	.69
5V4G	.98	12SA7GT	.59
5W4	.79	12SF5	.69
5Y3GT	.59	12SF7	.74
5Y4G	.69	12SG7	.86
5Z3	.67	12S7GT	.69
5Z4	1.29	12SK7GT	.54
6A7	.69	12SL7GT	.98
6A8GT	.79	12SN7GT	.94
6AC7	.98	12S07GT	.54
6AFG6	.89	12SR7	.54
6AG5	.78	14A4	.69
6AG7	1.29	14A7	.69
6AH6	1.86	14B6	.69
6AK5	1.86	14Q7	.69
6AK6	1.17	14R7	.69
6AL5	.78	198G6G	2.76
6AL7GT	1.24	19T8	1.37
6AQ5	.89	24A	.69
6AQ6	.84	25A6	.84
6AQ7GT	1.17	25L6GT	.69
6AS7G	2.97	25Z5	.69
6AT6	.69	25Z6GT	.59
6AU5GT	1.29	26	.54
6AU6	.89	27	.54
6AV6	.69	32L7GT	.98
6AX5GT	.67	35	.67
6B6G	.69	35A5	.69
6BA6	.78	35B5	.59
6BE6	.78	35L6GT	.59
6BG6G	1.97	35W4	.39
6BH6	.89	35Y4	.59
6BQ6GT	1.67	35Z3	.69
6C4	.29	35Z4GT	.49
6C6	.54	35Z5GT	.39
6CD6G	2.89	36	.59
6D6	.54	37	.59
6E5	.79	38	.69
6F5GT	.69	39	.49
6F6GT	.69	41	.79
6G6G	.78	42	.69
6H6GT	.49	43	.69
6J5GT	.59	45	.69
6J6	.94	45Z3	.69
6J7GT	.76	45Z5	.69
6K6GT	.69	46	.64
6K7GT	.64	47	.78
6L6G	1.24	50A5	.74
6N7GT	1.17	50B5	.59
6P5GT	1.17	50L6GT	.59
6Q7GT	.69	50X6	.98
6SA7GT	.54	50Y6GT	.74
6SC7	.69	70L7GT	1.67
6SF5GT	.64	75	.69
6SF7	.89	76	.49
6SG7	.89	77	.59
6SH7	.98	78	.59
6SJ7GT	.64	80	.39
6SK7GT	.54	117L7GT	1.39
6SL7GT	.86	117N7GT	1.39
6SN7GT	.69	117P7GT	1.39
6SQ7GT	.49	117Z3	.59
6SS7	.59	117Z6GT	.79
6U5	.86	VR105	.69
6V6GT	.69	VR150	.69

BROOKS RADIO DIST. CORP.
80 VESEY ST., DEPT. A, NEW YORK 7, N. Y.

GYROPHONIC PROJECTOR

Electronic organ tone deficiencies are generally attributed to the inability of the loudspeaker to provide the "mass" effect of a pipe organ or orchestra. To make the electronic organ sound less "electronic," the Allen Organ Company has developed a "Gyro-phonc Projector," shown in the photo, which has in its speaker housing a rotating baffle on which are mounted two 25-watt speakers.



The rotating speakers provide tone dispersion similar to that of a pipe organ when several pipes are speaking at once if a single key is depressed. The Doppler effect of the rotation also gives the tone a certain indefiniteness of pitch similar to that of an organ or a large orchestra or choir.

The baffle can be rotated at three basic speeds. The lowest speed adds a singing quality as that of an organ or orchestra. The second speed produces a desirable celeste quality, and the third speed gives an acoustic tremulant that is superior to an electronically-produced vibrato.

Electronic organs sometimes have more than one tone generator for a given tone to produce the ensemble effect of an orchestra. The Gyrophonc Projector gives the effect of doubling or tripling the number of tone sources.

STUDENTS DEMONSTRATE TV

WOI-TV, at Iowa State College became the nation's first educational television station when it began operation in February. The station marks a step forward in the 27-year-old development of educational broadcasting which has made Iowa State College a leader in the field with the most modern and best-equipped broadcast facilities of any college in the country.

WOI-TV broadcasts programs for schools in the afternoons and general programs in the evenings each week-day. The station serves an area of more than 55 miles in radius with a population of about 600,000 people in six major Iowa cities. The transmitter operates on channel 4 with a radiated output of 13.6 kw.

The television project has been under study since 1945, when Dr. Charles E. Friley, president of the institution, appointed a committee to appraise the future roles of television and FM

broadcasting for the school. The college has long been mindful of the major role which WOI, the AM station at the college has played in off-campus activities.

As a result of the study, FCC permission to construct and operate a new FM station and a new TV station were applied for. When the permission was granted, the college became the first educational institution with permission to operate its own TV facilities. At present, Iowa State is the only college or university equipped to operate on all three of the modern broadcast media.

Video programs will be designed to serve the special and general interests of Iowa farmers, homemakers, schools, and adult education groups. Operation plans stipulate programming in three phases to provide maximum initial service at least cost.

In its first phase, WOI-TV will transmit all programs on film and slide projectors, making use of a 16-mm film crew and rapid developer devices for local programming. The second phase will begin with the purchase of a mobile television unit and a field camera which can be used for live broadcasts of remote sports events, meetings, classroom demonstrations, and laboratory activities. The last phase will be the construction of television studios for live studio broadcasts.

In addition to providing programs to entertain and educate the public, WOI-TV will use its facilities to train young television engineers and program producers. Another area of activity will be research studies to determine the effect of television broadcasts and to find new techniques and methods in broadcasting.

Radio Thirty-Five Years Ago
In Gernsback Publications

HUGO GERNSBACK
Founder

Modern Electric	1908
Electrical Experimenter	1913
Radio News	1919
Science & Invention	1920
Television	1927
Radio-Craft	1929
Short-Wave Craft	1930
Television News	1931
Wireless Association of America	1908

Some of the larger libraries still have copies of ELECTRICAL EXPERIMENTER on file for interested readers.

AUGUST, 1916 ELECTRICAL EXPERIMENTER

- Radio in N.Y. Police Preparedness
- The Vacuum Detector and How It Works, by H. W. Secor
- New Radio Telephone Transmitter
- Modern Radio Receiving Apparatus, by Samuel Cohen
- A 100 K.W. Radio Frequency Alternator
- Long Distance Receiving With the Audion Heterodyne, by A. S. Blatterman, B.Sc.
- Sending on a Short Wave, by R. H. Soster
- Novel Detector Stand, by Harold S. Duey
- A Small Panel Type Radio Transmitter, by M. B. Sleeper
- Making a Hughes Induction Balance.

SERVICE FOR FREDDIE

Funds are still pouring in for the Service to Freddie fund. Freddie, as readers will remember from the June issue (page 36) is the 2-year-old son of Herschel Thomason, Arkansas radio service technician, who was born without either arms or legs.

As reported in our July issue, Freddie has already been fitted with preliminary legs, which will have to be changed from year to year as he grows up. He is now beginning to use his artificial legs, but it will be many agonizing years before he can be rehabilitated to use first his legs, second his arms which are to be fitted later. This is a long uphill fight and a very expensive one.

Readers of RADIO-ELECTRONICS have joined together to help Freddie overcome this great handicap. To date June 22, \$1536.00 has been collected to supply him with artificial limbs.

No contribution is too large or too small in this campaign to help Freddie. Make all checks, money orders, etc., payable to Herschel Thomason. Address all letters to:

Help-Freddie-Walk-Fund
% RADIO-ELECTRONICS
25 West Broadway
New York 7, N. Y.

Balance as of May 29.....\$1057.50
New Contributions..... \$478.50

Anonymous—Long Beach, Calif.	\$1.00
Anonymous—New York, N.Y.	1.00
Anonymous—Portland, Oregon	1.00
Anonymous—Hampton, Va.	1.00
James H. Baskerville—Amitville, N.Y.	5.00
Bill's Radio Service—Minnesota Lake, Minn.	2.00
D. R. Bittan Company—New York, N.Y.	15.00
H. Bixby—Collins, N.Y.	1.00
H. A. Black—Jersey City, N.J.	1.00
Bian, The Radio Man, Inc.—New York, N.Y.	5.00
J. Harold Brownell—Pointe Du Bois, Manitoba, Canada	5.00
Edwin F. Buckmaster—Vineland, N.J.	2.00
Buck's Radio & Television—Hempstead, N.Y.	10.00
Grant W. Canfield—Monrovia, Calif.	1.00
Juan Carranza—Monterrey, N.L., Mexico	5.00
W. I. Cochran—Cleveland, Ohio	3.00
Joseph Cohen—Los Angeles, Calif.	2.00
John L. Cooper—Fetal, Miss.	1.00
Eugene F. Coriell—New Brunswick, N.J.	5.00
Mr. & Mrs. Harold Davidson—Boston, Mass.	5.00
Leslie M. De Voe Co.—Indianapolis, Ind.	10.00
De Wald Radio Mfg. Corp.—Long Island City, N.Y.	20.00
Emerson Radio and Phonograph Corp.—N.Y.	5.00
Robert Farmer—Quincy, Ind.	5.00
Judson W. Foster—Sauquoit, N.Y.	1.00
R. F. Freeman—Oxnard, Calif.	1.00
Joseph A. Garcia—Rio Piedras, P.R.	1.00
Frank Gattie—San Bernardino, Calif.	10.00
John Gifford—Fort Chester, N.Y.	1.00
Albert M. Grassie—Cohasset, Mass.	1.00
Haines Radio Service—Washington, DC	5.00
E. R. Hall—Miami, Fla.	1.00
Mrs. Bruce W. Harris—Dallas, Texas	5.00
A. C. Jacobson—Clarkston, Wash.	5.00
John—Seneca, S.C.	1.00
Morris Joseph—Philadelphia, Pa.	5.00

NEW! TUBE—OHM—CAPACITY—TESTER!

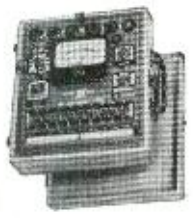

MODEL 202
• Tests all tubes including Novel & sub-miniatures!
• Standard emission method gives easy, direct reading!

- Completely flexible switching arrangement.
- Line Voltage Control.
- Checks shorts & leakages.
- Checks resistance to 4 megs.
- Checks capacity from .01 to 1 Mfd.
- Checks condenser leakage to 1 meg ohm.
- Individual sockets for every type tube base.
- Built-in roll chart.
- Tests tubes from .75 volts to 117 filament volts.

Complete in sturdy, hand-rubbed \$44.50 portable oak case with carrying handle, ONLY

Add \$6.00 for 220V operation

Export Dept., 303 W. 42nd St., N.Y.C.
Write Dept. B-8 for Free Catalog

EMC ELECTRONIC MEASUREMENTS CORP.
423 BROOME STREET, NEW YORK 13, N. Y.

Morton B. Kahn, Transmitter Equipment Mfg. Co., Inc.—New York, N.Y.	50.00
Samuel R. Kansas—Hurley, Wisc.	1.00
Ray K. Kingslow—Dallas, Texas	5.00
Charles F. Knobl—Harrisburg, Pa.	10.00
Mr. & Mrs. Frederick W. Koops—Asbury Park, N.J.	2.00
Mildred K. Krell—Tamaqua, Pa.	1.00
Casimer Kusak—Buffalo, N.Y.	1.00
Frank Larko—Brooklyn, N.Y.	1.00
Lewiston Radio Service—Lewiston, Idaho	5.00
Pierce F. Lohman—Harrisburg, Pa.	5.00
Thomas P. McCray—Fairmont, Va.	5.00
Edward S. McEwuen—Weston, W.Va.	1.00
James E. McEwuen—Weston, W.Va.	1.00
George E. McNamara—Hawley, Pa.	2.00
P. J. McNamara—Bowman, N.C.	1.00
Malech Family—San Francisco, Calif.	5.00
Mr. & Mrs. Harry Marcus & Daughter Deborah—New York, N.Y.	5.00
Mr. & Mrs. John Margulis & Girls—Chicago Heights, Ill.	1.00
Raymond May—McCall, Idaho	1.00
L. H. Meacham—Fairfield, Iowa	5.00
A. Mohr—North Bergen, N.J.	5.00
Edwin D. Nuttall—Shreveport, La.	5.00
Ronald & Janice Pederson—Queens Village, N.Y.	1.00
A. R. Peters—St. Louis, Mo.	1.00

TUBES Guaranteed, Brand New, Individual Cartons! Deduct 5c from the price of each tube when ordering any 20!

30¢ ea.	6J5	47	2A3	35W4
1F4	6K6	76	2A5	42
1G4	6R7	80	6A6	58¢ ea.
3B7	6S7	85	6AG5	024
12A6	6SH7	117Z3	6AV6	11N5
39/44	6SK7	2051	6CB6	1N4
38¢ ea.	6SL7	45¢ ea.	6K7	3Q5
6V5GT	6SQ7	174	6K8	12SG7
35Z5	6W4	1U4	6N7	50B5
2X2	6W4	5Y4	6SC7	50L6
42¢ ea.	6X5	6AG7	7A7	VR150
1Q5	5V6G	6SN7	7C5	69¢ ea.
1R5	7Y4	6SL6	7E6	6AC7
1U5	12BE6	25L6	7F7	6BG6G
5U4G	12SA7	25Z6	7F8	6B8
6AL5	12SH7	43	7H7	117L/M7
6AR5	12SJ7	49¢ ea.	7Q7	125N7
6AT5	12SK7	0A4G	125Y7	117Z6
6AU6	12SN7	1A5	148E	89¢ ea.
6BA6	12SQ7	1C5	14Q7	
6BE6	25R7	26	15Z5	6E5
6BE6	26	11L6		6L6
6H6	27	1Q5		

SPEAKERS ALNICO V MAGNETS
New Low Prices Ea. Lots of 5 Ass't.
3 1/2" P.M., .68 oz. \$3.79 5.75
4" P.M., .68 oz. .89 .85
4" P.M., 1 oz. .99 .95
6" P.M., 1.47 oz. 1.05 .99
4" x 6" P.M., 1 oz. 1.49 1.39
5" P.M., .68 oz. .89 .85
5" P.M., 1 oz. .99 .95
5" P.M., 1.47 oz. 1.05 .99
6" P.M., 1 oz. 1.29 1.19
6" P.M., 1.47 oz. 1.39 1.29
10" P.M., 6.8 oz. 3.69 3.59
12" P.M., 4.64 oz. 4.59 4.25

ELECTROLYTIC TUBULAR CONDENSERS
Fresh Stock! With mounting strap. Standard Brands—CD, Type EDL.
20 x 20—150 V. 1 meghom
40 x 40—150 V. 1 meghom
50 x 30—150 V. 1 meghom
34¢ ea.
10 for \$3.00

AC LINE CORDS
7 ft. Molded bakelite plug. 12c ea.
10 for \$1.10
8 ft. Reinforced U.L. approved rubber plug. 14c ea.
10 for \$1.25

SWEDGAL RADIO, INC.
96 Warren St., Dept. E-6, Cortlandt 7-6753
New York 7, N. Y.

Clement C. Pitz—Spencer, Ohio	1.00
John Rae—Gary, Ind.	2.00
Lester Reiss—New York, N.Y.	2.00
John F. Rey—San Diego, Calif.	5.00
Bibal's Radio Service—Turtle Creek, Pa.	5.00
Danna C. Richards—Lodi, Calif.	20.00
Mrs. Minnie L. Richards—Lodi, Calif.	5.00
R. Edgar Richards—Lodi, Calif.	25.00
Rite Way Radio Co.—Rochester, Minn.	5.00
Karen & Stanley Rogers—Mincola, N.Y.	1.00
James A. Russell, Jr.—Lawrence, Va.	1.00
Ferry Saffler—New York, N.Y.	5.00
Mabel Secoid & George P. Steiner—Cleveland, Ohio	10.00
Walter Soule—Framingham, Mass.	2.00
Lewis & Merie Smith—San Francisco, Calif.	5.00
Sparky's Radio Service—Hanover, Kansas	1.00
Paul Stetzer—Fort Wayne, Ind.	10.00
Raymond Tlac—San Antonio, Texas	1.00
Robert J. Tyborsky—Gypsy, W.Va.	1.00
Fred Upton—Jackson, Miss.	5.00
WZKIC—Amsterdam, N.Y.	1.00
C. R. Walters—Harrisburg, Pa.	10.00
Robert Well—Albany, N.Y.	5.00
Raymond Westbrook—Ontario, Oregon	5.00
Edward L. Williams—Stockton, Calif.	2.00
Willis Radio Service—North Bend, Ohio	5.00
Fred H. Zolm—Milwaukee, Wisc.	2.00

FOR BEST PICTURES • USE THE BEST TWIN-LEAD
300 ohm TELEVISION TRANSMISSION WIRE OBTAINABLE.

Ask for **J. S. C. WIRE** MOST LEADING DISTRIBUTORS HAVE IT IN STOCK

MANUFACTURED BY **Jersey Specialty Co. • LITTLE FALLS, NEW JERSEY**

Visit Us At The **Cleveland N.E.D.A. Trade Show**
National Convention
Booth No. 231
August 29-31, 1950
at the **Cleveland Auditorium**
Cleveland, Ohio

All Phones Little Falls 4-0784, 1404, 1405

3/4 RPM ANTENNA ROTATOR MOTOR

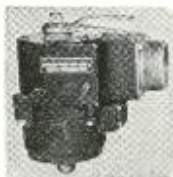

High torque, reversible motor—operates directly from 110 Volt 60 cycle by use of condenser. Light weight, quiet running, ruggedly built, positive stop, easily mounted. Normally operates from 110 V. 400 cycle. Complete, with instructions. New: \$4.95

10 MFD 400 Volt Cond. \$1.00; SPST Momentary Switch, 35c; DPDT Momentary Switch, 75c; Resistor, 100 ohm 25 Watt, 50c; 4 Wire Cable, 5c per Ft. COMPLETE KIT OF PARTS: Motor, Cond., SPST Switch, and Resistor \$5.95

Car Shaver Motor

Use your electric shaver in your car. Dynamotor will supply 110-120 Volt DC approx. 15 Watts from 6 Volt DC auto battery and will operate most types of AC-DC shavers. Order No. RE-6250. Price—only \$2.00

HAND TOOL MOTOR—12 Volt AC-DC 5600 RPM. Size: 3/4" L x 1 1/4" D with splined shaft 3/8" D x 1/2" L Price \$2.95

GASOLINE ENGINE GENERATORS:
HOMELITE Engine Generator—output 30 V. DC 50 amp. (1500 W.) driven by 3 HP single cylinder two cycle air cooled gas engine, rope or electric start. Used to charge batteries or auxiliary light plant. Reconditioned. No. REG-105 \$49.50

DELCO Engine Generator—output 12 V. DC 750 Watt driven by 2 HP one cylinder 4 cycle air cooled gas engine with self starter, voltage regulator, output meter, and switch. Used to charge batteries or auxiliary light plant. Reconditioned. Order No. REG-106 \$59.50

WHIP ANTENNA—MAST BASES, INSULATED:
 MP-132—1" heavy coil spring, 2" insulator. Overall length: 11 1/2". Wt. 2 3/4 lbs. Price \$3.95
 MP-22—Spring action direction of bracket. 4" x 6" mounting. Price \$2.95

MAST SECTIONS FOR ABOVE BASES:
 Tubular steel, copper coated, painted, 3 foot sections, screw-in type. MS-53 can be used to make any length. MS-52-51-50-49 for taper. Any section .50c Ea. Sections MS-54 or MS-55 (Larger than MS-53) 75c Ea. **BA BG-56** 1/2" carrying 5 mast sections .50c

TRANSFORMERS—110 Volt 60 cycle Primaries:
 Sec. 12 V. 1 amp. \$1.50 Sec. 24 V. 2 amps. \$2.25
 Sec. 24 V. 1 amp. 1.85 Sec. 24 V. .5 amp. 1.50
 Sec. 36 V. 2.5 amps. 2.95 Sec. 24 V. 4 1/2 amps. 3.95
 Sec. 14-14 or 28 V. 7 1/2 or 15 amps. 4.95

Address Dept. RE • Prices F.O.B., Lima, Ohio • 25% Deposit on C.O.D.'s • Minimum Order \$2.00

BLOWER 115 Volt 60 cycle Blower, approx. 100 Cubic Ft. Dis. 3/4" Intake, 2" outlet. Motor size: 3 1/2" x 3". 1525 RPM. Complete with mounting bracket. Gov't. surplus. Brand New and Boxed. Order No. RE-3604 \$7.95

FAN OR BLOWER MOTOR—110 Volts, 1550 RPM. Motor size: 3" x 3". Shaft size: 3/16" x 1" \$3.95

AC ELECTRIC MOTOR—110 V. 60 cycle ball bearing motor, approx. 3500 RPM, 1/25 HP. Shaft size: 3/16" x 3/8". Motor size: 7" x 4". Ideal for models, fans, etc. Converted from Govt. surplus. Only \$3.00

BC-223 TRANSMITTER and SPARE PARTS

30 Watt Transmitter with crystal or MO control on four pre-selected channels, 2000 to 5250 KC., by use of three plug-in coils. Five Tubes: two 80C1 & three 46. With TU-17 Tuning Unit 2000 to 3000 KC. and Cable, less mtr. New \$24.95. Used: \$19.95
OPERATING MANUAL for BC-223. \$2.00
SPARE TUBE KIT for BC-223—Contains 5 spare tubes in metal box. Price. \$4.95

TUNING UNITS: TU-17—2 to 3 MC.; TU-18—3 to 4.5 MC.; TU-25—4.5 to 5.2 MC. NEW: \$3.50 Ea. USED: \$2.50 Ea.

PE-125 VIBRATOR POWER SUPPLY for BC-223 Transmitter. 12/24 Volt input; output 500 Volt 150 MA. Price NEW: \$9.95

MOUNTING for PE-125 1.50

SPARE VIBRATOR & TUBE KIT. For PE-125—Contains 2 spare tubes, 2 spare vibrators and fuses in metal box. Price. \$4.95

CABLE only—Transmitter to Power Supply 1.75

BC-645-A TRANSCEIVER 110 VOLT TRANSFORMER AND CHOKE

15 Tube Transceiver, ideal for conversion to 460 MC. Citizens Band. Frequency coverage 435 to 500 MC. With conversion instructions—New and Boxed. BC-645-A \$14.95

TRANSFORMER for BC-645-A—110 V. 60 cycle input; output 400 V. 150 MA. after filter. 12, 9, and 6 V. AC. 4 amps and 5 V. 3 amps. No. RE-645 \$6.95

CHOKE—15 Hy. 150 MA. No. RE-646 \$2.95

PE-101 DYNAMOTOR—13/26 Volt input. \$2.95

NEW TRANSFORMERS—CASED—115 V.A.C. 60 CYCLE INPUT:

OUTPUT: 600-0-600 V.A.C. at 250 MA. 12 V.A.C. at 3 amps; 12 V.A.C. at 3 amps; and 5 V.A.C. at 3 amps. Designed for Army Surplus transmitters. No. RE-108 \$7.75

OUTPUT: 250-0-250 V.A.C. at 60 MA. 24 V.A.C. at .6 amps; 6.3 V.A.C. at .6 amps. Designed for Army Surplus receivers. No. RE-109 \$3.50

NEW CHOKE—CASED: 13 Henries at 250 MA. filter choke, 1500 V. insulation. No. RE-121 \$4.95

TV DX REPORTS

Now that summer is with us, the ionosphere is really bouncing those TV signals around and we've received a number of interesting reports from dx-ers. Most of the reports include KLEE-TV, that channel 2 station in Houston, Texas, which seems to be operating on a nation-wide basis.

Mr. A. W. Crowl, of Welsh, Louisiana, has sent in a list of 21 dx receptions made in the past year and a half on his Air King, a 10-inch set with a 630TS-type chassis. He uses one booster at the set and a remotely controlled booster at the antennas. The antennas are a Vee-DX RD-13A and a JFD double-stacked array cut near channel 3. A relay changes from one antenna to the other and a pair of 60-cycle, 110-volt selsyns control the booster as well as a rotating mechanism for the Vee-DX antenna. The antenna is 76 feet above the ground.

Besides KLEE-TV, some of the dx receptions which Mr. Crowl had with this setup are WBKB, channel 4, Chicago; WMAR-TV, channel 2, Baltimore; WJKB-TV, channel 2, Detroit; WWJ-TV, channel 4, Detroit; WTCN-TV, channel 4, Minneapolis; WBN-TV, channel 4, Buffalo; WCBS-TV, channel 2, New York; and WFIL-TV, channel 6, and WPTZ, channel 3, Philadelphia.

One television dx viewer, Maurice Dubreuil of Lavaltrie, Quebec, found himself on the front page of the Sunday Section recently. *La Patrie* of Montreal devoted the full page (plus a long continuation) of the June 11 issue to his success in receiving American stations and holding "open house" in the lobby of his hotel, so that the inhabitants of this little town about 35 miles from Montreal are more familiar with television than the residents of Canada's metropolis.

Main stations received are WRGB, Schenectady, and WSYR, Syracuse, though New York City and Boston have also been received. Mr. Dubreuil, an experienced radio technician and amateur (VE2SV) constructed his own receiver, to which he has since added a pre-amplifier. His antenna is the dipole-with-reflector type, and he uses three bays, though he intends to design a new antenna shortly. The antenna is 62 feet high.

Rembert Pate of Clio, South Carolina, also sent in a list of stations which he received on his Hallicrafters T-54. His antenna is a dipole stacked array 42 feet high. In addition to KLEE-TV, Mr. Pate received WTMJ, channel 3, Milwaukee, WKY, channel 4, Oklahoma City; KEYT, channel 3, Omaha; and WBAP-TV, channel 5, Fort Worth.

Leon Kraitz of Portsmouth, Virginia, has an RCA model 9TC272-M receiver and a 114-302A Amphenol stacked array with which he has received WOR-TV, channel 9, New York; WCAU-TV, channel 10, Philadelphia; WFIL-TV, channel 6, and WPTZ, channel 3, Philadelphia; and last, but not least, that Texas station.

FAIR RADIO SALES 132 SOUTH MAIN ST. LIMA, OHIO

DON'T REMOVE THE TV SET! Now! SHOOT 90%* of TV TROUBLES on-the-Spot with 2 OAK RIDGE miniatures!

SYNCO-SWEEP GENERATOR (Model 104)

The only unit of its kind in the world! Completely trouble-shoots and tests Horizontal and Vertical Linearity, Sync, Sweep and High Voltage circuits of all TV sets—in less than 8 minutes! Generates Vertical and Horizontal Linearity Bars, and Vertical and Horizontal Sync and Saw-tooth signals! Shoots the trouble trigger-fast, "on-the-nose"—entirely independent of station operation! 5 3/4 x 4 x 2 1/4". Complete with leads, Dealer's Net \$39.95.

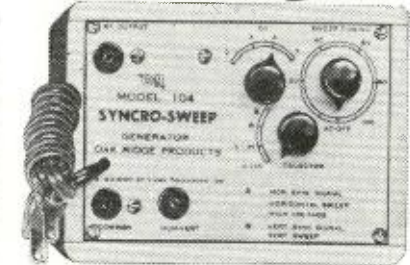

TV-FM SIGNAL GENERATOR (Model 103)

"Lands" any signal failure from ANT to CRT or SPKR with bull's-eye precision in 2 minutes flat! Has 4 separate tuning bands & modulation output and attenuator. Complete tester for RF, Osc, Mixer; Video & Audio IF, 2nd Det and Amplifier; Sound & Adjacent Picture Trap; and ANT Orientation & Sensitivity. Also is complete Marker Generator. 5 3/4 x 4 x 2 1/4". Complete with leads, Dealer's Net \$29.95.

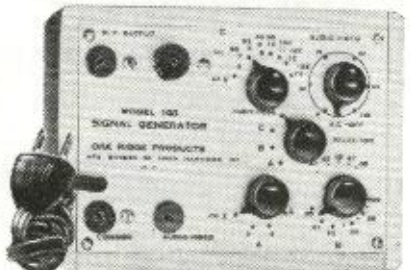

SUBSTITUTION TESTER (Model 101)—Substitutes for most-often-faulty components. Also acts as Audio Signal Tracer. Complete with leads, Dealer's Net \$16.25.

TV HIGH VOLTAGE TESTER (Model 102)—Checks all h-v in all TV sets. Scales 0-500V, 0-15KV, 0-30KV. Supplied with special h-v lead, Dealer's Net \$14.95.

• With the Oak Ridge Miniatures in your tool-kit, you take your job to the set! You double your servicing time and earnings! Ask your jobber for them. Write for your free Catalog T-E.

*National surveys show 90% of all TV troubles occur in those circuits for which Models 104 and 103 are specifically designed.

OAK RIDGE PRODUCTS 239 EAST 127 STREET, NEW YORK 35, N.Y. Manufacturing Division of VIDEO TELEVISION, INC.

TERRIFIC BUYS FOR SMART, SKEPTICAL BUYERS

ARMY AIRCRAFT RECEIVER— BC-946-B

Covers 520 Kc to 1500 Kc Broadcast Band. 6 Tubes: 3—12SK7, 1—12SR7, 1—12A6, 1—12K8. Designed for dynamotor operation; can be easily converted to 110 volt or 32 volt use. Two IF Stages. Three-gang tuning con. BRAND NEW, in sealed carton, with tubes and instruction manual, less dynamotor.....

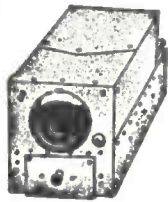

\$29.50

SMASH VALUES IN RADIO RECEIVERS

	Used	New
BC-453 RCVR.	\$4.95	\$21.95
BC-454 RCVR.	6.95	7.95
BC-455 RCVR.	1.95	3.45
BC-456 MOD.	6.95	8.95
BC-457 XMTR.	6.95	8.95
BC-458 XMTR.		23.95
BC-459 XMTR.	14.95	24.95

BC-348 Receiver, New.....\$149.50
BC-348 Receiver, Used, good as new..... 129.00
BC-221 Freq. Meter, Exc. Cond.... 77.50
MN-26C Compass Rcvr. New..... 28.50

BC-645 XMTR RECEIVER 15 Tubes 435 To 500 MC



BRAND NEW!

\$16.95
each

to 490 mc. Brand new BC-645 with tubes, less power supply in factory carton. Shipping weight 25 lbs.

PE-101C DYNAMOTOR for above BC-645..... **\$2.95**
UHF ANTENNA ASSY. for above BC-645..... **\$2.45**

SETCHEL-CARLSON Beacon Radio Receiver BC-1206-C

Receives A-N beam signals, operates on 24-28 V DC. 5 Tubes: 3—14H7, 14R7, 28D7. Tunes 195 to 420 Kc. Size 4"x4"x6 1/4" wide. 4 lbs. In original carton. Good Used..... **\$6.75**

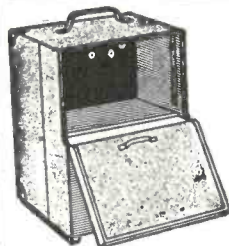

FREQUENCY METER CABINET

For BC-221 Series freq. meters. BRAND NEW! 3 compartments. Massively built. 14 1/2"x10 1/2"x10". Value \$20.00. Complete with canvas cover for both ends. Yours for only **\$4.95**

DC AMMETER 0-15 Amps

A terrific buy! 3 1/2" easy reading scale. 75 divisions. Black plastic case 4 1/2"x 5 1/4"x2 1/4". Rubber covered test clip leads plus black metal carrying case with hinged cover. Brand New. Wonderful for automotive, battery charging, general test work. Value \$25. All yours for only **\$4.59**



STROMBERG TELEPHONE
It's a real desk type carbon microphone, with press-to-talk switch. Very massive construction, cord and plug included. Excellent condition. Specially priced..... **\$3.95**

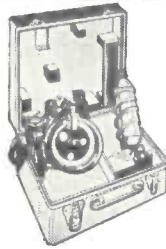

BUBBLE SEXTANT

12.95 COMPLETE

Terrific value for boat owners! Actually worth \$100 or more! Has illuminated averaging disc for nighttime use. Complete with carrying case, recording discs, flash light with rheostat for using sextant at night, 2X telescope for faint stars, and Allen wrench. Hurry! Only a few left!

GE THYRATRON FG-105

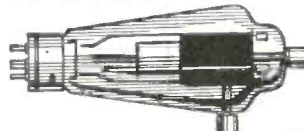

Brand New MERCURY RECTIFIER Individually boxed in factory sealed cartons. List Price \$40 your cost..... **\$11.95** each

While They Last!
For continuous rectifier and welder control service. Tetrode type, indirectly heated cathode; 10000 V peak, 10000 V peak inverse. Av. Max. current 6.4 amps continuous, 2.4 to 4 amps welder control service.

MONEY SAVING VALUES! CHECK EACH ONE

Headsets and Mikes

HS23 High Imp. Headset New.....	\$2.85
HS33 Low Imp. Headset New.....	2.85
HS30 High Imp. Headset New.....	1.39
HS30 High Imp. Headset Used.....	.79
T17B. Mikes. New.....	2.45
T17B. Mikes. Used.....	.88
T24 High Imp. Mike. New.....	1.19
T30 Breast Mike. New.....	.88
T45 (or Navy) Lip Mike New.....	.98
CD307 Cord for headsets. New.....	.55
WE Carbon Breast Mike. New.....	.88
PL55 Plug New.....	.25
PL68 Plug New.....	.19
TS13 Handsets New.....	3.95
TS9 Handset.....	3.97



Sensational Value! 80-Meter Receiver

RCA Model AVR-20-A LIMITED QUANTITY! Originally designed for Aircraft and boats. Tunes 2300 to 6500 Kc. Perfect for 80 meter Ham work. Crystal controlled. Phone and CW. Provision for low and high impedance phones. Tubes used: 6B8, 6F7, 6S7, 6K8. 3-gang tuning cond. vernier tuning. Designed for 6 volt operation. Easily converted to 110 volts AC. Less power supply. SENSATIONAL GIVE-AWAY. PRICE WITH TUBES..... **\$14.95**

McElroy Automatic KEYER



For Xmttr keying or code practice. Has photocell and sensitive relay. Variable speed motor. 110V AC or DC. Complete with 2-117Z6 and 1-117L6 tubes, your cost..... **\$17.95**

QUANTITY PRICES

Inquiries welcomed from institutions, wholesalers, dealers, large users. Phone, write, wire for quantity prices.

Please include 25% Deposit with order—Balance C.O.D. MINIMUM ORDER \$3.00. All Shipments F.O.B. Our Warehouse N.Y.C.

G & G GENUINE MAJESTIC
RADIO PARTS SERVICE
53 VESEY STREET · NEW YORK 7, N.Y.

ARMY FIELD TELEPHONES

Type EEB—Talk as far as 17 miles. Dependable 2-way communication at low cost. Ideal for home, farm, field. Up to six phones can be used on one line. Each phone complete with ringer. Originally cost gov't. \$39.90 each. Used, good as new! **\$12.95** each



TERRIFIC VALUE 24-VOLT STORAGE BATTERY, BRAND NEW 17 AMP. HRS.

Made by Delco. 12 cells, heavy duty, very rugged. Shipped dry, uses standard sulphuric acid electrolyte.

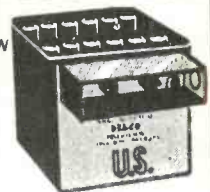

VERY SPECIAL
\$17.95



WILLARD 2-VOLT STORAGE BATTERY 20 Ampere-Hours

Exact replacement for GE Model LB-530 portables—brand new. 5" high, 3 1/4" wide, 3" deep.

Each..... **\$1.95**

7-PRONG 2-VOLT VIBRATOR for portable and farm sets. Replacement for GE LB530—

\$1.65

GOULD 6-VOLT STORAGE BATTERY

Navy Standard. Black Rubber Case. BRAND NEW. 15 Amp. Hour Rating..... **\$6.95**

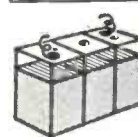

WILLARD MIDGET 6-V STORAGE BATTERY

3 amp hour rating. Transparent plastic case. Brand new. 3 1/2"x1 1/2"x2 1/2" high. Uses standard electrolyte. Each..... **\$2.65**

1-QUART BOTTLE BATTERY ELECTROLYTE

Made by Willard, for above storage batteries, 1 qt. sufficient for 2 two-volt cells. Hermetically sealed. SPECIAL. per qt. bottle..... **\$1.25**

SCR-522

Very High Frequency Transmitter-Receiver COMPLETE WITH ALL COMPONENTS

100-156MC, 4 channels. XTAL-controlled, Amplitude Modulated Voice. Electrically tested. Complete as illustrated..... **\$77.50**



UHF ANTENNA AN80-A

Suitable for 400 Mc citizens' band, fine for UHF experimenters. 5 1/4" flat antenna rod, mounted on porcelain base, with mounting plate and right angle feed through. Brand new. Special at..... **49c**



BC 605 INTERPHONE AMPLIFIER

Can be easily converted to an intercom. set—ideal for office, home or factory. New..... **\$4.95**
Like New..... **\$3.95**

T-85/APT5 UHF TRANSMITTER

Operates over a frq. range of 300-1400 MCPC with nominal output of from 10-30 watts. Comes equipped with 110 V. 50 CPS filament transformer; blower; lecher wire test freq. set and 8 tubes: 1—931A, 2—6AC7, 2—6AG7, 1—6L6G, 2—829B and 1—3C22 (GL522 Oscillator). Brand new in original box, operating instructions. Manual included..... **\$69.50**

SAVE \$ \$ \$

3 RED HOT SPECIALS

ANY ITEM 33¢

MIX 'EM UP—SAVE \$ \$ \$

Buy 10-99 Assorted—Deduct 10%

Buy 100 Assorted—Deduct 20%

MIDGET I. F. TRANSFORMERS
Discounts up to 86%



Midget 456 Kc, 1 1/2" sq. 3" tall, HI-Q ceramic coils. Matched pairs.
Input - - - - - 72 B5G
Output - - - - - 72 B6G



VOLUME CONTROLS
Discounts to 85%

CENTRALAB, STACKPOLE, complete with attached switch. Ohms-10M-15M-25M-50M-100M-250M-500M-2000M



CONDENSERS
Discounts to 78%

AEROVOX tubulars, type PRS. 2 FAST MOVERS.
20 MFD-250 VOLT 40 MFD-150 VOLT

INTERCOM & RADIO

AT A PRICE THAT CAN'T BE BEAT



6 tube superhet—3 tube intercom permits communication between radio-master and up to 4 sub-stations.

WHILE THEY LAST \$29.95

With 1 sub-station and 50 feet of cable
Extra Sub-Stations \$3.95 each

Original cost \$64.50

PUSHBACK WIRE



25% below Mill Cost

1st class, Essex or Lenz. ALL SOLID tinned copper, double cotton serve, waxed finish.

SIZE	COLORS	100 feet	1000 feet	10,000 ft. production reel
22	Black-Brown	.39	\$3.79	\$3.65M
20	White-Blue	.49	4.49	3.95M

ORDER INSTRUCTIONS

Minimum order—\$2.00. 25% deposit with order required for all C.O.D. shipments. Be sure to include sufficient postage—excess will be refunded. Orders received without postage will be shipped express collect. All prices F.O.B. Detroit.

Quantity and Export Orders Solicited

RADIO SUPPLY & ENGINEERING CO., Inc.
85 SELDEN AVE. DETROIT 1, MICH.

ZENITH CHASSIS 5647

If the volume control does not affect the audio output of the set, check to see that the grid caps are on the correct tubes. The lead from the first i.f. transformer goes to the 6K7 and the shielded lead to the 6Q7. If the leads are reversed, you cannot regulate the volume.

—William Gamboney

A.C.-D.C. RECEIVERS

Always check the heater voltage on each tube in an a.c.-d.c. receiver when tubes are burning out too frequently. If one tube has a low-resistance heater, the voltage drop across the other tubes will be too high, reducing their life. Carefully check the oscillator tube. A low-resistance heater may keep it from oscillating or cause intermittent operation.

—Peter J. Foradas

PHILCO 46-1201 AND 48-1201

If these models hum on RADIO and not on PHONOGRAPH check the 15- μ f capacitors in the voltage-doubler circuit before looking elsewhere for the trouble.

—C. R. Lutz

BELMONT CHASSIS 18DX21A AND 7DX21

These chassis include a dynamic limiter which was designed to reduce noise and external interference. It was later discovered that interference and noise were not as objectionable as expected, and therefore the dynamic limiter can be eliminated with an increase in a.f. sensitivity of approximately three times.

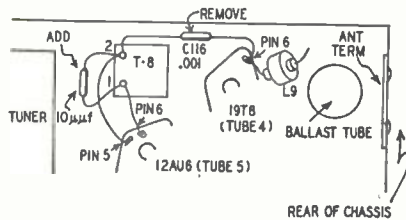

REAR OF CHASSIS

Remove the 1,000- μ f capacitor C116 from between terminal 2 of transformer T8 and pin 6 on the 19T8 tube. If it is not convenient to realign T8, connect a 10- μ f capacitor from terminal 1 to terminal 2 on the transformer. This small capacitor compensates for misalignment which resulted with the removal of C116. The diagram shows the location of the pertinent components.

—Service Bulletin, Belmont Radio Corp.

TRUETONE TX D1990 AND D2987

Complaint: Horizontal sweep is not stable or cannot be properly adjusted.

This trouble has been traced to two causes. The 1,800-ohm resistor in the plate circuit of the 12AU7 horizontal multivibrator may change its value enough to shift the natural frequency of the oscillator outside the range of the hold control.

Secondly, a 47- μ f capacitor C-89 in the grid circuit of the horizontal multivibrator may be open or may be 470 μ f. Replace this capacitor if its capacitance does not measure close to 47 μ f.

—Sidney S. Goodkin

WIDENING TV PICTURES

This scheme can be used to increase the width of a picture on TV sets using kickback power supplies. Disconnect the lower end of the width coil from the transformer and connect it to position 1 of a four-position rotary

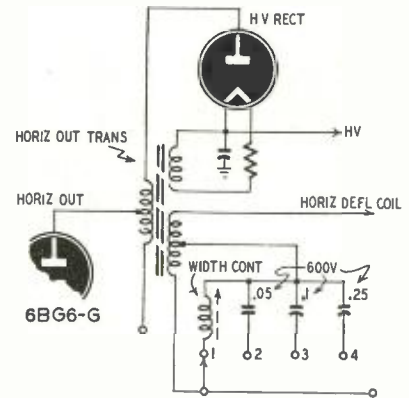

switch. Connect the capacitors between the switch points and the other end of the width control as shown in the diagram. The width of the picture increases in steps as the switch is advanced.

—Olaf W. Bailey

ADMIRAL 20A1, 20B1 and 21A1

In areas where two adjacent channels may be received, the sound from the lower may interfere with the picture on the upper channel. This type of interference may be reduced or eliminated by adding a sound trap to the second video i.f. amplifier.

Obtain a sound trap (part number 72A 88-1) and remove two turns from the coil at the end farthest from the slug screw, then resolder the coil to the lug. Do not remove the capacitor. Clip the white lead and bare tinned lead from the coil.

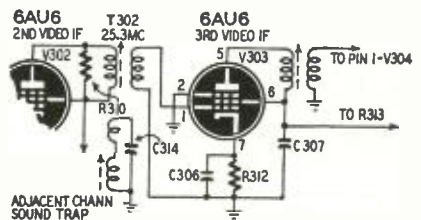

Remove the cover from the video i.f. strip and locate T302, the second video i.f. transformer. Wind 1 1/2 turns (approximately 3 inches) of No. 24 or 26 insulated wire in a clockwise direction around the small-diameter portion of T302 at the end farthest from the slug screw. Loop one end of the wire under itself to hold the coil in place in a manner similar to the coupling coil on T301. Connect one end of the 1 1/2-turn loop to the ground connection on T302.

On some chassis, there is a 1/4-inch hole between the second and third video i.f. tubes. If the hole is not there, drill one and insert the new trap. Connect the black lead from the new trap to ground and connect the loose end of the 1 1/2-turn coupling coil to the other lug on the trap.

Realign the video i.f. stages. Because of the shape of the video i.f. curve, it is difficult to set the new trap to 27.25

7 HARD TO GET ITEMS AT BIG SAVINGS TO YOU

AMAZING BLACK LIGHT



250-watt ultra-violet light source. Makes fluorescent articles glow in the dark. Fits any lamp socket. For experimenting, entertaining, unusual lighting effects. Ship. wt. 2 lbs. ITEM NO. 87 **\$1.95** A SAVING AT

LITTLE GIANT MAGNET

Lightweight 4 oz. ALNICO permanent magnet. 1 3/4" x 1 1/2". Lifts more than 20 TIMES ITS OWN WEIGHT! Ideal for hobbyists, experimenters. Shipping weight 3/4 lbs.



ITEM NO. 159 **\$1.25** BIG VALUE AT

POWERFUL ALL PURPOSE MOTOR



Sturdy shaded pole A.C. induction motor. 15 watts, 3000 rpm. 3"x2"x1 1/4". 4 mounting studs; 7/8" shaft, 3/16" diameter; 110-120 volts. 50-60 cycles. A.C. only. When geared down, this unit can operate on 18" turntable with a 200 lb. dead weight. Use it for fans, displays, timers and many other practical purposes. Ship. wt. 2 lbs.

ITEM NO. 147 **\$1.95** UNUSUAL BUY

WATTHOUR METER

Leading makes — completely overhauled ready for service. 100-110 volts, 60 cycles, 2-wire A.C. Heavy metal case 8 1/2" x 6 1/4" x 5" Easy to install. Shipping weight 14 lbs.



ITEM NO. 33 **\$3.95** NOW ONLY

WESTERN ELECTRIC BREAST MIKE

Lightweight 1 lb. carbon microphone. Aircraft type. Breastplate mounting, adjustable 2-way swivel. Easily fastened straps. For home broadcasts, communications etc. Complete with 6 foot cord hard rubber plug. Sherardized plate, non-rusting finish. Ship. wt. 2 lbs.

ITEM NO. 152 **95c** NEW LOW PRICE

TELEPHONE TRANSMITTERS

Genuine transmitters made by Kellogg, Western Electric, Stromberg Carlson. Work on two dry cells. For P.A. systems, intercoms, other practical uses. Shipping weight 1 lb.



ITEM 160 **\$1.95** REAL VALUE

250 POWER TELESCOPE LENS KIT

Make your own high powered 6 ft. telescope! Kit contains 3" diam., 75" focal length, ground and polished objective lens and necessary eye pieces. Magnifies 50x to 250x. Full instructions. Ship. wt. 1 lb.

ITEM NO. 123 **\$2.45** YOU SAVE AT

HUDSON SPECIALTIES CO.
40 West Broadway, Dept. RE-8-50
New York 7, N. Y.

I am enclosing full remittance for items circled below. Shipping charges included.

OR, my deposit of \$... \$5.00. Ship balance C.O.D. MINIMUM C.O.D. ORDER \$5.00.

C.O.D. ORDERS ACCEPTED ONLY WITH 20% DEPOSIT INCLUDE SHIPPING CHARGES.

Circle items wanted
87 139 147 33 152 160 123

Name.....
Please Print Clearly
Address.....
City..... Zone..... State.....

mc with a signal generator. Adjust the slug in the trap for minimum interference in the picture. Use a scope and sweep generator to make sure the video i.f. bandpass has not been affected by the trap adjustment. The sketch shows the connections for the trap.—*Admiral Radio & Television Service Bulletin.*

LEAKY 12JP4 C-R TUBES

Some 12JP4's develop leakage between grid and cathode after several months of operation. This condition causes horizontal tearing and loss of horizontal sync, which is not correctable by normal servicing methods. Substitute a new tube for a conclusive test.

The internal short can sometimes be removed or burned out by connecting an induction-type spark coil between cathode and grid pins on the tube.—*Service Dept., Transvision, Inc.*

PHILCO A.C.-D.C. SETS

Distortion after the set has been on for approximately 5 minutes can be caused by a leaky coupling capacitor or a shorted 50B5 output tube. Check the tube and capacitor because both may be contributing to the trouble.—*A. O. Burden*

TROUBLESHOOTING AUTO RADIOS

When an auto radio has a bad vibrator and a replacement is not immediately available, checking the rest of

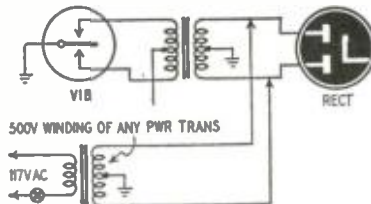

the circuits must wait until a vibrator is obtained. To save time in repairing the set or preparing an estimate, remove the vibrator and connect the set to the 6-volt supply or storage battery. Using a standard 500-volt, center-tapped power transformer, apply 250 volts to each plate of the rectifier tube as shown in the diagram. This method can be used for a dead vibrator or open power transformer.—*H. A. Blake*

SILVERTONE 8117 and 8118

If these models start to fade after a few months of service, look for a defective antenna coupling capacitor. This is the .05- μ f capacitor (C1 on the manufacturer's service notes) mounted directly above the 7C5 power amplifier tube.

The heat from the tube causes the wax to melt and run out of the capacitor, thus causing it to open. Replace this capacitor and insert a sheet of asbestos between it and the tube. This prevents a return of the trouble.

FLOYD A. ROBERTS,

Kearney, Neb.

(It is advisable to use a plastic molded paper capacitor as a replacement. This type is designed for high-temperature service and is less likely to cause trouble in this position.—*Editor*)

BUY TROUBLEPROOF TELEVISION

The 630 TV Will Work Where Others Fail!

Own the Television Set preferred by more Radio and Television Engineers than any other TV set ever made! The Advanced Classic 630 TV Chassis.

With the latest 1950 improvements the 630 TV will out-perform all other makes in every way. The 30 plus tube circuit should not be compared to the cheaply designed 24 tube sets now being sold.

- **Greater Brilliance**
Assured by the new 14-16 KV power supply
- **Flicker-Free Reception**
Assured by the new Keyed AGC circuit—no fading or tearing of the picture due to airplanes, noise, or other interference.
- **Greater Sensitivity**
Assured by the new standard Tuner, which has a pentode RF amplifier and acts like a built-in High Gain Television Booster on all channels! The advanced 630 chassis will operate where most other sets fail, giving good performance in fringe Areas, and in noisy or weak locations.
- **Larger—Clearer Pictures—far 16" or 19" tubes**
Assured by advanced circuits. Sufficient drive is available to easily accommodate a 19" tube.
- **Trouble-Free Performance**
Assured by use of the finest materials such as molded condensers, overrated resistors, RCA designed coils and transformers, etc.
- **RMA Guarantee**
Free replacement of defective parts or tubes within 90 day period. Picture tube guaranteed fully for an entire year at no extra charge.

PRICE COMPLETE, LESS PICTURE TUBE **\$149.50**

EXTRA CLEAR PICTURE TUBES—Standard Brands

ONE YEAR GUARANTEE	PRICE
Glass 16" Black Face (round).....	\$39.50
Glass 16" Regular (round).....	\$39.50
Glass 16" Rectangular (black).....	\$39.50

YOUR MONEY RETURNED IN FULL

If the New Regency Television Booster fails to improve your television enjoyment; bring your picture out of the snow and reduce interference!

- Push-Pull Neutralized triode design assures high gain without adding snow.
- No external impedance matching devices required.
- Inductive tuning assures same high-gain wide-band operation on all channels.
- Single knob tuning control.
- Underwriters approved with 90 day RMA guarantee

LOWEST Price **ONLY \$17.61**

HIGH GAIN X TELEVISION ANTENNAS

Covers channels 2 to 13 without separate section. Constant non-varying center impedance. Better than 12 Db front to back ratio. Can be used with 72, 150 or 300 ohm line. Works well in weak areas and gives a sharp conical beam. Price **\$4.95** each less mast. Extra for 10 ft. mast **\$1.50**

FRINGE AREA ANTENNAS

Stacked X Antennas for extra gain in fringe areas including heavy 10 ft. mast. Price **\$12.95**

WRITE FOR COMPLETE CATALOG C-8

RADIO DEALERS SUPPLY CO.

154 Greenwich St., New York 6, New York



Jim Quam
says—

"You are in business to make money—so are we. If you don't, we won't either, because you are not going to buy our speaker.

"That's why we're selfishly interested in building speakers on which you can make a profit!

"Can a serviceman make money and build his business by installing inferior replacement speakers?

"Suppose you install a cheap speaker in a customer's set. Because it's cheaply built, it will not stand up. In a year or two your customer has trouble again—you will replace it at your own expense—or lose a friend. Either way, you lose!

"Now, suppose you replace with a Quam Adjust-A-Cone. First—you make more money. Second—you are installing a precision built, quality-engineered speaker that will deliver top performance for years and ensure customer satisfaction. Third—it is easier to install. Fourth—it has the backing of our company which has, under the same management, built fine speakers for over a quarter of a century. Fifth—similar Quam speakers are used as original equipment in millions of fine sets.

"Maybe I'm prejudiced, but I think it pays to replace with Quam!"



Send for Catalog

Quam-Nichols Co.
521 E. 33rd Place
Chicago 16, Illinois

Please send me Quam catalog.

Name.....

Address.....

City..... State.....

EASY TO LEARN CODE

It is easy to learn or increase speed with an Instructograph Code Teacher. Affords the quickest and most practical method yet developed. For beginners or advanced students. Available tapes from beginner's alphabet to typical messages on all subjects. Speed range 5 to 40 WPM. Always ready—no QRM.

ENDORSED BY THOUSANDS!

The Instructograph Code Teacher literally takes the place of an operator-instructor and enables anyone to learn and master code without further assistance. Thousands of successful operators have "acquired the code" with the Instructograph System. Write today for convenient rental and purchase plans.



INSTRUCTOGRAPH COMPANY

4701 Sheridan Rd., Dept. RC, Chicago 40, Ill.

John G. Wilson, executive vice president in charge of the RCA VICTOR DIVISION, died June 1 in his Wynnewood, Pa., home after a brief illness.

A graduate of Northwestern University, Mr. Wilson served as a captain of artillery in World War I. He joined RCA in June, 1944, as administrator of accounts and finance of the Victor Division. In 1945 he was elected operating vice president. He rose to vice president and general manager in 1947 and executive vice president in 1948.



Vinton K. Ulrich has been appointed manager of the renewal tubes sales division of NATIONAL UNION RADIO CORP. A veteran of the radio trade since 1935, Mr. Ulrich was previously manager of Hytron's commercial engineering department.

James Calvin Affleck was appointed to the newly created post of sales promotion manager, receiver sales division of ALLEN B. DU MONT LABORATORIES, INC. For the past five years Mr. Affleck has been advertising and sales promotion manager for Radiomarine Corporation of America.

Robert B. Tomer has been appointed chief commercial engineer of the HYTRON RADIO & ELECTRONICS CORP. In this capacity he will supervise relations between the engineering divisions and customers.

Mr. Tomer has had 15 years experience in the radio and electronic industry. He was also instrumental in developing the proximity fuse and the Land camera. He has been associated with Hytron for the past three years.

Robert J. Cannon, eldest son of the founder of the CANNON ELECTRIC DEVELOPMENT CO., Los Angeles, has been elected president and treasurer of the company. He has served as vice president and general manager since 1942.

Burton Browne was awarded the degree of Doctor of Science in Business Administration by the University of Hollywood. Mr. Browne is head of the Chicago Advertising Agency bearing his name. The agency specializes in industrial advertising for radio and television products. The university also presented the degree of Doctor of Science in Audio Engineering to **John K. Hilliard**, chief engineer of ALTEC LANSING CORP.



Other officers elected were **Richard L. Rowen**, vice president and production manager, and **John B. Milliken**, secretary.

Caxton Brown resigned as chairman of the executive committee of the WESTON ELECTRICAL INSTRUMENT CORP. He will, however, remain on the board of directors and be available to the company as consultant. Mr. Brown joined Weston in 1901.

Paul McKnight Deeley was elected a director of the CORNELL-DUBILIER ELECTRIC CORP. A recognized authority in radio engineering, Mr. Deeley was responsible for the design and installation of the first radio broadcasting station in Mexico. He has served as Cornell-Dubilier's vice president since 1932. During World War II, Mr. Deeley headed the capacitor division of the War Production Board.

Edgar K. Wimpy has been appointed director of quality control for HYTRON RADIO & ELECTRONICS CORP. He will direct the development and application of methods for controlling the quality of incoming material, parts assemblies, and finished products. Mr. Wimpy joined Hytron in 1946.

Dr. Richard K. Cook, chief of the sound section of the NATIONAL BUREAU OF STANDARDS, has received the Washington Academy of Sciences Award for achievement in the engineering sciences by researchers under 40 years of age. He received this honor for his work in acoustics, particularly the development of an absolute method of calibrating microphones.

All incumbent officers of the STEWART-WARNER CORP., including **James S. Knowlson**, president and chairman of the board; **Frank A. Hiter**, senior vice president; **George L. Meyer, Jr.** and **Arden W. Le Fevre**, vice-presidents, were re-elected to office. All incumbent directors were also re-elected.

Sam Norris has been elected president of AMPEREX ELECTRONIC CORP. He had previously been executive vice president and has long been associated with the company.



Personnel Notes

Benjamin Abrams, president of EMERSON RADIO & PHONOGRAPH CORP., was elected a director of the Better Business Bureau of New York City. . . . **John S. Meck**, **Leslie Evan Roberts**, **Russell G. Eggo**, and **F. W. Adams** were elected directors of SCOTT RADIO LABORATORIES, INC. . . . **Glenn E. Webster**, former NBC operations supervisor, has been named distribution manager at Scott. . . . **C. E. Mead** named vice president of LEAR INC. . . . **Daniel S. Rohrer** assumed the post of advertising manager of CHANNEL MASTER CORP.

W. S. Hartford, general sales manager, and **C. B. Dale**, director of research of the WEBSTER-CHICAGO CORP., were elected vice-presidents in charge of sales and research, respectively.

RADIO-ELECTRONICS for

IDEA FOR TV STATIONS

Dear Editor:

When television stations broadcasting test patterns are making adjustments to transmitters, they should make that fact known in some way. Too many times we have started to work on what we thought to be a bad receiver, only to find that the test pattern was distorted by the station itself during transmitter tuning, changing cameras or power, and so on. The vertical wedges play peek-a-boo with you, the bandwidth changes every few minutes, horizontal interlace goes crazy, and along about that time they decide to cut power in half.

My suggestion is that the letter T (or some other letter) be placed in the test pattern whenever it is not normal to notify the service technician that the fault may not be in the receiver. I have written this suggestion to all the local television stations and hope you will publish it to see what other service technicians think.

WES JAYNE

Woodhaven, N. Y.

GREEK VETERAN

Crippled by the war and now living on a meager pension, George Christodoulou, a Greek veteran of the Royal Hellenic Air Force, has expressed to the editors an earnest desire to study radio to become a good radio technician.

He is now studying some books and past issues of RADIO-ELECTRONICS we have sent him, but books and radio equipment are still difficult to get in war-torn Greece. If your junk box is too full and your bookshelf crowded, why not give him a hand and send him the surplus. Any spare piece of equipment or parts that you can send him will be a big help in getting him back on his feet. The address is:

George J. Christodoulou
Neon Elefterochorion
Katerini, Greece

500 FORMULAS TO SUCCESS

Many million dollar firms started with a single formula, for which they paid a big price. Here you have 500—no less—tried and tested formulas, recipes and processes for making things . . . all at the ridiculously low price of 25c. Here is your opportunity to start a business with but a few dollars' capital and with undreamed of profits in prospect. You can also use these formulas in your own home to cut household expenses to the bone. Or you can put them to use in your workshop to cut costs as much as 100%. Quit paying out many dollars in profits to manufacturers, wholesalers, and dealers, when you can make the same thing yourself for a few cents. It's so easy when you follow our simple instructions.

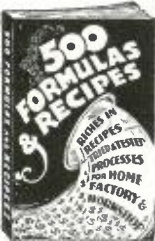

66 PAGES, 47,000 WORDS IN TEXT
Send for "500 FORMULAS AND RECIPES" today. Enclose 25c, that's all! You won't be asked for another cent now or later. Sold on a money-back guarantee.
NATIONAL PLANS COMPANY
1966R Broadway, New York 23, N. Y.

SNYDER TV ANTENNA \$2.95
XA-30 KIT

- Includes Hi-Band Adapters
- Connecting Stubs Supplied
- 1/2" Aluminum Alloy throughout
- Kit form—perfect for service crews.

ALMO RADIO CO.
509 Arch St. Phila., Penno. 100% Cash With Orders

TV DEALERS Here's Logic . . .

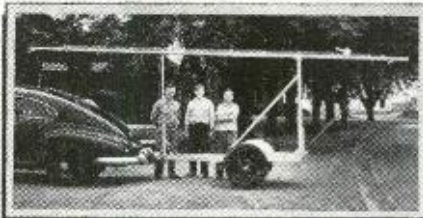

. . . Extra Demonstrations = Extra Sales . . . Lower Demonstration and Installation Cost = **GREATER PROFITS** with **PRICE TENNA-TRAILER**

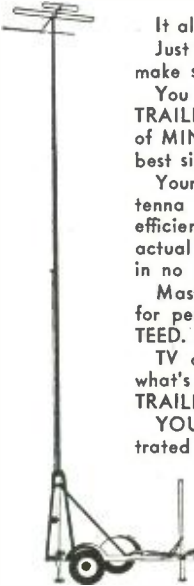

It all adds up! Just think how YOUR profits would soar if just ONE man could make several demonstrations each evening. You or any ONE of your salesmen can hitch the TENNA-TRAILER to his car, drive to the prospect's home and—in a matter of MINUTES—run up a 51' mast with antenna attached, orient for best signal and have the television set operating at its finest. Your demonstrations are more effective too, because the antenna is UP HIGH. Prospects are impressed by the speed and efficiency of your preparations and more receptive during the actual demonstration. They're pleased too that their property is in no danger of possible damage. Mast stands rigid in high winds without guys and is available for permanent installations. Trailer ruggedly built and GUARANTEED. Comes complete with tires and standard coupling. TV dealers all over the country are reporting more sales and, what's important, greater profits by using the PRICE TENNA-TRAILER. YOU too can TRIPLE YOUR TV SALES! Write today for illustrated folder.

PRICE TENNA-TRAILER CO.
WATSEKA, ILLINOIS

LEARN
Television - Radio OR Electricity
IN THE GREAT SHOPS OF **COYNE**

COYNE 51st YEAR

TRAIN QUICKLY! OLDEST, BEST EQUIPPED SCHOOL of ITS KIND in U.S. 2 Opportunity Fields

Come to the Great Shops of COYNE in Chicago. Our 51st Year! Get quick, practical training in TELEVISION-RADIO or ELECTRICITY. G. I. Approved. Finance plan for non-veterans. Mail Coupon Today for complete details.

NOT "HOME-STUDY" COURSES! You learn on real, full-size equipment, not by mail. Finest staff of trained instructors to help you get ready quickly for a better job a fine future.

FREE BOOKS Clip coupon for big illustrated Coyne book on either TELEVISION-RADIO or ELECTRICITY. Both books sent FREE if you wish. No obligation; no salesman will call. Act NOW!

B. W. COOKE, Pres.
COYNE Electrical & Television-Radio School,
500 S. Paulina St., Chicago 12, Ill. Dept. CO-81H
Send FREE BOOK and full details on:

TELEVISION-RADIO ELECTRICITY

NAME.....
ADDRESS.....
CITY..... STATE.....

An Indispensable EMERGENCY Tool for Every TV and Electronic Technician!

QUIK-SHOT SOLDERING IRON

- 250 Watts • Maintains Soldering Temperature for 6 to 8 Minutes • No Electricity • No Flame • No Blowtorch

Full the Trigger and the Iron Heats Itself In Less Than 10 Seconds!

QUIK-SHOT is a "must" for every emergency when line power is not available nor convenient. Heat is generated internally through the QUIK-SHOT cartridge which is inserted into the iron. UNCONDITIONALLY GUARANTEED! Absolutely safe. Accepts 3/8", 3/8" and 1" tips.

Model QS 38 (3/8" Pyramid or Chisel Tip) \$7.50
Model QS 58 (1/2" Pyramid or Chisel Tip) \$7.50
Model QS 100 (1" Chisel Tip Only) \$8.25
All standard models complete with 4 QUIK-SHOT Cartridges and Pyramid Tip.

QUIK-SHOT Cartridges (12 in carton) \$1.92
SEPARATE TIPS
3/8" or 1/2" Pyramid or Chisel \$2.25
1" Chisel Only \$3.00

Ask Your Jobber or write direct

JOHN F. RIDER LABORATORIES, Inc.
480 Canal Street • New York 13, N. Y.

OUTSTANDING - TV - VALUES

MODEL #300
Folded dipole complete with reflector and high frequency adapter. Covers 13 channels. All alum. construction. Less mast. Shpg. wt. 7 lbs. Price: **\$4.10**

MODEL #200-D
Stacked array. Consists of 2 complete conicals and connecting bars. Very rigid construction. Covers all 13 channels. Matches 300 Ohm or 72 Ohm. Center impedance 150 Ohm. Ideal for low signal areas. An outstanding buy. Shpg. wt. 12 lbs. less mast. **SENSA \$7.75**
TIONAL OFFER at...

MODEL 200-S
Single array. Same construction as above. Shpg. wt. 7 lbs. Price, less mast. **\$3.50**

MODEL #500
All-band folded dipole antenna. Ideal for rotator use. Maximum gain on any channel. Alum. construction. Less Mast. Shpg. wt. 8 lbs. Price **\$4.25**

MODEL #Y-100
5 element Yagi Hi-Gain beam designed specifically for fringe area use. All alum. construction. Cut to specific channels. Shpg. wt. 4 lbs. Channel #7, **\$3.75**; Channel #9, **\$3.50**; Channel #11, **\$3.35** and Channel #13, **\$3.25**. The prices are less mast. "V" type antenna. Price **\$3.75**

- ANTENNA ACCESSORIES**
- CM-100 Chimney Mount **.98**
 - WM-100 3" Wall Bracket **.50**
 - WM-100 15" Wall Bracket **\$2.75**
 - 5-ft. 1 1/4" OD Steel Mast, Plated **.75**
 - 5-ft. 1 1/4" OD Alum. Mast. **\$1.50**
 - 5-ft. 1" OD Alum. Mast. **\$1.25**
 - 3/4" 300-ohm stand-off insulators (fit coax cable) - **\$2.50** per 100 **\$40.50** per 500 **\$19.50** per 1000
 - "U" Bolt Assembler—ideal for mast couplings— **12 for \$1.50** 50 for **\$5.00**
 - Best Quality 300-ohm twin lead— **100'—\$1.05** **1000'—\$9.00**
 - High Quality 72-ohm Coax Cable— **100'—\$2.95** **500'—\$13.75**
 - Fold Dipole Hi-Frequency Adapters **\$1.35**
 - Conical Hi-Frequency Adapters **1.50**
 - Straight Dipole Hi-Frequency Adapters **1.25**

TERMS: All shipments F.O.B. Newark, New Jersey. 25% deposit with orders, balance C.O.D. Minimum order \$2.00. Include ample postage.

EAST COAST ELECTRONICS
40 St. Francis Street Newark 5, New Jersey

BRITON PREFERS R-E

Dear Editor:

I have been a constant reader of your magazine for many years and wish to express my appreciation of your educational, constructional, and other interesting articles. I am not an American, but find that I personally prefer your publication to any other (including British) which may be on sale. I am of the opinion that, in general, British radio magazines (with possibly one exception) seem to have fallen into the old groove of repetition. Each month I can pick up a certain British magazine and be sure that 95% of the articles inside are rehashes with only minor changes of material previously published.

That particular magazine claims that it caters to the new experimenter in radio, which of course is essential to any radio magazine. But this is no excuse for only 5% of progressive articles being published. For this reason I prefer RADIO-ELECTRONICS, because I know that when I open its pages I will find an even distribution of articles of past, present, and future, both theoretical and practical, and information on almost any piece of equipment connected with the forward trend of radio and TV.

To sum it up in as few words as possible, RADIO-ELECTRONICS publishes material for the guidance of the person who looks ahead, while most other magazines here cater, on the whole, to the man who looks to the past. RADIO-ELECTRONICS forces the technical education of the individual to an ever-higher standard while still maintaining the interest of the newcomer to radio and TV.

E. W. MERCER

Liverpool, England

CRAZY LIKE A FOX

Dear Editor:

Your editorials are forward-looking and your predictions are usually borne out by facts—much to the chagrin of the people who scoff at Gernsback and his "crazy ideas."

The magazine hardly ever fails, too, to have something new, novel, unusual, to make the radioman think. You gave the transistor and the electret a big play; you have articles on the latest microwave developments, and a "New Patents" department, all of which keep the reader up to date and give him ideas for experiment. In fact, the magazine is highly imaginative, a much-to-be-desired quality. It is not a "how-to-do-it" magazine, but one that teaches basic theories so that the radioman has concrete ideas of what it's all about instead of blindly following instructions. It is a thinker's magazine.

PETER N. SAVESKIE

Baton Rouge, La.

WANTS BETTER TV

Dear Editor:

Your directory of television receiver characteristics is of great value in estimating new sets.



Don't cry, Joe
Buffalo Radio Supply is
the place to go
For Super Bargains
219-221 Genesee St.,
Buffalo 3, N. Y.

PE98 Dynamotors for running SCR522's or other sets from 12 volt source. Brand New and Guaranteed—**\$29.50**. SCR522's have already been approved for taxicab use by the FCC. WE HAVE THEM ALSO. Write for prices.

- Wire Wound Resistors, 12 Asst. **\$1.00**
- Knobs, Assorted, 30 for **1.00**
- Sockets, 9, 8, 7, 6, 5 prong, 25 for **2.50**
- Coil Forms, Large & Small Asst., 20 for **1.00**
- Rotary Switches, Asst., 6 for **1.75**
- Resistors, Asst., 100 for **1.95**
- Insulators, Asst., 20 for **1.00**
- Bathub Oil Condensers, Asst. 6 for **1.00**
- Solder Lugs, Asst. Types, 800 for **1.00**
- Asst. Oscillator Coils, 7 for **1.00**
- Asst. Toggle Slide Switches, \$3.00 value, 5 for **1.00**

WE BUY BC654's, SCR284's, PE103's and other surplus in large or small quantities.

BUFRAD SECTIONAL TOWER



This addition to the famous line of BUFRAD antenna products makes up to a hundred foot tower from any number of strongly welded ten foot sections, which are shipped assembled and painted. Erection is a matter of minutes. Assembly is a one man job, and is accomplished by climbing up the completed portion of the tower with the next 25 lb. section to be installed. Hand and foot-holds are provided for safety and ease. Cap at top of tower provides bearing surface for rotating, and prevents water from entering tubes. Useful for police or amateur transmitters. In addition, tower provides satisfactory TV reception where otherwise impossible. Ideal for supporting temporary or permanent power lines, wind generators, stadium public address speakers or spotlights for gas stations or parking lots. "B" and "C" sections together cost a total of **\$15.75** and total 50 feet. "A" sections, which make up the entire tower except for the top, are each ten feet long and cost but **\$12.75** apiece. Mast base (not shown) is obtainable for only **\$6.00**. Base is especially useful when erecting tower on a sloping roof.

GENERAL ELECTRIC 15 TUBE TRANSMITTER-RECEIVER SET. This brand new 15 tube transmitter-receiver was designed for mobile storage battery powered service. It's a cinch for the experimenter to connect this unit for 110 volt A.C. operation by following the instructions and diagrams supplied, which cover numerous applications, including FM and amateur television transmission and reception. For those intending to use on car or boat, a new dynamotor, exactly as originally supplied, costs only \$15.00. Don't fail to write for FREE descriptive bulletin. Order our RT-1248 for only **\$29.95**, or two for **\$53.90**.

HEAVY POWER RHEOSTAT

Exceptionally Rugged. Trouble-free design. Withstands severe overloading to many times watt rating without burning or smoking. Perfect motor speed control or line voltage adjuster. 3 sizes available: 50, 60 and 200 ohms. Regular price \$5.00. Special **\$1.00**



PHONO SCRATCH ELIMINATOR

Consists of 2 condensers and powdered iron core choke connected in filter network. Same as used in most jukeboxes. Connects instantly between pick-up and amplifier **\$2.00**

NEW G.E. TRANSMITTER

Brand new General Electric BC-375, BC-191 transmitters, including both 12 and 24 V. dynamotors, export packed, absolutely complete and including complete set of spare tubes as well as 10 and 20 meter conversion instructions **\$100.00**
BC-315, BC-348 or BC-24 receivers sold only with the above transformers (unit for unit) **\$125.00**

SCR610 PORTABLE

6, 12 and 24 V crystal-controlled portable transmitter receiver with built-in loudspeaker and receiver complete **\$59.95**

CYBERNETICS!

RT1463 12 Stage Electronic Brain containing 3—7F7, 1—7Y4, 3—7N7, 4 potentiometers, numerous resistors, filter and bypass condensers, filter chokes, power and audio transformers, and six sensitive plate relays. A military development that provided amazing stepless control proportional to correction required, in the original application. This phenomenal unit, with its 3 multistage push-pull amplifiers and six 5,000 ohm relays in bridge circuits, will accurately control any 3 operations, related or unrelated, in minutely adjustable uniquely quantitative variations in either forward or reverse directions. Shock crackle aluminum case. Brand new in original carton **\$9.95**

Arkay
Fine Quality
Radio
and
Test Equipment
Kits
at popular prices!

— 19 —
Different Models!

ask your dealer for catalog or write direct to us!

ARKAY
By: RADIO KITS, INC.
120 Cedar St., New York, N.Y.

Many of the new receivers are now using some form of intercarrier sound. Unfortunately, many of the manufacturers who use intercarrier are also reducing the overall bandwidth of their receivers.

Let's not try to kid ourselves. Video frequency components up to 4.5 mc are transmitted by TV stations. Although frequencies above 4 mc are attenuated at the transmitter, the receiver must be able to pass up to 4 mc to reproduce all the picture detail available in the signal.

Very few of the current intercarrier receivers pass 3.5 mc, and some don't recognize anything over 3 mc. Some manufacturers are using peaking coils in their video amplifiers to compensate for lack of bandpass. Peaking coils are important in any TV set, but they can't replace high-frequency components which cannot get through preceding stages.

FRANK M. FIELD
Washington, D. C.

INDEX TO CONVERSION DATA

A 13-page booklet, *Bibliography of Radio Conversion Articles*, compiled by Elizabeth and J. Henry Lugg, is available upon request from U. S. Department of Commerce, Office of Technical Services, Washington 25, D.C. The booklet is free of charge.

Equipment is listed with the service nomenclature in alphabetical and numerical order. References give a description of the article and the issue and page of the publication carrying it.

**TECHNICIANS!
AUDIO MEN!**

Two Important
New Low Priced
Books—written to
help you!

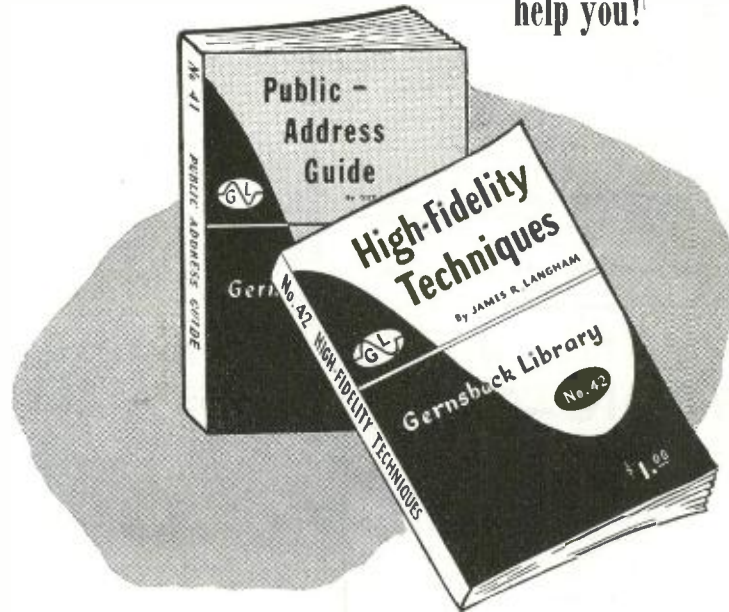

These new Gernsback Library Books belong on your book shelf! Public-Address Guide tells how P. A. work can add dollars to your income every week. High-Fidelity Techniques by James R. Langham, RADIO-ELECTRONICS' popular audio writer, answers all the tough questions about audio—in your own language! Order these two new value-packed books from your distributor, today.

No. 41—PUBLIC-ADDRESS GUIDE
by Guy S. Cornish. 75¢

Install, operate and service public address systems—and make money at it. This handbook covers the subject from how to get started, to the construction of a practical P.A. system that will handle 90% of the calls you'll ever be asked to service. 80 pages.

PARTIAL LIST OF CONTENTS:—
Sales, installations, rentals. Types of P.A. systems. Microphones, phonographs, amplifiers. Preventive maintenance, trouble shooting. Construction.

No. 42—HIGH-FIDELITY TECHNIQUES
by James R. Langham. \$1.00

Langham debunks high-fidelity double talk! In a salty, straight-forward style he tells you how to design your own high-fidelity equipment and how to get top performance from it. This is the book all audio men have been waiting for—get your copy today. A real "find" for only one dollar! 112 pages.

PARTIAL LIST OF CONTENTS:—
Distortion. Speakers and Baffles. Power Amplifiers. Voltage Amplifiers. Power Supplies. Phonographs.

See Your Distributor—or use coupon
RADCRAFT PUBLICATIONS, INC.

OTHER GERNSBACK LIBRARY BOOKS

- 50¢ BOOKS—64 Pages**
No. 29—Handy Kinks and Short Cuts
No. 30—Unusual Patented Circuits
No. 31—Radio Questions and Answers
No. 32—Advanced Service Technique
No. 33—Amplifier Builder's Guide
No. 34—Radio-Electronic Circuits
No. 35—Amateur Radio Builder's Guide
No. 36—Radio Test Instruments
No. 37—Elementary Radio Service
No. 38—How to Build Radio Receivers
75¢ BOOKS
No. 39—Practical Disc Recording—96 Pages
No. 40—The Cathode-Ray Oscilloscope. 112 Pages

RADCRAFT PUBLICATIONS, INC. Dept. 80
25 W. Broadway, N.Y. 7, N.Y.

I have enclosed \$..... for
copies checked.

- 41 P.A. Guide 42 H.F. Techniques
 29 30 31 32 33 34
 35 36 37 38 39 40

Name

Address

City..... State.....

DO YOU NEED METERS?

We carry a complete line of SURPLUS-NEW-GUARANTEED meters and accessories suitable for every requirement—ham rigs, broadcast equipment, recording, testing, schools, laboratories, etc. All types, sizes and ranges—portable, panel, switchboard, aircraft, laboratory etc.

- | | |
|---------------|------------------------|
| VOLTMETERS | FREQUENCY METERS |
| AMMETERS | DECIBEL METERS |
| MICROAMMETERS | POWER LEVEL INDICATORS |
| MILLIAMMETERS | RADIO FREQUENCY |

Over 75,000 meters in stock.

TYPICAL VALUES

- VU METER, Weston 862, type 30 Scale B with Internal Illum. List price \$55.50.....Only \$22.50
A.C. VOLTMETER, 0-150, Triplett 832-JPC, 3½" Round flush metal case.....Only 4.00
D.C. MILLIAMMETER, 0-200, General Electric DO-41, 3½" Round flush bakelite case.....Only 4.50
R.F. AMMETER, 0-1.5, Westinghouse RT-35, 3" Square flush bakelite case.....Only 5.50

We also stock various surplus components, transmitters, tachometers, shunts, multipliers, etc.

A postcard with your name and address will bring our

FREE CIRCULAR

MARITIME SWITCHBOARD

336 E. Canal St. New York 13, N. Y.
WOrth 4-8217

Each month RADIO-ELECTRONICS supplies the leading parts distributors with bills of material listing the parts used in our main constructional articles. Some of these bills of materials are not printed in the magazine on account of their length, but may be available at your distributor. Ask him!

Radio School Directory

RADIO Engineering

Complete Radio Engineering Course incl. Telev., U.H.F., and F.M. B.S. Degree Courses also in Civil, Elect., Mech., Chem., and Aero. Eng.; Bus. Adm., Acct. Visit campus, see well equipped labs. Low cost. Prep. courses. Personalized instruction. Grads successful. Founded in 1884. Enter Jan., March, June, Sept. Write for catalog.

DEGREE IN 27 MONTHS

TRI-STATE COLLEGE
2480 College Avenue Angola, Indiana

Your Future in RADIO-TV

Your future in radio-TV begins *right now*, with proper training. The Don Martin School of Radio Arts, established in 1937, offers the training you want . . . for every type of job in Radio-TV—script writer, announcer, disk jockey, newscaster, technician. Free job placement service for graduates. Day and night classes. . . . Write for our FREE booklet, "YOUR FUTURE IN RADIO." Approved for veterans.

Don Martin School of Radio Arts
1655 No. Cherokee, Hollywood 28, Calif. HUdson 23281

Build Your Career! Become an Electrical Engineer

★ Major in Electronics or Power
★ B. S. Degree in 36 Months



World-famous courses in Radio-Television, Electronics and Electrical Power. 6 to 24-month technician courses. 35,000 former students. Write for free pictorial booklet, "Your Career" and 110-page catalog. State if World War II vet. See full-page advertisement in this issue. Page 17.

MILWAUKEE SCHOOL OF ENGINEERING
Dept. REB-850 N. Broadway, Milwaukee, Wis.

RADIO COURSES

Preparatory Mathematics, Service, Broadcast, Television, Marine Operating, Aeronautical, Frequency Modulation, Radar.

Classes now forming for the Fall term beginning Oct. 1st Entrance exam, Sept. 25th

Veterans. Literature.

COMMERCIAL RADIO INSTITUTE
(Founded 1920)
38 West Biddle Street, Baltimore 1, Md.

BLISS Electrical Training

Intensive 32 weeks' residence course in fundamentals of industrial electrical engineering, including radio and electronics. Extensive laboratory, shop work, drafting. Prepares for electrical technician and engineering aides in

communications, power, manufacturing, business machines, sales, service. G.I. approved. 57th year. Enter Nov. 6. Catalog.

7548 TAKOMA AVENUE, WASHINGTON 12, D. C.

TELEVISION

Laboratory and theoretical instruction under the guidance of experts, covering all technical phases of Radio, Frequency Modulation and Television. Prepares for opportunities in Broadcasting, Industry or Own Business.

MORNING, AFTERNOON or EVENING SESSIONS. Licensed by N. Y. State. Free Placement Service. APPROVED FOR VETERANS.

ENROLL NOW FOR NEW CLASSES
Apply Daily 9-9; Sat. 9-2
VISIT, WRITE or PHONE

RADIO-TELEVISION INSTITUTE

Pioneers in Television Training Since 1938
480 Lexington Ave., N. Y. 17 (46th St.)
PLaza 9-5665 2 blocks from Grand Central

HAVE YOU A JOB FOR A TRAINED TECHNICIAN?

We have a number of alert young men who have completed intensive training in Radio and Television Repairing. They learned their trades thoroughly by working on actual equipment under personal, expert supervision. If you need a trained man, we invite you to write for an outline of our course, and for a prospectus of the graduate. No fees, of course. Address:

Placement Manager, Dept. P108-8

COMMERCIAL TRADES INSTITUTE
1400 Greenleaf Chicago 26

TELEVISION

PREPARE FOR A GOOD JOB!

COMMERCIAL OPERATOR (CODE) RADIO SERVICEMAN

TELEVISION SERVICING BROADCAST ENGINEER

V. A. Furnishes Books and Tools
SEND FOR FREE LITERATURE

BALTIMORE TECHNICAL INSTITUTE
1425 Eutaw Place, Dept. C, Baltimore 17, Md.

TV ELECTROMAGNETIC SERVICING COURSE

Practical Shop and Laboratory Training at Largest Resident TV School in the East!

Also RADIO SERVICE & REPAIR, F-M & TELEVISION Preparation for F. C. C. LICENSE EXAMS

★ Approved for Veterans ★

DELEHANTY SCHOOL of TELEVISION
105A EAST 13th STREET • NEW YORK 3, N. Y.

RADIO ENGINEERING

FM—Television—Broadcast

Police Radio, Marine Radio, Radio Servicing, Aviation Radio and Ultra High mobile applications. Thorough training in all branches of Radio and Electronics. Modern laboratories and equipment. Old established school. Ample housing facilities. 7 acre campus. Small classes, enrollments limited. Our graduates are in demand. Write for catalog.

Approved for Veterans

VALPARAISO TECHNICAL INSTITUTE
Dept. C VALPARAISO, INDIANA

AUDIO ENGINEERING SCHOOL

Practical engineering training in Audio fundamentals, Disc, Film, Magnetic Recording, and Audio frequency measurements. Studio training simulates Broadcast, Motion Picture, Television, and Commercial Recording work. Approved for Veterans

HOLLYWOOD SOUND INSTITUTE, Inc.
1040-E North Kenmore, Hollywood 27, Calif.
Specify if Veteran or Non-Veteran

RADIO ENGINEERING DEGREE IN 27 MONTHS

Intensive, specialized course including strong basis in mathematics and electrical engineering, advanced radio theory and design, television. Modern lab. Low tuition. Self-help opportunities. Also 27-month courses in Aeronautical, Chemical, Civil, Electrical, and Mechanical Engineering. Approved for G.I.'s. Enter Sept., Dec., March, June. Catalogue.

INDIANA TECHNICAL COLLEGE
158 E. Washington Blvd., Fort Wayne 2, Indiana

RCA RADIO and TELEVISION

Thorough Training in All Technical Phases

APPROVED FOR VETERANS

DAYS—EVENINGS WEEKLY RATES
FREE PLACEMENT SERVICE FOR GRADUATES
For Free Catalog Write Dept. RC-50

RCA INSTITUTES, Inc.
A Service of Radio Corporation of America
350 WEST 4TH STREET NEW YORK 14, N. Y.

CODE SENDING RECEIVING SPEED

Be a "key" man. Learn how to send and receive messages in code by telegraph and radio. Commerce needs thousands of men for jobs. Good pay, adventure, interesting work. Learn at home quickly through famous Candler System. Quality for Amateur or Commercial License. Write for FREE BOOK.

CANDLER SYSTEM CO.
Dept. 3-7, Box 928, Denver 1, Colo., U.S.A.

RADIO COURSES

- RADIO OPERATING • CODE
- RADIO SERVICING • ELECTRONICS
- F.M. TELEVISION
- REFRIGERATION SERVICING

Write for Catalog TE and Picture Brochure

Y.M.C.A. TRADE & TECH. SCHOOL
229 W. 46 St., N. Y. 23
INDicart 2-8117

RADIO and TELEVISION

Over 30 years N.E. Radio Training Center. Train for all types FCC operators' licenses. Also Radio and Television servicing. FM-AM broadcasting transmitters at school. Send for Catalog R.

MASS. RADIO SCHOOL
271 Huntington Avenue Boston 15, Mass.
Lic. by Comm. Mass. Dept. Educ.

AUDIO (SOUND) ENGINEERING HOME STUDY TRAINING

Practical, easy-to-understand lessons, written by competent Audio Engineers and Educators, prepare you for a better job and a good future in the Television, Radio, Motion Picture, and Recording Industries.

Write today for details—Learn while you earn!!

HOLLYWOOD TECHNICAL INSTITUTE
Div. RE
4925 Santa Monica Blvd., Hollywood 27, California.

DIAL CORD STRINGING GUIDE, DC2, compiled and published by Howard W. Sams & Co., Inc., Indianapolis, Ind. 5½ x 8½ inches, 48 (unnumbered) pages. Price \$1.00

The second volume of a series, this book begins with dial-stringing arrangement 553, where Volume 1 left off, and continues with 510 new diagrams representing dial cord setups in receivers manufactured since Volume 1 appeared some two years ago. The book uses the straight graphic presentation of the earlier book, with the diagrams numbered and an index by manufacturers.

ELECTRONICS IN THE FACTORY, edited by H. F. Trewman. Published by Sir Isaac Pitman & Sons, Ltd., London, England. 5¾ x 8½ inches, 188 pages. Price 20 shillings.

Prepared for industrial plant managers, directors, and other nontechnical persons who wish to keep abreast of the latest developments in the field of industrial electronics, this book describes equipment which is used for heating, measuring, controlling, inspecting, and timing operations. Being nontechnical in scope, it is devoted entirely to basic theory and possible applications of the equipment. No technical information, specifications, or diagrams are given.—R.F.S.

QUESTIONS AND ANSWERS IN TELEVISION ENGINEERING, by Carter V. Rabinoff and Magdalena E. Wolbrecht. Published by McGraw-Hill Book Co., New York. 6¼ x 9¼ inches, 300 pages. Price \$4.50

Similar to question-and-answer manuals designed for use in preparation for radio operators examinations, this book is a new and interesting approach to the home-study method of training for television. It is divided into twelve sections which are devoted to different phases of television. The sections are grouped in logical order which begins with antennas and related circuits and progresses through the receiver to the picture tube. Other subjects cover regulations, transmitter theory, and the like.

The questions and problems are clearly presented and their answers are prepared in essay form with diagrams and formulas where necessary. Problems are solved by beginning with the formula and following it through step-by-step to the solution.

This book is a handy tool to assist

SAVE MONEY—BUILD YOUR OWN SPEED LIGHT EQUIPMENT

FOR PROFESSIONAL AND AMATEUR

Easy to follow . . . step-by-step instructions
Write for FREE list of complete Kits and Components

CINEX, INC.

Dept. RE-8 165 W. 46th St., N. Y. 19, N. Y.

WANT \$10,000?

Earn the govern- Super Sensitive P.R.I. ment bonus. Locate Uranium with a **GEIGER COUNTER**
Find gold, silver, and other valuable ores with a P.R.I. Treasure Locator. World's finest instruments. FREE catalog.
Write today.



PRECISION RADIATION INSTRUMENTS, Inc. Dealer Inquiries Invited
5478E Wilshire Blvd., Los Angeles 36, Cal.

DURABLE DURANITE

● Durable! That's why Duranite tubulars are so popular. This radically different molded capacitor features Aerolene, the new impregnated new processing methods; new Duranite molded casing.

Drop, bang, scratch—no damage to that durable Duranite casing. Unaffected by high temperatures. Immune to high humidity. Stock them well in advance if you wish—no shelf deterioration. Pigtails won't pull out. Definitely, the durable Duranite.

See Your Jobber . . .
Insist on Duranites for durable tubulars. Ask your local distributor for latest Aerovox catalog featuring many new capacitor types and extended listings.

AEROVOX capacitors

CAPACITORS • VIBRATORS • TEST INSTRUMENTS

For Radio-Electronic and Industrial Applications

AEROVOX CORPORATION, NEW BEDFORD, MASS., U. S. A. • Sales Offices in All Principal Cities
Export: 41 E. 42nd St., New York 17, N. Y. • Cable: AEROCAP, N. Y. • In Canada: AEROVOX CANADA LTD., Hamilton, Ont.

BUILD YOUR OWN GEIGER COUNTER!

It's EASY to build your own Searchmaster Geiger Counter with this COMPLETE kit. Contains everything you need! Headset, tubes, batteries, metal case. Fully guaranteed! Sensitive to both beta and gamma radiation! Illus. instructions. FREE radioactive specimen.

Write for FREE literature

SCIENCE KITS LTD.
5514-R Hollywood Blvd. • Hollywood 28, Calif.

TELEVISION RECEIVER—\$1.00

Complete instructions for building your own television receiver. 16 pages—11"x17" of pictures, pictorial diagrams, clarified schematics. 17"x22" complete schematic diagram & chassis layout. Also booklet of alignment instructions, voltage & resistance tables and troubleshooting hints.—All for \$1.00.

CERTIFIED TELEVISION LABORATORIES
Dept. C, 5507-13th Ave., Brooklyn 19, N. Y.

NEW YORK'S RADIO TUBE EXCHANGE
We buy, we sell, we exchange. Write for lists.

LIBERTY ELECTRONICS, INC.
135 LIBERTY STREET NEW YORK 6, N. Y.
PHONE WORTH 6-2262

REPRESENTATIVES WANTED

In all territories except Eastern Seaboard from Maine to Washington, D.C. New electronic chemical line now making great headway with parts jobbers and servicemen in key Eastern cities. Send qualifications, including lines now handled.

DAKOLINE CHEMICAL CO., INC.
357 Atlantic Avenue, Brooklyn 2, N. Y.

STOP COSTLY SERVICE CALLS

Use **Electro Antenna Kote** plastic insulation

—for all exterior television and radio connections. Will eliminate rust and corrosion on all exposed High Frequency, exterior television and radio connections (dries hard in 8 hours) a non-electrical conductor. Does away with use of tape, comes in 2, 4 and 8 oz. bottles. Dielectric strength—Volts/mil 1050, may be used for arrest of voltage leakage, excellent resistance to heat, oil, acid, salt water, chemical and moisture.

Sold at leading jobbers, write for details.

DAKOLINE CHEMICAL CO., INC.
(Electronics Chemical Div.)
357 Atlantic Avenue, Brooklyn 2, New York

GREYLOCK RADIO TUBE BARGAINS!

GT. Glass and Miniature Types

1A4P 6AU6	6U7G	12SR7GT	\$3495
1A6 6BA6	6X4	25L6GT	
1C6 6C4	12ABGT	25Z6GT	
1F4 6BE6	12A6	35B5	
1S5 6BH6	12AU6	35B8	
1T4 6CSGT	12BE6	39/44	
3A4 6K6GT	12BF6	53	
6A05 6SK7GT	12J5GT	57	
6AT6 6SQ7GT	12Q7GT	77	
		117Z3	

per 100 asstd.

Also available in smaller quantities at 39c each.

SPEAKER SPECIALS!

3", 4", or 5" PM, less output Alnico 5, each 97c
In cartons of 30, each 87c
6" x 9" Oval PM, Alnico 5, 3.16 oz. magnet, each \$2.59
In cartons of 24, each \$2.39

TERMS: Net C.O.D., F.O.B. NYC.
Minimum Order \$10.00. 100% Deposit on all COD orders.
Write for terrific CR tube prices and Bargain Catalog C-8
"Economy-Wise means Greylock supplies!"

Greylock Electronics Supply Co.
115 Liberty Street New York 6, N. Y.

NEW ELIMINATOR KIT!

FOR AUTO-RADIO SERVICING
Supplies 5-8 volts at 10 amperes continuous, 15 amps. intermittent. Step voltage control, ripple less than 3%! Power on instantly—no warm up period required. For 115 VAC-50/60 cycles.

HERE'S WHAT YOU GET:

- Heavy duty power transformer
- Full wave Selenium Rectifier
- Low Resistance Filter Choke
- High Capacity Filter Condenser
- Multi-position tap switch

Complete with operating and instruction manual. Shpg. wt. 24 lbs. Sorry no COD's.

Kit #EL-2
\$19.50
Serviceman's net.

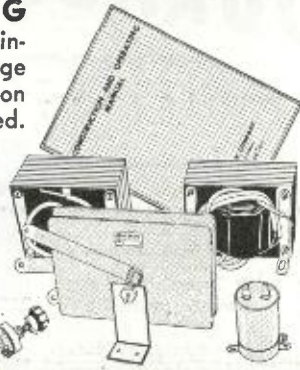

OPAD-GREEN COMPANY

71 Warren St. W. New York 7, N. Y. Phone: BEekman 3-7385-6

ARC/5 Xmt's VFO Drivers
40 Watts Output

3-4 Mc \$6.95
Used Good Cond.

Superhet Recvrs W/Dyn
Can be converted to 110V 60cy.

190 550 Kc.	\$6.95
3-6 Mc 4.95	
6-9 Mc 4.95	

Used Good Cond.

BC-605 INTERPHONE AMPLIFIER
Easily converted to an ideal inter-communications set for office-home-or factory. Original. New w/conversion Diagram \$4.49

SPECIAL CHOKES

10 HY 250 MA.	\$3.25
20 HY 300 MA.	6.49
6 HY 150 MA.	.99
25 HY 75 MA.	1.28
8.5 HY 125 MA.	1.29
11.5 HY 90 MA.	1.39
5 HY 150 MA.	1.45
Dual 7 & 11 HY.	90 MA. 1.39
10 HY 450 MA.	11.95
5 HY 200 MA.	1.29
10 HY 500 MA.	12.95

Many others. Write.

SPECIAL XFMRS.
115V. 60 CY.

36V/3.5 A for Rect., etc.	\$2.75
24V/1.5A for ARC/5, etc.	1.95
2500V/4Ma.	5.79
2.5/2A	5.79
1080Vct/55Ma.	2x6.3/1.2A 4.49
720Vct/220Ma. 6.4/8.7A. 6.4/6.5v/3A. 1.25/3A	\$2.95

ARR2 Homing Rec. Tunes 234-258 MC Contains 4-6AK5 6-9004 1-12A6 IDEAL For 2-6-10 Wtr. Conv. As is Fair Cond. \$4.95

GIBSON GIRL
The Emergency Radio Transmitter. Sends S.O.S. signals automatically on 500KC. 150-mile range. No batteries required. Has hand-driven generator, tubes, wire. New. 16's only \$32.49

BC 223 XMITR
30 Watt Transmitter with crystal oscillator control on four pre-selected channels—also master oscillator. Frequency coverage 2000 KC. to 2250 KC. by use of three plug in coils. Five tube operation. 801 oscillator, 801 power amplifier, two 46 modulators, and one 46 speech amplifier. Price with TU-17 Tuning Unit, 2000 to 3000 KC. \$32.95

NAVY ARS RECEIVER
195 Kc thru 9 Mc.—Includes broadcast band. Can be converted easily to a good ham receiver. 28 V. DC input. Covers 4 bands. This is a deluxe type super-het receiver. Note: The frequency coverage includes the standard broadcast band. Has 4-gang tuning condenser; can be converted to 110 V. AC receiver. Complete with tubes: 12SF7, 12SA7, 3-12SF7 and 12A6. Dial is built on front of chassis. Electric driven or Manual band change switch. Weight 28 lbs. Size 6" x 7" x 18". Complete with tubes and dynamotor. (Fair as is Cond.) \$19.95

T.V. Transformer, 7" or 9" scope, 3000V/5MA, 720vct/200MA. 6.4/8.7A. 6.4/6A. 5/3A. 1.25/3A. 115V 60 cy input. Price..\$3.95

Send M.O. or CHK. Mds. Guard. Shpg. Charges Sent C.O.D. Price F.O.B. N.Y.C. Phone Di. 9-4124

COMMUNICATIONS EQUIPMENT CO.
131 Liberty St., Dept. C8 New York City 7, N. Y.

NEW CONDENSER TESTER
Finds Intermittent Condensers Instantly

Pres-probe's sliding tip with variable resistance prevents condenser heating. Tests with power on. Requires no adjustment. Stops guesswork. Saves time. Convenient probe size (7 1/2" long). Satisfaction guaranteed.

795
Postpaid U.S.A.

See Your Dist. or Order Direct

PRES-PROBE CO.
2326 N. THIRD ST., MILWAUKEE 12, WIS.

DE LUXE TV RECEIVER CONSTRUCTORS

Complete set of Video IF, Audio IF, Discr. and trap coil forms. Discr.—surplus—see Page 24, March R.E. All others special made with cores and single hole mounting, less wire.

Set of 8 coil forms \$3.80

R.F. coil forms and trimmer cap. forms as shown page 41, Feb. R-E.

Complete set of 13 pieces \$9.90

Station selector switch—special made. See page 39, Feb. R-E (less rear spring & mounting plate). Available July 20. Each \$4.60

Set of large prints and templates (9) to use in conjunction with Jan.-July Radio-Electronics. Postage included \$2.50

Include 20c postage with coil sets or 40c with complete order.

Address checks or postal notes to:

CHAS. A. VACCARO
15 Park Ave., Ambler, Penna.

PEN-OSCIL-LITE

Extremely convenient test oscillator for all radio servicing; alignment • Self powered • Range from 700 cycles audio to over 600 megacycles u.h.f. • Output from zero to 125 v. • Low in cost • Used by Signal Corps • Write for information.

GENERAL TEST EQUIPMENT
38 Argyle Ave. Buffalo 9, N. Y.

EVERY RADIOMAN
Can Use These SERVICE HINTS!
Valuable Manual Yours—FREE!

Every page of "How to Simplify Radio Repairs" is packed with on-the-bench, practical ideas. Contains photos, charts, diagrams—no fluff—no vague theory. In plain every-day language it gives you priceless suggestions—new servicing ideas. You'll use and benefit from the experience of experts.

Partial list of contents: How to Localize Trouble; How to Service Amplifiers; How to Test for Distortion; How to Test Audio Circuits; How to Test Speakers; How to Find Faults in Oscillators; How to Test Radio Parts—and it's all yours—FREE! No obligation.

FEILER

SEND COUPON OR PENNY POSTCARD FOR YOUR FREE COPY TODAY!

FEILER ENGINEERING CO., Dept. SRCS
1601 S. Federal St., Chicago 16, Illinois

Please RUSH my FREE copy of "How to Simplify Radio Repairs."

Name

Address

City..... Zone... State.....

ADVERTISING INDEX

Adson Radio & Electronics	81
Aerovox Corporation	79
Allied Radio Corporation	15
Almo Radio Corporation	75
Amplifier Corporation of America	81
Approved Electronic Instrument Corp.	81
Arkay	76
Bell Telephone Laboratories, Inc.	49
Boyce-Roche Book Company	62
Brooks Radio Dist. Corporation	68
Buffalo Radio Supply	76
Capitol Radio Engineering Institute	7
Certified Television Laboratories	79
Cinex, Incorporated	79
Cleveland Institute of Radio Electronics	18
Communications Equipment Company	80
Coyne Electrical School	11, 75
Dakoline Chemical Company, Inc.	79
DeForest's Training, Incorporated	9
Du Mont, Allen B. Laboratories	6
East Coast Electronics	76
Electro-Technical Industries	58
Electronic Instrument Company	59
Electronic Manufacturing Co.	81
Electronic Measurements Company	69
Fair Radio Sales	70
Feiler Engineering Company	80, 81
G & G Radio Parts Service	71
General Electronic Dist. Company	52, 53
General Industries Company	65
General Test Equipment Company	80
Greylock Electronic Supply Company	79
Heath Company	16
Hudson Specialties Company	73
Hytron Radio & Electronics Corporation	13
Instructograph Company	74
Jersey Specialty Company	69
Leotone Radio Corporation	64
Liberty Electronics	79
Littelfuse, Incorporated	82
Maritime Switchboard	77
Midwest Radio Corporation	55
Milwaukee School of Engineering	17
Murray Hill Books, Incorporated	81
National Plans Company	75
National Radio Institute	3
National Schools	5
Oak Ridge Products	70
Opad Green Company	80
Opportunity Adlets	81
Precision Apparatus Company	63
Precision Radiation Instrument Company	79
Pres-Probe Company	80
Price Tenna-Trailer Company	75
Progressive Electronics Company	65
Quam-Nichols Company	74

RADIO SCHOOL DIRECTORY (Page 78)

Baltimore Technical Institute
Bliss Electrical School
Candler System Company
Commercial Radio Institute
Commercial Trades Institute
Delehanty Institute
Hollywood Sound Institute
Hollywood Technical Institute
Indiana Technical College
Martin School of Radio, Don
Massachusetts Radio School
Milwaukee School of Engineering
RCA Institutes
Radio Television Institute
Tri-State College
Valparaiso Technical Institute
YMCA Trade & Technical Schools

RCA Victor Division Radio Corporation of America	Inside Front Cover, Back Cover
Rodcraft Publications, Inc.	77
Radio Apparatus Corporation	56
Radio City Products	64
Radio Corporation of America	12
Radio Dealers Supply Co.	73
Radio Supply & Engineering Company	72
Rider, John F., Publisher	75
Sams & Company, Incorporated, Howard W.	57
Science Kits, Ltd.	79
Senco Radio, Incorporated	66
Smith Company, William M.	60
Sprague Products Company	4
Sprayberry Academy of Radio	Inside Back Cover
Standard Transformer Corporation	56
Sun Radio & Electronics	10
Sutton's Wholesale Electronics, Bill	67
Swedgal Radio, Incorporated	69
Sylvania Electric Products	8
Technifax	64
Tel-A-Ray Enterprises, Inc.	51
Telrex, Inc.	67
Thomas Electronics	63
Transvision, Incorporated	67
Trio Manufacturing Company	14
Vaccaro, Charles A.	80
Weller Manufacturing Co.	58
Workshop Associates, Inc. (The)	61

Approved

MODEL A-710

12 TUBE FM-AM TUNER

\$57.50

TUBES USED ON FM: 1-6BE6 RF Amp; 1-6BE6 Mixer-Detector; 1-6J6 Osc.; 1-6AU6 IF Amp; 2-6AU6 Lim. Amps; 1-6AL5 Diode; 1-6X4 Rectifier. USED ON AM: TUBES RF Amp; 1-6BE6 Converter; 1-6BE6 Amp; 1-6AT6 IF (audio amplifier common to AM-FM).

Chassis dimensions: 8 1/2" x 5 3/4" high, 8" deep. Net weight: 5 1/2 lbs.

Power requirements: 170 V DC 20 MILS and/or 140 V DC 37 MIL. 6.3 V 4 AMP.

For the first time in radio history, there is really available a high quality FM-AM tuner, designed for drift-free, realistic high fidelity reception AT A PRICE THAT PLACES IT WITHIN EASY REACH OF THE CUSTOM BUILDER, SERVICE-MAN, MANUFACTURER, EXPERIMENTER, ETC.

JOBBERS!

Write Dept. RE-J for New 16 page Catalog and Jobber Net Prices.

APPROVED ELECTRONIC INST., CORP.
142 Liberty St. N.Y.C.

OPPORTUNITY AD-LETS

Advertisements in this section cost 25c a word for each insertion. Name, address and initials must be included at the above rate. Cash should accompany all classified advertisements unless placed by an accredited advertising agency. No advertisement for less than ten words accepted. Ten percent discount six issues, twenty percent for twelve issues. Objectionable or misleading advertisements not accepted. Advertisements for September, 1950, issue, must reach us not later than July 24, 1950.

Radio-Electronics, 25 W. Broadway, New York 7, N.Y.

MAGAZINES (BACK DATED)—FOREIGN, DOMESTIC, arts, Books, booklets, subscriptions, pin-ups, etc. Catalog, 10c (refunded). Cicerone's, 86-22 Northern Blvd., Jackson Heights, N.Y.

LANCASTER, ALLWINE & ROMMEL, 436 BOWEN Building, Washington, D. C. Registered Patent Attorneys. Practice before United States Patent Office. Validity and infringement investigations and Opinions. Booklet and form "Evidence of Conception" forwarded upon request.

VITOX, for longer storage-battery life. 50c prepaid. LYONART, Trinidad, Colorado.

5D-201 SOLDERING FLUX, 50c up. Parts Distributor or write LYONART, Trinidad, Colorado.

RADIOMEN, SERVICEMEN, BEGINNERS — MAKE more money, easily, quickly. \$250 weekly possible. We show you how. Information free. Mertl Products, 216-32L 132nd Avenue, Springfield Gardens 13, New York.

Five Element TV Yagi Beams, High Band \$6.75, Low Band \$8.50. Aluminum Tubing, Etc. Willard Radcliff, Postoria, Ohio.

AMATEURS—RADIO AND ELECTRICAL RESEARCH Engineering. Hy Twillmann, R.R. #1, Chesterfield, Mo.

CHOICE OF ENGINEERS EVERYWHERE

TWIN-TRAX* TAPE RECORDER

Available to you direct from the factory at savings that make TWIN-TRAX the only professional-type recorder in the popular-price field. More than a dozen model variations for portability, long-play, continuous operation, etc. For a better tape recorder that combines professional quality with operating ease and trouble-free construction, it's TWIN-TRAX. Write today for complete literature. *Trade Mark Registered

AMPLIFIER CORP. OF AMERICA
398-10 Broadway • New York 13, N. Y.

NEW VACUUM TUBE VOLTMETER Best instrument buy of the year!

AC and DC ranges: Kil Form 0-5/10/100/500/1000 volts, Ohmmeter from .2 ohms to 1000 mega. Zero Fact. Assemb. center scale for TV. \$48.95 Has 0-1 ma. full scale meter; 48 meg. input Imped.; 2% accuracy; big 4 1/2" meter; 8" x 9" h. X 6" overall.

FEILER ENGINEERING CO. Dept. SRCV5
1601 S. Federal St. Chicago 16, Ill.

instructors in preparing examinations and to help students check their progress in the study of conventional texts. Its scope and style make it useful for radio amateurs, students, instructors, and engineers.—R.F.S.

APPLICATION OF THE ELECTRONIC VALVE IN RADIO RECEIVERS AND AMPLIFIERS, Book IV, by B. G. Dammers, J. Haantjes, J. Otte and H. Van Suchtelen. Published by N. V. Philips' Gloeilampenfabriken, Eindhoven, Netherlands. (Distributed in the United States by Elsevier Publishing Co., New York, N. Y.) 6 1/2 x 9 inches, 416 pages. Price \$5.00.

The title above is that of the individual volume, which is book IV in the series "Electronic Valves." This volume is the first of a proposed three on applications of electronic tubes, which form a series within a series. The present book deals with tube applications in r.f. and i.f. amplification, frequency-changing and detection. The next volume will cover a.f. amplification and the third (Book VI in the Electronic Valves series) will cover miscellaneous applications such as a.v.c., a.f.c. feedback, parasitics, and other phenomena.

Book IV resembles closely a work on receiver design, though certain features are omitted, in line with the authors' intention to describe tube (valve) circuits. Thus antennas are not discussed, and we are told that loudspeakers will not be.

As a design work dealing with modern tubes, this series should be highly topical and useful. Its usefulness is increased by the "Survey of the Literature" at the end of each chapter.—F.S.

HOW TO BECOME A RADIO AMATEUR (11th Edition) published by the American Radio Relay League. 6 1/2 x 9 1/2 inches, 58 numbered pages plus several advertising pages. Price 50 cents.

The new edition is aimed especially at the new Novice Class of amateur license which the FCC is about to make available. A simple receiver with a 3A4 and a transmitter with a 6V6 are shown for the beginner, with a four-tube super and 30-watt oscillator-amplifier transmitter for the better prepared would-be amateur. The "pictorial" method of teaching radio schematic symbols will be appreciated by the beginner.

WANTED TO BUY

Large and small quantities of new or used electronic government or manufacturers' surplus tubes and equipment. Highest prices paid. State quantity, condition and best price in first letter.

Box No. F-2 c/o Radio-Electronics
25 West Broadway
New York 7, N. Y.

ADSON FOR VALUE!

SAVE \$\$ ON JFD TV ACCESSORIES!



JFD TWIN LEAD TV LIGHTNING ARRESTER
Protects television sets against lightning and static charges. Underwriter's Laboratories Approved for all-weather outdoor-indoor use. Quickly and easily attached to any type twin lead.
AT102, for regular twin lead \$1.32 ea.
AT103, for oval jumbo and tubular twin lead 1.32 ea.



JFD "PANORAMA" INDOOR TV ANTENNA
Absolutely tip-proof, 3-section, triple-chrome plated brass telescopic dipoles can be adjusted from 15 to 41 inches for easy orientation. Strong signal gain. Complete with 300 ohm twin lead \$2.35

JFD "QUICK-STRIP" TWIN-LEAD STRIPPER
Saves time and money in preparing twin lead for installation. Insert line in one end, press both ends together and pull lead over. Presto, the lead is stripped neatly without any crushing or breaking of wire strands \$9c



"RADIO KITS"
3-Way Portable Receiver Kit
Make this 5 tube radio for portable battery operation and AC-DC house use. Smartly designed leatherette case with modern grille and slide rule dial. 5" Alnico V speaker. Complete with extra low current drain tubes for long battery life.
KIT MODEL
3W10A \$17.50

2-BAND 5-TUBE AC/DC RECEIVER KIT, standard and foreign broadcast, Kit Model S-5X . . . \$15.95
5-TUBE AC/DC SUPERHET KIT, Model S-5 . . . \$13.95

Satisfaction guaranteed. Send check or money order. 25% deposit with C.O.D. All orders shipped within 24 hours, F.O.B. New York. Please include postage.

ADSON RADIO & ELECTRONICS CO.
DEPT. 10H
221 Fulton Street, New York 7, N.Y.

MAKES AUTO RADIO REPAIR TWICE AS EASY!

Here—prepared by an auto radio expert of 20 years standing—is everything you need to know to install, service and repair all types of auto radios faster—easier—more profitably. Covering every type of auto radio from the mid-1930's, this compact book gives you complete installation, troubleshooting and repair procedures plus tips on how to set up shop and get business.



SERVICING THE MODERN CAR RADIO by A. L. Hurlbut

2nd Edition, 702 pages, 8 1/2 x 11, 222 illus. and over 500 car radio diagrams. Price \$7.50.

You'll really know how to repair auto radios profitably after reading this great book! From basic theory through step-by-step servicing methods, every detail of the work is explained in a way you can easily understand. Differences between car and ordinary radios; antennas; antenna input circuits; power supply; circuit features; automotive electrical systems; installations; loudspeakers; interference; vibrator maintenance; alignment, push-button tuning and other related subjects are covered completely.

OVER 500 CIRCUIT DIAGRAMS

Of particular importance, SERVICING THE MODERN CAR RADIO contains over 500 circuit diagrams giving circuit details of specific car radio types you are most likely to be called upon to repair. This feature alone can save you many times the cost of the book. Read it at OUR risk. Use coupon today!

10-DAY MONEY-BACK GUARANTEE

Dept. RE-80, MURRAY HILL BOOKS, Inc., 232 Madison Ave., New York 16, N.Y.

Send me Hurlbut's SERVICING THE MODERN CAR RADIO book for which I enclose \$7.50 (\$8.00 outside U.S.A.) or, send C.O.D. for this amount plus postage. (No foreign C.O.D.'s.) If book is not satisfactory it is understood I may return it in 10 days and you guarantee to refund my \$7.50.

Name.....
Street.....
City & Zone..... State.....

SNAP-ON TV FUSE HOLDER!

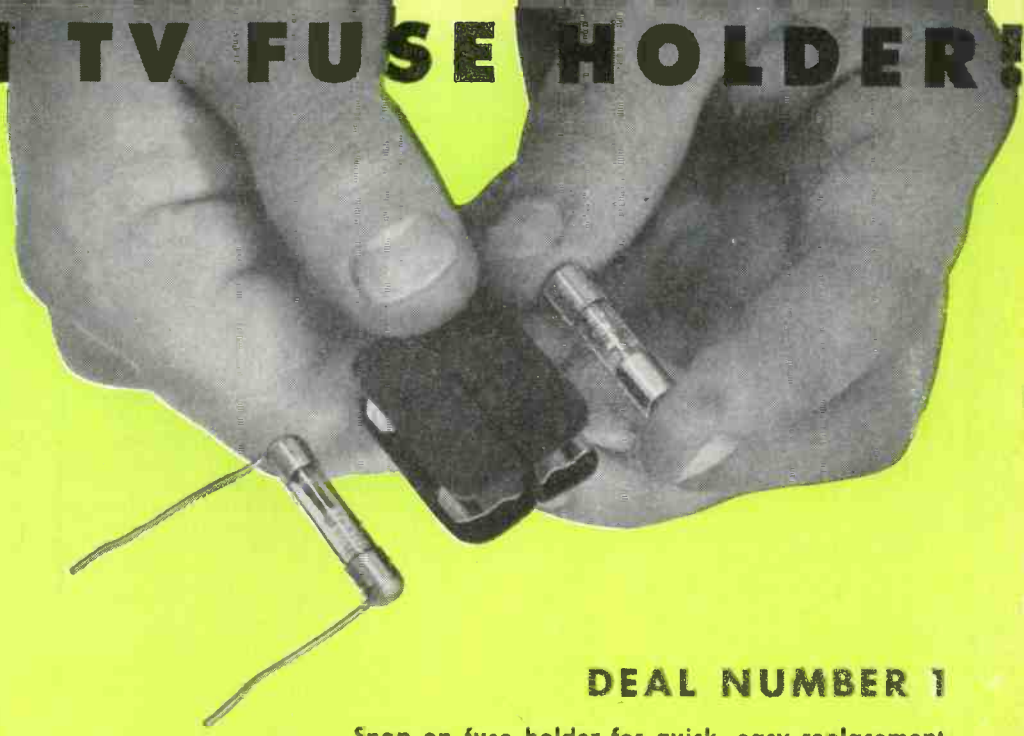
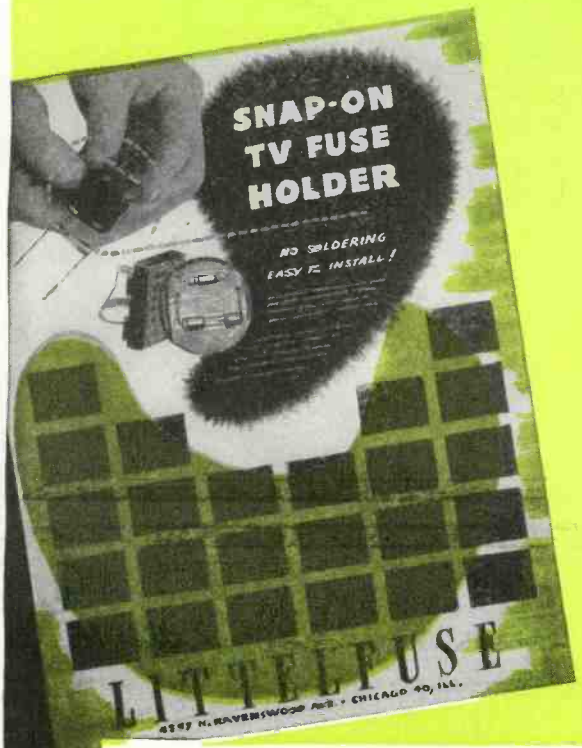

DEAL NUMBER 1

Snap-on fuse holder for quick, easy replacement of TV pigtail fuses. Snap one side of holder on blown pigtail fuse in set. Snap regular replacement fuses in other side—the job is done. No more cutting out the pigtail. No more messy soldering. No more fuses blown by hot irons. Save time, save work, save the customer's money, and still make big TV profits. Service dealer cost, 15c each.

LITTELFUSE INC.

4757 N. RAVENSWOOD AVE., CHICAGO 40, ILLINOIS

2 TV PROFIT DEALS!

DEAL NUMBER 2

TV fuse kit—10 assorted fuses that service all TV receivers — Admiral, Philco, RCA, Zenith, Emerson, Hallicrafters, etc., etc., etc. The serviceman needs the right fuse in his box — it is in this kit when he needs it. Saves time, saves profit. Service dealer cost, 98c each.

LITTELFUSE INC.

4757 N. RAVENSWOOD AVE., CHICAGO 40, ILLINOIS

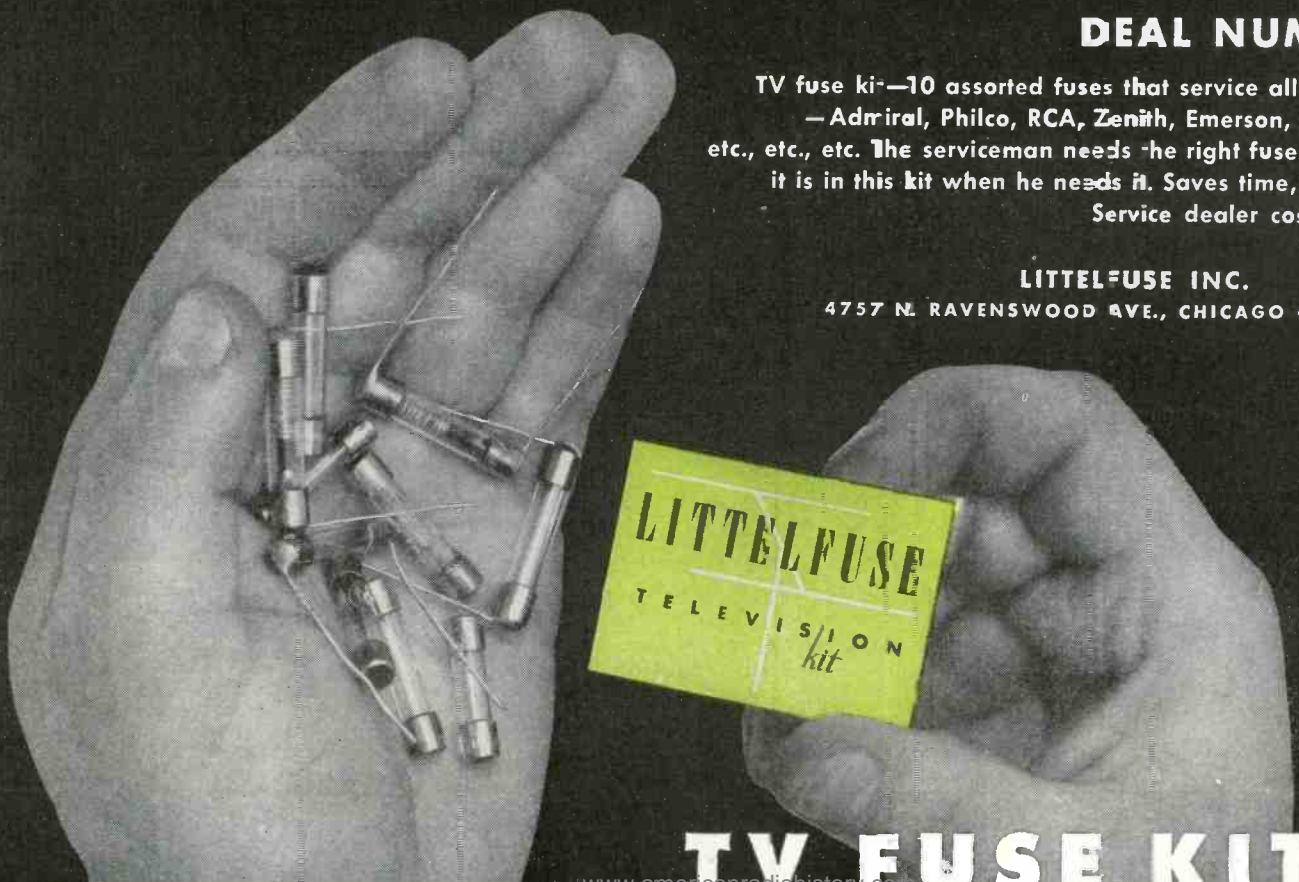

TV FUSE KIT

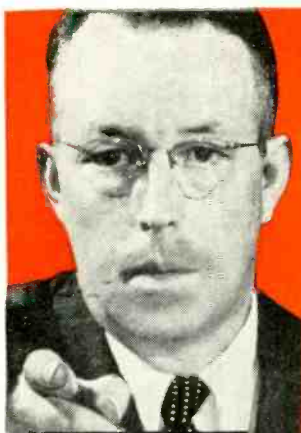

Train at Home in Spare Time for **RADIO** and **TELEVISION**

**I Send You
18 BIG
KITS
OF RADIO-
TELEVISION
EQUIPMENT**

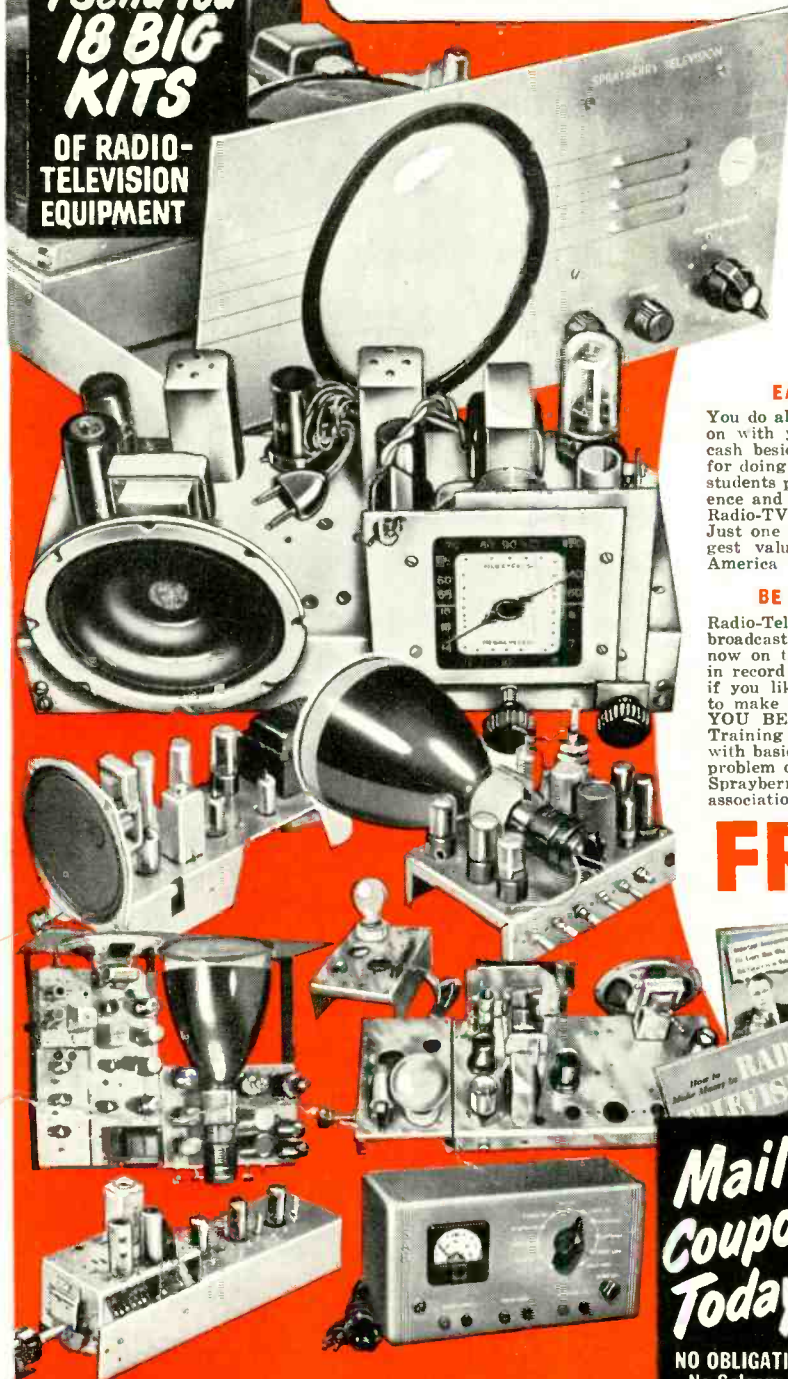

**My Famous Training System Prepares You
Double Quick For a Good Job or Your Own
Profitable Radio-Television Business**

Radio-Television is now America's greatest opportunity field! Trained men are needed to fill good jobs and handle profitable Radio-Television Service work. I have trained hundreds of men for success in Radio-Television—and I stand ready to Train you too, *even if you have no previous experience.* My training is 100% practical—designed to give you the knowledge and experience you need to make money in Radio-Television in the shortest possible time. I Train you with up-to-the-second revised lessons—PLUS many big kits of Radio-Television equipment. You actually do over 300 demonstrations, experiments and construction projects. In addition, you build a Powerful 6-tube-2-band radio, a multi-range test meter and a complete Television receiver! All equipment is **YOURS TO KEEP.**

EASY TO MAKE EXTRA MONEY WHILE YOU LEARN

You do all your training with me **AT HOME** in spare hours. Keep right on with your present job and income while learning—and earn extra cash besides! The day you enroll I begin sending you plans and ideas for doing profitable spare time Radio-TV work. Many of my Sprayberry students pay for their entire training this way! You get priceless experience and many plans for making extra money. You build all your own Radio-TV Test Equipment from parts I send you—nothing else to buy. Just one more reason why I believe I offer the ambitious man the biggest value in top notch Radio-TV Training available anywhere in America today.

BE READY FOR TOP PAYING RADIO-TELEVISION JOBS

Radio-Television is growing with amazing speed. More than 2000 Radio broadcasting stations PLUS an additional 102 Television stations are now on the air. Radio sets and TV receivers are being made and sold in record breaking numbers. If you enjoy working with your hands . . . if you like to do interesting and varied work . . . if you really want to make good money and work in an industry that has a future . . . **YOU BELONG IN RADIO-TELEVISION.** But you **MUST** have good Training to "cash in" . . . the kind of training that starts you out with basic fundamentals and carries you right through every circuit and problem of Radio-Television Servicing and Repair. In a word . . . that's Sprayberry Training . . . the course backed by more than 20 years of association with the Radio-Television industry!

FREE 3 BIG RADIO AND TELEVISION BOOKS

I want you to have ALL the facts about my complete system of Radio-Television Training! Act now! Rush the coupon for my three big Radio-Television books: "How To Make Money in Radio-Television," PLUS my new illustrated Television bulletin PLUS an actual sample Sprayberry Lesson—all FREE with my compliments. No obligation and no salesman will call on you. Send the coupon in an envelope or paste on back of post card. I will rush all three books at once!

**Sprayberry Academy of
Radio, Dept. 20-M**
111 North Canal St., Chicago 6, Ill.

**Mail
Coupon
Today!**
**NO OBLIGATION
No Salesman
Will Call**

SPRAYBERRY ACADEMY OF RADIO, Dept. 20-M
111 North Canal St., Chicago 6, Ill.

Please rush to me all information on your Radio-Television Training plan. I understand this does not obligate me and that no salesman will call upon me.

Name..... Age.....
Address.....
City..... State.....
Please Check Below About Your Experience
 Are You Experienced? No Experience

VETERANS: My Radio Training is Approved for Veterans.

IF YOU ARE EXPERIENCED in Radio I'll qualify you for Television in 4 to 8 weeks. Rush coupon.

THE QUALITY OF RCA TUBES IS UNQUESTIONED



RCA for *Deflection Tubes* ... with dependability

Each standard by which you judge a tube in service is considered in establishing the design requirements of RCA tubes. Dependable performance of deflection circuits starts with *dependable* tubes. For example.

RCA-designed driver tubes, such as the 6SN7-GT and 12AU7—as well as the RCA-6K6-GT and RCA-6AQ5 vertical-deflection tubes—are exceptionally low in microphonics. They are built for *dependable* performance.

RCA-designed horizontal deflection tubes, such as the 6BG6-G, easily withstand peak plate voltages of 5000 volts, and as readily meet peak emission demands on the cathode. They, too, are built for *dependable* performance.

For these reasons, RCA tubes offer *dependability* beyond the average. With fewer service failures and fewer costly call-backs, there is, then, an additional hidden profit in every RCA tube and kinescope you sell.

Always keep in touch with your RCA Tube Distributor



RADIO CORPORATION of AMERICA
ELECTRON TUBES

HARRISON, N. J.