

RADIO — ELECTRONICS

LATEST IN
TELEVISION
SERVICING
AUDIO

HUGO GERNSBACK, Editor

formerly

**RADIO
CRAFT**



JULY

1950

30¢

U. S. and
CANADA

MICROWAVE LENSES FOCUS SOUND WAVES — SEE AUDIO SECTION

www.americanradiohistory.com



Mallory Plascap*

... Made with Amazing Mallocene*!

World's First Completely Engineered Plastic Tubular Capacitor

Here's the plastic tubular that's years ahead of its time . . . made possible *now* by Mallocene, amazing Mallory plastic development that gives you *four exclusive* performance firsts, leaves ordinary plastic tubulars far behind!

Gone is the old bugaboo of "call-backs" due to construction weaknesses beyond your control. For the Mallory Plascap is dependable. No oil leakage, no unsoldered leads, no off-center or deformed cartridges, no messy outside wax coating, no insulation problems. The Mallory Plascap makes your service job easier! See your Mallory Distributor.

The Secret of Mallocene . . .

There is only *one* logical way to build a molded type plastic tubular capacitor . . . with a plastic that sticks to the metal leads! But with ordinary construction methods, this has been impossible, for such a plastic would stick to the metal mold!

Here's the secret of the Mallory Plascap. First, an extremely tough plastic shell is molded. The cartridge is carefully centered within this shell. Then, the cartridge is surrounded with Mallocene. When Mallocene hardens, it actually becomes part of the outer plastic shell, and *sticks to the metal leads!* Thus, Mallocene provides a solid plastic tubular capacitor with the *first* moisture-proof construction!



TRISEAL CONSTRUCTION—Sealed *three* ways —with moisture-free Mallotrol* . . . tough outer plastic shell . . . exclusive Mallocene!



DISTORTION-FREE WINDING — No flattened cartridges due to molding pressures . . . no failures due to "shorts"!



FASTITE LEADS—Permanently fastened . . . sealed with Mallocene . . . unaffected by soldering-iron heat!



TRU-CENTER CARTRIDGE—Cartridge centered every time . . . uniform insulation guaranteed at all points!

Plus these Top Features: Operates at 85°C . . . No messy outside wax coating required . . . Great mechanical strength . . . Small in size . . . Light in weight . . . High dielectric strength . . . Lead to outside foil clearly identified . . . Handsome yellow case . . . Legible part-numbers and ratings.

P. R. MALLORY & CO., Inc. **MALLORY** CAPACITORS . . . CONTROLS . . . VIBRATORS . . . SWITCHES . . . RESISTORS . . . RECTIFIERS . . . VIBRAPACK* POWER SUPPLIES . . . FILTERS
*Reg. U.S. Pat. Off.
APPROVED PRECISION PRODUCTS

P. R. MALLORY & CO., Inc., INDIANAPOLIS 6, INDIANA

*Trade Mark

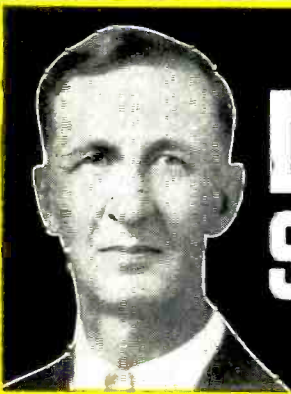

I Will Show You How to LEARN RADIO-TELEVISION SERVICING OR COMMUNICATIONS by Practicing in Spare Time



YOU PRACTICE RADIO SERVICING

You build the modern Radio shown below as part of my Servicing Course. I send you the speaker, tubes, chassis, transformer, loop antenna, EVERYTHING you need to build this modern Radio Receiver. Use it to make many tests, get practical experience.

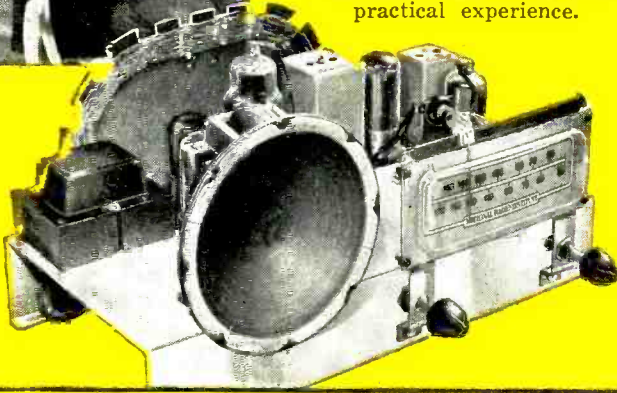

YOU PRACTICE RADIO COMMUNICATIONS

I send you parts to build the Transmitter shown below as part of my new Communications Course. Conduct actual procedure of Broadcast Operators, practice interesting experiments, learn how to put a transmitter on the air.



NEW

YOU BUILD THIS TESTER

as part of my Servicing Course, with parts N. R. I. sends. It soon helps you EARN EXTRA MONEY fixing neighbors' Radios in spare time.

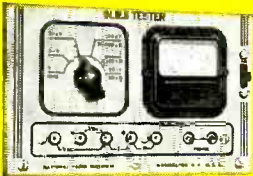

YOU BUILD THIS WAVEMETER

as part of my NEW Communications Course. Use it with Oscillator you also build that furnishes basic power to transmitter and determines transmitter frequency.

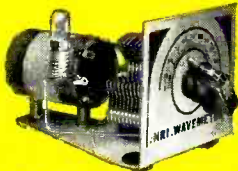

I Will Train You at Home with MANY KITS of Parts I Send

Want a good-pay job in the fast-growing Radio and Television Industries, or your own money-making Radio-Television shop? I've trained hundreds of men WITH NO PREVIOUS TRAINING to be Radio technicians. Or now you can enroll in my NEW practical course in Radio-Television COMMUNICATIONS—learn to be a Broadcasting and Communications technician. You get practical Radio experience with MANY KITS OF PARTS I send you in my train-at-home method. All equipment yours to keep.

MAKE EXTRA MONEY IN SPARE TIME

As part of my Radio Servicing Course, I send SPECIAL BOOKLETS starting the day you enroll. Make EXTRA MONEY fixing Radios in spare time while training. Then start your own Radio sales and service shop

or get a good-pay job in Police, Aviation or Marine Radio, Broadcasting, Public Address work, etc. Or think of amazing Television opportunities. Already manufacturers are producing over 100,000 sets a month. New stations going on the air everywhere! Television is America's fastest-growing industry and men who know it will be in demand

GET ACTUAL LESSON AND BOOK FREE

My DOUBLE FREE OFFER entitles you to actual SAMPLE LESSON and my 64-page book, "HOW TO BE A SUCCESS IN RADIO—TELEVISION—ELECTRONICS," both

FREE. Mail coupon now. See how quickly, easily you can start. J. E. SMITH, President, Dept. OGX, National Radio Institute, Pioneer Home Study Radio School, Washington 9, D. C.

VETERANS

Get this training under G. I. Bill
MAIL COUPON NOW

I TRAINED THESE MEN

Good Job in Radio Station



"Am Chief Engineer of Radio Station WOED in charge of four men. Owe all know about Radio to NRL"—CLYDE J. BURDETTE, Spartanburg, South Carolina.

Has Own Radio Business



"Now have two Radio shops servicing about 200 sets a month. Have largest service establishment in Southeastern Missouri!"—ARLEY STUDYVIN, Desoto, Missouri.

Good for Both—FREE

Mr. J. E. SMITH, President, Dept. OGX
National Radio Institute, Washington 9, D. C.

Mail me FREE Lesson and 64-page book.
(No salesman will call. Please write plainly.)

Name..... Age.....

Address.....

City..... Zone..... State.....

Check If Veteran Approved for Training Under G. I. Bill

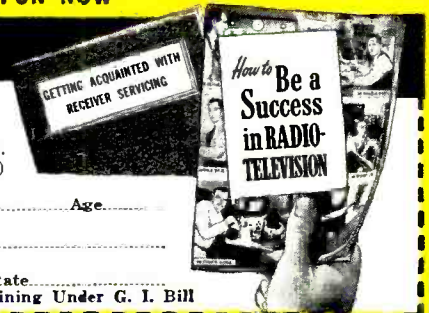

**A TESTED WAY
TO BETTER PAY**

RADIO — ELECTRONICS

formerly **RADIO-CRAFT**

MEMBER
AUDIT BUREAU OF CIRCULATIONS

Incorporating
SHORT WAVE CRAFT* TELEVISION NEWS*
RADIO & TELEVISION

*Trademark registered U. S. Patent Office

Hugo Gernsback, Editor-in-Chief

Fred Shunaman, Managing Editor
Robert F. Scott, WZPWG, Technical Editor
I. Queen, Editorial Associate

M. Harvey Gernsback, Editorial Director
Angie Pascale, Production Manager
Wm. Lyon McLaughlin, Tech. Illustration Director

Lee Robinson, General Manager
John J. Lamson, Sales Manager

G. Aliquo, Circulation Manager
Robert Fallath, Promotion Manager

CONTENTS ————— JULY, 1950

Editorial (Page 23)			
Medical Electronics.....	by Hugo Gernsback	23	
Television (Pages 24-33)			
Lead-ins for TV Antennas.....	by Joseph Racker	24	
Transitron as Sync Separator.....	by Kerrison Jones	26	
TV Deep Freeze Stumps the FCC.....	by Manfred G. Wentzel	27	
Picture Tube Safety Precautions.....	by Matt Mandl	28	
A De Luxe Televiser, Part VII.....	by Charles A. Vaccaro	29	
Antennas for Fringe Reception.....		31	
Television Service Clinic.....	by Walter Buchsbaum	32	
Electronics (Pages 34-35)			
"Radio Electronics in the Home" Prize Contest Winners.....		34	
Servicing—Test Instruments (Pages 36-45)			
Extended-Range Test Oscillator.....	by Harold Pallatz	36	
Vacuum-Tube Voltmeter has Interesting Features.....	by Rufus P. Turner	38	
Selenium Rectifiers Simplify Fixed Bias.....	by J. T. Cataldo	40	
Fundamentals of Radio Servicing, Part XVII.....	by John T. Frye	41	
Audio Freqmeter has a Tubeless Indicator.....	by I. Queen	43	
A Midget Double-Trace Scope.....	by Otto von Guericke	44	
Audio (Pages 46-53)			
Microwave Lenses Focus Sound Waves (Cover Feature).....	by Fred Shunaman	46	
Electronics and Music, Part I.....	by Richard H. Dorf	48	
A 3-Channel Hi-Fi Amplifier.....	by R. L. Eordley Wilmot	50	
Square Wave Analysis for Audio Amplifiers, Part I.....	by Eugene J. Thompson	52	
Amateur (Pages 54-57)			
Seven Basic Steps to Learn the Code.....	by Samuel Freedman	54	
FM (Pages 60-65)			
British Test AM & FM for Hi-Fi Broadcasting.....	by R. W. Hallows	60	
Supersensitive FM I.F. Unit.....	by Joseph Marshall	62	
Construction (Pages 66-69)			
An Economy Size Code Set for the Beginner.....	by Harold Gould	66	
Meter for Fractional-Ohm Measurements.....		67	
A Capacitance Relay of High Sensitivity.....	by Ernest J. Schultz	68	
Broadcasting and Communications (Pages 72-77)			
Receiver Circuits in Mobile Radio Service.....	By I. Queen	72	
New Design (Page 78)			
Review of New Tubes.....		78	
Departments			
The Radio Month.....	6	Radio Electronic Circuits.....	84
Radio Business.....	10	Try This One.....	86
Technotes.....	79	Miscellany.....	87
New Patents.....	80	Question Box.....	89
Association News.....	81	Communications.....	91
New Devices.....	82	People.....	93
Book Reviews.....	95		

ON THE COVER:

F. K. Harvey of Bell Telephone Laboratories at Murray Hill, N. J., and the audio lens. Kodachrome by Avery Slack.

RADIO-ELECTRONICS, July, 1950, Volume XXI, No. 10. Published monthly. Publication Office: Erie Ave., F to G Streets, Philadelphia 32, Pa. Entered as second class matter September 27, 1948, at the post office at Philadelphia, Pa., under the Act of March 3, 1879. SUBSCRIPTION RATES: In U. S. and Canada, in U. S. possessions, Mexico, South and Central American countries, \$3.50; \$6.00 for two years; \$8.00 for three years; single copies 30c. All other foreign countries \$4.50 a year, \$8.00 for two years, \$11.00 for three years. Allow one month for change of address. When ordering a change please furnish an address stencil impression from a recent wrapper. **RADIO-CRAFT PUBLICATIONS, INC.** Hugo Gernsback, Pres.; M. Harvey Gernsback, Vice-Pres.; G. Aliquo, Sec'y. Contents copyright, 1950, by Radio-Craft Publications, Inc. Text and illustrations must not be reproduced without permission of copyright owners. EDITORIAL and ADVERTISING OFFICES, 25 West Broadway, New York 7, N. Y. Tel. REctor 2-9690. BRANCH ADVERTISING OFFICES: Chicago: 520 N. Michigan Ave. Telephone SUperior 7-1796. Los Angeles: Ralph W. Harker, 1127 Wilshire Blvd., Tel. MA 6-1271. San Francisco: Ralph W. Harker, 582 Market St., Tel. GArdfield 1-2481. FOREIGN AGENTS: Great Britain: Atlas Publishing and Distributing Co., Ltd., London EC4; Australia: McGill's Agency, Melbourne. France: Brentano's, Paris 2e. Holland: TTElecton, Heemstede, Greece: International Book & News Agency, Athens. S. Africa: Central News Agency, Ltd., Johannesburg; Capetown; Durban. Natal: Universal Book Agency, Johannesburg. Middle East: Steimatzky Middle East Agency, Jerusalem. India: Broadway News Centre, Dadar, Bombay #14. K. L. Kannappa Mudaliar, Madras 2. Pakistan: Paradise Book Stall, Karachi 3. POSTMASTER: If undeliverable send form 3578 to: RADIO-ELECTRONICS, 25 West Broadway, New York 7, N. Y.

PREMIUM QUALITY AT NO EXTRA COST

Sprague Black Beauty Telecap* Tubulars are different from and superior to every other molded paper capacitor because they are made by the same dry assembly process as large metal-encased oil capacitors. They cannot be contaminated by dust or moisture during manufacture.

Ask for Black Beauty Telecaps at your jobber's.

*Trade Mark

Non-flammable,
dense bakelite
phenolic-molded
housing

Hollow eyelet terminal for all impregnation after molding

Uniform windings of high purity paper and aluminum foil



Solder seal as in large metal-encased oil capacitors

SPRAGUE

SPRAGUE PRODUCTS COMPANY
(Distributors' Division of Sprague Electric Co.)

81 Marshall Street
NORTH ADAMS, MASS.

RADIO-ELECTRONICS for



Get Into

TELEVISION, RADIO ELECTRONICS

Master ALL Phases



YOU RECEIVE THIS PROFESSIONAL MULTITESTER YOU BUILD ALL THESE AND MANY OTHER UNITS WITH PARTS WE SEND YOU!

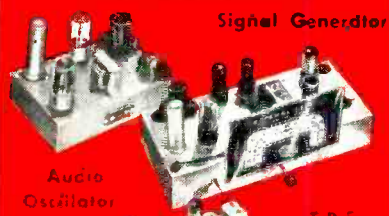

Signal Generator



Audio Oscillator



R.F. Receiver

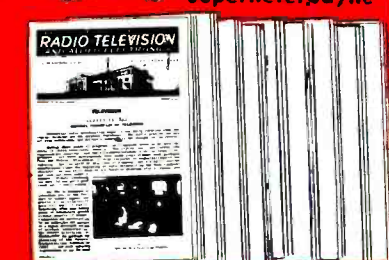

You Build This Superheterodyne

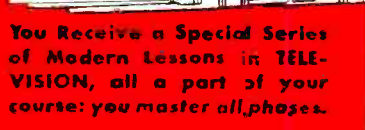

You Receive a Special Series of Modern Lessons in TELEVISION, all a part of your course: you master all phases.

Get Complete Training. You Receive and Keep All Tubes, Equipment, Parts and Lessons. No Extra Charges.

GOOD PAY and Unlimited Opportunities in JOBS LIKE THESE:

- Business of Your Own
- Radio Manufacturing, Sales, Service
- Broadcasting, Telecasting
- Television Manufacturing, Sales, Service
- Laboratories: Installation, Maintenance of Electronic Equipment, Electrolysis, Call Systems
- Garages: Auto Radio Sales, Service
- Sound Systems and Telephone Companies; Oil Well and Drilling Companies; Engineering Firms
- Theatre Sound Systems, Police Radio

And scores of other good jobs in many related fields

YOU CONDUCT MANY EXPERIMENTS LIKE THESE!

- Checking action of condensers
- Experiments with AF and RF amplifiers
- Experiments with resonance
- Producing beat frequencies
- Calibrating oscillators
- Experiments with diode, grid-bias, grid-leak and infinite impedance detectors
- Practical experience in receiver trouble shooting
- Application of visual tester in checking parts and circuits
- Experiments with audio oscillators
- Advanced trouble-shooting
- ... and many, many others

You will find all lessons easy to understand because they are illustrated throughout with clear diagrams and step-by-step examples that you work out yourself. Every piece of the equipment and complete lesson material we send you is yours to keep and enjoy, including the multimeter, experimental equipment, all parts of the Superheterodyne, tube manual, radio dictionary, and complete, modern Television texts. All parts are standard equipment.

Shop Method Home Training . . . Earn While You Learn

With our practical resident Shop Method Home Training, you study in your spare time. You receive Spare Time Work Lessons, which show you how to earn while you learn. Service neighbors' radios and TV receivers, appliances, etc., for extra money and experience. Many National students pay all or part of their training with spare time earnings!

DON'T DELAY! The Radio-Television Industry needs trained men NOW!

APPROVED FOR VETERANS!
Check coupon below!

For quick action, mail coupon today and we'll rush you full information.

Free!
NEW, ILLUSTRATED OPPORTUNITY BOOK AND SAMPLE LESSON SHOW YOU HOW WE TRAIN YOU . . . SEND FOR THEM TODAY! NO COST. NO OBLIGATION.



Complete Training by Practical Resident Trade School, Est. 1905

The same highly trained faculty, instruction materials and methods used here in our large, modern resident school, are adapted to your training in your own home. Shop Method Home Training has been proved by hundreds of successful graduates.

Both Resident and Home Study Courses Offered

YOU LEARN BY DOING

You receive special laboratory experiment lessons to show you how to build with your own hands various experimental units such as those shown at left, and how to conduct many tests.

NATIONAL SCHOOLS

LOS ANGELES 37, CALIF. • EST. 1905

FIND OUT NOW . . . MAIL COUPON TODAY

National Schools, Dept. RE-7
4000 South Figueroa Street
Los Angeles 37, California

Send me your FREE book "Your Future in Radio" and the sample lesson of your course. I understand no salesman will call on me.

NAME.....AGE.....
 ADDRESS.....
 CITY.....ZONE.....STATE.....
 Check here if Veteran of World War II

Mail in envelope or paste on penny postal.



NEW!Rectangular
BLACK TUBE**16 in. TELEKIT**TELEKIT
PRICES
START AT **49.95**
LESS TUBES

Jobbers: Write for Confidential Price Information

16 BR Telekit
\$79.95 Less
Tubes

Now you can build your own rectangular black tube TV set! This exciting new Telekit has a big 16 inch screen from a non-glare rectangular black tube. The entire set is engineered for simplicity, and has new 70% deflection, with video tube mounted directly on chassis. Brightness is assured by a 14 KV hi-voltage doubler circuit. The streamlined circuit is easy to assemble. No previous knowledge of TV is required. All you need is pliers, screw driver and soldering iron. The tuning unit and hi-voltage supply are factory wired and assembled for you. A big 54 page illustrated instruction book guides you through easy assembly. Satisfactory performance is guaranteed by our Telekit Factory Service Plan and warranty. Write today for full details.

**12-B Telekit**
\$69.95
8-B Telekit
\$49.95
Less Tubes

Here are new low prices on Telekits. Now you can have a fine 8 1/2- or 12 1/2- inch set at a price far below comparable commercial sets costing much more.

Over 30,000 Telekits have been assembled by following the big Telekit instruction book. No previous knowledge of TV is required. Satisfactory results are guaranteed under the Telekit Factory Service Plan. Write for full information.

**Telekit**
Booster
\$12.95

This Telekit Booster will bring in TV signals bright and clear. Especially helpful in fringe areas. Will give brilliant performance with any TV set. NOT A KIT. Completely assembled with tubes.

Write for FREE catalogue listing Telekits, cabinets, tubes, antennas, boosters and television accessories.

**TELEKIT****ELECTRO-TECHNICAL INDUSTRIES**
1432 N. BROAD ST. DEPT. B PHILADELPHIA 21 PA.

MASS SPECTROMETER which uses velocity rather than magnetic selection has been developed at the National Bureau of Standards by Dr. Willard H. Bennett.

In ordinary mass spectrometers, the ions are separated by passing the ion beam through a strong magnetic field which separates ions of different mass in the beam. The velocity spectrometer has three sets of three tungsten-wire grids spaced along a glass tube to form three stages. A radio frequency is applied to the middle grid of each stage.

The distances between grids and between stages are selected accurately so that for any particular ion mass there is a single radio frequency which can speed up ions of that mass as they pass through each stage. The increased speed of those ions enables them to overcome the opposing potential on the collector while all other ions are turned back.

This new spectrometer will be particularly useful for detecting dangerous radioactive particles in large-scale atomic processes.

SIGNAL CORPS INTRODUCES TELE-PHONE

Video-telephone, demonstrated in this photo by Pfc. Dorothy Burrus and Cpl. James Rheads, permits two-way look as well as two-way conversation. It was shown on Armed Forces Communications Association Day at Ft. Monmouth, N. J.

ULTRASONIC ENERGY rather than surgery or medicine may in the future be used to treat gallstones and kidney stones.

Gallstones can be shattered into tiny fragments by an intense ultrasonic beam, and these can then be excreted through natural elimination. Experiments on dogs have been successful with no apparent ill effects on the animals. The method has not yet been tried on humans because of the lack of suitable equipment.

This possibility was reported by Dr. Harold Lampert of the Yale School of Medicine and Drs. Herbert F. Newman and Ralph Eichhorn of Beth Israel Hospital, New York, at a recent meeting of the Federation of American Societies for Experimental Biology.

TRANSOCEANIC communication advanced another step with the introduction by RCA Communications Inc., of TEX, a two-way radio teleprinter service which now makes direct typed communication possible between business offices equipped with standard teleprinters in the United States and the Netherlands. Material typed by a stenographer in one country becomes visible immediately in the office of the company receiving the message. Though the direct customer-to-customer contact is an important feature of the new service, Tex service will be available at RCA offices for firms not equipped with teleprinters. Charge will be \$9 for the first three minutes and \$3 for each additional minute.

Developed by Dr. H. C. A. van Duuren, Chief Engineer of the Netherlands Postal and Telecommunications Administration, it converts standard teleprinter code into one in which the characters consist of seven units, and are all the same length. Should static or interference mutilate any character, the machine stops receiving and sends an automatic call for a repeat.

SERVICEMENS' BOYCOTT is alleged by Milton J. Shapp and Jerrold Electronics Corporation of Philadelphia, in a suit filed in the United States District Court in Philadelphia against the Philadelphia Radio Service Men's Association (PR SMA) and the Federation of Radio Service Associations of Pennsylvania (FRSAP). Several individual radio technicians were also named in the complaint.

Jerrold claims losses of \$20,000 and Shapp \$75,000 as a result of the alleged boycott, and claim triple damages under the Clayton Act.

The suit is based on the allegation that the defendants last February put a plan into effect to have all their members refuse to handle any Jerrold products, or any handled by Shapp as an agent for various radio, television, and electronic manufacturers, unless Jerrold agreed to allow only regular dealers to handle its goods, and not sell direct to such consumers as hospitals, apartment houses, and the like.

A telephone call to Dave Krantz of Philadelphia, one of the chief defendants, elicited the opinion that the suit was "nonsense." Krantz claimed that he himself had purchased within the past few weeks several hundred dollars worth of goods manufactured by companies represented by Shapp.

819-LINE TELEVISION station at Lille, France, has commenced regular operation. This is the first time a transmitter of such high definition has worked on regular schedules. The 819-line station at Paris has been broadcasting experimentally for some time. At present practically the complete program of the Lille transmitter consists of movie films, but construction of a series of microwave stations between Paris and Lille is now under way. As soon as they are completed the northern station will rebroadcast the Paris programs.



STOP DREAMING!



START PLANNING!

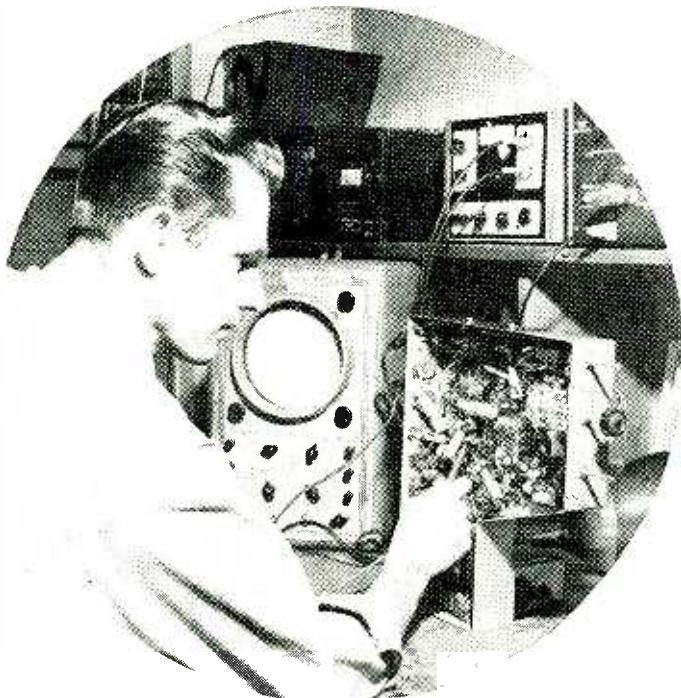

CREI Can Help You EARN MORE MONEY

with practical training in

TELEVISION and FM SERVICING!

Learn Now How to INSTALL and SERVICE All Types of TV & FM Receivers!

LAATEST FIGURES show over 2,200,000 TV receivers now in use in the U. S. Twelve million sets are predicted by 1953, and practically every area of the nation will be within range of a TV station! Servicemen will have greater and greater opportunities, and those servicemen with *specialized* Television and FM training will have a bigger advantage over those with knowledge of AM only—both in competing for jobs and in trying to make a go of their own repair businesses.

CREI knows what you need. This specialized servicing course is the practical answer to the technical problems that bother the average serviceman when he faces the job of servicing today's intricate TV and FM equipment. Every lesson in this course is practical and helpful in your daily work. Lessons are revised as new developments become accepted by the industry.

Start your training now and you start applying your new-found knowledge immediately. You will be in demand and can be earning more money as you find yourself handling TV and FM work that only a few months ago looked "impossible."

This can be your big chance! Write today for complete facts.

SAMPLE LESSON FREE! "Television and FM Trouble Shooting"—this lesson is devoted to live, "dollar-and-cents", practical practice based on day-to-day servicing problems. Read this interesting lesson and see for yourself how CREI training can help you. Mail coupon for this sample lesson, free booklet and details.

THE THREE BASIC CREI COURSES:

- ★ **PRACTICAL RADIO ENGINEERING**
Fundamental course in all phases of radio-electronics
- ★ **PRACTICAL TELEVISION ENGINEERING**
Specialized training for professional radiomen
- ★ **TELEVISION AND FM SERVICING**
Streamlined course for men in "top-third" of field

CAPITOL RADIO ENGINEERING INSTITUTE

An Accredited Technical Institute Founded in 1927

Dept. 147B, 16th Street & Park Road, N. W.
Washington 10, D. C.

Branch Office:
San Francisco (2) 760 Market St.

JULY, 1950



FREE BOOKLET
plus
SAMPLE LESSON

CAPITOL RADIO ENGINEERING INSTITUTE

Dept. 147B, 16th & Park Rd., N. W. Washington 10, D. C.

Gentlemen: Send me FREE SAMPLE LESSON and complete details of the TV and FM Servicing home study course. Also send brochure that explains the CREI self-improvement program and gives complete details and outline of course. I am attaching a brief resume of my experience, education and present position.

Check Field of Greatest Interest

<input type="checkbox"/>	TV, FM & ADVANCED AM SERVICING
<input type="checkbox"/>	PRACTICAL TELEVISION ENGINEERING
<input type="checkbox"/>	PRACTICAL RADIO ENGINEERING
<input type="checkbox"/>	AERONAUTICAL RADIO ENGINEERING
<input type="checkbox"/>	BROADCAST RADIO ENGINEERING (AM, FM, TV)
<input type="checkbox"/>	RADIO-ELECTRONICS IN INDUSTRY

NAME _____ AGE _____

ADDRESS _____

CITY _____ ZONE _____ STATE _____

I am interested in Residence School Training.

PUZZLED?



- TUBE TESTER?
- BATTERY TESTER?
- CONDENSER TESTER?
- AM SIGNAL GENERATOR?
- AUDIO OSCILLATOR?
- FM SIGNAL GENERATOR?
- MULTITESTER?

Here's Your Answer Now
ALL IN ONE!

SERVISHOP MODEL 8573

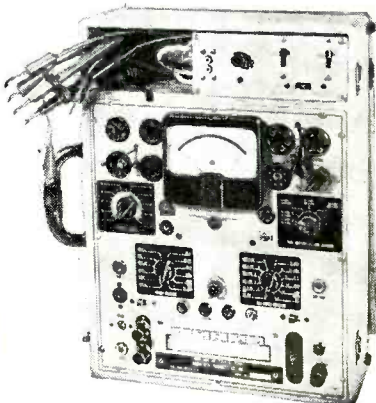

EQUIVALENT TO A COMPLETE SERVICE SHOP!

- TUBE TESTER
- SET TESTER
- BATTERY TESTER
- CONDENSER TESTER
- AUDIO R. F. - F. M. SIGNAL GENERATOR

\$99.95

Every square inch solid-packed with value! Look what you get in this phenomenally low-priced tester: (1) A complete tube tester with over 800 listings in its famous Rollindex roll chart, (2) a battery tester indicating actual voltage under rated load, (3) A capacitor tester, (4) A fixed point calibrated AM-FM signal generator, (5) An audio oscillator; and a dozen additional features.

Readable scale divisions on the ohm meter start at 0.05 ohm to 25 megohms.

- DC Volts: 0, 2.5, 10, 50, 250, 1000, 5000
- AC Volts: 0, 10, 50, 250, 1000, 5000
- DC Milliamps: 0, .5, 2.5, 10, 50, 250, 1000
- DC Amps: 0, 10
- Ohms: 0, 250, 2500, 25000
- Megohms: 0, 2.5, 25
- Decibels: -8 to +15, 15 to 29, 29 to 49, 32 to 55
- Output Voltmeter: 0, 10, 50, 250, 1000, 5000

Complete with tubes, batteries and test leads, output leads, etc., housed in natural finish oak case; hammertone gray panel. See this outstanding buy at your jobber today—or write for new catalogue RE-7.

RCP INSTRUMENTS—BEST FOR EVERY TEST

RADIO CITY PRODUCTS CO., INC.

152 West 25th St.  New York 1, N. Y.

TRAFFIC LIGHT that talks, the first of its kind, was installed in downtown Syracuse, N. Y. In a joint experiment by G-E, the local police, and the chamber of commerce, an automatic

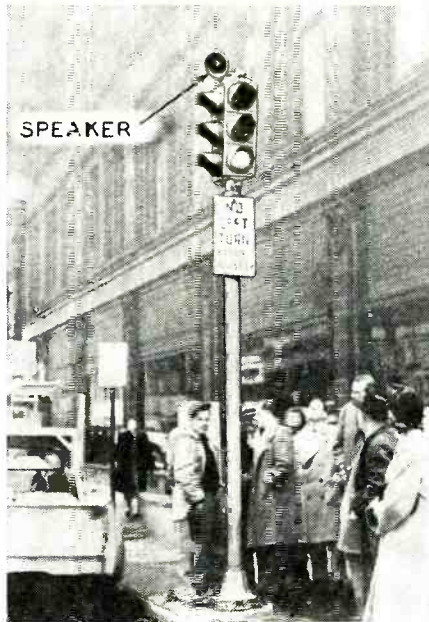

tape recorder was installed to provide the light with a voice that repeats a warning message to pedestrians each time the light changes. The speaker atop the light delivers such slogans as "Look right—look left—it may save your life. Long chances shorten lives."

THREE-COLOR TUBE PATENT was issued to Allen B. De Mont Laboratories May 16. The patent had been filed October 26, 1945. At that time the inventor, Henry Kasperowicz of Passaic, New Jersey, who is shown below with his tube, was only 27 years old.

The patent covers both an iconoscope and a kinescope. The screen of the tube is divided into minute squares (roughly a thousand to the vertical height of the picture) which are covered successively with red, blue and green phosphors. The beam is then so modulated that it excites the phosphor of the desired color. In the iconoscope, photoelectric substances which are most strongly excited by the primary colors are disposed in the same checkerboard fashion, thus producing a beam modulated according to the color of the scene scanned.

The new tubes are still in the developmental stage, and their perfection depends to some extent on the setting of standards for color television.

COMPULSORY LICENSING for television servicing concerns, proposed in the New York City Council by a Bronx councilman, was given a cool reception at a public hearing held May 16. Only representatives of the larger television service contracting concerns spoke for the measure, while representatives of radio publishers and service technicians condemned it.

Chief weakness of the proposed bill was that—though it recognized the service contract as the main source of abuses—it was so worded as to practically exclude from business the small technician who does not often work on a contract basis.

Provisions of the proposed local law would have included: \$60 annual license fee, \$500 financial responsibility bond, \$5,000 to \$10,000 contractor's insurance; minimum size of establishment to be 500 square feet; minimum personnel three persons (one supervisor, one full-time helper and one full-time office worker). A minimum complement of service instruments — including "sweep generator" (minimum five-inch cycloscope)—was also listed!

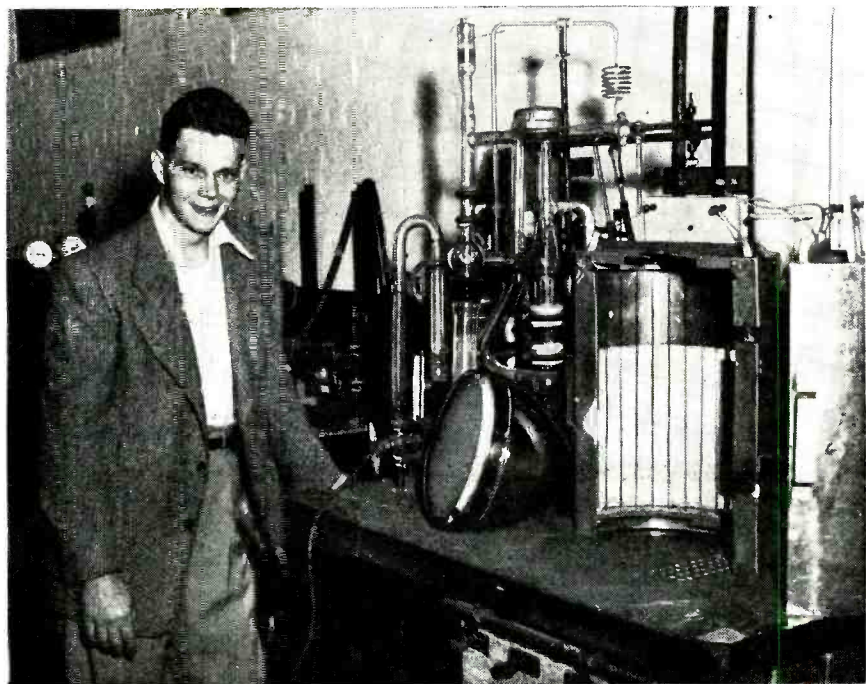

RADIO-ELECTRONICS for

The look that keeps telephone costs

DOWN

Through his microscope this Bell metallurgist examines a bit of material which is proposed for telephone use. From what he sees of grain structure, he gains insight into performance not provided by spectrum or chemical analysis. He learns how to make telephone parts stand up longer, so that telephone costs can be kept as low as possible.

The items which come under scrutiny are many and varied, ranging from manhole covers to hair-thin wires for coils, from linemen's safety buckles to the precious metal on relay contacts.

In joints and connections—soldered or welded, brazed or riveted—photomicrographs reveal flaws which would escape ordinary tests. They show if a batch of steel has the right structure to stand up in service; why a guy wire let go in a high wind or a filament snapped in a vacuum tube; how to make switchboard plugs last longer.

In their exploration of micro-structure, Bell Telephone Laboratories scientists have contributed importantly to the metallographic art. You enjoy the benefits of their thoroughgoing testing and checking in the value and reliability of your telephone system, and the low cost of its service.



Examining specimen on metallographic microscope at Bell Telephone Laboratories.

Photomicrograph of white cast iron which is hard and brittle.

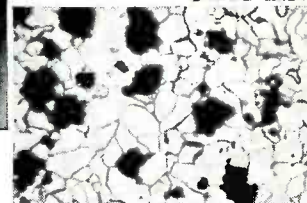
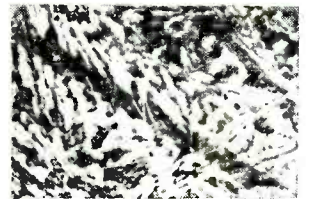

Same iron rendered malleable by heat treatment. Shows spots of nodular carbon.

BELL TELEPHONE LABORATORIES



WORKING CONTINUALLY TO KEEP YOUR TELEPHONE SERVICE BIG IN VALUE AND LOW IN COST



NATIONAL Videometer

Now, at last, you can predict TV receiver operation at a given location with laboratory accuracy! Now, you can make a perfect TV installation every time — ghost and interference free — and eliminate costly call-backs! The National Videometer, described in the December issue of SERVICE, shows you BOTH the TV picture AND meter readings on both field intensity and line voltage — gives you a complete, fool-proof check on antenna orientation, transmission line, voltage, etc.



METER
A.C. LINE SIG. STR.

METER CHECK ON BOTH FIELD INTENSITY AND LINE VOLTAGE

Set the meter switch to A.C. LINE and read the line voltage at the receiver input terminal directly on the 0-150 volt scale. Set the switch to SIG. STR. and read the field intensity on the 0-10 scale. A table is provided to convert directly to microvolts. Reading indicates field intensity at antenna input and is independent of contrast and brightness controls. \$169.95



Merchandising News

RCA Victor held the second in its nation-wide series of six Television Service Clinics, beginning May 1. The clinics are sponsored jointly by the RCA Victor Home Instrument Dept., its national distributors and the RCA Service Co.

The second lecture was devoted to the servicing of the r.f. unit, the picture i.f., and the sound channel in RCA receivers. It also covered test methods and equipment. Booklets covering the material discussed in each session were given to the technicians who attended.

Colonial Radio & Television Division of Sylvania Electric Products, Inc., announced a price protection policy on all current Sylvania television models. In the event of a price change, distributors will reimburse dealers for all new and unused models of the receivers reduced.

General Electric Co. is offering an illuminated steel display case for elec-



tronic tubes to all service dealers. Called the "Selector-Salesman", the unit can hold up to 200 tubes.

The unit acts as both a display and a storage cabinet for tubes. Additional units may be attached. It is 34 inches high, 21 inches wide, and 8 inches deep.

Raytheon has announced a one-year guarantee policy on television picture tubes. In making the announcement, the Raytheon Replacement Tube Department stated that it had taken steps to eliminate red tape in processing necessary adjustments.

Centralab Division of Globe-Union, Inc., announced that it has introduced printed electronic circuits to the distributor trade. Until now these circuits were available only in manufacturers' quantities.

The company also announced a new 60-day price protection policy and a comprehensive method of maintaining up-to-date inventories through an inventory exchange plan. Centralab also made known its cooperation with the Sams' Photofact Service beginning with folder No. 93.

Insuline Corp. has made a two-color all steel display stand for auto antennas available to dealers. The stand will be sent to dealers who order six antennas.

James B. Lansing Sound, Inc., will start a flying electronics exhibit on



July 10. The exhibit, lasting two weeks, will travel exclusively by airplane.

Lansing speaker systems, Magnacord wire recorders, and MacIntosh amplifiers will be shown to the trade. Stopovers include Lincoln, Neb., St. Louis, Kansas City, Wichita, and Omaha.

International Resistance Co. has produced a new Concentrikit stock assortment to meet service technicians' increasing need for replacement concentric dual controls. The assortment contains 94 parts.



It is designed to enable technicians to assemble concentric duals in a matter of minutes. Step-by-step instructions are given.

Financial reports

(First Quarter of year)

	1950	1949
Admiral Corp.		
Earnings	\$ 4,158,449	\$ 1,536,217
Sales	\$36,291,409	\$23,513,097
American Phenolic Corp.		
Earnings	\$ 224,906	\$ 175,649
Sales	\$2,765,336	\$2,788,759
Globe-Union (parent co. Centralab Div.)		
Earnings	\$ 540,904	\$ 259,957
Sales	\$7,200,388	\$5,414,923

RADIO-ELECTRONICS for



**YOU DON'T HAVE
TO QUIT YOUR
PRESENT JOB...
To Prepare for an
Exciting,
Profitable
Job in...**

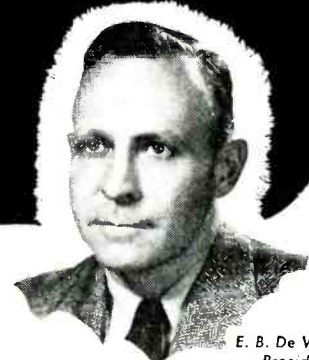

E. B. De Vry,
President
DeForest's Training, Inc.

TELEVISION RADIO and ELECTRONICS!

NO PREVIOUS EXPERIENCE NECESSARY! PREPARE AT HOME OR IN OUR CHICAGO LABORATORY!

Yes—that's exactly what we mean. You don't have to quit your present job in order to prepare for real money, interesting work, and a thrilling future in one of America's most promising opportunity fields.

DeForest's Training, Inc. provides EVERYTHING YOU NEED for real laboratory type training . . . in your spare time, AT HOME. No previous experience needed. You learn-by-seeing, learn-by-reading, learn-by-doing as you prepare for a real job or your own business in thrilling Television-Radio-Electronics. This even includes the opportunity to build and keep a big 16 inch rectangular picture tube TELEVISION RECEIVER—an optional feature available at small added cost after completing training described below.

YOU ALSO USE HOME MOVIES

If you choose to come to Chicago, we shall find comfortable living quarters for you. If you train at home, we shall send you modern, practical equipment. In either of these two methods, you will have the supervision of some of the finest instructors in the country. Fill in coupon below and we shall send you, absolutely FREE, full information about our program of building men for better opportunities in TELEVISION-RADIO-ELECTRONICS. DeForest's Training, Inc. also includes instruction in FM Radio and Industrial Electronics.

If you prefer to remain at home, you receive 16 big kits of radio parts and assemblies from which you can work over 300 fascinating experiments . . . including the building of a Multimeter, Signal Generator and Oscilloscope . . . which you keep. In addition, you receive the use of a 16 mm. motion picture projector and 16 information-packed reels of film which help you learn faster . . . easier. You also get modern lessons.

EMPLOYMENT SERVICE

When you complete your training our effective Employment Service helps you get started toward a real future. Mail coupon today . . . do not delay.

OPTIONAL

When you complete your training you have the optional privilege of building and keeping a 16 inch rectangular tube Television Receiver, available at slight additional cost.

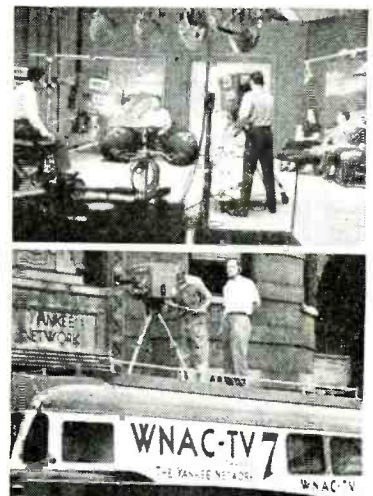
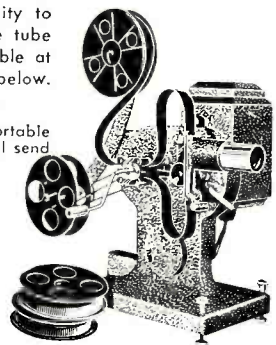
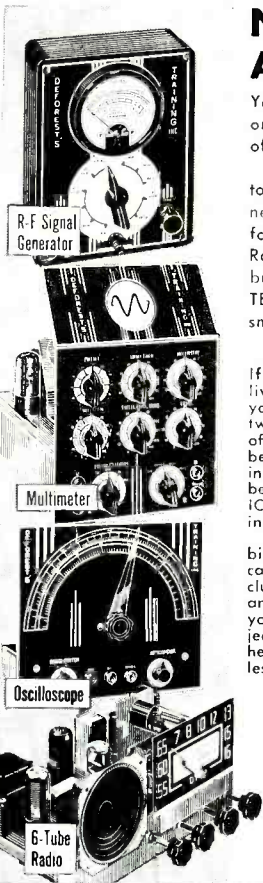

MAIL THIS OPPORTUNITY COUPON NOW!

Mr. E. B. De Vry, President
DeForest's Training, Inc.
2533 N. Ashland Avenue, Dept. RE-G-7
Chicago 14, Illinois

Please show me how I may get started toward a good job or a business of my own in Television-Radio-Electronics.

Name _____ Age _____
Address _____ Apt. _____
City _____ Zone _____ State _____
 If under 16, check here for special information.

DeForest's Training, Inc.
CHICAGO 14, ILLINOIS
Associated with the De Vry Corporation
Builders of Movie & Electronic Equipment

**TOP SALES PROVE TV
SET OWNERS WANT THE
QUALITY PERFORMANCE
AND QUALITY APPEARANCE
OF**

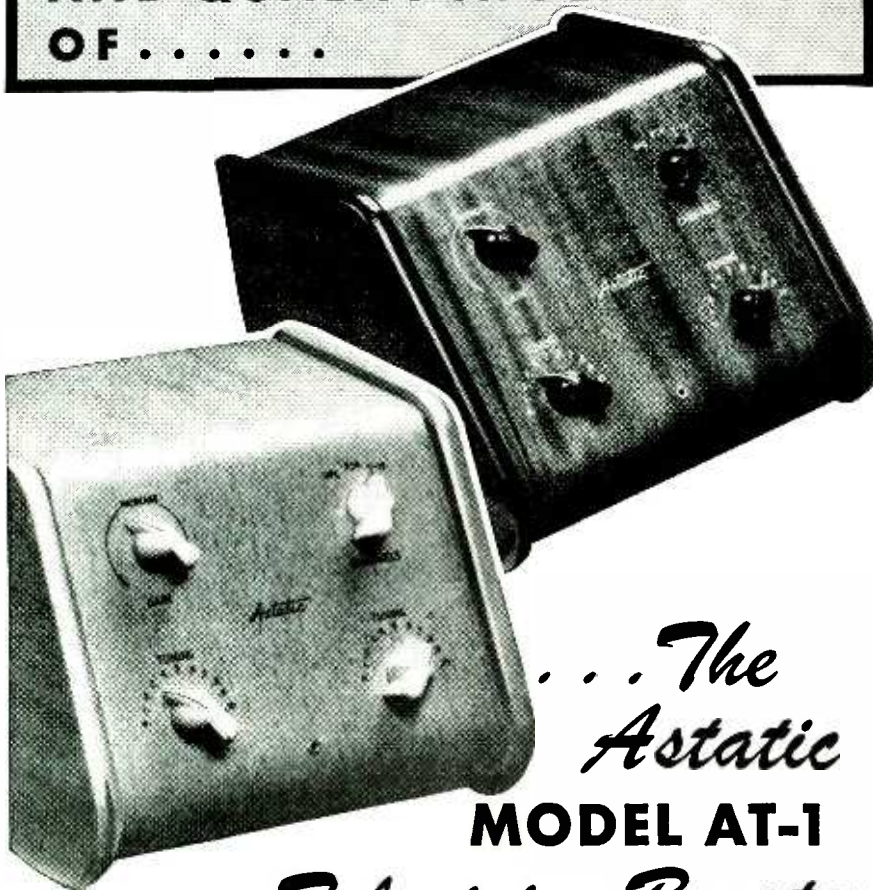

*. . . The
Astatic
MODEL AT-1
Television Booster*

YES, the proof is in! When TV set owners want improved reception, they want the best in boosters — as witness the soaring sales of Astatic's Model AT-1. This is the powerful booster with four tubes, and such exclusive features as dual tuning and variable gain control, the latter permitting pinpoint tuning for exact amount of boost required for best picture and sound. The Astatic AT-1 Booster not only outperforms any other on the market, but it looks the part — in handsome, furniture-finish mahogany or blond cabinet to complement the finest receivers and other costly furnishings. These are typical advantages which have made the Astatic Model AT-1 Television Booster the undisputed leader today. Why not write for complete details, technical data?

Astatic Crystal Devices manufactured under Brush Development Co. patents



	1950	1949
Hoffman Radio Corp.		
Earnings	\$680,595	not reported
Sales	\$6,240,660	not reported
Hytron Radio & Electronics		
Earnings	\$ 473,705	\$ 128,906
Sales	\$6,646,046	\$3,233,743
Magnavox Co. (estimated)		
Earnings	\$ 624,742	not available
Sales	\$9,000,000	not available
Motorola, Inc.		
Earnings	not reported	not reported
Sales	\$15,200,000	\$35,500,000
Noblitt-Sparks Industries, Inc.		
Earnings	\$718,496	\$502,067
Sales	not reported	
Olympic Radio & Television, Inc.		
Earnings	\$ 368,454	\$ 79,270
Sales	\$4,778,448	\$1,531,249
RCA		
Earnings	\$11,236,231	\$ 5,932,083
Sales	\$127,369,550	\$92,327,827
Raytheon Mfg. Co.		
Earnings	\$ 752,000	\$ 419,000
Sales	\$16,500,000	\$14,100,000
Sylvania Electric Products		
Earnings	\$ 1,225,844	\$ 1,176,815
Sales	\$29,347,911	\$27,108,895
Webster Chicago Corp.		
Earnings	\$ 364,076	\$ 304,076
Sales	\$3,708,808	\$3,577,779
Weston Electrical Instrument Corp.		
Earnings	\$70,127	\$146,788
Sales	not reported	not reported

New plants and expansions

The Workshop Associates, Inc., has acquired a new building in Needham Heights, Mass. The additional space will be used for development activities and producing new television antennas.

Centralab Division of Globe-Union, Inc., established its fifth plant devoted to the exclusive manufacture of electronic component parts. Property consists of 42,000 square feet of floor space in two buildings in Milwaukee.

Trio Manufacturing Co., manufacturer of FM and television antennas and accessories, has added 8,000 square feet of space in Griggsville, Ill. . . . Telrex Inc. has acquired a new testing site in Belmar, N. J., where it will construct a fully equipped laboratory for antenna design and development.

. . . Crosley Division of AVCO Mfg. Corp. has leased 160,000 square feet of space in buildings in Cincinnati. The space will be used for warehousing, permitting expanded production at the main plant.

Telequip Radio Co. moved to larger quarters in Chicago which will permit it to triple TV set production. . . .

Noblitt-Sparks Industries, Inc., has begun construction on a new factory in Columbus, Ind. It will be devoted exclusively to the manufacture of Arvin television sets. . . . Air King Products Co., Inc., has acquired 40,000 square feet of space in Brooklyn, N. Y.

Business briefs

Sylvania Electric Products is completing a new cathode-ray exhaust machine which will speed up and reduce the cost of TV tube production. . . . Allen B. DuMont Laboratories is now marketing its industrial color TV system. . . . Mexico's first TV station will go on the air this Summer.

RADIO-ELECTRONICS for

CHANNEL MASTER'S

Super-Fan!

BM 313 SERIES

• STRENGTH • RIGIDITY • SENSITIVITY

SUPERSEDES
THE BM 312
FAN FLECTOR
SERIES

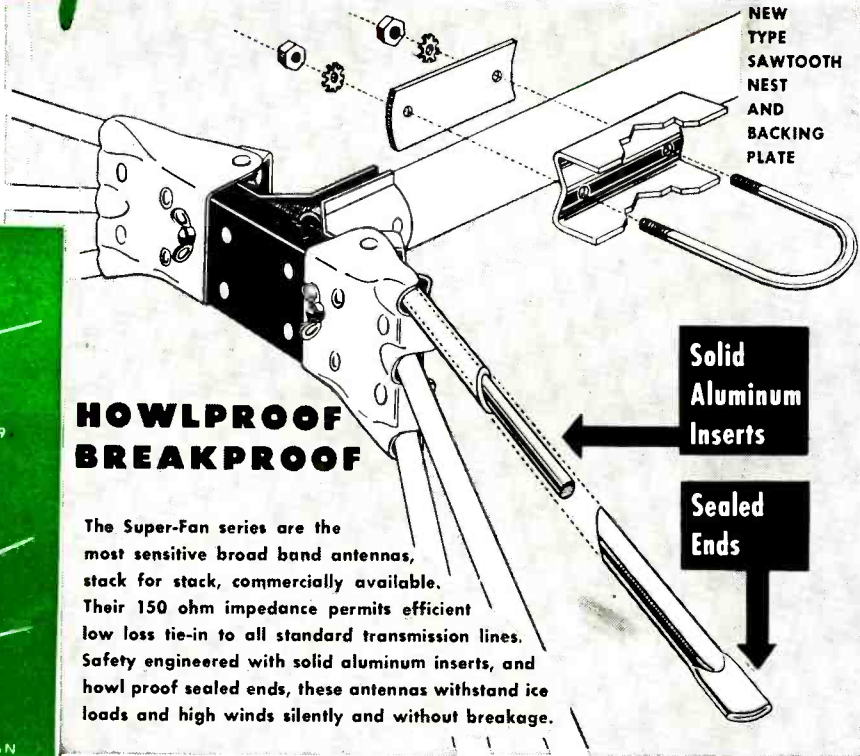

- LOWER PRICES
- SMALLER BOX
- SUPERIOR PREASSEMBLY

HOWLPROOF BREAKPROOF

The Super-Fan series are the most sensitive broad band antennas, stack for stack, commercially available. Their 150 ohm impedance permits efficient low loss tie-in to all standard transmission lines. Safety engineered with solid aluminum inserts, and howl proof sealed ends, these antennas withstand ice loads and high winds silently and without breakage.

These models also feature *Swing-Lock-Action*, the patented preassembled feature of all Channel Master antennas. Just swing out elements and lock them in place — as easy as that.



A TELEVISION SET IS NO BETTER THAN ITS ANTENNA
THERE IS NO BETTER ANTENNA THAN THE SUPER-FAN

GAIN OF THE SUPER-FAN SERIES

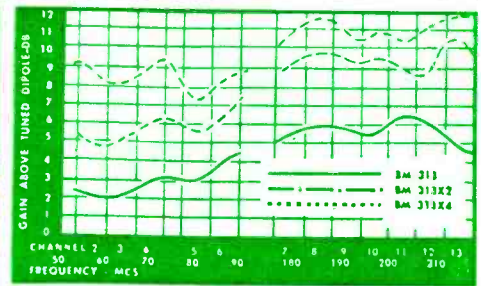
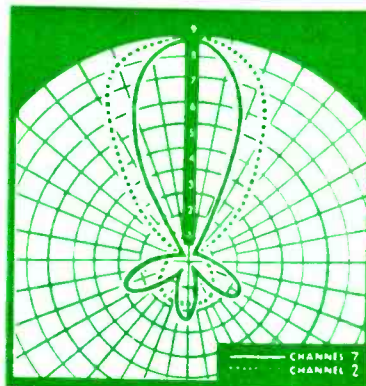

GAIN CURVES

CHANNEL	2	3	4	5	6	7	8	9	10	11	12	13
313	3.1	2.3	3.0	3.0	2.0	5.5	5.8	5.9	5.7	6.3	6.0	6.7
313X2	4.8	5.0	6.1	5.7	6.8	9.0	8.7	8.3	8.4	8.8	8.0	10.8
313X4	9.0	8.1	9.0	7.5	8.5	11.0	11.4	10.8	10.8	10.3	11.3	11.9

GAIN IN DB. ABOVE TUNED DIPOLE



FIRST IN PRE-ASSEMBLED ANTENNAS

ELLENVILLE, N. Y.

JULY, 1950

TO: CHANNEL MASTER CORP., ELLENVILLE, N. Y. E-7

Please send me:

Name of nearest Channel Master Distributor

Technical data and literature

YOUR NAME

COMPANY NAME

ADDRESS

CITY STATE

NEW 1950

Heathkits

have all the Features

New 1950 Heathkit

PUSH-PULL EXTENDED RANGE 5" OSCILLOSCOPE KIT

Features

- The first truly television oscilloscope.
- Tremendous sensitivity .06 Volt RMS per inch deflection.
- Push-pull vertical and horizontal amplifiers.
- Useful frequency range to 2½ Megacycles.
- Extended sweep range 15 cycles to 70,000 cycles.
- New television type multivibrator sweep generator.
- New magnetic alloy shield included.
- Still the amazing price of \$39.50.



\$39.50

The new 1950 Push-Pull 5" Oscilloscope has features that seem impossible in a \$39.50 oscilloscope. Think of it—push-pull vertical and horizontal amplifiers with tremendous sensitivity only six one hundredths of a volt required for full inch of deflection. The weak impulses of television can be boosted to full size on the five inch screen. Traces you couldn't see before. Amazing frequency range clear useful response at 2½ Megacycles made possible by improved push-pull amplifiers. Only Heathkit Oscilloscopes have the frequency range required for television. New type multi-vibrator sweep generator with more than twice the frequency range. 15 cycles to 70,000 cycles will actually synchronize with 250,000 cycle signal. Dual positioning controls will move trace over any section of the screen for observation of any part. New magnetic alloy CR tube shield protects the instrument from outside fields. All the same high quality parts, cased electrostatically shielded power transformer, aluminum cabinet, all tubes and parts. New instruction manual now has complete step by step pictorials for easiest assembly. Shipping Weight 30 lbs. Order now for this winter's use.

CONVERSION FOR OTHER MODEL HEATHKIT OSCILLOSCOPES

A conversion for all 03 and 04 scopes is available changing them to the new push-pull amplifiers (does not change the sweep generator). Complete kit includes new chassis, tubes and all parts. For a small investment, add the latest improvements to your present oscilloscope (Except C.R. Tube Shield). Shipping weight 10 lbs. **\$12.50**
Order 05 Conversion Kit No. 315

THE NEW Heathkit

HANDITESTER KIT

MORE Features THAN EVER BEFORE

- Beautiful streamline Bakelite case.
- AC and DC ranges to 5,000 Volts.
- 1% Precision ceramic resistors.
- Convenient thumb type adjust control.
- 400 Microampere meter movement.
- Quality Bradley AC rectifier.
- Multiplying type ohms ranges.
- All the convenient ranges 10-30-300-1,000-5,000 Volts.
- Large quality 3" built-in meter.

The instrument for all—the ranges you need—beauty you'll enjoy for years and you can assemble it in a matter of minutes—an instrument for everyone. The handiest quality volt-ohm-meter of all. Small enough to put in your pocket yet a full 3" meter. Easy pictorial wiring diagrams eliminate all assembly problems. Uses only 1% precision ceramic divider resistors and wire wound shunts. Twelve different ranges. AC and DC ranges of 10-30-300-1,000-5,000 Volts. Ohms ranges of 0-3,000 ohms and 0-300,000 ohms. Milliampere ranges of 10MA and 100MA. Hearing aid type ohms adjust control fits conveniently under thumb for one hand adjustment. Banana type jacks for positive low resistance connections. Quality test leads included. The high quality Bradley instrument rectifier was especially chosen for linear scales on AC. The modern case was styled by Harrah Engineering for this instrument. The 400 microampere meter movement comes already mounted in the case protected from dust during assembly. An ideal classroom assembly instrument useful for a lifetime. Perfect for radio service calls, electricians, garage mechanics, students, amateurs and beginners in radio. The only quality volt-ohm-meter under \$20.00. An hour of assembly saves you one-half the cost and quality parts give you a better instrument. Order today. Shipping weight 2 lbs.



\$13.50

Note
HANDY
OHMS
ADJUST.

EXPORT DEPT.
13 East 40th St.
NEW YORK CITY (16)
CABLE: ARLAB-N.Y.

The **HEATH COMPANY**

... BENTON HARBOR 20, MICHIGAN

MORE QUALITY in

1950 Heathkits

The NEW V-4 Heathkit

VACUUM TUBE VOLTMETER KIT

Features

- Meter scale 17% longer than average 4½" meter.
- Modern streamline 200 ua meter.
- New modern streamline styling.
- Burn-out proof meter circuit.
- 24 Complete ranges.
- Isolated probe for dynamic testing.
- Most beautiful VTVM in America.
- Accessory probes (extra) extend ranges to 10,000 Volts and 100 Megacycles.
- Uses 1% precision ceramic divider resistors.
- Modern push-pull electronic voltmeter circuit.
- Electronic AC circuit. No current drawing rectifiers.
- Shatterproof plastic meter face.

The new Heathkit Model V-4 Vacuum Tube Voltmeter has dozens of improvements. A new modern streamlined 200 microampere meter has Alnico V magnet for fast, accurate readings. The new electronic AC voltmeter circuit incorporates an entire new balance control which eliminates contact potential and provides greater accuracy. New simplified switches for quicker assembly. New snap-in battery mounting is on the chassis for easy replacement.

The Heathkit VTVM is the only kit giving all the ranges. Check them — DC and AC full scale linear ranges of 0-3V, 0-10V, 0-30V, 0-100V, 0-300V, 0-1000V and can be extended to 0-3000V and 0-10,000V DC with accessory probe at slight extra cost. Electronic ohmmeter has six ranges measuring resistance accurately from .1 ohm to one billion ohms. Meter pointer can be offset to zero center for FM alignment.

The DC probe is isolated for dynamic measurements. Has db scale for making gain and other audio measurements.

The new instruction manual features pictorial diagrams and step-by-step instructions for easy assembly. The Heathkit VTVM is complete with every part — 110V transformer operated with test leads, tubes, light aluminum cabinet for portability, giant 4½" 200 microamp meter and complete instruction manual.

Order now and enjoy it this entire season. Shipping weight 8 lbs., Model V-4

Accessory: 10,000V high voltage probe, No. 310, \$4.50.
Accessory: RF crystal diode probe kit extends RF range to 100 Mc., No. 309, \$6.50.

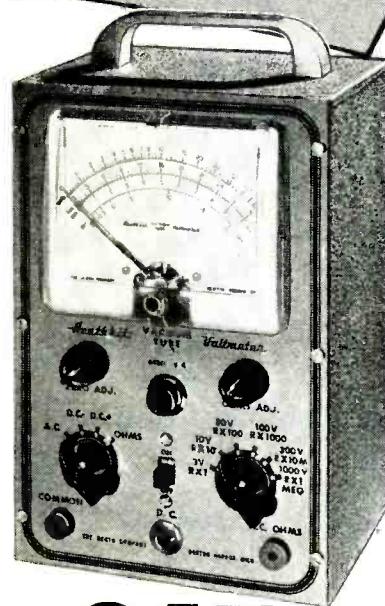

\$24⁵⁰

New 1950 VERNIER TUNING R.F. Heathkit

SIGNAL GENERATOR KIT

Features

- New 5 to 1 ratio vernier tuning for ease and accuracy.
- New external modulation switch—use it for fidelity testing.
- New precision coils for greater output.
- Cathode follower output for greatest stability.
- 400 cycle audio available for audio testing.
- Most modern type R.F. oscillator.
- Covers 150Kc. to 34Mc. on fundamentals and calibrated strong harmonics to 102 Mc.

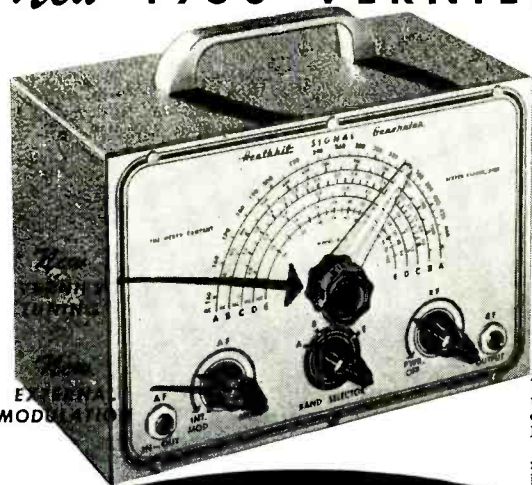

\$19⁵⁰

The most popular signal generator kit has been vastly improved—the experience of thousands combined to give you the best. Check the features in this fine generator and consider the low price \$19.50. A best buy for any shop, yet inexpensive enough for hobbyists. Everyone can have an accurate controlled source of R.F. signal voltage.

The new features double the value—think of being able to make fidelity checks on receivers by inserting a variable audio signal. Internal 400 cycle saw-tooth audio oscillator modulates R.F. signal and is available externally for audio testing. The new 5 to 1 ratio vernier drive gives hairline tuning for maximum accuracy in scale settings. The coils are already precision wound and calibrated. Uses turret type coil and switch assembly for ease of construction. The generator is 110 V. 60 cycle transformer operated and comes complete in every detail—cabinet—tubes—coils—beautiful two color calibrated panel and all small parts—new step-by-step pictorial diagrams and complete instruction manual make assembly a cinch even for novices. Why try to get along without a signal generator when you can have the best for less than a twenty dollar bill. Better order it now. Shipping weight 7 lbs. \$19.50

CONVERSION KIT FOR G-1 GENERATORS

Conversion kit for G-1 generators for vernier tuning and external modulation includes new high band coil for greater output. Gives all the features of new G-5 listed above. Order G-5 Conversion Kit No. 316 \$4.50

EXPORT DEPT.
13 East 40th St.
NEW YORK CITY (16)
CABLE: ARLAB—N. Y.

The HEATH COMPANY

... BENTON HARBOR 20, MICHIGAN

Beauty · Quality · Economy



Only
\$69.50

Nothing
ELSE TO BUY

New Heathkit IMPEDANCE BRIDGE KIT

A LABORATORY INSTRUMENT NOW WITHIN
THE PRICE RANGE OF ALL

Measures Inductance from 10 microhenries to 100 henries capacitance from .00001 MFD to 1000 MFD. Resistance from .01 ohms to 10 megohms. Dissipation factor from .001 to 1. "Q" from 1 to 1000.

Ideal for schools, laboratories, service shops, serious experimentors.

An impedance bridge for everyone — the most useful instrument of all, which heretofore has been out of the price range of serious experimentors and service shops. Now at the lowest price possible. All highest quality parts. General Radio main calibrated control. General Radio 1000 cycle hummer. Mallory ceramic switches with 60 degree indexing — 200 micro-amp zero center galvanometer — 1/2 of 1% ceramic non-inductive decade resistors. Professional type binding posts with standard 3/4" centers. Beautiful birch cabinet. Directly calibrated "Q" and dissipation factor scales. Ready calibrated capacity and inductance standards of Silver Mica, accurate to 1/2 of 1% and with dissipation factors of less than 30 parts in one million. Provisions on panel for external generator and detector. Measure all your unknowns the way laboratories do — with a bridge for accuracy and speed.

Internal 6 volt battery for resistance and hummer operation. Circuit utilizes Wheatstone, Hay and Maxwell circuits for different measurements. Supplied complete with every quality part — all calibrations completed and instruction manual for assembly and use. Deliveries are limited. Shipping weight, approximately 15 lbs.

Heathkit CONDENSER CHECKER KIT

\$19.50



Features

- Power factor scale
- Measures resistance
- Measures leakage
- Checks paper-mica-electrolytics
- Bridge type circuit
- Magic eye indicator
- 110V. transformer operated
- All scales on panel

Checks all types of condensers, paper-mica-electrolytic-ceramic over a range of .00001 MFD. to 1000 MFD. All on readable scales that are read direct from the panel. NO CHARTS OR MULTIPLIERS NECESSARY. A condenser checker anyone can read without a college education. A leakage test and polarizing voltage for 20 to 500 volts provided. Measures power factor of electrolytics between 0% and 50%. 110V. 60 cycle transformer operated complete with rectifier and magic eye tubes, cabinet, calibrated panel, test leads and all other parts. Clear detailed instruction for assembly and use. Why guess at the quality and capacity of a condenser when you can know for less than a twenty dollar bill. Shipping weight, 7 lbs. Model C-2.

New Heathkit TELEVISION ALIGNMENT GENERATOR KIT



\$39.50

Nothing ELSE TO BUY

Everything you want in a television alignment generator. A wide band sweep generator covering all TV frequencies 0-46.54 to 100 — 174 to 220 Megacycles, a marker indicator covering 19 to 42 Megacycles, AM modulation for RF alignment — variable calibrated sweep width 0-30 Mc. — mechanical driven inductive sweep. Husky 110V. 60 cycle power transformer operated — step type output attenuator with 10,000 to 1 range — high output on all ranges — band switching for each range — vernier driven main calibrated dial with over 45 inches of calibration — vernier driven calibrated indicator marker tuning. Large grey crackle cabinet 16 1/8" x 10 3/8" x 7-3/16". Phase control for single trace adjustment. Uses three high frequency triodes plus 5Y3 rectifier — split stator tuning condensers for greater efficiency and accuracy at high frequencies — this Heathkit is complete and adequate for every alignment need and is supplied with every part — cabinet — calibrated panel — all coils and condensers wound, calibrated and adjusted. Tubes, transformer, test leads — every part with instruction manual for assembly and use. Actually three instruments in one — TV sweep generator — TV AM generator and TV marker indicator.

EXPORT DEPT.
13 East 40th St.
NEW YORK CITY (16)
CABLE: ARLAB-N.Y.

The **HEATH COMPANY**

... BENTON HARBOR 20, MICHIGAN

all in HEATHKITS...

Heathkit TUBE CHECKER KIT Features

1. Measures each element individually
2. Has gear driven roller chart
3. Has lever switching for speed
4. Complete range of filament voltages
5. Checks every tube element
6. Uses latest type lever switches
7. Uses beautiful shatterproof full view meter
8. Large size 11" x 14" x 4" complete
9. Checks new 9 pin piniaures

Check the features and you will realize that this Heathkit has all the features you want. Speed—simplicity—beauty—protection against obsolescence. The most modern type of tester—measures each element—beautiful Bad-Good scale, high quality meter—the best of parts—rugged oversize 110V. 60 cycle power transformer—finest of Mallory switches—Centralab controls—quality wood cabinet—complete set of sockets for all type tubes including blank spare for future types—fast action gear driven roller chart uses brass gears to quickly locate and set up any type tube. Simplified switching cuts necessary time to minimum and saves valuable service time. Short and open element check. No matter what arrangement of tube elements, the Heathkit flexible switching arrangement easily handles it. Order your Heathkit Tube Checker today. See for yourself that Heath again saves you $\frac{2}{3}$ and yet retains all the quality—this tube checker will pay for itself in a few weeks—better build it now.

Complete with detail instructions—all parts—cabinet—roller chart—ready to wire up and operate. Shipping Wt., 15 lbs.

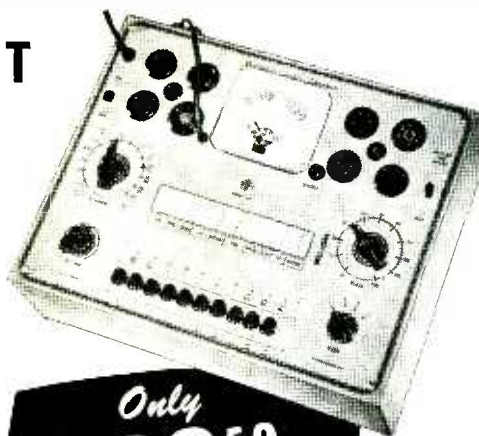

Only
\$29⁵⁰

Nothing
ELSE TO BUY

Heathkit SINE AND SQUARE WAVE AUDIO GENERATOR KIT



Nothing
ELSE TO
BUY

\$34⁵⁰

Experimenters and servicemen working with a square wave for the first time invariably wonder why it was not introduced before. The characteristics of an amplifier can be determined in seconds compared to several hours of tedious plotting using older methods. Stage by stage, amplifier testing is as easy as signal tracing. The low distortion (less than 1%) and linear output (\pm one db.) make this Heathkit equal or superior to factory built equipment selling for three or four times its price. The circuit is the popular RC tuning circuit using a four gang variable condenser. Three ranges 20-200, 200-2,000, 2,000-20,000 cycles are provided by selector switch. Either sine or square waves instantly available at slide switch. All components are of highest quality, cased 110V. 60 cycle power transformer. Mallory F.P. filter condensers, 5 tubes, calibrated 2 color panel, grey crackle aluminum cabinet. The detailed instructions make assembly an interesting and instructive few hours. Shipping Wt., 13 lbs.

New Heathkit BATTERY ELIMINATOR KIT

Nothing
ELSE
TO BUY

\$22⁵⁰

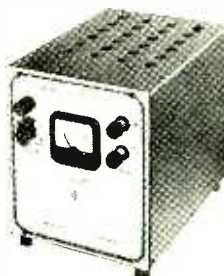

Now a bench 6 Volt power supply kit for all auto radio testing. Supplies 5 - 7 $\frac{1}{2}$ Volts at 10 Amperes continuous or 15 Amperes intermittent. A well filtered rugged power supply uses heavy duty selenium rectifier, choke input filter with 4,000 MFD of electrolytic filter. 0 - 15 Volt meter indicates output. Output variable in eight steps. Excellent for demonstrating auto radios. Ideal for servicing—can be lowered to find sticky vibrators or stepped up to equivalent of generator overload—easily constructed in less than two hours. Complete in every respect. Shipping Wt., 18 lbs.

NEW Heathkit SIGNAL TRACER AND UNIVERSAL TEST SPEAKER KIT

Nothing
ELSE
TO BUY

\$19⁵⁰

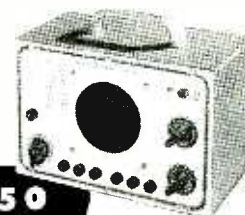

The popular Heathkit signal tracer has now been combined with a universal test speaker at no increase in price. The same high quality tracer follows signal from antenna to speaker—locates intermittents—defective parts quicker—saves valuable service time—gives greater income per service hour. Works equally well on broadcast—FM or TV receivers. The test speaker has assortment of switching ranges to match push pull or single output impedance. Also test microphones, pickups—PA systems—comes complete—cabinet—110V. 60 cycle power transformer—tubes, test probe, all parts and detailed instructions for assembly and use. Shipping Wt., 8 lbs.

EXPORT DEPT.
13 East 40th St.
NEW YORK CITY (16)
CABLE: ARLAB-N.Y.

The **HEATH COMPANY**

... BENTON HARBOR 20, MICHIGAN

Become an Electrical Engineer



Major in Electronics



B.S. Degree in 36 Months



Prepare Here for Specific Career-Objectives

Your success in the expanding, fascinating field of Electronics will be influenced materially by the type of educational program you choose.

Important advantages are gained at this Technical Institute and College of Electrical Engineering. For example, you achieve the Technician's occupational certificate upon completion of your first level of study toward a B.S. degree. The *comprehensive* nature of the courses gives you other special advantages in securing positions such as are listed below:

Major in Electronics
B. S. Degree

(36 successive months of study which include the 12-month Electronic Technician program)

Typical job objectives:

- Design Engineer
- Electronics Research Engineer
- Radio Engineer
- Sound Engineer
- Application Engineer
- Field Engineer
- Patent Attorney (with additional training in law)
- Salesman of Electronic Equipment
- Manufacturing Supervisor
- Communications Engineer
- Industrial Electronics Engineer
- Television Engineer

Electronic Technician

(12 months of objective study which also completes a third of the program leading to the B.S. degree)

Typical job objectives:

- Laboratory Technician
- Electrical Tester (radio mfg.)
- Maintenance and Repair Technician
- Contractor
- Manufacturing Supervisor
- Salesman of Electronic Equipment

Radio-Television Technician
(18 months of study)

Typical job objectives:

- Radio-Television Serviceman
- Audio, Transmitter or Communication Technician.
- Broadcast Operator (upon passing FCC examinations)

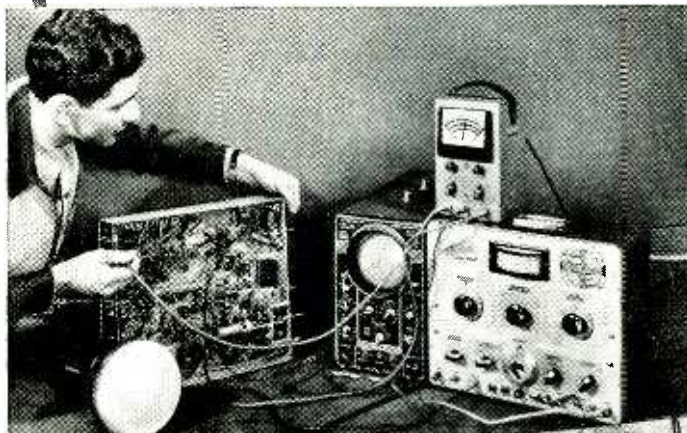

A VALUABLE FEATURE of this educational program is the manner in which LABORATORY experience is woven into each successive term to assure a thorough, practical background. You receive electrical practice and technical studies *immediately*. You train with modern equipment such as you will use after graduation.



"HUMAN ENGINEERING" is essential to the full success of tomorrow's technical man. Therefore, courses also include combinations of English, Economics, Engineering Law, Industrial Psychology, Speech and other Humanities.

THIS world-famous course in Electronics presents thorough technical training plus a solid education in the basic sciences, electrical engineering and allied fields. You have an opportunity to save a valuable year by using the option to study the year-round. Thus, you earn your B.S. degree in 36 months.

MILWAUKEE SCHOOL of ENGINEERING

Technical Institute • College of Electrical Engineering

- The 1,555 students enrolled in this 47-year-old school represent 48 states and 23 countries. Over 35,000 alumni. Terms open Oct., Jan., April, July.
- Military, practical or prior academic training will be evaluated for advanced credit. Preparatory and refresher courses are also available.



Write or send coupon today for the helpful 44-page pictorial bulletin, "Your Career," and the 110-page catalog.

MILWAUKEE SCHOOL OF ENGINEERING
Dept. RE-750
1020 N. Broadway, Milwaukee, Wis.

Without obligation send the 44-page "Your Career" bulletin and 110-page catalog.

(Check 6 to 36-month courses which interest you)

- Electrical Engineering: Electronics
 Electrical Power
 Radio-Television Heating Refrigeration
 Air Conditioning Electricity Welding

Name Age.....

Address

City Zone..... State.....

Check if World War II Veteran

They climbed the world's tallest tower so you could see farther

Installation of
NBC's television antennas has been a job
for daring steeplejacks!

No. 6 in a series outlining high
points in television history

Photos from the historical collection of RCA

● Dwarfed ant-small by their height above Manhattan's streets, skilled and daring workmen—in 1931—offered New Yorkers a sight as exciting as the highwire act at a circus . . . but much more significant.

Task of these men, as they clambered about atop the tower of the Empire State Building—1250 feet in the air—was to install an antenna for experimental telecasts from NBC's television station. "Why did it have to be so high?" was a question on thousands of watchers' lips.

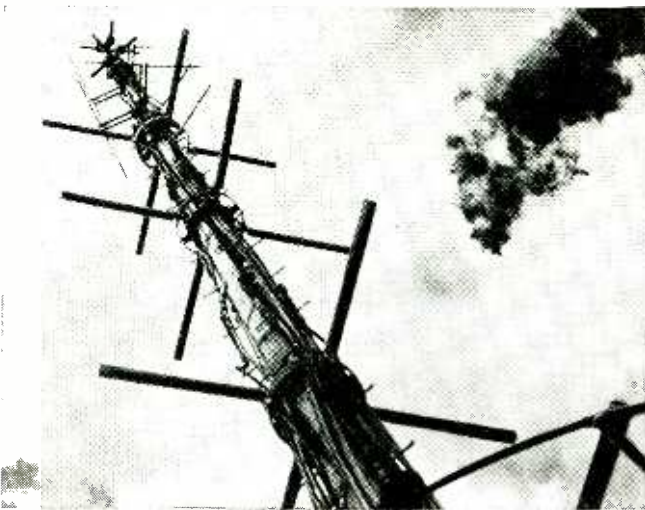

A familiar sight on the New York skyline, NBC's television antenna—installed in 1946—was the successor to those erected in 1931, 1936 and 1938, and used by RCA and NBC to perfect television.



Steeplejacks at work on an NBC television antenna—1250 feet above the sidewalks of New York. Its height gives telecasts a wider range in the New York and New Jersey area.

As might have been expected, with television an unfamiliar art, the average layman thought of it in relation to radio broadcasts, whose waves he knew could circle the globe. That telecasts were fundamentally limited by the line of the horizon was little known. To increase this limiting range, scientists, engineers, and technicians, sought the highest available vantage point.

With its antenna installed, this experimental television station was able to transmit pictures a distance of about 42 miles, and farther under highly favorable conditions. Receivers dotted around the New York area picked up the first telecasts, providing encouraging and instructive information to be studied by RCA's scientists.

Facts gathered in this period included new data on the behavior of very short waves, as well as how to handle them. New knowledge about interference was acquired, including the fact *that much of it was man-made* and therefore could be eliminated.

Other studies undertaken at the time included basic work on the "definition" most suitable for regular commercial telecasts. Definition as coarse as 60-lines was used in early days. Then came 341-line, and 441, until today's standard of 525-line definition was finally adopted.

That we may now, as a matter of course, see sharp, clear pictures on the screens of our home television receivers is in good part the result of experimental work initiated by RCA scientists, and carried out by NBC engineers since the erection of the first station in the Empire State Building. A share should also be credited to the steeplejacks who climbed to dizzy heights so that you could see farther!



Radio Corporation of America

WORLD LEADER IN RADIO—FIRST IN TELEVISION

RADIO-ELECTRONICS for

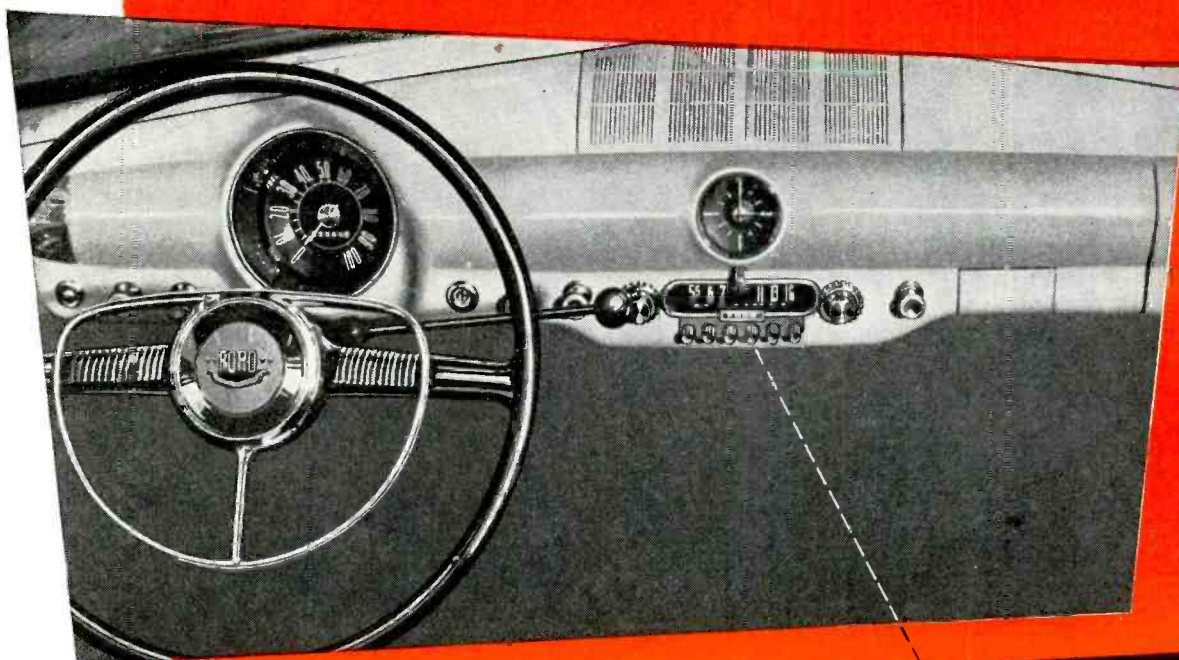

FORD for '50 HYTRON for '50



Thrifty, nifty fifty Ford. On the dash a fine new Ford radio receiver. And again tubes by Hytron. Hytron continues as a major supplier of Ford auto radio tubes. Because Hytron *specializes* in auto radio tubes. Engineered for leaders like Ford, these Hytron tubes are leaders too. 'Nuff said! Buying auto radio tubes? Buy wise . . . like Ford. Buy Hytron!



MAIN OFFICE: SALEM, MASSACHUSETTS

NEW 4TH EDITION — Hytron Reference Guide for Miniature Electron Tubes. Free from your Hytron jobber, or write us. Original . . . unique. Lists all miniatures to date, regardless of make. Six pages. 132 miniatures — 4" new, 70 basing diagrams. Lists similar larger prototypes. Get your copy today.



FREE — Hytron Tool Catalogue. Describes famous Hytron service-shop tools; Soldering Aid, Tube Lifter, 7-Pin and 9-Pin Straighteners, Tube Tapper and Auto Radio Tool. Find out how these Hytron tools can ease your work . . . help you make more money. Write today.

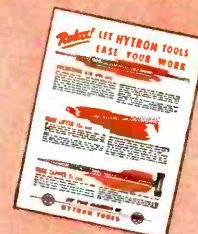

FREE

TELLS HOW—

WE GUARANTEE TO TRAIN AND COACH YOU AT HOME UNTIL YOU GET YOUR FCC LICENSE

if you have had any practical radio experience—amateur, Army, Navy, radio repair, or experimenting

TELLS HOW—

Amazingly Effective Job-Finding Service Helps CIRE Students Get Better Jobs. Here are just a few recent examples of Job-Finding results:

GETS JOB WITH CAA

"I have had a half dozen or so offers since I mailed some fifty of the two hundred employment applications your school forwarded me. I accepted a position with the Civil Aeronautics Administration as a Maintenance Technician. Thank you very much for the fine cooperation and help your organization has given me in finding a job in the radio field."

Dale E. Young, 122 Robbins St., Owosso, Mich.

GETS JOB IN PUBLIC UTILITIES

"I have secured the position of Radio Technician with the Toledo Edison Company. I want to thank you once more. The help you gave me was much more than would ordinarily be expected—both in obtaining my license and in finding employment."

Norman W. Stokes, Jr., Rt. 11, Box 612, Toledo 7, Ohio

GETS JOB AS DEVELOPMENT ENGINEER

"I wish to express my thanks for the Applications-For-Employment you recently prepared for me. I received 3 telephone calls and one letter. As a result I am now employed in a development engineering capacity."

K. E. Forsberg, 26 Soley St., Charlestown, Mass.

GETS JOB IN BROADCASTING

"I have accepted a position with KWAD. I secured this position through the help of your Job-Finding Service and I had at least six other offers. I am sincerely under obligation to you."

Fred W. Kincaid, Box 241, Wadena, Minn.

HERE'S PROOF FCC LICENSES ARE OFTEN SECURED IN A FEW HOURS OF STUDY With OUR Coaching AT HOME in Spare Time:

NAME AND ADDRESS	LICENSE	HRS. OF TRAINING
James A. Gram, 11 West Main St., Cuba, New York	1st class telephone	34
Ernest K. Hodson, Box 1001, Caldwell, Idaho	1st class telephone	71
Howard J. Kischassey, Rt. 2, Box 736, El Cajon, California	2nd class telephone	49
Ralph I. Nichols, 510 Elm St., Kerrville, Texas	2nd class telephone	34
Elbert L. Risinger, P. O. Box 122, Bedias, Texas	1st class telephone, 2nd class telegraph	34
Harry R. Rogers, R. R. 6, Lafayette, Ind.	2nd class telephone	50

CLEVELAND INSTITUTE OF RADIO ELECTRONICS
 Desk RE-19, 4900 Euclid Bldg., Cleveland 3, Ohio
 (address to Desk No. to avoid delay) Approved G. I. Training

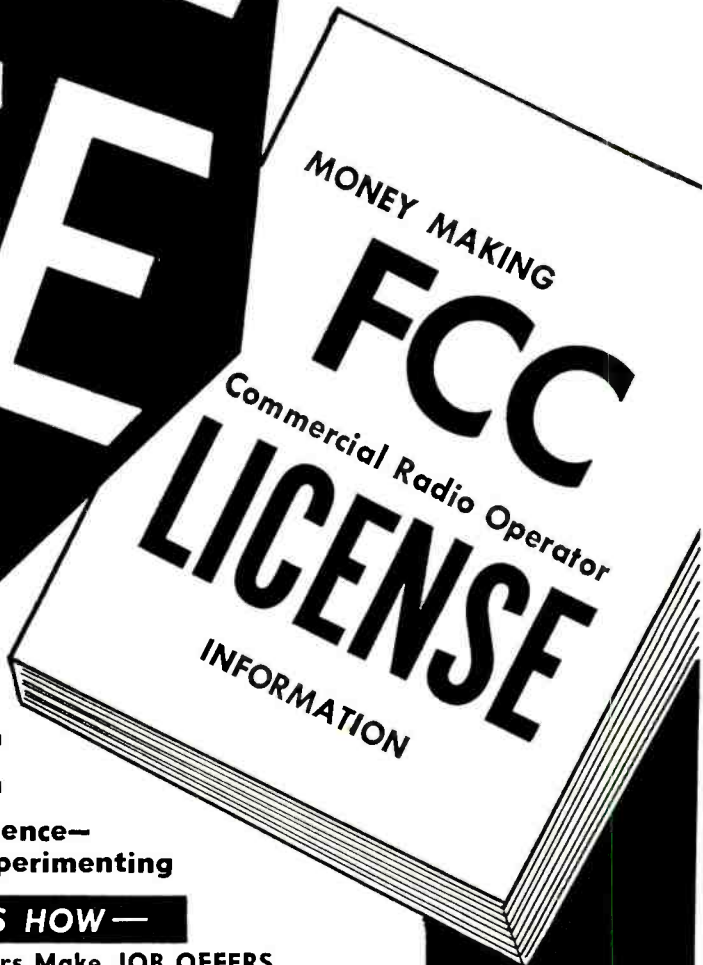

TELLS HOW—

Employers Make JOB OFFERS Like These to Our Graduates Every Month!

Telegram, Apr. 7, 1950 from Chief Engineer, Broadcast Station, Pennsylvania. "Immediate opening for engineer. Automobile and First Phone a must. If graduate available, please forward name and address."

Letter, Apr. 14, 1950 from Chief Engineer, Broadcast Station, Montana. "Immediate opening for Engineer-Announcer. Basic salary \$62.50 . . . real future for right man."

Letter, January 30, 1950 from Chief Engineer, Broadcast Station, Tennessee. "Have opening for operators. If you have men, please have them contact us."

These are just a few examples of the job offers that come to our office periodically. Some licensed radioman filled each of these jobs; it might have been you!

Ours is the only home study course which supplies FCC-type examinations with all lessons and final tests.

ACT NOW!
Get All 3 FREE



Your FCC Ticket is Always Recognized in All Radio Fields as Proof of Your Technical Ability.

MAIL COUPON NOW

CLEVELAND INSTITUTE OF RADIO ELECTRONICS
 Desk RE-19, 4900 Euclid Bldg., Cleveland 3, Ohio
 (address to Desk No. to avoid delay)
 Approved G.I. training

I want to know how I can get my FCC ticket in a few short weeks. Send me your FREE booklet, "How to Pass FCC License Examinations" (does not cover exams for Amateur License), as well as a sample FCC-type exam and the amazing new booklet, "Money-Making FCC License Information."

NAME

ADDRESS

CITY ZONE STATE

Veterans check for enrollment information under G. I. Bill.

MEDICAL ELECTRONICS

. . . An immense field beckons the researcher . . .

By Hugo Gernsback

There is perhaps no field today which requires electronic applications more urgently than medicine. The reason for this is that medicine is as yet not an exact science, but rather an art. The medical man still falls back upon most of his five senses when he makes a diagnosis. His trained eyes see many tell-tale signs, his touch interprets temperature, pulse beat, etc., his ear evaluates heart, chest and lung sounds, his nose can often recognize certain diseases, such as measles, scarlet fever and others that have characteristic odors. Old-time practitioners touched the back of their patient's hands with the tip of their tongue—the salinity, the acidity, etc., of the skin frequently was a good index of certain diseases.

Methods such as these seem crude and archaic in the electronic age. The human body is a most complex machine, with most of its machinery hidden and inaccessible. Its electric organs are delicate and deep-seated. Its chemical plants are distributed widely throughout the body and are often difficult to contact. The body's heating and cooling plants are still little understood. The blood circulatory system—while better explored—still holds many unsolved problems.

Thousands of medical books covering every part and function of the human body cannot begin to more than scratch the surface of the subject. This is particularly true of the vast field of diagnosis.

Electronically the human body can be compared to a sealed up radio or television receiver, with only a few exposed connections. The service technician parallels the physician who now is called upon to locate the hidden defect. But the physician today has no universal "analyzer" that can locate faults or troubles throughout the vast and complex domain of the "sealed-unit" human machine.

But there no longer remains any valid reason why electronic science should not give the medical practitioner a biological-electronic analyzer that could in time diagnose *any* disease, *any* dysfunction. The oscilloscope, the amplifier, the millivoltmeter and ammeter, the sensitive thermo-couple and dozens of other electronic instruments can all be combined into a portable *bio-analyzer*.

Even now, medical science uses thermionic amplification plus a graphic galvanometer for recording heart impulses, brain waves and uterine contractions. The photoelectric cell has already been made an indispensable part of bio-chemical technique; the colorimeter is calibrated to read grams of haemoglobin per hundred cubic centimeters of blood directly, or milligrams of nitrogen . . . or creatine or uric acid. Heart sounds are accurately analyzed on a tape; murmurs are measured to a hundredth of a second. It is only a question of time until these present uses and

others added are all integrated into one portable unit.

Once such an instrument has been evolved and perfected and the practicing physician has learned how to master its complexities, medicine will have a valuable tool to combat disease effectually. There will then no longer be any guesswork as to diagnosis.

The doctor then can make his blood tests, his blood count on the spot—without puncturing the patient's skin—and without the necessity of going to a technician who specializes in such work. He will take his cardiogram on the spot. He will know the *exact* status of an appendix and will know if it is to be excised or if it can be treated. Puzzling rises of temperature of a patient can be tracked down fast—hidden abscesses for instance can be located by local temperature variations. Usually the site of an internal abcess has a higher temperature index than other parts of the body. Hundreds of similar examples could be cited to prove that bio-electronic diagnosis is possible and that undoubtedly it will be commonplace in the not too distant future.

Much research will have to be done in the meanwhile to make it an accomplished fact. Electronic and medical research teams will have to pool their joint talents and knowledge in collaboration with instrument technicians to evolve a medically acceptable bio-analyzer. Finally doctors will have to be trained to use the instrument and to evaluate all its ramifications. Admittedly this will take time, effort and money but it *will* be done.

I am not unmindful of the fact that as early as 1916 the notorious Dr. Albert Abrams sold an electric gadget to medical doctors that was supposed to analyze any disease from a cold to a hidden cancer. He was exposed in due time because his gadget was a palpable fraud—made to sell to gullible medical men, who did not know that the gadget was not a scientific instrument. Similar fakes have been sold by other unscrupulous promoters—indeed this magazine exposed one of the most flagrant ones in the February 1944 issue.

If this proves anything, it indicates that there is a wide demand for a bio-analyzer—even if false starts were made in developing some worthless ones. Television, too made a great many false starts (albeit no fraudulent ones) during the past 30 years, before it became a resounding success.

Incidentally, the bio-analyzer will, in time be big business. There are today some 200,000 physicians in the United States. If only 60% of these physicians were to buy a bio-analyzer set at a projected price of \$1,500 each, this would then represent a total of \$180,000,000. This appears a very interesting figure for analyzer people to contemplate.



By JOSEPH RACKER

WITH customers more critical than ever because of increased competition and many demonstrations, the responsibility of the television installer has become greater than ever. The customer—or the technician who installs his own set—won't be satisfied until his picture quality is at least as good as that obtained on the best "neighbor" receiver.

In many cases this attitude is justified because of the improved design of virtually all receivers, and the development of new types of antennas and transmission lines, which overcome difficulties encountered in many previously adverse locations. In this article we will consider the selection of the best transmission line system.

Little importance has been attached to the type of transmission line used in most installations. The attitude has been to use 300-ohm flat ribbon line for receivers with 300-ohm inputs, and

70-ohm coaxial cable for 70-ohm sets. Alternative lines are rarely considered though—for 300-ohm units in particular—an appropriate choice of transmission line can greatly improve reception.

The term picture "quality" has little specific meaning in judging the performance of transmission lines. To overcome this difficulty we shall define "quality" in terms of signal-to-noise (S/N) ratio. A signal-to-noise ratio of at least three at the input to the receiver is necessary for a picture of passable quality. As the S/N ratio is increased, the picture quality improves until a point is reached where further improvement in this ratio cannot be seen on the screen. This point (usually about 6:1) varies for different sets and there is no reason to try to exceed it. We will refer to it as the optimum S/N.

Transmission line systems that provide the optimum signal-to-noise ratios should be used, if possible. Two characteristics of any line are of interest.

The first is its ability to deliver maximum signal to the receiver input, and the second its ability to pick up a minimum of noise. Noise in this article is defined as any type of interference, including "ghosts". These two characteristics are independent of each other, and will be considered separately.

A transmission line should transmit the signal picked up at the antenna to the receiver input as efficiently as possible. An ideal transmission line would do this with no loss of signal at all, but in practice it is impossible to design such a line. Losses in signal strength may be caused by the line for two reasons. One is the attenuation of the line and the other is possible mismatch between line and receiver input.

The attenuation of a transmission line is usually given in decibels of power. To review briefly, the decibel (db) is a way of expressing the ratio of two compared powers. This relationship is expressed by the equation:

$$\text{db} = 10 \log P_1/P_2,$$

where P_1 and P_2 are the powers compared. When voltage ratios are used, the db (in power) is equal to $20 \log (V_1/V_2)$, if both voltages are measured across the same impedance.

For example, if an antenna picks up a 10-microvolt signal and only 1 microvolt is delivered to the receiver, the loss in the transmission line in db is $20 \log 10$, or 20 db.

To simplify the calculation of decibels gained or lost, see the conversion table (Table 1). From this table the reader can convert db into power or voltage ratios or the ratios to db without logarithm tables or a slide rule.

Many technicians have an exaggerated view of the losses caused by mismatch between the characteristic impedance Z_0 of the cable and the input impedance Z_i of the receiver. It is true

TABLE 1

LOSS		DB	GAIN	
Power Ratio	Voltage Ratio		Power Ratio	Voltage Ratio
1.000	1.000	0	1.000	1.000
0.977	0.988	0.1	1.023	1.011
0.955	0.977	0.2	1.047	1.023
0.891	0.944	0.5	1.122	1.059
0.794	0.891	1.0	1.259	1.122
0.631	0.794	2.0	1.585	1.259
0.501	0.708	3.0	1.995	1.413
0.398	0.631	4.0	2.512	1.585
0.316	0.562	5.0	3.162	1.778
0.251	0.501	6.0	3.981	1.995
0.199	0.447	7.0	5.012	2.239
0.158	0.398	8.0	6.310	2.512
0.126	0.355	9.0	7.943	2.818
0.100	0.316	10.0	10.000	3.162
.010	0.100	20.0	100.00	10.00
.001	0.0316	30.0	1000.00	31.62

that no power will be lost because of mismatch when a 300-ohm line is used to feed a 300-ohm receiver. However, in evaluating the over-all efficiency of the cable, it is important to know what the loss is when a cable with a different characteristic impedance is used. The losses due to mismatch, shown graphically in Fig. 1, are a function of impedance ratio. It is conventional to express the impedance ratio with a number greater than 1: if Z_0 is larger than Z_L , the ratio of Z_0/Z_L is used; and if Z_L is larger, the ratio is Z_L/Z_0 . Fig. 1 shows an important fact: for impedance ratios less than 2:1 the power loss is less than 1 db.

Let us consider a typical problem. A 100-foot line must be used to connect an antenna to a receiver in an area where maximum possible signal strength must go to the 300-ohm input receiver. Table 2 lists the available cables and their characteristics.

Obviously the choice is between the two unshielded cables. The 300-ohm line will not introduce mismatch but will attenuate the signal 1.85 db at 200 mc. The 200-ohm cable, with an attenuation of 0.66 db (at 200 mc) and a mismatch loss of 0.2 db (from Fig. 1), has a total attenuation of only 0.86 db. Therefore, the 200-ohm cable is better.

This may come as a surprise to the reader. Practice proves that in low-signal-strength (and low-noise) areas, where the antenna must be high and needs a long lead-in, the 200-ohm cable is far superior.

Another fact to consider is the actual loss versus the calculated loss. Manufacturers figures for attenuation and characteristic impedance of unshielded lines assume that the cable is dry and completely isolated from ground. This is not true for many installations and both the attenuation and characteristic impedance of the cable may vary from the figures given. In the extreme cases of a wet line touching a metallic ground, the lead-in may short-circuit the signal.

Two measures are necessary to minimize this effect. Keep the cable away from metallic grounds such as radiators and water pipes, and keep horizontal runs of cable on roof top to a minimum. With the lead-in lying on the roof, the likelihood of water seeping into the cable is far greater than if the cable were vertical. Of course shielded lines with a waterproof jacket will maintain a constant characteristic impedance and attenuation regardless of cable position or weather conditions.

Noise introduced by lead-in

In many locations the problem is not lack of signal as much as it is too much noise. Noise introduced into the system by the antenna or receiver cannot be eliminated by choice of transmission line. But noise picked up by unshielded lines can be reduced. Tests in noisy areas have shown that a large percentage of the noise picked up by a receiver is traceable to unshielded line.

An unshielded cable acts as an an-

tenna for all signals in the atmosphere from very low frequency to v.h.f. and u.h.f. In contrast, the antenna is a highly selective circuit choosing only signals in the TV band. The harmonics of any one of the signals picked up by the unshielded line, or the sidebands of two such signals, could easily fall within the television frequency range and be introduced to the receiver as noise.

The unshielded lead-in also acts as an antenna for ghosts. A ghost is the result of a multiple path signal mixing with a direct path signal. A 100-foot unshielded lead-in is far more likely to pick up ghosts than the approximately 4-foot antenna. (The efficiency of a "balanced" transmission line as an antenna is often underestimated. Try a piece a few feet long, connected to the input posts of a television receiver.)

Ghosts also may be caused by impedance mismatch between cable and receiver, but this effect is not serious until mismatch is of the order of 3:1. A mismatch of this magnitude may occur if the weather conditions radically change the characteristic impedance of an unshielded line.

A shielded line can be used to minimize these effects. Recent development of shielded 300-ohm balanced lines makes good picture quality possible in noisy areas. A shielded line delivers to the receiver only the signal picked up by the antenna. If the antenna is shielded from the source of noise, high signal-to-noise ratio is possible even in industrial areas.

However, the attenuation of shielded lines is greater than that of unshielded lines and the reduction in noise obtained through their use should be large enough to overcome the increased signal attenuation. The technician should always remember that improvement in signal-to-noise ratio is the ultimate objective.

A short length of unshielded cable between the input and r-f stage within the receiver itself may be picking up noise. It is usually advisable to replace this cable with shielded line if a shielded line is required between antenna and receiver.

Installation procedure

To select the most economical transmission line system that will provide the optimum signal-to-noise ratio, some means of measuring signal strength must be available. In the absence of a

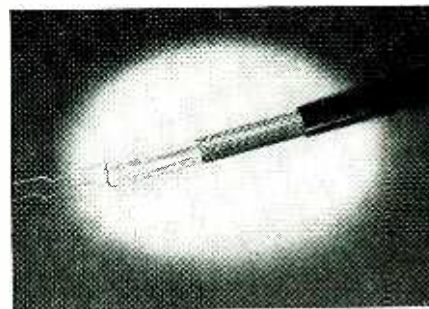

The new balanced 300-ohm shielded line.

better instrument, the author suggests one of the relatively inexpensive portable 3-inch television sets with the following modification: place a v.t. voltmeter across the output of the final i-f stage. With a signal generator, calibrate this meter to read directly in power or voltage input. To use this test

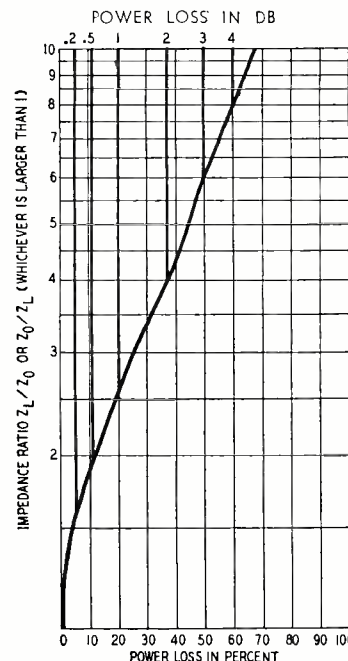

Fig. 1—Graph showing mismatch losses.

set to measure r-f signal strength, determine the minimum signal necessary for a good picture on the different models of receivers that you install. Mark these directly on the meter. You have now established reference levels for your installations..

At the customer's house the following procedure can be used to determine the best transmission line system:

TYPE	Characteristic Impedance (ohms)	Attenuation in DB/100 ft.		
		40 mc	100 mc	200 mc
Unshielded	300*	0.75*	1.27*	1.85*
Unshielded	200*	0.43*	0.55*	0.66*
Shielded	300	2.2	3.4	5.0
Shielded (Low Loss)	300	1.55	2.65	3.9

* Measured with cable isolated from ground.

Transitron as Sync Separator

By KERRISON JONES

USED under certain bias conditions, the transitron has proved to be capable of fulfilling all the major requirements for an economical and yet efficient sync separator—a prerequisite for good interlocking and effective interlacing.

In operation there are two distinct actions which occur in this "see-saw" transitron, the modified circuit of

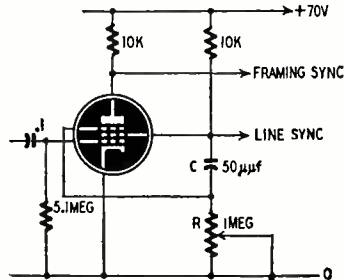

The transitron sync separator circuit.

which is shown in the diagram. The "see" occurs when the screen grid, drawing current, drives the suppressor grid sufficiently negative to cut off plate current completely. When this happens C gradually charges at a rate which is dependent upon the time constant of R and C, and the sup-

pressor potential rises until plate current, as well as screen current, is permitted to flow. The latter action represents the "saw" in the transitron circuit.

The above actions form the basis of the arrangement utilized in the separation of two pulses which have similar amplitudes and similar shape but whose durations differ, such as the sync signals of a television transmission. For that purpose, the tube is biased so that it conducts only during the period when sync signals are being transmitted. D.c. restoration occurs at the grid of the tube. On the arrival of a line pulse the tube conducts and the suppressor grid is immediately driven negative, thus effectively preventing plate current from rising. The time constant of R-C is such that the horizontal pulse has ceased before the capacitor is sufficiently charged to permit plate current to flow. Thus, while a steep-front pulse is produced at the screen grid and is utilized to trigger the horizontal time base, no signal appears at the anode, which is operating at maximum plate voltage throughout the whole operation.

The vertical pulse however, is much

longer in duration. Its arrival at the grid of the tube results in a similar action to that described above for the horizontal pulse, but there is a difference in that the time constant of R-C is shorter than the duration of the vertical pulse. As a result, the capacitor has sufficient time to charge fully and to permit the flow of plate as well as screen current. The result is a large, steep-front pulse at the screen of the tube and a similar pulse at the anode, the latter being used to trigger the vertical time base.

The requisite for correct operation is that the time constant of R-C should be such that it is longer than the horizontal pulse duration but shorter than that of the vertical sync pulse. This assures that the line pulse will not have time to trigger the vertical time base while the longer vertical pulse has ample time to charge the capacitor sufficiently.

Adjustment of the circuit is made relatively simple by observation of the vertical pulse at the plate of the tube. In practice, R should be slowly increased until practically all the horizontal pulse is eliminated in the circuit connected to the vertical time base.

◀ LEAD-INS FOR TV ANTENNAS (Continued from page 25)

Note the signal in the calibrated receiver for the worst station at the position where the set is to be installed. If signal strength at this point exceeds the minimum calibrated value, an indoor installation will be sufficient. Otherwise an outdoor installation is necessary.

Connect a long piece of unshielded lead-in to the calibrated receiver and tune the receiver to a channel that is



A 200-ohm twin-lead transmission line.

not broadcasting. Note the amount of noise in the receiver. To get a signal-to-noise ratio better than 6:1, the signal must be 16 db greater than the noise level. If this is greater than the reference level on the meter, use this higher value as the new reference level.

At this point it may become obvious that a shielded cable should be used. In this case note the noise in the receiver with shielded cable.

Check signal strength at a number of convenient locations (usually on roof) until a point is found where signal strength exceeds the minimum required. When determining the best location for the antenna be sure to consider the length of transmission line necessary from the antenna to receiver. For example, if a 2-db advantage is obtained at a location requiring 100 feet of additional lead-in—resulting in a 3-db loss in signal—nothing is gained by using this location, in fact there is a loss of 1 db.

Erect the antenna at the point selected and connect it to the calibrated receiver. Evaluate the excess signal in terms of db. For example, if the minimum signal required is 10 millivolts, and a signal strength of 50 millivolts is recorded, the excess signal is $20 \log 5$, or about 14 db. This means that the maximum tolerable loss in the transmission system is 14 db.

Starting with the most economical transmission line (300-ohm unshielded line), determine whether adequate signal can be obtained. The lowest cost

line that meets signal requirements should be used.

Another factor to be checked before making final installation are ghosts on the calibrated receiver at both antenna and receiver locations. If they are excessive, a shielded line may be necessary even though signal-to-noise ratio is otherwise sufficient. Determine also if there are any noise sources in the neighborhood that were not present during these tests but which might disturb reception during certain times of the day. These might be such things as diathermy machines, sparking motors, etc.



This 300-ohm line is most economical.



The 70-ohm coaxial transmission line.

RADIO-ELECTRONICS for

TV Deep Freeze Stumps the FCC

*Station allocation, color
and interference are some
of the worst difficulties*

By **MANFRED G. WENTZEL**

IN THE Fall of 1948 the Federal Communications Commission announced that it was suspending action on all pending applications for television stations. For over a year and a half television broadcasting has been beset by the "freeze" imposed by that order.

At that time there were 37 stations in operation, 86 more had been granted construction permits, and there were 303 applications pending. At the time of the freeze it was made clear that stations holding construction permits would be allowed to go ahead with their plans. Many of these stations have since gone on the air.

The freeze was imposed because it became alarmingly apparent by the middle of 1948 that the allocation of television channels was completely inadequate. There were then, as now, 12 channels in the very-high-frequency range with channels 2 to 6 covering the 54- to 88-mc band, and channels 7 to 13 the 174- to 216-mc band. In addition, a large band from 480 to 920 mc in the ultra-high-frequency range was reserved for experimental television.

Little was known about tropospheric effects on adjacent channel and co-channel interference, but it was obvious by that time that this interference was becoming a major factor in television transmission. The freeze was called to allow time for a study of the tropospheric effects.

The freeze was expected to last for about six months, but new issues have so beclouded the problem that now it is not likely that the final solution will be forthcoming until this fall or early next year. Some of the more important of these issues are a priority system for station allocation which emphasizes area rather than population coverage, a plan to use the ultra high frequencies for television broadcast, and possible revision of standards to include color television.

History of the freeze

Shortly before the war the FCC had adopted a set of television standards which provided for 18 commercial channels in the very high frequencies. By the time the war stopped construction, five stations had managed to get on the air. These kept television alive during the war.

Before the war ended, the FCC held a long series of hearings to determine where to fit television into the spectrum of frequencies. This was a great opportunity to reorganize the entire spectrum for all services and to expand into the new ultra-high-frequency range which had been opened as a result of war developments.

The television industry was split into two factions. One group was anxious to get a quick start in the very high frequencies immediately after the war. The other wanted television assigned to the ultra highs where there would be room for hundreds of television stations in a continuous band with no interference from each other or from other services.

The latter plan would have caused a delay of perhaps two years in getting television to the public because wartime restrictions were still in effect and there had yet been no field operations in these frequencies.

In the fall of 1944 the Commission established the Radio Technical Planning Board which was to give hearing to the various viewpoints on the subject. After one of the most comprehensive proceedings of its kind, the Board presented the Commission with a plan recommending 18 channels in the very high frequencies.

The commission took action on this recommendation, but could only jam 13 channels, each 6 mc wide, into the already crowded very high frequencies (Some of these were to be shared with other services.) One of these, channel 1, was later withdrawn from television. An allocation chart was drawn up

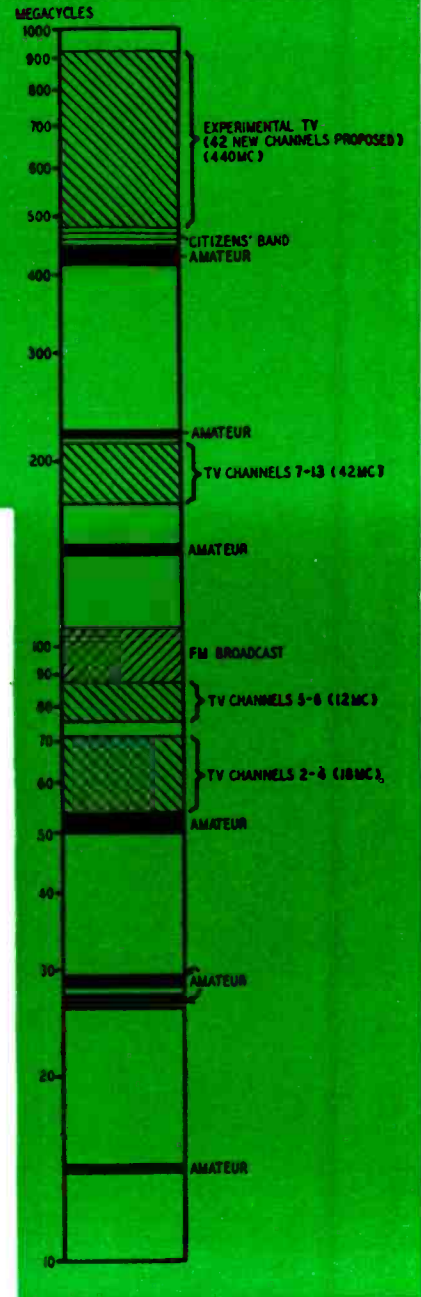

The present frequency allocations for TV, FM, amateur and citizens' band are shown in this chart. The rest of the spectrum is used up by other services.

which allowed for television channels in 140 metropolitan districts throughout the country.

This chart was adopted by the Commission in 1945, and the process of parceling out broadcasting licenses began. FCC engineers were instructed to allow a minimum separation of 200 miles between co-channel stations and 85 miles between adjacent-channel stations.

This plan allowed only four stations in the New York City area and therefore was opposed strongly by the broadcasters who wanted co-channel station separation reduced to as low as 60 miles. The Commission reduced its

safety factor to a 150-mile separation for co-channel stations and 75 miles for adjacent-channel stations. These station allocations were based on ground wave calculations.

It was known then that the effects of the troposphere might cause more interference than the ground wave calculations predicted, but no one knew how much. Not until a number of stations got on the air did the Commission realize that such interference could not be ignored.

In 1948 the Commission proposed a revision that would provide television outlets to many communities not originally covered, but the new service areas would be much smaller because of tropospheric interference.

In June of that year a hearing was begun, and that hearing is still in progress.

An engineering conference called to investigate the situation soon concluded that there was not much available information on tropospheric interference.

The Commission realized that it could not safely proceed with further allocations until a more detailed study could be made, and late in September it announced the freeze on station applications.

As soon as the freeze was put in effect, the Commission appointed a committee to study the tropospheric problem. This committee, with the cooperation of the Bureau of Standards, FCC engineers, and the industry, spent several months digging up information on the problem and making a report to the Commission.

In the meantime, two other issues were brought up that complicated the problem. The first was a new proposal to move television into the ultra highs. The other was a proposal that any new rules should include provisions for color television.

If moved into the ultra-high-frequency range, television could have a continuous band of channels, with the bandwidth of each increased to allow transmission of a better picture. The ultra highs would allow room for more and better television, both color and black-and-white.

On the other hand, this move would make obsolete practically all receiving equipment now in the hands of the public. Possibly converters could be made to adapt present sets to the new frequencies, but this would mean additional investment for the set owner. It has yet to be demonstrated that mass-produced television sets can be made to work on frequencies from 480 to 920 mc.

And color, too!

The color problem adds to the dilemma. The ideal which the FCC is looking for is a color system which can use the present 6-mc bandwidth and 525 scanning lines. It also must be fully compatible with black-and-white television. That is, a black-and-white set must be capable of receiving color

transmission (with a black-and-white picture, of course).

Three major proposals have been made so far. CBS has offered a system that will fit into the 6-mc bandwidth, but it requires a mechanical color wheel and it is not fully compatible.

RCA has a 6-mc color system, but until recently it required three kinescopes and an elaborate system of mirrors to bring the colors together. Now RCA has developed a new all-electronic single tube for color reception. The system is fully compatible.

Another compatible system is that demonstrated by CTI (Color Television Incorporated). This is also all-electronic with a line sequential color interlace.

Whatever decision the FCC makes, provisions must be made for color. Furthermore, there is no room for color except in the ultra high frequencies. If these ranges are opened for television, the Commission must take great care not to render millions of present sets obsolete.

The proposed allocation table is another problem that must be clarified. The present proposal gives first priority of allocation to provide at least one television service to all parts of the

United States, giving priority to square miles over people. The peculiar situation has come up that some villages of less than 1,000 persons would be authorized television stations, while some cities with populations as large as 10,000 would not.

If these decisions were purely technical they would not be so difficult because they could be made on the basis of technical research. The trouble is that the issues are just as much political as technical.

The FCC is in the unpleasant position of having to please several factions within the industry as well as fulfill its avowed purpose of providing the best possible standards for the public. At the same time the growing demands of television must not be allowed to crowd out the host of other services, both military and civilian, which are vital to the safety and welfare of the country.

All of these issues are tightly interwoven. Whatever the final ruling of the FCC will be cannot be predicted at this time. The only thing that is certain is that whatever decision is made will not please everyone. Perhaps the best decision will be the one which displeases everyone about equally.

Picture Tube Safety Precautions

TELEVISION picture tube manufacturers recommend the use of protective goggles and gloves when replacing such tubes in a receiver and when handling them for any other reason. Too many technicians neglect these precautions and run the risk of being severely cut by flying chips of glass should the tube break.

All cathode-ray tubes, from the smallest 3-inch tube in an oscilloscope to the largest direct-view tube in a TV receiver, have an extremely high vacuum. The air pressure around such a tube is enormous, and a 10-inch TV receiving tube has as much as $\frac{3}{4}$ ton of pressure on the tube face. When such a tube is dropped or hit sharply with another object, it can easily shatter, scattering glass in all directions at high velocity. Many tubes have been dropped without breaking, but breakage depends on the distance dropped, how hard the material is upon which it falls, and how the tube itself falls. Falling neck first invariably breaks a tube. The manner in which it breaks may not always result in excessive flying glass.

The very fact that results are unpredictable indicates the need for constant precaution. It is better to put up with the inconvenience of goggles and other handling precautions than to suffer severe cuts around face and arms when something does happen—particularly when the danger to eyesight is so great.

When installing a new tube of the 10-inch size or larger, it should be

handled by the flared sides, and not the neck. Care must be taken that the neck does not strike the bench or chassis, because this thinner section is more easily broken than the rest of the tube. Insert the tube neck into the yoke and focus coil assemblies with great care, using no force if it should stick.

After the tube has been properly set, the tube ring tension should be increased until the tube is held firmly on the chassis. Some sets use flexible cloth straps while others use metal rings with a soft material such as rubber between them and the tube rim. The photograph shows a typical tube mounting.

With any of these methods the tension should be increased only to the point at which the tube is held with satisfactory rigidity. If the draw bolts of a metal ring, for instance, are pulled up too tightly, it will exert an excessive pressure on the tube and increase breakage danger. Any glass tube will break more easily when under excessive pressure and this means that accidentally hitting the tube under such a condition may cause it to shatter when ordinarily it would have withstood the blow. The fact that the rings are often mounted with a soft material between them and the tube rim does not mean excessive pressure cannot be applied. The ring can be tightened until the flexibility of the material has reached its limit, and the pressure increases as the draw bolt is tightened further.—*Matthew Mandl*

A DeLuxe Televiser

Part VII—Trouble shooting and possible changes are discussed

By

CHARLES A. VACCARO

THIS is the concluding installment of a series which began in the January issue. In it we will discuss trouble-shooting and possible circuit modifications in this televiser.

Circuit voltages as measured with a 1,000 ohms-per-volt meter and with a v.t.v.m. are shown on the main schematic in Fig. 17. These voltages and the patterns in Fig. 23 are to facilitate trouble shooting and to allow the constructor to make a complete check on the operation of the various circuits. The patterns were recorded on a Dumont 241 scope. The captions show the settings of the vertical attenuator and vertical gain control. The attenuator ratios of 1 to 1, 10 to 1, and 100 to 1 correspond to low, medium, and high settings as recorded on the patterns. In some tests, a 10,000-ohm isolating resistor was inserted in series with the probe or hot test lead.

Do not attempt to measure the voltage on the plate of the 6BG6-G horizontal output tube or across the kickback power supply.

A safe way of measuring the high voltage output is to connect the voltmeter across the grounded 20-megohm resistor in the high-voltage bleeder. If the 15 bleeder resistors were purchased at one time, their tolerances are likely in the same direction and the output high voltage will be 15 times the measured voltage.

After the receiver has been in operation for some time it may become necessary to replace tubes in the i.f. amplifiers or front end. When one of the tuner or i.f. amplifier tubes is replaced, slight readjustment of the coil cores in the associated circuits may be necessary.

When the 6AG5 is replaced only the .25-3- μ f trimmer in its plate circuit requires adjustment. When the 7F8 is replaced, the trimmer in the mixer grid circuit and the one across the fine tuning control may require readjustment and the i.f. transformer in the mixer plate may require slight retuning. Switch to one of the high-frequency channels—preferably channel 13—and adjust the trimmers for proper alignment on that channel only. The other channels will automatically fall into proper alignment.

Circuit Variations

It is strongly recommended that no changes or variations be made in the

circuits until after the receiver has been built according to instructions and is operating properly. A few variations will be described for which provisions have been made.

1—The blank position on the selector switch provides a convenient means of making the r.f. amplifier and oscillator inoperative during i.f. alignment. This position can be used for other functions if desired. In a 7-inch model of this receiver coils were added to allow a portion of the 88-108 mc FM band to be heard. This provided a convenient check on the operation of the receiver in an area where it is not known that a TV station is on the air. It has been used to advantage in various parts of the country where the receiver has been set up and operated. When the blank position is used for FM stations, it is essential to make the oscillator inoperative by other means when the audio or video i.f. amplifiers are being aligned. This can be done by shorting the grid of the oscillator ground with a jumper.

2—The unused section of the station selector switch can be used to cut off B-plus voltages from sweep circuits etc. when the blank position of the same switch is used for FM. This section was included for possible uses which may arise in the future such as the addition of another r.f. stage, switching of antennas, switching of converter for u.h.f. television, etc.

3—Other 10 or 12-inch picture tubes can be used instead of the 10FP4. The circuits require no changes but the diameter of the tube mounting ring must be increased by approximately 2 inches for 12-inch types. The 10FP4 has an aluminized screen which reduces internal reflections and also eliminates the need for an ion trap. For other tube types requiring an ion trap, a permanent magnet or an electromagnet type can be used. Connect the red lead to the end of the 20-ohm resistor towards the horizontal centering control and the black lead to the end towards the focus control. The 20-ohm resistor is replaced by two parallel 100-ohm, 1-watt resistors. (See Fig. 17.)

4—Another change that can be made if there is certainty that the extra AM, FM, etc. functions are not going to be desired in the future, is that of omitting the selector switch and two jacks. This can be done by connecting the wires directly so the circuits are the same as they would be when the switch

is the TV position and by adding the on-off switch to the volume control or preferably to the tone control.

5—Another change that can be made is the omission of either of the horizontal sync control systems. However both systems have definite advantages and it has been found very convenient to have both incorporated. The a.s.c. system has the advantage of staying in sync better with rapid types of interference such as interfering r.f., spurious oscillations in the transmitted signal, diathermy interference, etc. However, its disadvantage is that it requires much more signal to pull it into synchronization than the other system. Furthermore; phase shift in the transmitted sync signals shows up as distortion on the sweep. This becomes visible as curved posts, doors, etc. Throwing the switch to the other system when this becomes annoying immediately restores the linearity.

The directly driven sync (d.s.c.) system, besides having the above advantage, is simple, has few components to cause trouble, and pulls the oscillator into sync with a small amount of signal. This is important if you are interested in pulling in some of those weak dx signals. This latter system has a slight disadvantage when receiving a signal with a severe ghost on it. In the N.Y.C. area a TV transmitter located about one half mile north of the Empire State building sends out a signal. At the same time some of the signal goes back, hits the Empire State and is reflected back to arrive at receivers north of the city a few microseconds later. Two sets of sync signals with nearly equal amplitudes arrive at the grid of the synchronized horizontal multivibrator and the tube has a tough time deciding which one to sync on. Although this situation was considered in the design of the horizontal sync circuits, the only complete remedy at the receiver is to switch to some other channel.

6—Placing the focus control on the rear panel or front panel is a matter of choice. Once set it does not require adjustment for quite some time. However for those who wish to have this control on the front panel, the potentiometer bracket is located so the potentiometer can be mounted with the shaft facing the front panel.

7—A spare socket has been included on the chassis to change from single

to push-pull audio output if desired. The added 6V6 can be driven by a portion of the output of the existing output amplifier or from a dual-triode phase inverter substituted for the 6SF5 audio amplifier. *Be prepared to redesign and make changes to the focus, horizontal centering and bias circuits in the negative side of the supply before starting this or any other change that will increase the current requirements from the power supply.*

8—A.g.c. was left out of the receiver because up until about a year ago, when it was decided to make no further changes to the receiver design, no suitable system had been devised. All the available systems affected either the quality of the receiver or its immunity

to noise bursts and static interference. Some were so complicated that the results were not worth the additional tubes and components. For those who wish to experiment with a.g.c., the bias for it can be taken from the negative side of the power supply. This leaves the half of the 6H6 that is now being used as a bias rectifier free to be used as an a.g.c. detector.

9—Although this receiver was designed for a console model it can be made as a table model if several factors are carefully considered. There is probably sufficient room around the picture tube and below the chassis for the power supply. With the weight distributed as the receiver is now designed it is safe to operate the receiver on its side

with the picture tube mounted. With the extra weight of the power supply on the chassis this would be dangerous. The additional weight on the chassis would also make it difficult to handle during construction, alignment and experimenting. Another disadvantage in having the power supply on the main chassis is that additional heat that would be generated. This one factor is so important to the stability of circuits and components that a large part of the design time of the receiver circuits was spent in minimizing heat from components underneath the chassis.

Probably the best solution to converting to a table model would be to build the power supply on a separate chassis that would fit in the space above the tubes and to the right of the picture tube over the main chassis. This would have to be mounted by brackets to either the main chassis or to the cabinet itself and should be easily removable to allow access to tubes and adjustments underneath. It should also be kept back far enough to allow for mounting of the speaker.

There are many advantages to having the separate and larger power supply chassis which the console model permits. One advantage which has not been previously mentioned is that the larger space permits larger and overrated components to be used thus mini-

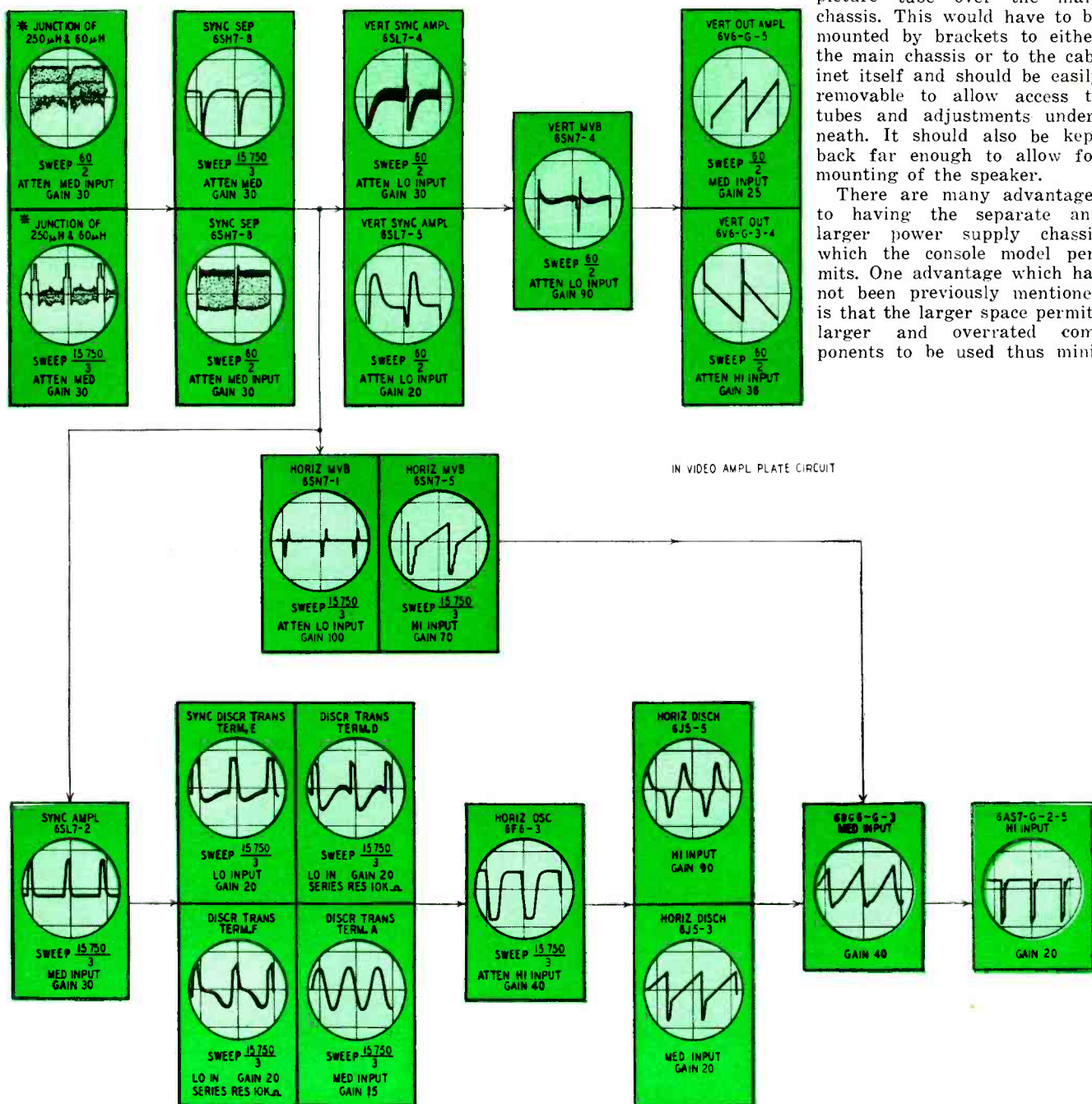

Fig. 23—The patterns above will help the constructor make a complete circuit check and will aid in trouble shooting.

mizing replacements. It also permits a combination of transformers to be used in place of one large one which may be harder to obtain.

The receiver may be mounted in a wall if precautions are observed to allow for adequate ventilation. Note that in all cases either felt or rubber feet should be fastened to the bottom of the perforated chassis bottom plate to allow air to enter the bottom of the chassis.

During more than two years of operation of the experimental model and a year of operation of the final model the replacement of only one item has been necessary. This was a surplus 6SN7 tube.

It is hoped that the builders and users of this receiver have as many enjoyable and trouble-free hours of entertainment.

Editor's Note

Several additional errors and omissions have been called to our attention by Mr. Vaccaro and by readers. These can be seen in Fig. 17 in the March issue.

The 10,000-ohm grid resistor in the second video stage is shown floating. This resistor should continue down to the .001- μ f bypass capacitor and to the junction of the 1,000-ohm resistors in the line between the grid returns of the first and third video i.f. stages.

The shaping resistor ahead of the horizontal discharge tube is shown as 680,000 ohms. Its correct value is 6,800 ohms. The charging resistor in the plate circuit of the 6SN7 horizontal multivibrator is shown as 160,000 ohms. It should be 150,000 ohms.

The 15- μ f capacitor in the B-plus side of the height control and the 30- μ f plate decoupling capacitor for the 6V6-G vertical output tube are shown with 300-volt ratings. These should be rated at 450 volts. The 50- μ f capacitor in the 225-volt lead from pin 4 of the power supply plug is shown to have a 600-volt rating. The rating need not be higher than 300 volts.

Pins 2 and 4 of the 6H6 video detector and bias rectifier are shown as being connected to heater lead X1. They are actually connected to heater lead X as shown in the heater hook-up diagram in the lower right-hand corner of Fig. 17.

The schematic shows a common heater ground lead for the tubes in the tuner and another for the heaters in the video i.f. amplifier. Actually, there are separate grounds for each heater in these circuits. Correct connections are shown in Figs. 1 and 7.

The vertical output tube is shown as a 6Y6-G in Figs. 17 and 20. This tube should be a 6V6-G.

Type numbers for the focus coil and horizontal output transformer are RCA 202D1 and RCA 211T1 respectively.

The sound detector is called a ratio detector in the text. It is a standard discriminator which was modified for a common cathode connection.

Antennas For Fringe Reception

YAGI-type beams used in TV-dx and fringe-area reception experiments conducted by the Commercial Engineering Dept. of Sylvania Electric Products, Inc. are described in *Sylvania News*.

The upper part of Fig. 1 shows the construction of a four-element beam for channel 4. The directors and reflectors were made from $\frac{3}{8}$ -inch aluminum tubing. The conductors of the folded dipole are made from 1-inch and $\frac{1}{4}$ -inch tubes spaced $1\frac{1}{4}$ inches center-to-center to step up the impedance to 300 ohms. The dipole conductors are cut 1 inch longer than is necessary and are shorted together $\frac{1}{2}$ inch from the ends. A $\frac{3}{4}$ -inch gap is left in the center of the smaller conductor to permit connection of the transmission line.

Two of these four-element units may be stacked 0.475 wavelength apart if the dipoles are made from $\frac{3}{4}$ - and $\frac{3}{8}$ -inch tubes spaced $1\frac{1}{4}$ inches center-to-center. The stacked sections are con-

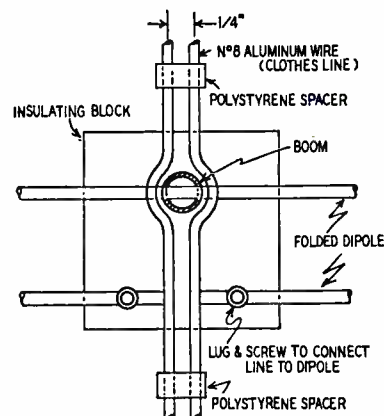

Fig. 3—Detail of the insulating block where the line is led around the boom.

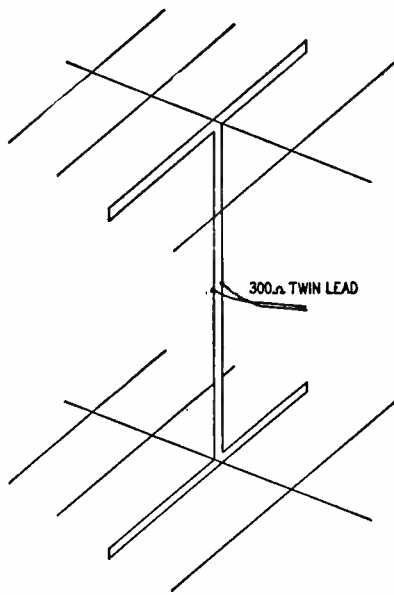

Fig. 1—Two 4-element Yagis stacked vertically form a highly directional and sensitive antenna. One 4-element beam is satisfactory in many areas.

nected by 300-ohm line, and a 300-ohm line is connected to the center of the phasing line as shown in the figure.

Fig. 2 shows the connections for the dipoles of a 16-element stacked array. Dimensions are for channel 13. The four-element sections are 0.475 wavelength apart. The elements are all made of No. 8 aluminum wire (clothesline) and the boom is $\frac{3}{8}$ -inch tubing. The dipole is cut in one piece, folded to place the conductors $\frac{3}{4}$ inch apart. Fig. 3 shows how the phasing line crosses over the two booms.

The length of the elements and spacing between them—in wavelength—is the same as for the channel-4 antenna in Fig. 1.

The antennas were designed for the low-frequency end of the channels; therefore, the maximum gain is centered on the video-carrier frequency. To convert frequency to wavelength in meters, divide 300 by the frequency in megacycles. Convert meters to inches by multiplying by 39.37.

All tubing in these arrays should be 3SH14 grade or harder.

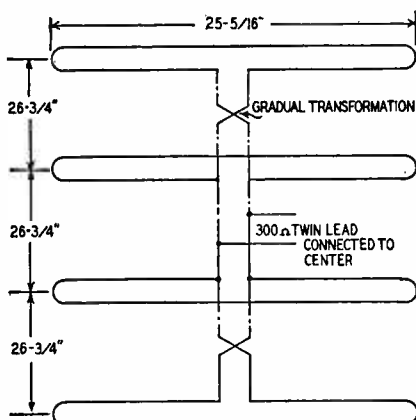
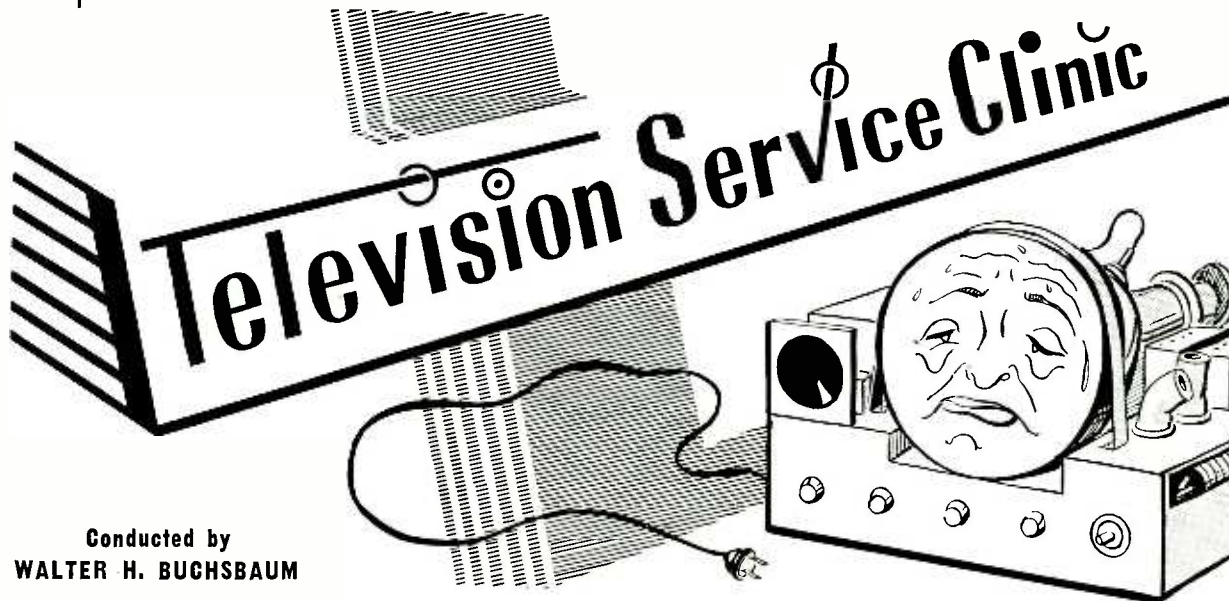

Fig. 2—Where maximum signal pickup is needed, 4 elements may be stacked.

COLOR-BLIND TECHNICIANS?

The advent of color television, when it comes, will pose new problems for service technicians, according to the *Dallas Radio and Television News*, published by the Dallas Radio Sales and Service Association, Inc. Not only must the test pattern be correct but the colors will have to be just right. If you ever went shopping for yarn for the little woman, you'll know what that means. And if Mrs. Doe calls up to say that Senator Blank has a green face, red arms, and blue feet, you won't be able to say it probably is something he ate.

And what's going to happen to the black-and-white television technician who suddenly finds out that he's color-blind?



Conducted by
WALTER H. BUCHSBAUM

Several letters concerned with television reception at distances of 100 miles and over have been received. To answer all questions on DX television would require more space than is available and we are therefore limited to a summary of measures which will improve reception from distant stations, in fringe areas or wherever weak signals are received.

Three different methods are practicable. The first and most obvious is to increase the pickup of the antenna. If this is impractical or not sufficient, the next step is to improve the gain of the r.f. stage. The third method is to increase the i.f. amplification.

Raising the antenna

Increasing the height of the antenna is often effective, especially in near-fringe areas, but the expense of constructing a suitable tower and the difficulty of finding a strong enough base for it limit the practical use of this step. When an antenna is raised, not only does it pick up more signal, but it also introduces more noise. In some areas, the distant signal may come down at an angle, and raising the antenna is not effective.

The larger the number of individual antennas, the greater will be the signal strength. Arranging dipoles or conical antennas in arrays doubles and quadruples the r.f. signal going to the receiver although it also increases vertical directivity, a disadvantage if the signal does not arrive horizontally. The limitations of this method again are mechanical. While 1-inch steel pipe might be strong enough for a single dipole with a reflector, it is not advisable to mount a four-section array on such a mast. The size, weight, and cost of the mast and antenna structure usually limits an array to about four sections.

If only a single station is to be received, it is possible to increase the signal pickup by using an antenna tuned exactly to the desired channel. The Yagi antenna is widely used for

this purpose. In addition to increased pickup of the desired station, this antenna is very directive and can be beamed accurately toward a station. For best results the Yagi should be cut to resonate in the center of the 6-mc television channel of the desired station.

$$\text{length (feet)} = \frac{234}{\text{frequency (mc)}}$$

Increasing r.f. gain

The most obvious method of increasing r.f. gain is to add another r.f. amplifier. If only a single station is received, it is not too difficult to design and build an additional stage right on the receiver. When it is desired to receive several channels, the extra r.f. stage must be tunable to all these stations. Since this complicates the design greatly, the majority of cases warrant the purchase of a finished preamplifier or booster. The manufacturer's instructions regarding matching the booster to the antenna and to the receiver should be followed carefully. Mismatch between the different impedances can nullify the amplification of the booster. Another method of increasing r.f. gain is to change the design of the r.f. amplifier slightly.

Increase B-plus voltage up to 200 volts if a 6AG5, 6AU6, 6CB6, or 6BC5 is used.

Remove r.f. amplifier grid bias lead from a.g.c. bias line and return it to

ground. For best noise characteristic the above-mentioned tubes should have about 0.8 volt of bias (if a 6CB6, -1.5 volts).

Substitute a 6AK5 for any of the above tubes. Do not increase the plate voltage beyond 180 volts for the 6AK5, but ground the grid return lead. This tube works wonders on channels 7 to 13.

Increasing i.f. gain

Several possibilities exist in the i.f. stages. In stagger-tuned i.f. amplifiers it is possible to align the individual stages to give less bandwidth but increased gain. To avoid regeneration subsequent coils should be tuned to different frequencies. For instance the first, third, and fifth coils can be tuned to 25.2 mc and the second and fourth coils to 22.7 mc. This will result in an over-all width of about 3 to 3.5 mc at the 70% points. To keep the over-all response curve even, it may be advisable to peak one of the odd-numbered coils to about 24 mc or shunt it with a resistor lower than any of the others. Some technicians peak i.f. stages to 23.5 and 25 mc, respectively, to get about 2-mc bandwidth as shown in Fig. 1.

Adding a small positive voltage in series with the a.g.c. bias increases the gain at low signal levels. The positive voltage, about 1.5 volts, overcomes the usual residual bias due to noise and some diode current. Increasing the B-plus voltage on the i.f. amplifiers also helps to increase the gain.

Substituting the new type 6CB6 miniature pentodes is another way of obtaining more i.f. amplification. The transconductance of this tube is about 15% greater than a 6AG5 and this increase is multiplied by the number of i.f. stages. When these tubes are substituted for the 6AU6's or 6AG5's already in the set, the entire i.f. section should be re-aligned, since the new tubes have different interelectrode capacitance. In an actual experiment it was found that substituting a 6CB6 for a 6AG5 in a four-stage i.f. section increased the

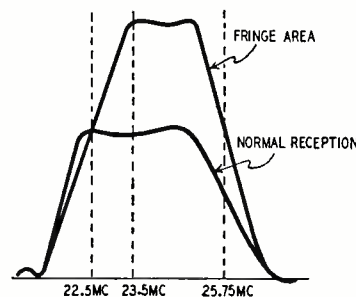

Fig. 1—Stagger-tuned i.f.'s can be re-aligned for less width but higher gain.

over-all sensitivity of the receiver by a factor of two. Pins 2 and 7 on 6AG5 sockets must be tied together for the 6CB6.

Arcing and corona

Several readers have inquired about locating the source of arcing or corona in the high-voltage compartment.

In many cases the arc can be seen clearly or, when the compartment is darkened, the bluish glow of a corona discharge is visible. The cure for this is simply to smooth out all sharp points in the wiring and clean the insulating surfaces. The application of a little polystyrene coil dope often works wonders.

Very often the discharge is so fine that it cannot be seen and the sharp point or leaky insulation is hard to find. A good way to locate such a defect is to use a rod of good insulating material such as polystyrene, lucite, or Plexiglas about a foot long. By touching the tip of this rod to different solder joints, wires, tube pins, etc., it will be possible to find one where the rod will stop the discharge.

Insufficient width

Insufficient width with poor linearity or foldover on the right appear on the Hallicrafters T54. In addition horizontal synchronization is unstable with occasional vertical instability.—J. K., Chicago, Ill.

The defect is either in the horizontal oscillator or the sync pulse separator preceding it. The circuit is shown in Fig. 2.

Interchange the 12SN7 tubes used as V12, V17, and V19. If this does not clear up the trouble, check the choke in the grid circuit causes a loss of horizontal sync pulse and unbalance in the multivibrator circuit. Check the grid and cathode circuits of both sections of V12 with an ohmmeter.

If an oscilloscope is available, connect the scope to the grids of V19, pins 1 and 4. The waveform should be a linear sawtooth of constant amplitude. If it is not linear, the defect is in the output half of V17; if the amplitudes are not equal, the defect lies in either half of V19. Sync pulses should be observed clearly at pin 5 of V12 if the tube is operating properly.

Picture shift

In the Motorola 7VT2 the picture shifted about 1½ inches to the left and cannot be brought back with the horizontal centering control.—E.S.F., Nellsville, N. Y.

The manufacturer's data gives the following possible remedies for this defect:

Carefully readjust the horizontal hold and size controls. Reduce the contrast and increase the brightness until the retrace lines are visible. If the hold and size are adjusted properly, a blanked-out space should be visible both on the left and right edges of the

picture. Now adjust the centering control again. If it still does not function properly, the defect lies in the centering circuit alone.

Turn the set off and open the back

11. Loosen the picture tube mounting strap and rotate the tube 180 degrees. Plug the picture tube in, turn on the set, and rotate the picture tube until the raster edges are parallel with the

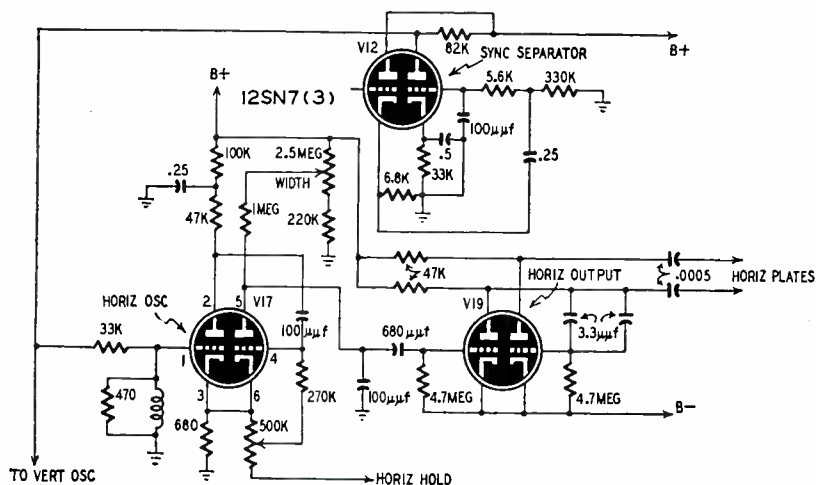

Fig. 2—The sync separator and horizontal oscillator of the Hallicrafters T54.

of the cabinet. Remove the kinescope socket. Interchange the connections between pins 7 and 8 and between 10 and

cutout in the cabinet. Adjust the centering control again. The picture now will center as it should.

All-Electronic Color TV By CBS

AN all-electronic color television receiver was demonstrated by CBS to the FCC recently. The receiver, a projection type with a picture size equivalent to that of a 22-inch tube, was demonstrated to show that all-electronic receivers can be used with the CBS system. However, CBS does not yet consider the receiver suitable for commercial use.

The receiver has a single tube with

a single gun. Three images are produced on the face of the tube and these are combined optically.

CBS also demonstrated a new compact color television camera chain for industrial and surgical uses. The chain has two units, a camera and a control unit. The camera occupies less than ½ cubic foot as compared with about 3 cubic feet of a standard black-and-white camera and weighs 29 pounds.



Photo courtesy CBS

Dr. Peter C. Goldmark (right), research director of CBS, and James J. Reeves, a CBS engineer, inspecting the new 29-pound compact color television camera.

Prize Contest Winners

Uses for radio-electronics in the home

RESULTS of the first month's RADIO-ELECTRONICS IN THE HOME contest have not been particularly gratifying. We are not sure whether readers did not fully grasp the idea of the contest or whether they have not been able to think of any good electronic devices to use in the home.

To repeat: the purpose of the contest is to turn up ways in which electronics may be used to lighten the burden for the tired housewife or the equally tired husband home from a hard day's work—any electronic means whatever to make home work lighter and home life happier.

Despite the relatively weak entries, we have decided to allot the three main prizes and publish the ideas to give other readers something to improve on in future contests. No entry could be found worthy of the fourth prize.

First prize was awarded to a simple intercom built from an old radio.

Second prize goes to an automatic rain indicator. This entry was excellently and carefully worked up and would have received first prize were it not that it does not depend entirely on electronics. The same thing can be done electrically.

Third award is an automatic radio silencer which cuts the volume of the radio receiver when the telephone receiver is lifted.

Perhaps some would-be contestants have been a little timid about entering their ideas for fear of competition. Such timidity is unfounded. Send in your entries! And remember that any ideas used as the subject of a full-size article will be paid for as articles as well as winning the cash prize.

First Prize, \$50, Charles J. Spaid, Lewisburg, Pa. A Two-Way radio intercom.

The Winners	
Two-way Radio Intercom	
Charles J. Spaid.....	\$50
Rain Indicator	
Otto van Guericke.....	\$25
Radio Silencer	
John W. Cook.....	\$15

With only a standard output or intercom input transformer, a d.p.d.t. switch, and a small PM speaker, any radio set can be converted into a two-way intercom, as Fig. 1 shows. While the intercom is not a new device, it has not often been used to advantage around the house where it can be a great step saver for the busy housewife.



Fig. 2—The complete rain indicator. Sensitivity depends on the funnel size.

The a.f. amplifier shown in the schematic is typical of those used in small receivers. In most cases it is necessary to ground the secondary of the output transformer and the speaker voice coil of the master station with two separate leads. This is important, because a common ground lead will usually cause oscillation.

Another d.p.d.t. switch on the remote station makes possible control from either station, and more stations can be added if each is equipped with a d.p.d.t. switch.

If it is desired to use the radio as well as intercom, the s.p.d.t. switch is installed. With it hooked up, the distant speaker cannot call when the s.p.d.t. is in radio position. Should this be a disadvantage, the input transformer secondary should be connected

permanently to the hot end of the volume control.

Second Prize, \$25, Otto von Guericke, Göttingen, Germany. Rain Indicator.

This unique device sounds an alarm when a small container is filled with water. Further, after throwing a

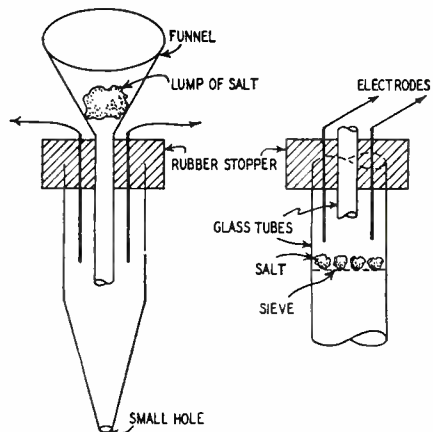

Fig. 3—"Water switch" for the rain indicator (a) and the level indicator (b).

switch, it gives a warning when the water level has dropped below a certain point. It can be used to signal when the bathtub is full or to let the housewife know when it is raining outside so she can get her laundry off the line before it gets soaked. Fig. 2 is a photo of the complete unit.

The heart of the device is a "water switch" which consists of two electrodes separated from each other in a glass tube as shown in Figs. 3a and 3b. When water fills the switch, the salt dissolves and current flows between the electrodes.

The tube in Fig. 3-a is for rain indication. The size of the funnel of course determines the sensitivity, and the small hole at the bottom allows the water to flow off and open the switch when the rain has stopped. The tube in Fig. 3-b is for water level indication. The resistance of the water switch is about 100 ohms when filled with water, and about 30,000 ohms after the water has trickled out but the electrodes and walls of the tube are still wet.

The electronic circuit, Fig. 4, consists of a 6SN7, one half used as a voltage amplifier and the other as a power amplifier, and a neon tube relaxation oscillator which supplies an audio signal of about 1,000 cycles.

With the d.p.d.t. switch in the position shown, the amplifier is cut off by 15 volts positive on the cathode. When the water switch conducts, the grid is shorted to cathode potential and the amplifier tube conducts. If the d.p.d.t.

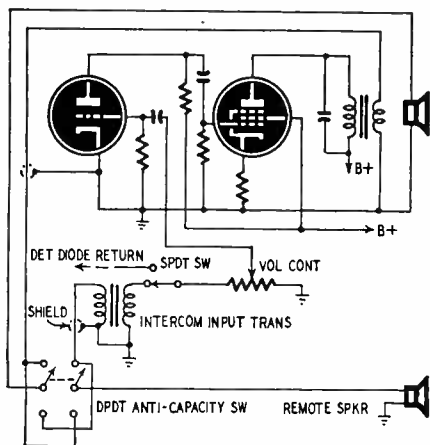

Fig. 1—A speaker, a d.p.d.t. switch, and a transformer can be used to convert almost any radio to a two-way intercom.

switch is thrown to the other position, the amplifier tube is cut off when the water switch is shorted and conducts when the switch is open. With this arrangement, the warning can be made to sound either when the water switch opens or when it closes.

Third prize, \$15, John W. Cook, Waynesboro, Va. Radio silencer.

If the radio or phonograph is on when the phone rings, it is often necessary to detour to the telephone to turn down the radio's volume before answering. The radio silencer automatically does this whenever the telephone receiver is lifted from its cradle.

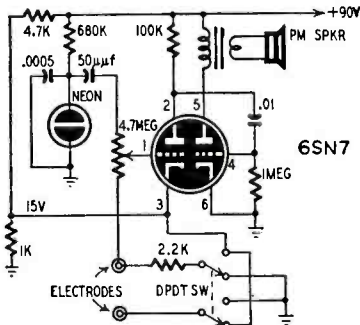

Fig. 4—The circuit of the water alarm.

A small s.p.s.t. microswitch is installed on the phone base directly below the center of the handset of the telephone (see Fig. 5). The switch must be of the normally closed type. When the receiver is in its cradle, its weight

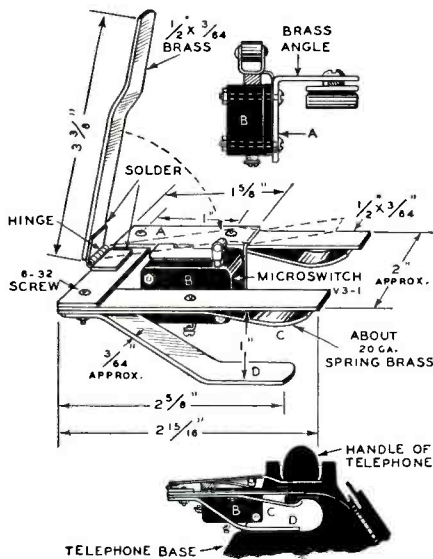

Fig. 5—The radio silencing switch is mounted under the telephone receiver.

keeps the switch open. Raising the receiver closes the switch to short out the voice coil of the speaker on the radio as shown in Fig. 6.

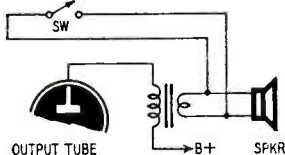

Fig. 6—When the receiver is lifted off the cradle, the speaker is shorted out.

Continuing

**\$1,200.00 PRIZE CONTEST
RADIO-ELECTRONICS IN THE HOME**

DESPITE the amazing and extraordinary progress made in radio-electronics during the past two decades, one phase seems to have been neglected completely. We refer to radio-electronic applications **IN THE HOME.**

Practically all present-day inventions and patents concern themselves with industrial applications. Even such obvious applications as automatic electronic door openers are used chiefly in railroad terminals, restaurants, and other public places.

The home is the place where radio-electronic devices are really needed today. There are potentially thousands of ingenious ideas that can be used in the modern home, not only to lighten our work, but to make life safer, to give us more leisure, to safeguard our health, and to give us conveniences which are often urgently needed.

These applications need not necessarily be new inventions. It is simply a matter of applying ourselves to adapt the innumerable radio-electronic devices and instruments available. Most of our readers can solve these various problems at not too great a cost in their spare time.

There are literally hundreds of potential applications of radio-electronics that will fulfill serious needs in every American home.

We are sure that readers of **RADIO-ELECTRONICS** have many worth-while ideas for applying radio-electronics in the home.

We therefore invite you to contribute to this monthly Prize Contest, which will run for a total time of one year.

Monthly prizes totaling \$100 will be given for the best ideas submitted during the month. These are cash prizes as follows:

FIRST PRIZE	\$50
SECOND PRIZE	\$25
THIRD PRIZE	\$15
FOURTH PRIZE	\$10

Please Note the Following Rules

1. This is a monthly cash Prize Contest for the best idea submitted during the month for a practical new radio-electronic application in the home.

2. The highest prizes will go to those contestants who have *actually built* the devices they describe and who submit photographs to prove it. Lesser prizes may be given for "ideas" not reduced to practice and for entries unaccompanied by photographs.

Entries of constructed devices must be accompanied by photographs, full description, and complete circuit diagrams.

3. Ideas for new devices which have not actually been built must be stated in complete detail and accompanied by complete diagrams, drawings, and all other possible descriptive material.

4. All the descriptions and photographs of the prize-winning devices or ideas will become the property of **RADIO-ELECTRONICS**, which will publish a descriptive article on each device or application. The prize winners will be paid regular rates for their articles, in addition to the prize money. Entries not winning prizes will be returned.

5. If two or more entries submitted during the same month are judged to be of equal worth, identical prize awards will be made for both entries. Devices which have been awarded prizes in previous contests will not be considered unless they show marked improvement on earlier entries.

6. All entries will be judged by the Board of Editors of **RADIO-ELECTRONICS**. Prizes will be awarded in accordance with novelty, general importance of the application or device, smallness of cost involved in building it, and practicability. The decisions of the Board of Editors of **RADIO-ELECTRONICS** will be final.

7. Excluded from this contest are **RADIO-ELECTRONICS** employees and their relatives.

8. The fourth monthly contest closes July 31 at midnight, Eastern Standard Time. All entries post-marked not later than July 31 will be judged in the fourth month's contest.

9. Announcement of the second monthly prize award will be made in the August issue of **RADIO-ELECTRONICS**. The second month's prizes will be paid on the publication date of the August issue of **RADIO-ELECTRONICS**.



An extended range covering 20 cycles to 700 kc with a clean waveform makes the oscillator at left a valuable instrument

Extended-Range Test Oscillator

By

HAROLD PALLATZ

RADIO shop and laboratory measurements are simplified if a wide-range oscillator is available. The unit shown in Fig. 1 will not only provide the technician with a valuable audio oscillator, but will also supply any intermediate frequency as well. It has a range from 20 cycles to 700 kc covered in five bands. Band 1 covers 20-200 cycles; band 2, 200-2,000 cycles; band 3, 2-20 kc; band 4, 20-200 kc; and band 5, 150-700 kc. The total harmonic distortion of this oscillator is less than 0.5% on all audio frequencies. This clean waveshape permits quicker and more dependable measurements on amplifiers or test equipment. The purity of waveform is obtained by using a variable capacitor for changing fre-

quency. A good capacitor will track closer over longer periods of time than a dual potentiometer of the same cost.

This circuit is a modification of the famous Hewlett-Packard audio oscillator. The design uses the resistance-capacitance principle and eliminates the need for tuned coils (See Fig. 1).

A video amplifier incorporated in the unit has a response to 2.5 mc and is very useful for increasing the strength of weak signals. It can serve as an oscilloscope preamplifier, a signal tracing aid, and a v.t.v.m. adapter or bridge null amplifier. A series circuit consisting of a meter (1 ma), a crystal rectifier, and 2- μ f capacitor connected to the output jack makes it a sensitive a.c. voltmeter (see Fig. 2).

Two impedance and voltage levels are available separately or simulta-

neously, from the oscillator. The low-impedance output jack is used with circuits up to 100 ohms. Higher circuit impedances are more closely matched with the high-impedance output. At the high-impedance jack 10 volts output is obtained and $\frac{1}{2}$ -volt output at low impedance. Output on band 5 is in the order of 2 volts at high impedance.

Flat output of the oscillator is maintained with a 3-watt bulb and two balancing capacitors. The first four ranges are kept at a constant level and the fifth band, while at a lower level, also has a constant output.

For adequate shielding at all frequencies, coaxial cable and associated hardware are used. A number of convenient binding post adapters were made for the lower frequency measurements. Hum pickup was reduced by installing a soft-iron partition to isolate the power supply from the oscillator circuits. Two partitions are used: one above, the other below the chassis.

Components and construction

A 4-gang 500- μ f variable capacitor is used for tuning. This item requires a little diligent searching for, but is obtainable. The minimum capacitance should be around 15 μ f. A 465- μ f unit will serve as a substitute, but the range will be reduced slightly.

The low-impedance output transformer is of the "Ouncer" variety. This is rated for the audio frequencies, but it does give a flat output on the high bands in this circuit, although the output is somewhat lower on band 5. The 3-watt bulb (115 v) supplies the required current-vs-resistance characteristics to keep the oscillator output constant. The power transformer is a standard type with 100-ma current rating.

A plate choke for the video amplifier may be wound on $\frac{3}{8}$ -inch-diameter Bakelite rod, or it may be purchased

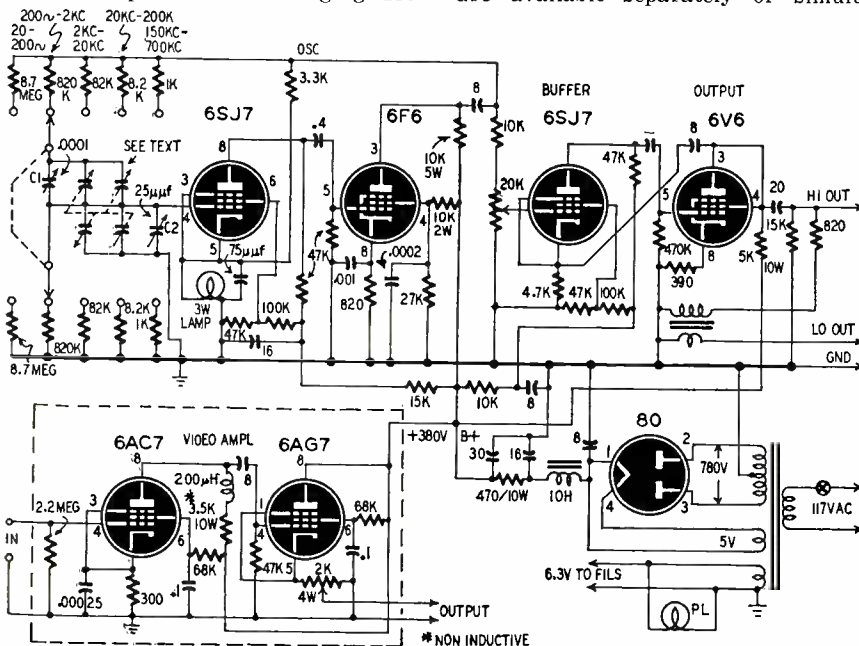

Fig. 1—Tuned coils and transformers are eliminated in the oscillator circuit.

ready made. The rod should be cut to a length of 1½ inches, and wound with 100 turns of No. 30 enameled copper.

The front panel may be either aluminum or steel. The partition for power supply isolation is galvanized iron covered with wrinkle paint.

The body of the variable capacitor is insulated from ground by rubber washers. Fiber washers also can be used. Hum pickup by the floating variable capacitor is eliminated by mounting it next to the power supply partition.

Calibration and operation

The coaxial jacks on the left are for the video amplifier input and output, and the high- and low-impedance oscillator output jacks are on the right. Separate controls vary the output level of the oscillator and the video amplifier.

Before calibration, the unit should be checked for proper output on all bands. C1 and C2 should then be balanced until turning the variable capacitor (while on band 2) gives no change in output level. This will be the approximate calibration of the audio oscillator. Final calibration should be made only after the unit is aged by leaving the set on for at least 12 (preferably 24) hours at normal line voltage.

The set should be calibrated while it is still warm. Two scale calibrations are necessary: one for bands 1 to 4, and a separate one for band 5. If it is impossible to get tracking on any of the first 4 bands, vary the values of the pair of frequency-determining resistors of that band. Tracking at the lower frequencies within 5% or better is sufficient.

In selecting the frequency-determining resistors, it must be remembered that the harmonic content of the signal (percent of distortion) depends on how well the resistors are matched. Precision-built film-type resistors are best.

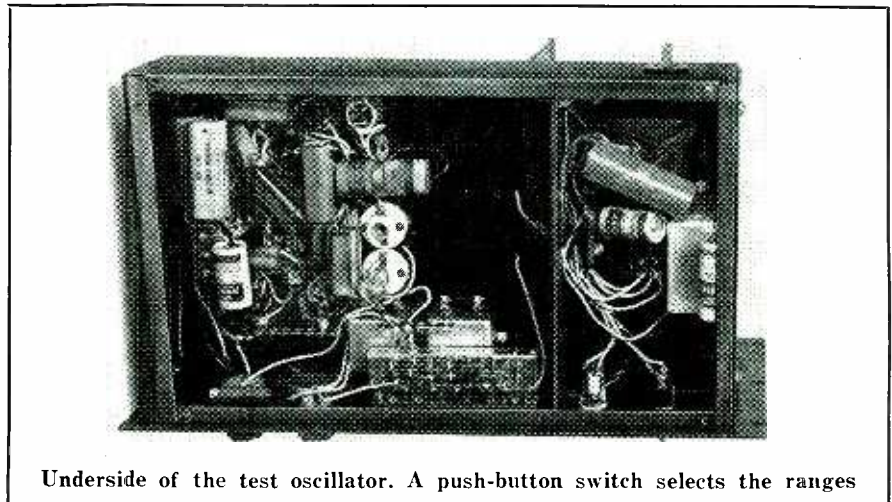

Underside of the test oscillator. A push-button switch selects the ranges

Do not use inductively wound units.

The oscillator scale is best calibrated with the help of an oscilloscope. A good method for doing this is described in RADIO-ELECTRONICS for October, 1948.

Band 5 is calibrated in the same way as an r.f. signal generator. This unit was checked with heterodyne frequency meter on band 5. Calibration with a broadcast receiver tuned to the harmonics of band 5 will do in the absence of a good frequency standard.

The low-impedance output is obtained through an output transformer. This transformer tends to introduce waveform distortion if used below its rated range. Therefore, when very low distortion is required of a low-frequency signal, use the high-impedance jack. The 820-ohm resistor in the high-impedance output broadens the response.

Frequency response of the video amplifier may be checked up to 700 kc by applying the output of the oscillator to the video input. Wide-response a.c.

voltmeters should be connected to the input and output of the amplifier. A s.p.d.t. switch may be used to permit measurements with one meter. Response should remain flat throughout this range. Higher frequency response may be checked with any reliable metered r.f. signal generator.

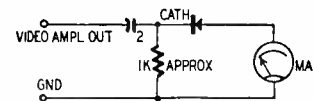
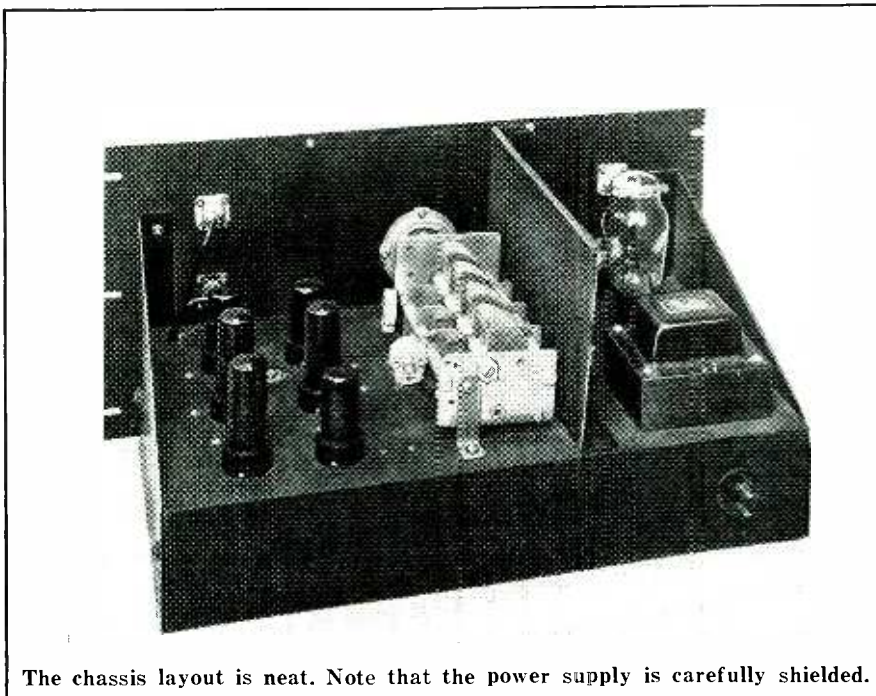

Fig. 2—Adaption circuit for v.t.v.m.

Practical applications

The response of any amplifier may be checked by the method previously described (video amplifier response test). Measurements on audio amplifiers should be made with the speaker or its equivalent load across the output. The volume, gain, and tone controls will affect results; therefore take several readings. The response of typical audio amplifiers will fall between 10 and 50 cycles for the lower limit and 5 to 20 kc for the upper limits.

Phase shift of amplifiers is easily checked by using this oscillator with a good oscilloscope. The method consists of feeding the oscillator to both the input of the amplifier under test and to the vertical scope amplifier. The output of the amplifier is then fed to the horizontal scope amplifiers. Any phase



The chassis layout is neat. Note that the power supply is carefully shielded.

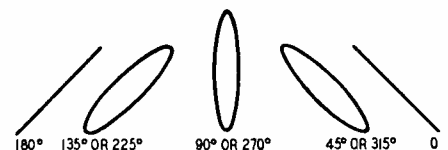

Fig. 3—Scope patterns for phase check.

shift occurring in the amplifier will cause a rotation of the scope pattern. The scope gain controls should be set to develop a pattern like that in Fig. 3 at 400 cycles. Varying the oscillator frequency through the usable response range of the amplifier will instantly show any phase shifts. This method assumes no phase shift in the scope amplifier.



A closeup view of the completed meter.

Vacuum-Tube Voltmeter Kit Has Interesting Features

Popular v. t. v. m. kits have many features found in costlier commercial instruments

—By RUFUS P. TURNER

TO design a trouble-free, wide-range, stable vacuum tube voltmeter-ohmmeter "from scratch" with the hope of beating the price of factory-built instruments is a tough job. It demands a stiffer background of engineering skill and much more time than most experimenters and servicemen have. Even when skill and time are available, the home-built instrument seldom approaches a factory-built job in appearance. Furthermore, the final cost of a home-made model is apt to equal the price of the manufactured article, especially if much cutting

and trying is involved. Thus the technician with a limited instrument budget finds the popular kit-type instruments well suited to his situation.

The new Heathkit model V-4 vacuum-tube voltmeter is an excellent example of these. An improved version of an earlier model, it is an inexpensive instrument having features of more costly electronic meters. The average radio-man can assemble and adjust it in a few hours. Its construction is an excellent project for students.

Electrical characteristics

The unit measures a.c. and d.c. voltages, d.c. resistance, and decibels. Six a.c. and d.c. voltage ranges are provided: 0-3, 0-10, 0-30, 0-100, 0-300, and 0-1,000 volts. The lowest dial-marked voltage is 0.05 volt, while 0.025 volt can be estimated with good accuracy. A high-voltage d.c. test probe is available as a separate kit for measuring voltages as high as 10,000.

The input resistance of the instrument is constant at 11 megohms on all d.c. voltage ranges. One megohm of this resistance is an isolating resistor in the handle of the shielded d.c. test probe. The isolating resistor, together with the shielding of the d.c. probe and cable, minimizes hand capacitance.

Sensitivity of the model V-4 is approximately 3.7 megohms per volt on the 3-volt range—approximately 183 times the sensitivity of the popular 20,000-ohm-per-volt nonelectronic meters. The selector switch includes both positive and negative d.c. positions.

The a.c. voltage ranges are the same as the d.c. ranges, and are read on the same scales. There are no special scales for any a.c. ranges. R.m.s. voltage values are indicated. The a.c. portion of the instrument is essentially a negative-peak indicator. The meter indications are r.m.s. values of a sine wave, or 0.707 of the peak value of complex waves.

The a.c. circuit is fully electronic (see Fig. 1), consisting of a shunt diode 6H6 signal rectifier. One diode section of the tube acts as the rectifier, while the other half supplies the contact potential for balancing out the

contact potential of the first section. A.c. voltage may be measured throughout the audio-frequency spectrum. At higher frequencies, up to a maximum of 200 megacycles, an external crystal-type probe is available as a separate kit, and plugs into the d.c. input jack.

Six resistance ranges are provided when the selector switch is thrown to its OHMS position: 0.1 to 1,000 ohms, 1 to 10,000 ohms, 10 to 100,000 ohms, 100 ohms to 1 megohm, 1,000 ohms to 10 megohms, and 100,000 ohms to 1,000 megohms. The ohmmeter circuit is powered by two self-contained 1.5-volt jumbo flashlight cells.

For direct testing of audio equipment, six decibel ranges are provided: -10 to +5, -20 to +15, -30 to +25, -40 to +35, -50 to +45, and -60 to +55 db. The decibel scale is based on a standard zero level of 6 milliwatts into a 500-ohm load. This places zero db at 1.73 volts on the 10-volt a.c. scale.

Test probes are the shielded d.c. test probe which contains the 1-megohm isolating resistor, connected to a shielded cable, and terminated by a phone plug; the COMMON (black) lead terminated by a crocodile clip, normally fastened to the chassis (B-minus) of the device under test; and the A.C.-OHMS (red) lead, terminated by a pencil-type test prod.

Fig. 1 is the complete circuit of the instrument. The basic electronic d.c. voltmeter section is a highly stable bridge circuit using the two triode sections of a 6SN7 tube. The indicating meter is a 0-200 d.c. microammeter.

The 12,000-ohm zero-adjust potentiometer has a 2,000-ohm limiting resistor connected to each end of its winding. The range of adjustment is sufficient to allow close setting of the meter to zero and the maximum swing of the meter with this adjustment is sufficient to permit setting the pointer to half-scale when a center-zero instrument is desired. There is no zero shift when switching from one voltage range to another, from a.c. to d.c., or from positive to minus volts.

Separate potentiometers are provided for initial standardization of the a.c. and d.c. voltage ranges. Only one

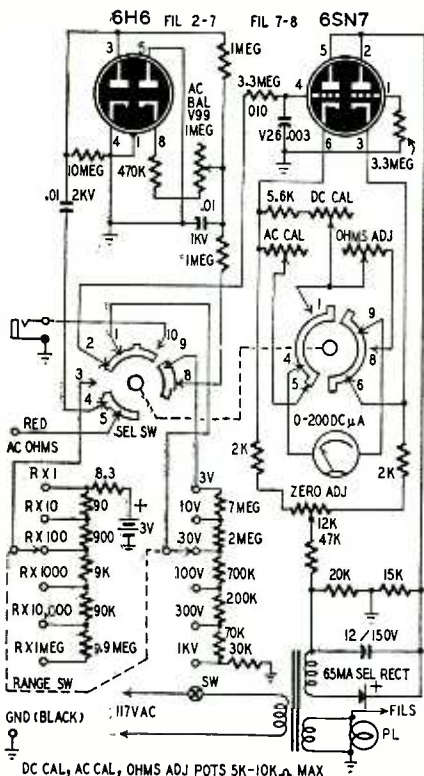
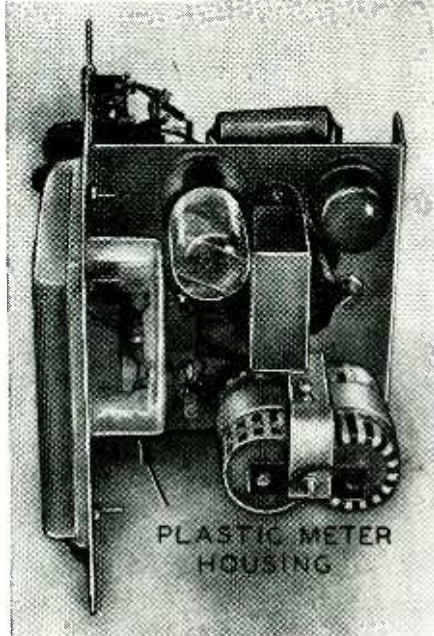

Fig. 1—Schematic of the v.t.v.m. The basic circuit is of the bridge type.

adjustment is needed in each case to standardize all of the scales.

A 3.3-megohm resistor (010 in Fig. 1) and 0.003- μ f capacitor V26 form a low-pass filter to remove any



The top of the chassis. Note that the meter housing is transparent plastic.

fluctuating component from d.c. voltages on the active grid of the 6SN7 tube.

The input coupling capacitor for the a.c. voltage ranges is a 2,000-volt, 0.01- μ f unit. This is a decided improvement over other models having lower-voltage capacitors in this position. One half of the 6H6 tube acts as the signal rectifier which delivers d.c. (corresponding to the a.c. signal voltage) to the active grid of the 6SN7 tube. Since the 6H6 has an appreciable contact potential which deflects the microammeter continuously, giving a false indication of voltage, the second half of the 6H6 acts as a contact potential generator whose voltage bucks out the contact potential of the first section. A 1-megohm potentiometer V99 is used to set this bucking voltage to the exact value required to reduce the false deflection to zero.

Mechanical features

The instrument is contained in a lightweight aluminum cabinet, 10 x 6 x 5 7/8 inches. The complete kit weighs about 8 pounds.

The microammeter is a new Triplett unit with a fine knife-edge pointer, enclosed in a completely transparent shatter-proof plastic case. Volt and ohm scales are inscribed in black; the decibel scales in red.

The chassis, front panel, and cabinet are supplied with all holes punched. No mechanical work other than bolting the parts together is necessary. Wire is furnished for electrical work.

Preliminary adjustment

After the instrument has been assembled and the wiring carefully

checked, plug into the power line, set the selector switch to D.C.+, range switch to 3 volts, throw the power switch to its ON position, and allow about 15 minutes for the initial warmup.

D.c. voltage: The voltage of one of the ohmmeter cells supplied with the kit is measured accurately by the Heath laboratories and the exact voltage value is marked on the jacket of the cell. Remove this cell temporarily from the instrument. Set the meter to zero on the 3-volt range with the zero-adjust potentiometer. Connect the d.c. test leads to the calibrated cell (black COMMON lead to the negative terminal; shielded d.c. test probe to the positive terminal), noting that the meter reads upscale. Now, adjust the d.c. calibration potentiometer to bring the pointer of the meter to the voltage indicated on the calibrated cell. The meter now is standardized on all of the d.c. ranges. Replace the calibrated cell in the ohmmeter battery bracket.

A.c. voltage: With no test leads plugged into the jacks, set the range switch to 3 v and the selector switch to its A.C. position. The meter will be deflected. Adjust the screwdriver-adjusted a.c. balance control potenti-

Conversion Table for Decibel Readings

A.C. Scale (volts)	Decibel Scale
0-3	subtract 10 db from reading
0-10	read direct
0-30	add 10 db to reading
0-100	add 20 db to reading
0-300	add 30 db to reading
0-1,000	add 40 db to reading

ometer to bring the meter pointer to zero. No meter movement should now be noticed when the selector switch is moved through its +D.C., -D.C. and A.C. positions. If there is any movement of the pointer during switching, the a.c. balance control potentiometer must be more closely set. Plug in the A.C. and COMMON test leads, set the range switch to 300 v, and connect the test leads to the power line. (The power line voltage must be checked with a known correct a.c. voltmeter; and the operator must be careful in making this test, since this voltage is dangerous.) Adjust the a.c. calibration control potentiometer to bring the pointer of the meter exactly to the line voltage value.

Ohms: When the selector switch is set to its OHMS position, the meter will be deflected upward. Adjust the OHMS ADJUST panel knob to bring the pointer exactly to full scale. This adjustment must be made at each setting of the range switch.

Using the instrument

Voltage measurements: Check d.c. voltages with the selector switch in its +D.C. or -D.C. position, whichever will give upscale deflection of the meter with the test leads properly connected

to the circuit under test. In normal operation, the shielded test probe will be in contact with the positive terminal of the voltage source. Use the COMMON (black) and shielded d.c. test probe. Always check an unknown voltage (a.c. or d.c.) first on the highest (1,000-v) range, switching successively to lower ranges until the reading is obtained in the upper part of the meter scale. This procedure prevents slamming the pointer, and reading near the top of the scale gives best accuracy.

Check a.c. voltages with the selector switch in its A.C. position, and with the COMMON (black) lead plugged into the COMMON jack and the red lead into the A.C.-OHMS jack. Sensitivity of the instrument on the 3-volt a.c. range is great and may result in a small deflection of the meter due to pickup of a.c. fields in the room. For this reason, the operator should keep his fingers near the end of the a.c. test probe to minimize body capacitance.

Resistance measurements: For resistance measurements, plug the COMMON (black) test lead into the COMMON jack, and the red lead into the A.C.-OHMS jack. Set the selector switch to its OHMS position, and the range switch to its R \times 1 MEG position. Set the pointer of the meter to full scale by means of the OHMS ADJUST knob. Touch the two test prods together, noting that the meter is deflected toward zero. Touch the test prods firmly to the resistor under test and read the resistance value on the meter scale. Switch to another range, if required, for closer reading. When switching to a new range, disconnect the unknown resistor and, with the test prods out of contact with each other, reset the pointer to full scale with the OHMS ADJUST knob.

Decibel measurements: The a.c. meter is used also to check decibels. The red db scale is direct-reading on the 10-volt a.c. range.

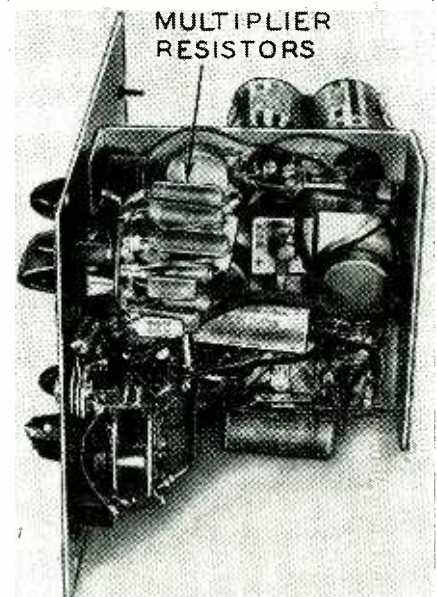

The precision multiplier resistors are mounted directly on the range switch.

Selenium Rectifiers Simplify Fixed Bias

By J. T. CATALDO

FIXED grid bias offers several advantages over the conventional cathode bias in amplifiers and receivers, provided that the cathode resistor is not intended to obtain degeneration. The greatest advantage of fixed bias is for class-AB1 push-pull amplifiers. When used in this type of circuit, fixed bias provides higher power output, increased stability, and less distortion for a given plate current. For example, when fixed bias is used on 2A3, or 6B4 tubes, the power output is increased by about 50% and the distortion is decreased by about 50% for the same current rating.

Although cathode bias has eliminated the disadvantages of batteries and bias cells, it presents another problem because the bias supply voltage subtracts from the available B-plus voltage. In the usual a.c.-d.c. receiver, where the B-plus voltage is at a premium, the available plate voltage for the biased tube is lowered by the amount of its bias and the output is less. Contact bias does not have this disadvantage, but it cannot be used for more than 1 or 2 volts bias.

The selenium rectifier as a replacement for vacuum-tube rectifiers has found many uses in radio and television receivers. One application is for grid bias supply, eliminating the disadvantage of cathode bias. Since selen-

ium rectifiers can be made with a wide range of voltage and current ratings, they can be used to supply grid bias to tubes that draw large grid currents as well as those that draw negligible current.

Selenium rectifiers with large plates are used for tubes drawing large grid currents. However, where the grid current is in the order of a few milliamperes, smaller compact half-wave, low-current selenium rectifiers may be used. At the present writing, a number of companies, are producing such a compact selenium rectifier in limited quantities. (See Fig. 1.) Because of its two pigtail leads and completely insulated,

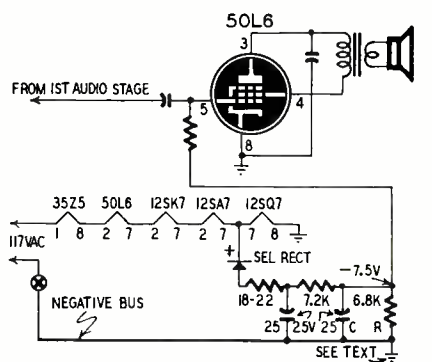

Fig. 2—A circuit for supplying fixed bias to the output tube of a receiver.

simplest one that the service technician or experimenter can try in his workshop is supplying fixed bias to the power output tube of a conventional five-tube a.c.-d.c. superheterodyne receiver.

The only components required are a selenium rectifier, three 1/4-watt resistors, and two electrolytic capacitors. These components are wired as shown in Fig. 2. A dual electrolytic with a common negative lead cannot be used. Instead, two single capacitors or a dual with a common positive lead must be used.

To make the change, remove the cathode resistor from pin 8 of the 50L6 and solder a wire from this pin to ground. In some sets, ground is the chassis while in others, ground is the B-minus line or one side of the a.c. line, usually the one in which the on-off switch is wired. (Caution: do not play the radio with only this con-

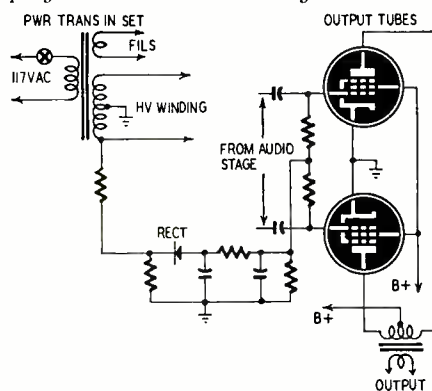

Fig. 3—Fixed bias for push-pull stage.

nection made. The 50L6 now has zero bias and, if the set is operated, will draw a large current which may damage the tube and the output transformer.)

The cathode of the selenium rectifier (equivalent to the cathode of a vacuum diode) is usually marked with a K, +, or a red mark, depending on its manufacturer. Solder this terminal to the high side of the filament of the 12SQ7. The rest of the components can be wired in the most convenient place for the particular receiver.

Disconnect the grid resistor of the 50L6 from ground (same ground mentioned above) and solder it to the junction of C and R in Fig. 2. With this connection made, the power output tube has been converted for fixed bias. This will provide additional power output because the output tube plate voltage has been raised by approximately 7.5 volts.

Fig. 3 shows the output stage of a push-pull receiver or amplifier in which fixed bias for the output tubes is obtained from the high-voltage winding of the transformer with a voltage divider, a selenium rectifier, and a filter network. There is no need to consider the loading effect on the transformer as the additional current is negligible.

A bias supply for the output and r.f. stages of an a.c. receiver is shown in Fig. 4. This circuit is essentially the same as for the a.c.-d.c. set except that

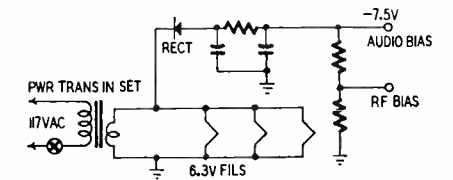

Fig. 4—A bias supply circuit for the audio and r.f. stages of an a.c. set. the a.c. input to the selenium rectifier is obtained from the filament winding of the transformer.

Fig. 5 is a circuit for a TV receiver bias supply. This supply can be used to supply bias to the synchronization amplifiers, audio stages, and r.f. and i.f. stages of the set. The variable r.f. and i.f. bias can be used as the contrast control for the picture tube. This is desirable as it eliminates the problem of current changes in one circuit affecting the other circuits as when obtaining bias from a bleeder circuit. The action of the a.v.c. and the contrast control and tube aging, each of which changes the total bleeder current, can

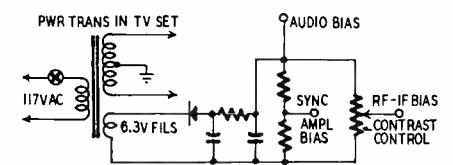

Fig. 5—Variable r.f. and i.f. bias is used for contrast control on a TV set.

defocus the set and change picture brightness level and important bias voltages.

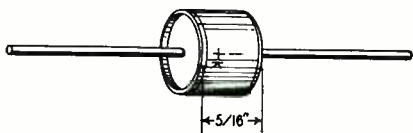

Fig. 1, 3, and 4 Courtesy Radio Receptor Co., Inc.

Fig. 1—A small-sized selenium rectifier for use in fixed bias supplies.

ium rectifiers can be made with a wide range of voltage and current ratings, they can be used to supply grid bias to tubes that draw large grid currents as well as those that draw negligible current.

Selenium rectifiers with large plates are used for tubes drawing large grid currents. However, where the grid current is in the order of a few milliamperes, smaller compact half-wave, low-current selenium rectifiers may be used. At the present writing, a number of companies, are producing such a compact selenium rectifier in limited quantities. (See Fig. 1.) Because of its two pigtail leads and completely insulated,

Fundamentals of Radio Servicing

Part XVII—The Voltage Amplifier

By JOHN T. FRYE

IN OUR crablike method of progressing backward through a radio receiver, we always assume that each stage will receive just the right kind of a signal from the stage before it. When we discussed power amplifiers last month, we found that we need an audio-frequency signal on the grid of that amplifier to make it work.

This audio voltage must be pretty husky if the output tube is to be worked at full power. A little reflection shows why this is so: a power output tube must have a relatively heavy plate current to develop much power (power is always the product of voltage and current) in its plate circuit. This means that the plate resistance of the tube must be low. The way to lower the plate resistance of a triode is to move the plate closer to the filament, thus (December 1949 issue) reducing the amplification factor of the triode. A low amplification factor makes it necessary to have large swings of grid voltage to produce large swings of plate current.

In a triode power amplifier, the peak-to-peak voltage required on the grid for full power output may be as high as 70 to 80. Screen grid and beam tubes can deliver high power outputs with much lower grid voltage swings, but even they require audio voltages of several volts on their grids.

But the audio voltage that results when the audio portion is peeled off the carrier by the detector is often only a small fraction of a volt. Before this puny voltage can swing the grid of our power amplifier back and forth as it should be swung, it must be given a shot of spinach juice or something that will make it many times more powerful.

The "builder-upper" that does this trick is called an *audio-frequency amplifier* or simply an *audio amplifier*. Its job is to take the little audio voltage delivered to it by the detector and consisting of frequencies from 50 to 15,000 cycles per second and amplify this voltage many times, being careful to play no favorites and to boost all of the frequencies exactly in proportion to the amplitude they had before the boosting operation started. If all of the frequencies are not uniformly boosted, we have what is called *distortion*. The voice or music that comes out of the amplifier no longer sounds like what

went into it. The result is about the same aurally as the visual experience of peering into one of those magnifying shaving mirrors: there is plenty of enlargement, but the perceived result does not bear much resemblance to the original! If necessary, two or more stages of audio amplification can be used between the detector and the power amplifier; but this is usually not necessary, at least in small receivers; a single pentode can amplify a signal 150 times or more.

Fig. 1 shows the basic circuit of an audio amplifier stage. A triode is used

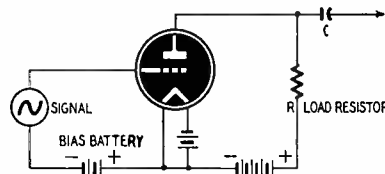

Fig. 1—Basic audio amplifier circuit.

for simplicity. This should look familiar to you for it is nearly the same circuit as that of the power amplifier studied in the last chapter. The only difference is that we have a resistor in the plate lead instead of an output transformer primary.

A power amplifier and a voltage amplifier are really first cousins. The big difference lies in what we want them to deliver. Last month we wanted *power* (volts \times amperes) to drive our speaker; so we selected a tube with a husky plate current and adjusted our plate load for very nearly maximum power output. You will recall that this load was raised from the one that would give the most power output (equal to the plate resistance) to about twice this figure in order to reduce distortion.

Now we are not interested in power. No power is used in the grid circuit of the power amplifier because no current flows in this circuit. Only voltage is needed; therefore, all our audio amplifier stage need do is amplify voltage. With that in mind, we select a tube with a high amplification factor, such as a pentode or a high- μ triode, and we use a plate-loading resistor with a value several times the plate resistance of the tube. Fig. 2 shows how the actual amplification of the tube ap-

proaches its amplification factor as the plate load resistance is increased.

Remember the discussion of the dynamic characteristics of vacuum tubes? If you don't, go back and look it up in the February, 1950, issue. These dynamic characteristics revealed exactly how the plate current varied in accordance with the grid voltage when various values of plate resistance were used. Fig. 3 shows a whole family of dynamic-characteristic curves for a small triode. Each curve represents a different plate resistance.

Fig. 4 is a close-up study of what happens when we select one of these curves, the one with the 50,000-ohm plate resistor, and apply an audio voltage that swings 2 volts either side of zero center to the grid. This audio voltage is applied in series with -5 volts of bias on the grid.

Notice that if you read along the left side, of the graph, the vertical divi-

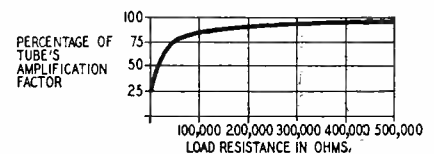

Fig. 2—Curve showing voltage amplification vs load resistance for a triode with a plate resistance of 10,000 ohms.



An audio amplifier having two voltage amplifier stages and push-pull output.

sions represent plate current in milli-amperes; while if you read along the right side, they stand for the actual voltage on the plate after the voltage drop across R has been subtracted from the 300-volt plate supply.

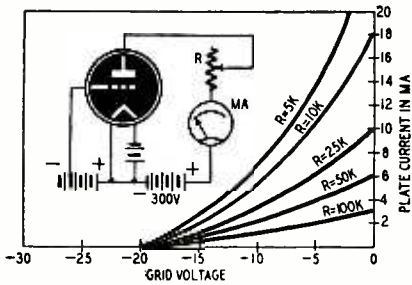

Fig. 3—Triode dynamic characteristics.

Before the audio signal is applied to the grid, our -5 volts of bias causes the tube to draw 2 milliamperes of plate current. The drop through R ($.002 \times 50,000$) is 100 volts, leaving 200 volts on the plate. When the audio grid swings to its maximum negative value of 2 volts, the total grid voltage is $-5 + -2$, or -7 volts. At this point our plate current falls to about $1\frac{1}{4}$ milliamperes, the drop across R ($.0013 \times 50,000$) is only about 65 volts, and the voltage on the plate rises to 235 volts.

On the other hand, when the audio voltage swings to its most positive value, the total grid voltage becomes $-5 + +2$, or -3 volts; and the plate current rises to the vicinity of $2\frac{2}{3}$ milliamperes. This makes the voltage

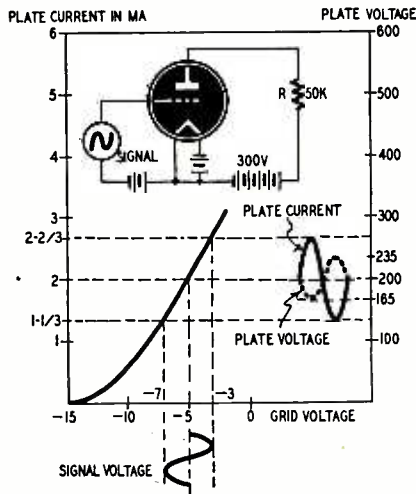

Fig. 4—Curve showing how grid signal varies both plate current and voltage.

drop across R ($.00266 \times 50,000$) approximately 135, and the plate voltage falls to 165.

Keep in mind that for every value of grid voltage lying between these extremes there is a corresponding different plate current value and consequently a different plate voltage value. Any movement of the grid voltage in a positive direction immediately produces a proportionate increase in the voltage drop across R and an accompanying decrease in actual voltage on the plate of the tube. By the same token an in-

crease of the grid voltage in the negative direction produces an increase in the positive plate voltage on the plate for the reasons just mentioned. Since a negative-going grid voltage results in a positive-going plate voltage, we say the grid and plate voltages are 180 degrees out of phase.

If we concern ourselves only with the voltage actually appearing across R—and we can separate this varying voltage from the d.c. voltage by leading it off with a capacitor C—we find that we have a king-size replica of the voltage on the grid of our audio amplifier. In the example we have been studying we know that our actual plate voltage varied from 165 to 235, or a total range of 70. Since this was produced by a peak-to-peak grid voltage of 4, we can see that our amplifier has amplified the grid voltage about $17\frac{1}{2}$ times.

Yes, a radioman has to be as familiar with curves as beauty contest judge.

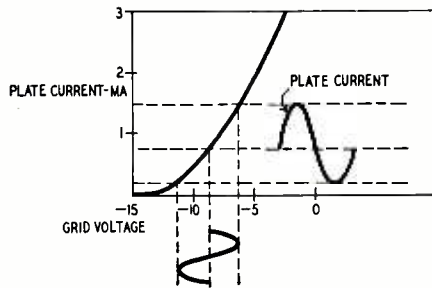

Fig. 5—Incorrect biasing of the tube will cause the output to be distorted.

Not only must he know which curve to select but he must also know what portion of that curve to use. Fig. 5 shows what happens if the fixed bias is set so that the curved instead of the straight portion of the "curve" is used. No longer is the plate current pattern a faithful reproduction of the audio voltage presented to the grid. It is non-symmetrical or lopsided. Under such conditions the audio signals being amplified by the tube are certain to be distorted and will not sound true to the ear.

In the same way too large a signal on the grid of the tube will result in distortion as shown by Fig. 6. If the audio signal is too great, the extremes of its swing cannot be kept on the straight portion of the curve, even though the bias is correctly set for the middle of this straight part. In this case the tips of the sine wave are flattened by this "overloading" of the audio amplifier.

By using two tubes in a push-pull circuit such as the one shown in Fig. 7, we can have an exciting voltage for our amplifier that is twice that of a single tube. In this circuit the audio voltage is delivered to the grids by means of the input transformer. When one end of the secondary of T1 is positive, the opposite end is negative; so only half of this total audio grid voltage can appear between the negative terminal of the bias battery and either grid. In the same way, while

the plate current of one tube is rising that of the other tube is falling. Because of the way they pass through the two halves of the primary of T2, these opposite-going currents produce voltages in the transformer that are in the same direction and so add together. This means that a push-pull stage has twice the power output of a single stage. As a matter of fact, it has more than twice the power output because a push-pull amplifier has less distortion and so can be made to put out increased power without exceeding the usual 5% permissible distortion figure.

To understand why a push-pull stage has less distortion, you must realize that an audio signal is like a pretty girl: it is seldom seen by itself. Accompanying it are other lesser audio voltages called harmonics. A harmonic is an audio voltage that is some multiple of the fundamental audio frequency. For example, if our fundamental frequency is 400 cycles, the second harmonic is 800 cycles; the third, 1,200; the fourth, 1,600, etc. Unfortunately the voltages of these harmonics combine with the voltage of the fundamental and produce changes in the waveshape of that fundamental that spell distortion. Fig. 8 shows how the presence of a second-harmonic voltage wave can foul up a nicely shaped fundamental wave.

In a push-pull amplifier, the even-numbered harmonics are made to cancel out their distorting effects on a signal passing through a single tube by combining the output of both tubes in the transformer in the plate circuit. Fig. 9 shows exactly how this takes place. At A the solid line shows the harmonic-distorted wave produced by tube No. 1 of the push-pull stage. The dotted line portrays the similarly distorted output of tube No. 2, but notice that here the higher peaks appear on the opposite side of the line than they

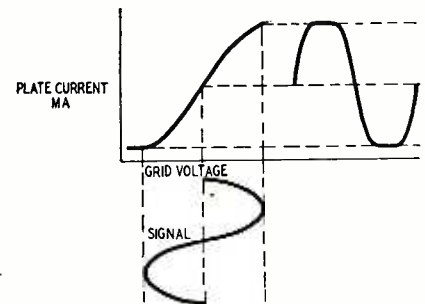

Fig. 6—Too large a signal on the grid causes distortion of the output signal.

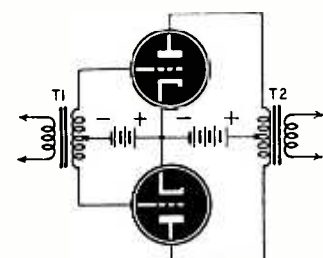

Fig. 7—Diagram of push-pull amplifier.

did for tube No. 1. At B is shown the amplified distortion-free wave that results from the combination of these two waves.

Incidentally, this same cancellation process also takes out any power supply hum that may be impressed directly on the plates of the push-pull output

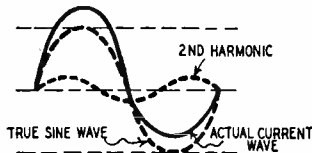

Fig. 8—The second harmonic adds to the sine wave and distorts the output.

tubes; it does not, however, remove any hum that may be introduced into the amplifier from preceding stages. Neither does a push-pull amplifier reduce the distortion produced by odd-numbered harmonics, such as the third, fifth, seventh, etc.; but since the amplitude of the harmonic usually diminishes as its frequency departs farther from that of the fundamental, getting rid of the second harmonic is very much worth while.

Let us summarize what we have said about audio amplifiers in this installment. The job of this part of the radio receiver is to build up the small signal that is put out by the detector so it will be big enough to drive the power output stage. The audio amplifier looks like the power amplifier except that it has a resistor in its plate lead instead of a transformer primary.

It must boost all the frequencies from 50 to 15,000 cycles in the same proportion, otherwise we get distortion. Sometimes a receiver needs two or more stages of audio frequency amplification.

Related to the voltage amplifier is the push-pull amplifier, which is a power amplifier using two tubes to put out twice as much power as one tube will. It also improves the output stage by canceling out even harmonics which are introduced by the tubes.

Push-pull stages are found more often in the power output portion of a receiver than they are in the voltage

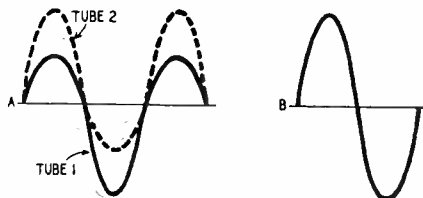

Fig. 9—Distortion from even harmonics cancels out in a push-pull amplifier.

amplifier section. As you will discover, push-pull action can be had without using an input transformer, but that is a refinement that will be taken up later. Right now, Watson, slip your service revolver into the pocket of your great-coat, bring me my fore-and-aft cap and my magnifying glass, for we are about to start studying *detection!*

Audio Freqmeter Has A Tubeless Indicator

By I. QUEEN

THE experimenter who wants to find the value of unknown audio frequencies quickly and simply will find the audio-frequency meter described in this article a useful instrument. In spite of its simplicity and the ease with which it may be built, this instrument is accurate for all audio frequencies.

The audio-frequency meter uses the standard Wien bridge circuit, the basis of most meters of this type. An unusual feature of this particular instrument is the built-in tubeless indicator, consisting of a 1N34 crystal diode and a d.c. microammeter. This capacitance-coupled indicator gives good sensitivity even at the low frequencies.

The instrument has three ranges: 20 to 200 cycles, 200 to 2,000 cycles, and 2,000 to 20,000 cycles. A ganged selector switch S1-S2 switches in pairs of identical capacitors to set these ranges. The ganged 50,000-ohm dual potentiometer R4-R5 is the main adjustable control, and a dial reading directly in cycles per second is attached to this potentiometer.

In use, the instrument is tuned in the following way: The unknown signal is fed into the input terminals, and the dial of R4-R5 is adjusted for a sharp downward dip of the microammeter pointer. When the lowest dip is obtained, adjustment of potentiometer R2 will make this null point sharper and therefore more closely readable on the R4-R5 dial. Adjustment of R2 will not affect the setting or calibration of the main tuning dial. For that reason, no dial is needed for R2.

If an audio oscillator is available, it may be used to feed various spot frequencies between 20 and 20,000 cycles into the audio-frequency meter. As the meter is set to null for each frequency, the corresponding point may be marked on the dial of potentiometer R4-R5. Only one dial scale is required.

If a calibrated oscillator is not available, the dial may be calibrated closely enough for most practical purposes by checking resistance settings of potentiometer R4-R5. The chart gives resistance readings corresponding to frequencies between 20 and 20,000 cycles. A resistance bridge or good ohmmeter may be used for the measurements. The values in the chart assume the range switch is in position C. When it is in position B, drop the last zero from the frequency figure (200-2,000 cycles); when in position A, drop two zeros (20-200 cycles).

The matched capacitors are made by paralleling combinations of oil-filled and mica capacitors to the correct value. If only one dial scale is used, the accuracy of tracking depends on the accuracy of the capacitors. The 5- μ f coupling capacitor can be made by paralleling several large paper capacitors. Do not use electrolytics.

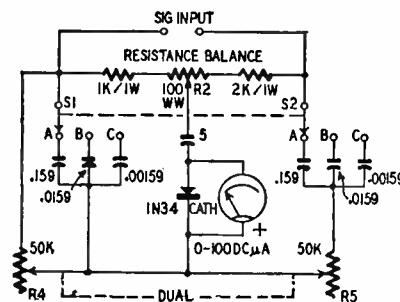

CALIBRATION TABLE

FREQUENCY (cycles)	RESISTANCE (ohms)
2000	50,000
2500	40,000
3000	33,300
3500	28,500
4000	25,000
4500	22,200
5000	20,000
5500	18,200
6000	16,700
6500	15,400
7000	14,300
7500	13,400
8000	12,500
8500	11,800
9000	11,100
9500	10,500
10,000	10,000
11,000	9100
12,000	8300
13,000	7700
14,000	7150
15,000	6660
16,000	6250
17,000	5900
18,000	5550
19,000	5250
20,000	5000

The values in the table are calculated from the standard formula for the Wien bridge:

$$f = \frac{1}{2\pi RC}$$

In this case R is the measured resistance of one of the dual pots and C is the value of one of the matched capacitors. A calibration point for any frequency can be found with this formula.

A Midget Double-Trace Scope

By OTTO VON GUERICKE



Fig. 1—The scope takes up little room.

FOR my work I needed an oscilloscope with the following qualities: it must have all the features of the lower-priced oscilloscopes and should contain them in a small case that could be handled easily and always be placed in the position most convenient for observation.

In addition, the scope should be double-traced with a built-in electronic switch to connect the vertical deflection plates alternately to two different inputs. The switching frequency must be high enough to make simultaneous observation of both inputs possible.

To reduce the size of the apparatus, I selected the 2AP1 cathode-ray tube, although friends had warned me that counting waves in frequency measurements was very difficult on a 2-inch screen. When I first tried out the tube, I found the focusing much sharper than on a 5-inch tube, and this compensated for the loss in size.

Using this tube enabled me to keep the dimensions of the cabinet down to $7\frac{1}{4} \times 7\frac{1}{4} \times 9\frac{1}{4}$ inches with enough room left to accommodate two rectifier



Fig. 2—A front view of the instrument.

tubes, three 6J7 amplifiers, a 6N7 multivibrator, an 884 sweep oscillator, transformers, and other components.

Fig. 1 indicates how little room is taken by the oscilloscope as I work at my table. Fig. 2 shows the completed instrument.

The small dimensions caused some trouble with magnetic hum from the stray fields of the transformers. I cured this in two steps. First I connected the primaries of two transformers mounted side by side so that the instantaneous fields had opposite polarities. This reduced the stray magnetic field as indicated in Fig. 3 and helped a great deal.

The 2-mm iron tubing around the cathode-ray tube still was unable to keep out the remaining magnetic field completely. Adding another iron tube 6 mm thick, with air gap between the two shields, completely eliminated the magnetic hum. Thus it is not impossible to operate a C-R tube and line transformers at close quarters if some precautions are taken.

The 6J7 amplifiers, the C-R tube circuits, the flyback blanking, and the 884 sweep generator were copied from issues of RADIO-ELECTRONICS and worked satisfactorily, so nothing more need be said about them. I did work out some special circuits myself. (See Fig. 4.)

I center-tapped the high-voltage transformer and provided a switch, S1, on the front panel (just below the C-R tube) to connect either 1,000 or 500 volts to the rectifier. The power supply then furnishes two different d.c. potentials to the C-R tube. To observe a weak signal, I apply the lower voltage to get a higher deflection sensitivity. To view a quick phenomenon, I use the higher voltage which gives a brighter trace. This simple trick is very useful and to be recommended highly.

The intensity grid of the C-R tube is brought out to the panel across an RC network. The horizontal amplifier (when not used for double tracing) is connected to this same terminal when the sweep is switched to the horizontal deflection plates with S5. In this position of the switches, the horizontal amplifier acts as an intensity amplifier.

Another advantage of this arrangement is that this terminal may be connected to the vertical input with a shielded wire so that the signal fed to the horizontal amplifier input is amplified by both amplifiers in series. The gain is about 500 at 50 cycles. In most cases this has no effect on the intensity

grid because this arrangement is used only for very small signal voltages.

To get double tracing, the vertical and horizontal amplifiers are connected to the vertical deflection plates and blocked alternately with the square-wave output of a multivibrator. A multivibrator is most convenient because it provides the two necessary signals 180° out of phase at the two plates of this circuit.

I tried all three grids of the 6J7 to find that most suitable for injecting the blanking pulses. The best results were had from the suppressor grid. This was also convenient for switching from normal operation to double tracing because the pulses can be supplied through an RC network, leaving the suppressor at ground potential when the multivibrator is not working.

Experimentation with the plates of the 6J7's, which had to be connected to the vertical deflection plates, showed it best to use a common load resistor. Thus all that I needed to go from normal to double-trace operation was a d.p.d.t. switch S6.

To get square waves with steep sides, the capacitors in the multivibrator circuit must be made as small as possible (I used 20- μ mf air padders) and the grid resistors relatively large. For the latter I used 2.2-megohms with d.p.d.t. switch S7 to add 1-megohm resistors in parallel to raise the frequency about four times. The frequency is about 3,000 c.p.s. with the 2.2-megohm resistors and adding the 1-megohm shunt across each raises the frequency to about 10,000 c.p.s.

The position of the two traces is controlled by the 5,000-ohm potentiometer in the cathode circuit of one of the amplifiers. Fig. 5 shows how it looks when there are no input signals and

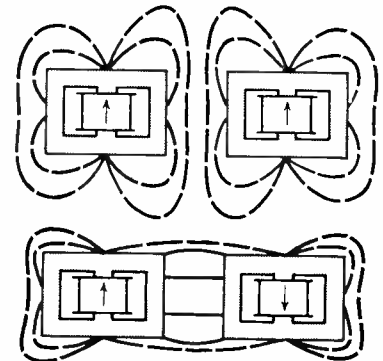

Fig. 3—Transformers are connected so that stray fields oppose each other.

RADIO-ELECTRONICS for

the sweep frequency is so high that the switching cycle is visible. If the sweep frequency is lowered, only two parallel lines with a thin veil between them are visible.

The two lines can be made to coincide by adjusting the cathode potentiometer and, if there is no signal on one input, an x axis is formed for the signal on the other (Fig. 6).

There are so many applications for an oscilloscope, especially one with a double trace, that it seems worth while to mention a few less common ones.

A pulse of very short duration may easily pass the attention of the observer because the quicker the movement of the beam, the less the screen is illuminated. In such cases, intensity modulation is very useful. The pulse is fed to the vertical input and to the intensity terminal at the same time.

If the pulse voltage is small, the horizontal amplifier can be used as long as the sweep is used also. The result is a bright trace instead of a nearly invisible one. If the signal also includes a sine voltage, it is advisable to pass it through an R-C network to attenuate the sine voltage but not the pulse.

If it were of interest to observe the parts of a signal voltage which rise most quickly, the same connections can be used. The quickest rise is indicated by the brightest trace, while a drop in voltage makes the trace less bright.

Lissajous figures are formed when sinusoidal voltages are applied to both the horizontal and vertical deflection plates. Interpretation of these patterns is a method of frequency measurement. An easier way is to connect one frequency to the intensity grid instead of the horizontal deflection plates (with the sweep on). The number of dark or bright spots on one cycle of the curve shows the frequency of the signal on the intensity grid compared with that on the vertical plates. Of course the higher frequency must be connected to the intensity terminal.

The advantage of this method is that the voltages need not be sinusoidal. It is also easier to count the spots than to examine the circumference of a Lissajous pattern.

A sinusoidal voltage may be used as a time base. The sine wave is applied to both the horizontal input and to the intensity terminal. Only half of the sine wave becomes visible and a sawtooth wave is formed. The sawtooth is by no means ideal, but for many applications it is sufficiently linear.

The advantage of using a double trace can be stated simply: comparison of two periodic waves as to shape, amplitude, frequency, and phase can be made at a glance.

In Fig. 7, one trace is left with no signal and is so shifted that it just touches the negative peaks of a sine wave on the other trace. This is a quick and simple way to compare peak amplitudes no matter what the shapes of the voltages are.

Fig. 8 shows an easy way to check

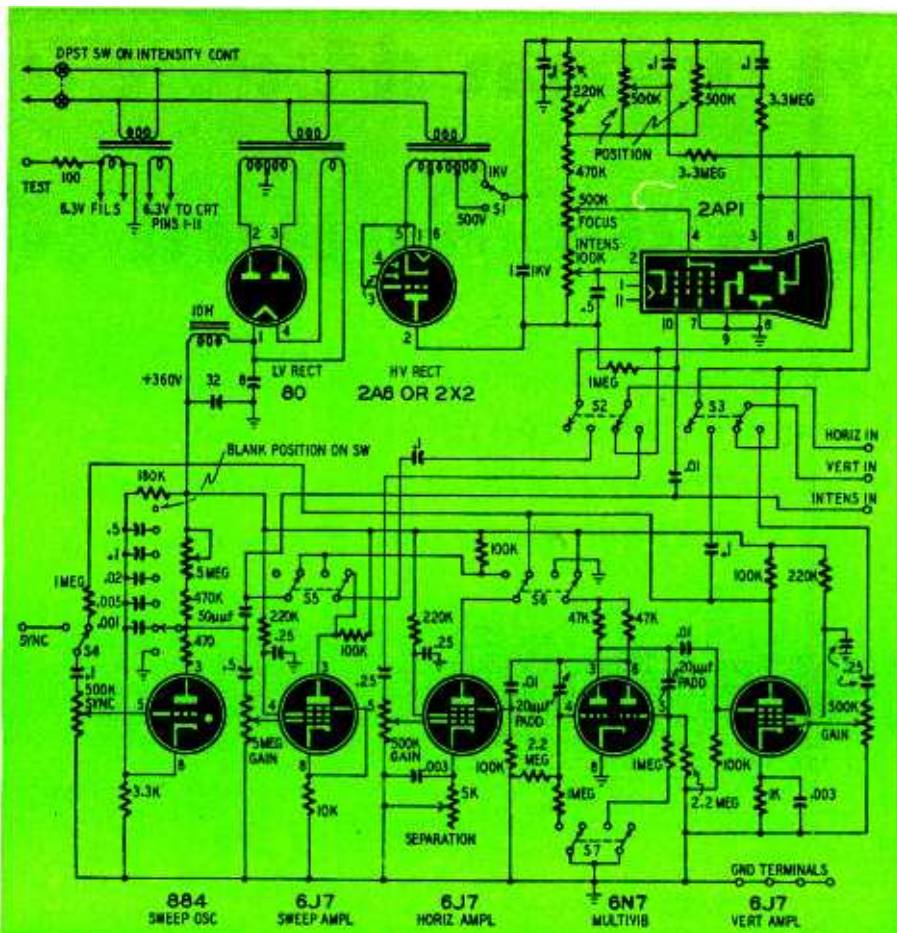

Fig. 4—Schematic of the oscilloscope. The built-in multivibrator provides for double tracing. The tapped high-voltage supply gives two sensitivities.



FIG. 5

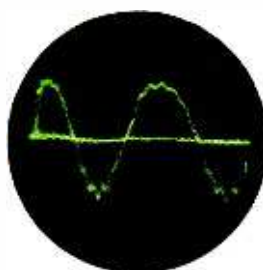

FIG. 6



FIG. 7

Fig. 5—The switching cycle as it appears when the sweep frequency is too high with no signal input.

Fig. 6—The horizontal amplifier cathode potentiometer adjustment makes the sweeps coincide. One may be used as an x-axis for a trace on the other.

Fig. 7—Rapid peak amplitude comparison of two signals can be made if one trace is positioned at the negative peak of a signal on the other trace.

Fig. 8—The double trace simplifies amplifier response check. The input signal is applied to the upper trace and the output to the lower trace.



FIG. 8

the frequency response of an amplifier. The upper trace is the signal at the amplifier input, and the lower trace the signal at the output. The pattern shows that the amplification of the fundamental frequency is about 1, while the harmonic in the signal is amplified about 10 times. Phase shift also can be detected at a glance.

The frequency response of an amplifier can be checked quickly with a square wave. As the multivibrator used to generate the square wave may not have an ideal waveform, reliable results are possible only when the square wave is viewed both at the input and the output of the amplifier—another use for double tracing.

Microwave Lenses

Focus Sound Waves

The artificial-dielectric lens is useful for beaming u-h-f radio waves and for audio waves of roughly the same wave length

By FRED SHUNAMAN

HERTZ was the first to prove that radio waves could be reflected and refracted with lenses like light waves. His discovery was for many years one of the well known but unused facts of radio. It was not until microwaves came into use that the lens idea was applied to bending or beaming radio waves.

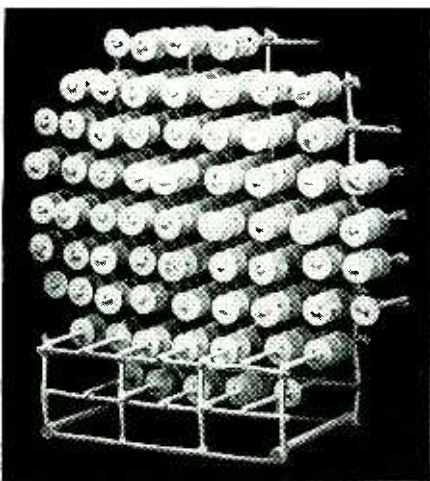

Fig. 1—An early type of artificial-dielectric lens made of metal discs.

The first of the modern electro-magnetic lenses was patterned on waveguide principles. It was developed at the Bell Telephone laboratories and described in this magazine July, 1947. The waveguide type of lens was highly directive and could focus radio waves in a narrow beam. It had one disadvantage—a given lens was confined to a narrow band of frequencies.

A later lens, also developed by scientists of the Bell Telephone Laboratories, overcame this drawback. It was composed of small spheres or discs of conducting material, and slowed the radio waves down as a lens of glass slows down a ray of light. Fig. 1 is a lens of this type. It can be used over a very wide band of frequencies, yet is

capable of focusing microwaves in a narrow beam. Discs or spheres are replaceable by metal strips, making the lens relatively simple to construct. Such strip lenses are the ones now used in the New York-Chicago microwave relay circuits of the Bell System for telephone and television network use.

A most interesting development—and the one that forms the subject for our cover this month—is the adaption of the microwave lens for use with sound waves of approximately the same wavelength as the radio waves for which the lens was designed originally. This is an important step in the microwave field as well as in audio, for the lens can not only be used to beam sound waves, but the characteristics of a lens intended for microwave frequencies can be determined with the simpler and cheaper equipment which can be used to produce sound waves rather than the more costly microwave equipment.

How a lens works

A lens of the obstacle type consists of a collection of objects which are small compared to the wavelength of the radiation being focused. W. E. Kock, who invented the waveguide lens and the obstacle lens, reasoned that in a glass lens for refracting light, the molecules of glass are so small as to give the impression (even under a microscope) of a perfectly smooth and homogeneous medium. As the wavelength is increased, the size of the obstacles and their spacing can be increased till, for sound waves in the order of several thousand kilocycles (or microwaves in the centimeter region), they look like the lens of Fig. 1 or the cover photo.

According to the commonly accepted theory of lens action, a lens slows down the waves transmitted through it because of reflections from the small elements that make up the lens. Thus the

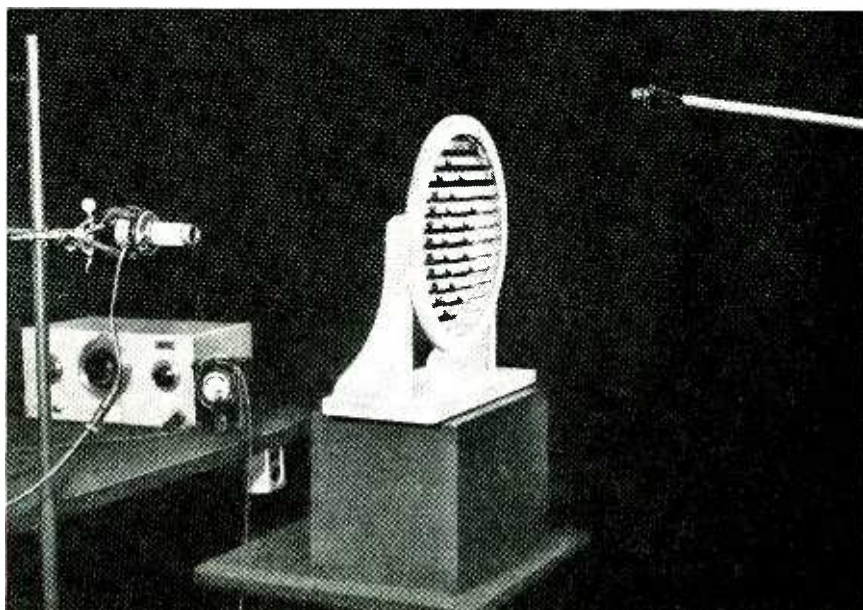

Fig. 2—This is the setup used to produce the pattern shown on the cover.

RADIO-ELECTRONICS for

molecules of glass reflect back part of the light that impinges on them, and the beam which finally emerges from the lens is a resultant of the original wave which entered it and all the small reflections from the molecules of glass.

In an electric lens, the "molecules" should be perfectly conducting to make a perfect lens—in an acoustic or audio lens they should be perfectly rigid. Although perfection is not often found in the field of physical experiment, the metal of which the lenses are made is a sufficiently good conductor and also mechanically rigid enough to make an efficient lens. The focus pattern can be seen on the front cover. (A "perfect" photograph would have shown a sharper focus at the point of greatest light intensity.)

The equipment which plotted the field has the simplicity of genius. A neon bulb and a microphone are mounted on the end of a rod (Fig. 2) which is attached to a carriage. The rod swings slowly up and down, at the same time backing away from the lens at a rate that makes each swing one-tenth of an inch further from the lens than the last one. The microphone is connected to the input of an audio amplifier and the neon bulb to the output. The lamp therefore lights brightest in regions of maximum signal. The sound is produced by a standard audio oscillator and is beamed at the lens by a high-frequency horn or transducer, like the one on the cover or in Fig. 2.

The above explanation is a simplification, as a second signal of the same frequency must be mixed with the wave to produce the interference pattern which gives the standing waves shown in the photograph, but is correct in the fundamentals. A camera takes a time exposure of the flickering neon lamp in complete darkness to make a permanent record of the pattern.

One of the simplest types of lenses is that illustrated on the cover. Originally developed for microwaves by Dr. Winston E. Kock and later used with sound waves by Kock and F. K. Harvey of the Bell Telephone Laboratories, it consists of a simple array of metal strips. Aluminum is used in the lens portrayed here, though there is no good reason why copper or any other metal with the necessary requirements of rigidity and conductivity should not be used. Fig. 3 gives the details and dimensions of the lens. This lens cuts off at around 10,000 cycles (audio waves) or with radio waves at a little longer than 3 centimeters. Waves of lower frequencies (longer wavelengths) are refracted over a wide band, though the efficiency of the lens is greater for wavelengths of less than twice the lens diameter.

Metal arrays can be used for diffusing as well as focusing sound waves. One use is broadening the usually very directive field of high-frequency horns. Although a wide-angle lens of the strip type described above could be used, the slant plate type of lens illustrated in Fig. 4 is preferred. Instead of slowing

down the wave by partial reflections, it leads portions of the wave along a longer path than they would normally

discussed in this article. Meanwhile they can shed a great deal of information on the behavior of microwave

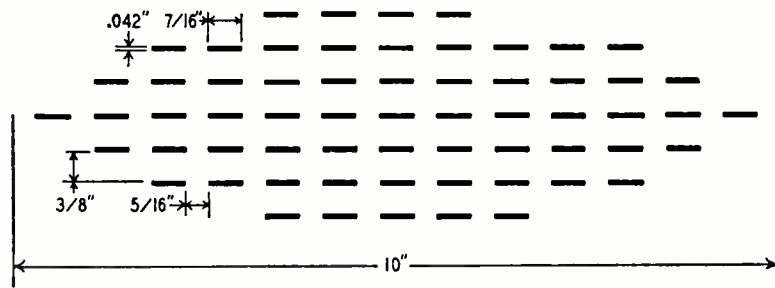

Fig. 3—Cross-section of the 10-inch lens. Drawing is 40% actual size. The individual strips of which the lens is made are cut to such lengths that their ends fall on circles which are ten, eight, six and three inches in diameter.

them. The focusing (or rather diffusion) pattern can be changed by varying the shape of the lens. Those por-

lenses at frequencies where performance of electronic equipment is not always invariable.

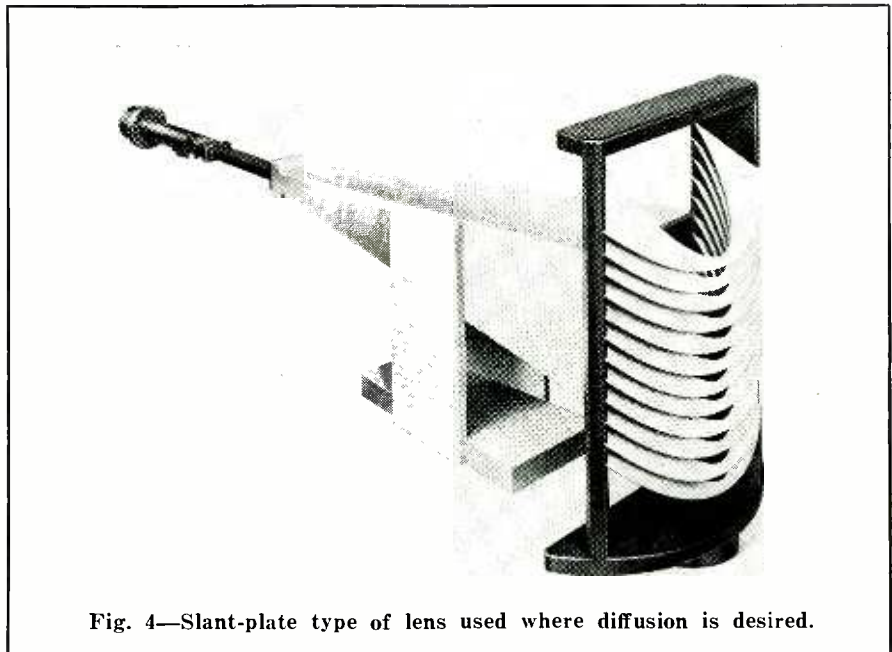

Fig. 4—Slant-plate type of lens used where diffusion is desired.

tions of the sound wave that are detoured farthest can be compared to those which go through the thickest part of the obstacle lens.

Audio lenses may well have a number of future applications other than those

The experimenter may be interested in constructing a lens like that shown in Fig. 3, either for audio or radio waves of 3 to 10 centimeters and longer wave lengths. The necessary dimensions are given in the figure.

TELEPHONE AID FOR HARD-OF-HEARING

Telephone conversations for the hard of hearing or in noisy surroundings are often difficult if not impossible. A recent invention to overcome this difficulty is a pocket-size portable induction coil pickup and amplifier that slips under a telephone and amplifies the conversation. A supplementary headphone is used with the device.

For those who wear their own individual hearing aids, only the pickup will be provided. A jack fitted to the hearing aid will cut out the microphone when the telephone pickup coil is in use. Patent applications have been made for this device by Erich Hausdorf of Ottawa, Canada.



Electronics and Music

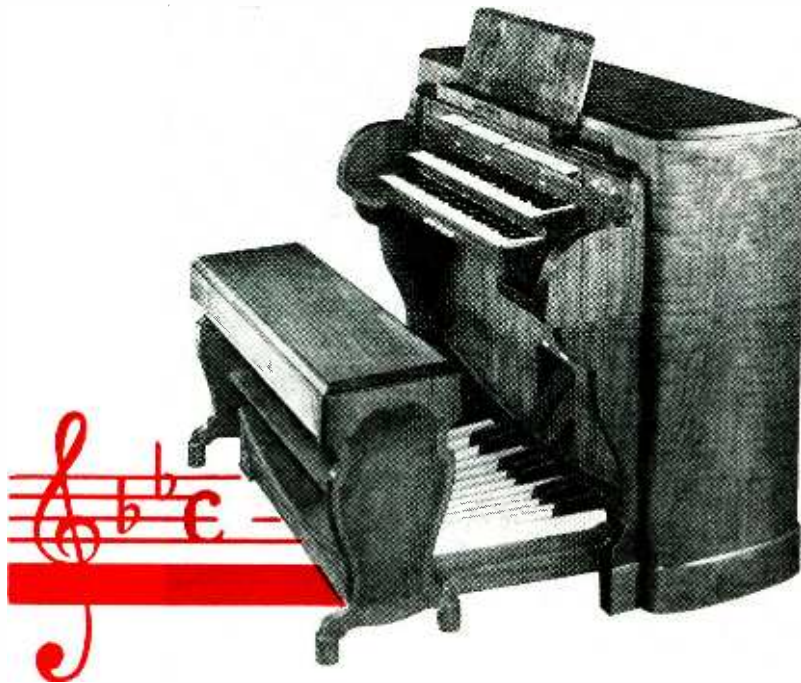

The "mighty Wurlitzer" console looks conventional but today's model speaks from loudspeakers, not organ chamber.

PART I

Beginning a series on practical electronic instruments

By RICHARD H. DORF

NOT a week passes that the editors of RADIO-ELECTRONICS do not receive from three to a dozen letters asking for information on electronic music. The letters are interesting from other standpoints than mere volume. They indicate that, while there is much evidence of burning ambition, there is a striking lack of information on the problems involved.

Most letter writers assume that the main problem is to get together some sort of system that will produce the notes of the scale. Magazine articles describing home-built organs and solo instruments show exactly the same thing. It's too bad—because it simply isn't so! The classic example is the Theremin, which can produce any note in the scale (and any note *not* in the scale, too), but which is still unacceptable as a musical instrument—because of its monotony of tone color, difficulty of control, and sharp attack and decay.

What is music?

Music is a succession of tones of various frequencies and characteristics, sounded sometimes simultaneously and sometimes consecutively, in such a way that the result is pleasing to the ear. That seems a pretty poor definition but it's about as good a one as you can expect. Music is not a science but an *art*, which means that its effect is almost entirely subjective. What sounds good to you may not sound good to me. What a Chinese would call beautiful

melody might sound to you like a horrible noise, and vice versa.

What people mean when they refer to "the science of music" is that the *tools* of music have been artificially conventionalized for the sake of convenience. For example, all of the tones in the musical range are divided into units called octaves. The highest tone of each octave is twice the frequency of the lowest. The octave is further divided into twelve tones, each of which is said to be one half step higher than the preceding one. The ratio between any pair of half tones is equal to the twelfth root of 2 or 1.05946309.

A major scale consists of eight notes, with a half-tone separation between the third and the fourth and the seventh and eighth notes, and the rest are separated by two half tones or a full tone. Minor and other types of scales are made by putting the two half-tone intervals between different notes of the scale.

There is nothing particularly "natural" about this arrangement, but it is convenient. And we are so used to it that music played with other intervals sounds "unnatural." That is why oriental music sounds strange, even unbearable. Some occidental composers have tried to break the convention but have had difficulty in getting public acceptance.

We can further "scientize" the tools of music by showing on an oscilloscope that the tones produced by any instru-

ment are far from pure. Each tone consists of the fundamental plus a number of harmonics. That is one of the most important aspects of electronic music synthesis. If the tone were pure sine wave, it would be devoid of interest—no audience would listen to it. Probably the closest approach to that kind of sound in music is the lower register of the flute when played softly. It is very effective for short periods but the flute would hardly be much good if that were the only tone it could produce. As it is, the flute is at its best when part of an ensemble.

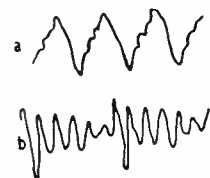

Fig. 1—Waveforms of violin (a) and French Horn (b). At different pitches the oscillograms will look different.

The type of harmonics (whether predominantly odd or even) and the relative strength of each at each fundamental frequency, largely determine the tone quality—whether the tone sounds like a trumpet or a fiddle. Fig. 1-a, for example shows a cycle of the tone produced by a violin; at b is the waveform of a French horn. Every electronic music enthusiast should find an opportunity to examine the traces of

several different instruments (one at a time) on a scope. Even without calculations, he will be able to recognize each one after a while.

But no instrument is worth its salt unless it can generate tones of *varying* quality. Most reed instruments vary somewhat from upper to lower register. Additional tonal effects are produced when the player blows harder. Stringed instruments like the violin family can produce an infinite variety, brought about by changes in bowing angle, bowing speed, use of mutes, and in other ways. The percussive and plucked strings—piano, guitar, etc.—vary in tone quality with touch. And so on. An organ produces a wide variety by using many ranks of pipes, each rank sounding a complete frequency range with a distinctive tone quality. It is really several instruments in one. Music would not be music without this variety.

The electronic approach

Theoretically, electronics allows us to reproduce any natural harmonic structure and even make up new ones. The process is essentially a simple one (until you try to reduce it to practice). If a certain tone shows that it is made up of the fundamental plus certain harmonics, each harmonic having a certain relative amplitude, you can synthesize the tone by mixing together sine-wave tones corresponding to the fundamental and the harmonics, and regulating the amplitude of each harmonic correctly. That method is used in the Hammond organ.

Approaching the same problem from the other end, you can begin by generating a very complex wave, sawtooth, for instance, and synthesize the waveform you want by removing, with filters, the undesired harmonics and regulating the attenuation of each. That is the basis of the Baldwin electronic organ. Whichever you choose, a very formidable problem is how to do it without running costs and space requirements sky-high.

Not all electronic instruments are intended to duplicate the tones of standard instruments, and simpler ways of varying tone color are used. Clippers may add odd or even harmonics to a sine wave, depending on whether one or both of the peaks of each wave are clipped and the degree of clipping of each. Driving a tube into the grid-current region produces a certain type of distortion that results in even harmonics unless two such stages are used in cascade, in which case the harmonics may be odd or even or both. Simple tone controls—high-, low-, or bandpass—alter not only the over-all balance of an instrument but also the harmonic structure of the individual tones.

All acoustical instruments, particularly those of the string family, have *formants*. The body of the instrument is naturally resonant at some frequency above the normal range of pitches played; each time the body is "hit" or shock-excited by a transient in the primary tones, it generates a

damped-wave train at its resonant frequency. This gives a distinctive quality to the instrument and is one reason why some violins are superior to others. The same thing happens to the human voice in the oral cavity, the

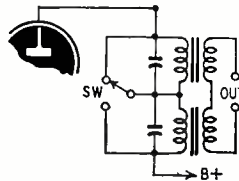

Fig. 2—Selectable resonant circuits simulate resonance of instrument body.

shape of which we adjust to produce the various vowel sounds. The natural frequency of the cavity is a formant. Formants can be produced electronically by passing the audio through a transformer tuned to the formant frequency. The circuit of Fig. 2 produces one of two formants, depending on the position of the switch.

Tremolo or vibrato is characteristic of almost all instruments, including the voice. Tremolo is a small change in *volume* that occurs about six times a second. Vibrato is a change in *pitch* at the same rate. Too much of either is very annoying, but none at all yields an uninteresting musical tone. Whether vibrato or tremolo is preferable is a matter of opinion. Vibrato can be produced electronically by connecting a reactance tube across the tone oscillator and feeding a 5-8-cycle sine signal to its control grid. A tremulant can be made by inserting a variable-mu tube in the audio amplifier and varying its gain with a 5-8-cycle oscillator. (There are, of course, other ways, which will be described in this series.) Fig. 3 shows that tremolo is really am-

plitude modulation at the 5-8-cycle rate, while vibrato is FM.

Another highly important point is the rate of *attack* and *decay*—the shape of the keying envelope. If you connect an audio oscillator to a loudspeaker and put a switch in the line, closing the switch produces the tone much too abruptly. It doesn't sound like music because in every real instrument (including the percussive piano, guitar, celeste, etc.) tone buildup or *attack* takes an appreciable time. Opening the switch shuts off the sound abruptly, which, again, is unnatural. When the player of an acoustical instrument stops blowing or lets go his key, the tone takes a certain time to die away or *decay*. Fig. 4 shows the difference between the keying envelopes. Instruments other than the piano have much longer attack times and shorter decay. Electronic instruments that have no at-

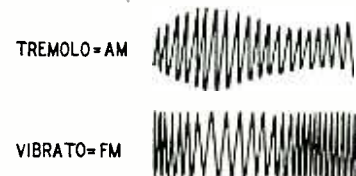
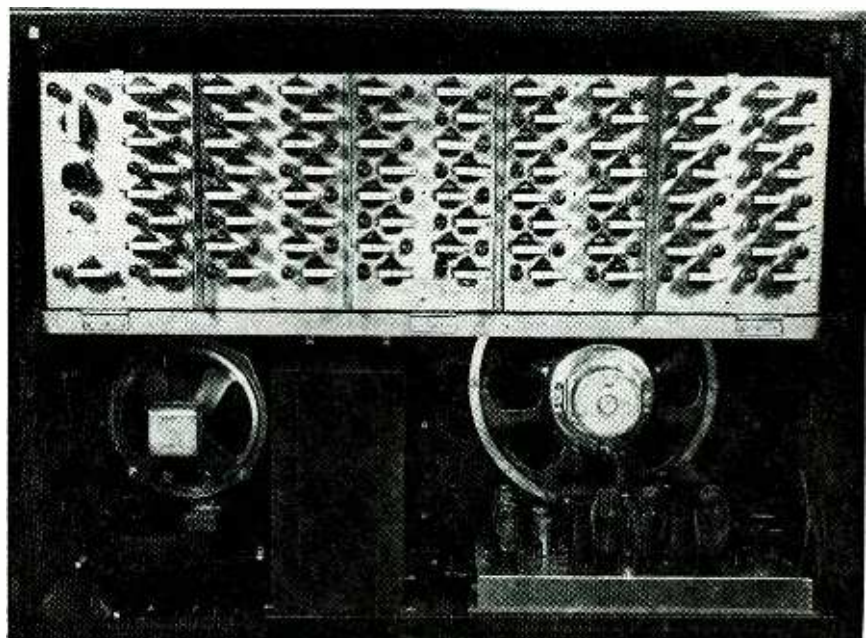

Fig. 3—Tremolo varies the amplitude and vibrato varies the frequency or pitch. Vibrato is generally preferred.

tack and decay control sound very much like code-practice oscillators.

The delay can easily be brought in by using R-C time-constant circuits (among other methods) though again the story may not be so simple in practice, for a harmonic-synthesis instrument like the Hammond organ, for instance, would need a separate delay circuit for each harmonic of each note.

There is one more musical quality, that accounts for the peculiar beauty



In this one-manual-and-pedal Consonette, 73 vacuum-tube oscillators generate the tones. Three more shape the tones and six others amplify the music for the two speakers. This is rear of console, which contains everything.

A 3-Channel Hi-Fi Amplifier

Wanted: An audio amplifier for phonograph and AM-FM radio in the average home. Said amplifier must be so faithful in its reproduction that the most critical ear cannot detect any distortion, and anyone should be able to adjust its response so that the balance of frequencies is right by his or her ear. All this to be built by any radio experimenter in his own shop in spare time and at low cost.

An amplifier designed for low distortion and a versatile frequency balance system

By R. L. EARDLEY-WILMOT

In the *Radio-Electronics Reference Annual* for 1947 there appeared an article by M. Contassot on a high-fidelity 3-channel amplifier. The writer was impressed with the idea and determined to construct a similar set at the earliest opportunity. The two big snags were, as usual, time and money for experimentation.

The first step was to get "wealthy chum" interested in the job. That took a bit of time, but one day WC said,

"Bob, I've decided that amplifier is too good to remain on paper. Let's build it."

"O.K." I replied, "let's start modifying the circuit."

"Oh, no," he said, "there is one condition: we build it just like the man says."

(WC knew little about radio, but had previous experience with my destruction of other people's circuits.)

The next thing was to explain that

certain things had to be changed because of parts that were not available, and also that such modern things as single-ended tubes would improve the design. As long as I was able to give very convincing reasons for changes they were accepted by WC. Then I discovered a better way to get the changes I wanted. That was to educate him in the intricacies of amplifiers. He is a quick learner and after a while I was able to make him think that the changes were his idea. Eventually he came out with original ideas such as,

"That point-one has got to come out of the cathode of the 6SJ7 and be replaced by a 25 μ f. The guy didn't know what he was about!"

I was amazed and delighted. With due apologies to M. Contassot, the 0.1 was quite inadequate in the final product.

The first step in redesigning was to choose tubes to use. No very serious changes here, except to put in single-ended tubes: 6SF5's, 6SJ7, 6F6-G, 5V4-

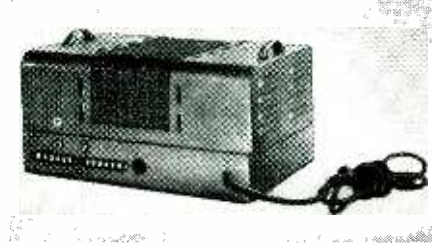

Rear view of the completed amplifier.

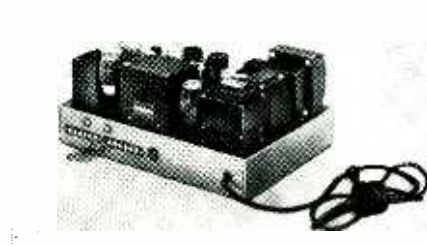

The same view with the cover removed.

◀ ELECTRONICS AND MUSIC (Continued from page 49)

of the sound heard when several similar instruments play in unison. In the first-violin section of an orchestra, for example, all the instruments may sound the same notes; but since the vibrato is produced separately by each player, it not only varies somewhat in rate among the players, but also in phase. At any instant one violin may be sounding a frequency slightly high, another slightly low, and the others anywhere between the maximum and minimum frequency produced by the vibrato swing. Fig. 5 is a graph showing how the frequencies of two violins shift up and down slightly with vibrato. D is the instantaneous frequency difference between the two caused by the independent vibratos. The slight frequency differences make for a *choir* effect. The most impressive proof of its importance is a choir of voices. Each individual voice may be far from good but the ensemble sound (provided the singers at least hit the right pitch) is invariably very acceptable.

Choir effect is one of the hardest things to duplicate on an electronic in-

strument. I know of only one that attempts it (though there may be others), the Hammond organ, in which a complete duplicate set of tone generators is switched in, with the pitches a

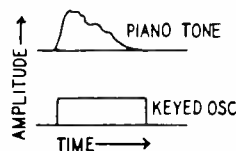

Fig. 4—Manner in which tones build up (attack) and die away (decay) is an important factor in determining character of instrument. Abrupt start and stop of keyed oscillator appears unmusical to the ear, so some way of preventing the tones from "spitting" is always needed.

shade different from those of the main generators. Even so, the sound is not as good as when the variations are random. Besides being difficult to get, this random effect requires a large number of tone generators to give the effect of a large orchestra or choir.

The purpose of this introductory article is to convince the enthusiast that

just producing the right frequencies is not enough to make music. There are many other considerations, and more than those discussed here. Beginning next month, we'll give actual, practical circuits. We will show several ways of obtaining each of the necessary effects. Some of the circuits will be commercial, some experimental, with development up to you. We'll give complete analyses, too, of several of the more important commercial instruments, including schematics and all specifications.

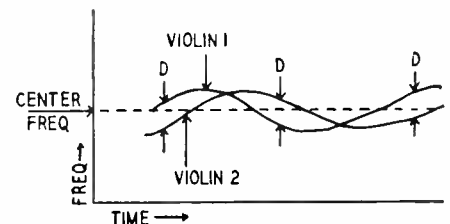

Fig. 5—Differences in instantaneous frequency between instruments in ensemble creates the pleasing "chorus" effect so hard to do electronically.

G being obvious substitutions. We left the 6C5 unchanged. For the other power rectifiers we decided on 6X5-GT's, and for the push-pull amplifiers we were able to get 6B4-G's which are a direct substitution for the 6A5's except that they have directly heated cathodes.

The next items were the power transformers. This reduced to determining what currents the tubes would draw at arbitrary voltages. Let us consider them one at a time.

The power supply for the output tubes required 350-0-350 volts and a 5-volt filament winding. The one we used had a center-tapped 6.3 volt winding at 4.0 amp which was more than enough for the filaments of the 6B4-G's. Then we allowed for two 40- μ f filter capacitors and a 30-henry, 150-ma, 190-ohm choke. That is a huge one, and in another set I should probably use three capacitors and two 10-henry chokes instead. We used 30 μ f in the plate circuit of the 6F6-G and 6SF5 which are also fed from this supply. The current drawn here is about 112 ma.

Next was the grid bias supply. Here we used a 6X5-GT and a transformer having 200-0-200 volts and a 6.3-volt, 2 amp. filament winding. The latter feeds the first five tubes. One side must be grounded to reduce hum. In the filtering of this supply we again used 40- μ f capacitors. The original bleeder was not correctly proportioned for the voltage we were applying, so we put 10,000 ohms on the high side and 3,000 ohms on the low side of the 5,000-ohm potentiometers. That gave plenty of leeway on both sides of the proper bias point.

The last power supply really took a beating, but mostly because we added voltage regulators. We got a transformer with 310-0-310 volts and 6.3 volts at 2.4 amp. The latter was used for the two 6X5-GT's. There being a 5-volt winding on this transformer, we supplied the pilot light from it to insure long life for that piece of finery. For filtering here, we again used two 40- μ f capacitors and a single 7-henry, 40-ma, 340-ohm choke. A 3,000-ohm, 10-watt resistor served where the 25,000-ohm adjustable was shown in the original diagram, and the two OD3's were connected in series causing the current from this supply to be 30 ma.

The next thing was the other transformers and here there is no point in trying to save money. The best, and only the best, is the rule. Hammond, of Canada, puts out one (the 1713) that suits the push-pull output to perfection. Its full range is 30 to 12,000 c.p.s. \pm 1 decibel, and it is free from core saturation down to 30 cycles at full rated output of 15 watts. Primary impedance is 3,000 ohms center-tapped, and output taps are 4, 8, 15, 30, 125, 250, and 500 ohms. Its feedback winding was not used. The original feedback seems quite satisfactory; and because the tubes are running class A1, you can't use current feedback. This transformer's cost of just over \$10

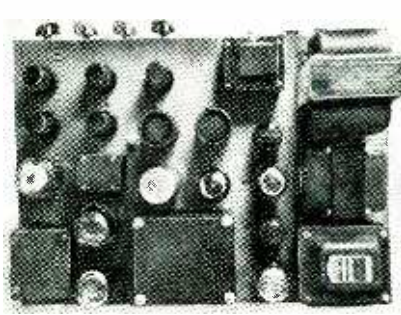

A top chassis photo of the amplifier.

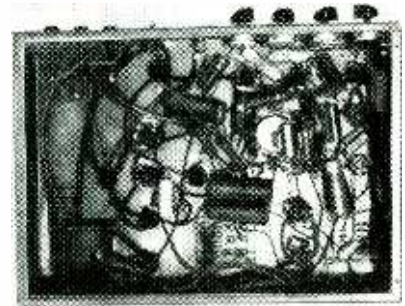

A look at the underside of the chassis.

made it the most expensive part of the amplifier. United States constructors may get an American brand for slightly less or more, depending on quality.

Hammond had a tiny transformer (the 834) for the input coupling in this channel. It has a frequency range of 30 to 15,000 c.p.s., a primary impedance of 20,000 ohms, and a secondary impedance of 10,000 40,000 ohms.

Finally, the other output transformer (Hammond 954) is also flat from 30 to 15,000 c.p.s. and has a primary impedance of 4,000 ohms. Secondary taps provide for 1.5-, 3.75-, 6-, 7.5-, 10-, and 15-ohm voice coils. The maximum output level is rated at 10 watts which is quite satisfactory for a tweeter.

The last question, and one that has never been settled, is the proper value

for the blocking capacitor between the 6C5 and the coupling transformer. By all the rules it should be dependent on the transformer primary inductance, running from 4.0 μ f, if the inductance is 10 henries, to 0.5 μ f if the inductance is as high as 150 henries. We used 0.1 μ f and it seems O.K., but the original circuit called for 0.02 μ f which just doesn't work out, at least mathematically.

The total cost of the amplifier was around \$100 in Canada, including the cost of a specially made chassis; it should be well under that figure in the States. At any price it would be a bargain, for its performance is out of this world.

The photographs and diagrams tell the rest of the story.

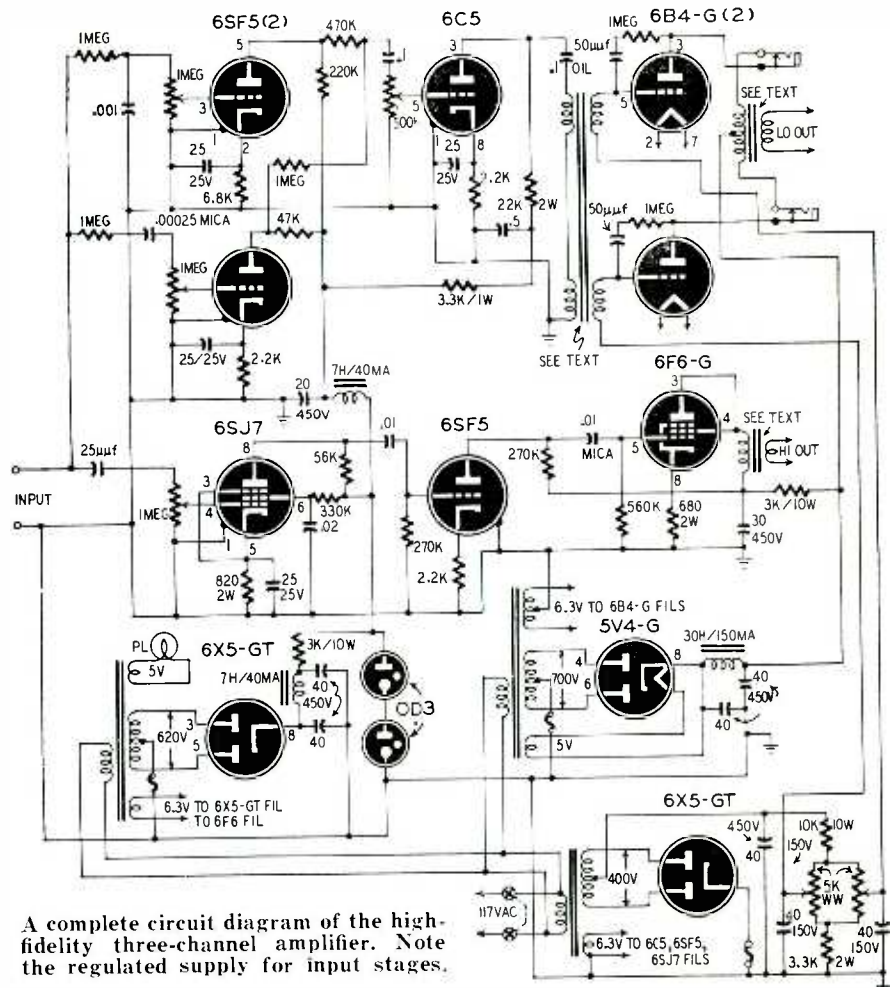

A complete circuit diagram of the high-fidelity three-channel amplifier. Note the regulated supply for input stages.

Square Wave Analysis For Audio Amplifiers



**Part I — Simplified test procedures
make use of the complex square wave
and require fewer test instruments**

◀ One of the essentials of successful square wave analysis is a reliable wideband cathode-ray oscilloscope.

By EUGENE J. THOMPSON

SQUARE-WAVE analysis is a comparatively new and more efficient method for determining frequency characteristics and certain other properties of electronic circuits. It is more rapid and requires less equipment than older test procedures. Although used chiefly for audio work, it has many other applications, some of which will be discussed in these articles.

Fig. 1 is a schematic of a general-purpose audio amplifier whose frequency response must be checked. This particular amplifier circuit is shown only for the purpose of illustration. All of the test procedures described in this article can be applied just as well to any other audio amplifier.

Fig. 2 shows the test setup for obtaining this information by the older

amplitude-vs-frequency method. The output of the amplifier is measured with the v.t.v.m. and recorded on graph paper, while a series of signals of different frequencies but the same amplitude are fed into it. A response curve is drawn through the points marked on the graph paper, plotting the output amplitude against frequency (Fig. 3).

This curve indicates that the frequency response starts to drop off above 8,000 cycles. Therefore, the test must be repeated, stage by stage, and new curves drawn up, to determine the stage or stages at fault. The circuit constants for that stage must then be changed, and the entire test procedure repeated after each substitution until a satisfactory response curve is obtained.

Because of the phase inversion which occurs when a signal passes through an odd number of stages, the output of the signal generator must be absolutely sinusoidal when using this method. The reason for this is that the v.t.v.m. records the amplitude of only the positive half-cycle of the input or output signals; and if both half-cycles are not perfectly symmetrical, the amplitude measurements are erroneous.

The frequency response can also be determined by measuring the *phase shift* which a signal undergoes in passing through the amplifier. The testing arrangement is illustrated in Fig. 4. This method is more sensitive than the previous one because even minute changes in amplitude are accompanied by large shifts in phase. The test procedure is the same as that for the amplitude-vs-frequency method except that the input and output signals are compared as to phase by applying them to the vertical and horizontal plates of a cathode-ray oscilloscope. Depending upon the degree of phase shift, the resulting pattern, called a Lissajou figure, will be a straight line, a circle, or an ellipse, as shown in Fig. 5. The phase shift may be estimated from the shape of the figure, but is best calculated from the formula, $\phi = 2 \tan^{-1} (b/a)$, where ϕ is the phase-shift angle in degrees, b is the length of the shorter axis, and a is the length of the longer axis. See Fig. 5 for an illustration of axes a and b .

As an example, in Fig. 6, the short a is 10 units long. Therefore, $b/a = 6/10 = 0.6$. Looking in a table of \tan^{-1}

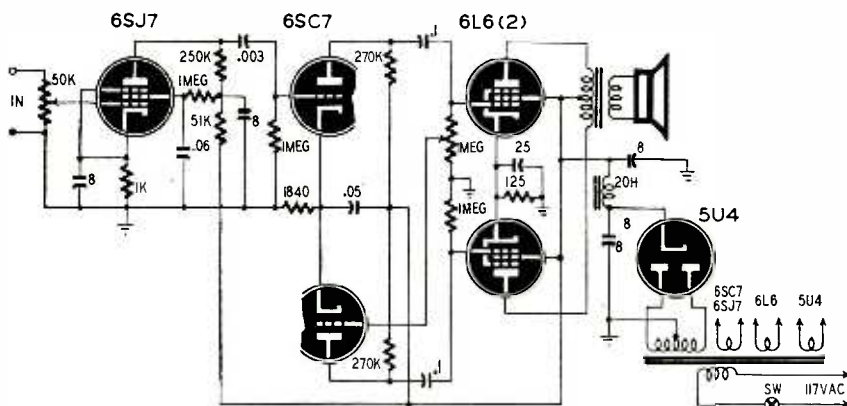

Fig. 1—Circuit of the audio amplifier to be checked with square-wave analysis.

gents to find the angle whose tangent is 0.6090, we find that the closest one is 0.6009, which is the tangent of 31 degrees or 149 degrees. Multiplying these angles by 2 as the formula states, the phase shift is $31 \times 2 = 62$ degrees or $149 \times 2 = 298$ degrees. To determine which of the two is the correct phase

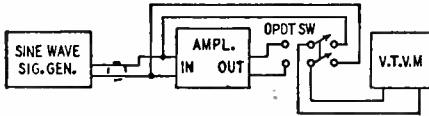

Fig. 2—Test setup for frequency check.

angle, note that the Lissajou figure in Fig. 6 is tipped over to the left. Hence, the phase shift is approximately 62°. Had it been tipped over to the right, the phase angle would be about 298°.

The calculation is made for every frequency fed into the amplifier, from 500 to 15,000 cycles. However, in draw-

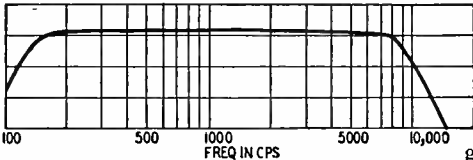

Fig. 3—Response curve of the amplifier.

ing up the response curve, phase shift, instead of amplitude, is plotted against frequency. If the curve is not sufficiently flat, the faulty stage or stages must be located by point-to-point testing, substitutions made, and the entire procedure repeated as before.

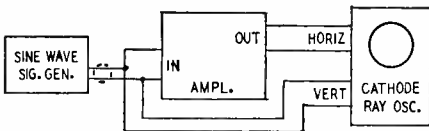

Fig. 4—Hookup for phase shift check.

Compared to these procedures, square-wave analysis (Fig. 7) is simplicity itself. To apply it, set the fundamental frequency of the square-wave generator at 500 cycles. The input signal to the amplifier is viewed on the wideband oscilloscope to make sure that it is square. A slight adjustment in the coupling capacitor between the generator and the amplifier input may be necessary to compensate for loading effects which distort the square wave-shape. The scope is then switched to the output of the amplifier and the waveform viewed to see if it is square. If it is, the frequency response is satis-

factory from 500 to 15,000 cycles. If the output waveform is distorted, the amplifier needs adjustment. The scope is then switched to the output of the next to the last stage, then the stage before that, and so on, until the wave-shape becomes square. This localizes the difficulty to the following stage.

Adjustments are made in the amplifier until the waveform assumes a square shape. The amplifier is then passing all frequencies between 500 and 15,000 cycles. There are no multi-

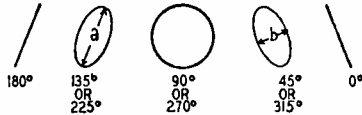

Fig. 5—The patterns show phase shift.

ple-frequency checks, no calculations, and no curves to be drawn!

Strangely enough, square-wave analysis is so simple because square waves are so complex. Theoretically, a square wave is the algebraic sum of a fundamental frequency and an infinite number of its harmonics, all sinusoidal in shape and all having a common time of origin. In practice, however, the 30th harmonic is the highest order of sufficient amplitude to be of consequence. Fig. 8 suggests how the fundamental and its harmonics combine to produce a square wave by flattening the top and steepening the sides of the original sinusoidal waveform.

Not all square waves are alike. They may differ in period or repetition rate, frequency, amplitude, and percentage width. The *period* or *repetition rate* is the reciprocal of the frequency of the fundamental and is defined as the time between the beginning of any two successive pulses. The time duration of the pulse t_1 is called the *pulse width*. These characteristics of the square wave are illustrated in Fig. 9.

The ratio of the pulse width t_1 to the period t , when multiplied by 100, is known as the *percentage width*: $t_1/t \times 100 = \text{percentage width}$. The percentage width depends upon the harmonic content of the particular square wave. It is possible to prove this by a complex mathematical procedure known as a Fourier expansion. This operation is used to analyze com-

plex wave-shapes and to determine the amplitudes and natures of their components. A tabulation of the amplitudes of the fundamental and all its harmonics up to the 30th of square waves

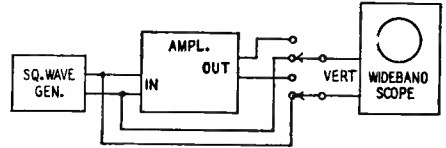

Fig. 7—Square wave amplifier check.

of different percentage widths is given in the table of square-wave components. This table lists percentage widths in steps of 10%, from 10% to 90%. The figures in it were obtained by using a Fourier expansion.

The next and concluding article of this series will describe various types of circuits for producing square waves and the practical applications of square-wave analysis.

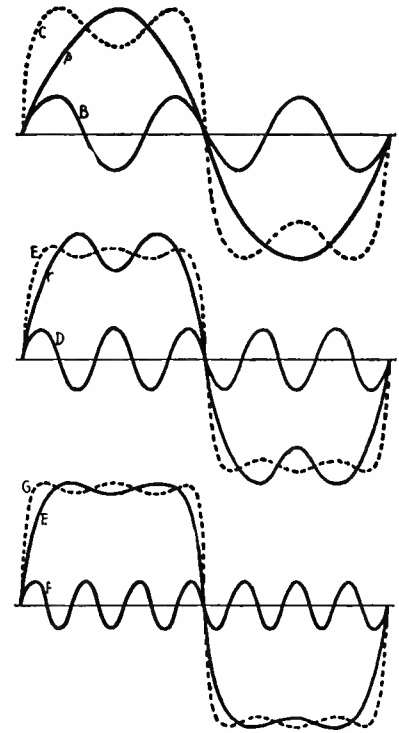

Fig. 8—These curves indicate how the harmonics add to form the square wave.

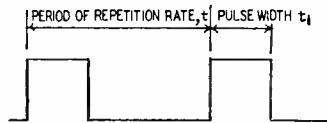

Fig. 9—Square wave time definitions.

SQUARE-WAVE COMPONENT TABLE

Percentage width	Harmonic																													
	1	2	3	4	5	6	7	8	9	10	11	12	13	14	15	16	17	18	19	20	21	22	23	24	25	26	27	28	29	30
10% or 90%*	.20	.19	.17	.15	.13	.10	.07	.05	.02	0	-.02	-.03	-.04	-.04	-.04	-.04	-.03	-.02	-.01	0	.01	.02	.02	.03	.03	.02	.02	.01	.01	0
20% or 80%*	.37	.30	.20	.09	0	-.06	-.09	-.08	-.04	0	.03	.05	.03	.03	0	-.02	-.04	-.03	-.02	0	.02	.03	.03	.02	0	-.01	-.02	-.02	-.01	0
30% or 70%*	.52	.30	.07	-.09	-.13	-.06	.03	.08	.06	0	-.05	-.05	-.02	.03	.04	.02	-.01	-.03	-.03	0	.02	.03	.01	-.02	-.03	-.01	.01	.02	.02	0
40% or 60%*	.61	.19	-.13	-.15	0	.10	.05	-.05	-.07	0	.06	.03	-.03	-.04	0	.04	.02	-.02	-.03	0	.03	.02	-.02	-.03	0	.02	.01	-.01	-.02	0
50%	.64	0	-.21	0	.13	0	-.09	0	.07	0	-.06	0	.05	0	-.04	0	.04	0	-.03	0	.03	0	-.03	0	.03	0	-.02	0	.02	0

*Reverse signs given in table for pulse percentages over 50%



The author (rear left) gives weekly instruction to a naval reserve unit, whose members later applied their training on the Murmansk run and in the Pacific.

Seven Basic Steps To Learn The Code

By SAMUEL FREEDMAN

THIRTY years ago I learned the continental or international code. Since that time, I have been rated on sounder or buzzer or on actual signals at such typical speeds as 38 words per minute for coded material containing many consonants and 55 words per minute for plain language containing many vowels.

I have repeatedly seen men flunk their code tests for amateur radio license even though they definitely were able to copy well in excess of the required speed (13 words per minute) before reporting for FCC examination. The reason is always the same: over-practice in the letters which appear most often in common English, such as newspaper text. These letters generally have the simplest and shortest dot-and-dash combinations to remember. The most practice is needed in these letters which appear least often in plain English text and which have the more complex or longer dot-and-dash combinations.

This very thing which flunks them is just what makes possible the art of cryptography or the breaking down of

a coded message. For example, the letter E appears 128 times more frequently than the letter Q in English. The letter E is one dot and very easy to remember as well as quick to transmit. The letter Q is dash-dash-dot-dash, which is more difficult to remember and actually requires about 13 times longer to transmit or receive than the letter E.

Telegraphy appears either easy or difficult to master, depending on the student's viewpoint and introduction. The difficult approach is to say that learning the code is equivalent to learning a foreign language. *But*, where could a student ever hope to find a language that contained only 26 symbols to learn, plus 10 numerals and a few punctuation marks and procedure signals? The English language has approximately 380,000 words in its vocabulary. The language of the code has only 40 to 50 characters. (The higher figure includes abbreviations and foreign accented letters not used in English.) Knowing these 40 to 50 characters, the telegrapher can converse with no trace of accent or eccen-

Code teaching experience of the author has led to a break-down of the code that makes learning easy

tricity with a telegrapher of any other nation in the world, whether German, Japanese, Scandinavian, Russian, South American, or anyone else. Even an infant can learn that many words or details in its repertoire.

The telegraph code as required for radio license and radio telegraphy throughout the world is made up entirely of dots and dashes. The dots are called or sounded like "dits" and the dashes each sound like "dah". The letter A sounds dit-dah; B, dah-dit-dit-dit; etc.

Telegraphy code units

The *dot* is the unit of size. The time required to send a dot regulates the length of the dash and the interval spacings. The over-all code speed is dependent on the size of the dot used. A short dot is therefore associated with a high telegraphic speed while a longer dot is associated with a reduced telegraphic speed.

The *dash* is three times longer in duration than the dot.

The *space* between dots, or dashes, or dots and dashes, within a single letter is usually said to be the duration of one dot. It should be long enough to make the separation obvious but not long enough to make it appear detached in the letter being formed. For example, A is dot-dash (sounded dit-dah). If the interval between the dot and dash is too long, the listener will think it is a letter of one dot (E) plus another letter of one dash (T).

The spaces between letters or numerals should be equal to a dash or three dots in duration. In practice, it may be a little more for beginners learning the code and a little less for speed demons trying to get maximum code speed.

The spaces between words should be equal to about five dots (more or less, as in the case above).

Just as a typewriter has the most commonly used letters conveniently located, so does the telegraph code have the more commonly used letters (based on all languages rather than on the English language alone) provided with the shortest dot and dash combinations. It is done to save time in transmission. Whether by design or by accident, the fact remains that the letters used least often in the common languages of the world have the longer combinations of dots and dashes while those used the most often (particularly some of the vowels) have the shortest combinations. If one were to catalogue the letters of all the words in a lengthy normal

(Continued on page 56)

RADIO-ELECTRONICS for

it's ALLIED for hallicrafters!



the De Luxe S-72 All-Wave Portable

ONLY
\$9.00
DOWN

Enjoy powerful all-wave reception wherever you go! The S-72 covers 4 bands: 540-1600 kc, 1500-4400 kc, 4.3-13 mc, and 13-31 mc. Has two built-in antennas—loop for standard broadcast and 27" whip for short wave. Automatic Noise Limiter; sensitivity control; AVC; BFO; main and fine tuning controls; tone control; phone jack; provision for attaching external antenna. Brown leatherette-covered plywood cabinet, 14" wide, 12 1/4" high, 7 1/4" deep. For 105-125 volts DC, or 60 cycle AC, or self-contained battery. Complete with tubes, less battery. Shpg. wt., 16 lbs.

97-505. S-72 Portable. *Only*..... **\$8995**
\$9.00 down, \$7.15 monthly for 12 months
80-585. A-B Battery Pack for above. NET..... **\$3.85**



ONLY **\$17.95** DOWN

SX-71 Communications Receiver

A top-performing communications receiver at amazingly moderate cost! Designed especially for the discriminating Amateur. Covers five full bands: 538-1650 kc; 1600-4800 kc; 4.6-13.5 mc; 12.5-35 mc; 46-56 mc. Features double conversion superhet circuit, high image rejection, razor-sharp selectivity, extremely high sensitivity. Includes: full electrical bandspread; tuned RF stage, 3-step crystal filter; built-in NBFM adapter; automatic noise limiter; calibrated "S" meter; BFO pitch; tone control; extra-wide-vision dials; 3-watt communications-peaked audio; temperature compensation; universal antenna input. In satin-black steel cabinet; 18 1/2 x 7 3/8 x 12". Complete with 11 tubes, rectifier and regulator. For 105-125 volts, 50-60 cycles. Shpg. wt., 33 lbs.

97-506. SX-71, less speaker. *Only*..... **\$17950**
\$17.95 down, \$14.27 monthly for 12 months
97-786. R-44B matching speaker. 19 lbs..... **\$24.50**

For Airports
Airplane
Owners
Marine
Service

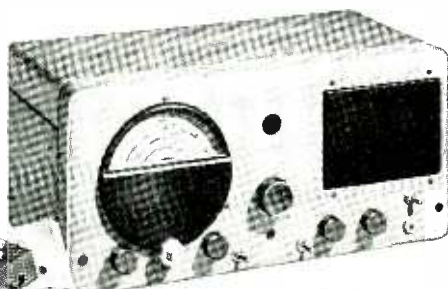

ONLY
\$14.95
DOWN

S-51 Marine and Airport Receiver

Designed especially for marine use, weather stations, time signal reception, etc. Ideal for getting weather reports from range stations. Also covers standard Broadcast and HF Aircraft bands. Has 4-band range from 140 kc to 12.0 mc, plus 3 pre-set frequencies—one between 200 and 300 kc, and two in the 2 to 3 mc range. Has BFO pitch control; automatic noise limiter; tone control; permeability-tuned IF's; universal antenna input. Accurately calibrated dial with inertia fly-wheel drive. Built-in PM dynamic speaker. All metal parts plated to resist corrosion. For 110-120 volts AC or DC (6, 12, or 32 volt power packs available at \$22.50 extra). Complete with 9 tubes and rectifier.

97-564. S-51 Receiver. *Only*..... **\$14950**
\$14.95 down, \$11.89 monthly for 12 months



**NEW ALLIED
CATALOG
SUPPLEMENT**

Latest Releases - Special Values

Send for ALLIED's latest Supplement! Packed with new TV releases, recorders, Hi-Fi Music and P. A. Systems, new electronic developments—plus hundreds of big values. Write for your FREE ALLIED Catalog Supplement today!

ALLIED RADIO

Everything in Radio, TV & Electronics

ALLIED RADIO CORP.,
833 W. Jackson Blvd., Chicago, 7, Ill., Dept. 2-G-O
 Send FREE ALLIED Catalog Supplement
 Enter order for Hallicrafters Model.....
 Enclosed \$..... Full Payment
 Part Payment (Bal. C.O.D.)
 Send Time Payment details and order blank.

Name.....

Address.....

City.....Zone.....State.....

newspaper article, it would average up approximately as indicated below.

LETTER	FREQUENCY PER THOUSAND LETTERS	MAKEUP	TIME REQUIRED TO HANDLE (Dot Units)
E	128	- dit	1
T	86	- dah	3
O	81	--- dah-dah-dah	11
A	78	-- dit-dah	5
N	69	-- dah-dit	5
I	68	-- dit-dit	3
R	65	--- dit-dah-dit	7
S	62	--- dit-dit-dit	5
H	60	--- dit-dit-dit-dit	7
D	40	--- dah-dit-dit	7
L	37	--- dit-dah-dit-dit	9
U	31	--- dit-dit-dah	7
C	30	--- dah-dit-dah-dit	11
M	29	--- dah-dah	7
P	22	--- dit-dah-dah-dit	11
F	20	--- dit-dit-dah-dit	9
Y	19	--- dah-dit-dah-dah	13
W	18	--- dit-dah-dah	9
G	17	--- dah-dah-dit	9
B	14	--- dah-dit-dit-dit	9
V	11	--- dit-dit-dit-dah	9
K	8	--- dah-dit-dah	9
J	5	--- dit-dah-dah-dah	13
X	3	--- dah-dit-dit-dah	11
Z	2	--- dah-dah-dit-dit	11
Q	1	--- dah-dah-dit-dah	13

The letters which are among the ten lowest in frequency while at the same time being among the fifteen requiring the longest time to transmit are Q, Z, X, J, K, V, B, G, W, and Y. They should be given heavy inclusion in practice texts for code instruction.

The letters which are among the ten highest in frequency of occurrence and among the fifteen requiring the shortest time to transmit—are least complex in makeup—are E, T, A, N, I, R, S, H, D, and O. These should get lighter treatment in practice texts. The remaining letters C, P, L, F, U, and M should get moderate inclusion.

Numerals are very easy to remember because they follow a simple pattern of construction, but are confusing when used in a mixed text of letters and numerals. Use heavy practice texts of mixed letters and numerals, particularly consonants or low-frequency letters with the numerals. Table 1 lists the code classifications as used in the continental code throughout the world.

The Seven Steps

Starting with no knowledge of the code, it can be learned in a series of steps. An hour of instruction (plus the review of previously studied steps) should cover each step until all have been covered and reviewed. Thereafter, the student should work the entire code on lengthy practice texts made up of a small amount of plain language, a medium amount of coded texts, and a large amount of mixed letters and numeral groups. The usual practice is to use five-character groups although deviations from this are permissible and even desirable for part of the practice.

1. Dots alone and dashes alone

(total 7 letters)

..	(dit) E
...	(dit-dit) I
....	(dit-dit-dit) S
.....	(dit-dit-dit-dit) H
-	(dah) T
--	(dah-dah) M
---	(dah-dah-dah) O

Practice Text:

SHIEH TOTOM TOMME ESEIS OMTTO
 TIEHO IEHSI MTMOO HESMT SISHE
 MOOTM MOHSI SSHIE TOMMO SITOH
 SEHIS OTMIO EMOTS IHSEH OTOMT
 IHMTO ISEHS MMTOT OSHOM OHETE
 ETIES EIHIIH MTMMT ISMIIH EHIES
 SHIEM EHTHI.

The above text has averaged groups of dots alone, dashes alone, and of dots and dashes together.

2. Combination dot-dash letters

Plus those in step 1 (total 12 letters).
 -- (dit-dah) A
 --- (dit-dit-dah) U
 ---- (dit-dit-dit-dah) V
 - (dit-dah) A
 -- (dit-dah-dah) W
 --- (dit-dah-dah-dah) J

Practice Text:

VAUIJW JTEMU AVIJU EIJWJ WUAJVJ
 IMVJW UAVIV WEMAV JWUWA VSTUM
 JVVAV SASVA UAJVW HVITO WUAU
 UWHOH AWWVJ TJOST VJWUA AHUIS
 OUAHE MOWEI AOHMW TEJAU.

3. Combination dash-dot letters

Plus those in steps 1 and 2 (total 16 letters).
 --- (dah-dit) N
 ---- (dah-dit-dit) D
 (dah-dit-dit-dit) B
 - (dah-dit) N
 -- (dah-dah-dit) G

Practice Text:

NGBDG JNDWB BNDNB VGUEA DGBDB
 MIOST HBNWM GNDBN DEHAV BDGGD
 UJTIS GOAWU NBNND VJMHG BNSTI
 DNBGB DIHOA UWSEG GBNDG EDMTN
 WJETS INBJG AWMDO GBJND.

4. Combination dot-dash-dot letters

Plus those in steps 1 to 3 inclusive (total 20 letters).
 ---- (dit-dah-dit) R
 (dit-dah-dit-dit) L
 ----- (dit-dit-dah-dit) F
 - (dit-dah-dah-dit) P

Practice Text:

F PRR JLETM LFRPL VRWHI FAUSP
 J RFLP NPBGO LESTI RPLFL RMVJN
 RRPLF GBPDF WAOLU LFRLL VRWLJ
 MALHU PFRPL DJBIG FRLPF BREPL.

5. Combination dash-dot-dash letters

Plus rest of alphabet steps 1 to 4, inclusive (total 26 letters).
 ---- (dah-dit-dah) K
 (dah-dit-dit-dah) X
 ----- (dah-dit-dah-dah) Y
 - (dah-dit-dah-dit) C
 -- (dah-dah-dit-dit) Z
 --- (dah-dah-dit-dah) Q

Practice Text:

This practice text material heeds the frequency table but favors the lower-frequency letters with the longer and more complex makeups.

HNRVQ JYQPC MXZWF LOSER GAITU
 DUNCE BEAST WOMAN KGFHK LONEC
 BJQYX UNITE DBQVZ HURTS PURER
 FOUND GLADY JINXY COMET SVQZK
 PFGBH LIVID WALKS YOUNG QUACK
 BFHMJ QPXZJ NAILO XHPYC MVZYQ
 WBDFE GHJIK RMLPS QTVZW XJLRT
 VZYKG CHIMP BEDOX FQWCY JQCYZ

6. Numerals

-----	(dit-dah-dah-dah-dah)	1
-----	(dit-dit-dah-dah-dah)	2
-----	(dit-dit-dit-dah-dah)	3
-----	(dit-dit-dit-dit-dah)	4
-----	(dit-dit-dit-dit-dit)	5
-----	(dah-dit-dit-dit-dit)	6
-----	(dah-dah-dit-dit-dit)	7
-----	(dah-dah-dah-dit-dit)	8
-----	(dah-dah-dah-dah-dit)	9
-----	(dah-dah-dah-dah-dah)	0

Numerals are easy to learn by themselves since they follow a simple and obvious pattern. The number 1 has one dot and four dashes; 2 has one more dot and one less dash, etc. By the time

5 is reached, all the dashes have been used and the number is all dots. Then the reverse takes place: 6 is one dash and four dots; 7 is one more dash and one less dot. By the time zero (after 9) has been reached, the character is all dashes. In practice, a very long dash is sometimes sent instead of five dashes for the numeral zero (although this is not theoretically correct). In every case, a numeral has five dots or dashes or combination of the two. To avoid confusion between letter "O" and numeral "0" (zero), it is customary to indicate zero with a slant, thus "0/", when used in mixed makeups of letters and numerals.

Practice Text:

15643 #5876 29842 317#5 96318 27#27 4#194
 58623 61738 59#54 81369 45#95 5#713 83716
 24892 32685 7865# 491#4 34651 72#72 53641
 5#768 48922 17#35 68139 7#227 4#491 85632
 78613 #9554 84582 37437 21455 26359 15#34
 28942 69119 85#57 43217 95281

7. Mixed letters and numerals

(26 letters and 10 numerals)
Practice Texts: These should be made up in random combinations of letters alone, numerals alone, and letters and numerals, but in every case should be so averaged as to give equal familiarity with all letters and numerals. It is also desirable to favor the harder-to-remember combinations in the ratio of three to two or even two to one. Typical examples are:

B6 H5 SI QY CK WJ 4V X7 82 O# DA E3
 Z1 UT FM GL RP N9 CB# DG5 JP2 E4A
 3VK FH6 IS9 MLQ WXY UZ1 87# NRT X4UD
 YQ6J VLNP RCA7 KOTE GFH3 IMOS BW5Z
 2189 JA5U YP2IC FNQ#L 4RKHT SIOMW
 BG4D7 X6JVE 3ZCJQ ZXK#5

Do not worry about learning plain language texts. That will be acquired automatically with the use of coded or cipher text material.

General rules to remember

1. Frequent short practice periods are much better than infrequent long practice periods. Daily periods of 30 minutes each are many times more effective than 7 hours once a week.

2. Skip about the alphabet rather than using alphabetical or numeral sequences.

3. Memorize each letter and numeral as an audible dit or dah combination. Do not make things hard for yourself by going through a double conversion (visual conception as laid out on paper and aural conception as it is heard on headphones or from a buzzer).

4. When two persons are practicing, the one doing the sending will be less competent than the one doing the receiving. Receiving should be 90% (not 50%) in acquiring a knowledge of the code. It is always easy to learn how to send if you know the code and can receive it.

5. Plain language text does not make for good instruction. It is too easy to guess missing letters or the last part of words.

6. In sending practice, make sure that parts of a letter are not disengaged. Do not separate the dash from the three dots in B so it sounds like T and S. Likewise, do not let C sound like

NN, F like IN, Q like MA, V like ST, X like TU, Y like NM or TW, G like ME, J like AM, L like AI, P like AN, U like IT, or Z like MI. This *always* happens during initial code instruction and must be avoided by proper formation and spacing of the characters.

7. *Win the battle!* Don't linger or ponder when one letter is missed. Leave a blank space and *keep going*. Otherwise you get out of the groove and lose a whole chunk of text before being able to resume again. *Stay in the groove* even if you miss an occasional letter.

8. You have not really learned the code until you can hold part of it in your mind and copy behind. I, like other professional telegraphers, can stay several words behind on plain language and a word or two behind on code and cipher. This ability is very useful so a man can light a pipe or cigarette while telegraphing, hop over to the water cooler for a cold drink, or munch a sandwich while on watch if no relief is available and traffic will not end. At speeds of 25 words per minute or less this is not too difficult.

9. Too slow telegraphing will put anyone to sleep. Regardless of code speed ability, *make the characters fairly fast* and allow any length interval between letters and words that may be necessary. In the beginning the interval will be long. Later this is reduced until it becomes normal or the minimum necessary to permit intelligible reception. Make your characters smart and sharp. Make A as "dit-dah" not "deeeeeeeet-dahhhhhhhhhhhhhhhhhhh".

10: Speed is a very relative thing. It depends largely on the exact letters used to make up the words. Letters made up of several dashes are going to come through much slower than those made up of few dots. It takes 13 times longer to handle Y, J, or Q than it does E. Raise your speed on an average of all characters used to make up five-word groups. If you base it on newspaper text, chop off a third of the computed speed.

How elaborate or modest the equipment for code practice happens to be has little importance so long as the equivalent of a key and buzzer is available. Even prisoners can telegraph prison-wide with surprising efficiency by use of the "Devil's Island" code which may be transmitted by tapping on conducting metal. They simulate dashes by the use of two dots run closely together. B for example is tapped "dit-dit dit dit dit".

The advantage of code is the ease in which intelligence can be conveyed without a specially provided modulation system, making possible the simplest form of radio transmitter. It provides intelligibility under conditions that are unfavorable for voice (conditions of static, signal fluctuations, etc.).

Above all, code is necessary to qualify for an amateur radio license or for any position involving radio-telegraphic operation. All of radio and electronics and much of nucleonics was founded on offshoots of the radio-telegraphic art. Telegraphy will be

with us a long time professionally and forever as a hobby.

TABLE I
CLASSIFICATION OF THE
CONTINENTAL CODE.
DOTS ONLY

E
I
S
H
5

DASHES ONLY

T
M
O
CH
Zero

NUMERALS

1
2
3
4
5
6
7
8
9
0

DOT-DASH

A
U
V
4

A
W
J
1

R
L
Wait
F
P

DASH-DOT

N
D
B
6

N
G
(disregard signal)
9

K
X
Break, equal sign
or separation
Hyphen
C
Y
Q
Z

ABBREVIATIONS (TYPICAL)

HL	(Hasta Luego. Spanish So Long).
AW	(Auf Weidersehen German).
GM	Good morning.
GN	Good night.
GB	Goodbye.
OM	Old man.
73	Best regards.
88	Love and kisses.
TMW	Tomorrow.
CUL	See you later.
N	No or negative.
Y	Yes or affirmative.
R	Received and understood.
TU	Thank you.
SVC	A service message.

Many other clever abbreviations exist including mischievous and profane.

MISCELLANEOUS

K or go ahead and send.
Wait or stop sending.
Starting signal.
German dual letter CH.
French accented letter é.
German accented letter ü.
Spanish accented letter ñ.
Error signal. Start word again.
End of a message.
End of entire transmission.
Dutch accented letter ö.
Scandinavian accented letter ä.
French accented letter á.
Parenthesis sign. One each end.
Quotation mark sign. One each end.
Fraction mark or slant sign.
SX or dollar sign.
L or English pound (sterling) sign.

Patent Pending

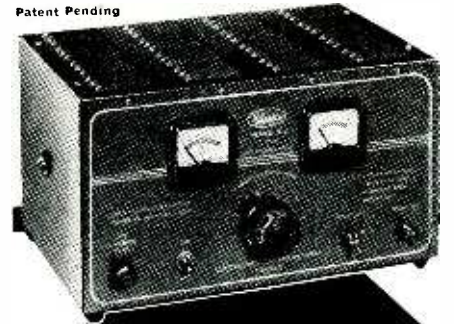

new!
LOW COST DC SOURCE
ELECTRO "BJ" JUNIOR
SUPPLIES 1 to 12.5 AMPS.
6 VOLTS CONTINUOUS DUTY

3 to 9 Volts
at Other Ratings

Demonstrate and Test from AC Lines . . .

Auto Radios • Relays • Telephone Circuits • Instruments • Other Low Voltage Devices

New Electro Model "BJ" Junior filtered power supply utilizes the same exclusive application of selenium rectifiers being used in the famous Model "B". This application, using conduction cooling, doubles the rectifier power rating, dissipates over 3 times the heat and provides lower cost per ampere output over other types. Provides ample power, with a peak instantaneous current rating of 25 amperes (from standard 50/60 cycle 115 volt source.) Heavy duty components withstand high over-loads. AC ripple less than 0.4 volts at 6 volts DC 8 amperes.

Net Price Only \$32⁴⁰

UNMATCHED PRICE • PERFORMANCE • QUALITY

SEND FOR FACTS TODAY!

Electro Products Laboratories
4507-BJ N. Ravenswood Ave.,
Chicago 40, Ill.

Send me specifications, prices and name of my nearest distributor.

Name.....

Address.....

City.....State.....



2 Pages of TEST EQUIPMENT at prices every serviceman can afford!

OUR POLICY

KITS? *We have discontinued advertising Test Equipment in kit form. After handling kits for some months, we have come to the conclusion that it is impractical to successfully complete instrument*

MONEY BACK? Every unit we advertise is offered on a strict "money-back-if-not-satisfied-basis". No if's—no but's—no maybe's. If you are not

GUARANTEE? Every unit sold by us is covered by a one year guarantee.

kits at home without the expensive calibration standards and other equipment available when instruments are factory produced.

completely satisfied after a 10 day trial—return for complete refund. No explanation—you are the sole judge. Plain enough?

**SUPERIOR'S
NEW
MODEL TV-10**

TUBE TESTER



Specifications:

★ Tests all tubes including 4, 5, 6, 7, Octal, Lock-in, Peanut, Bantam, Hearing-aid, Thyatron, Miniatures, Sub-Miniatures, Novals, etc. Will also test Pilot Lights.

★ Tests by the well-established emission method for tube quality, directly read on the scale of the meter.

★ Tests for "shorts" and "leakages" up to 5 Megohms.

★ Uses the new self-cleaning Lever Action Switches for individual element testing. Because all elements are numbered according to pin-number in the RMA base numbering system, the user can instantly identify which element is under test. Tubes having tapped filaments and tubes with filaments terminating in more than one pin are truly tested with the Model TV-10 as any of the pins may be placed in the neutral position when necessary.

★ The Model TV-10 does not use any combination type sockets. Instead individual sockets are used for each type of tube. Thus it is impossible to damage a tube by inserting it in the wrong socket.

★ Free-moving built-in roll chart provides complete data for all tubes.

★ Newly designed Line Voltage Control compensates for variation of any line voltage between 105 Volts and 130 Volts

The Model TV-10 operates on 105-130 Volt 60 Cycles A.C. Comes housed in a beautiful hand-rubbed oak cabinet complete with portable cover.

\$39⁵⁰
NET



SUPERIOR'S new model TV-30

TELEVISION SIGNAL GENERATOR

ENABLES ALIGNMENT OF TELEVISION I. F. AND FRONT ENDS WITHOUT THE USE OF AN OSCILLOSCOPE!

FEATURES—Built-in modulator may be used to modulate the R. F. Frequency also to localize the cause of trouble in the audio circuits of T. V. Receivers. Double shielding of oscillatory circuit assures stability and reduces radiation to absolute minimum. Provision made for external modulation by A. F. or R. F. source to provide frequency modulation. All I. F. frequencies and 2 to 13 channel frequencies are calibrated direct in Megacycles on the Vernier dial. Markers for the Video and Audio carriers within their respective channels are also calibrated on the dial. Linear calibrations throughout are achieved by the use of a Straight Line Frequency Variable Condenser together with a permeability trimmed coil. Stability assured by cathode follower buffer tube and double shielding of component parts.

SPECIFICATIONS—Frequency Range: 4 Bands—No switching; 18-32 Mc. 35-65 Mc., 54-98 Mc., 150-250 Mc.

Audio Modulating Frequency: 400 cycles (Sine Wave). Attenuator: 4 position, ladder type with constant impedance control for fine adjustment. Tubes Used: 6C4 as Cathode follower and modulated buffer. 6C4 as R.F. Oscillator. 6SN7 as Audio Oscillator and power rectifier.

Model TV-30 comes complete with shielded co-axial lead and all operating instructions. Measures 6" x 7" x 9". Shipping Weight 10 lbs.

\$29⁹⁵
NET

--- TO ORDER—USE RUSH ORDER FORM ON NEXT PAGE ---

GENERAL ELECTRONIC DISTRIBUTING CO.

98 PARK PLACE
DEPT. RC-7
NEW YORK 7, N. Y.

TRANSVISION 19" KIT

\$104⁰⁰
less C.R. Tube*

Finest Quality



ANYONE can easily assemble the famous Transvision Kit. No technical knowledge or instruments required. Instruction sheet is simple (each part is packaged and numbered). *ALL IF'S are wired and pre-tuned.* NOTE: Kit comes complete with all parts except picture tube.

COMPLETE LINE: TV only ("A" line). Also TV-and-FM Radio ("D" line). 12½", 16", 19". Choice of tuners includes famous DuMont Inputuner.

* **PICTURE TUBES:** 16" all glass, fully guaranteed net\$35.00
19" all glass, fully guaranteed net\$62.00

WIRED TV CHASSIS

Completely Wired and Aligned

Transvision "A" Chassis (TV only) comes completely wired, aligned and operating. Especially designed for fringe area reception. 23 tubes, AFC, AGC. Wired-in phono plug. Picture tube and speaker not included. Transvision "D" Chassis (TV-and-FM Radio) has famous DuMont Inputuner.

PRICES: 16" TV Chassis ("A" line) ... net \$115.00*
19" TV Chassis ("A" line) ... net 122.00*

* Picture tube and speaker are extra.

TV CABINETS

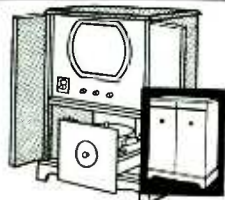

Newly styled complete line of beautiful hand-rubbed cabinets for 19" and 16" TV Chassis or Kits. Also **CONVERSION CABINETS** to convert any small screen set to a giant 16" or 19" size.

INSTRUMENTS and PARTS

Transvision FIELD STRENGTH METER

Improves installations; saves ½ the work. Model FSM-1, complete with tubes. net **\$79.00**

Deflection Yoke...net **\$2.95**

Flyback Transformer net **\$2.95**

TRANSVISION, INC., Dept. RE, NEW ROCHELLE, N. Y.

Branches—**Jamaica, L. I.**, 167-01 Hillside Ave.; **Syracuse, N. Y.**, 622 N. Salina St.; **Cleveland, O.**, 2001 Euclid Ave.; **Columbus, O.**, 54 E. Long St.; **Chicago, Ill.**, 4834 S. Ashland Ave.

ASK YOUR RADIO PARTS JOBBER! Representatives: Apply now for available territories.

Write for Folders on Complete TRANSVISION Line

BRITISH TEST AM AND FM FOR HI-FI BROADCASTING

By R. W. HALLOWS

THOUGH Britain has not yet a nation-wide v.h.f. high-fidelity service, do not think we are doing nothing in the way of FM—and wideband AM too. At the moment there are two brakes on the wheels of progress in high-fidelity transmission: the B.B.C. (quite rightly) regards the provision of a nation-wide television service as top priority and spends the bulk of its available money on that; and owing to our need to export all that we can, electrical and radio equipment is in short supply.

There is also a third reason of no small importance. There are no politics behind FM here and, having been subjected to no propaganda drives, we can take an entirely dispassionate view of the claims made for it. Experts in this country are by no means convinced that wideband AM can't do everything that FM can—and do it rather better.

At the moment our only FM broadcast transmitter is at the Alexandra Palace, on the outskirts of London, which is also the home of the metropolitan TV station. This radiates items of various broadcast-band programs from 11 am till noon, from 2.30 to 4.30 pm and from 6 pm until about 11.30 pm. All times are GMT. The carrier frequency is 90.3 mc, the deviation ±75kc, and the modulator characteristic almost flat up to 12 kc.

Other details are: power output 0.5 kw; polarization, vertical; antenna, a dipole near the top of the Alexandra Palace TV mast. The service area of this small station is remarkably large, consistently good reception being obtained in places up to 80 miles distant.

This transmitter, however, is a mere stop-gap. A twin AM and FM station is now being built at Wrotham some 15 miles south of London. From this the same programs will be radiated simultaneously by a 25-kw FM transmitter and an 18-kw AM transmitter. A number of observers will be appointed in various parts of a wide area. These will render reports showing which of the two systems regularly gives them the better results. Future high-fidelity policy will be based on the outcome of these powerful experimental transmissions.

What it boils down to is that Britain will have within the next 5 years a country-wide high-fidelity service with a modulation frequency range of not less than 12-15 kc. The results of practical experience under conditions devoid of pro-AM or pro-FM propaganda should be of value not only to us but to the rest of the world as well, for they will give an unbiased answer to the exceedingly vexed AM versus FM question.

Meantime, neither FM nor any other kind of high-fidelity broadcasting mean

Over 43,000 Technicians Have Learned
HOW TO GET THE MOST OUT OF BASIC TEST EQUIPMENT
Why Not You, Too?

SERVICING by SIGNAL SUBSTITUTION

A BEST SELLER FOR OVER 9 YEARS! (NEW, UP-TO-DATE, 11TH EDITION)

The Simple, Modern, Dynamic Speed Approach To Receiver Adjustment and Alignment Problems, AM-FM-TV.

- Nothing complex to learn
- Universal — non-obsolete
- No extra equipment to purchase
- Employs Only Basic Test Equipment

Ask for "S.S.S." at your local Radio Parts Jobber or order direct from factory.

PRECISION APPARATUS COMPANY, INC. • 92-27 Horace Harding Blvd., Elmhurst 4, N. Y.



only **40¢**

100 pages. Invaluable information that will help you re-double the value of your basic test equipment.

very much to John Buli and his wife, for the simple reason that they have never had any opportunity of hearing really wideband reproduction and judging for themselves what it can do.

The sound which accompanies the London TV transmissions is genuine high-fidelity stuff; but, since manufacturers have long been vying with one another to produce cheaper televisers, few receivers outside the luxury class can do anything like justice to it.

As for FM, I know hardly any radio receiver made in this country, outside the super-super-luxury class, which can be switched over to deal with this kind of modulation. FM reception is thus almost entirely confined at present to radio engineers engaged in experiments and to a comparatively small band of hams who have built their own sets. There will probably be a big change when the Wrotham stations get going, for manufacturers will quickly wake up to the powerful selling points offered by high-fidelity radio.

There are some who hold that the task of the manufacturers won't be an easy one. The public, they say, has become so used to the 4.5 kc modulation bandwidth (European channels are 9 kc apart) that it wants nothing better. That's not my view. I believe that, whether we eventually decide on AM or FM for our v.h.f. fidelity service, the new standards of reception made possible will have an even more popular welcome than that accorded five and twenty years ago to the then new kind of phonograph records, when electrical recording and reproduction began to replace the original mechanical methods.

Whichever is decided on, we feel certain it will be the best and most practical for our needs. In the meantime we can't get much in the way of good high-fidelity radio equipment at reasonable prices anyway. This, rather than being a drawback—even though we would like to get started—gives us at least some assurance that care will be taken in the final decision, and it will be based on several years of actual field tests.

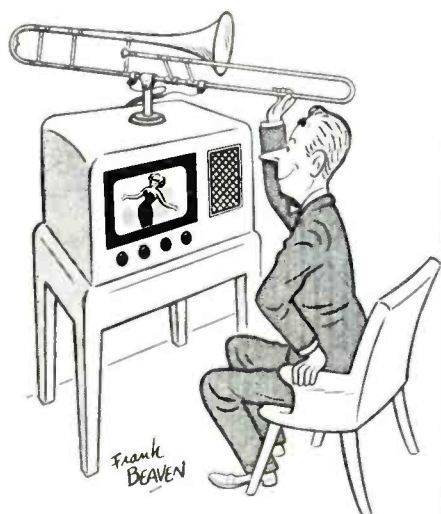

Suggested by Angelo Munari, Marcellis, Ill.

NEW WORKSHOP



PATENT PENDING

DUBL-VEE

TV ANTENNA

Outstanding ALL-CHANNEL Performance

THE "end-fire" DUBL-VEE sets a new standard in TV antenna performance. Higher gain, sharper directivity, and closer match assure superlative reception — clearer, steadier, sharper pictures. In fact, a single DUBL-VEE actually outperforms double-stacked models of most other types. Rugged — easy to assemble — economically priced. Your best buy at any price.

Clearer Pictures—higher gain brings in stronger signal — especially on higher channels

Clearer Pictures — narrow beam cuts down multi-path ghosts

Clearer Pictures—better impedance match on all channels maintains high signal strength

Clearer Pictures — true horizontal polarization—no out-of-phase ghosts

Clearer Pictures—no parasitic elements — all driven

Clearer Pictures—designed by the pioneers in the antenna industry

MODEL VV

Write for Bulletin D

THE WORKSHOP ASSOCIATES, Inc.

135 CRESCENT ROAD, NEEDHAM 94, MASS.

\$10.95 LIST

Model 2VV Double-Stack \$21.90 List

Specialists in High Frequency Antennas

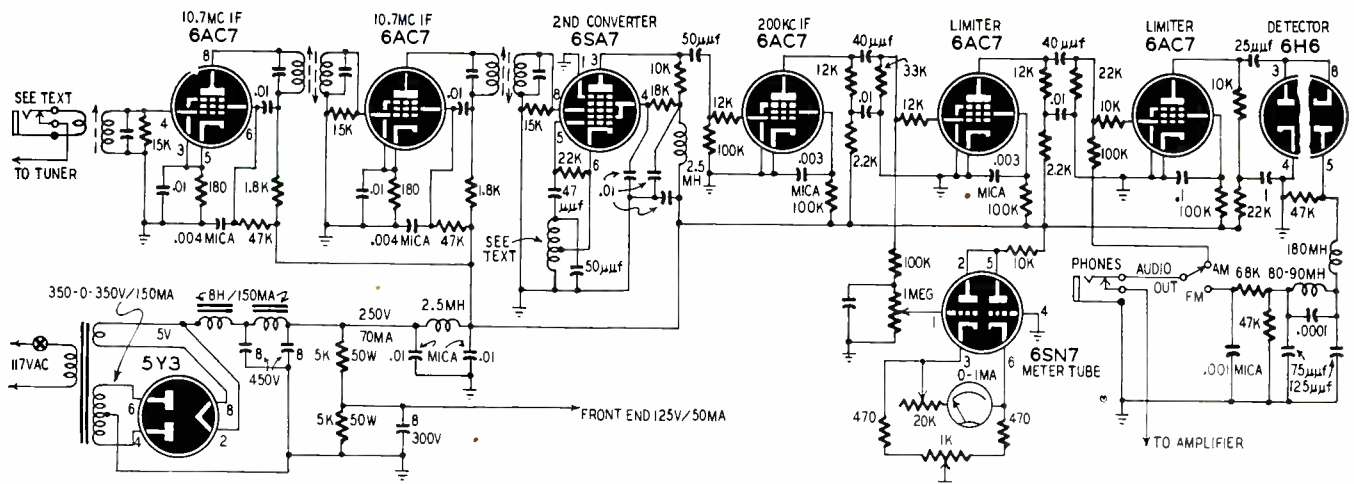

Schematic of the supersensitive i.f. amplifier. The power supply (on a separate chassis) also supplies the front end.

Supersensitive FM I. F. Unit

By JOSEPH MARSHALL

THE QTH here is in the mountains of Tennessee, 50 airline miles from Knoxville, 65 from Chattanooga, 120 from Nashville, and more than 150 from Atlanta and Louisville. The elevation of 1,700 feet increases the effective antenna height and the theoretical line of sight greatly.

On the other hand, the site is the bottom of a bowl, surrounded within 4 miles in every direction by mountains 500 to 1,000 feet higher which definitely put the location out of direct line of sight. The house is on the reverse slope of a mountain in the immediate shadow of a mountain to the west and north; finally, it is in the middle of a forest where any antenna lower than 70 feet is screened by trees in every direction. In short, with the exception of the ele-

vation, the site has almost everything against it for receiving v.h.f. dx.

Satisfactory reception was possible only from the Knoxville stations with a good commercial FM receiver; signals from more distant points were too far down in the noise for entertainment value. It was obvious that satisfactory reception of FM stations would require something heroic in the way of a receiver—an outfit which would provide full limiting on input signals of 5 microvolts or less.

Disregarding the antenna, the problem had two parts. The first was to provide an i.f. amplifier capable of very high gain; the second, to provide an r.f. front end with the best possible signal-to-noise ratio or noise figure. The r.f. front end was described in the June

issue of RADIO-ELECTRONICS; the i.f. amplifier is described here.

This amplifier being an independent unit, it can not only be used for FM reception but also makes an ideal i.f. channel for v.h.f. ham-band receivers with separate converters for the various bands. It provides for AM as well as FM reception at the turn of a switch. Aside from its extreme sensitivity, the amplifier has other qualities to recommend it. It is very simple to align; it uses a frequency-counting detector which is linear and free of distortion; the detector is very unresponsive to AM and therefore has good noise-suppression characteristics; the receiver can be tuned by ear with good results—in fact, it is no more difficult to tune correctly than an AM broadcast receiver.

The design, while novel, is not as complicated as a casual glance at the diagram might indicate, and has no critical elements. If the design is followed exactly, it should give no trouble in adjustment or operation. The i.f., with a front end, constitutes a double superheterodyne with two high-gain i.f. stages at 10.7 mc, followed by a second converter which converts the signal to 200 kc. This is followed by one resistance-couple stage at 200 kc, then by two cascaded limiters and a frequency-counting detector.* This detector has exceptionally low distortion.

The i.f. stages

The input to the amplifier is link-coupled. The front end is connected to the input through a length of coaxial cable; and a circuit-opening phone jack on the panel connects the amplifier with

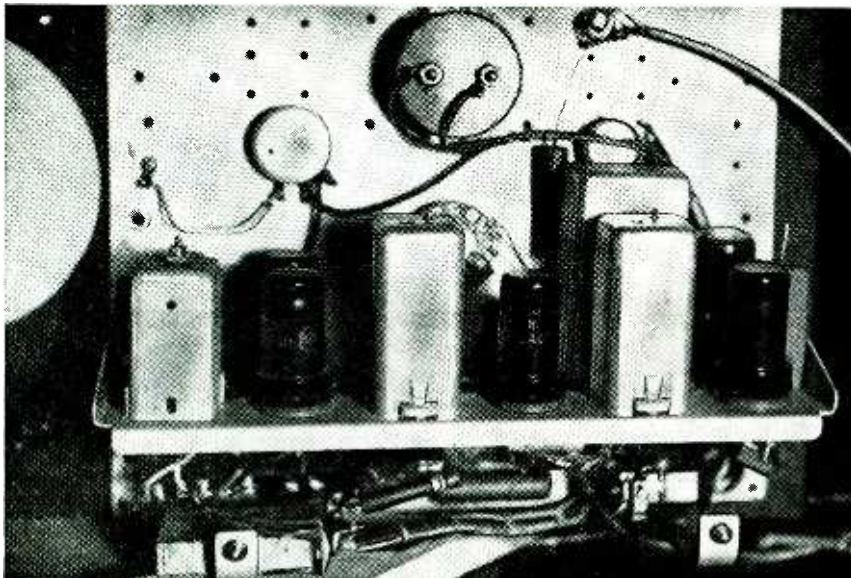

The 200-kc channel is next to the panel, 10.7-mc channel is on rear of chassis.

*This circuit was first developed by W. W. Moe, W1JKC (QST—Sept. 1946).

other front ends—insertion of a plug disconnects the FM input.

This type of input makes the i.f. amplifier an independent unit and improves the over-all performance. At v.h.f. frequencies, the connection from the converter plate to the input transformer should be critically dimensioned. On the other hand, it is difficult to lay out a receiver, even on a single chassis, so that the input transformer is close enough to both the converter plate and the first i.f. grid for best performance at both r.f. and i.f. frequencies. With link coupling, the layout can be arranged for optimum performance.

The input transformer is a home-made job, using a surplus slug-tuned form and a small shield can. A commercial i.f. transformer, especially the midget type, is easily modified for link-coupling and the small investment would avoid a great deal of uncertainty and adjustment.

To modify a commercial i.f. transformer, remove the shield can and disconnect the primary coil and capacitor—or remove them entirely. Wind about 4 turns of No. 28 enamel wire just below the ground end of the grid coil, and connect the two ends to the terminals formerly used for the primary winding. The i.f. transformer for the front end is treated similarly, except that the secondary is disconnected and the link is wound just below the B-plus end of the plate coil.

The layout for the amplifier is un-critical except for the usual precautions

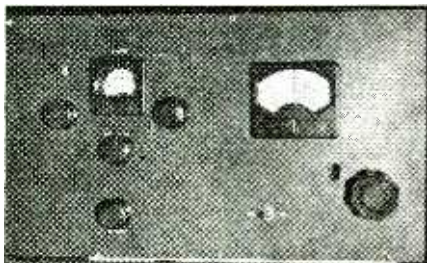

Front panel of the complete receiver.

against instability in the 10.7-mc channel. The stages can be put in line or doubled back as in this case. A 7x17-inch chassis would line up the various stages in line and leave room for a power supply or a.f. amplifiers, or both. This model was built on a surplus servo-amplifier chassis because its over-all shield promised more complete isolation. Although the chassis is crowded, there was no difficulty with stability.

The i.f. transformers and the tube sockets are mounted and oriented to have the plate and grid leads 1 inch or less long and on opposite sides of the sockets. The transformers are placed between the tubes to provide short leads and shielding as well. The .01- μ f bypass capacitors have leads 1/2 inch long. With such leads they resonate at about 11 mc and greatly improve the bypassing action. The two 6AC7 tubes are neutralized by returning the plate bypass capacitor to the screen and then bypassing from there to ground with .004- μ f mica capacitors. This forms

HOMESTRETCH!



...where Thomas tubes are really proven!

With all due respect to laboratory tests (and we use them continually), we like to think of "the homestretch" as the real proving ground of Thomas tube quality.

For after months of heavy daily use ordinary tubes begin to tire noticeably, but Thomas picture tubes still "run easily" at peak efficiency. In thousands upon thousands of homes throughout the country Thomas is building solid customer satisfaction for many receiver manufacturers and television servicemen. Better picture reproduction and longer tube life are the answer.

Are YOU installing Thomas picture tubes? Remember this: For the finest picture, use the finest tube — Thomas!!

THOMAS ELECTRONICS, Inc.

118 Ninth Street

Passaic, New Jersey



WHERE RADIOMEN MEET, EAT and SLEEP

Visit the
FAMOUS
FIESTA
LOUNGE
Renowned for
Fine Food

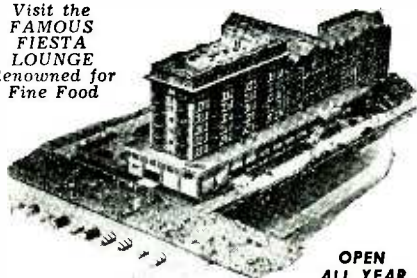

OPEN
ALL YEAR

HOTEL STRAND

Atlantic City's Hotel of Distinction

The Ideal Hotel for Rest and Relaxation • Beautiful Rooms • Salt Water Baths • Glass enclosed Sun Porches • Open Sun Decks atop • Delightful Cuisine • Garage on premises. • Moderate Rate Schedule.

Exclusive Pennsylvania Ave. and Boardwalk

\$1200.00 in prize money is being awarded in the RADIO-ELECTRONICS IN THE HOME contest. Any radio-electronic device that has potential use around the home is eligible for entry and may win a prize. The three best entries are selected each month. For details and rules of the contest, see page 36.

a bridge circuit which effectively neutralizes the plate-to-grid capacitance of the tubes and prevents feedback.

Loading resistors are used across the secondary windings of all transformers to widen the response curve. With these resistors the passband is better than 200 kc and the amplifier will reproduce 100% modulation of a 15,000-cycle tone without distortion. If the amplifier is to be used exclusively for ham-band communication, these resistors can be left out and there will be a considerable increase in the sharpness of tuning. In that case the passband is about 100 kc, which is just about right for ham-band use.

No gain control is used because in this remote location none was necessary. A cathode-bias gain control was tried and the photos show it. It was removed, because, if applied to one stage only, it modifies the response curve and increases distortion, especially on weak signals. If it is applied to both stages, it introduces feedback through common coupling. Where signals approach millivolt strength, it might be well to apply the control to the second stage to prevent overloading of the second converter. The effect on the quality of such strong signals will not be serious.

Second detector and limiter

The second converter is a 6SA7. The oscillator coil is a commercial iron-core item intended as replacement for shortwave receivers. The oscillator operates at 10.9 mc. The oscillator section should be shielded to keep the oscillator frequency from the front end and the previous i.f. stages. The coil should be in a shield, the leads very short and dressed close to the chassis. (A shielded compartment might be put around this converter section to isolate it from the others.) A choke in the plate circuit filters the frequency from the B-plus line, and a choke-capacitor filter is used where the B-plus lead enters the chassis since a separate power supply is used with this amplifier.

The 200-kc amplifier and limiters involve no trouble other than finding room for all the small components. The capacitors and resistors were mounted on a terminal board beforehand and then connected to the tube sockets. We were worried that such crowded placement might result in feedback, but had no trouble whatever. The plate bypass capacitor of the second limiter should be 1 μ f or larger to insure proper low frequency response.

The frequency-counting detector is simple and involves no problems either in construction or adjustment. This type of detector is perhaps the most satisfactory of all FM detectors; it certainly has the lowest distortion. It is not used ordinarily because it operates only at frequencies of 200 kc or less. No adjustment is necessary to put it into operation. If there is trouble in getting proper FM detection, it probably will be found in the second limiter which is closely associated with the detector. Regeneration in the i.f. stages is most likely to account for any dis-

ortion either by producing too sharp a bandpass or an asymmetrical one. If there is no regeneration and the i.f. is aligned to provide a passband of 200 kc, there should be no trouble.

The detector is followed by an elaborate low-pass filter which attenuates all frequencies above 15,000 cycles. This was made from surplus iron-core coils, intended for low-frequency aircraft receivers, and mounted in a shield can. The filter is desirable when the amplifier is used with a very-wide-band, high-fidelity audio amplifier which may respond to the unfiltered r.f. and cause distortion by driving the audio tubes into the bends of their curves. It can be left out, however, and in that case the cathode resistor should be bypassed by a 0.1- μ f capacitor.

The audio output is about 1 volt and can be connected to the crystal-phono input of any amplifier. A single stage or more of audio can be added if desired.

A 6SN7 is used as a meter tube. The circuit is the balanced type used in v.t.v.m.'s. The 1000-ohm potentiometer is for zero-setting. Although it is mounted on the panel in this amplifier, it can be placed on the chassis because it seldom needs readjustment. The meter sensitivity control can also be left out; it was included to provide a more versatile and accurate means of recording field strength of weak signals. The meter was calibrated with a calibrated signal generator, but for ordinary tuning it could be marked with arbitrary S units and tuned only

for maximum deflection.

The meter is not necessary for tuning. This is a simple combination to tune correctly and can be tuned by ear alone. Since the detection does not depend on the response curve—as in other FM detectors—it is necessary only to tune for maximum signal or minimum distortion.

Aligning the amplifier

Alignment is no problem if the amplifier is not oscillating or regenerating. Set the oscillator at the second converter to 10.9 mc. This can be done simply by placing a shortwave receiver adjacent to the amplifier, tuning it to 10.9 mc, and then turning the slug on the 10.9-mc oscillator until the carrier is received on the receiver. Set a test oscillator to 10.7 mc, couple it to the link input with a small capacitor, and adjust the i.f. transformers for peak reading on the signal meter. If no signal meter is built in, a v.t.v.m. connected to the grid of the first limiter will serve; and if no v.t.v.m. is available, a microammeter can be put in series with the bottom end of the grid leak of the first limiter and ground; if no meter is available, the signal can be modulated with a tone and the i.f.'s adjusted for maximum volume of the tone. When the 10.7-mc channel is peaked carefully, the 10.9-mc oscillator can be retouched for a peak reading.

If the amplifier is not oscillating or regenerating, it is not necessary to use visual equipment for alignment, although those who have such equipment

CIRCLE X ANTENNA

ENGINEERED TO PROVIDE
**CLEAR SHARP
PICTURES ON
ALL CHANNELS**

COMPARE CIRCLE-X
TO ANY OTHER TV ANTENNA

No other antenna combines all the mechanical and electrical features engineered into the Circle-X.

The high gain of the Circle-X is equal to stacked arrays. It is made of light weight corrosion resistant aluminum alloys that stand up in all atmospheric conditions.

When you use Circle-X you stock only one type of antenna for all jobs. It has one wire lead-in and weighs only 2½ lbs.

We urge you to compare Circle-X TV Antennas to any other TV antenna on the market.

Use Circle-X on your next tough TV installation. It may save you a lot of "no profit" call backs.

CIRCLE X
ANTENNA CORPORATION

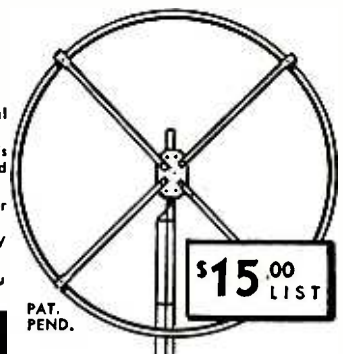

DEALERS: Air Express or Parcel Post Special Delivery direct from factory to you through your jobber, if he cannot supply you with the Circle-X from his stock.

CIRCLE-X ANTENNA CORP.
509 MARKET ST., PERTH AMBOY, N. J.

will find it useful in checking the symmetry of the response curve. The symmetry also can be checked with the signal meter and oscillator; detuning the oscillator on both sides should produce nearly exact deflection slopes on the meter.

Minor irregularities of the curve will not mar reception, though they may reduce sensitivity slightly. Any serious asymmetry or too sharp a bandpass will cause distortion in the FM position on the very high audio tones and the sibilants of voices. FM signals can be received in the AM position of the switch when the carrier is detuned to one side or other of the center. This is the result of slope detection.

The sensitivity of this amplifier alone is below 5 microvolts. Very little amplification is needed from a front end to get 1-microvolt sensitivity, although the best possible signal-to-noise ratio is more difficult to achieve. Any type of FM front end can be used with this amplifier.

The performance of this amplifier has been very satisfactory on FM and in brief tests, on the 50- and 140-mc ham bands. With the front end mentioned, regular reception with complete limiting includes FM stations in Knoxville, Chattanooga, Atlanta, Charlotte, and various intermediate cities; and almost every FM station within a radius of 250-300 miles has been logged at least once.

The amplifier has only one slight drawback. Despite the most heroic measures, one of the harmonics of the 10.9 oscillator appears in the tuning range at about 98 mc. The strength of this pickup is apparently in the order of 1 microvolt and is not serious. If this radiation should fall within a point in the band occupied by a station, the 10.9-mc oscillator frequency should be moved up or down to clear the channel. In that case the 10.7-mc channel will require slight retuning. However, the pickup is not great enough to cause any other interference and it is a slight price to pay for the many benefits.

The FM tuner made up of this i.f. amplifier and the front end described in the June issue not only has an unusually high sensitivity and very low noise, but very good frequency response and low distortion are also claimed for it. For this reason it is recommended that it be used with high-fidelity audio equipment.

Materials for i.f. amplifier

Resistors: 2—180, 2—470, 1—1800, 1—2,200, 4—10,000, 4—12,000, 3—15,000, 1—18,000, 3—22,000, 1—33,000, 4—47,000, 1—68,000, 6—100,000 ohms, 1/2 watt; 2—5,000 ohms, 50 watts, wire-wound; 1—1,000, 1—20,000 ohms, 1—1-megohm potentiometers.

Capacitors: 1—0.00025, 2—0.00040, 1—0.00047, 2—0.00050, 1—0.00075, 1—0.00100, 1—0.00125, 1—0.01, 2—0.03, 2—0.04, 2—0.1 uf mica; 9—0.1, 2—0.1 uf, 250 vlt paper; 1—1.0-uf bathtub type; 3—8 uf, 450 volts, electrolytic.

Transformers and chokes: 3—10.7-mc i.f. transformers; 1—5.3-16.5-mc oscillator coil; 1—80, 1—180-mh choke; 1—2.5-mh r.f. choke; 2—8-h, 150-ma filter chokes; 1—350-0-350 volts at 150 ma power transformer.

Miscellaneous: 5—6AC7, 1—6SA7, 1—6SN7, 1—6H6, 1—5Y3 tube types; switches, sockets, jacks, chassis, and hookup wire.

JULY, 1950

YOUR NEW STANCOR CATALOGS

are ready!

CATALOG OF TRANSFORMERS FOR RADIO, SOUND AND OTHER ELECTRONIC USES.

Here's a "must" for every user of transformers—serviceman, ham, experimenter, engineer. Detailed listings of more than 400 Stancor part numbers. Includes accurate electrical and physical specs, dimensions, prices, illustrations. Complete and up-to-date. Handy charts and easy-to-use indexes help to make this new Stancor catalog the book you'll want to find the part you need.



TELEVISION CATALOG AND REPLACEMENT GUIDE.

The sixth edition of the popular Stancor TV Replacement Guide (50,000 copies printed to date). Now combined in a big, 30-page book with a complete catalog of all Stancor TV components. Original part numbers, with Stancor replacements, are listed for more than 600 TV receiver and chassis models made by 64 manufacturers. Every Stancor component recommended in the guide is listed in the catalog section with complete specs, dimensions and prices. Gives you one convenient source of information. Makes your job quicker and easier.

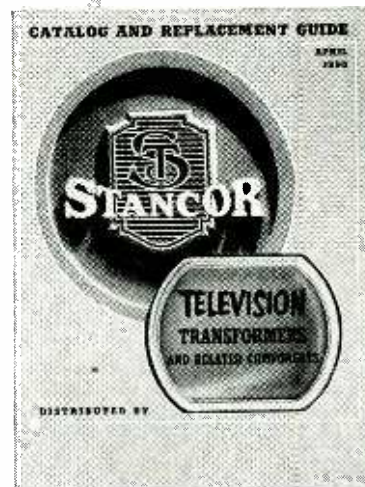

And remember, when you buy a Stancor transformer, you get a quality product used by the country's biggest set makers as original equipment. Stancor transformers have to be good!

See your Stancor distributor today for your free copies of these books. If he is out of stock, we'll be glad to send you copies. Write Standard Transformer Corporation, 3592 Elston Avenue, Chicago 18, Illinois.



Most Complete Line in the Industry

Want A Good Job in Radio?

Get your FCC License in a minimum of time. Add technical CIRE training to practical experience—study at home—in spare time. Then get real help finding a job with our Amazing Job-Finding service. It really works! Act now!

GET FREE BOOKLET

"Money-Making FCC License Information" tells you how to get a good FCC licensed job in Radio. Send for it now.

CLEVELAND INSTITUTE OF RADIO ELECTRONICS
4900-A Euclid Bldg., Cleveland 3, Ohio

Electronic cribbing was reported last month by a school inspector in Turin, Italy, when he caught two students using a walkie-talkie during exams. One had concealed a small transmitter in a plaster cast on his left arm, and the other had a receiver hidden in a bandage around his head.

EASY TO LEARN CODE

It is easy to learn or increase speed with an Instructograph Code Teacher. Affords the quickest and most practical method yet developed. For beginners or advanced students. Available tapes from beginner's alphabet to typical messages on all subjects. Speed range 5 to 40 WPM. Always ready—no QRM.

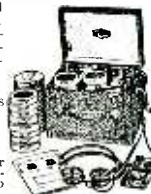

ENDORSED BY THOUSANDS!

The Instructograph Code Teacher literally takes the place of an operator-instructor and enables anyone to learn and master code without further assistance. Thousands of successful operators have "acquired the code" with the Instructograph System. Write today for convenient rental and purchase plans.

INSTRUCTOGRAPH COMPANY

4701 Sheridan Rd., Dept. RC, Chicago 40, Ill.

An Economy-Size Code Set for the Beginner

Variable pitch and loudspeaker operation make this an efficient practice oscillator

By HAROLD GOULD

PHOTOFACT BOOKS HELP YOU 4 WAYS!

1. SAVE TIME 2. SAVE WORK

3. EARN MORE 4. LEARN MORE



PHOTOFACT TELEVISION COURSE
 Gives you a clear understanding of TV principles, operation and practice. Complete coverage of all phases. 216 pages; profusely illustrated; 8½ x 11". Used by thousands. Order TV-1 Only \$3.00

TELEVISION ANTENNAS
 All you need to know about TV antennas—describes all types, tells you how to select, how to install, how to solve troubles. Saves time; helps you earn more. 192 pages; illustrated; handy pocket size. Order TAG-1 . . . Only \$1.25

TELEVISION TUBE LOCATION GUIDE
 Accurate diagrams showing the position and function of all tubes in hundreds of TV receivers. Diagnose trouble and replace tubes, in most cases without removing chassis. Over 200 pages; pocket size. Order TGL-1 Only \$1.50



1948 RECORD CHANGER MANUAL
 Covers 45 models made in 1948, including LP and dual-speed changers, plus leading wire recorders. Original data based on actual analysis of equipment. Over 400 pages; de luxe bound, 8½ x 11". Order CM-2. Only \$6.75

AUTO RADIO MANUAL
 Complete PHOTOFACT Service data on more than 100 post-war auto radio models. Complete, accurate, uniform information. Covers over 24 manufacturers. Makes auto radio servicing easier and more profitable. Over 350 pages. 8½ x 11". Order AR-1 Only \$4.95

THE RECORDING & REPRODUCTION OF SOUND
 A complete, authoritative treatment of the entire subject. Covers all phases of recording and amplification. 364 pages. 6 x 9", cloth binding. Order RR-1 Only \$5.00

NEW! DIAL CORD STRINGING GUIDE
 New Volume 2, covering receivers produced from 1947 through 1949. The only book that shows you the one right way to string a dial cord in thousands of receivers. Handy pocket size. Order DC-2 Only \$1.00

HOWARD W. SAMS & CO., INC.

Order from your Parts Jobber Today, or write direct to HOWARD W. SAMS & CO., INC., 2201 E. 46th St., Indianapolis 5, Ind.

My (check) (money order) for \$ enclosed. Send the following books:

<input type="checkbox"/> TV-1	<input type="checkbox"/> RR-1	<input type="checkbox"/> AR-1	<input type="checkbox"/> TGL-1
<input type="checkbox"/> TAG-1	<input type="checkbox"/> CM-2	<input type="checkbox"/> DC-2	

Name

Address

City Zone State

WITH the amateur radio world going through a stage where more people want to get into the act, many would-be hams are applying themselves to learning the code. To get the most out of code practice, the newcomer needs a source of audio-frequency power that will produce clear signals.

Pictured in the photos is a unit that makes for efficient code practice. This oscillator has stability and puts out a clear note with adjustable pitch. It provides for speaker operation. Using it, the instructor can illustrate his talk with actual demonstrations untrammelled by headphone cords or headphones.

With the easily accessible terminal strip the operator can cut the speaker out of the circuit, hook in headphones, or combine them with a remote line. It is also suitable for use as an extension speaker.

Above all, this little outfit rings the bell for economy.

Simplicity marks the circuit. However, one or two points need comment. Practically any output transformer will work, but greater volume results when the impedance the speaker reflects into the plate circuit is as high as possible—the specified 7,000 ohms to v.c. strikes an optimum and is easily obtained.

The choice of tube deserves explanation. The 6AK6 is used because it gives greater volume than a triode, its current compares favorably with many of the battery-type miniatures (it draws 107 ma in this circuit), it puts little strain on the pocketbook, being available at many surplus stores, and it stands more chance of finding use in later equipment than a battery tube.

Why use a 6-volt heater tube instead of a battery type? If the latter were used, the voltage would fall too low for speaker volume. A low-voltage tube would require a B-battery, which would add to the cost of the set. The heater-type tube also withstands rough treatment better than the more fragile filament type.

Except for the pitch control, the parts group around the speaker magnet. The potentiometer, with its switch, mounts on the wall of the case. Besides varying the signal pitch, this control compensates for differences in component values which might be used.

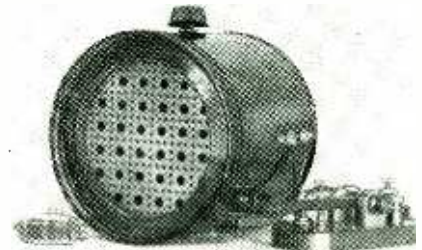

This code set is built into a jam tin.

Also, when you put additional impedance—headphones, say—into the plate circuit, the pitch changes. With the potentiometer, it is a simple matter to restore the previous pitch.

As the photos show, a flange joins the speaker to the lid of the container. This makes it slightly directional, but the builder may omit it if desired. To save drilling, the flange solders directly to the lid. Four generous spots of solder hold the 4-inch PM speaker to this flange.

An aluminum U-bracket holds the audio transformer, and bolts fasten this strap to two of the speaker's mounting holes. A 5 x 5-inch economy-size tin serves as a case for the set.

A novel method of mounting the tube socket requires an 8-32 machine screw, a nut, and a metal bracket. Start the screw into the lug side of the wafer socket's center hole. It will only go two or three turns before binding. This will anchor the socket firmly to the end of the screw. All you need to do then is back up the nut, which tightens the assembly to the bracket, and makes everything solid. This method eliminates cutting large holes in metal, or smaller ones for the mounting screws. One hole large enough for the 8-32 screw is all that is needed, once you bolt the other end of the bracket down.

Links shorting terminals 1 and 2, and

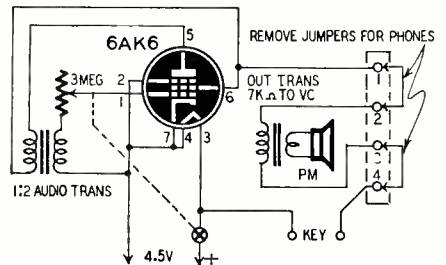

The circuit is simple and economical.

3 and 4 ready the set for speaker operation. Adding a pair of phones is simple: just substitute their leads for any two link connections, depending on whether the phones are to be in series or parallel with the speaker, or independent of it.



Most of the parts fit on the speaker.

To hook the unit to a remote station line, remove the appropriate link and connect the line to the vacant terminals. Used with such a remote line—a speaker and key at the other end—you'll need a switch that short-circuits the key when receiving.

The greatest claim to versatility of this unit is its ability to pinch-hit for a signal generator. It supplies a handy source of a.f. voltage for audio testing. Connect a lead to terminal 1 or 2 (with

speaker in circuit) through a 0.1- μ f paper capacitor. Then ground terminal 3 or 4 (key terminals shorted) to the chassis of the set under test. (Beware of midget a.c.-d.c. receivers with hot chassis!)

If you follow these directions, you will have an audio signal generator with a range of about 100 to 3,000 c.p.s. You can install the blocking capacitor into the container permanently, and use a separate binding post for a.f. output. A switch in series with the voice coil of the speaker will silence the speaker when making audio tests.

While its volume proves adequate for the average room under normal conditions, this oscillator cannot compete with a nearby boiler factory. Adding a battery in the plate line—anything from 3 volts upward—will boost the volume if necessary.

The unit can be placed with the speaker opening at the top, or it can rest on its side, alarm-clock style. To prevent rolling in the latter position, solder a brass nut about 1 1/4 inches from each side of a center line plumbed down from the pitch control. Equip these nuts with 3/8-inch machine screws for feet.

Install the flashlight cells, turn on the switch, and you're ready for the first mad "dash."

Meter For Fractional-Ohm Measurements

The resistance between contacts on switches, relays, connectors, and similar components is usually only a small fraction of an ohm, yet its absolute value plays a major role in insuring efficient operation of some electrical and electronic circuits. Because very low resistances cannot be read on standard ohmmeters, expensive bridges are often used. A simple electronic circuit for measuring contact resistance was described in *Electronic Engineering* (London).

V1 may be a power amplifier triode, tetrode, or pentode connected as a 1,000-cycle oscillator. T1 is a conventional push-pull output transformer. The oscillator may be adjusted to 1,000 cycles by changing the value of C and by varying the grid resistance. The oscillator should deliver approximately 1 ampere into the 2- and .04-ohm resistors in series.

V2 is a pentode voltage amplifier, and V3 is a diode v.t.v.m. using one half of a 6H6 or a similar half-wave

rectifier. The gain of V2 should be sufficient to deflect the meter to full scale when .04 volt is applied across R.

Adjust the meter to full scale with the 10,000-ohm control, then connect the relay contacts across R. The instrument is self-calibrating. Because R is fed from a high-impedance source (2 ohms), the meter will drop to half scale when the contact resistance equals R, or to one-fifth scale when contact resistance is .01 ohm.

R should be connected to the instrument through a heavy four-conductor cable to avoid long leads between it and the contact under test. Be sure that connections between test leads and contacts are good.

T2 should be a high-quality transformer having a mu-metal or similar core and a turns ratio of 50 to 1. A high-grade transformer designed to match a 5,000-ohm plate to a 2-ohm load should do the job. T3 should have a 1-to-1 turns ratio and a primary inductance of approximately 8 henries.

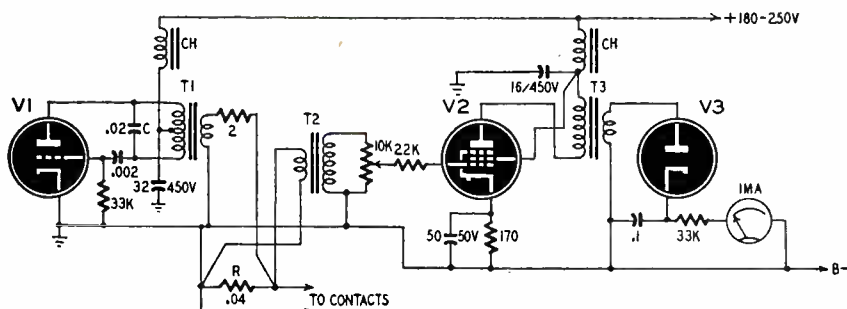

FREE WITH PHOTOFACT!



"Bonus" TV Supplements
Preliminary Service Data on
Hundreds of Television Models
for Your IMMEDIATE USE . . .
AT NO EXTRA COST!

TV set owners are calling for service within days—even hours—after installation. That's why you, the TV Technician, must have your service data *right now!* And *right now*, PHOTOFACT brings you the "rush" preliminary TV service data you need for *immediate use* to keep you going at full speed. FREE with the purchase of PHOTOFACT Folder Sets No. 91 and No. 93, you receive with each a separate 64-page Supplement containing preliminary data (in *advance* of regular PHOTOFACT coverage) on over 100 popular TV models. Place your standing order for PHOTOFACT today—it's the only way to get *without delay* the TV service data you must have *right now!*

Buy PHOTOFACT Folder Set No. 91 and get FREE TV SUPPLEMENT NO. 91A:
 Covers 114 important Television Receiver models, produced by 11 leading TV manufacturers.

Buy PHOTOFACT Folder Set No. 93 and get FREE TV SUPPLEMENT NO. 93A:
 Covers more than 100 leading Television Receiver models, produced by 17 TV manufacturers.

BUY BOTH! GET THE DATA YOU WANT NOW ON HUNDREDS OF TV MODELS

PHOTOFACT Set Nos. 91 and 93 are going fast—order today to avoid disappointment

HOWARD W. SAMS & CO., INC.

Order from your Parts Jobber today or write direct to HOWARD W. SAMS & CO., INC., 2201 East 46th Street, Indianapolis 5, Ind.

My (check) (money order) for \$..... enclosed. Send me the following:

- Photofact Set No. 91 and Supp. 91A. \$1.50
- Photofact Set No. 93 and Supp. 93A. \$1.50

Name.....

Address.....

City..... Zone..... State.....

NOW! PRESERVE EVERY TREASURED COPY of Your Favorite Radio Publications!

MAGAZINE LIBRARIES
Ingenious Custom-built Storage Files

Another Sensational Walter Ashe Value Scoop!

Made of high quality Kraft fibre board printed in rich colors and constructed to look like a Buckram bound book.

RADIO-ELECTRONICS

Only **25¢** ea. plus 6c ea. to cover cost of pkg. & pstg. (anywhere in U.S.) Holds 12 complete issues based on present size of 82 to 98 pages. Measures 12" x 8½" x 2¾"

RADIO & TELEVISION NEWS

Only **50¢** per set of 2 plus 15c per set to cover pkg. & pstg. Set holds 12 complete issues. Measures 12" x 8½" x 2¾"

Only **25¢** ea. **QST** plus 6c ea. to cover pkg. & pstg. Holds 12 complete issues. Measures 6¾" x 3¾" x 10"

Only **25¢** ea. **CQ** plus 6c ea. to cover pkg. & pstg. Holds 12 complete issues. Measures 6¾" x 3¾" x 10"

Order Now for Immediate Delivery!

Walter Ashe
RADIO CO.
1125 PINE ST. PHONE CH. 1175 ST. LOUIS 1, MO.

Want a Good Job in Radio?

Get your FCC License in a minimum of time. Add technical CIRE training to practical experience—study at home—in spare time. Then get real help finding a job with our Amazing Job-Finding service. It really works! Act now!

GET FREE BOOKLET

"Money-Making FCC License Information" tells you how to get a good FCC licensed Job in Radio. Send for it now.

CLEVELAND INSTITUTE OF RADIO ELECTRONICS
4900-D Euclid Bldg., Cleveland 3, Ohio

PEN-OSCIL-LITE

Extremely convenient test oscillator for all radio servicing; alignment • Small as a pen • Self powered • Range from 700 cycles audio to over 600 megacycles u.h.f. • Output from zero to 125 v. • Low in cost • Used by Signal Corps • Write for information.

GENERAL TEST EQUIPMENT
38 Argyle Ave. Buffalo 9, N. Y.

A Capacitance Relay of High Sensitivity

By ERNEST J. SCHULTZ

THE capacitance-operated relay is an amazingly simple device, considering the variety of its potential applications. It has been successfully used as a burglar alarm, a garage-door opener, and a window-display switch, as well as in practical jokes, magician's acts, and so on.

The practical circuit shown in the diagram consists of an 6SN7-GT oscillator and rectifier and an 884 gas triode. The oscillator section of the 6SN7-GT is designed so that, when carefully adjusted, a slight change in capacitance between its grid and ground results in a large reduction in the energy the tube puts out. The second section of the 6SN7-GT is connected as a diode and rectifies the oscillator voltage, producing a d.c. voltage dependent on the strength of the oscillator output. The d.c. voltage is applied to the grid of the 884 gas triode, biasing it to cutoff. A potentiometer in the grid of the 884 permits critical adjustment of the bias voltage, so that the device can be made extremely sensitive to a small reduction in bias. When any capacitance approaches the sensitive oscillator grid, the oscillator output decreases, resulting in less rectified d.c.; this reduces the grid bias on the 884, causing the tube to conduct and operate the plate relay.

As a.c. is used directly for plate voltage, it is necessary to connect a filter capacitor across the relay coil to prevent chattering. The device is an on-off affair: that is, when a capacitive body is brought near, the relay closes; and when the capacitance is removed, the relay opens.

The size of the relay filter capacitor is not critical. It can be made larger than specified in the schematic, resulting in a longer delay in shutoff time. The chassis was made from thin-gage aluminum and measures 6 x 5 x 2 inches.

The oscillator frequency is about 3 mc so that it will not interfere with the broadcast band. No connections are made directly to the chassis for safety's sake. The coil is 100 turns of No. 28 d.c.c. close-wound on a 1-inch diameter, 3-inch long Bakelite form.

When ready to test the instrument, connect a short wire to the antenna terminal, plug in the device, and allow a few minutes warmup. Turn the bias control on full (arm toward plate), and, with an insulated tuning screw-

driver, adjust the 140- μ f padder very slowly until the plate relay closes; then carefully back off the capacitor a hair or two until the relay opens again. When the hand is brought near the antenna, the relay should now close.

For added sensitivity, withdraw your hand and slowly reduce the bias voltage by adjusting the potentiometer until the relay again operates; then back off on the setting carefully until the relay opens. Now the sensitivity should be much greater. The sensitivity can be made very high, but too great a sensitivity is undesirable as the instrument will then become subject to line-voltage variations.

Great sensitivity with stability can

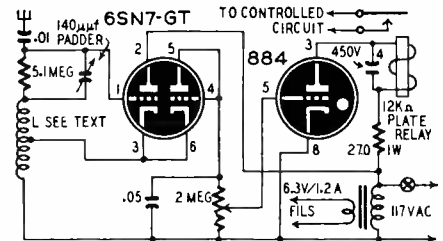

FIL PINS—6SN7-8&7; 884-2&7

The capacitance-operated relay circuit.

be obtained by connecting a large metallic "pickup" to the antenna. However, the "pickup" must not be grounded; a screen door or kitchen table top are good examples of the many common pickups around the home. If a long wire or large pickup is used, it may be necessary to connect a small capacitor in series with the antenna terminal. A 50- μ f trimmer was found to work with a 40-foot wire. Long wires are not recommended, however, as the device is an oscillator and might radiate enough signal to cause interference with radio services.

As pointed out before, the capacitance relay can be used to open doors of a garage or turn on display lights in a store window, but the load switched must not be greater than the relay contacts can handle. It may be necessary to use an auxiliary relay.

The relay can also be used to control another, locking-type relay which, once actuated, remains closed until reset, thus leaving a warning switched on until shut off.

(If the relay is to be used as a protective device such as a door opener or burglar alarm, use an all-wave receiver

to check for radiation from the oscillator. Since the coil is tuned by its distributed capacitance and the stray wiring capacitance, its frequency will be approximately 3 mc. FCC regulations require a license for operating radio equipment which radiates a signal in excess of 15 microvolts per meter at 1/6 wavelength from the antenna. This approximates being unable to receive the signal at a distance in feet from the antenna equal to 157,000 divided by the frequency in kc. If the oscillator in the alarm works on 3 mc (3,000 kc), the signal should not be detected at a distance equal to 157,000/3,000, or 52 feet.

(For the same length of antenna and power input to the oscillator, radiation falls off as the frequency is made lower; therefore, it is suggested that the oscillator coil be shunted with a capacitor which will cause the oscillator to operate below the broadcast band in frequency.—*Editor*)

PARTS LIST FOR CAPACITANCE RELAY

Capacitors: 1—4 uf, 150 volts, electrolytic; 1—.05, 1—.01 uf, 200 volts, paper; 1—140 uf, variable.

Resistors: 1—5.1 megohms 1/2 watt; 1—270 ohms, 1 watt; 1—2 megohms potentiometer.

Miscellaneous: 2—sockets, octal; 1—transformer, filament-type, 6.3 volts, 1.2 amp. secondary; 1—plate relay with 10,000 or 12,000 ohm coil, contacts to suit; 1—884, 1—6SN7 tube; line cord, hook-up wire, assorted nuts and bolts.

SLIDE RULE CALCULATION

Certain problems lead to an equation of the form $C = \sqrt{a^2 + b^2}$.

For example, a circuit with 28 ohms resistance and 18 ohms reactance has an impedance $Z = \sqrt{28^2 + 18^2}$.

An interesting slide-rule solution to this equation appeared recently in *Wireless World* (England). It was contributed by a reader.

The following description assumes familiarity with multiplying, dividing, and working with roots on a slide rule. The steps are listed as follows:

1. Taking the previous example, find 28/18, with the quotient appearing on the D scale. For convenience the larger number is placed in the numerator. Disregard the quotient, but note 2.42 on scale A (without changing the setting).

2. Mentally add 1, obtaining 3.42 and move the cursor to that number on A. Without changing the setting find the corresponding number on D (1.85).

3. Multiply 1.85 by the original denominator (18) by moving slide and cursor along D scale. The answer is 33.3.

Here is the proof. The first step gives $\frac{28^2}{18^2}$. The next step first produces $1 + \frac{28^2}{18^2}$ or $\frac{18^2 + 28^2}{18^2}$ which is equal to $\frac{Z^2}{18^2}$. This becomes Z/18 in the same step. Therefore the last step results in Z.

This type of calculation occurs frequently in radio work. A little practice with this method on the slide rule will save much time.

JULY, 1950

Audio Men

This new book blasts the double talk out of high-fidelity work!



JUST OFF THE PRESS only \$1.00

You've never read a book like HIGH-FIDELITY TECHNIQUES before! James R. Langham, Radio-Electronics' popular audio writer shoves aside the slide rule and engineering gobbledegook and tells how to design your own high-fidelity equipment. In his lively, informal way, just as he'd talk to you over his bench, Langham answers those audio questions that have had you stumped. Here's a book that's packed with "know how" built up by years of engineering study plus work bench experience. Just look at the angles covered. Worth many times the low price! 112 pages. 5 1/2 x 8 1/2 inches. Order from your jobber today.

HERE'S A PARTIAL LIST OF THE SUBJECTS COVERED

CHAPTER 1—Distortion: Harmonics, Transients, Intermodulation.

CHAPTER 2—Speakers & Baffles: Tuned boxes, Labyrinth, Infinite baffle, Flat baffle, Dual systems, Horns, Crossover networks, Phasing.

CHAPTER 3—Power Amplifiers: Power output, Output transformers, Output tubes, Cathode loading, Phase inversion.

CHAPTER 4—Voltage Amplifiers: Inverse feedback, Rp, Gm, Class AB triode amplifier, Frequency limits, Motorboating, Tone control, Filters, Oscillation, Hum, etc.

CHAPTER 5—Power Supplies: VR tubes, Electronic regulation.

CHAPTER 6—Phonographs, Pickups, Motors, Record changers.

RADCRAFT PUBLICATIONS, INC., 25 W. Broadway, New York 7, N. Y.



RADCRAFT PUBLICATIONS, INC. Dept. 70
25 W. Broadway, N. Y. 7, N. Y.
I have enclosed \$..... for copies of
Book No. 42—HIGH-FIDELITY TECHNIQUES
by James R. Langham.
NAME.....
ADDRESS.....
CITY..... STATE.....

SAVE MONEY AT

HERSHEL RADIO CO

• DETROIT 8, MICHIGAN

THE "FORTY-NINER" GEIGER COUNTER

\$89.50

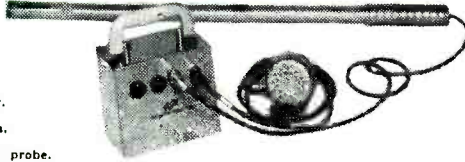

- Light weight uranium detector.
 - Detects beta and gamma rays.
 - Equipped with 36 inch search probe.
 - Contains two 67½ volt Minimax batteries in the well-known type of relaxation oscillator supply.
- Weight 4½ lbs. complete; size 4"x5"x6". Beautifully finished case with handle.
Complete with four tubes, including Geiger tube, batteries, search probe and ear-phone.

S-1 BOMBSIGHT WITH M2 MODIFICATIONS

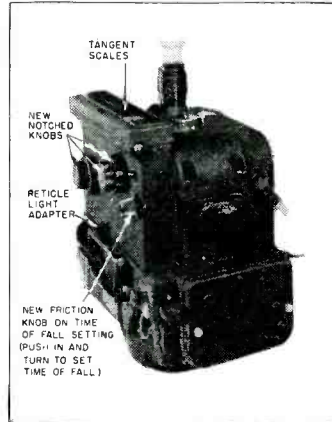

Contains many precision gears, cams—planetary assemblies gyros—switches, motors, slide rule, tangent scale, adjustable coated optic system, outside silvered mirrors. Comes in heavy, metal, safe-like container.

Brand new and complete.

Shipping weight 150 lb. **\$69.95**

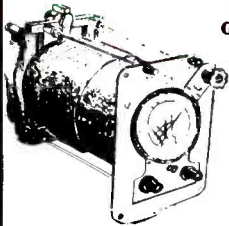

BANK - CLIMB GYRO - CONTROL

For Mark 4 Automatic Pilot

\$495

ALL-PURPOSE CHASSIS

Contains: 3 plugs, 2 vol. controls, 1 25 wt. resistor 2800 ohms, 250,000 ohms 10 wt. resistors, 13, 500 ohms, 10 wt. resistors, 3 ½ mfd, 3 bathtub condensers 600V, 3 sockets, 4 shock mounts and many other parts in a blank top chassis.

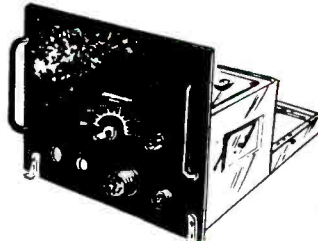

95c

POTTER AND BRUMFIELD OVERLOAD RELAYS



1, 5000 ohms, coil current 10 Ma., Relay 2, 110 V, 60 cy. AC. coil S.P.D.T. F236 \$1.95

5 GANG VARIABLE CONDENSER



Approx. 50 MMFD. per section with individual air tuned padders. . . . 18 to 1 vernier drive. F-243 \$1.95



304TL \$1.95

Just the tube for that IKW final—typical operation 2500 volts at 400 MA. An ideal tube for that induction heater or dielectric heater. Efficient operation at 1500 V. to 3000 V.

BC-746 Tuning Unit

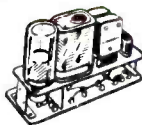

Plug in transmitter tuning unit from army Walkie Talkie. Contains antenna and tank coils, tuning condenser, transmitting and receiving crystals. Ideal transmitter foundation. Shipping Wgt. 1 lb. Each.

95c

AIRCRAFT POWER RHEOSTATS

50 W, 30 ohms 1.7 amps. max. F283 95c

5-TUBE SUPERHET AC-DC KIT

Full-sized 5 Tube Superhet Kit with automatic Volume Control, Built-in Antenna, Dynamic Speaker, Brown Plastic Cabinet. Build it yourself and enjoy fine performance! Uses 12SA7, 12SK7, 12SQ7, 50L6, 35Z5. For 110 volt AC or DC. Complete. . . . \$12.95

G.E. PHOTOCELL . . . 95c

Type used in movie projectors, burglar alarms, etc.

STANDARD MAKE CAPACITORS

2000 MFD, 50 V. F309 \$1.29

(W.P.) 2000 MMFD at 15V. F308 95c

STANDARD MAKE MICA CAPACITORS .0004 MFD .002 MFD, 3000 VDC. . . . 49c

OUTPUT TRANSFORMER

No. 227. Push pull 6V6's to 6-8 ohm voice coil, excellent characteristics. . . . 49c each

FILAMENT TRANSFORMER



Amertran Type WS For High Voltage Rectifiers. PRI. 115V., 50/60 Cycle. SEC. 5V., C/T @ 10 Amp. 35 KV R.M.S. Test 12 KV D.C. Operating. Uses 872A Tube or other tubes.

NEW \$5.95

872-A. . . . \$1.75

ULTRA HIGH-FREQUENCY TRANSMITTER T-85/APT-5

BRAND NEW! ONLY **\$95.00**

1500 Megacycle Transmitter made for U.S. Government, complete with the following tubes: 2-6AC7, 1-6L6, 2-829, 1-931A, 1-6AG7, 1-522 Ultra high freq. tube. Complete with high freq. cavity, 1 Blower to cool the 522, 1 time delay relay, 2 filament trans. cond. and many other component parts for ultra high frequency work. It has a frequency checker, complete Lecher wires, with slider and sensitive bulb for checking the wave length. The Lecher wires are so calibrated that the setting of the slider may be read directly in Centimeters. Operates on 115V. AC for filaments only. Does not include any plate supply. The tubes alone are worth many times more than what we are selling the complete transmitter for. Packed in original case—contains instruction book. Wgt 118 lbs.



COAXIAL FITTINGS

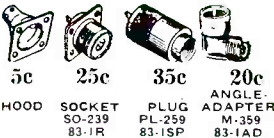

5c 25c 35c 20c
HOOD SOCKET PLUG ANGLE
SO-218 83-1R PL-259 M-359
83-1R 83-1SP 83-1AD

BK 22 K RELAY

\$2.95 Used in conjunction with SCR-269F, changeover contains 28V. step relay 5 deck, 6 position switch, 12V. DPST.



Banana Jack and Plug

75c Dozen Sets



THERMOSTAT

Normally opens at 95° F85-1 H5

49c



INDUSTRIAL PAPER OIL CAPACITATORS

1 MFD 5000 V. **\$2.95**
1 MFD 6000 V. **\$4.95**
2 MFD 6000 V. **\$8.95**
2 MFD 1000 V. **95c**

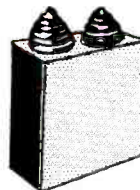

MODULATION TRANSFORMER AND DRIVER TRANSFORMER

RC 1206 modulation transformer. 815 Class AB2. 56W. audio. RC 1205 driver transformer. 65N7 to 815, Class AB2—Companion to RC 1206.

ONLY **\$4.95** FOR BOTH UNITS



SAVE MONEY BRAND NEW GUARANTEED GENERAL ELECTRIC SELSYN

Type 2J1G1

Will operate from 110 volts, 60 cycle by using a resistor or a condenser in series. Size is 2 1/4" in diameter x 4 3/4" long. Ideal for beam antenna position indicator.

Price **\$2.75** per pair —



POWERFUL ALL PURPOSE MOTOR

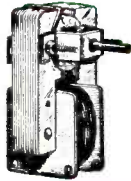

Sturdy shaded pole A.C. induction motor. 15 watts, 3000 rpm.; 4 mounting studs; 110-120 volts. 50-60 cycles. A.C. only. When geared down, this unit can operate an 18" turntable with a 200 lb. dead weight. Use it for fans, displays, timers and many other practical purposes. Ship. wt. 2 lbs.

UNUSUAL BUY **\$1.49**

SENSITIVE RELAY



Breaks at 3 MA. Beautifully Constructed and delicately pivoted. Approx. 2000 ohms resistance. Housed in dustproof aluminum can. Plugs into 5 prong socket.

Only **95¢**
\$1.95

5000 ohm D.P.S.T. relay normally open

SELSYN TYPE 32779

115 V. 60 cycle repeater. 2 1/2" diam. x 2 1/2" lg. Use as transmitter or repeater.

Price **\$3.95** each

SUPER SPECIAL

3 lbs. Asst. Hardware, No. F270D **\$1.00**

AIRCRAFT BATTERY PART NO. 3151 \$29.00

24 Volt Air Craft Battery 17 AH at 5 hour rate wt. filled. 52 lbs. made by Electric Storage.

IGNITION COILS FOR G.E., SYLVANIA, ETC. Photo Flash Tubes

\$1.29

Primary: 150V. condenser discharge. Secondary: 15,000 V. Can also be used on model airplanes.



POWER TRANSFORMER \$1.95 NO. OT-134

Primary 110V, 60 Cy. Sec. 700V each side of center at 80 MA, 6.3V at 1.2 Amps. 5V at 3 Amps. Hermetically sealed Size 6" x 3 1/2" x 3".



POWER TRANSFORMER \$1.95 NO. OT-144

110V, 60 Cy. Sec: 300V ea. side of center at 125 MA, 6.3 V at 2.1 Amps, 5V at 3 Amps. Hermetically sealed, size 6" x 3 1/2" x 4 1/4".



POWER TRANSFORMER \$1.95 NO. OT-145

110V, 60 Cy. Sec. #1: 4V at 16 Amps, Sec. #2: 2 1/2 V at 1.75 Amps; Ideal for 2 x 2 and 826 tubes. Hermetically sealed, size 6" x 3 1/2" x 4 1/4".

DIRECTIONAL GYRO M-1

A-5 Automatic pilot Mfd. by A. C. Spark Plug under license of Sperry Gyroscope Co., Inc.

\$9.95

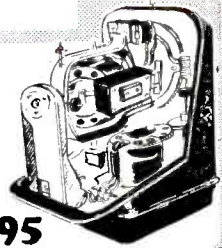

LIP MIKE



with head band and cord. NO. OT-131 **95¢**

DRAKE F15/U HARMONIC FILTER

Good for T.V. **\$2.95**

Standard Brand Noise Filter **95¢**

FL-17A



1 MEG PREC. RES. ± 1% 89¢

TOGGLE SWITCH

No. F223 D.P.S.T. 30 amps., black bakelite case. **39¢**

MATCHING TRANSFORMER

69¢ NO. OT-136

500 Ohms to grid, hermetically sealed

DUAL VAR. CONDENSER

No. F303 120 mmfd per sec. **95¢**

TYPE HE

100W, bleeder consisting of 5 sections 750 Ohms 23 Ohms, 23 Ohms, 7,500 Ohms, 3,000 Ohms. Total 11,296 Ohms.

NO. OT-147 **49¢**

TRANSFORMER

NO. OT-148 **95¢**

Audio osc. transformer with output and feedback winding.

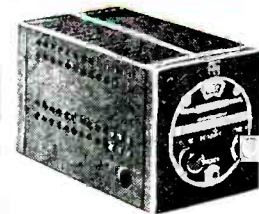

LAZY FIVER (BC 1206)

Setchell Carlson receiver; 4 x 4 x 6 5/8"; 3 lb. 14 oz. Draws .75 amps at 24V. D.C. IF freq. 135 kc; super-het.

\$6.95

CHASSIS

NO. OT-150 **\$1.95**

Containing: 110 AC relay, 3 miniature sockets with tube shields, 5 condensers and 6 res. 3" x 5" x 1".

MINE DETECTOR SCR 625

Detects metallic objects (ferrous or non-ferrous) to a depth of approx. 6 ft. Find outboard motors on the bottom of lakes, locate underground piping, treasure, metallic fragments in lumber, etc. Used..... **\$39.95**

WELL KNOWN CONDENSER NO. F219

1 MFD, 7000 V..... **\$1.95**
RELAY, No. F305, S.P.D.T. and S.P.S.T., 6500 ohms..... **\$1.95**

TUBES

815	—	\$1.95
3AP1	..	2.95
3BP1	..	2.95
5BP1	..	3.95
5FP7	..	2.95
7BP7	..	2.95
9LP7	..	3.95
VR150	..	.69
955	..	.44
9001	..	.44
9002	..	.44
9004	..	.44
9006	..	.44
5085	..	.89
35W4	..	.69
872A	..	1.95
RK60	..	.95
1T4	..	.44
3Q4	..	.44
354	..	.44
1N5	..	.69
1H5	..	.69
3Q5	..	.69
VT127A	..	2.95

SELSYN XMITTER AND INDICATOR



Ideal as Antenna Direction Indicator for Ham, Television, or Commercial Use. 6 V @ 60 cv. operates it. New **\$2.95**

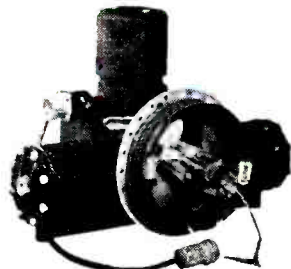

A-5 AUTOMATIC PILOT SERVO M1

Made by Delco-Remy

Has 1/4 horsepower shunt type DC motor, 27.5 V, 11 amps. input, speed 6000 rpm. Has hydraulic lift — (Intended use — Hydraulic lift actuates Ailerons on airplane). Overall length 16", width 12", height 11". Net weight 28 lbs. Shipping weight 35 lbs. Hardware for cable drum included. Brand new in original packing boxes.

\$4.95



S14 110 Volts 2 1/2 Watt Argon Bulbs **25¢ ea.**



DISCHARGE RESISTOR 95¢ NO. OT-128

General Elect. thyrity type 5F, 130 V.A.C. or D.C.

HERSHEL RADIO CO

DEPT. RE. 6

Write for Free Catalogue

5249 GRAND RIVER DETROIT 8, MICHIGAN

All orders F.O.B. Detroit—Minimum order \$2.00—Michigan customers add 3% sales tax—20% payment must accompany all orders.

AMPERITE

Studio Microphones
at P.A. Prices

Ideal for
BROADCASTING
RECORDING
PUBLIC ADDRESS

"The ultimate in microphone quality," says Evan Rushing, sound engineer of the Hotel New Yorker.

- Shout right into the new Amperite Microphone—or stand 2 feet away—reproduction is always perfect.
- Not affected by any climatic conditions.
- Guaranteed to withstand severe "knocking around."



Models
RBLG—200 ohms
RBHG—Hi-imp.
List \$42.00



"Kontak" Mikes
Model SKH, list \$12.00
Model KKH, list \$18.00

Special Offer: Write for Special Introductory Offer, and 4-page illustrated folder.

AMPERITE Company, Inc.

561 BROADWAY • NEW YORK 12, N. Y.

Canada: Atlas Radio Corp., Ltd., 560 King St. W., Toronto

CHELSEA'S FAMOUS 630-TYPE LIC. R.C.A. CHASSIS with Voltage Doubler

FOR 15" and 16" OPERATION

Less CRT . . . **\$139.95**

Plus \$2.25 Fed. Tax
CRT . . . \$39.00

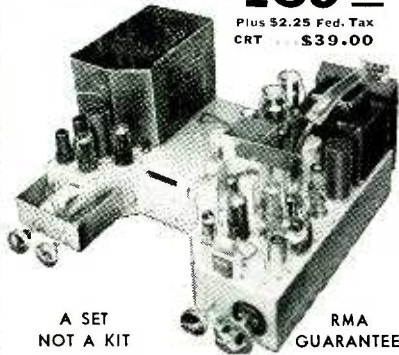

A SET
NOT A KIT

RMA
GUARANTEE

JUST PLUG IT IN . . . AND IT WORKS!

Completely wired, factory-engineered, aligned and tested. Quality-controlled all the way with AFC, keyed AGC and Standard Coil Front End down to 45 microvolts. 30 tubes. May be used for rectangular tubes (specify when ordering).

Same Chassis for 19" operation, with voltage doubler, . . . less CRT **\$144.95**
Plus \$2.25 Fed. Tax
CRT . . . \$59.50

Send certified check or money order for \$25 as deposit balance C.O.D. F.O.B. N.Y. Write or call Dept. C for literature and prices.

The House of Bargains

CHELSEA TELEVISION CENTER, INC.

Dept. 807, 130 West 42nd Street, New York 18
Tel: LOngacre 5-2254-5-6

Prices subject to change without notice.

Receiver Circuits in Mobile Radio Service

Squelch circuits and double conversion are common in these sets

By I. QUEEN

TRANSMITTERS for FM (or PM) are simpler than AM transmitters because they require so little speech equipment. It is much easier to swing the carrier frequency than to modulate its amplitude. It was shown in the article on mobile transmitters that very simple circuits are needed to phase-modulate a radiotelephone transmitter.

On the other hand, an FM receiver requires more elaborate design and more tubes than an equivalent AM set. High gain is necessary to saturate the limiters. The FM discriminator circuit is more complex and more critical to adjust than a conventional AM detector.

Receivers for the radiotelephone band are superhets, some using the double-conversion method. The use of two converters and two separate i.f. amplifiers gives excellent sensitivity and selectivity. Oscillators are generally crystal-controlled and held to a high stability (.005% or better).

In some cases different harmonics of the same crystal produce the two i.f. beats. In Fig. 1 the 18th harmonic of the crystal combines with the carrier to produce the first (high) i.f. This frequency is mixed with the second harmonic of the same crystal to produce the second (low) i.f. which is 1.6 mc. Both the first i.f. and the crystal frequency depend upon the assigned carrier.

Ordinarily, a receiver is left on continuously to await a call and a squelch circuit quiets it until a carrier is picked up. When the signal is powerful enough to saturate the limiter the squelch tube is blocked.

Sensitivity of a receiver is defined in terms of a "quieting signal". In any set the quieting signal is the voltage which reduces background noise by 20 db. It is measured in a shielded room to eliminate external r.f. pickup. A voltage is connected to the antenna terminals and varied until the set noise is reduced to 1/10th of its previous value. This input voltage is the quieting signal.

All receivers require a de-emphasis network to compensate for the pre-emphasized transmitted signal. Generally the receiver response is linear from 300-3000 cycles after de-emphasis.

The set should be turned on for about 30 minutes before alignment or retuning. Most of the circuits may be resonated with an AM signal generator. Overall response is checked with an oscilloscope. An FM signal generator should be used to align the critical discriminator primary. The r.f. section may be tuned with a v.h.f. generator and then trimmed by listening to a signal from the associated transmitter. A precise frequency meter is needed to tune the oscillator circuits.

A microammeter in the limiter grid circuit makes a good output meter. The signal should be kept low to prevent saturation and flattening of the response curve. Each amplifier stage is resonated to produce a maximum meter reading.

Some typical radiotelephone receivers have original and rather interesting circuits.

Philco PRT-150G

This 12-tube double conversion receiver has an i.f. bandwidth of 40 kc.

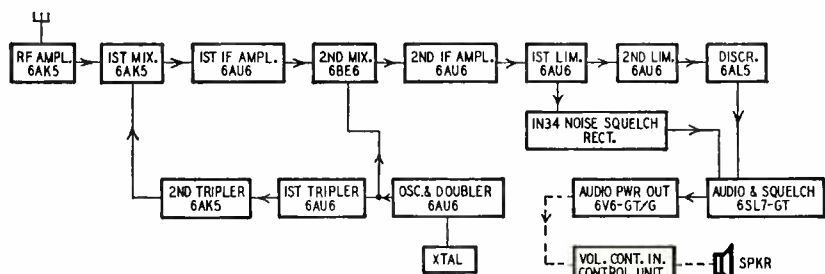

Fig. 1—Block diagram of a receiver typical of the double conversion type.

RADIO-ELECTRONICS for

Its response is 60 db down at 120 kc from the center frequency. Power input is 45 watts at 6.3 volts d.c. Fig. 2 shows the detector, squelch, and audio stages of this receiver.

The incoming signal (152-162 mc) is mixed with the 20th harmonic of a crystal to produce the high (15-mc) i.f. The second harmonic of another crystal mixes with the first i.f. to produce the second i.f. of 1 mc. The detector tube is an FM 1000 whose first and second grids operate as grid and anode of a modified Colpitts oscillator.

The higher frequency noise components of the audio signal are fed to a 6AQ6 noise amplifier which is coupled back to pin 4 of the 6SL7, a second noise amplifier, then to the 6AQ6 noise rectifier. When noise is high, the audio channel is blocked by the rectified noise voltage. The squelch control is set to just quiet the receiver when no signal is received.

General Electric ES 1B

This 15-tube receiver is a double superhet with 2 r.f. stages. The 18th harmonic of a crystal produces the high i.f., and the second harmonic of the same crystal produces the low i.f.

In the absence of a signal, the cascade limiters are not fully saturated and noise is present at the discriminator output. This noise is rectified and the d.c. voltage is used to block the audio amplifier and quiet the set. The noise voltage is negligible when a signal saturates the limiters.

Farnsworth M200-2

This 13-tube double conversion set is designed for railroad communications. Its response is 80 db down at 120 kc from the center frequency. Input power is 70 watts. As in the previous case, one crystal is used to produce both i.f.'s.

A squelch circuit triode gets its signal from the first limiter. With no signal, the limiter grid voltage is negligible so the squelch tube plate current is high. As the squelch plate is directly coupled to the first audio stage, the latter is blocked. A strong r.f. signal blocks the squelch triode and permits audio amplification. A crystal rectifier and network is provided to prevent unblocking of the audio tube by strong noise bursts.

Harvey 541

A signal conversion receiver, this set uses 14 tubes and three crystals. There are two r.f. stages and four i.f. stages, the last two of which operate as limiters. Total battery drain is 6 amps.

The discriminator is a conventional Foster-Seeley type using two crystals and the squelch rectifier is also a crystal. When no signal is being received, the noise output of the discriminator is amplified and fed to a crystal rectifier. This rectified voltage (positive) and a negative voltage from the discriminator center tap are both applied to the grid of the squelch tube. In the absence of a signal, the resultant volt-

RADIOMEN'S HEADQUARTERS • WORLD WIDE MAIL ORDER SERVICE!

SCR-274 COMMAND SET THE GREATEST RADIO VALUE IN HISTORY!

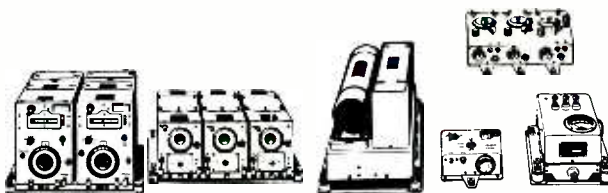

I.F. meter to measure power fed into antenna; four 28V dynamotors (alteration of set to 110V operation is quick and simple); two 40 Watt Transmitters including crystals; and Pre-Amplifier and Modulator so that transmitters can be used for voice as well as for code. 29 Tubes supplied in all. In guaranteed electrical condition. Transmitters and Receivers instantly removable from mounting racks which hold them in position in aircraft use, so that they can be split up and used separately at different locations just like any other sets. Only a limited quantity available, so get your order in fast. A super value at \$59.95.

A mountain of valuable equipment that includes not 1 but 3 of the hottest superhet Communication Receivers, the famous BC453, BC454 and BC455, each of which has a tuned R.F. stage, 3 gang condenser, crystal, and 6 working tubes not counting rectifiers. Also included are 2 Tuning Control Boxes; 1 Antenna Coupling Box with

SOS EMERGENCY TRANSMITTER SOS

This is the famous Gibson Girl Transmitter that saved so many lives during the war. It was used as a distress call transmitter on boats and airplanes. The Gibson Girl is the easiest transmitter in the world to operate. No instruction or experience necessary. No external power supply required for operation. It is merely necessary to crank the crank on the top of the transmitter and power is generated and the distress signal is automatically sent out on the international distress frequency. Brand New Gibson Girl transmitter complete with tubes. \$9.95.

\$9.95 TAKES ALL THREE BIG BARGAINS "B"

HOME WORKSHOP AT BARGAIN PRICE. Accurate and precise 2 speed guaranteed hobby lathe, the essential machine for the home workshop. Sturdy enough for light production work or factory standby service. Supplied with 567 of bedding for connecting to any available electric motor or power take-off. Also included in this unbelievable offer are such accessories as a 1/2" drill chuck with specially hardened tool steel jaws, a 4" electric furnace high speed grinding wheel, a cotton buffing wheel with a large supply of buffing compound, and a 4" steel wire scratch brush. Your cost \$6.00. Sole export agent. Distributor inquiries invited.

SENSATIONAL, FASCINATING, MYSTERIOUS SELSYNS. Brand new Selsyn made by G. E. Company easy or more connected together work perfectly on 110 V A.C. Any rotation of the shaft of one Selsyn and all others connected to it will rotate exactly as many degrees in the same direction, following unerringly as if the units were connected together by shafting instead of wire. This is true whether you twist the shaft of the master unit a fraction of a revolution or many revolutions. Useful for indicating direction of weather vanes, rotating directional antennas, or controlling innumerable operations from a distance. Complete with diagram and instructions. Per Matched Pair \$4.95.

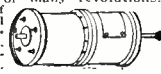

STROMBERG CARLSON

Power Switching Relay Box. Neat 3 1/2 x 4 x 5 1/2" Steel case with tight fitting cover finished in Stromberg's usual beautiful chocolate color crackle finish. \$1.00

GENERAL ELECTRIC 15 TUBE TRANSMITTER-RECEIVER SET. This brand new 15 tube transmitter-receiver was designed for mobile storage battery powered service. It's a cinch for the experimenter to connect this unit for 110 volt A.C. operation by following the instructions and diagrams supplied, which cover numerous applications, including FM and amateur television transmission and reception. For those intending to use on car or boat, a new dynamotor, exactly as originally supplied, costs only \$15.00. Don't fail to write for FREE descriptive bulletin Order our RT-1248 for only \$29.95, or two for \$53.90.

ANTENNA KIT FOR GIBSON GIRL TRANSMITTER. This kit was designed to improve the effectiveness of the Gibson Girl Transmitter by increasing the range several times. The kit includes 300 feet of special antenna wire, two balloons for raising the antenna in calm weather, two hydrogen generators to inflate the balloons, a special box kite for antenna erection in windy weather, and a searchlight, powered by the crank operated generator in the transmitter. Complete kit \$9.95.



WE ARE LOOKING FOR TUBES

and other surplus. Large or small quantities. Send your list for our bid.



SPEND YOUR DOLLAR WHERE YOU GET THE BIGGEST BARGAINS

Sensational Value in AC-DC POCKET TESTER

This analyzer features a sensitive repulsion type meter in bakelite case. The result of 15 years in the instrument field by a large company specializing in electronic test equipment. Specifications of the AC-DC Model Volt-Ohm-Milliammeter: AC Volts 0-25, 50, 125, 250; DC Volts—0-25, 50, 125, 250; Milliamperes AC—0 to 50; DC Milliamperes—0 to 50; Ohms Full Scale—100,000; Ohms Center Scale—2400; Capacity—0.05 to 15 Mfd. Total Price, prepaid in the U.S.A.—\$7.00. Similar 1 1/2" Meter, without the AC operated ranges of above, \$5.50 prepaid.



AUDIO AMPLIFIER—Brand new, Push-Pull state triode amplifiers having 2 of the valuable and scarce output type audio transformers that sell for over \$10.00 each. Neat aluminum case, fully enclosed (largest dimension 6 inches). Perfect for intercom system, phono amplifier, mike amplifier or signal tracer amplifier for testing radio sets. A sensational bargain at only... \$3.40 each

COMPRESSED AIR INSTANTLY ANYWHERE

Portable Air Compressor and storage tank. Ruggedly built of best materials using life-time lubricated ball-bearing on connecting rod and oil impregnated main bearing on shaft. Unusual design forever eliminates valve trouble, the most common fault in air compressors. **PATENTED** unique air intake system increases efficiency tremendously over other compressors so that air output is much greater than that from larger compressors powered by heavier motors. Will deliver approximately 3500 cu. inches of air per minute at maintained pressure of 30 lbs., or will inflate a 90 lb. truck tire in less than one minute. Comes complete with 100 lb. gauge, although finger-tip adjustment allows setting of output pressure at any value, which will automatically be maintained. Works from any 1/2 H.P. motor. Useful for spraying paints or lacquers, disinfectants, insecticides, annealing or brazing with natural gas, inflating tires, etc. Price \$14.50 postage prepaid anywhere in the U.S. Efficient, completely adjustable syphon type spray gun complete with 12 ft. of 100 in. tested hose available for only \$7.75 with pint container, also prepaid.



BRAND NEW 14 TUBE ELECTRONIC ALTIMETER. complete with accessories. Shows absolute height from plane to terrain below. Total weight 25 lbs. Descriptive literature on request. Cost the Govt. \$1000.00, your cost \$75.00 for the 12 volt model, or \$45.00 for the 24 volt. Essential for magnetometer surveying.

\$7.00 TAKES BARGAIN "C"
(All three items below)

ALUMINUM GEAR BOX 18x8x7 that contains two powerful electric motors and two matched gear trains. 62 gears in all varying in size from 1/2 to 4 inches in diameter. This unit is readily converted to rotate in beam antenna or any other similar use. \$5.00

SIGNAL CORPS INTERCONNECTOR RELAY BOX 730A

This valuable unit, made by Bell, and more familiarly known by the U. S. Army designation BC616, is encased in a highly polished aluminum case 6 1/2 x 5 1/2 x 2 1/2, and contains 150 mfd. of condenser capacity, sensitive relays, resistors, and terminal strips. Order several at the giveaway price of only... \$1.95



REMOTE CONTROL UNIT—Aluminum case 4 x 3 x 2 containing 2 potentiometers, triple pole switch, 4 knobs, phone jack, gear mechanism and revolution counter. Including 8 prong JAN connector to fit box \$1.39

BUFFALO RADIO SUPPLY
219-221 GENESEE ST., DEPT. RE, BUFFALO 3, N. Y.

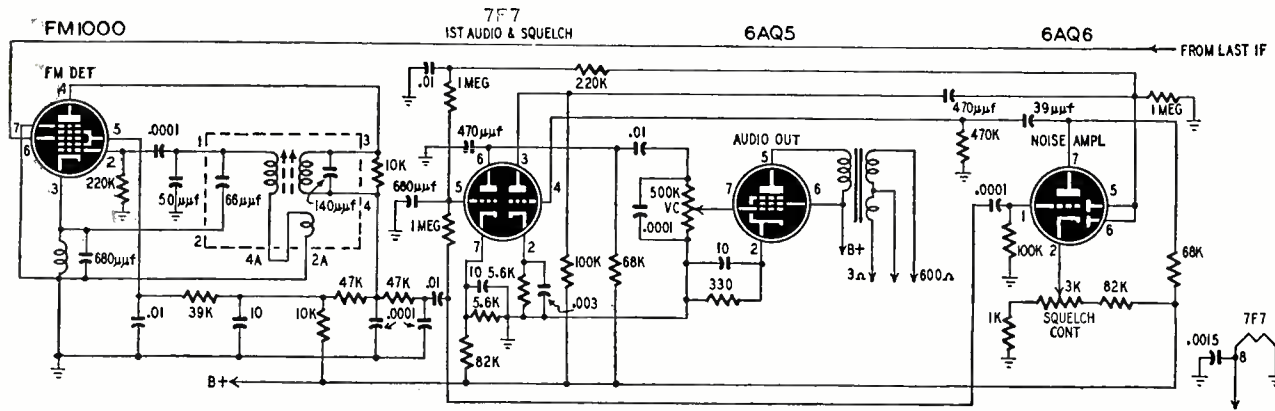

Fig. 2—Detector, squelch and audio circuits of the Philco set. The rectified noise voltage blocks the audio channel.

age is positive and the squelch tube conducts and blocks the audio. When a signal comes in, the net voltage is negative and the squelch tube is blocked.

Raytheon

The same receiver-transmitter unit is used for both mobile and fixed service. The receiver is a 12-tube single-conversion superhet with two r.f. and two i.f. stages. Sensitivity is better than 1 μ v for 50-mw output. Selectivity is 60 db down at 120 kc off center frequency.

Communications Co. Comco 275

This is another single conversion 14-tube set with two r.f. and three i.f. stages. Selectivity is 6 db down at 28 kc off resonance. Sensitivity is .75 μ v for 20 db quieting.

Motorola Research Line

This line of mobile equipment has a number of innovations (secured by



A typical radiotelephone set. This set, one of Motorola's "Research Line", has transmitter and receiver in one unit.



Control head of the Motorola receiver.

patents). For example, model 8433 receiver has a tuned cavity resonator,

a sharply-tuned filter and a tunable local oscillator for extreme selectivity. Response is 100 db down at 30 kc off center frequency and sensitivity is .8 μ v for 20 db quieting.

The power supply is on a separate chassis so the receiver may be operated from a battery or from the line. Model 8433 is a double superhet using 17 tubes.

Link 2210

The 2210 receiver is a double superhet with 12 tubes. Response is 85 db down at 150 kc off center. Sensitivity is .5 μ v for 20 db quieting.

In the absence of a carrier, AM noise is taken from the second limiter

and is amplified and rectified. This positive rectified voltage unblocks the squelch tube which in turn blocks the audio stage. When a carrier is tuned in, the AM noise voltage is lost due to limiter action and the squelch tube is cut off.

Bendix MRT-1

This receiver uses 17 tubes, four of which are common to both receiver and transmitter. These are four audio and compressor tubes. The receiver has double conversion and the second limiter saturates at 50 μ v. A Foster-Seeley discriminator feeds the audio amplifier.

(Continued on page 76) ▶

GASOLINE ENGINE GENERATORS:

HOMELITE Engine Generator—output 30 V. DC 50 amp. (1500 W.) driven by 3 HP single cylinder two cycle air cooled gas engine, rope or electric start. Used to charge batteries or auxiliary light plant. Reconditioned. No. REG-105 **\$49.50**

DELCO Engine Generator—output 12 V. DC 750 Watt driven by 2 HP one cylinder 4 cycle air cooled gas engine with self starter, voltage regulator, output meter, and switch. Used to charge batteries or auxiliary light plant. Reconditioned. Order No. REG-106 **\$59.50**

WHIP ANTENNA—MAST BASES, INSULATED:
 MP-132—1" heavy coil spring, 2" insulator. Overall length: 11½". Wt. 2¼ lbs. Price **\$3.95**
 MP-22—Spring action direction of bracket. 4" x 6" mounting. Price **\$2.95**

MAST SECTIONS FOR ABOVE BASES:
 Tubular steel, copper coated, painted, 3 foot sections, screw-in type. MS-53 can be used to make any length. MS-52-51-50-49 for taper. Any section 50¢ Ea.
 Sections MS-54 or MS-55 (Larger than MS-53). 75¢ Ea.
 BAG BG-56 t/carrying 5 mast sections 50¢

MARK II B-19 TRANSMITTER & RECEIVER 15 TUBE SET 2—8 MC., 240 MC., AND INTERCOM. FOR MOBILE OR STATIONARY USE!
PRICES—NEW: \$59.50 USED (Tested) \$39.50

NEW TRANSFORMERS—CASED—115 V.A.C. 60 CYCLE INPUT:

OUTPUT: 600-0-600 V.A.C. at 250 MA. 12 V.A.C. at 3 amps. 12 V.A.C. at 3 amps; and 5 V.A.C. at 3 amps. Designed for Army Surplus transmitters. No. RE-108 **\$7.75**
OUTPUT: 250-0-250 V.A.C. at 60 MA. 24 V.A.C. at 6 amps; 6 3 V.A.C. at 6 amps. Designed for Army Surplus receivers. No. RE-109 **\$3.50**
NEW CHOKE—CASED: 13 Henries at 250 MA. filter choke, 1500 V. insulation. No. RE-121 **\$4.95**
TRANSFORMERS—110 Volt 60 cycle Primaries:
 Sec. 12 V. 1 amp. \$1.50 Sec. 24 V. 2 amps. \$2.25
 Sec. 24 V. 1 amp. 1.95 Sec. 24 V. 5 amp. 1.50
 Sec. 36 V. 2.5 amps. 2.95 Sec. 24 V. 4½ amps. 3.95
 Sec. 14-14 or 28 V. 7½ or 15 amps. 4.95

Car Shaver Motor

Use your electric shaver in your car. Dynamotor will supply 110-120 Volt DC approx. 15 Watts from 6 Volt DC auto battery and will operate most types of AC-DC shavers. Order No. RE-6250. Price—only **\$2.00**

Address Dept. RE • Prices F.O.B., Lima, Ohio • 25% Deposit on C.O.D.'s • Minimum Order \$2.00

FAIR RADIO SALES

132 SOUTH MAIN ST. LIMA, OHIO

BC-223 TRANSMITTER and SPARE PARTS

30 Watt Transmitter with crystal or MO control on four pre-selected channels. 2000 to 5250 KC., by use of three plug-in coils. Five Tubes: two 801 & three 16. With TU-17 Tuning Unit 2000 to 3000 KC. and Cable, less mtg. BC-223 NEW: **\$24.95**

OPERATING MANUAL for BC-223 **\$2.00**
SPARE TUBE KIT for BC-223—Contains 5 spare tubes in metal box. Price **\$4.95**

TUNING UNITS: TU-17—2 to 3 MC.; TU-18—3 to 4.5 MC.; TU-23—4.5 to 5.2 MC. NEW: \$3.50 Ea. USED: \$2.50 Ea.

PE-125 VIBRATOR POWER SUPPLY for BC-223 Transmitter. 12/24 Volt input; output 500 Volt 150 MA. Price NEW: \$9.95

MOUNTING for PE-125 **1.50**
SPARE VIBRATOR & TUBE KIT. For PE-125—Contains 2 spare tubes, 2 spare vibrators and fuses in metal box. Price **\$4.95**

CABLE only—Transmitter to Power Supply **1.75**

BC-645-A TRANSCEIVER 110 VOLT TRANSFORMER AND CHOKE

15 Tube Transceiver, ideal for conversion to 460 MC. Citizens Band. Frequency coverage 435 to 500 MC. With conversion instructions—New and Boxed. BC-645-A **\$14.95**

TRANSFORMER for BC-645-A—110 V. 60 cycle input; output 400 V. 150 MA. after filter. 12, 9, and 6 V. AC. 4 amps and 5 V. 3 amps. No. RE-645 **\$6.95**

CHOKE—15 Hy. 150 MA. No. RE-616 **\$2.95**
PE-101 DYNAMOTOR—13/26 Volt input **\$2.95**

Gun Sights—Illuminated Sight Mark 8—Mod. 3. Contains the following lenses: 2¼" Concave-Conconv FL 4½"; 3¼" Double Concave FL 5"; 3¼" Double Convex FL 3"; 3½" Plain and Convex FL 8¾" Coated; also 1¾" Plain Rd. 5" x 3¾" x ½" Oblong Plain Optical—all mounted in a 4¾" Barrel with light socket level indicator and pistol sight holder. Price—only **\$6.95**

GEARED MOTOR

Ideal reversible motor for rotating antennas, displays, etc. Weight: 4 lbs. Overall size: 7" long, less shaft. Gear Box size: 3¼" x 3¼". Motor size: 4" x 2¼". Shaft size: ¾" x 1½" threaded. Operates from 21 Volt DC. 2.9 A., 9 RPM or 36 Volt AC at 75 lbs. torque per inch. Price **\$5.95**

TRANSFORMER—110 Volt 60 cycle primary; secondary 36 Volt AC **\$2.95**

RHEOSTAT—to control speed. 30 ohm 50 Watts **97¢**

HAND TOOL MOTOR—12 Volt AC-DC. 5000 RPM. Size: 3¾" L x 1¼" D with splined shaft ¼" D x ½" L. Price **\$2.95**

TERRIFIC BUYS FOR SMART, SKEPTICAL BUYERS

ARMY AIRCRAFT RECEIVER— BC-946-B

Covers 520 Kc to 1500 Kc Broadcast Band. 6 Tubes: 3—12SK7, 1—12SR7, 1—12A6, 1—12K8. Designed for dynamotor operation; can be easily converted to 110 volt or 32 volt use. Two IF Stages. Three-gang tuning con. BRAND NEW, in sealed carton, with tubes and instruction manual. less dynamotor

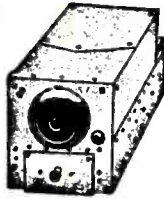

\$29.50

SMASH VALUES IN RADIO RECEIVERS

	Used	New
BC-453 RCVR.	\$21.95
BC-454 RCVR.	\$4.95	7.95
BC-455 RCVR.	6.95	9.95
BC-456 MOD.	1.95	3.45
BC-457 XMTR.	6.95	8.95
BC-458 XMTR.	6.95	8.95
BC-459 XMTR.	23.95
BC-696	14.95	24.95

BC-348 Receiver, New	\$149.50
BC-348 Receiver, Used, good	129.00
BC-221 Freq. Meter, Exc. Cond.	77.50
MN-26C Compass Rvr., New	28.50

BC-645 XMTR RECEIVER 15 Tubes 435 To 500 MC



BRAND NEW!

\$16.95

each
The electronic equipment that saved many lives in the war. Set can be modified to use for 2-way communication, voice or code, on following bands: ham band 420-450 mc, citizens radio 460-470 mc, fixed and mobile 450-460 mc, television experimental 470-500 mc. 15 tubes (tubes alone worth more than sale price!): 4—7F7, 4—7H7, 2—7E6, 2—6F6, 2—955 and 1—WE316A. Now covers 460 to 490 mc. Brand new BC-645 with tubes, less power supply in factory carton. Shipping weight 25 lbs.

PE-101C DYNAMOTOR for above BC-645 **\$2.95**

UHF ANTENNA ASSY. for above BC-645 **\$2.45**

SETCHEL-CARLSON Beacon Radio Receiver BC-1206-C

Receives A-N beam signals, operates on 24-28 V DC. 5 Tubes: 3—14H7, 14R7, 28D7. Tunes 195 to 420 Kc. Size 4"x4"x6 3/4" wide, 4 lbs. In original carton. Good Used **\$6.75**

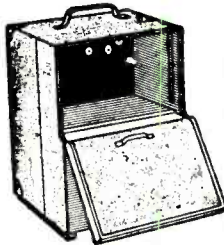

FREQUENCY METER CABINET

For BC-221 Series freq. meters. BRAND NEW! 3 compartments. Massively built. 1 1/2"x10 1/2"x10". Value \$20.00. Complete with canvas cover for both ends. Yours for only **\$4.95**

DC AMMETER 0-15 Amps

A terrific buy! 3 1/2" easy reading scale, 75 divisions. Black plastic case 4 1/2"x5 1/2"x2 1/4". Rubber covered test clip leads plus black metal carrying case with hinged cover. Brand New. Wonderful for automotive, battery charging, general test work. Value \$25. All yours for only **\$4.59**



STROMBERG TELEPHONE

It's a real desk type carbon microphone, with press-to-talk switch. Very massive construction, cord and plug included. Excellent condition. Specially priced **\$3.95**

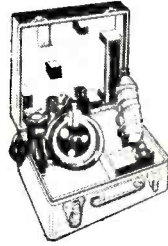

BUBBLE SEXTANT

12.95 COMPLETE

Terrific value for boat owners! Actually worth \$100 or more! Has illuminated averaging disc for nighttime use. Complete with carrying case, recording discs, flash light with rheostat for using sextant at

night, 2X telescope for faint stars, and Allen wrench. Hurry! Only a few left!

GE THYRATRON FG-105



Brand New MERCURY RECTIFIER

Individually boxed in factory sealed cartons. List Price \$40 your cost. **\$11.95** each

While They Last!

For continuous rectifier and welder control service. Tetrode type, indirectly heated cathode; 10000 V peak, 10000 V peak inverse. Av. Max. current 6.4 amps continuous, 2.4 to 4 amps welder control service.

MONEY SAVING VALUES!

CHECK EACH ONE

Headsets and Mikes

HS23 High Imp. Headset New	\$2.85
HS33 Low Imp. Headset New	2.85
HS30 High Imp. Headset New	1.39
HS30 High Imp. Headset Used79
T17B. Mikes. New	2.45
T17B. Mikes. Used88
T24 High Imp. Mike, New	1.19
T30 Breast Mike. New88
T45 (or Navy) Lip Mike New98
CD307 Cord for headsets. New55
WE Carbon Breast Mike. New88
PL55 Plug New25
PL68 Plug New19
TS13 Handsets New	3.95
TS9 Handset	3.97



Sensational Value! 80-Meter Receiver

RCA Model AVR-20-A LIMITED QUANTITY! Originally designed for Aircraft and boats. Tunes 2300 to 6500 Kc. Perfect for 80 meter Ham work. Crystal controlled. Phone and CW. Provision for low and high impedance phones. Tubes used: 6B8, 6F7, 6S7, 6K8. 3-gang tuning cond. vernier tuning. Designed for 6 volt operation. Easily converted to 110 volts AC. Less power supply. SENSATIONAL PRICE WITH TUBES. **\$14.95**

McElroy

Automatic

KEYER

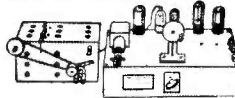

For Xmt'r keying or code practice. Has photocell and sensitive relay. Variable speed motor, 110V AC or DC. Complete with 2-117L6 and 1-117L6 tubes. your cost. **\$17.95**

QUANTITY PRICES

Inquiries welcomed from institutions, wholesalers, dealers, large users. Phone, write, wire for quantity prices.

Please include 25% Deposit with order—Balance C.O.D. MINIMUM ORDER \$3.00. All Shipments F.O.B. Our Warehouse N.Y.C.

G & G GENUINE MAJESTIC
RADIO PARTS SERVICE
53 VESEY STREET · NEW YORK 7, N.Y.

ARMY FIELD TELEPHONES

Type EE8—Talk as far as 17 miles. Dependable 2-way communication at low cost. Ideal for home, farm, field. Up to six phones can be used on one line. Each phone complete with ringer. Originally cost gov't. \$39.90 each. Used, good as new!



\$12.95 each

TERRIFIC VALUE 24-VOLT STORAGE BATTERY, BRAND NEW 17 AMP. HRS.

Made by Delco. 12 cells, heavy duty, very rugged. Shipped dry, uses standard sulphuric acid electrolyte.

VERY SPECIAL

\$17.95

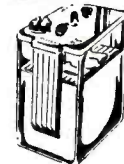

WILLARD 2-VOLT STORAGE BATTERY 20 Ampere-Hours

Exact replacement for GE Model LB-530 portables—brand new. 5" high, 3 3/4" wide, 3" deep. Each **\$1.95**

7-PRONG 2-VOLT VIBRATOR for portable and farm sets. Replacement for GE LB530—**\$1.65**

GOULD 6-VOLT STORAGE BATTERY

Navy Standard. Black Rubber Case. BRAND NEW. 15 Amp. Hour Rating **\$6.95**

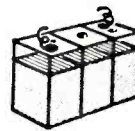

WILLARD MIDGET 6-V STORAGE BATTERY

3 amp hour rating. Transparent plastic case. Brand new. 3 3/4"x1 1/2"x2 3/8" high. Uses standard electrolyte. Each **\$2.65**

1-QUART BOTTLE BATTERY ELECTROLYTE

Made by Willard, for above storage batteries. 1 qt. sufficient for 2 two-volt cells. Hermetically sealed. SPECIAL. per qt. bottle. **\$1.25**

SCR-522

Very High Frequency Transmitter-Receiver COMPLETE WITH ALL COMPONENTS

100-156MC. 4 channels. XTAL-controlled. Amplitude Modulated Voice. Electrically tested. Complete as illustrated. **\$77.50**



UHF ANTENNA AN80-A

Suitable for 400 Mc citizens' band, fine for UHF experimenters. 5 1/4" flat antenna rod, mounted on porcelain base, with mounting plate and right angle feed through. Brand new. Special at **49c**



BC 605 INTERPHONE AMPLIFIER

Can be easily converted to an intercom. set—ideal for office, home or factory.

New **\$4.95**
Like New **\$3.95**

T-85/APTS UHF TRANSMITTER

Operates over a freq. range of 300-1400 MCPC with nominal output of from 10-30 watts. Comes equipped with 110 V. 50 CPS filament transformer; blower; lecher wire test freq. set and 8 tubes: 1—931A, 2—6AC7, 2—6AG7, 1—6L6G, 2—820B and 1—3C22 (GL522 Oscillator). Brand new in original box, operating instructions. Manual included. **\$69.50**

TELEVISION SCOPE

SUPERIORITY AT A GLANCE!

The vertical response of this economy TV scope is usable to 5000 kc, not 50 kc. Response is flat to 750 kc, down 3 db at 1000 kc. Amplifier supplies a voltage gain of 20 at 5000 kc.



AR-3

Check this necessary feature before you buy any scope for TV use.

The R.S.E., AR-3 Scope has been built by Ross Armstrong to our rigid specifications. It's a complete unit that embodies standard horizontal amplifier and sweep circuits with normal sensitivity.

The case is 8" high x 5" wide x 14" long, attractively finished in "hammered" opalescent blue enamel. Operates on standard 110 volts—60 cycles—40 watts. Tubes, 3BP1-6AC7-6SJ7-6X5-5Y3-884. Instructions included. Complete specifications upon request. Satisfaction or your money back.

PRICE \$4995

AVAILABLE TO JOBBERS IN QUANTITY

F. O. B. DETROIT

INTERCOM & RADIO

AT A PRICE THAT CAN'T BE BEAT



6 tube superhet—3 tube intercom permits communication between radio-master and up to 4 sub-stations.

WHILE THEY LAST \$2995

With 1 sub-station and 50 feet of cable Extra Sub-stations \$3.95 each

Original cost \$64.50

PUSHBACK WIRE



25% BELOW MILL COST!

1st class, Essex or Lens, ALL SOLID tinned copper, double cotton serve, waxed finish.

SIZE	COLORS	100 feet	1000	Production Reel
22	BLACK-BROWN	.39	3.79	3.65M
20	RED-WHITE-BLUE	.49	4.49	3.95M
18	BROWN	.69	5.98	

ORDER INSTRUCTIONS

Minimum order—\$2.00. 25% deposit with order required for all C.O.D. shipments. Be sure to include sufficient postage—excess will be refunded. Orders received without postage will be shipped express collect. All prices F.O.B. Detroit.



Demand This Seal of Quality

Quantity and Export Orders Solicited

RADIO SUPPLY & ENGINEERING CO., Inc.
85 SELDEN AVE. DETROIT 1, MICH.

The squelch circuit (Fig. 3) uses two relays. When a carrier is tuned in, plate current of one squelch tube is sufficient to operate a relay in its circuit. This relay completes B-plus to a d.c. amplifier and another squelch tube. The plate current of the latter tube operates a second relay. This

relay normally leaves the audio output cathodes floating, and sound can be heard at the speaker only when a carrier sufficiently strong to operate the squelch is present.

The audio level of this set is substantially constant because of compressor action.

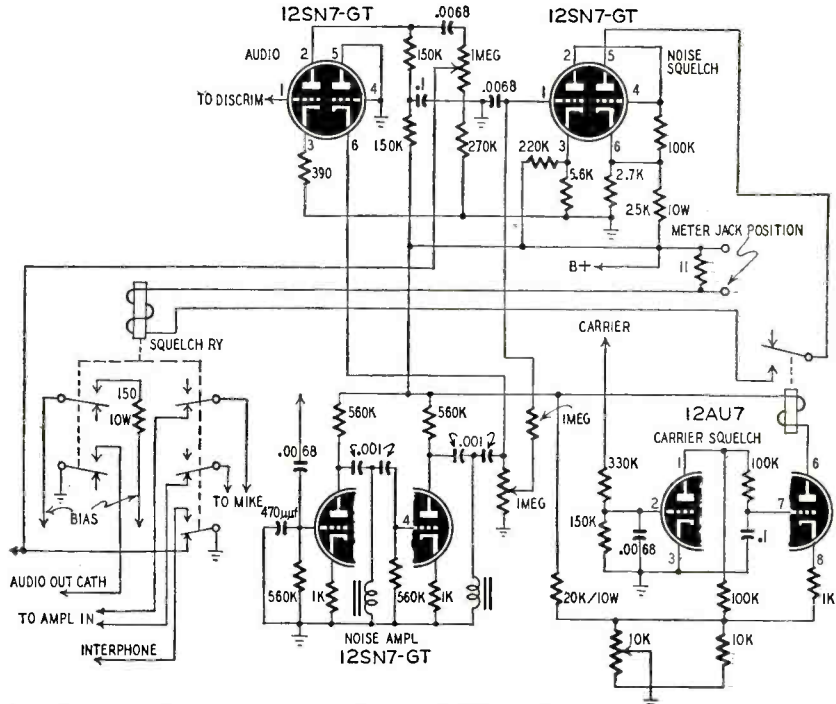

Fig. 3—Squelch circuit of the Bendix MRT-1. The carrier closes the plate relay of the 12AU7 which operates the squelch relay and unblocks the audio.

TELEVISION DX

This month we have four more letters to add to our growing list of DX reports.

Bob Butts of Beeville, Texas has sent us a long list of stations which he has received in the past year, most of them during last summer. On the list are: KNBH, channel 4, Los Angeles; WNBW, channel 4, Washington, D.C.; WTVJ, channel 4, Miami; WAGA-TV, channel 5, Atlanta; WBKB, channel 4, Chicago; WNBQ, channel 5, Chicago; WAVE-TV, channel 5, Louisville; WDSU-TV, channel 6, New Orleans; WMAR-TV, channel 2, Baltimore; WJBK-TV, channel 2, Detroit; WJTV-TV, channel 4, Detroit; WLW-TV, channel 4, Cincinnati; WLW-C, channel 3, Columbus; WDTV, channel 3, Pittsburgh; WMCT, channel 4, Memphis. Mr. Butts' receiver is a Motorola VT-107 and he uses a stacked Lyte all-channel antenna which is about 40 feet above the ground.

Little Jack Little, the orchestra leader, reported seeing WOAI-TV, Channel 4, San Antonio, one night last April while in Mexico City. He saw the program on a special receiver installation in his car.

Jerry Hines of Spooner, Wisconsin, also pulled in WOAI-TV recently. He has an Admiral receiver and a Vee-D-X model RLY Yagi antenna. Mr. Hines asks if we have any dx reports on

WTCN-TV or KSTP-TV. So far the answer is no, but perhaps some of our readers will oblige.

L. E. Benson of Leaksville, N.C., has received WKY-TV, channel 4, Oklahoma City; WNBW, channel 4, Washington, D.C.; and WTVR, channel 6, Richmond. The receiver is a Hallicrafters model 509 and the antenna a Ward two-bay antenna.

CANADIAN FM STATIONS

There were 36 FM broadcast stations operating in Canada—as of April 1, 1950. Operating between 88.3 and 106.9 mc, these stations have effective radiated powers ranging from 250 to 10,940 watts.

A complete list of these stations, their locations, frequencies, and effective radiated powers is printed for the benefit of FM listeners. FM dx'ers will probably want to listen for some of these stations when distant stations are coming through.

STATION	LOCATION	Frequency (MC/S)	Effective Radiated Power (Watts)
CBF-FM	Montreal, Que.	95.1	10940
CBL-FM	Toronto, Ont.	99.1	5580
CBM-FM	Montreal, Que.	100.7	4510
CBO-FM	Ottawa, Ont.	103.3	380
CBR-FM	Vancouver, B.C.	105.7	1400
CFA-FM	Kitchener, Ont.	106.1	10000

CFCF-FM	Montreal, Que.	106.5	7700
CFCH-FM	North Bay, Ont.	106.3	250
CFPL-FM	London, Ont.	95.9	4440
CFRA-FM	Ottawa, Ont.	93.9	383
CFRB-FM	Toronto, Ont.	99.9	600
CHEX-FM	Peterborough, Ont.	101.5	250
CHML-FM	Hamilton, Ont.	94.1	400
CHNS-FM	Halifax, N.S.	96.1	250
CHOK-FM	Sarnia, Ont.	97.5	250
CHRC-FM	Quebec, Que.	98.1	595
CHSJ-FM	Saint John, N.B.	100.5	325
CJBR-FM	Rimouski, Que.	101.5	570
CJCA-FM	Edmonton, Alta.	99.5	414
CJCB-FM	Sydney, N.S.	94.9	630
CJIC-FM	Sault Ste. Marie, Ont.	100.5	250
CJKL-FM	Kirkland Lake, Ont.	93.7	250
CJCB-FM	Winnipeg, Man.	103.1	250
CJRT-FM	Toronto, Ont.	88.3	9900
CISH-FM	Hamilton, Ont.	102.9	9200
CKGR-FM	Kitchener, Ont.	96.7	350
CKGB-FM	Timmins, Ont.	94.5	425
CKLW-FM	Windsor, Ont.	93.9	250*
CKOX-FM	Woodstock, Ont.	106.9	262
CKPC-FM	Brantford, Ont.	94.7	250
CKZR-FM	Fort William, Ont.	94.3	250
CKSF-FM	Cornwall, Ont.	104.5	522
CKTB-FM	St. Catharines, Ont.	97.7	250
CKUA-FM	Edmonton, Alta.	98.1	352
CKVL-FM	Verdun, Que.	96.9	10200
CKWS-FM	Kingston, Ont.	96.3	350

*Temporary authorization.

WWV STORM WARNINGS

Disturbance warnings for radio are broadcast regularly by WWV, the radio station of the National Bureau of Standards. The warnings give advanced notice of disturbances affecting high frequency transmissions and apply particularly to transmission paths across the North Atlantic such as New York-London and Washington-Berlin.

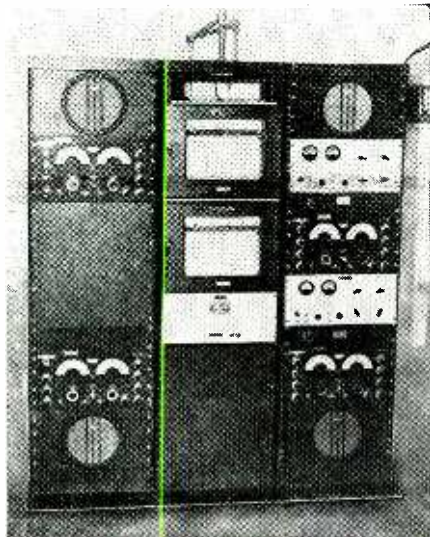

Given in code, the warnings follow the time announcements at 19 and 49 minutes past each hour. A series of N's signifies that propagation conditions are normal, a series of U's that they are unstable, and a series of W's that they are disturbed or are expected to become so within twelve hours.

The warnings are based on comprehensive observations of radio, ionospheric, solar, and geomagnetic phenomena at stations throughout the world.

Given a forewarning of a disturbance, a radio operator can minimize its effect by rushing through high priority traffic before the circuit deteriorates, by postponing operations requiring assured radio contact, or by rerouting traffic until the storm has subsided.

JULY, 1950

CORROSION... the iron curtain of TV reception
RAIN • SNOW • WIND • SEA AIR

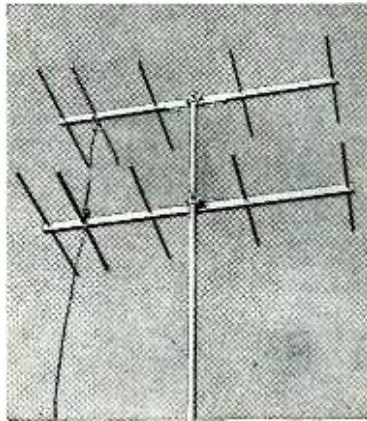

One of the major reasons for poor television reception is a corroded antenna . . . and in most cases you won't know when your antenna is corroded.

Corrosion changes the electrical characteristics of the antenna . . . results in imperfect — even poor — reception.

Only with antennas that do not corrode can you be sure of good reception.

Tel-a-Ray antennas can't corrode! They are constructed of Dural, with stainless steel fittings . . . all elements sealed by the exclusive Tel-a-Roll process.

You get perfect television reception all the time. Whether you are replacing a worn antenna or installing a new one — buy Tel-a-Ray.

Tel-a-Ray Antennas

"FIRST—BECAUSE THEY LAST"

TEL-A-RAY ENTERPRISES, INC.

P. O. BOX 322, DEPT. C, HENDERSON, KY.

SNYDER ANTENNAS

Super Chief TV-21

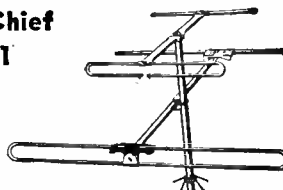

*Folded dipole with reflector and matched Hi-band adapter.

*Covers all channels *Overall height, 7 ft. erected. *Complete with two mating mast sections, guy wire, and stand-off insulators.

YOUR COST \$5.45
Lots of 10 \$4.75 ea.

XA-44 SERVICEMAN'S KIT

Array only. Recommended for servicemen and installation crews supplying their own accessories. Fifteen 3/8" aluminum alloy elements. Connecting stubs supplied for stacking array installations. Includes mast clamp.

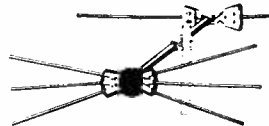

YOUR COST \$3.75
Lots of 10 \$3.25

ALMO RADIO CO.
 509 ARCH STREET • Philadelphia
 6205 MARKET STREET • West Phila.
 6th & ORANGE STS. • Wilmington
 4401 VENTNOR AVE. • Atlantic City

Get These TELEVISION SERVICING AIDS!



PRACTICAL TELEVISION SERVICING

Here's the book that was written to help you get where the big servicing money is—in TV! Complete—practical—easy to understand. Covers all phases of troubleshooting, diagnosing and remedying television receiver troubles plus what tools, parts and equipment to use. 334 pages, over 230 illus. Price only \$4.

FREQUENCY MODULATION

F-M in high-fidelity reception—in mobile systems—and now in television is a must subject for every opportunity-minded serviceman. This big book explains it fully—from FM theory to actual service practice. 418 pages, over 300 illus. Price \$5.



MODERN OSCILLOSCOPES and their uses



This new book brings you practical working data that makes it easy to use the oscilloscope fully. Each operation is clearly explained plus data on how to use the oscilloscope on specific service jobs. 326 pages, 370 illus. Price \$6.

10 DAY MONEY-BACK GUARANTEE

Dept. RE-70, MURRAY HILL BOOKS, Inc. 232 Madison Ave., New York 16, N. Y.
 Enclosed and \$_____ for books checked; or
 send C.O.D. (in U.S.A. only) for this amount plus postage and I will pay postman.
 If books are not what I want, I will return them postpaid in 10 days and you guarantee to refund the purchase price.
 PRACTICAL TELEVISION SERVICING, \$4.00
 FREQUENCY MODULATION, \$5.00
 MODERN OSCILLOSCOPES, \$6.00
 (Outside U.S.A. add 50c each to above prices. Cash only. Same return privilege).

Name

Address

City, Zone, State

REVIEW OF NEW TUBES

The ORIGINAL and Still the BEST
LIGHTNING ARRESTER

for all weather conditions

will not absorb moisture

completely waterproof

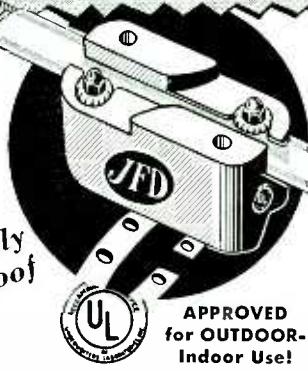

Protects Television Sets Against Lightning and Static Charges

JFD SAFE TV GUARD

Fits Any Type of Twin Lead

No. AT102 for Regular Twin Lead
No. AT103 for Oval Jumbo Twin Lead
No. AT103 Also for Tubular Twin Lead
BOTH Models Conform With Fire Underwriters and National Electrical Code Requirements for OUTDOOR installations.

\$2.25
EACH

SIMPLE TO INSTALL . . . For maximum efficiency, arrester should be mounted outside window nearest to TV receiver, with ground wire attached to nearest grounded point. No stripping, cutting or spreading of wires necessary. Supplied complete with 4 ft. length of Ductile Aluminum Ground Wire for Wall Mounting, and Strap for Mast or Grounded Pipe installation.

JFD MANUFACTURING CO., Inc.
6127 16th Avenue, Brooklyn 4, N. Y.
First in Television Antennas & Accessories

TECH-MASTER

Blue Ribbon

TELEVISION KIT
featuring **AGC**

(Keyed automatic gain control)

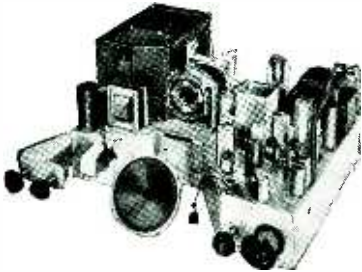

for 10" or 12" KINESCOPIES

Four-stage video IF—4Mc band width. Completely assembled . . . ready to wire. Factory tested parts of finest make. Trouble-free wiring diagrams permit wiring in a week-end.

Complete with all tubes, less Kinescope **\$119.95**

At your distributor, or write Dept. RE 7 for literature



TECH-MASTER PRODUCTS CO.
443-445 Broadway, New York 13, N. Y.

More leading engineers and technicians have built Tech-Master for their own use than any other Television Kit.



AMONG the new tubes announced recently, RCA has four, including the type 5879 sharp cutoff pentode designed especially for input stages of audio systems where low microphonics and hum are re-

quired. The tube has a 6.3-volt heater, a transconductance of 1,000 μ mhos, and a plate resistance of 2 megohms.

The RCA type 7MP7 is a long-persistence oscillograph tube having magnetic focus and magnetic deflection. Its two-layer screen has a bluish trace for short persistence and a greenish-yellow trace for persistence of several minutes. Heater voltage of the tube is 6.3 volts and maximum anode voltage is 8,000 volts.

The RCA type 5890 is a remote cutoff beam pentode designed for voltage regulation of d.c. supplies of up to 30,000 volts. The type 5826 is a small-size image orthicon having very high sensitivity and good spectral response.

Eitel-McCullough has announced a new u.h.f. triode, the Eimac type 4X-150G for frequencies up to 1,000 mc. The new tube features coaxial construction and lower lead inductance. In typical performance at 750 mc, power output is 100 watts with a power gain of 11. At 1,000 mc, the power output is reduced to 50 watts.

A giant-size 24-inch diameter picture tube has been made by G-E. The tube has a dark face plate and an aluminum-backed fluorescent screen to increase picture brightness. Limited production of this tube is expected.

G-E also announces a new 14-inch glass rectangular television picture tube. The 14CP4 has a useful picture area of 99 square inches. Maximum ratings of the tube are: anode voltage, 14,000 volts; grid No. 2, 410 volts; grid No. 1, 125 volts negative bias.

Another new G-E picture tube is the type 19AP4A, a black-face version of the 19AP4.

Du Mont also has a new glass rectangular Kinescope, the type 16TP4, which has a bent-gun design and a gray filter face-plate. As a conversion tube, the 16TP4 provides a larger picture in existing cabinets than the original round tube. Maximum ratings are: anode voltage, 16,000 volts; grid No. 2 voltage, 410 volts; grid No. 1 voltage, 125 volts for negative bias.

A general-purpose subminiature triode is Sylvania's type 6BF7. This duotriode has characteristics similar to the type 6J6 but has separate cathode leads. In typical class-A operation it has a mutual conductance of 4,800 μ mhos, plate resistance of 7,000 ohms, and an amplification factor of 34.



Base diagrams of some of the new tubes.

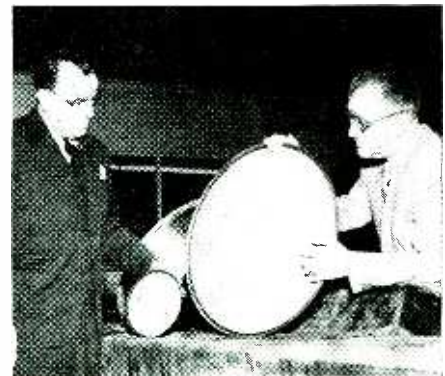

G-E's giant-size 24-inch picture tube.

TRACKING PHILCO RECEIVERS

If the 48-200, 48-300, and similar models cannot be made to track at both ends of the dial, check the .05- μ f a.v.c. bypass, the oscillator grid capacitor, and the resonant capacitor between B-minus and chassis.

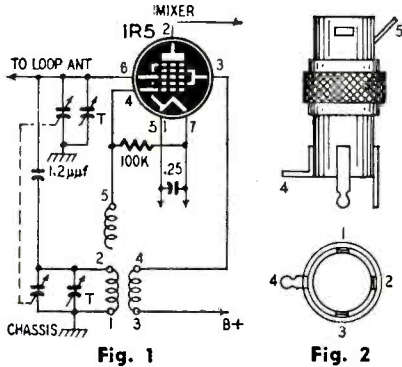

The 48-300 has a three-winding oscillator coil connected as shown in Fig. 1. The oscillator may operate, but tracking will be off if the windings are not connected as shown. Drawings in Fig. 2 show the terminals on the T400 oscillator coil used in this model.—*Herman F. Moe*

G-E MODELS 817 AND 821

Several sets have come in with the following complaints: (1) Picture is dim and reduced to one-half its normal width; (2) horizontal black bars across screen; (3) a high-pitched whine can be heard coming directly from the high-voltage compartment.

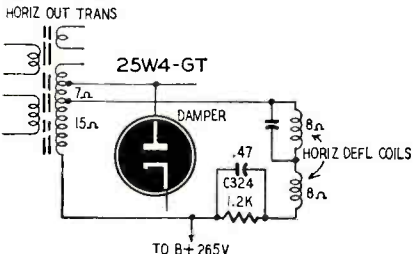

These troubles have been traced to a breakdown of the 0.47- μ f capacitor which bypasses the 1,200-ohm resistor in series with the horizontal deflection coils. This capacitor is C324 in the diagram. Corresponding capacitors can cause the same troubles in models 800, 805, 806, and 807.—*William Ford, Jr.*

TRANSVISION TV KITS

Filter capacitors fail rapidly in some TV kits because of insufficient under-chassis ventilation. I have cured this by drilling several large holes in the bottom of the cabinet and by making sure that there is a space between the bottom of the cabinet and the top of the table.

BUZZ IN ADMIRAL P5

If a buzz is present when this set—made by Continental Radio Corp.—is operated on a.c., try placing a grounded shield between the 117Z6-GT and 1H5-GT tubes.—*James R. Limbeck*

PHILCO 46-1201 AND 48-1201

If these models hum on RADIO and not on PHONOGRAPH, check the 15- μ f capacitors in the voltage-doubler circuit before looking elsewhere.—*C. R. Lutz*

SWEDGAL declares a Buyer's DIVIDEND!

FREE. A PLASTIC PILLOW FOR YOUR SUMMER PLEASURE!

Get this PLASTIC PILLOW FREE! Folds to matchbook size, blows up easily as a balloon (deflates as quickly), sturdy, waterproof, no metal parts, anti-allergic. For home, office, shop, ballgames, beach, fishing, picnics, etc. Have 100's of uses. Get Yours FREE for each \$3 order! A \$10 order brings you 2 Plastic Pillows FREE, etc. You'll want many... one for each member of your family!

New Low Prices on



SPEAKERS

5" P.M. 68 oz. .79	5 Asst. .75	5" P.M. 1 oz. .95	5 Asst. .89
4" P.M. 68 oz. .89	.85	5" P.M. 1.47 oz. 1.05	.95
4" P.M. 1 oz. .99	.95	6" P.M. 1 oz. 1.29	1.29
4" P.M. 1.47 oz. 1.05	.99	6" P.M. 1.47 oz. 1.39	1.39
4"x8" P.M. 1 oz. 1.49	1.39	10" P.M. 8.8 oz. 3.89	3.59
5" P.M. .68 oz. .89	.85	12" P.M. 4.64 oz. 4.59	4.25
		8" 6 V. Auto Speaker	2.49 2.35

Famous Make PILOT LIGHTS

Made in U.S.A., Guaranteed, Brand New! Boxed, 10 in a carton

Lamp No.	Volts	Base	Bead Color	Each	Ctn. of 10
40	6-8	Min. Scr.	Brown	6c	53c
42	3-2	Min. Scr.	Green	7c	64c
44	6-8	Min. Bay.	Blue	6c	53c
46	6-8	Min. Ser.	Blue	6c	53c
47	6-8	Min. Bay.	Brown	6c	53c

OUTPUT TRANSFORMERS

3Q5	.34c ea.	6V6 P.P.	49c ea.
8V6	.38c ea.	50L6 P.P.	38c ea.
50L6	.34c ea.		

LOOK AT THE PRICE OF THESE METERS

Westinghouse DC, 2" Round, 0 to 600 and 0 to 15 DC Volts, 500 microamp movement.
Triplett, 2" sq. 0 to 400 V. D. C.
Sun, 2" Round, 0 to 300 V., D. C.
Your choice... \$2.49 ea.

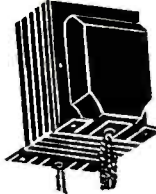

6V6 Push Pull 15 Watts
Sec. Taps 4, 8, 15, 250 & 500 ohms.
Fully Shielded.
only **89c** ea.

ELECTROLYTIC TUBULAR CONDENSERS

With mounting strap—Standard Brands—Fresh Stock! Type EDL.
20 x 20—150 V. 39c ea.
40 x 40—150 V. 39c ea.
30 x 30—150 V. 39c ea.
SPECIAL: Asst. 10 for \$3.80

PAPER TUBULAR CONDENSERS

.25 mfd. @ 200 V. 3c ea.
.015 mfd. @ 200 V. 3c ea.
.015 mfd. @ 400 V. 4c ea.
.02 mfd. @ 400 V. 4c ea.
.01 mfd. @ 400 V. 4c ea.
.005 mfd. @ 600 V. 4c ea.
.02 mfd. @ 600 V. 5c ea.
DEDUCT!
1c ea. in an asst. of 20!

3-SPEED PHONO MOTOR

FAMOUS BRAND
110 V., 60 Cycle, A.C. 3-speed, 33 1/3, 45 and 78 R.P.M. Complete with turntable.
Now only... \$4.75 ea.

Save Some Cool Change on These Swedgal Summer Specials!

- STANDARD BRAND ROTARY SWITCH, 2-pole, 5-position, for meters or hand-switches. 3/4" shaft. 29c ea.
- ANTENNA LOOP, 4-terminal, for AC-DC Bury, portables and small receivers. Extra powerful. Recommended instead of antenna coil. Cut to size. 12c ea.
- CRYSTAL RADIO, Piezo-Graph Kit, complete. 88c ea.
- BAKELITE KNOBS, Black, skirt type with finger-grip knob. 1/4" shaft. 1 1/8" wide, skirt diameter 1 1/8". 5c ea.
- 7 TERMINAL STRIP, No markings on strip, popular screw and solder terminals, caps to hold wires firmly under screw! Only 9c ea. Order 10 for 80c!
- STANDARD BRAND Moulded upright condenser, 5-400 V. ea. 15c
- ASTATIC CRYSTAL CARTRIDGE, Nylon 17. \$2.25
- CONDENSERS, Tiger, 1 mfd., 400 V. ea. 19c

PANEL BEARINGS

LOWEST PRICE YET!
Smooth operating, precision made, flatted shaft extends 1 1/2", bushing for 3/8" hole. Reduced to... 6c ea.
Order 10 for only 50c

AC LINE CORDS

7 ft., Moulded bakelite plug. Reduced to 12c ea.
10 for \$1.10
6 ft., Reinforced U.L. approved plug. Low priced... 14c ea.
10 for \$1.25



IF TRANSFORMERS
Precision Wound Radio Coils, Medium Size 456 KC, Input or Output—28c ea.
MidRet Iron Core 456 KC Input or Output 48c ea.



5-TUBE AMPLIFIER CHASSIS
Sturdy metal, all holes punched, 4 3/8" wide x 6" deep, 3 1/2" high. SPECIAL—7 for 89c. Only 49c ea.

Famous Make DC METER

Simple instrument to meet voltampere test requirements of practically any circuit. Hermetically sealed! Without shunts or multipliers, this meter can be used for readings from .002 volts or from 20 microamperes. Complete with 6 shunts, 6 multipliers, 2 meter fuses. Meter fuse easily accessible. Provides maximum protection against meter burn-out.
0-DC Voltage Ranges (at 1,000 ohms per volt)—
0 to 5/10/25/100/250/500 volts
0-DC Current Ranges—
0 to 5/10/25/100/250/500 ma.
List \$27.50
SWEDGAL PRICE: \$10.95 Complete



TUBES

All Brand New—Guaranteed—Individual Cords!

DEDUCT 5c from the price of each tube when ordering any 20!

30c ea.	65K7	617	707
1F4	65Q7	6SN7	12SR7
1G4	6X5T	25L6	14A7
3B7	6V6	25W4	14R6
6C4	6W4	25Z6	14Q7
12A6	6X4	43	25Z5
39/44	6X5	49c ea.	35W4
38c ea.	6Y6	6A4G	42
32Z5	12BA6	1A5	58c ea.
2X2	12BE6	1C5	024
42c ea.	12SA7	1LH6	1L5
1Q5	12SJ7	2A3	3Q5
1R5	12SK7	2A5	12SG7
1S5	12SQ7	523	354
1U5	26	6AG5	50L6
5U4G	27	6AV6	70L7
6ALS 47	6	6BC6	VR150
6AR5 76	6	6	
6AT6 78	6	6	
6AU6 80	6	6	
6BA6 85	6	6	
6BE6 117Z3	6	6	
6F6 2051	6	6	
6H6 45c ea.	6	6	
6J5 7A7	6	6	
6K5 7C7	6	6	
6K6 1T4	6	6	
6R7 1U4	6	6	
6S7 5Y3	6	6	
6SH7 5Y4G	6	6	
65J7 6AG7	6	6	

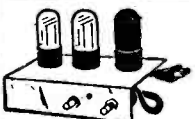

Sensational Savings!
3-TUBE PHONO Amplifier

110 V., 60 cycle, A.C. For all types of records. Full range tone and volume control with "soft" and "loud" switch. Completely wired!
ADDED FREE: 2 Round Dial Plates, Brass, marked "volume" and "tone."
Complete Less tubes... \$1.95 ea.

VOLUME CONTROLS

Order Many... Save Plenty!
Standard brands with switch, long shaft.
500 ohms 34c
100,000 350,000 500,000 1 megohm ea.
Buy any 10 for \$3.00
Less switch, long shaft.
500 ohms 9c
100,000 500,000 1 megohm 9c
250,000 1 megohm ea.
Order 10 for 80c ea.



KITS!

- 2-TUBE PHONO OSCILLATOR KIT, Complete with schematic diagram. 2 tubes. Only \$2.99 ea.
- CARBON RESISTOR KIT, 50 Assl. RMA Coded insulated resistors with popular ratings. 1/2, 1 & 2 Watt. All 5% tolerance. 50 Assl. for 99c.
- WIRE WOUND RESISTOR KIT, 1% Tolerance. 1/2 Watt. 10 Assl. \$1.49.
- FILTER CHOKE, 3/4" stack, 5 henries @ 75 ma. Reduced to only... 49c
- MUSIC WIRE SPRINGS, 100 Assl. compression, extension & tension. Highest quality, plated and tempered. Packed in neat embossed metal box. 100 for only... complete 79c
- TOOL KIT, heavy gauge, all-metal, reinforced handle at both ends, hump for lock, card holder in lid. 1 1/2" wide x 6 1/4" high x 8 1/4" deep. Brand new and only... \$2.49 ea.

POCKET MULTI-TESTER

RCP = 449A
5,000 Ohms per Volt RANGES:
DC Volts: 0-5-50-250-1000 V.
AC Volts: 0-5-50-250-1000 V.
DC MA.: 5-10-100-1000 MA.
Ohms: 0-2000-20,000-200,000-2 Megohms
Decibels: -6 to +52 DB in 4 ranges.
Output Meter: 0-5-50-250-1000.
List: \$24.50
SWEDGAL PRICE: \$21.95 Completely Wired!



SPEED DELIVERY: Order Today! Minimum, \$2.50. For C.O.D. shipment enclose 25% deposit. Include adequate postage. excess will be returned. All prices F.O.B. NYC.
WRITE FOR OUR FREE CIRCULAR.

SWEDGAL RADIO, INC.

96 Warren St., Dept. E-5 New York 7, N. Y. Cortlandt 7-6753

Leotone

- Portable DC Ammeter (Hoyt #515) . . . 0-15 Amps, 3 1/2" mirror fan scale. With 36" test leads & metal case. \$3.95
 - #30 P.E. Magnet Wire . . . 400 ft. roll. \$3.19, 6/1.00
 - PL-259 Plugs . . . 2 on 4 ft. RG8 cable. . . .49
 - Co-Ax Angle Plug . . . #3-1AP. . . . \$1.19, 6/1.00
 - PL-54 Plug & 1/2" tipped dial cord. . . . \$1.19, 6/1.00
 - JK-33A Jack for PL-68. . . . \$1.23, 5/1.00
 - DPDT 24VDC Relay (GE).69
 - DPDT 12VDC Relay (Kurtz).69
 - Brown Bakelite Panels (1/16").65
 - 7x10-.5-39; 7x14-.5-49; 7x18-.5-59; 9x15-.65
 - Selenium Rectifier . . . 1/2 wave, 50VAC. . . \$6.99, 4/2.49
 - 6V. Buzzer & Key (W.E.). . . 1/4" bakelite base. . . 1.25
 - 5AG Fuses . . . 1, 3 or 6A, 250V. . . \$0.06, 20/1.00
 - Mercury Switch . . . 115V/1A. . . . \$1.39, 3/1.00
 - DM-36 Dynamotor . . . 24VDC to 220VDC, 80 ma "Power-Packed". . . 2.5 H.P. Reversible Motor!! 3000 RPM, 3/8" shaft. 4 1/2"x7". 27 VDC. Shpg. wt. 12 lbs. . . . 3.95
 - 110VAC Induction Motor . . . 1750 RPM, Fract. H.P. 2 1/2"x3 1/4"x7 1/2". Shpg. wt. 2 lbs. . . . 1.39
 - Antenna Base . . . adjustable over 180°. . . .59
 - 18 Ft. Whip Antenna . . . 6 steel sects. (MS-49-54) . . . 2.49
 - Pilot Bulbs . . . #B21 3CP, 28V, S.C. base, auto base. . . . \$1.09, 15/ \$1.60, 100/4.75
 - . . . #1816-13V, min. bay.10/.39
 - NE-48 Neons-115V, D.C. bay. . . . \$1.19, 10/1.69
 - Thermocouple (W/ht) . . . 24, 40MV, 3 1/2" out. . . .59
 - Rubber Shock Mounts . . . 4 lb. 1 1/4" sq. . . . \$1.09, 15/1.00
 - "Ouncer!" Input Xfmr. . . . 50 ohm to grid. . . . 1.59
 - Tube Shields . . . GT/Localt. . . . \$0.55, 24/1.00
 - Radio Hardware Treasure . . . Full Pound Can of Screws, Nuts, Washers, Lug, etc.49
 - High Fidelity Crystal Mike . . . hi-imped. Rubber shock-mnt. 1 1/2" O.D. x 1 1/4". Less housing. . . .98
 - Aluminum Housing for crystal mike.15
 - T-30 Throat Mike \$1.39, 6/1.98
 - CD-508 Cord & Switch for T-30.49, 6/2.49
 - T-44 Magnetic Mike (SCR-522).69, 3/1.95
 - Handy Carbon Mike (res-83). \$1.19, 6/1.95
 - HS-33 Headset. Lo-imped. . . . 5 ft. cord & plug. . . 1.69
 - Radio Amplifier Steel Cabinet (made for RCA). . . Chrome Grille & Side Trim. Marine gray. 16 1/2"x10 1/2"x9 3/4". Shpg. wt. 11 lbs. . . . 1.98
 - DPDT Toggles (C-H) 20A/125V. . . Spring return. . . . \$1.39, 3/1.00
 - 3 Meg. Hear. Aid Pot. & Sw. . . . 7/8"x1 1/4". . . .49
- "SUPER-VALUE" KITS**
- New "Jumbo Radio Parts Kit" . . . 17 Full Pounds new & dismantled Coils, Wire, Sockets, Resistors, Condensers, Spkr. Access., etc. etc. Only \$2.95
 - Speaker Cones . . . 4" to 12" moulded & free-edge. Less voice coils. Kit of 12 ass'd. . . . 1.98
 - Speaker Repair Kit . . . Liberal assortment of: Solders, Mtg. Rings, Felt Strip, Leather Segs., 4-6 forms, Shims, Cement & Instructions. . . .75
 - SPECIAL!-Both "Cone & Repair Kits" for. . . 3.95
 - Cement & Solvent . . . 3 ozs. ea. & brush. . . .69
 - Moulded Bakelite Condensers00001 to .2mfd. 200-600V. 50 ass'd. . . . 2.49
 - "Ainico" Magnets . . . Powerful Bar, Block, "U", Ring, etc. Kit of 10 ass'd. . . . 1.98
 - Wire-Wound Resistors . . . 5-20W, 15 ass'd. . . .98
 - Spring Assortment . . . 60 comp. & tension. . . .98
 - Resistor Kit carb. & w.w. 1/4, 3/4W, 20 ass'd. . . .49
 - Knobs . . . Spring set. New. Kit of 25. . . .98
 - Wafer Sockets . . . 4 to 8 pin. 12 ass'd. . . .25
- MIN. ORDER \$2.00 20% Deposit Req. on all COD's Please add sufficient postage-excess refunded Full remittance with foreign orders

LEOTONE RADIO CO.
67 Dey Street, New York 7, N. Y.

SIX TUBE SUPER

Three Gang Condenser

\$33.30
NET
Crowe Panel
Kit Included



Panel kit to fit most all makes (Please specify make of car and year model). New up-to-date latest priced Catalog available to dealers.

Bill Sutton's
Wholesale Electronics

5th at Commerce Fort Worth, Tex.

TELEVISION RECEIVER—\$1.00

Complete instructions for building your own television receiver. 16 pages—11"x17" of pictures, pictorial diagrams, clarified schematics. 17"x22" complete schematic diagram & chassis layout. Also booklet of alignment instructions, voltage & resistance tables and troubleshooting hints.—All for \$1.00.

CERTIFIED TELEVISION LABORATORIES
Dept. C, 5507-13th Ave., Brooklyn 19, N. Y.

Want a Good Job in Radio?

Get your FCC License in a minimum of time. Add technical CIRE training to practical experience—study at home—in spare time. Then get real help finding a job with our Amazing Job-Finding service. It really works! Act now!

GET FREE BOOKLET

"Money-Making FCC License Information" tells you how to get a good FCC licensed job in Radio. Send for it now.

CLEVELAND INSTITUTE OF RADIO ELECTRONICS
4900-C Euclid Bldg., Cleveland 3, Ohio

RELAY-OPERATED VTVM

Patent No. 2,501,704

Robert G. Wilson, Washington, D.C.
(May be used by the U.S. Government without payment of royalties)

Operating on an entirely new principle, voltage on this v.t.v.m. is read directly on a conventional type d'Arsonval instrument and the tube is used only to control current through the meter. The tube tends to keep the voltage across the meter equal to the voltage to be measured.

When the winding of the polarized relay RY is not energized, its armature is in a neutral position between A and B and the tube is blocked because of the grid battery. Plate current is zero so no indication appears on the meter. When a voltage is applied across the terminals (with the upper terminal positive), current flows through RY and the armature is attracted to A. In this position R1 and R2 form a voltage divider between plate and cathode of the tube. C begins to charge with its upper plate going positive.

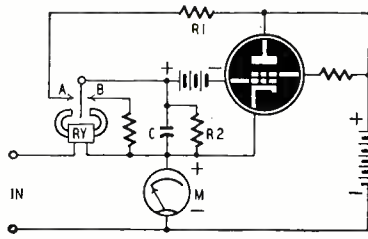

The grid voltage is now the resultant of the grid battery voltage and the voltage across C. When the voltage on C equals or exceeds the battery voltage, plate current begins to flow and the meter deflects. The plate current increases until the voltage across M is greater than the input. These voltages oppose, so the current through the relay RY reverses and the armature is drawn to B. This permits C to discharge and the grid bias goes more negative until the voltage across M decreases to less than the input. Again the current through RY reverses, and the armature swings back to A.

In normal operation the armature vibrates between A and B about three or four times per second. The voltage across M pulsates within a narrow range above and below the input voltage. When the meter is properly damped, it indicates an average value substantially equal to the input.

With this type of circuit, range linearity is a function of the d'Arsonval instrument alone, and no zeroing is needed from time to time. However, a small amount of power must be supplied by the source.

The relay may be a Weston type 813J which operates at 3 microamperes. The plate battery must be greater than the voltage to be measured. A grid battery of 300 volts is sufficient for measurements up to 150 volts.

ELECTRONIC TUNING

Patent No. 2,498,932

Marcel Wallace, New York City
(assigned half to Panoramic Radio Corp.)

Most radio tuning is done mechanically, that is either directly or through a system of gears or

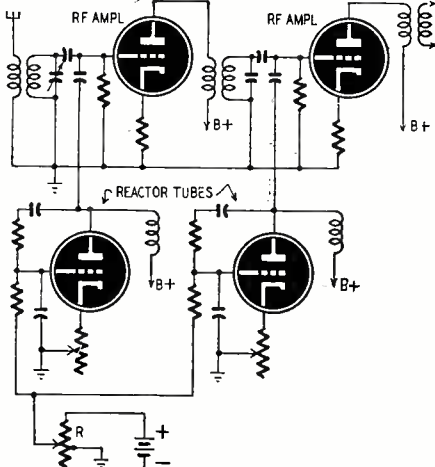

pulleys. Gang tuning requires that several variable capacitors or slug-tuned coils be positioned for mechanical coupling. It is not easy to adapt these systems for remote tuning.

This invention relies on reactor tubes to tune the r.f. and oscillator stages. The figure shows how the idea can be used in a t.r.f. set, for example. The reactor tubes shunt the tank coils and tune the circuits when R is varied. Each reactor tube is shown with a gain control (in the cathode circuit). If the reactor circuits are identical and if the r.f. stages are also similar, the single potentiometer R can tune all the stages of the receiver at once.

For remote tuning, R and its battery may be located at a distance.

H.F. RADIATION COUNTER

Patent No. 2,500,473

Charles Spaeth, Mamaroneck, N. Y.

This is a new type of radiation counter. The detector is a quartz crystal in a tube filled with a gas mixture. The mixture is of two gases: one an easily-ionized gas such as argon, neon or helium; the other a gas which quenches ionization, such as chlorine or iodine. One end of the tube is made of glass or copper to admit cosmic rays, gamma rays, neutrons or other radiation.

The crystal is part of an oscillatory circuit. P is adjusted so that high resistance shunts the crystal. The total grid leak is so high that oscillations cannot occur. When radiation falls on the tube and crystal, the gas ionizes and lowers the resistance across the crystal. The result is a burst of oscillation which is immediately quenched by the high grid leak resistance.

It is claimed that this detector is much more sensitive than a Geiger-Muller type. It does not require a high potential for operation and the

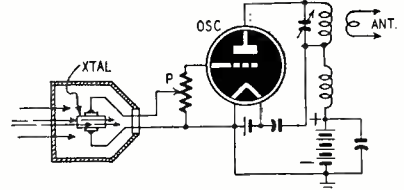

entire counter may be carried aloft in a balloon or located at a remote location such as a mountain top. The count is transmitted to a distant receiver as a radio signal.

RADIATION MEASUREMENT

Patent No. 2,501,174

Gerhard Herzog, Houston, Texas

(assigned to Texas Co., New York City)

The thickness of metals and the density of liquids may be measured by passing gamma rays

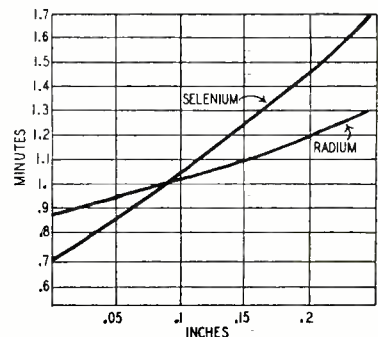

through them and measuring the energy which remains. Radium is often used as the source of the rays.

More precise measurements are possible when the rays are relatively weak. Then the absorption rate is greater and this makes it possible to determine thickness or density more accurately. The inventor has determined that artificial radioactive metals such as selenium possess weaker radiation than radium and therefore can give more accurate results.

The graphs shown here compare radium and selenium. They show exposure time versus thickness of iron or steel for a given radiation count. Selenium shows a much higher sensitivity because a small increase in thickness requires a greater exposure change.

The short half-life of selenium must be taken into account. The intensity of radiation decreases each day by an equivalent of .002 inches of steel.

CODE OF ETHICS

A 10-point code of ethics has been adopted by the Dallas Radio Sales & Service association to help improve customer relationship with its members. The provisions of the ten points are:

- 1—Members displaying the Association emblem guarantee fair treatment to the public.
- 2—Accurate statements of work done and charges therefor shall be rendered the customer.
- 3—No misleading statements, advertising, or promises shall be made by a member.
- 4—All property of customers shall be treated with due care and diligence.
- 5—All work shall be done in a neat and competent manner.
- 6—All replacement parts shall be of equal or better quality than those used originally, and all parts replaced shall be tendered the customer when his set is returned.
- 7—All workmanship by Association members shall be guaranteed for a reasonable length of time, and all disputes as to guarantees may be referred to the Association if all efforts to adjust them have failed.
- 8—A permanent, comprehensive record of all work done shall be kept as a permanent record, and all complaints shall be handled courteously.
- 9—Technical assistance shall be rendered to all members at their request.
- 10—All members, their shops and personnel shall at all times present a neat and businesslike appearance both in person and in their premises.

MORE TEST PATTERN

Three Texas TV stations have increased their test pattern time at the request of the Dallas Radio Sales & Service Association. The stations showing this fine spirit of co-operation are WBAP-TV of Fort Worth and KBTW and KRLD-TV, both of Dallas. Each of these stations is increasing its test pattern time 6 hours per week to give service technicians in the area more time for proper set adjustments.

DINNER MEETING

The annual dinner meeting and election of officers was held April 19 by the Vancouver chapter of the Associated Radio Technicians of British Columbia. Guest speaker was Bill Rea of station CKNW who discussed the TV situation in Canada.

Officers elected for this year are: W. Fitness, president; J. A. Clarke, vice president; Fred Lewis, secretary; Ed Mullins, treasurer; and H. Amos, recording secretary.

SET OWNERS COMPLAIN

Television set owners are increasing their complaints of being given the run-around by set manufacturers, service companies, and retailers, according to Frank J. Moch, president of the Television Installation and Service Association (Chicago) in a forum on television service recently sponsored by the association.

Service technicians attending the forum said that the number of service calls per set is showing a tendency to decline, but that cheaper components in recent sets may cause the number of calls per set to go up again.

The point was made that retailers, especially those who do not do their own servicing, should avoid making exaggerated performance claims. This was aimed particularly at indoor antennas, which generally do not work well in the Chicago area.

TELE CLASS GRADUATES

The second class of television students organized through the cooperation of the Associated Radio-Television Servicemen and the Board of Education of New York City graduated the third week of June. More than 30 technicians took the course.

The Board of Education and the ARTSNY plan to continue the program in the fall, with both classes in radio servicing and in television servicing, the latter for the more advanced students who are already capable radio service technicians, or television servicemen who wish to profit by more theoretical training.

ESFETA OFFICIALS AT BINGHAMTON MEETING



Three executives of the Empire State Federation of Electronic Technicians' Associations photographed during the annual meeting at Binghamton May 23. Reading from left to right are treasurer Ben de Young of Ithaca, president Max Liebowitz of New York City, and the secretary, Wayne Shaw of Binghamton.

you don't have to be scotch to know

SENCO PRICES are EXTRA LOW

BRAND NEW IMMEDIATE DELIVERY TUBES INDIVIDUALLY CARTONED GUARANTEED

SPECIAL QUANTITY DISCOUNT OFFER. Order 25 or More Assorted Tubes and Deduct 5c from the Price of Each Tube.

15¢ Ea.	45¢ Ea.	1L4	59¢ Ea.
2C34	1B5	1R4	0Z4
1626	1T5	1R5	1C5
E1148	2A5	154	1Q8
	2B7	155	1M5
	2S45	3Q4	1LA4
	3A4	354	1LB4
	3B7	3V4	1LC5
	6A1S	5T4	1LD5
	6A7S	5W4	1LE3
	6B8B	5Z3	1LW5
	6B8E	5Y4	1T4
	6B1G	6A6	5U4
	6AUG	6A6	5Z4
	6F5	6A8	6A7
	6G6	6A8E	6A8
	6J7	6A8S	6B4
	6K5	6A8S	6B5
	6K7	6AD7	6B6
	6P5	6AQ5	6B8
	6SF3	6A8S	6B9
	6SF7	6B6	6B9Q
	6SR7	6B7	6J8
	6V5	6B8	6K7
	7A4	6B8B	6L7
	7B6	6C5	6Y6
	7E5	6C7	7C7
	7K7	6D6	1L7
	7Y4	6E6	757
	1A3	6F8	14A7
	1U3	6K6	14Q7
	1U5	6L5	14R7
	1V	6L5J	22
	2A6	6L5J7	25Z5
	2A7	6T7	26B5
	2X2	6W5	70L7
	4A6	7A5	82
	6A84	7A7	
	6C4	7B7	
	6H6	7F7	
	6J5	7H7	
	6N4	7Q7	
	6S7	7C5	
	6S07	12AT6	
	6S07	12B6	
	6S07	12B6B	
	6S07	12S7	
	6S07	12S7A	
	6S07	12S7F	
	6S07	12S7K	
	6S07	12S7L	
	6S07	12S7N	
	6S07	12S7Q	
	6S07	12S7R	
	6S07	12S7T	
	6S07	12S7U	
	6S07	12S7V	
	6S07	12S7W	
	6S07	12S7X	
	6S07	12S7Y	
	6S07	12S7Z	
	6S07	12S7AA	
	6S07	12S7AB	
	6S07	12S7AC	
	6S07	12S7AD	
	6S07	12S7AE	
	6S07	12S7AF	
	6S07	12S7AG	
	6S07	12S7AH	
	6S07	12S7AI	
	6S07	12S7AJ	
	6S07	12S7AK	
	6S07	12S7AL	
	6S07	12S7AM	
	6S07	12S7AN	
	6S07	12S7AO	
	6S07	12S7AP	
	6S07	12S7AQ	
	6S07	12S7AR	
	6S07	12S7AS	
	6S07	12S7AT	
	6S07	12S7AU	
	6S07	12S7AV	
	6S07	12S7AW	
	6S07	12S7AX	
	6S07	12S7AY	
	6S07	12S7AZ	
	6S07	12S7BA	
	6S07	12S7BB	
	6S07	12S7BC	
	6S07	12S7BD	
	6S07	12S7BE	
	6S07	12S7BF	
	6S07	12S7BG	
	6S07	12S7BH	
	6S07	12S7BI	
	6S07	12S7BJ	
	6S07	12S7BK	
	6S07	12S7BL	
	6S07	12S7BM	
	6S07	12S7BN	
	6S07	12S7BO	
	6S07	12S7BP	
	6S07	12S7BQ	
	6S07	12S7BR	
	6S07	12S7BS	
	6S07	12S7BT	
	6S07	12S7BU	
	6S07	12S7BV	
	6S07	12S7BW	
	6S07	12S7BX	
	6S07	12S7BY	
	6S07	12S7BZ	
	6S07	12S7CA	
	6S07	12S7CB	
	6S07	12S7CC	
	6S07	12S7CD	
	6S07	12S7CE	
	6S07	12S7CF	
	6S07	12S7CG	
	6S07	12S7CH	
	6S07	12S7CI	
	6S07	12S7CJ	
	6S07	12S7CK	
	6S07	12S7CL	
	6S07	12S7CM	
	6S07	12S7CN	
	6S07	12S7CO	
	6S07	12S7CP	
	6S07	12S7CQ	
	6S07	12S7CR	
	6S07	12S7CS	
	6S07	12S7CT	
	6S07	12S7CU	
	6S07	12S7CV	
	6S07	12S7CW	
	6S07	12S7CX	
	6S07	12S7CY	
	6S07	12S7CZ	
	6S07	12S7DA	
	6S07	12S7DB	
	6S07	12S7DC	
	6S07	12S7DD	
	6S07	12S7DE	
	6S07	12S7DF	
	6S07	12S7DG	
	6S07	12S7DH	
	6S07	12S7DI	
	6S07	12S7DJ	
	6S07	12S7DK	
	6S07	12S7DL	
	6S07	12S7DM	
	6S07	12S7DN	
	6S07	12S7DO	
	6S07	12S7DP	
	6S07	12S7DQ	
	6S07	12S7DR	
	6S07	12S7DS	
	6S07	12S7DT	
	6S07	12S7DU	
	6S07	12S7DV	
	6S07	12S7DW	
	6S07	12S7DX	
	6S07	12S7DY	
	6S07	12S7DZ	
	6S07	12S7EA	
	6S07	12S7EB	
	6S07	12S7EC	
	6S07	12S7ED	
	6S07	12S7EE	
	6S07	12S7EF	
	6S07	12S7EG	
	6S07	12S7EH	
	6S07	12S7EI	
	6S07	12S7EJ	
	6S07	12S7EK	
	6S07	12S7EL	
	6S07	12S7EM	
	6S07	12S7EN	
	6S07	12S7EO	
	6S07	12S7EP	
	6S07	12S7EQ	
	6S07	12S7ER	
	6S07	12S7ES	
	6S07	12S7ET	
	6S07	12S7EU	
	6S07	12S7EV	
	6S07	12S7EW	
	6S07	12S7EX	
	6S07	12S7EY	
	6S07	12S7EZ	
	6S07	12S7FA	
	6S07	12S7FB	
	6S07	12S7FC	
	6S07	12S7FD	
	6S07	12S7FE	
	6S07	12S7FF	
	6S07	12S7FG	
	6S07	12S7FH	
	6S07	12S7FI	
	6S07	12S7FJ	
	6S07	12S7FK	
	6S07	12S7FL	
	6S07	12S7FM	
	6S07	12S7FN	
	6S07	12S7FO	
	6S07	12S7FP	
	6S07	12S7FQ	
	6S07	12S7FR	
	6S07	12S7FS	
	6S07	12S7FT	
	6S07	12S7FU	
	6S07	12S7FV	
	6S07	12S7FW	
	6S07	12S7FX	
	6S07	12S7FY	
	6S07	12S7FZ	
	6S07	12S7GA	
	6S07	12S7GB	
	6S07	12S7GC	
	6S07	12S7GD	
	6S07	12S7GE	
	6S07	12S7GF	
	6S07	12S7GG	
	6S07	12S7GH	
	6S07	12S7GI	
	6S07	12S7GJ	
	6S07	12S7GK	
	6S07	12S7GL	
	6S07	12S7GM	
	6S07	12S7GN	
	6S07	12S7GO	
	6S07	12S7GP	
	6S07	12S7GQ	
	6S07	12S7GR	
	6S07	12S7GS	
	6S07	12S7GT	
	6S07	12S7GU	
	6S07	12S7GV	
	6S07	12S7GW	
	6S07	12S7GX	
	6S07	12S7GY	
	6S07	12S7GZ	
	6S07	12S7HA	
	6S07	12S7HB	
	6S07	12S7HC	
	6S07	12S7HD	
	6S07	12S7HE	
	6S07	12S7HF	
	6S07	12S7HG	
	6S07	12S7HH	
	6S07	12S7HI	
	6S07	12S7HJ	
	6S07	12S7HK	
	6S07	12S7HL	
	6S07	12S7HM	
	6S07	12S7HN	
	6S07	12S7HO	
	6S07	12S7HP	
	6S07	12S7HQ	
	6S07	12S7HR	
	6S07	12S7HS	
	6S07	12S7HT	
	6S07	12S7HU	
	6S07	12S7HV	
	6S07	12S7HW	
	6S07	12S7HX	
	6S07	12S7HY	
	6S07	12S7HZ	
	6S07	12S7IA	
	6S07	12S7IB	
	6S07	12S7IC	
	6S07	12S7ID	
	6S07	12S7IE	
	6S07	12S7IF	
	6S07	12S7IG	
	6S07		

TV INSTRUMENT

National Co.
Malden, Mass.

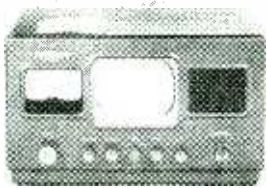

The Videometer is a complete TV receiver with a meter for checking both field strength and line voltage. With it, the technician can avoid measuring ghosts and noise instead of the desired signal when making installations.

TEST PRODS

United Technical Laboratories
Morristown, N. J.

The Klipzon test prod has a point with an opposed steel needle which, when pressed against a wire, lug, or terminal, slides on and grips until

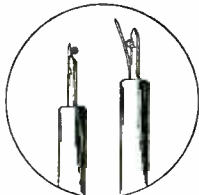

pulled off. The points are made of non-magnetic steel alloy and are needle sharp for piercing insulation. The prods are supplied with red and black Synthane handles and 4-foot red and black test leads.

GEIGER KIT

Science Kits, Limited
Hollywood, Cal.

The Searchmaster kit contains everything needed to assemble a Geiger counter that detects both beta and gamma radiation. The counter is completely portable.



Each set includes tubes, batteries, resistors, capacitors, sockets, type SK-1 Geiger tube, headset and a metal case as well as complete step-by-step instructions for assembling the instrument.

To demonstrate the kit, the manufacturer includes a radioactive specimen with each order.

PLASTIC CAPACITOR

P. R. Mallory & Co., Inc.
Indianapolis, Ind.

The Plascap capacitor is made with a plastic material which adheres securely to the wire leads. This technique, previously considered impossible because any plastic which would stick to the leads would stick to the molds, was achieved by centering the capacitor in a tough plastic shell and then filling with the special adhesive plastic compound. It results in a moisture-proof capacitor.

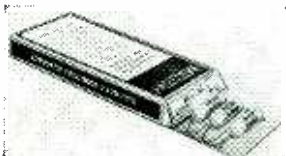
**MICROPHONE**

Radio Corporation of America
Camden, New Jersey

The RCA Type KB-3A is a high-fidelity microphone with anti-noise and anti-feedback properties.

It is a velocity ribbon-type microphone with bi-directional characteristics to which necessary acoustic resistances have been added. The response-frequency characteristic of the microphone for a source 3/4-inch distant is essentially flat over the audio range of 50 to 10,000 cycles.

The anti-noise microphone discriminates against a distant source in favor of a close source by values ranging from 6 db at 1,000 cycles to 30 db at 100 cycles for equal sound pressures at



the microphone element. In addition, because of the directional pattern, the discrimination against random noise is better than the above values by an additional 5 db.

MULTI-CELL TWEETER

Atlas Sound Corp.
Brooklyn, N. Y.

Model HR-2 multi-cellular tweeter and high-pass filter is designed for use with any suitable type of cone speaker woofer.



The horn has six cells which offer a wide-angle distribution pattern. The frequency response is efficient up to 15,000 cycles. The unit will handle 25 watts of program material above 1,000 cycles. The die-cast horn is 6 3/4 inches wide, 3 1/2 inches high, and 8 inches deep. The front of the horn is designed for flush mounting.

TV SWEEP YOKE

General Electric
Syracuse, N. Y.

This new sweep yoke will sweep up to 70-degree picture tubes with high efficiency. When used with associated G-E sweep components, the horizontal

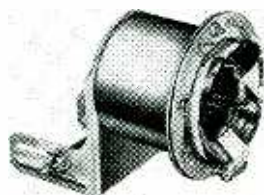

sweep system requires only 20 watts of horizontal input from a 250-volt line.

Horizontal inductance of the new yoke is 18 mh, while vertical inductance is 30 mh. It is available with either a laminated, or for higher efficiency, a ferrite core. These high efficiency units are designed especially for large-diameter tubes.

NEW V.T.V.M.

Feiler Engineering Co.
Chicago, Ill.

The model TS-9 is a new all-purpose v.t.v.m. Its ranges are: for both a.c. and d.c. voltages, 0.5-10-100-500-1,000 volts; decibels from -20 to -16 db; resistance from .2 ohms to 1,000 meg-



ohms in 5 steps; and 0-1 ma d.c. Input impedance is 26 megohms on d.c. and 3 megohms on a.c.

The meter uses two separate tubes in a balanced bridge type circuit with inverse feedback.

The two separate tubes are used because replacement costs in the event of tube failure are less than if a dual triode is used.

POCKETSCOPE

Waterman Products Co.
Philadelphia, Pa.

The model S-14-B Wide Band Pocket-scope is designed for compactness and



portability. It has amplifier fidelity constant within 2 db from d.c. to above 700 kc without peaking. Its linearized triggered or repetitive time base is continuously variable from 1/2 cycle to 50 kc with either \pm polarity of sync or trigger. Amplifier sensitivity is of the order of 50 mv r.m.s./inch and internal calibration of trace amplitude is provided. Observation of limited wave form areas are facilitated by a trace expansion better than four times screen face. Input attenuators and gain controls are non-frequency discriminating.

TV ANTENNA

Brach Mfg. Corp.
Newark, N. J.

The 6-Bar is a factory preassembled TV antenna having a fan-type arrangement of elements especially designed for fringe reception. It has a good front-to-back ratio and high signal-to-

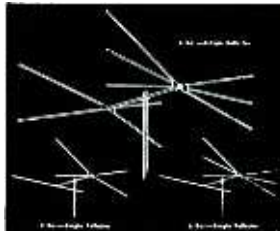

noise ratio and it can be coupled directly to 72-, 150-, and 300-ohm transmission lines. Horizontal or "X" type reflectors may be used.

The antenna is shipped with its elements folded against the boom. They fold out somewhat like an umbrella for installation.

NOISE LOCATOR

Sprague Products, Co.
North Adams, Mass.

The model 302 radio interference locator for the 550-kc to 30-mc frequency range is designed specifically for use by public utility troubleshooters and others interested in man-made radio noise location and reduction, and in power line preventive maintenance work.

The instrument uses a sensitive 8-tube superheterodyne circuit and operates either from self-contained batteries or 115-volt mains. An auxiliary inverter power supply is available for automobile battery operation.

Other features include a built-in loudspeaker, built-in dual range output meter and battery test meter, calibrated r.f. and audio gain controls, and a beat-frequency oscillator for detecting unmodulated signal sources.

Each locator is supplied with both a loop and a collapsible rod antenna for normal use. An r.f. search probe, insulated for 35,000 volts, is also available for cable fault location.

MICRO CAPACITOR

Aerovox Corp.
New Bedford, Mass.

Type P83Z Aerolite capacitors, called "micro-minatures", are only 3/16 inch in diameter and 7/16 inch long. They are available in 400-volt ratings with capacitances from .0005 to .003 μ f and in 200-volt ratings with capacitances from .005 to .01 μ f. Their small size is made possible by the use of a metallized dielectric which provides both dielectric and electrodes. These capacitors have a very low self inductance, which makes them useful for high frequency applications.

TANTALYTIC CAPACITOR

General Electric
Schenectady, N. Y.

The new 1- μ f, 150-volt Tantalytic capacitor has a size reduction of 90% in comparison to that required by paper capacitors and promises longer life than aluminum electrolytics. These characteristics are made possible by the use of tantalum, an inert metal, in

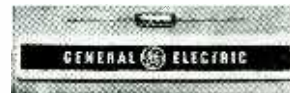

foil form together with a new non-corrosive electrolytic. The capacitor has lower leakage currents and better low temperature characteristics than conventional electrolytics and is particularly useful in applications where small size is a major factor.

OSCILLOSYNCHROSCOPE

Browning Laboratories, Inc.
Winchester, Mass.

The model ON-5 oscillosynchroscope is designed for study of pulse and transient phenomena as well as for conventional oscilloscope uses.

Vertical amplifier response is flat within 3 db from 5 cycles to 5 mc. Horizontal amplifier is direct-coupled with high-frequency response extending to 500 kc.

The sweep generator may be triggered or recurrent with direct-reading writing-rate calibration for any internal sweep condition. Triggered sweep



BIG MONEY IN RADIO and TELEVISION NOW!

See COYNE'S Brand New 7 Volume Set APPLIED PRACTICAL RADIO-TELEVISION **FREE!**



A BRAND NEW Set of books written for men who want to "go places" in TELEVISION and RADIO . . . men who know how a PRACTICAL working knowledge helps to get the BIG MONEY. Over 2500 pages of the latest Radio and Television "know how"; easy to understand with hundreds of crystal-clear illustrations. It's ALL here! EVEN COLOR TELEVISION AND UHF. How to install, service, align, balance ALL radio and TV sets . . . how to use new and old testing instruments for TV service . . . latest data on adapters, converters and MORE. Complete volume on Electronics and handy Radiomen's Handbook included. You name it and COYNE'S GOT IT, in this amazing new money-making 7-Volume Radio-Television Library.

Color Television Is Here!

Set contains most complete section ever published on Color Television and UHF, adapters and converters. FULLY ILLUSTRATED AND PRINTED IN 4 COLORS.

**PRACTICAL!
CLEAR!
COMPLETE!**

7 fact-packed volumes — 1400 illustrations and diagrams with step-by-step photographs which "break down" the equipment to show what makes it "tick." Up-to-the-minute, complete, easy to follow.

Act Now and Get FREE Book

Now you can see these new Coyne books for 7 days without cost and get Coyne's book of 150 Radio and Television Diagrams FREE. It's free just for examining the new 7-Volume Set. Full details of this sensational Coyne "prove it" offer are given below. Mail the coupon at once.

SEND COUPON—SEE SET FREE FOR 7 DAYS

You must SEE these new books to know how easy it is to prepare for the big jobs in radio and television. Here's our special offer:—we'll send the complete 7-volume set for your 7-Day FREE Examination. And with it, we'll include our valuable, new guide for all radiomen, "150 New Radio-Television Diagrams Explained," absolutely FREE! If you keep the 7-volume Set all you pay is \$3.00 within 7 days after the books arrive and \$3.00 per month until \$23.50 plus postage is paid — or you can pay \$22.00 cash. If you don't want the set, return it and you OWE NOTHING. But either way you keep "The Radio and Television Diagrams Book" as a gift. That book is ABSOLUTELY FREE.



SEND NO MONEY Coupon is just a request to see Set free and get FREE BOOK. Offer limited—act now.

**COYNE Electrical and
Radio-Television School**
500 S. Paulina St. Dept. 70-R1, Chicago 12, Ill.

Mail This Coupon NOW

Educational Book Publishing Division
COYNE ELECTRICAL & RADIO-TELEVISION SCHOOL
500 S. Paulina St., Dept. 70-R1, Chicago 12, Ill.
O.K. Send me postpaid, your new 7-volume set, "Applied Practical Radio-Television", on 7 days Free Trial per your offer. Be sure to include as a gift the book of 150 Radio-Television Diagrams absolutely FREE.

NAME _____ Age _____

ADDRESS _____

TOWN _____ ZONE _____ STATE _____

Where employed _____

speeds from 1.0 msec per inch to 25,000 msec per inch and recurrent sweeps of 10 to 100 kc are available.

An adjustable calibration voltage may be used for determination of vertical deflection voltage amplitudes. Either d.c. or a.c. connection may be made to all deflection electrodes. Also provided is a panel connection to the cathode-ray tube cathode for external beam modulation. The ON-5 is housed in a steel cabinet.

ANTENNA TOWER

Thompson & Ruby, Inc.
Brownstown, Ind.

This new all-aluminum home antenna tower is shipped in riveted sections ready for the installer to join together.

The tower is light in weight, and has a swivel base which makes it adaptable to any type mounting.

CHEST MICROPHONE

Altec Lansing Corp.
Hollywood, Cal.

The 155A Chestplate suspends from the user's neck and carries a 21B capacitor microphone just at the correct distance from the user's mouth. The combination is particularly useful for

in the chestplate, and the microphone may be used as far as 400 feet from associated equipment.

HV COUPLER

Clarostat Mfg. Co., Inc.
Dover, N. H.

The high-voltage coupler and spacer assembly, 59-186, with nylon insulator shaft, RN-3", for use in high-voltage circuits, is now made available in all Clarostat Pick-A-Shaft type controls, Types AM and AT.

The high-voltage insulator sleeve screws on to the control bushing while its threaded metal-stud end takes the mounting nut. The nylon shaft slips into the control's slot and is gently tapped to snap it permanently in place for the integral control and shaft combination. The high-voltage coupler is rated at 10,000 volts breakdown test.

FM-AM TUNER

Meissner Mfg. Div.
Mt. Carmel, Ill.

A new addition to the Meissner line of tuners, the 9A is complete with

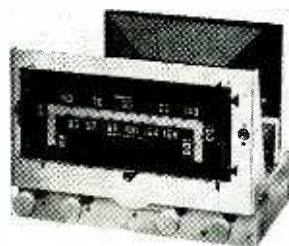

audio and is designed for the low price field.

The tuner has provisions for phono input, full tone control, temperature compensation on FM, and high selectivity and sensitivity. All controls are on the front panel and also operate on phono.

LINE TRANSFORMER

Lynmar Engineers
Philadelphia, Penna.

This transformer is made to match a 70-95-ohm coaxial line to the 300-ohm input of any television receiver. (It may also be used to match a 300-ohm antenna lead to a receiver made for 70-95-ohm coaxial line.)

Some television receivers have connections for both coaxial line and 300-ohm ribbon line. Even with these receivers an improvement is sometimes noted when the coaxial antenna lead is connected to the 300-ohm receiver input through one of these impedance matching transformers.

VOLTMETER

Industrial Devices, Inc.
Edgewater, N. J.

This new adaptation of the Mini-Volt Voltmeter is the model 410A. It features an expanded scale centered on the common 110- and 220-line voltages, and is accurate to within 2 volts at 110 volts a.c. All features that made the model 400B Mini-Volt famous are retained in this new model. Practically burn-out-proof operation is assured by the glow-lamp indicator which is guaranteed for a minimum of 25,000 hours of operation. 12-inch flexible test leads are tipped with heavily insulated test prods. To assure maximum user safety, the plastic case withstands rough treatment in everyday use. The 410A Mini-Volt as well as the model 400, is not subject to the false indication common to neon test lights.

LIGHTNING ARRESTOR

LaPointe-Plascomold Corp.
Unionville, Conn.

The new Model RW 204 is produced for use with the 4-wire cable employed with antenna rotators. It is also designed to serve with standard 300-ohm ribbon transmission line. Pin-point contacts eliminate the need for wire stripping—the arrestor is installed by simply tightening down the cover with two wing nuts.

END-FIRE ANTENNA

Workshop Associates, Inc.
Needham Heights, Mass.

The DUBL-VEE, an all-channel television antenna, uses the end-fire principle with two V's mounted in the same

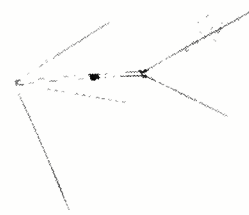

plane and driven in phase to achieve maximum gain.

Gains up to 7.5 db are possible with single bays, and a double stack has gains up to 10 db with an average standing wave ratio, when matched to 300-ohm line, of less than 2 to 1 over the entire band. Half power angle is 82 degrees on channel 2 and sharpens to 26 degrees on channel 13. The antenna is especially designed for reception in low signal strength areas.

PLUG-IN CHASSIS

Cinema Engineering Co.
Burbank, Cal.

This new line of plug-in amplifier chassis follow telephone equipment practices. They can be mounted in three positions: on the front or back of a relay rack, or horizontally through the front of the rack panel, whichever is most convenient.

When mounted on the front or back of a relay rack, chassis is vertical, similar to conventional telephone selector switch mounting. Mounting frames are available to accommodate either vertical or horizontal mounting. Chassis are available in a number of different widths.



announcers and lecturers who must move about while speaking. An impedance matching tube is contained

CRYSTAL FREQUENCY STANDARD

Section 12.135 of the FCC rules and regulations governing amateur radio services states that the licensee of an amateur station shall provide equipment or a means for measuring the carrier frequency of the transmitter. The equipment shall be independent of the transmitter control system and sufficiently accurate to assure operation within the band being used. Some amateurs use receivers to check the band edges although few receivers are sufficiently stable or accurate for this purpose. An inexpensive crystal calibrator which provides 100-kc and 1-mc markers to 30 mc or higher was shown in *Short Wave Magazine* (London).

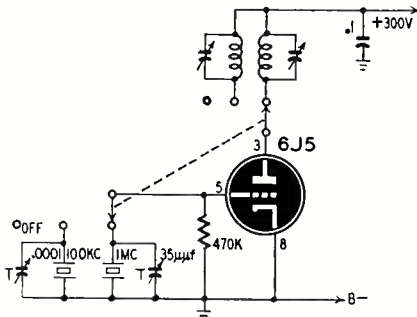

The circuit is a triode oscillator having 100-kc and 1-mc crystals and tuned circuits in the grid and plate circuits, respectively. The 100-kc coil may be a winding from a 132-kc i.f. transformer or a 30-mh choke. The 1-mc coil may be the secondary of a

broadcast antenna or r.f. coil, or a 0.75- to 2-mh r.f. choke. Each plate coil is tuned to resonance by connecting a 10- or 15-ma meter in the cathode circuit and adjusting its tuning capacitor for minimum current.

The crystals should be adjusted to exactly 100 kc and 1 mc by beating their harmonics of fundamentals against broadcast stations having frequencies harmonically related to the crystal frequencies. The 100-kc crystal can be checked against broadcast stations operating on 600, 700, 800, 900, and 1000 kc. The 1-mc crystal can be checked against the 1000-kc broadcast station or WWV on 5 or 10 mc.

SIMPLE MODULATION METER

A somewhat unusual modulation indicator for AM transmitters was built by G2AIQ and described in *Short Wave Magazine* (London). The circuit is shown.

The unit consists of a surplus 500-µa d.c. meter, crystal diode, two resistors, and a s.p.d.t. switch. When the switch is in the SET position, the meter measures the d.c. plate voltage applied to the modulated amplifier. Because the d.c. and a.c. voltage across the secondary of the modulation transformer are equal during 100% modulation, the a.c. voltage can be measured and the meter calibrated in modulation percentage.

Throw the switch to SET and adjust the 1-meg control until the meter reads

400 µa. Throw the switch to MOD and modulate the transmitter. The meter will then read the a.c. voltage across the secondary of the transformer. Since the meter is adjusted to 400 µa

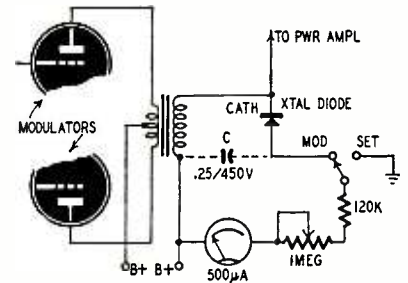

for the d.c. plate voltage, 400µa will indicate 100% modulation and 200 µa will indicate 50%.

Because this meter has a sensitivity of 2,000 ohms per volt, the resistors will have to be changed when the plate voltage is higher than 350 or when a different meter is used. Capacitor C damps the meter so it rises rapidly and falls slowly. The voltage rating of C should be sufficient to withstand voltage peaks across the secondary.

SIMPLE A.F. AMPLIFIER

A novel two-stage, general-purpose audio amplifier was described in *Short Wave Magazine* (London). Its circuit is shown in the diagram.

Because this unit may be used with crystal pickups, a bass-boost circuit consisting of R1, R2, and C1 were added. The author claims that the amplifier works well without bias on the 6J5. However, we would suggest that a 1,200-ohm resistor be inserted in the cathode circuit as an experiment. This resistor may or may not be bypassed. A 47,000-ohm resistor can be placed between the 6V6 grid and its grid resistor to insure stability.

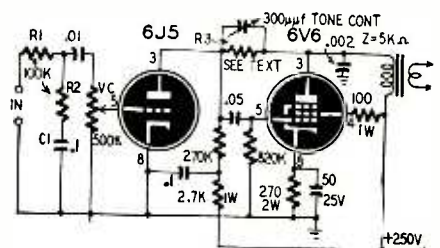

Negative feedback between the 6J5 and 6V6 plates is through resistor R3. Try a 4.7-megohm unit and experiment with other values to find one which gives noticeable improvement in quality without reducing the gain below useful levels. A 300-µmf trimmer capacitor is connected across this resistor as a tone control.

CALIBRATED ATTENUATOR

Calibrated attenuators are useful additions to audio oscillators and some types of special-purpose a.f. amplifiers. A switched attenuator having input and output impedances of 150 and 5,000 ohms, respectively, is described in *Wireless World* of London. The circuit is shown.

One switch is calibrated from zero to 20 in steps of five decibels, and another

Automatic 1949 & 1950 Custom-Built Auto Radios

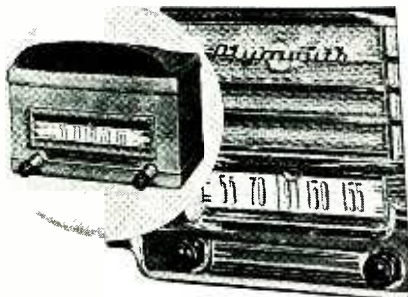

The perfect factory look of the Plymouth (illustrated) is equally as nice on the Ford, Dodge or Chevrolet. COMPLETE. SIMPLE TO INSTALL. FULLY GUARANTEED

FEATURES

Six-tube superheterodyne. Six volt storage battery operation. Two dual purpose tubes. Eight tube performance. Specifically designed to fit 1949 and 1950 Plymouth and Dodge cars. Single unit construction. Very simple installation. Three-gang tuning condenser and tuned R. F. stage for extreme sensitivity. Permanent magnet dynamic speaker with powerful Alnico #5 magnet. Low battery drain. Weight 10 lbs.

AT LOW NET WHOLESALE PRICES

FORD..\$34.97 DODGE or PLYMOUTH..\$34.97 CHEVROLET..\$36.49

BROOKS RADIO DISTRIBUTING CORP.

80 VESEY ST. (DEPT. A) NEW YORK 7, N. Y

COLOR ON YOUR TELEVISION NOW

Simply attach TELE-COLOR FILTER to front of your set, and enjoy favorite programs in a glorious color tone. Instead of dull black and white.

TELECOLOR Filter is one of the latest discoveries. Its special formula fluorescent coloring gives brilliant pleasing color tone. Experience new happiness and enjoyment in life-like color depth, reduced glare, and eye strain. Everyone is talking about and waiting for 3 color Television costing hundreds of dollars. Now for a small sum you can enjoy new color toning. This filter is guaranteed to work on every make or size of set.

TELECOLOR FILTER is a wonderful gift. Children love it.

TRADE DISCOUNTS	10 inch tube	\$3.00
	12 1/2 " "	\$4.00
	16 " "	\$6.00

HARVARD LABORATORY
659 Fulton St., Brooklyn 1, N. Y.

from zero to 80 in steps of 20 decibels. The resistors can be made by connecting in series and parallel known values or by winding them with resistance wire.

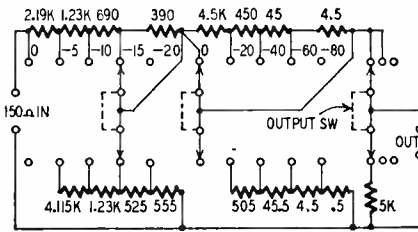

The output switch connects a 5,000-ohm resistor across the output of the network when correct termination is required. Additional positions are provided for feeding an external 5,000-ohm load and for turning off the signal. The attenuator calibration will not be correct if the load across the output is more or less than 5,000 ohms.

LOW-SPEED SWEEP GENERATOR

Designed to have an unusually low range of frequencies, this sawtooth generator was used to modulate a Klystron in a microwave spectrograph described in *The Review of Scientific Instruments*.

Covering from 2 to 160 cycles, this circuit will make a useful addition to oscilloscopes having sweep generators

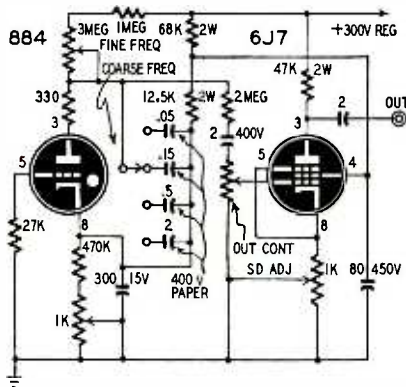

which cannot be adjusted lower than 20 or 25 cycles. In this case, the sweep may not be sufficiently stable or accurate at the end of its lowest range.

The 884 is a conventional relaxation oscillator and the 6J7 is a sawtooth amplifier delivering a sawtooth having its amplitude variable between 0 and 100 volts.

NOVEL TV ANTENNA

After reading "Antennas for Television" in the June, 1949, issue, I constructed a circular antenna for channel 5, the weakest in my location. Because the harmonics of channel 5 do not fall in the TV band, I was unable to receive channel 9. Not wanting to erect separate high- and low-band antennas, I experimented and developed what I call a tricircular antenna which performs well on both bands.

The antenna consists of three circular antennas connected as shown. The smaller ones, for channel 9, are 61 inches in circumference; and the

larger, for channel 5, is 145½ inches in circumference.

Points 1, 2, and 3 connect to the mast. Points 4 and 5 are 3 inches apart for connecting a 300-ohm transmission line. The ends of the larger loop connect to a smaller one at points a quarter wavelength from its open ends.

Reception can be peaked on any band by making the circles a full wavelength in circumference at the weakest channel. The circles are made from ½-inch aluminum or copper tubing.

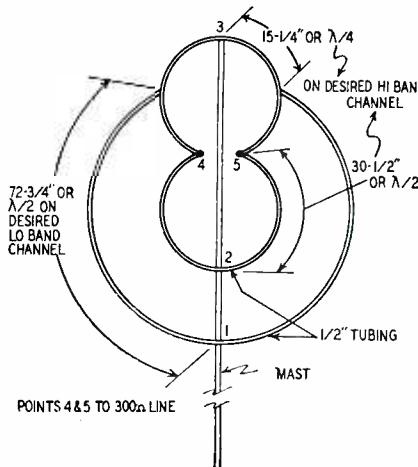

Dimensions for other channels are given in the article named in the June, 1949, issue. These dimensions need not be corrected for end effects.—C. F. Alberti

REPLACING BANDPASS COILS

Many of the older superhet receivers have three-gang tuning capacitors and a bandpass antenna circuit (Fig. 1) instead of a tuned r.f. amplifier. If it is necessary to replace either of these coils—they are usually on the same form—they are hardly ever available unless the manufacturer has them in stock.

Fig. 2 shows how the original circuit can be altered to permit the use of standard slug-tuned antenna coils. Remove and discard the old coils and replace them with two universal antenna coils mounted side by side so

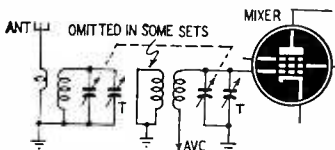

Fig. 1—Antenna circuit before changes. there is common coupling between them. The coils may be mounted above or below the chassis.

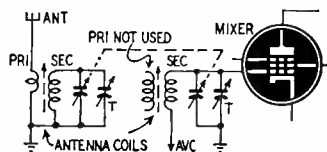

Fig. 2—The circuit after alterations. After aligning the slugs at 600 and the trimmers at 1600 kc, some sets perform better than they did with the original coils.—Wilbur J. Hantz

SIZZLING SUMMER SPECIALS!!

Surplus 3 Tube Amplifier with Loudspeaker—only \$3.95
Complete with 3 tubes—ready to play—110 volts AC/DC. Uses 1-6C6, 1-4J, and 1-25Z5 tubes and an electrodynamic loudspeaker. Has ear-phones plug-in jack and volume and tone controls.

SURPLUS RECORD PLAYER

Housed in a leatherette covered wood cabinet 16¾" wide, x 12" high, x 13¾" deep with a hinged opening top. Has a three tube amplifier with volume and tone controls. Single speed AC Flyer Motor 33 1/3 RPM with pre-war pickup arm which can easily be replaced by an LP pickup for playing Columbia LP records..... Limited Quantity—only \$9.95

33 1/3 LP PHONOGRAPH MOTOR

This Green Flyer motor is perfectly suited for a low cost LP record player. Single speed, operates from 105-130 volts AC..... only \$1.55

TELEVISION TRANSFORMER

Pri. 115 Volts 60 Cycles Sec. 2500 Volts @ 2 ma.: 6.3 Volts @ .6A.: 2.5 Volts @ 1.75A
Small size—brand new..... Price \$3.85

INTERCOMMUNICATION SYSTEM

A low priced system for executives, professionals or home use. Consists of a master station, and one remote. Simple to operate, simple installation. Neat, rugged, beautifully finished wood cabinet, will fit anywhere. Complete with tubes—ready to operate. Ideal for use as Radio Baby Nurse..... Price \$10.95

MODEL NFRD—RADIO NOISE FILTER

If it doesn't work, send it back!

We absolutely guarantee that our Model NFRD will eliminate all line noises when properly connected to radios, television sets, short wave sets, motors, electric shavers, refrigerators, vibrators, oil burners, transmitters, and all other sources of interference. This unit will carry up to 12 amperes or 1/4 KW of power and may be used right at the source of interference or at the radio.

Small size only 3"x11/2"x7/2". Very low price only Each \$1.95

A SCIENTIFICALLY DESIGNED PHONO SCRATCH FILTER

Resonated at approximately 4500 cycles effectively reducing objectionable needle scratch without altering the brilliancy of reproduction. Contains a HI-Q SERIES resonated circuit. Tested by means of an audio oscillator and an oscilloscope to give 22 db. attenuation with very low signal loss.

EASY TO ATTACH
Just two wires to clip on. Compact. Price \$1.98

PHONO OSCILLATOR

Wireless phono oscillator transmits recording for crystal pick-ups or voice from carbon mike through radio without wires. Can also be used as an intercomm by using P.M. speaker as mike. Price (excluding tubes) \$2.95
With Complete Set of Tubes \$3.95

SPECIAL! SPECIAL!

Mammoth assortment of radio and electronic parts, not less than TEN POUNDS of transformers, chokes, condensers, resistors, switches, coils, wire, hardware, etc. A super-buy for experimenters, servicemen, and amateurs for only \$1.25

Satisfaction guaranteed on all merchandise.
All prices F.O.B. New York City
WRITE FOR FREE CATALOGUE T7

RADIO DEALERS SUPPLY CO.

154 Greenwich St. New York 6, N. Y.

telrex INC.
CONICAL "V" BEAMS
 ASBURY PARK, NEW JERSEY

- THE SKILL TO DESIGN
- THE FACILITIES TO PRODUCE
- THE ABILITY TO DELIVER

MANUFACTURERS OF THE
 CONICAL "V" BEAM
 FOR TV AND FM RECEPTION

Available through Authorized
 TELREX Distributors

WRITE DEPT. R FOR CATALOG

BUY DIRECT SAVE!!
From Factory \$152.95
 New Improved RCA Licensed 16"—630 Chassis Plus \$1.90 Fed. Excise Tax (Less CRT)

- Complete with NEW, Electro-scope Magic-Eye Tuning indicator—for perfect synchronization of video and audio trap circuits.
- Completely wired and aligned by expert technicians.
- Newly developed 4 keyed automatic gain control.
- Voltage doubler.
- Latest type Standard Coil tuner for high sensitivity. UHF adaptation, and built-in booster action.
- Not 21—not 30—but the full 32-tube circuit.

19"—630 Chassis—\$157.95 plus \$1.90 Fed. Excise Tax. (Less CRT)

All glass 16" C-R Tubes.....\$38.90
 All glass 19" C-R Tubes.....\$73.25
 No extra charge for rectangular or black tube
 Regular RMA guarantee on all tubes and chassis
 Beautiful cabinets for above—available

Terms: \$25.00 deposit on all orders—Balance C.O.D.
 F.O.B.—N. Y. Factory
 Prices subject to change without notice

IMMEDIATE DELIVERY Visit our showrooms

AD-RITZ MFG. CORP.
 158 Grand Street New York, N. Y. Phone WO 4-6763
 231 Centre Street New York, N. Y. Phone WO 2-5962

EVERY RADIOMAN Can Use These SERVICE HINTS!
 Valuable Manual Yours—FREE!



Every page of "How to Simplify Radio Repairs" is packed with on-the-bench, practical ideas. Contains photos, charts, diagrams—no fluff—no vague theory. In plain every-day language it gives you priceless suggestions—new servicing ideas. You'll use and benefit from the experience of experts.

Partial list of contents: How to Localize Trouble; How to Service Amplifiers; How to Test for Distortion; How to Test Audio Circuits; How to Test Speakers; How to Find Faults in Oscillators; How to Test Radio Parts—and it's all yours—FREE! No obligation.



FEILER SEND COUPON OR PENNY POSTCARD FOR YOUR FREE COPY TODAY!

FEILER ENGINEERING CO., Dept. 7RCS
 1601 S. Federal St., Chicago 16, Illinois
 Please RUSH my FREE copy of "How to Simplify Radio Repairs."

Name

Address

City..... Zone... State.....

REDUCING BATTERY DRAIN

Some amplifiers and receivers designed for 6-volt operation have 300-ma tubes which place a heavy drain on the battery. Heater current can be reduced to half its original value by replacing the 300-ma tubes with corresponding 150-ma types. Some direct substitutions are: 6S7 for 6K7, 6SS7 for 6SK7, 6W7 for 6J7, 6T7 for 6Q7, 6D8 for 6A8, 6ST7 for 6SR7, and 6SZ7 for 6SQ7. The minor differences in transconductance, amplification factor, or plate and screen currents will not affect the performance of the average receiver or amplifier.

It is possible to substitute a 6ZY5 for a 6X5 or 6W5-G and save 300 or 600 ma, respectively, if the B-drain is less than 40 ma, a 6X5 for 6W5-G if the drain is less than 70 ma. An OZ4 will replace any of these rectifiers if the B-drain is between 30 and 75 ma.—*Charles Erwin Cohn*

TV ANTENNA INSTALLATIONS

TV antenna installations in fringe-areas can be simplified by using a detailed road map of your vicinity, a compass, and a radiation pattern of the antenna you plan to use. Mark the locations of all nearby TV stations on the map. Center the radiation pattern over the spot where the antenna is to be installed. You will be able to see exactly where the major lobes lie in respect to the different stations.

This system has been used to locate the source of reflections and has proved helpful in bringing in a weak channel. If the antenna you select does not have lobes which point toward all stations, try the pattern of another type of antenna.

Radiation patterns for various types of TV antennas can be obtained from manufacturers or from their catalogs and sales literature.—*John J. Pagano,*

TRANSMITTER METER PLUG

Metering a multistage transmitter is usually done with a rotary tap switch or by plugging the meter into panel jacks connected in the various circuits. The first method is convenient; but since the meter leads are usually soldered to the switch, the meter can not be used for other purposes. The plug-and-jack scheme is more flexible because it permits the meter to be used elsewhere; but it can be dangerous to the user, particularly where higher voltages are encountered and the jacks are above ground.

However, with equipment no more elaborate than an octal plug or an old tube base and a slightly modified Bakelite octal socket, it is possible to make a milliammeter switching plug-in arrangement that is foolproof, electrically safe, convenient, and universally usable.

Carefully file three additional locating grooves in the Bakelite octal socket, as shown. Since there are now four of these grooves in the socket, the octal plug may be plugged in in four different ways; to provide a maximum of

four circuits into which the meter can be switched. If more circuits are desired, a second socket can be used to supplement the first.

Then solder the meter leads, which can be of any convenient length, to the octal plug. One good way is to connect the meter positive lead to pin 1 and the negative lead to pin 8. That completes the meter plug.

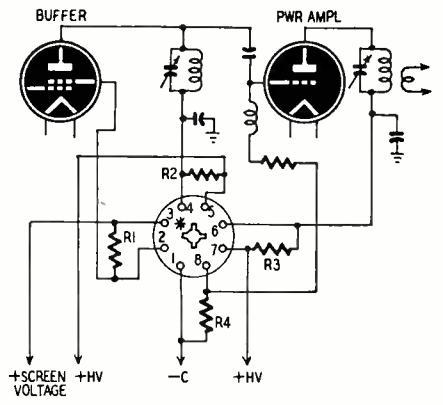

*FILE IN 3 ADDITIONAL KEY LOCATING GROOVES
 BOTTOM VIEW OF SOCKET SHOWN

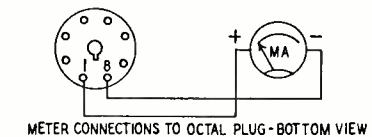

The modified socket may be wired into a typical circuit as shown in the diagram. Resistors R1, R2, R3, and R4 are shunting resistors which have a negligible effect on the operation of the meter or the circuit. They may be from 20 to 100 ohms in value. The higher resistances are used in low current circuits, and the lower resistances in high current circuits. The actual resistance value is not critical and 47- or 68-ohm, 2-watt carbon resistors will do very well. An alternative method is to use a 1-ma meter and make R1, R2, R3, and R4 appropriate shunting resistances to extend the range of the meter to the best value for the particular circuit in which it is to be used. When the meter is across R1, R2, R3, and R4, it reads buffer screen, buffer plate, power amplifier plate, and power amplifier grid currents, respectively when the plug is rotated.

Using the meter switching plug is quite simple. Just rotate the plug to the desired locating groove and plug it in. The meter will then measure the current in that circuit.—*Edwin W. Hill*

WORKBENCH KINK

I have a small but powerful permanent magnet fastened to the wall behind my work-bench. Whenever I am working from a diagram or from sheets of notes, I place the papers against the magnet and then lay a small piece of magnetic metal on top of them. Thus I have a magnetic clip board which does not damage the papers while keeping them out of the way where they will not become soiled, burned or torn.—*Forrest Rand*

TV RULER

A television ruler that checks a number of the important factors in television reception has been developed by the RCA tube department as an aid to service technicians. The "Microstick" is a flat plastic ruler that is held against the picture tube face while making checks.

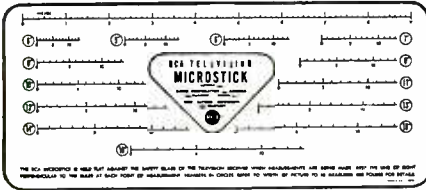

The Microstick may be used to measure the bandwidth of a receiver, calibrate vertical wedges in test patterns, determine the beat frequency of interference, and measure the air path distance of ghosts or other reflected signals.

The design of the ruler is based on the 53.3-microsecond duration of one horizontal line. The length of the ruler is equal to the picture width and it is divided into 53 equal divisions. Each division represents 1 microsecond so that the duration of any signal in the picture can be measured. Knowing the duration of the signal, its frequency can be calculated easily. The ruler is scaled for use with all picture tube sizes.

CK703 AUDIO OSCILLATOR



Photo of the CK703 crystal triode audio oscillator described in the June issue ("Experimental Circuits for Crystal Triodes", page 66). The fixed capacitor across the Ouncer winding is removed to get the highest frequency (in this case 5,000 cycles) from the transformer.

MISTAKE CORRECTOR

A new faculty for modern computers—the ability to correct mistakes as well as to detect them—has been developed at the Bell Telephone Laboratories by Dr. R. W. Hamming.

Most computers can recognize if they have made a mistake, but the new development makes it possible for the machine to correct its own mistake and proceed to the correct answer. The new method can be applied to any type of digital computer either of the electronic type or the relay type.

A laboratory model of the corrector has been made that will catch and correct one mistake and catch—but not correct—two simultaneous mistakes. The chances of two simultaneous mistakes occurring are about one in a million million.

ART RADIO Gives You 50-10 OFF

On Orders of 100 Tubes or More
50 & 5 On Orders of 25 Tubes or More
ONLY 50% DISCOUNT ON ORDERS LESS THAN 25 TUBES

"If You're Smart, You'll Buy from 'ART'"

All prices below are List prices, not selling prices. To find your cost, total the list price of the tubes selected. If 25 or more tubes are selected take 50% and 5% Off. If 100 or more tubes are selected take 50% and 10% Off. Only 50% Off on orders of less than 25 tubes . . .

ALL NATIONALLY KNOWN STANDARD BRANDS

BRAND NEW! JOBBERS FRESH STOCK. ALL IN ORIGINAL CARTONS! No orders accepted for individual Brands. Orders will be filled with whatever brand is available at time orders are received. You can depend on receiving First Class merchandise. All tubes carry standard RMA guarantee. No orders under \$5. All prices are subject to change without notice. 10% Deposit with all C.O.D. orders.

Type	List	Type	List	Type	List	Type	List	Type	List
0Y4	\$3.55	5Y3G	\$1.05	6K5GT	\$2.40	7F7	\$2.20	14Y4	\$2.40
0Z4	1.65	5Y4G	1.05	6K6GT	1.50	7F8	2.65	19	3.20
1A4P	3.90	5Z3	1.50	6K7	1.65	7G7 1232	2.65	19B6G6	6.00
1A5GT	1.80	5Z4	1.50	6K7G	1.80	7H7	2.00	19J6	3.20
1A6	3.55	6A3	3.20	6K7GT	1.65	7J7	2.65	19T8	2.90
1A7GT	2.00	6A6	2.65	6K8	2.40	7K7	2.65	24A	2.20
1A8S	2.65	6A7	2.00	6K8GT	2.40	7L7	2.65	25AG	2.65
1B3GT	2.65	6A8	2.00	6L6	3.55	7N7	2.20	25AGG	2.65
1B4P	3.90	6A8G	2.00	6L6G	2.90	7Q7	1.80	25AC5GT	3.90
1B5 25S	3.20	6A8GT	2.00	6L7	2.40	7R7	2.20	25B06GT	3.20
1B7GT	3.20	6A8H	2.00	6L7G	2.90	7S7	2.65	25L6GT	1.65
1C5GT	2.20	6A8S 6N5	2.65	6N6G	3.20	7V7	2.90	25W4GT	2.00
1C7G	3.20	6A8T	2.00	6N7	2.40	7W7	2.65	25Y5	1.50
1D5GP	3.90	6A8V	2.00	6N7GT	2.40	7X7 (XXFM)	1.80	25Z5GT	1.35
1D7G	3.20	6A9	2.90	6P5GT	2.40	7Z4	1.80	26	1.80
1R4GT	2.65	6A9GT	2.90	6Q7	2.00	7Z4	1.80	27	1.50
1E5GP	3.90	6A9S	2.65	6Q7G	2.00	7Z4	1.80	28	1.50
1E7GT	3.90	6A9T	2.65	6R7	2.65	7Z4	1.80	29	1.50
1F4	2.65	6A9V	2.65	6R7GT	2.65	7Z4	1.80	30	1.50
1F5	3.90	6AK6	2.40	6S4	1.65	7Z4	1.80	31	1.50
1F7G	3.90	6AL3	2.00	6S4G	1.65	7Z4	1.80	32	1.50
1G4GT	2.65	6AL5GT	2.65	6S7	2.00	7Z4	1.80	33	1.50
1G6GT	2.65	6AQ5	2.00	6S7GT	2.00	7Z4	1.80	34	1.50
1H4G	2.20	6AQ6	1.80	6S7GT	2.00	7Z4	1.80	35	1.50
1H5GT	3.20	6AR5	1.65	6S7GT	2.00	7Z4	1.80	36	1.50
1J6GT	3.20	6AS5	2.00	6S7GT	2.00	7Z4	1.80	37	1.50
1L4	2.65	6AT6	2.65	6S7GT	2.00	7Z4	1.80	38	1.50
1L6A	2.65	6AU6	2.00	6S7GT	2.00	7Z4	1.80	39	1.50
1L8A	2.65	6AV5GT	2.00	6S7GT	2.00	7Z4	1.80	40	1.50
1L9A	2.65	6AV6	1.50	6S7GT	2.00	7Z4	1.80	41	1.50
1L9C	2.65	6AW6	2.65	6S7GT	2.00	7Z4	1.80	42	1.50
1L9D	2.65	6AX5GT	1.35	6S7GT	2.00	7Z4	1.80	43	1.50
1L9E	2.65	6B4G	3.20	6S7GT	2.00	7Z4	1.80	44	1.50
1L9F	2.65	6B5	3.20	6S7GT	2.00	7Z4	1.80	45	1.50
1L9G	2.65	6B6G	2.20	6S7GT	2.00	7Z4	1.80	46	1.50
1L9H	2.65	6B7	2.20	6S7GT	2.00	7Z4	1.80	47	1.50
1L9I	2.65	6B8G	3.20	6S7GT	2.00	7Z4	1.80	48	1.50
1L9J	2.65	6B9G	1.80	6S7GT	2.00	7Z4	1.80	49	1.50
1L9K	2.65	6BA6	1.80	6S7GT	2.00	7Z4	1.80	50	1.50
1L9L	2.65	6BA7	2.65	6S7GT	2.00	7Z4	1.80	51	1.50
1L9M	2.65	6BC5	2.65	6S7GT	2.00	7Z4	1.80	52	1.50
1L9N	2.65	6BD6	2.00	6S7GT	2.00	7Z4	1.80	53	1.50
1L9O	2.65	6BE6	1.80	6S7GT	2.00	7Z4	1.80	54	1.50
1L9P	2.65	6BF6	1.65	6S7GT	2.00	7Z4	1.80	55	1.50
1L9Q	2.65	6BG6G	4.80	6S7GT	2.00	7Z4	1.80	56	1.50
1L9R	2.65	6BH6	2.00	6S7GT	2.00	7Z4	1.80	57	1.50
1L9S	2.65	6BJ6	2.00	6S7GT	2.00	7Z4	1.80	58	1.50
1L9T	2.65	6BK6GT	3.20	6S7GT	2.00	7Z4	1.80	59	1.50
1L9U	2.65	6CA	1.65	6S7GT	2.00	7Z4	1.80	60	1.50
1L9V	2.65	6C5	1.65	6S7GT	2.00	7Z4	1.80	61	1.50
1L9W	2.65	6C5GT	1.65	6S7GT	2.00	7Z4	1.80	62	1.50
1L9X	2.65	6C6	2.00	6S7GT	2.00	7Z4	1.80	63	1.50
1L9Y	2.65	6C6G	3.20	6S7GT	2.00	7Z4	1.80	64	1.50
1L9Z	2.65	6C8G	3.20	6S7GT	2.00	7Z4	1.80	65	1.50
2A4	2.40	6C8G	2.00	6S7GT	2.00	7Z4	1.80	66	1.50
2A6	2.65	6C8G	6.00	6S7GT	2.00	7Z4	1.80	67	1.50
2A7	2.65	6D6	1.65	6S7GT	2.00	7Z4	1.80	68	1.50
2B7	2.65	6D6G	1.65	6S7GT	2.00	7Z4	1.80	69	1.50
2B8GT	4.80	6E5	2.20	6S7GT	2.00	7Z4	1.80	70	1.50
3B7 1291	2.65	6F5	1.65	6S7GT	2.00	7Z4	1.80	71	1.50
3C6 XXB	3.20	6F5GT	3.20	6S7GT	2.00	7Z4	1.80	72	1.50
3D6 1299	2.65	6F6	2.00	6S7GT	2.00	7Z4	1.80	73	1.50
3E6	2.65	6F6G	1.65	6S7GT	2.00	7Z4	1.80	74	1.50
3E6	2.65	6F6GT	1.65	6S7GT	2.00	7Z4	1.80	75	1.50
3L4	2.65	6F7	3.20	6S7GT	2.00	7Z4	1.80	76	1.50
3Q4	2.40	6F8G	3.20	6S7GT	2.00	7Z4	1.80	77	1.50
3Q5GT	2.20	6G6G	2.65	6S7GT	2.00	7Z4	1.80	78	1.50
3S4	2.00	6H6	1.65	6S7GT	2.00	7Z4	1.80	79	1.50
3V4	2.00	6H6GT	1.65	6S7GT	2.00	7Z4	1.80	80	1.50
5A24	1.35	6J5	1.50	6S7GT	2.00	7Z4	1.80	81	1.50
5T4	3.90	6J5GT	1.50	6S7GT	2.00	7Z4	1.80	82	1.50
5U4G	1.50	6J6	2.90	6S7GT	2.00	7Z4	1.80	83	1.50
5V4G	2.40	6J7	2.00	6S7GT	2.00	7Z4	1.80	84	1.50
5W4	1.65	6J7G	2.00	6S7GT	2.00	7Z4	1.80	85	1.50
5W4GT	1.65	6J7GT	2.00	6S7GT	2.00	7Z4	1.80	86	1.50
5X4G	1.80	6J8G	3.20	6S7GT	2.00	7Z4	1.80	87	1.50

WHEN ORDERING TUBES ON THIS PAGE STATE "JOBBERS STOCK."

ALL MERCHANDISE SHIPPED F. O. B. NEW YORK WRITE FOR BARGAIN CATALOG C-7
ART RADIO CO. 115 LIBERTY St., New York 6, N. Y.
Phone: COrtlandt 7-2918

NEW CONDENSER TESTER

Finds Intermittent
Condensers Instantly

Pres-probe's sliding tip with variable resistance prevents condenser heating. Tests with power on. Requires no adjustment. Stops guesswork. Saves time. Convenient probe size (7/8" long). Satisfaction guaranteed.

See Your Dist. or Order Direct

PRES-PROBE CO.
3226 N. THIRD ST., MILWAUKEE 12, WIS.

NEVER BEFORE

SUCH A PHENOMENAL VARIETY OF FINE TAPE RECORDERS

within these pages: the tape recorder you want, at a popular price. Complete data on 2-speed recorders, 24 hour recorders, conference recorders, and many others. Accessories included. Write today for your free copy!

AMPLIFIER CORP. OF AMERICA
398-10 Broadway New York 13, N. Y.

MEASURE HI-VOLTAGE!



**Pocket-Size
"SEG HY-VOLTER"
BALL-GAP
KILO-VOLTMETER**

Perfect For
• Radio • X-Ray
• Television • Radar

Measures high voltage directly in KV—A.C. and D.C. pulse voltages. Metalus reading for later use. Pocket-size SEG Hy-Volter is a perfect tester for field work—saves wear and tear on expensive equipment. It is a complete instrument—not a probe! Easy to use. Sturdy Safe.

ONLY **\$3.45**

7" LONG

WRITE FOR THE NAME OF NEAREST JOBBER

SEG ELECTRONICS CO.

156 E. 56th St., Brooklyn 3, N. Y.

NOTHING ELSE LIKE IT

ELEMENTS of SINGLE and DUAL TRACK TAPE RECORDING and 1001 APPLICATIONS



ONLY **\$1.00** by A.C. Shaney POSTPAID

96 pages crammed with facts. Contains circuit diagrams, parts lists, construction hints, as well as elementary and advanced theory and design. **Send dollar bill. No C.O.D.'s.**

AMPLIFIER CORP. OF AMERICA

398-90 Broadway New York 13, N. Y.

ARC/5 Xmters VFO Drivers 40 Watts Output	
2.1-3 Mc	\$6.95
3.1-4 Mc	8.95
7-9.1 Mc	6.95
Used Good Cond.	
Supershet Recvrs W/ Dyn Can be converted to 110V 60 cy. 190-550 Kc	\$7.95
1.5-3 Mc	9.95
1.6 Mc	3.95
6-9 Mc	5.95
Used Good Cond.	

BC-605 INTERPHONE AMPLIFIER
Easily converted to an ideal inter-Communications set for office-home-or factory. Original. New w/conversion Diagram

\$4.49

GIBSON GIRL
The Emergency Radio Transmitter. Sends 5 O 5 signals automatically on 500KC. 150-mile range. No batteries required. Has hand-driven generator, tubes, wire. New. It's only

\$3.49

SPECIAL CHOKES
10HY250MA. \$3.25
20HY300MA. 6.49
6 HY 150 MA. .99
25 HY 75 MA. 1.29
8.5HY125MA. 1.29
11.5HY90MA. 1.39
5 HY 150 MA. 1.45
Dual 7 & 11
HY. 90 MA. 1.39
10HY450MA. 11.95
5 HY 200 MA. 1.29
10HY500MA. 12.95
Many others. Write.

BC 223 XMITR
30 Watt Transmitter with crystal oscillator control on four pre-selectable channels—also master oscillator. Frequency coverage 2000 KC. to 5250 KC. by use of three plug in coils. Five tube operation. 801 oscillator, 801 power amplifier, two 46 modulators, and one 46 speech amplifier. Price with TU-17 Tuning Unit, 2000 to 3000 KC.

\$32.95

SPECIAL XFMRs.
115V. 60 CY.
36V/3.5 A for Rect. etc.

\$2.75

NAVY ARB RECEIVER
195 Kc thru 9 Mc.—Includes broadcast band. Can be converted easily to a good ham receiver. 28 V. DC input. Covers 4 bands. This is a deluxe type super-het receiver. Note: The frequency coverage includes the standard broadcast band. Has 4-gang tuning condenser; can be converted to 110 V. AC receiver. Complete with tubes: 12SF7, 12SA7, 3-12SF7 and 12A6. Dial is built on front of chassis. Electric driven or Manual band change switch. Weight 28 lbs. Size 6" x 7" x 15". Complete with tubes and dynamotor. (Pair as is Cond.)

\$19.95

ARR2 Homing Rec.
Tunes 234-258 MC
Contains 4—6AK5.
6-9001.
1-12A6.
IDEAL For
2-6-10
Mtr. Conv.
As is Fair
Cond.

\$4.95

T.V. Transformer, 7" or 9" scope, 3000V/5MA, 720Vct/200MA. 6.4/8.7A. 6.4/6A. 5/3A. 1.25/3A. 115V 60 cy input. Price.

\$3.95

Send M.O. or CHK. Mds. Guard. Shpg. Charges Sent C.O.D. Price F.O.B. N.Y.C. Phone Di. 9-4124
COMMUNICATIONS EQUIPMENT CO.
131 Liberty St., Dept. C7 New York City 7, N. Y.

FREDDIE'S FUND

We have received the following letter a short time ago from Herschel Thomason, the radio technician whose little son's plight was described in the June issue of RADIO-ELECTRONICS.

"Dear Editor:

Received another bunch of checks from you yesterday and sure was glad to get them. I believe this brings the total to \$774.

"I am enclosing a picture of Freddie that was taken about two weeks after



he received his legs. You will notice that he is really interested in something on the sidewalk.

"We really appreciate your help and thank you again.

Herschel Thomason"

We are still accepting contributions for Freddie. Remember, no contribution is too small! A list of further contributors follows:

- Balance from April 26
- Anonymous—Philadelphia, Pa. \$769.00
- Anonymous—Pittsburgh, Pa. \$1.00
- Anonymous—San Antonio, Texas
- Belmont Radio—St. Petersburg, Fla. 5.00
- C. L. Bolton—Norfolk, Va. 5.00
- Louis T. Buelter—Jamaica, N. Y. 1.00
- Francis J. Chamberlain—Dover, N. H. 1.00
- Dan and Butch—Philadelphia, Pa. 5.00
- Walter De Clue—Herculaneum, Mo. 1.00
- Van H. Ferguson—Tallahassee, Fla. 2.00
- John T. Frye—Logansport, Indiana
- Robert M. Harvey—North Wilkesboro, N. C. 2.50
- A. A. Horton—Norfolk, Va. 1.00
- Lillian L. Horton—Norfolk, Va. 1.00
- Hytron Radio & Electronics Corporation —Salem, Mass. 100.00
- Inman's Radio Service—Frankfort, Ky. 5.00
- Insuline Corporation of America —Long Island City, N. Y. 10.00
- A. J. Kaluza—Conneaut, Ohio
- LaPointe Plascomold Corp.—Unionville, Conn. 5.00
- E. Ludwig—Port Clinton, Ohio
- Dean Post—Arlington, Va. 1.00
- Radio Center—Norfolk, Va. 5.00
- Lewis Scriven—Brooklyn, N. Y. 1.00
- Bobby and Linda Suter—Maple Heights, Ohio 10.00
- Sylvania Electric Products, Inc.—New York, N. Y. 100.00
- E. Williams—Port Clinton, Ohio
- R. V. Williams—Norfolk, Va. 5.00
- Wise—Chicago, Ill. 2.00
- Total as of May 29

TV SERVICE DATA

To meet the service technician's need for service data on new sets which have just appeared on the market, Howard

W. Sams Co. has initiated a new special service. A supplement containing manufacturers' schematics and other data on just-released televisers is being enclosed with each regular folder. The service technician can use the schematic to solve most of his problems until the complete folder on the receiver has been prepared.

**Radio Thirty-Five Years Ago
In Gernsback Publications**

HUGO GERNSBACK Founder	
Modern Electrics	1908
Electrical Experimenter	1913
Radio News	1919
Science & Invention	1920
Television	1927
Radio-Craft	1929
Short-Wave Craft	1930
Television News	1931
Wireless Association of America	1908

Some of the larger libraries still have copies of ELECTRICAL EXPERIMENTER on file for interested readers.

**JULY, 1916, ELECTRICAL
EXPERIMENTER**

Modern Radio Transmitting Apparatus
Receiving Two Radio Messages on One Aerial

A Listening-in Switch for Radio Receptors

High Spark Frequency in Radio-Teleg-raphy, by Peter G. M. Clute

A Precision Variable Condenser
Utilizing Fuse Parts in a Detector, by Frank Talone

New Hook-up for Undamped Oscilla-tions, by Francis R. Pray

Tubular Audion Hook-Up
Wave Length Computation

TWO CORRECTIONS

Captions are reversed on the re-sistance and capacitance zero adjust-ment controls in the "Signal Tracer and V.T.V.M. Combined," on page 44 of the May issue. Our thanks to Mr. Louis A. Josephson, of Bloomington, Ill., for this correction.

Mr. Hatfield, the designer of the in-strument informs us that by using a d.c. v.t.v.m. probe having a 1.1-megohm isolating resistor, it is possible to measure voltages in circuits having extreme-ly high impedance. This probe will multi-ply the meter reading by 1.1. A peak-reading a.c. probe can be used for measuring r.f. voltages. The multiplica-tion factor of the probe will depend on the type which you use.

The capacitor across the converter output transformer T1 in the schematic of the Low-Noise FM Front End on page 62 of the June issue is shown as 25 µf. The correct value is 26 µf. Its actual value may vary slightly with the transformer you use.

TITLE CHANGE

John F. Rider Publisher, Inc., an- nounces the title of its forthcoming book, *New Cathode-Ray Tube at Work*, has been changed to *Encyclopedia on Cathode-Ray Oscilloscopes and their Uses*. The book deals with oscilloscopes and syncroscopes manufactured during the past ten years.

800-WATT AMPLIFIER

? Please prepare a diagram of an 800-watt final amplifier and multiplier for use with my 25-watt, 80-meter v.f.o. I would like to use 813's in the final and one or two 3C24's in the multiplier stage. The Q of the final tank circuit should be about 12 on all bands between 3.5 and 30 mc. This unit is to be link-coupled to the v.f.o.—E.M., Philadelphia, Penna.

A. It is highly possible that the 3C24 will supply sufficient drive when its plate circuit is working at 2, 4, and 8

current of each 813 separately or the total grid current. The 15- μ f variable between the multiplier plate coil and ground balances the grid currents.

This rig will do a nice job on the phone bands if it is plate modulated. Approximately 400 watts of audio is required for 100% modulation. If the modulation transformer does not have separate plate and screen windings, the 813 screen voltage should be obtained from the plate supply through a dropping resistor. The v.f.o. should have a buffer stage to prevent frequency shift during modulation peaks or keying.

INSTANT-HEATING INTERCOM

? Have you printed a circuit of an instant-heating intercommunicator in the past two or three years? If so, in which issue? If you do not have a circuit, please prepare one for me.—R. C. B., Durham, N.C.

A. A circuit of an instant-heating intercom was described in an article on page 41 of the September, 1948, issue of RADIO-CRAFT. This issue is available from this office for 40¢.

A selenium rectifier and battery tubes eliminate the warm up time.

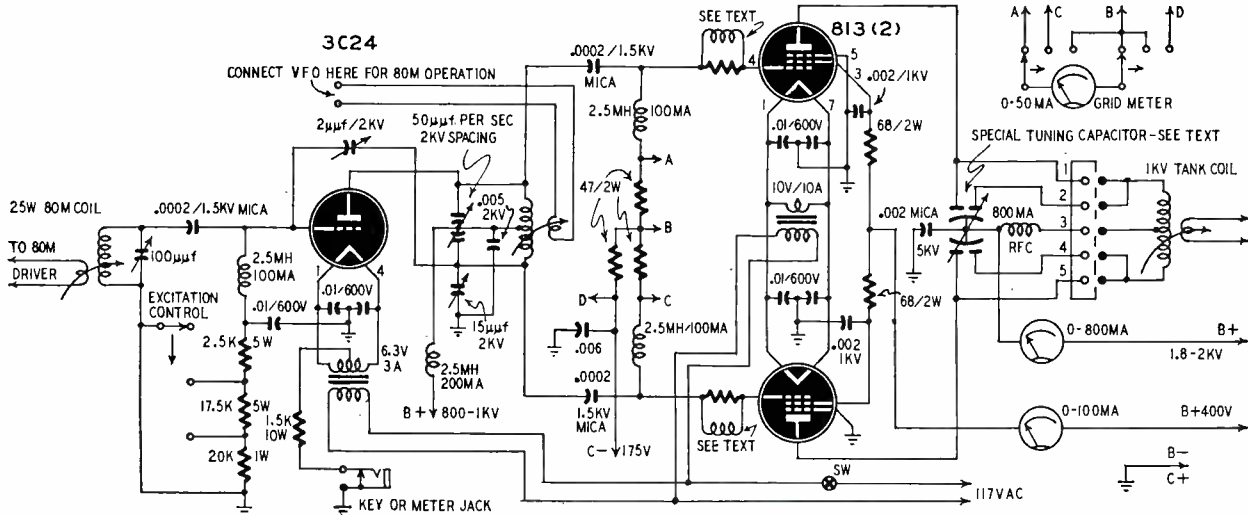

times the input frequency. When working straight through on 80 meters, the 3C24 should be turned off and the link from the v.f.o. connected to the 50-watt coil in 813 grid circuit. Swinging links and a variable grid leak in the multiplier stage permit the loading to be adjusted to meet operating conditions. 3C24 grid current is 15 ma for second-harmonic operation, about 8 ma for the fourth harmonic, and 5 ma on the eighth. It may be necessary to experiment with the grid current and grid-leak resistance when multiplying to 10 meters. Be sure that the plate dissipation does not exceed 25 watts.

Parasitic suppressors consisting of approximately 15 turns of No. 20 enamel wire around a 1-watt, 100,000-ohm resistor are placed in the grid circuits of the 813's. The r.f. choke in the 813 plate circuit should be of the all-band type. A National type R-175 or equivalent will work nicely.

The final tank capacitor is a special job made by isolating approximately one-fourth of the stator plates in each section of a 100- μ f-per-section variable with 0.2-inch spacing. The isolated sections are connected across terminals 1 and 5 on the jack bar. The remaining capacitor sections are connected to terminals 2 and 4. The 10- and 20-meter coils are modified to connect between terminals 1 and 5. The 80- and 40-meter coils have jumpers between plugs 1 and 2, and 4 and 5, therefore, the full capacitance of each section is available on these bands.

A switch on the grid meter permits the operator to read at will the grid

DON'T REMOVE THE TV SET!

Now! SHOOT 90%* of TV TROUBLES on-the-Spot with 2 OAK RIDGE miniatures!

SYNCO-SWEEP GENERATOR (Model 104)

The only unit of its kind in the world! Completely trouble-shoots and tests Horizontal and Vertical Linearity, Sync, Sweep and High Voltage circuits of all TV sets—in less than 8 minutes! Generates Vertical and Horizontal Linearity Bars, and Vertical and Horizontal Sync and Saw-tooth signals! Shoots the trouble trigger-fast, "on-the-nose"—entirely independent of station operation! 5 3/4 x 4 x 2 1/4". Complete with leads, Dealer's Net \$39.95.

TV-FM SIGNAL GENERATOR (Model 103)

"Lands" any signal failure from ANT to CRT or SPKR with bull's-eye precision in 2 minutes flat! Has 4 separate tuning bands & modulation output and attenuator. Complete tester for RF, Osc, Mixer, Video & Audio IF, 2nd Det and Amplifier; Sound & Adjacent Picture Trap; and ANT Orientation & Sensitivity. Also is complete Marker Generator. 5 3/4 x 4 x 2 1/4". Complete with leads, Dealer's Net \$29.95.

SUBSTITUTION TESTER (Model 101)—Substitutes for most-often-faulty components. Also acts as Audio Signal Tracer. Complete with leads, Dealer's Net \$16.25.

TV HIGH VOLTAGE TESTER (Model 102)—Checks all h-v in all TV sets. Scales 0-500V, 0-15KV, 0-30KV. Supplied with special h-v lead, Dealer's Net \$14.95.

• With the Oak Ridge Miniatures in your tool-kit, you take your lab to the set! You double your servicing time and earnings! Ask your jobber for them. Write for your free Catalog T-E.

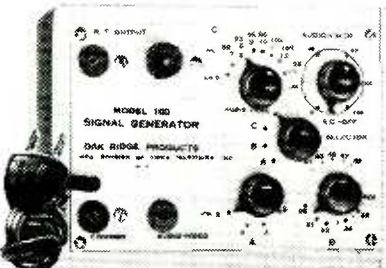
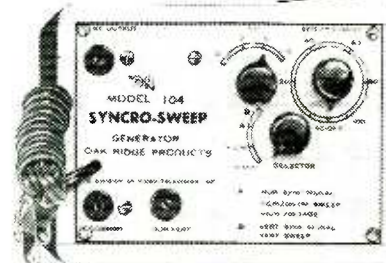

*National Surveys show 90% of all TV troubles occur in those circuits for which Models 104 and 103 are specifically designed.

OAK RIDGE PRODUCTS

239 EAST 127 STREET, NEW YORK 35, N. Y. Manufacturing Division of VIDEO TELEVISION, INC.

PUSH-PULL FINAL

? I have a Signal Shifter and would like a diagram of a pair of push-pull 807's to be driven by this unit. Please provide a means of protecting these tubes in the event of excitation failure. I would like to use commercial coils in the input and output stages. Please design the stage for 150 watts input.—W. C. K., Cumberland, Md.

A. This amplifier has been so designed that neutralization is not required. Mount the grid coil and its tuning capacitor under the chassis and the plate components above it. The 47-ohm resistors in the screen leads and the r.f. chokes in plate and grid leads eliminate parasitics. The chokes consist of 18 turns of No. 20 enameled

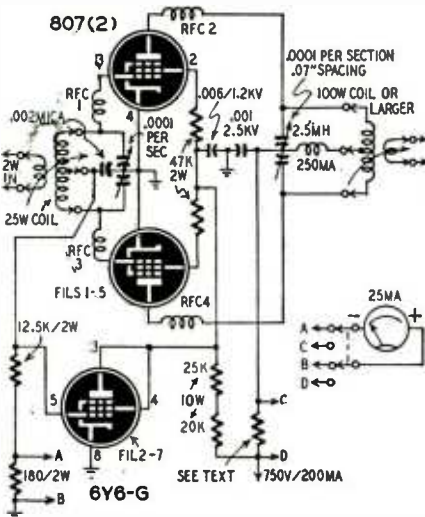

wire close-wound on a 1/4-inch form or a 1-watt resistor of several thousand ohms. The shunt between meter terminals C and D should be selected so the full-scale reading of the meter is 250 ma.

SURPLUS DIAGRAMS

? Can you tell me where I can obtain diagrams and conversion data on most of the surplus radio and electronic equipment on the market?—D. H. R., Canton, Ohio

A. Technical manuals on some types of equipment are available from the Superintendent of Documents, U. S. Government Printing Office, Washington 25, D. C. A catalog of available manuals will be sent upon request to the GPO.

Three multigraphed booklets titled *Schematic Manual for Surplus Electronic Equipment—Volumes I and II, and III*, available for \$1 each from Office of Technical Services, U. S. Department of Commerce, Washington 25, D. C. A free bibliography of sources of information on surplus equipment is also available from the same source.

Other publications on surplus radio and electronic equipment are: *Conversion Diagrams*, published by R & M Radio Co., 1426 N. Quincy St., Arlington, Va. Price \$2.00.

Surplus Circuit Diagrams and *SCR-*

274-N Circuit Diagrams with Conversion Data, published by Troup Engineering Co., 2221 Grand Ave., Long Beach 4, Calif. The price is \$2.00 for the former and \$1.00 for the latter.

Surplus Radio Conversion Manual, published by Techno-Graphic Publications, P. O. Box 877, Los Angeles 35, Calif. Price \$2.50.

R. E. Goodhart, 345 1/2 N. Palm Drive, Beverly Hills, Calif. has a variety of diagrams for sale. A comprehensive list of the available diagrams, cross-indexed for BC and SCR nomenclatures, is available from him for 25¢.

TRANSFORMER QUERY

? I have a 350-watt a.f. output transformer designed to be used with class-B 811's operated with zero bias and 1,250 volts on the plates. It has two secondaries. The turns ratio of half the primary to either secondary is 11.6 to 1. How can I use this transformer?—B. G.—New York, N. Y.

A. Because the turns ratio is 11.6 to 1 for half the primary to either secondary, the turns ratio of the full primary to either secondary will be twice this value or 23.2 to 1.

The square of the turns ratio N

equals the primary impedance divided by the secondary impedance, or $N^2 = Z_p / Z_s$.

Because the turns ratio is fixed when the transformer is manufactured, we have a choice of matching the load to the tubes or matching the tubes to the load. When the plate-to-plate impedance of a set of tubes is known, the required load impedance is $Z_s = Z_p / N^2$. If the tubes must match the load, the primary impedance is $Z_p = Z_s N^2$. In this instance, select tubes which will present a plate-to-plate load that approximates the desired primary impedance while delivering the desired power output.

Push-pull-parallel 811's operating under the conditions you have given have a plate-to-plate impedance of approximately 8,000 ohms. Connect the secondaries in parallel-aiding for 15-ohm loads and in series-aiding for 60-ohm loads.

If you use tubes having a plate impedance higher than 8,000 ohms, the load impedance will be higher than 15 and 60 ohms. If the plate impedance is lower than 8,000 ohms, the load impedance will be lower than 15 or 60 ohms if the generator and load circuits are to be matched.

BUILD 15 RADIOS...Only \$14.75

- ABSOLUTELY NO KNOWLEDGE OF RADIO NECESSARY
- NO ADDITIONAL PARTS NEEDED
- EXCELLENT BACKGROUND FOR TELEVISION

The PROGRESSIVE RADIO EDU-KIT will help you, if you want to get into a WELL-PAYING BUSINESS, or if you want to INCREASE YOUR KNOWLEDGE OF RADIO.

Each of the 15 radios you will build operates on 110-120 volts, AC or DC. These sets have been designed to teach you the PRINCIPLES OF RADIO. Therefore, you will build a variety of circuits. The PROGRESSIVE RADIO EDU-KIT is EXCELLENT FOR LEARNING THE PRINCIPLES OF RECEIVER, TRANSMITTER, AND AMPLIFIER DESIGN. It is used in many Radio Schools and Colleges in U.S.A. and abroad. It is used by the Veterans Administration for veteran training.

Quizzes are provided as part of the PROGRESSIVE RADIO EDU-KIT. They will be corrected by our staff at no extra cost.

FREE 1950 EXTRAS:

- ELECTRICAL AND RADIO TESTER
- SCREWDRIVER
- BOOK ON TELEVISION
- GENEROUS HANK OF WIRE
- ELECTRIC SOLDERING IRON ALIGNMENT TOOL
- SPOOL OF ROSIN CORE SOLDER
- MEMBERSHIP IN RADIO-TV CLUB

ORDER YOUR PROGRESSIVE RADIO KIT TODAY, OR SEND FOR FREE "KIT-KATALOG" POSTAGE PREPAID ON CASH ORDERS. C.O.D. ORDERS ACCEPTED IN U.S.A.

PROGRESSIVE ELECTRONICS CO., 497 Union Ave., Dept. RE-36, Brooklyn 11, New York

OPPORTUNITY AD-LETS

Advertisements in this section cost 25¢ a word for each insertion. Name, address and initials must be included at the above rate. Cash should accompany all classified advertisements unless placed by an accredited advertising agency. No advertisement for less than ten words accepted. Ten percent discount six issues, twenty percent for twelve issues. Objectionable or misleading advertisements not accepted. Advertisements for August, 1950, issue, must reach us not later than June 24, 1950.

Radio-Electronics, 25 W. Broadway, New York 7, N. Y.

Want a Good Job in Radio?

Get your FCC License in a minimum of time. Add technical CIRE training to practical experience—study at home—in spare time. Then get real help finding a job with our Amazing Job-Finding service. It really works! Act now!

GET FREE BOOKLET

"Money-Making FCC License Information" tells you how to get a Good FCC Licensed Job in Radio. Send for it now.

CLEVELAND INSTITUTE OF RADIO ELECTRONICS
4900-B Euclid Bldg., Cleveland 3, Ohio

MAGAZINES (BACK DATED)—FOREIGN, DOMESTIC, arts, books, booklets, subscriptions, pin-ups, etc. Catalog 10¢ (refund). Ciccone's, 86-22 Northern Blvd., Jackson Heights, N. Y.

1ST CLASS F.C.C. PHONE TECHNICIAN, would accept well paying, out-of-town position in broadcasting communications field. Roy Dashtukawich, 4439 Third Avenue, Bronx 57, New York.

LANCASTER, ALLWINE & ROMMEL, 438 BOWEN Building, Washington, D. C. Registered Patent Attorneys. Practice before United States Patent Office. Validity and infringement investigations and opinions. Booklet and form "Evidence of Conception" forwarded upon request.

51-201 SOLDERING FLUX, 50¢ up, Parts Distributor or write LYONART, Trinidad, Colorado.

RADIOMEN, SERVICEMEN, BEGINNERS — MAKE more money, easily, quickly, \$250 weekly possible. We show you how. Information free. Merit Products, 216-32L 132nd Avenue, Springfield Gardens 13, New York.

GEIGER COUNTER TUBE \$5.00 POSTPAID. No COD. J. H. Connor, 2304 S. Ogden Street, Denver, Colo.

BUILD YOUR OWN GEIGER COUNTER!

It's EASY to build your own Searchmaster Geiger Counter with this COMPLETE kit. Contains everything you need! Headset, tubes, batteries, metal case. Fully guaranteed! Sensitive to both beta and gamma radiation! Illus. instructions. FREE radioactive specimen.

SCIENCE KITS LTD.
5514-R Hollywood Blvd. • Hollywood 28, Calif.

Write for FREE literature

NEW VACUUM TUBE VOLTMETER Best instrument buy of the year!

AC and DC ranges: Kit Form
0-5/10/100/500/
1000 volts. Ohmmeter
from 2 ohms to
1000 mega. Zero Fact. Assemb.
center scale for TV. \$48.95
Has 0-1 meter; full
input imped.: 20 meg.

2% accuracy; big 4 1/2" meter; 2 1/2" x 9 1/2" x 6" overall.

FEILER ENGINEERING CO. Dept. 7RC5V
1601 S. Federal St. Chicago 16, Ill.

SUCCESSFUL VARIOTENNA

Dear Editor:

Having finally had time to build a slightly altered version of your Transpole Variotenna, here are some comments.

I'm located where gas storage tanks block direct pickup from most stations and where reflections travel crazily into a small enclosed court. I've used an indoor V, a folded dipole and reflector, and a Di-Loop, the latter two on a rotator outside the window. None of these gave satisfactory reception on all channels, and some channels required a booster. The Variotenna provides fair to excellent reception on all seven channels with no booster.

I'm more than satisfied with the results. I have a 4-mc band-pass receiver and want the nearest thing to monitor reception I can get. I consider the Variotenna the best answer I've seen.

LESTER DEL REY

New York, N. Y.

NOTHING NEW IN RADIO

Dear Editor:

In each issue of your magazine we read letters from disgruntled readers who find too much emphasis being placed on TV and non-radio applications of electronics.

Perhaps you should make a point of the fact that there has been nothing really new in AM radio in ten years, and little new information in fifteen. What advances have been made have been in the manufacture of better (in some cases cheaper) components.

Any reasonable comparison with a good 1938 radio and a good 1950 radio is apt to leave one with the feeling that maybe we're going downhill—and don't attempt to compare prices!

EDWARD A. BERNHOLZ

Syracuse, N. Y.

NEW ELIMINATOR KIT!

FOR AUTO-RADIO SERVICING

Supplies 5-8 volts at 10 amperes continuous, 15 amps. intermittent. Step voltage control, ripple less than 3%! Power on instantly—no warm up period required. For 115 VAC-50/60 cycles.

HERE'S WHAT YOU GET:

- Heavy duty power transformer
- Full wave Selenium Rectifier
- Low Resistance Filter Choke
- High Capacity Filter Condenser
- Multi-position tap switch

Kit #EL-2

Complete with operating and instruction manual. Shpg. wt. 24 lbs. Sorry no COD's. **\$19.50** Serviceman's net.

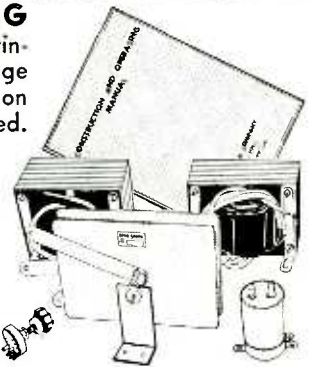

OPAD-GREEN COMPANY

71 Warren St. W. New York 7, N. Y. Phone: BEekman 3-7385-6

TRANSFORMER WINDING

Dear Editor:

I have found in the article on winding output transformers by James Langham (December 1948) that some important things have been left out which might prevent corrosion.

It is essential to exclude all moisture from the winding. Before touching the wire at all, dip your hands in high-grade transformer oil. Impregnate the interleaving paper with transformer oil. Make sure that the wires are clean. Use fine sandpaper to clean the wire, not a knife or razor. Clean all solder joints with benzine or carbon tet.

I hope these hints may be helpful.

D. E. O'N. WADDINGTON

Natal, South Africa

(Mr. Waddington obviously lives in a very humid climate. These precautions usually are not necessary in most of the United States, but may be useful to readers in other climates.—Editor)

announcing

"GONSET LINE"

LOW LOSS OPEN WIRE LINE
(lowest loss lead-line mfd.)

- 1/2 THE LOSS OF NEW MOLDED RIBBON
- 0.5 DB LOSS PER 100 FT. AT 200 M. C.
- POLYSTYRENE SPACERS

Ideal for

- TELEVISION
- AMATEUR
- COMMERCIAL
- FRINGE AREAS
- LONG RUNS
- BEACH AREAS

"Your antenna is no better than its lead-line."

GONSET CO., BURBANK, CALIF.

"I've seen that voice someplace before."

Suggested by Art Hawland, Los Angeles, Calif.

\$3.00 FOR CARTOON IDEAS

RADIO-ELECTRONICS prints several radio cartoons every month. Readers are invited to contribute humorous radio ideas which can be used in cartoon form. It is not necessary that you draw a sketch, unless you wish.

Address
RADIO CARTOONS, RADIO-ELECTRONICS
25 West Broadway, New York 7, N. Y.

Approved

MODEL A-710

12 TUBE FM-AM TUNER

\$57.50



For the first time in radio history, there is really available a high quality FM-AM tuner, designed for drift-free, realistic high fidelity reception AT A PRICE THAT PLACES IT WITHIN EASY REACH OF THE CUSTOM BUILDER, SERVICEMAN, MANUFACTURER, EXPERIMENTER, ETC.

JOBBERS!

Write Dept. RE-J for New 16 page Catalog and Jobber Net Prices.

TUBES USED ON FM:
 1-6AG6 RF Amp; 1-6BE6 Mixer-Detector; 1-6BJ6 Osc; 1-6AU6 IF Amp; 2-6AU6 Lim-criminators; 1-6AL5 Discriminator; TUBE USED ON AM: 1-6BA6 RF Amp; 1-6BE6 Converter; 1-6BE6 Amp; 1-6AT6 IF (audio amplifier) common to AM-FM.

Chassis dimensions: 8 1/2" x 5 3/8" high, 8" deep. Net weight: 5 1/2 lbs.

Power requirements: 170 V DC 2 MILS and/or 140 V DC 37 MIL. 6.3 V 4 AMP.

APPROVED ELECTRONIC INST. CORP.
 142 Liberty St. N.Y.C.

SAVE MONEY—BUILD YOUR OWN SPEED LIGHT EQUIPMENT FOR PROFESSIONAL AND AMATEUR

Easy to follow . . . step-by-step Instructions
 Write for FREE list of complete Kits and Components

CINEX, INC.
 Dept. RE-7 165 W. 46th St., N. Y. 19, N. Y.

NEW YORK'S RADIO TUBE EXCHANGE
 We buy, we sell, we exchange. Write for lists.



LIBERTY ELECTRONICS, INC.
 135 LIBERTY STREET NEW YORK 6, N. Y.
 PHONE WORTH 4-8242

BE YOUR OWN BOSS!

MAKE MORE MONEY

\$1.00 VALUE

25¢

40,000 WORDS IN TEXT

NO ADS ALL "MEAT"!

Money Back Guarantee.

NATIONAL PLANS COMPANY
 1966 R BROADWAY, NEW YORK 23, N. Y.

In "CASH IN" you now get THE real money-makers . . . dozens of profitable tested mail order plans, confidential business secrets, dozens of practical tested formulas, successful tested schemes—actual experiences of men who have started on a shoe-string—with less than \$10 capital. 25¢ a copy postpaid. Send U. S. stamps, money order, or coin.

LOOK AT PAGE 24!

Dear Editor:

The last two issues of your magazine were especially good. I particularly like the way articles are headed under different classifications such as FM, TV, Test Equipment, etc. Let us have more articles on transmission lines, wire recorders, and FM.

Television has not yet come to this city, but I am trying to keep up with it through your magazine.

RICHARD COOVERT
 Portland, Oregon

CAPACITANCE PICKUP

Dear Editor:

I would like to express my appreciation of Arthur Trauffer's courtesy, so often neglected by writers who discuss inventions, in his February story on "FM Phonograph Pickup".

There is one important point in the design of such pickups that will bear more emphasis. The mass, and therefore the motional reactance of the needle, should be reduced to the lowest possible minimum consistent with stiffness and a very high natural vibration frequency. Obviously a tubular form, without such appendages as a needle chuck, a vibratory axis, or extra electrode section will accomplish this object and at the same time provide ample surface area for the capacitance pickup function. Duraluminum or magnesium is the best material. The jewel tip may be cemented into one end of this tubular needle with shellac or other thermo-plastic material.

As Mr. Trauffer suggests, this is a fascinating and fertile field for experimentation with rich rewards in very closely approaching, if not actually realizing, the dream of perfect fidelity of reproduction.

I may add that, dynamically, the response of such a pickup is absolutely linear through much wider ranges of vibration amplitude than are encountered in phonograph recordings. The frequency response curve cannot be other than linear down to zero c.p.s. because this is an amplitude and not a velocity type of device when used with an FM or AM capacitive translator.

B. F. MIESSNER
 Miessner Inventions, Inc.
 Morristown, N. J.

LIKES MEATY ARTICLES

Dear Editor:

Your magazine is far ahead of anything in this country for the average intelligent radio enthusiast. It puts emphasis on the service technician's trials and tribulations and is a veritable mine of useful information.

The articles are of real meaty interest. I've gathered a larger stack of red hot circuits from one year's copies of RADIO-ELECTRONICS than I have in ten years from the "high-falutin" magazines which, if they do have a circuit diagram, often don't show circuit values.

LESLIE FIELD
 Yorks, England

WANTS MORE ON TV

Dear Editor:

I also live out here in Oregon where we have no TV yet, but I am in favor of your TV articles and hope to see many more. I can't agree with Mr. H. D. Thompson's letter in your March issue.

I also like the other articles in your magazine. I would like to see something on a portable vibrator tester that can be plugged in the a.c. line and doesn't take much space.

WM. R. THOMPSON
 Salem, Oregon

7 HARD TO GET ITEMS AT BIG SAVINGS TO YOU

AMAZING BLACK LIGHT



250-watt ultra-violet light source. Makes fluorescent articles glow in the dark. Fits any lamp socket. For experimenting, entertaining, unusual lighting effects. Ship. wt. 2 lbs.

ITEM NO. 87
A SAVING AT \$1.95

LITTLE GIANT MAGNET



Lightweight 4 oz. ALNICO permanent magnet. 1 3/4" x 1 1/2". Lifts more than 20 TIMES ITS OWN WEIGHT! Ideal for hobbyists, experimenters. Shipping weight 3/4 lbs.

ITEM NO. 159
BIG VALUE AT \$1.25

POWERFUL ALL PURPOSE MOTOR



Sturdy shaded pole A.C. induction motor, 15 watts, 3000 rpm. 3"x2"x1 3/4"; 4 mounting studs; 7/8" shaft, 3/16" diameter; 110-120 volts. 50-60 cycles. A.C. only. When geared down, this unit can operate an 18" turntable with a 200 lb. dead weight. Use it for fans, displays, timers and many other practical purposes. Ship. wt. 2 lbs.

ITEM NO. 147
UNUSUAL BUY \$1.95

WATT HOUR METER



Leading makes—completely overhauled, ready for service. 100-110 volts, 60 cycles, 2-wire A.C. Heavy metal case 8 1/2" x 6 1/4" x 5". Easy to install. Shipping weight 14 lbs.

ITEM NO. 33
NOW ONLY \$3.95

WESTERN ELECTRIC BREAST MIKE



Lightweight 1 lb. carbon microphone. Aircraft type. Breastplate mounting, adjustable 2-way swivel. Easily fastened straps. For home broadcasts, communications etc. Complete with 6 foot cord, hard rubber plug. Sherardized plate, non-rusting finish. Ship. wt. 2 lbs.

ITEM NO. 152
NEW LOW PRICE 95¢

TELEPHONE TRANSMITTERS



Genuine transmitters made by Kellogg, Western Electric, Stromberg Carlson. Work on two dry cells. For P.A. systems, intercoms, other practical uses. Shipping weight 1 lb.

ITEM 160
REAL VALUE \$1.95

250 POWER TELESCOPE LENS KIT



Make your own high powered 6 ft. telescope! Kit contains 3" diam., .75" focal length, ground and polished objective lens and necessary eye pieces. Magnifies 50x to 250x. Full instructions. Ship. wt. 1 lb.

ITEM NO. 123
YOU SAVE AT \$2.45

HUDSON SPECIALTIES CO.
 40 West Broadway, Dept. RE-7-50
 New York 7, N. Y.

I am enclosing full remittance for items circled below. Shipping charges included.

OR, my deposit of \$..... Ship balance C.O.D.
MINIMUM C.O.D. ORDER \$5.00.
C.O.D. ORDERS ACCEPTED ONLY WITH 20% DEPOSIT INCLUDE SHIPPING CHARGES.

Circle Items wanted

87 159 147 33 152 160 123

Name..... Please Print Clearly

Address.....

City..... Zone..... State.....



MAX F. BALCOM

Max F. Balcom was elected chairman of the Board of Directors of SYLVANIA ELECTRIC PRODUCTS, INC. Mr. Balcom has been associated with Sylvania since 1918, and has long been active in industry activities. President of the RMA in 1948-49, he is presently chairman of the association's television committee.

The board also announced the election of three new directors: EDWARD J. POOR, who resigned as chairman in 1943; RICHARD L. BOWDITCH, president of C. H. SPRAGUE & SON CO.; and H. WARD ZIMMER, vice-president in charge of operations.



J. E. TEMPLETON

J. E. (Earl) Templeton, former manager of the Los Angeles branch of P. R. MALLORY & CO. succeeds WALTER HARVEY as manager of the Wholesale Division. CHARLES GUTHEIL succeeds Mr. Templeton as Los Angeles manager.

Thomas A. White, president of the JENSEN MANUFACTURING CO., and LAURENCE A. KING, president of the ROLA CO., were elected to the Board of Directors of the MUTER CO., television component manufacturer. Both the Rola and the Jensen companies are subsidiaries of the Muter Co.



THOMAS A. WHITE

G. A. Bradford has been appointed advertising manager for the tube divisions of the GENERAL ELECTRIC COMPANY, Schenectady, N. Y.



G. A. BRADFORD

Mr. Bradford, a graduate of Colgate University, has been with General Electric since 1936 in various accounting, sales promotion and advertising positions. Prior to this new appointment, he was responsible for advertising and promoting General Electric motors and controls in the Apparatus Department. He was named credit and collection manager of the G-E Credit Corporation in 1942 before entering war service.

Harry P. Bridge, head of the HARRY P. BRIDGE CO., Philadelphia advertising agency which handles many accounts in the industry, received a life membership in the University of Florida Marketing Society.

Lawrence O. Paul, former business manager at ARMOUR RESEARCH FOUNDATION OF ILLINOIS INSTITUTE OF TECHNOLOGY, a nonendowed and nonprofit organization, was named assistant director. Mr. Paul joined the Foundation in 1946. In his new position he will plan and organize promotional and developmental activities.

J. Benton Minnick was named national merchandising manager for television by MOTOROLA, INC. HOWARD C. HANDWERG was appointed to a similar position in the auto radio division.

Barney Balaban, president of PARAMOUNT PICTURES, and EDWIN L. WEISL were elected to the Board of Directors of ALLEN B. DU MONT LABORATORIES, INC. They replace BERNARD GOODWIN and ARTHUR ISREAL, JR., who resigned.

Percy L. Spencer was named vice-president in charge of RAYTHEON MANUFACTURING CO.'s power tube division. At the same time, NORMAN B. KRIM was promoted to vice-president in charge of the receiving tube division and ERNEST F. LEATHEM was appointed

assistant to the president.

Alfred Zuckerman was elected a Vice-president of DAVID BOGEN CO., INC. He will continue as chief engineer in charge of design and development.

Clarence S. Tay, formerly general manager of the ADMIRAL CORP.'s four distributing divisions, has been elected president and board chairman of these divisions.

Personnel Notes

John S. Meck, Plymouth, Ind., television set manufacturer, has acquired a substantial stock interest in the SCOTT RADIO LABORATORIES, INC., and has assumed the presidency of that firm. . . .

Leonard Ashbach acquired a controlling interest in WILCOX-GAY CORP. Mr. Ashbach has assumed chairmanship of the board of directors. . . . Jack Pettersen appointed assistant advertising manager and N. H. (Terry) Terwilliger sales promotion manager of MOTOROLA, INC. . . . STARRETT TELEVISION CORP. named Stuart D. Clayton regional sales manager of the Midwest area. . . . AIR KING PRODUCTS CO., INC., announced the following appointments:—S. M. Decker, assistant chief engineer; I. J. Melman, head of the advanced development division; James White, manager of contract sales. . . . Dr. Donald B. Sinclair appointed chief engineer at GENERAL RADIO CO.

CHALK UP another First for SELETRON! Here is "mite-size" 8J1, keyed to the requirements of modern electronic circuits . . . A new and smaller 65 mil rectifier with particularly low reverse leakage, built to the following specifications: Input 130 V rms; Max. Peak Inverse Voltage 380 V; Max. D.C. Output Current 65 MA; Plate Size 11/16" square; Stack Thickness 9/16".

. . . And don't forget the 20 Mil "Mite"—No. 8Y1, designed especially for power and bias supply in Radio and Television!

A complete tabulation of all SELETRON miniatures is available. For your copy, write Dept. RS-27.

SELETRON DIVISION
RADIO RECEPTOR COMPANY, INC.
Since 1922 in Radio and Electronics
 Factory: 84 North 31st St., Brooklyn 11, N. Y. • Sales Department: 251 West 15th St., New York 11, N. Y.

* VOLOMETERS

*Reg. Trade Mark for Volt-Ohm-Millammeter

MODEL 102
 (1000 ohms per volt meter)
 • 3" SQUARE METER
 • 3 AC CURRENT RANGES (0-30/150/600 ma.)
 • Same zero adjustment for both resistance ranges (0-1000 ohms, 0-1 meg-ohms)
 5 DC & 5 AC Voltage Ranges to 3,000 Volts. Also 4 DC Current Ranges. **\$13.90**

MODEL 104
 (20,000 ohms per volt meter)
 • 4 1/2" SQUARE METER (50 micro-amperes—alnico magnet)
 • Includes carrying strap
 5 DC Voltage Ranges at 20,000 ohms/volt to 3,000 V.; 5 AC Voltage Ranges to 3,000 V.; 3 Resistance Ranges to 20 megs. Also 3 AC & DC Current Ranges. **\$24.95**

Export Dept., 303 W. 42nd St., N.Y.C.
 Write Dept. B-7 for Free Catalog
Gives More Measurement Value per Dollar!

EMC ELECTRONIC MEASUREMENTS CORP.
 423 BROOME STREET, NEW YORK 13, N. Y.

RADIO SCHOOL DIRECTORY



RADIO COURSES

Preparatory Mathematics, Service, Broadcast, Television, Marine Operating, Aeronautical, Frequency Modulation, Radar.

Classes now forming for the Summer term June 1st
Entrance exam, May 22nd.

Veterans. Literature.

COMMERCIAL RADIO INSTITUTE
(Founded 1920)
88 West Biddle Street, Baltimore 1, Md.

Your Future in RADIO-TV

Your future in radio-TV begins *right now*, with proper training. The Don Martin School of Radio Arts, established in 1937, offers the training you want . . . for every type of job in Radio-TV—script writer, announcer, disk jockey, newscaster, technician. Free job placement service for graduates. Day and night classes. . . Write for our FREE booklet, "YOUR FUTURE IN RADIO." Approved for veterans.

Don Martin School of Radio Arts
1855 No. Cherokee, Hollywood 28, Calif. HUdson 23281

HAVE YOU A JOB FOR A TRAINED TECHNICIAN?

We have a number of alert young men who have completed intensive training in Radio and Television Repairing. They learned their trades thoroughly by working on actual equipment under personal, expert supervision. If you need a trained man, we invite you to write for an outline of our course, and for a prospectus of the graduate. No fees, of course. Address:

Placement Manager, Dept. P108-6

COMMERCIAL TRADES INSTITUTE
1400 Greenleaf Chicago 26



RADIO ENGINEERING

FM—Television—Broadcast

Police Radio, Marine Radio, Radio Servicing, Aviation Radio and Ultra High mobile applications. Thorough training in all branches of Radio and Electronics. Modern laboratories and equipment. Old established school. Ample housing facilities. 7 acre campus. Small classes, enrollments limited. Our graduates are in demand. Write for catalog.

Approved for Veterans

VALPARAISO TECHNICAL INSTITUTE
Dept. C VALPARAISO, INDIANA

AUDIO (SOUND) ENGINEERING HOME STUDY TRAINING

Practical, easy-to-understand lessons, written by competent Audio Engineers and Educators, prepare you for a better job and a good future in the Television, Radio, Motion Picture, and Recording Industries.

Write today for details—Learn while you earn!!

HOLLYWOOD TECHNICAL INSTITUTE
Div. RE
4925 Santa Monica Blvd. Hollywood 27, California

Build Your Career! Become an Electrical Engineer

★ Major in Electronics or Power
★ B. S. Degree in 36 Months



World-famous courses in Radio-Television, Electronics and Electrical Power. 6 to 24-month technician courses. 35,000 former students. Write for free pictorial booklet, "Your Career" and 110-page catalog. State if World War II vet. See full-page advertisement in this issue, Page 19.

MILWAUKEE SCHOOL OF ENGINEERING
Dept. RE-750 N. Broadway, Milwaukee, Wis.

RADIO ENGINEERING 27 MONTHS DEGREE

Intensive, specialized course including strong basis in mathematics and electrical engineering, advanced Radio Theory and Design. Modern laboratory. Low tuition. Self-help opportunities. Also 27-month courses in Aeronautical, Chemical, Civil, Electrical, and Mechanical Engineering. Gov't approved for G.I.'s. Enter Sept., Dec., March, June. Catalogue.

INDIANA TECHNICAL COLLEGE
157 E. Washington Blvd., Fort Wayne 2, Indiana

TELEVISION

PREPARE FOR A GOOD JOB!

COMMERCIAL OPERATOR (CODE)
RADIO SERVICEMAN

TELEVISION SERVICING BROADCAST ENGINEER

V. A. Furnishes Books and Tools
SEND FOR FREE LITERATURE

BALTIMORE TECHNICAL INSTITUTE
1425 Eutaw Place, Dept. C, Baltimore 17, Md.



RADIO and TELEVISION

Thorough Training in All Technical Phases

APPROVED FOR VETERANS
DAYS—EVENINGS WEEKLY RATES
FREE PLACEMENT SERVICE FOR GRADUATES
For Free Catalog Write Dept. RC-50

RCA INSTITUTES, Inc.
A Service of Radio Corporation of America
350 WEST 4TH STREET NEW YORK 14, N. Y.

AUDIO ENGINEERING SCHOOL

Practical engineering training in Audio fundamentals, Disc, Film, Magnetic Recording, and Audio frequency measurements. Studio training simulates Broadcast, Motion Picture, Television, and Commercial Recording work.

Approved for Veterans

HOLLYWOOD SOUND INSTITUTE, Inc.
1640-E North Kemmere, Hollywood 27, Calif.
Specify if Veteran or Non-Veteran

Want a Good Job in Radio?

Get your FCC License in a minimum of time. Add technical CIRE training to practical experience—study at home—in spare time. Then get real help finding a job with our Amazing Job-Finding service. It really works! Act now!

GET FREE BOOKLET
"Money-Making FCC License Information" tells you how to get a good FCC licensed job in Radio. Send for it now.

CLEVELAND INSTITUTE OF RADIO ELECTRONICS
4900-E Euclid Bldg., Cleveland 3, Ohio

TRAIN FOR ALL TYPES FCC (RADIO OPERATOR) LICENSES

Complete Raytheon AM and FM broadcast transmitters and studio control equipment. Also TV camera chain unit. 30th anniversary year. Please send for catalog K.

MASS. RADIO SCHOOL
271 Huntington Ave., Boston 15, Mass.
Lto. by Comm. Mass. Dept. Bd.

RADIO Engineering

Complete Radio Engineering Course incl. Telev., U.H.F., and F.M. B.S. Degree Courses also in Civil, Elect., Mech., Chem., and Aero. Eng.; Bus. Adm., Acct. Visit campus, see well equipped labs. Low cost. Prep. courses. Personalized instruction. Grads successful. Founded in 1884. Enter Jan., March, June, Sept. Write for catalog.

TRI-STATE COLLEGE
2470 College Avenue Angola, Indiana

TELEVISION

Laboratory and theoretical instruction under the guidance of experts, covering all technical phases of Radio, Frequency Modulation and Television. Prepares for opportunities in Broadcasting, Industry or Own Business.

MORNING, AFTERNOON or EVENING SESSIONS. Licensed by N. Y. State. Free Placement Service. APPROVED FOR VETERANS.

ENROLL NOW FOR NEW CLASSES
Apply Daily 9-9; Sat. 9-2
VISIT, WRITE or PHONE

RADIO-TELEVISION INSTITUTE
Pioneers in Television Training Since 1938
480 Lexington Ave., N. Y. 17 (46th St.)
PLaza 4-5660 2 blocks from Grand Central

TV ELECTROMAGNETIC SERVICING COURSE

Practical Shop and Laboratory Training at Largest Resident TV School in the East!

Also RADIO SERVICE & REPAIR, F-M & TELEVISION
Preparation for F. C. C. LICENSE EXAMS

★ Approved for Veterans ★

DELEHANTY SCHOOL OF TELEVISION
105A EAST 13th STREET • NEW YORK 3, N. Y.

BLISS Electrical Training

Intensive 32 weeks' residence course in fundamentals of industrial electrical engineering, including radio and electronics. Extensive laboratory, shop work, drafting. Prepares for electrical technician and engineering aides in communications, power, manufacturing, business machines, sales, service. G.I. approved. 57th year. Enter Sept. 5. Catalog.

7547 TAKOMA AVENUE, WASHINGTON 12, D. C.



CODE SENDING SPEED

Be a "key" man. Learn how to send and receive messages in code by telegraph and radio. Commerce needs thousands of men for jobs. Good pay. Adventure. Interesting work. Learn at home quickly through famous Candler System. Qualify for Amateur or Commercial License. Write for FREE BOOK.

CANDLER SYSTEM CO.
Dept. B-H, Box 928, Denver 1, C.O., U.S.A.

RADIO-ELECTRONICS for

OUTSTANDING - TV - VALUES

MODEL #300
Folded dipole complete with reflector and high frequency adapter. Covers 13 channels. All alum construction. Less mast. Shpg. wt. 5 lbs. Price **\$4.10**

MODEL #200-D
Stacked array. Consists of 2 complete conicals and connecting bars. Very rigid construction. Covers all 13 channels. Matches 300 Ohm or 72 Ohm. Center impedance 150 Ohm. Ideal for low signal areas. An outstanding buy. Shpg. wt. 8 lbs. **SENSATIONAL OFFER at low mast. \$8.25**

MODEL 200-S
Single array. Same construction as above. Shpg. wt. 4 lbs. Price, less mast. **\$3.75**

MODEL #500
All-band folded dipole antenna. Ideal for rotor use. Maximum gain on any channel. Alum construction. Less Mast. Shpg. wt. 5 lbs. Price **\$4.25**

MODEL #Y-100
5 element Yagi Hi-Freq beam designed specifically for fringe area use. All alum construction. Cut to specific channels. Shpg. wt. 2 lbs. Channel #7, **\$6.50**; Channel #9, **\$6.35**; Channel #11, **\$6.25** and Channel #13, **\$6.00**. The prices are less mast.

ANTENNA ACCESSORIES

CM-100 Chimney Mount	\$.99
WM-100 1/2" Wall Bracket	1.50
WM-100 1" Wall Bracket	2.75
5-ft. 1 1/2" OD Steel Mast, Plated	7.25
5-ft. 1 1/2" OD Alum. Mast	1.50
5-ft. 1" OD Alum. Mast	1.25
31 1/2" 300-ohm stand-off insulators (fit coax cable)	—
100— \$2.50 per 100 \$19.50 per 1000	—
100— Bolt Assembler—ideal for mast coupling	—
12 for \$1.50 50 for \$5.00	—
Best Quality 300-ohm Uten Lead	100— \$1.05 1000— \$9.00
High Quality 72-ohm Coax Cable	100— \$2.95 500— \$13.75
Fold Dipole Hi-Frequency Adapters	\$1.35
Conical Hi-Frequency Adapters	1.50
Straight Dipole Hi-Frequency Adapters	1.25

TERMS: All shipments F.O.B. Newark, New Jersey. 25% deposit with orders, balance C.O.D. Minimum order \$2.00. Include ample postage.

EAST COAST ELECTRONICS
40 St. Francis Street Newark 5, New Jersey

DO YOU NEED METERS?

We carry a complete line of SURPLUS-NEW-GUARANTEED meters and accessories suitable for every requirement—ham rigs, broadcast equipment, recording, testing, schools, laboratories, etc. All types, sizes and ranges—portable, panel, switchboard, aircraft, laboratory etc.

VOLTMETERS **FREQUENCY METERS**
AMMETERS **DECIBEL METERS**
MICROAMMETERS **POWER LEVEL INDICATORS**
MILLIAMMETERS **RADIO FREQUENCY**

Over 75,000 meters in stock.

TYPICAL VALUES

VU METER, Weston 862, type 30 Scale B with internal illum. List price \$55.50... Only **\$22.50**

A.C. VOLTMETER, 0-150, Triplett 332-JPC, 3/4" Round flush metal case... Only **4.00**

D.C. MILLIAMMETER, 0-200, General Electric 100-II, 3/4" Round flush bakelite case... Only **4.50**

R.F. AMMETER, 0-1.5, Westinghouse RT-35, 3" Square flush bakelite case... Only **5.50**

We also stock various surplus components, transmitters, tachometers, shunts, multipliers, etc.

A postcard with your name and address will bring our

FREE CIRCULAR

MARITIME SWITCHBOARD
336 E. Canal St. New York 13, N. Y.
WOrth 4-8217

NAVY PHONES

VOICE POWERED - NO BATTERIES

Mfg. by RCA. Simple hook-up. Splice 2 wires and talk over 1/2 mile. Complete—no extras to buy. Each phone has headset, adjustable transmitter, chest plate, switch (on mike) PLUS 24' of rubber-covered cable. Navy cost \$99.00. Brand new—never used. For homeowners, farmers, contractors, mines, mills, television set installers, etc.

Money-back guarantee. Send check, cash. M.O. C.O.D.'s pp. for 2

pay postage. \$13.95. complete phones

GRAND HAWTHORNE SURPLUS
1439 SE Grand, Dept. RE-1, Portland, Oregon



RADIO COURSES

• RADIO OPERATING • CODE
• RADIO SERVICING • ELECTRONICS
• F.M. TELEVISION
• REFRIGERATION SERVICING

Write for Catalog TE and Picture Brochure

Y.M.C.A. TRADE & TECH. SCHOOL
229 W. 66 St., N. Y. 23
ENdicott 2-8117

TELEVISION SERVICING, by Solomon Heller and Irving Shulman. Published by McGraw-Hill Book Company, Inc., N.Y. 6 1/2 x 9 1/2 inches, 434 pages. Price \$5.50.

This practical book is written for the service technician who wishes to do television work. The first five chapters present enough information to enable the reader to make a good receiver installation, chapter 6 gives a summary of TV troubles, ten more chapters deal with individual receiver stages and trouble localization, and the last chapter discusses remedies for interference trouble. The book is written in a very clear, easy-to-read style.—*MW*

A DICTIONARY OF ELECTRONIC TERMS, edited by Harry L. van Velzer. Published by Allied Radio Corporation, Chicago, Ill. 6 x 9 inches, 64 pages. Price 25 cents.

Edited by an associate professor of electrical engineering of the University of Illinois, this dictionary contains over 2,500 television, radio and industrial electronic terms. The definitions cover modern techniques principally, though many words no longer in general use are included for historical reasons.

FUNDAMENTALS OF RADIO-VALVE TECHNIQUES, Book I of Philips' Technical Library, by J. Deketh. Published by N. V. Philips' Gloeilampenfabriken, Eindhoven, Netherlands. Distributed in U.S.A. and Canada by Elsevier Pub. Co., New York. 6 x 9 inches, 557 pages. Price \$5.00.

Devoted to properties, principles, and construction of radio and electronic tubes, this is an up-to-date work which will appeal to persons engaged in designing, maintaining, or studying radio receivers, amplifiers, or allied electronic circuits.

The 33 chapters have such titles as Basic Principles of the Action of a Radio Valve, Electron Emission, The Construction of Radio Valves, Consequences of Curvature of the Characteristics, Noise of Amplifying Valves, Negative Feedback, and Microphonic Effect. All chapters are illustrated with drawings, charts and photographs.

A 52-page appendix contains numerous charts, tables, equations, formulas, and other useful information.

Book II of the Philips' Technical Library Series is **DATA AND CIRCUITS OF RECEIVER AND AMPLIFIER VALVES**. Retailing for \$2.75, it has 409 pages which are devoted to technical specifications, operating data, and practical circuits for Philips tubes manufactured between 1933 and 1939.

Book III is the first supplement to Book II and contains similar material on tubes introduced in 1940 and 1941. Containing 213 pages, it sells for \$1.90.

Although the tubes described in these books are not employed in this country except in imported sets, the circuit information is thorough and much of it can be applied to similar tubes regardless of make. Complete receiver circuits are given including construction data on all-wave coils and i.f. transformers.—*RFS*

LEARN IT YOURSELF

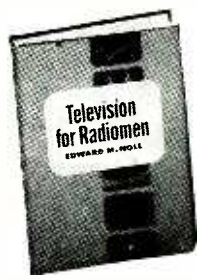

E. M. Nolle
Complete course of study and working instructions in the book

TELEVISION FOR RADIOMEN

will help you take advantage of the good jobs open to skilled television technicians today.

This book is not only a valuable handbook on television installation and servicing. It is also a complete course in *television fundamentals*. Written by a man widely known for his articles on television in the radio magazines, it explains in practical, easy-to-understand terms the construction and operating principles of every part of the television receiver and the essentials of television transmission.

Full working instructions show each step in the installation, adjustment, alignment, and trouble-shooting of today's receivers, with especially helpful material on antennas and handy charts for locating trouble quickly and accurately.

WHAT IS YOUR PROBLEM?

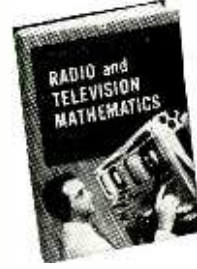

You will find the answer in the 721 problems and SOLUTIONS in

RADIO & TELEVISION MATHEMATICS

Here are step-by-step solutions to every problem commonly arising in work on receivers, power supplies, antennas, amplifiers, tubes, transmitters, etc. If you are ever "stuck" on a calculation; if you need a check on your figuring; or if you want to refresh your memory on the formulas to use for a certain problem—you will find your answer *quickly and easily* in this book.

Good practice for your FCC exams. This book shows you how to solve every problem requiring mathematics in the FCC STUDY GUIDE for licenses of all classes. You will find no better handbook for practice in solving problems with ease and accuracy.

SEE THEM FREE

The Macmillan Co., 60 Fifth Ave., New York 11

Please send me a copy of the books checked below. I agree to remit in full or return the books within ten days without further obligation.

Television for Radiomen, \$7.00

Radio & Television Mathematics, \$6.00

Signed.....

Address.....

E

DON'T BUY!

any tape recorder 'til you've learned all the facts about our **NEW PROFESSIONAL MODELS!**

We have more than 30 exciting models, 2-speed recorders, 24-hr. recorders, conference recorders and many others. Get the facts in our new 8-page catalog. Complete specifications given. Write today for your copy.

AMPLIFIER CORP. OF AMERICA
398-10 Broadway New York 13, N. Y.

WANT \$10,000?

Earn the govern- Super Sensitive P. R. I. ment bonus. Locate **GEIGER COUNTER** Uranium with a Find gold, silver, and other valuable ores with a P.R.I. Treasure Locator. World's finest instruments. FREE catalog. Write today.
PRECISION RADIATION INSTRUMENTS, Inc. Dealer Inquiries Invited
5478RE Wilshire Blvd., Los Angeles 36, Cal.

LEARN

Television-Radio OR Electricity

IN THE GREAT SHOPS OF COYNE

TRAIN QUICKLY!
OLDEST, BEST EQUIPPED SCHOOL OF ITS KIND IN U.S.
2 Opportunity Fields

Come to the Great Shops of COYNE in Chicago. Our 51st Year! Get quick, practical training in TELEVISION-RADIO or ELECTRICITY. G. I. Approved. Finance plan for non-veterans. Mail Coupon Today for complete details.

NOT "HOME-STUDY" COURSES!
You learn on real, full-size equipment, not by mail. Finest staff of trained instructors to help you get ready quickly for a better job, a fine future.

FREE BOOKS Clip coupon for big illustrated Coyne book on either TELEVISION-RADIO or ELECTRICITY. Both books sent FREE if you wish. No obligation; no salesman will call. Act NOW!

B. W. COOKE, Pres.
COYNE Electrical & Television-Radio School.
500 S. Paulina St., Chicago 12, Ill. Dept. 80-81-H

Send FREE BOOK and full details on:
 TELEVISION-RADIO ELECTRICITY

NAME _____
ADDRESS _____
CITY _____ STATE _____

WANTED TO BUY

Large and small quantities of new or used electronic government or manufacturers' surplus tubes and equipment. Highest prices paid. State quantity, condition and best price in first letter.

Box No. F-2 c/o Radio-Electronics
25 West Broadway
New York 7, N. Y.

ADVERTISING INDEX

Ad Ritz Manufacturing Corporation	86
Almo Radio Corporation	77
Allied Radio Corporation	55
Amperite Company	72
Amplifier Corporation of America	87, 88, 96
Art Radio Company	87
Ashe Radio Company, Walter	68
Astafic Corporation	12
Bell Telephone Laboratories	9
Brooks Radio Dist. Corporation	84
Buffalo Radio Supply	73
Capitol Radio Engineering Institute	7
Certified Television Laboratories	80
Channel Master Corporation	13
Chelsea Television Center Inc.	72
Cinex, Incorporated	92
Circle X Antenna Corporation	64
Cleveland Institute of Radio	22, 65, 68, 80, 90
Communications Equipment Company	88
Coyne Electrical School	83, 96
DeForest's Training, Incorporated	11
East Coast Electronics	95
Electro Products Laboratories	57
Electro Technical Industries	6
Electronic Instrument Company	98
Electronic Measurements Company	93
Fair Radio Sales	74
Feiler Engineering Company	86, 90
G & G Radio Parts Service	75
General Electronic Dist. Company	58, 59
General Test Equipment Company	68
Gonset Company	91
Grant Hawthorne	95
Harvard Laboratories	84
Heath Company	14, 15, 16, 17, 18
Hershel Radio	70, 71
Hudson Specialties Company	92
Hytron Radio & Electronics Corporation	21
Instructograph Company	65
JFD Manufacturing Company	78
Leotone Radio	80
Liberty Electronics	92
Macmillan Company (The)	95
P. R. Mallory & Company, Inc. Inside Front Cover	
Maritime Switchboard	95
Milwaukee School of Engineering	19
Murray Hill Books, Incorporated	77
National Company	10
National Plans	92
National Radio Institute	3
National Schools	5
Oak Ridge Products	89
Opod Green Company	91
Opportunity Adlets	90
Precision Apparatus Company	60
Precision Radiation Instrument Co.	96
Pres-Probe Company	87
Progressive Electronics	90

RADIO SCHOOL DIRECTORY

(Pages 94-95)

Baltimore Technical Institute	
Bliss Electrical School	
Candler System Company	
Cleveland Institute of Radio Electronics	
Commercial Radio Institute	
Commercial Trades Institute	
Deleahny Institute	
Hollywood Sound Institute	
Hollywood Technical Institute	
Indiana Technical College	
Martin School of Radio, Don	
Massachusetts Radio School	
Milwaukee School of Engineering	
RCA Institutes	
Radio Television Institute	
Tri-State College	
Valparaiso Technical Institute	
YMCA Trade & Technical Schools	

RCA Victor Division Radio Corporation of America	Back Cover
Radcraft Publications	69, 97
Radio City Products	8
Radio Corporation of America	20
Radio Dealers Supply	85
Radio Receptor Company, Inc.	93
Radio Supply & Engineering	76
Sams & Company, Inc., Howard W.	66, 67
Science Kits, Ltd.	90
Seg Electronics	88
Senco Radio, Incorporated	81
Sprague Products Company	4
Sprayberry Academy of Radio	Inside Back Cover
Standard Transformer Corporation	65
Hotel Strand	63
Sutton's Wholesale Electronics, Bill	80
Swedgal Radio, Incorporated	79
Tech-Master Products Company	78
Technifax	96
Tel-A-Ray Enterprises, Incorporated	77
Telrex, Incorporated	86
Thomas Electronics	63
Transvision, Incorporated	60
Workshop Associates, Inc. (The)	61

Technical Bulletins

EACH \$1.00 Postpaid Foreign \$1.25

Simplified technical information on many subjects of everyday usefulness, written in simple, easy-to-understand language. They contain no complicated mathematics, chemical and electrical theories, and are not based on the assumption that the reader has had a technical training.

(102) Cleaning Products for Many Purposes—Over 35 effective chemical cleaners that you can make and sell.

(110) Electroplating Non-Metallic Objects—Includes wood, leather, plaster, glass, flowers, insects, fabrics. Complete directions.

(114) Thermostats Easily Made—Designing and making automatic control units of many types for maintaining uniform temperatures, automatic furnace regulation, safety controls to prevent overheating, etc.

(115) Glue Molds for Casting Novelties—Making flexible glue molds for casting small objects, using plastics, magnesite.

(119) Electroplating with Alloys—Bronze, brass and cadmium-silver. Improves finish and provides durable coating.

(123) Mirror Silvering—Make money re-silvering old mirrors and making new ones. Colored, front-surface, transparent and photo mirrors.

(124) Soldering All Metals—Includes aluminum and die-cast alloys. Secrets of using the right flux and correct technique.

(125) Buffing & Polishing—All details on correct polishing. How to select the right abrasive for different kinds of metal. Gives wheel speeds, types and sizes of motors for best results.

(129) Coloring Metals Chemically—Tested formulas and directions to produce durable finishes in many colors on brass, copper, iron, aluminum and their alloys by chemical processes.

(130) Glass-Working Technique—How to cut, drill, grind and mount glass correctly; includes cutting of circles and internal openings.

(132) Working with Plastics—Covers all details of cutting, tooling, bending, cementing and polishing. Enumerates various kinds. Shows how to design articles. Includes using liquid plastics.

(139) Rubber Molds for Casting Novelties—Used for same purpose as glue molds but where greater elasticity is required.

(141) Recording Thermometer—How to make device to record room temperatures over 12-hour periods on a disk. Has alarm-clock mechanism.

(146) Simplified Casting Methods—Making small castings of soft metals without use of sand molds. For novelties, toys, etc.

(147) Drills and How to Use Them—How to use drills in different metals, plastics and other materials. How to sharpen correctly. Includes charts giving speeds and rate of drilling.

(149) Electroplating with Copper, Nickel, Chromium, Zinc, Lead and Cadmium—Enables anyone to do this fascinating work on a small scale.

(156) Home-Maintenance Formulas & Repairs—Includes a large number of simple, effective solutions for everyday household problems.

TECHNIFAX, 520 N. Michigan Ave. Chicago 11, Ill.

Enclosed find \$..... for which send the following Technical Bulletin at \$1.00 each (Foreign \$1.25) as indicated by numbers:

Name _____

Address _____

City & State _____

RE-7

RADIO TUBE VADE MECUM 1950, eighth edition. Published by P. H. Brans, Ltd., Antwerp, Belgium. (Distributed in the United States by Editors and Engineers, Ltd., Santa Barbara, California.) 8 x 11½ inches, 508 pages. Price \$3.20.

This new 1950 edition comes out in one large volume of more than 500 pages. A number of languages have been added, and this polyglot edition can be used in any of 15 European and 3 Asiatic languages.

New items, including nonodes, transducers, accelerometers, phasitrons, projection tubes, crystal diodes and transistors have been added for the sake of completeness. Tubes of all types to the number of 15,000, with their characteristics and a certain amount of data on equivalent types, comprise the rest of the book. The editors state that some of the material includes advance information on a large number of 1950 types which were not yet in production at the time the book was printed.

ACOUSTIC MEASUREMENT, by Leo L. Beranek. Published by John Wiley & Sons, Inc., N. Y. 6 x 8½ inches, 914 pages. Price \$7.

Intended as a reference for graduate students and workers in acoustics, this book covers the fundamentals of nearly every type of acoustical measurement, the details of many kinds of measuring apparatus, and the theory of many acoustic phenomena. Charts and diagrams and a careful mathematical treatment make the text a thorough one. A knowledge of advanced calculus is assumed.

COMMUNICATION CIRCUIT FUNDAMENTALS, by Carl E. Smith. Published by McGraw-Hill Book Co., N. Y. 6½ x 9 inches, 401 pages. Price \$5.

This volume, the second of four designed for a complete course in radio and communication engineering, covers the fundamentals of d.c. and a.c. circuit theory in the first 15 chapters. Five additional chapters serve as an introduction to vacuum-tube theory. The book is intended for use as a text in a planned study course, but should be useful for reference and home study. Knowledge of calculus (available in the first volume, *Applied Mathematics*) is assumed.

Two additional volumes of the series now in preparation are *Communication Networks* and *Audio and Radio Facilities*.

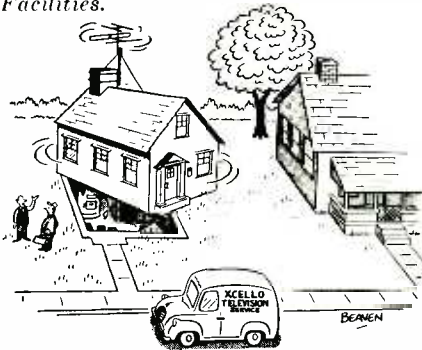

Suggested by: E. Abbott, Brooklyn, N. Y.
"Are you sure you hooked up that antenna rotor right?"

JULY, 1950

TECHNICIANS—You can BOOST YOUR INCOME

with this

NEW
Gernsback
Library
Book

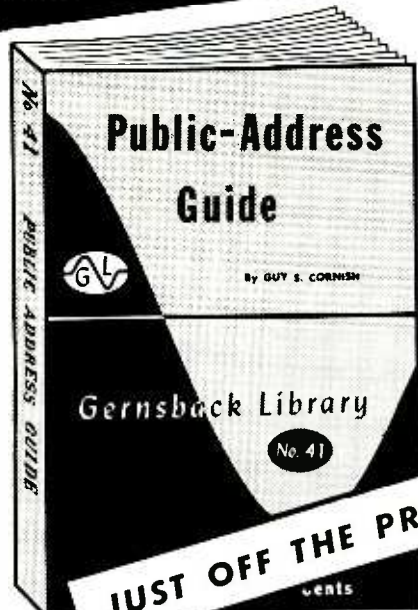

JUST OFF THE PRESS!

Only
75¢

Public-Address Guide

Increase your earning power—install, operate and service public address systems! This brand new, easy-to-read, guide tells you how. The author has spent a lifetime in the field. In a simple, straightforward way, he gives you all the technical "know-how" you need to turn P.A. installation and servicing into a profitable business. Buy the PUBLIC ADDRESS GUIDE at your jobber today. 80 pages. 5½ x 8½ inches.

JUST A PARTIAL LIST OF WHAT THIS BOOK OFFERS YOU

- CHAPTER 1.**—Uses of Public Address Systems . . . Types of Public Address Systems . . . Portable & Mobile Equipment . . . Outlay & Income.
- CHAPTER 2.**—Public Address Equipment . . . Characteristics of all Microphones . . . Phonographs & Pickups . . . Amplifiers . . . Speakers.
- CHAPTER 3.**—Installation . . . Acoustics . . . Choice of Amplifiers, Speakers, Microphones . . . Outdoor and Indoor Installations.
- CHAPTER 4.**—Maintenance & Servicing . . . Trouble shooting . . . Distortion . . . Hum . . . Motorboating . . . Howling . . . Weak Signals.
- CHAPTER 5.**—Practical construction of a P.A. system that can handle 90% of all calls the radio man will be asked to handle.

RADCRAFT PUBLICATIONS, INC., 25 West Broadway, New York 7, N. Y.

OTHER GERNSBACK LIBRARY BOOKS

50¢ BOOKS—(64 Pages)

- No. 29 Handy Kinks and Short Cuts
- No. 30 Unusual Patented Circuits
- No. 31 Radio Questions and Answers
- No. 32 Advanced Service Technique
- No. 33 Amplifier Builders Guide
- No. 34 Radio-Electronic Circuits
- No. 35 Amateur Radio Builders Guide
- No. 36 Radio Test Instruments
- No. 37 Elementary Radio Service
- No. 38 How To Build Radio Receivers

75¢ BOOKS

- No. 39 Practical Disc Recording—(96 pages)
- No. 40 The Cathode-Ray Oscilloscope—(112 pages)

SEE YOUR JOBBER

If he can't supply you use this coupon

RADCRAFT PUBLICATIONS, INC., Dept. 70
25 W. Broadway, N. Y. 7, N. Y.

I have enclosed \$.....in payment for volumes checked.

- No. 29 No. 30 No. 31 No. 32 No. 33 No. 34
- No. 35 No. 36 No. 37 No. 38 No. 39 No. 40

NAME

ADDRESS

CITY STATE

**YOU BUILD 'EM
IN ONE EVENING
BUT...**

THEY LAST A LIFETIME!

SAVE 50% WITH

**LABORATORY
PRECISION**



**INSTRUMENTS
& KITS**

**SENSATIONAL NEW
EICO Model 360-K TV-FM SWEEP
SIGNAL GENERATOR**

• Crystal marker oscillator with variable amplitude. • Covers all TV and FM alignment frequencies between 500 kc. and 228 mc. • Sweepwidth variable from 0-30 mc. with mechanical inductive sweep. • Extremely wide sweepwidth allows gain comparison of adjacent RF TV Channels. • Provides for injection of external signal generator marker. • Phasing control included. • Large, easy-to-read dial is directly calibrated in frequencies. • Vernier Tuning Condenser. • Comes complete with all tubes (including new, high-frequency miniature types): 6X5GT, 12AU7, two 6C4's. Crystal not included. 10"x8"x4 3/4". 5 Mc. Crystals available for above, each \$3.95
FACTORY-WIRED AND TESTED Model 360. Ready to use Sweep Signal Generator. \$39.95
See it at your local jobber!

\$29.95

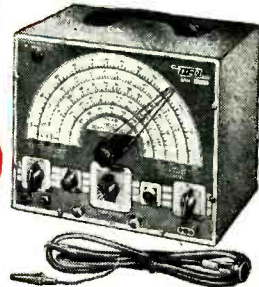

**ANYONE
CAN BUILD
THEM!**



**NEW! MODEL 320-K
SIGNAL GENERATOR**

For FM, AM alignment and to provide TV marker frequencies. Highly stable Hartley oscillator has range of 150 kc. to 102 mc. with fundamentals to 34 mc. Colpitts audio oscillator supplies pure 400 cycle sine wave voltage for modulation. Vernier Tuning Condenser. Use audio oscillator voltage to test distortion in audio equipment, bridge measurements, etc.
FACTORY-WIRED AND TESTED Model 320. Ready to use..... \$29.95

\$19.95



**VERSATILE MULTI-
SIGNAL TRACER**

Model 145-K. High gain—high frequency. Self-contained test speaker permits audible signal tracing of RF, IF, FM, audio and video circuits. Provision for visual tracing with VTVM. Response is well over 200 mc. 3-color hammertone panel. 110-125 V. AC. Size: 10"x8"x4 3/4". Comes complete with tubes and diode probe in kit form.
FACTORY-WIRED AND TESTED Model 145. Ready to operate..... \$28.95

\$18.95

**NEW PUSH-PULL 5"
TV OSCILLOSCOPE
Model 425-K Kit**

ALL-NEW laboratory precision scope has Push-Pull deflection and .05 to .1 volts per inch sensitivity. Wide-range, flat from 5 cps to 500 kc. with full gain setting, useful to 2 1/2 mc. Wide-range, multi-vibrator, sweep circuit from 15 cps to 75,000 cps. Direct connection to plates of CRT available at rear of cabinet. Z axis intensity modulation feature included. Size: 8 1/2"x17"x13" high. Complete with 3-6SN7s, 2-6J5s, 2-6Y3s, and 5B1 CRT.
FACTORY-BUILT OSCILLOSCOPE Model 425. Fully wired and tested \$69.95

\$39.95



**HIGH PRECISION
VACUUM TUBE
VOLTMETER
Model 221-K**

Tops in workbench versatility—15 different ranged AC and DC ranges: 0/5/10/100/500/1000 volts. Electronic ohmmeter ranges from .2 ohms to 1000 megohms in 5 steps. New features include Zero Center for TV discriminator alignment. 20 Meg. DC input impedance. Accurate, 4 1/2" meter cannot burn out. Double triode balanced bridge circuit assures guaranteed performance. Sturdy portable steel case with etched rubberproof panel. Will measure up to 30,000 V. and 200 Mc. when used with our HVP-1 or P-75 probes, 110-130 V. AC 50-60 cycle. Size: 9 7/16"x6"x5".
FACTORY-WIRED AND TESTED Model 221. Same, but completely wired, calibrated, and tested.... \$49.95

\$23.95



**DELUXE SIGNAL
GENERATOR
MODEL 315**

Completely wired, ready-to-use Signal Generator with 1% accuracy! A wonderful instrument with dozens of expensive features. Frequency range: 75 kc to 150 mc. Has microcycle band-spread vernier tuning for FM, AM, and TV. Voltage regulator. Write for \$59.95 full details.

**VOLT-OHM
MILLIAMMETER
Complete Pocket Kit**

Model 511-K. A "Must" for every serviceman! Small, handy instrument used a thousand times a day. Large 3" meter, beautifully etched panel. A perfect kit for beginners. Simple to assemble. Ranges: DC-0/5/50/250/500/2500 volts, AC-0/10/100/500/1000 volts. Output-0/10/100/500/1000 v. DC Ma.-0/1/10. DC A m.p.s.-0/1/10. Ohmmeter-0/500/100,000 ohms/0/1 meg. DB meter -8 to +55 Db.
\$14.95



ASSEMBLED—READY TO USE Model 511—Completely wired, tested, and assembled at the factory. Rugged, built for heavy duty.....
\$17.95

WRITE FOR NEW CATALOG C



HIGH VOLTAGE PROBE

Complete top-quality High Voltage Test Probe measures up to 30,000 volts. Special Helical-Wound Ceramic HV Multiplier Resistor adaptable to most VTVM's and 20,000 ohms per volt meters with 1000 or 5000 volt scales. Lucite head, plywood bakelite handle, large flashguards for additional safety. Specify your instrument. Complete ready to use.....
\$6.95

**ASK YOUR LOCAL
JOBBER**

About EICO's New Tube Tester Kit Model 625K —"the most versatile tube tester ever designed."

Don't settle for a substitute if jobber is out of stock. Insist on EICO, leading name in kits.

**Model
HVP-1**

HIGH FREQUENCY RF PROBE

Model P-75K germanium crystal probe for visual RF signal tracing and measurements to over 200 megacycles. Can be used with models 221 or 113A EICO instrument (state which when ordering). 6 1/2" long, 1/2" O.D., with wire, plugs, and all components.
IN KIT FORM..... \$3.75
Model P75K same as above, but for oscilloscopes; in kit form.....
\$3.75
Models P75 or P76 similar to above but factory wired, ready to operate. Each.....
\$7.50

EASY-TO-FOLLOW SCHEMATIC & PICTORIAL DIAGRAMS

Come complete with every EICO Instrument Kit. Each kit fully guaranteed to operate perfectly when assembled according to our simple instructions.
EXCLUSIVE LIFE-TIME REPAIR SERVICE: For a nominal charge, we will repair and service your EICO instrument, regardless of its age!



Prices Higher on West Coast

**ELECTRONIC INSTRUMENT CO., INC.
276 Newport Street, Brooklyn 12, N. Y.**



Train at Home in Spare Time for **RADIO** and **TELEVISION**

**I Send You
18 BIG
KITS
OF RADIO-
TELEVISION
EQUIPMENT**

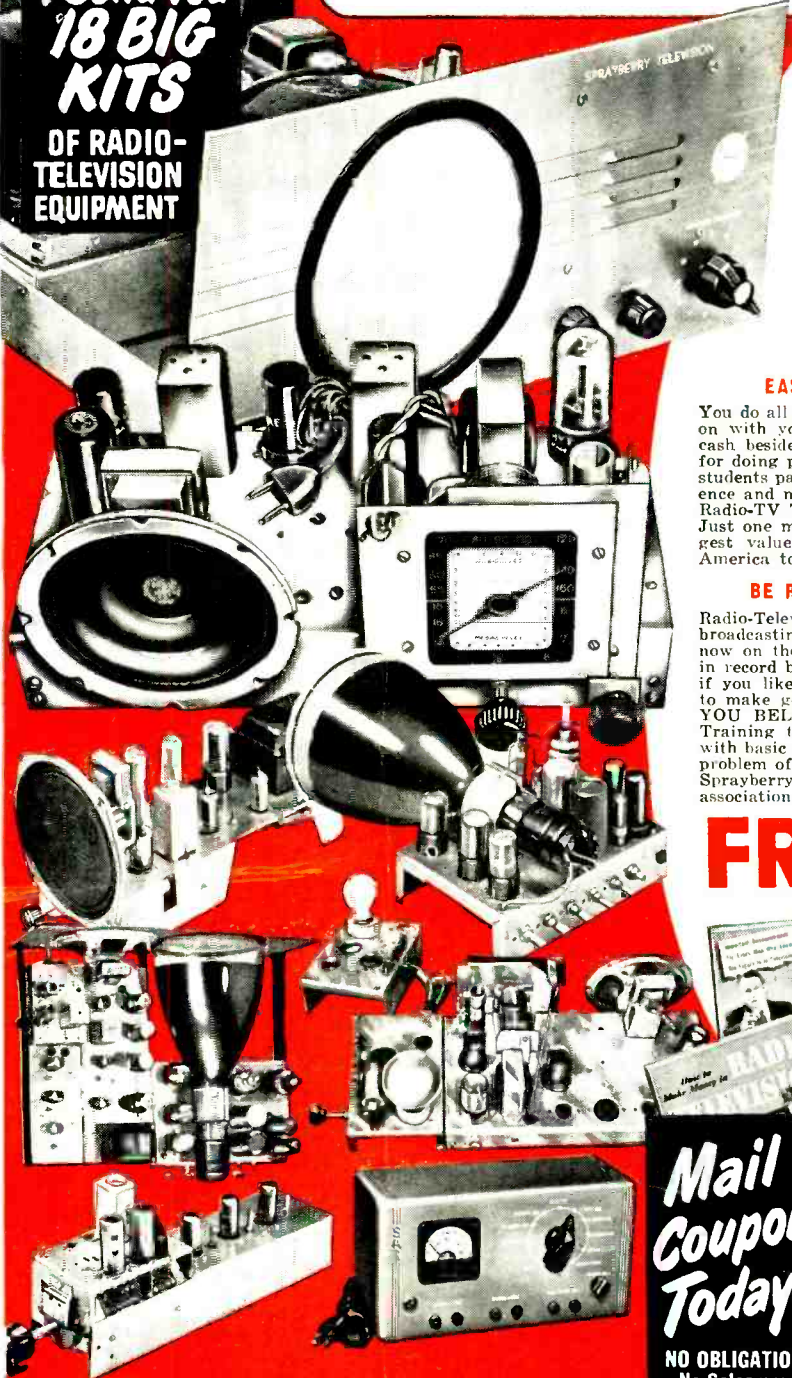

**My Famous Training System Prepares You
Double Quick For a Good Job or Your Own
Profitable Radio-Television Business**

Radio-Television is now America's greatest opportunity field! Trained men are needed to fill good jobs and handle profitable Radio-Television Service work. I have trained hundreds of men for success in Radio-Television—and I stand ready to Train you too, *even if you have no previous experience*. My training is 100% practical—designed to give you the knowledge and experience you need to make money in Radio-Television in the shortest possible time. I Train you with up-to-the-second revised lessons—PLUS many big kits of Radio-Television equipment. You actually do over 300 demonstrations, experiments and construction projects. In addition, you build a Powerful 6-tube-2-band radio, a multi-range test meter and a complete Television receiver! All equipment is **YOURS TO KEEP**.

EASY TO MAKE EXTRA MONEY WHILE YOU LEARN

You do all your training with me **AT HOME** in spare hours. Keep right on with your present job and income while learning—and earn extra cash besides! The day you enroll I begin sending you plans and ideas for doing profitable spare time Radio-TV work. Many of my Sprayberry students pay for their entire training this way! You get priceless experience and many plans for making extra money. You build all your own Radio-TV Test Equipment from parts I send you—nothing else to buy. Just one more reason why I believe I offer the ambitious man the biggest value in top notch Radio-TV Training available anywhere in America today.

BE READY FOR TOP PAYING RADIO-TELEVISION JOBS

Radio-Television is growing with amazing speed. More than 2000 Radio broadcasting stations PLUS an additional 102 Television stations are now on the air. Radio sets and TV receivers are being made and sold in record breaking numbers. If you enjoy working with your hands . . . if you like to do interesting and varied work . . . if you really want to make good money and work in an industry that has a future . . . **YOU BELONG IN RADIO-TELEVISION**. But you **MUST** have good Training to "cash in" . . . the kind of training that starts you out with basic fundamentals and carries you right through every circuit and problem of Radio-Television Servicing and Repair. In a word . . . that's Sprayberry Training . . . the course backed by more than 20 years of association with the Radio-Television industry!

FREE 3 BIG RADIO AND TELEVISION BOOKS

I want you to have ALL the facts about my complete system of Radio-Television Training! Act now! Rush the coupon for my three big Radio-Television books: "How To Make Money in Radio-Television," PLUS my new illustrated Television bulletin PLUS an actual sample Sprayberry Lesson—all FREE with my compliments. No obligation and no salesman will call on you. Send the coupon in an envelope or paste on back of post card. I will rush all three books at once!

**Sprayberry Academy of
Radio, Dept. 20-L**
111 North Canal St., Chicago 6, Ill.

**Mail
Coupon
Today!**
**NO OBLIGATION
No Salesman
Will Call**

SPRAYBERRY ACADEMY OF RADIO, Dept. 20-L
111 North Canal St., Chicago 6, Ill.

Please rush to me all information on your Radio-Television Training plan. I understand this does not obligate me and that no salesman will call upon me.

Name..... Age.....
Address.....
City..... State.....

Please Check Below About Your Experience
 Are You Experienced? No Experience

VETERANS: My Radio Training is Approved for Veterans.

IF YOU ARE EXPERIENCED in Radio I'll qualify you for Television in 4 to 8 weeks. Rush coupon.

Encore!



Again - Yours - **by popular demand . . .**
the Famous RCA Pict-O-Guide
Volume I or II with each order
of 100 tubes or 3 kinescopes

NOW . . . another big opportunity for service technicians to get Volumes I and II of the famous, *original* RCA Television Pict-O-Guide edited by John R. Meagher, the renowned TV service authority. Place your order with your RCA Tube Distributor at once to insure delivery of your copies before the supply is again exhausted, or the offer expires.

Acclaimed as one of the greatest practical and instructive aids to TV receiver trouble shooting in

the field, the *original* RCA Pict-O-Guide provides eyewitness identification of many faults common to all TV receivers and gives basic, authoritative remedies—the kind of practical information that pays off on the job.

There's no substitute for the quality of service information in the RCA Television Pict-O-Guide . . . just as there's no substitute for the quality of RCA tubes. *Both* are yours at no additional cost!

Always keep in touch with your RCA Tube Distributor



RADIO CORPORATION of AMERICA

ELECTRON TUBES

HARRISON, N. J.