

RADIO — ELECTRONICS

K

LATEST IN
TELEVISION
SERVICING
AUDIO

formerly

**RADIO
CRAFT**

HUGO GERNSBACK, *Editor*



SHE SERVICES AIRPLANE RADIO — SEE SERVICING SECTION

JUNE

1950

30¢

U. S. and
CANADA

\$10,000 IN PRIZES

FOR RADIO BATTERY RETAILERS and RCA BATTERY DISTRIBUTOR SALESMEN

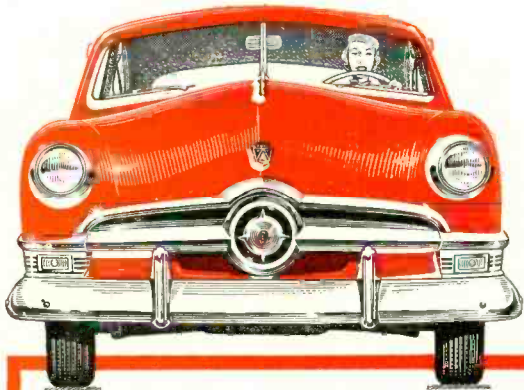

IN THE **RCA BATTERY** "GET THE FACTS" CONTEST

YOU CAN WIN
A '50 FORD
... OR OTHER
VALUABLE
PRIZES

FREE ENTRY... here's how

LOOK AT THESE DEALER AWARDS! FIRST PRIZE — 1950 FORD SEDAN

Factory equipped 8-cyl. Tudor Custom Sedan

- 2nd Prize \$700 Drexel Bedroom Suite
- 3rd Prize \$619 Drexel Dining Rm. Suite
- 4th Prize \$450 Deep Freeze Unit, 12 Cu. Ft.
- 5th Prize \$350 Rogers Sterling (Service for 12)
- 6th Prize \$260 Kaufmann Travel Luggage (4 matched pcs.)
- 7th Prize \$233 Kroydon Golf Clubs & Bag
- 8th Prize \$145 Kaufmann Travel Luggage (2 matched pcs.)
- 9th to 15th Prizes—\$100 Longines Wrist Watches
- 16th to 25th Prizes—\$25 U. S. Savings Bonds

**Duplicate Prizes for
RCA Battery Distributor Salesmen**

Purpose of this contest is to encourage Battery Retailers to Get The Facts on why it's best to stock and sell . . .

RCA The battery for the Radio Trade!

Mail coupon today if you DO NOT know the name of your local RCA Battery Distributor.



RCA Battery Sales
Radio Corporation of America, Harrison, N. J.

Sirs: I am a Radio Battery Retailer, but DO NOT know the name of my local RCA Battery Distributor.

Please forward this request to him for my FREE copy of the RCA Battery "Get The Facts" Official Contest Booklet containing the FREE Entry Coupon.

Signed _____
Co. Name _____
Street & No. _____
City & State _____

No purchases required—no sentences to complete! Simply get your FREE copy of the Official RCA "Get The Facts" Contest Booklet . . . from your nearest RCA Battery Distributor. Then, fill out and mail the Free Entry Coupon in the Contest Booklet to the address printed thereon. Contest closes June 30, 1950. All entries must be postmarked on or before that time.

This contest is open to all radio battery retailers within the continental U. S. A. and to full-time personnel whose duties include the selling of radio batteries.

Here's how prizes will be awarded

1. All entry coupons received will be assembled at Contest Headquarters for an impartial drawing to be held July 10, 1950.
2. The retailer whose name appears on the first coupon drawn will be contacted by telephone, person-to-person. He will be asked one of the easy questions about RCA Batteries appearing in the "Get The Facts" Contest Booklet. If this contestant gives the correct answer immediately, he will be awarded first prize.
3. If the contestant fails to give the correct answer immediately, another drawing is held.
4. The above procedure will be followed in awarding all prizes.

DON'T DELAY. Get *your* Contest Booklet from your nearest RCA Battery Distributor. A magnificent prize can be your reward!

Complete Entry and Prize Award Rules can be found in the Official Contest Booklet.

RADIO BATTERIES



**RADIO CORPORATION
of AMERICA**

HARRISON, N. J.

You Practice COMMUNICATIONS

I Send You Parts To Build This Equipment

As part of my new Communications Course I send you parts to build your own Transmitter. Conduct actual procedure demanded of Broadcast Station Operators, practice many interesting experiments and tests, learn how to put a transmitter on the air.



NEW

You Practice Radio REPAIRING

On This Modern Radio You Build With Parts I Send

...need to be a modern Radio Receiver that brings in local and distant stations. You use it to conduct many tests and experiments.



BE A RADIO-TELEVISION TECHNICIAN

Learn Servicing or Communications by Practicing in Spare Time with MANY KITS OF PARTS I Send

YOU BUILD this Tester as part of my Servicing Course. It soon helps you earn \$5, \$10 and more a week EXTRA MONEY fixing neighbors' Radios in spare time while learning.

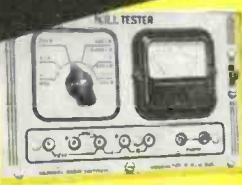

YOU BUILD this Power Pack as part of my new Communications Course. Use it to conduct fascinating experiments with frequency amplifiers and multipliers, buffer stages, etc.



YOU BUILD this Superheterodyne Receiver Circuit and conduct Frequency Modulation experiments and many other tests as part of my Servicing Course.

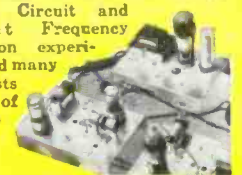

J. E. SMITH, President National Radio Institute

Want a good-pay job in the fast-growing Radio and Television industries or to be boss of your own money-making Radio and Television shop? I've trained hundreds of men with no previous experience to be Radio technicians. I can do the same for you! Or now, for the first time, enroll in my new practical course in Radio-Television Communications—learn to be a Broadcasting and Communications technician. You learn Radio and Television principles from clear, illustrated lessons. You get practical Radio experience with MANY KITS OF PARTS I SEND in my train-at-home method. All equipment yours to keep.

MAKE EXTRA MONEY IN SPARE TIME

As part of my Radio Servicing Course, I send EXTRA MONEY booklets, starting the day you enroll. Use your know-how to make \$5, \$10 and more a week EXTRA MONEY fixing Radios in spare time while training. The next step is your own Radio shop or a good-pay Radio servicing job. Or, if you prefer, get into Government, Police, Aviation or Marine Radio, Broadcasting, Radio Manufacturing or Public Address Work.

BRIGHT FUTURE IN TELEVISION

Think of the present and future opportunities in the fast-growing Television field. New stations are going on the air every month. . . . Television manufacturers are producing over 100,000 sets a month. It's a fast-growing field and the man who knows Television will be in demand.

GET ACTUAL LESSON AND BOOK FREE

Send now for my special DOUBLE FREE OFFER. Get actual lesson on Radio Repairing short-cuts absolutely free. Also get 64-page book, "HOW TO BE A SUCCESS IN RADIO-TELEVISION—ELECTRONICS." See how quickly, easily you can start. J. E. SMITH, President, Dept. OFX, National Radio Institute, Pioneer Home Study Radio School, Washington 9, D. C.

YOU BUILD this Signal Generator as part of my Servicing Course for more valuable experience. It provides amplitude-modulated signals for many interesting tests and experiments.



VETERANS

GET THIS TRAINING UNDER G. I. BILL MAIL COUPON

YOU BUILD this Wavemeter as part of my new Communications Course. Use it with Oscillator you also build that furnishes basic power to transmitter and determines transmitter frequency.



I TRAINED THESE MEN AT HOME



Good Job In Radio Station "Am Chief Engineer of Station WORD, in charge of four men. Owe all I know about Radio to NRI."—CLYDE J. BURDETTE, Spartanburg, South Carolina.



Makes Extra Cash In Spare Time "Earned enough spare time cash to pay for my course by time I graduated. NRI training is tops!"—ALEXANDER KISH, Carteret, New Jersey.



Operates Own Radio Business "Now have two Radio shops servicing about 200 sets a month. Have largest service establishment in Southeast Missouri."—ARLEY STUDYVIN, DeSoto, Mo.

Good for Both—FREE

MR. J. E. SMITH, President, Dept. OFX, National Radio Institute, Washington 9, D. C.

Mail me FREE Sample Lesson and 64-page book about how to win success in Radio and Television—Electronics. (No salesman will call. Please write plainly.)

Name.....Age.....

Address.....

City.....Zone.....State.....

Check If Veteran APPROVED FOR TRAINING UNDER G. I. BILL

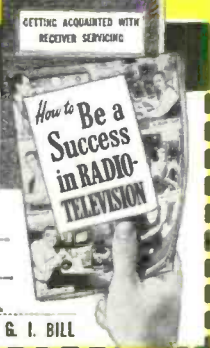

MAIL COUPON! FIND OUT ABOUT THIS TESTED WAY TO BETTER PAY

RADIO — ELECTRONICS

formerly RADIO-CRAFT

MEMBER
AUDIT BUREAU OF CIRCULATION

Incorporating
SHORT WAVE CRAFT* TELEVISION NEWS*
RADIO & TELEVISION
*Trademark registered U. S. Patent Office

Hugo Gernsback, Editor-in-Chief

Fred Shunaman, Managing Editor
Robert F. Scott, W2PWG, Technical Editor
I. Queen, Editorial Associate

M. Harvey Gernsback, Editorial Director
Angie Pascale, Production Manager
Wm. Lyon McLaughlin, Tech. Illustration Director

Lee Robinson, General Manager
John J. Lamson, Sales Manager

G. Aliquo, Circulation Manager
Robert Fallath, Promotion Manager

CONTENTS — JUNE, 1950

Editorial (Page 23)

Whither Radio Servicing?.....by Hugo Gernsback 23

Television (Pages 24-32)

Projection Unit for Television.....by David T. Armstrong 24
New Picture Tube for Color TV..... 27
Electronic TV Magnifier.....by Richard H. Dorf 28
A De Luxe Televiser, Part VI.....by Charles A. Vaccaro 30
Television Dictionary (concluded).....by Ed Buckstein 32

Servicing—Test Instruments (Pages 33-39)

Using the VR Tube.....by Carl W. Shipman 33
Fundamentals of Radio Servicing, Part XV.....by John T. Frye 34
Service for Freddie..... 36
Radio Repair for Aircraft.....by Margaret Latham 37
Set and Service Review (Oak Ridge Models 103 and 104)..... 38
Philco Service Hints.....by Harry Ashby 39

Audio (Pages 40-42)

Connecting Loudspeakers.....by Melvin C. Sprinkle 40
Automatic Intercom Switch.....by E. Aisberg 42

Electronics (Pages 43-44)

Radio Pulses Control Rats....by Verne Kallejian and J. A. Gengerelli 43
Commercial-Killer Improves Programs..... 44

Construction (Pages 45-56)

18-Tube High-Performance Communications Receiver
by Francis O. Davis 45
TV Antenna Phase Control.....by G. N. Carmichael 54

FM (Pages 56-63)

Low-Noise FM Front End.....by Joseph Marshall 58

Theory and Engineering (Pages 66-70)

Experimental Circuits for Crystal Triodes....by Rufus P. Turner K6AI 66

Broadcasting and Communications (Pages 71-75)

Mobile Radio Service.....by I. Queen 71
Wireless Curiosity..... 74

New Design (Pages 76-77)

Review of New Tubes..... 76

Departments

The Radio Month.....	8	Association News.....	86
Radio Business.....	10	Miscellany.....	87
New Devices.....	78	Question Box.....	88
New Patents.....	80	Technotes.....	90
Radio-Electronic Circuits.....	82	Communications.....	91
Try This One.....	84	People.....	93
Book Reviews.....	95		

ON THE COVER: Margaret Latham, of Beane Radio Service, Newark, New Jersey, engaged in a typical aircraft servicing operation. Kodachrome by Avery Slack.

RADIO-ELECTRONICS, June, 1950, Volume XXI, No. 9. Published monthly. Publication Office: Erie Ave., P. O. Box 22, Philadelphia 32, Pa. Entered as second class matter September 27, 1948, at the post office at Philadelphia, Pa., under the Act of March 3, 1879. SUBSCRIPTION RATES: In U. S. and Canada, in U. S. dollars, \$3.50; Mexico, South and Central American countries, \$3.50; \$6.00 for two years; \$8.00 for three years; single copies 30c. All other foreign countries \$4.50 a year, \$8.00 for two years, \$11.00 for three years. Allow one month for change of address. When ordering a change please furnish an address stencil impression from a recent wrapper. RADCRAFT PUBLICATIONS, INC. Hugo Gernsback, Pres.; M. Harvey Gernsback, Vice-Pres.; G. Aliquo, Sec'y. (contents copyright, 1950, by RADCRAFT Publications, Inc. Text and illustrations must not be reproduced without permission of copyright owners.) EDITORIAL and ADVERTISING OFFICES, 25 West Broadway, New York 7, N. Y. Tel. REctor 2-9690. BRANCH ADVERTISING OFFICES: Chicago: 520 N. Michigan Ave. Telephone SUPERior 7-1796. Los Angeles: Ralph W. Harker, 1127 Wilshire Blvd., Tel. MA 6-1271. San Francisco: Ralph W. Harker, 582 Market St., Tel. CA 4-1241. FOREIGN AGENTS: Great Britain: Atlas Publishing and Distributing Co., Ltd., London E.C.4. Australia: McGILL's Agency, Melbourne. France: Rrentano's, Paris 26. Holland: Trillectron, Heemstede. Greece: International Book & News Agency, Athens. S. Africa: Central News Agency, Ltd., Johannesburg. Capetown: Durban. Natal. Universal Book Agency, Johannesburg. Middle East: Stelmatsky Middle East Agency, Jerusalem. India: Broadway News Centre, Dadar, Bombay #14. K. L. Kannappa Mudalliar, Madras 2. Pakistan: Paradise Book Stall, Karachi 3. POSTMASTER: If undeliverable send form 3578 to: RADIO-ELECTRONICS, 25 West Broadway, New York 7, N. Y.

SPRAGUE

Molded

TELECAPS*

The greatest paper tubular development in 20 years



... premium quality

... plus performance

AT NO EXTRA COST!

You really get your money's worth in Sprague high-temperature phenolic molded Telecap tubular capacitors. They're the *only* molded tubulars made by the dry process—then impregnated* and solder-sealed just like expensive metal-encased oil-paper capacitors.

They're tops on ANY job—yet you buy them at ordinary tubular prices.

*Mineral oil impregnated from 600 to 10,000 volts d-c.

SPRAGUE PRODUCTS COMPANY
(Distributors' Division of Sprague Electric Co.)
81 Marshall Street
North Adams, Mass.



CASH IN ON THIS!

Get the better, more profitable service calls! Send

postcard for Sprague booklet "YOUR MONEY'S WORTH IN GOOD RADIO AND TELEVISION SERVICE" and details on how to put this sales-builder to work for your service business!

*Trademark

RADIO-ELECTRONICS for



Get Into

TELEVISION, RADIO ELECTRONICS

Master ALL Phases

Get Complete Training. You Receive and Keep All Tubes, Equipment, Parts and Lessons. No Extra Charges.

GOOD PAY and Unlimited Opportunities in JOBS LIKE THESE:

Business of Your Own
Radio Manufacturing, Sales, Service
Broadcasting, Telecasting
Television Manufacturing, Sales, Service
Laboratories: Installation, Maintenance of Electronic Equipment, Electrolysis, Call Systems
Garages: Auto Radio Sales, Service
Sound Systems and Telephone Companies; Oil Well and Drilling Companies; Engineering Firms
Theatre Sound Systems, Police Radio

And scores of other good jobs in many related fields

YOU CONDUCT MANY EXPERIMENTS LIKE THESE!

Checking action of condensers
Experiments with AF and RF amplifiers
Experiments with resonance
Producing beat frequencies
Calibrating oscillators
Experiments with diode, grid-bias, grid-leak and infinite impedance detectors
Practical experience in receiver trouble shooting
Application of visual tester in checking parts and circuits
Experiments with audio oscillators
Advanced trouble-shooting
... and many, many others

Complete Training by Practical Resident Trade School, Est. 1905

The same highly trained faculty, instruction materials and methods used here in our large, modern resident school, are adapted to your training in your own home. Shop Method Home Training has been proved by hundreds of successful graduates.

Both Resident and Home Study Courses Offered

YOU LEARN BY DOING

You receive special laboratory experiment lessons to show you how to build with your own hands various experimental units such as those shown at left, and how to conduct many tests.

You will find all lessons easy to understand because they are illustrated throughout with clear diagrams and step-by-step examples that you work out yourself. Every piece of the equipment and complete lesson material we send you is yours to keep and enjoy, including the multimeter, experimental equipment, all parts of the Superheterodyne, tube manual, radio dictionary, and complete, modern Television texts. All parts are standard equipment.

Shop Method Home Training . . . Earn While You Learn

With our practical resident Shop Method Home Training, you study in your spare time. You receive Spare Time Work Lessons, which show you how to earn while you learn. Service neighbors' radios and TV receivers, appliances, etc., for extra money and experience. Many National students pay all or part of their training with spare time earnings!

DON'T DELAY! The Radio-Television Industry needs trained men NOW!

APPROVED FOR VETERANS!

Check coupon below!

For quick action, mail coupon today and we'll rush you full information.

Free!

NEW, ILLUSTRATED OPPORTUNITY BOOK AND SAMPLE LESSON SHOW YOU HOW WE TRAIN YOU . . . SEND FOR THEM TODAY! NO COST. NO OBLIGATION.



YOU RECEIVE THIS PROFESSIONAL MULTITESTER YOU BUILD ALL THESE AND MANY OTHER UNITS WITH PARTS WE SEND YOU!



Signal Generator

Audio Oscillator

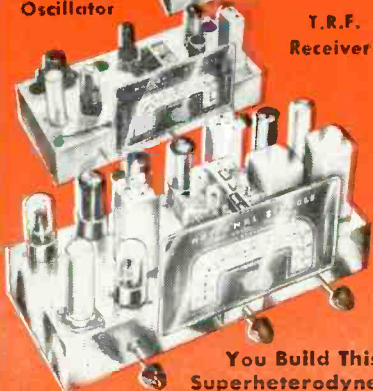

T.R.F. Receiver

You Build This Superheterodyne

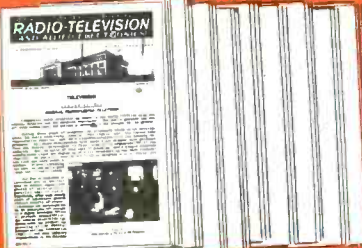

You Receive a Special Series of Modern Lessons in TELEVISION, all a part of your course: you master all phases.

NATIONAL SCHOOLS

LOS ANGELES 37, CALIF. • EST. 1905

FIND OUT NOW . . . MAIL COUPON TODAY

National Schools, Dept: RE-6
4000 South Figueroa Street
Los Angeles 37, California

Send me your FREE book "Your Future in Radio" and the sample lesson of your course. I understand no salesman will call on me.

NAME _____ AGE _____

ADDRESS _____

CITY _____ ZONE _____ STATE _____

Check here if Veteran of World War II

Mail in envelope or paste on penny postal.



STOP MEASURING "GHOSTS!"



See **WHAT YOU** *Measure*

NEW NATIONAL VIDEOMETER ENDS ALL TV INSTALLATION GUESSWORK!

You can't see ghosts or noise on a meter. That's why field strength readings alone are unreliable in making TV installations. Now, the new National Videometer gives you *both* meter readings and a TV picture. You see just what you measure. No more trouble-making initial installations! No more costly call-backs!

Meter Check on Both Field Intensity and Line Voltage

Set the meter switch to A.C. LINE and read the line voltage at the receiver input terminal directly on the 0-150 volt scale. Set the switch to SIG. STR. and read the field intensity on the 0-10 scale. A table is provided to convert directly to microvolts. Reading indicates field intensity at antenna input and is independent of contrast and brightness controls.

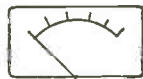

METER
A.C. LINE SIG. STR.

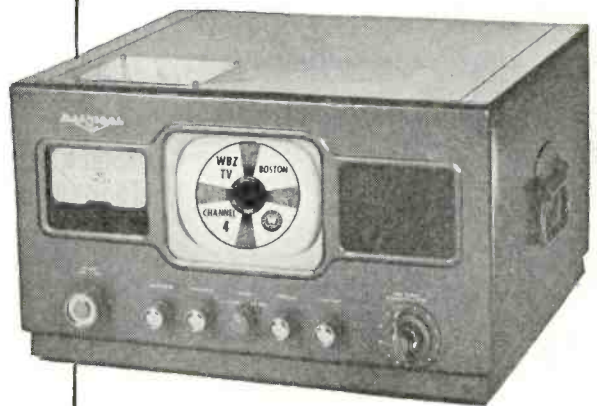

\$169.95
(Slightly higher west of the Rockies)



RADIO-ELECTRONICS for

TV Means Jobs—Good-Paying Jobs—for Technically Trained Men



★ ENGINEERS



★ OPERATORS



★ CAMERAMEN



★ TECHNICIANS



★ INSTALLERS

Here's How CREI Home Study Training
Prepares You for a Better Job in
TELEVISION

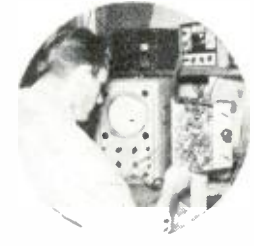

★ SERVICEMEN

Get in and get ahead in Television . . . the field that *Fortune Magazine* says is "the most dynamic single element in the entire American economy!" Within a few years, says the magazine, TV will be one of the *first ten* industries in the U.S.

New FCC frequency allocation plans call for 2,245 video stations in 1,400 communities. Since a television station requires many more technicians and engineers than the average AM station, you can readily see the great number of good jobs that are needed to be filled within the next year or two.

If you are now in radio, this is the time to prepare for your future in Television. CREI offers the very training you need to go after—and get—a good TV job. CREI courses can be studied in your spare time and can be fitted into the most crowded schedules. They are designed to give you a thorough grounding in basic principles (remember that all new elec-

tronic developments have their roots in past techniques) and take you step-by-step through the more advanced subjects of TV and its related fields.

Don't wait another day. Television won't wait for you. In all our 23 years of association with professional radiomen we know that the man who acts promptly is the man who succeeds. The facts about CREI, our courses, and what we can do for you, are described in our 32 page booklet. It's worth reading. *Send for it today.*

SAMPLE LESSON FREE!

Now, see for yourself, how interesting it is to study at home and improve your ability the CREI way.

"THE ORTHICON AND IMAGE ORTHICON"—this lesson describes the development of the small, 3-inch image orthicon tube; theory and operation of the orthicon; image orthicon; specific features.

THE 3 BASIC CREI COURSES:

- ★ PRACTICAL RADIO ENGINEERING
Fundamental course in all phases of radio-electronics
- ★ TELEVISION & FM SERVICING
Streamlined course for men in "top 1/3" of field
- ★ PRACTICAL TELEVISION ENGINEERING
Specialized training for professional radiomen

CAPITOL RADIO ENGINEERING INSTITUTE

An Accredited Technical Institute Founded in 1927

Dept. 146B, 16th and Park Rd., N.W.
Washington 10, D. C.

Branch Office:
San Francisco (2) 760 Market St.

MAIL COUPON TODAY



FREE BOOKLET
plus
SAMPLE LESSON

CAPITOL RADIO ENGINEERING INSTITUTE

Dept. 146B, 16th & Park Rd, N.W. Washington 10, D.C.

Gentlemen: Please send me FREE SAMPLE LESSON and booklet, "Your Future in the New World of Electronics" together with full details of your home study courses as checked. I am attaching a brief resume of my experience, education and present position.

- CHECK FIELD OF GREATEST INTEREST:
- PRACTICAL TELEVISION ENGINEERING
 - TV, FM & ADVANCED AM SERVICING
 - PRACTICAL RADIO ENGINEERING
 - AERONAUTICAL RADIO ENGINEERING
 - BROADCAST RADIO ENGINEERING (AM,FM,TV)
 - RADIO-ELECTRONICS IN INDUSTRY

NAME _____ AGE _____

ADDRESS _____

CITY _____ ZONE _____ STATE _____

POWER- PACKED

FOR
HEAVY
DUTY



SOLDERLITE

STREAMLINED

5-SECOND
HEATING

RIGID-TIP

LONGER REACH

DUAL HEAT

—single heat
200 watts,
dual heat
200/250 watts,
115 volts,
60 cycles



New WELLER 250-watt Soldering Gun

Heavy jobs and light jobs—the new 250-watt Weller Soldering Gun speeds them all. Chisel-shaped RIGID-TIP provides more soldering area for faster heat transfer. New “over-and-under” terminal design gives bracing action to tip. Your Weller Gun does delicate or heavy soldering with equal efficiency; compact and lightweight, it gets into the tightest spots.

Weller Guns actually pay for themselves in a few months. Fast 5 second heating means no time lost. Trigger-switch control means no current wasted—no need to unplug gun between jobs. Prefocused spotlight and longer length let you see the job and reach the job with ease. No other soldering tool offers so many time-and-money-saving features. Order your new 250-watt Weller Gun from your distributor today, or write for bulletin direct.

SOLDERING GUIDE

Get your copy of “SOLDERING TIPS”—new fully illustrated 20 page booklet of practical soldering suggestions. Price 10c at your distributor's or order direct.



WELLER

MANUFACTURING COMPANY

828 Packer Street, Easton, Pa.

The Radio Month

PLATE CHARACTERISTICS of electron tubes can be traced on an oscilloscope screen with an instrument developed at the National Bureau of Standards. The curve generator plots the family of plate current versus plate voltage curves for any receiving tube along with a standard rectangle which provides a direct scale for voltage and current measurements.

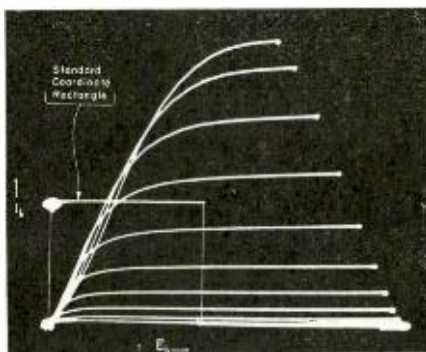

Plate characteristics of a 6AC7 tube.

The plate voltage applied to the tube under test is swept from zero to predetermined positive values. The voltage drop across the plate load resistor is used as a measure of plate current. This voltage drop is applied to the vertical plates of the oscilloscope and the plate voltage itself to the horizontal plates. These two voltages generate a plate current-plate voltage curve on the oscilloscope screen for the entire sweep interval.

The sweep sequence is repeated automatically for several values of grid bias to form a complete family of plate characteristic curves. The instrument also can provide a plate current versus grid voltage curve.

The complete family of curves is retraced sixty times a second; and the image is stationary and free from flicker.

FIELD OF ELECTRON microscope enables its inventor, Dr. Erwin Mueller of the Kaiser Wilhelm Institute of Berlin to see molecules as small as 1-25,000,000 of an inch in diameter. Cost of the instrument is small, about \$24.

The microscope—the inventor claims—is simple to make. It has a cold point, usually made of tungsten, on which the subject is mounted. The point is then caused to emit a stream of electrons which is directed to a screen about 10 centimeters away. The screen then shows the image of the molecule.

Only medium size molecules can be observed with the instrument at the present time. Dr. Mueller said he has made single atoms visible, but not with enough detail to be useful for study.

CHILDBIRTH can be made more safe with an electronic apparatus called the electrohysterograph. Three pairs of electrodes are connected to the patient's abdomen, two strain gages are connected to the abdominal wall, and the patient is given a hand switch to signal the beginning and end of each pain.

A 6-channel amplifier drives recording apparatus which graphs the signals from the pickup devices.

During normal labor, the apparatus records a characteristic sequence of activity. Any abnormal activity shows up on the graphs, and doctors can detect false labor, early labor or anything going wrong.

TORNADOS are dangerous mainly because they come without warning. Professor H. L. Jones of Oklahoma A & M College is developing a tornado tracking device with which he expects to distinguish a tornado from an electrical storm about thirty minutes before the twister actually forms.

Electrical storms always accompany tornadoes, but the electrical discharge is always of much higher intensity than ordinary lightning. In the warning system, an oscilloscope records the lightning intensity and distinguishes tornado lightning from the less dangerous variety. Once tornado discharges are discovered, directional equipment locates the twister.

PHOTOTRANSISTOR is a new type of photocell developed at the Bell Telephone Laboratories. It is similar in operation to the transistor, having a tiny chip of germanium, but it is controlled by light rather than by electric current and has only a collector wire.



The phototransistor, a new photocell.

Light focused on one side of the cell controls the current in the collector wire. The phototransistor has a high power output which in some cases is enough to operate a relay directly without the use of amplifiers. It has good response to rapidly fluctuating light source and is particularly sensitive to wavelengths of light given off by ordinary incandescent light bulbs.

The device is housed in a small cylinder about the size of a .22 calibre rifle cartridge and has no vacuum, no glass envelope, no grid, plate, or hot cathode.

RADIO-ELECTRONICS for

SIX BILLION electron volts will accelerate protons in the new bevatron being built at the California Institute of Technology under plans announced by the Atomic Energy Commission.

The machine is being built from a quarter-scale model now at the University of California. The model is being rebuilt to speed electrons to velocities only one-millionth of one percent less than the speed of light.

DIGITAL COMPUTER 5,000 times faster than a human brain has been developed by the General Electric Company for use within the company.

Unlike some other types of computers, the "Omibac" (Ordinal Memory Inspecting Binary Automatic Calculator) uses the binary system of counting. This is a simplified system which uses only two digits, 1 and 0, rather than the more familiar 10 characters of the decimal system. The decimal numbers 0 and 1 are 0 and 1 in the binary system, but decimal number 2 is 10, and 3 is 11 in binary, 4 is 100, 5 is 101 and so on.

The two digits of the binary system can respond to electronic, electric or mechanical on-off switching, which makes the system readily adaptable for high speed computers.

The computer has two memory devices which can remember more than 1,000 separate instructions and more than 1,000 numbers. The memory devices store the required information on fast spinning cylinders coated with magnetic material (See photo). The instruction cylinder tells the computer what to do and when, and the number cylinder supplies the numbers.

The memory devices of the Omibac make it particularly useful for repetitive problems.

SUPERSONIC AIRCRAFT are being fitted with electronic equipment to avert collisions in midair. The speed of modern fighter planes is so great that if two planes came out of clouds 8,000 feet apart straight toward each other, they would collide before either pilot could do anything about it, Col. Victor Byrnes of the Air Force reported to a scientific meeting last month. If the clouds were only 500 feet apart, the pilots wouldn't even see each other.

Now that faster-than-sound speeds have been reached, engineers are predicting speeds as high as 2,000 miles per hour. At such a speed, a pilot would travel nearly a mile before he could recognize another object and do something about it. Electronic eyes for the aircraft are essential to make them safe for these high speeds.

ROUND-THE-WORLD radio signals on very low frequencies have been detected at the National Bureau of Standards. The signals were transmitted from NSS, the Naval Radio Station at Annapolis, Maryland, on a frequency of 18 kc with a power of 350 kw and were received at a Bureau of Standards field station about 50 miles away.

The signals were received with a t.r.f. receiver and a large loop antenna 150 feet high. A dual-beam oscilloscope connected to the receiver showed the unrectified r.f. envelope along with an 18 kc reference voltage. The delay time, normally about one-tenth of a second, was measured by making a film record of the oscilloscope screen.

The test signal was a series of dots with each dot followed by a quiet period equivalent to five dots. The pulse length of each dot was about 40 milliseconds and the repetition rate was four pulses a second.

**Instant
change-over
TO EACH ANTENNA**

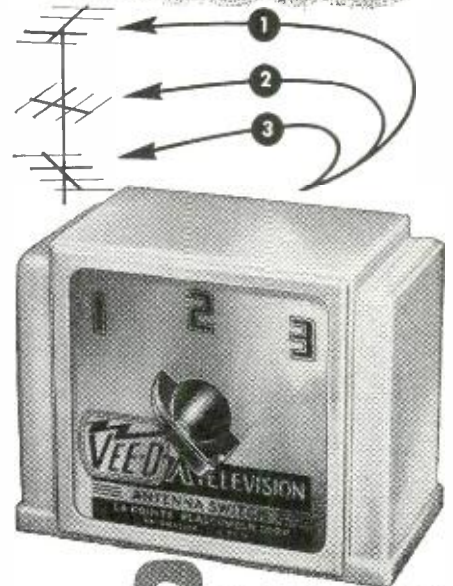

**Vee-D-X 3 WAY
ANTENNA SWITCH**
\$4.95 list

Separate lead-ins on multiple antennas are no problem with the new VEE-D-X antenna switch. Just turn the knob, and you can change over instantly from one antenna to another. Eliminates entirely the fuss and bother of changing transmission lines every time a different antenna is used. Very useful for T V Dealers when demonstrating more than one receiver from a single antenna.

Here are the features that make the VEE-D-X Antenna Switch the finest available:

- Specially designed switch prevents leakage.
- Furnished in attractive ivory plastic case with satin finished aluminum face.
- Terminal strip accommodates three separate lead-ins as well as output line to receiver.
- Easy to install.
- Lead-ins attach to rear and are hidden from view.

VEE-D-X

VEE-D-X means video distance

LA POINTE-PLASCOMOLD CORP., 1 Unionville, Conn.

Please send me further information about your TV antennas and accessories.

Name
Address
City Zone State

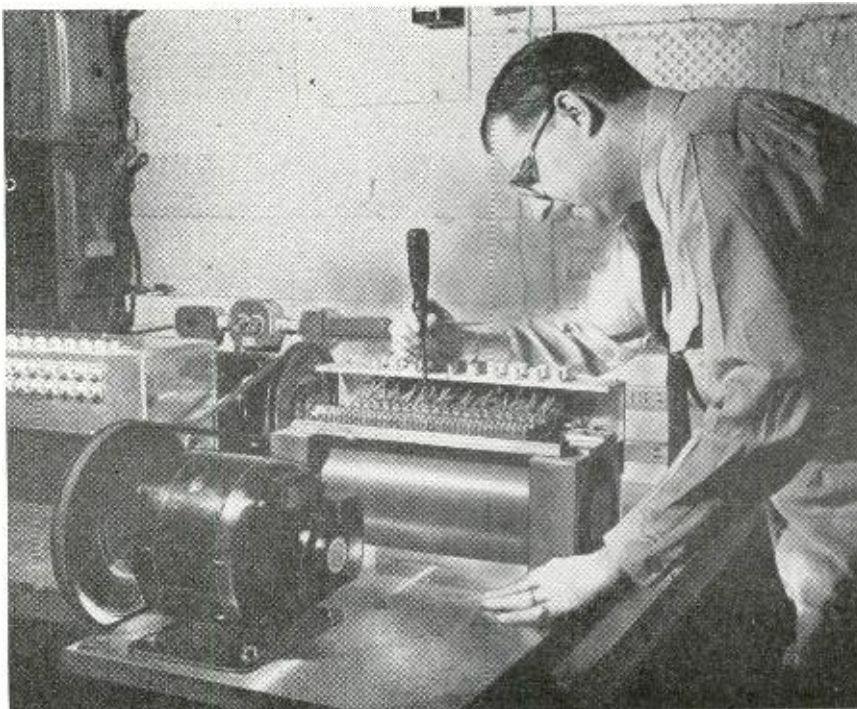

Engineer G. W. Hobbs makes an adjustment on Omibac's memory cylinders.

General Electric has offered a G-E aluminum-foil base voice coil sealed in a clear plastic case filled with water as proof that excessive moisture will not harm its speakers, as a promotion item for drive-in theater owners.



The company has also developed a three-piece promotion package for G-E speakers. Two streamers and a wall chart giving complete information on each speaker in the G-E line have been sent to all parts distributors.

Radio Corp. of America dedicated its new television picture tube plant at Marion, Ind. Governor Henry F. Schriker of Indiana was a guest of honor. He was accompanied by state and local officials and RCA executives.

It is expected that this plant will become one of the largest producers of picture tubes in the world. The plant's major product is the new short 16-inch metal picture tube recently developed by RCA.

The company announced that the Marion plant is the fourth of thirteen plants to be located in Indiana, which is becoming one of the nation's leading television manufacturing areas.

Allen B. Du Mont Laboratories, Inc., opened its new cathode-ray picture tube manufacturing plant in Clifton, N. J. It is the largest factory in the world devoted exclusively to the manufacture of television picture tubes.

The plant will be devoted to the making of 12-, 12½-, 15-, 16-, 19-, and 20-inch cathode-ray picture tubes for television receivers. Half the production will be devoted to metal tubes. Five hundred-fifty workers will work three shifts daily to meet the current large demand for tubes.

The company also announced it had developed a 30-inch, direct-view TV picture tube with a screen area nearly three times that of the 19-inch tubes now in use. It is meant specifically for hotels, schools, restaurants, and other public places.

R. C. Sprague, chairman of the Town Meetings Committee of the Radio Manufacturers Association, announced a national program by which large television manufacturers will cooperate to help improve sales, merchandising and advertising, and business management practices among dealers in 60 marketing areas.

The program, known as the Town Meetings of Television Dealers, will be modeled after the recent successful two-year program the RMA sponsored to

assist radio technicians to adapt themselves to the more complicated techniques demanded by television. Subjects to be covered include sales, merchandising and public relations, store management, and operating a profitable service department. These will be discussed with the aid of slide film presentations.

The initial list of participating television manufacturers includes Raytheon Manufacturing Co.; Crosley Division, Avco Manufacturing Corp.; Allen B. Du Mont Laboratories, Inc.; Emerson Radio & Phonograph Corp.; General Electric Corp.; Hoffman Radio Corp.; Industrial Television, Inc.; Motorola, Inc.; Noblitt-Sparks Industries, Inc.; Packard-Bell Co.; Philco Corp.; RCA-Victor Division; Stromberg-Carlson Co.; Westinghouse Electric Corp.; Zenith Radio Corp.; Other firms are expected to indicate their participation at a later date.

Tendency toward closer cooperation among TV set manufacturers, distributors, and service technicians is noted in the number of service clinics being held recently.

In New York City, Admiral and Zenith distributors held well-attended clinics for service technicians in the metropolitan areas. In Los Angeles, Leo J. Meyberg Co., RCA distributor, held similar meetings. Reports from other sections of the country indicate that other distributors are following suit.

The new action counter display illustrated is being distributed to dealers by ALLIANCE MANUFACTURING COMPANY. It incorporates a miniature antenna which is attached to one



of the rotators. The prospective customer may actually operate the control case right at the counter.

Sylvania Electric Products, Inc., is now guaranteeing all television picture tubes. Previously the company had a warranty which involved a pro-rated charge based on use.

Under the new system, if a picture tube fails because of defects in materials or workmanship within one year of the date of shipment from the factories or warehouses, it will be replaced without charge. A code date stamped on every picture tube will determine whether that tube was shipped within the period during which adjustment is allowed.

To be replaced without charge, the tube must be returned either by the set manufacturer or television service

technician to the Sylvania factory for inspection.

This new guarantee plan went into effect March 20, 1950.

Corning Glass Works has begun construction on a new plant in Albion, Mich., for the production of glass bulbs for television picture tubes. The plant, occupying a floor space of 300,000 square feet, will be erected on a 31-acre plot which was recently acquired by the company.

Financial reports released by leading companies in radio, television, and sound reflect a generally optimistic note. Statements of significant companies are listed:

Sprague Electric Co. 1949 net sales \$15,335,419 compared with \$12,596,620 for 1948. Net earnings for 1949, \$1,206,054 as against \$831,649 in 1948.

P. R. Mallory & Co. 1949 net sales \$24,647,429 against \$23,622,144 in 1948. Net income \$1,124,090 compared to \$1,154,091 in 1948.

Hytron Radio & Electronics Corp. 1949 net sales \$16,226,143 compared to \$7,937,423 in 1948. Net income \$565,171 for 1949 as against \$86,121 in 1948.

American Phenolic Corp. 1949 net profit \$567,275 compared to \$183,141 in 1948.

Maguire Industries (Meissner & Thordarson) net loss for year ending Oct. 31, 1949, \$103,508 compared with \$895,050 in previous year.

General Electric Co. reported the most profitable year in its history. Net sales of \$1,613,563,611 in 1949 were \$19,137,995 less than in 1948 but profit increased from \$123,835,316 in 1948 to \$125,639,051 in 1949.

Sylvania Electric Products, Inc., 1949 sales of \$102,539,866 yielded a profit of \$3,052,840 contrasted to sales of \$99,347,751 and a profit of \$3,823,382 in 1948.

Sangamo Electric Co. showed a net profit of \$1,392,000 in 1949 as against \$1,979,000 the previous year.

Aerovox Corp. 1949 net income \$675,000 compared to \$357,047 in 1948.

RCA net earnings for 1949 equalled \$25,144,279 on a gross income of \$397,259,020 compared with \$24,022,047 on an income of \$357,617,231 in 1948.

Muzak Corp. announced that its transcription division has entered the 45-r.p.m. record field. It has made its facilities available to the trade for recording, processing, and pressing the new discs.

Built-in Television is appearing in new home construction. A Long Island housing development advertised built-in Starrett TV sets last July. More recently, the huge Long Island development of Levittown advertised built-in Admiral sets for 4,000 new homes. Industrial Television, Inc., announced it was installing 16-inch built-in television in a new housing development in Paramus, N. J.

TELEVISION

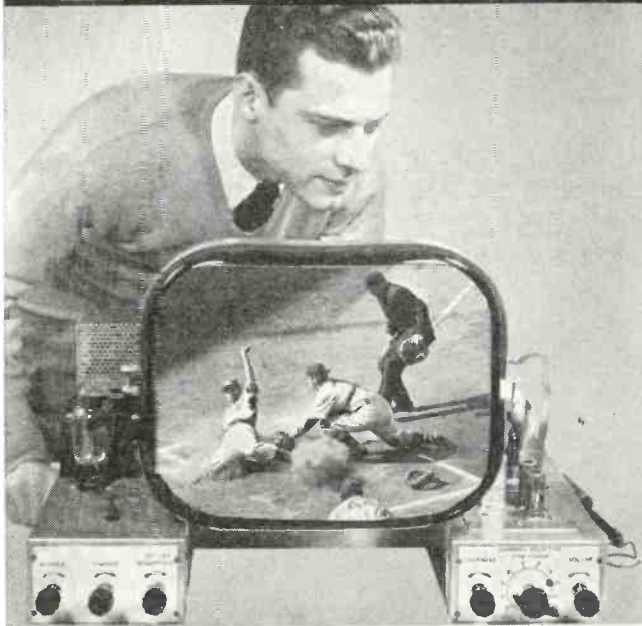

RADIO and ELECTRONICS OFFER YOU REAL MONEY and REAL JOB OPPORTUNITIES!

OPTIONAL FEATURE



BUILD AND KEEP FULL-VIEW 16-INCH RECTANGULAR "BLACK" PICTURE TUBE TELEVISION RECEIVER

PREPARE AT HOME . . . Become a TELEVISION • RADIO • ELECTRONICS TECHNICIAN! No Previous Experience Necessary

Here is everything you need to prepare you at home for FASCINATING WORK, GOOD MONEY and a THRILLING FUTURE in one of America's most promising fields. This includes the opportunity to build and keep the top-quality 16 inch rectangular picture tube television receiver shown above or a 10 or 12½ inch ROUND picture tube set . . . if you choose. No matter which tube you select, you will get bright, sharp, steady pictures. This is an optional feature—available at slight additional cost when you complete your training described below. Get the complete facts. See how D.T.I.'s wonderfully practical method meets industry's needs. No previous experience needed. Mail coupon today!

16 Big Shipments of Parts — Plus Lessons

Work over 300 electronic experiments and projects from 16 big shipments of parts. This includes building and keeping all test equipment and radio set shown at left side of page. Modern easy-to-read lessons with handy fold-out diagrams simplifies your entire training.

You Also Use Home Movies

D.T.I., alone, includes the modern, visual training aid . . . MOVIES to help you learn faster, easier at home. See electrons on the march and other fascinating "hidden action"—a remarkable home training advantage that speeds your progress.

EMPLOYMENT SERVICE

When you complete your training, our effective Employment Service helps you get started toward a real future in Television-Radio-Electronics.

Modern Laboratories

If you prefer, you can get ALL your preparation in our new, 6 Tube Chicago training laboratories . . . one of the finest of its kind. Ample instructors . . . modern equipment. Write for details!

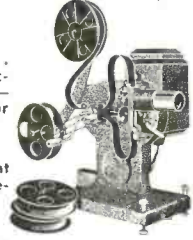
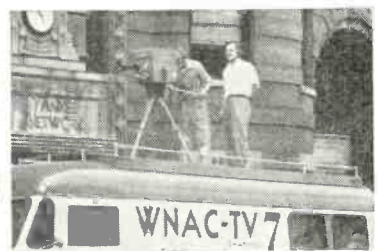
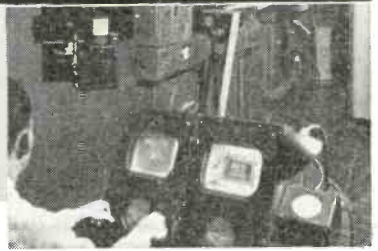
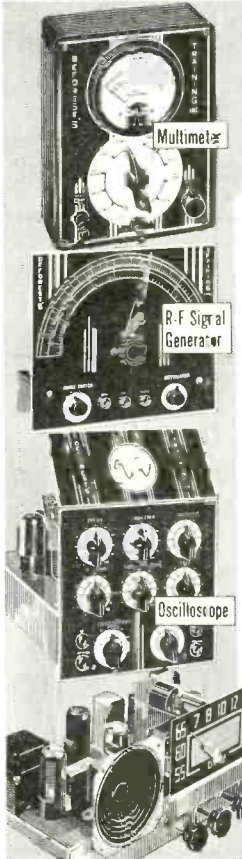

LEARN-BY-DOING



LEARN-BY-READING



LEARN-BY-SEEING



MAIL THIS COUPON TODAY!

DeFOREST'S TRAINING, INC., Dept. RC-G-6
2533 N. Ashland Ave.,
Chicago 14, Illinois If under 16, check here for special information.

Without obligation, give me complete facts showing how I may make my start in Television-Radio-Electronics.

Name..... Age.....
Street..... Apt.....
City..... Zone..... State.....

DeForest's Training, Inc.

CHICAGO 14, ILLINOIS
A DeVry Institution

Billions of speeding electrons set phosphors "on fire"

Gleaming luminescent materials, excited by an electron beam, help create television pictures

No. 5 in a series outlining high points in television history

Photos from the historical collection of RCA

● "Specpure Laboratory," said a sign at RCA Laboratories, "Do Not Enter. Dust Is Our No. 1 Trouble-maker." On the floor were moistened rugs to trap shoe-borne dust. Scientists and technicians had to change to clean white clothing before entering the room.

Purpose of this meticulous housekeeping was to provide a place where no speck of dirt would handicap the work in progress. RCA scientists were studying *luminescent materials*—seeking ways to produce them in bulk, while maintaining utmost quality and purity. Not even

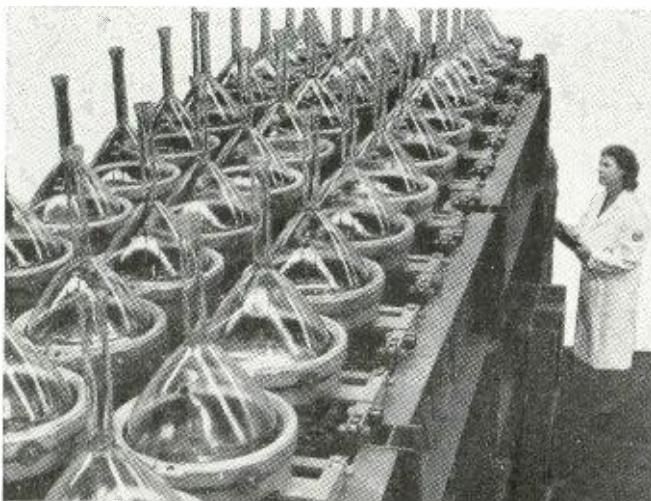

In a special vibration-free room, air-conditioned—and with temperature and humidity evenly controlled—tubes move at a snail's pace along this settling belt, while the luminescent coating settles on the face of the bulb in a delicate, film-like covering—a flawless surface, smooth and uniform.

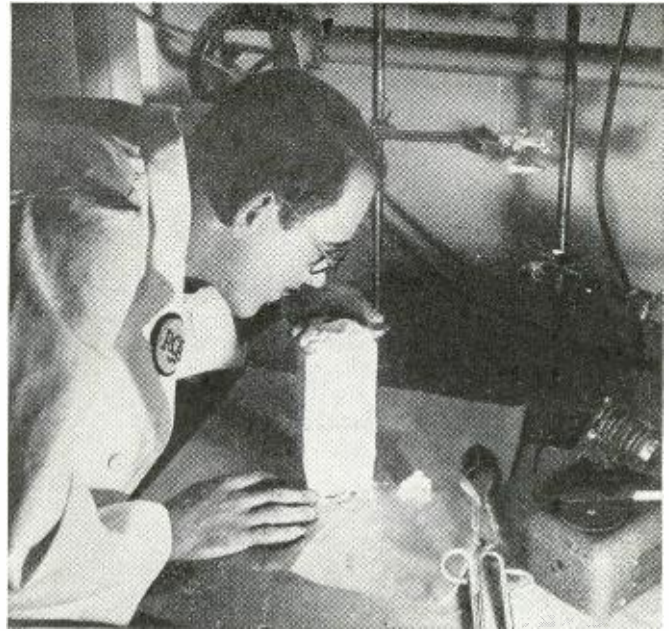

This block of luminescent material, energized by ultraviolet light, provided illumination for this photograph. Luminescent materials of the highest purity are produced in bulk at RCA Tube Plant.

a speck of foreign matter could be tolerated. One part of copper *in ten million* will show up as green spots on a television screen.

Although phosphors have been known for centuries—since even sugar, salt, and diamonds have been found to have luminescent properties—little intensive research was done until scientists began seeking to perfect these glowing materials for use on the screens of television receivers. A scientist at RCA Laboratories, in the Specpure Room, was one of the first to develop the fundamentals for a way of making luminescent materials in bulk for television.

This development is one of the reasons why, at RCA Tube Plant in Lancaster, Pa., they can now be made by the tankful! Even in mass production, each "batch" has uniform characteristics. White light, of the type most suitable for creating television pictures, is produced by mixtures of luminescent materials combined in exactly the correct proportion.

Guarded at every step against any trace of contamination, these phosphors are deposited in a delicate film-like coating on the faceplates of television tubes... where they cling to the glass by a form of molecular attraction. Excited by an electron beam, they glow with a brilliant white light and thus produce the crisp black-and-white pictures we see on television.

To television, the phosphors developed by RCA scientists are as important as paint is to a painter. The face of the kinescope tube is the "canvas." A picture appears as a visible image when the electron gun acts as a "paint brush" to create patterns in the phosphors!



Radio Corporation of America

WORLD LEADER IN RADIO—FIRST IN TELEVISION

RADIO-ELECTRONICS f o r

CHANNEL MASTER'S

Super-Fan!

BM 313 SERIES

• STRENGTH • RIGIDITY • SENSITIVITY

SUPERSEDES
THE BM 312
FAN FLECTOR
SERIES

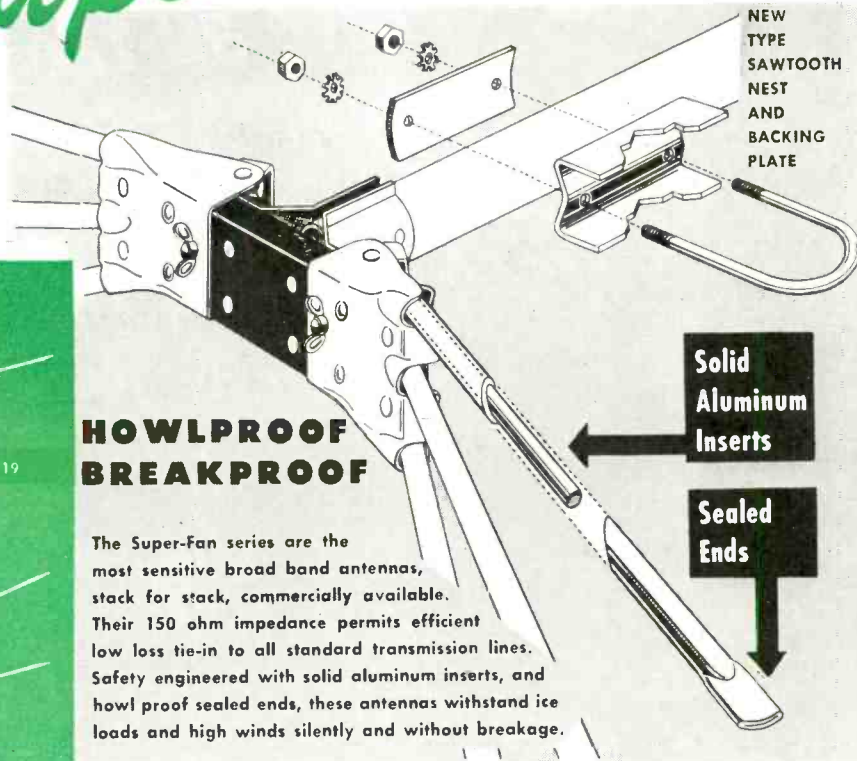

- LOWER PRICES
- SMALLER BOX
- SUPERIOR PREASSEMBLY

HOWLPROOF BREAKPROOF

The Super-Fan series are the most sensitive broad band antennas, stack for stack, commercially available. Their 150 ohm impedance permits efficient low loss tie-in to all standard transmission lines. Safety engineered with solid aluminum inserts, and howl proof sealed ends, these antennas withstand ice loads and high winds silently and without breakage.

These models also feature *Swing-Lock-Action*, the patented preassembled feature of all Channel Master antennas. Just swing out elements and lock them in place — as easy as that.

BM 313 SUPER-FAN LIST 12.19

BM 313X2 STACKED SUPER-FAN LIST 26.25

BM 313X4 DOUBLE STACKED SUPER FAN LIST 57.10

A TELEVISION SET IS NO BETTER THAN ITS ANTENNA
THERE IS NO BETTER ANTENNA THAN THE SUPER-FAN

GAIN OF THE SUPER-FAN SERIES

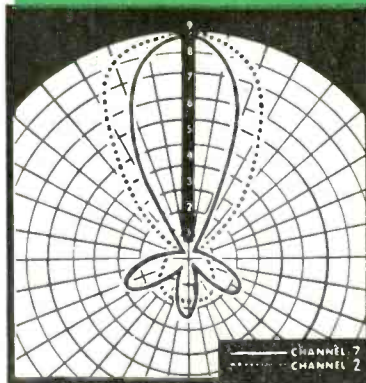

HORIZONTAL POLAR DIAGRAMS

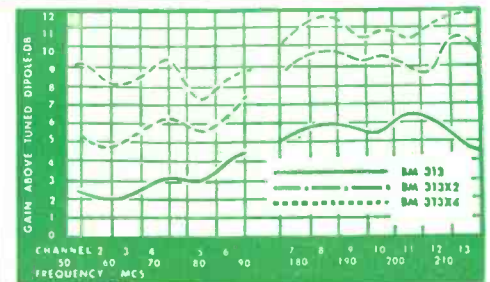

GAIN CURVES

CHANNEL	2	3	4	5	6	7	8	9	10	11	12	13
313	2.1	2.2	3.0	3.0	4.0		5.3	5.8	5.7	6.5	6.0	6.7
313X2	4.8	5.0	6.1	5.7	6.8		9.0	9.7	9.3	10.4	9.8	10.6
313X4	9.0	8.2	9.0	7.3	8.5		11.0	11.4	10.6	10.8	10.3	11.9

GAIN IN DB. ABOVE TUNED DIPOLE



FIRST IN PRE-ASSEMBLED ANTENNAS

ELLENVILLE, N. Y.

JUNE, 1950

TO: CHANNEL MASTER CORP., ELLENVILLE, N. Y.

Please send me:

Name of nearest Channel Master Distributor

Technical data and literature

YOUR NAME

COMPANY NAME

ADDRESS

CITY STATE

NEW 1950

Heathkits

have all the Features

New 1950 Heathkit

PUSH-PULL EXTENDED RANGE 5" OSCILLOSCOPE KIT

Features

- The first truly television oscilloscope.
- Tremendous sensitivity .06 Volt RMS per inch deflection.
- Push-pull vertical and horizontal amplifiers.
- Useful frequency range to 2½ Mega-cycles.
- Extended sweep range 15 cycles to 70,000 cycles.
- New television type multivibrator sweep generator.
- New magnetic alloy shield included.
- Still the amazing price of \$39.50.



\$39.50

The new 1950 Push-Pull 5" Oscilloscope has features that seem impossible in a \$39.50 oscilloscope. Think of it—push-pull vertical and horizontal amplifiers with tremendous sensitivity only six one hundredths of a volt required for full inch of deflection. The weak impulses of television can be boosted to full size on the five inch screen. Traces you couldn't see before. Amazing frequency range clear useful response at 2½ Megacycles made possible by improved push-pull amplifiers. Only Heathkit Oscilloscopes have the frequency range required for television. New type multi-vibrator sweep generator with more than twice the frequency range. 15 cycles to 70,000 cycles will actually synchronize with 250,000 cycle signal. Dual positioning controls will move trace over any section of the screen for observation of any part. New magnetic alloy CR tube shield protects the instrument from outside fields. All the same high quality parts, cased electrostatically shielded power transformer, aluminum cabinet, all tubes and parts. New instruction manual now has complete step by step pictorials for easiest assembly. Shipping Weight 30 lbs. Order now for this winter's use.

CONVERSION FOR OTHER MODEL HEATHKIT OSCILLOSCOPES

A conversion for all 03 and 04 scopes is available changing them to the new push-pull amplifiers (does not change the sweep generator). Complete kit includes new chassis, tubes and all parts. For a small investment, add the latest improvements to your present oscilloscope (Except C.R. Tube Shield). Shipping weight 10 lbs. Order 05 Conversion Kit No. 315..... **\$12.50**

THE NEW *Heathkit*

HANDITESTER KIT

MORE Features THAN EVER BEFORE

- Beautiful streamline Bakelite case.
- AC and DC ranges to 5,000 Volts.
- 1% Precision ceramic resistors.
- Convenient thumb type adjust control.
- 400 Microampere meter movement.
- Quality Bradley AC rectifier.
- Multiplying type ohms ranges.
- All the convenient ranges 10-30-300-1,000-5,000 Volts.
- Large quality 3" built-in meter.

The instrument for all—the ranges you need—beauty you'll enjoy for years and you can assemble it in a matter of minutes—an instrument for everyone. The handiest quality voltohmmeter of all. Small enough to put in your pocket yet a full 3" meter. Easy pictorial wiring diagrams eliminate all assembly problems. Uses only 1% precision ceramic divider resistors and wire wound shunts. Twelve different ranges. AC and DC ranges of 10-30-300-1,000-5,000 Volts. Ohms ranges of 0-3,000 ohms and 0-300,000 ohms. Milliampere ranges of 10MA and 100MA. Hearing aid type ohms adjust control fits conveniently under thumb for one hand adjustment. Banana type jacks for positive low resistance connections. Quality test leads included. The high quality Bradley instrument rectifier was especially chosen for linear scales on AC. The modern case was styled by Harrah Engineering for this instrument. The 400 microampere meter movement comes already mounted in the case protected from dust during assembly. An ideal classroom assembly instrument useful for a lifetime. Perfect for radio service calls, electricians, garage mechanics, students, amateurs and beginners in radio. The only quality voltohmmeter under \$20.00. An hour of assembly saves you one-half the cost and quality parts give you a better instrument. Order today. Shipping weight 2 lbs.



\$13.50

*Note
HANDY
OHMS
ADJUST.*

EXPORT DEPT.
13 East 40th St.
NEW YORK CITY (16)
CABLE: ARLAB-N.Y.

The **HEATH COMPANY**

... BENTON HARBOR 20, MICHIGAN

MORE QUALITY in

1950 Heathkits

The NEW V-4 Heathkit VACUUM TUBE VOLTMETER KIT

Features

- Meter scale 17% longer than average 4 1/2" meter.
- Modern streamline 200 ua meter.
- New modern streamline styling.
- Burn-out proof meter circuit.
- 24 Complete ranges.
- Isolated probe for dynamic testing.
- Most beautiful VTVM in America.
- Accessory probes (extra) extend ranges to 10,000 Volts and 100 Megacycles.
- Uses 1% precision ceramic divider resistors.
- Modern push-pull electronic voltmeter circuit.
- Electronic AC circuit. No current drawing rectifiers.
- Shatterproof plastic meter face.

The new Heathkit Model V-4 Vacuum Tube Voltmeter has dozens of improvements. A new modern streamlined 200 microampere meter has Alnico V magnet for fast, accurate readings. The new electronic AC voltmeter circuit incorporates an entire new balance control which eliminates contact potential and provides greater accuracy. New simplified switches for quicker assembly. New snap-in battery mounting is on the chassis for easy replacement.

The Heathkit VTVM is the only kit giving all the ranges. Check them — DC and AC—full scale linear ranges of 0-3V, 0-10V, 0-30V, 0-100V, 0-300V, 0-1000V and can be extended to 0-3000V and 0-10,000V DC with accessory probe at slight extra cost. Electronic ohmmeter has six ranges measuring resistance accurately from .1 ohm to one billion ohms. Meter pointer can be offset to zero center for FM alignment.

The DC probe is isolated for dynamic measurements. Has db scale for making gain and other audio measurements.

The new instruction manual features pictorial diagrams and step-by-step instructions for easy assembly. The Heathkit VTVM is complete with every part — 110V transformer operated with test leads, tubes, light aluminum cabinet for portability, giant 4 1/2" 200 microamp meter and complete instruction manual.

Order now and enjoy it this entire season. Shipping weight 8 lbs., Model V-4



\$24⁵⁰

Accessory: 10,000V high voltage probe, No. 310, \$4.50.
Accessory: RF crystal diode probe kit extends RF range to 100 Mc., No. 309, \$6.50.

New 1950 VERNIER TUNING R.F. Heathkit SIGNAL GENERATOR KIT

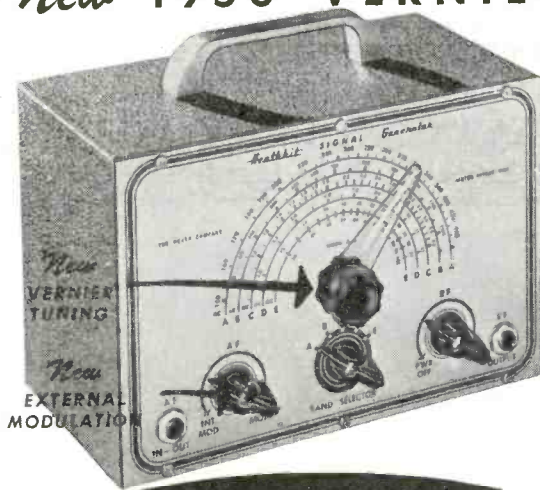

\$19⁵⁰

Features

- New 5 to 1 ratio vernier tuning for ease and accuracy.
- New external modulation switch—use it for fidelity testing.
- New precision coils for greater output.
- Cathode follower output for greatest stability.
- 400 cycle audio available for audio testing.
- Most modern type R.F. oscillator.
- Covers 150Kc. to 34Mc. on fundamentals and calibrated strong harmonics to 102 Mc.

The most popular signal generator kit has been vastly improved—the experience of thousands combined to give you the best. Check the features in this fine generator and consider the low price \$19.50. A best buy for any shop, yet inexpensive enough for hobbyists. Everyone can have an accurate controlled source of R.F. signal voltage.

The new features double the value—think of being able to make fidelity checks on receivers by inserting a variable audio signal. Internal 400 cycle saw-tooth audio oscillator modulates R.F. signal and is available externally for audio testing. The new 5 to 1 ratio vernier drive gives hairline tuning for maximum accuracy in scale settings. The coils are already precision wound and calibrated. Uses turret type coil and switch assembly for ease of construction. The generator is 110 V. 60 cycle transformer operated and comes complete in every detail—cabinet—tubes—coils—beautiful two color calibrated panel and all small parts—new step-by-step pictorial diagrams and complete instruction manual make assembly a cinch even for novices. Why try to get along without a signal generator when you can have the best for less than a twenty dollar bill. Better order it now. Shipping weight 7 lbs. **\$19.50**

CONVERSION KIT FOR G-1 GENERATORS

Conversion kit for G-1 generators for vernier tuning and external modulation includes new high band coil for greater output. Gives all the features of new G-5 listed above. Order G-5 Conversion Kit No. 316. **\$4.50**

EXPORT DEPT.
13 East 40th St.
NEW YORK CITY (16)
CABLE: ARLAB-N.Y.

The **HEATH COMPANY**

... BENTON HARBOR 20, MICHIGAN

Beauty · Quality · Economy



Only
\$69.50

Nothing
ELSE TO BUY

New Heathkit

IMPEDANCE BRIDGE KIT

A LABORATORY INSTRUMENT NOW WITHIN
THE PRICE RANGE OF ALL

Measures Inductance from 10 microhenries to 100 henries capacitance from .00001 MFD to 1000 MFD. Resistance from .01 ohms to 10 megohms. Dissipation factor from .001 to 1. "Q" from 1 to 1000.

Ideal for schools, laboratories, service shops, serious experimentors.

An impedance bridge for everyone — the most useful instrument of all, which heretofore has been out of the price range of serious experimentors and service shops. Now at the lowest price possible. All highest quality parts. General Radio main calibrated control. General Radio 1000 cycle hummer. Mallory ceramic switches with 60 degree indexing — 200 micro-amp zero center galvanometer — 1/2 of 1% ceramic non-inductive decade resistors. Professional type binding posts with standard 3/4" centers. Beautiful birch cabinet. Directly calibrated "Q" and dissipation factor scales. Ready calibrated capacity and inductance standards of Silver Mica, accurate to 1/2 of 1% and with dissipation factors of less than 30 parts in one million. Provisions on panel for external generator and detector. Measure all your unknowns the way laboratories do — with a bridge for accuracy and speed.

Internal 6 volt battery for resistance and hummer operation. Circuit utilizes Wheatstone, Hay and Maxwell circuits for different measurements. Supplied complete with every quality part — all calibrations completed and instruction manual for assembly and use. Deliveries are limited. Shipping weight, approximately 15 lbs.

Heathkit CONDENSER CHECKER KIT

\$19.50



Features

- Power factor scale
- Measures resistance
- Measures leakage
- Checks paper-mica-electrolytics
- Bridge type circuit
- Magic eye indicator
- 110V. transformer operated
- All scales on panel

Checks all types of condensers, paper-mica-electrolytic-ceramic over a range of .00001 MFD. to 1000 MFD. All on readable scales that are read direct from the panel. NO CHARTS OR MULTIPLIERS NECESSARY. A condenser checker anyone can read without a college education. A leakage test and polarizing voltage for 20 to 500 volts provided. Measures power factor of electrolytics between 0% and 50%. 110V. 60 cycle transformer operated complete with rectifier and magic eye tubes, cabinet, calibrated panel, test leads and all other parts. Clear detailed instruction for assembly and use. Why guess at the quality and capacity of a condenser when you can know for less than a twenty dollar bill. Shipping weight, 7 lbs. Model C-2.

New Heathkit

TELEVISION ALIGNMENT GENERATOR KIT



\$39.50

Nothing ELSE TO BUY

Everything you want in a television alignment generator. A wide band sweep generator covering all TV frequencies 0-46 54 to 100 — 174 to 220 Megacycles, a marker indicator covering 19 to 42 Megacycles, AM modulation for RF alignment — variable calibrated sweep width 0-30 Mc. — mechanical driven inductive sweep. Husky 110V. 60 cycle power transformer operated — step type output attenuator with 10,000 to 1 range — high output on all ranges — band switching for each range — vernier driven main calibrated dial with over 45 inches of calibration — vernier driven calibrated indicator marker tuning. Large grey crackle cabinet 16 1/8" x 10 3/8" x 7-3/16". Phase control for single trace adjustment. Uses three high frequency triodes plus 5Y3 rectifier — split stator tuning condensers for greater efficiency and accuracy at high frequencies — this Heathkit is complete and adequate for every alignment need and is supplied with every part — cabinet — calibrated panel — all coils and condensers wound, calibrated and adjusted. Tubes, transformer, test leads — every part with instruction manual for assembly and use. Actually three instruments in one — TV sweep generator — TV AM generator and TV marker indicator.

EXPORT DEPT.
13 East 40th St.
NEW YORK CITY (16)
CABLE: ARLAB-N.Y.

The **HEATH COMPANY**

... BENTON HARBOR 20, MICHIGAN

RADIO-ELECTRONICS for

all in HEATHKITS...

Heathkit TUBE CHECKER KIT

Features

1. Measures each element individually
2. Has gear driven roller chart
3. Has lever switching for speed
4. Complete range of filament voltages
5. Checks every tube element
6. Uses latest type lever switches
7. Uses beautiful shatterproof full view meter
8. Large size 11" x 14" x 4" complete
9. Checks new 9 pin piniaures

Check the features and you will realize that this Heathkit has all the features you want. Speed—simplicity—beauty—protection against absobescence. The most modern type of tester—measures each element—beautiful Bad-Good scale, high quality meter—the best of parts—rugged oversize 110V. 60 cycle power transformer—finest of Mallory switches—Centralab controls—quality wood cabinet—complete set of sockets for all type tubes including blank spare for future types—fast action gear driven roller chart uses brass gears to quickly locate and set up any type tube. Simplified switching cuts necessary time to minimum and saves valuable service time. Short and open element check. No matter what arrangement of tube elements, the Heathkit flexible switching arrangement easily handles it. Order your Heathkit Tube Checker today. See for yourself that Heath again saves you $\frac{2}{3}$ and yet retains all the quality—this tube checker will pay for itself in a few weeks—better build it now.

Complete with detail instructions—all parts—cabinet—roller chart—ready to wire up and operate. Shipping Wt., 15 lbs.



Only
\$29⁵⁰

Nothing
ELSE TO BUY

Heathkit SINE AND SQUARE WAVE AUDIO GENERATOR KIT



Nothing
ELSE TO BUY

\$34⁵⁰

Experimenters and servicemen working with a square wave for the first time invariably wonder why it was not introduced before. The characteristics of an amplifier can be determined in seconds compared to several hours of tedious plotting using older methods. Stage by stage, amplifier testing is as easy as signal tracing. The low distortion (less than 1%) and linear output (\pm one db.) make this Heathkit equal or superior to factory built equipment selling for three or four times its price. The circuit is the popular RC tuning circuit using a four gang variable condenser. Three ranges 20-200, 200-2,000, 2,000-20,000 cycles are provided by selector switch. Either sine or square waves instantly available at slide switch. All components are of highest quality, cased 110V. 60 cycle power transformer. Mallory F.P. filter condensers, 5 tubes, calibrated 2 color panel, grey crackle aluminum cabinet. The detailed instructions make assembly an interesting and instructive few hours. Shipping Wt., 13 lbs.

New Heathkit BATTERY ELIMINATOR KIT

Nothing
ELSE TO BUY

\$22⁵⁰



Now a bench 6 Volt power supply kit for all auto radio testing. Supplies 5 - 7 $\frac{1}{2}$ Volts at 10 Amperes continuous or 15 Amperes intermittent. A well filtered rugged power supply uses heavy duty selenium rectifier, choke input filter with 4,000 MED of electrolytic filter. 0 - 15 Volt meter indicates output. Output variable in eight steps. Excellent for demonstrating auto radios. Ideal for servicing—can be lowered to find sticky vibrators or stepped up to equivalent of generator overload—easily constructed in less than two hours. Complete in every respect. Shipping Wt., 18 lbs.

NEW Heathkit SIGNAL TRACER AND UNIVERSAL TEST SPEAKER KIT

Nothing
ELSE TO BUY

\$19⁵⁰

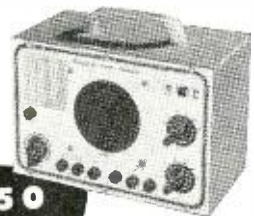

The popular Heathkit signal tracer has now been combined with a universal test speaker at no increase in price. The same high quality tracer follows signal from antenna to speaker—locates intermittents—defective parts quicker—saves valuable service time—gives greater income per service hour. Works equally well on broadcast—FM or TV receivers. The test speaker has assortment of switching ranges to match push pull or single output impedance. Also test microphones, pickups—PA systems—comes complete—cabinet—110V. 60 cycle power transformer—tubes, test probe, all parts and detailed instructions for assembly and use. Shipping Wt., 8 lbs.

EXPORT DEPT.
13 East 40th St.
NEW YORK CITY (16)
CABLE: ARLAB-N.Y.

The **HEATH COMPANY**

... BENTON HARBOR 20, MICHIGAN

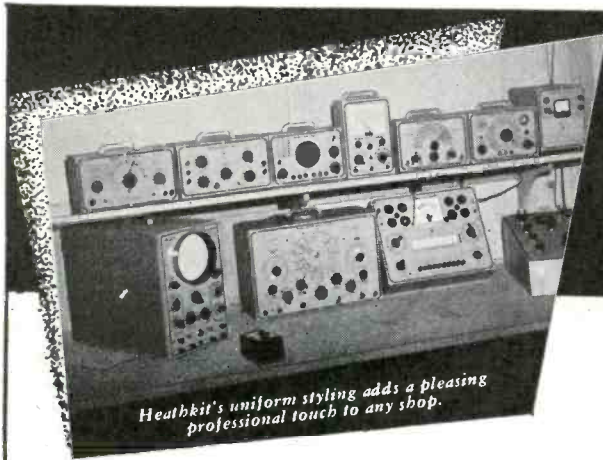

Heathkit's uniform styling adds a pleasing professional touch to any shop.

Heathkits PROVIDE PROFESSIONAL LABORATORY APPEARANCE

New Heathkit BROADCAST AND 3 BAND SUPERHETERODYNE RECEIVER KIT

BROADCAST MODEL BR-1
550 to 1600 Kc.

\$19.50

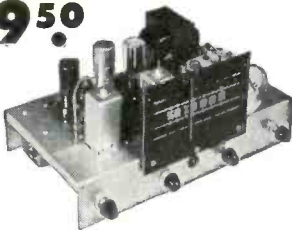

Two new Heathkit Superheterodynes featuring the best of design and material. Beautiful six inch slide rule dials—110 V. 60 cy. AC power transformer operated—metal cased filters—quality output transformers, dual iron core metal can IF transformers—two gang tuning condenser. The chassis is provided with phono-radio switch—110 V. outlet for changer motor and phono pickup jack. Each kit is complete with all parts and detailed instruction booklet. Pictorial diagrams and step-by-step instructions make assembly quick and easy.

3 BAND MODEL AR-1
550 Kc. to 20 Mc.

\$23.50

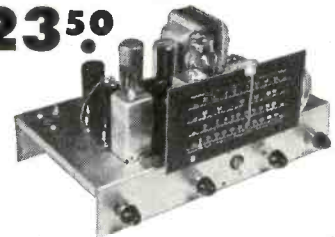

Ideal AC operated superheterodyne receiver for home use or replacement in console cabinet. Comes complete with attractive metal panel for cabinet mounting. Modern circuit uses 12K8 converter, 12SH7 input IF stage, 12C8 output IF stage and first audio 12A6 beam power output stage, 5Y3 rectifier. Excellent sensitivity for distant reception with selectivity which effectively separates adjacent stations.

The husky 110 V. cased power transformer is conservatively rated for long life. The illuminated six inch slide rule dial is accurately calibrated for DX reception. Enjoy the pleasure of assembling your own fine home receiver. Has tone, volume, tuning and phono-radio controls. Chassis size 2 1/4" x 7" x 12 1/2". Comes complete with all parts including quality output transformer to 3.4 ohm voice coil, tubes, instruction manual, etc. (less speaker). Shipping Wt., 10 lbs. No. BR-1 Receiver \$19.50.

No. 335 Communications Type Table Model Metal Cabinet..... \$4.50
No. 320 High Quality 5" PM Speaker for above..... 2.75

Enjoy the thrill of world wide short wave reception with this fine new AC operated Heathkit 3 band superheterodyne—amazing sensitivity 15 microvolt or better on all bands. Continuous coverage 550 Kc. to over 20 Mc. Easy to build with complete step-by-step instructions and pictorial diagram. Attractive accurately calibrated six inch slide rule dial for easy tuning. Six tubes with one dual purpose tube gives seven tube performance. Beam power output tube gives over 3 watts output.

Separately assembled coil turret with band switch eliminates difficult construction. Conservatively rated 110 V. power transformer supplies full operating voltages to all tubes for maximum reception. Has band switch, tuning, volume, tone and phono-radio controls. Chassis size 2 1/4" x 7" x 12 1/2"—supplied complete—punched chassis—tubes—controls—transformers (quality output to 3.4 ohm voice coil)—all small parts—hardware and instructions (less speaker). Shipping Wt., 10 lbs. No. AR-1 Receiver \$23.50.

No. 335 Communications Type Table Model Metal Cabinet..... \$4.50
No. 320 High Quality 5" PM Speaker for above..... 2.75

Heathkit

PUSH-PULL HIGH FIDELITY AMPLIFIER KIT



\$12.50

Build this high fidelity push-pull amplifier and save two-thirds the cost—has two pre-amplifier stages, phase inverter stage and push-pull beam power output stage. Comes complete with six tubes—quality output transformer (to 3-4 ohm voice coil) tone and volume controls—varnish impregnated cased 110V. power transformer and detailed instruction manual and all small parts. Six watt output with output flat within 1 1/2 db between 50 and 15000 cycles. Build this amplifier now and enjoy it for years. Shipping Wt. 7 lbs. Model A-4 12" PM Speaker for above..... \$6.95

ORDER BLANK

HEATH CO. BENTON HARBOR MICHIGAN		FROM _____		SHIP VIA	
		_____		<input type="checkbox"/> Parcel Post <input type="checkbox"/> Express <input type="checkbox"/> Freight <input type="checkbox"/> Best Way	
Quan.	DESCRIPTION	Price	Total		

ENCLOSED FIND CHECK . . . MONEY ORDER FOR _____
PLEASE SHIP C.O.D. . . . POSTAGE ENCLOSED FOR _____ POUNDS

EXPORT DEPT.
13 East 40th St.
NEW YORK CITY (16)
CABLE: ARLAB-N.Y.

The HEATH COMPANY
... BENTON HARBOR 20, MICHIGAN

THESE LEADING SET MAKERS

Emerson Admiral Westinghouse
 hallicrafters BENDIX RADIO STROMBERG-CARLSON
 Motorola Spartan PHILCO Majestic
 airOking Sentinel TRAV-LER GAROD SETHCELL-CARLSON, INC.
 CROSLLEY

Seen these Hytron firsts in popular new TV sets? The prominent TV set makers shown are using them. And the list is growing.

DuMont, for example, now uses the 1X2 and 6BQ6GT. You'll see many more of these famous tubes. And many more new Hytron types designed for low-cost TV for the mass market. When you buy these Hytron firsts, follow the leading set manufacturers. Buy the original. Buy Hytron!

choose one or more of
 THESE HYTRON TV FIRSTS

HYTRON TV FIRST

1X2 compact, high-voltage TV rectifier.



HYTRON TV FIRST

6U4GT high-performance damping diode.



HYTRON TV FIRST

16RP4 original rectangular TV picture tube.

HYTRON TV FIRST

6BQ6GT, 25BQ6GT extra-performance deflection amplifiers.



HYTRON TV FIRST

12BH7 twin-triode sweep amplifier with superior efficiency.



Relax! LET HYTRON TOOLS EASE YOUR WORK

SOLDERING AID 49c net

TUBE LIFTER 15c net

TUBE TAPPER 5c net

BY THE MAKERS OF HYTRON TUBES

FREE

New Hytron Tool Catalogue. Describes all the famous Hytron Service Shop tools to date: Soldering Aid, Tube Lifter, 7-Pin and 9-Pin Straighteners, Tube Tapper, and Auto Tool. Find out how these Hytron Tools can ease your work. Learn how you can save money. Send for your free copy today!

OLDEST MANUFACTURER OF RECEIVING TUBES
HYTRON
 RADIO AND ELECTRONICS CORP.

MAIN OFFICE: SALEM, MASSACHUSETTS



NOV! Convert 10"-12½"

Quickly, Profitably, Easily with

NEW! NORELCO DUO-VUE
world's first dual-purpose TV offers
3' x 4' picture — \$199.50 list*

NEW! PROTELGRAM "CONVERSION PACKAGE"
makes possible huge 234 sq. in.
picture for trade-in buyers



This 2½" 3NP4 is smallest projection tube on market, is lowest in cost (\$19.50 retail), produces largest home picture (3'x4').

NORTH AMERICAN
PHILIPS
COMPANY, INC.



PROTELGRAM

North American Philips has really BIG PROFIT NEWS for you—and BIGGER, BETTER PROTELGRAM TV pictures for your customers, up to 3' x 4' in the sensational NORELCO DUO-VUE now making its world première at \$199.50 — more television picture for less money than ever before offered!

What is there in it for you? PROFITS from PROTELGRAM'S Four-Way Plan described on the right.

Philips makes it easy and profitable for you to—

1. Sell PROTELGRAM to set builders interested in bigger pictures — 13½" x 18".

2. Sell PROTELGRAM for custom-built, large-screen installation, up to 3' x 4' for homes, clubs, bars, hotels, etc.

3. Sell NORELCO DUO-VUE, television's newest, finest and biggest picture used with the customer's direct-view table set to produce 3' x 4' pictures on a home-movie screen. A flip of a switch selects either picture, and you can connect DUO-VUE to almost any table-model receiver in less than an hour.

4. Sell PROTELGRAM in a conversion cabinet to customers wanting to convert their 10 or 12½" direct-view receivers to a picture larger than a 20" tube gives. And you can make the conversion in less than one hour following the simple, straightforward instructions provided.

Right NOW is the time to make extra profits with PROTELGRAM. Read every word of this ad. Then get in touch with your distributor or send the coupon now for all the facts.

**Prices slightly higher west of Rockies. Connection charges extra.*

NORTH AMERICAN PHILIPS COMPANY, INC.

100 E. 42nd Street, New York 17, N. Y.

RADIO-ELECTRONICS for

16" Sets to BIG PICTURE TV **PROTELGRAM**

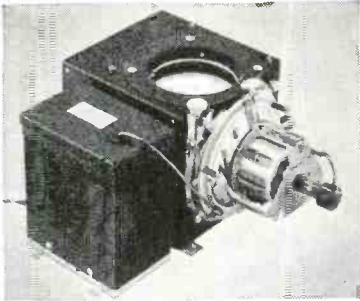

PROTELGRAM UNIT

Projection box measures only 8½" x 9" x 13", contains optical system and alignment assembly, is designed for quick easy service and adjustment. The 2½" 3NP4 projection tube is long-lived, extremely low in cost. Compact 25KV high-voltage unit is only 8½" x 4½" x 7".

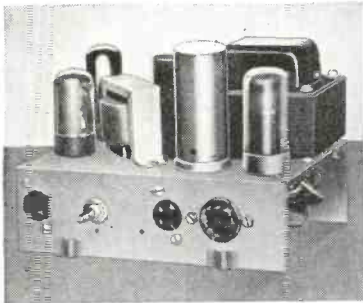

AUXILIARY CHASSIS

New auxiliary chassis fills additional electrical requirements essential to adaption of TV chassis to PROTELGRAM; makes change-over quick and easy. Measures only 8" x 12" x 4".



CONVERSION CABINET

Console cabinet measuring 22" x 27¾" x 46½" provides space for installation of customer's 630 Type TV chassis, comes equipped with complete PROTELGRAM system, auxiliary chassis, cabinet mirror and viewing screen.

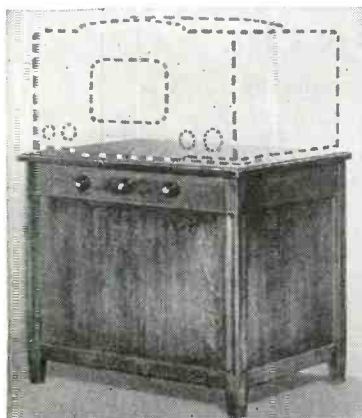

NORELCO DUO-VUE

Beautiful cabinet contains PROTELGRAM unit. Only 23½" high. 20" x 26" top holds most any 10" or larger direct-view table model. Concealed ball-bearing casters make it easy to pull out from wall for 3' x 4' viewing on external screen. Offers customers choice of two picture sizes for small and large group viewing.

FOUR-WAY Profit Plan

Sell PROTELGRAM to the man who builds his own!

Thousands of TV kits have been sold to the man who likes to build his own equipment. These handymen are ripe for PROTELGRAM, because they can combine it with a TV chassis, get life-size TV at a reasonable cost.

Sell PROTELGRAM to custom set buyers

Clients who want built-in installations in walls or cabinets are perfect prospects for PROTELGRAM. Huge picture size, plus compactness and flexibility, makes it the answer for this type of user.

Sell PROTELGRAM to trade-in customers

PROTELGRAM sells itself to customers who want bigger pictures, but are reluctant to take a trade-in loss. You can now use their present TV chassis, connect it with PROTELGRAM in a cabinet such as shown at (3) left. They get a 234 square-inch picture, 13½" x 18".

Sell NORELCO DUO-VUE for largest home-TV pictures

Only with NORELCO DUO-VUE can you offer both direct-view and 3' x 4' movie-size TV... and at a reasonable price. This is the newest thing in television for your customers who want the best. Lots of sales opportunities in bars, clubs, institutions and hospitals, too.

CONTACT YOUR DISTRIBUTOR OR SEND COUPON TODAY

• NORTH AMERICAN PHILIPS COMPANY, INC.
 • Dept. PI-6, 100 East 42nd Street, New York 17, N. Y.
 • Gentlemen: Please send full information as checked
 • PROTELGRAM SYSTEM NORELCO DUO-VUE unit
 • PROTELGRAM SYSTEM PROTELGRAM SYSTEM
 • with auxiliary chassis for conversion console
 • NAME..... POSITION.....
 • FIRM NAME.....
 • ADDRESS.....
 • CITY..... STATE.....
 • Check here for Dealer Information on
 Norelco Electric Shaver Lady Norelco Electric Razor

Which Do You Want?



Better Pay



A Nice Home



A New Car



Greater Security



Happy Vacations and Travel

Get Your FCC Ticket Jobs eventually paying **\$3,000 to \$7,500** (Average Pay Reported by FCC Nationwide Survey) are opening up right now for **FCC Licensed Radiomen**

Add Technical Training to Your Practical Experience and

Get Your FCC COMMERCIAL RADIO OPERATOR LICENSE



in a Minimum of Time

It's EASY if you use CIRE Simplified Training and Coaching AT HOME in SPARE TIME

Get your license easily and quickly and be ready for the jobs open to ticket holders which eventually will pay \$3000-7500 yearly (average pay reported FCC Nationwide Survey).

OURS IS THE ONLY HOME STUDY COURSE OF COACHING AND TRAINING PRIMARILY PLANNED TO LEAD DIRECTLY TO AN FCC COMMERCIAL LICENSE

Your FCC ticket is always recognized in all radio fields as proof of your technical ability

NEW JOB SERVICE to CIRE Graduates

When you get your FCC License, your name is automatically mailed to every Chief Engineer in the U.S.A., every month, until you get a job. Find out how this NEW SERVICE can help you get the job you want.

CIRE Job-Finding Service Brings Amazing Offers of Jobs!

"I now hold ticket Number P10-3787, and holding the license has helped me to obtain the type of job I've always dreamed of having. Yes, thanks to CIRE, I am now working for CAA as Radio Maintenance Technician, at a far better salary than I've ever had before. I am deeply grateful."
A. S. Bukowsky, 3110 Boss Ave., Shreveport, La.
"I am working at WRJM as transmitter engineer, and I received this position in response to one of the employment applications sent me upon completion of my course and the receiving of my Diploma. I received my 1st class Radiotelephone License on March 2, 1949. I want to express my sincere appreciation to the staff of CIRE."
George Hugo, 1141 Townsend Ave., New Haven, Conn.

CLEVELAND INSTITUTE OF RADIO ELECTRONICS
Desk RE-18 4900 Euclid Bldg Cleveland 3, Ohio
Approved for Veteran Training under "G.I. Bill of Rights"

GET THIS AMAZING NEW BOOKLET

1. Tells of Thousands of Brand New Better-Paying Radio Jobs Now Open to FCC License Holders.
2. Tells How We Guarantee to Train and Coach You Until You Get Your FCC License.
3. Tells How Our Amazing Job-FINDING Service Helps You Get the Better-Paying Radio Job Our Training Prepares You to Hold.



Get All 3 FREE Send Coupon Now!

CLEVELAND INSTITUTE OF RADIO ELECTRONICS
Desk RE-18, 4900 Euclid Building, Cleveland 3, Ohio
(Address to Desk No. to avoid delay.)

I want to know how I can get my FCC ticket in a minimum of time by training at home in spare time. Send me your FREE booklet "Money Making FCC License Information," as well as a sample FCC-type exam and FREE booklet, "How to Pass FCC License Examinations," (does not cover exams for Amateur License).

Name

Address

City Zone State

Veterans check for enrollment information under G. I. Bill.

RADIO-ELECTRONICS for

Whither Radio Servicing?

... The future of U. S. radio servicing is in for a boom ...

By Hugo Gernsback

THE editorial entitled "Unprofessional Servicing" in our April issue, while uncomplimentary to a minority group of service technicians, brought a surprising amount of mail agreeing with our findings. There was little disagreement on the whole.

But one letter, from Mr. Alex Johns, who operates the Johns Radio Shop of Dubuque, Iowa—was caustic in his comments. Yet some of the points that Mr. Johns makes are thought-provoking. His lengthy letter, broken down for simplicity follows:

1. Comparing a disorganized group of fanatics (service technicians) with telephone servicing people is unfair. The telephone company according to Johns, has a complete monopoly on the telephone. Furthermore, the telephone service people are backed by a union.

2. How would we like it if one of the largest radio corporations in the United States were to take complete charge of radio and TV, manufacturing as well as servicing; then give the public a choice of a table model or a console, charge for installation, plus a monthly fee, and if you want the set moved charge for that too. That would be a monopoly similar to that the telephone company has now.

3. Radio service technicians *are* fanatics because if they weren't so in love with their work they would stop working long hours for starvation wages. The radio repairman gets no protection—everyone is out for his scalp. No one goes to bat for him. What is more, what support do the radio magazines give the radio service technician?

4. Mr. Johns complains that the surplus-house advertisers make unfair competition for radio service people who have to pay much higher prices for the components which they buy—sometimes from 5 to 10 times more than the surplus houses get for their merchandise.

He concludes his letter with a pessimistic: "I never have and never will urge men into servicing. It's too rough".

Let us now analyze the four points cited above in their correct order.

Point 1. In the editorial "Unprofessional Servicing" the parallel between the radio service technician and the telephone service men was made purposely to induce radio people to appreciate that the public demands *and is entitled* to good service nowadays.

An obvious and most important point which we did not feel necessary to make was that *it does not cost more to give good, courteous service than sloppy and careless treatment to the customer*. No economics whatsoever is involved in this. Yet that elementary point is frequently missed. It has nothing whatsoever to do with monopoly, as should be readily apparent.

Point 2. The suppositious case cited by Mr. Johns has no reality anywhere in the world, not even in Russia. It would be difficult to imagine it in any country. Nor does even the American Telephone and Telegraph Company—usually thought of as a monopoly—cover the entire country. There are in Continental U. S. A. 5,700 independent telephone companies which have no financial connection with the American Telephone and Telegraph Company. The independents incidentally buy their telephone equipment from various telephone manufacturing companies.

Point 3. Many years ago, in 1930, and for some years thereafter, this magazine—at great expense and effort—tried its best to bring into life a national association for radio service people. We organized the "Official Radio Servicemen's Association", endeavored to have local chapters formed, supplied the technicians with stationery, badges, advertising matter etc. in an attempt to improve their standing. The magazine met with little encouragement by the service people in this effort, because too many of them could not see sufficiently far into the future and resisted all organization. Unfortunately, they are now paying the price for this.

Point 4. We live in a free country, in a free economy. Magazines just cannot lawfully refuse one class of advertising and accept another. This should be obvious. It is also true that merchandise varies in price in *every* line in the United States. You can buy surplus standard telephones and you can buy surplus plumbing and automobile components, too. *Service people in all lines buy where they can*. If they buy standard new merchandise they must charge more money for their work. If they buy surplus merchandise they can charge less—although the customer should be told if new components or surplus parts are to be used. *Then, let the customer choose*.

In the last analysis it resolves itself down to the following:

The service technician must be a good businessman if he wishes to succeed. The American public has been taught to pay for what it gets. We have found, as a rule, that the high-class courteous, careful, and businesslike service technician makes money, that he has the confidence of his customer and that his customer usually refers him to his friends. No service technician worth his salt has to work for starvation wages. *He does not have to compete with cut-price starvation competition if he does not want to*.

We also repeat what we have said in these columns before: Television is now in its ascendancy and radio servicing in this country is headed for the greatest prosperity it has ever seen. All signs indicate that this condition will continue at least until 1955 and quite possibly much longer.

Projection Unit for TV

*An optical system
for custom TV sets*

By

DAVID T. ARMSTRONG

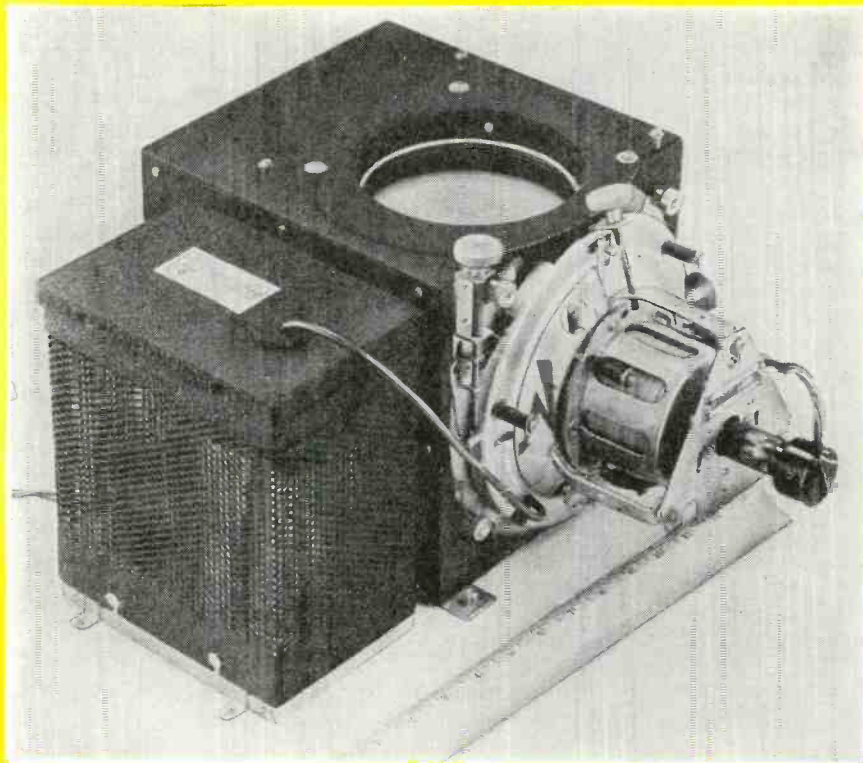
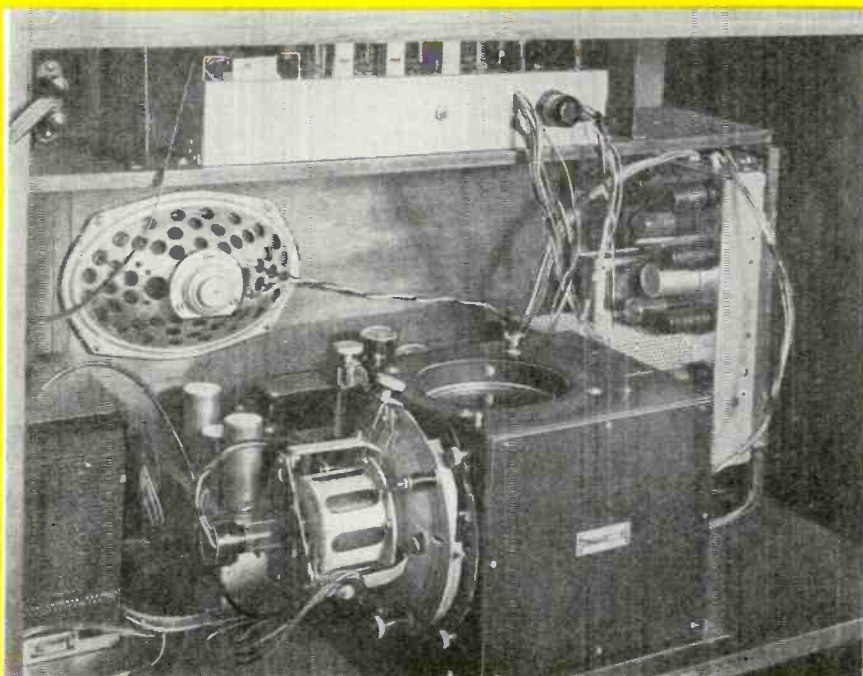

Photo of the television optical system and its high-voltage supply (front). The unit can be adapted to existing sets or built into custom installations.



A typical installation. Chassis at top contains front end, sound, and video i.f.'s. Chassis at right houses the sweeps. High-voltage power supply is at left.

UNTIL recently projection TV has been a luxury product for the carriage trade. Now, it is possible to manufacture compact projection sets at prices comparable to those of 16- and 20-inch direct view receivers. The Norelco Protelgram is such a unit which can be adapted to existing sets or used with specially designed circuits.

Several picture sizes are available with the basic Protelgram unit. The size of the picture depends upon the "throw distance" which is measured from the top of the corrector lens to the viewing screen. The throw distance may be straight-line distance, or it may be the sum of two or three straight-line distances bent to any convenient angle by plane surface mirrors. See Fig. 1 for illustrations of three common throw distance designs in receivers.

The throw distance varies according to the lens used. All the optical parts of the projection system are the same for all units; the corrector lens is the only part that requires changing when the projection throw distance is changed. This operation must be performed at the factory. Three models with the indicated throw distances are now available; for data study the figures in the table.

A high voltage unit

The high-voltage supply now used with the unit operates with a divided type of plate power supply of the type popularized in the 630 TS chassis. The negative side of the plate power input is insulated from the chassis. (See Fig. 2.) Since the maximum permissible B-minus voltage is determined by the heater-cathode rating of the 6BG6-G tube, this voltage must be limited to 135 volts. The 100 volts B-minus provided is well within this limit.

The output of this high voltage unit varies with the d.c. input supply voltage. The high voltage output is rated at $25 \text{ kv} \pm 2 \text{ kv}$ at no load with an input supply voltage of 350 volts. As little as a 10-volt change, plus or minus, of the input voltage will show up as approxi-

* Vice President Electronics Research.

RADIO-ELECTRONICS for

mately 750 volts change in the output potential.

The receiver power supply should provide an input potential of 350 volts maximum during projection, with a beam current of approximately 100 μ a. When the line voltage varies between the normal RMA limits of 105 to 125

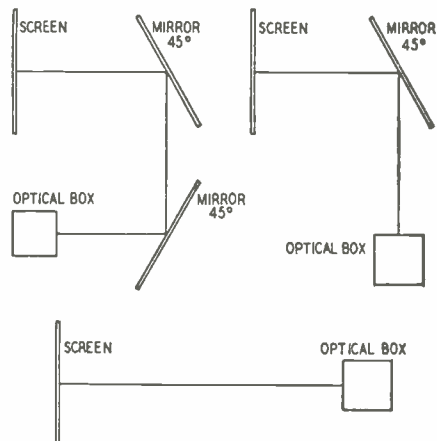

Fig. 1—Three methods of getting throw distance. Mirrors decrease efficiency.

volts the input supply voltage should not exceed 380 volts, nor be less than 320 volts.

When the beam current is varied from 0 to 100 μ a, the input current changes by approximately 12 ma. Any receiver that is to operate under abnormal line voltage conditions must have a regulated input supply. This is important because the quality of the picture depends on the performance characteristics of the high voltage which supplies the second anode of the picture tube.

Dust and spurious light

Dust accumulation on the surface of the corrector plate of the optical box is undesirable because it affects the brightness and contrast of the projected image. There is loss of illumination and the tiny dust particles cause dispersion of the light emanating from the projection box.

Two possible remedies are dust proofing the optical path from the projection box to the screen and eliminating or shielding reflecting surfaces close to the optical path. Fig. 3 suggests an effective type of dust proof enclosure. The black buckram shroud should not sag into the optical path. This can be avoided by drawing it up tightly and fixing it firmly about the corrector lens with a rubber band.

Mounting the projection box in a position which puts the corrector plate in a vertical plane minimizes dust accumulation.

The optical system

The correct adjustment of the optical system requires that the center of the correction lens be exactly at the center of the curvature of the concave mirror. Adjusting screws facilitate this correction and two v shaped marks are brought together apex to apex to form a cross.

Because the projection tube is small, only 2.5 inches in diameter, the focal length may be as little as 4 inches. This makes possible the projection of a 13.5 x 18-inch picture with a straight line throw distance of 32 inches from the correction plate to the viewing screen, or a total of 40.5 inches from the base of the optical box.

The optical system has a numerical aperture (the sine of the semi-apex angle of the cone of gathered light) of 0.64. The optical efficiency of the mirror is the square of the numerical aperture, or 41%. Masking, absorption, transmission, and reflection losses reduce the overall optical efficiency to approximately 20%. This 20% optical efficiency assumes straight-line projection from the correction plate to the viewing screen.

In most projection receivers there is an additional plane mirror set about 45 degrees to bend the light beam from a vertical to a horizontal plane. The use of this one mirror decreases the overall optical efficiency to approximately 17%.

The sharpness of the images produced by this optical system is extremely good, for the system can easily

quality, selection, and mounting of the mirror adjacent to the optical projection box.

The optical quality of mirrors made from standard 13/64 or 1/4-inch polished plate glass is satisfactory for most projection receiver installations.

Protecting the picture tube

In direct view television receivers, comparatively little attention is given to protection of the expensive picture tubes against the possibilities of screen burns if the sweep circuit fails.

Where the second anode voltage is developed by the flyback method there is automatic protection against horizontal sweep failure, and even against a combination failure of both the horizontal and vertical sweep circuits. But for a simple and single vertical sweep failure no protection is provided. This is not so careless as it seems, for the electron beam is not likely to be strong enough to produce any fixed line burn if the vertical sweep circuit fails. Furthermore, the majority of sweep failures occur in the horizontal sweep circuit.

The separate high voltage unit in the Protelgram does not depend upo.

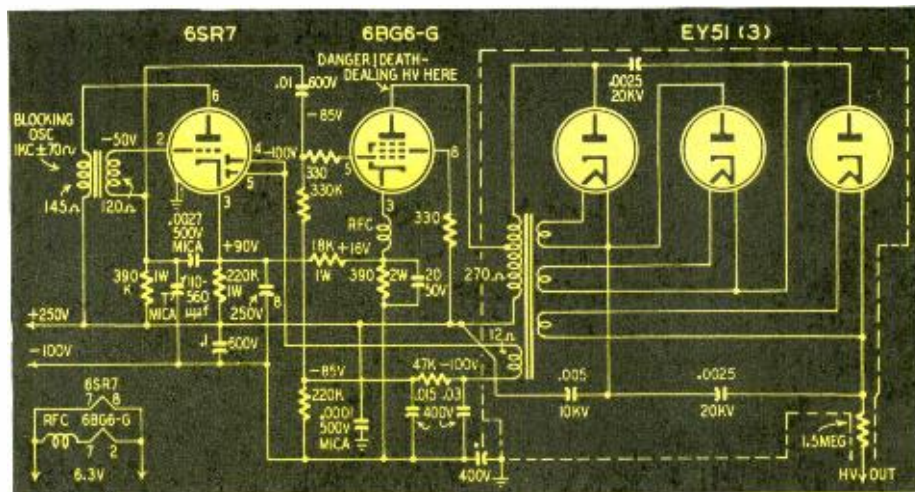

Fig. 2—Circuit of high-voltage supply. The rated output is 25 kv at no load.

render a definition of 1,000 lines, and will readily reproduce the 525 lines now used.

Although you get the best projection picture with straight-line horizontal projection, most installations do not permit a total of 40 1/2 inches overall distance in a horizontal plane (32 inches for the throw distance and 8 1/2 inches depth from the correction lens to the end of the optical box). Most projection receivers using Protelgram require one or more cabinet mirrors to fold the light beam. Any such projection receiver cabinet mirror must be a first surface or plane surface mirror, of good quality.

Any deviation of the reflecting surface from a perfect plane will cause optical distortion. Further, the closer the mirror is positioned to the projection box the more critical it is with respect to its flatness characteristic. Therefore, in any two-mirror system special attention must be given to the

the sweep circuit for its operation. The electron beam energies of 90 μ a, with highlight peaks of more than 500 μ a, in the 3NP4 are sufficiently great to



Fig. 3—The optical system is shielded from stray light and dust by a shroud.

destroy the screen face in a few seconds if any part of the sweep fails.

Bitter and costly field experience has

revealed that of sweep failure may occur often enough to warrant simple precautions to prevent tube face burns. Sweep burns, either line burns or spot burns, usually destroy the usefulness of the tube.

The diagram in Fig. 4 suggests a simple protection circuit. The video

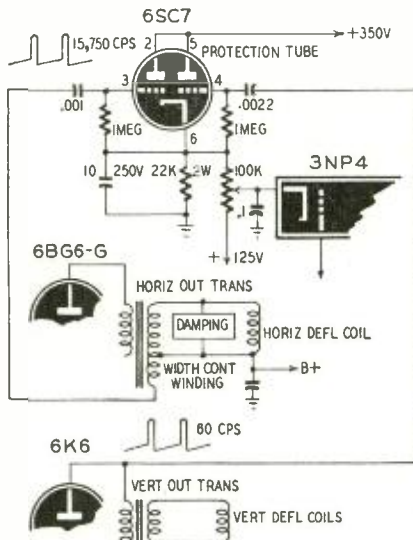

Fig. 4—This circuit protects the 3NP4 if either of the sweep circuits fails.

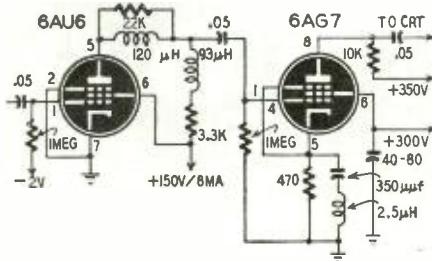

Fig. 5—A video amplifier with cathode compensation for use with Protelgram.

drive is applied to the grid of the cathode ray tube and the direct current brightness control is supplied by a positive voltage on the cathode of the picture tube. Positive horizontal

pulses are taken from the secondary winding of the horizontal output transformer and applied to the grid of one triode section of the 6SC7 protection tube through the .001-µf capacitor. This grid-cathode circuit then operates as a diode and forms a grid leak bias which cuts off this triode section whenever horizontal sweep output voltage is present. In a like manner, positive vertical pulses cut off the other section of the 6SC7 dual triode protection tube when vertical sweep output voltage exists.

If the signals from the horizontal or vertical sweep disappear, either or both of the triode sections of the 6SC7 control tube will begin to draw large plate currents which will increase the potential at the cathode. Such cathode voltage will bias the picture tube as it is also applied to the cathode of the picture tube.

The plate voltage applied to the 6SC7 must be obtained from the same source that supplies input potential for the high voltage unit to insure protection if the sweep power fails.

A video amplifier

A cathode compensated video output stage will supply all the Protelgram requirements and requires far less power. For the same bandwidth the plate load is larger than in the conventional type amplifier. More output voltage can be obtained for the same current swing, or, better still, a specified output voltage can be developed with much less current swing. The lower average current reduces the drain on the power supply by as much as 30 ma. It is also possible to use a wider selection of tubes for the video output.

One disadvantage is that at the high frequencies the maximum output of the amplifier is somewhat reduced as a result of the shunting effect of the output capacitance across the relatively large plate load.

Fig. 5 shows a cathode-compensated video amplifier which has worked out well. The total output capacitance of

this amplifier is about 45 µf. This is made up of the output capacitance of the 6AG7 tube, the input capacitance of the 3NP4 projection kinescope, the wiring capacitance, and the capacitance of the three-foot lead to the projection tube.

The 6AU6 driver stage uses the conventional shunt-series peaking and provides for noise clipping at the cut-off in its grid circuit. The 6AG7 uses cathode compensation. Bandwidth is 4.5 mc at 3-db points.

The cathode compensation cannot be

	Throw Distance (inches)	Width (inches)	Height (inches)
Model 161A For table models	23 3/8 to 23 3/4	13 1/2	10
Model 160A For consoles	31 to 32	16 to 18	12 to 13 1/2
Model 162A For large scale projection.	70 to 110	32 to 64	24 to 52

Table shows the picture size and throw distance of the three different models.

given theoretically, but must be determined by experiment in each case, for it depends upon the individual chassis arrangements and choice of components. Values shown may be used as starting points. Decrease inductance as capacitance is increased. Cathode bias is 11 volts at low frequencies.

An adaptor and power supply

The Protelgram system may be added to existing chassis and an adaptor circuit with its plug in possibilities is illustrated in Fig. 6. This adaptor circuit requires the addition of two Amphenol sockets to an existing chassis and another small power supply unit with the protection tube circuit built in. The power supply may be added to the existing chassis if there is room or it may be built on another small chassis of its own. This adaptor circuit offers intriguing possibilities to the experimenter since it is an attachable-detachable package unit.

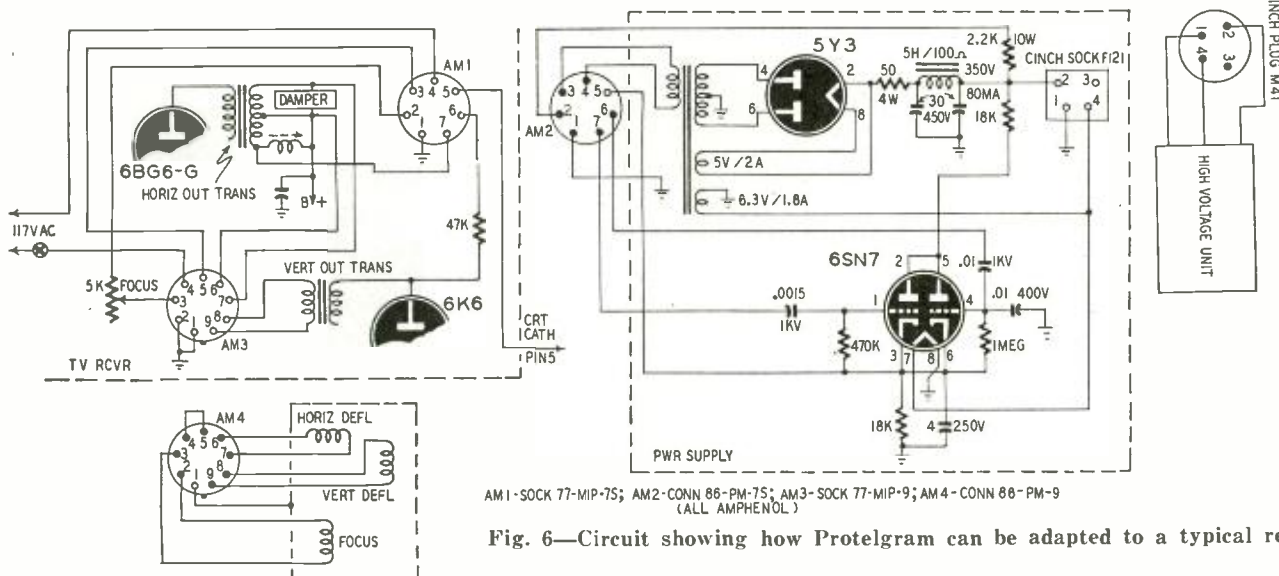

AM1 - SOCK 77-MIP-75; AM2 - CONN 86-PM-75; AM3 - SOCK 77-MIP-9; AM4 - CONN 86-PM-9 (ALL AMPHENOL)

Fig. 6—Circuit showing how Protelgram can be adapted to a typical receiver.

New Picture Tube for Color TV

COLOR television for the general public is now one step nearer, because of a new color viewing tube just developed by RCA. The new kinescope is based on a different principle from any previously described, though it has some resemblance to the Geer tube or Du Mont Trichromoscope.

The new tube may be built with either one or three electron guns, with no change in the principle of operation, though of course with some variation in the details of circuitry and construction. It has been demonstrated with RCA 525-line dot-sequential color transmissions, but could be used with other systems if desired.

The screen of the new kinescope is made up of a vast number of dots of color phosphors, arranged in triangular groups of one green, one red and one blue dot. There are 117,000 of these triangles in the present developmental tubes, or 351,000 dots in an approximately 15-inch tube.

Directly behind the fluorescent screen is a metal mask which contains 117,000 holes of approximately the same size as the dots of color phosphor. The holes are opposite the center of each triangle, so they overlap equally the green, red and blue dot of the group. The angle at which the beam comes through the hole then determines which color dot will be excited (See Fig. 1).

Positioning of the guns in the three-gun tube of course determines the angle at which the beam will be projected through the holes at the fluorescent screen. Each gun takes the place of one of the tubes in the RCA three-tube system (RADIO-ELECTRONICS, January, 1950, page 28). When the red dot is being received, the beam from the red gun is modulated, being strengthened or weakened in proportion to the amount of red at that point in the scene being scanned. The blue gun takes over as the blue dot is received, and since its beam reaches only the blue dot on the screen, the blue phosphor is excited in proportion to the amount of blue in the point of the scene being scanned. Thus each color in the transmission is reproduced.

A means for converging the three beams at the same point is required. This is an additional electrode in the three-gun tube. The degree of convergence should vary during the line scan, on account of the varying angle which the sweeping beam makes with the practically flat screen. This is provided for by varying the voltage on the convergence electrode.

An ingenious dodge makes the single-gun tube the practical equivalent of three guns. The beam from the single gun is magnetically rotated, so that it occupies in quick succession the posi-

tions of the guns in the three-gun kinescope. The beam is rotated by a special deflection yoke (Fig. 2) which can be adjusted on installation so that it is in the position of the green gun when the green dot is being received, then moves to the positions of the red and blue guns at the correct instant.

Convergence, which is controlled electrostatically in the three-gun tube, is controlled magnetically in this tube. The variation in convergence as the beam swings farther from the center of the tube is provided for by a dynamic convergence circuit, output from which is applied through a yoke shown just inside the convergence yoke in Fig. 2.

At least two research receivers have been built for the new color kinescopes. Both include a 27-tube standard black-and-white chassis. One has 19 additional tubes for color synchronization, sampling, additional power supply, etc. The other, a simplified circuit, uses 10 extra tubes for these purposes.

Both the one- and three-gun tubes operate with a final anode voltage of 18,000. The convergence electrode of the three-beam tube operates at 9,000 volts and focussing voltages are in the order of 3,000 volts.

A new circuit on these receivers— not developed at the time of the January article—is that for *color synchronization*. Not only must lines and frames be kept in perfect synchronization with those of the transmitter, but in the color receiver synchronization of the color dots is essential. In early models, there was a tendency for the receiver to drift, with the result that the transmitter might be sending out a red dot

while the receiver was only half way between blue and red. The result was that part of the red dot would be interpreted as blue and the rest of it as red, causing a mixture of the two colors on the screen.

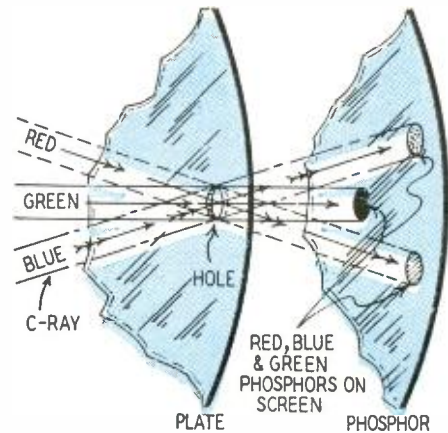

Fig. 1—Angle of beam determines color.

Additional pulses sent by the transmitter during the blanking period after each line are picked up from the video amplifier just as are the other sync signals. They are made to control the sampling so that the receiver is locked into step with the transmitter colorwise as it is for line and frame scan.

Additional improvements are in progress on these tubes and circuits, but enough has already been demonstrated to prove that an electronic color television system with a single viewing tube is possible today, and should be economically and technically practical within the next couple of years.

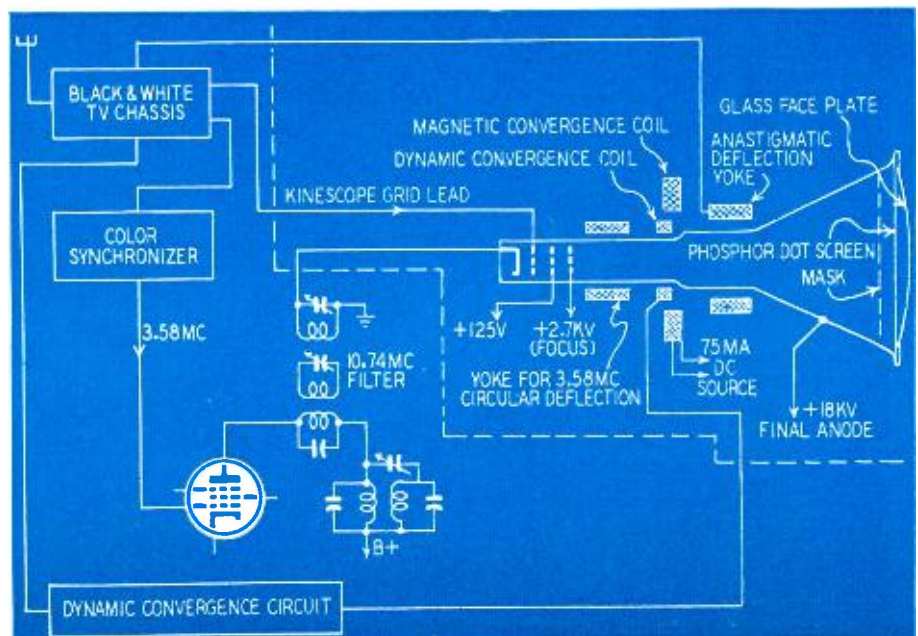

Fig. 2—Diagram of the single gun system adapted to a black-and-white TV set.

Electronic TV Magnifier

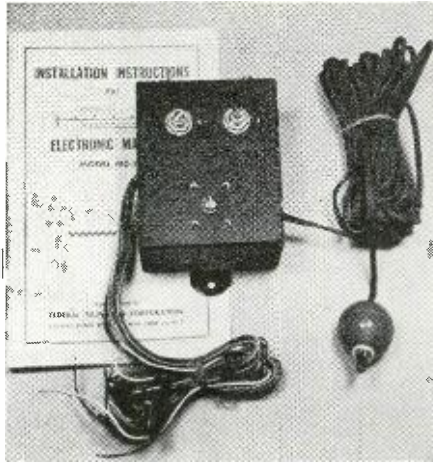

Photo 1—Complete kit includes metal box with relay, resistors, and capacitor inside, and booklet showing connection diagrams for use with any TV receiver.

Adapter unit provides blown-up images on electromagnetic sets.

By RICHARD H. DORF

NOWADAYS anyone can add electronic enlargement to almost any television receiver with the aid of a little device put out by Federal Television Corp., New York—the electronic magnifier, model MD-100. The effect is the same as that of the Garod Tele-zoom introduced some time ago and since incorporated in other manufacturers' models. At the press of a hand-held button, the picture enlarges as if the camera had suddenly moved closer to the performer. Another press and it returns to normal.

The actual effect on the eye varies considerably with the particular picture. For some psychological reason, some enlarged scenes give a tremendous effect of greater nearness while others seem to change hardly at all.

The entire magnifier consists of the little black steel box shown in photo 1. Inside it are one fixed and two variable resistors, a capacitor and a 6.3-volt relay with four s.p.d.t. contact assemblies. Leads from the contacts and components come out through one hole and a 23-foot cable comes out of another. On the end of the cable is a small hollow plastic sphere in which a push-button switch is mounted.

The magnifier is diagrammed in the figure and the inside appears in Photo 2. It was installed on an Admiral 30A1 chassis, as the diagram indicates. The instruction book that comes with the unit has 33 separate installation diagrams covering almost all electromagnetically deflected models of 62 manufacturers.

How it works

In the diagram the relay contacts are shown in their normal position, the relay unenergized. The control button

at the end of the cable closes the circuit when pushed once and opens it on the next push. The brown and black relay leads are connected to any convenient source of 6.3-volt a.c. Dotted lines in the diagram indicate connections that were removed when the magnifier was installed. In each case, the connection is remade by a closed pair of relay contacts.

Now suppose we push the control button once to energize the relay. In the original receiver circuit, the plate voltage of the discharge section of the 6SN7-GT vertical oscillator is varied to control height. The white and special

leads from the magnifier box connect a 3.2-megohm potentiometer in shunt with the set's height control. Relay contact section D switches the vertical oscillator plate to the new 3.2-megohm resistor arm, which can then be adjusted for the desired expanded height. The set's original height control still varies the height when picture size is normal. It must be readjusted, of course, as its total value is changed by the shunt. (The 3.2-megohm potentiometer, by the way, is listed in Federal's diagrams as 2.5 megohms, but its case says 3.2. Its shaft has a red dot to identify it.)

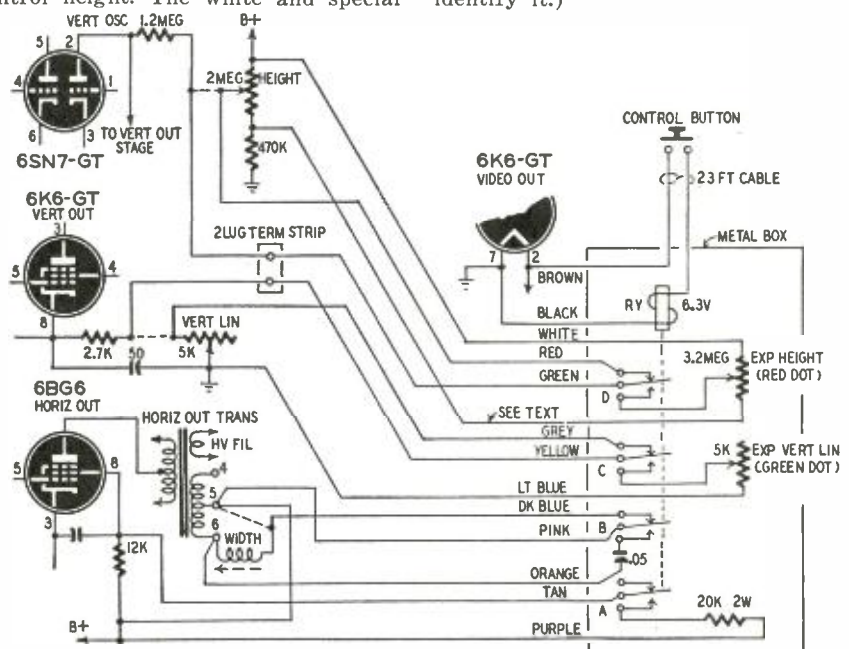

Schematic of magnifier installed in Admiral 30A1 chassis. Other diagrams come with the unit. Use tie lugs where possible to join long wires under chassis.

The special lead is not in place when the magnifier is bought. Some receivers use a voltage-dropping rather than a voltage-dividing arrangement for height control, in which case only the B-plus connection is needed. The diagrams in the instruction book indicate when the special lead must be added.

Vertical linearity is controlled in the Admiral by varying the cathode resistance of the 6K6-GT vertical output stage. The original circuit, as shown, varies slightly from the expanded circuit. In the original, both end connections of the 5,000-ohm potentiometer are used, while in the magnifier circuit only the arm and one end are connected. The advantage in the original is that, if the arm fails to make contact due to dirt or age, the vertical deflection will not fail entirely. That can be duplicated in the magnifier, but the writer did not think it worth while to bother adding the extra lead.

Two long wires in the chassis must be connected to wires from the magnifier—those from the vertical oscillator plate and the vertical output cathode. Rather than taping them and leaving them hanging, install a two-terminal strip inside the rear chassis apron between the height and vertical linearity controls.

To increase the horizontal deflection two things are changed. First, a 20,000-ohm resistor is shunted across the 12,000-ohm screen resistor of the 6BG6 horizontal output stage. That increases the screen voltage and the output, which raises both secondary outputs of the horizontal output transformer. The width control is replaced by a .05- μ f capacitor. The capacitance is reflected into the high-voltage winding, reducing the voltage to something slightly below normal and making the beam less stiff so that the deflection current has greater effect. The reflected effect on the high-voltage winding reduces high voltage to a greater degree than it reduces deflection current because the high-voltage winding is of much higher impedance. The net result is more deflection current and less high voltage which gives a boost to the picture width.

Installation

Installing the magnifier is easy. The only thing to be careful about is the C-R tube—don't let anything fall on it and don't drop the chassis when you're carrying it.

The instructions suggest mounting the black metal box in the cabinet. Two wood screws are provided for the purpose. The writer did not like that idea, as the box would have to be detached and dangled every time the chassis came out. First thought was to hang it like a rumble seat on the rear chassis apron, but a better place was found on top of the high-voltage cover. It was mounted far enough forward to leave the ventilating grill almost completely clear. Very short self-tapping screws avoid having anything stick down near the high voltage.

To make the job look shipshape. all

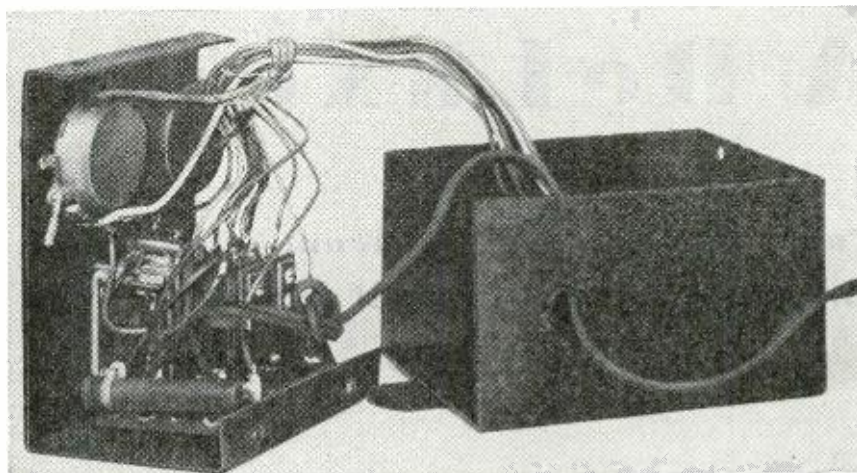

Photo 2—All the parts are mounted in the box, held together with four screws.

the colored leads were laced together with waxed cord to the point where they enter the chassis. All the leads for vertical circuits were pushed through the hole provided for the C-R tube socket connections. The rest were led back about 4 inches to the hole through which the deflection—and focus—coil leads come.

The brown and black leads for the relay coil were soldered to pins 2 and 7 of the 6K6-GT video output tube, which happens to be the most convenient. The white and gray leads were attached directly to the controls, and the other two were brought to the two-terminal strip installed for the purpose.

The color code is clear—but watch the brown and light blue leads (the word "light" is not used in the instruction book) to avoid confusing them with the tan and dark blue ones. If in doubt, use an ohmmeter. In addition, most of the colors agree with those used in the set's own wiring.

The tan and purple leads go directly across the 12,000-ohm resistor in the 6BG6 screen circuit—no trouble there. Lead the orange, dark blue, and pink wires over to the high-voltage compartment, then up again through one

of the holes. The transformer terminals are marked clearly (though upside down).

Clip the width-control connection away from terminal 5, leaving enough wire hanging out of the spaghetti for connection. Scrape it with steel wool, as it is enameled. Then tie the dark blue lead to it. The writer wanted to use a terminal but couldn't find a place to mount it without more drilling, so the connection was simply wrapped with Scotch electrical tape and left alone. The leads are all laced and there is no strain, but when taking off the high-voltage cover with the magnifier box mounted on it, it won't be a good idea to tug too hard on the leads.

Putting the chassis back in the cabinet is the next step, followed by adjustment. Push the button once or twice to see that the relay clicks, then, with size normal, readjust all the set's controls in the usual way. Push the button for enlargement, then adjust the two control shafts on the magnifier box for the desired magnification. Set the horizontal drive on the receiver to maximum, adjust width in normal condition with the width control, and you'll have all the expanded width you want.

TELEVISION DX

Long-distance television reception is a seasonal thing, with the summer months a little more favorable than the winter. With this in mind, we hope to be getting more reports before long.

J. F. Hunnicutt, West Hartford, Conn., reports having received WTMJ-TV, Milwaukee, on channel 3 last July with perfect picture and sound. He uses a 7-inch Telitone with a Transvision booster. Antennas are a stacked conical, a modified Yagi array, a stacked folded dipole, and a reflector high-band array which is used for dx-ing. These are all homemade. Mr. Hunnicutt has also received Stratovision station W10XWB.

G. F. Early, Topeka, Kansas, reports receiving WKY-TV, Oklahoma City, some 290 miles away. The unusual feature of this reception is that his an-

tenna was at all times oriented on WDAF-TV in Kansas City. A look at the map tells the story. Receiver was a Motorola 12VT13, and the antenna a Ward T-49.

William Bashta of Los Alamos, N. Mex. reports receiving KOB-TV, channel 4, Albuquerque, N. Mex.; WBKB, channel 4, Chicago; and WTMJ-TV, channel 3, Milwaukee, Wis.

R. Ulbrich of Erie, Pa. received with very good picture and sound on March 6: WNBK, channel 4, Cleveland, Ohio; WBNB-TV, channel 4, Buffalo, N. Y.; WXYZ-TV, channel 7, Detroit, Mich.; WWJ-TV, channel 4, Detroit; WJKB-TV, channel 2, Detroit; and WHAM-TV, channel 6, Rochester, N. Y. The receiver is a Motorola Model 9L1 and the antenna a BM312X2 stacked fan Flecton.

A DeLuxe Televiser

Part VI—Aligning the front end and checking with visual method

By

CHARLES A. VACCARO

If you have followed closely the construction of this televiser since the series began in the January issue, you will probably have completed the set and will have aligned the i.f.'s with AM-type test equipment. In this installment, we will discuss the alignment of the tuner and will show how alignment can be done or checked with a sweep generator and scope.

It is difficult to completely align the front end or tuner when it is in position on the chassis because some of the high-frequency coils are hard to reach. Adjusting these is made easier by using a special bracket made of .064-inch or heavier 1-inch aluminum. The bracket is bent as shown in the photo and drilled for mounting holes. It should be long enough to hold the tuner chassis at an angle where the high-band coils and antenna terminals can be reached. Remove the extension shafts and nuts and bolts which hold the tuner to the main chassis. Fasten the tuner to the bracket as shown.

The Oscillator Coils

The oscillator coils can be aligned when stations in your area are on the air. The picture need not be a test pattern.

Switch to the different channels. If the audio from the station can be heard around the middle range of the fine tuning capacitor, leave that oscillator coil and proceed to another channel. If the audio comes in near minimum capacitance or if the picture is seen but the audio cannot be heard at all at the minimum-capacitance setting, then leave the capacitor at about half capacitance and decrease the inductance by spreading the turns on the coil until the audio is heard. If the audio comes in near maximum capacitance or if neither picture or sound is received and it is known that the station is on the air then proceed to increase the inductance by squeezing the turns of the oscillator coil until the sound and picture come in. The only exception to the above is for U-shaped coils for channels 10 to 13 inclusive. In this case, squeezing the two sides together will decrease the inductance thereby increasing the frequency while spreading the sides out or making the coil more circular will increase the inductance and therefore decrease the oscillator frequency.

One end of a high-frequency oscillation

can be unsoldered and the coil lengthened or shortened slightly to increase or decrease its inductance. This applies to the r.f. and mixer coils as well. If it is necessary to do this in more than one or two cases, check the wiring of the entire tuner before proceeding. Make sure that the switch, components, wires etc. to and from the switch do not differ from the layout. If the layout is followed, you need not do more than squeeze or spread the coil turns. Insulated rods and pliers will be handy for these coil adjustments.

The r. f. and mixer coils

These coils are coupled together and their adjustments are similar. Adjustments must be made with a test pattern on the screen and the audio carefully tuned in. Squeeze the plate coil turns together. If the signal gain decreases, spread the coil turns apart until the picture gain becomes maximum or the test pattern begins to tear. Then squeeze the turns together until the picture just starts to get weaker. At this point the picture quality im-

each active station are adjusted, the oscillator coils can be touched up so the fine tuning control will bring in the different channels at approximately the same position of its range. Set it to the middle of its range and leave it there. Switch to the various channels and adjust each oscillator coil slightly so the sound can be heard for each. The only occasion where you may not want each channel to fall on the same fine tuning control position is if you are located where signals can be received on two adjacent high-band channels such as 8 and 9, 10 and 11 or 12 and 13. In this case, the higher of the two must tune as closely as possible to minimum capacitance so the lower channel can be tuned near maximum capacitance. This will usually be an exception so in most cases you will be able to set the osc. coils so the channels in the area will fall in at the same tuning position when the selector switch is rotated.

After the high channels have been aligned and the tuner is fastened back down to the main chassis, it may be necessary to touch up the coil adjustments slightly. This is due to the reduced inductance to ground after adding the other two ground leads.

The tuning of the r.f. and mixer coils is usually unaffected and that of the oscillator coils will be slight if at all.

After the front end alignment has been completed, an additional improvement can usually be gained in picture quality by touching up three of the cores in the i.f. strip. Tune in the channel displaying the best test pattern. Touch up the 25.0-, 25.3-, and 25.4-mc adjusting screws. These will not require more than one and usually not more than $\frac{1}{4}$ of a turn. Turn the screw slowly clockwise and note if an improvement is apparent. If no improvement is noted, return the screw to its former position and move up to the next one in the order listed. The trailing edges of the shaded circles of the test pattern will appear to stand out or have a third dimension as the core is turned in. Back off the adjustment to the point where this effect just disappears. If the screw is backed off too much, the whites will become streaked with gray and the sharp portions of the picture will smear. Do not touch any adjustments other than the

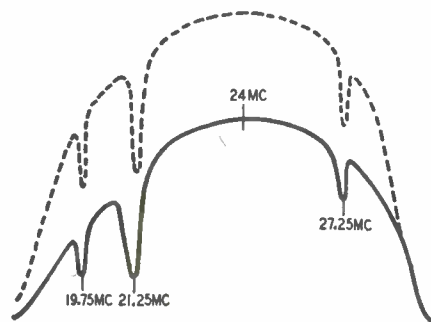

Fig. 22—Response of the loaded i.f.'s.

proves. Repeat the procedure for the mixer grid coil. Retouch each coil in turn until the lines in the vertical wedges are as distinct as possible. It will be possible to see these lines clearly all the way in—or nearly—in to the most narrow part of the wedge.

If you have succeeded with other channels but one cannot be brought up to the same quality, skip over it for a day or two and hope the quality of the transmission will improve. This occurs at times when adjustments are being made to the transmitting equipment and quite often an improvement is made within a few hours.

After all the transformer coils for

three that have been mentioned.

Place the sync selector switch in the ASC position and readjust focus and contrast controls.

Decrease the width of the raster if necessary by turning the core out of the width control. Turn down the contrast control slightly so the blanking bars can be seen on the edges of the raster. Turn the ASC horizontal hold control to the middle of its range. Adjust the horizontal discriminator adjustment screw protruding from the rear panel while switching the station selector switch off and on the channel being viewed. Adjust the screw so the picture is in sync the instant the channel is switched on. Then adjust the phasing screw at the opposite end of the discriminator transformer so the blanking bars are equal on each side of the picture. If this latter adjustment has to be changed very much the procedure should be repeated. The adjustment can be checked by rotating the ASC horizontal hold control to full clockwise and counter-clockwise positions. The picture should not go out of sync in either direction.

It is a good time now to become familiar with the proper vertical hold position for interlacing. The picture may or may not slip out of sync at the extreme ends of the vertical hold control. However near both ends of the control the space between the horizontal lines will be wide and appear stationary. At a position about half way between these two limits the lines will appear to be moving and the space between lines will be very thin. This is the proper position for the vertical hold control.

Using sweep gen. and scope

Although not entirely necessary, an oscilloscope and sweep generator are useful for checking the passband and response of the various circuits.

To check the alignment of the video i.f.'s, set the sweep generator at 24 mc, adjust it to sweep through 10 mc, then connect it to the mixer grid. Connect the scope between the junction of the 6AC7 video peaking coils and ground. Keep the output low so the amplifiers are not overloaded. Use an accurate signal generator or marker generator to check the response at points shown on Fig. 20. Be sure that the 25.75-mc marker is half way down the slope. If the curve differs from Fig. 20, repeat the alignment as described in the May issue. Complete the check with the marker generator set at 21.25 mc.

Connect the sweep generator between the grid and ground of the 6SH7 limiter on the sound i.f. strip. With the marker still set to 21.25 mc, tune the sweep generator to this frequency and set it to sweep approximately 2 mc. Connect the scope to the grid of the 6SF5 or 6V6 a.f. amplifiers. Advance the gain on the scope and keep the generator output just high enough to produce a fair-sized pattern on the scope.

Adjust the *bottom* screw of the a.f.

discriminator transformer for maximum deflection on the scope and adjust the *top* one for the typical discriminator response curve. Continue the adjustments until the center portion of the trace is as straight as possible between peaks, and the peaks have maximum and equal amplitudes above and below the 21.25-mc marker. See Fig. 21. The *bottom* adjustment affects the amplitude of the trace while the *top* shifts the response about the center or marker frequency.

Move the signal generator to the mixer grid and adjust both cores of the sound i.f. transformer so the response is maximum and the linearity is as shown in Fig. 21. Check this by moving the marker to 21.15 and 21.35 mc. These points should be equidistant from the peaks.

Unless the sweep generator has crystal-controlled frequencies for the r.f. sound carrier for each channel, use the station's sound carrier to adjust the oscillator coil as described in the beginning of *this* installment. Just be sure that the stations all come in at approximately the same position on the fine tuning control.

Remove the 300-ohm line between the antenna terminals and the tuner. Connect the generator to the tuner, using a non-inductive resistor—usually 100 or 200 ohms—to match the tuner to the generator. Shunt the 22-mc mixer plate coil with approximately 350 ohms and connect the scope between ground and the junction of this coil, the .0047- μ f capacitor, and 36,000-ohm resistor. Turn down the contrast control and leave it until the preliminary adjustment of the front end is completed.

Switch the tuner to the lowest channel and adjust the generator as closely as possible to the center of the channel. Adjust the sweep to 10 mc. Set the scope and generator gain controls so the trace is visible. Adjust the mixer grid and r.f. plate coils to obtain a nearly-flat, maximum-response curve. Sacrifice some gain for a nearly-flat curve if it droops in the center. Spreading and squeezing the turns on the coils will increase and decrease their resonant frequencies, respectively. Separating the two coils will decrease the bandwidth. Moving them together increases the bandwidth and reduces the amplification. Coil changes will be minor if they are reset as shown in Fig. 14. Crystal-controlled markers can be used to mark the edges of the band.

For the dual-channel positions 8-9, 10-11, and 12-13, select stations which are or will be in your area and adjust the coils for maximum response. To cover the six highest channels, adjust the oscillator coils so the sound for the higher of each pair comes in at minimum setting of the fine tuning control. The r.f. and mixer coils are adjusted wide enough to cover both channels. For example; a range of 180 to 192 mc is required to admit both channels 8 and 9.

Set the sweep generator to the *upper* limit of the *lower* channel and sweep it over 15 mc. Adjust the coils for as flat a response as possible over approximately 12 mc. If crystal markers are not available, shunt the five video i.f. coils with non-inductive resistors of about 350 ohms. Connect the generator and scope as described for video i.f. alignment. Use a 10,000-ohm resistor in series with the scope. Adjust the sweep to 15 mc. The pattern of the loaded i.f.'s will be similar to the solid curve shown in Fig. 22.

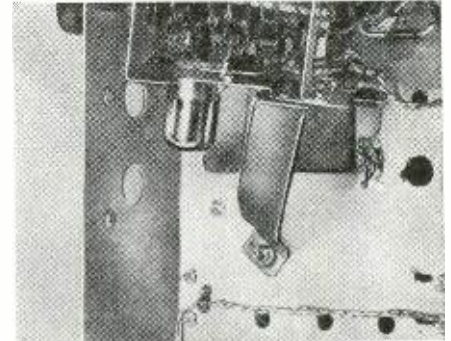

Bracket holds tuner during alignment

Reconnect the generator to the tuner antenna terminals to check the overall video response. Advance the contrast control to nearly maximum and set the fine tuning control for the sound on the *lower* channel. Adjust the generator to sweep 15 mc centered on the *upper* limit of the upper channel. The response will be similar to the broken curve in Fig. 22. However, it should not drop too sharply at 19.75 mc. Swing the fine tuning control to minimum or to the best tuning point for the *upper* channel. The response curve will be the same but it should not drop too sharply at the 25.75-mc end of the curve.

The table shows the TV channels with band-edge, carrier, and receiver oscillator frequencies. Refer to it when setting the sweep and marker generator frequencies and when making calculations.

Table of the Important TV Frequencies

Channel No.	Band	Video Carrier	Audio Carrier	Rcvr. Osc.
2	54-60	55.25	59.75	81
3	60-66	61.25	65.75	87
4	66-72	67.25	71.25	93
5	76-82	77.25	81.75	103
6	82-88	83.25	87.75	109
7	174-180	175.25	179.75	201
8	180-186	181.25	185.75	207
9	186-192	187.25	191.75	213
10	192-198	193.25	197.75	219
11	198-204	199.25	203.75	225
12	204-210	205.25	209.75	231
13	210-216	211.25	215.75	237

Note: Band, carrier, and oscillator frequencies are in megacycles.

This completes the front-end alignment, so touch up the video i.f. and sync discriminator adjustments as previously outlined in *this* installment.

Television Dictionary

(Continued from page 38 of the May issue)

Scanning

The process of exploring an image, usually with an electron beam, in a predetermined pattern. In standard television practice, scanning of an image is accomplished in 525 horizontal lines.

Scattering

The tendency of an electron stream to spread out or diverge due to the repelling influence exerted on every electron in the stream by every other electron.

Schmidt optical system

A method of projecting the im-

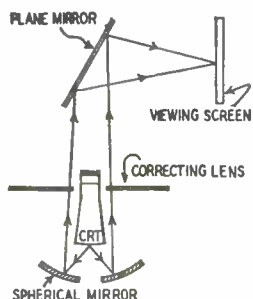

age from the screen of a cathode-ray to a larger viewing screen. The system uses a spherical mirror and a correcting lens to compensate for spherical aberration.

Separator

A clipping circuit used to remove a portion of a waveform by virtue of its amplitude. In the television receiver, a separator circuit is used to extract the synchronizing pulses from the composite signal. (See Amplitude separation.)

Sequential color transmission

A system of color television in which picture elements of the same color are transmitted as an individual field. (See Color sequence.)

Sequential interlace

A system of interlacing in which the fields are scanned in a progressive order. (See Progressive interlace.)

Serrated Vertical Pulses

The wide vertical synchronizing pulse is divided into a number of narrower pulses in order to prevent loss of horizontal synchronization during vertical flyback.

Shading

An undesired reduction of background illumination of the image, caused by secondary electrons returning to the mosaic. In the iconoscope, the impact of the scanning beam knocks secondary electrons out of the mosaic. Such secondary electrons may return to other globules and reduce the charge of the globule capacitance.

Shading generator

A device for reducing shading by generating waveforms

which are 180 degrees out of phase with the shading signals produced by the return of secondary electrons to the mosaic.

Spectral response

The same as spectral sensitivity.

Spectral sensitivity

The relative response of a photosensitive device to the different wavelengths within its range of response. For instance, some phototubes have a spectral sensitivity which is high in the blue region, while other tubes are more sensitive to red.

Spherical aberration

A defect of a spherical mirror which prevents the light from coming to a sharp focus on the principal axis.

Spherical mirror

A curved reflecting surface of such shape that it causes the rays of light striking it to focus upon a point on the principal axis. (See Concave mirror.)

Spurious signals

The shading signals produced by the return of secondary electrons to the mosaic of a pickup tube. (See Shading.)

Staggered interlace

A system of interlace in which the fields do not follow in a progressive order. (See Quadruple staggered interlace.)

Staggered tuning

Alignment of successive tuned circuits to slightly different frequencies in order to widen the over-all response.

Stratovision

A proposed system of increasing the range of television coverage by transmitting the signal from an airplane.

Sweep

Movement of the spot across the screen of a cathode-ray tube. Sweep is normally accomplished either by applying a sawtooth voltage to the deflection plates (electrostatic deflection) or by passing a sawtooth current through the deflection coils. (electromagnetic deflection).

Synchronization

Timing of an electrical action or waveform. In the television receiver, the horizontal and vertical sweep oscillators are synchronized or locked-in by the synchronizing pulses which accompany the transmitted signal.

Synchronization clipper

A circuit designed to remove the synchronizing pulses from the composite signal. (See Separator and Amplitude separation.)

By ED BUKSTEIN

Synchronization pulses

Pulses transmitted along with the picture information and used to lock-in the frequency of the sweep generators in the receiver.

Synchronization separator

Same as synchronization clipper.



Tearing

Splitting of the television picture due to improper synchronization.

Teletext

A television broadcast.

Televise

The process of converting an optical image into an electrical image for transmission.

Test pattern

A fixed television image used to determine the quality and correctness of adjustment of a television system. (See Resolution chart.)

Tilt

Scanning a field of view by moving the camera in a vertical plane.

Trace

The path followed by the spot as it moves across the screen of a cathode-ray tube.

Trap

A tuned circuit used to eliminate a given signal or to keep it out of a given circuit. For instance,

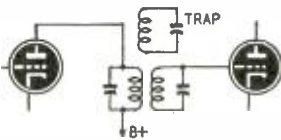

in the television receiver, traps in the video circuits keep the sound signal out of the picture channel. One type of trap is simply a tuned circuit which absorbs the energy of the signal to be eliminated.

TV

A commonly used abbreviation for television.



Vertical blanking

The application of cutoff bias to the cathode-ray tube during the vertical retrace.

Vertical centering control

The adjustment which shifts the image in the vertical direction so

that it may be centered on the screen.

Vertical hold

The adjustment which varies the free-running frequency of the vertical sweep oscillator in the television receiver. When this adjustment is properly set, the incoming synchronizing pulses will "lock-in" the frequency of the vertical oscillator.

Vertical retrace

The movement of the spot from the bottom of the image to the top after each vertical sweep. The cathode-ray tube is biased beyond cutoff during this time.

Vertical synchronization

Locking-in of the vertical sweep oscillator by the incoming vertical synchronizing pulses. (See Vertical hold.)

Vestigial sideband transmission

A method of transmission in which one set of sidebands is largely, but not completely, eliminated. This system is employed in commercial television practice.

Video

Pertaining to television signals or equipment.

Video amplifier

The amplifier stages following the video detector in a television receiver. They are designed to have a flat response up to several megacycles.

Video detector

The demodulator circuit which

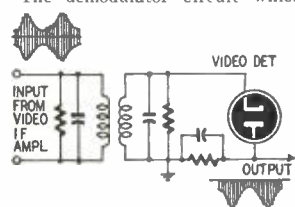

extracts the picture information from the modulated carrier.



Width

The horizontal dimension of the television image.

Width control

The adjustment which varies the horizontal size of the television picture. This is accomplished by controlling the amplitude of the horizontal sawtooth.



Yoke

The assembly containing the deflection coils used for electromagnetic deflection. (See electromagnetic deflection.)

(This concludes the Television Dictionary, which began in the January 1950 issue, and continued through every issue thereafter.)

Using the VR Tube

How to use voltage regulator tubes in designing power supply circuits

By CARL W. SHIPMAN

SOME types of circuits, such as oscillators and unbalanced amplifiers, are adversely affected by changes in supply voltages. A voltage regulator tube in the power supply circuit may improve their operation greatly.

Voltage changes may be due to variations in the a.c. supply or to variations in the load current acting through the resistance of the power supply. A voltage regulator tends to isolate its output from changes of either type.

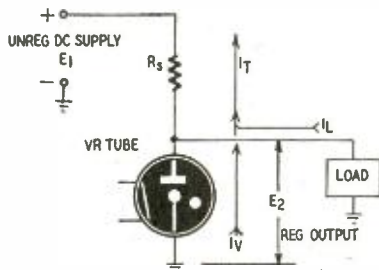

Fig. 1—Typical circuit using a VR tube.

Voltage regulator tubes are cold-cathode, gaseous-discharge diodes. A characteristic of gas-filled tubes is a relatively constant internal voltage drop within wide limits of current. In these tubes, a current variation of 600% will produce a voltage change from plate to cathode of less than 5%.

Gas-filled diodes have three characteristic voltages, determined by the gas or gases used and the construction of the tube. The starting or ionization potential is the voltage which must be impressed to start the initial ionization and current flow. When the gas becomes ionized, the voltage across the tube falls to a lower value, called the operating potential. This operating potential is maintained over a large range of current values. If the voltage is reduced below the operating potential, a point is reached where conduction stops. This is the de-ionizing voltage.

The first two of these constants are important in voltage regulation and are specified by the manufacturer for each tube type.

The regulator tubes most commonly used are the OA3, OC3, and OD3, which are also designated VR75, VR-105, and VR150, respectively. In the latter designations, VR stands for voltage regulator and the 75, 105, or 150 is the operating voltage drop across the tube. These tubes have a maximum current rating of 40 milliamperes. Regulation is somewhat better if the current does not exceed 30 ma. In these three

types the minimum current at which the voltage is stable is 5 ma.

A filtered but unregulated voltage considerably higher than the operating potential for the tube must be supplied to the regulator circuit. Operating voltages and currents for these three types are shown in the table below.

The VR tube is placed in series with a resistor R_s across the higher, unregulated voltage E_1 , and the regulated output E_2 . The load is connected in parallel with the regulator tube.

The total current I_T , which flows through R_s consists of the load current I_L plus the regulator tube current I_V . R_s is chosen so that the total current causes a voltage drop across it equal to the difference between the d.c. applied voltage and the desired regulated output.

If the supply voltage increases, the voltage across the VR tube and the load begins to increase. However, a very small change in voltage across the VR tube produces a large change in current. This increase in current increases the voltage drop across R_s . The result is that the voltage across the tube and the load remains practically constant. This same reasoning applies to a decrease in supply voltage.

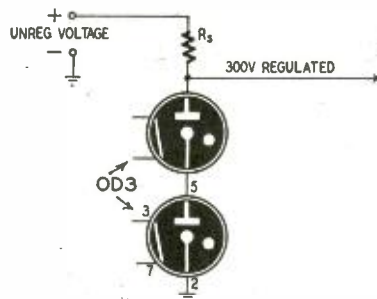

Fig. 2—A 300-volt VR regulated supply.

If the load current increases, it tends to reduce the voltage across the VR tube, due to the increased voltage drop across R_s . The tube responds by reducing its current flow so that the total current through R_s is virtually the same, with the result that the regulated voltage undergoes only a slight variation. If the load current decreases, the tube current then increases a corresponding amount.

The value of the series resistor R_s

is found by dividing the current which flows through it into the voltage across the resistor. This voltage is equal to the difference between the unregulated d.c. voltage and the regulated d.c. voltage. In Fig. 1, this voltage is E_1 minus E_2 . The current through the series resistor is taken to be the maximum rated current of the VR tube. In the following example, this is 40 ma.

Suppose it were desired to supply a regulated 150 volts to a small load. An OD3 would be placed in the circuit of Fig. 1. The unregulated supply voltage must exceed 160 volts to ionize the tube, and should be considerably higher to allow drop across R_s . If 250 volts were available, the required voltage drop across the series resistor would be 250 minus 150 volts, or 100 volts. The value of R_s is calculated by dividing 100 volts by 40 ma, resulting in 2,500 ohms. The power dissipation in the resistor is 100 volts multiplied by 40 ma, or 4 watts. A value at least twice as large as this would be used to allow a safety factor.

If the load current in this circuit is zero, the tube will draw 40 ma and the output voltage will be 150 volts. If the load current increases, the VR tube current will decrease correspondingly, maintaining a relatively constant output voltage. If the load current rises to 35 ma, the current through the VR tube will then be 5 ma, which is its minimum value. Therefore this circuit will provide regulation for any value of load current between zero and 35 ma.

Two or more voltage regulator tubes may be connected in series to provide higher values of output voltage as shown in Fig. 2.

A jumper within the tube is connected to two of the socket pins. The power supply may be wired so that removal of the VR tube will disconnect the load. This is an excellent safety and alarm device and should not be overlooked in circuits where application of unregulated voltage is undesirable.

Tube type	Operating voltage	Starting voltage	Supply voltage
OA3	75	100	105
OC3	105	115	133
OD3	150	160	185

Fundamentals of Radio Servicing

Part XV—The Power Output Stage

By JOHN T. FRYE

“Tinker to Evers to Chance!”

THAT hallowed phrase from the world of baseball is a classic description of split-second, three-way co-operation. In a radio receiver, though, we have another example of one-two-three team play that might well be paraphrased: “output stage to transformer to speaker.”

Let us examine this trio, starting with that familiar member, the speaker. In the last chapter we learned that to make a speaker “work,” we must have a varying current flowing through the voice coil. This voice coil cannot contain many turns of wire for two good reasons: first, there simply is not room for a large coil in the restricted space in which the voice coil moves, and this

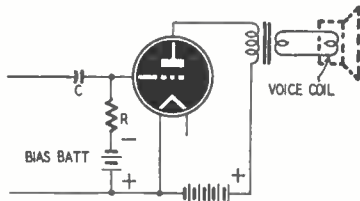

Fig. 1—A single triode output stage.

space cannot be increased without weakening the strong magnetic field needed in the air gap.

Second, more turns of wire would increase the inductance, and inductance is something we do *not* need in a voice coil. The reason is that inductive reactance—unlike pure resistance—plays favorites with frequencies, and it has low-down tastes. It will allow a low frequency to pass with comparatively little hinderance, but its opposition grows stronger and stronger as the frequency becomes higher and higher. Such partiality would mean that a speaker with a highly inductive voice coil would unduly accent some audio frequencies and play down others. The sounds coming from such a speaker would not be a true reproduction of the sound originally heard in the broadcasting studio.

Voice-coil inductances are like whiskers: we cannot get rid of them entirely, but we can keep them whittled down. The way to keep inductance small is simply to keep the number of turns low. Unfortunately this solution, like the solution of nearly every other prob-

lem in this wacky radio business, gives birth to a new problem. The strength of the magnetic field produced by currents in the voice coil depends on two things—the number of turns in the coil and the strength of the current. If we are going to have few turns, we are going to have to have lots of current. Heavy current means large wire. Large wire means low resistance—and that is what our voice coil has. You will soon see why this low resistance complicates coupling a speaker to the radio receiver.

Usually the d.c. resistance of a dynamic speaker voice coil lies somewhere between 1 and 20 ohms, the average being in the neighborhood of 5 ohms. The impedance of the coil—resistance plus inductive reactance—is roughly 25% higher than the pure resistance. For example, a voice coil that has 4 ohms of resistance will present approximately a 5-ohm impedance to a frequency of 400 cycles per second, this being the frequency at which voice coil impedances are usually measured. This is good, for the impedance of our coil consists chiefly of resistance and will present a fairly uniform impedance to all audio frequencies.

The output stage

Now let us go to the other end of this triple-play combination and consider the *output stage* of the receiver. By “stage” we mean a tube or combination of tubes, together with proper input and output circuits, that performs a single operation on the signal

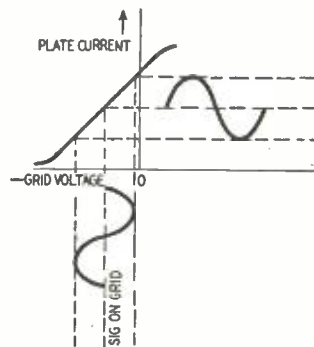

Fig. 2—Output varies with grid signal.

passing through the receiver. The output stage is the one that handles the signal just before it is delivered to the speaker. For the purpose of our study,

we shall assume that our output stage consists of a single triode tube connected as shown in Fig. 1.

An alternating, audio-frequency voltage is delivered through capacitor C from the preceding stage to the grid of our output tube and appears across resistor R. This means that the alternating voltage is really in series with the fixed negative voltage that the bias battery delivers to the grid. Voltages in series can be added like positive and negative numbers in algebra. That means that when the audio voltage is on the negative half of the cycle, its value is added to the bias voltage and makes the grid more negative. During the positive half of the cycle, its value is subtracted from the negative bias voltage and the grid becomes less negative.

Fig. 2 shows what happens to the plate current while the grid voltage is waltzing around in this dizzy fashion. As might be predicted from our study of triode action, the plate current rises and falls right in step as the voltage on the grid becomes less and more negative. As is evident from Fig. 2, the pattern of the plate current is a reproduction of the audio voltage applied to the grid.

“Eureka!” you are probably shouting in your best Greek accent. “Here we have exactly what we need to make our speaker do its stuff: a varying current that follows curves better than a lastex suit! All we have to do now is to place our voice coil in the plate lead of the output tube and sit back and listen to the program rolling in loud and clear.”

Not so fast, my friend! You are forgetting something—or several somethings. Remember we said few turns on the voice coil meant heavier currents—or rather excursions of current, for it is variation in current that makes our voice coil move back and forth. Well, the plate current swings of our triode are not likely to exceed 100 milliamperes, and that is far too small a current to get much action out of our speaker.

And there is another point. You will recall that when we talked about characteristics of vacuum tubes we found that every tube has a *plate resistance*. If we consider our output tube a generator of power—and it really is—this plate resistance represents the internal resistance of our generator. It is an

easily demonstrated fact that a maximum transfer of energy takes place between a generator of power and the thing receiving the power when the "giver" exactly matches that of the "givee." (I'm haunted by the feeling that there is some sort of an analogy in there to a playboy trying to give a mink coat to a chorus girl, but I can't quite pin it down.)

To demonstrate this "easily demonstrated fact," suppose we consider Fig. 3. Here we have a 100-volt generator with an internal resistance R_i of 10 ohms and a variable external resistance R_e that is used as the load. The table shows what happens to the cur-

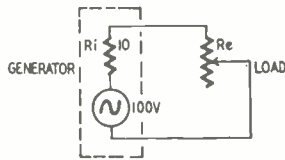

Fig. 3—Output varies as R_e is changed.

I R_e (Ohms)	II Current (Amperes)	III Voltage across R_e	IV Power in Watts $II \times III$
1	9.09	9.09	82.6
5	6.66	33.3	222.0
10	5	50.0	250.0
40	2	80.0	160.0
100	0.909	90.9	82.6

rent, the voltage drop across R_e , and the power dissipated by R_e as its resistance is set at various values. It is readily seen that the *maximum power* is delivered to the load when its resistance is 10 ohms, the same as the internal resistance of the generator. Either increasing or decreasing this load resistance results in a loss of power. You might also note, for future reference, that the *maximum voltage* across the load resistance does *not* appear at this point but goes up as the load resistance increases.

This is easy to see if you will consider that when R_e is made smaller, the output voltage gets smaller, until R_e gets to zero and there is no output voltage. With no output voltage there can't be any power because the power is equal to voltage \times current.

Going the other way, if R_e is made larger, the current keeps getting smaller until there isn't enough current to have any output power.

If our output tube is a 45 with 250 volts on the plate, its plate resistance is 1,610 ohms; and it will deliver the most power to a load in its plate circuit if the impedance of this load is also 1,610 ohms. But, when a tube is thus putting out its maximum amount of power, the plate current variations do not exactly follow the grid voltage current changes, and we have some *distortion* of the signal. (More about this distortion subject in the next chapter.)

This distortion can be reduced by increasing the load resistance to something more than twice the plate resis-

tance. This means a reduction from the maximum power output of our tube, but the loss is so small the ear cannot detect it. For obtaining maximum "undistorted power output" from our 45 tube, the manufacturer recommends a load resistance of 3,900 ohms.

And now we see why the low resistance of our voice coil presents a problem. There is a lot of difference between the 3,900 ohms needed in series with our output tube's plate lead and the 5 ohms or so of impedance in our voice coil. If we placed the voice coil in the plate lead, practically no power would be delivered to the speaker. What we need is some dings that will allow us to "match" the high plate resistance of the output tube to the low voice-coil impedance of the speaker in the same way that a plumber uses a reducing coupling when he wants to connect a large pipe and a small one together.

Output transformer

In discussing the transformer (October, 1949, issue of RADIO-ELECTRONICS), we said it provided a method of changing high voltage at low current into low voltage at high current. Suppose we place a transformer between the output tube and the speaker as is shown in Fig. 1. Let the primary winding placed in series with the plate lead, while the secondary connecting across the voice coil is made up of a few turns of heavy wire.

A review of the transformer action story will help us understand exactly what takes place when an audio signal appears on the grid of the output tube. First, this causes the plate current to rise and fall. The surging of this varying current through the primary of the transformer sets up an expanding and contracting magnetic field that, in turn, produces an alternating current in the secondary winding. The flow of this current through the voice coil makes the cone move back and forth and pro-

duce sound from the loudspeaker.

Because of the high inductance of the primary, a considerable voltage appears across this winding. Since our transformer is of the "step-down" type, much less voltage appears across the secondary, but the current in the secondary is accordingly much heavier than in the primary.

As explained before, when a low resistance is placed across the secondary of a transformer, the heavy current that this causes to flow in that winding produces a magnetic field that weakens the back-electromotive-force or impedance of the primary. If we increase the value of this load resistance and so reduce the current in the secondary, more "bucking voltage" is available to the primary and its impedance to the flow of a variable current rises. It follows then that we can make the primary impedance anything we wish simply by varying the load across the secondary. The whole thing works like a pair of long-bladed scissors in which a $\frac{3}{4}$ -inch opening of the handles results in a couple of inches of separation of the points.

Just as the amount of control that the handles have over the blades of the shears depends upon the ratio of the lengths of these two elements, so does the effect of secondary load upon the primary impedance of our output transformer depend upon the ratio between the number of turns of wire on each of these two windings. This relationship has been neatly expressed in one of those formulas so dear to the heart of the engineer:

$$N = \sqrt{\frac{Z_s}{Z_p}}$$

In this formula N is the turns ratio, secondary to primary; Z_s is the impedance of the load connected to the secondary; and Z_p is the impedance presented by the primary. Let's see if we can use this simple-looking critter to

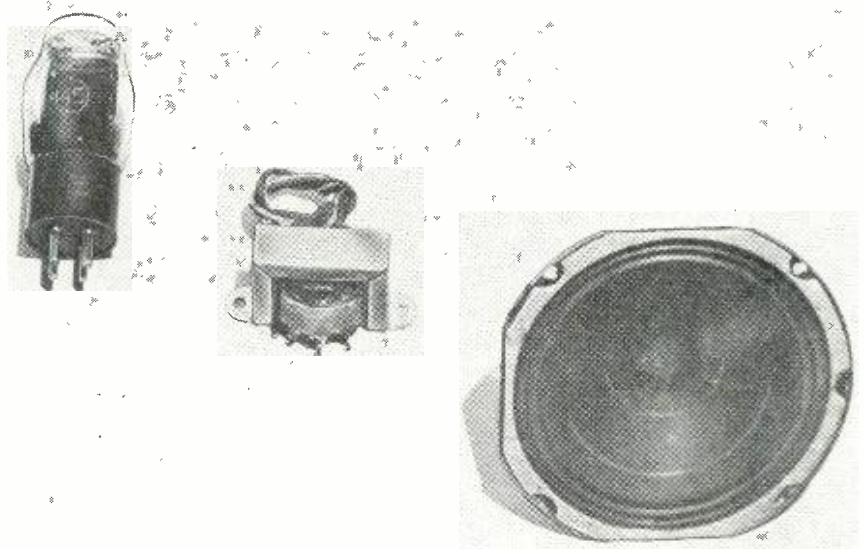

Three essentials of the output stage are tube, transformer, and loudspeaker.



Acme Photo

BORN without arms and legs is the extreme misfortune that befell Freddie, son of service technician Herschel Thomason of Arkansas. This unusual freak of nature is a continuous disaster for the parents. It will cost a fortune to equip Freddie with artificial arms and legs throughout the years.

With this issue we are putting Freddie's plight up to our readers and RADIO-ELECTRONICS is starting a collection for him. Every service technician knows full well how he would feel if such a terrible misfortune would befall his family.

Service for FREDDIE

Freddie Thomason, 2-year-old son of a radio service technician, gives a big smile for his mom.

As Freddie's father is a service technician himself, we trust that every reader of RADIO-ELECTRONICS will contribute handsomely to the "Help - Freddie - Walk-Fund."

The publisher of RADIO-ELECTRONICS has already sent out an appeal to the trade and we are happy to announce a number of contributions received up to the time we went to press.

No contribution is too small to help in this worthwhile effort to make the lot of Freddie's parents easier.

Make checks, money orders, etc., payable to Herschel Thomason and send remittances to:

Help-Freddie-Walk-Fund
% RADIO-ELECTRONICS
25 West Broadway
New York 7, N. Y.

Contributions received up to April 26:
Anonymous—Akron, Ohio \$25.00
S. B. Darmstadter—Chicago, Ill. 10.00
De Forest's Training, Inc.—Chicago, Ill. 50.00

Allan W. Fritzsche, The General Industries Co.—Elyria, Ohio 50.00
Hugo Gernsback—New York 100.00
S. Gernsback—Chicago, Ill. 10.00
Charles Golenpaul, Aerovox Corp.—New Bedford, Mass. 5.00
W. S. Halligan—Hallcrafters, Inc., Chicago, Ill. 50.00
Heath Co.—Benton Harbor, Mich. 50.00
L. M. Heineman, Permoflux Corp.—Chicago, Ill. 5.00
National Union Radio Corporation—Newark, N. J. 50.00
National Radio Institute—Washington, D.C. 25.00
E. G. Perkins, Supreme, Inc.—Greenwood, Miss. 10.00
Mrs. Helen S. Quam, Quam-Nichols Company—Chicago, Ill. 5.00
Ray Sparrow, P. R. Mallory—Indianapolis, Ind. 10.00
Sprague Electric Company—North Adams, Mass. 100.00
Sprayberry Academy of Radio—Chicago, Ill. 25.00
Standard Transformer Corp.—Chicago, Ill. 10.00
Superior Instruments Company—New York, N. Y. 50.00
Supreme Publications—Chicago, Ill. 4.00
Telrex, Inc.—Asbury Park, N. J. 25.00
The Astatic Corp.—Conneaut, Ohio 100.00
The Muter Co.—Chicago, Ill. 50.00
University Loudspeakers, Inc.—White Plains, N. Y. 5.00
Weller Mfg. Co.—Easton, Pa. 20.00
Wholesale Radio Parts Co., Inc.—Baltimore, Md. 15.00
TOTAL—\$769.00

FUNDAMENTALS OF RADIO SERVICING (Continued from page 35)

figure out the turns ratio needed:

Z_s is 5 ohms; Z_p is 3,900 ohms; so
N must equal $\frac{\sqrt{5}}{3,900}$ or $\frac{\sqrt{1}}{780}$. Unless

my slide rule has slipped, that means that our turns ratio will be just about 1/28. If our primary contains 280 turns, our secondary should have 10 turns.

In practical radio servicing it would be most inconvenient to have to obtain an exact duplicate unit for each output transformer replacement job, and it isn't necessary. "Universal" output transformers, of the type diagrammed in Fig. 4 are provided for this purpose. A tapped secondary allows you to have any turns ratio needed. Either the primary or the secondary could be tapped to secure the proper turns ratios needed for matching various output tubes to

a wide variety of voice coils, but it is easier to tap the secondary.

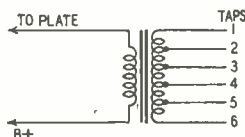

Fig. 4—Taps allow variety of matching.

You do not have to use your adding machine, slide rule, or abacus to figure out just which taps to use for matching a certain tube to a certain voice coil. A chart furnished with the transformer tells exactly what taps are needed to do any job you may encounter. For example, one such chart shows that if a single 45 is connected across the primary, a 1-ohm voice coil should be connected across taps 5-6 of the secondary;

a 6-ohm coil across taps 1-5; a 12-ohm coil across taps 1-6, etc.

If the proper match is not made, the quality of reproduction will suffer, although the average ear may not notice the distortion until the mismatch is quite serious. In general, the distortion will be worse if the tube is forced to work into a load that is below its plate resistance than if it works into a load that is higher than the recommended value. Usually the low frequencies are accentuated if the output tube is made to work into a too-high impedance, while the high frequencies are pushed up when the output impedance is too low.

Many output stages consist of two tubes working in a *push-pull* circuit, but this will be taken up in the next chapter in which we really delve into the *Care, Feeding, and Love-Life of the Audio Amplifier*.

Radio Repair For Aircraft

By MARGARET LATHAM*

PRIVATE aircraft radio servicing, one of the most fascinating branches of the radio field, is certainly not one of the easiest. The service technician must have a genuine interest in aircraft and the people who fly them, as well as a thorough knowledge of the principles of radio, because as often as not he is called upon to cancel his own personal plans to complete repairs on an aircraft radio.

In scheduled airline work "Sparks" gives the equipment an operational check and simply removes and replaces any defective unit, sending it to the shop for repair. The private operator seldom has stand-by equipment—it is necessary to service the set on the spot.

In our business at Newark Airport, we service aircraft of all sizes and all kinds. Our customers are divided into three main types: executive aircraft, non-scheduled air carriers, and small private planes.

The average executive aircraft—an airplane owned and operated by a corporation head or a bank president—usually has the very best of radio equipment. It carries a 50- or 100-watt m.h.f. transceiver, often equipped with radio-telephone channels; a range receiver; one or two automatic direction finders; a marker beacon receiver; two-way v.h.f. equipment; and either a blind landing system or complete omnidirectional equipment. The audios from the various sets are selected by toggle switches on a control panel, and every set is controlled from the cockpit.

We have built mock-ups of all the more popular types of radio equipment used in aircraft so that we may properly bench check sets. Our customers often have a definite schedule to follow, and we have a limited time to service the radio. Normal procedure is to remove the equipment from the aircraft and completely bench check. If the set functions normally, we must then check the various circuits in the aircraft itself.

Often intermittent conditions show up only at given speeds in flight. One of our very good customers kept complaining of a ticking noise in his range receiver. We gave the set an exhaustive

The author checking frequencies in a set from a small aircraft. ▶

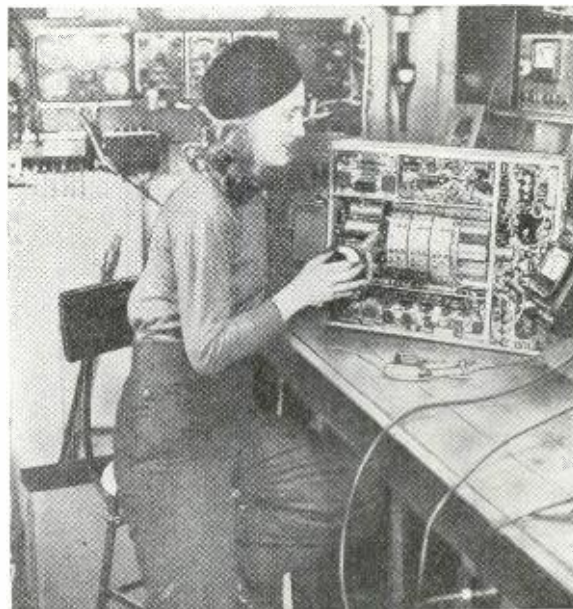

bench check—traced and checked every connection in every junction box and on every antenna fitting. Still the noise persisted. Finally, we checked the radios with the engines running, and found a vibrating shackle on an antenna support. Securely bonding the shackle to ground eliminated the noise. Although the support was not actually a part of the antenna, the receiver was so sensitive that it picked up the noise.

Sometimes radio trouble is definitely pilot error. We made a routine pre-flight check on a carrier one afternoon, and found everything satisfactory. The plane was scheduled to depart at eleven that night. The weather was very bad, with snow and cold. About ten-thirty in the evening, we were called to rush to the airport—the radio on the aircraft was out of commission and the flight couldn't depart until it was working. We wondered what could have gone wrong as we dashed back to the hangar. But the trouble wasn't too hard to locate—the transmitter was in a constant keyed position, throwing the antenna relay to the transmitter so that the receiver appeared not to be working. The manual key on the transmitter control was screwed down securely, and as soon as we released it the equipment functioned satisfactorily. Sometime much later, the pilot admitted to us that he had screwed the key down, hoping the flight would be cancelled because of radio failure, and he could stay home.

Installation problems

Private operators like ourselves usually do a lot of installation of new radios. This kind of work calls for a great many more skills than merely a knowledge of radio. To begin with, an aircraft is a very carefully balanced device, divided into two "arms" by a

central point or "datum line", and any added equipment must be carefully checked as to weight and distance on the arm, and whether the craft can "carry" the addition. Then a shelf or shelves must be fabricated for mounting the equipment. External antennas must be attached in a manner which will meet CAA approval.

All cables must be attached to the connectors carefully, every soldered joint made so that it will stand up under constant vibration. Wiring must be run so that it will not be subjected to any rubbing that may damage the insulation, and so that it will not interfere with any control cables. Most executive aircraft have a very "plush" interior, and all wiring must go out of sight behind the upholstery. It often takes hours to remove and replace trim to complete a job that ordinarily would take minutes.

A special job

One of the most ticklish installations we ever had was a pleasure radio installed in the cabin for the entertainment of the passengers. We selected a small receiver designed for light aircraft, which usually performs very well as a cabin radio. Speaker and receiver were mounted on the inner side of the doors of an ornate wooden cabinet, so that the interior of the cabinet could still be utilized for glasses and bottles. The doors required a lot of special woodwork to make the installation blend with the aircraft interior. However, the cabin was so effectively sound-proofed that, potent as the receiver was, the volume was not sufficient to carry properly in the "dead" cabin. We had to redesign the audio section of the receiver and build an additional amplifier stage before the set could be heard.

*Beane Radio Service, Newark Airport, Newark, N. J.

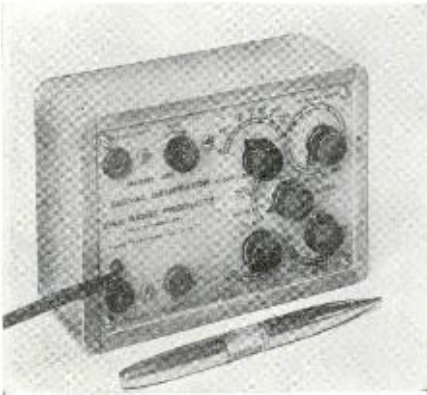

Model 103 is less than six inches long.

THE lack of truly portable signal generators and allied test equipment has been a major drawback to TV servicing and troubleshooting in the field. Smaller than most multimeters are the new Oak Ridge model 103 and 104 signal generators which were developed for signal tracing in the customer's home and facilitate on-the-spot servicing.

The model 103 generates modulated or unmodulated signals at TV video and sound carrier frequencies, at FM carrier frequencies, at TV sound and picture intermediate frequencies, and supplies a 500-cycle note for testing a.f. systems of FM and TV receivers.

A diagram of the 103 is shown. The circuit consists of a 6C4 operating as a grounded-plate oscillator on bands A, B, and C, and a Hartley oscillator on band D; and a 6J6 multivibrator-type a.f. oscillator. When it is turned on by opening the switch across one of its grid resistors, the r.f. oscillator is modulated by the 500-cycle signal which is also available at the AUDIO-VIDEO output jack.

Bands A, B, and C have separate tuning controls. Band A tunes from 55 to 83 mc and C tunes from 84 to 109 mc. The fundamentals of A and C cover the low TV and FM bands respectively. The second harmonics of C tune across the high TV band. Band A is marked with settings for the sound carrier frequencies of channels 2, 3, 4, and 5; and C is calibrated in megacycles and has settings for sound carrier frequencies of the high-band TV stations. Band B tunes from 20 to 28 mc. The fundamental and second harmonic are used when working with video and sound i.f.'s between 20 and 28, and 40 and 56 mc.

When the SELECTOR switch is on AUDIO-VIDEO, the 6C4 is converted to a Hartley oscillator fixed at 4.5 mc. Its signal is used to check the sound i.f.'s of intercarrier receivers, video amplifiers, and 4.5-mc traps.

Signals from the 103 make it easy to locate a defective stage in a TV receiver by signal injection. To check the front-end of a TV or FM receiver,

Set and Service Review



The Syncro-Sweep is a twin to the 103.

set the generator to deliver a modulated signal at the TV sound or FM broadcast frequency. Connect the test leads to the RF OUTPUT and COMMON jacks. Allow the r.f. output lead to lay near the receiver, or clip it to the lead-in or to the receiver antenna terminals and clip the common lead to the receiver chassis. The connection depends on the strength of the desired test signal. If the 500-cycle note is heard, it indicates that the set is operating OK from antenna to speaker. When testing a TV set, rotate the generator's frequency control to a point approximately halfway between the desired channel and the channel below it. Bars on the screen indicate that the set is working properly from antenna to the C-R tube.

If no signal is seen or heard, check the high-frequency oscillator. Set the

Useful testers for outside servicing

receiver and generator to a specific channel. Turn off the modulation, clip the r.f. test lead to the mixer grid and tune the generator toward the next higher channel until you can tune in a station by tuning the generator. If a station comes in, the receiver's oscillator is defective.

I.f. amplifiers are checked by applying a modulated signal to the plate of the mixer and tuning the generator to the intermediate frequency. The presence of bars on the picture or sound from the speaker indicates that the video, i.f., and a.f. amplifiers are working properly. If sound or video is missing, advance the r.f. lead to grid then plate of successive audio or video i.f. amplifiers until the signal comes through. This procedure is the same as when testing AM receivers by signal injection—the only difference being in the injected frequencies.

Video and a.f. amplifier stages are checked applying 4.5-mc or 500-cycle signals from the AUDIO-VIDEO jack to the grid of the first amplifier and looking or listening for the signal in the output. The AUDIO-VIDEO attenuator should be set for maximum output during these tests. If the signal is not evident, advance the test lead to each plate and grid right up to the speaker or C-R tube.

If the signal is not reproduced when fed into the plate of the last i.f. stage

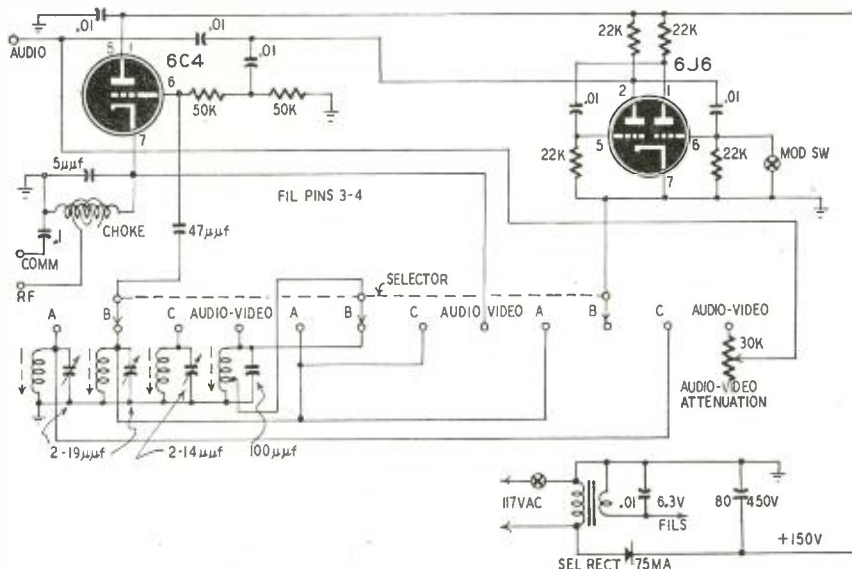

Schematic of the 103 multi-signal generator for television and FM testing.

but can be fed through the video or a. f. amplifiers, the trouble is in the FM or video detector circuits.

Adjust sound traps in the video i. f. amplifier by turning the contrast and volume controls to maximum and feeding the modulated signal into the mixer

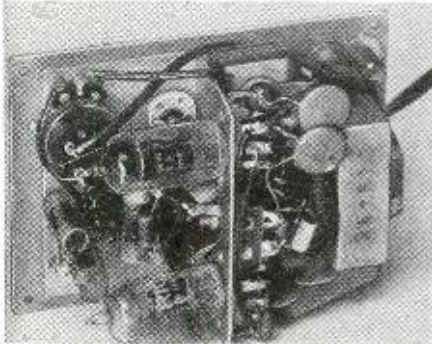

Behind-the-scenes photo of model 103.

plate. Adjust the tuning control of band B for maximum sound output. If the sound traps are detuned, bars will appear on the raster. Tune the sound traps for minimum intensity of the bars. Note the generator setting which produces the maximum sound from the receiver. Tune the generator 6 mc higher and adjust the adjacent-channel traps so the bars are reduced to minimum.

The Syncro-Sweep

The model 104 Syncro-Sweep generator is designed for checking the horizontal and vertical deflection circuits. It contains an r. f. oscillator tunable between channels 2 and 5 and a modulator which supplies frequencies several times the horizontal and vertical sweep rates to generate bars used when adjusting the set's linearity, size, and position controls. The number of vertical bars is variable between five and nine and the horizontal bars between seven and fifteen.

The r. f. oscillator can be modulated with sync signals which are used to check the sync circuits in the receiver. The modulating signals are available as sawtooth voltages at a separate output terminal.

If the set does not produce a raster, the sawtooth waveforms may be injected into the deflection and output circuits to produce one. In sets having fly-back high-voltage supplies, the high-voltage fails when the horizontal oscillator or any of the horizontal deflection circuits fail. The faulty circuit is located by injecting the sawtooth into horizontal grid and plate circuits until high voltage appears.

When these instruments are used with a multimeter and tube tester, it is possible to isolate the trouble in a receiver without returning it to the service shop. In many cases, the trouble is caused by a capacitor or resistor which can be replaced on the spot. Without such equipment, it would be necessary to take the set to the shop in order to locate a faulty component which could have been spotted and replaced in the field.

Philco Service Hints

By HARRY ASHBY

INFORMATION in this article will enable you to improve the performance of many 1948-49 models of Philco television receivers. Also included are service hints which should be beneficial to anyone servicing these receivers.

One of the difficulties encountered, especially in weak-signal areas, is drift. This is due to failure of the a. f. c. to overcome the combination of oscillator and discriminator drift. You have this trouble if you have to readjust the oscillator coil continually.

Discriminator drift can be reduced considerably by installing a new-type discriminator transformer, available from Philco as part No. 32-4317. After the transformer has been installed, change the discriminator balancing choke to a 47-ohm resistor. The 5- μ f capacitor from the second sound i. f. plate to ground should also be removed.

To reduce oscillator drift, the oscillator grid-tank capacitor should be replaced with a special capacitor of the proper temperature coefficient, available as part No. 30-1224-51. This capacitor should not be changed, however, unless the new-type discriminator is installed. After making the changes, allow the set to warm up for 15 or 20 minutes before making any adjustments.

If you have had the above trouble, no doubt you have made several adjustments on the oscillator coils, especially on the higher channels. Since the adjustment screws on the oscillator coils are brass, several adjustments will cause the threads to wear, resulting in a loose fit. Unless this is corrected, the set will still get out of adjustment due to turning of the channel selector. The continual turning from channel to channel will cause the screw to loosen of its own accord. Tension on the screw can be increased in several ways.

Fig. 1 is a drawing of the oscillator coil with its adjustment screw. To increase tension, remove the coil from the turret by depressing the spring clip at the rear of the coil and lifting out. If the coil does not come out freely, it may be necessary to turn the adjusting screw in a few turns until it clears the front of turret. After removing the coil, note the position of the screw and then turn it all the way out.

Apply solder to the threads. When the screw is entirely coated, remove the soldering iron and shake off the excess solder. Turn the screw back to where it was. Take a short length of wire, approximately No. 20, and solder one end to the front of the coil at point A, as indicated in Fig. 1. Run the wire up and around the screw and pull it fairly tight. Solder the other end of the wire to point B. These two things will keep the screw tight and eliminate some return service calls.

After the coil is reinserted in the turret, make the final adjustment after the set has warmed up.

The current models of Philco television have wire clips already attached to the coil to help hold the screw in place. If a new model is available, simply remove the clip from the oscillator coil of an unused channel and place it on the one that is loose.

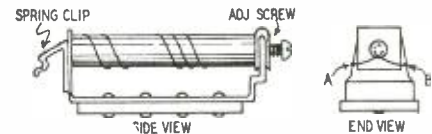

Fig. 1—The coil and adjusting screw.

Another method which is quicker but not quite as effective is to remove the coil and turn the screw out a few turns. Then apply a small amount of fast-drying cement to the threads. Quickly reinsert the coil and make the adjustment before the cement sets. Be sure the set has been on for 15 or 20 minutes *before* doing this, as no adjustment can be made after the cement hardens.

Fine tuning

Another improvement which can be made in Philco television receivers is the addition of a channel adjuster or fine tuner. It is particularly suitable for weak-signal areas. The channel adjuster is so constructed so that it makes full use of the a. f. c. incorporated in the receiver. The kit includes a dual potentiometer with on-off switch, necessary components, and complete instructions. Installation consists of removing the contrast control and replacing it with the dual potentiometer, one section of which is reconnected for use as the contrast control. The other section is used as the fine tuner. On a weak signal the on-off switch on the potentiometer is turned on and the station is tuned in manually. On strong signals, the switch is turned off and full use is made of the automatic tuning. This kit, available for all 1949 Philco television receivers, is ordered as part No. 45-1659. For the Philco model 48-700, the part number is 45-1653. For the 48-1000, 48-1001, 48-1050, and the 48-2500, the part number is 45-1654.

Dirty contacts on the oscillator and the antenna-r. f. coils also give rise to trouble but that is easily remedied by removing both coils and cleaning them lightly. Go over the contacts with fine No. 400-A emery paper. If the contacts on the coil are badly worn, the complete coil should be replaced.

Acknowledgment is made to the *Philco Service and Accessory Merchandiser*, in which many of the procedures described above are described.



CONNECTING LOUDSPEAKERS

Know-how on a subject
that has puzzled many

By MELVIN C. SPRINKLE



An audio amplifier is like a mule—if you don't hitch him to a load, he won't do any work. An audio amplifier is useless unless connected to a load, which is usually one or more loudspeakers. As in the case of a mule, unless the load is properly connected, results are unsatisfactory.

When only one loudspeaker is used with an amplifier, correct connection is relatively simple. The speaker is connected to the amplifier output tap whose impedance as marked most nearly approaches the speaker impedance. Even this simple operation, however, may be beset with problems if the speaker is located far from the amplifier.

When a number of loudspeakers are operated from an amplifier, as in a large sound system, and the power fed to each speaker is different, the fun starts! This article is intended to present a few simple rules to help the sound technician to do a properly engineered job with preassured results.

The term "transmission line" brings to mind high mathematics, nepers, and surge impedance, especially if associated with television. In audio, things are simpler. An audio transmission line is just a pair of wires that connect one audio device to another, as, for example, an amplifier to its loudspeakers. Surge impedance, propagation constant, etc., don't bother us until the line gets pretty long, say a good fraction of a

wavelength. At audio frequencies (15,000 cycles) a $\frac{1}{4}$ -wavelength line is some 3 miles long, and the length increases as the frequency gets lower.

Two things plague the audio man: conductor resistance and shunt capacitance. The former causes power losses as heat and the latter limits high-frequency performance. Their effects depend on the line impedance.

The impedance of a line is the nominal value (magnitude) of the impedance across the receiving end of that line. The definition is so stated because in high-quality audio amplifiers, the source impedance, looking back into the amplifier, may be but a fraction of the load impedance. Thus the same pair of wires can be a 4-ohm line, a 16-ohm line, or a 500-ohm line, depending on the load.

Selecting a speaker line

All conductors have resistance. Accordingly, when current flows in the line, there is a loss of power, the energy being converted into heat. Resistance losses—or copper losses as they are sometimes called—may be minimized by using larger diameter conductors and by making the line as short as possible. Copper losses are most important on low-impedance (16 ohms or less) lines since the lower the impedance, the more current flows for a given power, and there is greater I^2R power loss as heat.

Commercial sound engineers usually like to use the smallest possible wire size because the smaller sizes are less expensive and are easier to install and conceal in existing buildings. The smaller the wire size, the greater the resistance per foot and the greater the power loss, so a compromise must be made. Sound engineers allow 0.25-db loss (about 5% power loss) in the wiring to speakers.

To eliminate calculations, Fig. 1 has been prepared to show the maximum length of line which can be used for various line impedances and wire sizes. The chart is simple to use. For example, a single 16-ohm loudspeaker can be connected to an amplifier with No. 18 wire and can be any distance up to 75 feet

from the amplifier. For No. 14 gage, the distance may be up to 190 feet.

Three conditions may occur when using the chart:

1. If the point of intersection of the line length and load impedance falls above the line labeled No. 22 gage, No. 22 wire or any larger size may be used. Smaller wires are not recommended.

2. If the point falls between two curves for wire size, the larger size should be used.

3. If the point falls below the curve for No. 14 wire, the load impedance is unreasonably low for the length of line required and matching transformers to make the line impedance higher must be used. This point will be considered a little later.

Multiple speaker installations

Installing a single loudspeaker involves no problems since its impedance may be used directly in finding the

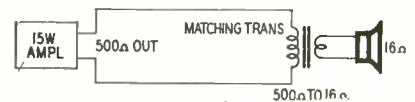

Fig. 2—One speaker on a 500-ohm line.

wire size from the chart. When two or more loudspeakers are used, there are two methods of connection: series and parallel. The series connection is often attractive but is not recommended except as an emergency measure. There are two reasons for this: the series connection is unreliable because if one speaker fails the entire series group is silenced. At some frequency a loudspeaker goes through cone resonance and its impedance becomes much greater than its nominal impedance value. Where several speakers are used, especially several makes or several sizes, their resonant frequencies may be different. When one speaker in a series string goes through resonance, the sound volume from the others changes. This effect can be very annoying, and is almost entirely absent in parallel-connected speakers.

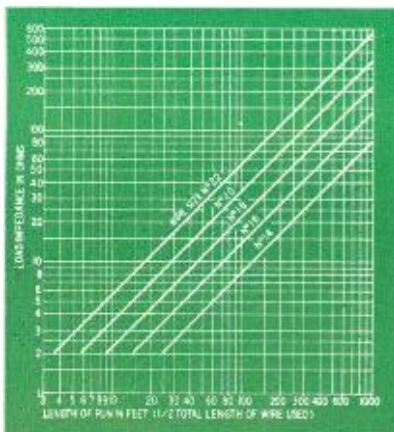

Fig. 1—Chart of maximum line length for given wire size and line impedance.

When two or more speakers are connected in parallel, their impedances are combined in the same way as parallel resistances. The *equivalent* impedance of the total speaker system is used in the line chart, Fig. 1, in the same way as that of one speaker. The group is

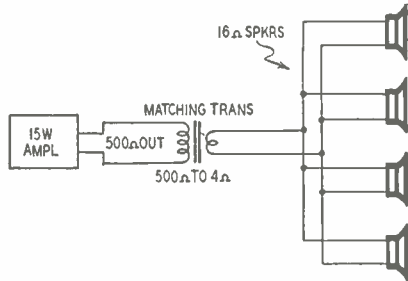

Fig. 3—Power per speaker is 3.75 watts.

connected to the amplifier tap which corresponds to the *equivalent* impedance of the system. If an exact tap is not available, connect to the next *lower* amplifier output tap.

Assume that we have three speakers, each with a voice coil impedance of 16 ohms, and that the group is to be 30 feet from the amplifier. The equivalent impedance of the speaker load is $16/3$ or $5\frac{1}{3}$ ohms. On the chart the point of

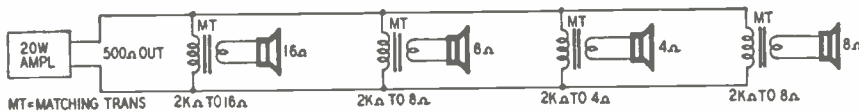

Fig. 4—Each speaker needs a matching transformer if the lines are long.

intersection of 5 ohms and 30 feet falls between the curves for No. 18 and No. 16 wire. Thus No. 16 wire is the smallest wire that can be used.

The speaker line should be connected to a 5-ohm tap, but most amplifiers do not have a 5-ohm tap, so the line should be connected to the 4-ohm tap, a common value. The reason for using a lower tap is that an output transformer reflects to its primary an impedance which is the load for the output stage. Connecting a slightly higher load to a tap, as in this case, causes the reflected impedance to be higher in the same proportion, which is better for an amplifier than having a slightly lower load.

When several speakers have their voice coils in parallel, the impedance of each voice coil should be the same. Any parallel system is a constant-voltage system and the voltage across each speaker is the same. Each speaker will draw the same power, and, assuming equal efficiency, will deliver the same sound level.

If several values of impedance are used in parallel, as two speakers of 8 ohms and one of 4 ohms, each 8-ohm speaker draws only half the power of the 4-ohm speaker. This unequal power distribution may be useful at times to provide different power levels in speakers. However, unequal amounts of power distribution are best distributed with matching transformers and higher impedance lines. Parallel combinations often give nasty combinations of impedances; the line impedance gets below 4 ohms and that makes for short

runs or big wire or both. The best method is to use equal impedance and power distribution for these voice coil lines, and keep the line impedance 4 ohms or higher.

Matching transformers

In discussing the speaker line chart, Fig. 1, it was pointed out that in some cases the length of line is great for the load impedance, and the line loss is greater than 0.25 db unless very heavy conductors are used. For such cases we borrow a trick from the power engineers who deal with power transmissions over long distances. The power boys get around the problem of line loss by stepping up the voltage at the sending end and stepping it down at the receiving end.

Audio engineers use a similar stunt with an output transformer at the amplifier that has a different turns ratio (gives higher voltage) than those ordinarily used with voice coils. Sometimes both voice coil and line impedances are present on the output taps. The usual line impedance is 500 ohms although 250 and 125 ohms are used. Broadcast engineers usually use 600 ohms as a line impedance because tele-

phone lines (used for low levels only) have about 600 ohms characteristic impedance.

Impedances greater than 500 ohms are not used because shunt capacitance in long lines causes rolloff in response at the higher audio frequencies. When using a 500-ohm line, a matching transformer is used at each speaker (or group of speakers) to step down the line voltage to values suitable for voice coils. The speaker matching transformer reflects the voice coil impedance to 500 ohms (or other value depending on the line impedance).

This fundamental axiom is often overlooked, but should be stated for the sake of completeness. The rated power of the speaker or speakers should be at least equal to the rated power output of the amplifier; and the rated power of the amplifier should be equal to the total power desired in the speakers. The first proposition assures that the speakers will not be overloaded, and the second that they will provide adequate sound. Not all amplifiers will put out their rated power even at mid-range frequencies, but following this simple rule and using good amplifiers will assure success.

In laying out a 500-ohm distribution system one rule covers all cases of equal or unequal power distribution:

1. Determine the power to be fed to each speaker or group of speakers.
2. Select an amplifier capable of this power, and multiply the amplifier power by the desired line impedance.
3. Divide the number obtained in

step 2 by the power desired in the first speaker or group of speakers. This quotient is the primary impedance of the matching transformer for the speaker(s).

4. Repeat step 3 for each speaker or group of speakers.

Some typical cases

The use of the rule is best shown by examples of several types of matching situations.

Fig. 2 shows a single speaker fed by a 15-watt amplifier through a 500-ohm line. The power capacity of the speaker is 30 watts and its nominal impedance is 16 ohms. Here the limiting factor is amplifier power and we proceed to step 2: 15×500 is 7500. Dividing by 15 (as all the power goes to the one speaker) gives us 500 ohms as the correct primary impedance for the matching transformer. The secondary impedance is 16 ohms.

Had there been four speakers to be fed from one transformer, the primary impedance would have been the same, but the secondary would be set for four ohms. In this case the total power for the group is still 15 watts (used in step 3) but the power per speaker is $15/4$ or 3.75 watts. The case is shown in Fig. 3.

Fig. 4 shows four speakers strung along a 500-ohm line. If there is considerable separation between speakers, it is best to use a separate matching transformer at each speaker. Let us say that we have a 20-watt amplifier

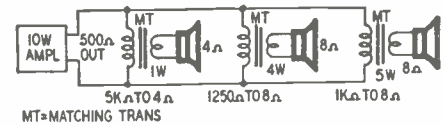

Fig. 5—If power distribution is unequal, each speaker needs transformer.

and the desired power per speaker is 5 watts. The rated power of each speaker being 10 watts, we are safe. In step 2: 20×500 is 10,000. In step 3: we divide 10,000 by 5, giving us 2,000 ohms as the primary impedance for each transformer. Since each speaker has the same power, we need calculate but once. The secondary of each matching transformer is set to the impedance of each voice coil which need not be the same for all speakers.

Let us proceed to a problem shown in Fig. 5 where we have unequal power distribution. A 10-watt amplifier with 500-ohm output is to feed three speakers. The first is to be fed 1 watt, the second 4 watts and the third 5 watts. For this type of circuit each speaker must be equipped with a matching transformer even though they are near each other. In step 2 we multiply 500×10 to get 5,000. Dividing by 1 in step 3 gives us 5,000 ohms for the primary impedance of the matching transformer for the first speaker. The secondary is set for the correct voice coil impedance. For the second speaker, (step 4), we divide 5,000 by 4 to get 1,250 ohms for the matching trans-

(Continued on page 42) ▶

Automatic Intercom Switch

ONE of the greatest inconveniences of practically all intercommunicators is the necessity of switching from "talk" to "listen" and back again, as the conversation changes. The "talk-listen" switch



Body capacitance switches the intercom.

is almost invariably on the speaker, connecting it either to the input of the amplifier, where it acts as a micro-

* Editor, *Toute la Radio*, Paris.

By E. AISBERG*

phone, or—when the set is acting as a receiver—to the output in its own proper character of speaker.

At the recent radio exhibition at Brussels, we saw an intercom with an automatic switching which was exceptionally ingenious and absolutely reliable. The equipment looked like a normal intercom, with the exception that a curved arm supporting a plate of chromium-plated copper rose out of the cabinet. (See photo.)

When the person using the apparatus moves his head toward the plate (without touching it, of course), the interphone automatically assumes the "talk" position. Drawing the head away turns it to "listen." The important point is that the movement of the head toward the intercom as one begins to speak is entirely instinctive. One can use this intercom without any practice and without risk of error.

Any radioman will have guessed that the unit is capacitance-actuated. The capacitance between the head and the metal plate is, as the schematic reveals, in parallel with that of a variable capacitor C, which tunes an oscillating circuit in the plate circuit of which there is a sensitive relay RY1. The

capacitor C is adjusted to the point where the least increase in capacitance will cause the circuit to stop oscillating. A small variable resistor R (variable from zero to 50 or 100 ohms) reduces

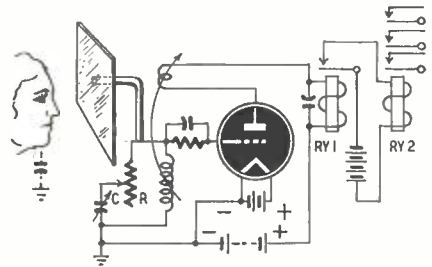

Oscillation stops at approach of head.

the Q of the circuit to render the adjustment uncritical. Now the least increase in capacitance—such as might be caused by the user's head approaching the metal plate—stops the oscillations. The tube's plate current stops and the relay is thrown to "talk." In the Brussels equipment a second relay RY2 operating on a low-voltage battery, operated the "talk-listen" switch.

The idea of a capacitive relay is by no means new, but its use in an intercom is a particularly happy and rather a novel application.

Another interesting new idea (seen at the French Radio Parts Exhibition in Paris,) was a variable capacitor with automatic bandspread. The slotted metal disc just behind the dial switches three semifixed padders into the circuit. Most of the capacitance normally required for a given band is contained in the padder, making it possible to have bandspread on three bands without any other switching. Each band covers approximately 60 degrees on the dial. The padders are connected successively in parallel for lower frequen-

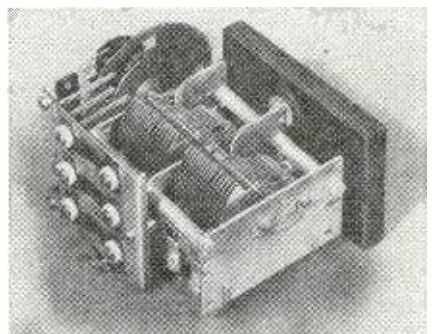

The slotted disc switches in padders.

cies as the capacitor meshes; thus either international shortwave (such as the popular 25, 31, and 49-meter combination), amateur, or other bands can be received by proper adjustment of each padding capacitor.

▶ CONNECTING LOUSPEAKERS

(Continued from page 41)

former primary. Repeating for the third speaker we get 1000 ohms as the impedance for the third matching transformer. To check the calculations, we can combine the three impedances as parallel resistors. We get 500 ohms, which show that we have a matched system.

The 500-ohm line is not a sacred cow. Lower impedances such as 250 ohms will work equally well if larger wires are used for runs over 400 feet. This information is obtained from Fig. 1. A lower impedance sometimes may be required. For high power amplifiers with many speakers the required primary impedance of some of the matching transformers may be greater than 10,000 ohms. In this case the line impedance should be lowered to say 250 ohms, as high quality matching transformers are generally not made with primary impedances higher than 10,000 ohms.

If there are several speakers to be fed from a single matching transformer, the speakers need not be adjacent to each other. For example, one of the speakers of Fig. 3 could be up to 30 feet from the matching transformer, if it is connected with No. 16 gage wire or larger. Fig. 1 should be consulted to find out if such a scheme (which reduces cost because wire is

cheaper than good matching transformers) is practicable.

The maximum recommended length for speaker lines, even at 500 ohms, is 1,000 feet. One reason is that the shunt capacitance in a 1,000-foot line may build up to the point where it is severe restriction on quality. In high-fidelity work loss of high frequencies is disastrous. In public address work loss of high frequencies causes a reduction in intelligibility and a decrease in the usefulness of the system.

Another reason is power loss. If kept to 0.25 db, that is a 10% power loss. In a 50-watt system it means 5 watts lost. The cost per watt in amplifiers is high, so losses mean money. If a speaker line must be run much over 1,000 feet, it is better to put a booster power amplifier nearer the speakers and feed it on a 500-ohm line at lower power level where a 10% loss means fewer watts. Such a scheme permits equalization to counteract loss of high frequencies. Speaker lines can be run over 1,000 feet if the limitations are known and efforts are made to minimize their effects.

In another article, we will cover the new RMA standard 70-volt distribution system, high-fidelity speaker connections and selection of matching transformers.

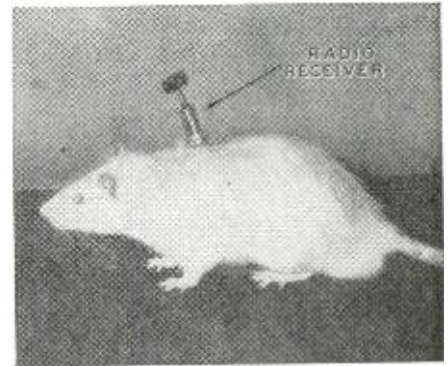
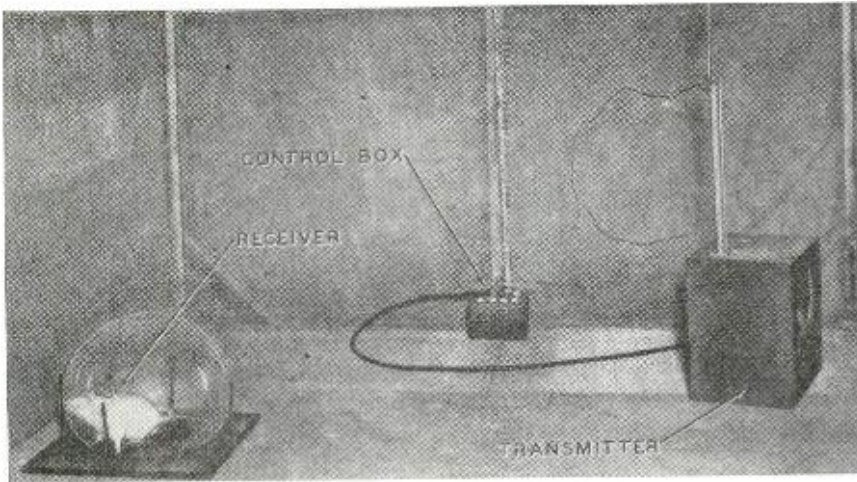

Interior of shielded cage showing the transmitter. Rat is kept under Lucite bubble during field strength tests.

Radio Pulses Control Rats

By VERNE KALLEJIAN and J. A. GENGERELLI

THE relative lack of knowledge about the functioning of the central nervous system is due in part to the enormous complexity of the system on the one hand, and to a lack of adequate methods with which to study it in the intact organism on the other. Many investigators have been hampered by the lack of a technique which would permit the controlled stimulation of a normal healthy unencumbered animal while it was actually in the process of performing normal functions, such as learning, problem solving, eating, etc. For the psychologist who is studying the learning process the problem is one of stimulating some portion of the brain of an animal with a controlled stimulus, while it is in a learning situation.

Learning is assumed to be associated with complex physical changes within the central nervous system, in particular the brain, and some of these changes are brought about by electrical impulses which are sent to the brain from the receptor system of the animal. The characteristics of the impulses which might account for these changes are the frequency, pulse duration, intensity and wave form.

If this is true it might be possible to test this and other hypotheses if a technique could be devised which permits the systematic variation of these variables in stimulating different portions of the brain of an animal in controlled situations.

The radio equipped rat is an attempt

to solve this problem. The laboratory animal becomes a mobile receiving station with the output of a receiver coupled to his brain.

The receiver shown schematically in Fig. 1 is a small crystal detector built in two parts. The receiver mounting (Fig. 2a) which the rat carries with him at all times is a silver frame ($\frac{3}{8}$

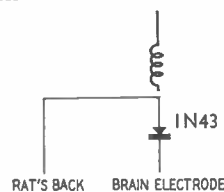
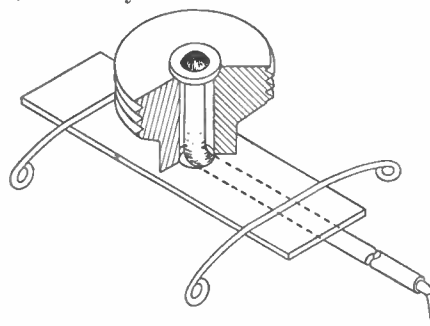

Fig. 1—Schematic diagram of receiver.

x $\frac{1}{4}$ inches) surgically mounted under his skin on the back of his neck so that the threaded stub protrudes about one-half inch above his back. This stub is fitted with a small hole in its center which accommodates the insulated lead from the electrode. This lead terminates at the top of the stub in a solder bubble. The bubble is insulated from the stub by a lucite washer.



The needle electrode is inserted into the brain so that the exposed tip makes contact with the desired cortical area. Within a few days after the operation the animal recovers completely with no apparent ill-effects and it is impossible to distinguish him from other laboratory animals except for the small stub protruding from his back.

The receiver (Fig. 2b) is a plastic cylinder about three-fourths an inch long which holds the 400A (1N43) crystal. It has a threaded magnesium sleeve on the bottom and a small threaded pin on the top which contacts the crystal on the inside of the cylinder. The antenna is coupled to the top of this pin.

When the holder is screwed onto the mounting stub on the rat, one leg of the circuit is from the antenna to the sleeve, to the stub which is part of the mounting attached to the animal's body. The other leg is from the exposed end of the crystal to the bubble of solder in the center of the stub along the wire to the electrode in the brain. The return circuit is through the body of the animal. The receiver unit can thus be removed when the animals are in

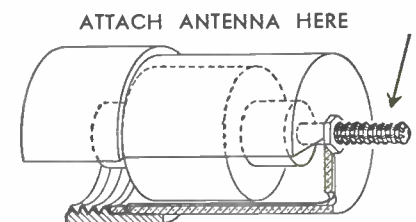

Fig. 2a, left—The receiver mounting. Fig. 2b, above—The receiver housing.

This article is based on research now under way at the University of California at Los Angeles, under the direction of J. A. Gengerelli, Professor of Psychology.

the cages and the same unit can be used on all animals which insures constancy in the output for each rat.

The antenna attached to the top of the receiver is bottom loaded with a 3/8-inch diameter coil of 9 1/2 turns to bring it into resonance at 250 megacycles. The overall length of the antenna is 2 inches. The entire system is so light that the animal can carry it comfortably for short periods.

In certain experiments in which the animal is required to maneuver in con-

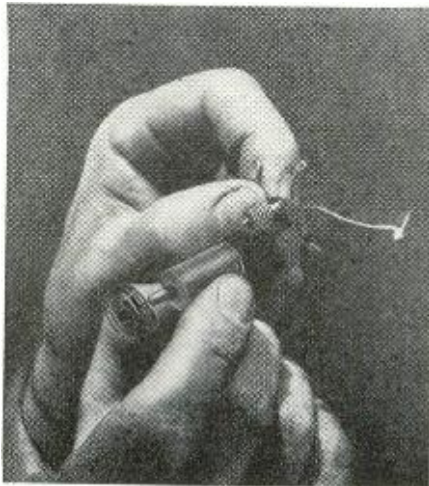

Closeup of the receiver and mounting.

ditioned quarters a smaller antenna is used which consists of a coil of 8 turns of wire approximately 1/2-inch in diameter.

The signal which the rat receives is generated by a pulse-modulated transmitter (Fig. 3). The oscillator is a pair of 8012's in a t.p.t.g. circuit operating at 250 megacycles. This unit is housed in a small box and coupled to a vertically oriented dipole mounted about 2 feet above the floor surface. The grid return of the oscillator is to the plates of two 6L6's in parallel. The grids of these tubes are pulsed by a square wave generated by a conventional multivibrator and negative clipper. The pulse generator is designed so the pulse frequency and pulse duration controls are virtually independent and thus the output of the oscillator is a square wave pulse whose frequency and width can be varied. Signal strength is controlled by a variac in the primary of the power transformer. Using a 50 percent pulse with a frequency of 30 cycles per second this unit draws about 100 watts average power.

In order to prevent spurious radiations from the laboratory as well as to keep extraneous signals from disturbing the animal a 10x6x6-foot double shielded cage is used to house the experimental area and the oscillator. A short cable connects the oscillator to the power source outside the cage. A receiver unit suspended in the cage is connected by a shielded lead to the vertical plates of an oscilloscope which serves as a monitor for the signal.

When the animal is placed in the cage for an experimental run the receiver unit is attached to the stub on

its back and the transmitter is turned on at low power. As there are no pain receptors in the brain, very weak stimulation causes no apparent discomfort to the animal. If the electrode is embedded in a "motor" area, a strong stimulus will cause the animal's whiskers to vibrate back and forth synchronously with the pulse frequency. A brief shock at full power will cause permanent damage to the animal while a mild shock is adequate to keep an animal out of an area in which the shock was received.

It is impossible to predict how fruitful the application of this technique will be in enhancing the present understanding of animal or human behavior. It is hoped that a wide variety of problems and theories can now be

explored which have hitherto resisted experimental attack. It may be possible to gain new insights into brain function, for by using appropriate tech-

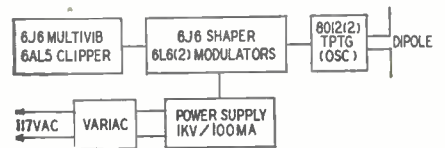

Fig. 3—Diagram of pulse transmitter.

niques and sufficient power certain areas of the brain can be destroyed and the behavior of the animal photographed during the process. In the study of learning, an approach of this nature may supply part of the answer as to how learning takes place at the physiological level.

Commercial-killer Improves Programs

RELIEF for the harried radio listener is promised in a new "commercial-killer" devised by Dr. I. Clyde Cornog of the University of Pennsylvania and described in the *American Journal of Physics*, February 1950.

The "commercial-killer" is a special time-delay using thyatronns, which opens the loudspeaker circuit when "ordered" to do so by any sharp sound, such as a hand-clap. The length of time the radio remains off the air can be adjusted by R, a 3-megohm potentiometer. The time interval for different settings of R appears on the insert chart. Most radio commercials last about 60 seconds.

The schematic shows the equipment in its non-active position. When the set is turned on current from the power supply closes relay V, connecting the dry cell to the carbon microphone M. Potentiometer P is so adjusted that current through the 885 is just below that required to close relay X. Thus the 2A4G

grid is connected to its cathode through S and R. Operating practically at zero bias, it conducts normally and keeps the relay Z closed, closing both the speaker circuit and the plate circuit of the 885.

Any loud sound will cause the current through the 885 to rise, closing relay X. This breaks the circuit between grid and cathode of the 2A4G and connects the grid direct to point B. The cathode is now connected (through a 100,000-ohm resistor) to a point 105 volts more positive than B. The 105-volt negative charge is also placed across C. The 2A4G tube cuts off and relay Z opens, stopping the program and opening the circuit of the 885. Relay X immediately opens and the charge on C leaks off to cathode through the resistors S and R, again closing relay Z. Pushbutton switch SS may be pressed to discharge the capacitor and bring the set back into action immediately if desired.

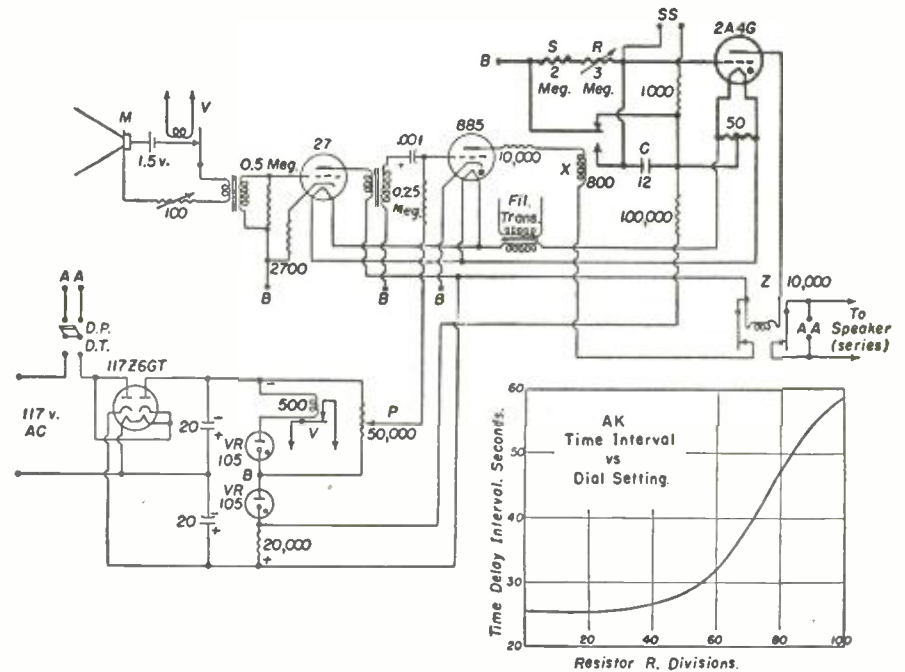

18-Tube High-Performance Communications Receiver

By FRANCIS O. DAVIS*

SO MANY amateurs use factory-made communications receivers today that the ham who wishes to construct his own finds little or no up-to-date design information available. But the amateur who lacks funds to buy or wishes to build a communications receiver with his own hands can construct a piece of equipment that will equal the best commercial jobs.

The cost of this receiver depends on the varying surplus market, but should not run much over \$100. A v.t.v.m.-analyzer, BC-221 frequency meter or signal generator, and a simple calibrated grid-dip meter are needed to test and calibrate the set.

It receives the 6-, 10-, 20-, 40-, and 80-meter bands with high frequency stability and high signal-to-noise ratio, has variable selectivity without a crystal filter, and also receives WWV on 5 mc.

To obtain these results, double conversion and some unconventional principles were used. For example, the oscillator operates at all times in the vicinity of 5 to 7 mc, and is temperature-compensated. Doublers multiply the frequency for the other bands. There are absolutely no tracking problems. The cathode-coupled 6J6 r.f. stage has the best signal-to-noise ratio the writer has seen. The 6J6 output tube and the 6AK5 mixer input use the same tuned circuit. Oscillator signal injection is kept very low.

In the BROAD i.f. position, the signal from the first (1425-kc) i.f. amplifier goes to the diode-detector-a.v.c. In the SHARP i.f. position, it is converted to 85 kc and further amplified. A 1- μ f capacitor prevents the large signal from the last 1425-kc stage from overloading the 6SA7 second converter grid. The 85-kc stage is designed for unity gain—there should be no change in signal strength in going from BROAD to SHARP position.

A 1N34 serves as a shunt noise limiter. A 1,000-cycle c.w. filter is provided. When it is switched in, one section of a 6SN7 amplifies the signal leaving the filter, making up the 14-db insertion loss.

Two potentiometers are associated with the 0-1-ma signal strength meter: one to zero-set it, the other to adjust the full-scale sensitivity. A switch on the panel below the meter cuts it off for c.w. operation.

WWV is received by turning on the plate voltage, to a separate front end with a crystal oscillator. A 6SJ7 r.f.

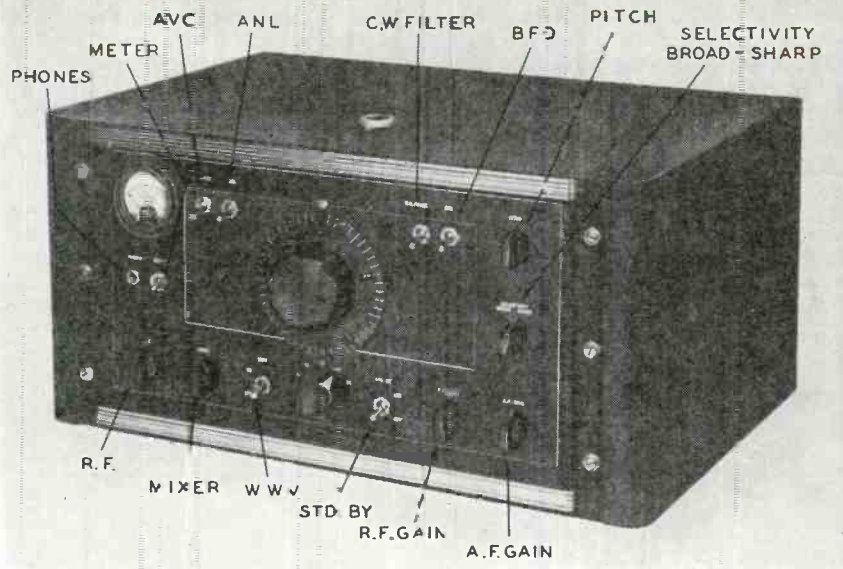

In appearance and performance, this receiver rivals the better commercial jobs.

stage and 6K8 converter is fixed-tuned to 5 mc while the converter's oscillator section is operated as a Pierce crystal oscillator on 6425 kc. The 1425-kc conversion signal is coupled to the first 1425-kc. i.f. transformer through a small variable capacitor.

separate chassis. The power supply is on an 11x6x3½-inch chassis, the high-frequency r.f. stages are on an 11x7x3-inch chassis, while the i.f. and audio stages are on a 13x6x2-inch chassis.

Mounted on the power supply chassis are an 0D3 regulator tube, the transformer, the dual filter capacitor, and the 5Z3 rectifier tube. Under it are the filter choke, two potentiometers used in the S-meter circuit, a terminal strip,

A three-chassis receiver

The receiver is constructed on three

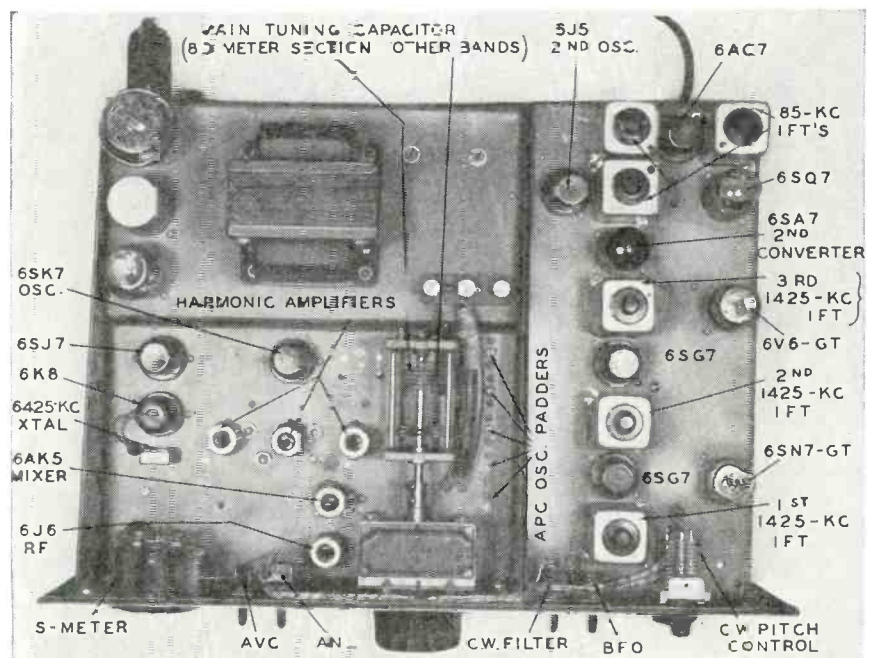

The receiver is built on three separate chassis. The i.f. and audio section is at right, power supply at left rear and the high-frequency section left front.

*Research Laboratory Analyst, Douglas Aircraft Co. Inc., Santa Monica, Calif.

and miscellaneous small parts. The power input cable plug, the power fuse, and pin jacks for the speaker voice coil leads are on the back apron of this chassis.

The points should be provided on the terminal strip for leads that go to other parts of the set. These are +250 volts, plate voltage from the meter circuit, 150 volts regulated, two meter leads, two leads to line switch (on back of audio gain control) and 6.3 volts a.c. for the filaments.

Two grommets connect the power chassis to the high-frequency chassis. Some of the interconnecting wires go along the right side of the high-frequency chassis. Others leave at the left end of the power supply and are out of sight under the left end of the high-frequency chassis lip.

After the power supply has been checked, the i.f. and audio chassis

panel. Extending down the outside of this chassis is a protective apron. Below this chassis are mounted the r.f. and a.f. gain controls. On the apron is mounted the 1,000-cycle-pass c.w. "range filter" obtained on the surplus market for about \$1.00. It is marked "voice in," "ground," "voice out," "range in," and "range out." The "ground" is wired to the chassis, and the "range in" and "range out" are the 1,000-cycle filter, in and out. The "voice" connections are not used.

About two-thirds of the way back, bottom view, is the three-pole, two-position ceramic wafer selectivity switch, with its shaft passing under the c.w. filter and extended to the front panel above the a.f. gain control. In the back corner of the chassis is the 1340-kc transformer, L 13. The 85-kc b.f.o. transformer L 14 is in the front corner. The 1340-kc unit is the 1415-kc b.f.o.

possible. Shield the following: the lead from the audio coupling capacitor to the top end of the audio volume control, the lead from the arm of the volume control to the grid of the 6SQ7, and all the audio leads going to the c.w. filter switch.

When this section is wired and checked, hook it to the power supply with temporary leads and tune up. Turn the selectivity switch to the BROAD position with the r.f. gain on full. Put a 1425-kc signal on the grid of the last 6SG7 tube, through a capacitor, and peak this stage, using a vacuum-tube voltmeter on the a.v.c. Attach the signal generator to the grid of the first 6SG7 tube and repeat this adjustment, as well as tuning the middle 1425-kc i.f. transformer. The first i.f. transformer cannot be tuned at this time, due to the removal of the 170- μ f capacitor from its input.

Place the d.c. probe of the vacuum-tube voltmeter on the 6J5 1340-kc oscillator grid. If it is oscillating, about 10 volts or more of self-rectified grid voltage will be measured. Using the frequency meter, tune this oscillator to 1340 kc. Adjust the oscillator injection capacitor until 10 volts are measured on the control grid (pin 5) of the 6SA7. Then retune the oscillator until the frequency is exactly 1340 kc.

Turn the selectivity switch to SHARP and tune the 85-kc transformers. The 85-kc transformers have a variable coupling adjustment. Pull the little fiber rod in the center of each transformer all the way out. If it is cemented, loosen it with coil cement thinner or nail polish remover.

Apply a 1425-kc signal to the first 6SG7 grid; a.v.c. voltage should result. Peak the 85-kc transformers for maximum a.v.c. voltage. The little padding capacitor between the back-to-back 85-kc transformers, should be at minimum capacitance for this adjustment.

Now switch the selectivity control to BROAD and note the value of a.v.c. voltage. Adjust the input coupling from the signal source until about 6 or 8 volts of a.v.c. are measured. Note this value and switch to sharp selectivity. The a.v.c. voltage may be slightly less now. If it is, adjust the coupling capacitor between the two 85-kc transformers until the a.v.c. voltage is the same as on broad selectivity. If the a.v.c. voltage is slightly more, the value of the 6AC7 cathode resistor can be increased until unity gain is obtained. But if it is much greater, the grid coupling capacitance on the 6SA7 tube must be reduced.

Now turn on the b.f.o., making sure the selectivity switch is at SHARP. With the pitch control half way in, the b.f.o. is set to zero-beat by adjusting the tuning screw in the center of the b.f.o. transformer. With the b.f.o. on, turn on the c.w. filter switch. If everything is connected right, the c.w. tone can be peaked very sharply at 1,000 cycles with the pitch control.

At this point you are ready to start on the high-frequency section. Its lay-

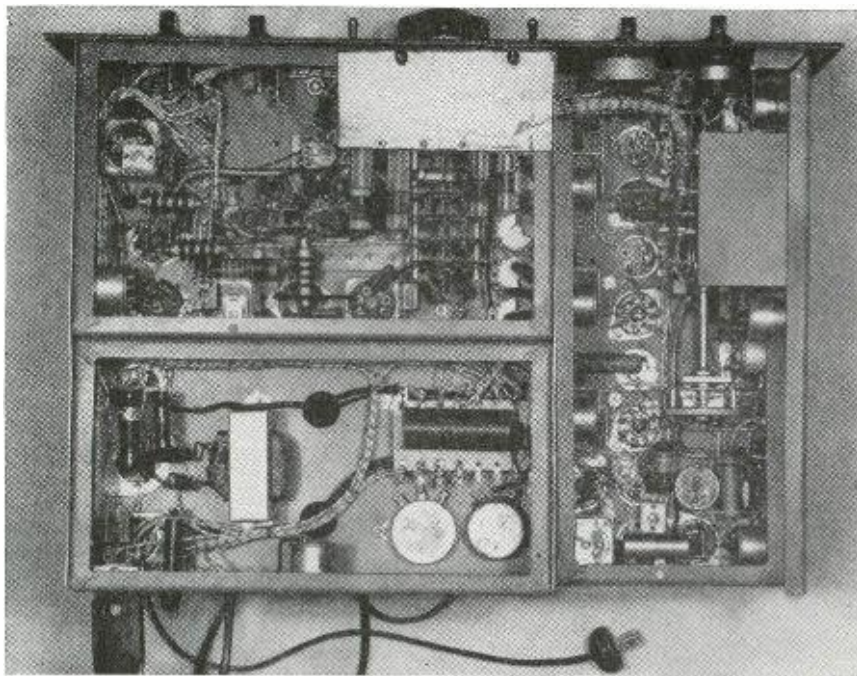

Judicious cabling of wires helps to keep the receiver's underchassis clear.

should be built.

First procure on the surplus market a BC-453 and a BC-454 receiver (part of the 274-N aircraft command set). The BC-453 has a range of 190 to 550 kc, and the BC-454 one of 3 to 6 mc. Remove from them all the i.f. transformers, the b.f.o. transformer (located under the chassis), all the bypass capacitors, and all the mica insulated tie-point strips. Also remove from the BC-454 the three cans under the three-gang tuning capacitor.

The layout of the i.f. amplifiers is shown in the photo of the top of the chassis. The position of the switches for the i.f. system may be observed in the front-panel photo. The off-on switches for the a.v.c. and a.n.l. are to the left of the tuning dial while the c.w. filter and b.f.o. switches are on the right.

The i.f. chassis is mounted with its bottom 3½ inches above the base of the

transformer from the BC-454. A 25- μ f silver mica capacitor is shunted across the tuning capacitor in this unit to make it tune to 1340 kc.

The 1415-kc i.f. transformers from the BC-454 will tune to 1425 kc without modification. The first transformer must have the 170- μ f ceramic button capacitor which goes from the plate to B-plus removed. This is placed at the plate of the 6AK5 mixer later. The 6V6 plate-to-voice coil transformer is out of sight under the c.w. filter.

The bypass capacitors from the BC-453 and BC-454 are spaced around the chassis as shown. The mica insulated resistor mounts are used between the bypass capacitors. These tie points are used to mount various cathode, screen, a.v.c., and plate decoupling resistors. The resistors on them are removed and saved.

Use care in wiring the i.f. section, keeping leads as short and direct as

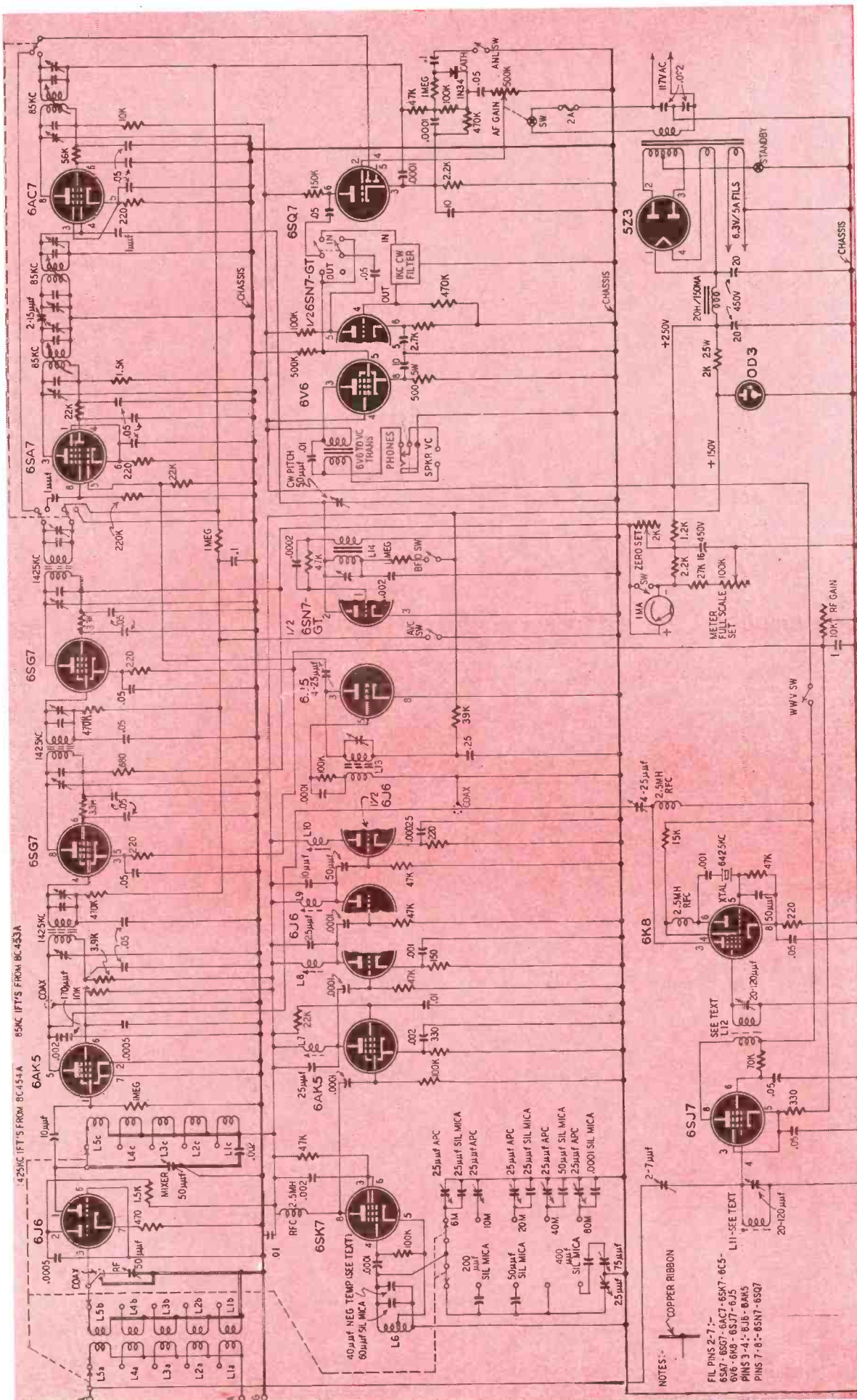

tivity obtained on c.w. with the 1,000-cycle filter. An excellent receiver for the advanced amateur who prefers to construct his own equipment as well as for the man with a cellar full of surplus he wants to put to use.

included for frequency checks. All the amenities, including a signal-strength meter, noise silencer and 1,000-cycle filter for c.w. are provided. Selectivity at ten times down can be varied from 10 kc to 200 cycles, plus the extra selec-

ceivers. Double conversion provides either narrow or broad tuning with no change in volume. Oscillator problems are minimized with a low-frequency oscillator and doublers for the higher bands. A special receiver for WWV is

Schematic of the high-performance communications receiver. Constructed almost entirely from surplus materials, this set owes its outstanding performance to a number of features not commonly found in home-constructed re-

- NOTES:
- FILE PINS 2-7
 - 6S7 - 6S7 - 6AC7 - 6SK7 - 6C5 -
 - 6V6 - 6V6 - 6S17 - 6J5
 - PHNS 3 - 4 - 6J6 - 6AK5 -
 - PHNS 7 - 8 - 6SN7 - 6SQ7

out is shown in the top view of the chassis. At the extreme right are the APC-type padding capacitors for the oscillator. The rear one is for 80 meters with 40, 20, 10, and 6 meters proceeding in that order toward the front.

After all holes are cut in this chassis, the three chassis can be assembled. Panel brackets at each end of the r.f. and power supply and on one side of the i.f. chassis hold these together. The other side of the i.f. unit is supported by the protective apron as shown, looking at the bottom view. With the chassis assembled in this manner, the top caps on the i.f. transformers are just

placing it at the plate of the mixer, the inductance and capacitance of the long coax lead becomes a part of the i.f. tuned circuit. Because of the added capacitance of the coax, a .002- μ f capacitor is placed in series with the 170- μ f button capacitor at the plate of the mixer to reduce its capacitance.

The lead from the 6K8 WWV converter tube to the plate of the 6AK5 mixer is now put in. It is the short piece of low-capacitance coax shown in the bottom view near the right center of the high-frequency chassis. At the junction of this lead and the 6AK5 plate is the 4—25- μ f padding capaci-

to ground, to adjust the compensation to fit any given temperature condition. Wire the band switch as shown on the diagram using stiff wire.

When the oscillator is finished, turn it on and adjust the trimmers. Switch to the 10-meter position and turn the main tuning capacitor all the way out. Adjust the 10-meter trimmer until the frequency of the oscillator measures approximately 7070 kc.

If the specifications are carefully followed, the APC capacitor will be approximately half-way meshed. If the oscillator will not tune to 7070 kc with the APC at about half capacitance, the size of the 60- μ f silver mica across L6 can be changed slightly. If more than 10- μ f change in this capacitor is needed, L6 is probably not right or else a mistake has been made in choosing some other circuit component. Now run the main tuning capacitor in until 6650 kc is reached. This should occur with the main tuning capacitor nearly at maximum capacitance.

Switch to the 6-meter position and set the main tuning capacitor near maximum capacitance. Adjust the 6-meter APC padder until the oscillator frequency is 6070 kc. The main tuning capacitor should tune the oscillator to 6575 kc at near minimum capacitance.

The same procedure is followed on 20, 40, and 80 meters where the maximum and minimum frequencies are 6990 and 6280, 5880, and 5570 kc and 5430 and 4920 kc, respectively.

The oscillator frequency or its harmonic is always 1425 kc lower than the corresponding amateur band, with the exception of the 80-meter band where it is 1425 kc higher.

Next wire the 6AK5 isolation amplifier and the 6J6 harmonic amplifiers. When they are completed, use a grid dip meter and adjust L7 to 5.5 mc, L8 to 12.8 mc, L9 to 27.3 mc and L10 to 50.5 mc. This is done by adjusting the tuning slugs in the inductances with the power off, but with the 6AK5 and 6J6 tubes in their sockets. The coil forms used for L7, L8, L9, and L10 are the type used in the oscillator of an SCR-522. National Manufacturing Co., however, makes a slug-tuned coil form which is ideal for this purpose.

The isolation amplifier and harmonic amplifiers are broad enough to give ample output on all bands even though they are not exactly harmonically related.

The r.f. and mixer stages are straightforward. All bypass capacitors used in these stages are the button type mounted for minimum lead length.

The lead from the r.f. stage tuning capacitor to the band switch being relatively long, it is made part of the tuned circuit by using a short piece of low-capacitance coax. The ground lead on the r.f. tuning capacitor is heavy ¼-inch copper ribbon which furnishes the return for the tuned circuit. Copper ribbon is also used in the mixer tuned circuit for the tuning capacitor lead to the switch as well as the coil return to the capacitor. A .002- μ f capacitor

(Continued on page 50)

COIL DATA TABLE

	Ant.			R.F.			Mixer			form dia. (in.)	remarks
	coil	turns	wire size	coil	turns	wire size	coil	turns	wire size		
80 mtr.	L1A	16	35	L1B	77	35	L1C	85	35	1/2	close-wound
40 mtr.	L2A	9	30	L2B	45	30	L2C	48	30	1/2	close-wound
20 mtr.	L3A	7	30	L3B	28	26	L3C	30	26	3/8	close-wound
10 mtr.	L4A	4	30	L4B	14	26	L4C	15	26	3/8	L4A close-wound L4B, L4C spaced wire dia.
6 mtr.	L5A	3	18	L5B	6	18	L5C	7	18	3/8	L5A close-wound, L5B, L5C spaced for 1/2-in. length.

OSCILLATOR CIRCUITS

coil	turns	wire size	form dia (in.)	remarks
L6	20	26	3/8	spaced wire dia.
L7	34	30	1/2	close-wound, slug-tuned
L8	16	24	1/2	close-wound, slug-tuned
L9	12	22	1/2	close-wound, slug-tuned
L10	8	24	1/2	spaced wire dia., slug-tuned

even with the top of the 8¾x19-inch panel.

The first thing to wire on the r.f. chassis is the WWV section. The coils for this section are obtained from the BC-454. Remove the three cans under the main tuning capacitor on the BC-454 and open them. One contains a coil wound on a ceramic form. Set this aside for the h.f. oscillator. The other two (designated L11 and L12 in the diagram) are tuned to 5 mc.

All the interconnecting wires between the i.f. chassis and the power supply can now be run in. They come through the r.f. chassis and go along the left side through to the power supply. Other wires from the i.f. chassis come along the front of the r.f. chassis where they terminate at various points or go up to the phone jack or a.v.c. disabling switch. The S-meter wires, together with power wires for the high-frequency section, go along the right side, looking at the bottom, of the r.f. chassis into the power supply.

The connection between the 6AK5 mixer plate and the first 1425-kc i.f. transformer is made with low-capacitance coax (capacitance 13 μ f per foot). The reason for removing the 170- μ f capacitor from the first i.f. transformer now becomes apparent. By

L11 and L12 are r.f. and mixer coils from 3-6-mc BC-454-A.

L13 is b.f.o. transformer from BC-454-A.

L14 is b.f.o. transformer from BC-453-A.

L1A and L2A are spaced 3/8 inch from cold end of L1B and L2B, respectively.

L3A, L4A, L5A are each spaced 1/16 inch from cold end of their respective B-coils.

All coils wound with enameled wire.

tor which couples the converted signal from the WWV section to the first i.f. transformer lead, and is set at about 4—7 μ f.

The WWV section can now be turned on and the first 1425-kc i.f. transformer tuned. Be sure the 6AK5 mixer tube is in its socket. Adjust the trimmers on the 5-mc r.f. and mixer while feeding in a 5-mc signal.

The next step is the oscillator section. The main tuning capacitor was made from a dual 100—100- μ f capacitor found on the surplus market. The plates were removed with a pair of long-nose pliers until one section measured about 25 to 30 μ f and the other about 75 μ f. The 75- μ f section is used for 80 meters and the 25- μ f section for the remaining bands.

Wind the oscillator coil L6 very carefully on the ceramic coil form set aside when the coils were removed from the BC-454. Dope it well and let it dry. The negative-temperature-coefficient capacitor shown on the diagram is placed close to the oscillator coil and cemented in place. This assembly is then placed inside the shield can and mounted near the back of the band switch.

The negative-temperature-coefficient capacitor is actually a 50- μ f capacitor. One end is connected to the hot end of the coil inside the can. The other is brought to one of the unused terminals on the bottom of the can and a 200- μ f silver mica capacitor is connected there

IT'S ALLIED FOR RCA



**TUBES RECEIVING,
KINESCOPE, INDUSTRIAL
AND BROADCAST TYPES
BATTERIES
PARTS TV & RADIO
TEST EQUIPMENT**

It's RCA for quality! It's ALLIED for dependability! You can count on immediate delivery from ALLIED because we constantly maintain the world's largest stocks of RCA Tubes, Parts, Batteries and Test Instruments. Look to ALLIED first and always—your Headquarters for RCA Parts and Equipment . . .

ALLIED presents 3 NEW RCA TV TEST INSTRUMENTS

RCA WR-59B TV SWEEP GENERATOR. Features continuous IF coverage up to 50 mc, including video and intercarrier sweep ranges; sweep width is 10 mc. Provides output on 13 television RF channels, in steps. Output, 100,000 microvolts rms or better on every range; amplitude varies less than ± 1 db on all ranges. RF output attenuator is balanced capacitor type, and is 20,000-to-1 continuously variable. Has blanking control to provide single image and base line on scope; also has phase control. RF output impedance 300 ohms, balanced to ground. IF/Video Frequency range has 100-ohm termination and single-ended output. Intended for use with Model WR-39B TV Marker Generator, for highly accurate measurement of television receiver bandwidths on oscilloscope, such as WO-57A. Supplied complete with tubes, IF/VF and RF output cables, and instruction manual. Blue-gray Hammeroid case; $9\frac{3}{4} \times 13\frac{1}{2} \times 7\frac{1}{2}$ ". For 105-125 volts, 50-60 cycles AC. Shpg. wt., 35 lbs. **\$274.50**
84-074. NET



\$27.45 down, \$21.80 monthly for 12 months



RCA WR-39B TV MARKER GENERATOR. Crystal-calibrated variable frequency signal generator plus 2 built-in crystal oscillators. Provides dual markers with WR-59B or any sweep generator when measuring receiver bandwidth on scope. Ranges: 19-110 mc in 4 bands: 170-240 mc in 2 bands—all on fundamentals. Variable 100:1 attenuator. Output, 0.1 rms v, 100 ohms. Permits TV set linearity adjustments in absence of test pattern when variable oscillator is modulated by internal crystal or external oscillator. Serves as heterodyne frequency meter; has detector audio amplifier with speaker. Markers removed 4.5 mc and 250 kc from main marker for TV IF and sound discriminator alignment. Provision for external marker injection. Has crystal-controlled 4.5 mc output for alignment of sets with intercarrier sound. Complete with all tubes, 3 crystals and leads. Blue-gray Hammeroid case, $9\frac{3}{4} \times 13\frac{1}{2} \times 7\frac{1}{2}$ ". For operation on 105-125 v, 50-60 cycles. Shpg. wt., 22 lbs. **\$224.50**
84-072. NET

\$22.45 down, \$17.85 monthly for 12 months

RCA WO-57A 3" OSCILLOSCOPE. Features high sensitivity: 25 millivolts/inch deflection. Vertical amplifier response, flat within 3 db from zero to 500 kc, down only 55% at 1 mc and useful beyond 2 mc. Has frequency-compensated and voltage-calibrated step attenuation with vernier control and calibrating voltage source. 60-cycle sweep with phasing control. Separate input jacks for DC and AC signal tests. Linear sweep range is 15 to 30,000 cps. Has exclusive RCA sweep direction-reversing switch—positive or negative syncing. Direct-coupled amplifiers provide low frequency square-wave reproduction essential for correct sweep alignment. High-frequency square-wave response up to 100 kc reproduces blanking and sync pulse wave shapes with excellent fidelity. Provision for external sync. Hammeroid case; $9\frac{3}{4} \times 13\frac{1}{2} \times 8\frac{1}{2}$ ". With tubes, type WG-214 probe to reduce input capacity to 10 mmf., cable assembly, and instructions. For 105-125 volts 50-60 cycles AC. Shpg. wt., 20 lbs. **\$145.00**
84-073. NET



\$14.50 down, \$11.50 monthly for 12 months

IT'S **ALLIED**
FOR **RCA**

**FOR ALL YOUR TV & RADIO NEEDS
SEE YOUR ALLIED CATALOG . . .**

Refer to the Leading Buying Guide—your ALLIED Catalog—for everything in Radio and Television. Get every advantage: largest stocks, fastest shipment, lowest prices, finest personal service—always!

ALLIED RADIO

ALLIED RADIO CORP., Dept. 2-F-O
833 W. Jackson Blvd., Chicago 7, Illinois

- Enter order for RCA Test Instrument Model
Enclosed \$ Full Payment
 Send FREE ALLIED Catalog Down Payment

Name

Address

City Zone State



NEW WORKSHOP

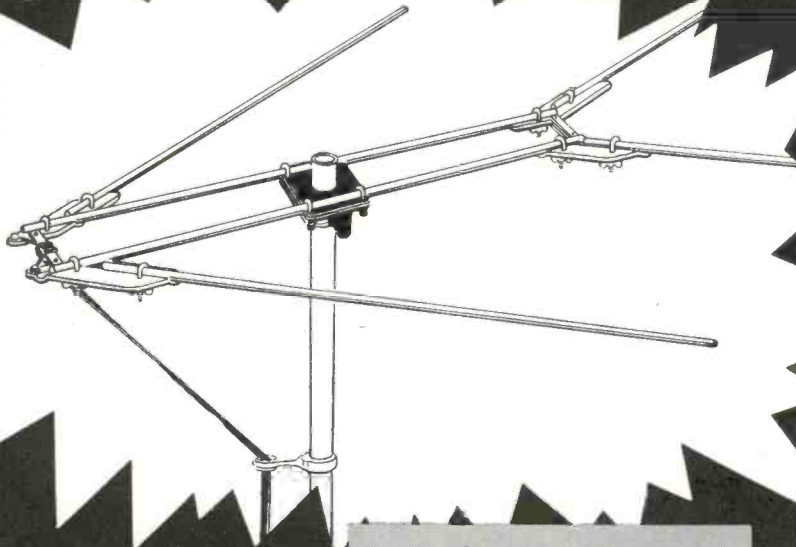

DUBL-VEE
TV ANTENNA

Outstanding ALL-CHANNEL Performance

THE "end-fire" DUBL-VEE sets a new standard in TV antenna performance. Higher gain, sharper directivity, and closer match assure superlative reception — clearer, steadier, sharper pictures. In fact, a single DUBL-VEE actually outperforms double-stacked models of most other types. Rugged — easy to assemble — economically priced. Your best buy at any price.

MODEL VV

Write for Bulletin D

THE WORKSHOP
ASSOCIATES, Inc.

135 CRESCENT ROAD,
NEEDHAM 94, MASS.

Clearer Pictures—higher gain brings in stronger signal — especially on higher channels

Clearer Pictures — narrow beam cuts down multi-path ghosts

Clearer Pictures—better impedance match on all channels maintains high signal strength

Clearer Pictures — true horizontal polarization—no out-of-phase ghosts

Clearer Pictures—no parasitic elements — all driven

Clearer Pictures—designed by the pioneers in the antenna industry

\$10.95 LIST

Model 2VV Double-Stack \$21.95 List

Specialists in High Frequency Antennas

(Continued from page 48)

blocks direct current at this point.

This direct and heavy construction is important! The copper ribbon reduces the inductance in the leads and puts it in the coupled circuits where it can do some good. Performance on 6 meters was very poor until this refinement was made. The heavy lines in the diagram show the leads referred to.

Take care to prevent oscillation in the 6J6 r.f. stage. If the 6J6 plate-6AK5 mixer tuned circuit is coupled back in any way to the first 6J6 grid, instability will result. This can be prevented by the partition shield between the r.f. and mixer coils. It is made of 3/16-inch aluminum, held by putting it in place of one of the wafers in the band switch. The edges are drilled and tapped so they can be bolted to the chassis. The r.f. coils have a thin copper shield over them between this partition and the front of the chassis.

The partition has four holes for the coil forms cut in it, two 1/2-inch and two 3/8-inch, and is slotted lengthwise so the forms can be clamped in place.

The 80- and 40-meter mixer coils are on the right side of the switch while the 20- and 10-meter coils are on the left (viewed from the front with the set upside down). The r.f. coils are on the other end of the same forms under the copper shield. The 6-meter coils are self-supporting and are mounted on the switch below the 20-meter coils. There are more wafers on the switch than are used because several front ends were tried and it would have been inconvenient to add wafers for experiment.

The oscillator injection to the mixer should provide about 1/2 volt on the 6AK5 grid. Any more raises the noise from the mixer without increasing the signal. The mixer grid voltage on all bands was between 1/10 and 2/10 volt with no coupling other than stray capacitance between the mixer circuits and the harmonic amplifiers. If there isn't enough coupling, some could be provided by a very small capacitor from the hot end of the mixer coil to the hot end of the harmonic amplifier coil on the band where more coupling is needed.

All bands on this receiver start with the low-frequency end at 20 on a 0-500 division dial. All the bands end at about 425 to 450 on the dial, giving over 400 divisions of bandspread.

This receiver was tested with a Measurements Corp. model 80 signal generator and was found to have 4 microvolts absolute sensitivity on 6 meters, 1.8 microvolts on 10 meters, and 1 microvolt on 20, 40, and 80.

The selectivity is the number of cycles off resonance when the signal is 10 times down. On broad selectivity it measured 10 kc; on sharp it measured 1.8 kc; and on c.w. with filter in, it measured 200 cycles.

The stability is perfect. You can beat on the set without hearing any more change in the note than if you were pounding on a crystal oscillator. The drift during warm-up is about 1,000 cycles in one hour at 10 meters.

This picture was taken in the Bridgeport office of The Southern New England Telephone Company, one of the 22 operating telephone companies which the Laboratories serve through the Bell System.

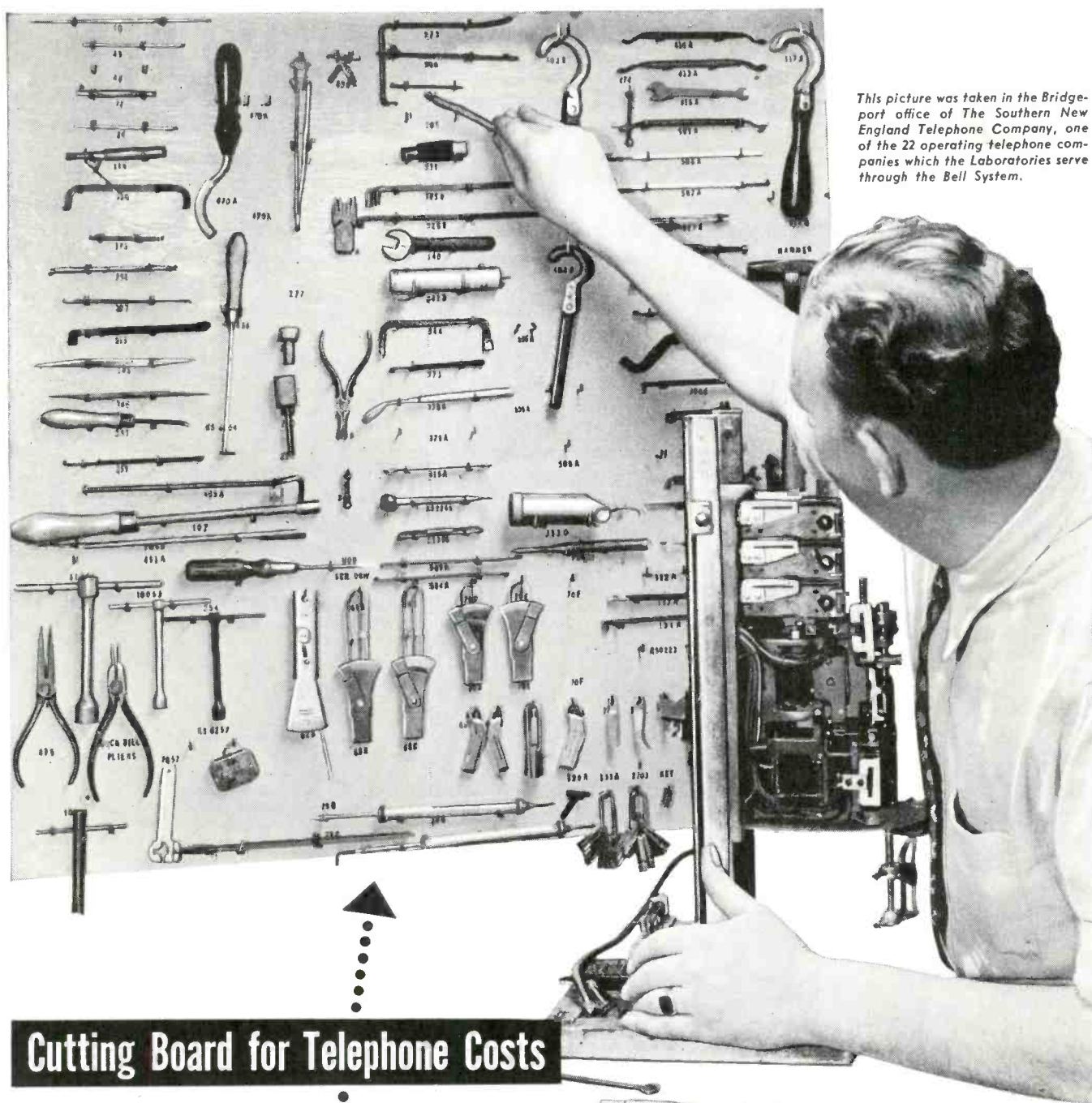

Cutting Board for Telephone Costs

Few of these tools have sharp edges. But they are powerful cost cutters. Whenever a telephone craftsman reaches for one, he finds the right tool ready to his hand. There's no time wasted trying to do a complicated job with makeshift equipment.

Most telephone tools are highly specialized. 90% of dial system tools

were designed by Bell Laboratories. Each saves time in maintenance, installation or construction.

There are tools with lights and mirrors to work deep within relay bays; tools to brush, burnish and polish; tools that vacuum clean—even a tool to weld on new contact points without dismantling a relay. There are gauges to

time dial speeds, others to check spring tension. Some look like a dentist's instruments. Some you have never seen.

Keeping the telephone tool kit abreast of improvements is a continuing job for Bell Telephone Laboratories. It's another example of how the Laboratories help keep the value of your telephone service high, the cost low.

BELL TELEPHONE LABORATORIES

WORKING CONTINUALLY TO KEEP YOUR TELEPHONE SERVICE BIG IN VALUE AND LOW IN COST



2 Pages of TEST EQUIPMENT at prices every serviceman can afford!

OUR POLICY

MONEY BACK? Every unit we advertise is offered on a strict "money-back-if-not-satisfied-basis". No if's—no but's—no maybe's. If you are not

completely satisfied after a 10 day trial—return for complete refund. No explanation—you are the sole judge. Plain enough?

GUARANTEE? Every unit sold by us is covered by a one year guarantee.

KITS? We have discontinued advertising Test Equipment in kit form. After handling kits for some months, we have come to the conclusion that it is impractical to successfully complete instrument

kits at home without the expensive calibration standards and other equipment available when instruments are factory produced.

**SUPERIOR'S
NEW
MODEL TV-10**

TUBE TESTER



Specifications:

★ Tests all tubes including 4, 5, 6, 7, Octal, Lock-in, Peanut, Bantam, Hearing-aid, Thyatron, Miniatures, Sub-Miniatures, Novals, etc. Will also test Pilot Lights.

★ Tests by the well-established emission method for tube quality, directly read on the scale of the meter.

★ Tests for "shorts" and "leakages" up to 5 Megohms.

★ Uses the new self-cleaning Lever Action Switches for individual element testing. Because all elements are numbered according to pin-number in the RMA base numbering system, the user can instantly identify which element is under test. Tubes having tapped filaments and tubes with filaments terminating in more than one pin are truly tested with the Model TV-10 as any of the pins may be placed in the neutral position when necessary.

★ The Model TV-10 does not use any combination type sockets. Instead individual sockets are used for each type of tube. Thus it is impossible to damage a tube by inserting it in the wrong socket.

★ Free-moving built-in roll chart provides complete data for all tubes.

★ Newly designed Line Voltage Control compensates for variation of any line voltage between 105 Volts and 130 Volts

The Model TV-10 operates on 105-130 Volt 60 Cycles A.C. Comes housed in a beautiful hand-rubbed oak cabinet complete with portable cover.

\$39⁵⁰
NET



SUPERIOR'S new model TV-30

TELEVISION SIGNAL GENERATOR

ENABLES ALIGNMENT OF TELEVISION I. F. AND FRONT ENDS WITHOUT THE USE OF AN OSCILLOSCOPE!

FEATURES—Built-in modulator may be used to modulate the R. F. Frequency also to localize the cause of trouble in the audio circuits of T. V. Receivers.

Double shielding of oscillatory circuit assures stability and reduces radiation to absolute minimum. Provision made for external modulation by A. F. or R. F. source to provide frequency modulation.

All I. F. frequencies and 2 to 13 channel frequencies are calibrated direct in Megacycles on the Vernier dial. Markers for the Video and Audio carriers within their respective channels are also calibrated on the dial.

Linear calibrations throughout are achieved by the use of a Straight Line Frequency Variable Condenser together with a permeability trimmed coil.

Stability assured by cathode follower buffer tube and double shielding of component parts.

SPECIFICATIONS—Frequency Range: 4 Bands—No switching: 18-32 M 35-65 Mc., 54-98 Mc., 150-250 Mc.

Audio Modulating Frequency: 400 cycles (Sine Wave). Attenuator: 4 position, ladder type with constant impedance control for fine adjustment. Tubes Used: 6C4 as Cathode follower and modulated buffer. 6C4 as R.F. Oscillator. 6SN7 as Audio Oscillator and power rectifier.

Model TV-30 comes complete with shielded co-axial lead and all operating instructions. Measures 6" x 7" x 9". Shipping Weight 10 lbs.

\$29⁹⁵
NET

— — — — TO ORDER—USE RUSH ORDER FORM ON NEXT PAGE — — — —

GENERAL ELECTRONIC DISTRIBUTING CO.

98 PARK PLACE
DEPT. RC-6
NEW YORK 7, N. Y.

RADIO-ELECTRONICS for

THE NEW MODEL 200
AM and FM

SIGNAL GENERATOR

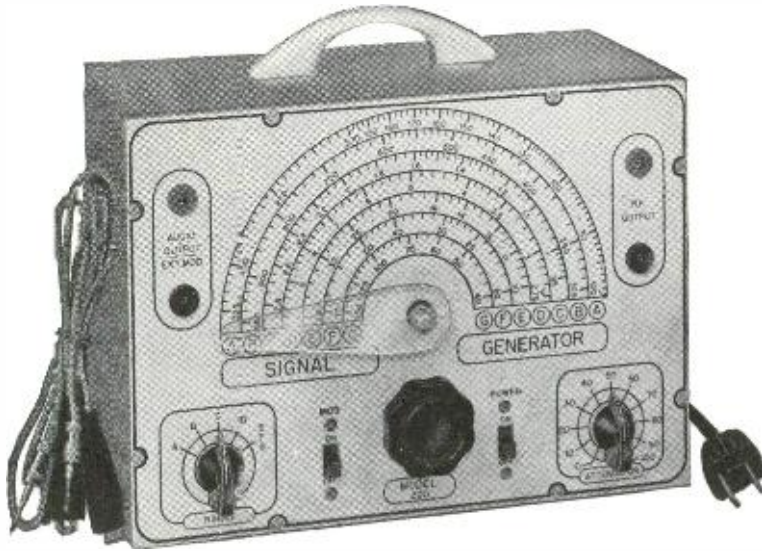

Specifications

- **R.F. FREQUENCY RANGES:** 100 Kilacycles to 150 Megacycles.
 - **MODULATING FREQUENCY:** 400 Cycles. May be used for modulating the R.F. signal. Also available separately.
 - **ATTENUATION:** The constant impedance attenuator is isolated from the oscillating circuit by the buffer tube. Output impedance of this model is only 100 ohms. This low impedance reduces losses in the output cable.
 - **OSCILLATORY CIRCUIT:** Hartley oscillator with cathode follower buffer tube. Frequency stability is assured by modulating the buffer tube.
 - **ACCURACY:** Use of High-Q permeability tuned coils adjusted against 1/10th of 1% standards assures an accuracy of 1% on all ranges from 100 Kilocycles to 10 Megacycles and an accuracy of 2% on the higher frequencies.
 - **TUBES USED:** 12AU7—One section is used as oscillator and the second is modulated cathode follower. T-2 is used as modulator. 6C4 is used as rectifier.
- The Model 200 operates on 110 Volts A.C. Comes complete with output cable and operating instructions

\$18⁸⁵
NET



Superior's new model 770

AN ACCURATE POCKET-SIZE VOLT-OHM MILLIAMMETER

(SENSITIVITY: 1000 OHMS PER VOLT)

FEATURES: Compact—measures 3 1/8" x 5 7/8" x 2 1/4". • Uses latest design 2% accurate 1 Mil. D'Arsenal type meter. • Same zero adjustment holds for both resistance ranges. It is not necessary to readjust when switching from one resistance range to another. This is an important time-saving feature never before included in a V.O.M. in this price range. • Housed in round-cornered, molded case. • Beautiful black

etched panel. Depressed letters filled with permanent white, insures long-life even with constant use.

The Model 770 comes complete with self-contained batteries, test leads and all operating instructions.

SPECIFICATIONS: 6 A.C. VOLTAGE RANGES: 0—15/30/150/300/1500/3000 VOLTS. 6 D.C. VOLTAGE RANGES: 0—7.5/15/75/150/750/1500 VOLTS. 4 D.C. CURRENT RANGES: 0—1.5/15/150 MA. 0—1.5 AMPS. 2 RESISTANCE RANGES: 0—500 OHMS 0—1 MEGOHM.

\$13⁹⁰
NET

Superior's new model 670

SUPER-METER

A COMBINATION VOLT-OHM MILLIAMMETER PLUS CAPACITY REACTANCE INDUCTANCE AND DECIBEL MEASUREMENTS

SPECIFICATIONS:

- D.C. VOLTS:** 0 to 7.5/15/75/150/750/1,500/7,500 Volts
- A.C. VOLTS:** 0 to 15/30/150/300/1,500/3,000 Volts
- OUTPUT VOLTS:** 0 to 15/30/150/300/1,500/3,000 Volts
- D.C. CURRENT:** 0 to 1.5/15/150 Ma. 0 to 1.5 Amperes
- RESISTANCE:** 0 to 500/100,000 Ohms 0 to 10 Megohms
- CAPACITY:** .001 to .2 Mfd. .1 to 4 Mfd. (Quality test for electrolytics)
- REACTANCE:** 700 to 27,000 Ohms 13,000 Ohms to 3 Megahms

INDUCTANCE: 1.75 to 70 Henries 35 to 8,000 Henries

DECIBELS: -10 to +18 +10 to +38 +30 to +58

ADDED FEATURE:

The Model 670 includes a special GOOD-BAD scale for checking the quality of electrolytic condensers at a test potential of 150 Volts.

The Model 670 comes housed in a rugged, crackle-finished steel cabinet complete with test leads and operating instructions. Size 5 1/2" x 7 1/2" x 3".

\$28⁴⁰
NET



GENERAL ELECTRONIC DISTRIBUTING CO. DEPT. RC-6, 98 PARK PLACE, NEW YORK 7, N. Y.

RC-6

GENTLEMEN: PLEASE RUSH THE MATERIAL LISTED BELOW:

QUANTITY	MODEL	PRICE		
TOTAL				

Name

Address

City..... Zone..... State.....

\$.....
(Payment in Full Enclosed)

\$.....
(Deposit Enclosed...
Ship Balance C.O.D.)

TV Antenna Phase Control

Co-channel interference is reduced and signal strength increased with a variable phasing control antenna

By G. N. CARMICHAEL

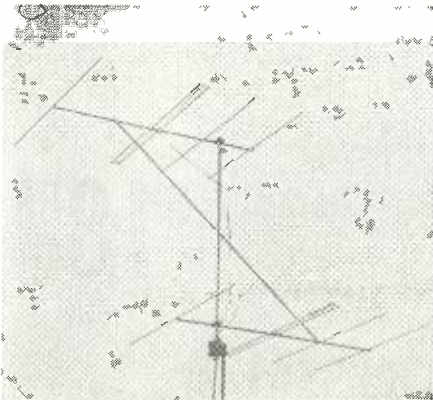

The antenna as viewed from the ground. The two Yagis are offset so that a wave front intercepts the two antennas with a phase difference of about 90 degrees.

AS the number of television stations has increased in recent months, co-channel interference has become a serious problem in fringe areas. Few fringe areas are completely free from this difficulty.

Before this situation actually occurred at the author's location, much thought was given possible solutions. The advent of WOC-TV in Davenport, Iowa at a distance of 120 miles north, on the same channel as KSD-TV in St. Louis, Mo., at a distance of 90 miles south by south-east, provided the necessary signals for a series of antenna experiments.

The author has felt that the Yagi type of antenna, even when tuned for maximum front to back ratio, would not be 100 percent effective. This proved to be the case, though a sharply directive Yagi was sufficient in many installations. Screen reflectors and multi-reflector parasitic elements gave some improvement but added so much to the bulk and wind resistance of the antenna, that this line of experiment was dropped.

The final solution was found by using a variable phasing control to add the voltages from two antennas in a way that nearly completely suppressed the undesired signal. At the same time, this method greatly added to the signal gain from the desired direction.

For a complete understanding of the operation of this antenna system, it will be necessary to review some simple cases.

Let us consider two half-wave antennas A and B, with a horizontal spac-

ing of one-quarter wavelength, and with independent feed-lines to the receiver. Fig. 1 shows voltages and phases of signals from opposite directions.

A signal from one direction produces a voltage in antenna A (curve 1) which leads the corresponding voltage in antenna B (curve 2) by 90 degrees. At the same time, the signal from the opposite direction produces a voltage in antenna A (curve 3) which lags the corresponding voltage in antenna B (curve 4) by 90 degrees.

If the feed-lines to the receiver are of the same length, there is neither complete addition of the desired signal nor complete cancellation of the undesired signal. However, if we shift the voltage phase by 90 degrees, for example, by lengthening one feed line by a quarter wavelength, both of these results can be obtained; that is, addition of the desired voltages and cancellation of the undesired voltages.

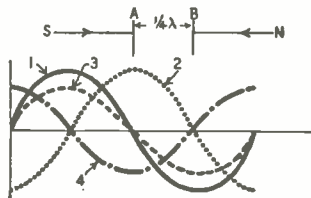

Fig. 1—Diagram of phase difference of two signals from opposite directions.

The above discussion assumes that both signals intercept the antennas from a horizontal direction. In practice this is not the case. The vertical wave angle is not constant from day to day, nor is it the same for signals from different distances. Fig. 2 shows an end view of the two half-wave antennas, indicating the horizontal wave and one with a different vertical wave angle.

The perpendicular distance between the wave fronts through each antenna represents the difference in phase of the voltages induced in these. If the desired signal from one direction has a vertical wave angle of 15 degrees, for example, and the undesired signal from the opposite direction has a vertical wave angle of 12 degrees, then the desired results can not be obtained by a shift of phase of 90 degrees for one of the voltages.

If the difference in horizontal direc-

tion is not 180 degrees, the situation is similar, as can be seen from Fig. 3. However, in both these cases, we can still obtain either maximum signal or maximum cancellation, or, in some cases, both, by properly phasing the voltages.

For complete flexibility, it is necessary to have controllable phase shift of one of the voltages. This control can then be used to get either maximum suppression or maximum forward gain.

The next step in developing a useful antenna system is to provide a better source of signal voltage than a half-wave antenna.

The complete antenna as designed by the author and produced by Trio Manufacturing Co., Griggsville, Illinois, consists of two Yagis with double dipole antennas mounted on one mast with the dipoles offset so that the wave front will intercept the two antennas with an approximate 90-degree phase difference for the vertical angles commonly encountered in fringe area reception. The vertical spacing between the two antenna bays is a compromise between minimum interaction of the antenna elements and difficulty of installation.

The feed lines from each of the Yagis are brought down separately to the phasing control. A schematic of the phasing control is shown in Fig. 4. The inductance and capacitance in the phasing control are carefully chosen for minimum variation in input impedance.

The Yagi antennas used for the voltage pick-up are 4-element arrays, con-

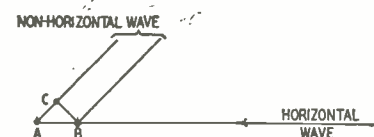
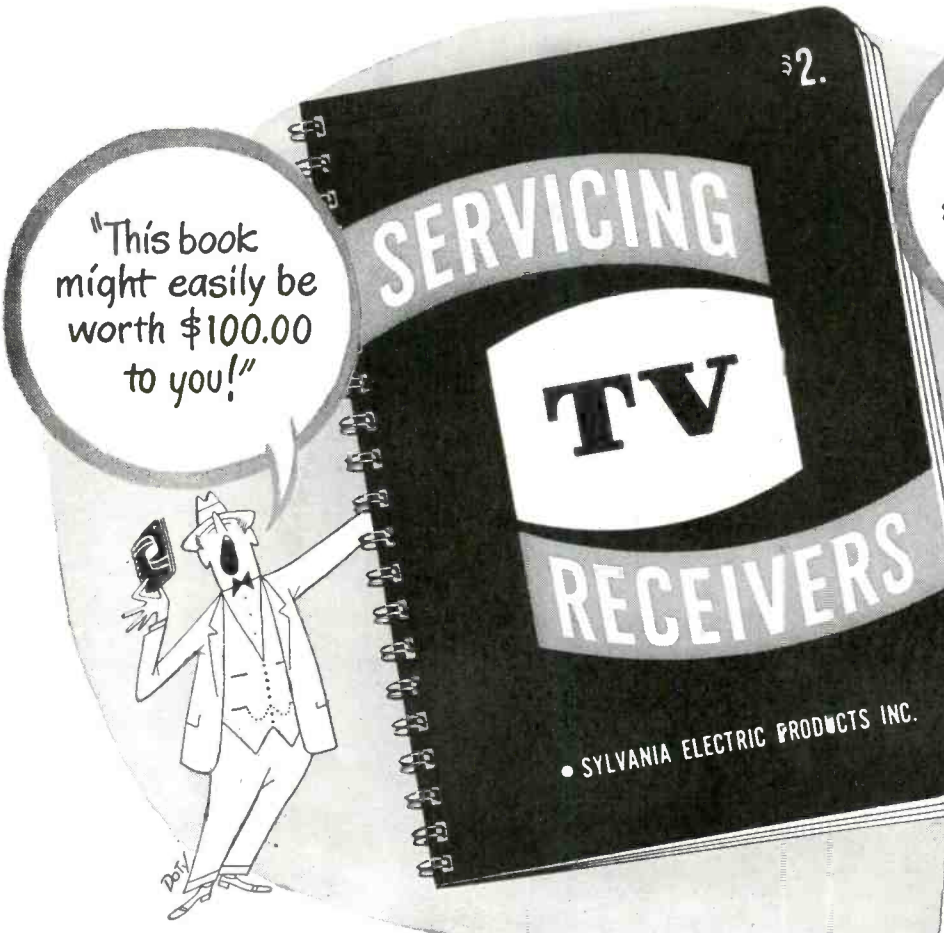

Fig. 2—End view of the dipoles. AB is the phase difference for the horizontal wave, AC for the non-horizontal wave.

sisting of an active element, one reflector and two directors.

The active element is a double folded dipole with a $\frac{3}{8}$ " driven element paralleled by two $\frac{5}{8}$ " elements to give the desired impedance. This is a simple method of obtaining a large increase in impedance without adding greatly



"The most complete TV servicing book ever printed"

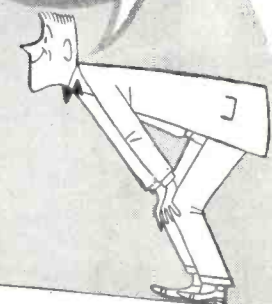

JUMPING PICTURE—NOISY SOUND

Characteristics
 1. Picture is unsteady, jumps and is erratic
 2. Thin white horizontal lines through picture
 3. Sound is distorted by noise

Cause	Remedy
A. Int. sync	
Lead shorts in 1 legged	
Excess cal rd resistor	

SPLIT PICTURE (VERTICALLY)

Characteristics
 1. Horizontal bar in center of screen
 2. Half of picture on each side of bar
 3. Picture wobbles up on bottom
 4. Top picture vertically in a single frame
 5. Vertical frequency too high or too low

Cause	Remedy
Vertical hold control not properly set (R104)	Manually reset vertical hold control
Resistor in vertical oscillator amplifier section is changed in value (R103)	Check for resistance value with ohmmeter referring to manufacturer's service guide
Shorted or leaking condenser (C187) in vertical oscillator amplifier circuit	Check for short in circuit with ohmmeter. Replace defective component
Shorted turns in vertical holding inductor transformer (T58)	Check transformer for non-unity or a short with ohmmeter. Replace if defective

FREE NOW!...

with your order for 100 Sylvania Receiving Tubes or 3 Sylvania Picture Tubes

Could be this book'll be worth its weight in dollar bills. For it explains in clear, plain language and illustrations how to identify TV set trouble . . . and what to do about it.

Contains more than 100 pages . . . filled with diagrams and photos to help you more quickly locate trouble . . . solve problems . . . improve your TV set repair business.

FREE only until August 31st

Remember, you can't buy this book. It's yours free from your regular Sylvania distributor during June, July, and August, with the purchase of 100 Sylvania Receiving Tubes or 3 Sylvania Picture Tubes.

So call your distributor today . . . while his supply lasts. Ask him for the book that will improve your television service, and the tubes to improve your profits . . . SYLVANIA.

HERE'S WHY YOU NEED THIS BOOK

- Shows more than 80 actual photos of screen test patterns. Shows how to identify trouble by pattern behavior.
- Gives simple, concise instructions for making repairs, proper adjustments.
- Contains complete circuit diagrams of typical television receiver.
- Explains latest television developments.
- Tells about television test equipment and what each instrument will do.
- Provides a practical dictionary of television set trouble.

SYLVANIA ELECTRIC

RADIO TUBES; TELEVISION PICTURE TUBES; ELECTRONIC PRODUCTS; ELECTRONIC TEST EQUIPMENT; FLUORESCENT LAMPS, FIXTURES, SIGN TUBING, WIRING DEVICES; LIGHT BULBS; PHOTOLAMPS; TELEVISION SETS
 JUNE, 1950

TELEVISION SCOPE

SUPERIORITY AT A GLANCE!

The vertical response of this economy TV scope is usable to 5000 kc, not 50 kc. Response is flat to 750 kc, down 3 db at 1000 kc. Amplifier supplies a voltage gain of 20 at 5000 kc.



AR-3

Check this necessary feature before you buy any scope for TV use.

The R.S.E., AR-3 Scope has been built by Ross Armstrong to our rigid specifications. It's a complete unit that embodies standard horizontal amplifier and sweep circuits with normal sensitivity.

The case is 8" high x 5" wide x 14" long, attractively finished in "hammered" opalescent blue enamel. Operates on standard 110 volts—60 cycles—40 watts. Tubes, 3BP1-6AC7-6SJ7-6X5-5Y3-884. Instructions included. Complete specifications upon request. Satisfaction or your money back.

PRICE \$4995

AVAILABLE TO JOBBERS IN QUANTITY

F. O. B. DETROIT

INTERCOM & RADIO

AT A PRICE THAT CAN'T BE BEAT



6 tube superhet—3 tube intercom permits communication between radio-master and up to 4 sub-stations. **WHILE THEY LAST \$2995**

With 1 sub-station and 50 feet of cable Extra Sub-stations \$3.95 each

Original cost \$64.50

PUSHBACK WIRE



25% BELOW MILL COST! 1st class, Essex or Lens, ALL SOLID tinned copper, double cotton serve, waxed finish.

SIZE	COLORS	100 feet	1000	Production Reel
22	BLACK-BROWN	.39	3.79	3.65M
20	RED-WHITE-BLUE	.49	4.49	3.95M
18	BROWN	.69	5.98	

ORDER INSTRUCTIONS

Minimum order—\$2.00. 25% deposit with order required for all C.O.D. shipments. Be sure to include sufficient postage—excess will be refunded. Orders received without postage will be shipped express collect. All prices F.O.B. Detroit.



Quantity and Export Orders Solicited

RADIO SUPPLY & ENGINEERING CO., Inc.
85 SELDEN AVE. DETROIT 1, MICH.

to the bulk and weight of the antenna.¹ Reflector spacing is a quarter wavelength from the active element, and spacing for the directors is one-eighth wavelength. Such an antenna provides a 10 db forward gain on the optimum channel as compared with a reference dipole.

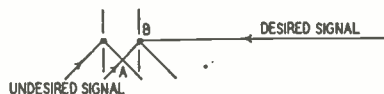

Fig. 3—A top view. AB represents the phase difference of undesired signal.

To understand the operation of the phasing control, it is convenient to analyze the phase shift obtainable by manipulating the lengths of the feed-lines. If we could continuously vary the length of the feed line from one of the antenna bays by as much as a quarter wavelength, we could get a phase shift of 90 degrees. If one lead-in is equipped with a d.p.d.t. polarity reversing switch, an additional 180 degree shift could be obtained.

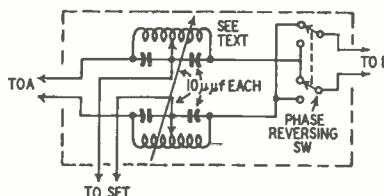

Fig. 4—Circuit of the phasing control.

Let us consider an arrangement such as that in Fig. 5. The lead-ins from the two antenna bays are connected to the two ends of a quarter-wave two-wire line, and the lead-in to the set is tapped on this quarter-wave section. As the position of the tap is varied, the total length to the set, of one line becomes longer, while the other is shortened. The total phase shift available in one is 90 degrees in one direction, while the other varies 90 degrees in the other direction. This 180 degree variation, together with a polarity reversing switch will then give complete control.

The phase control itself consists of two solenoid coils mounted on a rotatable shaft, and each provided with a wiping contact which is continuously variable from one end of the coil to the other as the shaft is rotated. Each coil consists of 10 turns of silver wire on

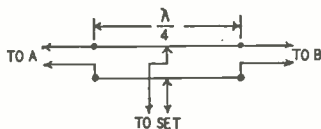

Fig. 5—A 1/4-wave line phasing control.

a grooved form of 1-inch diameter, with silver wiping contacts to provide the end terminals. Small fixed capacitors, each 10-μf are connected from each end terminal to the variable contact. This phasing control gives results precisely the same as that obtained by varying the tap on the quarter-wave section of two-wire line.

The combination of the sharp pattern of the Yagi, together with the phasing control, provides adequate re-

jection of the interfering signal in nearly all cases. Of course, very little can be done when the interfering signal is from the same direction as the desired signal. This situation is very uncommon, however, because of frequency allocations.

If the direction of the interfering signal is less than 135 degrees from the direction of the desired signal, the directivity of the Yagis provides the necessary rejection, and the phasing can then be set for maximum forward gain. A rotator is practically a necessity because the pattern of the Yagi is quite sharp.

If the interference is coming from one of the back lobes, the adjustment of the phasing control for maximum rejection eliminates the unwanted signal while still giving gain in the desired direction. Front to back, or rejection, ratios of 35 to 40 db. can be obtained while maintaining a gain of 15 db as compared with a reference dipole oriented in the desired signal direction.

Since the video and audio carriers are not on the same frequency it is sometimes impossible to eliminate completely interference on both picture and sound. In such cases, the phasing control is set to provide a clear sound carrier, free from chatter, and the picture interference is then slight enough to be scarcely noticeable.

A certain amount of retuning of the phasing control is necessary to compensate for shift in the vertical wave angles. This is especially true when the signals are subject to heavy fading, an indication of large changes in the vertical wave angle.

This antenna system gives adequate reception in areas where other types of antenna will not.

¹G. N. Carmichael, "Impedance Considerations in TV Antenna Design", Radio and Television Retailing, p. 86 Feb. 1950. The formula for the impedance step-up of such a dipole is

$$\left[1 + \frac{2 \log D/R_1}{\log D/R_2} \right]^2$$

where R_1 is the radius of the driven element of the dipole, R_2 the radius of the paralleled elements, and D is the center-to-center spacing between driven element and paralleled elements.



"Please have a seat—the doctor will see you in a moment"

VEE-D-X

LOW PRICED

Yagi Arrays

- Transformer ratio of stepped-up driven element provides perfect match to 300 ohm line.
- Lowest standing wave ratio insures maximum transfer of signal.
- High front to back ratio prevents co-channel interference.
- Sharp horizontal pattern helps reject unwanted interference of all types.
- Extra high forward gain makes this the ideal antenna for single channel fringe reception.
- Not designed to replace the famous heavy-duty RLY and EC series.

J SERIES

JA

V. S. W. R. = 1.34
Z = 335 ohms

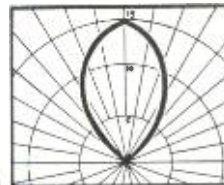

Gain in decibels

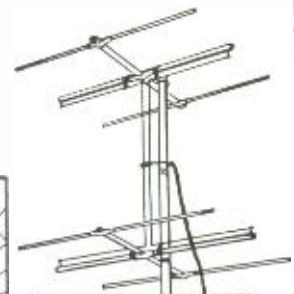

LOW CHANNEL
\$17.35 list
HIGH CHANNEL
12.50 list
For double stack as shown

Including phasing rods

JB

V. S. W. R. = 1.26
Z = 315 ohms

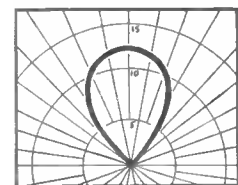

Gain in decibels



LOW CHANNEL
\$13.20 list
HIGH CHANNEL
6.95 list

JC

V. S. W. R. = 1.28
Z = 317 ohms

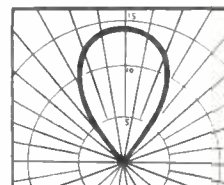

Gain in decibels

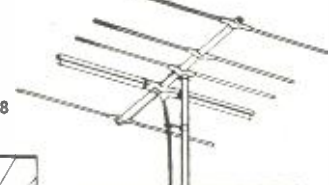

LOW CHANNEL
\$14.60 list
HIGH CHANNEL
7.95 list

PRE-ASSEMBLED FOR FAST, EASY INSTALLATION

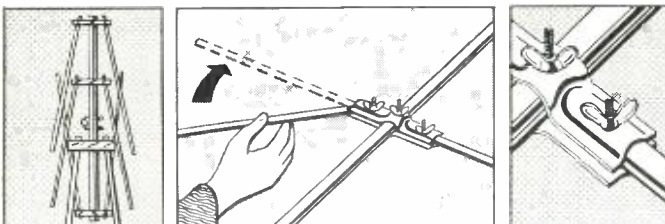

All the parts are in one package ready for assembly. The new clamp type construction makes it easy to swing each element in place and secure it firmly with the wing nut. No bag of hardware to fuss with — no bolts or screws to lose.

THESE ANTENNAS STAY UP

Only the highest quality duraluminum alloys are used.

Yield Strength	36,000 lbs. per sq. inch
Ultimate Strength	41,000 lbs. per sq. inch
Shearing Strength	24,000 lbs. per sq. inch
Endurance Limit	20,500 lbs. per sq. inch

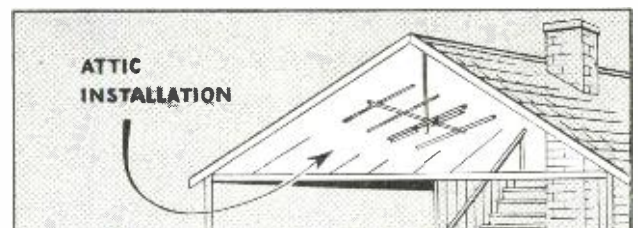

Because of the high gain of this antenna, many people have found that they can obtain excellent results with a single bay attic installation.

LAPOINTE-PLASCOMOLD CORP.,
UNIONVILLE, CONNECTICUT

1

Send me information on the entire line of VEE-D-X antennas and accessories.

NAME

COMPANY

STREET

CITY ZONE..... STATE.....

Low-Noise FM Front End

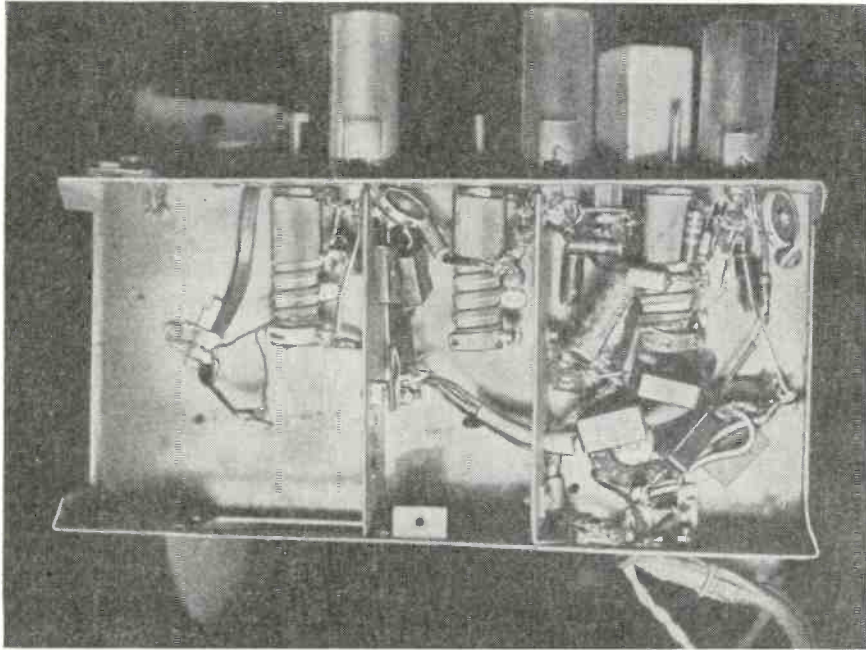

An underchassis view of the front end before addition of the first r.f. stage.

THE design of front ends for television, FM and v.h.f. is more complicated than other high-frequency circuits because the front end must provide a high signal-to-noise ratio as well as considerable gain. It is difficult to design and construct a conventional i.f. amplifier for FM with a gain of

more than 80 db, and the usual FM i.f. channel does not have more than 60 db gain up to the limiter. To get sensitivity better than 50 microvolts, the front end must provide high gain. Since gain and noise level rise together a really sensitive, low-noise front end requires careful design.

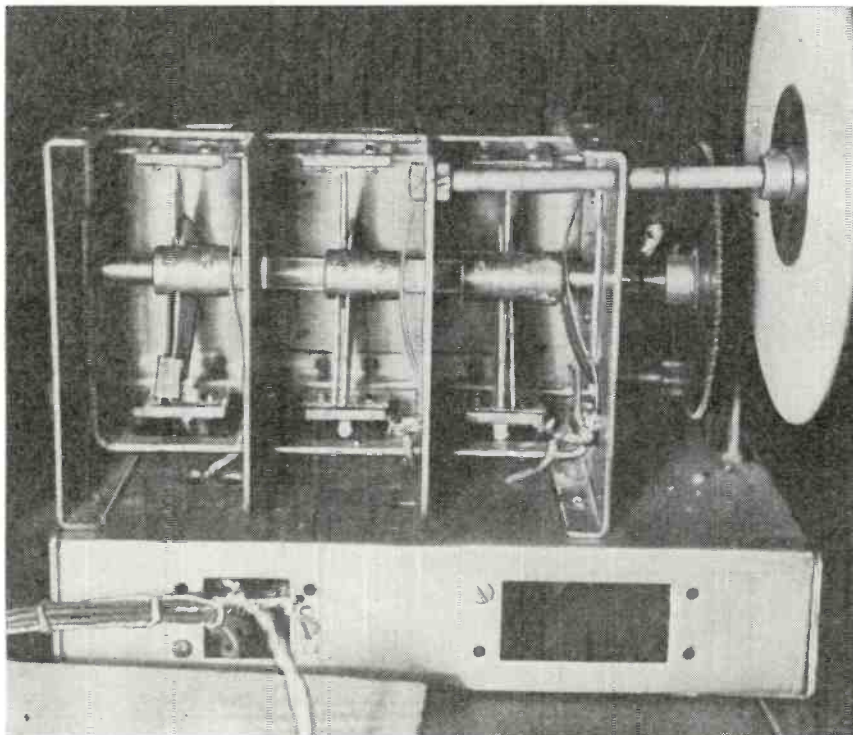

Photo of the modified broadcast set capacitor. Note the polystyrene shaft.

The front end for a high-gain tuner

By JOSEPH MARSHALL

By using an i.f. amplifier of very high gain, it is possible to achieve a low noise level in the front end. One such amplifier, using double conversion, two stages of 10.7-mc amplification, a second converter, one stage of 200-kc amplification, two limiters, and a frequency-counting detector, provides nearly 120 db of gain and will be described in a following article. Only normal gain is then needed at the front end to get better than 5 microvolts sensitivity on the FM band; and if the noise is really low, the usable sensitivity can be brought to 1 microvolt. A front end for the FM band which, if used with the i.f. amplifier mentioned, provides 1-microvolt sensitivity on the FM band, is described here. The circuit can be modified easily by changes in the coils and capacitors for use on v.h.f. ham bands or communications bands.

The front end uses triodes throughout: four 6J6s—two as r.f. amplifiers, one as a converter, and one as an oscillator. It is tuned with a home-made ganged capacitor. Because of the high losses and uneven gain, this is not the best method of tuning a v.h.f. front end when high efficiency is desired. It also may cause regeneration through coupling in the common shaft. The capacitor was used for the simple reason that no better tuning unit was available, and we had a capacitor which seemed well suited for such use.

In this case the performance has been highly satisfactory because the front end does not need to give very high gain. Very good capacitors for FM are available for about \$1.50 and one of these will save the trouble of improvising from the junk-box. On the other hand, the home-made capacitor using parts from the junk box, can equal it in performance.

The capacitor started as a three-gang unit in an ancient Scott receiver. It had three plates in two of the sections and a number in the third. What made the condenser attractive was the spacing of the sections which was wide enough for good placement of components in the various stages and low capacitance between sections. The rotor of each section was a heavy brass sleeve sliding independently on the

(Continued on page 60)

**YOU BUILD 'EM
IN ONE EVENING
BUT...**

THEY LAST A LIFETIME!

SAVE 50% WITH

**LABORATORY
PRECISION**



**INSTRUMENTS
& KITS**

SENSATIONAL NEW

**EICO Model 360-K TV-FM SWEEP
SIGNAL GENERATOR**

• Crystal marker oscillator with variable amplitude. • Covers all TV and FM alignment frequencies between 500 kc. and 228 mc. • Sweepwidth variable from 0-30 mc. with mechanical inductive sweep. • Extremely wide sweepwidth allows gain comparison of adjacent RF TV Channels. • Provides for injection of external signal generator marker. • Phasing control included. • Large, easy-to-read dial is directly calibrated in frequencies. • Vernier Tuning Condenser. • Comes complete with all tubes (including new, high-frequency miniature types): 6X5GT, 12AU7, two 6C4's. Crystal not included. 10"x8"x6 3/4". 5 Mc. Crystals available for above, each \$3.95
FACTORY-WIRED AND TESTED \$39.95
Model 360. Ready to use Sweep Signal Generator. See it at your local jobber!

\$29.95

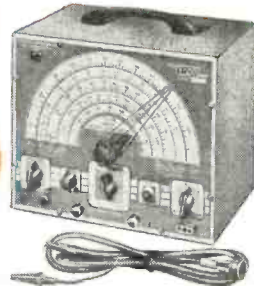

**ANYONE
CAN BUILD
THEM!**



\$19.95

**NEW! MODEL 320-K
SIGNAL GENERATOR**

For FM, AM alignment and to provide TV marker frequencies. Highly stable Hartley oscillator has range of 150 kc. to 102 mc. with fundamentals to 34 mc. Coilcits audio oscillator supplies pure 400 cycle sine wave voltage for modulation. Vernier Tuning Condenser. Use audio oscillator voltage to test distortion in audio equipment, bridge measurements, etc.

FACTORY-WIRED AND TESTED \$29.95
Model 320. Ready to use.

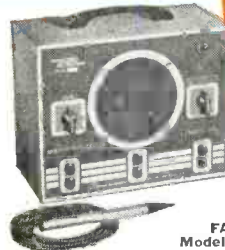

\$18.95

**VERSATILE MULTI-
SIGNAL TRACER**

Model 145-K. High gain—high frequency. Self-contained test speaker permits audible signal tracing of RF, IF, FM, audio and video circuits. Provision for visual tracing with VTVM. Response is well over 200 mc. 3-color hammer-tone panel. 110-125 V. AC. Size: 10"x8"x4 3/4". Comes complete with tubes and diode probe in kit form.

FACTORY-WIRED AND TESTED \$28.95
Model 145. Ready to operate.

**NEW PUSH-PULL 5"
TV OSCILLOSCOPE**

\$39.95

Model 425-K Kit

ALL-NEW laboratory precision scope has Push-Pull deflection and .05 to .1 volts per inch sensitivity. Wide-range, flat from 5 cps to 500 kc. with full gain setting, useful to 2 1/2 mc. Wide-range, multi-vibrator, sweep circuit from 15 cps to 75,000 cps. Direct connection to plates of CRT available at rear of cabinet. Z axis intensity modulation feature included. Size: 8 1/2"x17"x13" high. Complete with 3-6SN7s, 2-6J5s, 2-5Y3s, and 5BP1 CRT.

FACTORY-BUILT OSCILLOSCOPE \$69.95
Model 425. Fully wired and tested



**HIGH PRECISION
VACUUM TUBE
VOLTMETER**

\$23.95

Tops in workbench versatility—15 different ranges! AC and DC ranges: 0.5/10/100/500/1000 volts. Electronic ohmmeter ranges from .2 ohms to 100 megohms in 5 steps. New features include Zero Center for TV discriminator alignment. 26 Mc. DC input impedance. Accurate, 4 1/2" meter cannot burn out. Double-triode balanced bridge circuit assures guaranteed performance. Sturdy portable steel case with etched, rubberproof panel. Will measure up to 30,000 V. and 200 Mc. when used with our HVP-1 or P-75 probes, 110-130 V. AC 50-60 cycle. Size: 9 7/16"x8"x5 1/2".

FACTORY-WIRED AND TESTED \$49.95
Model 221. Same, but completely wired, calibrated, and tested.



**DELUXE SIGNAL
GENERATOR**

MODEL 315

Completely wired, ready-to-use Signal Generator with 1% accuracy! A wonderful instrument with dozens of expensive features. Frequency range: 75 kc to 150 mc. Has microcycle Band-spread vernier tuning for FM, AM, and TV. Voltage regulator. Write for \$59.95 full details.

**VOLT-OHM
MILLIAMMETER
Complete Pocket Kit**



\$14.95

Model 511-K. A "Must" for every serviceman! Small, handy instrument used a thousand times a day. Large 3" meter, beautifully etched panel. A perfect kit for beginners. Simple to assemble. Ranges: DC-0.5/50/250/500/2500 volts. AC-0/10/100/500/1000 volts. Output-0/10/100/500/1000 v. DC Ma.-0/1/10. DC A m p s.-0/1/10. Ohmmeter - 0/500/100,000 ohms/0/1 meg. DB meter - 8 to +5 Db. \$14.95

ASSEMBLED-READY TO USE
Model 511 - Completely wired, tested, and assembled at the factory. Rugged, built for heavy duty. \$17.95

WRITE FOR NEW CATALOG



**Model
HVP-1**

HIGH VOLTAGE PROBE

Complete top-quality High Voltage Test Probe measures up to 30,000 volts. Special Helical-Wound Ceramic HV Multiplier Resistor adaptable to most VTVM's and 20,000 ohms per volt meters with 1000 or 5000 volt scales. Lucite head, plywood bakelite handle, large flashards for additional safety. Specify your instrument. Complete ready to use. \$6.95

**ASK YOUR LOCAL
JOBBER**

About EICO's New Tube Tester Kit Model 625K — "the most versatile tube tester ever designed."

Don't settle for a substitute if jobber is out of stock. Insist on EICO, leading name in kits.

HIGH FREQUENCY RF PROBE



Model P-75K germanium crystal probe for visual RF signal tracing and measurements to over 200 megacycles. Can be used with models 221 or 113A Eico instrument (state which when ordering). 6 1/2" long, 1/2" O.D., with wire, plugs, and all components.

IN KIT FORM \$3.75
Model P76K same as above, but for oscilloscopes; in kit form. \$3.75
Models P75 or P76 similar to above but factory wired, ready to operate. Each \$7.50

EASY-TO-FOLLOW SCHEMATIC & PICTORIAL DIAGRAMS

Come complete with every EICO Instrument Kit. Each kit fully guaranteed to operate perfectly when assembled according to our simple instructions! **EXCLUSIVE LIFE-TIME REPAIR SERVICE!** For a nominal charge, we will repair and service your EICO instrument, regardless of its age!



Prices Higher on West Coast

ELECTRONIC INSTRUMENT CO., INC.
276 Newport Street, Brooklyn 12, N. Y.

$\frac{3}{8}$ -inch steel shaft, and each sleeve was wiped independently by a heavy brass grounding strap. The capacitor had a chromed cover which completely shielded it, not only electrically, but also from dust and grime. It occurred to us that if the steel shaft were replaced by a low-loss dielectric shaft, each section would be electrically isolated and this would reduce the common coupling effects. The steel shaft was removed and cut in two places, leaving just enough at the two bearing ends to fit the sleeves solidly. The remainder was replaced with a length of polystyrene rod of the same diameter. The bakelite insulation was replaced with polystyrene strips, and the third section was cut down to three plates. The whole thing was then checked and adjusted until it operated smoothly.

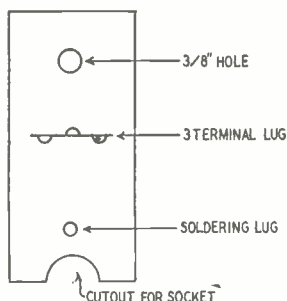

Fig. 1—Sketch of the partition shield.

The capacitors are connected to the coils with series ceramic capacitors of 25 μf for the r.f. sections and of 20 μf for the oscillator section. This reduces the minimum capacitance and gives a bandspread covering the FM band plus a megacycle or two on each end. The series capacitor also replaced what would have been a 2-inch lead.

If a commercial FM capacitor is used, the series capacitor is not needed to reduce the tuning range. If leads longer than 1 inch or so are necessary, it might be advisable to use a 50- μf coupling capacitor instead of the leads. If the capacitor leads are kept within a total of $1\frac{1}{2}$ inches or less, the result should be good.

The rotors of each section are grounded to the capacitor frame at a single point. A length of shielded braid, stretched to its thinnest diameter, connects this point to the socket ground. The braid has a relatively low inductance for a given length.

Before going into construction, a few words about the circuit. One of the big problems at these frequencies is getting a stable oscillator with an adequate signal over the whole band. This oscillator uses a 6J6 with the two sections in parallel. It works at a frequency higher than the r.f. because it is more difficult to track at the lower frequency with equal-section capacitors. The oscillator coil is identical to the r.f. coils, and all are standard National AR-5 coils without modification. No difficulty was experienced in tracking

because, the series capacitor for the oscillator being the smaller, the total capacitance is less and because the coil slug permits plenty of leeway in inductance. The total minimum capacitance is less than 12 μf , including circuit and tube capacitance. The two tube sections in parallel give an adequate and uniform carrier with good stability.

When this front end is used with the i.f. amplifier mentioned previously, there is no need for retuning after the initial few minutes. The i.f. amplifier and its detector are not affected as much by slight detuning as discriminator-and-ratio-type detectors. The front end is fed by a power supply without electronic regulation, but the supply has a heavy bleeder and the front end is fed through a 5,000-ohm series resistance which contributes to regulation. Changes of line voltage as great as 15 volts will not make retuning necessary.

The hot side of the oscillator filament is fed through a choke, and the other side is connected to the cathode so the filament current travels through the oscillator coil to insure hum-free performance of the oscillator. The only precaution necessary with this oscillator is to keep the leads to the grid, coil, and cathode as short as possible—less than an inch in any case.

The converter is another 6J6 with the sections in parallel. This reduces noise and increases gain. Aside from the arrangement of the components which will be discussed later, only one little trick is necessary with this converter. The capacitor across the i.f. coil must be removed from the shield can and placed near enough to the socket to keep the lead from plate to capacitor exactly 1 inch long. This gives just enough inductance to overcome degenerative effects. The inductance introduces a negative resistance component into the grid circuit which reduces the loading at input frequencies. Be careful not to make the lead longer, for a greater inductance might result in a negative input resistance and regeneration or even oscillation.

The converter is quite free of pulling effect, and the sensitivity is extremely good because of the high grid leak. All in all, it is a highly satisfactory converter with a good deal less noise than a 6AK5 r.f. stage and many times less than pentode or pentagrid mixers.

The converter is preceded by a cathode-coupled r.f. stage. If the specified layout or a close approximation of it is used, this is an uncritical type of r.f. amplifier to construct and adjust. There is a cathode choke in addition to the resistor. This choke is broadly resonant at about 100 mc with circuit capacitance and increases the gain. The filament, as all the others, is fed through a choke and has plenty of decoupling and bypassing. Button-type silver mica capacitors are used close to the chassis and the smallest size of 1,000- μf mica capacitors are used where spacing between element and

ground is too great for button capacitors. All ground returns are to a single point. The use of the tuning capacitor with insulated shaft no doubt accounts for part of the stability, but an ordinary capacitor would probably work very well if the same or similar layout were used.

The noise of this stage, though very low, is not optimum because the noise contributed by the parallel tube sections is twice that of a single section. However, the gain is more than enough to override the noise contributed by the converter.

To reduce the noise still further, a grounded-grid amplifier is used as an antenna stage, again with the 2 sections of a 6J6 in parallel. Thus connected, the 6J6 has about the same transconductance and less noise than the much more expensive 6J4, which has the lowest noise figure of all available tubes. The filament is kept at cathode potential by a simple bifilar choke.

The cathode input circuit uses a self-supporting coil wound of surplus silver-plated wire. A piece of No. 18 hookup wire stripped of its insulation will do. This coil is not very critical and need not have a very high Q. The exact inductance is not critical either because the stage is very broad; and if the circuit resonates with tube and stray capacitance anywhere from 80 to 150 mc, nearly maximum and uniform gain will be obtained over the whole FM band. The input impedance of this stage matches a 150-ohm line almost exactly but a mismatch to a 300-ohm line will not make any appreciable difference unless the front end is on the verge of regeneration. In this case, the standing waves on the line might throw the stages into regeneration. If a coaxial cable of 50 or 75 ohms is to be used, the coil can be tapped halfway for the input.

There is an input balancing coil, or elevator, between the cathode and the transmission line input to preserve the line balance and prevent the line from acting as an antenna. This is very important if the front end is used with the i.f. amplifier described previously because an unbalanced line would pick up c.w. interference and harmonics of the oscillator.

The decoupling and filter networks in the power leads are quite elaborate. The B-plus lead is filtered where it enters the chassis. This keeps 10.7- or 10.9-mc signals from the i.f. and helps keep the r.f.'s from the i.f.'s where they may be re-radiated and picked up by the front end to cause regeneration. The filament is also filtered and bypassed for the same reasons. There is a parallel resonant circuit in the B-plus line between the oscillator section and the r.f. sections. This consists of a 3.5- μh choke and a 50- μf capacitor which resonate at about 11 mc and offer a high impedance to the i.f.'s. These measures are necessary to real-

(Continued on page 62)

ize the full value of the low noise and high gain of the front end and i.f. stage. Any interference picked up at the intermediate frequencies will be amplified to some degree in spite of the two tuned r.f. circuits and may add enough additional noise to reduce the sensitivity.

No claim is advanced that this front end has the best possible noise figure. There may well be other combinations of r.f. amplifiers and converters which give better results. Additional work on the input stage and its coupling to the r.f. stage may reduce the noise somewhat; but, as it stands, this combination is about as good as possible with ordinary measuring and testing equipment. The sensitivity is well below 1 microvolt. As a matter of fact, any signal distinguishable from the background noise is readable, although that does not mean it would provide good listening. This seems to be about all one can expect. It is difficult to measure gain accurately at these frequencies with ordinary service-type equipment and no great effort was made to attain high gain, but the amplifier provides a gain of at least 40 db at the high-capacitance end.

Construction details

At these frequencies the mechanics of construction are extremely important. Great care in placement, shielding, dressing of components and wiring, and other such details is essential. The layout used in this front end should be duplicated as closely as possible unless previous experience at these frequencies indicates otherwise.

The chassis used is from one of the tuning units of a BC-610 transmitter. This chassis is well suited for this amplifier and will greatly reduce construction work; if one can be obtained at a reasonable price, it is well worth getting. However, a regular 4 x 8 x 1½-inch aluminum chassis with a cover plate will make nearly exact duplication possible.

The arrangement of components and shields is quite simple and is the same for the two r.f. stages and the converter. The tube sockets and coils are mounted along the center line of one of the long narrow edges of the chassis. In the tuning unit chassis, the sockets

were mounted in holes already present. Three of these are exactly right to take a shielded mica-filled socket, and the fourth needs only slight enlargement. If a new chassis is used, the tube sockets can be spaced 2 inches apart, with the coils in the middle of the intervening space. Better yet, the sockets can be spaced to match the tuning capacitor used, so that the leads from capacitor to coil will be as short as possible.

The partition shields are cut from aluminum or copper sheet in the shape indicated in Fig. 1. The shields are fastened to the chassis only at the rear, and are grounded at the front to the middle of the tube socket. The semi-circular cutout along the edge fits over the socket and must clear the socket terminals. The shield is mounted to bisect the socket, leaving the grid and cathode leads on one side and the plate and one filament lead on the other. The other filament lead, pin 4, will be exactly in the middle under the shield; and, when oriented this way, the socket mounting screws will be placed so that one is on one side of the shield and the other on the other. Do not drill the mounting holes for the sockets until you have checked this orientation.

Before the shield is put in place, the sockets are mounted, with a soldering lug under the mounting screw between the plate and cathode leads. A short length of bare hookup wire is worked through the hole in the center shield of the socket to pin 4 and through the soldering lug to make a grounded bus bar. The filament choke and its button capacitor are wired in, and the ground side of the capacitor is soldered to pin 4. The socket ends of all the chokes, resistors, and capacitors are then wired in and the ground ends of the bypass capacitors are wired to the common ground.

The shield has a 3-terminal lug mounted about 2 inches above the cut-out and a soldering lug just above the cutout. There are also one or more small holes at the back to pass the power supply leads from one stage to another. The shield is fastened in place and the soldering lug above the cutout is soldered to the center post of the socket. The plate circuit components can now be wired to the terminal

strips. Before the coil is put in place, a short lead should be soldered to the grid terminal of the socket and the lead from the tuning capacitor (actually the 20- μmf ceramic capacitor) arranged to connect to the grid tap of the coil with the shortest possible lead. When the coil is put in place, it is necessary only to connect the leads to the coil and the coupling capacitor from the previous stage.

The same arrangement, with only slight changes, is used in the two r.f. stages and the converter. The arrangement within the oscillator compartment is not critical except that the lead of the coupling capacitor between converter and oscillator should not exceed 1½ inches, and the leads to the coil, grid and cathode should be as short as possible. No dividing shield is needed for the oscillator socket.

The input filters are now arranged in the oscillator compartment. Do not ground any supply line bypass to the shield between oscillator and converter. Use a single, separate ground point for these bypasses. Mica capacitors are specified for the filters. Paper capacitors will do, but micas are more reliable and efficient. This arrangement is simple and effective, and it makes a good-looking job.

Alignment and adjustment

If the specified coils and a capacitor with a minimum capacitance of 5 μmf per section or less is used, there should be no difficulty in putting this front end into operation. With a 100-mc signal fed through a 1-turn loop of hookup wire wrapped around the ground end of the converter coil, the oscillator and converter can be tracked by adjusting the coil inductance. Then the hookup wire loop can be moved to the r.f. coil and this stage adjusted. Finally, the signal can be fed to the antenna input, and the whole front end peaked. Be sure to check each stage several times.

If the layout has been followed carefully with good workmanship, and the plate supply voltage is not much over 100, there should be no oscillation. If there is oscillation, check the partition shields for grounding and for undesired grounding of tube contacts to the shield. If the oscillation is sporadic and occurs suddenly at any point in the tuning range, check the capacitor wipers for good contact and the circuit for loose connections, especially ground connections. If one part of the range is hotter than the rest, check the filters in the plate and filament leads.

Much trouble will be saved if great care is used in the initial wiring, especially in making every joint mechanically strong and well soldered. Be sure to make the right connection to the cathode-coupled stage. It is easy to confuse the various socket contacts and get the wiring of the two sections mixed up. Finally, be sure to avoid radiation by both front end and i.f. This model is completely shielded, capacitor and all, so there is not much

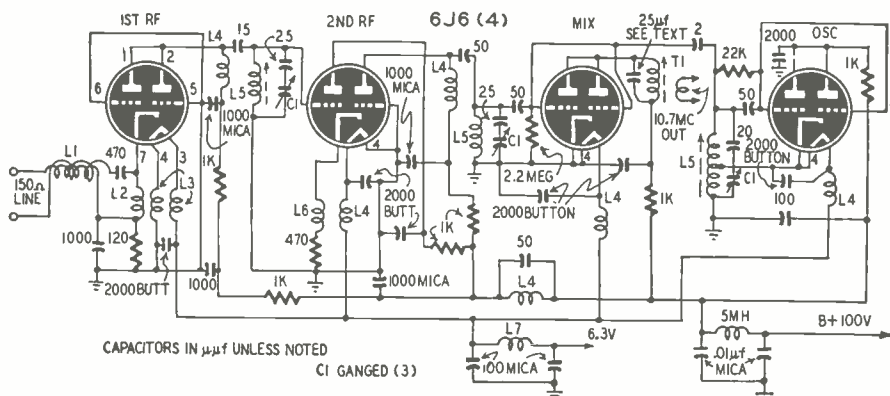

Schematic of the front end. It is designed for a high-gain i.f. amplifier.

BARGAINS AT

HERSHEL RADIO CO

• DETROIT 8. MICHIGAN

THE "FORTY-NINER" GEIGER COUNTER

\$89.50



- Light weight uranium detector.
- Detects beta and gamma rays.
- Equipped with 36 inch search Probe.
- Contains two 67 1/2 volt Minimax batteries in the well-known type of relaxation oscillator supply.

Weight 4 1/2 lbs. complete; size 4"x5"x6". Beautifully finished case with handle.

Complete with four tubes, including Geiger tube, batteries, search probe and ear-Phone.

BANK - CLIMB ALL-PURPOSE GYRO - CONTROL CHASSIS

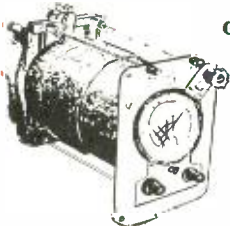

For Mark 4 Automatic Pilot

\$495

Contains 3 plugs, 2 vol. controls, 1 25 wt. resistor, 2800 ohms, 250,000 ohms, 10 wt. resistors, 13,500 ohms, 10 wt. resistors, 3 1/2 mmfds, 3 bathtub condensers 600V, 3 sockets, 4 shock mounts and many other parts in a blank top chassis.

95c

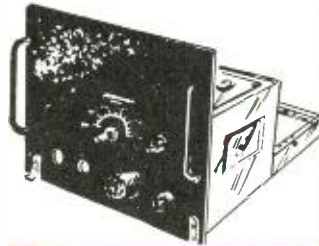

S-1 BOMBSIGHT WITH M2 MODIFICATIONS

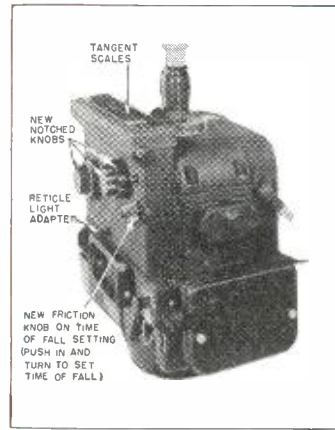

Contains many precision gears, cams—planetary assemblies gyros—switches, motors, slide rule, tangent scale, adjustable coated optic system, outside silvered mirrors. Comes in heavy, metal, safe-like container.

Brand new and complete.

Shipping weight 150 lb.

\$69.95

POTTER AND BRUMFIELD OVERLOAD RELAYS

1, 5000 ohms, coil current 10 Ma., Relay 2, 110 V, 60 cy. AC. coil S.P.D.T. F236 \$1.95

5 GANG VARIABLE CONDENSER

Approx. 50 MMFD. per section with individual air tuned padders. . . . 18 to 1 vernier drive. F-243 \$1.95

AIRCRAFT POWER RHEOSTATS

50 W, 30 ohms 1.7 amps. max. F283 95c

5-TUBE SUPERHET AC-DC KIT

Full-sized 5 Tube Superhet Kit with automatic Volume Control, Built-in Antenna, Dynamic Speaker, Brown Plastic Cabinet. Build it yourself and enjoy fine performance! Uses 12SA7, 12SK7, 12SQ7, 50L6, 35Z5. For 110 volt AC or DC. Complete. . . . \$12.95

G.E. PHOTOCELL . . . 95c

Type used in movie projectors, burglar alarms, etc.

STANDARD MAKE CAPACITORS

2000 MFD, 50 V. . . . F309 \$1.29
(W.P.) 2000 MMFD at 15V. . . . F308 95c
STANDARD MAKE MICA CAPACITORS
.0004 MFD .002 MFD, 3000 VDC. . . . 49c

OUTPUT TRANSFORMER

No. 227. Push pull 6V6's to 6-8 ohm voice coil, excellent characteristics. . . . 49c each

FILAMENT TRANSFORMER



Amertran Type WS
For High Voltage Rectifiers.
PRI. 115V., 50/60 Cycle.

SEC. 5V., C/T @ 10 Amp.

35 KV R.M.S. Test 12 KV D.C.
Operating. Uses 872A Tube or other tubes.

\$5.95

872-A. . . \$1.75

304TL \$1.95



Just the tube for that 1KW final—typical operation 2500 volts at 400 MA. / n ideal tube for that inductor heater or dielectric heater. Efficient operation at 1500 V. to 3000 V.

ULTRA HIGH-FREQUENCY TRANSMITTER T-85/APT-5

BRAND NEW! ONLY **\$95.00**

1500 Megacycle Transmitter, made for U.S. Government, complete with the following tubes: 2-6AC7, 1-6L6, 2-829, 1-931A; 1-6AC7, 1-522 Ultra high freq. tube. Complete with high freq. cavity, 1 Blower to cool the 522, 1 time delay relay, 2 filament trans. cond. and many other component parts for ultra high frequency work. It has a frequency checker, complete Lecher wires, with slider and sensitive bulb for checking the wave length. The Lecher wires are so calibrated that the setting of the slider may be read directly in Centimeters. Operates on 115V. AC for filaments only. Does not include any plate supply. The tubes alone are worth many times more than what we are selling the complete transmitter for. Packed in original case—contains instruction book. Wgt 118 lbs.



COAXIAL FITTINGS

- 5c HOOD
- 25c SOCKET SO-239 83-1R
- 35c PLUG PL-259 83-1SP
- 20c ANGLE-ADAPTER M-359 83-1AD

BK 22 K RELAY

\$2.95 Used in conjunction with SCR-269F, changeover contains 23V. step relay 5 deck, 6 position switch, 12V. DPST.



Banana Jack and Plug Sets

75c Dozen Sets



THERMOSTAT

Normally opens at 95° **49c**



BC-746 Tuning Unit



Plug in transmitter tuning unit from army Walkie Talkie. Contains antenna and tank coils, tuning condenser, transmitting and receiving crystals. Ideal transmitter foundation. Shipping Wgt. 1 lb. Each. . . .

95c

T-17 MIKE



Lowest Price Ever! Slightly used, guaranteed perfect and clean. Single button carbon hand mike. Light, efficient. 200 ohms. Press-to-talk switch. 5-ft. rubber cord with PL-68 plug attached.

Special **69c**

Butterfly Condensers

Oscillator assembly 76 to 300 MC with acorn tube socket mounted on condenser **\$3.95**
Type B Frequency range 300-1000 megacycles **2.95**
BC4 Antenna condenser 105-330 MC. . . **3.95**
Oscillator 105-330 M.C. . . . **3.95**



INDUSTRIAL PAPER OIL CAPACITATORS

- 1. MFD 5000 V. **\$2.95**
- 1. MFD 6000 V. **\$4.95**
- 2. MFD 6000 V. **\$8.95**
- 2 MFD. 1000 V. **95c**



MODULATION TRANSFORMER AND DRIVER TRANSFORMER

RC 1206 modulation transformer. 815 Class AB2. 56W. audio. RC 1205 driver transformer. 65N7 to 815, Class AB2—Companion to RC 1206.



ONLY **\$4.95** FOR BOTH UNITS

Experimental Circuits For Crystal Triodes

By RUFUS P. TURNER, K6AI

NEW!

Rectangular
BLACK TUBE

16in. TELEKIT

TELEKIT
PRICES
START AT **49.95**
LESS TUBES

Jobbers: Write for Confidential Price Information

16 BR Telekit
\$79.95 Less
Tubes

Now you can build your own rectangular black tube TV set! This exciting new Telekit has a big 16 inch screen from a non-glare rectangular black tube. The entire set is engineered for simplicity, and has new 70% deflection, with video tube mounted directly on chassis. Brightness is assured by a 14 KV hi-voltage doubler circuit. The streamlined circuit is easy to assemble. No previous knowledge of TV is required. All you need is pliers, screw driver and soldering iron. The tuning unit and hi-voltage supply are factory wired and assembled for you. A big 54 page illustrated instruction book guides you through easy assembly. Satisfactory performance is guaranteed by our Telekit Factory Service Plan and warranty. Write today for full details.



12-B Telekit
\$69.95

8-B Telekit
\$49.95

Less Tubes

Here are new low prices on Telekits. Now you can have a fine 8 1/2- or 12 1/2-inch set at a price far below comparable commercial sets costing much more.

Over 30,000 Telekits have been assembled by following the big Telekit instruction book. No previous knowledge of TV is required. Satisfactory results are guaranteed under the Telekit Factory Service Plan. Write for full information.



Telekit
Booster
\$12.95

This Telekit Booster will bring in TV signals bright and clear. Especially helpful in fringe areas. Will give brilliant performance with any TV set. NOT A KIT. Completely assembled with tubes.

Write for FREE catalogue listing Telekits, cabinets, tubes, antennas, boosters and television accessories.



TELEKIT

ELECTRO-TECHNICAL INDUSTRIES
1432 N. BROAD ST. DEPT. B PHILADELPHIA 21 PA.

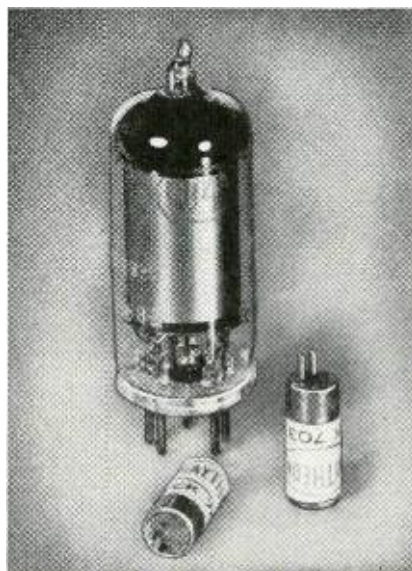

Two CK703 germanium crystal triodes shown with a 1U4 tube for size comparison.

THE germanium crystal triode, also known as the *transistor*, can be applied in a variety of ways to experimental electronic circuits. Much interesting and valuable work can be done with these new components by experimental-minded radio technicians who are interested in crystal devices. Small in size and having no filament, the crystal triode offers attractive possibilities in circuit miniaturization. The Raytheon CK703 crystal triode is only 0.225 inch in diameter or slightly more than 1/4 inch and has an over-all length, including its tiny base pins, of 0.775 inch (slightly more than 3/4 inch). See Fig. 1.

Operating data for the CK703 and base connections are given in the accompanying table. The crystal triode has two whiskers (emitter and collector) in contact with the germanium crystal. In the CK703 the two whiskers are connected to the base pins. The crystal is connected to the brass shell which encloses the device. The photo shows two CK703 transistors beside a 1U4 miniature tube for size comparison.

Contrary to vacuum-tube practice, a *positive* bias voltage is applied to the emitter whisker (grid) and a *negative* voltage to the collector whisker (plate). Unlike the vacuum tube, the transistor has a low input impedance and high

output impedance. Input (emitter) impedance of the CK703 is 500 ohms; output impedance (collector) is 10,000 ohms. Aside from these features, transistor circuits resemble triode tube circuits.

In about three months of experimenting, the author assembled and tested several dozen breadboard circuits either worked out entirely by himself or suggested by his associates. The circuits given in this article are the ones which performed best and seem most satisfactory for amateur experimenters.

Audio amplifiers

The author had no success with resistance-coupled transistor audio amplifier circuits. In the resistance-coupled circuit, the 10,000-ohm output of one crystal triode must feed into the 500-ohm input of a second triode. This results in considerable signal voltage reduction, and a prohibitive number of stages is necessary for enough voltage gain. Also, the collector resistance of one stage, interstage coupling capacitor, and lower emitter resistance of the following stage constitute a high-pass filter which spoils frequency response.

Best results are obtained with transformer coupling. However, the transformers must be connected backward from conventional practice—that is, the high-impedance winding must be connected to the output of one transistor and the low-impedance winding to the input of the following transistor.

(Continued on page 68)

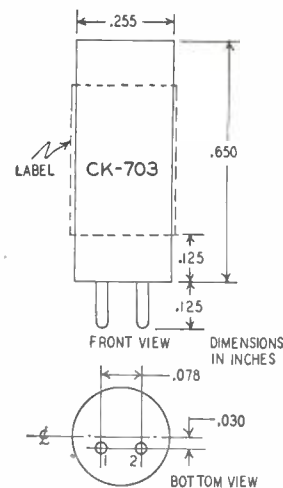

Fig. 1—Dimensions of the CK703 triode.

COMPLETE TRAINING

FOR BETTER JOBS
in Radio-Electronics



ONLY
\$14

5 MONTHS TO PAY!

Here are three world-famous books so thoroughly covering radio theory, troubleshooting and servicing methods; so clearly explaining every phase of the work that, with a minimum of time, you'll soon be able to handle repairs on any type of Radio-Electronic Equipment and qualify for better jobs, bigger pay checks! You couldn't get a finer, more complete or easier to understand training course AT ANY PRICE. Remember! These are the same Ghirardi books that were more widely used for wartime radio-electronic training than any other books or courses of their type!

Ghirardi's BIG-3 RADIO SERVICING LIBRARY

These three big books contain a total of 3016 pages and 1214 illustrations covering the complete range of basic radio-electronic and service subjects:

1—RADIO PHYSICS COURSE

Complete basic training for beginners. Makes even the most difficult subjects easy to understand! 972 pages, 508 illus. Price \$5.00.

2—MODERN RADIO SERVICING

The 1300-page book that teaches you to work by truly professional methods. Explains all about test instruments, how to use them, circuit analysis, component replacements and dozens of other subjects. 1300 pages, 706 illus. Price \$5.00.

3—RADIO TROUBLESHOOTER'S HANDBOOK

The great Ghirardi book that cuts service time in half on most jobs. Tells what to do, exactly how to do it in making quick repairs on over 4500 specific radio models. 744 manual-size pages. \$5.00.

Let A. A. Ghirardi train you for Radio-Electronics—AT ABSOLUTE MINIMUM COST! Starting with the fundamentals of basic electricity, these 3 books take you step-by-step through the efficient radio testing, adjustment and repair procedures that mean time saving and more profitable work. Hundreds of working data on tubes, color codes, transformers, resistors capacitors, record changers and other components help you solve job snags in record time.

NEW LOW PRICE . . . Easy Terms

Bought singly, the books in this fact-packed library would cost you \$15. Under this special offer, you save \$1 and also have the privilege of paying in easy monthly installments, while you use the books. No waiting for monthly lessons. You learn fast—and you learn right!

10 DAYS' MONEY BACK EXAMINATION

Dept. RE-60, MURRAY HILL BOOKS, Inc.
232 Madison Ave., New York 16, N.Y.

Send me GHIRARDI'S BIG-3 Radio-Electronics Library. I enclose \$2 as my first installment and will send you \$3 a month for four months until the total special price of only \$14 is paid. It is understood I may read the books for 10 days. Paid. If not satisfactory, I will return them postage paid and you agree to refund my \$2 and cancel the remaining installments. (Offer good in U.S. only)

Name
Address
City, Zone, State
Occupation

Figs. 2, 3, and 4 show three transformer-coupled audio amplifiers using crystal triodes.

The circuit in Fig. 2 uses a "cathode" resistor to obtain the required 0.2-volt d.c. bias required by the emitter electrode. This resistance will be between 500 and 1,000 ohms, the exact

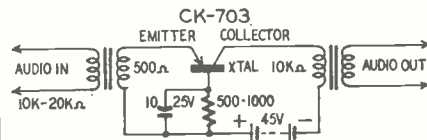

Fig. 2—Self-biased audio amplifier.

value for best output and stable operation is being determined experimentally for individual crystal triodes.

The author's procedure was to connect a 1,000-ohm wire-wound rheostat (volume control type) in each "cathode" lead and to adjust it for best operation. The rheostat then was removed from the circuit without disturbing its setting, and its resistance was measured with an ohmmeter. The rheostat then was replaced with a series-connected combination of ½-watt fixed resistors giving the same total resistance.

This single stage gives an output of 2 milliwatts or slightly better for a sig-

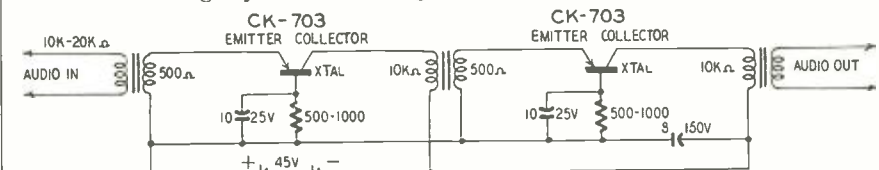

Fig. 3—Two transformer-coupled stages in cascade. The gain per stage is 16 db.

nal input power of 50 microwatts. Several stages may be operated in cascade, as in Fig. 3, with a maximum power gain of 16 db per stage.

Fig. 4 is a circuit for operating the crystal triode at fixed bias. Both emitter and collector voltages are adjusted with 5,000-ohm potentiometers in series across the single 45-volt battery. Potentiometer R_1 is set for a positive voltage of 0.2 volt between emitter and crystal terminals; R_2 for a negative voltage of 30 volts between collector and crystal terminals. Make all voltage measurements with a d.c. vacuum-tube voltmeter. Remove the input signal from the amplifier while making voltage adjustments.

This circuit gives somewhat higher output power than the self-biased arrangement. It also permits grounding of the metal shell (crystal terminal) of the CK703 to chassis, an advantage in some constructions.

The author's three-stage amplifier of this type, feeding into 2,000-ohm headphones, gave a small amount of steady noise hiss, which is characteristic of transistor operation. This noise is not severe, however, and is not noticed at all with a full-output or half output signal. The inherent noise level of the transistor will, at least for the present, limit the number of maximum-gain stages which can be used in audio service. With the relatively low power out-

put of the CK703, we did not get loud-speaker operation with any audio amplifier circuit.

Interstage transformers used in these audio amplifier circuits must provide a 10,000-to-500-ohm impedance ratio. This corresponds to a 4.47:1 turns ratio. A satisfactory miniature transformer for this purpose is the U. T. C. Ouncer type 0-9. A somewhat larger small-size transformer is the tube-base Kenyon A-40. Larger-size transformers which can be used where physical dimensions are of no consequence include Stancor A-3250, Utah 8316, and U. T. C. S11 and S14.

Unless the "cathode" resistors in circuits Figs. 2 and 3 are adequately bypassed, the circuit will tend to oscillate because the resistance is common to both emitter and collector circuits.

This oscillation starts off as a slight rise in the normal noise level and the ordinarily light hiss takes on a sharp, brittle characteristic similar to the frying noise of a superregenerative receiver. In severe cases, the hiss breaks into a ragged singing or whining sound.

D.c. voltage amplifier

Fig. 5 is the circuit for a d.c. voltage amplifier with a voltage gain of 10. Maximum d.c. signal input voltage is 0.1 v. At zero signal voltage input, the

d.c. voltage across the output is 15 volts. With a signal input of 0.1 volt, the voltage output increases to 16 volts as measured with a d.c. vacuum-tube voltmeter. This 1-volt increase represents a voltage gain of 10 through the amplifier. The initial 15 volts output can be bucked out of an external high-resistance voltmeter circuit with an external voltage of the same amount. This will reduce the initial meter reading to zero. The meter then will be deflected upward proportionally to applied d.c. signal voltages applied to the amplifier input terminals.

For higher gains, several such amplifier stages may be cascaded in the same way as conventional d.c. amplifiers of the tube type. Three CK703 stages, for example, will provide a d.c. voltage gain of 1,000.

The single d.c. amplifier stage gave no noticeable drift effects. However, in several cascaded stages, the drift troubles of tube-type direct-coupled d.c. amplifiers were found. That is, small current or voltage shifts in the first stage showed up as rather sizeable changes in the output meter reading.

Signal tracer

In Fig. 6, a shunt-diode crystal rectifier probe is followed by a CK703 d.c. amplifier stage. This unit may be used for signal tracing in either a.f. or r.f. circuits. It will operate equally well

with modulated or unmodulated signals.

The amplifier allows higher sensitivity than ordinarily can be obtained with the shunt-diode crystal circuit. The shunt-diode arrangement is desirable, since the input capacitors isolate the instrument circuit from any harmful d.c. component in the circuit under test. Also, the circuit under test is not required to complete the d.c. return path of the crystal rectifier.

An a.f. or r.f. input signal of 0.1 volt

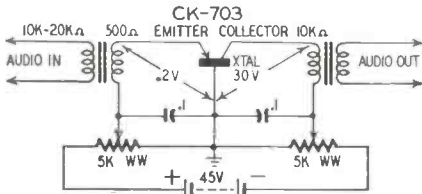

Fig. 4—A fixed-bias audio amplifier.

r.m.s. will deflect the indicating meter to full scale. Stronger signals should be reduced by turning down the output control of the generator which supplies the signal.

Regenerative broadcast receiver

Fig. 7 shows the circuit of a simple regenerative broadcast-band receiver with CK703 detector. If desired, this detector circuit can be followed with a transformer-coupled CK703 audio amplifier, such as the ones given in Figs. 2 and 3.

In this circuit, regeneration (and

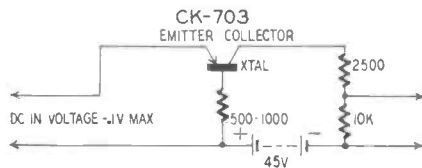

Fig. 5—D.c. amplifier with gain of 10.

also oscillation) is obtained through coil L2, which is a common impedance to both input and output circuits. L1 and L2 are primary and secondary windings, respectively, of a standard, factory-made broadcast antenna coil. Regeneration is controlled with the 5,000-ohm rheostat in the emitter circuit.

This simple circuit gave much pleasure to the author, who has worked with

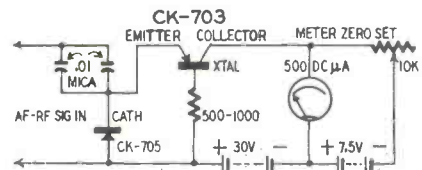

Fig. 6—A CK703 signal tracer circuit.

crystals since the early 1920's and often despaired of their inability to make straight c.w. signals audible. It was exhilarating to hear this little detector whistle when it is tuned in on a carrier with the regeneration control advanced.

R.f. oscillator

The radio-frequency oscillator circuit shown in Fig. 8 follows the design suggested by Dr. T. Stuart Martin and

POSITIVE PROTECTION For Every TV, FM or Antenna Rotator Installation
VEE-D-X LIGHTNING ARRESTORS

4 Wire Model RW 204

Required for 4 wire antenna rotator lead-ins



- First 4 wire arrester.
- Chisel-point contact eliminates stripping of wires.
- Easy installation by simply tightening down the cover with two wing nuts.
- Attractive low loss amber color polystyrene case.
- Will not absorb moisture.
- Designed for installation in accordance with the National Electrical code (see below).

• Manufactured in accordance with Underwriters' Laboratories Inc. specifications, for outdoor or indoor use.

Excerpt from NATIONAL ELECTRICAL CODE

Lightning arrestors shall be located outside the building, or inside the building, between the point of entrance of the lead-in and the radio set or transformers, and as near as practicable to the entrance of the conductors to the building. The lightning arrester shall not be located near combustible material nor in a hazardous location.

2 Wire Model RW 300

For use with 2 wire standard antenna ribbon type transmission line for TV or FM.



- First and most popular twin lead arrester.
- Unnecessary to cut transmission line for installation.
- Does not vary impedance.
- Unnecessary to change spacing of transmission line.
- High dielectric, mica-filled plastic material.
- Approved by Underwriters' Laboratories, Inc., for outdoor and indoor use.

There's only one right way to Mount a Lightning Arrester

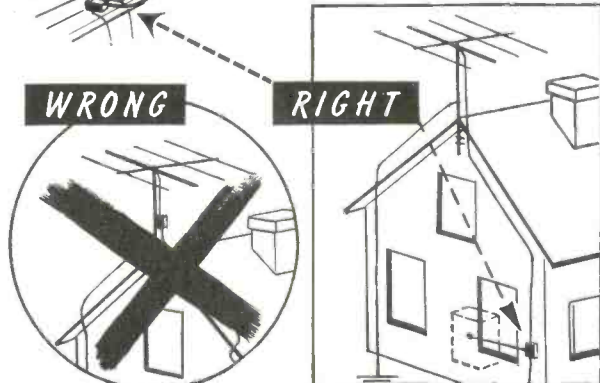

LaPOINTE-PLASCOMOLD CORP., UNIONVILLE, CONN.

TRANSVISION 19" KIT

\$104⁰⁰

less C.R. Tube*

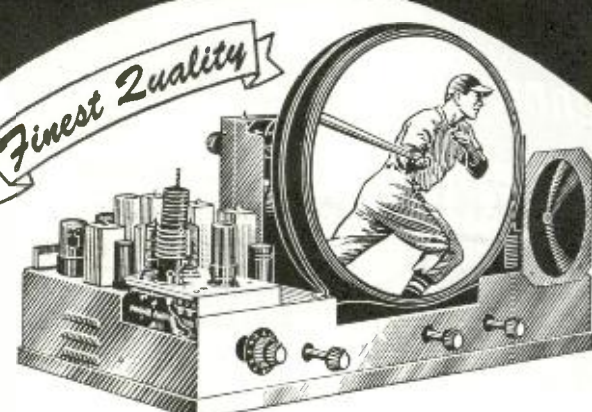

Finest Quality

ANYONE can easily assemble the famous Transvision Kit. No technical knowledge or instruments required. Instruction sheet is simple (each part is packaged and numbered). *ALL IF'S* are wired and pre-tuned. NOTE: Kit comes complete with all parts except picture tube.

COMPLETE LINE: TV only ("A" line). Also TV-and-FM Radio ("D" line). 12½", 16", 19". Choice of tuners includes famous DuMont Inputuner.

* PICTURE TUBES: 16" all glass, fully guaranteed net \$35.00
19" all glass, fully guaranteed net \$62.00

WIRED TV CHASSIS

Completely Wired and Aligned

Transvision "A" Chassis (TV only) comes completely wired, aligned and operating. Especially designed for fringe area reception. 23 tubes, AFC, AGC. Wired-in phono plug. Picture tube and speaker not included. Transvision "D" Chassis (TV-and-FM Radio) has famous DuMont Inputuner.

PRICES: 16" TV Chassis ("A" line) ... net \$115.00*
19" TV Chassis ("A" line) ... net \$122.00*

* Picture tube and speaker are extra.

TV CABINETS



Newly styled complete line of beautiful hand-rubbed cabinets for 19" and 16" TV Chassis or Kits. Also CONVERSION CABINETS to convert any small screen set to a giant 16" or 19" size.

INSTRUMENTS and PARTS

Transvision FIELD STRENGTH METER

Improves installations; saves ½ the work. Model FSM-1, complete with tubes. net \$79.00

Deflection Yoke...net \$2.95

Flyback Transformer net \$2.95

TRANSVISION, INC., Dept. RE, NEW ROCHELLE, N. Y.

Branches—Jamaica, L. I., 167-01 Hillside Ave.; Syracuse, N. Y., 622 N. Salina St.; Cleveland, O., 2001 Euclid Ave.; Columbus, O., 54 E. Long St.; Chicago, Ill., 4834 S. Ashland Ave.

ASK YOUR RADIO PARTS JOBBER! Representatives: Apply now for available territories.

Write for Folders on Complete TRANSVISION Line

The r.f. oscillator may be modulated by the transistor audio oscillator shown in Fig. 9.

Audio oscillator

The CK703 audio oscillator circuit shown in Fig. 9 uses an Ouncer trans-

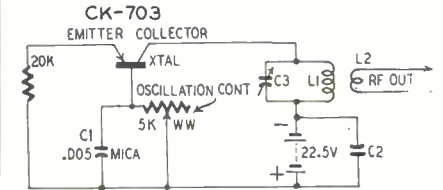

Fig. 8—An oscillator circuit using the triode. Output is 2 volts at 100 kc.

former to provide tickler-type feedback. Maximum output of this circuit is approximately 10 volts r.m.s. across 10,000 ohms resistance.

The frequency of oscillation is determined by the fixed capacitor C1 and

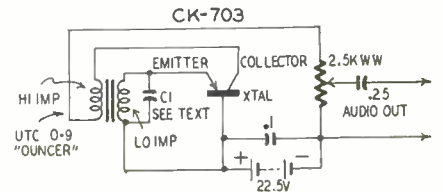

Fig. 9—An audio oscillator circuit.

inductance of the low-impedance winding of the transformer. A capacitance of 0.1 µf will give a frequency of approximately 600 cycles. Other frequencies may be obtained by switching in other capacitances.

The circuits described in this article are only some of the possible uses to which the germanium crystal triode can be put. The experimenter can use these as a starting point from which to work out new circuits. Besides adapting it to standard circuits, the crystal triode has many interesting possibilities such as using it with printed circuits for greater space saving or with the new light-sensitive germanium crystal known as the phototransistor in photoelectric control circuits.

Germanium Crystal Triode Type CK703

Terminal Connections:

- Lead 1 Emitter
- Lead 2 Collector

Case Crystal Connection

Maximum Ratings:

Collector voltage	-70 volts
Collector current	4 ma
Collector dissipation	200 mw
Emitter current	10 ma

Characteristics and Typical Operation:

Collector voltage	-30 volts
Emitter voltage	0.2 volts
Collector current	2 ma
Emitter current	0.75 ma
Transconductance	5000 µmhos
Collector impedance	10,000 ohms
Emitter impedance	500 ohms
Average power output*	2 mw
Average power gain*	16 db

*Measured at 50 µw input power to emitter

Harold Heins in their paper "Germanium Crystal Diode and Triode Development" in Proceedings of the Radio Club of America (Vol. 26, No. 2, 1949).

The frequency is determined by the

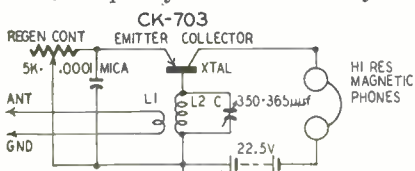

Fig. 7—A broadcast receiver hookup. values of L1 and C3. Tuning capacitor C3 may be a 350- or 365-µmf midget unit. For low frequencies, L1 and L2 are the two coils of an i.f. transformer. For higher frequencies, factory-made test oscillator coils may be used, or satisfactory coils may be wound, using

the tables given in the various radio handbooks.

A 2½-millihenry pi-wound r.f. choke as L1 and a 0.001-µf silvered mica capacitor as C3 gave a frequency close to 100 kc. The r.f. output was checked at 2 volts r.m.s. with a high-impedance r.f. vacuum-tube voltmeter.

The 5,000-ohm "cathode" rheostat is adjusted to start oscillation and also to control oscillator output amplitude. Output will be highest at the low frequencies, decreasing rather rapidly above the standard broadcast band. This circuit gave more stable performance than one using tickler feedback.

At 1500 kc, the output signal voltage could not be detected on the 0-3-volt scale of an r.f. vacuum-tube voltmeter, but a beat note could be obtained in a receiver tuned to a 1500-kc broadcast station.

Mobile Radio Service

**Two-way radiotelephone service offers
an important field for technicians**

By I. QUEEN

MANY radio technicians are taking advantage of opportunities in the widening field of two-way radiotelephone communications. Numerous mobile and fixed stations are now owned and operated by public utilities, transportation lines, public telephone companies, taxicabs, trucking fleets, and other groups. Channels are assigned in the 152-162-mc band for this type of communication.

grees. Varying the gain of one path relative to the other varies the proportions in which the two quadrature (90-degree-apart) components are mixed. The phase of the resultant varies accordingly.

A less common method takes advantage of the fact that a reactance shunted across a signal source changes the phase of the signal. A fixed reactor would produce no modulation (though it may be used to produce the 90-degree-out-of-phase voltage needed for the "mixture" method). The change in phase is proportional to the value of the reactance; thus if that is varied at an audio rate, the phase will vary with it. The practical way to produce this effect is to shunt a reactance tube across the oscillator output. While the frequency of the crystal oscillator cannot be changed, the phase of its output varies in step with the audio at the reactance-tube grid.

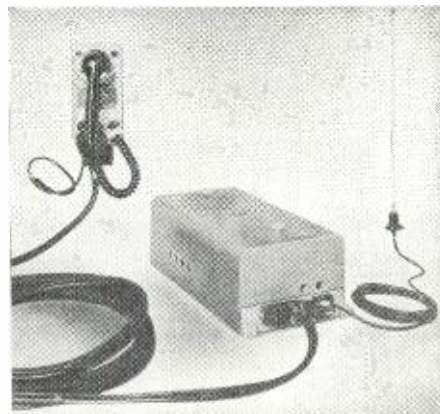

Photo of the Link radiotelephone unit.

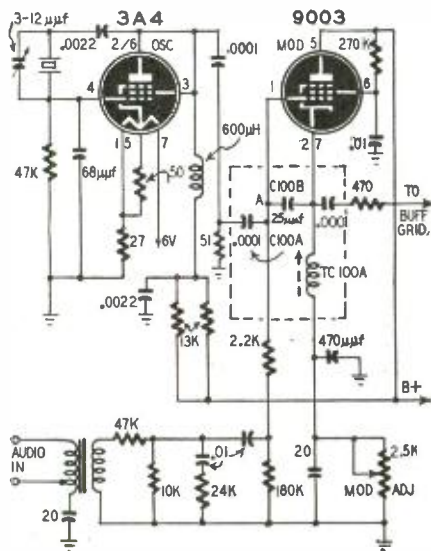

Fig. 1—Modulator circuit of PRT 150GT

Mobile and fixed radiotelephone equipment requires expert installation and maintenance. Adjustments to a transmitter may be made only by a licensed (second-class telephone or higher) technician. However, an unlicensed person also may do the work under direct supervision of a licensed person.

The transmitters are all crystal-controlled and phase-modulated. Phase modulation is one of the simplest possible means of superimposing intelligence on a carrier and requires practically no audio equipment. Its effects as far as the receiver is concerned are exactly the same as FM.

Two practical methods of making the phase of a signal change at an audio rate are used in mobile transmitters. The most common is to combine two signals from the oscillator. One is a direct feed and is in phase with the oscillations; the other is fed through a phase-shifting network and leads or lags the oscillator voltage about 90 de-

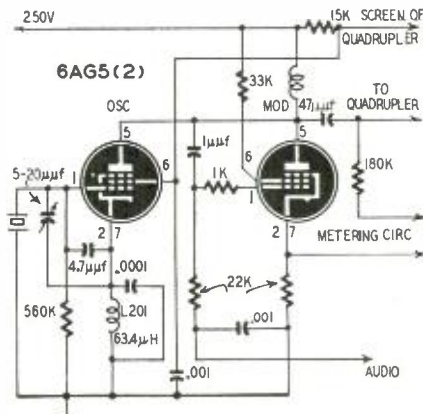

Fig. 2—The G-E set has reactance tube.

During positive peaks the modulator tube, a cathode follower with a gain of 1, is fully conductive. The cathode load is the coil TC100A, the output of which, as in any cathode follower, is in phase with the input.

At full tube conduction, the input

Philco PRT 150GT

This transmitter uses a Pierce oscillator (Fig. 1). The modulator is excited by two signals at point A, r.f. from the oscillator and a.f. from a single-button carbon mike. During negative audio peaks the modulator tube is cut off, leaving only an L-C series network between point A and ground. The reactance of coil TC100A at the oscillator frequency is half that of the capacitor C100B. If, therefore, the voltage across the coil measures 1 unit, that across the capacitor measures —2 units. The r.f. input to the combination must be the vector sum of these two voltages, or —1. Since the +1 volt across the coil is the output and the input is at —1, input equals output but has opposite phase.

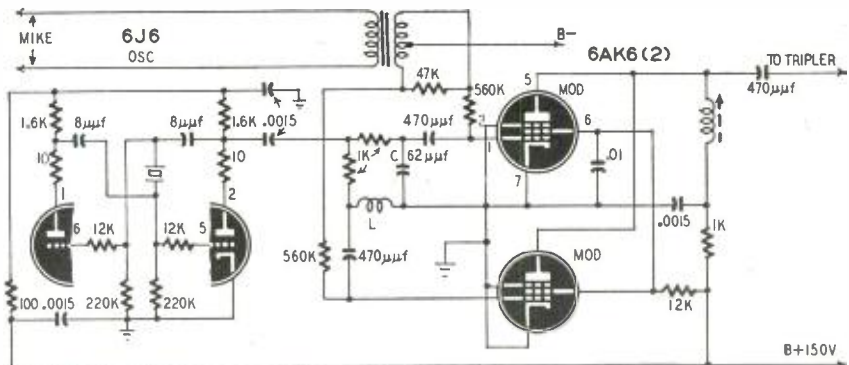

Fig. 3—The modulator output is shifted in phase by varying output of each tube.

Because of its large cathode resistor, the modulator triode has extremely low gain. Its "amplified" output, in fact, compares with the voltage appearing across the load due to the path through the internal plate-to-grid capacitance of the tube.

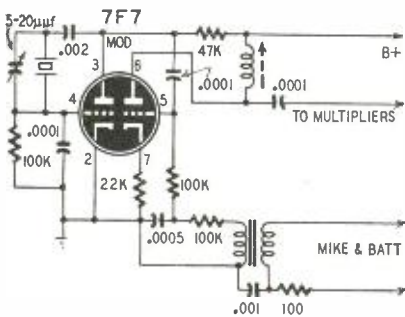

Fig. 4—Circuit of the Link modulator.

The r.f. reaching the load through the interelectrode capacitance is fixed in amplitude and is about 90 degrees out of phase with the input. The output produced by the amplifying action of the tube is 180 degrees out of phase with the input and varies in amplitude according to the audio applied to the grid. The mixture produces a resultant phase shift varying from 90 to 180 degrees.

Harvey Model 542

This transmitter can be used with a plug-in power supply for either 6 volts d.c. or 117 volts a.c. The type of power determines the tube complement.

The output of the Pierce oscillator (Fig. 5) is connected across R1 and R2.

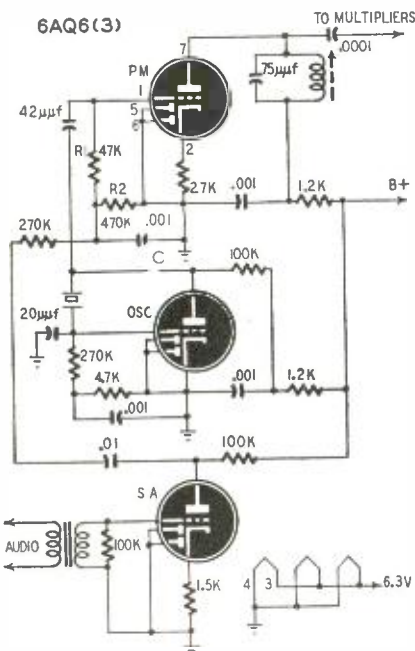

Fig. 5—The Harvey modulator circuit.

R2 is shunted by C, which shifts the phase of the r.f. voltage across it. The grid of the modulator therefore receives an r.f. voltage whose phase is the resultant of the unshifted voltage across R1 and the shifted voltage across R2.

The output of the speech amplifier appears across R2. The level of r.f.

TECHNICIANS—You can BOOST YOUR INCOME

with this

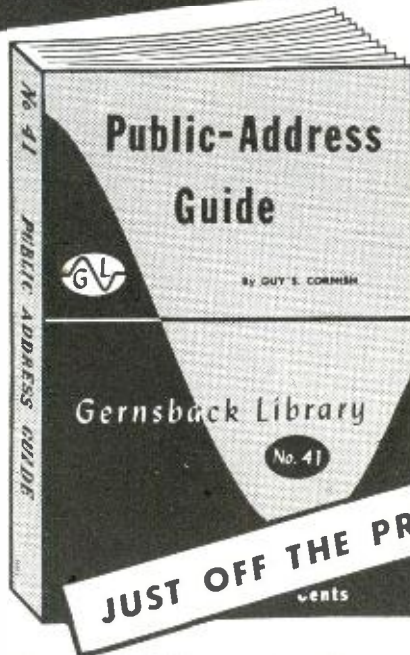

NEW
Gernsback Library Book

Only **75¢**

Public-Address Guide

Increase your earning power—install, operate and service public address systems! This brand new, easy-to-read, guide tells you how. The author has spent a lifetime in the field. In a simple, straightforward way, he gives you all the technical "know-how" you need to turn P.A. installation and servicing into a profitable business. Buy the PUBLIC ADDRESS GUIDE at your jobber today.

JUST A PARTIAL LIST OF WHAT THIS BOOK OFFERS YOU

- CHAPTER 1.**—Uses of Public Address Systems . . . Types of Public Address Systems . . . Portable & Mobile Equipment . . . Outlay & Income.
- CHAPTER 2.**—Public Address Equipment . . . Characteristics of all Microphones . . . Phonographs & Pickups . . . Amplifiers . . . Speakers.
- CHAPTER 3.**—Installation . . . Acoustics . . . Choice of Amplifiers, Speakers, Microphones . . . Outdoor and Indoor Installations.
- CHAPTER 4.**—Maintenance & Servicing . . . Trouble shooting . . . Distortion . . . Hum . . . Motorbooting . . . Howling . . . Weak Signals.
- CHAPTER 5.**—Practical construction of a P.A. system that can handle 90% of all calls the radio man will be asked to handle.

RADCRAFT PUBLICATIONS, INC., 25 West Broadway, New York 7, N. Y.

OTHER GERNSBACK LIBRARY BOOKS

- 50¢ BOOKS
- No. 29 Handy Kinks and Short Cuts
 - No. 30 Unusual Patented Circuits
 - No. 31 Radio Questions and Answers
 - No. 32 Advanced Service Technique
 - No. 33 Amplifier Builders Guide
 - No. 34 Radio-Electronic Circuits
 - No. 35 Amateur Radio Builders Guide
 - No. 36 Radio Test Instruments
 - No. 37 Elementary Radio Service
 - No. 38 How To Build Radio Receivers
- 75¢ BOOKS
- No. 39 Practical Disc Recording
 - No. 40 The Cathode-Ray Oscilloscope

SEE YOUR JOBBER

If he can't supply you Use this Coupon
RADCRAFT PUBLICATIONS, INC. Dept. 60
25 W. Broadway, N. Y. 7, N. Y.

I have enclosed \$.....in payment for volumes checked.

- No. 29 No. 30 No. 31 No. 32 No. 33 No. 34
 No. 35 No. 36 No. 37 No. 38 No. 39 No. 40

NAME

ADDRESS

CITY STATE



FOR . . .

- RADIO SERVICING
- TELEVISION SERVICING
- AMATEUR RADIO
- HIGH FIDELITY SOUND

Stancor transformers are original components in thousands of radio and television receivers made by the biggest names in the industry—they have to be good to be specified by critical design engineers and value-conscious purchasing men!

Why shop around? Specify Stancor for your replacement work. You will get a dependable, honestly-rated transformer. You'll cut down on expensive call-backs. You will keep your customers.

FREE For complete, accurate specs and prices of the complete Stancor stock line, write for your copies of the literature illustrated above. Just ask us for the Stancor transformer library. Standard Transformer Corporation, 3592 Elston Avenue, Chicago 18, Illinois.

It's Stancor
FOR TRANSFORMERS

MOST COMPLETE LINE IN THE INDUSTRY



Over 43,000 Technicians Have Learned
HOW TO GET THE MOST OUT OF BASIC TEST EQUIPMENT
Why Not You, Too?

SERVICING by SIGNAL SUBSTITUTION
A BEST SELLER FOR OVER 9 YEARS! (NEW, UP-TO-DATE, 11TH EDITION)

The Simple, Modern, Dynamic Speed Approach To Receiver Adjustment and Alignment Problems, AM-FM-TV.

- Nothing complex to learn
- No extra equipment to purchase
- Universal — non-obsolescent
- Employs Only Basic Test Equipment

only **40¢**

100 pages. Invaluable information that will help you re-double the value of your basic test equipment.

Ask for "S.S.S." at your local Radio Parts Jobber or order direct from factory.

PRECISION APPARATUS COMPANY, INC. • 92-27 Horace Harding Blvd., Elmhurst 4, N. Y.

across R2 rises and falls with the audio wave, which amplitude-modulates it. The proportion of shifted to unshifted r.f. voltage across the R1-R2 combination varies with audio, and the resultant phase of the r.f. reaching the modulator grid also varies.

Bendix MRT-1G and MRT-1H

These mobile transmitters have a very simple modulation system which makes use of an effect amateurs find undesirable and make every effort to avoid.

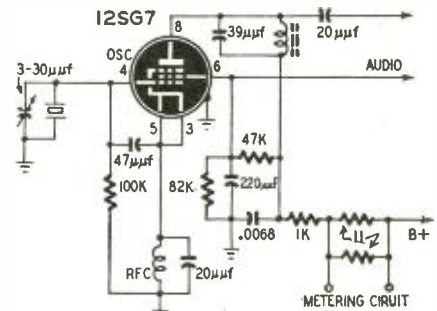

Fig. 6—Hookup of the Bendix modulator.

The signal from the microphone is fed to the screen of the oscillator tube (Fig. 6) to vary the transconductance of the tube. Amplitude modulation is produced, of course, but it is swamped out in the following multipliers. More important, the audio-rate changes in tube characteristics affect the input and output capacitances, which varies the phase of the output r.f., producing the desired phase modulation.

WIRELESS CURIOSITY

Mysterious interference in aircraft radio began last September at Essenden in Victoria, Australia. Pilots reported hearing broadcast stations when they tuned to the control tower frequency of 118.1 mc at Essenden Airport. Reports were sporadic at first, but by the end of the year, the interfering signal was being heard daily with such strength that it became a hazard to flying.

The interference was heard in all types of v.h.f. equipment and in all kinds of aircraft from Tiger Moths to DC-6's, but it was confined to the Melbourne area and one station seemed to appear most often, although other stations were heard occasionally. Capt. Doug Secomb, a pilot who had a v.h.f. receiver in his home, also received the interference regularly.

The fact that all types of aircraft, both in the air and on the ground, were getting the interference showed that the v.h.f. receivers were not at fault. Experts thought that cross-modulation might be the cause. A carrier from one transmitter might be interfering with another transmitter to create a new signal that happened to be on the airport frequency. They tried to calculate the possible frequencies of the unknown transmitter and through *Amateur Radio*, they got the cooperation of amateurs. Every transmitter in the area was switched off in turn to see

which was the culprit. The local radio station also cooperated and changed from its main transmitter at nearby Alphington to an emergency station in the city. During the changeover a delay occurred and the station was off the air for a few seconds. At the time of the blackout, the carrier of the interfering signal was still heard, thus eliminating the cross-modulation idea.

The next step was to use mobile direction-finding equipment to locate the source. The trouble was traced to a small group of houses in West Preston. Eventually it was run down to a 14-year-old, homemade, five-tube superhet receiver. When it was turned off, the interference stopped.

The set had deteriorated with age and become a very efficient v.h.f. transmitter which rebroadcast whatever program it happened to be receiving. It received only one station well, and that is why one station was heard most often by the pilots.

Radio experts are now investigating the unique behavior of this set with the hope of finding out what makes it act the way it does.

ECHOLESS ROOM

Anechoic room at the Naval Ordnance Laboratory, White Oak, Md., has recently been completed. Floor, ceiling, and walls of the 50 x 53 x 35-foot room are covered with fibre glass wedges designed to absorb all noise from a sound source within the room.

In contrast to the almost 100% echo reflection in an ordinary room, with hard surfaced walls, the echo in this room is only a few tenths of a percent. Any noise produced in the room can be studied by scientists in its original form without distortion or disturbance caused by echos.

Transducers are hung from pulleys on remotely-controlled overhead cranes and sound emitting and receiving devices can be positioned any place in the room. A catwalk allows access to the test equipment.

The fibre glass wedges which line the interior of the room are 40 inches long and 12 x 4½ inches at the base.

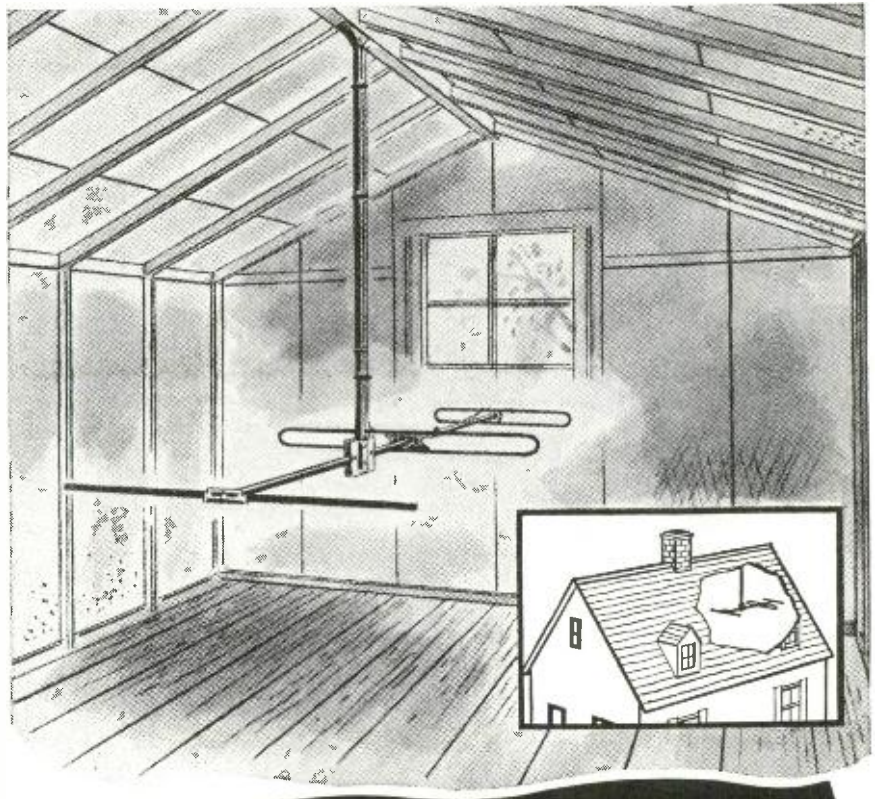

for a PERFECT ATTIC INSTALLATION

• WARD TVH-52 is a high-gain high-low antenna that can be conveniently hidden away inside a building and yet give you the best outdoor reception. Suspended upside down with WARD bracket C-14 it occupies no usable space whatever! This is a neat trick that has many, many uses and has been thoroughly field-tested. You can use it.



WARD PRODUCTS CORPORATION

Division of the Gabriel Co.
1523 EAST 45TH STREET • CLEVELAND 3

FREE TELEVISION FREE CATALOG FREE
OF
ALL T-V COMPONENTS EQUIPMENT • PARTS • KITS CABINETS • ANTENNAS, ETC.
NOW READY—BULLETIN J2 WRITE NOW
ARROW ELECTRONICS INCORPORATED
82 CORTLANDT STREET • N. Y. C. 7, N. Y.

BE YOUR OWN BOSS!
MAKE MORE MONEY
In "CASH IN" you now get THE real money-makers — dozens of profitable tested mail order plans, confidential business secrets, dozens of practical tested formulas, successful text & audio schemes — actual experiences of men who have started on a shoestring—with less than \$10 capital. 25¢ a copy postpaid. Send U. S. stamps, money order, or coin.
Money Back Guarantee.
NATIONAL PLANS COMPANY
1966R BROADWAY, NEW YORK 23, N. Y.

\$1.00 VALUE
25¢
40,000 WORDS IN TEXT
NO ADS ALL "MEAT"!

THE FIRST BOOK OF ITS KIND!

For TV Installation Engineers • TV Experimenters
and TV Reception Enthusiasts



"BETTER TV RECEPTION in fringe and low-signal areas"

By W. W. SMITH, author of the "ANTENNA MANUAL" and R. L. Dawley, editor of the "RADIO HANDBOOK"

- Emphasis on concise, clear how-to-do-it information.
- Many tried-and-proved practical suggestions to improve that poor picture when standard set-ups fail.
- The only book of its kind, with much new information and a compilation of all the most useful data from many sources.

Practical, how-it-works data on TV signal propagation into the fringe areas. Evaluation of all common TV antennas in terms of their performance under low-signal conditions. Selecting the best transmission line. Making a rapid TV survey of an area, locating the "hot" radials and areas of high signal caused by focusing. Eliminating ghosts in difficult installations. Practical methods of minimizing fading.

Selection of boosters and receivers; practical suggestions for improving receiver performance in fringe areas. Full information on rhombics of all practical sizes. Using open-wire line when the antenna must be at a distance from the receiver.

Full treatment of masts and towers including data on installation and guying. Keeping the antenna from coming down in a high wind. One complete chapter on reducing TV interference.

\$2.50

AT YOUR FAVORITE DEALER—On mail orders from us, \$2.60 postpaid. Add sales tax in California.

Editors and Engineers 1305 KENWOOD ROAD Santa Barbara CALIFORNIA

DON'T REMOVE THE TV SET! Now! SHOOT 90%* of TV TROUBLES on-the-Spot with 2 OAK RIDGE miniatures!

SYNCHRO-SWEEP GENERATOR (Model 104)

The only unit of its kind in the world! Completely trouble-shoots and tests Horizontal and Vertical Linearity, Sync, Sweep and High Voltage circuits of all TV sets—in less than 8 minutes! Generates Vertical and Horizontal Linearity Bars, and Vertical and Horizontal Sync and Saw-tooth signals! Shoots the trouble trigger-fast, "on-the-nose"—entirely independent of station operation! 5 3/4 x 4 x 2 1/4". Complete with leads, Dealer's Net \$39.95.



TV-FM SIGNAL GENERATOR (Model 103)

"Lands" any signal failure from ANT to CRT or SPKR with bull's-eye precision in 2 minutes flat! Has 4 separate tuning bands & modulation output and attenuator. Complete tester for RF, Osc, Mixer; Video & Audio IF, 2nd Det and Amplifier; Sound & Adjacent Picture Trap; and ANT Orientation & Sensitivity. Also is complete Marker Generator. 5 3/4 x 4 x 2 1/4". Complete with leads, Dealer's Net \$29.95.

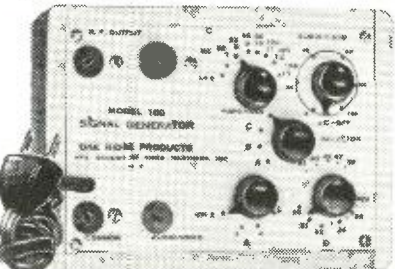

SUBSTITUTION TESTER (Model 101)—Substitutes for most-often-faulty components. Also acts as Audio Signal Tracer. Complete with leads, Dealer's Net \$16.25.

TV HIGH VOLTAGE TESTER (Model 102)—Checks all h-v in all TV sets. Scales 0-500V, 0-15KV, 0-30KV. Supplied with special h-v lead, Dealer's Net \$14.95.

• With the Oak Ridge Miniatures in your tool-kit, you take your lab to the set! You double your servicing time and earnings! Ask your jobber for them. Write for your free Catalog T-E.

*National surveys show 90% of all TV troubles occur in those circuits for which Models 104 and 103 are specifically designed.

OAK RIDGE PRODUCTS 239 EAST 127 STREET, NEW YORK 35, N.Y. Manufacturing Division of VIDEO TELEVISION, INC.

Review of New Tubes

AMONG the new tubes recently issued are RCA's type 6AS6 pentode and the type 6AX5-GT full-wave rectifier.

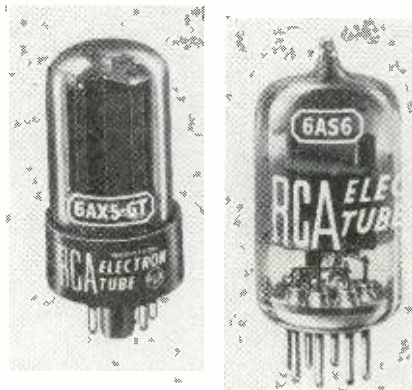

The 6AS6 is a sharp-cutoff pentode of the 7-pin miniature type. The Grids 1 and 3 can each be used as independent control grids to make the tube especially useful for gated amplifier circuits, delay circuits, gain-controlled amplifiers, and mixer circuits. It is usable for frequencies up to about 400 mc.

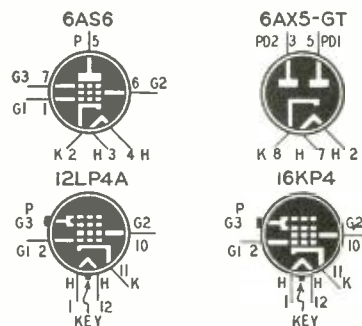

The 6AX5-GT is a full-wave vacuum rectifier of the heater-cathode type designed for economy in a.c. receivers and automobile radios having high power output.

Peak inverse plate voltage rating is 1250 volts maximum, and the peak plate current rating is 375 ma per plate.

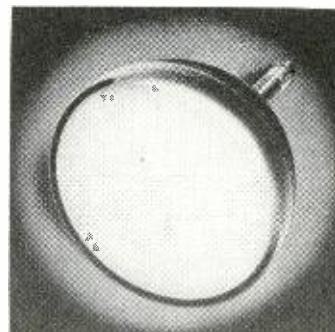
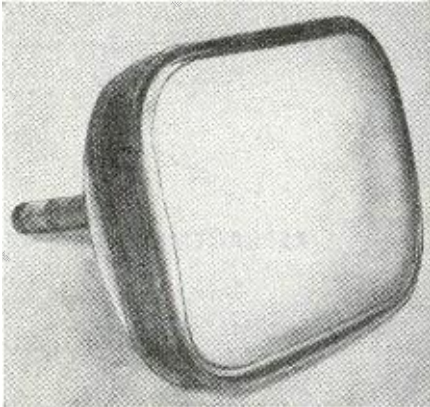

Photo of the new Du Mont picture tube.

Du Mont has released the type 12LP-4A, a 12-inch magnetic focus and deflection television picture tube. The tube has a gray filter face plate to increase contrast in lighted rooms. The electron gun has a bent electrode struc-

ture to be used with an external magnet to eliminate ion spot.

A rectangular television picture tube, the 16KP4, is now being produced by General Electric. The tube has a useful picture area of about 136 square



The 16KP4, a new G-E rectangular tube.

inches and an offset gun structure for use with an external ion trap magnet. The neutral-density face plate is designed to increase picture contrast and detail under high ambient light conditions.

Other new tubes include a set of miniature tubes for portable radios announced by Sylvania. These tubes, type 1U6, a heptode converter with a separate oscillator anode; type 1AF4,

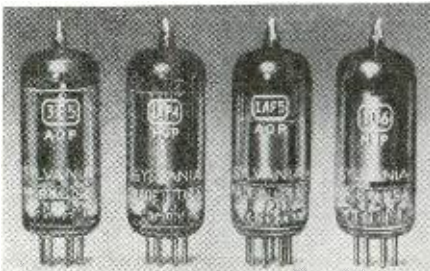

a sharp cutoff r.f. pentode; type 1AF5, a diode pentode; and type 3E5, a beam power output tube require a filament current of only 25 ma. Performance of these tubes compares to other battery types.

G-E has three new tubes for television receivers, the type 6AS5, type 6AV5-GT, and type 25AV5-GT. The 6AS5 is a miniature beam power amplifier intended for audio output in television receivers and small radios. The 6AV5-GT and 25AV5-GT feature compact design and power economy for magnetically deflected television tubes. They can operate from a power supply of 125 volts. Maximum d.c. plate voltage is 250 volts and maximum plate current is 100 ma.

Two new Sylvania subminiatures are the type 5645 medium- μ triode having a transconductance of 2700 μ mhos and an amplification factor of 20, and type 5646 high- μ triode having a transconductance of 2400 μ mhos and an amplification factor of 70. These tubes are 1.3 inches long and 0.3 inches in diameter.

JUNE, 1950

IT'S NEW ...

IT'S DIFFERENT ...

It's GENERAL INDUSTRIES' latest sound reproduction triumph

MODEL 250

TAPE-DISC Recorder Assembly

NOW ... for the first time ... General Industries offers you a revolutionary new type of recording instrument—for both tape and disc use. Here, indeed, is the answer to a long-standing need for an all-purpose recording unit inexpensive enough to be incorporated in moderately-priced home entertainment instruments.

Yet, despite its low cost, the Model 250 Tape-Disc Recorder offers many quality features ... is built to the same rigid performance standards which characterize all GI Smooth Power products.

A new catalog sheet, describing all of the recording and play-back features of the Model 250, now is available. Write, wire or phone for your copy today.

- * Records on tape
- * Records on discs
- * Plays back both
- * Plays any 78 R.P.M. Record

(*) when connected with the proper amplifier.



The GENERAL INDUSTRIES Co.

DEPARTMENT C • ELYRIA, OHIO

EASY TO LEARN CODE

It is easy to learn or increase speed with an Instructograph Code Teacher. Affords the quickest and most practical method yet developed. For beginners or advanced students. Available tapes from beginner's alphabet to typical messages on all subjects. Speed range 5 to 40 WPM. Always ready—no GRM.

ENDORSED BY THOUSANDS!

The Instructograph Code Teacher literally takes the place of an operator-instructor and enables anyone to learn and master code without further assistance. Thousands of successful operators have "acquired the code" with the Instructograph System. Write today for convenient rental and purchase plans.



INSTRUCTOGRAPH COMPANY

4701 Sheridan Rd., Dept. RC, Chicago 40, Ill.

CHOICE OF ENGINEERS EVERYWHERE

TWIN-TRAX* TAPE RECORDER

Available to you direct from the factory at savings that make TWIN-TRAX the only professional-type recorder in the popular-price field. More than a dozen model variations for portability, long-play, continuous operation, etc. For a better tape recorder that combines professional quality with operating ease and trouble-free construction, it's TWIN-TRAX. Write today for complete literature. *Trade Mark Registered

AMPLIFIER CORP. OF AMERICA

398-10 Broadway • New York 13, N. Y.

**ELECTROMETER
PENTODE**

Raytheon Manufacturing Co.
Newton, Mass.

The CK5889 is a new subminiature electrometer pentode featuring a low filament current of 7.5 ma. In single stage circuits where the tube must ac-

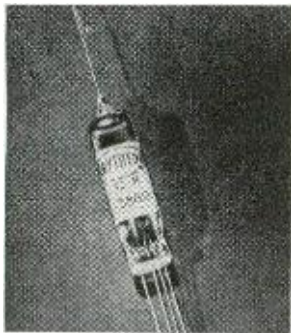

tuate indicating or recording devices, the tube has sufficient reserve emission to provide operation for several thousand hours. The filament power may be reduced in multistage circuits. Other electrical characteristics are similar to those of the CK5886.

SOLDER ALLOYS

Division Lead Co.
Chicago, Ill.

The new solder alloys have been developed for use with silver printed circuits and plated conducting mediums. They work equally well on ceramic, plastic, bakelite, and other base materials which have been coated with silver.

These solders have two melting ranges, DIVCO no. 233 solder is recommended where abnormally high temperatures are not encountered, and no. 276 should be used with assemblies operating above 350 degrees Fahrenheit. The solders are available in bar, solid wire, or rosin core shapes.

**DETENT
SWITCH CONTROLS**

JFD Manufacturing Co. Inc.
Brooklyn, N. Y.

Four detent switch controls for use as replacements in a large number of standard television receivers are announced. Made with brass and phenolic shafts, they are engineered to fit most television tuner units in use today.

**YAGI ANTENNAS**

LaPointe-Plascomold Corp.
Unionville, Conn.

Three new low-price Yagis have been added to the VEE-D-X line of TV antennas. Known as the "J" series, the antennas are the JA with 2 bays and 3 elements, the JB with 4 elements, and the JC with 5 elements. Each antenna has a clamp type construction and is shipped completely assembled with all elements folded against the boom to eliminate assembly difficulties.

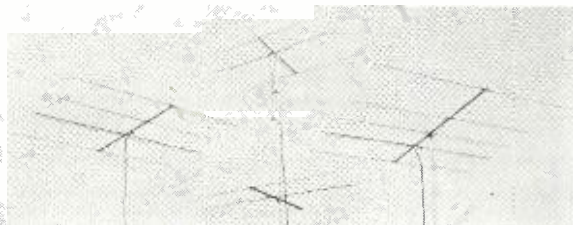
**D.C. POWER SUPPLY**

Electro Products Laboratories
Chicago, Ill.

The new model BJ low voltage d.c. power supply supplies 1 to 12.5 amps at 6 volts in continuous duty and up to 25 amps in intermittent duty. It supplies 3 to 9 volts at other ratings and operates from 115 volts 50-60 cycles. The supply is well filtered and has a 0-10 voltmeter and 0-25 ammeter. It is housed in a steel cabinet with a blue hammerloid finish.

SWEEP GENERATOR

Sylvania Electric Products Inc.
New York, N. Y.

This new sweep signal generator, specially designed for servicing FM and television receivers, incorporates electronically controlled sweep circuits. FM sweep range is from 0 to 600 kc, television sweep 0 to 15 mc. Fundamental output frequencies of the generator range from 2 to 230 megacycles, which are covered in four bands.

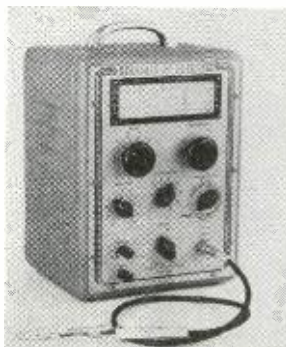

Output is at least 100 millivolts on all bands controlled by a smooth attenuator. Double shielding prevents signal leakage and frequency stability is assured by voltage regulated power supply. Wide range phasing control permits adequate adjustment for single oscilloscope response curve. Voltage for driving or synchronizing horizontal oscilloscope deflection is provided.

SUPERHET TUNER

Approved Electronic Instrument
Corp.
New York, N. Y.

This tuner, adapted for use with public address systems, portable amplifiers, record players, tape or wire recorders, etc., uses a 12BE6 converter, 12BA6 i.f., 12AT6 detector-first audio and 35W4 rectifier.

Specifications: Maximum output approximately 10 volts (high impedance) adjustable in three steps of 1 volt, 3 volts or 10 volts; a.c.-d.c. self-con-

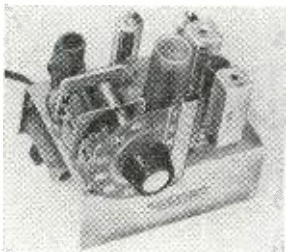

tained power supply for 115-volt line; 2 1/2-foot shielded output cable; attached 5-foot antenna. Size is 4 x 4 x 5 inches. A model with isolating transformer is also available.

FM MONITOR

Browning Laboratories Inc.
Winchester, Mass.

The new Model MD-25 F.M. modulation monitor is designed to continuously cover 30 to 50 mc, 72 to 76 mc, and 152 to 162 mc in four bands, making it possible for the one instrument to be used in checking transmitters on widely separated frequencies or on different



bands. Coarse and fine tuning controls permit precise adjustment to the carrier frequency. Either upward or downward swing can be measured up to 20 kc with an accuracy of better than 1 kc on an easily read 4 inch meter, which is also used as a tuning indicator. An audio output is provided so that the instrument may be used as an aural monitor or a visual monitor when used in conjunction with an oscilloscope. The sensitivity of the instrument makes possible measurements with less than 1 millivolt on the antenna terminals. This permits checking mobile transmitters without bringing the transmitter to the monitor.

ELECTRIC PLANT

D. W. Onan & Sons Inc.
Minneapolis, Minn.

Designed for applications requiring a portable source of electric power, this is a 400-watt, 60-cycle, a. c. electric generating plant that will operate for five hours on a single gallon of gasoline. Only 19 inches long, with a width of 14 1/4 inches and a height of 16 1/4 inches, this little generating plant produces ample power for amateur

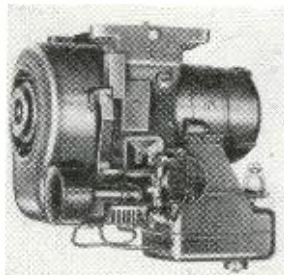

radio operations, emergency floodlights, public address systems, sound recorders and geophysical instruments.

ATTIC TV ANTENNA

Telrex Inc.

Asbury Park, N. J.

Attic V Beam folds into a compact package for easy handling and placement, and opens up completely assembled, into a full two-bay conical V beam array, complete with transmission line. The array is extremely light and entirely self supporting. It may be suspended or rested on flooring, beams, or rafters.

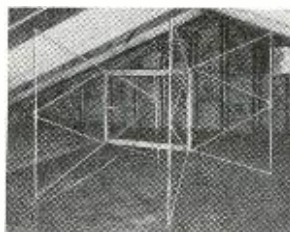

The new antenna is suited for private homes, garden apartments and other multiple dwellings, clubs, churches and other places in which conventional outdoor antennas are impractical or prohibited. It will be especially welcome to TV viewers who are now forced to get along on ineffective built-in or indoor antennas because of local zoning regulations or landlord opposition.

TV ANTENNA

Walter E. Peek, Inc.
Indianapolis, Ind.

The Wepco Model V 88 double stack antenna is designed to provide high gain over the entire television and FM bands from 40 to 260 megacycles.

The co-linear dipoles are positioned as illustrated. Transmission line is connected directly to the dipole terminal screws—no matching bars are required.

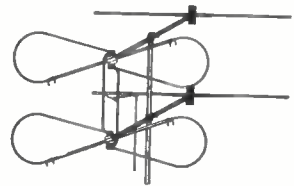
**REPLACEMENT DETENT**

Tele-Matic Industries Ltd.
Brooklyn 2, N. Y.

This replacement part, known as the Sturdy-Tune detent, is especially designed to fit the RCA tuner as used in the 630-TS and many other TV chassis. It is available for use with the original locating plate.

**POWER SUPPLIES**

Amplifier Corp. of America
New York, N. Y.

A new series of electronically regulated and stabilized power supplies, utilizing a new type of direct-coupled amplifier to control a pair of thyatron rectifier tubes, is now in production.

Two separate series of 250 watt (output power) supplies are available. The Standard Series is stabilized against line changes of 90 to 130 volts within $\pm 0.5\%$, and load regulated within $\pm 0.5\%$ from no load to full load. The Super Series, with a more sensitive error control circuit, is line-stabilized and load-regulated to within $\pm 0.1\%$.

The following power supplies comprise each series: 0 to 25 volts up to 10 amperes; 0 to 50 volts up to 5 amperes; 0 to 125 volts to 2 amperes; 0 to 250

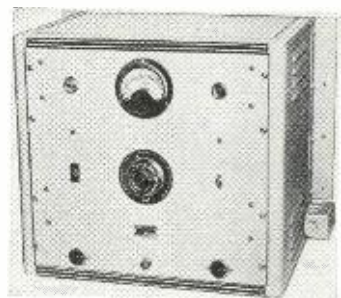

volts to 1 ampere; 0 to 500 volts to 500 milliamperes. Each of the ten units has a continuously adjustable and smoothly controlled d.c. output to full voltage and current rating.

MINI-VOLT METER

Industrial Devices, Inc.
Edgewater, N. J.

A new model of the Mini-Volt Voltmeter features an expanded scale centered on 110 and 220 volts.

This new Model 410A is accurate to within 2 volts at 110 volts a.c. Practically burnout proof operation is assured by the glow-lamp indicator which is guaranteed for 25,000 hours' operation.



tion minimum. 12-inch flexible test leads are tipped with heavily insulated test prods, assuring user maximum safety.

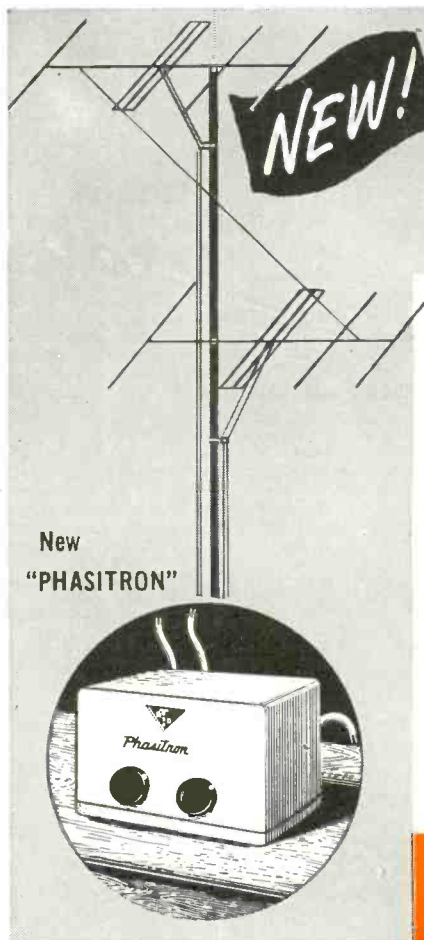

NEW!

New
"PHASITRON"

The TRIO "CONTROLLED PATTERN"

PATENT APPLIED FOR

TV ANTENNA SYSTEM MODEL 604

Eliminates Venetian Blind Effect!

USES NEW "PHASITRON" and DOUBLE DIPOLE YAGI

ELIMINATES CO-CHANNEL INTERFERENCE
With 17 db Gain in Forward Direction!

TRIO MFG. COMPANY takes pride in announcing the greatest advance in TV antennas for fringe areas. It's the new TRIO "Controlled Pattern" Antenna System, the culmination of extensive research by G. N. Carmichael, TRIO's Chief Engineer, and one of the nation's foremost antenna authorities.

The new lightweight, yet rugged antenna not only provides terrific gain in the forward direction, but overcomes that ever increasing problem in fringe areas — co-channel interference. This is how the unique system works: high voltage from two double dipole Yagis is phased by the use of the new tuneable "PHASITRON" to provide addition of voltages from the desired direction and cancellation of undesired voltages.

How well the system works is demonstrated by the fact that with voltage ratios up to 25 to 1, i.e., one signal is 25 times as strong as the other, the signal from the weaker will provide a sound carrier free from chatter and a picture free from venetian blind effect. The "PHASITRON" also permits tuning for maximum signal regardless of changing vertical wave angle. Uses two 300 ohm feed lines of random length, two DOUBLE-FOLDED Yagis for exact impedance matching. Separate antenna systems available for each of 12 channels, though considerable gain achieved on adjacent channels.

FOR FULL DETAILS WRITE FOR ILLUSTRATED FOLDER ON MODEL 604 ©1950 by:



TRIO MANUFACTURING COMPANY

GRIGGSVILLE, ILLINOIS

V. T. V. M. TEST SET

Precision Apparatus Co.
Elmhurst, N. Y.

The Series EV-20 affords 48 ranges to 1,200 volts, 2,000 megohms, 12 amperes, +63db and d.c. v.t.v.m. ranges to 12,000 and 30,000 volts when used with the Precision TV super-high voltage test probe.

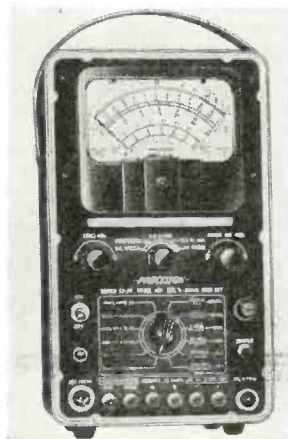

Important features include direct-reading, all-zero center v.t.v.m. which indicates both polarity and magnitude without switching or test lead reversal; voltage-regulated bridge circuit; master range and function selectors to eliminate frequent and inefficient shifting of test loads; shielded connectors which permit simultaneous and non-interfering connection of both the d.c. circuit isolating test probe and optional high frequency vacuum-tube probe.

Direct reading high frequency voltage scales are incorporated in this instrument. The dual-balanced electronic bridge ohmmeter-megohmmeter circuit uses only two 1.5-volt flashlight cells, easily replaceable at rear of cabinet. The 1,000 ohms/volt functions

permits simple a.c.-d.c. voltage, db and current measurement free of power line requirements.

MIDGET BATTERIES

General Dry Batteries, Inc.
Cleveland, Ohio

The K-cell is a new midget dry battery only $\frac{3}{8}$ inch in diameter. Besides making possible actual pen-size flashlights, the new batteries will be useful in electronic equipment in which space and weight are important factors.

TUBE TESTER

Electronic Measurements Corp.
New York, N. Y.

The Model 201 is a mutual conductance tube tester that does checking on a calibrated micromho scale as well as on a Reject-Good scale.

It also checks tubes for gas content and checks all tubes from 75 to 117 filament volts as well as all local, octal, 9-prong miniature and sub-miniature tubes; Cold cathode, magic eye, voltage regulator and ballast resistor tubes can also be tested. Individual sockets for each type tube base eliminates possible errors.

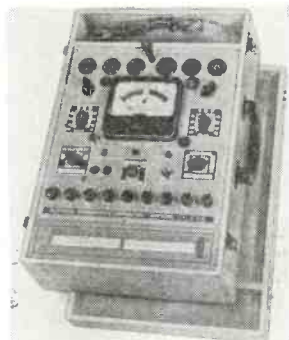

ISOTAP TRANSFORMER

RCA Victor Division
Radio Corporation of America
Camden, N. J.

This unique test instrument combines an auto-transformer and an isolation transformer. It is designed to bring a new degree of safety and efficiency to the testing and servicing of TV receivers and other electrical equipment.



VARIABLE H-V SUPPLY

Inductograph Products
New York, N. Y.

The variable high voltage r.f. power supply Model 99 delivers from 1 to 40 kv, either negative or positive polarity. The output voltage is obtained from an r.f. transformer and rectified by a half-

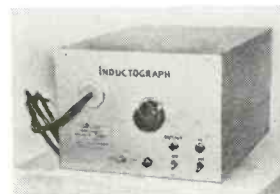

wave voltage tripler rectifying system. Rectifier filaments are heated by a second r.f. transformer to maintain constant filament current.

NEW PHONE PLUG

Insuline Corp. of America
Long Island City, N. Y.

The PJ-055B is a precision-made phone plug manufactured to meet JAN speci-

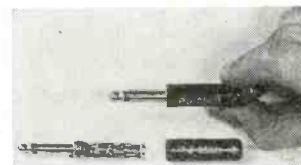

fications. The metal members are highly polished brass. High compression-molded Resinox insulation provides durability with high dielectric and tensile strengths and low moisture absorption.

TUBE TESTER ADAPTER

VHF Labs
Boonton, N. J.

This adapter is for testing the 632A and 829B tubes used in v.h.f. communication equipment ARC/1, ARC/3, ARC/5 and SCR 522 as well as the



new commercial models of ground station, marine, mobile and airborne equipment. It indicates output, shorts and balance between sections, and eliminates time-consuming substitution of questionable tubes.

THE FINEST 16" TELEVISION SET EVER DESIGNED!

With Automatic Gain Control (AGC)

Now you can have the finest 1950 model Voltage Doubler Giant Screen Television Set ever designed. Custom built and improved with unusually high brilliance—will give you thousands of hours of fine entertainment during day or evening hours. A bright, clear steady picture is assured by the most famous television set ever produced, the RCA designed 630 type chassis. This identical type TV set is used by more Radio & TV Engineers than any other set ever manufactured!

The 30 tube circuit is more sensitive than any of the cheaper sets having less tubes and the new Standard Tuner has a pentode RF stage which acts as a high-gain built-in Television Booster on all channels. Also featured is an automatic frequency control system that keeps the picture steady and makes tuning easier.

Factory wired and tested, ready to operate. Shipped complete with tubes, less 16" picture tube **\$149.50**

Extra-Clear 16" glass picture tube—guaranteed for one year— **\$39.50**

Super-Giant 19" Television Set. 630 type similar to above, but modified to provide a whopper-sized picture. Shipped complete with tubes, less 19" picture tube. Price.... **\$169.50**

Extra-Clear 19" glass picture tube—guaranteed for one year— **\$79.50**

DE LUXE TELEVISION CABINETS

Beautifully designed to match the 630 chassis without any cutting or drilling.

16" Table Model—Mahogany or Walnut **\$39.95**

19" Table Model—Mahogany or Walnut **\$44.95**

SPECIAL!

16" Console—Mahogany or Walnut **\$47.50**

It's AUTO RADIO PROFIT TIME Custom Auto Radios for Popular Cars

Radiomen! Here's your chance to make large extra profits with practically no work! Get in touch with the local Ford, Plymouth, Dodge and Chevrolet automobile dealers, tell them that you can supply Custom Buil radios to fit and match perfectly the 1949 and 195 models of these cars for about half the price that is usually charged! Simple installation—no holes to drill. Specifications: Powerful 6 tube superheterodyne. Has 3 gang condenser with extra stage of RF for out-of-town reception. When ordering specify Ford, Plymouth, Dodge or Chevrolet. List Price \$42.95.

Your cost **\$34.97**

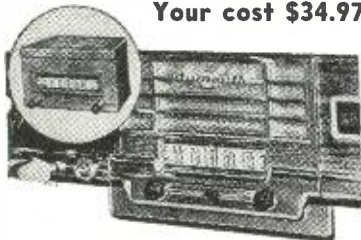

UNIVERSAL AUTO RADIO

Matches any car. Designed to fit under the dash. mounts with only three bolts to dashboard and bulkhead. Using dual-purpose tubes in a 5-tube superhet circuit, it gives the equivalent of 7-tube performance. Tube complement includes one 6BE6, one 6BA6, one 6AT6, one 6AQ5, one 6X4 (rectifier). Cabinet dimensions: 10 1/2"x6 1/4"x4 1/2".

Complete with 5 tubes only..... **\$23.36**

Similar to above, but has RF Stage **\$25.87**

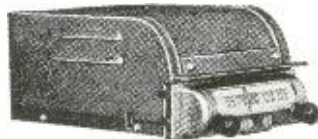

6 Tube Model

For complete listings of special buys for experimenters, radio technicians, laboratories, schools and engineers, write for catalog T-6.

RADIO DEALERS SUPPLY CO.
154 GREENWICH ST. NEW YORK 6, N. Y.

MICROPHONE COMPRESSION AND EXPANSION

Patent No. 2,495,809

George K. Graham, Oceanside, N. Y.
(Assigned to Radio Corp. of America)

Sound compression is necessary in broadcasting and sound recording to prevent overloading of the equipment and to keep the level sufficiently high above the noise. To regain the original fidelity the sound must be expanded during reproduction. This circuit expands or compresses the sound picked up by a dynamic or ribbon microphone. The control takes place at the microphone itself.

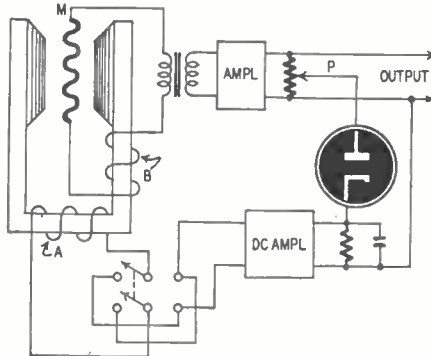

The figure shows a ribbon microphone M. The ribbon vibrates in accordance with the sound wave velocity. This induces an e.m.f. in the ribbon by cutting the magnetic field. A matching transformer couples the microphone to the amplifier.

A portion of the microphone output (as determined by P) is rectified and filtered. The d.c. amplifier feeds winding A to control the magnetic field. The switch reverses the current so that A either aids or opposes the field as desired. In the first case more microphone output strengthens the magnet and results in still greater output. In the second case more microphone output weakens the field and makes the microphone less sensitive. These are the conditions of expansion and compression, respectively.

The ribbon e.m.f. should be the result of flux cutting only. The variations in the field (due to changes in A) should not contribute to this e.m.f. Winding B is added to cancel out any such induced voltage.

RANGE MARKER GENERATION

Patent No. 2,496,283

James E. Gall, Washington, D. C.
(May be used by the United States Government without royalty payments)

Radar receivers use range markers to indicate distance from the station. The markers are pips which appear spaced regularly across the CRO screen. To simplify the equipment, the markers may be generated in the same circuit which develops the horizontal sweep voltage.

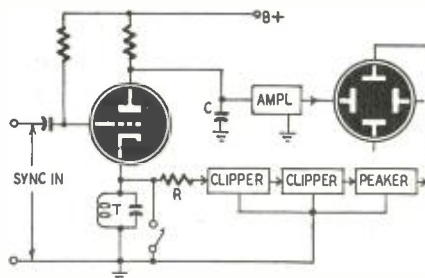

The triode shown here is a conventional sweep generator. Normally it is conducting and its plate voltage is low. A negative pulse cuts off plate current and allows the plate voltage to rise to the value of the power supply, thus charging the plate capacitor. When the tube returns to its normal conducting state, the capacitor is quickly discharged. The sawtooth voltage across C is amplified and connected across the horizontal plates of the CRO.

When the plate current drops abruptly to cut-

off, the tank T is shocked into oscillation. A train of damped waves passes through the isolating resistor R to the clippers. These square off the waves and the peaker sharpens the leading edge. The sharp pulses have a frequency equal to the resonant frequency of circuit T. They are used to measure equivalent distances from the radar antenna.

OBSTACLE DETECTION FOR THE BLIND

Patent No. 2,496,639

John W. Richardt, Jr., Terre Haute, Ind., and Oscar A. Shann, Short Hills, N. J.
(Assigned to Bell Telephone Labs, Inc.)

Blind people can detect obstacles in their path by tapping a cane and noting from which directions the sound is reflected. This invention is a distinct improvement because it relies upon supersonic waves, which are more directional and are not objectionable to nearby persons.

The supersonic energy is projected into space from an air whistle or a crystal transmitter located at the bottom of a cane. A frequency of about 20 kc is satisfactory. Echoes are reflected from nearby obstacles. These high-frequency signals are picked up by a crystal receiver, amplified and modulated by an oscillator (19.6 kc in this example). An a.f. beat of 400 cycles is reproduced in the headphone.

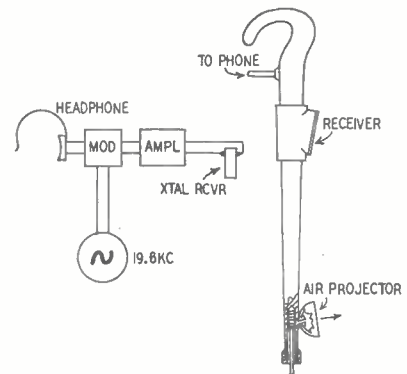

All receiving equipment may be located within the upper part of the cane. Leads connect it to the headphone. The transmitter may be controlled by the blind individual, who operates it by pressing down on the cane.

R.F. MEASUREMENT

Patent No. 2,495,268

John P. Leiphart, U.S. Navy
(May be used by the U.S. Government without royalty payment)

A thermistor can be used to measure r.f. current. The current flows through the thermistor, heating it and causing a change in its resistance. The resistance may be measured on a bridge calibrated in terms of current. In the absence of r.f. the bridge is balanced. Unfortunately, the thermistor resistance varies with ambient temperature as well as r.f. current, so the calibration can be correct at only one value of room temperature.

This circuit compensates for changes in ambient temperature. An a.c. coil warms the

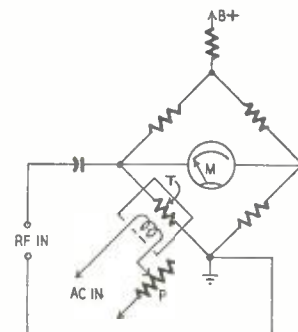

thermistor T to some temperature above normal ambient, and the bridge is calibrated at that

RADIO-ELECTRONICS for

temperature. A rise or fall in the ambient tends to introduce error, but this can be cancelled out by adjusting P. The adjustment is correct if the bridge balances when the r.f. is shut off.

ULTRASONIC CARRIER SYSTEM

Patent No. 2,461,344

Harry F. Olson, Princeton, N. J.
(Assigned to Radio Corp. of America)

There are occasions when some people desire to listen to a radio or phonograph while others in the same room do not. This can be done by reproducing the sound on an ultrasonic carrier so it remains inaudible except to those equipped with a special receiver. The figure shows a special

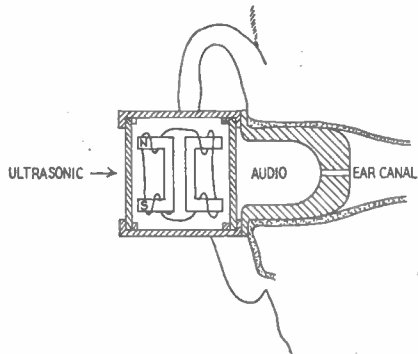

receiver adapted to be worn in the ear. The unit has a diaphragm at each end. At the input end is a permanent magnet and at the output an unpolarized magnet. Each magnet has a coil and these are connected in series.

An incoming ultrasonic carrier forces vibration of the input diaphragm (at the left). A voltage is induced in the coil wound on the permanent magnet and is transferred to the electromagnet coil. Since its magnet is not polarized, it attracts the output diaphragm on both positive and negative alternations. This distorts the wave.

The combination of polarized and unpolarized transducers demodulates the carrier and the a.f. is projected into the ear canal.

WIDE RANGE COUPLING

Patent No. 2,499,443

Norman H. Young, Jr. and Louis W. Parker
Jackson Heights, N.Y.
(assigned to Federal Telecommunication Labs.)

This circuit can pass a wide frequency range from video signals down to d.c. The amplifying tubes (shown as triodes in the figure) are coupled by a capacitor C and by the resistors R1 and R2.

The pentode plate current is maintained constant because of the VR tube in the grid circuit and the negative feedback (unbypassed) resistors in the cathode circuit. This current flows through R1, producing a negative voltage at the lower end. Since the drop across R1 is constant, the bias on the second tube is also fixed.

Slow fluctuations pass from the plate of the first triode to the grid of the second through R1 and R2. Higher frequencies pass through C as usual since its reactance is much lower than the total resistance R1 and R2.

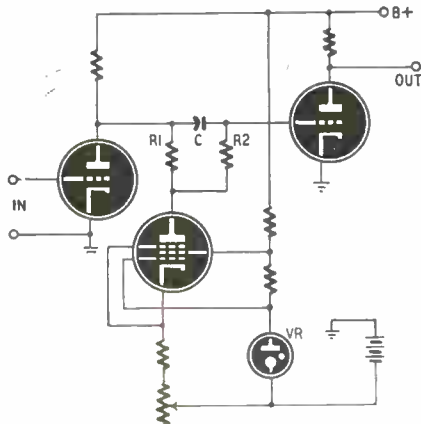

THE STANDARD by WHICH ALL TELEVISION CHASSIS ARE MEASURED!



BUY FROM THE ACCEPTED LEADER IN THE FIELD

A 30 tube TV chassis for top quality performance in 16", 19" and rectangular tubes . . . at rated brilliance and full width! Supplies 13 to 14Kv under load. A duplicate of **RCA's unexcelled 630 circuit** plus voltage doubler and **keyed automatic gain control**. Unequaled performance in **long range and difficult reception areas**. Competitively priced for volume sales.

- Super Powered
- Greater Sensitivity
- Superior Definition
- Longer Range
- Quality Components
- RMA Guarantee

Largest manufacturers of the RCA 630 type chassis.

VIDEO PRODUCTS CORP

42 WEST STREET • RED BANK, NEW JERSEY

PARTS JOBBERS: Write us for information on "How You Can Attain a More Prominent Position in the Television Picture."

Contact Our New York Sales Office, 2061 Broadway, N. Y. C.

WANT \$10,000?

Earn the government Super Sensitive P.R.I. Uranium with a **GEIGER COUNTER**. Find gold, silver, and other valuable ores with a P.R.I. Treasure Locator. World's finest instruments. FREE catalog. Write today.

PRECISION RADIATION INSTRUMENTS, Inc. Dealer Inquiries Invited
5478RE Wilshire Blvd., Los Angeles 36, Cal.

PEN-OSCIL-LITE

Extremely convenient test oscillator for all radio servicing; alignment • Small as a p'n • Self powered • Range from 700 cycles audio to over 600 megacycles u.h.f. • Output from zero to 125 v. • Low in cost • Used by Signal Corps • Write for information.

GENERAL TEST EQUIPMENT
38 Argyle Ave. Buffalo 9, N. Y.

FOR THE TAPE RECORDING ENTHUSIAST

ELEMENTS of SINGLE and DUAL TRACK TAPE RECORDING and 1001 APPLICATIONS by A.C. SHANEY

\$1.00 Postpaid

Written for the layman, technician and engineer by A. C. Shaney, outstanding author and engineer.

96 pages crammed with facts. Contains circuit diagrams, parts lists, construction hints, as well as elementary and advanced theory and design. Contains data never before in print. Send dollar bill. No C.O.D's.

AMPLIFIER CORP. OF AMERICA
398-90 Broadway New York 13, N. Y.

ELECTRONIC VOLTAGE-REGULATED BIAS SUPPLY

FREE WITH PHOTOFACT!

This is your **FREE** Howard W. Sams' **PHOTOFACT FOLDER SET**

FREE WITH THIS FOLDER SET! **PHOTOFACT FOLDER SET**

FREE WITH PHOTOFACT SET No. 91 **"BONUS" TV Supplement!**

Preliminary Service Data on Over 100

TELEVISION RECEIVER MODELS

yours for immediate use AT NO EXTRA COST!

COMING WITH THE PHOTOFACT SET No. 93 **"BONUS" TV Supplement!**

Preliminary Service Data on Over 100

TELEVISION RECEIVER MODELS

yours for immediate use AT NO EXTRA COST!

"Bonus" TV Supplements

Preliminary Service Data on Hundreds of Television Models for Your IMMEDIATE USE . . . AT NO EXTRA COST!

TV set owners are calling for service within days—even hours—after installation. That's why you, the TV Technician, must have your service data *right now!* And *right now*, PHOTOFACT brings you the "rush" preliminary TV service data you need for *immediate use* to keep you going at full speed. FREE with the purchase of PHOTOFACT Folder Sets No. 91 and No. 93, you receive with each a separate 64-page Supplement containing preliminary data (in advance of regular PHOTOFACT coverage) on over 100 popular TV models. Place your standing order for PHOTOFACT today—it's the only way to get *without delay* the TV service data you must have *right now!*

Buy PHOTOFACT Folder Set No. 91 and get FREE TV SUPPLEMENT NO. 91A: Covers 114 important Television Receiver models, produced by 11 leading TV manufacturers.

Buy PHOTOFACT Folder Set No. 93 and get FREE TV SUPPLEMENT NO. 93A: Covers more than 100 leading Television Receiver models, produced by 17 TV manufacturers.

BUY BOTH! GET THE DATA YOU WANT NOW ON HUNDREDS OF TV MODELS
 PHOTOFACT Set Nos. 91 and 93 are going fast—order today to avoid disappointment

HOWARD W. SAMS & CO., INC.

Order from your Parts Jobber today or write direct to HOWARD W. SAMS & CO., INC., 2201 East 46th Street, Indianapolis 5, Ind.

My (check) (money order) for \$_____ enclosed. Send me the following:

- Photofact Set No. 91 and Supp. 91A. \$1.50
- Photofact Set No. 93 and Supp. 93A. \$1.50

Name _____

Address _____

City _____ Zone _____ State _____

Bias voltages for class B and C amplifiers should be obtained from sources having good regulation. Many amateurs use power supplies delivering current 15 or 20 times the rectified grid current of the amplifier, the excess current being wasted in the form of heat in a heavy bleeder resistor. Besides wasting power, this type of supply does not have the regulation required for class B service. An electronic bias supply having regulation of 1 μ v per ma is described in *RCA Ham Tips*.

The circuit shown in the diagram can handle rectified grid currents to 200 ma when delivering bias between 20 and 80 volts. Voltage can be reduced to 20 volts when grid current does not exceed 100 ma.

V1 and R2 and V3 and V4 are in

parallel across the output of the supply. Because V1 and V4 are voltage-regulator tubes, the voltage drops across them will be constant. Therefore, a change in voltage across V3 will also appear across R2, the cathode bias resistor of V2. Any change in cathode bias on this tube will be amplified and will appear across R1 which is connected between plate and grid of the 6AS7-G output tube. The change in voltage across R1 swings the grid of V3 to keep its output constant. For voltages between 30 and 80, the output voltage changes 200 mv when the rectified grid current varies from zero to 200 ma.

Resistor R3 is set so the current through it is approximately 40 ma when the 100,000-ohm voltage control is set for approximately 75 volts output.

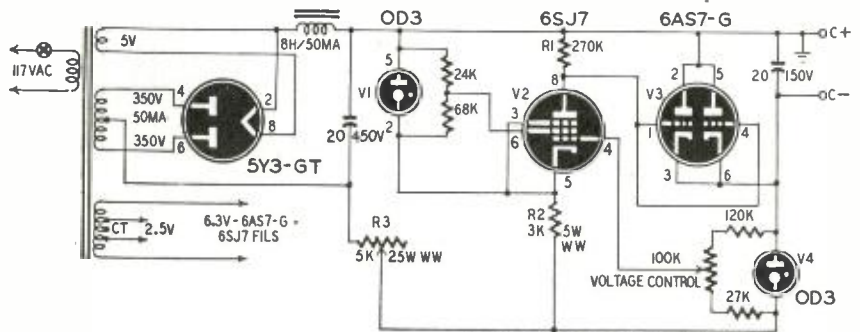

MULTIPLE TELEVISION RECEIVING ANTENNAS

Several methods of connecting two or more receivers to a common TV antenna or booster were described in *Wireless World* (England) recently. Because the resistive matching networks have insertion loss, these systems are suitable only where the signal level is unusually high or where boosters are used to bring the signal to an acceptable level.

The circuit in Fig. 1 can be used to feed any number of receivers having the same input impedance. The value of each resistor R is $Z \times n - 1/n + 1$, where Z is the impedance of the transmission lines and receiver input terminals and n is the number of receivers. Because the power divides equally between the receivers, the input to each is 20 log n decibels below the antenna output.

Fig. 2 shows an alternate method of connecting two receivers to a common antenna. In this circuit, R is equal to the impedance of the transmission lines. In Fig. 2, two of the resistors

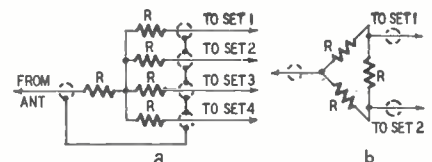

Fig. 1—Circuit for several receivers.

have been replaced by ribbon-type transmission lines, making it possible to feed four receivers. One resistor is left in the circuit to make each receiver input see its correct terminating impedance.

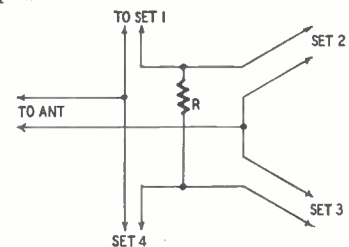

Fig. 2—A two-receiver antenna system.

NOTES ON CLAPP OSCILLATORS

The stability of a well-designed Clapp oscillator can approach that of the average crystal oscillator, but its output changes considerably if the frequency is varied over a wide range. Furthermore, bandspreading this circuit usually results in increasing the minimum capacitance of the tuning capacitor and reducing the stability. Two circuits for improving performance of Clapp oscillators are described

in *Short Wave Magazine* (London).

Fig. 1, developed by G2DC1, provides constant output over the entire tuning range by shunting the series-tuned network with a variable capacitor C2 having a maximum-to-minimum capacitance ratio equal to that of the main tuning capacitor C1. C1 and C2 are ganged so the ratio between the series and parallel capacitors will be constant throughout the tuning range.

OPPORTUNITY AD-LETS

Advertisements in this section cost 25c a word for each insertion. Name, address and initials must be included at the above rate. Cash should accompany all classified advertisements unless placed by an accredited advertising agency. No advertisement for less than ten words accepted. Ten percent discount six issues, twenty percent for twelve issues. Objectionable or misleading advertisements not accepted. Advertisements for July, 1950, issue, must reach us not later than May 24, 1950.
Radio-Electronics, 25 W. Broadway, New York 7, N.Y.

GIGANTIC SURPLUS EQUIPMENT MAIL SALE. Amazing values. Everything must go. Meters, burglar-fire alarms, telephones, transmitters, cathode ray tubes, thermostats, motors, electric drills, A-C generators, air compressors, relays, 110-volt elements, etc. Everything less than manufacturer's cost. We pay parcel post charges. Rush card for sale catalog. Burdon Sales Co., 843 "O" St., Lincoln, Nebr.

MAGAZINES (BACK DATED)—FOREIGN, DOMESTIC. arts, Books, booklets, subscriptions, pin-ups, etc. Catalog. 10c (refunded). Clecron's, 86-22 Northern Blvd., Jackson Heights, N. Y.

WE REPAIR ALL TYPES OF ELECTRICAL INSTRUMENTS, tube checkers and analyzers. Hazleton Instrument Co. (Electric Meter Laboratory), 140 Liberty Street, New York, N. Y. Telephone—BARclay 7-4239.

BIG MONEY. PART-FULL TIME. RADIO. Television Electronics. Complete information free. R. Johnson, 32611 Park Row Building, New York 7, N. Y.

SALE. RADIO TUBES, PARTS. TOP QUALITY. Send for free listing. KANE ELECTRONICS, 245 Echo Place, Bronx 57, N. Y.

LANCASTER, ALLWINE & ROMMEL, 436 BOWEN Building, Washington, D. C. Registered Patent Attorneys, Practice before United States Patent Office. Validity and infringement Investigations and Opinions. Booklet and form "Evidence of Conception" forwarded upon request.

RADIOMEN, SERVICEMEN, BEGINNERS — MAKE more money, easily, quickly. \$250 weekly possible. We show you how. Information free. Merit Products, 218-322, 132nd Avenue, Springfield Gardens 13, New York.

SURPLUS: BC221 FREQUENCY METERS, CLEAN and in perfect condition \$39.50 each. Send orders to Monarch Electric Company, 411 Wood Street, Pittsburgh 22, Pa.

SNIPERSCOPE & SNOOPERSCOPIES wanted. Any condition. Needed immediately. Box F1, Radio-Electronics, 25 W. Broadway, New York 7, N. Y.

Five Element TV Yagi Beams. High Band \$6.75. Low Band \$8.50. Aluminum Tubing, Etc. Willard Radcliff, Potosi, Ohio.

TELEVISION—SHARP AND CLEAR. ADJUST present aerial. Build low-cost Precision Antennae. Complete instructions, trouble-shooting chart, diagrams, construction plans, dimensions, no mathematics. Propson's, Lumberton, New Jersey.

The circuit in Fig. 2 was developed by G2RX to provide better bandspread performance. C1 is the bandset capacitor. It is tapped at a point on the

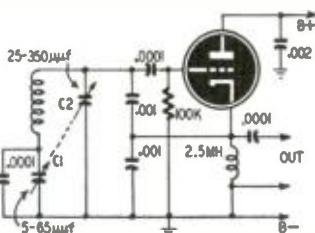

Fig. 1—Series-parallel tuning system.

ground end of the coil which will result in the desired bandspread. C2 is the bandspread capacitor and C3 is the minimum value needed to maintain oscillation when C2 is reduced to a low value. C4 and C5 are made as large as

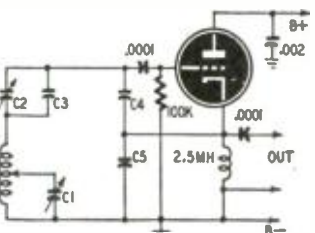

Fig. 2—Clapp circuit with bandspread.

possible. Their maximum value will depend on the Q and inductance of the coil and will be approximately .001 µf for most 160- and 80-meter coils.

SPEAKER SERVICING KINK

Before drilling a hole on or near a loudspeaker, coat the area with a layer of service cement at least 2 inches in diameter. Drill the hole before the cement dries. The cement will catch and hold any chips and prevent them from entering the gap between the loudspeaker's pole piece and voice coil.
—Marty Arslan

PHOTOFACT BOOKS HELP YOU 4 WAYS!

1. SAVE TIME 2. SAVE WORK

3. EARN MORE 4. LEARN MORE



PHOTOFACT TELEVISION COURSE

Gives you a clear understanding of TV principles, operation and practice. Complete coverage of all phases. 216 pages; profusely illustrated; 8½ x 11". Used by thousands. Order TV-1 Only \$3.00

TELEVISION ANTENNAS

All you need to know about TV antennas—describes all types, tells you how to select, how to install, how to solve troubles. Saves time; helps you earn more. 192 pages; illustrated; handy pocket size. Order TAG-1. . . Only \$1.25

TELEVISION TUBE LOCATION GUIDE

Accurate diagrams showing the position and function of all tubes in hundreds of TV receivers. Diagnose trouble and replace tubes, in most cases without removing chassis. Over 200 pages; pocket size. Order TGL-1. Only \$1.50



1948 RECORD CHANGER MANUAL

Covers 45 models made in 1948, including LP and dual-speed changers, plus leading wire recorders. Original data based on actual analysis of equipment. Over 400 pages; de luxe bound, 8½ x 11". Order CM-2. Only \$6.75

AUTO RADIO MANUAL

Complete PHOTOFACT Service data on more than 100 post-war auto radio models. Complete, accurate, uniform information. Covers over 24 manufacturers. Makes auto radio servicing easier and more profitable. Over 350 pages. 8½ x 11". Order AR-1. Only \$4.95

THE RECORDING & REPRODUCTION OF SOUND

A complete, authoritative treatment of the entire subject. Covers all phases of recording and amplification. 364 pages. 6 x 9", cloth binding. Order RR-1. . . . Only \$5.00

NEW! DIAL CORD STRINGING GUIDE

New Volume 2, covering receivers produced from 1947 through 1949. The only book that shows you the one right way to string a dial cord in thousands of receivers. Handy pocket size. Order DC-2. Only \$1.00

HOWARD W. SAMS & CO., INC.

Order from your Parts Jabber Tadoy, or write direct to HOWARD W. SAMS & CO., INC., 2201 E. 46th St., Indianapolis 5, Ind.

My (check) (money order) for \$.....enclosed. Send the following books:

TV-1 RR-1 AR-1 TGL-1
 TAG-1 CM-2 DC-2

Name

Address

CityZone....State.....

BUILD 15 RADIOS . . . Only \$14.75

- ABSOLUTELY NO KNOWLEDGE OF RADIO NECESSARY
- NO ADDITIONAL PARTS NEEDED
- EXCELLENT BACKGROUND FOR TELEVISION

The PROGRESSIVE RADIO EDU-KIT will help you, if you want an EDUCATIONAL AND INTERESTING HOBBY, or if you want to get into a WELL-PAYING BUSINESS, or if you want to INCREASE YOUR KNOWLEDGE OF RADIO.

Absolutely no knowledge of radio is necessary. The PROGRESSIVE RADIO EDU-KIT is the product of many years of teaching and engineering experience. The detailed instructions and quizzes are clearly written and illustrated, so that they can be understood by anyone between the ages of 12 and 80.

The PROGRESSIVE RADIO EDU-KIT is not merely a collection of radio parts accompanied by a radio diagram. IT IS PRACTICALLY A RADIO COURSE, offered at a mere fraction of its real value. You will be taught to build radios in a progressive manner. First, you will build a very simple 1-tube receiver. The next set is a little more advanced. Gradually you will find yourself constructing elaborate radio sets, and doing work like a professional radio technician. Every part is illustrated. EVERY STEP INVOLVED IN BUILDING THESE SETS HAS BEEN CAREFULLY PLANNED. YOU CANNOT MAKE A MISTAKE.

Each of the 15 radios you will build operates an 110-120 volts, AC or DC. These sets have been designed to teach you the PRINCIPLES OF RADIO. Therefore, you will build a variety of circuits. The PROGRESSIVE RADIO EDU-KIT is EXCELLENT FOR LEARNING THE PRINCIPLES OF RECEIVER, TRANSMITTER, AND AMPLIFIER DESIGN. It is used in many Radio Schools and Colleges in U.S.A. and abroad. It is used by the Veterans Administration for veteran training.

Quizzes are provided as part of the PROGRESSIVE RADIO EDU-KIT. They will be corrected by our staff at no extra cost.

FREE 1950 EXTRAS: ELECTRICAL AND RADIO TESTER SCREWDRIVER BOOK ON TELEVISION GENEROUS HANK OF WIRE

FREE 1950 EXTRAS: ELECTRIC SOLDERING IRON ALIGNMENT TOOL SPOOL OF ROBIN CORE SOLDER MEMBERSHIP IN RADIO-TV CLUB

ORDER YOUR PROGRESSIVE RADIO KIT TODAY, OR SEND FOR FREE "KIT-KATALOG" POSTAGE PREPAID ON CASH ORDERS. C.O.D. ORDERS ACCEPTED IN U.S.A.

PROGRESSIVE ELECTRONICS CO. 497 Union Ave., Dept. RE-36 Brooklyn 11, New York

FOR THE VERY BEST TV *Tel-a-Ray* ANTENNAS

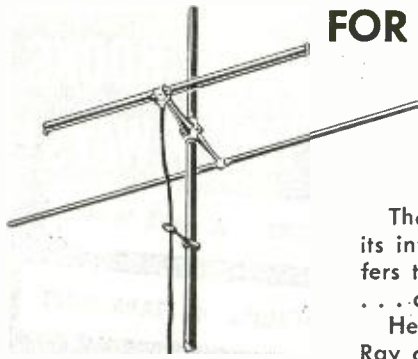

Tel-a-Ray Model C—for multi-channel reception in high signal areas. (Write for results of performance tests.)

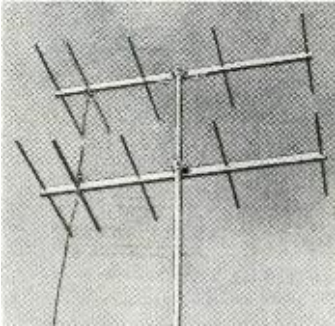

Tel-a-Ray Model TD—brings good reception to low signal areas. (Write for results of performance tests.)

The televiewer who tells you "TV is still in its infancy" is probably the person who suffers through faint signals . . . blurred images . . . off-and-on reception.

He's the person who doesn't have a Tel-a-Ray antenna.

Tel-a-Ray antennas fill the requirements of almost every televiewer, regardless of location. For low signal areas, the Model T brings in good reception from stations 200 miles away! Tel-a-Ray low-cost C-Series—designed for metropolitan areas—gives users the widest possible range at the lowest possible cost.

And Tel-a-Ray antennas fill the other big requirement of good antennas: they are durable. Constructed from Dural with stainless steel fittings, Tel-a-Ray antennas withstand corrosion . . . rain . . . snow . . . and high winds.

Wherever you live—if you have TV—you'll have better reception with Tel-a-Ray.

First--because they Last

Tel-a-Ray ENTERPRISES, INC.

P. O. BOX 332, DEPT. C, HENDERSON, KY.

CAPACITOR DECADE

A capacitor decade box having a range of 10 μf to 0.1 μf can be made from 16 capacitors and eight toggle or slide-type s.p.d.t. switches connected

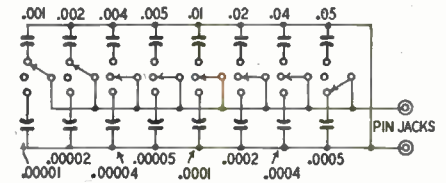

as shown in the diagram. The switches should have a "dead" or off position so capacitors not in use are out of the circuit. The decade box is set at .0035 μf in the diagram.—Horace Shafer

ELECTRICAL WIRING HINT

Solder all splices and connections and avoid solderless connectors when installing power and light wiring on or near radio and TV service benches or sensitive electrical and electronic instruments.

A solderless connector is not likely to cause power loss, but oxidation and corrosion may result in small transient currents in the joint. Such currents can cause noise and spurious responses in sensitive equipment connected to the line.—R. C. Roetger

INTERFERENCE ELIMINATION

TV and FM receiving antennas frequently take on a heavy charge of static electricity which produces interference as it leaks off in a corona discharge. This can be eliminated by placing plastic beads or a coating of tar on the ends of the antenna elements and other sharp projections on the assembly.—G. W. Deuchler

NOTE TO CONSTRUCTORS

It has been suggested that iron or steel nuts and bolts can be installed in hard-to-reach places by using the magnetic field surrounding the tip of a Weller-type soldering gun. This method has several disadvantages: the heat from the gun may damage other components, the magnetic field at the tip will not hold the fitting rigid, brass fittings cannot be installed by this method.

Positioning brass or iron fittings is made easy by soldering the fitting to the tip of the gun and allowing it to cool. After the fitting is secured in position, heat the gun to melt the solder. This operation takes less than a minute and does not have the disadvantages of the magnetic method.—Walter Blazek

SELF-LOCKING PHOTO RELAY

Some photoelectric relays close an external circuit when light falls on the phototube and open the circuit when light fails. By adding a few simple parts, the external circuit can be locked on until opened manually. Locking-type relays or internal circuit changes are not required.

Mount a 6-watt, 117-volt lamp on or near the control unit and reflect its light into the phototube with a small

RADIO-ELECTRONICS for

Gun Sights—Illuminated Sight Mark 8—Mod. 3. Contains the following lenses: 2 1/4" Concave-Convex FL 4 1/2"; 3 1/4" Double Concave FL 5"; 3 1/4" Double Convex FL 3"; 3 1/4" Plain and Convex FL 3 1/2" Coated; also 1 1/2" Plain FL, 5" x 3 1/4" x 1/4" Oblong Plain Optical—all mounted in a 4 1/2" Barrel with light socket level indicator and pistol sight holder. Price—only... **\$6.95**

Car Shaver Motor

Use your electric shaver in your car. Dynamotor will supply 110-120 Volt DC approx. 15 Watts from 6 Volt DC auto battery and will operate most types of AC-DC shavers. Order No. RE-6250. Price—only... **\$2.00**

GEARED MOTOR

Ideal reversible motor for rotating antennas, displays, etc. Weight: 4 lbs. Overall size: 7" long, less shaft. Gear Box size: 3 1/4" x 3 1/4". Motor size: 4" x 3 1/2". Shaft size: 3/8" x 1 1/2" threaded. Operates from 24 Volt DC. 2.9 A., 9 RPM or 36 Volt AC at 75 lbs. torque per inch. Price... **\$5.95**

TRANSFORMER—110 Volt 60 cycle primary; secondary 36 Volt AC... **\$2.95**

RHEOSTAT—to control speed. 30 ohm 50 Watts... **97c**

PHONOGRAPH MOTOR only—110 Volt 60 cycle. 78 RPM for automatic record changers... **\$1.50**

GEAR TRAIN MOTOR—Low inertia reversible type. Can be used to operate small displays, models, etc. Operates from 12 V. AC with use of condenser. Normally operates 26 Volt 400 cycle. Motor 588 RPM; low speed 14 RPM; separate gear 1/2 RPM. Complete motor, gear train, condenser, & instructions... **\$2.50**

MODEL MOTOR—12 Volt AC-DC. 1/2" double end shaft. Motor size: 2 1/2" L x 2 1/2" W x 1 1/2" H. Price... **\$2.50**

HAND TOOL MOTOR—12 Volt AC-DC 5600 RPM. Size: 3 3/4" L x 1 1/4" D with splined shaft 1/4" D x 1/4" L. Price... **\$2.95**

6 VOLT AC OR DC MOTOR—Ideal for auto heaters, defrosters, fans, models, etc. Used by Govt. In aircraft. Shaft size: 1/4" x 3/8". Price... **\$1.50**

BC-357 MARKER BEACON REC. 2 Tubes—Used: **\$2.95**

TRANSFORMERS—110 Volt 60 cycle Primaries:
Sec. 12 V. 1 amp... **\$1.50** Sec. 24 V. 2 amps... **\$2.25**
Sec. 24 V. 1 amp... **1.95** Sec. 24 V. 5 amp... **1.50**
Sec. 36 V. 2.5 amps... **2.95** Sec. 24 V. 4 1/2 amps... **3.95**
Sec. 14-14 or 28 V. 7 1/2 or 15 amps... **4.95**

SELSYN TRANSMITTER & INDICATOR SYSTEM—Ideal for antenna direction indicator to remote position. Complete with Autosyn Trans. 3" I-81 Indicator, Transformer, and instructions. Price **\$6.75** Autosyn Trans. only: **\$2.95** Plug I-1-81: **\$1.00**

BC-645-A TRANSCEIVER 110 VOLT TRANSFORMER AND CHOKE

15 Tube Transceiver, ideal for conversion to 460 MC. Citizens Band. Frequency coverage 435 to 500 MC. With conversion instructions—New and boxed. No. RE-645-A... **\$14.95**

TRANSFORMER for BC-645-A—110 V. 60 cycle input; output 400 V. 150 MA. after filter. 12, 9, and 6 V. AC. 4 amps and 5 V. 3 amps. No. RE-645... **\$6.95**

CHOKE—15 Hy. 150 MA. No. RE-646... **\$2.95**

PE-101 DYNAMOTOR—13/26 Volt input... **\$2.95**

PM FIELD DYNAMOTORS—POWER SUPPLY:

Completely filtered 12/24 Volt input; output 275 Volt 110 MA. & 500 Volt 50 MA. housed in a metal case 8" x 6" x 10". Contains: 2 PM Dynamotors, 2 Switches, 12 Cond., Fuses, Light, Brushes, Chokes, Resistors, Plugs, etc. Shipping weight: 62 lbs. Order No. RE-#3... **\$5.00**

WHIP ANTENNA—MAST BASES, INSULATED:

MP-132—1" heavy coil spring, 2" insulator. Overall length: 11 1/2". Wt. 2 3/4 lbs. Price... **\$3.95**

MP-22—Spring action direction of bracket. 4" x 6" mounting. Price... **\$2.95**

MAST SECTIONS FOR ABOVE BASES:

Tubular steel, copper coated, painted, 3 foot sections, screw-in type. MS-53 can be used to make any length. MS-52-51-50-49 for taper. Any section... **50c Ea.**

Sections MS-54 or MS-55 (Larger than MS-53) 75c. Ea. BAG BG-56 f/carrying 5 sections... **50c**

BC-1206 RECEIVER—200-400 KC. 5 Tubes. Operates from 24-28 VDC. If Freq. 135 KC. Size: 4"x3"x6" L.N... **\$6.95**

POWER SUPPLY KIT—110 Volt AC to 24 VDC... **\$6.95**

MARK II B-19 TRANSMITTER & RECEIVER 15 TUBE SET 2—8 MC., 240 MC., AND INTERCOM. FOR MOBILE OR STATIONARY USE!

PRICES—NEW: **\$59.50 USED (Tested) \$39.50**

NEW TRANSFORMERS—CASED— 115 V.A.C. 60 CYCLE INPUT:

OUTPUT: 600-0-600 V.A.C. at 250 MA. 12 V.A.C. at 3 amps; 12 V.A.C. at 3 amps; and 5 V.A.C. at 3 amps. Designed for Army Surplus transmitters. No. RE-108 **\$7.75**

OUTPUT: 250-0-250 V.A.C. at 60 MA. 24 V.A.C. at 6 amps; 6.3 V.A.C. at 6 amps. Designed for Army Surplus receivers. No. RE-109... **\$3.50**

NEW CHOKE—CASED: 13 Henries at 250 MA. filter choke, 1500 V. insulation. No. RE-121... **\$4.95**

Address Dept. RE • Prices F.O.B. Lima, Ohio • 25% Deposit on C.O.D.'s • Minimum Order \$2.00

FAIR RADIO SALES 132 SOUTH MAIN ST. LIMA, OHIO

IN THE SETS OF THE BEST MANUFACTURERS FOR YEARS...

NOW!

it's **TEL-O-TUBE** for **REPLACEMENT!**

**IMMEDIATE DELIVERY ON ALL TYPES!
PROVED SUPERIORITY!**

For manufacturers, Tel-O-Tube has long meant higher picture tube quality at lower cost. The list of famous TV set makers who have specified Tel-O-Tubes for their production is a virtual who's who of the industry—Admiral, Ansley, Crosley, Emerson, Garod, Olympic, Starrett, Tele-King, Tele-Tone, Sightmaster, Video Corporation of America, etc. Again and again, Tel-O-Tubes meet the critical approval of these receiver manufacturers. Here is indisputable proof of Tel-O-Tube superiority!

Now Tel-O-Tube means more replacement sales at lower costs for more profits for you. We have stepped up our production to a new high of 1800 a day, and are pushing higher every week—to fill your replacement needs for the finest picture tubes of every type—with immediate delivery!

Tel-O-Tubes are made in our 3 new modern plants under the newest, most stringent quality controls and test tolerances, backed by the latest engineering "know-how." That's why you get more dependable performance and longer life—for more sales and more profits—with Tel-O-Tubes.



New Tel-O-Tube 16XP4 16" Rectangular

Take a tip from the quality-conscious receiver manufacturers—specify Tel-O-Tube. We have a "honey" of a sales story for every TV serviceman interested in profits in picture tubes. For full details, write NOW to Dept. E-1.

TEL-O-TUBE SALES CORPORATION

580 FIFTH AVENUE, NEW YORK 19, N.Y.

Telephone: JUdson 2-2967-8-9

mirror as shown in the diagram. Connect the lamp to the a.c. output contacts in parallel with the external circuit. When a light pulse falls on the

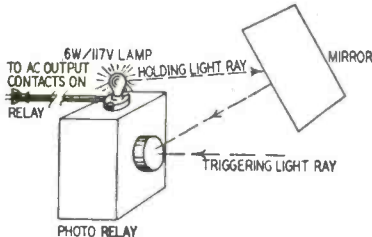

phototube, the external circuit is closed and the 6-watt lamp comes on. Its light will be reflected into the phototube so the relay remains closed. Turn off the 6-watt lamp to open the external circuit or to restore the relay to momentary-type operation.—O. C. Vidden

ANCHORING RADIO PARTS

The conventional method of mounting such components as extractor fuse posts, spring-mounted sockets, grommets, etc., may permit them to be turned enough to break the leads or cause a short circuit. This may be prevented by applying a cement such as EC-847 (Minnesota Mining & Mfg. Co.) to the components which must be anchored securely.

This cement can be used to make outdoor PA equipment water- and weatherproof. Apply a coat of the cement to junctions between cables and plugs and to other joints where water and moisture may enter.—H. Zave

**SHOOTS TROUBLE
FASTER!** **MAKES MORE MONEY
FOR YOU ON THE JOB
OR AT SERVICE BENCH**



Signalette
MULTI-FREQUENCY GENERATOR

In radio service work, time means money. Locate trouble faster, handle a much greater volume of work with the SIGNALETTE. As a trouble shooting tool, SIGNALETTE has no equal. Merely plug in any AC or DC line, start at speaker end of circuit and trace back, stage by stage, listening in set's speaker. Generates RF, IF and AUDIO Frequencies, 2500 cycles to 20 Megacycles. Also used for checks on Sensitivity, Gain, Peaking, Shielding, Tube testing. Wt. 1 1/2 oz. Fits pocket or tool kit. Satisfaction, or your money back. See at your distributor or order direct.

Clippard INSTRUMENT LABORATORY, INC.

DEPT. B, 1125 BANK STREET
CINCINNATI 14, OHIO
Qualified Jobbers write, wire for details.

The ORIGINAL and Still the BEST
LIGHTNING ARRESTER

for all weather conditions
will not absorb moisture

completely waterproof

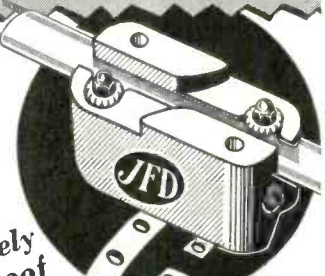

APPROVED for OUTDOOR-Indoor Use!
Protects Television Sets Against Lightning and Static Charges

JFD SAFE TV GUARD

Fits Any Type of Twin Lead

No. AT102 for Regular Twin Lead
No. AT103 for Oval Jumbo Twin Lead
No. AT103 Also for Tubular Twin Lead
BOTH Models Conform With Fire Underwriters and National Electrical Code Requirements for OUTDOOR installations.

\$2.25
EACH

SIMPLE TO INSTALL... For maximum efficiency, arrester should be mounted outside window nearest to TV receiver, with ground wire attached to nearest grounded point. No stripping, cutting or spreading of wires necessary. Supplied complete with 4 ft. length of Ductile Aluminum Ground Wire for Wall Mounting, and Strap for Mast or Grounded Pipe installation.

JFD MANUFACTURING CO., Inc.
6127 16th Avenue, Brooklyn 4, N. Y.
First in Television Antennas & Accessories

NEW YORK RADIO TECHNICIANS CONVENE

The 1950 annual meeting of the Empire State Federation of Electronic Technicians Associations (ESFETA) was held April 23 at the Hotel Arlington in Binghamton, N. Y. Seven of New York State's nine radio technicians' associations were represented: Long Island, New York City, Southern Tier, Endicott, Corning, Central New

York and Rochester. Hudson Valley and Kingston were not present.

Officers elected for the 1950-51 term are: Max Liebowitz, ARSNY, president; Larry Raymo, Rochester Radio Technicians Guild, vice-president; Wayne Shaw, Southern Tier Radio Servicemens Association, secretary; Ben de Young, Central New York

RTG, treasurer; and Ed Fisk, Rochester RTG, sergeant-at-arms. This is a re-election of the 1949-50 chief officials, excepting that Larry Raymo replaces vice-president Margaret Snyder, who withdrew her name from nomination because of preparations for her expected forthcoming marriage June 28.

Most important subject of general discussion was the winter series of technical lectures. Methods of better co-ordination between local associations and speakers were worked out, with the object of having smoother meetings and avoiding mistakes and accidents of the type which caused a 3-week run of speakerless meetings both at Binghamton and Rochester.

Also discussed was the question of ethical advertising of television sales and service, a sore problem with many technicians who are called upon to make good the dealer's claims, whether exaggerated or otherwise. On this point Max Liebowitz gave a short report of the conferences sponsored by the New York City Better Business Bureau with the aim of setting up standards for advertising claims.

SOCIAL AND DANCE HELD BY N. Y. C. TECHNICIANS

ARSNY, the Associated Radio-television Servicemen of New York, N. Y., held their first annual social and dance at the Hotel Diplomat, New York City, on March third. Attendance was well over 200.

The dance was accompanied by an excellent floor show, and a large number of door prizes were distributed, including a Motorola radio, a Philco Pocketscope and late Rider Manuals.

NEWELMINATOR KIT!

FOR AUTO-RADIO SERVICING
Supplies 5-8 volts at 10 amperes continuous, 15 amps. intermittent. Step voltage control, ripple less than 3%! Power on instantly—no warm up period required. For 115 VAC-50/60 cycles.

HERE'S WHAT YOU GET:

- Heavy duty power transformer
- Full wave Selenium Rectifier
- Low Resistance Filter Choke
- High Capacity Filter Condenser
- Multi-position tap switch

Kit #EL-2
Complete with operating and instruction manual. Shpg. wt. 24 lbs. Sorry no COD's. Serviceman's net.

\$19.50



OPAD-GREEN COMPANY
71 Warren St. W. New York 7, N. Y. Phone: BEekman 3-7385-6

ADSON FOR VALUE!

SAVE \$\$\$ ON TV ACCESSORIES!

ANCHOR TV BOOSTER
Recommended By Famous Consumer Research Lab. Boosts signal in fringe areas and trouble locations. Gives 2 1/2 times more gain in signal strength across all channels. Minimizes ghosts. Features exclusive impedance matching of its output to in-600 ma put of set. **\$22.00**

DIETZ ENLARGING LENS
4-Way Adjustable Bracket. Optically perfect picture magnifier gives bigger and better pictures for your TV enjoyment. Compare these prices and order today!

7"	\$ 8.95
10"	11.95
12"	15.95

TV WAVE TRAPS
An amazing device for improving TV reception. Connects to lead-in line. Choose one of three to eliminate interference from FM, diathermy, or amateur stations. Each, only \$2.89

Low Priced! EMC MULTITESTER
A versatile, compact tester for radio receiver servicing. 3" square metal. Ranges—Volts AC: 0-12/120/600/1200/3000. Volts DC: 0-6/60/300/600/3000. Mill Amps DC: 0-6/30/120 ma., 0-1.2 amps. Mill Amps AC: 0-30/150/600 ma. Ohms: 0 to 1 megohm. **MODEL 102 \$13.90**

"RADIO KITS"

3-Way Portable Receiver Kit
Make this 5 tube radio for portable battery operation and AC-DC house use. Smartly designed leatherette case with modern grille and slide rule dial. 5" Alnico V speaker. Complete with extra low current drain tubes for long battery life. **KIT MODEL \$17.50**

3W10A
2-BAND 6-TUBE AC/DC RECEIVER KIT, standard and foreign broadcast. Kit Model S-6X. **\$18.45**

5-TUBE AC/DC SUPERMET KIT, Model S-5. **\$13.95**

Satisfaction guaranteed. Send check or money order. 25% deposit with C.O.D. All orders shipped within 24 hours. F.O.B. New York. Please include postage.

The Book that takes Drudgery out of Mathematics

Only \$1. postpaid

SOLVES EVERYDAY PROBLEMS HELPS YOU GET AHEAD IN LIFE

How many times have you lost money because of a mistake in figuring? Do you know how to figure quickly and correctly? Can you figure discounts, interest rates, taxes and all the other calculations you meet up with in your daily life? Are you having trouble qualifying for Civil Service Exams or Armed Services Promotions, because you're not up on mathematics? Here is the book that gives you a good background in mathematics; that takes all the irritation and drudgery out of it. You don't need to be scared of mathematics, because here's the subject explained without frills, without useless computations. Here's the book for men in radio jobs; for business men; technicians and craftsmen, explaining and answering everyday mathematic problems in easy-to-understand words and illustrations. Yes, it's the key to a simple understanding of mathematics. It's a real home-study course in mathematics for the man who's alert to its importance in the world today.

ELEMENTARY MATHEMATICS

• EASY — SIMPLIFIED — PRACTICAL •

CONTENTS OF BOOK

CHAPTER I. Arithmetic—Addition—Subtraction—Multiplication—Division.

CHAPTER II. Factoring and Cancellation—Fractions—Decimals—Percentage—Ratio—and Proportion.

CHAPTER III. The Metric System.

CHAPTER IV. How to Measure Surfaces and Capacity (Geometry).

CHAPTER V. Powers and Involution—Roots and Evolution.

CHAPTER VI. Mathematics for the Manual and Technical Craftsman—Thermometer conversions—Graphs or Curve Plotting—Logarithms—Use of the Slide Rule.

CHAPTER VII. Special Mathematics for the Radio Technician.

CHAPTER VIII. Commercial Calculations—Interests—Discounts—Short Cut Arithmetic.

CHAPTER IX. Weights and Measures—Useful Tables.

ONLY \$1. POSTPAID

Send Stamps, Cash or Money Order.

Send Today for Your Copy of This Indispensable Book, It Can Be Carried Readily in Your Pocket.

TECHNIFAX
520 N. Michigan Ave., Chicago 11, Ill.

EVERY RADIOMAN Can Use These SERVICE HINTS! Valuable Manual Yours—FREE!

Every page of "How to Simplify Radio Repairs" is packed with on-the-bench, practical ideas. Contains photos, charts, diagrams—no fluff—no vague theory. In plain every-day language it gives you priceless suggestions—new servicing ideas. You'll use and benefit from the experience of experts. Partial list of contents: How to Localize Trouble; How to Service Amplifiers; How to Test for Distortion; How to Test Audio Circuits; How to Test Speakers; How to Find Faults in Oscillators; How to Test Radio Parts—and it's all yours—FREE! No obligation.

FEILER SEND COUPON OR PENNY POSTCARD FOR YOUR FREE COPY TODAY!

FEILER ENGINEERING CO., Dept. 6RCS
1601 S. Federal St., Chicago 16, Illinois
Please RUSH my FREE copy of "How to Simplify Radio Repairs."

Name
Address
City Zone State

ADSON RADIO & ELECTRONICS CO.
221 Fulton Street, New York 7, N. Y.

SERVICE TECHNICIAN SURVEY

The editors wish to thank the service technicians who replied to the Service Technicians' Survey questionnaire which appeared in the November issue of RADIO-ELECTRONICS, especially the many who supplemented their answers with interesting explanatory letters.

Here is a summary of the most generally interesting and pertinent results of this survey:

1) The technicians who replied definitely indicated their preference for a greater percentage of articles on TV servicing. For more TV servicing articles: 79%; against: 14%.

2) Approximately 38% of the replying technicians service radio receivers only, 2% TV only and 54% both. About 40% of those who serviced only radio indicated that they were in non-TV areas and that their specialization in radio was only temporary.

3) A large majority (73%) said that they were asked to recommend various makes of TV receivers. Of the 21% who were not asked for such endorsements, roughly 30% were in non-TV areas.

CORRECTION

There is an discrepancy in the text of the article "A Ten-Tube FM Receiver for Only \$10." in the March issue. The paired capacitors across the secondary of the discriminator transformer are listed as 40 µf each. The values are 50 µf as shown on the diagram.

We thank Mr. Ray Appechaws, of Pen Mar, Pa. for this correction.

Radio Thirty-Five Years Ago
In Gernsback Publications

HUGO GERNSBACK
Founder

Modern Electrics	1908
Electrical Experimenter	1913
Radio News	1919
Science & Invention	1920
Television	1927
Radio-Craft	1929
Short-Wave Craft	1930
Television News	1931
Wireless Association of America	1908

Some of the larger libraries still have copies of ELECTRICAL EXPERIMENTER on file for interested readers.

June, 1916, ELECTRICAL EXPERIMENTER

- Electricity and Wireless Solve Secret Service problems
- Wireless Music with Your Meals, by Albert Marple
- Tesla's Early Work with Radio Controlled Vessels
- Radio League of America News
- United States Signal Corps Use Radio In Mexico
- High Speed Radio Telegraphy, by C. V. Logwood
- Hook-Up for Undamped and Damped Oscillations, by Harry Y. Higgs, R.E.
- Emergency Telephone Headband, by Cecil H. Ostermerer
- Pocket Radio Receptor with 60 Mile Range, by Earl H. Swanson
- High-Voltage Battery for Audions, by Francis R. Pray
- Variable Inductance for Transformers, by Chase Hutchinson
- A Practical Portable Wireless Set, by Milton B. Sleeper

JUNE, 1950

Here's Your Complete Kit -- PEERLESS High-Efficiency Triode Amplifier



This great amplifier, featuring high efficiency triode design and described in an article by Mr. Melvin C. Sprinkle in the May 1950 issue of Radio & Television News is supplied in complete kit form by Sun Radio & Electronics Co., Inc. -- since 1922 one of America's favorite parts supply houses, renowned for its friendly, square-dealing service.

PEERLESS KIT: contains 4 Peerless transformers, chassis, bottom plates, RC mounting board, all instructions and diagrams \$46.80

SUN ACCESSORY COMPONENT KIT: contains all additional parts needed -- sockets, switches, plastic case capacitors, tubes, knobs, connectors, everything \$34.75

TOTAL COST, both kits complete \$81.55 (Either kit sold separately)

FAST MAIL ORDER SERVICE TO ANY PART OF THE UNITED STATES. Send full amount to speed handling, 25% required with COD's.

We are exclusive distributors in the New York area for Peerless transformers -- not only for this kit but for the complete line of high-fidelity audio, power and other types of transformers and chokes. Write us for the Peerless catalog.

FEATURES

Response: 20-20,000 cps ± 0.5db. 15W output at 4% Intermodulation Distortion. 7db of feedback around 5 stages & output transformer. Cathodyne phase inverter. Cathode follower driver. Fixed bias, 8 tubes: 2 - 6J7, 1 - 6J5, 2 - 6SN7, 2 - 6A5G, 1 - 5V4G. Equalized for GE, Pickering pickups. Terminal strip for easy construction, servicing. Peerless transformers.

Sun Radio & ELECTRONICS CO. INC.
122-C DUANE ST. • NEW YORK 7, N.Y.
2 Blocks North of Chambers St.
BARCLAY 7-1840

TRIPLEX WAVE MASTER

YOUR BEST ANTENNA BUY!!!!

TRIPLE DIRECTORS

1/4 Wavelength Stacked

Conical with 3-Element Dipole

GHOST FREE RECEPTION ALL CHANNELS

NO BOOSTER REQUIRED

YOUR COST

\$8.90

INSTANT ASSEMBLY

MATCHES ANY OHM WIRE 75-150-300



Third Dipole Element provides exceptional broad band response across both bands.

EASY INSTALLATION APPROX. WT. 7 POUNDS

Price List

\$2690

UNDER ACTUAL TESTS...PROVED!

- Most advanced design to date.
- Easier tuning, added selectivity on any receiver.
- 30% more gain than former 4X antennas.
- These tests conducted in fringe areas and locations up to 250 miles from transmitting stations—not by meter or laboratory tests, but under average home installation.
- Reception available in fringe and formerly unsatisfactory locations, all channels.

SOLD DIRECT—WRITE—WIRE—CALL—FA IRFAX 9171

RAYTRON MFG. CO.

441 SUMMIT ST.

TOLEDO, OHIO

Question Box

You Don't Need a SLIDE RULE to Show Senco PRICES are EXTRA LOW

BRAND NEW IMMEDIATE DELIVERY TUBES INDIVIDUALLY CARTONED GUARANTEED

SPECIAL QUANTITY DISCOUNT OFFER. Order 25 or More Assorted Tubes and Deduct 5c from the Price of Each Tube.

15¢ Ea.	K42B K49B L42B L42D L49B L49C	1F5 1G4 1G5 1G6 1H4 1H6 1J6 1L4 1P5 1R4 1R5 1S4 1S5	50Y6 59A 6C7 75 81 89 2051 59¢ Ea.
19¢ Ea.	100-77 100-79 JFD Type A	1R4 1R5 1S4 1S5	
29¢ Ea.	1B5 1T5 2A5 2B7 25-45 3B7 6AL5 6AT5 6BA6 6BE6 6BJ6 6AU6	1R4 1R5 1S4 1S5 304 354 374 574 5W4 5Y3 5Y4 5Z3 6A8 6AE6 6AB 6AC5 6AD7 6AQ5 6AR5 6B7 6B8 6B86 6C5 6C6 6D6 6E6 6F5 6F6 6F7 6G5 6G6 6H7 6I5 6I6 6J5 6K4 6SA7 6SD7 6SH7 6SK7 6S07 6U7 6X4 6X5 12A8 12A8G 12AB6 12J5 12J7 25L6 31 34 35 43 46 53 56 58 80 84 117Z3 1A5 1B4P 1C6 1C7 1D5 1D7 1D8 1E7 1F4	69¢ Ea.
39¢ Ea.	1A3 1U4 1U5 1V 2A6 2A7 2X2 4A6 6AB4 6C4 6H6 6J5 6N4 6SA7 6SD7 6SH7 6SK7 6S07 6U7 6X4 6X5 12A8 12A8G 12AB6 12J5 12J7 25L6 31 34 35 43 46 53 56 58 80 84 117Z3 1A5 1B4P 1C6 1C7 1D5 1D7 1D8 1E7 1F4	69¢ Ea.	69¢ Ea.

MINIMUM ORDER \$2.50. Send 25% deposit for all C.O.D. shipments. Include sufficient postage, excess will be refunded. Orders without postage will be shipped express collect. All Prices F.O.B. New York City.

BOTH FREE!
CONDENSER-RESISTOR COLOR CODE CHART
RECEIVING TUBE INTERCHANGEABILITY CHART

Senco's Latest Condenser-Resistor Color Code and Receiving Tube Interchangeability Charts are yours for the asking. This is Senco's way of thanking Old Customers and welcoming New Ones.

NOTHING TO BUY—FILL IN COUPON—MAIL TODAY!

NAME
ADDRESS
CITY ZONE STATE

Radio Men Who Know
SAVE AT SENCO

SENCO RADIO, INC., Dept. V
73 West Broadway New York 17, N. Y.

SERVICING HALLICRAFTERS 505
? I have a Hallicrafters model 505 TV receiver. After it warms up, the picture slides downward to the extent that it cannot be centered with the vertical position control. How can I cure this trouble?—E.R. McC., Gunter, Texas

A. When the picture slides in any direction and cannot be centered with the positioning controls, it is likely that one of the high-voltage coupling capacitors between the deflection amplifiers

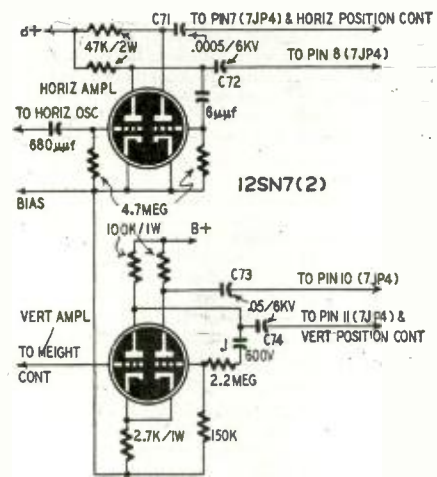

\$1,200.00 PRIZE CONTEST RADIO-ELECTRONICS IN THE HOME

Midnight of July 1, Eastern Standard Time marks the closing of the third month's Radio-Electronics in the Home contest. Entries for the July contest must be postmarked before this date. The closing date for the June contest is midnight, June 1.

- FIRST PRIZE \$50
- SECOND PRIZE \$25
- THIRD PRIZE \$15
- FOURTH PRIZE \$10

Monthly prizes totaling \$100 are given for the best ideas on applications of radio-electronics in the home.

Prizes will be awarded in accordance with novelty, general importance of the application or device, smallness of cost involved in building it, and practicability.

Any ideas may be submitted. Highest prizes will be awarded to contestants who have actually built the device and submit photographs to prove it. Lesser prizes will be given for "ideas" and entries not accompanied by photographs.

For complete details and rules of the contest see page 35 of **RADIO-ELECTRONICS** for March.

EMC KITS—KITS
EMC Model 120
20,000 ohms-per-volt
VOLOMETER
\$22.95

Portable Model Illustrated 26.95
The ONLY 20,000 ohms-per-volt instrument that gives you

- 6 D.C. Volt ranges at 20,000 ohms/volt to 6000 volts
- 6 A.C. Volt ranges at 10,000 ohms/volt to 6000 volts
- 5 current ranges to 6 amps
- 4 resistance ranges to 300 megs

Completed Unit (open face)... \$29.95
Completed Unit (portable)... \$34.95

EMC MODEL 300 VACUUM TUBE Volt-Ohm-Capacity METER
\$23.95

Hammertone Metal Carrying Case

- DC VOLTS—6 ranges to 1000 volts!
- AC VOLTS—5 ranges to 1000 volts!
- RESISTANCE—6 ranges to 1000 meg-ohms
- CAPACITY—4 ranges (.000025 mfd to 20 mfd)
- ZERO CENTER POSITION
- INCLUDES LEADS

Completed Unit \$39.50
CAPACITY RANGES and ZERO CENTER POSITION are features not available in competitive VTVM kits.

EMC MODEL 500K R. F. SIGNAL GENERATOR
\$18.75

- Employs electrostatically shielded transformer for 115V 60 cycle operation.
- All coils not in use are automatically shorted out.
- Provision for external modulation.
- Attractive 3 color panel.
- Covers range from 150KC to over 30 megacycles on fundamentals—over 100 megacycles on harmonics.
- 400 cycle internal modulation available.

Export Dept., 303 W. 42nd St., N. Y. C.

Write Dept. B-6 for Free Catalog
Gives More Measurement Value per Dollar!
EMC ELECTRONIC MEASUREMENTS CORP.
423 BROOME STREET, NEW YORK 13, N. Y.

GIVE TO CONQUER Cancer

AMERICAN CANCER SOCIETY

and the C-R tube is leaky. The deflection amplifiers and coupling capacitors are shown in the diagram.

Replace capacitor C74 if the picture moves downward or C73 if it moves upward. When the picture moves right or left, replace capacitor C72 or C71.

OPEN-WIRE FEEDERS FOR TV

? My TV antenna is over 100 feet from the house and is connected to the receiver by 300-ohm ribbon-type transmission line. A combination of salt air and bright sunlight causes the transmission line to deteriorate within a comparatively short time. Can I use No. 12 wire in an open line?—F. M., Erma Park, N. J.

A. Open-wire line can be used. Because 2-inch spreaders are the smallest generally available, it is advisable to use these. Two No. 12 conductors spaced 2 inches gives the line a characteristic impedance of approximately 465 ohms. A 375-ohm matching stub should be used on each end of the 465-ohm line. Each stub should be a quarter-wavelength long. They may be made from No. 6 wire spaced 1 3/4 inches or 3/8-inch tubing spaced 4 inches.

9LP7 BASE CONNECTIONS

? Please print the socket connections for a 9LP7 cathode-ray tube.—F. D., Baltimore, Md.

A. Connections for the elements of a 9LP7 are: pin No. 2, heater; No. 3, grid No. 2; No. 5, control grid; No. 7, cathode; and No. 8, heater. The high-voltage supply connects to the button on the cone of the tube.

TROUBLE IN TV RECEIVER

? There is a continuous ripple in the picture on my Admiral 24D1 chassis when it is powered by a 117-volt, gasoline generator. What causes the trouble? How can I eliminate it?—E. K. W., Grand Rapids, Mich.

A. A strong field around the power transformer causes the ripple when transmitter and receiver power sources are not synchronized. Admiral's Service Division, 201 E. North Water St., Chicago, Ill., has a special replacement transformer which does not cause this trouble. Their bulletin TV-85 describes in detail the trouble and its cure.

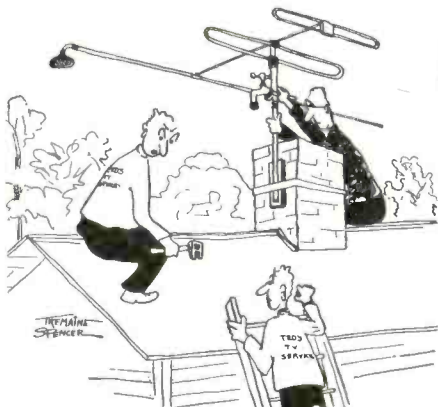

"I still say the boss made a mistake by hiring a plumber."

THE NEW MERIT LINE OF INSTRUMENT KITS by RCP

NOW you can get in KIT FORM the best professional test equipment made by RCP—one of the outstanding manufacturers of test instruments for 18 years. Thousands and thousands of RCP testers are in use — giving satisfaction for years.

EASY TO BUILD!

Each Kit contains simple step by step illustrated instructions — clear wiring diagrams — assembly diagrams — multi-colored stranded wires for easy checking and trouble shooting — easiest to follow.



MERIT MODEL 345K SUPER VACUUM TUBE VOLTMETER

Features long scale 4 1/2" meter in burn out proof meter circuit — electronic balanced bridge type push pull circuit—negligible current drawn due to high input impedance of 25 megohms — Isolation Probe — center of ohm scale 10 ohms — 5 ohmmeter ranges reading from 2 ohms to 1 billion ohms (1000 megohms). 20 voltage ranges 0-1000 volts including AC and DC — Complete D.B. meter. Discriminator alignment scale with zero center permitting operation in both directions. Operates on 105-130 volts, 50-60 cycles—Extra heavy panel, case and chassis. Size 10" x 6" x 5". Weight 8 1/4 lbs. Shipping weight 11 lbs.

MODEL 345K KIT COMPLETE.....\$23.95
Complete factory built and wired.....\$49.95

Super High Voltage Model HV345K — includes high voltage multiplier probe and has extra DC voltage ranges — 0-5-25-100-250-500-1000-2500-10,000-25,000 volts with certified safety probe. Complete Kit.....\$27.95
Factory built and wired complete.....\$57.95

Super Model HVHF345K both High Voltage Multiplier Probe and High Frequency Probe which extends the frequency range of the 345K to 400 megacycles. This covers a complete Television and Citizens band. Complete Kit HVHF345K.....\$31.25
Complete factory built and wired...\$64.95

HIGH VOLTAGE MULTIPLIER KIT MODEL HVMP-1K



Permits multiplying all ranges X100 of Model 345 or any other similar impedance V.T. voltmeters — special ceramic helical high voltage resistor certified safe for all ranges up to 33,000 volts.

Complete Kit.....\$5.95
HVMP-1—Complete factory built.....\$7.95

ULTRA HIGH FREQUENCY PROBE KIT MODEL HFP-1K



Uses germanium crystal with low impedance network permitting measurements up to 400 megacycles.

The finest in performance and appearance. Complete Kit.....\$3.65
HFP-1—Complete factory built.....\$6.95

Buy them from your jobber, or, if he cannot supply you, write factory direct. Accept no substitute. See these units on display at the Radio Parts & Electronic Equipment Show Chicago — May 22-25 — Stevens Hotel — Booth 416 or Display Room 556A

Write for Catalog RE-6

RADIO CITY PRODUCTS CO., INC.

152 WEST 25th ST — NEW YORK 1, N. Y.



WANTED TO BUY

Large and small quantities of new or used electronic government or manufacturers' surplus tubes and equipment. Highest prices paid. State quantity, condition and best price in first letter.

Box No. F-2 c/o Radio-Electronics
25 West Broadway
New York 7, N. Y.

NEW CONDENSER TESTER

Finds Intermittent Condensers Instantly



Pres-probe's sliding tip with variable resistance prevents condenser heating. Tests with power on. Requires no adjustment. Stops guesswork. Saves time. Convenient probe size (7/8" long). Satisfaction guaranteed.



See Your Dist. or Order Direct

PRES-PROBE CO.

2326 N. THIRD ST., MILWAUKEE 12, WIS.

LE-Hi

Guaranteed
Pre-tested
RADIO TUBES
for QUALITY, PERFORMANCE
and DEPENDABILITY

Every individual tube must undergo rigid tests before it leaves the Le-Hi plant. This guarantee of pre-testing is but one assurance of the BEST BUY from Le-Hi. Rugged construction, dependable performance and economical service at LOWEST PRICES make our tube even MORE DESIRABLE. Compare performance, quality and price with any standard tube—and remember EVERY Le-Hi Tube is FULLY GUARANTEED.

Type	Price	Type	Price	Type	Price	Type	Price	Type	Price	Type	Price
1A5	.57	5Y3GT	.39	6C6	.55	6SN7GT	.53	12Q7GT	.50	35L6GT	.47
1A7GT	.57	5Z4M	.86	6D6	.59	6SQ7GT	.39	12S8GT	.72	35W4	.39
1B3GT	.82	5Z3	.48	6E5	.39	6T8	.79	12SA7GT	.46	35Z4GT	.39
1B4P	.39	6A7	.69	6F5GT	.39	6U7G	.59	12SF5GT	.52	35Z5GT	.39
1C5GT	.70	6A8G	.56	6F6GT	.41	6V6GT	.46	12SF7GT	.53	36	.39
1C6	1.05	6A84	.52	6F7	.39	6W4GT	.47	12SJ7GT	.49	37	.39
1C7G	.39	6AC5GT	.77	6F8G	.39	6X4	.39	12SK7GT	.44	38	.39
1F4	.39	6AG5	.56	6H6GT	.45	6X5GT	.39	12SL7GT	.61	39/44	.39
1G4GT	.39	6AK5	.87	6J5GT	.39	7A7	.59	12SN7GT	.53	41	.59
1H5GT	.45	6AL5	.43	6J6	.70	7B6	.59	12SQ7GT	.39	42	.59
1H6G	.39	6AQ5	.46	6J7GT	.49	7C4	.49	12SR7	.49	45Z5GT	.48
1N5GT	.57	6AR5	.40	6K5GT	.60	7C5	.59	12Z3	.29	46	.39
1P5GT	.86	6AS5	.47	6K6GT	.39	7F7	.59	19B6G6	1.53	47	.39
1R5	.55	6AT6	.39	6K7GT	.49	7Y4	.49	19T8	.77	50B5	.47
1S5	.46	6AU6	.46	6K8GT	.59	12AL5	.43	24A	.59	50C5	.47
1T4	.56	6AV6	.47	6L5G	.39	12AT6	.39	25A7GT	2.02	50L6GT	.47
1T5GT	.86	6BA6	.44	6L6G	.78	12AT7	.72	25AC5GT	.87	53	.39
1U4	.55	6AW6	.65	6N6	.90	12AU6	.48	25BQ6	.85	55	.39
1U5	.45	6BA7	.59	6P5GT	.55	12AU7	.58	25L6GT	.47	56	.39
1V	.39	6BE6	.46	6Q7GT	.50	12A8GT	.59	25W4GT	.47	57	.39
1X2	.68	6BF6	.40	6S7	.72	12AV6	.39	25Z5	.41	58	.39
2A7	.69	6BH6	.57	6SA7GT	.46	12AX7	.61	25Z6GT	.39	70L7GT	1.11
2X2	.49	6BJ6	.48	6SC7GT	.59	12BA6	.44	26	.50	75	.59
3A4	.39	6B5	.59	6SD7GT	.56	12BA7	.59	27	.39	76	.59
3A5	.39	6B8	.39	6SF5GT	.52	12BE6	.46	30	.39	77	.39
3Q4	.62	6BQ6	.85	6SF7GT	.59	12BF6	.40	32L7GT	.91	80	.39
3Q5GT	.65	6BG6G	1.35	6SH7GT	.39	12J5GT	.40	33	.39	117LM7GT	1.11
3S4	.59	6C4	.39	6SJ7GT	.44	12J7GT	.55	35/51	.55	117P7GT	1.11
3V4	.60	6C5GT	.48	6SK7GT	.44	12K7GT	.47	35B5	.47	117Z3	.40
5U4G	.39	6BC6	.51	6SL7GT	.61	12K8GT	.49	35C5	.47	9002	.39

Distributors' and Jobbers' Inquiries Solicited

Each tube individually boxed. 50¢ handling charge on orders under \$5. Save 5% discount on orders of 100 tubes or more! All orders shipped C.O.D. Prices subject to change without notice.



LE-Hi ELECTRICAL COMPANY

412 Halsey Street

Newark 2, N. J.

Telephone Market 3-8294

STILL THE
LEADER!

The famous ACA-100 Amplifier — a self-balancing, drift-correcting, direct-coupled amplifier — the most satisfying musical amplifier ever designed. Based on early Lottin-White circuits, perfected by A. C. Shaney in 1936, and now brought to a standard of quality far above that of any corresponding amplifier. Exclusive features include:

- Push-Pull Triode Expander.
- Non frequency-discriminating noise suppressor.
- Push-pull hi and lo freq. variable equalizers.

If you are satisfied with nothing less than the best, write today for free technical literature.

Special models for all magnetic cartridges.



AMPLIFIER CORP. OF AMERICA

398-10 Broadway

New York 13, N. Y.

telrex INC.
CONICAL "V" BEAMS

ASBURY PARK, NEW JERSEY

- THE SKILL TO DESIGN
- THE FACILITIES TO PRODUCE
- THE ABILITY TO DELIVER

MANUFACTURERS OF THE
CONICAL "V" BEAM
FOR TV AND FM RECEPTION

Available through Authorized
TELREX Distributors

WRITE DEPT. R FOR CATALOG

Temperature changes that affect oscillator frequency take place in the tuned circuit, tube, and surrounding air. The first is by far the most important.

ZENITH S-11468 CHANGER

When the tone arm skips grooves and repeats, the vertical hinge on the tone arm may be too tight, thus causing the arm to hang slightly. This prevents the needle from exerting enough pressure on the record to follow the grooves. Use long-nose pliers to bend the horizontal U-shaped bracket until it pivots freely.—*Baron von Huene*

BELMONT MODEL 22A21

No raster, sound OK. Check the .001-µf filter capacitors in the high-voltage rectifier circuit. One of these capacitors has been shorted in several sets. Replace the defective unit with a high-grade .001-µf capacitor having a working voltage of 5,000 or higher.—*Wilbur J. Hantz*

SENTINEL 400-TV and 405-TVM

Shorted or intermittent screen-by-pass capacitors in the 6Y6-G high-voltage oscillator are the cause of no picture or intermittent picture. Replace this unit with a 0.1-µf, 600-volt unit. If the old one was shorted, check the 33,000-ohm screen dropping resistor because it may have been damaged by the overload. Replacement is always safest.—*W. E. Tooney*

WESTINGHOUSE MODEL H-196

Poor vertical sync in older models can be improved by replacing the 12AU7 sync amplifier with a 12AT7. The latter has higher mu and will provide greater sync amplitude. No wiring changes are required.

Insufficient picture width under low line voltages, even though the width control is at maximum, may be caused by the deflection yoke. Check its code number located under the "V" number on the yoke. If the number is 98, 108, or 118, replace the yoke with one carrying any other code number. The old yoke will perform satisfactorily with normal line voltages.

Hum in the a.f. section of this model and the H-207 may be reduced by connecting a 30-µf capacitor across C99 between the screen of the 6AQ5 output tube and ground. This additional capacitor will be found in later models.—*Westinghouse Service Hints*

ZENITH 4G800

Noisy or erratic reception may be caused by a broken antenna lead. First remove the chassis from the case, and then remove the plastic handle. The break, caused by opening and closing the front cover, will probably be found directly under the handle.

—*Frank N. Verni*

ELIMINATING IGNITION NOISE

To cure stubborn cases of ignition noise in auto radios, construct a three- or four-turn, 2-inch loop, using insulated, unshielded wire. Connect this loop in series with the antenna lead-in with shielded wire. Move this noise-pickup coil close to potential sources of noise. Orient the coil for maximum noise cancellation; then fasten the coil in this position.—*Charles Buscombe*

BIG MONEY IN RADIO and TELEVISION NOW!

See **COYNE'S Brand New 7 Volume Set**
APPLIED PRACTICAL RADIO-TELEVISION **FREE!**



A BRAND NEW Set of books written for men who want to "go places" in TELEVISION and RADIO . . . men who know how a PRACTICAL working knowledge helps to get the BIG MONEY. Over 2500 pages of the latest Radio and Television "know how"; easy to understand with hundreds of crystal-clear illustrations. It's ALL here! EVEN COLOR TELEVISION AND UHF. How to install, service, align, balance ALL radio and TV sets . . . how to use new and old testing instruments for TV service . . . latest data on adapters, converters and MORE. Complete volume on Electronics and handy Radiomen's Handbook included. You name it and COYNE'S GOT IT, in this amazing new money-making 7-Volume Radio-Television Library.

Color Television Is Here!
 Set contains most complete section ever published on Color Television and UHF, adapters and converters. FULLY ILLUSTRATED AND PRINTED IN 4 COLORS.

**PRACTICAL!
 CLEAR!
 COMPLETE!**

7 fact-packed volumes — 1400 illustrations and diagrams with step-by-step photographs which "break down" the equipment to show what makes it "tick." Up-to-the-minute, complete, easy to follow.

Act Now and Get FREE Book

Now you can see these new Coyne books for 7 days without cost and get Coyne's book of 150 Radio and Television Diagrams FREE. It's free just for examining the new 7-Volume Set. Full details of this sensational Coyne "prove it" offer are given below. Mail the coupon at once.

SEND COUPON—SEE SET FREE FOR 7 DAYS

You must SEE these new books to know how easy it is to prepare for the big jobs in radio and television. Here's our special offer. — we'll send the complete 7-volume set for your 7-Day FREE Examination. And with it, we'll include our valuable, new guide for all radiomen, "150 New Radio-Television Diagrams Explained," absolutely FREE! If you keep the 7-volume Set all you pay is \$3.00 within 7 days after the books arrive and \$3.00 per month until \$23.50 is paid — or you can pay \$22.00 cash price. If you don't want the set, return it and you OWE NOTHING. But either way you keep "The Radio and Television Diagrams Book" as a gift. That book is ABSOLUTELY FREE.



SEND NO MONEY Coupon is just a request to see Set free and get FREE BOOK. Offer limited—act now.

COYNE Electrical and Radio-Television School
 500 S. Paulina St., Dept. 60-F2, Chicago 12, Ill.

Mail This Coupon NOW

Educational Book Publishing Division
COYNE ELECTRICAL & RADIO-TELEVISION SCHOOL
 500 S. Paulina St., Dept. 60-F2, Chicago 12, Ill.
 O.K. Send me postpaid, your new 7-volume set, "Applied Practical Radio-Television", on 7 days Free Trial per your offer. Be sure to include as a gift the book of 150 Radio-Television Diagrams absolutely FREE.

NAME _____ Age _____
 ADDRESS _____
 TOWN _____ ZONE _____ STATE _____
 Where employed _____

MALTA SHORTWAVE SERVICE

Dear Editor:

We have received a great number of reception reports from your readers. At present our service consists of two 7½-kw high-frequency installations on Malta, and a number of medium-wave stations here, in North Africa and on Cyprus. Our present schedules are:

Frequency (mc)	Time (GMT)
4965	0400-0700
	1330-2200
7270	0400-0700
	1400-2200
11895	0930-1300

It is our intention to start a special Shortwave Listeners hour later on in 1950. This will have to be timed after closedown of our standard schedule. I would suggest about 2200 GMT as a good hour. Perhaps your shortwave listeners would let me know if they think the idea sound, and the time satisfactory?

LESLIE KNIGHT

Chief Broadcasting Officer, MELF
 Malta Garrison, Malta.

TUBE NUMBERS AGAIN

Dear Editor:

The manufacturers of radio tubes have been very lax about putting the numbers on tubes so they will stay put. Something should be done about it!

JAMES G. SHELLER

Claysville, Pa.

JUNE, 1950

IT'S HERE! THE EASY TO ERECT HYDRAULIC TELEVISION MAST



NO GUY WIRES NECESSARY

An all hydraulic sectional mast extended with hand or power pump. Mast constructed of cold drawn seamless steel tubing. Cadmium plated for permanent rust protection.

EASY INSTALLATION

ENERGY Masts can be installed in a short time, either clamped to side of building or set in concrete away from building, then raised and lowered hydraulically as service requires.

Weight of 60 foot mast is 330 pounds, 22 feet in length collapsed. Hand or power pumps can be furnished.

- One mast can serve many outlets.
- Manufactured in two sections—40 feet and three sections—60 feet.
- Mast will withstand 100-mile wind.
- Also recommended for two-way taxi and "Ham" radio installations.



IDEAL FOR PORTABLE DEMONSTRATION ANTENNA

Smooth quick operation, ideal for commercial car demonstration.

For any test location, can be set up in a few minutes.

Write today for literature and prices.

ENERGY FARM EQUIPMENT CO.
 MONTICELLO, IOWA

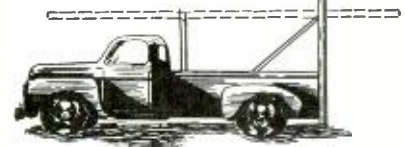

NOW!
a book
to help you
"GROW UP" WITH
TELEVISION!

700 pages
of helpful
how-to-do-it
engineering
know-how!

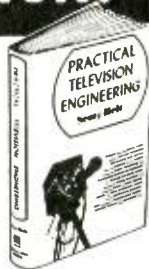

Just Out
**PRACTICAL TELEVISION
ENGINEERING**
by Scott Helt

Research Division Allen B. DuMont Laboratories
—Instructor, Columbia University
700 pages, 6 x 9, 385 illus., \$7.50

Here, for the first time, is a really modern book that can help pave your way to a good paying job in Television manufacturing, laboratory, or broadcasting studio work—the ideal book for study, reference or actual engineering practice! PRACTICAL TELEVISION ENGINEERING is exactly what its name indicates—a complete, easy-to-understand book that equips you with factual TV engineering know-how from the ground up. Starting at the very beginning—with a clear explanation of picture transmission fundamentals—it guides you through every phase of Television equipment and station engineering.

AN UP-TO-DATE GUIDE!

Best of all, PRACTICAL TELEVISION ENGINEERING is the first book written since the close of the war which covers Television from the viewpoint of a practical engineer actually employed in the field.

Written by an experienced engineer, it provides a comprehensive knowledge of both fundamental theory and practice, particularly as related to Television manufacturing and broadcasting.

- | | |
|---|--|
| <ul style="list-style-type: none"> Fundamentals of Picture Transmission Cathode-Ray Tubes Cathode-Ray Oscillographs Electron Tubes and Image Pickup Synchronizing Generators—Timing, Shaping, and Preflection Circuits | <ul style="list-style-type: none"> The Video Amplifier and Cathode Follower Voltage-regulated Power Supplies Television Receivers Television Camera Chains Television Transmitters Television Broadcasting Techniques Glossary of Terms |
|---|--|

IT PAYS TO SPECIALIZE!



PRACTICAL TELEVISION ENGINEERING explains the cathode-ray tube fully—shows the part played by each element of the Television camera chain; explains telecasting techniques and studio problems. Other helpful data ranges from circuit and component explanations to transmitting problems, theoretical and practical aspects of lenses, lighting, oscillographs, camera tubes, synchronizing generators, video amplifiers, regulated power supplies, TV receivers and transmitters and many other subjects.

Use coupon today. Read this big new book for 10 full days AT OUR RISK!

10 DAY MONEY-BACK GUARANTEE

Dept. RE-60, Murray Hill Books, Inc.,
232 Madison Ave., New York 16, New York

Enclosed find \$7.50 (\$8.00 outside U.S.A.) for Helt's PRACTICAL TELEVISION ENGINEERING; or send C.O.D. and I will pay postman this amount plus postage. In either event, if book is not what I want, I may return it within 10 days and you GUARANTEE to refund the purchase price. (Cash only outside U.S.A., same return privilege.)

Name

Address

City, Zone, State

TELE IN THE DEEP FRINGE

Dear Editor:

Like so many fellows who have written you about running too many TV articles, I live in a remote part of the country far from any TV station. But I have been studying it for some time and have learned a lot from your magazine.

With the help of your articles and some home-study courses, I have done what other technicians said would be impossible. One person who complained to you last summer about too much TV lives only 12 miles from me in Baxter Springs, Kansas. I have already installed two sets in that town and nine in this area, where they said TV wouldn't arrive for 10 years.

We receive three stations here: WKY-TV, Oklahoma City, 200 miles; WDAF-TV, Kansas City, 130 miles; and KOTV, Tulsa, Oklahoma.

ALBERT DUNIVIN

Galena, Kansas

VALUABLE ARTICLES

Dear Editor:

Being only a novice, I find the "Fundamentals of Radio Servicing" of great value to me and I now feel that I thoroughly understand some of the things which were unfathomable mysteries before I began studying his articles.

Another article which received much of my attention is "How to Become a Ham" by George Shuart. I expect to construct a code oscillator soon and get a license before long.

JEROME VRIESMAN

Whitehall, Michigan

TV AND FLYING SAUCERS

Dear Editor:

What's wrong with the readers? Where is the American spirit? They seem to think a magazine must cater to a particular group. A large part of our good old U.S.A. has television and another large part is fringe area, so I'd guess that more than not readers are interested in TV. Your policy is to cover the field; and while TV is the newest and biggest thing, it's only natural that TV should be given more space.

If and when (I said *if*) a flying saucer crashes to earth (a possibility, as two magazines on the market would have us believe), I will look to RADIO-ELECTRONICS to bring us all the electronic data and theories of the story if our government will permit them to be released. I have that much faith in the magazine.

There are many electronic devices which most radio men never see, but it is interesting to know something about them; so please give us a few articles from time to time about such things as the electronic microscope, the electric brain, etc.

W. G. ESLICK

Wichita, Kansas

**HAVE YOU A JOB FOR A
TRAINED TECHNICIAN?**

We have a number of alert young men who have completed intensive training in Radio and Television Repairing. They learned their trades thoroughly by working on actual equipment under personal, expert supervision. If you need a trained man, we invite you to write for an outline of our course, and for a prospectus of the graduate. No fees, of course. Address:

Placement Manager, Dept. P108-6

COMMERCIAL TRADES INSTITUTE
1400 Greenleaf Chicago 26

Like peas
in a pod

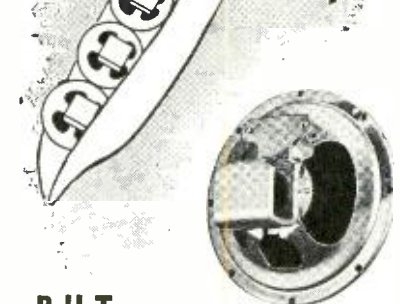

BUT

QUAM

IS DIFFERENT

YOU CAN TELL by the U-SHAPED COIL POT, an exclusive QUAM feature. It provides an unbroken path for the magnetic lines of force, producing a stronger magnetic field with higher efficiency and improved performance.

YOU CAN TELL by the QUAM Adjustable Voice Coil, which permits accurate centering after assembly and virtually eliminates rubbing voice coils.

YOU CAN TELL that QUAM has been making speakers for more than a quarter century, for no other speaker offers such outstanding extra features and extra value. For all your replacements, specify QUAM.

FREE Catalog
Mail today!



Quam-Nichols Co.
521 E. 33rd Place
Chicago 16, Illinois
Please send me Quam catalog.

Name

Address

City..... State.....

RADIO-ELECTRONICS for

Austin C. Lescarbourea, journalist and industrial advertising consultant in the electronics field, was given the Cross of Chevalier of the Legion of Honor by the French government.

The award was made in recognition of Mr. Lescarbourea's long-time technical service to the French cause and especially for recent assistance to industrial missions sent to the United States to aid in the rehabilitation of industry in post-war France.



This is the third decoration Mr. Lescarbourea, a New Yorker of French ancestry, has received from the government of France. In 1919 he received the Officer d'Academie decoration, followed in 1947 by promotion to Officier de l'Instruction Publique.

Walter E. Poor, chairman of the board of SYLVANIA ELECTRIC PRODUCTS INC. died in New York City.

Born in Salem, Mass., Mr. Poor graduated from Massachusetts Institute of Technology in 1908. After a short period as electrical engineer for the Boston Elevated Railway, Mr. Poor

joined his brothers in the manufacture of electric lamps at Danvers, Mass., at the Hygrade Lamp Co., the predecessor of Sylvania Electric Products. Mr. Poor became executive vice president in 1940, president in 1943, and chairman of the board in 1946.



Besides heading the board of Sylvania, Mr. Poor was a director of the Sound-Scriber Corp.

Norman A. Woodford has been appointed Sales Manager, Television Division of NORTH AMERICAN PHILIPS Co.

Mr. Woodford has been active in the radio and television business for the past 27 years. Since 1940 he has been associated with the Philips organization in various capacities. In his new capacity, Mr. Woodford will have charge of building a distributor and dealer organization on the firm's new Duo-Vue television unit which enables the customer's own table model to offer a choice of direct viewing or a 3 x 4 foot picture projected on a home movie screen. He will also handle sales of Protelgram Television systems.



Josua Sieger was elected vice president in charge of engineering by the Board of Directors of the FREED RADIO CORP. He will direct Freed Radio's new research laboratories.

SWEDGAL declares a Buyer's DIVIDEND!

REPEATED BY CUSTOMERS' DEMAND!

Get this PLASTIC PILLOW FREE! Folds to matchbook size, blows up easily as a balloon (deflates as quickly), sturdy, waterproof, no metal parts, anti-allergic. For home, office, shop, ballgames, beach, picnics, etc. Has 100's of uses. GET YOURS FREE—for each \$5 order. A \$10 order brings 2 Plastic Pillows FREE, etc. You'll want quite a few—one for each member of your family!

TUBES

All Guaranteed—Brand New—Individual Cartons

DEDUCT: 5c from the price of each tube when ordering any 20!

24¢ ea.	6C6	12BE6	12SQ7
6C4	6D6	12SN7	49¢ ea.
12A6	6F6	24A	1A5
34¢ ea.	6H6	25L6	5Z3
6X4	6J5	26	6J6
36	6K5	27	14Q7
38¢ ea.	6K6	35/51	25Z5
1R5	6SA7	35Z5	25Z5
1S5	6S7	47	58¢ ea.
1U5	6SJ7	77	0Z4
5U4G	6SK7	80	6BG6G
5V3	6SL7	85	50L6
5Y4G	6SN7	117Z3	VR150
6AL5	6SQ7	16Z5	69¢ ea.
6AL7	6SS7	2051	6AC7
6AR5	6V5GT	45¢ ea.	117L/M7
6AT6	6V6	174	89¢ ea.
6AU6	6W4	1U4	6L6
6BA6	6X5	6AG5	6U5/6G5
6BE6	6Y6G	12SA7	50A5
6C5	12BA6	12SK7	

SPEAKERS

5 Asst. Lots of

3 1/2" P.M. .68 oz.	.79	5" P.M. 1 oz.	1.29
4" P.M. .68 oz.	.89	5" P.M. 1.47 oz.	1.05
4" P.M. 1 oz.	.99	6" P.M. 1 oz.	1.29
4" P.M. 1.47 oz.	1.05	6" P.M. 1.47 oz.	1.39
4 1/2" P.M. 1 oz.	1.49	5" P.M. .68 oz. with 501L6 Output	1.24
5" P.M. .68 oz.	.89		1.15

OUTPUT TRANSFORMERS

3Q5 .34c	1S4 P.P. .49c	6K6 P.P. .49c
6V6 .38c	3S4 P.P. .49c	6V8 P.P. .49c
25L6 .34c	6V4 P.P. .49c	25L6 P.P. .38c
35L6 .34c	6F8 P.P. .49c	35L6 P.P. .38c
50L6 .34c		50L6 P.P. .38c

6V6 P.P. 15 Watts, Sec. taps 4, 8, 15, 250 & 500 ohms. Fully Shielded. Only 89¢ ea.

VOLUME CONTROLS

Standard Brands with switch, lock shaft!

ohms	ohms	1 megohm	34c
100,000	350,000	500,000	
250,000	500,000	1 megohm.	

Order any 10 for \$3.00

SAVE \$2.55 ON THIS RCP TESTER!

Fully Guaranteed by SWEDGAL and RADIO CITY PRODUCTS. POCKET MULTITESTER MODEL 449A—At 5,000 ohms per volt—Completely Wired At a never before Low Price! Uses a 3" square meter at 5,000 ohms per volt (necessary for accurate testing) with a basic movement of 200 microamperes.

RANGES:
DC Volts: 0-5-50-250-1000 V.
AC Volts: 0-5-50-250-1000 V.
DC Ohms: 50-100-1000 MA.
Ohms: 0-2000-20,000-∞-2-2.2 Megohms

Declines—5 to 4-52 DB in 4 ranges
Output Meter: 0-5-50-250-1000
Complete in black metal case with self-contained batteries. Ready to operate. Size: 5 1/8" x 3 1/16" x 2 1/8". Weight: 1 3/4 lbs.

TO SPEED DELIVERY: Order now! Minimum \$2.50. For C.O.D. shipment enclose 25% deposit, include adequate postage, express will be returned. All prices F.O.B. New York, N.Y.

WRITE FOR FREE CIRCULAR!

List: \$24.50
Now \$21.95

SWEDGAL RADIO, INC.

96 Warren St., Dept. E-4 New York 7, N. Y. Cortlandt 7-6753

COLOR ON YOUR TELEVISION NOW

Simply attach TELE-COLOR FILTER to front of your set, and enjoy favorite programs in a glorious color tone. Instead of dull black and white.

TELE-COLOR Filter is one of the latest discoveries. Its special formula fluorescent coloring gives brilliant pleasing color tone. Experience new happiness and enjoyment in life-like color depth, reduced glare, and eye strain. Everyone is talking about and waiting for 3 color Television costing hundreds of dollars. Now for a small sum you can enjoy new color toning. This filter is guaranteed to work on every make or size of set.

TELECOLOR FILTER is a wonderful gift. Children love it.

10 inch tube	\$3.00
12 1/2 " " "	\$4.00
16 " " "	\$6.00

Dept. RE-6

HARVARD LABORATORY
659 Fulton St., Brooklyn 1, N. Y.

ALMO SPOTLIGHT SPECIAL

GREEN FLYER Dual Speed Motor

Model D 33 1/2 and 78 r.p.m. 115 Volts A. C. 50-60 cycles

YOUR COST \$6.95

Furnished with 10" turntable and complete with mounting plate ready for installation. Has powerful governor-controlled gear drive motor. Fully inclosed with silent helical-cut gears running in oil bath in sealed housing. Lever-type speed regulator and gear shift.

ALMO RADIO CO.

509 ARCH STREET • Philadelphia
6205 MARKET STREET • West Phila.
6th & ORANGE STS. • Wilmington
4401 VENTNOR AVE. • Atlantic City

SIX TUBE SUPER

Three Gang Condenser

\$33.30 NET
Crows Panel
Kit Included

Panel kit to fit most all makes (Please specify make of car and year model). New up-to-date latest priced Catalog available to dealers.

Bill Sutton's
Wholesale Electronics
5th at Commerce Fort Worth, Tex.

Peoria Amateur Radio Association is holding its annual hamfest June 11 at Pleasant Valley Park, 1 1/2 miles south of Dunlap and 10 1/2 miles from Peoria, Illinois.



RADIO COURSES

Preparatory Mathematics, Service, Broadcast, Television, Marine Operating, Aeronautical, Frequency Modulation, Radar.

Classes now forming for the Summer term June 1st Entrance exam, May 22nd.

Veterans. Literature.

COMMERCIAL RADIO INSTITUTE
(Founded 1920)
38 West Biddle Street, Baltimore 1, Md.

Make Your Career RADIO and TV

In no other industry does the future hold brighter financial promise and security than in AM and FM Radio, Television. These fields need and want men trained as announcers, script writers, disc jockeys, and radio technicians. It will pay you to investigate the Don Martin School of Radio Arts, established in 1937. Complete day and night classes . . . the latest equipment . . . and a staff of 30 nationally known instructors. Over 97% of the combination men graduates are placed on jobs immediately through the free placement service. Approved for veterans.

FREE—Write for Free Booklet "Your Future in Radio."

Don Martin School of Radio Arts
1655 No. Cherokee, Hollywood, Calif. HUdson 23281



RADIO COURSES

- RADIO OPERATING • CODE
- RADIO SERVICING • ELECTRONICS
- F.M. TELEVISION
- REFRIGERATION SERVICING

Write for Catalog TE and Picture Brochure

TRADE & TECH. SCHOOL 229 W. 66 St., N. Y. 23
ENdicott 2-8117

AUDIO ENGINEERING SCHOOL

Practical engineering training in Audio fundamentals, Disc, Film, Magnetic Recording, and Audio frequency measurements. Studio training simulates Broadcast, Motion Picture, Television, and Commercial Recording work. Approved for Veterans

HOLLYWOOD SOUND INSTITUTE, Inc.
1040-E North Kenmore, Hollywood 27, Calif.
Correspondence Courses Available
Specify if Veteran or Non-Veteran.

There's A Future for YOU in TELEVISION

- Build Your Career in a Minimum of Time
- Enroll Now for Day or Evening Classes

Television industry needs trained technicians and engineers now. Graduates of CREI residence school are preferred because of their *training and ability*. That's why our men find good jobs. 23 years' experience in the professional radio and television fields. This is a high level technical course requiring the average student about 20 months to complete. Approved for veteran's training.

Write for Free Booklet and Details.

CAPITOL RADIO ENGINEERING INSTITUTE
Dept. 306B, 16th and Park Rd., N. W.
Washington 10, D. C.

BLISS Electrical Training

Intensive 32 weeks' residence course in fundamentals of industrial electrical engineering, including radio and electronics. Extensive laboratory, shop work, drafting. Prepares for electrical technician and engineering aides in communications, power, manufacturing, business machines, sales, service. G.I. approved. 57th year. Enter Sept. 5. Catalog.

7546 TAKOMA AVENUE, WASHINGTON 12, D. C.

TELEVISION

Laboratory and theoretical instruction under the guidance of experts, covering all technical phases of Radio, Frequency Modulation and Television. Prepares for opportunities in Broadcasting, Industry or Own Business.

MORNING, AFTERNOON or EVENING SESSIONS. Licensed by N. Y. State. Free Placement Service. APPROVED FOR VETERANS.

ENROLL NOW FOR NEW CLASSES
Apply Daily 9-9; Sat. 9-2
VISIT, WRITE or PHONE

RADIO-TELEVISION INSTITUTE

Pioneers in Television Training Since 1938
480 Lexington Ave., N. Y. 17 (46th St.)
PLaza 9-5665 2 blocks from Grand Central



RADIO Engineering DEGREE IN 27 MONTHS

Complete Radio Engineering Course incl. Telev., U.H.F., and F.M. B.S. Degree Courses also in Civil, Elect., Mech., Chem., and Aero. Eng.; Bus. Adm., Acct. Visit campus, see well equipped labs. Low cost. Prep. courses. Personalized instruction. Grads successful. Founded in 1884. Enter Jan., March, June, Sept. Write for catalog.

TRI-STATE COLLEGE

2460 College Avenue Angola, Indiana



RADIO and TELEVISION

Thorough Training in All Technical Phases

APPROVED FOR VETERANS
DAYS—EVENINGS WEEKLY RATES
FREE PLACEMENT SERVICE FOR GRADUATES
For Free Catalog Write Dept. RC-50

RCA INSTITUTES, Inc.
A Service of Radio Corporation of America
350 WEST 4TH STREET NEW YORK 14, N. Y.

TV ELECTROMAGNETIC SERVICING COURSE

Practical Shop and Laboratory Training at Largest Resident TV School in the East!

Also RADIO SERVICE & REPAIR, F-M & TELEVISION
Preparation for F. C. C. LICENSE EXAMS

★ Approved for Veterans ★

DELEHANTY SCHOOL OF TELEVISION
105A EAST 13th STREET • NEW YORK 3, N. Y.

TELEVISION

PREPARE FOR A GOOD JOB!

COMMERCIAL OPERATOR (CODE)
RADIO SERVICEMAN

TELEVISION SERVICING
BROADCAST ENGINEER

V. A. Furnishes Books and Tools
SEND FOR FREE LITERATURE

BALTIMORE TECHNICAL INSTITUTE
1425 Eutaw Place, Dept. C, Baltimore 17, Md.

Become an Electrical Engineer

B. S. Degree in 36 Months



MAJOR IN ELECTRONICS

Important advantages are yours at this non-profit Technical Institute and College. A valuable year is saved by gaining your B.S. degree in 36 months of continuous study. You get both practical, specialized training in well-equipped laboratories—and a solid education in Electrical Engineering and related arts.

The program includes 19 technical specialty courses in Engineering Electronics, along with four courses in Electronic Design—plus Chemistry, Physics, Mathematics, Economics and basic Electrical Engineering subjects.

You Become an **ELECTRONIC TECHNICIAN** after 12 months study in the Electrical Engineering course. Electronics is of tremendous growing importance in communications, broadcasting, radio-television, power-system control, high frequency heating, printing and other fields.

The Radio-Television Technician's certificate can be yours in 18 months. You are then equipped for specific positions in receiver and transmitter testing, servicing, sales and production. This course will be credited toward your B.S. degree in Electrical Engineering.

Military, Academic or Practical Training is evaluated for advanced credit. Preparatory courses are also available.



Faculty of 85 specialists. 1555 currently enrolled from 48 states and 23 foreign countries. Over 35,000 alumni. Terms open July, Oct., Jan., April.

MILWAUKEE SCHOOL of ENGINEERING

Technical Institute • College of Electrical Engineering

Write for free 110-page catalog and 48-page pictorial booklet, "Your Career".



MILWAUKEE SCHOOL OF ENGINEERING
Dept. RE-650
1020 N. Broadway, Milwaukee, Wis.

Without obligation, send me the 110-page catalog and 48-page "Your Career" booklet.

I am interested in _____ course.

NAME _____ AGE _____

ADDRESS _____

CITY _____ ZONE _____ STATE _____

Check if World War II Veteran

V RADIO ENGINEERING
FM—Television—Broadcast
 Police Radio, Marine Radio, Radio Servicing, Aviation Radio and Ultra High mobile applications. Thorough training in all branches of Radio and Electronics. Modern laboratories and equipment. Old established school. Ample housing facilities. 7 acre campus. Small classes, enrollments limited. Our graduates are in demand. Write for catalog.
 Approved for Veterans
VALPARAISO TECHNICAL INSTITUTE
 Dept. C VALPARAISO, INDIANA

TRAIN FOR ALL TYPES
FCC (RADIO OPERATOR) LICENSES
 Complete Raytheon AM and FM broadcast transmitters and studio control equipment. Also TV camera chain unit. 30th anniversary year. Please send for catalog R.
MASS. RADIO SCHOOL
 271 Huntington Ave., Boston 15, Mass.
 Lic. by Comm. Mass. Dept. Ed.

RADIO ENGINEERING 27 MONTHS
 DEGREE IN 27 MONTHS
 Intensive, specialized course, including strong basis in mathematics and electrical engineering, advanced Radio Theory and Design. Modern laboratory. Low tuition. Self-help opportunities. Also 27-month courses in Aeronautical, Chemical, Civil, Electrical, and Mechanical Engineering. Gov't approved for G.I.'s. Enter June, Sept., Dec., March. Catalogue.
INDIANA TECHNICAL COLLEGE
 156 E. Washington Blvd., Fort Wayne 2, Indiana

CODE SENDING
RECEIVING SPEED
 Be a "key" man. Learn how to send and receive messages in code by telegraph and radio. Commerce needs thousands of men for jobs. Good pay, adventure, interesting work. Learn at home quickly through famous Candler System. Quality for Amateur or Commercial License. Write for FREE BOOK
CANDLER SYSTEM CO.
 Dept. 3-G, Box 928, Denver 1, Colo., U.S.A.

AUDIO (SOUND) ENGINEERING
HOME STUDY TRAINING
 Practical, easy-to-understand lessons, written by competent Audio Engineers and Educators, prepares you for a better job and a good future in the Television, Radio, Motion Picture, and Recording Industries.
 Write today for details—Learn while you earn!!
HOLLYWOOD TECHNICAL INSTITUTE
 Div. RE
 4925 Santa Monica Blvd., Hollywood 27, California

Downtown N. Y. Headquarters
T.V. ACCESSORIES
RADIO PARTS—TUBES

ASTATIC Channel Chief TV Booster
 A superior, new type of TV Booster offering a vast new scope of enjoyment. Extremely high gain extends fringe area. 4 tubes with band-pass on all channels. Gain control. Dual tuning for separate tuning on sound and picture. Self-contained power supply. Mahogany cabinet.
 Cat. No. MM859 Your cost **\$29.10**

RADIONIC
EQUIPMENT CORPORATION
 Tribune Theater Entrance
 170-MM Nassau Street New York 7, N. Y.
 Worth 2-0421 : Open daily 9 to 6—Saturday 9-5

RAPID RADIO REPAIR
JUST OUT!
 The John D. Burke Co.
 168-08 90th Avenue,
 Jamaica 3, N. Y.
 \$1.25 Postpaid, or C.O.D.
 Jobbers' Inquiries Invited
 \$1.25 John D. Burke RADIO REPAIRMAN

RAPID RADIO REPAIR, by John D. Burke. Published by the John D. Burke Co., Jamaica, N. Y. 5¼ x 8½ inches, 100 pages. Price \$1.25.

This is an unusually hard book to review; it can be judged by no conventional standards. The author is a radio service technician who has achieved success with his own methods, some of which are unconventional and controversial.

His writing style is equally unconventional. As impatient with methods of writing radio books as he is with some servicing procedures, he makes a conscious attempt to represent in his writing the repairman who "must approach his work from many angles." The result looks disorganized at a first glance, but may be as effective as the textbook approach.

Whether the radio technician agrees with all Mr. Burke's servicing methods or not, he will find this little work—which seems to have been written right on a service bench—a refreshing change from the standard type of book on radio servicing.

MOST-OFTEN-NEEDED 1950 TELEVISION SERVICING INFORMATION, compiled by M. N. Beitman. Published by Supreme Publications, Chicago. 8¼ x 10½ inches, 144 pages plus 10 fold-ins. Price \$3.00.

Prepared in the same familiar style as other editions of the Most-Often-Needed series, this manual is a compilation of diagrams and service data for approximately 100 television receiver models or chassis. Alignment data, response curves, chassis drawings, and other pertinent servicing information is included on most sets.—R.F.S.

THE MATHEMATICS OF CIRCUIT ANALYSIS, by Ernst A. Guillemin. Published by John Wiley & Sons, Inc., N. Y. 6½ x 9½ inches, 590 pages. Price \$5.00.

As one of the MIT Principles of Electrical Engineering series, this book is intended to present a variety of mathematical principles and methods essential to a thorough understanding of electrical network theory. The topics covered are advanced algebra, vector analysis, functions of a complex variable, and Fourier series and integrals.—M.W.

THEORY AND DESIGN OF ELECTRON BEAMS, by J. R. Pierce. Published by D. Van Nostrand Company, Inc., N. Y. 6½ x 9½ inches, 197 pages. Price \$3.50.

This book presents an advanced treatment of the theory of electron beams and electron focusing in devices other than electron microscopes and image tubes. The material is presented completely enough so that it can be understood without reference to other sources and much material on electron optics is included. A knowledge of calculus is assumed.—M.W.

ELECTRONIC DISTRIBUTORS FROM COAST TO COAST

We can now serve you with J.S.C. 300 ohm T.V. twin lead transmission wire, like we have been serving about 50% of television wire requirements in the metropolitan areas during the past year.

Remember — our prices are right, our quality the highest, our deliveries the fastest.

Write for quantity quotations.

Sold to wholesale distributors only.

JERSEY SPECIALTY CO.

Manufacturers of Wire Products

Little Falls, New Jersey

Phone—Little Falls 4-0784-1404-1405

COMING SOON

another new Gernsback Library Book

HIGH-FIDELITY TECHNIQUES

by JAMES R. LANGHAM.

RADIO-ELECTRONICS' popular audio writer

WATCH FOR IT!

LEARN
Radio-Television, or Electricity
 IN THE GREAT SHOPS OF **COYNE**

COYNE 51st ANNIVERSARY
TRAIN QUICKLY!
OLDEST, BEST EQUIPPED SCHOOL of ITS KIND in U.S.
2 Opportunity Fields

Come to the Great Shops of COYNE in Chicago during our 51st Anniversary Year! Get quick, practical training in RADIO-TELEVISION or ELECTRICITY. G I Approved. Finance plan for non-veterans. Mail Coupon Today for complete details.

NOT "HOME-STUDY" COURSES!

You learn on real, full-size equipment, not by mail. Finest staff of trained instructors to help you get ready quickly for a better job, a fine future.

FREE BOOKS Clip coupon for big illustrated Coyne book on either ELECTRICITY or RADIO-TELEVISION. Both books sent FREE if you wish. No obligation; no salesman will call. Act NOW!

B. W. COOKE, Pres.
 COYNE Electrical & Radio-Television School.
 500 S. Paulina St., Chicago 12, Ill. Dept. A0-81H

Send FREE BOOK and full details on:

RADIO-TELEVISION ELECTRICITY

NAME.....

ADDRESS.....

CITY..... STATE.....

Adson Radio & Electronics Company	86
Allied Radio Corporation	49
Almo Radio Corporation	91
Amplifier Corporation of America	77, 81, 90
Approved Electronics	96
Arrow Electronics	75
Bell Telephone Laboratories, Inc.	51
Brooks Radio Dist. Corporation	97
Buffalo Radio Supply	72
Burke, John D.	95
Capital Radio Engineering Institute	7
Certified Television Laboratories	63
Channel Master Corporation	13
Chelsea Television Center	97
Cinex, Incorporated	63
Cleveland Institute of Radio	22
Clippard Instrument Lab., Incorporated	85
Commercial Trade Institute	92
Communications Equipment Company	96
Coyne Electrical School	93, 95
DeForest's Training, Incorporated	11
Allen B. DuMont Laboratories	98
Editors and Engineers	76
Electro-Technical Industries	66
Electronic Instrument Company, Inc.	59
Electronic Measurements Company	88
Energy Farm Equipment Company	93
Esse Radio Company	61
Fair Radio Sales	84
Failer Engineering Company	63, 86
G & G Radio Parts Service	67
General Electronics Dist. Company	52, 53
General Industries Company	77
General Test Equipment Company	81
Greylock Electronic Supply Company	63
Harvard Laboratory	91
Heath Company	14, 15, 16, 17, 18
Hershel Radio	64, 65
Hudson Specialties Company	96
Hytron Radio & Electronics Corporation	19
Instructograph Company	77
JFD Manufacturing Company	85
Jersey Specialty Company	95
La Pointe-Plascomold Corporation	9, 55, 69
Le-Hi Electrical Company	90
Leotone Radio Corporation	97
Liberty Electronics	63
Miller Company, J. W.	97
Murray Hill Books, Incorporated	68, 92
National Company	6
National Plans	75
National Radio Institute	3
National Schools	5
North American Philips Company	20, 21
Oak Ridge Products	76
Opad-Green Company	86
Opportunity Adlets	83
Precision Apparatus Company	74
Precision Radiation Instrument Co.	81
Pres-Probe Company	89
Progressive Electronics	85
Quam-Nichols Company	92

RADIO SCHOOL DIRECTORY
(Pages 94-95)

Baltimore Technical Institute	
Bliss Electrical School	
Candler System Company	
Capitol Radio Engineering Institute	
Commercial Radio Institute	
Delehanty Institute	
Hollywood Sound Institute	
Hollywood Technical Institute	
Indiana Technical College	
Martin School of Radio Arts, Don	
Massachusetts Radio School	
Milwaukee School of Engineering	
RCA Institute	
Radio Television Institute	
Tri-State College	
Valparaiso Technical Institute	
YMCA Trade & Technical Schools	

RCA Victor Division Radio Corporation of America	
Inside Front Cover, Back Cover	
Radcraff Publications	73
Radio City Products	89
Radio Corporation of America	12
Radio Dealers Supply Company	80
Radio Supply & Engineering Company	56
Radionic Equipment Corporation	95
Raytron Mfg. Company	87
Sams & Company, Inc., Howard W.	82, 83
Sanco Radio, Incorporated	88
Sprague Products Company	4
Sprayberry Academy of Radio	Inside Back Cover
Standard Transformer Corporation	74
Sun Radio & Electronics	87
Sutton's Wholesale Electronics, Bill	91
Swedgal Radio, Incorporated	91
Sylvania Electric Products	57
Technifax	86
Tel-A-Ray Enterprises, Incorporated	84
Tel-O-Tube Sales Corporation	85
Telrex, Incorporated	90
Transvision, Incorporated	70
Trio Manufacturing Company	79
Video Products Corporation	81
Ward Products	75
Weller Manufacturing Company	8
Workshop Associates, Inc., The	50

7 HARD TO GET ITEMS
AT BIG SAVINGS TO YOU

AMAZING BLACK LIGHT



250-watt ultra-violet light source. Makes fluorescent articles glow in the dark. Fits any lamp socket. For experimenting, entertaining, unusual lighting effects. Ship. wt. 2 lbs. ITEM NO. 87 A SAVING AT

\$1.95

LITTLE GIANT MAGNET

Lightweight 4 oz. ALNICO permanent magnet. 1 3/4" x 1 1/2". Lifts more than 20 TIMES ITS OWN WEIGHT! Ideal for hobbyists, experimenters. Shipping weight 3/4 lbs.



ITEM NO. 159
BIG VALUE AT

\$1.25

POWERFUL ALL PURPOSE MOTOR

Sturdy shaded pole A.C. induction motor. 15 watts, 3000 rpm. 3/32" x 1 3/4". 4 mounting studs; 7/8" shaft, 3/16" diameter; 110-120 volts. 50-60 cycles. A.C. only. When geared down, this unit can operate an 18" turntable with a 200 lb. dead weight. Use it for fans, displays, timers and many other practical purposes. Ship. wt. 2 lbs.

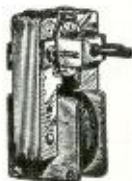

ITEM NO. 147
UNUSUAL BUY

\$1.95

WATTHOUR METER

Leading makes — completely overhauled, ready for service. 100-110 volts, 60 cycles, 2-wire A.C. Heavy metal case 8 1/2" x 6 1/4" x 5". Easy to install. Shipping weight 14 lbs.



ITEM NO. 33
NOW ONLY

\$3.95

WESTERN ELECTRIC BREAST MIKE

Lightweight 1 lb. carbon microphone. Aircraft type. Breastplate mounting, adjustable 2-way swivel. Easily fastened straps. For home broadcasts, communications etc. Complete with 6 foot cord, hard rubber plug. Sheradized plate, non-rusting finish. Ship. wt. 2 lbs.



ITEM NO. 152
NEW LOW PRICE

95¢

TELEPHONE TRANSMITTERS

Genuine transmitters made by Kellogg, Western Electric, Stromberg Carlson. Work on two dry cells. For P.A. systems, intercoms, other practical uses. Shipping weight 1 lb.



ITEM 160
REAL VALUE

\$1.95

250 POWER TELESCOPE LENS KIT

Make your own high powered 6 ft. telescope! Kit contains 3" diam., 75" focal length, ground and polished objective lens and necessary eye pieces. Magnifies 50x to 250x. Full instructions. Ship. wt. 1 lb.



ITEM NO. 123
YOU SAVE AT

\$2.45

HUDSON SPECIALTIES CO.
40 West Broadway, Dept. RE-6-50
New York 7, N. Y.

I am enclosing full remittance for items circled below. Shipping charges included.

OR, my deposit of \$..... Ship balance C.O.D.
MINIMUM C.O.D. ORDER \$5.00

INCLUDE SHIPPING CHARGES.

Circle items wanted

87 159 147 33 152 160 123

Name..... Please Print Clearly

Address.....

City..... Zone..... State.....

Approved MODEL A-460
TELEVISION
FIELD STRENGTH METER



\$79.50
ONLY

Field Strength Meter: television 12 channel tuner; video IF channel; large 6" directly calibrated meter; ham-mertone finished panel; ideal for locating antenna systems; testing transmission lines; testing efficiency of indoor antennas; checking booster efficiency, etc.

Model A-460 is housed in heavy gauge steel cabinet, battleship grey finish with 6 tubes (standard brands) IN34 Crystal, operating instructions, circuit diagram and guarantee. Weight 25 lbs. D-8" x H-10" x W-12".

Write for 12-page catalogue.

APPROVED ELECTRONIC INST., CORP.
142 Liberty St. N.Y.C.

RADAR SETS

AFS-2	Airborne	10 CM. Major Units	New
AFS-4	Airborne	3 CM. Compl.	Used
AFS-15	Airborne	3 CM. Major Units	New
SD-4	Submarine	200 MC. Compl.	New
SE	Shipboard	10 CM. Compl.	New
SF-1	Shipboard	10 CM. Compl.	New
SJ-1	Submarine	10 CM. Compl.	Used
SL-1	Shipboard	10 CM. Compl.	Used
SN	Portable	10 CM. Compl.	Used
SO	Portable	10 CM. Compl.	Used
SO-1	Shipboard	10 CM. Compl.	Used
SO-8	Shipboard	10 CM. Compl.	Used
Mark 4	Gunlaying	800 K. Less Ant.	Used
Mark 10	Gunlaying	10 CM. Compl.	New
Above—Less Rack	New, Less Rack	Used	
CPN-3	Beacon	10 CM. Major Units	Used
CPN-6	Beacon	3 CM. Compl.	New
CPN-8	Beacon	10 CM. Compl.	New
		Less Ant.	New
SCR-533	IFF/AIR	500 MC. Search	Tracer
Airborne Radar Altimeter	500 MC.	Compl.	New

PHONE OR WRITE FOR INFO AND PRICE Ask for Qty.

MAGNETRONS

Tube	Frg. Range	Pk. Pwr. Output	Price
2J27	2965-2992 mc.	275 KW.	\$6.50
2J31	2820-2860 mc.	265 KW.	\$25.00
2J21 A	9345-9405 mc.	50 KW.	\$25.00
2J22	3267-3233 mc.	265 KW.	\$25.00
2J26	2992-3019 mc.	275 KW.	\$25.00
2J27	2965-2992 mc.	275 KW.	\$8.50
2J32	2760-2820 mc.	285 KW.	\$45.00
2J37			\$45.00
2J38 Pkg.	3249-3263 mc.	5 KW.	\$35.00
2J39 Pkg.	3267-3233 mc.	87 KW.	\$38.00
2J40	9305-9325 mc.	10 KW.	\$65.00
2J49	9000-9160 mc.	58 KW.	\$85.00
2J34			\$55.00
2J51	3000-3100 mc.	35 KW.	\$55.00
2J62	2914-3010 mc.	35 KW.	\$65.00
3J31	24,000 mc.	50 KW.	\$55.00
5J30			\$39.50
714AY			\$25.00
718DY	2720-2890 mc.	250 KW.	\$25.00
720BY	2800 mc.	1000 KW.	\$50.00
720CY	2860 mc.	1000 KW.	\$17.50
725-A	9345-9405 mc.	50 KW.	\$25.00
730-A	9345-9405 mc.	50 KW.	\$25.00
730-A, B, C, D			\$50.00
706 AY, BY, CY, DY, EY, FY, GY			\$50.00
Klystrons, 723A/B \$12.50; 707B W/Cav.			\$20.00
417A \$25.00; 2K41			\$65.00

"CW" MAGNETRONS

QK 62	3150-3375 mc	\$65.00 ea.
QK 59	2675-2900 mc	New.
QK 61	2975-3200 mc	Guaranteed
QK 60	2800-3025 mc	Guaranteed
QK 915 Raytheon		\$150.00
FIL. TRANSF. for above 115V/60 cy. Pri; four		\$ 27.50
6.3V/4A Sec. 00000V		\$ 27.50
Mag. Kit of four QK's 2675-3375 inc. w/trans.		\$250.00

MAGNETRON MAGNETS

Gauss	Pole Diam	Spacing	Price
4850	3/4 in.	5/8 in.	\$12.50
5200	2 1/2 in.	3/4 in.	\$17.50
1300	1 5/8 in.	1 5/16 in.	\$12.50
1880	1 5/8 in.	1 1/2 in.	\$14.50

Electromagnets for magnetrons \$24.50 ea.
GE Magnets type M7765115. Gt Distance Between pole faces variable. 2 1/16" (1900 Gauss) to 1 1/2" (2200 Gauss) Pole Dia. 1 5/8" P/O SCR 584. \$34.50
Hated Consignees Send P.O.

Send M.O. or CHK. Mds. Guard. Shpg. Charges Sent C.O.D. Price F.O.B. N.Y.C. Phone Di. 9-4124

COMMUNICATIONS EQUIPMENT CO.

131 Liberty St., Dept. C6 New York City 7, N. Y.

\$3.00 FOR CARTOON
IDEAS

RADIO-ELECTRONICS prints several radio cartoons every month. Readers are invited to contribute humorous radio ideas which can be used in cartoon form. It is not necessary that you draw a sketch, unless you wish.

Address

RADIO CARTOONS, RADIO-ELECTRONICS
25 West Broadway, New York 7, N. Y.

the new **DUMONT** type 12LP4A TELETRON*



Bent-Gun, exclusive DuMont design, bends the electron beam only once instead of twice as in other designs. Permits sharper spot focus.

New Du Mont gray face plate

Featuring
the

BENT-GUN

Specifications

Overall Length	18 3/4"
Diameter of Bulb	12 7/8"
Useful Screen Diameter	11"
Base	Duodecal 5 Pin
Bulb Contact	Recessed Small Cavity Cap
Anode Voltage	11,000 Volts D. C.
Grid No. 2 Voltage	250 Volts D. C.
Focusing Coil Current	110 Approx. Ma D. C.
Ion Trap Current	120 Approx. Ma D. C.
Grid No. 1 Circuit Resistance	1.5 Max. Megohms

For the first time this popular tube type is offered with all the refinements of the Du Mont design.

Modification of the Bent-Gun makes possible the use of single or double magnet beam-benders thus assuring direct interchangeability with other 12LP4's, yet assuring that extra sharpness possible only with the Du Mont gun structure.

An ideal tube for improving the performance of existing receivers, using the Type 12LP4, or for incorporation in new receiver design.

Literature and quotations on request

DUMONT
Teletrons

FIRST WITH THE FINEST IN T-V TUBES

*Trade-Mark

ALLEN B. DU MONT LABORATORIES, INC., Tube Division, Clifton, N. J. Plants at Allwood and Passaic, N. J.



HERE IS THE LONG SOUGHT ANSWER IN TELEVISION TRAINING FOR THE MAN ALREADY IN RADIO! TRAIN AT HOME—FULL PROGRAM—4 TO 8 WEEKS!

Low Cost—Monthly Payments. Everything You Need to Learn...

TELEVISION

I Send You NOT JUST an Ordinary TV Kit—But a Complete Training System Including TV Test Equipment

Here is the NEW Combination Sprayberry Television Training System

Out of my laboratory has come an entirely new Television Training...cutting months off the time required in old methods. I give all the knowledge and experience you need in weeks instead of months. I start where your present radio experience ends. The same day you enroll with me, I rush the first of many big Television kits that I will send during your training. From the first hour you are experimenting and testing practical TV circuits...and you keep right on from one fascinating experiment to another. You build the remarkable new Television Receiver-Tester illustrated at the left and useful TV Test Equipment. I give you theory, too, but it's 100% practical stuff that will make money for you in Television.

YOUR CHOICE OF 7, 8½ OR 10 INCH TELEVISION PICTURE SIZE

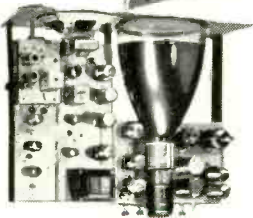

Exclusive THREE-UNIT Construction

You build my Television Receiver-Tester in three separate units—one unit at a time...each complete and self contained within itself. With each unit you perform dozens of important experiments—and each unit may be used in actual Television receiver servicing. In this way my training may save you many dollars by eliminating the need for costly TV Test Equipment. With these three units you can locate most TV Receiver troubles quickly and easily.

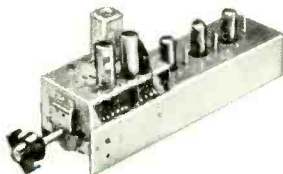

TV Tuner—I.F. Unit

Contains the RF amplified local oscillator, mixer and three stages of broad band IF amplification and the video second detector. The output constitutes the video signal and audio IF signal. For training, it is used to build and test video second detector, and stagger tuned IF amplifier obtaining 4.5 mc band pass. For TV servicing, it becomes a TV calibrator for IF alignment, substitute tuner, IF signal injector and second detector.

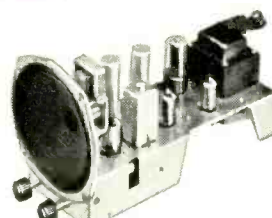

Video-Audio Amplifier Unit

Provides 4.5 mc IF ratio detector, low voltage power supply. For TV, it becomes the audio output, including speaker, video output and low voltage power supply for RF and IF stages. For training, it is used to build and test transformer type power supplies, audio, video, IF amplification and FM detection. For TV servicing, it is an audio signal tracer, IF signal tracer, video signal tracer and low voltage power supply.



Video Tube "Scope" Unit

Scope unit contains low and high voltage (6000 V.) power supply for independent operation. For television, it becomes the sync, vertical and horizontal sweep circuits and their power supplies. For training, it is used to build and test most TV power supply, deflection, sweep, oscillator, and sync circuits. For TV servicing, it is a video signal tracer and sweep signal analyzer as well as substitute high and low voltage power supplies.

BE READY FOR TOP PAYING TELEVISION JOBS

If you are a radio-serviceman, experimenter, amateur or advanced student... YOUR FUTURE IS IN TELEVISION. Depending upon where you live, Television is either in your town now... or will be there shortly. This is a vast new industry that needs qualified trained men by the thousand to install and service TV sets. There's really big money in Television, but you MUST know what you are doing to "cash-in" on it. I will train you in a few short weeks if you have had previous radio training or experience.

IMPORTANT—FOR MEN JUST STARTING OUT IN RADIO-TELEVISION

If you have no previous experience in Radio work, be sure to mark that fact on the coupon below. I will send you complete information about my Radio-Television training that starts with basic fundamentals and carries you right through my new Radio and Television Training. I will send you my two big Radio-Television books, including an actual lesson selected from my course. I want you to know exactly what this great industry has in store for you. There is no obligation, of course, and NO SALESMAN WILL CALL.

VETERANS—Radio portion of training available under G. I. Bill



FILL OUT AND MAIL COUPON
Get these Valuable Books **FREE!**

Every Radio Serviceman today realizes his future is in Television. He knows he MUST have training—the right kind of practical training such as I am now offering—to protect his job, his business for the future. This is equally important for the man just starting out. And so I urge you to get the facts I offer you FREE and without obligation. Learn how quickly and easily you can get into Television. Fill out and mail the coupon TODAY.

SPRAYBERRY ACADEMY OF RADIO, Dept. 20-K
111 North Canal St., Chicago 6, Ill.

Please rush to me all information on your Radio-Television Training plan. I understand this does not obligate me and that no salesman will call upon me.

Name..... Age.....

Address.....

City..... State.....

Please Check Below About Your Experience

Are You Experienced? No Experience

SPRAYBERRY ACADEMY OF RADIO, 111 N. Canal, Dept. 20K, Chicago 6, Ill.

THE QUALITY OF RCA TUBES IS UNQUESTIONED



Seven of the Top Ten are **RCA**

... pioneered for AM, FM, and TV

AMONG THE RECEIVING TUBES used industry-wide during 1949, seven of the top ten volume types were RCA pioneered. Of the remaining three, two were of basic RCA design. Almost one-half of these industry-wide leaders were also among the top ten volume types used in the radio and television service business during 1949.

Only tubes of unquestionable quality—both as to design and manufacture—could merit such acceptance by the industry. Here are leaders designed by the Leader—familiar types, such as the

RCA 6SN7-GT and 6AG5 . . . and more recently the 1B3-GT, 6BA6, 6J6, 6AU6, and 6AL5. Their wide-spread application has permitted production to be concentrated on fewer types . . . which, in turn, has accounted for lower costs, improved quality, and greater uniformity.

This is but one instance of how RCA's engineering leadership adds value beyond price to the RCA tubes you sell. It is a value shared alike by you and your customers.

Always keep in touch with your RCA Tube Distributor



RADIO CORPORATION of AMERICA

ELECTRON TUBES

HARRISON, N. J.