

# RADIO — ELECTRONICS

HUGO GERNSBACK, Editor

formerly

**RADIO  
CRAFT**



**ATOMIC ENERGY BEAM  
RIVALS HEAT OF SUN**  
SEE ELECTRONICS SECTION

**MAR**  
1950

**30¢**

U. S. and  
CANADA

**LATEST IN RADIO — ELECTRONICS — TELEVISION**

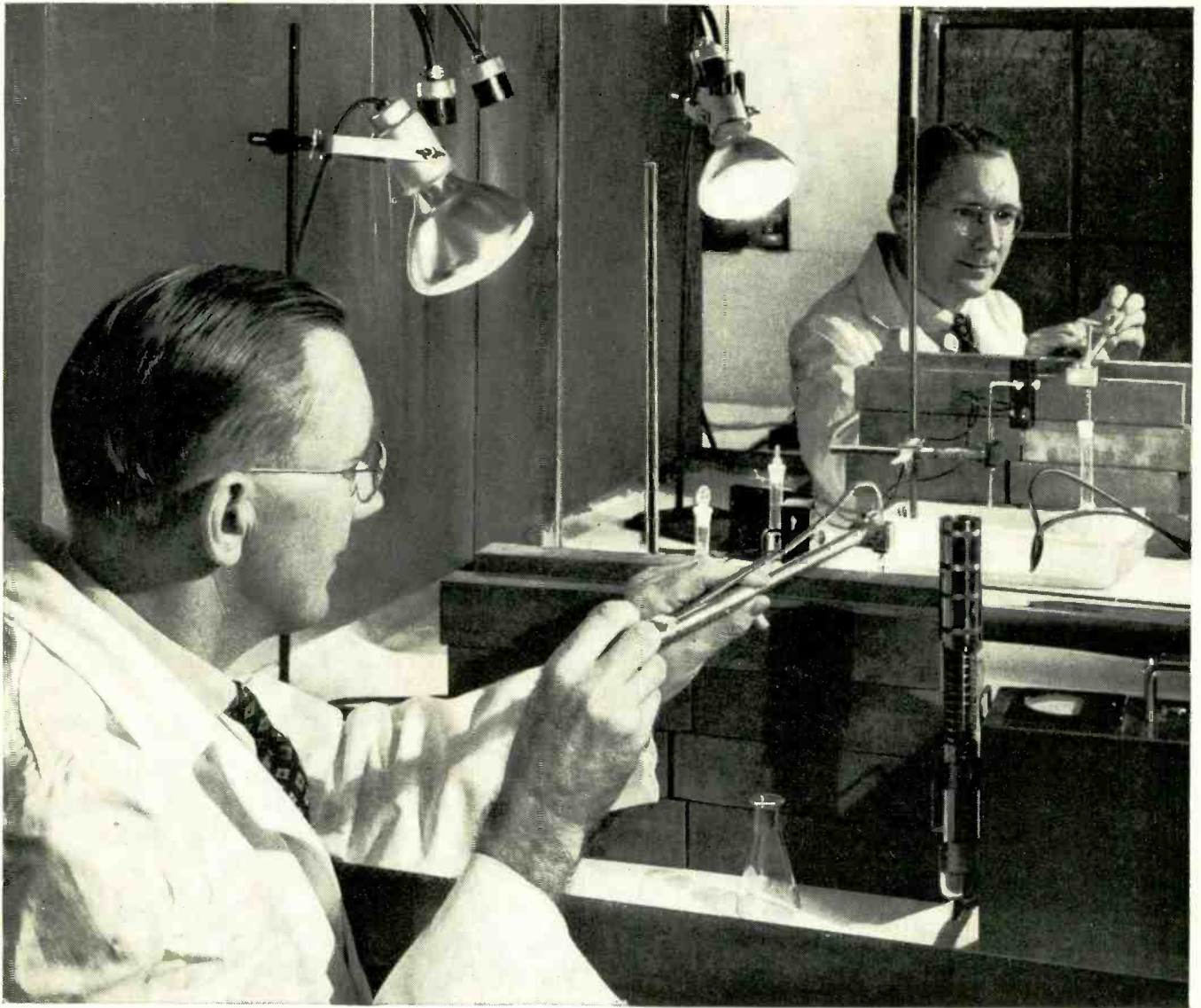

## IT'S **DONE WITH MIRRORS!**

Protected by a wall of lead bricks and using a mirror to guide his instruments, this Bell Laboratories scientist is preparing a solution of a radioactive isotope, for use as a tracer to study materials for your telephone system.

Bombardment by neutrons turns some atoms of many chemical elements into their "radioactive isotopes"; these are unstable and give off radiation which can be detected by a Geiger counter. Chemically a "radioactive isotope" behaves exactly like the original element. Mix the two in a solution or an alloy and they will stay together; when the Geiger counter shows up an isotope, its inactive brother will be there too. Minute amounts beyond the reach of ordinary chemical methods can be detected — often as little as one part in a billion.

The method is used to study the effect of composition on the performance of newly developed germanium transistors — tiny amplifiers which may one day perform many functions which now require vacuum tubes.

It enables Bell scientists to observe the behavior of microscopic impurities which affect the emission of electrons from vacuum tube cathodes. It is of great help in observing wear on relay contacts. And it may develop into a useful tool for measuring the distribution and penetration of preservatives in wood.

Thus, one of science's newest techniques is adopted by Bell Laboratories to make your telephone serve you better today and better still tomorrow.



**BELL TELEPHONE LABORATORIES**

EXPLORING AND INVENTING. DEVISING AND PERFECTING. FOR CONTINUED IMPROVEMENTS AND ECONOMIES IN TELEPHONE SERVICE.



# BE A SUCCESS AS A RADIO-TELEVISION TECHNICIAN

**TWO FREE BOOKS SHOW HOW MAIL COUPON**

## America's Fast Growing Industry

### I TRAINED THESE MEN AT HOME

**OWNS SUCCESSFUL BUSINESS**  
"Today I am considered an expert Radio-Television Technician. I have four employees working in my shop. Repair business has doubled."—PAUL MILLER, Toledo, Ohio.

**RADIO ENGINEER ABC NETWORK**  
"4 years ago, I was a bookkeeper with a hand-to-mouth salary. Now I am a Radio Engineer with key station of the ABC network."—NORMAN H. WARD, Ridgefield Park, New Jersey.

**\$5 TO \$10 WEEK IN SPARE TIME**  
"While learning, made \$5 to \$10 a week in spare time. Now have a spare time shop in my home and earn as high as \$25 a week."—LEANDER ARNOLD, Pontiac, Michigan.

**SERVICING BUSINESS PROFITABLE**  
"For the past two years, I have been operating my own Servicing business. Net profit, \$6,850. N.R.I. training made it possible."—PHILIP G. BROGAN, Louisville, Kentucky.

**GETS FIRST JOB THROUGH N.R.I.**  
"My first job, with KDLR, was obtained for me by your Graduate Service Dept. Am now Chief Engineer, Police Radio Station WQOX."—T. S. NORTON, Hamilton, Ohio.

**SEES PROFIT IN RADIO-TELEVISION**  
"I am operating my own Radio Sales and Servicing business. With FM and Television, we are looking forward to a very profitable future."—ALBERT PATRICK, Tampa, Florida.

**SPARE TIME SERVICE PAYS WELL**  
"Work only in spare time at Radio and average about \$40 a month. Knew nothing about Radio before enrolling with N.R.I."—SAMUEL T. DEWALD, St. Clair, Pennsylvania.

## Offers You All Three

### 1. EXTRA MONEY IN SPARE TIME

As part of my servicing course, I send you SPECIAL BOOKLETS starting the day you enroll that show how you can make \$5, \$10 or more a week EXTRA fixing neighbors' Radios in spare time while learning. Tester you build with parts I send helps

### 2. GOOD PAY JOB

Your next step is a good job installing and servicing Radio-Television sets, or becoming boss of your own Radio-Television Sales and Service Shop, or getting a good job in a Broadcasting Station. In 1945, there were 943 Radio Stations. Today, about 2,700 are on the air! Result—thousands of qualified men stepped into good jobs. Then add developments in FM, Two-Way Radio, Police, Aviation, Marine, Micro-wave Relay Radio. Think what this means! New jobs, more jobs, good pay for qualified men.

### 3. BRIGHT FUTURE

And think of the opportunities in Television. Only 19 Stations were on the air in 1947. Today, more than fifty. And the experts say there will be over 1,000 within three years. Manufacturers are producing over 100,000 Television sets a month. Be a successful Radio-Television Operator or Technician . . . get in line for success and a bright future in America's fastest-growing industry!



# I Will Train You at Home

## You Practice Servicing or Communications with MANY KITS

I've trained hundreds of men with no previous experience to be successful TECHNICIANS. I will train you, too. Or now you can enroll for my NEW practical course in Radio-Television Communications. Train for your FCC operator's or technician's license. You learn Radio-Television theory from clear, illustrated lessons in my tested home study courses.

As part of both my Servicing and Communications course, I send you MANY KITS of modern equipment that "bring to life" theory you learn.

### You Build This MODERN RADIO

As part of my Servicing course, I send you speaker, tubes, chassis, loop antenna, transformer, EVERYTHING you need to build this modern Radio. Use it to conduct many valuable tests and practice servicing. It's yours to keep.

### You Build This TRANSMITTER

As part of my New Communications course, I send parts to build this low-power broadcasting Transmitter that shows how to put a station "on the air." Perform procedures demanded of Broadcast Station operators, conduct many tests, experiments. It's yours to keep.

Building circuits, conducting experiments with them, introducing and repairing defects, gives you valuable, practical experience. (Some of the equipment you get is shown below.) Everything I send is yours to keep.

### Mail Coupon for Books FREE

Coupon entitles you to ACTUAL LESSON on Radio Servicing with many pictures and diagrams plus my 64-page book, "HOW TO BE A SUCCESS IN RADIO-TELEVISION" . . . both FREE. See what my graduates are doing and earning. Send coupon today. J. E. SMITH, President, Dept. OCX, National Radio Institute, Pioneer Home Study Radio School, Washington 9, D. C.

## VETERANS

**GET THIS TRAINING WITHOUT COST UNDER G. I. BILL. MAIL COUPON NOW.**

## Good for Both - FREE

**MR. J. E. SMITH, President, Dept. OCX. National Radio Institute, Washington 9, D. C.**

Mail me Sample Lesson and 64-page Book about How to Win Success in Radio-Television—both FREE. (No salesman will call. Please write plainly.)

Name..... Age.....

Address.....

City..... Zone..... State.....

Check if Veteran Approved Under G. I. Bill



# RADIO — ELECTRONICS

formerly RADIO-CRAFT

MEMBER  
AUDIT BUREAU OF CIRCULATION

Incorporating  
SHORT WAVE CRAFT\* TELEVISION NEWS\*  
RADIO & TELEVISION  
\*Trademark registered U. S. Patent Office

Hugo Gernsback, Editor-in-Chief  
Fred Shunaman, Managing Editor  
M. Harvey Gernsback, Consulting Editor  
Robert F. Scott, W2PWG, Technical Editor

R. H. Dorf, Associate Editor  
I. Queen, Editorial Associate  
Angie Pascale, Production Manager  
Wm. Lyon McLaughlin, Tech. Illustration Director

Lee Robinson, General Manager  
John J. Lamson, Sales Manager

G. Aliquo, Circulation Manager  
Robert Fallath, Promotion Manager

## CONTENTS — MARCH, 1950

Announcing \$1,200.00 Prize Contest—Radio-Electronics in Home . . . . . See Page 35

<b>Editorial (Page 23)</b>	
Home Radio-Electronics . . . . .	by Hugo Gernsback 23
<b>Television (Pages 24-29)</b>	
A De Luxe Televiser, Part III . . . . .	by Charles A. Vacarro 24
Reports from Television Dx-ers . . . . .	27
Television Dictionary (Continued) . . . . .	by Ed. Bukstein 28
Television Service Clinic . . . . .	by Walter H. Buchsbaum 29
<b>FM (Pages 30-32)</b>	
A Ten-Tube FM Receiver for Only \$10.00 . . . . .	by Robert C. Minnick 30
<b>Audio (Pages 33-37)</b>	
Applause Meter . . . . .	by Guy S. Cornish 33
Miniature-Tube A.F. Amplifier . . . . .	by R. Cameron Barritt 36
Amplifier Has Unusual Circuits . . . . .	37
<b>Electronics (Pages 38-41)</b>	
Atomic Energy Beam Rivals Heat of Sun (Cover Feature) . . . . .	38
Electronics Detects Cancer with Vacuum Tube Voltmeter . . . . .	39
Electronics Goes to the Dogs . . . . .	40
Everything Radiates . . . . .	by Baldur Meyer 41
<b>Amateur (Pages 42-43)</b>	
How to Become A Ham, Part VI . . . . .	by George W. Shuart; W4AMN 42
<b>Servicing (Pages 44-52)</b>	
Murder by Radio . . . . .	by Guy Slaughter 44
Review of Recently Issued Tubes . . . . .	45
Repairing Radios from a Wheelchair . . . . .	by Wendell Ward 46
Shunting Potentiometers . . . . .	by Hugh Lineback 48
Fundamentals of Radio Servicing, Part XIII—The Power Supply by John T. Frye	50
<b>Construction (Pages 54-60)</b>	
Seven Unusual Power Supplies . . . . .	by Lyman E. Greenlee 54
<b>Test Instruments (Pages 62-69)</b>	
Multi-Purpose Tester . . . . .	by P. F. Egerton, Jr. 62
Z-Axis Input for Scope . . . . .	by Ted Ladd 64
Miniature Tester Uses 1-inch-Diameter Meter by Rufus P. Turner, K6AI	66
Calibrating Frequency Bridge . . . . .	by I. Queen 69
<b>Departments</b>	
The Radio Month . . . . .	8
Radio Business . . . . .	10
New Patents . . . . .	70
Technotes . . . . .	75
Try This One . . . . .	78
Radio-Electronic Circuits . . . . .	80
Miscellany . . . . .	82
New Devices . . . . .	86
Question Box . . . . .	88
People . . . . .	90
Communications . . . . .	92
Book Reviews . . . . .	95

**ON THE COVER:** Dr. J. D. Cobine melting a quartz rod with General Electric's new nitrogen-atom torch. Kodachrome courtesy General Electric Co.

RADIO-ELECTRONICS, March, 1950, Volume XXI, No. 6. Published monthly. Publication Office: Erie Ave. F to G Streets, Philadelphia 32, Pa. Entered as second class matter September 27, 1948, at the post office at Philadelphia, Pa., under the Act of March 3, 1879. **SUBSCRIPTION RATES:** In U. S. and Canada, In U. S. possessions, Mexico, South and Central American countries, \$3.50; \$6.00 for two years; \$8.00 for three years; single copies 30c. All other foreign countries \$4.50 a year, \$8.00 for two years, \$11.00 for three years. Allow one month for change of address. When ordering a change please furnish an address stencil impression from a recent wrapper. **RADIO-CRAFT PUBLICATIONS, INC.** Hugo Gernsback, Pres.; M. Harvey Gernsback, Vice-Pres.; G. Aliquo, Sec'y. Contents copyright, 1950, by Radio-craft Publications, Inc. Text and illustrations must not be reproduced without permission of copyright owners. **EDITORIAL and ADVERTISING OFFICES, 25 West Broadway, New York 7, N. Y.** Tel. REctor 2-9690. **BRANCH ADVERTISING OFFICES:** Chicago: 308 W. Washington Street. Telephone RAndolph 6-7363. Los Angeles: Ralph W. Harker, 1127 Wilshire Blvd., Tel. MA 6-1271. San Francisco: Ralph W. Harker, 582 Market St., Tel. GArfield 1-2481. **FOREIGN AGENTS:** Great Britain: Atlas Publishing and Distributing Co., Ltd., London E.C.4. Australia: McGill's Agency, Melbourne. France: Brentano's, Paris 2e. Holland: Trilectron, Heemstede. Greece: International Book & News Agency, Athens. So. Africa: Central News Agency, Ltd., Johannesburg; Capetown; Durban. Natal. Universal Book Agency, Johannesburg. Middle East: Steimatzky Middle East Agency, Jerusalem. India: Sualil Gupta (Distributors) Co., Calcutta. Broadway News Centre, Dadar, Bombay #14. K. L. Kannappa Mudaliar, Madras 2. Pakistan: Paradise Book Stall, Karachi 3.

See the  
Whole Picture  
on all-new 16"

**NATIONAL**  
TELEVISION



Now at last, see the whole picture exactly as transmitted on a big 16" rectangular screen. No lost corners! No corner distortion! The new black face increases the contrast, eliminates glare. Even old films are reproduced on these new history-making National models with a sharpness and clarity never before achieved!

**ALL-NEW CHASSIS** features a built-in "turnstile" antenna with directional switch, a highly sensitive turret tuner, four stages of I.F. for extra gain in fringe areas, and a full 4 mc. video bandwidth for magnificent "hair-line" fidelity!



**MODEL TV-1625**

Handsome console of hand-rubbed mahogany veneer with the revolutionary 16" rectangular tube, all-new chassis and a 12" speaker. . \$339.95

Also available in table model  
TV-1601 at \$289.95

**National**



**NATIONAL COMPANY, Inc.**  
MALDEN, MASSACHUSETTS

RADIO-ELECTRONICS for



**YOU  
Build This  
Superheterodyne**

You receive complete standard equipment, including latest type High-Mu Tubes, for building various experimental and test units. You progress step by step until you build a complete Superheterodyne Receiver. It is yours to use and keep.

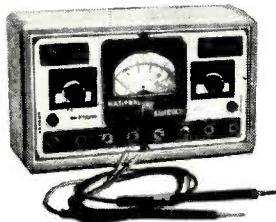

**YOU RECEIVE THIS  
PROFESSIONAL MULTITESTER!**

You will use this professional instrument to locate trouble or make delicate adjustments—at home—on service calls. You will be proud to own this valuable equipment. Complete with test leads.

#### SIGNAL GENERATOR

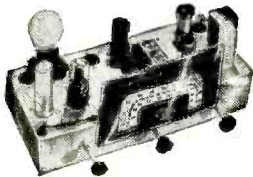

You construct the Transitron Signal Generator shown here, demonstrating Transitron principles in both R.F. and A.F. stages. You study negative type oscillators at firsthand.

#### AUDIO OSCILLATOR:

An electronic device, which produces audio-frequency signals for modulating R.F. (radio frequency) carrier waves, testing A.F. (audio frequency) amplifiers, speakers, etc.

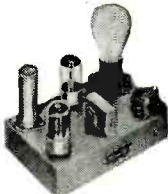

#### T.R.F. RECEIVER

You build several T.R.F. Receivers, one of which, a 4-tube set, is shown here. You learn construction, alignment, make receiver tests, and do trouble shooting.

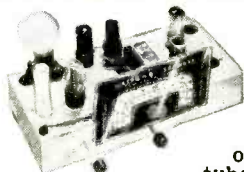

# Get Into **RADIO, TELEVISION** and **ELECTRONICS** *Master ALL Phases*

**Get Complete Training. You Receive and Keep All Tubes, Equipment, Parts and Lessons. No Extra Charges.**

**GOOD PAY  
and Unlimited Opportunities  
in JOBS LIKE THESE:**

Business of Your Own  
Radio Manufacturing, Sales, Service  
Broadcasting, Teecasting  
Television Manufacturing, Sales, Service  
Laboratories: Installation, Maintenance of Electronic Equipment,  
Electrolysis, Call Systems  
Garages: Auto Radio Sales, Service  
Sound Systems and Telephone Companies; Oil Well and Drilling Companies; Engineering Firms  
Theatre Sound Systems, Police Radio

**And scores of other good jobs  
in many related fields**

**YOU CONDUCT MANY  
EXPERIMENTS LIKE THESE!**

Checking action of condensers  
Experiments with AF and RF amplifiers  
Experiments with resonance  
Producing beat frequencies  
Calibrating oscillators  
Experiments with diode, grid-bias, grid-leak and infinite impedance detectors  
Practical experience in receiver trouble shooting  
Application of visual tester in checking parts and circuits  
Experiments with audio oscillators  
Advanced trouble-shooting  
... and many, many others

### Complete Training by Practical Resident Trade School, Est. 1905

The same highly trained faculty, instruction materials and methods used here in our large, modern resident school, are adapted to your training in your own home. Shop Method Home Training has been proved by hundreds of successful graduates.

**Both Resident and Home Study  
Courses Offered**

### YOU LEARN BY DOING

You receive special laboratory experiment lessons to show you how to build with your own hands various experimental units such as those shown at left, and how to conduct many tests.

You will find all lessons easy to understand because they are illustrated throughout with clear diagrams and step-by-step examples that you work out yourself. Every piece of the equipment and complete lesson material we send you is yours to keep and enjoy, including the multimeter, experimental equipment, all parts of the Superheterodyne, tube manual, radio dictionary, and complete, modern Television texts. All parts are standard equipment.

### Shop Method Home Training ... Earn While You Learn

With our practical resident Shop Method Home Training, you study in your spare time. You receive Spare Time Work Lessons, which show you how to earn while you learn. Service neighbors' radios and TV receivers, appliances, etc., for extra money and experience. Many National students pay all or part of their training with spare time earnings!

**DON'T DELAY! The Radio-Television Industry needs trained men NOW!**

**APPROVED  
FOR  
VETERANS!**  
Check coupon below!

For quick action,  
mail coupon  
today and we'll  
rush you full information.

**Free!**

**NEW, ILLUSTRATED  
OPPORTUNITY  
BOOK AND SAMPLE  
LESSON SHOW YOU  
HOW WE TRAIN  
YOU ... SEND FOR  
THEM TODAY! NO  
COST. NO  
OBLIGATION.**

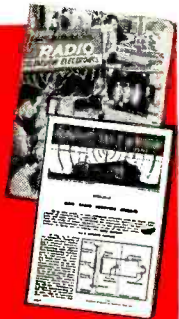

## NATIONAL SCHOOLS

LOS ANGELES 37, CALIF. • EST. 1905

**FIND OUT NOW ... MAIL COUPON TODAY**

National Schools, Dept. RE-3  
4000 South Figueroa Street  
Los Angeles 37, California

Send me your FREE book "Your Future in Radio" and the sample lesson of your course. I understand no salesman will call on me.

NAME ..... AGE .....

ADDRESS .....

CITY ..... ZONE ..... STATE .....

Check here if Veteran of World War II

Mail in envelope  
or paste on  
penny postal.

Used by leading TV manufacturers  
... RCA Test Equipment



## Only RCA Makes the VoltOhmyst\*

**The Master VoltOhmyst . . . the most versatile instrument of its kind.** The instrument that "has everything"—the RCA WV-95A Master VoltOhmyst has no equal for fast and accurate servicing of AM, FM, and TV receivers. It's a profitable investment because *this one instrument measures capacitance, current, voltage, and resistance.*

With the WV-95A you can measure ac and dc voltages to 1000 volts, dc current from 1 microampere to 10 amperes, resistance from 0.1 ohm to 1000 megohms, and capacitance from 4 mmf to 1000 mf—all with the usual efficiency and absence of circuit loading characteristic of all RCA VoltOhmysts.

When used with the RCA WG-275 accessory diode probe, the WV-95A can be used to measure rf voltages at frequencies up to 250 Mc.

For full details, ask your RCA Test Equipment Distributor for Bulletin 2F721—or write RCA, Commercial Engineering, Section C49X, Harrison, N. J.

\*Reg. Trade Mark, U.S. Pat. Off.

**The Standard VoltOhmyst . . . work horse of the servicing field.** The RCA Type 195A measures ac and dc voltages to 1000 volts, resistance to 1000 megohms, in six ranges. Reads db at all audio frequencies. Has zero-center scale for discriminator alignment. Its 10-megohm dc input resistance insures accuracy of readings in high-impedance circuits. WG-263 accessory crystal probe permits rf voltage measurements to 100 Mc.



**The Battery VoltOhmyst . . . the meter you can use anywhere.** The RCA WV-65A is completely portable. Batteries last up to 10 months. Measures ac and dc voltages to 1000 volts, resistance to 1000 megohms, and direct current to 10 amperes. WG-263 accessory crystal probe permits rf voltage measurements to 100 Mc. Best buy of the year at the new low price of \$39.50.



Available from your RCA Test Equipment Distributor



**RADIO CORPORATION of AMERICA**  
TEST EQUIPMENT  
HARRISON, N. J.

RADIO-ELECTRONICS for

To a \$60 a week man interested in earning \$100 a week and more in

# TELEVISION and FM SERVICING



**CREI can show you how to qualify for jobs like these!**

**Q**UALIFIED TV REPAIRMEN are in demand. The ads shown (taken from a single issue of the Washington *Sunday Star*) prove it. Every area with TV stations has openings for servicemen. Every area with TV stations planned (750 stations by 1955 is a conservative estimate) will have more openings.

Anyone in the field—if he is to get ahead—needs to know how to use test equipment, how a TV set works, why it works, and how to make it work better. You can't repair "by ear" anymore. You need *knowledge*. CREI's practical course in TV-FM servicing provides it. Designed by teaching specialists, taught by practical TV instructors, reviewed and checked by qualified service experts, **KEPT UP-TO-DATE** through daily contact with CREI's affiliated retail sales-and-servicing stores (one of

Washington's largest retailers of TV sets), the CREI course equips you to qualify for the \$100-a-week jobs.

TV is developing fast. Now's the time to get on the bandwagon! CREI offers you—in one practical course at a popular price—greater earnings and a secure future. Don't delay. Start your training now—and start applying your new-found knowledge in your daily work. The facts are yours for the asking. Mail the coupon now for complete data.

**Veterans:** CREI training is available under the G.I. Bill. For most veterans, July 25, 1951 is the deadline. **ACT NOW!**

## FREE SAMPLE LESSON

"Television & FM Trouble Shooting" devoted to live, "dollar-and-cents", practical practice based on day-to-day servicing problems. Read this interesting lesson! See for yourself how CREI training can help you. Mail coupon for sample lesson, free booklet and details.



### THE THREE BASIC CREI COURSES:

- ★ **PRACTICAL RADIO ENGINEERING**  
*Fundamental course in all phases of radio-electronics*
  - ★ **PRACTICAL TELEVISION ENGINEERING**  
*Specialized training for professional radiomen*
  - ★ **TELEVISION AND FM SERVICING**  
*Streamlined course for men in "top-third" of field*
- ALSO AVAILABLE IN RESIDENCE SCHOOL COURSES



## CAPITOL RADIO ENGINEERING INSTITUTE

An Accredited Technical Institute Founded in 1927  
Dept. 143B, 16th Street & Park Road, N. W.  
Washington 10, D. C.  
Branch Offices  
New York (7) 170 Broadway • San Francisco (2) 760 Market St.

### MAIL COUPON FOR FREE BOOKLET

**CAPITOL RADIO ENGINEERING INSTITUTE**  
Dept. 143B, 16th & Park Rd., N. W., Washington 10, D. C.

Gentlemen: Send me FREE SAMPLE LESSON and complete details of the TV and FM Servicing home study course. Also send brochure that explains the CREI self-improvement program and gives complete details and outline of course. I am attaching a brief resume of my experience, education and present position.

- Check the Field of Greatest Interest:
- |   |   |
|---|---|
| <input type="checkbox"/> TV, FM & Advanced AM Servicing   | <input type="checkbox"/> Aeronautical Radio Engineering           |
| <input type="checkbox"/> Practical Television Engineering | <input type="checkbox"/> Broadcast Radio Engineering (AM, FM, TV) |
| <input type="checkbox"/> Practical Radio Engineering      | <input type="checkbox"/> Radio-Electronics in Industry            |
- I AM ENTITLED TO TRAINING UNDER G.I. BILL.

NAME \_\_\_\_\_ AGE \_\_\_\_\_  
 ADDRESS \_\_\_\_\_  
 CITY \_\_\_\_\_ ZONE \_\_\_\_\_ STATE \_\_\_\_\_  
 SEND DETAILS ON RESIDENCE SCHOOL.

# American Beauty

## ELECTRIC SOLDERING IRONS

are sturdily built for the hard usage of industrial service. Have plug type tips and are constructed on the unit system with each vital part, such as heating element, easily removable and replaceable. In 5 sizes, from 50 watts to 550 watts.

### TEMPERATURE REGULATING STAND

This is a thermostatically controlled device for the regulation of the temperature of an electric soldering iron. When placed on and connected to this stand, iron may be maintained at working temperature or through adjustment on bottom of stand at low or warm temperatures.



For descriptive literature write

**AMERICAN ELECTRICAL  
HEATER COMPANY**  
DETROIT 2, MICH., U. S. A.

**RADAR AND LORAN**, when put into more general use on ships, will reduce insurance costs enough to amortize the costs of installation, according to Rear Admiral Telfair Knight, chief of the Maritime Commission's bureau of services. In a speech last month at a luncheon celebrating the third birthday of the service's radar-loran school in New York, Admiral Knight cited reductions already in effect for radar-equipped vessels making the hazardous winter run to Alaska. More than 1,600 merchant marine deck officers have graduated from the school since its inception. It is open to all licensed deck officers; each course lasts one week.

**SERVICE CONTRACTS** for television receivers were purchased by less than 25% of those who purchased television receivers during the first month WSAZ-TV, Huntington, W. Va., was on the air. The station is the area's first. Other interesting facts shown by a survey last month are a strong preference for sets with built-in antennas and largest sales (75%) to low- and middle-income groups.

**COLOR TELEVISER** improvised last month by Forest W. Killy, a Roselle, N. J., electrician, to pick up experimental color broadcasts from New York's CBS station, cost only 30 cents, plus about \$4 worth of material from the junk box. After modifying the sweep circuits of a standard TV receiver to conform with the frequencies of the CBS color system, Killy made a 12-inch color wheel (see photo) out of cardboard and cellophane. Attached to a phonograph motor mounted on a wood base, the wheel spins at high speed in front of the C-R-tube screen, reproducing the scenes in color.

Publication of the report in the daily press brought to light a number of similar devices made by New York and Washington radio technicians and experimenters.

**MOVING MOUNTAINS** is still not very practical but a report from Westinghouse last month says that the next best thing was done recently in a Pennsylvania power-station installation. A generating plant and a substation of the Pennsylvania Electric Co. at Johnstown are 12 miles apart and separated by a mountain. The expense of running telephone lines between generator and substation was too high, but microwave communication was blocked by the mountain. The solution was to bend the waves around the mountain. This was done with a 20-foot-square sheet of aluminum placed on a 50-foot tower 2 miles from the substation. It is within sight of both locations. Microwaves hitting it are reflected to bypass the mountain and reach their destination in either direction.

**TRAFFIC SURVEYS** in Los Angeles are now being made by a set of special detectors in conjunction with an electronic digital computer. Science Service revealed last month. Detectors, which close a circuit when a car passes over them, are sealed to the pavement with cover tape and rubber cement. They are connected to a digital computer in the University of California at Los Angeles engineering laboratory a mile away. The setup records the speed of passing vehicles, tells what lane they are in, totals the number of vehicles in each lane in a given period and records speed distribution in a selected lane during any hour of the day.

**1950 IRE CONVENTION** will be held from March 6 through 9 with headquarters at the Hotel Commodore in New York City. Technical papers by outstanding technical workers will, as usual, cover all the important fields of electronic endeavor. The engineering show will again be at Grand Central Palace. **RADIO-ELECTRONICS** will be present in Booth K.

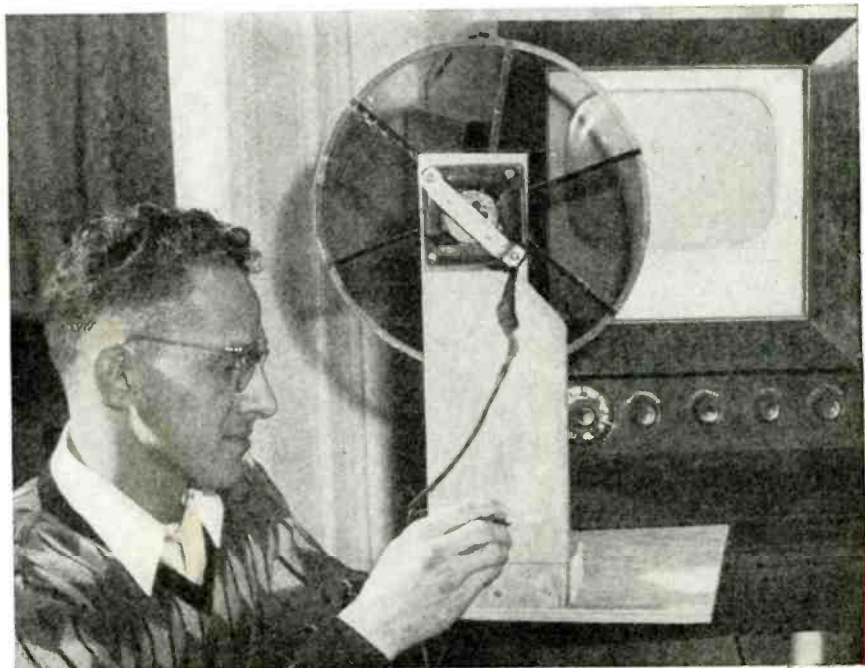

Experimenter Killy and his color wheel. Wheel diameter allows for 6-inch picture.

RADIO-ELECTRONICS for



**MEDAL OF HONOR** of the Institute of Radio Engineers will be awarded to Prof. Frederick Emmons Terman, dean of the School of Engineering of Stanford University, at the annual IRE convention, to be held March 6-9 in New York City. The medal, the Institute's highest award, will be given Prof. Terman for his many contributions to radio as teacher, author, scientist, and administrator. He is best known to radio engineers throughout the world for his two books, *Radio Engineering* and *Radio Engineers Handbook*, which are standard reference works.



Prof. Terman is a native of English, Ind. He earned his B.A. and E.E. degrees at Stanford and a D.Sc. at MIT. He has been a member of the Stanford faculty since 1925 except for a break from 1942 to 1945, when he headed the Harvard University Radio Research Laboratory. He has been dean of the engineering school since his return from Harvard in 1946. He is a past president of the IRE.

**SYNTHETIC MICA** with essentially the same properties as natural mica, but able to withstand much higher temperatures, has been crystallized successfully by Dr. Herbert Insley, Alvin Van Valkenburg, and Robert Pike, the National Bureau of Standards announced last month. To allow the mica to form at atmospheric pressure instead of under high pressure as it does in nature, fluorine in the form of fluorosilicates is used as a crystallizing agent. The other components are like those often used to make glass—quartz, magnesite, and bauxite. The raw mixture is melted in a platinum-lined crucible in an electric furnace at almost 1,400 degrees C. As the furnace cools, mica crystals grow from a tiny seed at the bottom of the crucible.

The largest crystals so far grown at the Bureau have a surface area of 4 square inches, and have a dielectric constant of about 6.3.



Flakes of new mica are examined by microscope for possible structural defects.

**X-RAY MICROSCOPE** which makes visible the internal parts of materials opaque to light was announced last month by General Electric. Future refinements of the instrument, which is still purely experimental, may result in sharper images and more magnification than possible with visible light. It may be able to compete with electron microscopes, with the additional advantage that specimens need not be enclosed in a vacuum. At present, magnifications of 100 diameters have been obtained.

The unit operates on the principle that X-rays can be reflected from polished surfaces if they strike at very small angles. The apparatus consists of an X-ray tube and a pair of curved mirrors. The rays strike the mirrors at an angle of less than one-half degree after passing through the sample. Like a convex lens acting on a light beam, the mirrors bend the rays so as to form a magnified image on photographic film. The mirrors in the experimental setup are platinum-coated slabs of fused quartz which can be curved by hand-controlled mechanical pressure to obtain best focus.

**ELECTROSTATIC CHARGES** on sheets of paper running off a printing press are detected with a new powder announced last month by R. R. Donnelley & Sons Co., Chicago last month. Developed by Harry H. Hull, the powder is a mixture of red and blue powders. When sheets are dusted with it, red remains where there is a positive charge and blue where there is a negative one. The blue powder is dyed lycopodium and the red, carmine mixed with sulphur. Many drugstores carry both.

**CANADIAN TELEVISION** plans announced last month by the CBC call for two stations in Montreal, one French and the other English, plus a station in Toronto. The first test programs may be on the air next fall and regular service is expected by September, 1951.

**WWV AND WWVH**, U.S. Bureau of Standards radio stations in Beltsville, Md., and Maui, T. H., inaugurated a revised schedule of services on January 1. WWV broadcasts on 2.5, 5, 10, 15, 20, 25, 30, and 35 mc. Time announcements are given at 5-minute intervals by voice in Eastern Standard Time and by code in the Universal Time 24-hour system. The standard 440-cycle audio transmissions alternate with a 600-cycle tone, which is broadcast for 4 minutes beginning on the hour and every 10 minutes thereafter. Other services, such as the tick every second and the propagation disturbance warnings, continue.

WWVH, recently established in Hawaii, broadcasts experimentally on 5, 10, and 15 mc with substantially the same program as WWV. The National Bureau of Standards, Washington 25, D.C., welcomes reports on reception of the two stations, especially WWVH, whose purpose is to cover many areas not served by WWV.

## 2 IMPORTANT NEW PHOTOFACT BOOKS

### "TELEVISION TUBE LOCATION GUIDE"



Gives Tube position and function in hundreds of important TV receiver models, made by 56 manufacturers.

### FIND THE TROUBLE AND REPLACE TUBES WITHOUT REMOVING CHASSIS

Nothing like it! The only book that shows the position and function of tubes in hundreds of TV receivers. Often an operational check in the customer's home . . . looking at the picture tube and listening to the sound . . . can give you a clue to the trouble. Many times only a tube failure is responsible. TGL-1 makes trouble diagnosis and tube replacement quick and simple, in most cases without removing the chassis! Each model has its own clear, accurate diagram. Book fully indexed for quick reference. Over 200 pages, handy pocket size, 5½ x 8½". Get two copies . . . one for outside calls and one for your bench. Pays for itself on the first job!

ORDER TGL-1 Only . . . . . \$1.50



### "DIAL CORD STRINGING GUIDE"

NEW! SECOND VOLUME

Covers models from 1947 to October 1949

Over 45,000 servicemen bought the first volume of this invaluable book! New second volume includes 511 different dial cord stringing diagrams used in almost 1000 receivers produced from 1947 to October, 1949 (all new data continuing from where the first volume left off). There's only one right way to string a dial cord . . . and here's the only book that shows you how. Saves time—saves effort. Handy pocket size. Order copies for your tool kit and work bench today.

ORDER DC-2 Only . . . . . \$1.00

### HOWARD W. SAMS & CO., INC.

Order from your Parts Jobber today, or write direct to HOWARD W. SAMS & CO., INC., 2201 East 46th Street, Indianapolis 5, Ind.

My (check) (money order) for \$ . . . . . enclosed. Send the following books:

- TGL-1 "TV Tube Location Guide" \$1.50
- DC-2 "Dial Cord Stringing Guide" \$1.00

Name . . . . .

Address . . . . .

City . . . . . Zone . . . . . State . . . . .

**Yardney International Corp.**, New York, has announced that initial commercial tests have proved that the first industrially effective silver-cell battery, now being manufactured on a pilot basis, is successful.

For many years, it has been known that such a storage battery would be possible if it could be charged and discharged repeatedly over a number of cycles comparable with or in excess of that achieved from the better known lead-acid types now in use.



The Silvercell is only 1/3 to 1/5 the weight and its volume only 1/2 to 1/3 of common batteries now in use. The ampere-hour efficiency of the Silvercell approaches 100% and the energy efficiency 85%, which is almost 20% higher than that of lead and nickel batteries.

The unique construction of the entire battery completely eliminates the hazards of leakage and spilling. The Yardney cell can withstand heavy discharges without any damage, in common with most alkaline batteries. Noticeably absent during the charging cycles or discharging cycles are corrosive and poisonous fumes characteristic of other types of storage batteries.

**Hytron Radio & Electronic Corp.**, Salem, Mass., recently laid the cornerstone of its new television picture tube plant at Newburyport, Mass.

Ultra-modern, the new plant is designed for mass production of television picture tubes. With it, Hytron will expand its production of these tubes begun nearly a year ago. Three thousand television picture tubes will roll off the new production lines daily. Ranging in size up to 20 inches, they will be both round and of the new rectangular design.

**Howard W. Sams & Co. Inc.**, Indianapolis, publisher of radio and television service data, is now located in its new plant at 2201 E. 46 Street.

The new building, comprising 30,000 square feet of daylight, air-conditioned floor space, houses the entire business.

New high-speed photo-offset presses and other modern equipment have been installed in the new plant, where the complete line of Photofact publications is being produced.

**Channel Master Corp.**, Ellenville, N. Y., announces that Judge Edward R. Koch, of the Supreme Court, New York County, has decided that Channel Master Corp., as assignee of Joseph Y. Resnick, is the owner of U.S. patent 2,465,331 for a foldable television antenna, and that Video Television, Inc., is not entitled to it. Video Television brought the action against Channel Master and Mr. Resnick, claiming the invention.

**Sylvania Electric Products, Inc.**, has announced that the new 1N34A and 1N58A germanium diodes will be marketed to Sylvania distributors in a new carton and counter merchandiser. The improved individual crystal carton was adopted after considerable study of effective color combinations and methods of cartoning for individual crystals, and ties in with Sylvania's new counter merchandiser carton for 25 units.

The new individual packing measures approximately 4 1/8 x 1 1/4 x 3/8 inches with an oval window in the top permitting visual inspection of the improved "glass" product against a bright red carton insert. Type number and Sylvania trade mark are printed in black on white, and over-all design is white on bright green. The new 25 - pack counter merchandiser was adopted to promote retail sales to experimenters who now represent an appreciable market for the product.



**RCA Service Co.** has introduced a special, low-cost television service contract under the terms of which the customer pays a base fee (smaller than the usual one) and after the first 90 days pays for each service call.

The new contract plan will be available as an alternative choice for purchasers of RCA Victor television receivers who desire protection at a smaller initial cost than that required for the complete coverage contract. The present complete contract plan, which will be maintained, covers installation, one year's parts and tube protection, and unlimited service for annual fees

beginning at \$45 with a built-in antenna and \$65 with a standard outdoor antenna for 10-inch sets.

The new alternative contract, available starting January 1, provides for complete installation, instruction of the customer, parts and tube protection, including the kinescope, for a year, unlimited service for 90 days, and, after that, a preferred flat rate of \$5.75 per call for service-as-needed, with contract prices starting at \$22.95 with a built-in antenna and \$39.95 with an outdoor antenna for 10-inch sets.

Comparable charges for sets with larger tubes will be \$24.95 and \$44.95 for 12 1/2-inch models, \$29.95 and \$49.95 for 16-inch models, and \$39.95 and \$59.95 for projection models. Prices will be slightly higher for combination instruments and in outlying areas, but the preferred flat rate charge for service calls after the 90-day period will be \$5.75 for all models.

The RCA Service Co. now makes available a library copy of service notes and service information, at no charge, to all service associations and service trade publications. This is in addition to widespread distribution of individual copies of these notes through RCA Victor distributors to dealers, independent servicemen, and service technicians.

**Admiral Corp.**, Chicago, has purchased the 64,000-square-foot General Mills plant in Bloomington, Ill., JOHN B. HUARISA, Admiral's executive vice-president, has announced.

The factory, which is located just outside the Bloomington city limits opposite the Lakeside Country Club, was originally the property of Colonial Radio Corp. and was taken over by General Mills in January, 1948.

**RCA Victor** will now release some of its Red Seal records in 33 1/3 r.p.m., long-playing versions. It will continue to issue releases on standard 78 r.p.m. and the newer 45 r.p.m. discs. With this move, all major record manufacturers are now making 33 1/3-r.p.m. LP records.

**New industry committee**, to be composed of both RMA members and non-member companies to develop further plans for educational Town Meetings of television dealers, was arranged by a score of television manufacturers at a conference in the Stevens Hotel, Chicago. The conference was called by Chairman R. C. SPRAGUE of the RMA Town Meetings Committee and included several non-RMA members.

Original plans for the television dealers' meetings proposed TV distributor-dealer conferences in 60 principal cities for presentation of four 20-minute films on major subjects to assist dealers. The new industry committee will further study these plans toward development of a more definite program underwritten by set manufacturers in cooperation with distributors. A meeting of the new planning committee within the next few weeks is planned.



New plant in Indianapolis houses the entire Howard W. Sams & Co. business.

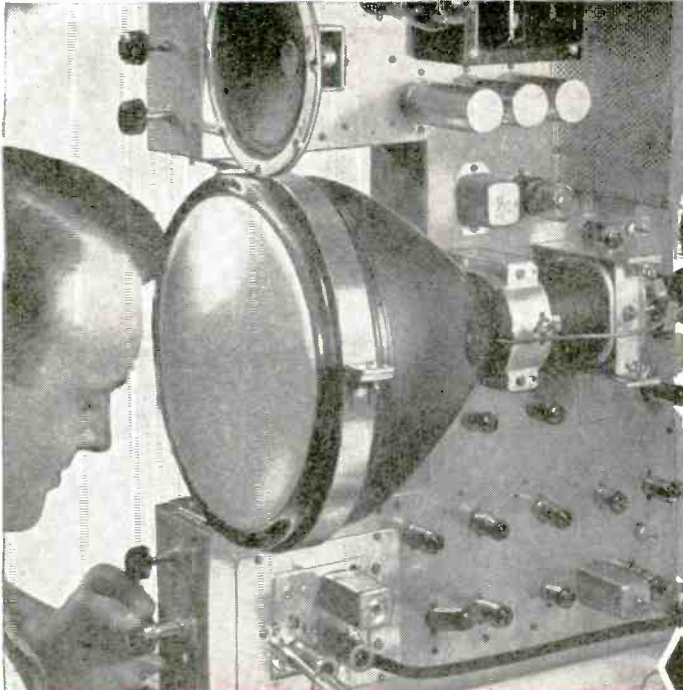

Only D.T.I.  
offers you the  
**"BIG 5"**  
**TELEVISION**  
**RADIO-ELECTRONICS**  
Laboratory Type  
**HOME TRAINING**

**Build and Keep 10, 12½ or 16 inch Picture Tube Quality TELEVISION RECEIVER as you prepare for a Profitable Future**

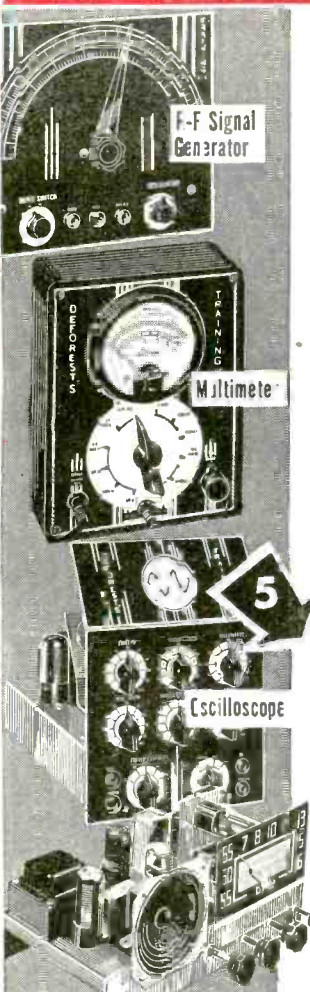

Here is everything you need to prepare you at home for FASCINATING WORK, GOOD MONEY and a THRILLING FUTURE in one of America's most promising fields.

This includes the opportunity to build and keep the top quality Television Receiver shown above—with choice of a 10, 12½ or 16 inch picture tube that gives big, bright, sharp, steady pictures. Get the complete facts. This is an optional feature — available when you complete your training described below. See how D.T.I.'s wonderfully practical "BIG 5" method meets industry's needs. No previous experience needed. Mail coupon today!

**16 Big Shipments of Parts — Plus Lessons**

Work over 300 electronic experiments and projects from 16 big shipments of parts. This includes building and keeping all test equipment and radio set shown at left side of page. Modern easy-to-read lessons with handy fold-out diagrams simplifies your entire training.

**You Also Use Home Movies**

D.T.I., alone, includes the modern, visual training aid . . . MOVIES to help you learn faster, easier at home. See electrons on the march and other fascinating "hidden action"—a remarkable home training advantage that speeds your progress.

**EMPLOYMENT SERVICE**

When you complete your training, our effective Employment Service helps you get started toward a real future in Television-Radio-Electronics.

**Modern Laboratories**

If you prefer, you can get ALL your preparation in our new, Chicago training laboratories . . . one of the finest of its kind. Ample instructors . . . modern equipment. Write for details!

6 Tube  
Radio  
Receiver

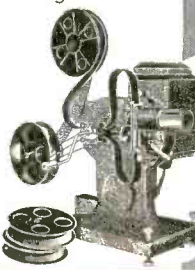
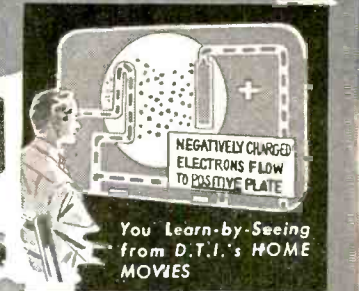
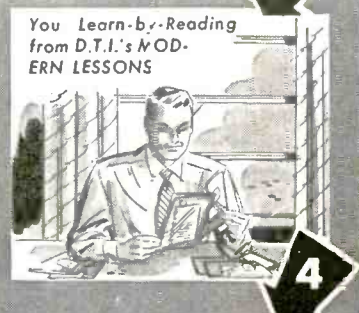

**DeFOREST'S TRAINING, INC.**  
Chicago 14, Illinois  
A DeVry Institution

**MAIL THIS COUPON TODAY!**

DeFOREST'S TRAINING, INC.  
2533 North Ashland Avenue, Dept. RC-G3  
Chicago 14, Illinois.

Without obligation, give me complete facts showing how I may make my start in Television-Radio-Electronics.

Name \_\_\_\_\_ Age \_\_\_\_\_  
Street \_\_\_\_\_ Apt. \_\_\_\_\_  
City \_\_\_\_\_ Zone \_\_\_\_\_ State \_\_\_\_\_



WE'RE STILL IN  
THE *RADIO* BUSINESS

Seems as though everything nowadays is TV . . . TV . . . TV. We've had so much TV news for you! Hytron's new 16RP4 rectangular picture tube. Hytron's new low-cost deflection-circuit tubes: 1x2, 6BQ6GT, 6U4GT, 6W4GT, 25BQ6GT, and 25W4GT. And many more Hytron designed-for-TV tubes coming.

But we're still in the *radio* business — both of us. Radio still is king. We realize that. Also that most service problems are still radio — not TV. You can depend on Hytron *radio* tubes. Whether it is the original Hytron GT . . . miniature . . . G . . . metal . . . or loctal. For a-c/d-c, portable, f-m, phono, or auto radio. Hytron will strive to give you the most dependable *radio* (as well as TV) replacement tubes.



OLDEST MANUFACTURER OF RECEIVING TUBES  
**HYTRON**  
RADIO AND ELECTRONICS CORP.



MAIN OFFICE: SALEM, MASSACHUSETTS

**Relax! LET HYTRON TOOLS EASE YOUR WORK**

**SOLDERING AID 49c net**

**TUBE LIFTER 15c net**

**TUBE TAPPER 5c net**

BY THE MAKERS OF HYTRON TUBES

**FREE**  
New Hytron Tool Catalogue. Describes all the famous Hytron service-shop tools to date: Soldering Aid, Tube Lifter, 7-Pin and 9-Pin Straighteners, Tube Topper, and Auto Radio Tool. Find out how these Hytron tools can ease your work. Mail the coupon today.

HYTRON RADIO & ELECTRONICS CORP.,  
Salem, Massachusetts

I want to know how the Hytron tools can help me make more money. Please send me the free Hytron Tool Catalogue at once.

(PLEASE PRINT)

NAME .....

STREET .....

CITY .....

STATE .....

RADIO-ELECTRONICS for

# Study THE Features

# Heathkits ARE THE QUALITY LINE OF TEST EQUIPMENT KITS

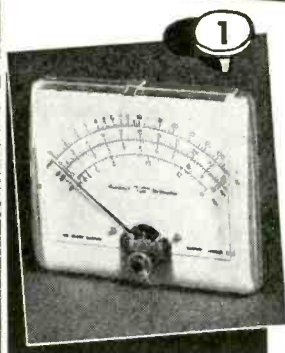

## 1 MODERN STYLING

Heathkits have brought a new conception of beauty to laboratories and service benches.

Many organizations have standardized on Heathkits to make their shops appear attractive and uniform.

The panels are produced in grey and maroon and the modern streamline aluminum handles give the instruments a pleasant, professional appearance.

There is no waste space or false effort to appear large in Heathkits—space on service benches is at a premium and the size of Heathkit instruments is kept as small as is consistent with good engineering design.

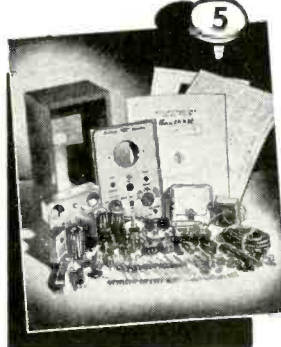

## 5 COMPLETE KITS

When you receive your Heathkit, you are assured of every necessary part for the proper operation of the instrument.

Beautiful cabinets, handles, two-color panels, all tubes, test leads where they are a necessary part of the instrument, quality rubber line cords and plugs, rubber feet for each instrument, all scales and dials ready printed and calibrated. Every Heathkit is 110V 60 cy. power transformer operated by a husky transformer especially designed for the job.

## BEST OF PARTS

You will find many famous names on the parts in your Heathkit. Mallory switches and filter condensers, Chicago Transformer Corporation and Electrical Assembly Transformers, Centralab Potentiometers, Belden Cable, IRC and Allen Bradley resistors, G.E. tubes, Cinch and Amphenol sockets with silver plated contacts, DeFrance variable condensers, Eby binding post and many other quality parts. The finest of parts are used to assure long trouble-free service from Heathkits.



## 2 PRECISION PARTS

Wherever required, the finest quality 1% ceramic resistors are supplied. These require no aging and do not shift. No matching of common resistors is required. You find in Heathkit the same quality voltage divider resistors as in the most expensive equipment.

The transformers are designed especially for the Heathkit unit. The scope transformer has two electrostatic shields to prevent interaction of AC fields.

These transformers are built by several of the finest transformer companies in the United States.

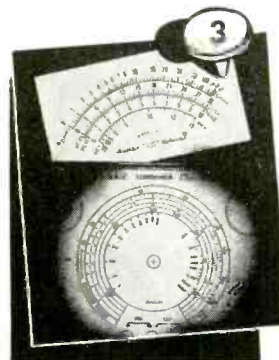
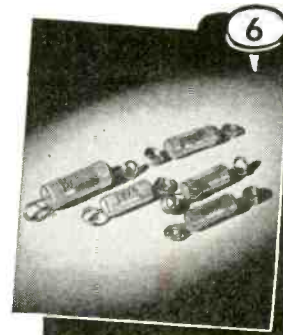

## 3 LARGE EASILY READ CALIBRATIONS

No charts or calculations are necessary to use any Heathkit properly. All scales are simply and plainly marked.

The operator instantly knows the proper use of the instrument and can proceed confidently. No multiplication is required as each scale is calibrated independently of the others.

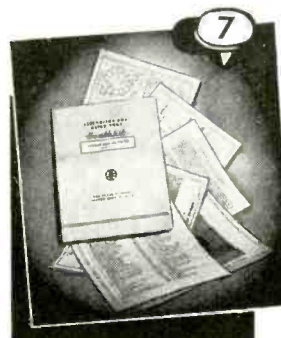

## 7 COMPLETE INSTRUCTION MANUALS

Everyone is pleased at the thorough instructions covering the assembly of each Heathkit instrument. Every detail of the assembly is covered, together with sections on the use of the instrument and trouble shooting instructions in case of difficulty. Actual photos of the assembled instrument enable fast and accurate assembly, clear schematics and pictorial diagrams of the confusing parts such as rotary switches, enable the wiring to be completed quickly.

## KITS THAT FIT

Heathkit chassis are precision punched to fit the quality parts supplied. The grey crackle aluminum cabinet and the two-color panels are die punched to assure proper fitting.

Many builders have written marveling at the ease with which assembly can be accomplished.

The chassis are specially engineered for easy assembly and wiring—there are no small, tight corners which cannot be reached—the ends of the chassis are left open in order that installation of parts and soldering can be done with both hands.

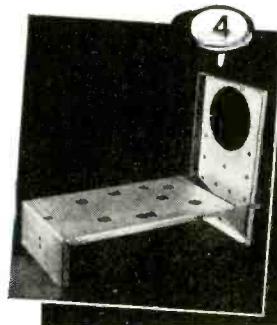

## 4 IDEAL FOR SCHOOLS

Heathkits have been adopted as standard equipment of many of the largest universities and colleges. The low cost plus the fact that the students learn by actual assembly make them ideal training mediums. Many high schools and small colleges are finding that they too can have a modern physics and electronics laboratory by using Heathkits.

Some of the largest technical schools recommend Heathkits to their students as the best means of securing the necessary equipment to start their own shops.



EXPORT DEPT.  
13 East 40th St.  
NEW YORK CITY (16)  
CABLE: ARLAB-N.Y.

# The HEATH COMPANY

... BENTON HARBOR 20, MICHIGAN

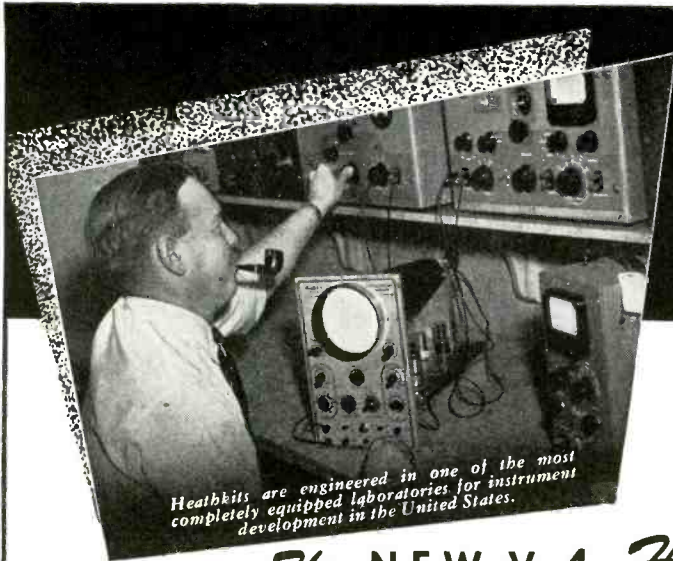

*Heathkits are engineered in one of the most completely equipped laboratories for instrument development in the United States.*

# Heathkits ARE LABORATORY ENGINEERED . . .

## The NEW V-4 Heathkit VACUUM TUBE VOLTMETER KIT

### Features

- Meter scale 17% longer than average 4 1/2" meter.
- Modern streamline 200 ua meter.
- New modern streamline styling.
- Burn-out proof meter circuit.
- 24 Complete ranges.
- Isolated probe for dynamic testing.
- Most beautiful VTVM in America.
- Accessory probes (extra) extend ranges to 10,000 Volts and 100 Megacycles.
- Uses 1% precision ceramic divider resistors.
- Modern push-pull electronic voltmeter circuit.
- Electronic AC circuit. No current drawing rectifiers.
- Shatterproof plastic meter face.

The new Heathkit Model V-4 Vacuum Tube Voltmeter has dozens of improvements. A new modern streamlined 200 microampere meter has Alnico V magnet for fast, accurate readings. The new electronic AC voltmeter circuit incorporates an entire new balance control which eliminates contact potential and provides greater accuracy. New simplified switches for quicker assembly. New snap-in battery mounting is on the chassis for easy replacement.

The Heathkit VTVM is the only kit giving all the ranges. Check them — DC and AC full scale linear ranges of 0-3V, 0-10V, 0-30V, 0-100V, 0-300V, 0-1000V and can be extended to 0-3000V and 0-10,000V DC with accessory probe at slight extra cost. Electronic ohmmeter has six ranges measuring resistance accurately from .1 ohm to one billion ohms. Meter pointer can be offset to zero center for FM alignment.

The DC probe is isolated for dynamic measurements. Has db scale for making gain and other audio measurements.

The new instruction manual features pictorial diagrams and step-by-step instructions for easy assembly. The Heathkit VTVM is complete with every part — 110V transformer operated with test leads, tubes, light aluminum cabinet for portability, giant 4 1/2" 200 microamp meter and complete instruction manual.

Order now and enjoy it this entire season. Shipping weight 8 lbs., Model V-4



# \$24.50

THE FINEST VTVM KIT AVAILABLE FOR THIS PRICE.

Accessory: 10,000V high voltage probe, No. 310, \$4.50.  
Accessory: RF crystal diode probe kit extends RF range to 100 Mc., No. 309, \$6.50.

## New Heathkit HANDITESTER KIT

### Features

- Beautiful streamline Bakelite case.
- AC and DC ranges to 5,000 Volts.
- 1% Precision ceramic resistors.
- Convenient thumb type adjust control.
- 400 Microampere meter movement.
- Quality Bradley AC rectifier.
- Multiplying type ohms ranges.
- All the convenient ranges 10-30-300-1,000-5,000 Volts.
- Large quality 3" built-in meter.

A precision portable volt-ohm-milliammeter. An ideal instrument for students, radio service, experimenters, hobbyists, electricians, mechanics, etc. Rugged 400 ua meter movement. Twelve complete ranges, precision dividers for accuracy. Easily assembled from complete instructions and pictorial diagrams. An hour of assembly saves one-half the cost. Order today. Model M-1. Shipping wgt., 2 lbs.



# \$13.50

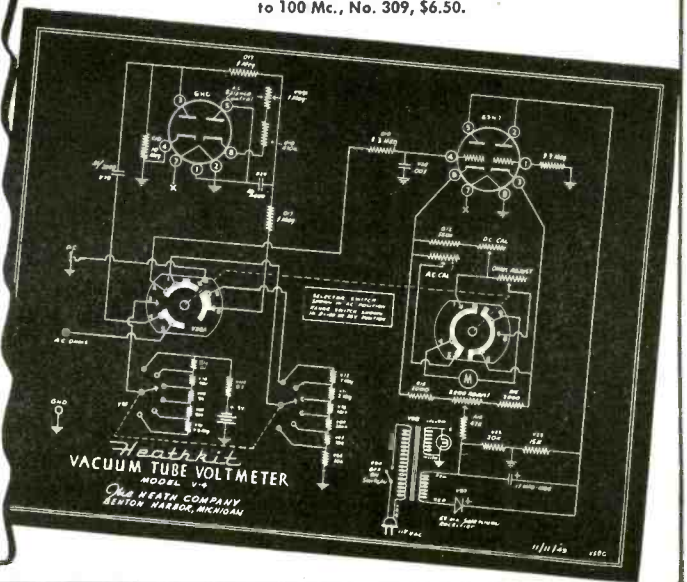

EXPORT DEPT.  
13 East 40th St.  
NEW YORK CITY (16)  
CABLE: ARLAB-N.Y.

# The HEATH COMPANY

... BENTON HARBOR 20, MICHIGAN

RADIO-ELECTRONICS for

# TEST INSTRUMENT KITS

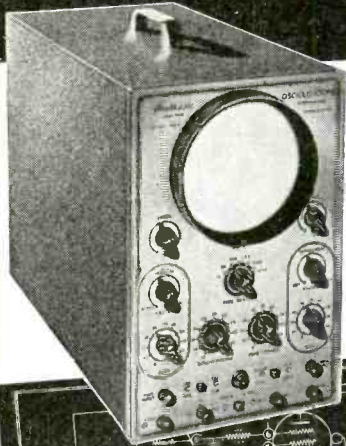

Only  
**\$39<sup>50</sup>**

## Heathkit PUSH-PULL EXTENDED RANGE 5" OSCILLOSCOPE KIT

### Features

- The first truly television oscilloscope.
- Tremendous sensitivity .06 Volt RMS per inch deflection.
- Push-pull vertical and horizontal amplifiers.
- Useful frequency range to 2½ Megacycles.
- Extended sweep range 15 cycles to 70,000 cycles.
- New television type multivibrator sweep generator.
- New magnetic alloy shield included.
- Still the amazing price of \$39.50.

The new 1950 Push-Pull 5" Oscilloscope has features that seem impossible in a \$39.50 oscilloscope. Think of it—push-pull vertical and horizontal amplifiers with tremendous sensitivity only six one-hundredths of a volt required for full inch of deflection. The weak impulses of television can be boosted to full size on the five-inch screen. Traces you couldn't see before. Amazing frequency range, clear, useful response at 2½ Megacycles made possible by improved push-pull amplifiers. Only Heathkit Oscilloscopes have the frequency range required for television. New type multivibrator sweep generator with more than twice the frequency range. 15 cycles to 70,000 cycles will actually synchronize with 250,000 cycle signal. Dual positioning controls will move trace over any section of the screen for observation of any part. New magnetic alloy CR tube shield protects the instrument from outside fields. All the same high quality parts, cased electrostatically shielded power transformer, aluminum cabinet, all tubes and parts. New instruction manual now has complete step-by-step pictorials for easiest assembly. Shipping weight, 25 lbs. Model O-5

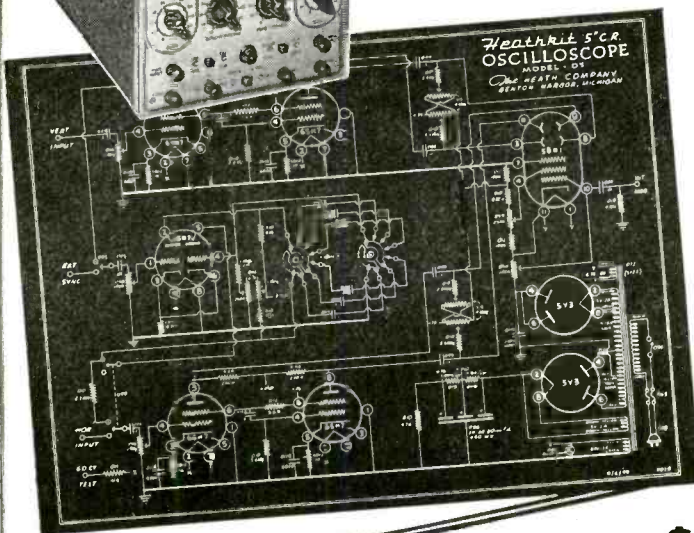

**\$34<sup>50</sup>**

## Heathkit

## ELECTRONIC SWITCH KIT

DOUBLE THE UTILITY OF ANY SCOPE

An electronic switch used with any oscilloscope provides two separately controllable traces on the screen. Each trace is controlled independently and the position of the traces may be varied. The input and output traces of an amplifier may be observed one above the other or one directly over the other illustrating perfectly any change occurring in the amplifier. Distortion-phase shift and other defects show up instantly, 110V. 60 cycle transformer operated. Uses 5 tubes (1 6X5, 2 6SN7's, 2 6SJ7's). Has individual gain controls, positioning control and coarse and fine switching rate controls. The cabinet and panel match all other Heathkits. Every part supplied including detailed instructions for assembly and use. Shipping weight 11 lbs. Model S-1

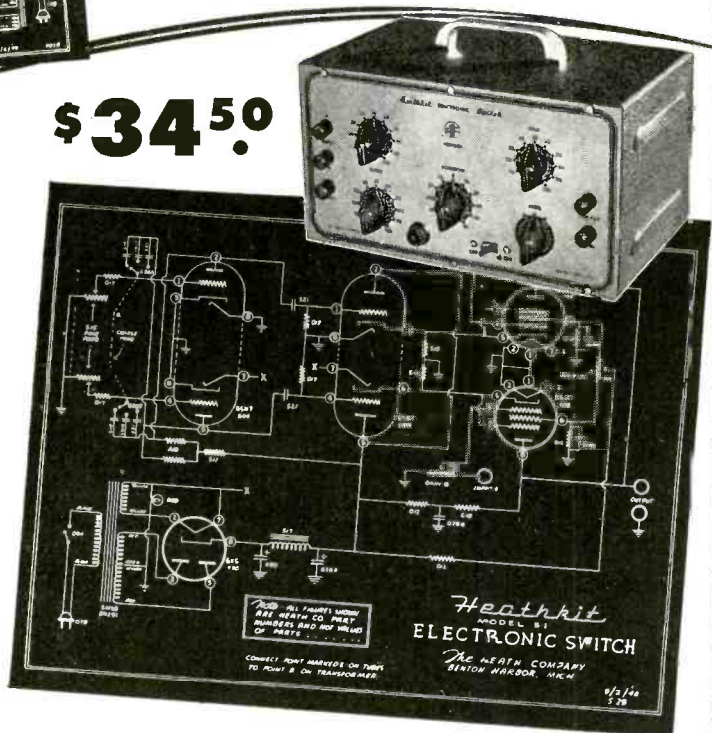

EXPORT DEPT.  
13 East 40th St.  
NEW YORK CITY (16)  
CABLE: ARLAB-N.Y.

The **HEATH COMPANY**

... BENTON HARBOR 20, MICHIGAN

MARCH, 1950

# Heathkits ENABLE THE BUILDER



By assembling your own laboratory equipment, you control the quality of workmanship and learn the entire story of the instrument.

## New 1950 VERNIER TUNING RF Heathkit SIGNAL GENERATOR KIT

### Features

- New 5-to-1 ratio vernier tuning for ease and accuracy.
- New external modulation switch — use it for fidelity testing.
- Covers 150 Kc. to 34 Mc. on fundamentals and calibrated strong harmonics to 102 Mc.
- 400 cycle audio available for audio testing.
- Most modern type R.F. oscillator.
- New precision coils for greater output.
- Cathode follower output for greatest stability.

The most popular signal generator kit has been vastly improved — the experience of thousands combined to give you the best. Check the features in this fine generator and consider the low price \$19.50. A best buy for any shop, yet inexpensive enough for hobbyists. Everyone can have an accurate controlled source of R.F. signal voltage.

The new features double the value — think of being able to make fidelity checks on receivers by inserting a variable audio signal. Internal 400 cycle saw-tooth audio oscillator modulates R.F. signal and is available externally for audio testing. The new 5-to-1 ratio vernier drive gives hairline tuning for maximum accuracy in scale settings. The coils are already precision wound and calibrated. Uses turret type coil and switch assembly for ease of construction. The generator is 110V. 60 cycle transformer operated and comes complete in every detail — cabinet, tubes, beautiful two color calibrated panel and all small parts — new step-by-step pictorial diagrams and complete instruction manual make assembly a cinch even for novices. Why try to get along without a signal generator when you can have the best for less than a twenty-dollar bill. Better order it now. Shipping weight, 7 lbs. Model G-5.

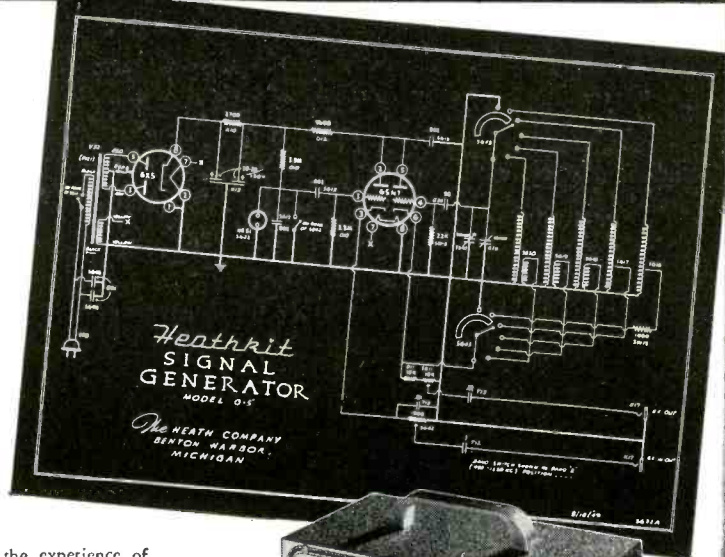

**\$19<sup>50</sup>**



**\$34<sup>50</sup>**

### Heathkit

## SINE AND SQUARE WAVE AUDIO GENERATOR KIT

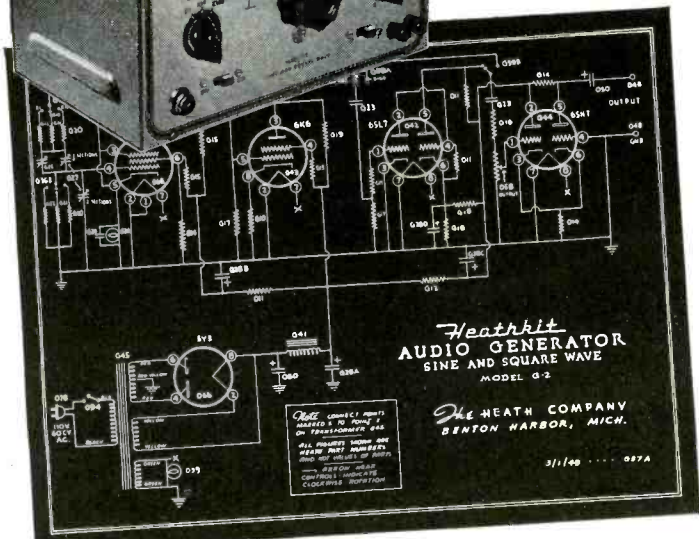

Experimenters and servicemen working with a square wave for the first time invariably wonder why it was not introduced before. The characteristics of an amplifier can be determined in seconds compared to several hours of tedious plotting using older methods. Stage by stage, amplifier testing is as easy as signal tracing. The low distortion (less than 1%) and linear output ( $\pm$  one db) make this Heathkit equal or superior to factory built equipment selling for three or four times its price. The circuit is the popular RC tuning circuit using a four gang variable condenser. Three ranges 20-200, 200-2,000, 2,000-20,000 cycles are provided by selector switch. Either sine or square waves instantly available at slide switch. All components are of highest quality, cased 110V. 60 cycle power transformer. Mallory F.P. filter condensers, 5 tubes, calibrated two-color panel, grey crackle aluminum cabinet. The detailed instructions make assembly an interesting and instructive few hours. Shipping weight, 12 lbs. Model G-2.

*Nothing ELSE TO BUY*

EXPORT DEPT.  
13 East 40th St.  
NEW YORK CITY (16)  
CABLE: ARLAB-N.Y.

**The HEATH COMPANY**

**... BENTON HARBOR 20, MICHIGAN**

RADIO-ELECTRONICS for



# TO USE THE *Best* OF WORKMANSHIP

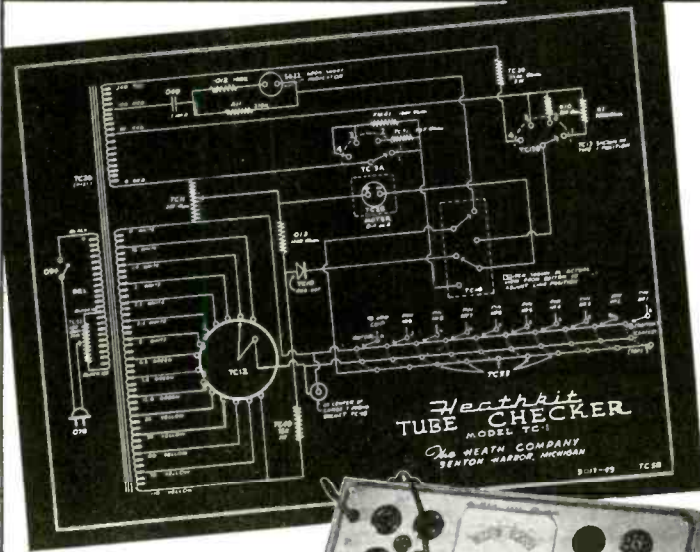

*Nothing*  
ELSE  
TO BUY

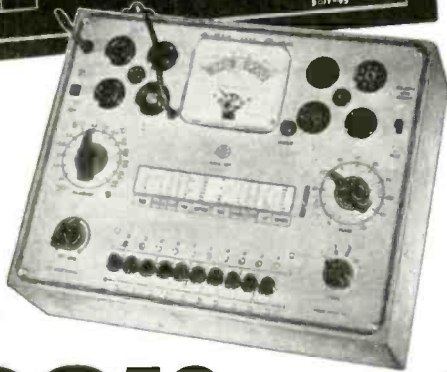

## *Heathkit* TUBE CHECKER KIT

### *Features*

1. Measures each element individually.
2. Has gear driven roller chart.
3. Has lever switching for speed.
4. Complete range of filament voltages.
5. Uses latest type lever switches.
7. Uses beautiful shatterproof full view meter.
8. Large size 11" x 14" x 4" complete.
9. Checks new 9 pin miniatures.

Check the features and you will realize that this Heathkit has all the features you want. Speed, simplicity, beauty, protection against obsolescence. The most modern type of tester — measures each element — beautiful Bad-Good scale, high quality meter — the best of parts — rugged oversize 110V. 60 cycle power transformer — finest of Mallory switches — Centralab controls — quality wood cabinet — complete set of sockets for all type tubes including blank spare for future types — fast action gear driven roller chart uses brass gears to quickly locate and set up any type tube. Simplified switching cuts necessary time to minimum and saves valuable service time. Short and open element check. No matter what arrangement of tube elements, the Heathkit flexible switching arrangement easily handles it. Order your Heathkit Tube Checker today. See for yourself that Heath again saves you two-thirds and yet retains all the quality — this tube checker will pay for itself in a few weeks — better build it now.

Complete with detailed instructions, all parts, cabinet, roller chart, ready to wire up and operate. Shipping weight, 12 lbs. Model TC-1.

Only **\$29<sup>50</sup>**

## *Heathkit* BATTERY ELIMINATOR KIT

Now a bench 6 Volt power supply kit for all auto radio testing. Supplies 5 - 7½ Volts at 10 Amperes continuous or 15 Amperes intermittent. A well filtered rugged power supply, uses heavy duty selenium rectifier, choke input filter with 4,000 MFD of electrolytic filter. 0 - 15 Volt meter indicates output. Output variable in eight steps. Excellent for demonstrating auto radios. Ideal for servicing — can be lowered to find sticky vibrators or stepped up to equivalent of generator overload — easily constructed in less than two hours. Complete in every respect. Shipping wgt., 19 lbs. Model BE-1

*Nothing* ELSE TO BUY

**\$22<sup>50</sup>**

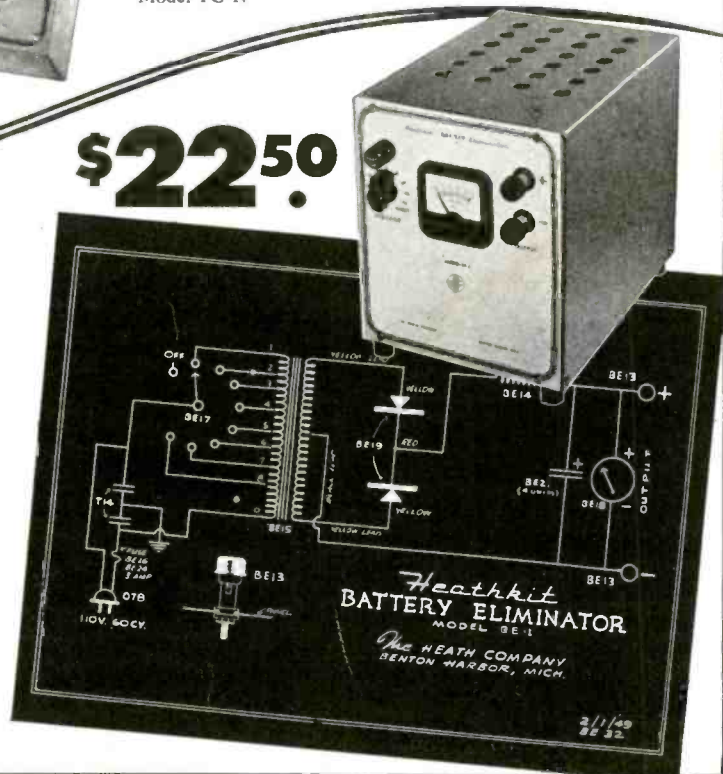

EXPORT DEPT.  
13 East 40th St.  
NEW YORK CITY (16)  
CABLE: ARLAB-N.Y.

*The* **HEATH COMPANY**

... BENTON HARBOR 20, MICHIGAN

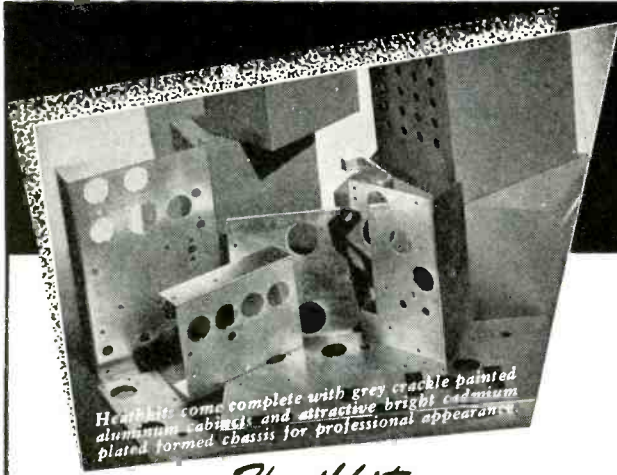

Heathkit comes complete with grey crackle painted aluminum cabinet and attractive bright cadmium plated formed chassis for professional appearance.

# Heathkits ELIMINATE

## Heathkit TELEVISION ALIGNMENT GENERATOR KIT

Everything you want in a television alignment generator. A wide band sweep generator covering all TV frequencies 0 to 46 — 54 to 100 — 174 to 220 Megacycles, a marker indicator covering 19 to 42 Megacycles, AM modulation for RF alignment — variable calibrated sweep width 0-30 Mc. — mechanical driven inductive sweep, Husky 110V, 60 cycle power transformer operated — step type output attenuator with 10,000 to 1 range — high output on all ranges — band switching for each range — vernier driven main calibrated dial with over 45 inches of calibration — vernier driven calibrated indicator marker tuning. Large grey crackle cabinet 16 1/8" x 10 3/8" x 7-3/16". Phase control for single trace adjustment. Uses three high frequency triodes plus 5Y3 rectifier — split stator tuning condensers for greater efficiency and accuracy at high frequencies — this Heathkit is complete and adequate for every alignment need and is supplied with every part — cabinet, calibrated panel, all coils and condensers wound, calibrated and adjusted, tubes, transformer, test leads — every part with instruction manual for assembly and use. Actually three instruments in one — TV sweep generator — TV AM generator and TV marker indicator.

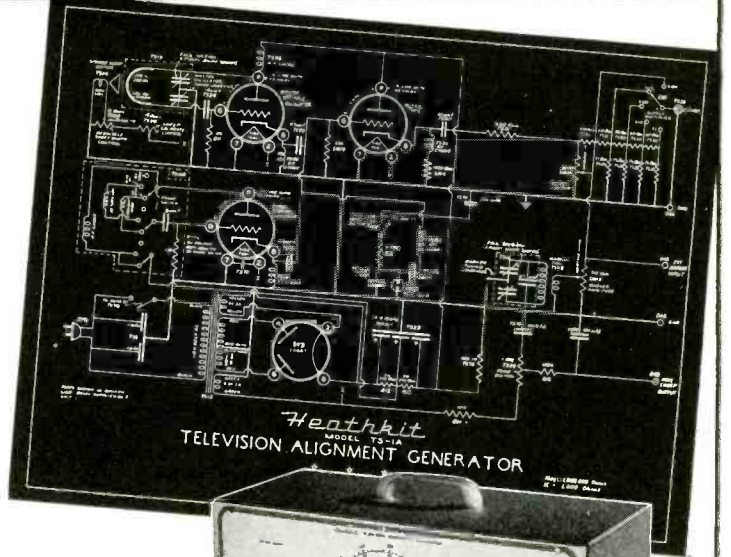

**\$39.50**

Shipping weight 20 lbs.  
Model TS-1A

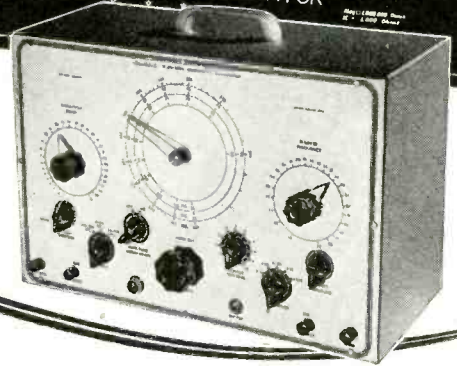

**\$69.50**

Shipping weight 15 lbs.  
Model IB-1

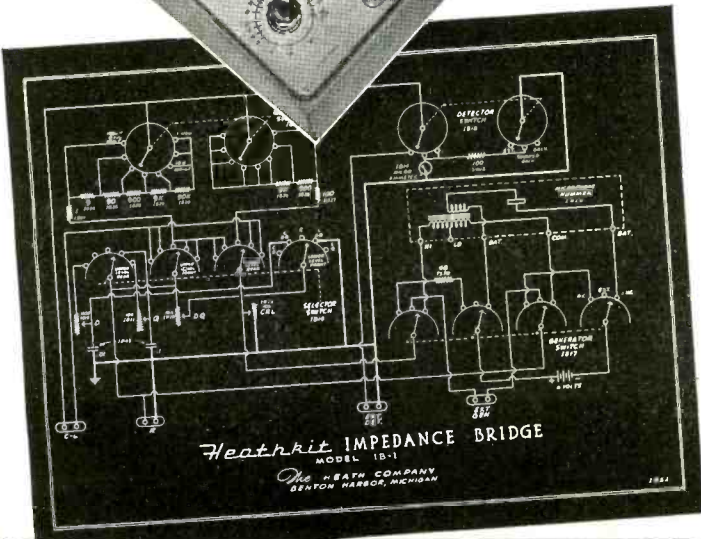

## New Heathkit

# IMPEDANCE BRIDGE KIT

A LABORATORY INSTRUMENT NOW WITHIN  
THE PRICE RANGE OF ALL

Measures inductance from 10 microhenries to 100 henries capacitance from .00001 MFD. to 100 MFD. Resistance from .01 ohms to 10 megohms. Dissipation factor from .001 to 1. "Q" from 1 to 1000.

Ideal for schools, laboratories, service shops, serious experimenters.

An impedance bridge for everyone — the most useful instrument of all, which heretofore has been out of the price range of serious experimenters and service shops. Now at the lowest price possible. All highest quality parts. General Radio main calibrated control. General Radio 1000 cycle hummer. Mallory ceramic switches with 60 degree indexing — 200 microamp zero center galvanometer — 1/2 of 1% ceramic non-inductive decade resistors. Professional type binding posts with standard 3/4" centers. Beautiful birch cabinet. Directly calibrated "Q" and dissipation factor scales. Ready calibrated capacity and inductance standards of Silver Mica, accurate to 1/2 of 1% and with dissipation factors of less than 30 parts in one million. Provisions on panel for external generator and detector. Measure all your unknowns the way laboratories do — with a bridge for accuracy and speed.

Internal 6 Volt battery for resistance and hummer operation. Circuit utilizes Wheatstone, Hay and Maxwell circuits for different measurements. Supplied complete with every quality part — all calibrations completed and instruction manual for assembly and use. Deliveries are limited.

EXPORT DEPT.  
13 East 40th St.  
NEW YORK CITY (16)  
CABLE: ARLAB-N.Y.

The **HEATH COMPANY**

... BENTON HARBOR 20, MICHIGAN

RADIO-ELECTRONICS for

# DIFFICULT METAL FABRICATION.....

## NEW *Heathkit* SIGNAL TRACER AND UNIVERSAL TEST SPEAKER KIT

The popular Heathkit Signal Tracer has now been combined with a universal test speaker at no increase in price. The same high quality tracer follows signal from antenna to speaker, locates intermittents, defective parts quicker, saves valuable service time, gives greater income per service hour. Works equally well on broadcast, FM or TV receivers. The test speaker has assortment of switching ranges to match push-pull or single output impedance. Also tests microphones, pickups, PA systems; comes complete—cabinet, 110V. 60 cycle power transformer, tubes, test probe—all parts and detailed instructions for assembly and use. Shipping Wt., 8 lbs. Model T-2.

**\$19.50**

*Nothing ELSE TO BUY*



**\$19.50**



## *Heathkit* CONDENSER CHECKER KIT

### *Features*

- Power factor scale
- Measures resistance
- Measures leakage
- Checks paper-mica-electrolytics
- Bridge type circuit
- Magic eye indicator
- 110V. transformer operated
- All scales on panel

Checks all types of condensers, paper-mica-electrolytic-ceramic over a range of .00001 MFD. to 1000 MFD. All on readable scales that are read direct from the panel. NO CHARTS OR MULTIPLIERS NECESSARY. A condenser checker anyone can read without a college education. A leakage test and polarizing voltage for 20 to 500 volts provided. Measures power factor of electrolytics between 0% and 50%. 110V. 60 cycle transformer operated complete with rectifier and magic eye tubes, cabinet, calibrated panel, test leads and all other parts. Clear detailed instruction for assembly and use. Why guess at the quality and capacity of a condenser when you can know for less than a twenty dollar bill. Shipping weight, 7 lbs. Model C-2.

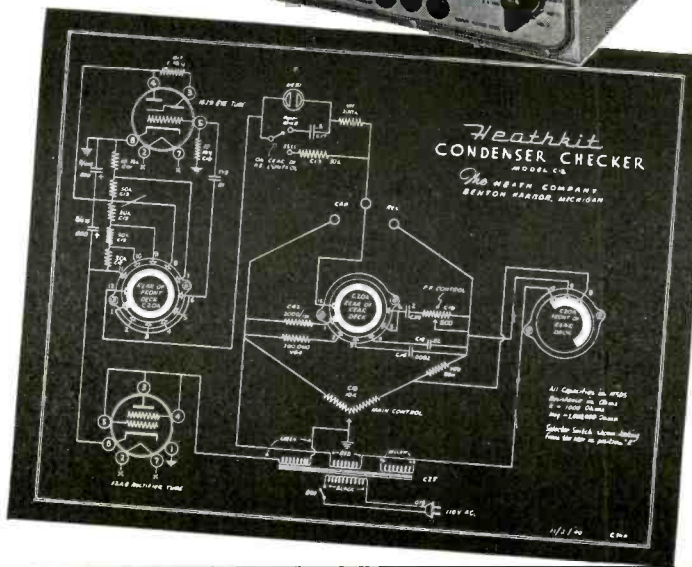

EXPORT DEPT.  
13 East 40th St.  
NEW YORK CITY (16)  
CABLE: ARLAB - N.Y.

**The HEATH COMPANY**

**... BENTON HARBOR 20, MICHIGAN**

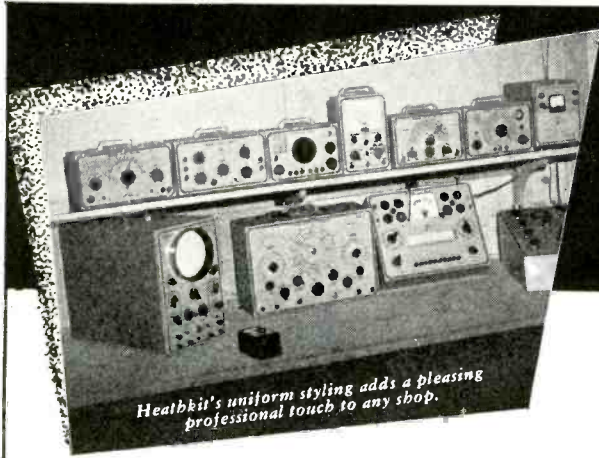

Heathkit's uniform styling adds a pleasing professional touch to any shop.

# *Heathkits* PROVIDE **PROFESSIONAL LABORATORY APPEARANCE**

**BROADCAST MODEL BR-1**  
550 to 1600 Kc.

**\$19.50**

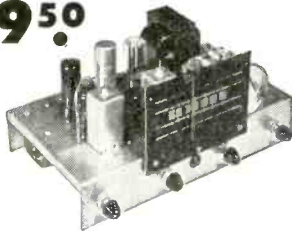

Ideal AC operated superheterodyne receiver for home use or replacement in console cabinet. Comes complete with attractive metal panel for cabinet mounting. Modern circuit uses 12K8 converter, 12SH7 input IF stage, 12C8 output IF stage and first audio 12A6 beam power output stage. 5Y3 rectifier. Excellent sensitivity for distant reception with selectivity which effectively separates adjacent stations.

The husky 110 V. cased power transformer is conservatively rated for long life.

The illuminated six inch slide rule dial is accurately calibrated for DX reception. Enjoy the pleasure of assembling your own fine home receiver. Has tone, volume, tuning and phono-radio controls. Chassis size 2 1/4" x 7" x 12 1/2". Comes complete with all parts including quality output transformer to 3.4 ohm voice coil, tubes, instruction manual, etc. (less speaker). Shipping Wt., 10 lbs. No. BR-1 Receiver \$19.50.

No. 335 Communications Type Table Model Metal Cabinet..... \$4.50  
No. 320 High Quality 5" PM Speaker for above..... 2.75

Two new Heathkit Superheterodynes featuring the best of design and material. Beautiful six inch slide rule dials — 110 V. 60 cy. AC power transformer operated—metal cased filters—quality output transformers, dual iron core metal can IF transformers — two gang tuning condenser. The chassis is provided with phono-radio switch—110 V. outlet for changer motor and phono pickup jack. Each kit is complete with all parts and detailed instruction booklet. Pictorial diagrams and step-by-step instructions make assembly quick and easy.

*New Heathkit*  
**BROADCAST AND 3 BAND  
SUPERHETERODYNE  
RECEIVER KIT**

**3 BAND MODEL AR-1**  
550 Kc. to 20 Mc.

**\$23.50**

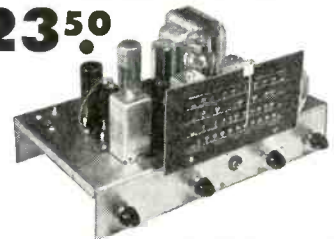

Enjoy the thrill of world wide short wave reception with this fine new AC operated Heathkit 3 band superheterodyne — amazing sensitivity 15 microvolt or better on all bands. Continuous coverage 550 Kc. to over 20 Mc. Easy to build with complete step-by-step instructions and pictorial diagram. Attractive accurately calibrated six inch slide rule dial for easy tuning. Six tubes with one dual purpose tube gives seven tube performance. Beam power output tube gives over 3 watts output.

Separately assembled coil turret with band switch eliminates difficult construction. Conservatively rated 110 V. power transformer supplies full operating voltages to all tubes for maximum reception. Has band switch, tuning, volume, tone and phono-radio controls. Chassis size 2 1/4" x 7" x 12 1/2" — supplied complete — punched chassis — tubes — controls — transformers (quality output to 3.4 ohm voice coil) — all small parts — hardware and instructions (less speaker). Shipping Wt., 10 lbs. No. AR-1 Receiver \$23.50.

No. 335 Communications Type Table Model Metal Cabinet..... \$4.50  
No. 320 High Quality 5" PM Speaker for above..... 2.75

*Heathkit*  
**PUSH-PULL HIGH FIDELITY  
AMPLIFIER KIT**



**\$12.50**

Build this high fidelity push-pull amplifier and save two-thirds the cost—has two pre-amplifier stages, phase inverter stage and push-pull beam power output stage. Comes complete with six tubes—quality output transformer (to 3.4 ohm voice coil) tone and volume controls—varnish impregnated cased 110V. power transformer and detailed instruction manual and all small parts. Six watt output with output flat within 1 1/2 db between 50 and 15000 cycles. Build this amplifier now and enjoy it for years. Shipping Wt. 7 lbs. Model A-4 12" PM Speaker for above..... \$6.95

## **ORDER BLANK**

<b>HEATH CO.</b> BENTON HARBOR MICHIGAN		FROM _____	<b>SHIP VIA</b>	
		_____	____Parcel Post	
		_____	____Express	
		_____	____Freight	
			____Best Way	
<b>Quan.</b>	<b>DESCRIPTION</b>	<b>Price</b>	<b>Total</b>	

ENCLOSED FUND  CHECK . . .  MONEY ORDER FOR \_\_\_\_\_  
PLEASE SHIP C.O.D. . . . POSTAGE ENCLOSED FOR \_\_\_\_\_ POUNDS

EXPORT DEPT.  
13 East 40th St.  
NEW YORK CITY (16)  
CABLE: ARLAB—N.Y.

# The **HEATH COMPANY**

**. . . BENTON HARBOR 20, MICHIGAN**

RADIO-ELECTRONICS for

# Sylvania's NEW

## Tube Testers

are one jump  
ahead of  
tomorrow!



MODEL 220

Once again Sylvania has anticipated radio and television developments. Sylvania's new tube testers, both counter and portable models, are not only capable of testing every modern receiving tube . . . they are calibrated to Sylvania's latest tube production standards.

Experts in tube-testing have built this new instrument . . . but you don't have to be an expert to operate it. Counter clerks, uninitiated in radio technicalities, can use it after a few minutes'

instruction. For the benefit of the customer, the illuminated meter reads "GOOD" or "REPLACE" for all tubes, including diodes. Gas tests can be made easily. It is the first tester with both circular and linear subminiature sockets. The new fast, smooth-running roll-chart is easily removable from the front panel.

Modern styling of both models tells even the layman that your up-to-the-minute service is one jump ahead of tomorrow!

MODEL 219

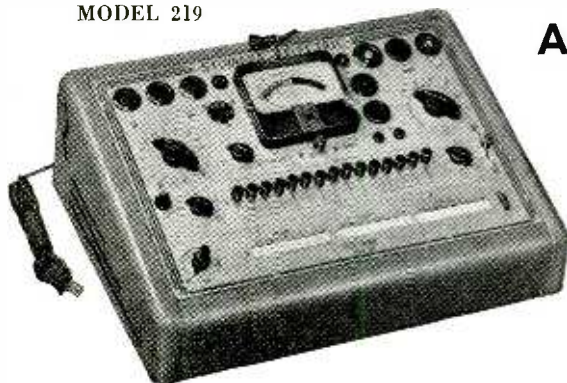

### A few more facts on what's NEW

In Tube Testers 219 (Counter) and 220 (Portable)

- Novel voltage controls prevent tube damage
- Switch-numbers correspond to tube pin-numbers
- Switching arranged for easiest operation
- Exclusive ohmmeter-type indicator for shorts and leakage
- Shorted tube reads "REPLACE"—no neon lamp
- Double-size power transformer

#### NOTE ON "KNOW-HOW"

A comprehensive explanation of tube characteristics and tube tester applications comes free in each Operating Manual.

# SYLVANIA ELECTRIC

RADIO TUBES; CATHODE RAY TUBES; ELECTRONIC DEVICES; FLUORESCENT LAMPS, FIXTURES, SIGN TUBING, WIRING DEVICES; LIGHT BULBS; PHOTOLAMPS  
MARCH, 1950

# Want To Double Your Pay?



## How To Pass **FCC** **COMMERCIAL** **RADIO OPERATOR** **LICENSE** **EXAMINATIONS**

**GET THIS AMAZING NEW BOOKLET FREE!**

Add Technical Training to Your Practical Experience and

### GET YOUR **FCC** **COMMERCIAL** **RADIO OPERATOR** **LICENSE**

**IN A FEW SHORT WEEKS!**

It's **EASY** if you use **CIRE Simplified Training & Coaching AT HOME** in **SPARE TIME**

Get your license easily and quickly and be ready for the jobs open to ticket holders which lead to \$3000 to \$7500 (average pay reported by FCC nationwide survey). CIRE training is the only planned course of coaching and training that leads directly to an FCC license.

**CIRE Job-Finding Service**  
**Brings Amazing Offers of Jobs!**

"I am working at WRJM as transmitter engineer, and I received this position in response to one of the employment applications sent me upon completion of my course and the receiving of my Diploma. I received my 1st class Radiotelephone License on March 2, 1949. I want to express my sincere appreciation to the staff of CIRE."



1. Tells of Thousands of Brand-New Better Paying Radio Jobs Now Open to FCC License Holders.

2. Tells How We Guarantee to Train and Coach You Until You Get Your FCC License.

3. Tells How Our Amazing **Job-FINDING** Service Helps You Get the Better Paying Radio Job Our Training Prepares You to Hold.

**YOUR FCC TICKET IS ALWAYS RECOGNIZED IN ALL RADIO FIELDS AS PROOF OF YOUR TECHNICAL ABILITY**

**Get All 3 FREE** Send Coupon Now!

**CLEVELAND INSTITUTE OF RADIO ELECTRONICS**  
Desk RE-15—4900 Euclid Bldg., Cleveland 3, Ohio  
(Address to Desk No. to avoid delay)

I want to know how I can get my FCC ticket in a few short weeks by training at home in spare time. Send me your amazing new FREE booklet "Money Making FCC License Information," as well as a FREE sample FCC-type exam and FREE booklet, "How to Pass FCC License Examinations" (does not cover exams for amateur License).

Name.....

Address.....

City..... Zone..... State.....

Veterans check for enrollment information under G.I. Bill

Student No. 2608 AT  
"Thanks for the Application for Employment you recently prepared for me. I found satisfactory employment. I submitted 57 letters, enclosing the resume you supplied. I received 17 letters indicating my application was filed for future reference; 3 telephone calls, and one letter requesting personal interviews. As a result, I am employed in a development engineering capacity."  
Student No. 4235 NB

**CLEVELAND INSTITUTE OF RADIO ELECTRONICS**  
Desk RE-15 • 4900 Euclid Bldg. • Cleveland 3, Ohio  
Approved for Veteran Training under the "G. I. Bill of Rights"

RADIO-ELECTRONICS for

# Home Radio-Electronics

. . . *A neglected, but lucrative field for technicians and experimenters . . .*

By HUGO GERNSBACK

**A**S POINTED out elsewhere in this issue, the home is the one place from which radio-electronics has been practically excluded for reasons difficult to fathom. If there is one place where such applications are definitely needed, it is in the home. There are literally hundreds of radio-electronic devices which can improve existing archaic conditions and make homes more secure and more healthful. In this short article we give only a few suggestions as to what can be accomplished in this direction.

It is well to note that most of the required apparatus and components are already in existence. By combining them, any clever constructor handy with tools can often achieve spectacular results.

**PHONE RECORDER:** There are a number of commercially made phone recorders on the market. Unfortunately, these are expensive. Yet home-made phone recorders are not difficult to build. One of the simplest and best methods is to devise a new cradle for the hand set to rest on. When the phone bell rings either a mechanical contact of the bell energizes a circuit or a microphone intercepts the sound and a small amplifier energizes a magnetic trip which raises the hand set. This starts a phonograph record revolving. The sound of the record is picked up by the microphone of the hand set, and the distant speaker is invited to leave his message, which is then recorded. After a few minutes the mechanism stops automatically and is ready for the next call.

All this sounds complicated, but is not. Such a system can be built for not too great a cost by anyone acquainted with radio-electronics and possessing a reasonable knowledge of mechanics. The device will soon pay for itself. It can be enclosed in a small box less than 1 foot square.

**RADIO ALARM:** The ordinary clock alarm is satisfactory only in that, if you set it once a day, it will faithfully wake you up at the prescribed hour. This is true of most existing mechanical or electrical alarm clocks. If, however, you forget to set them, you will not be called at the expected hour.

Clearly what is needed is a 24-hour alarm, there being no very low priced models on the market today. Anyone can take two cheap clocks, either mechanical or electric, mount them side by side and arrange a number of contacts so that the hour hand will sweep over them. These contacts can be 15 minutes apart around the clock. One contact—usually the 12 o'clock one—is electrically wired so that when the hour contact reaches 12 the circuit is automatically switched

to the next clock. Thus we have a 24-hour alarm. Simple contact trips are arranged to sound the alarm at any hour of the day or night. It is, therefore, possible not only to be awakened by radio, but one can also select any radio or television program during the day or evening which then turns on the radio or television set for any program desired.

**INTRUDER ALARM:** Burglaries in this country still run into the millions of dollars every year. Most of us are careless when we leave our homes unprotected. Expensive caretakers or watchmen are required for unoccupied country houses occupied only a few months during the year. The usual burglar alarms are not of much use.

Here is a suggestion for service technicians who can cash in on this situation, if they specialize in home protection. The main doors should be protected with infrared beams; breaking the beam will put into the circuit the alarm system explained further on. All windows should be protected with a thread, criss-crossing the window four to six times. The best material is a shoemaker's waxed thread, which is very strong, does not absorb humidity, and, therefore, does not stretch or shrink. These threads are thin and almost invisible when stretched across windows; any intruder touching them will close a contact. Normally the entire thread is under tension. Pushing against the thread increases the tension and closes one contact. Cutting the thread, closes another contact. Once a contact has been made by an intruder, either through the door or through the window, a series of bells ring outside the house simultaneously. At the same time the telephone hand-piece is lifted from its cradle and a small motor either rotates the phone dial to "Operator" or (on non-dial phones) energizes a phonograph which notifies the operator that the house has been broken into and that the police be notified. Such a system is practically fool-proof. Even if the intruder cuts the telephone wire, the racket of the ringing bells is sufficient to frighten off even the most stout-hearted burglar. In addition to setting off the bells, a number of house lights can be switched on automatically, making any intruder most uncomfortable.

There is a secret switch, its location known only to the rightful owner. This master switch is turned off when the owner wishes to enter the premises and therefore no alarm is set off.

These are only a few simple radio-electronic home suggestions. There are, of course, hundreds of other worth-while applications, many of which can be readily worked out by any of our enterprising readers.

# A De Luxe Televiser

## Part III—The audio, sweep, and power circuits are described in this issue

By  
**CHARLES A. VACCARO**

**C**OMplete details for constructing the video i.f. strip and tuner of the deluxe televiser were given in the January and February issues. The sound i.f., sweeps, audio, and power supply circuits will be discussed in this installment.

The schematic of the televiser is shown opposite. Note that the tuner circuit has been simplified by omitting the channel-selector switch and the various inductors. The 6AC7 video i.f. strip in this diagram can be used in place of the 6AG5 strip shown in Fig. 1 of the January installment.

Constructing the sound i.f. strip is the next step toward completing the televiser. The sound i.f. transformer, shown in Fig. 15, is constructed around the same type of forms and core material as the video i.f. transformers described in Part I. The forms are of  $\frac{3}{16}$ -inch o.d. Bakelite tubing,  $2\frac{1}{4}$  inches long. The cores are  $\frac{3}{16}$ -inch in diameter and  $\frac{3}{16}$ -inch long, with 1-inch screws. The primary and secondary have 19 and 14 turns, respectively. The windings are close-wound with No. 30 Formex- or Formvar-insulated wire and spaced as shown in the drawings of Fig. 15.

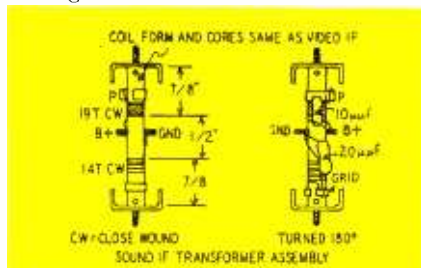

Fig. 15—The sound i.f. transformer.

The a.f. discriminator transformer, Fig. 16, is a little more difficult to construct because most of the discriminator-circuit components are mounted in it. Among the surplus permeability-tuned i.f. transformers that can be reworked to make the discriminator transformer are the double-tuned i.f.'s from the SCR-268 radar receiver and transformers bearing stock numbers P7763830G1 and P7763832G1 and code numbers T308 and T310. The last two items are available at Wholesale Radio Co., 206 S. Fulton Avenue, Mount Vernon, N. Y. If these or similar items

are not available, the transformer can be assembled from a  $2\frac{3}{4}$ -inch piece of  $\frac{3}{8}$ -inch, low-loss tubing and two powdered-iron cores (J. W. Miller Co. type

**The chassis layout and drilling template being much too large to be reproduced here, the author has agreed to supply full-size, black-and-white prints of the chassis layout, a chassis wiring layout diagram, drawings of the potentiometer and C-R-tube mounting brackets, and a large schematic, for \$2.50. Be sure to make your postal note or money order payable to Charles A. Vaccaro, c/o Radio-Electronics.**

**Because of the many components used in this receiver, a complete parts list is much too long to be included in any one installment; therefore, a parts list will be sent to readers who request it. Address Parts List, Radio-Electronics, 25 West Broadway, New York 7, N. Y., and enclose a stamped, self-addressed envelope.**

1703 or equivalent) ground down for a sliding fit inside the form.

Cut top and bottom plates from sheet bakelite or similar material and drill holes for eyelets as shown in Figs. 16-d and 16-e. Mount a slug in the bottom plate and mark the coil dimensions on the form. The outside coils are wound in the same direction and can be wound as one continuous coil. Fasten one end of the wire at a convenient place at the top of the form and wind the upper coil, adding a few more turns than are shown in Fig. 16-a. Wind five or six widely spaced turns to bring the wire to the point at which the lower coil begins. Add a few extra turns at the bottom of this coil; tuck the loose end of the wire into the bottom of the form and wedge it in place. This keeps the wire tight while the coils are being coated with cement. When the cement is thoroughly dry, cut the wire in the center of the form and unwind it so the insides of the upper and lower coils are spaced as shown in Fig. 16-a. Unwind the outsides of the coils until each has the correct number of turns. Leave approximately 2 inches of wire on each end for leads. Wind the center coil, making sure it is wound in the opposite direction from the others. Coat it with cement and let it dry. Trim this coil to the correct number of turns and spacing. Leave about 2 inches for leads. The three coils on this transformer are wound with No. 24 Formex wire.

The posts or terminals are made from No. 16 solid, tinned-copper wire. They should have a small hook on the

bottom end and should be long enough to project  $\frac{1}{16}$  inch above the top plate. Insert the posts in the bottom plate, soldering them to the eyelets. Fasten the form to the bottom plate and bend the leads as shown in Fig. 16-e. Strip and tin the leads and clip them to approximately 1 inch. Add the top plate, and solder the posts to the eyelets to hold it in place. Solder the leads, capacitors, and resistors to the terminals. Make sure that these components will not interfere with the shield can which will be placed over the assembly. Place a loose-fitting rubber grommet over the screw of the top slug to prevent the shield from shorting to the solder or eyelets.

The variable inductor in the cathode return of the 6SN7 horizontal multivibrator is a surplus inductor bearing the number P7764182G1 and code L201, obtained from Westchester Wholesale Radio Co. If this coil is not available, one like the 21-25-mc trap coil shown in Fig. 4 can be constructed. This coil should have an inductance of 2 mh to resonate at 15,750 cycles with a .05- $\mu$ f capacitor. A range of 1.5 to 2.9 mh can be obtained by winding 520 turns on a  $\frac{3}{16}$ -inch form, 460 turns on a  $\frac{3}{8}$ -inch form, or 380 turns on a  $\frac{1}{2}$ -inch form. Approximately 56 feet of No. 36 s.s.c.

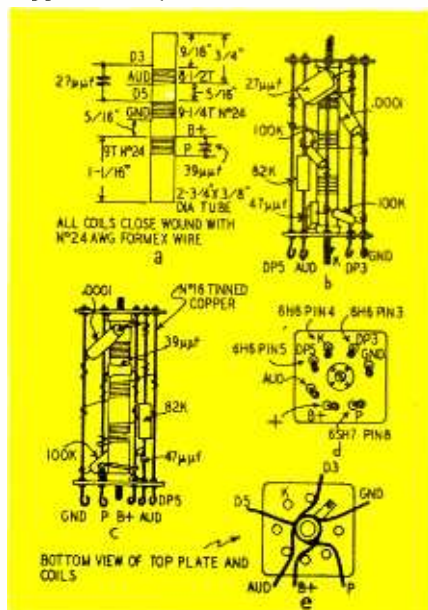

Fig. 16—Details for building and winding the sound discriminator transformer.

RADIO-ELECTRONICS for



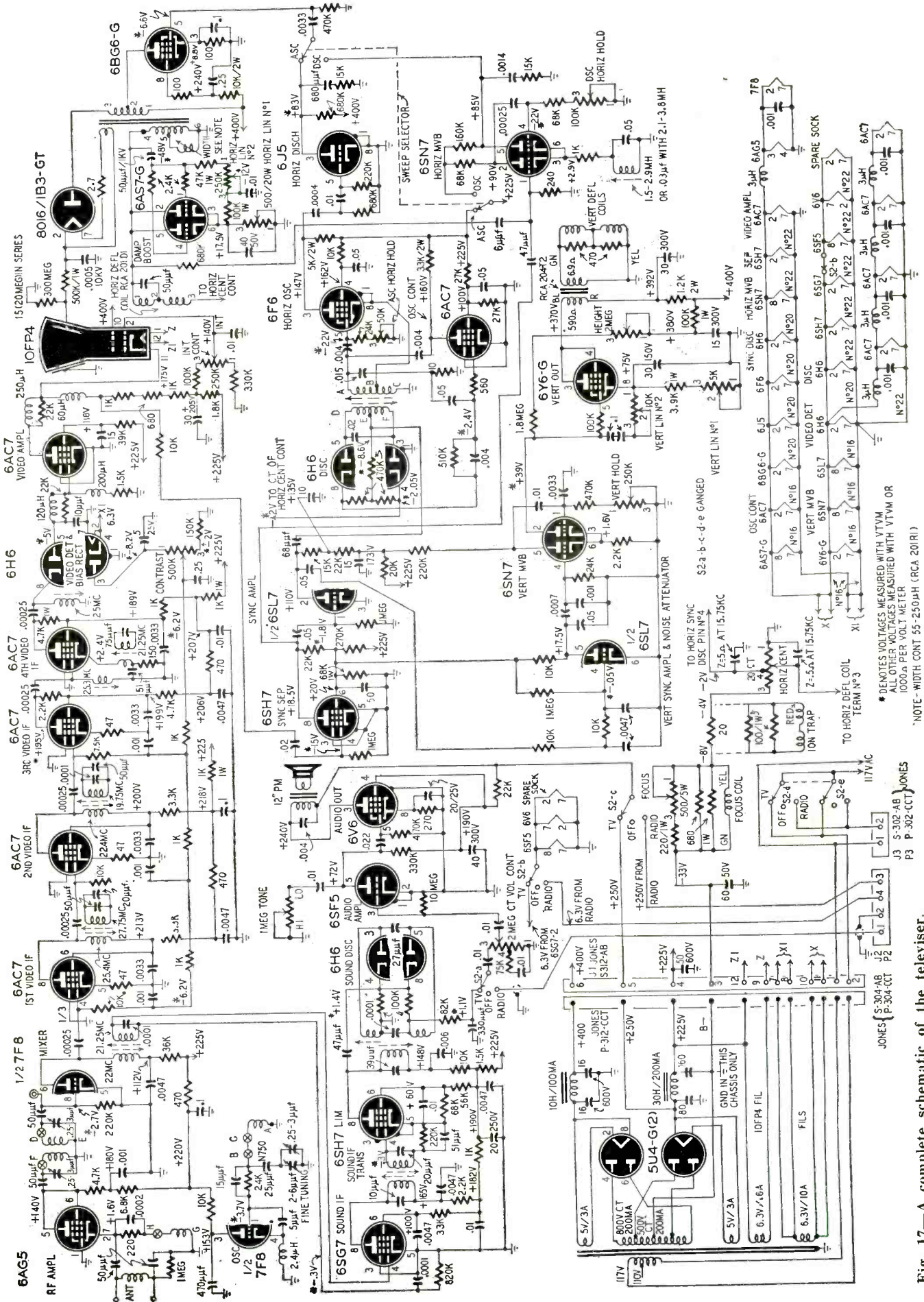

Fig. 17—A complete schematic of the televiser.

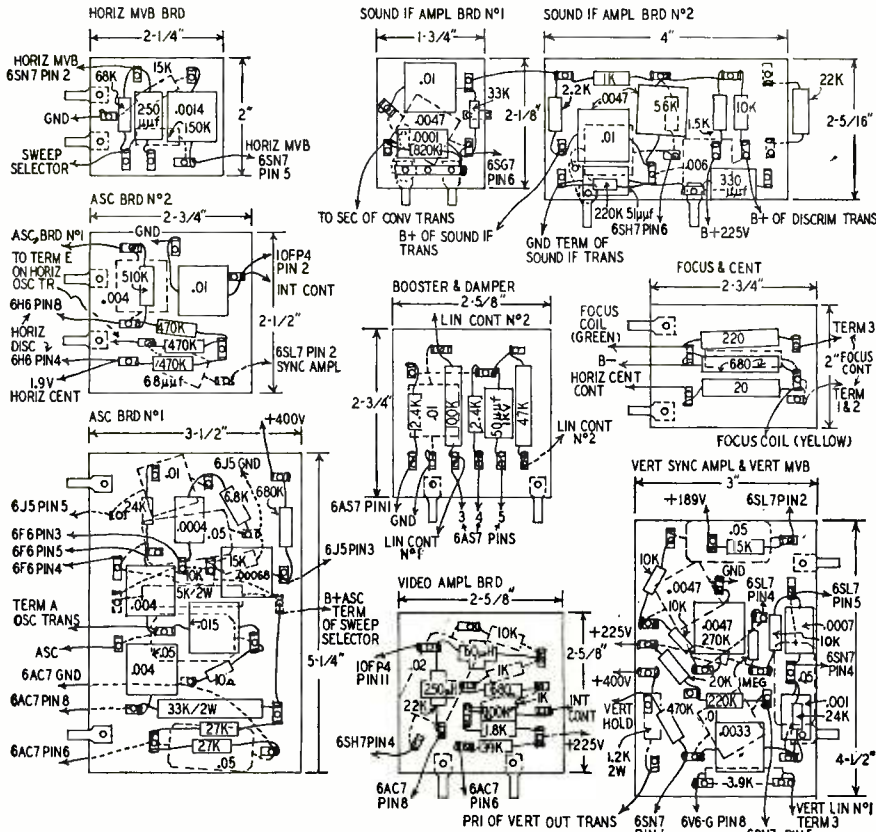

Fig. 18—Most of the smaller components are mounted on terminal boards as shown.

enameled wire will be required for winding the inductor on either of these forms. The coil is random-wound to occupy approximately 3/8 inch directly over the powdered-iron core when it is screwed all the way in. Hold the coil in place with household cement.

Most of the smaller components are on mounting boards, as shown in Fig. 20. These boards (see Fig. 18) are constructed in much the same manner as those used in the video i.f. amplifier described in the January issue. Note that some of the boards have soldering lugs under the nuts which hold the

3/16 inch with a 1/4-inch drill. Place the lugs on the smooth side of the plastic and ream them over in the depressions made by the countersink. Remove all pins except Nos. 2, 4, and 7 from the rectifier tube socket and mount it with its pins on the terminal side of the board as shown in Fig. 21.

The two independent, low-voltage power supplies are on a separate chassis. One delivers 250 and 225 volts and

the other 400 volts. The transformer shown in Fig. 17 is a surplus unit having a multiple high-voltage secondary; two 5-volt, 3-amp. windings for rectifiers; a 6.3-volt, 0.6-amp. winding for the C-R tube; and a 6.3-volt, 10-amp. heater winding for the other tubes in the set. Almost any combination of transformers can be used if they deliver 250 volts at 175 ma or more and 400 volts at 60 ma or more. If the output of your supply is not more than 20 volts high, it can be reduced by using a smaller input filter capacitor and by using a filter choke having a higher resistance. Increase the voltage by using a larger input filter capacitor.

The heaters require 10 or 12 amperes. Two or more low-current filament transformers can be paralleled to supply this current. Connect an a.c. voltmeter across the paralleled secondaries and connect the primaries in parallel across an a.c. line. The meter should deflect as soon as the power is turned on. If it does not, immediately turn off the power and reverse one of the windings. This insures that the transformers are correctly phased.

All leads to and from the low-voltage chassis are in a 12-conductor cable which is terminated with a Jones type P-312-CCT male connector which plugs into a type S-312-AB socket on the receiver chassis. The cable is made from 4-foot lengths of No. 14 or 16 flexible wire. Two of these are connected in parallel for each side of the 6.3-volt, 10-ampere filament line. Each of the pairs is connected to the same terminal on the transformer and to separate terminals on the plug and socket.

The chassis, 18 x 19 x 4 inches, was bent from soft aluminum sheet, .064 inch thick, and the high-voltage power supply is in a two-piece metal box 9 1/2

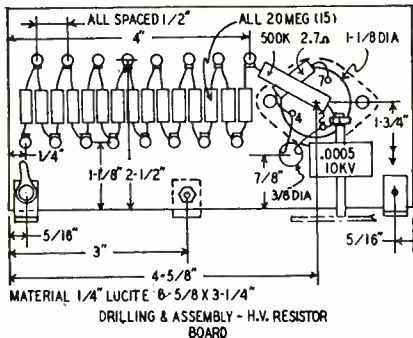

Fig. 19—The h.v. rectifier components.

space bolts. Solder the lugs to the nuts to insure a good ground at these points.

The high-resistance bleeder in the high-voltage supply consists of 15 20-megohm resistors mounted on a Plexiglas or Lucite sheet and connected in series as shown in Fig. 19. The resistors are soldered to eyelet-type soldering lugs. To fasten these lugs to the plastic board, drill 3/8-inch holes for the lugs and countersink one side of each hole

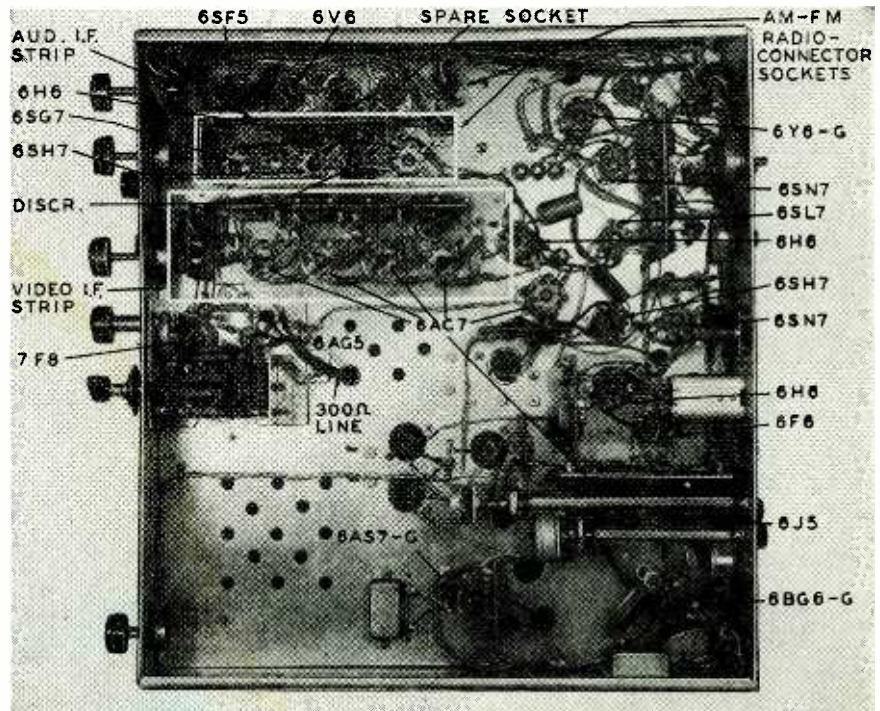

Fig. 20—Terminal boards keep the underchassis free from a maze of wires.

inches deep, 3½ inches wide, and 7 inches high. It can be made from solid metal sheet or from perforated metal screening.

When the chassis and the various metal brackets and fittings have been made and all components installed on their mounting boards, begin wiring the chassis. Connect the heaters as shown in Fig. 17. The wire sizes given are selected for minimum voltage drop in the heater circuit. Use two twisted wires and ground only at the points indicated. Continue with the rest of the wiring, using almost any procedure desired. One method is to start in the corner near the TV-OFF-RADIO switch and work down this side of the chassis, installing mounting boards, filter capacitors, potentiometers, and other components as they are needed. Leave out heavy or bulky components until the major part of the wiring is completed. Use a good grade of flexible insulated wire for the connections. The mounting boards are designed so bare copper wire can be used in most cases. We suggest that the wires from the boards be wrapped around the tube socket terminals rather than placed in the holes. This facilitates removal of the boards if it ever becomes necessary.

Before installing the tuner on the chassis, put four soft rubber grommets in the four large mounting holes. Place lockwashers on two ¼ x 6-32 screws and fasten these permanently in the two mounting holes in the top section of the chassis with 6-32 nuts. Slide the tuner into position by placing the shafts at the front into the two large holes in the front of the chassis and pushing the unit down on the two mounting screws. Place a washer on each of these screws to cover the grommet, then a nut pulled only tight enough to allow the front end to float. Place the solder terminals at the end of the braid on the screws; put another nut on top of these and pull it up tightly. Repeat for the two mounting holes on the front of the chassis with the exceptions that a nut is not used against the chassis and the screw on the right side does not have a grounding braid.

### Editor's Note

Inquiries from readers have indicated that a number of points needed clarifying in the first installment of the article "De Luxe Televiser" in the January issue.

The mixer plate decoupling capacitor is shown as .003 µf in Fig. 1 and as .0047 µf on board No. 1 in Fig. 6. Both values will work; however, the larger value is preferred.

The dimensions for the terminal boards shown in Fig. 1 (January issue) are: No. 1, 2½ x 2¾ inches; Nos. 2, 3, and 4, 1¾ x 2¾ inches; No. 5, 2 x 2¾ inches.

The notch in the lower left corner of the video i.f. chassis (Fig. 5) is ½ inch deep and its left edge is 1½ inch from the left side of the drawing.

On the 6AC7 i.f. strip, Fig. 5-a, add grounds from the No. 1 pin to the socket ground between pins 1 and 2

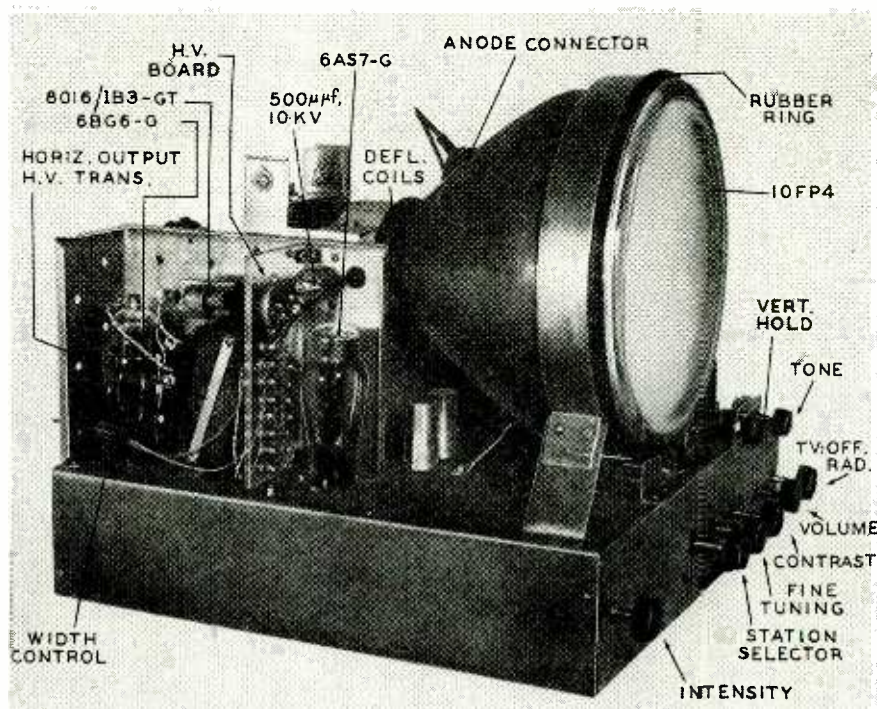

Fig. 21—Side view of the receiver. Note layout of parts in high-voltage supply.

on the first three stages only. The ground leads between pins 3 and 4 remain as they are.

Formex and Formvar insulated wire is used in small motors and generators. This wire can be obtained from most electric motor and armature repair shops. A number of surplus stores sell unmounted field coils wound with wire suitable for winding some of the coils.

A number of the mica and ceramic capacitors used in this set have JAN values such as .0033 µf, and 51 and

75 µf. Such values are widely available on the surplus market but are seldom available from regular manufacturer's stock. If the required values are not available, get the nearest commercial value or parallel standard values to get the required value.

The double-eyelet terminals were obtained from World-Wide Radio, 88 Cortlandt St. and the bakelite tubing from Highridge Electronics, 343 Canal St. and Edlie Electronics Inc. 154 Greenwich St., both in New York.

## Reports From Television DX-ers

TELEVISION viewers in many parts of the country are receiving programs over long distances. Here are some of their reports.

George E. Marshall, Wichita, Kans., received WPTZ, Philadelphia, Pa., and WMAR-TV, Baltimore, Md., at 8 pm on November 1. Sound and picture were excellent for 45 minutes. A Motorola 10-inch receiver and Regency booster were used with a Hy-Lite Yagi antenna 3 feet above the chimney of a two-story house.

Mrs. Renee Pannell, Allendale, Ill., reports several instances of dx reception. The most interesting are WBAP, Fort Worth, Tex., and WATV, Newark, N. J., each of which were received several times. The receiver was a G-E 805 and the antenna a Telrex. Mrs. Pannell, incidentally, is a ham and a radio service "man."

Edwin Cox, Garden City, Kans., reports reception of WMBR-TV, Jacksonville, Fla., at 8:10 pm on November 16, 1949. Sound was good but the picture was a little spotty. A Sentinel 1U-400TV receiver was used with a Jerrold booster and a Workshop 2A-4 antenna.

R. H. Hall, San Diego, Calif., received KRLD-TV, Dallas, Tex., on

channel 4—with the Los Angeles channel-4 station on the air at the same time. There was no interference when the antenna was rotated correctly for each. The antenna is a stack of four folded dipoles and the receiver has an RCA 630TS front end. KRLD-TV was received on December 6 from 5:10 to 5:45 pm.

Don Ossege, Toledo, Ohio, received KNBH, Los Angeles, Calif., on September 11, with a Magnavox CT-220 receiver and high- and low-band folded dipoles with reflectors.

Floyd Murphy, Thompson, Ohio, received a test pattern from KLEE-TV in Houston, Tex., last July 5. On one occasion he viewed a program relayed through a Stratovision aircraft with the call W10XWB. A Du Mont Chatham receiver was employed with an RMS booster.

Nelson B. Teal, Burlington, N. C., reports receiving three dx stations on a July afternoon last year. First WBAP, Fort Worth, Tex., came in for several hours. Then KLEE-TV in Houston was seen with a signal strong enough to wash out all local ignition noise. After that, channel 4 yielded excellent reception for the rest of the day from WKY-TV, Oklahoma City.

# Television Dictionary

(Continued from page 33 of the February issue)

## Dissector

A type of pickup tube used in the television camera, more properly referred to as an *image dissector*. The scene to be televised is focused through a system of lenses upon a photosensitive surface. The electron emission from every point on this surface is directly proportional to the intensity of the light falling upon that point. Since emission takes place simultaneously from all points on the surface, an electron image corresponding to the optical image is formed. This electron image is deflected in such a manner that a small portion of it at a time passes through a window or aperture, on the other side of which is an electron-multiplier tube. The output contains signal currents corresponding to the optical image.

## Diverging lens

A lens which causes the light passing through it to diverge or spread

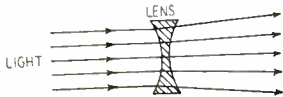

out. Such a lens is thinnest at its center and becomes thicker toward the edges.

## Dynode

An intermediate electrode between the cathode and plate of an electron-multiplier tube. The dynode emits many secondary electrons for each incident electron striking it. (See Electron multiplier tube.)

## E

### Electromagnetic deflection

The process of bending or altering the path of an electron stream by means of a magnetic field. The magnetic field is normally created by the passage of current through deflection coils.

### Electron lens

An arrangement of electrodes for focusing or otherwise influencing the electron stream in a manner comparable to the way a beam of light is influenced by optical lenses.

### Electron multiplier tube

A tube in which many electrons eventually arrive at the plate for every electron leaving the cathode. Electrons emitted from the cathode are attracted by a positive charge

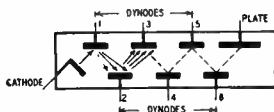

on an adjacent electrode called a dynode. For every electron striking it, the dynode produces several secondary electrons. The secondary electrons are attracted to a second dynode where secondary emission again produces additional electrons. A number of such dynodes may be used, the number of electrons being increased considerably

before they eventually reach the plate.

### Electronic scanning

Scanning of a television image by means of an electron beam, as distinguished from mechanical scanning.

### Electrostatic deflection

The process of bending or deflecting the electron stream in a cathode-ray tube by the use of an electrostatic field, as distinct from electromagnetic deflection which employs a magnetic field for the same purpose.

## F

### Field

The picture information produced by scanning the image from top to bottom in the standard interlaced scanning system. The odd and even lines are scanned separately; thus two fields are necessary to produce the complete picture.

### Field frequency

The number of fields scanned per second. Under present television standards, this frequency is 60 fields per second.

### Field of view

The area included in a televised image as "seen" by the camera.

### Field period

The length of time required to scan one field. The field period is equal to 1 divided by the field frequency.

### Field repetition rate

Same as field frequency.

### Flicker

The visual sensation resulting from presenting a series of images at a slow rate. This rate must be at least 16 per second to enable the persistence of vision of the eye to fill in the time interval between successive images. In standard television practice, the fields are presented at a rate of 60 per second.

### Fluorescent screen

The face of a cathode-ray tube when the inside of the glass is coated with phosphor.

### Flyback

In cathode-ray tubes, the return of the spot between successive sweeps. Flyback is also known as retrace. In some oscilloscopes and in all television receivers, the cathode-ray tube is biased beyond cutoff during this period.

### Flying spot

A system of televising in which a phototube is used instead of an inoscope or other conventional pickup tube. The image to be tele-

vised is scanned by a small spot of light. This light, reflected or directed into the phototube, produces the signal currents.

### Focal length

In an optical system, the distance between the center of the lens or

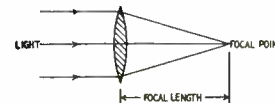

mirror and the point at which the rays of light converge. The focal length is also called the focal distance.

### Focal point

The point at which the rays of light converge after passing through a lens or after being reflected from a mirror. The distance between this point and the center of the lens or mirror is the focal length.

### Focus

Influencing a ray of light or a stream of electrons so that it converges to as small a point as possible.

### Focusing control

The adjustment which varies the potential of the first anode in a cathode-ray tube. When it is properly adjusted, the stream of electrons converges to a sharp point at the exact instant it strikes the fluorescent screen.

### Foot-candle

A unit of measurement for indicating intensity of illumination upon a surface. One foot-candle is the intensity of illumination on a surface located at a distance of 1 foot from a 1-candlepower source.

### Frame

The total picture information contained in a scanned image. In the standard interlaced scanning system, one frame consists of two fields. The frame frequency is therefore equal to one-half of the field frequency, or 30 frames per second.

### Frequency divider

A circuit which produces an output frequency equal to a submultiple of the input frequency. The input signal is applied to the plate of a diode which has a capacitor in its cathode lead. On the positive alternations of the input signal, the diode conducts and charges the capacitor. On each successive posi-

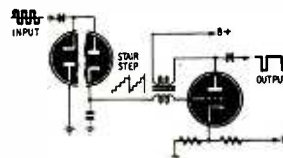

tive alternation the capacitor receives an additional charge. The voltage across the capacitor therefore builds up in the form of stair-steps.

The voltage of the capacitor is applied to the grid of a modified blocking oscillator, which is biased beyond cutoff by the application of positive voltage to its cathode. When the charge on the capacitor has built up sufficiently to overcome the cutoff bias, the triode conducts current. The flow of triode plate current through the primary of the transformer induces a voltage in the secondary. This induced voltage is of such polarity that it drives the triode grid positive. The resultant flow of grid current discharges the capacitor, and the cycle repeats itself. Since the blocking oscillator is pulsed once for a number of input steps, its output frequency is equal to a submultiple of the input frequency. Frequency dividers are also known as counters.

## G

### Ghost

A duplicate image on the screen of a television receiver. The ghost image is caused by a reflected signal which arrives at the receiver a short time after the direct signal.

### Grounded-grid amplifier

A circuit in which the incoming signal is applied to the cathode rather than to the grid of the tube. A stage of this type, also called a cathode-input amplifier, has a low input impedance. It is sometimes used as the input stage in television receivers to match the low impedance of the antenna.

## H

### Halation

An area of glow surrounding the spot on a fluorescent screen. Halation causes blurring of the television image.

### Halo

A ring of light surrounding the spot on a fluorescent screen.

### Height

The vertical dimension of a television image.

### Hold controls

The adjustments which control the free-running frequency of the horizontal and vertical sweep oscillators in a television receiver.

### Horizontal blanking

The application of cutoff bias to the cathode-ray tube during the horizontal retrace.

### Horizontal centering control

The adjustment which permits the television image to be shifted in the horizontal direction so that it may be centered on the screen.

(To be continued)

# Television Service Clinic

## National model NC-TV 7

To insure proper operation of this receiver with low line voltage, the manufacturer recommends adding an autotransformer to give the required voltage either at 105 or 115 volts a.c. Fig. 1-a shows the circuit. Putting the fuse in a second fuse holder (labeled 105-115) compensates for low line voltage.

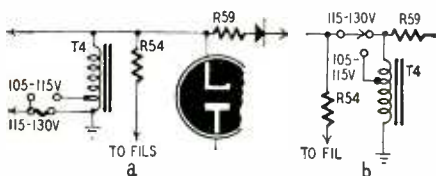

Fig. 1—Autotransformer raises voltage.

In Fig. 1-b the autotransformer is connected to raise only the B-plus voltage. A switch permits the set owner to compensate for low line voltage at certain times.

## Du Mont metal tube

The new 19-inch metal-envelope Du Mont picture tube has some unique features which require special attention when the tube is substituted for any other.

The horizontal deflection angle is 70 to 75 degrees while the standard 10-, 12-, 15-, and 16-inch picture tubes have a 55-degree angle. (The new 16GP4 has a 70-degree deflection angle). This means that standard deflection yokes will not provide a wide enough picture. Three possible modifications can be made to sweep the 19-inch tube. Adding an 82-150- $\mu$ f mica capacitor from the plate of the damper tube to ground and shunting the width-control coil with a .003-.05- $\mu$ f capacitor often gives enough additional width.

Another method is to use a second horizontal output amplifier tube in parallel with the existing one, or else modify the circuit for use with a new ceramic-core-type horizontal output transformer (the 77J1). This transformer, developed by General Electric Co., will be produced by several manufacturers.

The third method is the use of a special 75-degree deflection yoke. Samples of this yoke are now being tested by the industry.

The 19-inch tube, and the 16GP4, as well as the new all-glass 16-inch tube, employ a bent-gun type of ion trap requiring only a single magnet. This means that the double-magnet ion traps used on such tubes as the 10BP4, 12LP4, and 16AP4 will not produce a raster on the new tubes. A special ion trap using a small, single, permanent magnet is currently being produced for the 16- and 19-inch Du Mont tubes.

\* Chief Engineer, Tech-Master Products Co.

by

WALTER H. BUCHSBAUM\*

In past issues we have run a series of answers to television servicing queries. This article presents more information along the same lines, though in slightly different form. Future publication of additional solutions for specific groups of problems depends on whether or not this type of information is valuable to you. If it is, your queries mailed to RADIO-ELECTRONIC for answering in future issues will prove the matter.

## Admiral model 20A1, 20B1

Television Custom Built, Brooklyn, N. Y., reports that the picture is very good on all channels and because of the a.g.c. system the contrast control needs no adjustment, except on channel 4. This channel comes in very strong and appears to be over-modulated. When it is tuned in, a horizontal jitter appears which can be cured by resetting the horizontal hold control. In some cases the rear adjustment must be used. If channel 4 is synchronized properly, all other stations are out of sync. Two Admiral models 20A1 behaved that way, but a third one brought in for re-alignment did not show this defect.

The solution lies in the sync separator circuit. On channel 4 the strong signal apparently overdrives the 6AU6 used as sync-separator tube. To avoid this, the manufacturer has made a change in later production runs which completely eliminates the jitter. A 47,000-ohm resistor goes from the screen (pin 6) of the 6AU6 to ground and an 82,000-ohm resistor to B-plus, as in Fig. 2. If the 47,000-ohm resistor is removed and the 82,000-ohm one connected to the centertap of the contrast control, the screen voltage will be

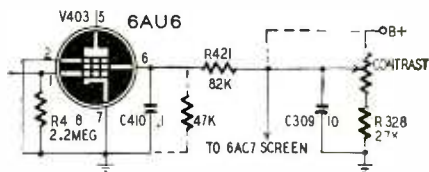

Fig. 2—Modifications eliminate jitter.

decreased as the contrast is decreased. This prevents overdriving the sync separator even at the strongest signals and eliminates the horizontal jitter.

## 1948 Teletone

Joe's Radio Service, Ridgewood, N. Y., reports complaints of insufficient vertical sweep or no vertical sweep at all on 10-inch Teletone receivers. This set uses the circuit shown in Fig. 3. A

6SN7 is used as blocking oscillator and output amplifier. The plate load of the blocking-oscillator section is made up of R65 (1.5 megohms) and the height control R66 (2.5 megohms).

It was found in most cases that R65 was either shorted or open. Replacing this with a resistor of the same value, but with a 1-watt rating permanently cures the defect.

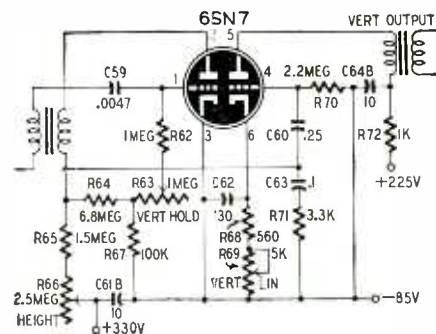

Fig. 3—Teletone vertical sweep circuit.

In this same model another defect, common to many other magnetic deflection TV sets, was found. The picture showed "wrinkles" on the left side, an indication of insufficient damping in the horizontal flyback circuit. Changing the 5V4 damper tube did not rectify the trouble. The faulty component turned out to be the 56- $\mu$ f capacitor connected across one of the two horizontal deflection coils. The capacitor is inside the deflection yoke, on the neck of the picture tube.

## Fada models

Garcia Radio & Television Service of Flushing, N. Y., reports the following experience with several 10- and 16-inch Fada sets. Customers have complained of horizontal jitter which may be steady or intermittent. The defect seems to be cured by substituting some new tubes, especially a new 6K6 horizontal oscillator tube. After about 2 hours the jitter returns and can now be cured by changing the 6AC7 horizontal sync reactance tube. Two hours later the same condition prevails again. Each time one of these tubes is exchanged it seems to remedy the defect, but the remedy is always only temporary.

The true source of the trouble writes Mr. Garcia, is a .005- $\mu$ f capacitor connected across the synchrolock transformer. This capacitor becomes leaky to the extent that it distorts the pulse passing through it and thus creates an unbalance which affects the rest of the sync circuit. Putting in new tubes changes the capacitances temporarily. After a thorough warm-up the old trouble shows up again. Only replacement of the leaky capacitor is a permanent remedy.

# A Ten-Tube FM Receiver

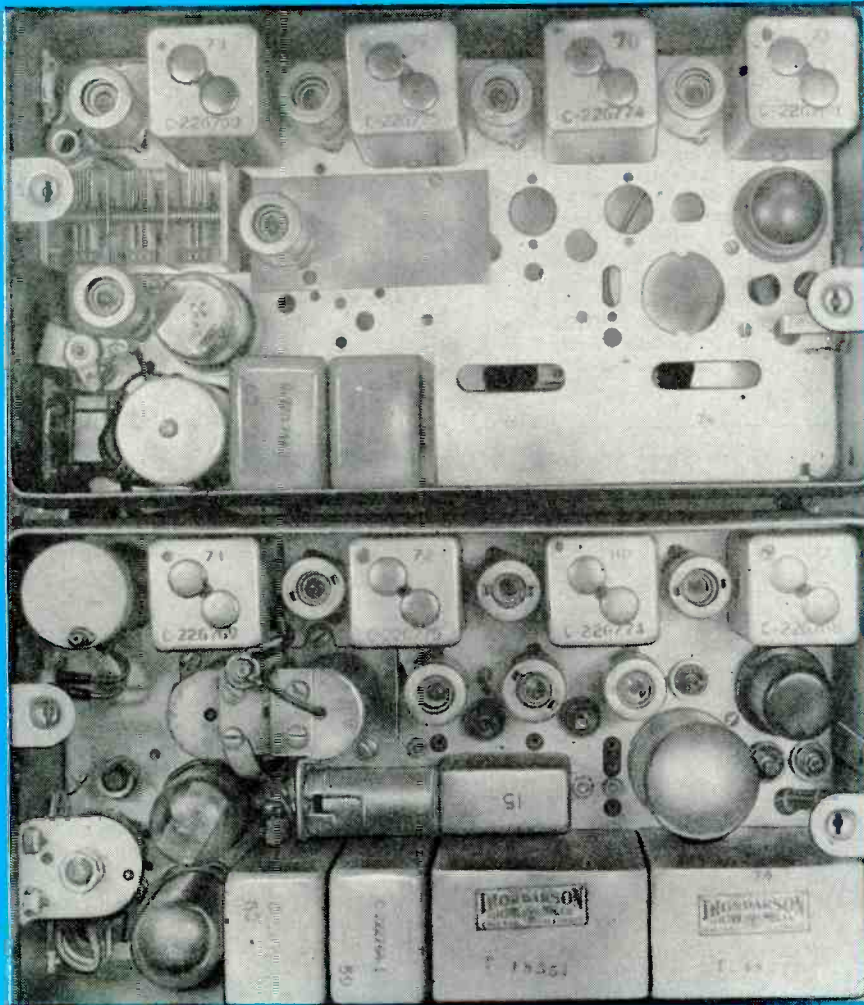

The before-and-after photographs of the chassis deck. Below, the R89/ARN-5-A receiver in new condition; above, appearance after conversion for FM.

less without the side covers. The i.f. strip is broad-banded and already tuned to 21.5 mc. Thus very few changes have to be made to the original i.f. section.

The FM set will be described in three sections, tuner, power supply, and amplifier, as some experimenters may have amplifiers or power supply which could be used instead of building a new one.

### The tuner

The first step is to remove everything from the chassis of the glide-path receiver *except* the following: the i.f. strip, consisting of four i.f. cans and three 6AJ5 tubes; three resistor strips—one near the chokes and two on the rear chassis wall; the two chokes marked 59 and 60; the sockets for the 12SR7 and the 12SN7 near the front of the chassis. (Refer to the photographs.) In removing the wiring, be careful to leave intact the bundle of wires running next to the i.f. strip, as it contains the wires carrying the plate, screen, and heater supplies. Put aside the parts that have been removed for future use.

The next step is to mount the three miniature tube sockets, tuning capacitor, two coil forms, phone jack, antenna input socket, filter capacitor, pilot light, and power switch. If the amplifier described below is used, its parts should be mounted also. This will necessitate a moderate amount of drilling and filing, but most of the holes are small and the only tools necessary are a hand drill, a keyhole-type metal saw, and rattail and flat files.

**I**N THESE days of high-priced radio parts, it seems impossible to build anything at moderate cost. Yet through careful design and the use of a piece of readily available surplus equipment, a high-quality FM set can

be built. The tuner has a stage of r.f., two i.f. stages, limiter, and discriminator. The detector circuit used is similar to the one employed in the better FM receivers. The total cost is less than \$10.

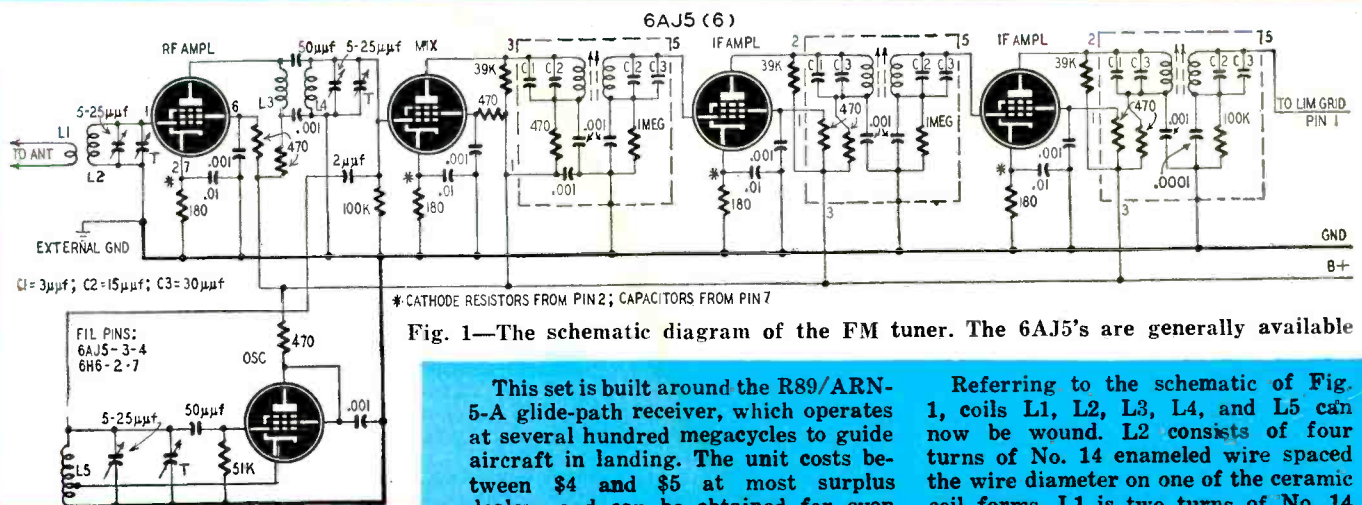

Fig. 1—The schematic diagram of the FM tuner. The 6AJ5's are generally available

This set is built around the R89/ARN-5-A glide-path receiver, which operates at several hundred megacycles to guide aircraft in landing. The unit costs between \$4 and \$5 at most surplus dealers and can be obtained for even

Referring to the schematic of Fig. 1, coils L1, L2, L3, L4, and L5 can now be wound. L2 consists of four turns of No. 14 enameled wire spaced the wire diameter on one of the ceramic coil forms. L1 is two turns of No. 14

# for Only \$10.00

A few modifications convert surplus R89/ARN-5-A to receive FM broadcasts

By ROBERT C. MINNICK

cotton-covered wire wound between the turns of L2. Solder a 4-inch piece of wire to each end of L2, and cut L1 so that its ends will just reach the antenna-input receptacle. L5 consists of three and one-quarter turns of No. 14 enameled. It is tapped one-quarter turn from ground. The ground end should be at the open end of the coil form—away from the slug. L4 has three and three-quarter turns of No. 14 enameled wire wound on one of the ceramic coil forms and then slipped off the end to be mounted without a form. L3 is a 47,000-ohm resistor on which 25 turns of No. 24 enameled wire are closewound and soldered at each end. The forms containing the L1-L2 combination and L5 may now be mounted, L1 and L2 projecting above the chassis and L5 below. The leads from L2 should be pushed through a hole to the bottom of the chassis.

The front end (r.f., oscillator, and mixer) can now be wired. It is very necessary in these stages to have all the leads as short as possible. All the ground leads should go to a common point on the tuning capacitor. L4 is mounted directly from pin 1 of the 6AJ5 mixer tube to the common ground point.

Fig. 2 shows the i.f. strip before it is changed. Comparison with Fig. 1 shows that very few modifications have to be made. In fact, the second i.f. can need not be opened. In working on the i.f. strip do not move the slugs as the coils are already tuned to 21.5 mc. This will

shine slug. Care should be taken when drilling the Bakelite as it has a tendency to crack easily. Fourteen turns of No. 24 enameled wire are to be wound on this form. The two 40- $\mu$ f capacitors across this coil should be chosen as nearly alike as possible, as they are to provide an electrical centertap for the coil.

The only remaining wiring to be done in the tuner is that of the discriminator tube. The tube used is a 6H6 if the a.f. amplifier given below is to be used or a 12H6 if the tuner is to work into an external amplifier. The resistors and

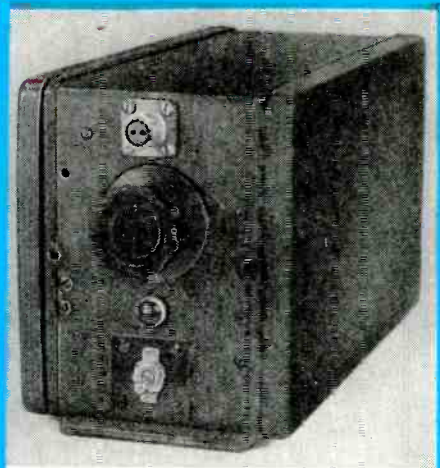

Completed FM tuner looks businesslike and sounds good. Controls are at side.

capacitors between the cathodes of the discriminator should match fairly well. They are to be mounted on the resistor strip near the last i.f. can.

### Power supply

Figs. 4-a and 4-b give the details of two alternate power supplies. The

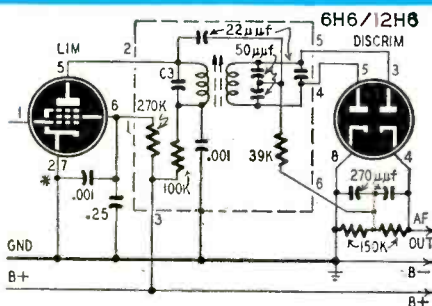

on the surplus radio components market.

save considerable trouble in alignment later. It is necessary to install a secondary coil in the last i.f. can. To do this, carefully drill or ream out the hole in the top Bakelite plate and mount the ceramic coil form having a

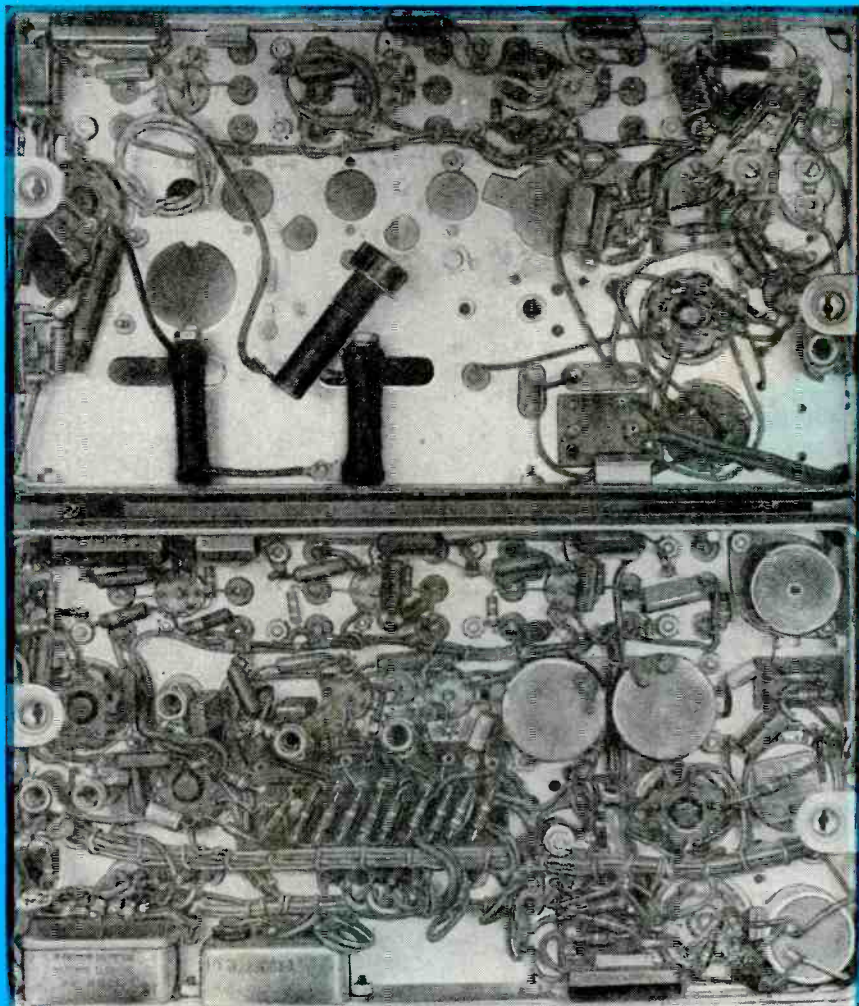

Looking underneath the chassis. Some of the components shown below are removed and used in the conversion. At top, the set after its adaption for FM.

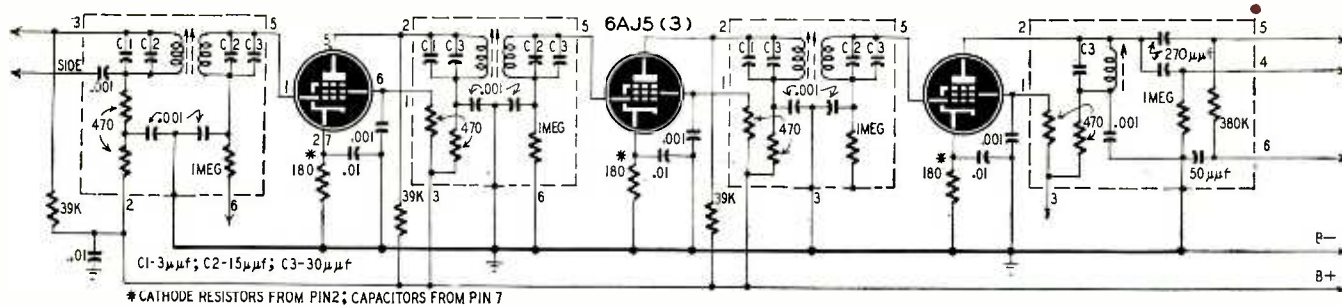

Fig. 2—The original i.f.-strip hookup. Comparing this diagram with Fig. 1 shows that little modification is necessary.

heaters are connected in series; but if only 6.3-volt tubes are used, a small filament transformer may be substituted. The series connection has the advantage of economy, but slightly better performance may be obtained by using a filament transformer. If the amplifier recommended below is used, the filaments should be connected as in Fig. 3-a. If an external amplifier is used, the filaments should be connected as in Fig. 3-b. Note that the line cord has only one conductor. The chassis

Fig. 4 gives a simple two-tube amplifier which makes use of one of the tubes removed from the receiver.

**Alignment**

In aligning this FM receiver, a frequency-modulated signal generator which operates at 21.5 mc is helpful but not absolutely necessary. If no such generator is available, the set may be aligned by ear. Anyone who has aligned an ordinary AM superheterodyne receiver will see the similarity between

amplifier to the tuner and allow the set to warm up for at least 10 or 15 minutes.

2. As the i.f. is already in alignment or nearly so, some signal should be heard. Judging by ear or by a v.t.v.m. connected across the 6H6 cathodes, adjust the primary of the discriminator i.f. coil for maximum output. Then adjust the secondary slug for a minimum of distortion, or, using the v.t.v.m. across the cathodes of the discriminator, until the meter reads zero. Repeat this step if the adjustments turn out to be large.

3. The i.f. strip can now be touched up. Start with the secondary of the next-to-the-last i.f. can (the last one has been adjusted in step 2) and work backwards. The tuning should be rather broad, and for maximum fidelity the coils should be tuned exactly to the center of the passband.

4. Tune to several stations to determine if the frequency range of the receiver (88 to 108 mc) is correct. If not, adjust the oscillator trimmer until the correct range is obtained. It may be necessary to adjust the number of turns on the oscillator coil. Finally, adjust the r.f. and mixer trimmers.

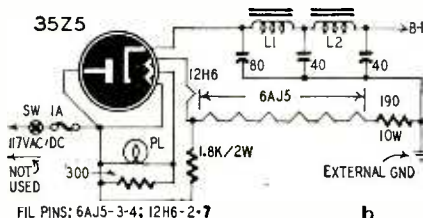
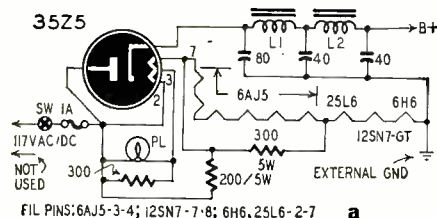

Fig. 3—The supply at a is used if the a.f. amplifier (25L6 and 12SN7) is built in. If an external amplifier is used, substitute a 12H6 for the 6H6 and use b.

must be firmly connected to a good external ground.

The filter chokes (L1 and L2) are parts 59 and 60, respectively, in the glide-path receiver. L1 consists of two coils connected in series. For best results only the side of this choke having the higher d.c. resistance should be used.

**Audio amplifier**

The audio system may be mounted on the same chassis, or the tuner may work into an external amplifier and speaker. One way in which the construction of an amplifier and a power supply could be avoided would be to connect the tuner into the audio section of an ordinary AM receiver and to take the B+ from the radio's power supply. Be sure that the maximum ratings of the power supply are not exceeded.

AM alignment and the procedure given below for FM.

1. Check the amplifier with an external signal source and make any necessary adjustments. Connect the

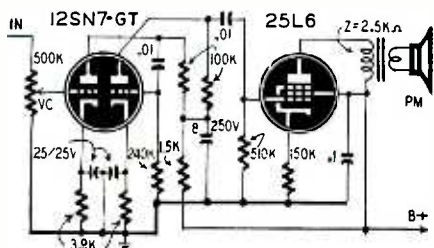

Fig. 4—This simple audio amplifier can be placed in the receiver case. Better fidelity is possible, however, with an external unit employing push-pull tubes.

**Checking NBFM Transmitters**

**N**ARROW-BAND FM — commonly called NBFM—is permitted in portions of amateur phone bands so long as the frequency modulated signal does not occupy any more space than a 100% modulated AM signal having the same modulation frequencies. The bandwidth of an AM signal is twice the modulating frequency.

When a carrier is frequency modulated a number of sidebands are generated. These sidebands are separated by the modulation frequency and their number is determined by the modulation index which is the carrier deviation divided by the modulation frequency producing it. With NBFM, the modulation index is approximately 0.6 when the amplitude of the second pair of sidebands is 20 db below the amplitude of the unmodulated carrier. At this point, the spacing between the second pair of sidebands may be regarded as the effective bandwidth.

One method of checking deviation is to use a calibrated a.f. oscillator and a communications receiver. Allow the receiver to warm up thoroughly, then

zero-beat the unmodulated signal from the exciter or oscillator. Connect a six- or eight-volt variable voltage to the grid of the reactance tube and increase the voltage until carrier deviation is indicated by a beat note in the receiver output. Measure the beat note by comparing it with the signal from the a.f. generator. Record the beat frequency and the d.c. voltage producing it. Reverse the battery and repeat the procedure, using several voltages up to the maximum. Transfer the measurements to graph paper. The resulting plot should be linear at the desired bandwidth. If it is not, the deviation capabilities of the oscillator are exceeded at the point where the line curves. The peak a.f. signal on the reactance tube should not exceed the highest d.c. voltage which produces linear deviation.

If deviation is not linear at the desired bandwidth, the oscillator should be operated at a submultiple of its present frequency and bandwidth made up in the frequency multipliers which produce the output frequency.



# Applause Meter

by GUY S. CORNISH

**W**HENEVER a church, club, school or other organization gives an entertainment in which local talent competes for prizes, the winners usually are selected by popular applause. If the ones who judge the applause rely solely upon their ears, the job becomes very difficult. But if some means is at hand to register and record the intensity of the applause for each contestant, a comparison of the readings will be accepted without question.

Such a device, known as an applause meter, consists of a means of converting sound into electrical energy which is fed to a suitable indicating device. To eliminate any question of a misreading on the part of the judges, the indicating hand does not return to zero after each round of applause, but stays instead at the maximum position to which it was deflected until the judges have recorded the reading.

The applause meters available on the market are expensive. For the average service technician their limited use does not justify the expense of purchase. However, a simple, easily handled meter is a source of revenue for any radio technician. For those who have some spare time and are handy with tools and possess one of those famous junk-boxes found in all radio shops, here is a home-made applause meter.



The assembled meter without its case.



The applause meter comprises three principal items. A high-impedance magnetic speaker (or a standard PM with a voice-coil-to-grid transformer) acts as a microphone to pick up the sound of the applause. A standard audio amplifier amplifies the sound and feeds it to a meter. The meter is the heart of the device and must be built especially for its purpose. Since it must be seen by the audience, it must be large; and to eliminate controversy, it must stay at maximum deflection rather than returning to zero after the peak.

The meter is of the simplest possible type and reminiscent of certain battery testers (and some cheap prewar radio meters). Fig. 1 and the photographic Fig. 2 practically explain it. References to letters and numbers in the following description are to the lettered and numbered pieces shown in those two figures.

The indicating mechanism is constructed on the well known solenoid principle, a soft iron armature being drawn into the field of a coil when current is flowing in it. As the current is alternating, the armature must be thin, light, and free from all traces of residual magnetism. Thin transformer laminations make excellent material for this purpose. When no current is flowing in the winding, the armature should rest just outside the coil. As the

flow of current increases in the coil, the armature will be drawn in. The coil form is made from  $\frac{1}{16}$ -inch formica sheet, cut in the form of an arc as shown in Fig. 1-a.

Two of these are required, and can be cut by hacksaw and finished by proper files. They are separated by four spacer washers and one segment spacer cut from  $\frac{1}{8}$ -inch formica sheet or similar material. Screws and nuts hold the form together, with a little speaker cement to hold the segment in place. The winding consists of 180 turns of No. 28 cotton-covered enameled wire, bound with coil cement after winding. Starting from the left-hand side, the wire is wound over to the right, keeping the turns tight together along the smaller arc edge and then back again to the left in the same manner. This will take about 155 turns. The remaining 25 turns must be wound over the left end as shown in b. About 8 inches of wire should extend from each end of the winding for terminal connections.

The armature also is in the form of an arc and moves into the coil with a circular motion. This rocker armature consists of a thin piece of transformer lamination, cut to the dimensions shown in Fig. 1-c. The arc is riveted to a thin piece of magnesium alloy, also shown in c. The celluloid pointer is cemented to it. The magnesium sheet, salvaged

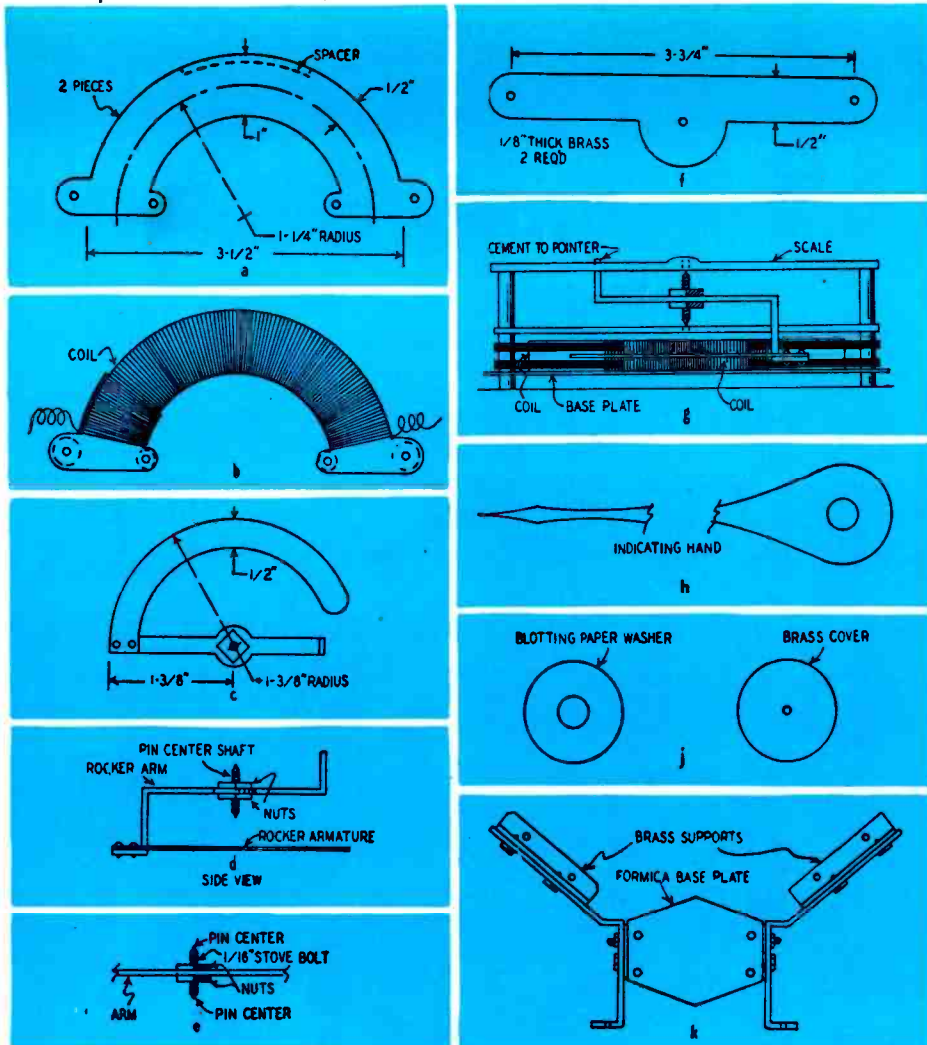

Fig. 1—Sketches show how each individual part of the applause meter is made.

from war surplus material, was chosen for its lightness. However, aluminum will give as good results. The rocker armature, normally just outside the coil, will move in as the current increases. This can be done by either spring action or gravity. In favor of simplicity, the writer chose the latter. To minimize friction in the bearings, pin center mounting is used. For a shaft we used a 1/16-inch stove bolt cut to a length of 3/4 inch. With our shop lathe, both ends were tapered down to a fine point as shown at d.

If the technician does not have access to a lathe, a drill press or a breast drill clamped in a bench vise can be used. The stove bolt can be clamped in the chuck and, while being rotated, a fine file can be used to taper both ends. After the stove bolt has been tapered, it is mounted in the rocker arm and held firmly by two nuts as shown at e.

The bearing plates f are made of brass, 1/8 inch thick and 1/2 inch wide. A center punch was used to make a deep indentation in these plates to receive the bearing points of the stove bolt shaft. Be sure the angle of the punch is greater than the angle of the pointed shaft, in order that the bearing is on the points and not the sides of the shaft. Care must be exercised in marking off this position: the shaft must

be perpendicular to the plates when mounted, as shown at g. The plate spacers must be carefully made and the plates spaced so that, although there is no end-play in the shaft, the rocker will swing freely without binding.

To prevent rust, a drop of 3-in-1 oil was used on each bearing. The brass bearing plates are held in position by two 1/16-inch stove bolts, 2 inches long, which also hold the coil form on the formica base plate (4 in Fig. 2). On the outer bearing plate is mounted a circular brass disc (see h in Fig. 1 and 6 in Fig. 2) 1 5/8 inches in diameter, with a 5/8-inch boss in the center, 1/16 inch high. This is the bearing for the celluloid indicating hand or pointer. A 10-32 machine screw extends from the center of the boss to hold a brass cover plate. Washers cut from blotting paper are used to give the indicating hand just enough friction to hold it in any position on the scale when moved by the rocker arm. See j in Fig. 1. A knob on the end of the screw forms the "0 return" (see photographs).

The base plate holding the complete indicating mechanism is mounted between two brass supporting arms (2 and 3 in Fig. 2 and at k in Fig. 1). These arms also support the 0-100 scale, which was made with black india ink on white glazed drawing paper of

the sort on which ink drawings are made. A 15-watt, 117-volt lamp will pass sufficient light through this paper to give a well-illuminated scale.

The divisions are not calibrated to any actual units, but are simply reference points which enable the judges to make their comparisons. The scale should be laid out lightly with a lead pencil and then retraced with black drawing ink.

The meter was built from scrap materials taken from our junk-box, and the sheet aluminum, wire, and wood for the cabinet, was salvaged from war surplus purchases. The indicator hand was made from white celluloid. The metallic sheet supporting the scale was cut from aluminum, 1/16 inch thick. The brass bars, 1/8 inch thick and 1 inch wide, used for the bearing plates and the supporting arms were purchased for this purpose. The formica was salvaged from old panel scrap material. The materials used and dimensions given are offered only as a guide to those who may desire to construct the meter. Because many readers may have ideas of their own on construction and design, we have not dwelt too much on details.

The amplifier used is very similar to one described in the *Sylvania Tube Manual* several years ago. It has a 6SJ7 and 6C5 as voltage amplifiers, a 6N7 phase inverter, and 6L6-G's in pushpull—a very standard circuit. While it has given excellent results, a technician may have a pet circuit of his own, which may be substituted if the gain and power are ample. The output transformer should be heavy enough to handle 15 or 20 watts and should have a 4- and 8-ohm tap. When the meter is completely assembled and housed, try first 4 and then 8 ohms. The one that gives the best results should then be permanently connected in circuit.

In Fig. 3 are shown the two functions of the feed lever. When it is in the left position, the amplifier output is kept out of the indicator mechanism, thus preventing needle swing on ordinary conversation. When the lever is moved slowly to the right while the ap-

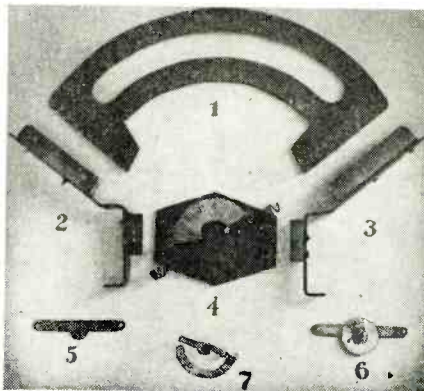

Fig. 2—Exploded view of meter. 1—scale plate; 2 and 3—support brackets; 4—base plate; 5—bearing plate; 6—bearing plate with indicator bearing; 7—The rocker armature and its shaft.

plause is on, the rocker arm will move the indicating hand up gradually to the maximum position, assuring a relatively correct comparison between each round of applause.

Care must be exercised in the placement of the pickup. No doubt the best position would be above the heads of the people, near the ceiling, in the center of the room. If a light fixture is available, the pickup may be attached to it. A satisfactory and far more convenient location would be in a corner of the room, hanging the pickup at such an angle that the sound received would be reflected from the ceiling.

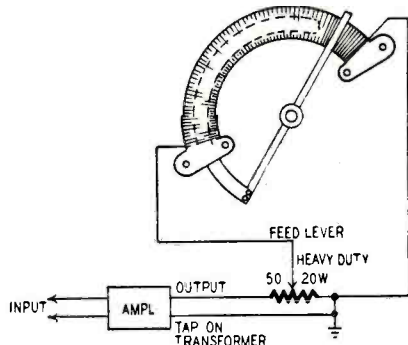

Fig. 3—Feed lever works output control.

Several precautions must be taken in operating the applause meter if satisfactory results are to be expected. It should be turned on to warm up about 10 or 15 minutes before use. Just before the program starts, the master of ceremonies should request everyone to applaud vigorously while the gain is adjusted to a point where the indicating hand registers 100 on the scale. He now tightens the lock to hold the gain in this position and brings the indicator back to 0 by turning the 0 RETURN knob to the left. This knob is normally held in the right position by spring action. As a check, he asks the audience to applaud once more while he turns the feed lever to the right as far as it will go and then lets it return to the left or starting position. The indicating hand should now register approximately 100 on the scale.

If there is a possibility that a number of people may enter the room after the meter is set and locked, it will be advisable for the m.c. to adjust the gain to read 90 instead of 100 on the scale. This will permit the late-comers' applause to register.

For best results, the audience should be instructed to applaud their favorites by hand-clapping only and not by stamping and whistling. They should also be told that it is intensity of applause not the length that registers.

The reading of each contestant is recorded by the judges and awards are made from these figures. In case of a close or tie decision, the judges can request that the applause be repeated. Sponsors of this type of entertainment, after becoming familiar with the applause meter, will never go back to the old method of selecting by ear. To local radio technicians having such a meter, every such group is a potential permanent customer.

## Announcing

# \$1,200.00 PRIZE CONTEST RADIO-ELECTRONIC IN THE HOME

**D**ESPITE the amazing and extraordinary progress made in radio-electronics during the past two decades, one phase seems to have been neglected completely. We refer to radio-electronic applications IN THE HOME.

Practically all present-day inventions and patents concern themselves with industrial applications. Even such obvious applications as automatic electronic door openers are used chiefly in railroad terminals, restaurants, and other public places.

The home is the place where radio-electronic devices are really needed today. There are potentially thousands of ingenious ideas that can be used in the modern home, not only to lighten our work, but to make life safer, to give us more leisure, to safeguard our health, and to give us conveniences which are often urgently needed.

These applications need not necessarily be new inventions. It is sim-

ply a matter of applying ourselves to adapt the innumerable radio-electronic devices and instruments available. Most of our readers can solve these various problems at not too great a cost in their spare time.

On page 40 we present a single example of applied electronics—in this instance to do away with an annoyance. While this particular application has its humorous features, there are other hundreds of serious applications that are critically needed in the home.

We are sure that readers of RADIO-ELECTRONICS have many worth-while ideas for applying radio-electronics in the home.

We therefore invite you to contribute to this monthly Prize Contest, which will run for a total time of one year.

Monthly prizes totaling \$100 will be given for the best ideas submitted during the month. These are cash prizes as follows:

<b>FIRST PRIZE</b> .....	<b>\$50</b>
<b>SECOND PRIZE</b> .....	<b>\$25</b>
<b>THIRD PRIZE</b> .....	<b>\$15</b>
<b>FOURTH PRIZE</b> .....	<b>\$10</b>

### Please Note the Following Rules

1. This is a monthly cash Prize Contest for the best idea submitted during the month for a practical new radio-electronic application in the home.

2. The highest prizes will go to those contestants who have *actually built* the devices they describe and who submit photographs to prove it. Lesser prizes may be given for "ideas" not reduced to practice and for entries unaccompanied by photographs.

Entries of constructed devices must be accompanied by photographs, full description, and complete circuit diagrams.

3. Ideas for new devices which have not actually been built must be stated in complete detail and accompanied by complete diagrams, drawings, and all other possible descriptive material.

4. All the descriptions and photographs of the prize-winning devices or ideas will become the property of RADIO-ELECTRONICS, which will publish a descriptive article on each device or application. The prize winners will be paid regular rates for their articles, in addition to the

prize money. Entries not winning prizes will be returned.

5. If two or more entries submitted during the same month are judged to be of equal worth, identical prize awards will be made for both entries.

6. All entries will be judged by the Board of Editors of RADIO-ELECTRONICS. Prizes will be awarded in accordance with novelty, general importance of the application or device, smallness of cost involved in building it, and practicability. The decisions of the Board of Editors of RADIO-ELECTRONICS will be final.

7. Excluded from this contest are RADIO-ELECTRONICS employees and their relatives.

8. The first monthly contest closes April 3 at midnight, Eastern Standard Time. All entries postmarked not later than April 3 will be judged in the first month's contest.

9. Announcement of the first monthly prize award will be made in the July issue of RADIO-ELECTRONICS. The first month's prizes will be paid on the publication date of the July issue of RADIO-ELECTRONICS.

# Miniature-Tube A.F. Amplifier



The complete miniature amplifier. The chassis measures only 4 x 5 x 2 inches.

WITH the development of miniature tubes to meet almost every need, it has become possible to make electronic equipment extremely small.

Described here is a miniature, high-fidelity, 4-watt, a.c.-d.c. amplifier that is flat  $\pm 1\frac{1}{2}$  db from 30 cycles to 10 kc, has less than 2% distortion, a gain of 60 db, and a noise level 70 db below 4-watt level. Tubes used are two 50B5's and a 12AU7. The amplifier is constructed on a 4 x 5 x 2-inch aluminum chassis, and over-all measurements are  $5\frac{1}{2}$  x 6 x 4 inches. It takes less than half the space of a conventional amplifier using 50L6's. The push-pull 50B5's are employed in a cathode-driven phase-inversion circuit (see schematic), and the two triodes of the 12AU7 are in cascade. This results in 10 times the gain that would be possible if the two triodes were used in the conventional type of inverter circuit.

Although the two triodes in the 12AU7 envelope are identical, the circuit constants are different, being designed for minimum distortion at the levels presented to each.

It is almost impossible to show the actual placement of chassis connections in the circuit schematic, but care in these is most important for low noise level. There are but three chassis connections and they all go to the lugs on the 12AU7 socket. Buses run from here to the metal-can capacitors, the only other chassis connections. (An additional minor one is the 50-ohm bias control for the 50B5's.) The input jack is

insulated with fiber washers. One ground point instead of several results in less inductive hum pickup because of elimination of closed low-impedance loops. We consider this feature of the amplifier a major contribution to its low noise level. The wiring is as compact as possible, and signal leads are close to the chassis and well shielded. Filament leads are twisted tight, the chassis-connected end of the string going to pin 4 of the 12AU7 voltage amplifier.

Many other points of mechanical construction in the amplifier help stability and keep noise down. For example, the lugs of the phono jack are moved close together. A shielded lead covered with spaghetti runs from this jack to the 12AU7 socket, and the inside lead is drawn out through an appropriate hole to make connections at the volume control. Center socket shields are grounded. Whenever possible, socket lugs are soldered together without utilizing wires. The a.c. plug and switch are kept close together and on the opposite side of the chassis from the input jack. Output jacks are mounted on the other end of the small chassis.

It is necessary to mount the filter choke directly underneath the output transformer, but no trouble has been experienced with hum. The cathode bypass capacitor in the first stage does not raise gain, as it would appear, but eliminates hum. Incidentally, a 450-volt capacitor is used instead of a 150-volt unit on the input of the B-plus filter to minimize maintenance, as it is subject to surges. For the same reason a selenium rectifier instead of a vacuum tube is used. The filter capacitors are exposed to a considerable amount of heat, but the Mallory FP units used are designed for this and have proven that they can take it without going bad.

The cathode phase-inversion circuit of the 50B5's permits economical use of tubes. It is also probably the best for maintaining balance through wide frequency bands. It is not unstable, tricky, or difficult to adjust. The reason for the wideband performance is that

no capacitors are involved. The phase-inverting cathode resistor is made equal to the reciprocal of the tubes' transconductance and is adjustable. (The transconductance of 6B5's is in the order of .0075 mho; thus the resistor is adjustable around 133 ohms.) A cathode-coupled phase-inverter has the gain of a single tube, the signal voltage being effectively split and half applied to each side of the push-pull circuit.

This is how it works. The signal from the 12AU7 is coupled to the grid of the upper 50B5 in the usual way. The cathode of the 50B5 is unby-passed. The signal plate current, passing through the cathode resistor to ground, creates a voltage drop between cathode and ground, which changes at an audio rate. The grid of the lower 50B5 is grounded and its cathode is connected to that of the upper tube. Any voltage appearing across the cathode resistor as the result of signal through the upper tube, also appears between cathode and grid of the lower tube.

There are several ways of adjusting the bias of the tubes for balanced inversion. Probably the best and easiest is to note with a pair of headphones

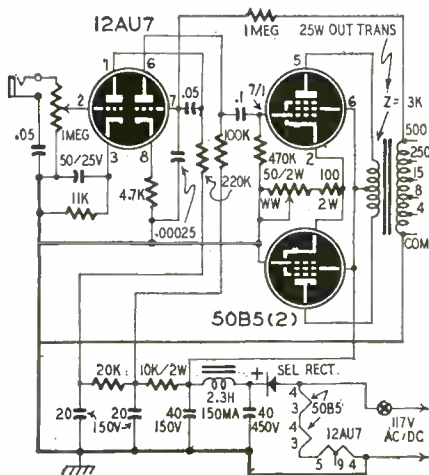

Schematic diagram of the amplifier. Output power is approximately four watts.

\* WQAN, Scranton, Pa.

(connected to the 500-ohm output) the point at which the hum is balanced out. The adjustment is brought all the way up until a loud hum is heard in the phones and then gradually worked down to the position where the hum just fades out.

An ideal feedback loop should go from output to input. In this amplifier the volume control is in the first stage, and feedback introduced here would change with the setting of the volume control. To overcome this difficulty the feedback is applied to the second stage. As the first stage works at a very low level, it contributes negligible distortion. The output transformer and power tubes are the greatest contributors to distortion.

The use of inverse feedback to flatten response calls for a feedback loop with no frequency discrimination. Since no capacitors are used, the feedback loop in our amplifier meets this requirement. The grid resistor of the second 12AU7 triode returns to ground through the secondary of the output transformer.

When the output winding of the transformer is in the feedback loop, there is a frequency at which the phase of feedback is reversed due to the stray inductance of the windings. At this frequency there is oscillation, a.f., ultrasonic, or r.f. While the oscillation may be inaudible, it may overload the amplifier and distort the audible signal. The 1-megohm grid resistor and the 250- $\mu$ f capacitor isolate the inductance of the transformer and provide a low-impedance path to ground for r.f. and ultrasonics.

The polarity of the primary and secondary of the output transformer must be correct so that the feedback is negative, not positive. If it is not right on the first try, interchange the connections.

Frequency runs at various levels have been plotted, and there is much improvement in performance when the output transformer is run well under saturation. This is the reason for a 25-watt transformer in a 4-watt amplifier; the larger the transformer, the better the bass response and the lower the distortion.

(Note this warning carefully: the chassis and the capacitor cans in this amplifier are directly connected to one side of the line—and it may be the hot side! To make the amplifier safe for use, several methods are possible, though none are entirely safe and precaution is still required.

The entire unit may be enclosed in a nonmetallic cabinet so that no metal part can be touched. If the input is "isolated" from the line with a .05- $\mu$ f capacitor (not used originally by the author) a phonograph pickup connected to it may be touched with little danger.

The best procedure is probably to bring all points shown connected to chassis to a common negative point, from which the chassis can then be entirely isolated. Two-terminal filter capacitors with insulated cans would, of course, be necessary. This method is used in underwriter-approved receivers, most of which also use an .05- $\mu$ f capacitor between chassis and negative B.

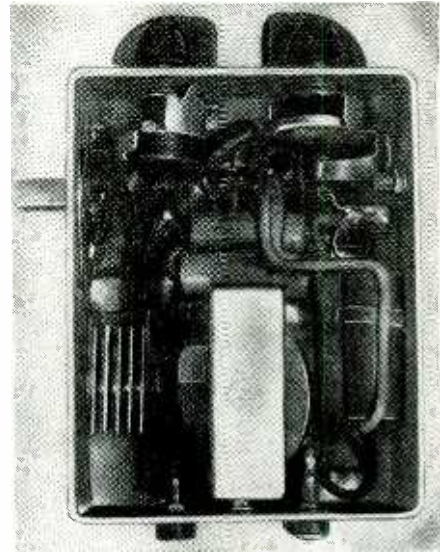

Getting components into small space is not easy but can be done with planning.

Another method would be to orient the power plug in the wall socket so that the chassis side of the line is the grounded side. The socket and plug can then be so marked that the orientation will be the same in the future. While electrically preferable, this method is psychologically unsound—even a brilliant radioman will forget some day and get burned. If, however, the amplifier is to be connected to a tuner or any other powered device, the polarized-plug trick is the only way to be safe—and it may also be the only way to keep out hum.—Editor)

## Amplifier Has Unusual Circuits

RATHER unusual tone-control and phase-inverter circuits are used in this amplifier, described originally in *De Radio Revue* (Belgium). The 6SJ7 is a conventional microphone preamplifier. One section of a 6SN7 V1-a is the first voltage amplifier and mixer tube. This section is resistance-capacitance-coupled to V1-b, connected as a low-frequency amplifier. The highs are bypassed around R5 by the .05- $\mu$ f capacitor. The amplitude of the lows appearing on the grid of V1-b is controlled by the setting of R5.

The output of V1-b is connected to the second 6SN7, which is a "long-tailed" amplifier (see "Phase-Inverter Circuits" in the July, 1948, issue of this magazine). In the original circuit, the grid of V2-b is grounded through a large capacitor C2. In this circuit, the designer has connected one end of C2 to an R-C network consisting of R1, R2, R3, R4, and C1. When the arm of R3 is close to the junction of R1 and R2, the grid of V2-b is effectively grounded. When the arm is at the opposite end of R3, the highs developed across R4

are applied to the grid of V2-b. In this way, the second 6SN7 works as a phase inverter and as a tone-control mixer tube.

### Materials for Amplifier

**Resistors:** 1—470, 2—1,000, 1—4,700, 1—20,000, 1—30,000, 8—47,000, 2—300,000, 4—240,000, 5—470,000 ohms, 1—3.3, 1—6.2 megohms, 1/2 watt; 1—220, 1—1,500, 1—15,000 ohms, 5 watts, wirewound; 4—500,000 ohms, audio taper potentiometers.  
**Capacitors:** 3—.001, 1—.005, 4—.01, 2—.05, 1—.01  $\mu$ f, 450 volts, paper; 1—.0001  $\mu$ f, mica; 3—8, 4—16  $\mu$ f, 450 volts electrolytic; 1—50  $\mu$ f, 50 volts, electrolytic.  
**Transformers:** 1—15-watt output, 11,000-ohm primary, multitap secondary; 1—power, 650 volts, c.t., at 60 ma, 6.3 volts at 2 amps, 5 volts at 2 amps.  
**Miscellaneous:** Chassis, sockets, tubes, switch, speaker, hookup wire, and shielding braid.

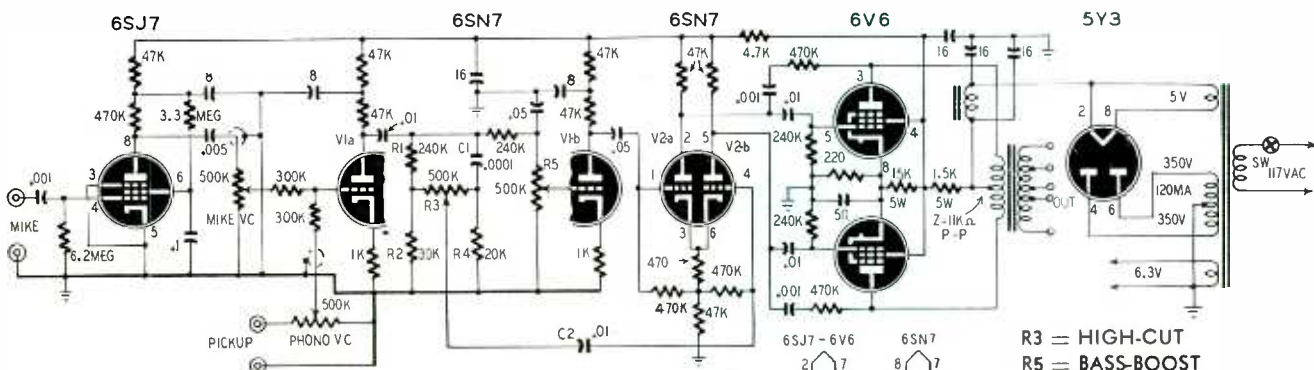

# Atomic Energy Beam Rivals Heat of Sun

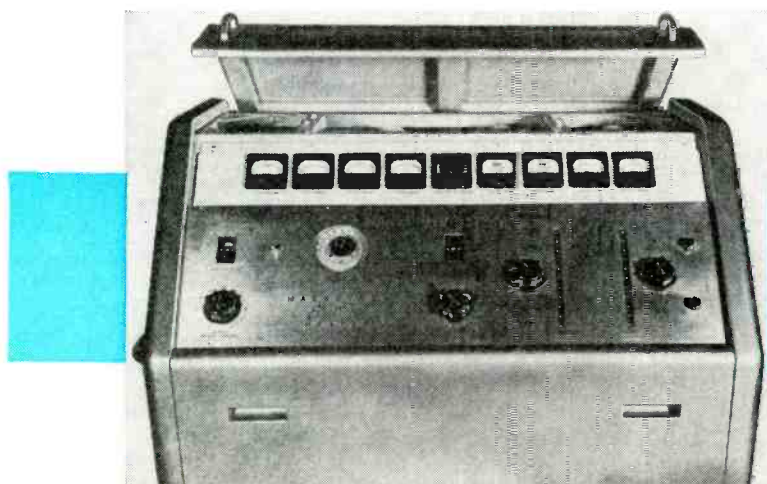

Control panel and top of the magnetron electronic heater.

**M**UCH of the atomic energy one hears about is really nucleonic energy—not that it is any less worthy of respect for that reason. On our cover this month is an illustration of *true* atomic energy—energy due to the action of single whole atoms.

The equipment used to produce this energy is a magnetron u.h.f. heater designed by General Electric to operate at 1040 mc, and used chiefly for dielectric heating. It has a water-cooled magnetron with an output power of 5 kw, coupled by a co-axial line to a heating chamber in which the work is normally

placed. An arc is made to form across the end of the output line. Nitrogen is passed through this arc, and it is the beam of nitrogen gas which forms the atomic blowtorch. Not that the gas is hot—it remains relatively cool till it reaches its work!

The answer to the paradox is simple. Atoms of many types of elements are sociable—they prefer to go around in pairs or groups and are disturbed if forced to separate. In fact, it takes a tremendous amount of energy to pull them apart.

Atoms of nitrogen gas travel in pairs. But the beating they get in passing through the 915-mc, 5-kw arc is more than enough to separate large numbers of them from their partners. They still feel the urge to get together again and do so as soon as they contact any solid object with which they can form molecules. Each time a pair meet again, they give up in the form of heat the energy required to separate them, and in doing so may raise the temperature in the area immediately surrounding them to a very high value. An exact measurement of the highest possible temperature obtainable from the new beam has not yet been made, but the cover picture shows it melting a rod of quartz, which requires 4,118 degrees F. Tungsten, which has a melting point of 6,092 degrees F, has been melted. In tests, it melted not only the metals, but

*Photos courtesy General Electric Co.*

Rear view of the 5-kilowatt electronic heater, which with the help of a nitrogen stream produces temperatures which can melt such substances as firebrick.

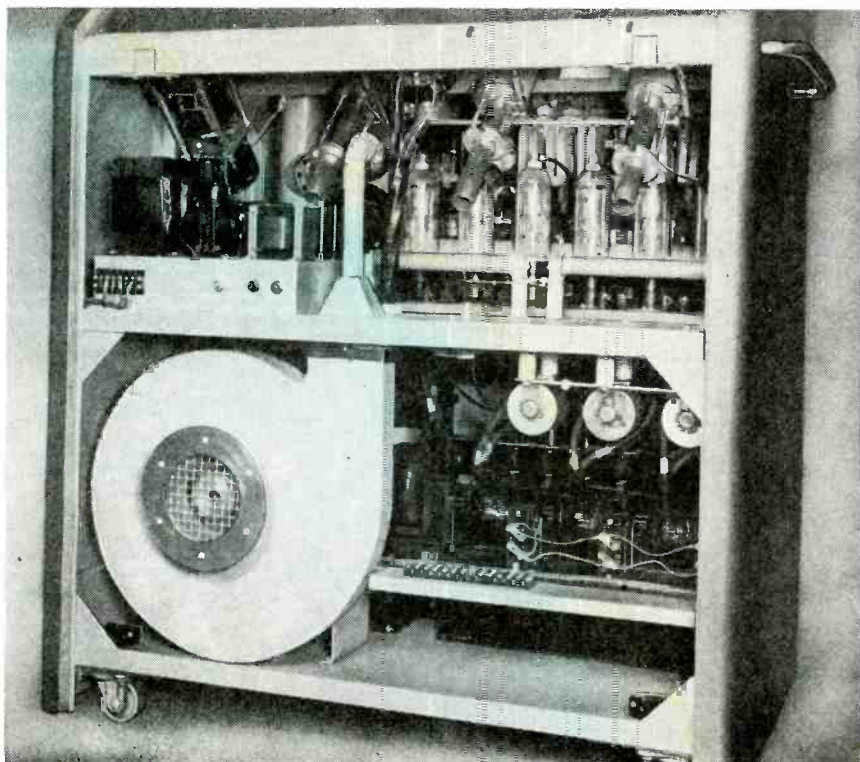

RADIO-ELECTRONICS for

also the firebrick which is used in furnaces.

The stream of gas is not in itself hot—it remains cool until it impinges on some solid substance with which it can form molecules. It is only when the atoms begin to recombine that heat is given out. This can be demonstrated with such absolutely inert gases as argon or neon, which never combine with anything. Passed through the arc, they glow as their electrons are displaced from their orbits, but remain so cool that a hand has been placed in a stream of gas from the arc without ill effects.

There is an important difference between this type of energy and that produced by nuclear action or atomic fission. The energy of fission—once a chain reaction has been started—is supplied by the atoms themselves. The power released in the atomic blowtorch is that supplied by the ultrahigh-frequency beam.

The generator that supplies the power is by no means complex. From the rear (see photo), it looks like mostly blower. The tube itself is water-cooled, and the blower simply cools the output seal. To the right of the blower are transformers for the filament supply. Filament temperature control equipment is in the upper left corner. Elaborate controls are necessary on high-power magnetrons, as the filament temperature depends not only on the current supplied by the filament transformer, but also upon the plate current and the match to the load. If a great deal of power is reflected back to the tube, filament temperature increases. Normal filament current is 53.5 amperes at 10.5 volts—over 500 watts for the heater alone.

The six plate-supply rectifiers are seen along the shelf at the top. The Z-1492 magnetron uses 2 amperes at 5,000 volts. The tube itself is directly behind the blower, but the co-axial output line may be seen ascending in the upper left, behind the filament control equipment.

No circuit is given, as the fundamental circuit is simply that of a diode with a piece of co-ax running out of it. Two directional couplers (see RADIO-ELECTRONICS, December, 1948, page 26)—one to measure the power going down the co-ax from the tube and the other to measure any power reflected back from the load—are connected to the co-ax and show whether the equipment is operating normally. While there is a considerable amount of auxiliary apparatus, it is associated either with the power supplies or with the control and safety circuits, and is therefore of much more interest to the technician maintaining the set than to anyone else.

The uses of the new equipment have not yet been thoroughly explored. As a new and convenient source for extremely high temperatures, it will no doubt open up new fields for itself as well as facilitate present processes which require use of particularly high temperatures.

## Electronics Detects Cancer With Vacuum-Tube Voltmeter

ONE of the latest marriages between electronics and medicine has resulted in the conception of a new method of detecting malignant tissue in the body, particularly that caused by cancers.

Developed by Drs. Harold S. Burr of Yale University and Louis Langman of the New York University College of Medicine, the technique measures the minute electrical potentials developed by body tissue. These researchers have found that healthy tissue generates a positive voltage, while malignancy is indicated by negative readings. So effective are the polarity indications that in tests with 428 female patients at New York's Bellevue Hospital, 81.9% of those proved healthy by other methods showed the positive reaction, while 98.7% of those known to have cancers gave negative indications. These percentages of correctness are higher than are obtainable with any other comparable test.

While negative readings do not always indicate cancer—certain other conditions, such as pregnancy, ovarian cysts, and fibroid tumors will also cause negative potentials—they do at least warn the physician that further tests are advisable.

The tests have been made so far only on women patients to detect cancer of the genital tract. Vaginal electrodes were made by filling the interior of shallow-S-shaped Lucite tubes with paraffin after inserting silver-silver-chloride wire, which projects slightly at one end. The protruding end of a wire is covered by gauze or cotton soaked in a saline solution, a precaution to prevent contact potentials from developing between the electrode and the body.

The reference electrode is another similar wire wrapped in saline-soaked cotton or gauze, held in a Lucite cup with a handle of the same material.

The minute potentials generated by the section of the body tested are measured by a bridge-type, vacuum-tube microvoltmeter, the schematic of which appears on this page. A single 2C21 is used in a cathode-follower circuit. By shorting the input with the switch and adjusting the 10,000-ohm cathode rheostat, the instrument can be balanced exactly at free grid potential. This is an absolute necessity; the balance is aided, along with stability, by a voltage-regulating transformer at the input to the power supply.

The output of the bridge is connected to a photoelectric galvanometer which

makes permanent records of the patient's voltages on a moving paper. The basic movement of the galvanometer is 3  $\mu$ a, but sensitivity can be set at other points by adjusting a 10,000-ohm potentiometer which may be placed between the galvanometer and the bridge.

Because of the bridge arrangement, readings (tracings on the moving tape) show the polarity of the input voltage—the important point—as well as its amplitude.

In operation, the vaginal electrode is introduced into the patient, with the protected tip in the posterior fornix of the vagina against the cervix. The reference electrode is bandaged to the abdomen.

The potentials are measured for 15 minutes to a half hour. At the start, there is often a drift, either negative or positive, but for the rest of the run, the readings remain surprisingly constant.

Due to the newness of the technique and the extremely small potentials involved, many precautions are necessary and much experience must precede reproducible results. Once mastered, how-

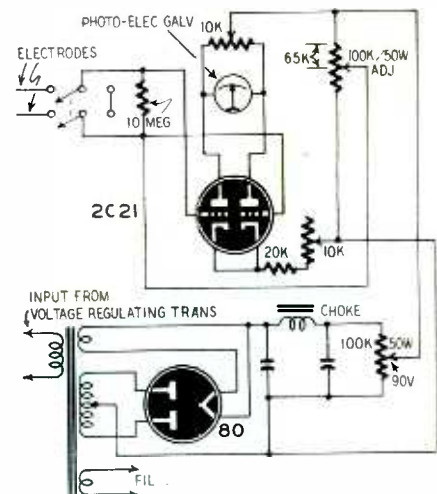

The equipment. Diagnosis is made on a basis of the polarity of the readings.

ever, this new method of detecting cancer is comparatively simple to use. Because today's knowledge permits effective treatment of cancer only in its early stages, quick detection is the greatest hope for recovery.

Interested physicians will find somewhat more detail (especially of the purely medical variety) in the report written by Drs. Langman and Burr in the February, 1949, issue of the *American Journal of Obstetrics and Gynecology*.

# Electronics

## Goes to the Dogs

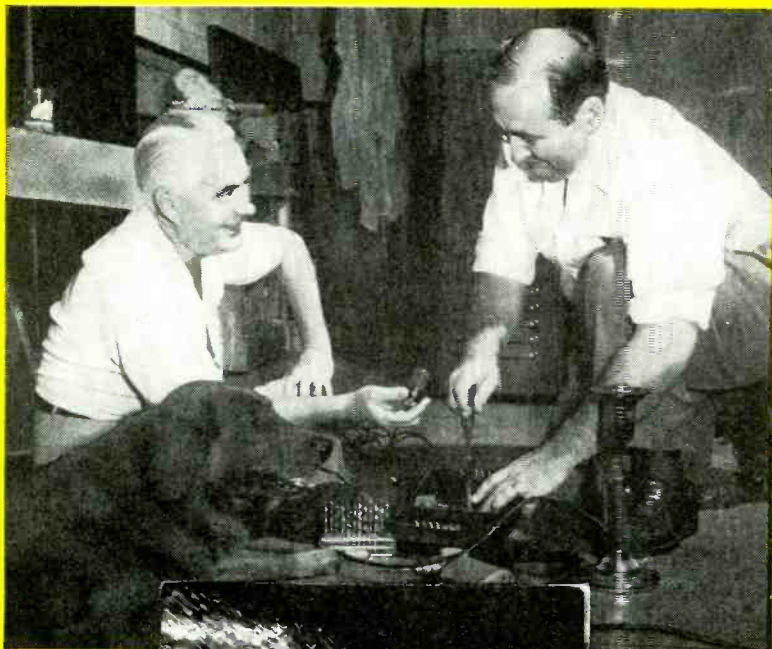

AMPLIFIER

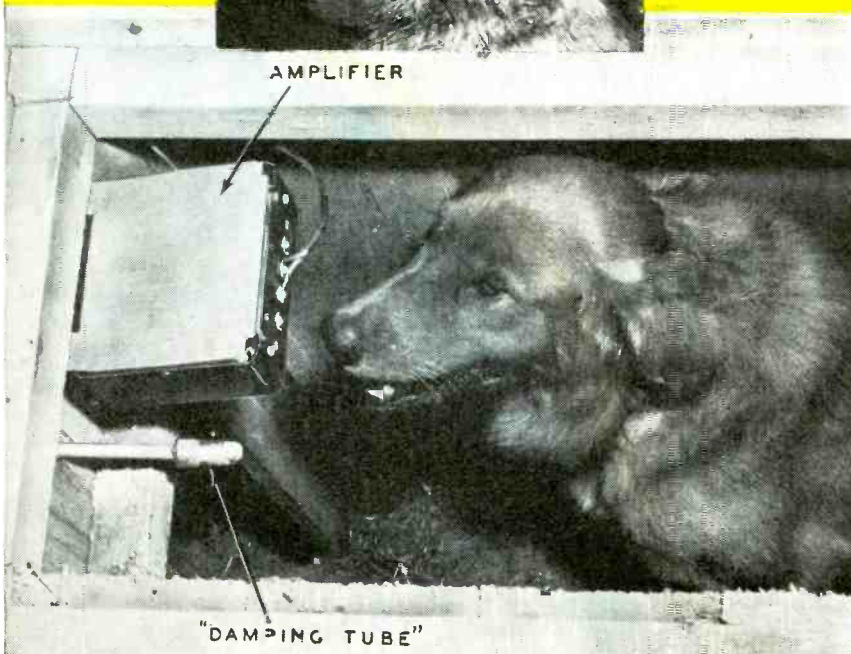

"DAMPING TUBE"

PERSONS working in any given field sometimes get so close to the details of their work that they fail to see opportunities or techniques that an outsider would have expected them to have seen at the first glance. To most radiomen, electronic equipment means radio, sound, and television, with hearing aids and industrial control equipment hovering somewhere in the fringe area. The idea of applying electronics to solve everyday problems rarely occurs to them.

Yet everyday life can be benefited by the application of electronics; witness such devices as the electronic rat trap (RADIO-CRAFT, May, 1944) and the later electronic baby watcher used by a group of veteran college students to permit one sitter to "watch" all the babies in a G.I. student barracks.

As a more recent example, note the problem of W. J. McGoldrick, electronics engineer and vice president of the Minneapolis-Honeywell Co., manufacturer of electronic controls and regulators. Awakened at 4:30 every morning by the barking of his golden retriever, Major, he lost so much sleep that he began to worry about his health. Surely electronics, which could regulate so many processes, could be used to control the nocturnal barking of a dog.

After a little consultation, it was decided that a device already in production by the company could readily be adapted to silence the troublesome dog. The device was an electronic amplifier, designed originally to take information from a bridge of temperature-sensitive resistors and amplify it to actuate a relay, which controlled the power to a radiant-panel heating system. The relay amplifier of the *Electronic Modu-flow* control system is a two-tube unit. The first tube, a 12SL7, acts as a two-stage voltage amplifier (see schematic). The final amplifier is half of the 12SN7, which receives the signal from the second 12SL7 stage and has the relay coil in its plate circuit. The other half of the tube acts as the rectifier for the 12SL7 plate supply. The 12SN7 amplifier section is connected directly across half the high-voltage winding of the power transformer, acting as its own rectifier.

It was a matter of only a few min-

Top—Major watches the adaption, little guessing the equipment is for him. Center—Result of short yelp, 4:30 a.m. Bottom—A now quiet Major inspects the gadget with considerable respect.



utes to disconnect a few parts and hook in a microphone, making the amplifier a sound-operated device. The load circuit was connected to a solenoid-operated valve which released a spray of water every time the relay operated. Major soon learned that silence was the price of a dry kennel.

The above is only one example of home electronic gadgetry. There are no doubt hundreds of other prosaic, simple, and useful opportunities in the average community. The radio technician who develops a few of these may discover in them a welcome addition to his income; and some device or application, properly protected and marketed, may possibly put him into an altogether new and higher income bracket!

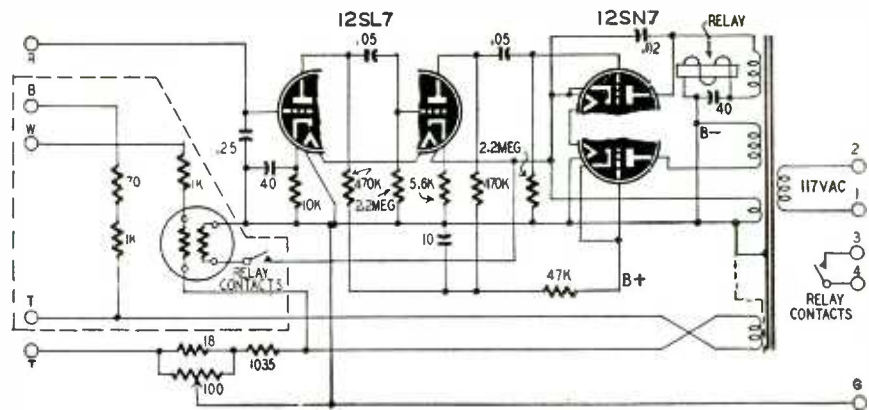

The Moduflow relay amplifier. Mike is connected between R and T and load between 3 and 4. Parts inside dashed lines were not used in the application.

# Everything Radiates

By BALDUR MEYER

ACCORDING to the law of Stefan-Boltzmann, any material whose temperature is above absolute zero (-273 degrees C) puts out infrared radiations. Since no way has yet been found to reduce temperature to absolute zero, every material radiates—including ice! The infrared radiation output of any material (in watts) is  $5.4 \times 10^{-12} \times T^4/A$ . T is the temperature in degrees K (273 + degrees C), and A is the area of the radiating surface in square centimeters. Using this formula, you will find that even small surfaces at room temperature emit astonishing amounts of infrared. The rays are often very penetrating, some radiating through more than 3 feet of water without losing all their energy.

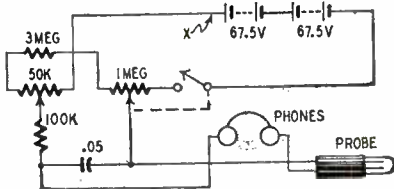

Detector is simple neon-tube oscillator adjusted to work at very low frequency.

The little instrument described here is so sensitive an indicator of infrared that the radiation from such odd objects as magazines, copper cups, books, and a piece of ice can easily be detected (see photos). It was discovered by accident while the writer was trying to build a radium-radiation counter using an NE-51 neon lamp instead of a Geiger-Müller tube. While it detects radium, it is so sensitive on infrared that radium and infrared radiation cannot be told apart. It is also sensitive to radio waves and indicates strongly in the presence of an unshielded superhetrodyne oscillator. It

reveals the presence of alternating power-line current, too, when the probe is held near a power cord as well as detecting many other kinds of radiation. The NE-51 is truly a miraculous—and to most people, an unexpected—radiation detector.

The instrument is very easy to build. It is simply a neon-lamp relaxation oscillator adjusted to the point at which the frequency is in the order of one cycle every few seconds. The diagram gives the complete story. Mount the NE-51 on the end of a plastic probe and connect it to the circuit with a lampcord cable.

The batteries can be old ones as long as they still have some no-load voltage. If they are fairly new and their voltage is above 100, it may be necessary to insert a resistance at point X to reduce the voltage so the "background count" will be very slow. Experiment with values.

To use the instrument, set the 50,000-ohm potentiometer to approximately the middle of its range (both controls should have linear tapers). Now adjust the 1-megohm potentiometer until oscillations begin. Next, regulate the 50,000-ohm control until the rate of oscillation is very slow—a single discharge should take place only every few seconds.

Any small quantity of radiation will now increase the capacitor discharge rate and raise the frequency of the clicks in the headphones. Begin by holding the luminous dial of your watch near the lamp. Then take a black book, a colored paper, a white paper, a metal box, your hand, a piece of wood, a stone—even a piece of ice—and hear the click rate go up each time, indicating radiation.

To prove that this is no accident, put the cover of your fountain pen over



Instrument was placed in small plastic container with batteries. Here it detects infrared radiation from a piece of ice. Pen cap was placed over lamp.

the lamp. The results are nearly the same. But shield the lamp with a metal tube, and the detector goes out of business. (Presumably the pen cap was a hard rubber one. Rubber is often used to filter out visible light and pass infrared.—Editor)

The beam of a flashlight influences the NE-51, too; it acts like a photo-

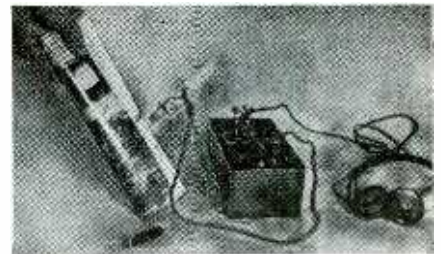

A check on the October, 1949, number of this magazine probably indicates how much "hot material" it contains.

tube. It is a good idea, incidentally, to conduct all experiments in dim light for that reason.

This inexpensive little "wonder counter" is an ideal way for anyone to prove to himself and his friends that we live in a radiating world!

# How to Become a Ham

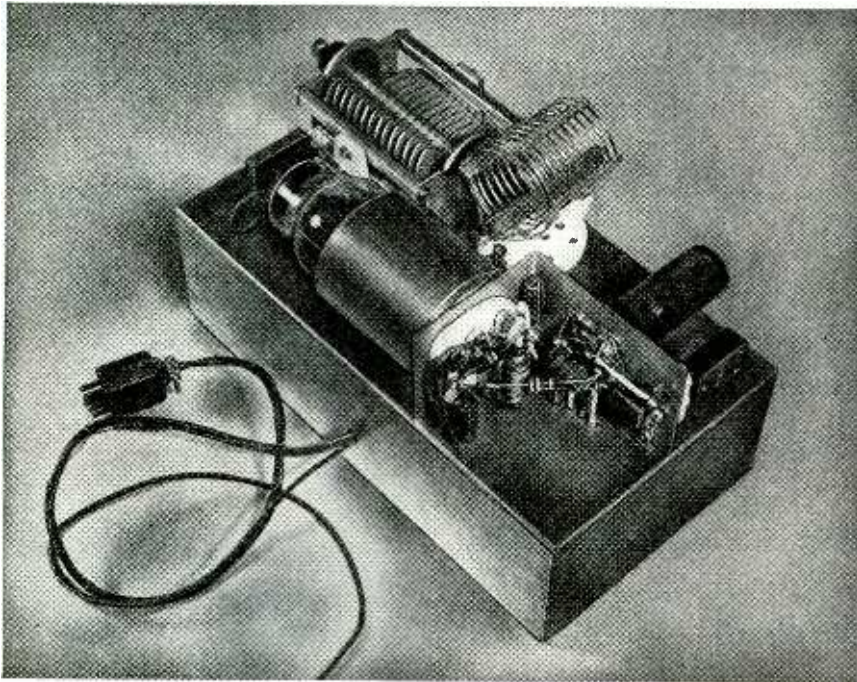

This rear view of the transmitter shows how the components are wired to the tube sockets. The author used a Millen 807 shield but you can make your own.

**M**ANY newcomers to the radio game, especially those well supplied with folding money, start off with elaborate transmitters of relatively high power. A great many more, however, begin with the very simplest kind of gear. It is our opinion that the low-power angle is by far the best approach to ham radio. In angling, the highest honors go to the light-tackle boys simply because they demonstrate the greatest skill. So it is with ham radio: the fellows with simple, low-powered rigs must exercise great care in the operation of their stations. Many of them have established enviable records.

Although the newcomer is primarily interested in simplicity, there are a number of other considerations, of which mechanical stability, low harmonic output, good keying characteristics, safety of the operator, are a few though not necessarily in that order of importance. Compromises must be made. For example, the transmitter shown in the photos and diagrammed in Fig. 1 works on only one amateur band with any one crystal. Separate crystals are needed for operation on the 3.5- and 7-mc bands. If the design were changed slightly, we could operate the output amplifier as a doubler, thus covering an additional band. However, a good doubler is necessarily rich in harmonics, and that is just what we are trying to avoid.

The oscillator stage employs a 6AG7 in a Pierce circuit. This stage will operate on the 80- and 40-meter bands with suitable crystals. The Pierce circuit was chosen because of its simplicity. No tuned circuits are needed with normally active crystals. However, this circuit is *not* recommended for use with crystals ground for 14 mc or higher. Capacitive coupling is employed between the oscillator and amplifier stages, resulting in only one tuned circuit for the entire transmitter.

An 807 was the natural choice for the output tube; no other gives so much for so little. Admittedly the 807 is temperamental; but, when handled properly, it behaves very well. Most difficulties encountered with 807's can be traced to

## Part VI—Building a 60-watt transmitter and a power supply for it

By **GEORGE W. SHUART,**  
W4AMN

overdriving, improper screen voltage, too little capacitance in the output circuit, and the like. Shielding, too, is very important! This 807 is operated with an input of 60 watts (600 volts at 100 ma), and the output, as close as we can determine, is 40 watts.

Two decisions must be made early in the design of a transmitter: first, whether or not the power supply is to be a separate unit; and second, whether the whole business is going to be built on metal chassis or a wood base. We vote for the metal-chassis type of construction because it provides a much better ground system. We like a separate power supply because that permits its use with other apparatus without the necessity for tearing into carefully wired circuits.

The r.f. portion of this transmitter is built on a 5½ x 9 x 3-inch welded-aluminum chassis. Nearly all the components are above deck. A 2¼-inch strip of aluminum is bent to form an L-shaped sub-base having one 2¼-inch side, on which the 807 is mounted, and another side 3¼ inches long for accommodating the 6AG7 tube and the crystal. Three spade bolts are used to fasten the sub-base to the main chassis. All wiring is completed before the sub-base is mounted. This arrangement and procedure is of great convenience since it makes it unnecessary to handle the whole transmitter during the greater part of the wiring job.

When the sub-base has been wired, it is placed in position and the main base marked for the holes through which the heater, screen, and plate-voltage wires

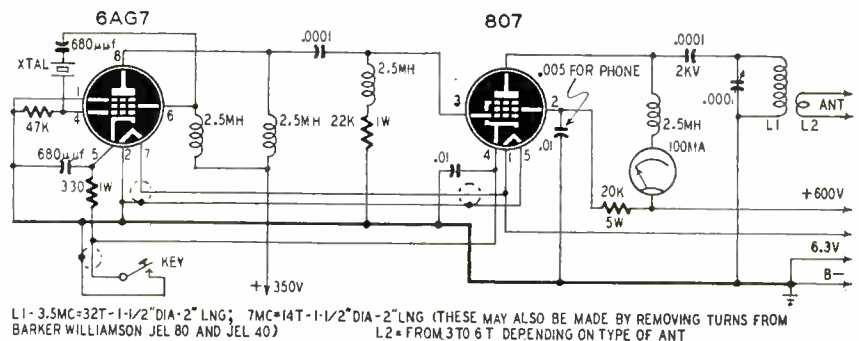

Fig. 1—This transmitter is simpler to construct than a little audio amplifier; yet a large percentage of seasoned amateurs are satisfied with one like it.

RADIO-ELECTRONICS for

pass. Below deck will be found only the 6AG7 plate and screen chokes, the 6AG7 grid leak, the 807 screen dropping resistor, and the final plate choke. Small four-lug terminal boards (three are used) support the underneath wiring.

In an all-out effort to keep r.f. currents where they belong, all low-potential wiring employs braided shield covering. The heater circuit uses the shield as one leg of the circuit. The shield is grounded at each end and wherever it passes through the aluminum base. A shielded keying lead is also used. Here, the braid forms one leg of the circuit.

Since we are little concerned with minimum capacitance in the output circuit, except that it should be high, we have used parallel plate feed and the plate capacitor has been mounted directly on the metal chassis with its rotor grounded. This frees the plate capacitor and the coil of dangerous high voltage. The main thought here was for the operator's safety. To be sure, high-potential r.f. voltages are present, but they are less dangerous to life should the operator come in contact with either the capacitor or the coil (though they can cause bad burns). The capacitor illustrated is war surplus and has excessive plate spacing and capacitance. The diagram shows the correct value. A receiving-type capacitor with 750-volt breakdown rating will be entirely satisfactory. The coils may be home-wound or B&W JEL80 and JEL40 coils may be cut down to fit the specifications in Fig. 1.

Only one meter is needed to operate the transmitter because only one circuit requires metering. The final amplifier plate current readily indicates the operation of other circuits. The meter used in the original transmitter is a 0-100 milliammeter mounted directly on the front apron of the main chassis. Any meter will serve so long as it will indicate at least 100 ma.

The power-supply unit is really a dual supply; there are two separate units built on the same chassis, as Fig. 2 shows, thus allowing separate low voltage for the oscillator. In addition there is a voltage-regulated circuit which may be used to operate other small apparatus such as the converter previously described. The particular transformer employed in the low-voltage section has a rating of 350 volts each side of center at 165 milliamperes. Thus it may be used to supply a number of low-power stages. To extend further the application of the low-power section, a separate 6.3-volt filament winding of the power transformer so that tubes having 12-volt heaters may be used if desired.

High voltage is supplied by a transformer having a rating of 650 volts at 250 ma. While the current rating is about twice that required by the 807, such a transformer is a good investment for the simple reason that it allows the use of two tubes in the final amplifier should the builder so desire. Since transformers usually last a long

time, give the subject considerable thought before making a selection. Choose transformers which will have wide application—they will pay dividends in the long run.

A power supply with good regulation is one whose output voltage does not vary widely when the load current is changed. Poor regulation may be due to overloading, use of improper rectifier tubes, a poorly designed filter, or just poor transformer design. Poor regulation should be avoided, especially in keyed transmitters and in class-B modulators.

The filter for the low-voltage supply is a brute-force type with capacitor input. Such a filter is satisfactory with a high-vacuum rectifier. Sufficient inductance and capacitance are used to assure smooth, ripple-free output. The high-voltage supply, however, presents quite a different problem because here we employed mercury-vapor rectifiers for improved regulation. Choke input is a *must* with mercury-vapor tubes. Less filtering is required for c.w. transmitters than for phone transmitters. For c.w. work, a single-section choke-input filter is sufficient. The product of the inductance of the choke under load and the capacitor value (in  $\mu\text{f}$ ) should be equal to 20 or better to reduce the output ripple to 5% or less. Thus a 20.5-henry swinging choke, and a 4- $\mu\text{f}$  capacitor would do the trick with full-wave rectification on 60-cycle current. An additional section should be used with phone transmitters.

Output connections on the power supply are made through Jones plugs. This is a safety measure—there are no exposed hot terminals to be accidentally touched. Separate toggle switches provide flexible control of the output voltages. A single fuse protects the entire unit. If the two supplies were separately fused, there might be danger of causing serious damage to the equipment were one section to go out and the other left running. By using a single fuse that danger is avoided: both will go out at the same time.

### Firing up the rig

Before any attempt is made to operate this equipment, check the wiring thoroughly. The most likely place for mistakes is probably at the tube sockets.

Insert the oscillator power plug into the low-power receptacle on the power supply. Do not, at this point, connect up the amplifier high-voltage plate lead! Turn on the low-voltage supply—be certain that the other switches are *off*. Place a small neon bulb ( $\frac{1}{4}$ -watt size) against the plate terminal of the oscillator tube. The neon lamp should glow when the key is closed if the crystal is in place and the tube is oscillating.

Next, place the correct coil in the amplifier coil socket. A 40-meter coil is used with a 40-meter crystal. Connect the high-voltage plate lead of the amplifier to the low-voltage supply, not to

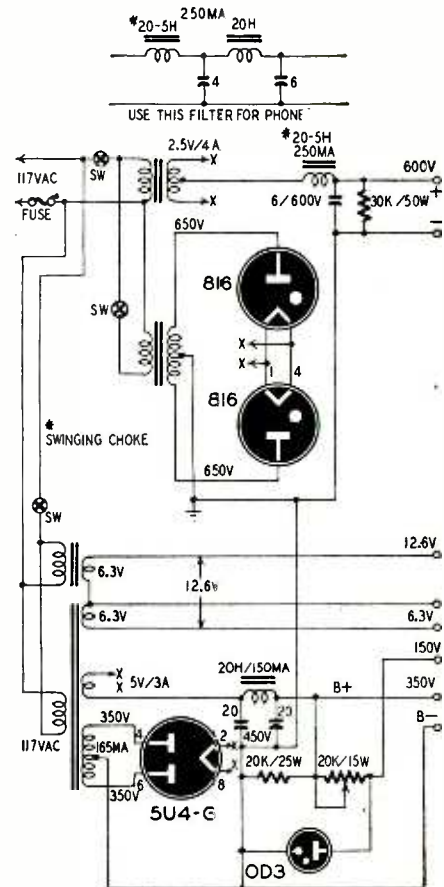

Fig. 2—The dual power supply is more elaborate than necessary for the rig of Fig. 1, but you will find it useful for powering other equipment in the future.

the high voltage. Then, as the key is closed, swing the plate capacitor from full capacitance downward toward minimum. There should be a pronounced dip in plate current somewhere between maximum and half capacitance. This point of minimum current indicates that the amplifier is in resonance with the crystal frequency. Repeat the above procedure with a crystal for the other band.

The rig is now ready to receive the high voltage and be connected to the antenna system. When the antenna is connected, the plate current will rise, and the dip, or point of minimum current, will become less pronounced. As the antenna coupling is increased (if a variable link or an external antenna coupler is used), the plate current of the amplifier will continue to rise.

Always reset the plate capacitor to minimum value of plate current to maintain resonance. The amount of change needed to restore resonance will be negligible if there is a good match between the antenna feed system and the output circuit of the amplifier. In no case should the plate circuit of the 807 be loaded beyond 180 ma. Off-resonance plate current can run extremely high and seriously damage the 807. That is why it was recommended that tuning be done with the low voltage instead of the full 600 volts applied to the 807.

# MURDER

## By Radio

By GUY SLAUGHTER

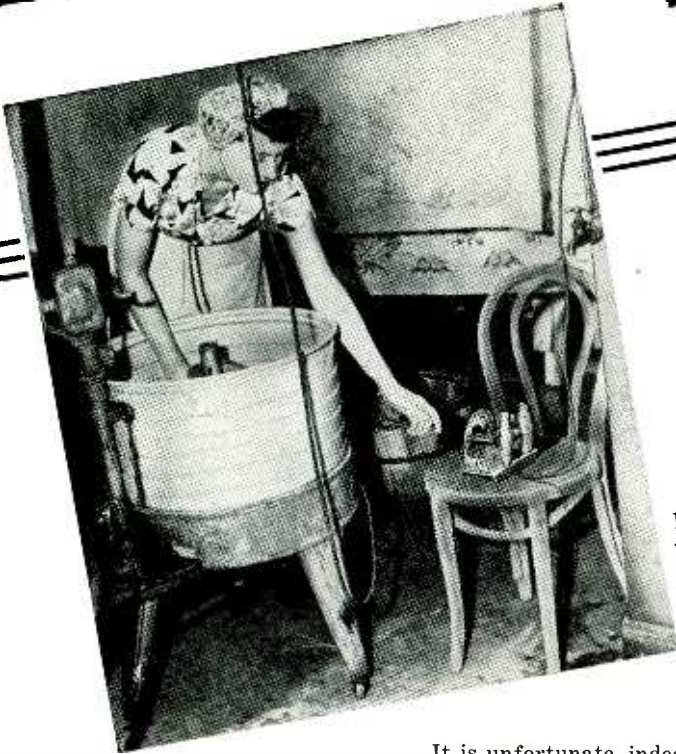

Mrs. Peeble tunes in on her last radio program.

**M**RS. PEEBLE," the obituary notice concludes, "was apparently electrocuted while swirling suds in her washing machine with one hand and tuning her radio with the other."

Obituary columns make morbid reading, perhaps, but they annually chronicle the untimely demise of thousands of solid citizens and citizenesses who accidentally draw more current than their circuits can handle. The details differ, of course, but most home electrocutions involve simultaneous contact with a grounded object and a transformerless radio.

The underwriters' labs have tabooed the hot chassis for years, it is true, and as a consequence most reputable manufacturers have adopted the policy of isolating the chassis from the line return through a bypass capacitor. But still obtainable everywhere are "bargain radios" whose chassis are at line potential, and the innocent purchaser seldom suspects that the absence of a little paper sticker labeled "UL" may mean a future tragedy in his family. Nor does he suspect that even an approved radio can bring sudden death through the untimely failure of a paper capacitor.

It is unfortunate, indeed, that plastic cabinets and plastic knobs, good insulators in their own right, get cracked and broken through rough handling. It is even more unfortunate that such a beat-up radio is usually the one which is relegated to the basement where its exposed chassis and the dampness of the concrete floor combine to make an excellent instrument of execution. But most unfortunate of all is the deplorable fact that often a "repaired" radio comes home to roast minus its isolation capacitor, with its chassis tied directly to one side of the line. It is doubtful, of course, whether a bona fide radio serviceman would ever delete this safety device, but many an amateur repairman and screwdriver mechanic has traced a motorboating or intermittent condition to the line-isolation capacitor and gleefully effected an economical repair by shunting it with a piece of hook-up wire. Imagine his consternation if one of these tinkers should be indicted for premeditated murder after his "repair job" had turned into an electronic booby trap!

Electrocutions by transformerless radios are considered "accidental," of course, in every sense of the word. There must be a combination of conditions set up, a sort of circumstantial accessory-before-the-fact. The radio must have its chassis at line potential, either through cheap design, capacitor

breakdown, or tinkering; the a.c. plug must be in the socket in such a way that the chassis is connected to the ungrounded side of the line; the victim must simultaneously contact a grounded object—bathtub, sink, radiator, water pipe, or concrete floor—and the chassis.

Since certain conditions must be met before a transformerless radio becomes a death-dealing booby trap, it follows that removing the conditions will remove the danger of accidental death by shock. It follows, too, that it lies within the power of the radio industry to save many lives by removing some of these circumstantial conditions.

Radio service technicians can help reduce the needless toll of radio-electrocutions by following a simple three-point program:

1. Refusing to stock, sell, or repair the "bargain radio" having no provision for isolating the line from the chassis.

2. Checking every transformerless radio that crosses the repair bench for shorted or "shunted" isolation capacitors, replacing them in either case.

3. Educating customers on the importance of looking for the Underwriters' label on every electric appliance they buy, as well as avoiding contact with *any* electrical device while wet or otherwise grounded.

So much for existing radios in existing homes, but much more can be done to improve the safety factor of the future transformerless radio in the future home. If electrical wiring codes are amended and revised to require polarized sockets for all wall outlets (90% of existing outlets are already polarized; if you don't believe it, look for yourself!) and to standardize one particular pole for ground connection; and if radio manufacturers are required to utilize the corresponding pole of polarized a.c. plugs for the grounded side of the line in their transformerless radios, then the electronic booby trap will cease to exist. Until such conditions obtain, Mrs. Peeble and her unfortunate kin will continue to furnish material for the obituary columns of a thousand morning papers.

Poor Mrs. Peeble!

RADIO-ELECTRONICS for

# Review of Recently Issued Tubes

**T**WO kine-copes are among the new tubes released during the month. Raytheon announced the 16LP4, a glass 16-incher which employs an external ion trap. RCA's contribution is the 16GP4, a short, metal-cone picture tube. The face is made of Filterglass for increased contrast in lighted rooms. The cone-to-neck section is newly designed for a longer, more efficient yoke. The design also facilitates centering the yoke on the neck; in combination with improved beam centering inside the neck, this contributes to better uniformity of focus. An ion trap is required.

General Electric has brought out 6- and 12-volt versions of the gated-beam discriminator, 6BN6 and 12BN6. The tubes are miniatures used as combination limiter, discriminator, and audio voltage amplifier in FM receivers designed for them.

Two more miniatures were introduced by G-E, the 6AB4 and the 12AY7. The former is an r.f. grounded-grid amplifier triode usable also as a frequency converter or oscillator up to about 300 mc. There is an internal shield.

The 12AY7 is a 9-pin, miniature, medium- $\mu$  twin triode with separate cathodes. Designed for input stages of high-gain audio amplifiers, it is a low-noise, low-microphonic tube. The heater is center-tapped to allow operation on either 12.6 volts at 150 ma or 6.3 volts at 300 ma.

Sylvania is responsible for three miniatures. The 6AB4 is similar to the G-E tube. A new pentode, the 6BA5, has a 3,300- $\mu$ mho transconductance; that of the 6AD4 is 2,700. Both have 6.3-volt, 150-ma heaters.

Three new industrial-type tubes have the Sylvania label. They are the 5691, 5692, and 5693. The first is a high- $\mu$  twin-triode voltage amplifier with series-unit heaters. The 5692 is a medium- $\mu$  twin triode suitable for balanced d.c. amplifiers, multivibrators,

and blocking oscillators, as well as for voltage amplifiers. The 5693 is a sharp-cutoff pentode designed for high-gain resistance-coupled amplifiers. Life for all three is rated at 10,000 hours, and all can resist impact shocks of 100 G for long periods or up to 500 G for short durations.

RCA's 1V2 is a halfwave rectifier in a miniature, nine-pin envelope. It is designed for use in high-voltage power supplies of the pulse type. Peak inverse plate voltage is 7,500, peak plate current 10 ma, and average plate current 500  $\mu$ a. Filament voltage is 0.625 at 300 ma.

Two new deflection amplifier tubes are announced by RCA especially for use with the new 16GP4.

The 6CD6-G is a high-perveance, beam-power amplifier featuring low  $\mu$ , high plate current at low plate voltage, and a high operating ratio of plate current to screen current. Because of these features, the 6CD6-G makes possible the design of an efficient horizontal deflecting circuit in which the plate voltage for the tube is supplied in part by the circuit and in part by the low-voltage d.c. power supply of the receiver.

The 6S4 is a high-perveance, medium- $\mu$  triode of the nine-pin miniature type. In suitable vertical deflecting circuits, the 6S4 will deflect fully a 16GP4 or any other similar kinescope having a deflection angle up to 70 degrees and operating at an anode voltage up to 14 kv.

The world's smallest X-ray tube, for use in dental radiography, has been announced by Amperex.

The Mini-X 045A measures only 2 1/4 inches in length (including the pins), has a diameter of 1 1/8 inches and has an extremely small and critical focal spot of 0.8 square millimeter (conventional X-ray tube focal spots vary from 1.5 to 2.1 square millimeters).

The tube is designed for oil-immersed operation at 45 kv peak and 7 ma.

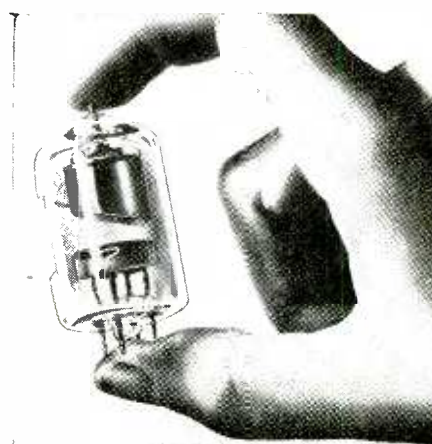
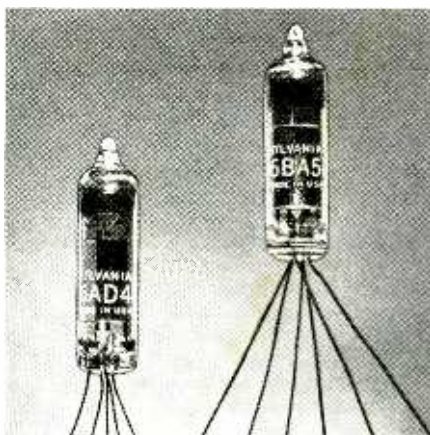

Mini-X 045A, the smallest X-ray tube.

# Repairing Radios from a Wheelchair

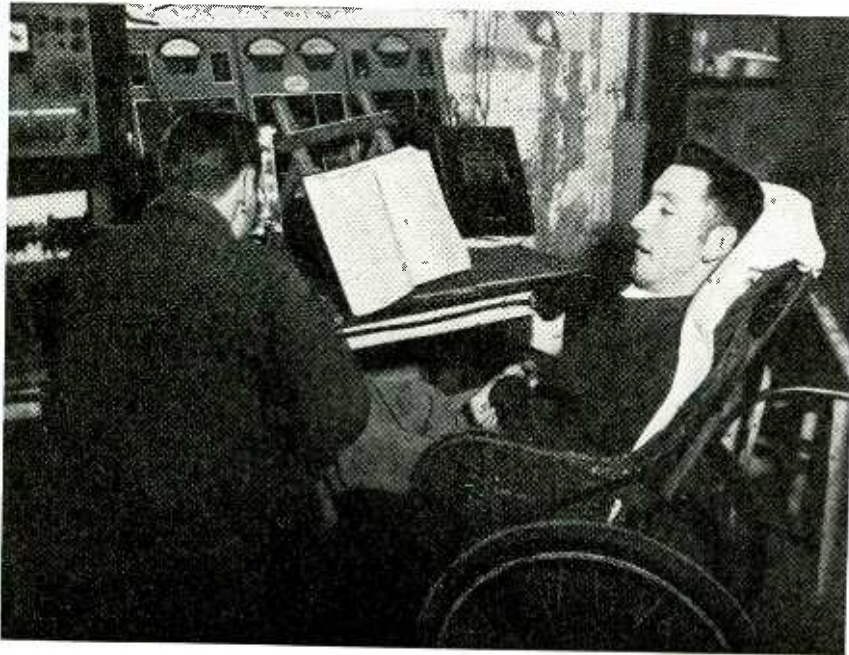

Author consults a service manual, then tells assistant how to make the repair.

**Unable to use arms or legs, Wendell Ward makes a living repairing radio sets by directing assistants' work**

By **WENDELL WARD**

**R**ADIO repair is undoubtedly one of the most intricate of vocations, demanding a high degree of hand and brain coordination and manual dexterity, and an ability to use fine tools with precision. I possess none of these characteristics: I am a spastic cripple, strapped to a wheel chair, without the use of either arms or legs. Yet I am a radio repairman, able to hold my own in a highly competitive business and to equal or better my rivals in quality and dependability of work.

How did I come to choose radio repair—above all things—as a career? How did I become interested in radio itself? How can I, almost completely helpless physically, test and repair radio equipment? And what are some of the special problems confronting the handicapped radioman? All of these

questions I hope to be able to answer in this article. The answers may be of interest, not only to those in the field, but to the general public as well, particularly to the disabled.

My interest in radio dates back almost to its infancy, as well as to my own. In a manner of speaking, we were brought up together. In 1924, when I was six years old, I heard my first broadcast, an exciting and thrilling event that I shall always remember. Here at last was diversion, entertainment, and education all wrapped into one, and, best of all, easily available to a crippled child. Those primitive earphones of my first set opened wonderful vistas for me then, and even today radio remains my main source of pleasure and recreation besides being my bread and butter.

For 12 years my interest and delight in radio grew. Gradually from that interest came a desire to know the function of radio, a curiosity to know the workings of the gadget that had brought so much pleasure into a fairly prosaic, wheelchair existence. Whenever the opportunity presented itself, I watched radio repairmen at work; and a conviction began to grow within me that I too could learn the art.

In the early spring of 1940, the long-awaited chance arrived. A close friend became interested in radio and began a primary course in repair. I immediately began to learn with him. An old set acquired from a skeptical but friendly neighbor became our first experiment. After long hours of kitchen-table mechanics—much to the dismay of my mother and grandmother—we finally completed our job successfully. The set worked! From that start, it was a natural step to a real paying job (\$3.00 for a simple part replacement in a set belonging to another neighbor, which I immediately invested in a pair of pliers, 29 cents' worth of solder, and some parts. Now I was in business—part-time anyway.

At first, jobs were scarce; and since I could invest very little in advertising, I could easily handle all of the work I received. In eight months, however, the picture changed. Because of the war, customers became plentiful, and it was a question of going all-out or of quitting altogether. After deciding to make radio repair my full-time career, I ran head-on into the difficult business of getting scarce testing equipment. After a furious search, I acquired an ancient tube-tester and a venerable ohmmeter. In 1942 I put my first advertisement in the local paper; the response was overwhelming. I was launched in business on a full-time schedule and have been going ever since.

The obvious question arises as to how I can work on radio equipment without the use of my hands. True, I am physically handicapped to the extent that I have practically no control over or use of my body, but I do have two things that I can and do use: my brain and my voice. I have learned the theory and practice of radio repair through constant and exhaustive study of manuals, diagrams, and other learning aids. I know radio cold. I have even developed a photographic memory of sorts that enables me to picture intricate wiring diagrams and complicated layout designs in my mind without recourse to the books containing them.

With my voice I transfer this knowledge to assistants whom I have originally trained and who do the actual work. In a way my system can be compared to that of the surgeon who, under local anesthetic, directs an operation upon himself. In the beginning I supply the know-how and my assistants are my hands. Eventually, through training, they become more and more inde-

RADIO-ELECTRONICS for

pendent, but in tricky and difficult jobs, I continue to direct them with my voice.

It is as simple as that. But with all its simplicity, it is a system that involves many problems never dreamed of by the radioman without disability; and above all, it takes a dogged determination to succeed plus a stubbornness that amounts nearly to fanaticism. It is not to be recommended to those who do not relish the thoughts of long—appallingly long—hours of concentrated, tedious work and study.

With the laborious acquisition of the system of repair described above, the business would still be useless without customers. Here I find my biggest problem. In a sense, this is the problem faced by every man in business: to sell oneself and one's ability to the skeptical public. How doubly difficult it is for one with a disability as severe as mine to convince a total stranger who has a valuable radio to be repaired that I am capable of doing the job efficiently, when I am totally unable to meet him at the door or assist him into the shop with his set or even shake his hand! This business of selling myself to the public is a problem that haunts me from day to day, and I have worked almost as hard on its solution as I have on mastering radio repair itself.

In my experience, the only answer to this problem is psychological. I must have implicit confidence in myself and I must transmit that confidence to the prospective customer. That takes doing as well as some analysis of the customer before it can even be attempted. The hesitant or skeptical prospect must be assured that I am highly competent and capable of repairing his particular set. I can convey this feeling of confidence only through word-of-mouth. I must talk him into belief in my ability; I cannot show him.

One of the most perplexing problems in setting up my particular system of radio repair was the difficulty of transferring my thoughts to assistants, especially in the early stages of training. Such difficult concepts as circuit functions of radio receivers, r.f., oscillator, and amplifier circuits, and the functions of different tubes in these circuits are extremely difficult to explain through speech alone. I can't even use my hands enough to point at what I am referring to at the particular moment; they are strapped to my sides.

Training assistants to know each necessary point so that it will not be necessary to explain again and again as each new job comes in is just a sample of the complications that arise. Many people have difficulty transmitting their thoughts to their own fingers, but my trouble arises when I attempt, as I must, to transfer my thoughts to other people's fingers in a type of work that demands the utmost coordination between mind and muscle.

Some of the other more common difficulties and problems are certainly not exclusive with me, but must also be shared by radio repairmen all over the country. The tremendous difficulty of

obtaining parts and equipment during wartime must be mentioned here. It was an obstacle of no mean proportions during the first, crucial five years of my business career.

Among the most common complaints of all radiomen—and most certainly one of mine—is the lack of replacement parts standardization. Many parts could be used interchangeably if there were some standardized system of parts manufacture. As it is, many repairmen working on a limited budget—and I include myself in that category—must go to the expense of stocking all types of tubes and other replacement parts. Not only does this make radio repair more expensive, but it also causes delay and confusion, since we must deal directly with each manufacturer, rather than doing business with a jobber who could supply us quickly and directly if standardization were in effect.

In the technical area, my chief difficulty has been in tracing and troubleshooting oscillator circuits in new FM-AM radios. This especially occurs where the same oscillator is used for both. Most of the trouble is brought about by the intricate band-switching circuit and—again—by the failure of the manufacturers to standardize circuits.

The delay in receiving service dia-

grams is another cause of headache to all repairmen. Without service diagrams the repair of some modern radios is inexcusably slow and tedious, a process not unlike that of a blind man attempting to thread a fine needle. The diagrams are usually sent at least a year after the new set has been released for sale. By that time the capable technician has figured out repair procedures and doesn't need the diagram.

So much for my troubles. Most of them are no different from those of the ordinary repairman except in degree. The career that I have made for myself in radio has amply repaid me in satisfaction for any headaches that it has brought in the process. Latest statistics show that there are eight or nine hundred thousand physically handicapped persons in this country today. Many of them are totally or partially dependent on the state or on some individual for support. That is not necessary! My own case and hundreds of similar ones prove it beyond a doubt. The important thing is to get some sort of work that you are capable of doing, and do it. The type of work is not important; the important thing is to get it. Once a feeling of satisfaction is aroused at being able to produce, nothing can stop you. The rest will take care of itself.

## Recommend Price Displays

A RECENT study in 10 different cities, made by National Analysts, Inc., and reported by *Sales Management* magazine revealed that displaying price information in store windows and on sales counters is highly effective in increasing sales. RCA quoted the survey in connection with its recent campaign directed to service technicians.

According to the survey, 85% of customers want to see prices on each item in the window and the same number want prices in printed advertising. Price tags on counter merchandise are desired by 87% of those queried. A significant fact is that 50% will not ask prices, fearing they will be too high—and that means loss of sales! On the other hand, 80% make "impulse" purchases when the price is clearly shown.

More sales losses are found in these figures: 72% will not enter a store to ask the price, even of something they want or need; and 77% of those who didn't buy in a given instance would have bought if they had known the price.

The lesson here for the radio dealer and service technician who sells receivers or parts is plain. If it's for sale—put a price on it. If you're ashamed of the price, you shouldn't be selling it. If you don't display the price, you probably won't sell it!

That every item is plainly priced does not mean that your window or counter need look like a bargain basement. The arrangement of merchandise

can be just as tasteful as before, but a small card, with lettering large enough to be readily legible, should be set on or next to each item. RCA is now furnishing pricing kits with movable numbers, through tube jobbers. Alternatively, you can have a local draftsman, artist, or sign painter make up price cards for a small charge. Another good suggestion is to invest in a couple of lettering templates, a bottle of India ink, and a lettering pen. If you purchase a little lettering set, such as a Wrico, at your local art or drafting supplies store, you can learn to do beautiful lettering in a very few minutes.



Suggested by: Hugh Lineback

"It may be some time before we can fix your loudspeaker."

# Shunting Potentiometers

**Shunting a variable resistor alters its taper. Curves show what tapers and resistances result**

by HUGH LINEBACK\*

ALTHOUGH radio technicians have long been familiar with different tapers on volume controls and circuits requiring nonuniform resistance changes, the experimenter may sometimes wonder how he can obtain some special resistance variation. Or it may be that the variable resistors at hand are of high values, and the designer would like to know how the characteristic is affected by using a fixed resistor as a shunt.

In the accompanying charts two common rheostat connections are shown, with the variable element  $R_v$  shunted by a fixed resistor  $R_s$ . The horizontal axis represents the amount of rotation of the movable arm from left to right in the diagrams. The vertical axis gives the percentage of maximum resistance available at the different settings for any curve.

In using the charts it must be remembered that the maximum resistance depends on the values in parallel when  $R_v$  is set at its highest resistance. The tables indicate how the maximum resistance may be determined for a certain rheostat. For example, suppose it is desired to shunt a 1,000-ohm linear variable resistor to give it characteristic of curve A in Fig. 1. From

\* School of Technical Training, Oklahoma A & M College.

the table,  $R_s$  must be 0.1  $R_v$ , or 100 ohms. The highest resistance obtainable with this combination would be 9.1% of 1,000, or 91 ohms. On the chart the 100% point of the curve would represent this maximum value, and the resistances for other settings may be calculated. Thus, at 10% of the rotation the resistance would be 55% of the maximum, or 50 ohms ( $91 \times 0.55$ ).

In order to keep the maximum circuit resistance near the value of the original rheostat, it would be necessary to use a 10,000-ohm variable resistor with a 1,000-ohm shunt, giving a maximum resistance of 910 ohms.

Using the same 1,000-ohm resistor to obtain curve B, in which case  $R_s$  would be 500 ohms, the maximum resistance would be 333 ohms.

Several interesting relationships will be noticed in the curves and the resistance ratios they represent. Curve A of Fig. 1 shows a rapid rate of resistance change at first; in fact, over half the total change occurs in the first 10% of rotation. Such a characteristic might be desired for providing fine adjustments over most of the range; beyond 30% rotation the change in resistance takes place very gradually. The same effect is shown with less

emphasis by curves B and C. Curve D is practically linear, and ratios with  $R_s$  greater than 5 times  $R_v$  merely make the curve come closer to being a straight line.

A different effect appears in curves A and B of Fig. 2. Again assuming a 1,000-ohm variable resistor, with  $R_s$  equal to zero the peak of curve A would represent 250 ohms. Study of the curves will show that the halves of curve A actually correspond to a more gradual rate of resistance change than curve D when they are applied to the same rheostat. This may not be evident at first from glancing at the entire figure, as the 100% reference will correspond to different values of actual resistance in each of the two cases.

The two circuits given are for rheostats. Another common situation occurs with potentiometers, when, for instance, the constructor shunts a volume control to obtain a lower-resistance unit. The grid finds a resistance equal to the net shunt value when the arm is at the top of the potentiometer and a higher value as the slider moves down, as in Fig. 2. That is frequently important because it may introduce or accentuate Miller effect, which is often highly undesirable.

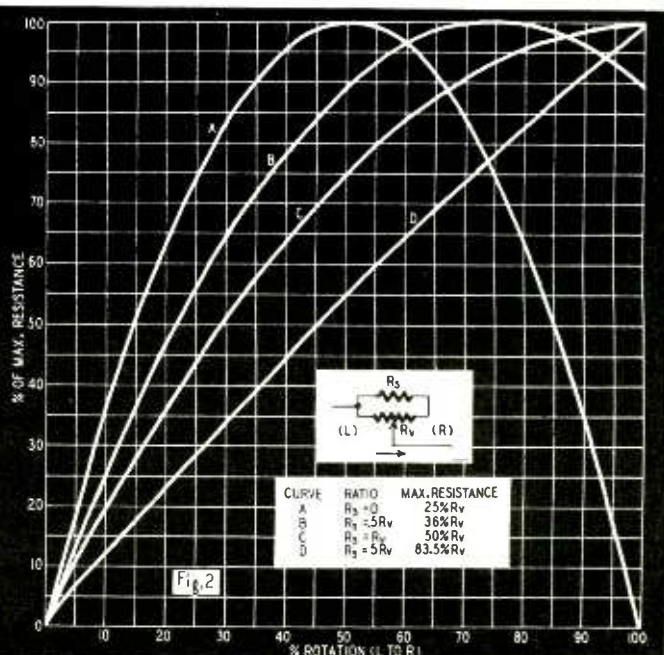
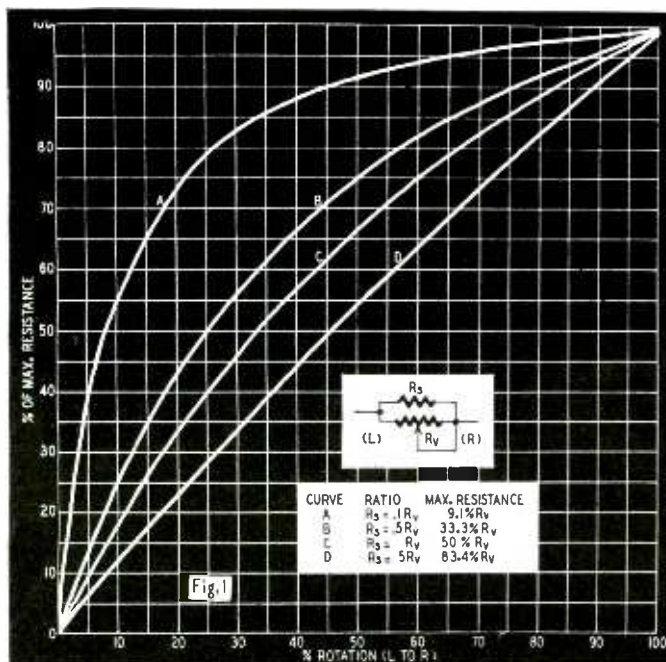



# There's Only ONE COMPLETE CATALOG that Brings You EVERYTHING IN RADIO, TELEVISION & ELECTRONICS

IT'S YOUR **FREE**  
**ALLIED** 196-PAGE  
 VALUE-PACKED CATALOG!

**SEND FOR IT TODAY**



## Get Radio's Leading Buying Guide

Here's the Buying Guide to *everything* in radio for *everyone* in radio! It's the *one complete* catalog, preferred in the field because it fills *every* TV, Radio, and Electronic supply need. It's packed with the world's largest selections of quality equipment at lowest money-saving prices. See the latest in TV, AM and FM receivers; radio-phonos; new Sound Systems, P.A. equipment and high-fidelity sound components; recorders and accessories; full selections of newest Amateur receivers and station gear; test instruments; builders' kits; huge listings of parts, tubes, tools, books, diagrams.

ALLIED gives you every buying advantage: speedy delivery, expert personal help, lowest prices, assured satisfaction—plus the most liberal Time Payment plan in radio. Get the 1950 ALLIED Catalog—it will save you time and money. Send today for your FREE copy!

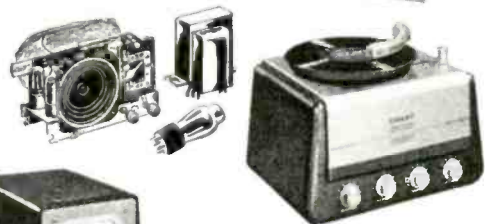

## WORLD'S LARGEST STOCKS

*Radio Parts Unlimited*  
*Test Instruments—All Makes*  
*Television & Home Radios*  
*P. A. and Hi-Fi Equipment*  
*Amateur Station Gear*  
*Experimenters' Supplies*

**QUICK, EXPERT SERVICE**

## ALLIED IS YOUR TELEVISION HEADQUARTERS



You keep up with TV when you depend on ALLIED! Count on us for the latest releases and largest stocks of picture tubes, component parts, antennas and accessories—plus the latest in TV receivers, tuners and kits. If it's anything in TV—we have it in stock! So remember—for TV—it's ALLIED First!

# ALLIED RADIO

THE WORLD'S LARGEST RADIO SUPPLY HOUSE

*Everything in Radio, TV and Electronics*

Send for Radio's Leading Buying Guide

**FREE**

ALLIED RADIO CORP.  
 833 W. Jackson Blvd., Dept. 2-C-0  
 Chicago 7, Illinois

Send FREE 196-page 1950 ALLIED Catalog.

Name .....

Address .....

City ..... Zone ..... State .....

# Fundamentals of Radio Servicing

## Part XIII—The Power Supply

By JOHN T. FRYE

THE crystal set and its modern lineal descendant, the transistor receiver, are the only radio receivers that do not use vacuum tubes. All the rest—AM, FM, and TV sets—lavishly employ these so-called “electronic wonder-workers.”

By itself, though, a vacuum tube is a cold and lifeless thing, about as full of magic as an empty pop bottle. Not until a filament current has warmed the cathode and given its electrons a stimulating hotfoot do they start swarming from the cathode surface; and only when the proper voltages have been applied to the tube's electrodes can these darting electrons be pushed and pulled into precise behavior patterns that are able to delight our eyes with the sight of distant events and our ears with the sound of faraway music.



This power supply puts out 500 volts at 200 ma, with choke input. The meter measures the output current and the small lamp, in the centertap, is a fuse.

It follows, then, that all ordinary radio receivers must have some source of power that will light up the filaments of the tubes and provide proper voltages for their electrodes. Batteries, the first answer to this need, are still used in portable receivers. A low-voltage, high-current A-battery is used to heat the filaments, connected either in series or in parallel. A higher-voltage, lower-current B-battery furnishes the electrode potentials. Quite often both of these batteries are packaged in a single battery pack.

Battery power, while practical for sets providing limited volume and used only intermittently, is expensive if called upon to supply a powerful, multi-tube console that is tuned in on a wake-up program the first thing in the morning, kept in a lather by soap operas all day long, and not turned off

until after the last newscast at night. Radio engineers looking around for a cheaper source of power focused on the house-current socket. If they could make the electricity that came out of that socket do the job that the electricity from their batteries had been doing, they would be sitting pretty. The only catch was that batteries furnished d.c. whereas a.c. came from the light sockets.

That did not daunt our heroes. First they set out to solve the problem of how to use a.c. to heat the filaments. They could not use this pulsing, reversing current to heat the slender filaments of their early 201A's because those filaments heated and cooled too quickly—so quickly, in fact, that the temperature, and consequently the emission, of these tubes rose and fell right in step with the reversing 60-cycle current. The result was a bad hum.

Two separate solutions were quickly found. First, increasing the bulk and current-carrying capacity of the filament allowed it to store sufficient heat so it could stay hot and continue to emit during the brief periods when the a.c. was falling to zero and reversing its direction. Second, heating the emitting cathode *indirectly* from a separate filament made the emission independent of rapid filament-current variations.

### B-supply rectifiers

That took care of the A-supply, but getting rid of the B-battery was not so easy. The voltages applied to the plates and screens of the tubes had to be steady direct current. The manner in which the neat trick of converting a.c. into smooth-flowing d.c. is performed is really a two-part drama. Act One is called *Rectification*, and Act Two is titled *Filtering*.

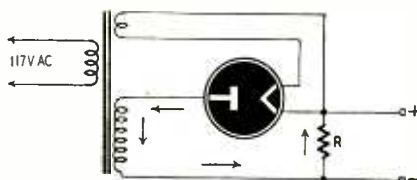

Fig. 1—The basic half-wave rectifier.

Fig. 1 shows one way of rectifying an alternating current. The transformer's primary is connected to the house current. The smaller secondary devel-

ops the correct voltage for heating the heavy filament of the diode tube. The larger secondary develops an a.c. voltage slightly higher than the d.c. voltage required.

From our study of a.c. we know that, during one half of every cycle of voltage, the top end of the high-voltage secondary will be positive, and during the next half negative, with respect to the bottom end, which is connected through R to the filament. When the top end is positive, the plate of the rectifier is positive with respect to the filament. Under these conditions, electrons from the filament are attracted to the plate and flow down through the transformer winding and up through resistor R back to the filament, as shown by the arrows. When the top end is negative, however, no current flows, the electrons being repelled by the negative charge on the plate.

The result of this check-valve action exerted by the rectifier tube is shown

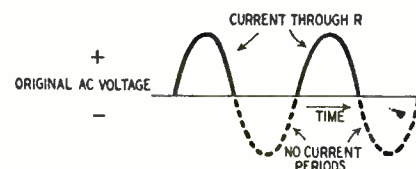

Fig. 2—Half of the a.c. wave is used.

in Fig. 2. Notice that the current flowing through resistor R is in the form of pulses resembling half of a sine wave. Note, too, that these pulses are separated by the time interval required for the supply voltage to go through the negative half of its cycle. Since the system uses only half of the 60-cycle wave, it is a *half-wave rectifier*.

The efficiency-loving engineers, though, couldn't bear to see their rectifying system just sit there and twiddle its thumbs during half of every a.c. cycle; furthermore, smoothing out that pulse, wait-a-while, pulse, wait-a-while kind of d.c. took quite a bit of doing. Pressed by these annoyances, they worked out the *full-wave rectifier* shown in Fig. 3.

Again we have a transformer with a secondary winding to heat the filament of our rectifier tube, but now our rectifier has *two* plates. What is more, the high-voltage secondary has its ends connected to these two plates, while a lead

## WE KNOW THE PRICE IS UNBELIEVABLY LOW,

but that's not all! In addition, this finely engineered instrument provides a degree of accuracy never before attained in a unit selling for even double this price. Furthermore—in designing this unit, we took advantage of every recent improvement in components. For example, by using slug-tuned coils, we are able to efficiently adjust each instrument for

perfect accuracy. This feature will also enable you to recalibrate the model 200 periodically without having to return it to the factory. The use of a Noval tube (the 12AU7) with its extremely low inter-electrode capacity enabled us to reach a higher frequency range than was heretofore possible in a unit of this type.

# THE NEW MODEL 200 AM and FM SIGNAL GENERATOR

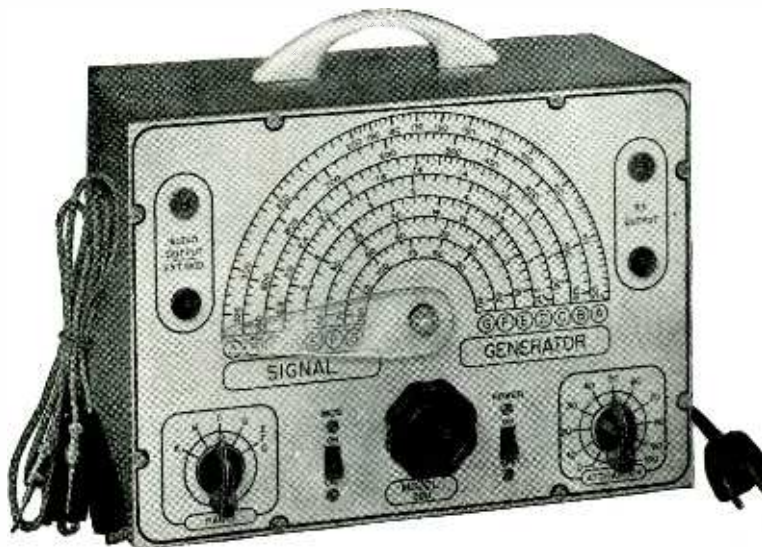

### SPECIFICATIONS

- ★ **R.F. FREQUENCY RANGES:** 100 Kilocycles to 150 Megacycles.
- ★ **MODULATING FREQUENCY:** 400 Cycles. May be used for modulating the R. F. signal. Also available separately.
- ★ **ATTENUATION:** The constant impedance attenuator is isolated from the oscillating circuit by the buffer tube. Output impedance of this model is only 100 ohms. This low impedance reduces losses in the output cable.
- ★ **OSCILLATORY CIRCUIT:** Hartley oscillator with cathode follower buffer tube. Frequency stability is assured by modulating the buffer tube.
- ★ **ACCURACY:** Use of high-Q permeability tuned coils adjusted against 1/10th of 1% standards assures an accuracy of 1% on all ranges from 100 Kilocycles to 10 Megacycles and an accuracy of 2% on the higher frequencies.
- ★ **TUBES USED:** 12AU7—One section is used as oscillator and the second is modulated cathode follower. T-2 is used as modulator. 6C4 is used as rectifier.

The Model 200 operates on 110 Volts A.C. Comes complete with output cable and operating instructions.

\$ **18**<sup>85</sup>  
NET

—20% DEPOSIT REQUIRED ON ALL C. O. D. ORDERS (Sold on a "MONEY-BACK-IF-NOT-SATISFIED" Guarantee)—

**GENERAL ELECTRONIC DISTRIBUTING CO.**

Dept. RC-3, 98 PARK PLACE  
NEW YORK 7, N. Y.

brought out from the center of the winding now goes to R. Now the a.c. voltage across the ends of the transformer winding is slightly more than twice the d.c. voltage required.

Let us say that the voltage appearing

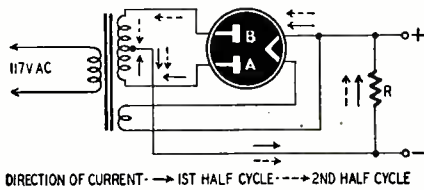

Fig. 3—Duo-diode full-wave rectifier.

across this winding is 600 volts. Then, when the top end is 600 volts positive with respect to the bottom end, it is 300 volts positive with respect to the lead brought out from halfway down the winding. And when the bottom end is 600 volts positive with respect to the top end, that bottom end is 300 volts positive with respect to the centertap. That centertap is just like a man sitting in the middle of a see-saw: first one end of the board rises above him and then the other; there is always a downgrade to him from one of the two ends of the plank.

Recalling that the ends of the winding are connected to the plates of the tube and the centertap is connected through R to the filament, you can see that one plate or the other of the tube is always positive with respect to the filament. We know that under these conditions electrons will go from it to whichever of the plates happens to be positive at the time, will flow down through one half of the winding to the centertap, and then will return through

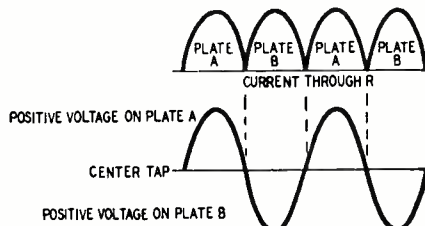

Fig. 4—Tube plates conduct alternately.

R to the filament. During the time a plate is negative, of course, it catches no electrons; thus each plate works only half of the time. But between the two of them, they keep current pulsing through R almost continuously. Fig. 4 shows this clearly.

### Smoothing filters

The output of the full-wave rectifier is a decided improvement over that of the half-wave job, but it still looks too much like the bouncing path of a frog for use on the plates of our tubes. We have to smooth out those peaks and valleys, and that is where our *filter* comes in.

Fig. 5 shows a *choke-input filter* connected directly across the output of our rectifier. C is a capacitor of several microfarads and L is an iron-core filter choke of 10 to 30 henries. When the rectifier tries to send its pulsing direct

current through L, it runs head on into the choke's strong dislike for any *change* in the amount of current passing through it. We learned in our study of inductance that self-induction bucks any increase in current through a choke, while the collapsing field of the inductance will provide extra current in an attempt to prevent any faltering or reduction in the steady value. These efforts on the part of the choke to keep the current on an even keel result in lowering the peaks and filling in the valleys of the pulsing current delivered to the input of the filter from the rectifier.

Capacitor C stores up current during the small voltage peaks delivered to it from the choke and then returns this stored charge to the load when a dip in voltage starts to occur. This action still further smooths out the voltage across the load resistance. If additional filter-

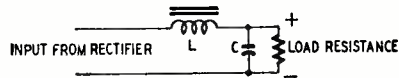

Fig. 5—A choke-input smoothing filter.

ing is wanted, another choke and capacitor can be added.

Fig. 6 is the diagram of a *capacitor-input filter*. The only difference is the addition of another capacitor C1, which charges to the peak voltage available from the rectifier. Between peaks this charge is partially lost by current flowing through the choke and the load resistance, but each peak restores the charge, as is shown by Fig. 7.

The only time current flows from the rectifier is during the intervals when the rectifier output voltage is higher than the charge on C1. This means that current is taken from the rectifier during only a small portion of each cycle in the capacitor-input filter instead of flowing continuously as in the choke-input type. For a given amount of current drawn from the outputs of the filters, this means that the rectifier will have to deliver considerably heavier pulses of current to the filter of Fig. 6 than it will to that of Fig. 5, since the same amount of current has to be delivered in considerably less total time. That is why it is much easier to overload the rectifier tube with a capacitor-input filter than with a choke input.

Another difference between the two is in the d.c. voltage output. The output voltage of the choke-input filter is usually the *average* voltage of the rectifier

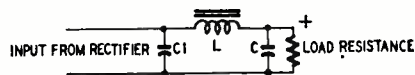

Fig. 6—This filter has capacitor input.

output, while the output of the capacitor-input filter, especially with light loads, approximates the *peak* voltage of this output (minus the drop across the choke resistance). However, the output of the choke-input system falls off much more slowly under an increasing current load than will that of the capacitor-input filter. In general, though, the higher voltage available

from a transformer with a capacitor-input filter makes this type by far the most popular with radio manufacturers.

Power-supply troubles put lots of money into the pockets of radio technicians, and most of these troubles are quite easy to locate. For example, a rectifier tube that does not light because the filament is broken can usually be spotted at a glance; yet a radio containing such a tube will be as dead as a burnt match.

The eyes, too, are useful in deciding if there are any shorted filter capacitors. When a veteran technician first turns on a radio set, he watches closely the rectifier plates. If these plates show no color, he feels safe in leaving the set turned on while he makes other tests; but if the plates start to turn red, he quickly snaps off the receiver before damage is done to the rectifier tube or the transformer. In the latter case, he can feel fairly sure that one of the filter capacitors has shorted and provided a low-resistance return path for the electrons, allowing millions of them to bombard the plates and make them red hot from the impact very quickly.

On the other hand, if one of the capacitors opens up, the ears can easily detect the hum that appears in the speaker because of loss of the filtering action of the defective unit. The trained ear can even tell *which* of the two capacitors has opened because of the subtle difference in the type of hum produced.

Even the nose has its place in analyzing power supply troubles, for it can quickly detect the odor that clings to a transformer that has been overheated.

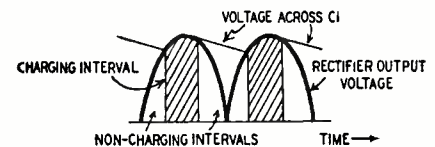

Fig. 7—Rectifier delivers heavy pulses.

This foul, pungent odor, beside which that of a skunk is pleasant by comparison, is impossible to describe adequately, but, once smelled, it is impossible to forget it or to mistake it for anything else.

However, I am not trying to say that you should depend entirely on your senses to locate power supply troubles. The point is that they are not hard to find, and those that cannot be seen, heard, felt, tasted, or smelled can be readily ferreted out with a volt-ohm-meter.

We are not through with the subject of power supplies. What we have studied this far are the fundamental types. Now we are ready to go ahead and investigate the a.c.-d.c. or transformerless power supply, the auto radio type, the three-way portable power supply, the voltage-doubling rectifier, and so on. These and other interesting and practical variations will be taken up in the next chapter.

# GET AHEAD IN TELEVISION . . . INCREASE YOUR INCOME . . .

## FIND THE ANSWERS TO ANY TV PROBLEM QUICKLY . . .

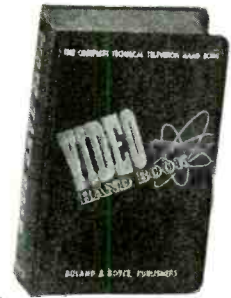

**OVER  
900  
PAGES**

**INVALUABLE  
HELP FOR YOU . . .**

*Fully Illustrated with  
charts and diagrams*

*If you are an engineer, technician, student,  
or in television work of any kind*

**COMPLETE  
AUTHORITY**

**ONLY \$5.00**

**14 BOOKS COMPLETE IN ONE  
VOLUME . . . SAVES YOU TIME**

When trouble shooting, testing, installing, constructing, either receivers or transmitters, you can use the data and basic knowledge found in this one handy book. It can help you solve basic problems quickly in your shop, drafting room, studio, or in the field. You have just one source to find the answers quickly to all problems. If your income depends on any one of the many phases of television you cannot afford to be without this reference book.

MARCH, 1950

**TWO VALUABLE REFERENCE BOOKS**



**RADIO DATA BOOK**  
Over 900 pages.  
12 sections,  
completely il-  
lustrated ONLY  
\$5.00



**VIDEO HANDBOOK**  
Over 900 pages,  
860 illustrations  
14 sections  
ONLY \$5.00

**COMPLETE RADIO & TV  
LIBRARY**

Both Radio and Video Hand-  
book in attractive slip case. Buy  
both books and save money.  
ONLY \$9.00.

Get them at your favorite deal-  
er's. If he cannot supply you,  
order direct, using the coupon.



**MAIL ORDER  
COUPON NOW**

**BOYCE-ROCHE BOOK CO.  
MONTCLAIR, NEW JERSEY** RE-3

Please send me the following, postpaid:

- Radio & Video Library @ \$9.00
- Radio Data Book @ \$5.00
- Video Data Book @ \$5.00

Check or M. O. enclosed in amount of \$.....

Name.....

Address.....

City.....State.....

# SEVEN UNUSUAL POWER SUPPLIES

By LYMAN E. GREENLEE

THE power supplies described in this article all use standard, easily obtainable parts. That is important to the constructor who wishes to build an experimental unit without buying or making special equipment. Results will depend largely on the quality and insulation of the components, since some transformers

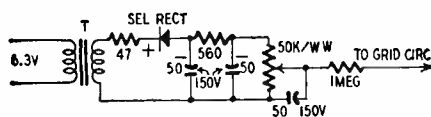

Fig. 1—Bias supply with 6.3-volt source.

and other units are operated at higher than normal voltages. However, the constructor need not worry too much. The tubes, capacitors, and transformers are all low-cost items; and if one unit breaks down and has to be discarded, a replacement probably will stand the gaff.

## Bias supply

The circuit shown in Fig. 1 provides a practical way of obtaining an isolated source of bias voltage from any 6.3-volt heater winding without adding a heavy load to the amplifier power transformer. The isolating transformer T may be either a small 6.3-volt filament transformer or a midget output transformer. A universal output transformer is particularly desirable as the taps allow a variation of output voltage. The 47-ohm resistor in series with the selenium rectifier acts as a protective fuse in case the rectifier breaks down or the output is shorted. The maximum voltage under load should not run higher than the rated operating values for the rectifier and filter capacitors, usually 150 volts. A tube rectifier could be used, but this would add an extra heater load to the power transformer and there would be no advantage.

## Supply for test equipment

The supply shown in Fig. 2 is ideal for supplying B-voltage to vacuum-tube voltmeters, small portable radios, oscillators, signal generators, or any equipment requiring not more than 135 volts at about 50 ma. T1 and T2 are two small filament transformers with

their 6.3-volt windings connected together. They will have enough power-handling capacity to run one or two tubes and supply filament current, but the total wattage for filament and plate must be kept below the rating of the two transformers so they do not overheat. Since it is often difficult to determine the actual wattage these small transformers will handle, the circuit should be hooked up breadboard fashion and allowed to run for a considerable time under maximum load. Allowance must be made for mounting the parts in a cabinet in which heat dissipation may be less because of inadequate ventilation.

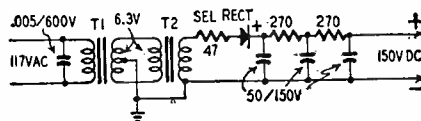

Fig. 2—Utility supply for instruments.

The author has successfully used a small output transformer for T2. This circuit is very good for use with r.f. signal generators because of the excellent isolation of the d.c. circuit from the power line.

## Voltage multiplier

The voltage multiplier of Fig. 3 may at first glance appear to be too complicated and expensive for practical use. Analysis of the circuit reveals, however, that the cost is not too high (about \$15 for parts) and there are certain advantages of light weight, small space, and instant starting. An unusual feature is that output voltages in steps of about 150 volts (no load) are available for testing purposes or for operating multiplier phototubes and similar devices. The only big disadvantage of the circuit is that it is not isolated from the power line. Such isolation would require a transformer, which would add to the weight and cost.

In constructing the voltage multiplier, the individual selenium rectifiers should be attached to an insulating strip of bakelite or something similar and separated to provide adequate insulation at the working voltages indicated on the diagram. Do not use very high capacitances with this circuit be-

cause of the danger of accidentally kicking back a high-voltage surge into the power line. With values of .05  $\mu$ f or less, there will be little such danger, but a large capacitor charged to around 2,000 volts may seriously damage other equipment if accidentally discharged back through the power line.

This very lightweight supply is dependable and rugged because of the large voltage tolerances specified for the capacitors used. These voltage ratings permit the use of standard television capacitors. Note that voltages shown on the diagram are approximate open-circuit voltages and will drop under load.

## Vibrator-multiplier supply

The power supply shown in Fig. 4 is of particular interest to those looking for a portable source of high voltage for operating a Geiger tube or for any similar use such as with a small battery-powered scope. A standard auto radio transformer and vibrator may be used with a 6-volt battery, or one of the midget radio transformers and vibrator assembly may be used on 2 to 4 volts. Output from the low-voltage section should be in the 250-300-volt range, not higher, to avoid overloading the rectifiers and exceeding their voltage rating. The buffer should be carefully chosen to reduce surges to a minimum and prevent rectifier breakdown. In some instances it may be advisable to use three midget selenium rectifiers in series to avoid breakdown from excessive surge voltages.

(Continued on page 59)

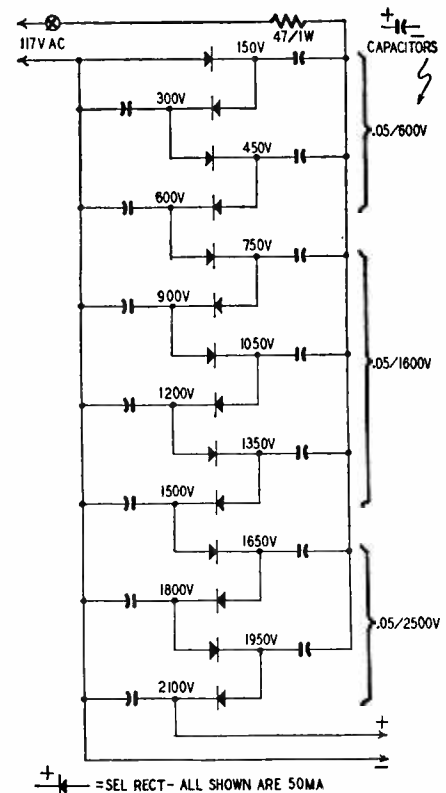

Fig. 3—A multiplier yields 2,500 volts.



*Here are some of the many reasons why there are more Simpson 260 high sensitivity volt-ohm-milliammeters in use today than all others combined. The Simpson 260 has earned world-wide acceptance because it was the first tester of its kind with all these "Firsts":*

# Simpson 260 SET TESTER

## WORLD FAMOUS FOR ALL THESE "FIRSTS"

- First high sensitivity instrument to use a metal armature frame.
- First to use fully enclosed dust proof rotary switch with all contacts molded in place accurately and firmly.
- First to do away with harness wiring.
- First to provide separate molded recesses for resistors, batteries, etc.
- First to cover all resistors to prevent shorts and accidental damage and to protect against dust and dirt.
- First with a sturdy movement adapted to the rugged requirements of a wide range of service work or laboratory testing.
- First to provide easy means of replacing batteries.
- First to use all bakelite case and panels in volt-ohm-milliammeters.
- First volt-ohm-milliammeter at 20,000 ohms per volt with large 4½" meter supplied in compact case (size 5¼" x 7" x 3⅛").
- First and only one available with Simpson patented Roll Top Case.
- First to provide convenient compartment for test leads (Roll Top case).
- First to offer choice of colors.

**RANGES**

20,000 Ohms per Volt DC, 1,000 Ohms per Volt AC

**VOLTS:** AC & DC—2.5, 10, 50, 250, 1,000, 5,000

**OUTPUT:** 2.5, 10, 50, 250, 1000

**MILLIAMPERES, DC:** 10, 100, 500

**MICROAMPERES, DC:** 100

**AMPERES, DC:** 10

**DECIBELS:** (5 ranges)—12 to +55 DB

**OHMS:** 0-2,000 (12 ohms center), 0-200,000 (1200 ohms center), 0-20 megohms (120,000 ohms center).

Prices: \$38.95 dealers net; Roll Top \$45.95 dealers net.



*The Model 260 also is available in the famous patented Roll Top safety case with built-in lead compartment. This sturdy, molded, bakelite case with Roll Top provides maximum protection for your 260 when used for servicing in the field or shop.*

25,000 volt DC Probe for television servicing, complete, for use with 260, \$12.85

**SIMPSON ELECTRIC COMPANY** • 5200-18 W. Kinzie St., Chicago 44, Ill. • In Canada: Bach-Simpson, Ltd., London, Ont.



# ESSE RADIO COMPANY

40-A West South St. • Indianapolis, Ind.

## Esse's Special Offer!

### POWER WIRE-WOUND RESISTORS

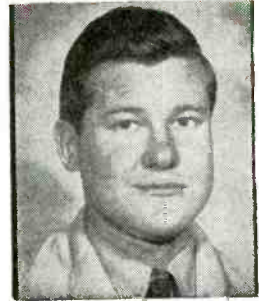

Below is offered a fine assortment of fixed and adjustable types of high-grade vitreous enamel resistors of assorted wattages and ratings. This is one of the greatest surplus offers that Esse has ever offered and should be of tremendous interest to anyone interested in resistors. In most of these resistors, our quantity is substantial to take care of all orders although the prices that we are offering these for should create such an interest that our sales will probably be tremendous.

These resistors are strictly first class merchandise, are brand new and full of life. They are not out-dated or old. We will sell these with the absolute guarantee that you must be completely satisfied in every way or you may return them for full refund and, on these resistors, if you are not satisfied, we will even pay any transportation charges that you have been out at the time we make refund. We know that these are "tops". We also know that the prices we are quoting herein will be far far less than you could buy them elsewhere.

10 WATT—ADJUSTABLE VITREOUS ENAMEL RESISTORS—TUBE SIZE 5/16" x 1 3/4"					10 WATT—FIXED VITREOUS ENAMEL RESISTORS—TUBE SIZE 5/16" x 1 3/4"					20 WATT—FIXED VITREOUS ENAMEL RESISTORS—TUBE SIZE 1/2" x 2"					25 WATT—ADJUSTABLE VITREOUS ENAMEL RESISTORS—TUBE SIZE 5/8" x 2 1/2"					50 WATT—ADJUSTABLE VITREOUS ENAMEL RESISTORS—TUBE SIZE 5/8" x 4 1/2"					50 WATT—FIXED VITREOUS ENAMEL RESISTORS—TUBE SIZE 3/4" x 4 1/2"					80 WATT—ADJUSTABLE VITREOUS ENAMEL RESISTORS—TUBE SIZE 5/8" x 6 1/2"					100 WATT—ADJUSTABLE VITREOUS ENAMEL RESISTORS—TUBE SIZE 1 1/8" x 6 1/2"					100 WATT—FIXED VITREOUS ENAMEL RESISTORS—TUBE SIZE 1 1/8" x 6 1/2"																																																																																																													
Catalog No.	Wattages	Resistance Ohms	Current Milliampers	Price	Catalog No.	Wattages	Resistance Ohms	Current Milliampers	Price	Catalog No.	Wattages	Resistance Ohms	Current Milliampers	Price	Catalog No.	Wattages	Resistance Ohms	Current Milliampers	Price	Catalog No.	Wattages	Resistance Ohms	Current Milliampers	Price	Catalog No.	Wattages	Resistance Ohms	Current Milliampers	Price	Catalog No.	Wattages	Resistance Ohms	Current Milliampers	Price	Catalog No.	Wattages	Resistance Ohms	Current Milliampers	Price																																																																																																														
101	10	1	3150	25c	106	10	100	100	25c	111	10	3500	53	25c	115	10	3	1800	20c	117	10	4	1580	20c	121	10	20	707	20c	122	10	150	220	20c	123	10	200	150	20c	124	10	450	150	20c	125	10	700	120	20c	126	10	1000	100	20c	127	10	1500	100	20c	128	10	2000	100	20c	129	10	3000	100	20c	130	10	4000	100	20c	131	10	5000	100	20c	132	10	7500	100	20c	133	10	10000	100	20c	134	10	15000	100	20c	135	10	20000	100	20c	136	10	30000	100	20c	137	10	40000	100	20c	138	10	50000	100	20c	139	10	75000	100	20c	140	10	100000	100	20c	141	10	150000	100	20c	142	10	200000	100	20c	143	10	300000	100	20c	144	10	400000	100	20c	145	10	500000	100	20c

ATTENTION: If you purchase any assortment of these resistors in total amounts to exceed \$100.00, deduct 20%.

### T-39/APQ-9 RADAR TRANSMITTER

This is the transmitter described in February "CQ" for conversion for the 420-450 Mc. Amateur band and is now being subjected to approval by the F.C.C. for the 465 Mc. Citizen's band. Albert N. Gahmer, dba/ Home Radio & Electric Co. at Indianapolis, Indiana, has been conducting exhaustive tests experimentally in the Citizen's band frequency under experimental license KS2XAB. He states that the oscillator has excellent frequency stability and that two-way communications are possible for distances of 22 miles between his shop and auto. The above person is requesting approval for licensing this equipment on the 465 Mc.

If conversion is not desired, the transmitter contains many excellent parts for the VHF experimenter such as a cavity oscillator using 2—RCA 8012 tubes rated at full output to 500 Mc. Tubes are forced air cooled by 24 V. DC motor, which is easily converted for 110 V. AC operation. Other valuable parts such as a pair of 807's, 2—6AC7, 1—931 and 1—6AG7 tubes, ceramic switch, potentiometers, gears, revolution counter, etc.

Price... **\$1750** ea.

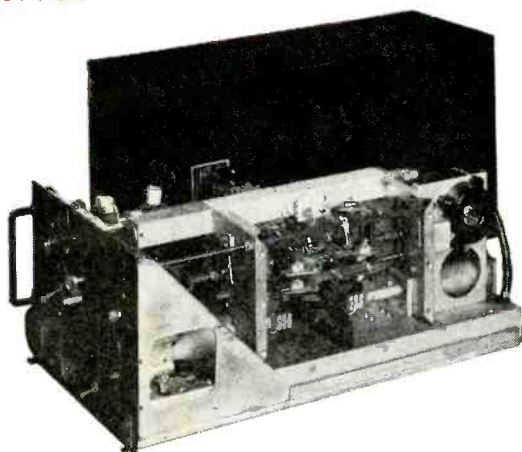

### AN-80A ANTENNA

470 Mc. This antenna was designed for use with the BC-645 and is ideally suited for use on the Citizen's band, for roof-top, mobile or other installations. Has fittings for RG-8/U Coaxial cable. Includes porcelain mounting insulator and flange. Element length 5 1/2", overall length 8 1/2", maximum width 1 1/2"x3". Price each, New \$2.00

ESSE RADIO CO. • 40-A West South St. • Indianapolis, Indiana



**ESSE RADIO CO.**

*Esse's Special Offer!*

**INDIANAPOLIS  
INDIANA**

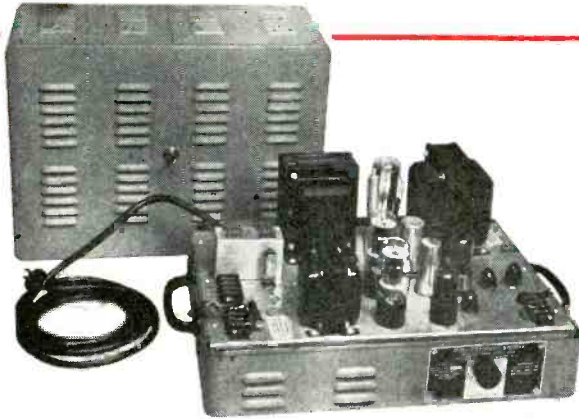

**E3G7—15 WATT POWER AMPLIFIER, MODEL F.** Manufactured by Personal Music Company. Delivers 15 watts of undistorted audio power. Has excellent frequency response. Tube line-up is 1—2D21, 1—6AL5, 1—6SJ7, 1—6SN7, 2—6L6G's, 1—5U4G. Total power drain 300 watts from 110 V. 60 cycle AC power source. Treble, bass, vernier volume and master volume controls are provided. Sturdily built, beautifully designed unit. Can be used for continuous day and night service. Hi/Low AC line switch, AC line fuse, good ventilation of chassis and cover, external carrying handles, lock and key, and heavy duty AC line cord are provided. Use this unit for microphone, phonograph or radio input or fix it for combinations of such inputs. Foolproof and trouble free. For dance bands, lecture halls, schools, sports events, for rental purposes, for inter-office communication. It will handle a number of loudspeakers. Original price \$129.50, to jobbers. Esse's price, while 200 of them last, a tremendous bargain. These are brand new. Price \$29.50



**TELRAD 18-A  
FREQUENCY  
STANDARD**

Checks signals in the range of 100 Kc. to 45 Mc. with a high degree of accuracy. Self-contained power supply is 110, 130, 150, 220, and 250 V. 25-60 cycle AC. Complete with tubes, dual crystal, and instruction book. Brand new. Price.....\$15.00

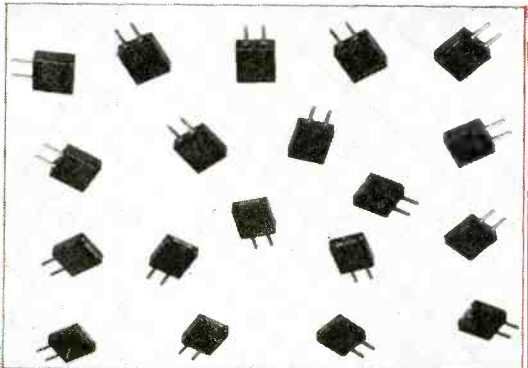

**CRYSTALS IN HOLDERS THAT FIT STANDARD 5-PRONG SOCKETS.**

8347	8450	8245	7670
8341	8367	8130	7660
8320	8382	7990	7340
8188	8361	7970	7320
8486	8360	7950	7300
8180	8357	7710	7290
8177	8352	7700	7280
8476	8351	7690	7270
8452	8250	7680	7200
8451			

Price ..... \$1.00 each  
Or Six (choice) for 5.00

**MINE DETECTOR SCR-625 BRAND NEW**

ATTENTION "Ye" Gold hunters, precious metal prospectors, treasure hunters, timbermen, plumbers, factories, etc.

If there is a metal, or its resemblance, buried in the ground, mountainside, rocks, trees, or anywhere else that it would be possible to detect, by the use of a mine detector, this is the gadget you have been looking for. Truly the finest of all metal detectors, originally built for the U.S. Army to find mines but, today's use suggest a variety of thoughts. We have sold hundreds of these, through ads in science magazines and radio magazines and other advertising mediums. Actually fellows, there is a time in most anyone's life when a detector such as this would be useful. If you have a pipe buried under the yard or driveway, a nail or other piece of metal concealed within a log or any other such what-not, this detector will find it quickly and surely. If you are prospecting for gold, silver, etc., why take hours for something that you might find in minutes? Do you know where there is a possibility of some hidden metallic money underneath the ground, in a basement wall or elsewhere? If so, this is the "Baby" you have been looking for. We have but 600 of these detectors left. They are brand new; in fact, they are still packed in overseas shipping boxes. Our price each, while they last.

**\$79.50**

**A TREMENDOUS BARGAIN**  
**Quartz Crystals without Holders**

Get an assortment of these and grind to your own frequencies or use them as they are. 5x6" B-cut lapped on faces and squared on edges. (Ready to use). We will give you an assortment of these from approximately 13 thousandths of an inch to 24 thousandths of an inch whereby you can grind to frequencies desired. These crystals are now ground to the approximate following frequencies:

3880	4640	6225	7300
3900	4900	6275	7400
4140	5300	6700	7500
4600	5580	6850	7800
4620	5800	6900	7900

Formula for converting thicknesses of B-cut crystals to frequency is as follows:  $F = 98.4/T$  where F is frequency in kilocycles and T is thickness in inches.  
AN ASSORTMENT OF 20 ..... \$1.50

**BUDGIT ELECTRIC  
CHAIN OPERATED  
HOIST**

10 ft. lift, 1/4 hp., 110 V. 60 cycle AC motor. Capacity of hoist 500 lbs. These hoists were sold as used by W.A.A.; however, we cannot tell them from new as appearance is new and they are packed in original shipping boxes. We are using these hoists in our warehouse and have lifted loads of over 1200 lbs. without difficulty. Here is a time and back saver for any business. Our Price .....\$85.00 ea.

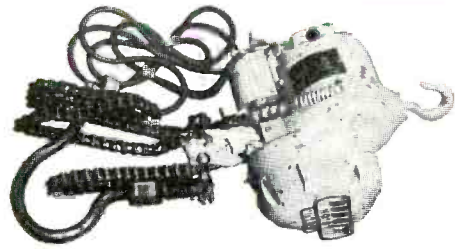

**ESSE RADIO CO. • 40-A West South St. • Indianapolis, Indiana**

**ESSE RADIO CO.**

*Esse's Special Offer*

**INDIANAPOLIS  
INDIANA**

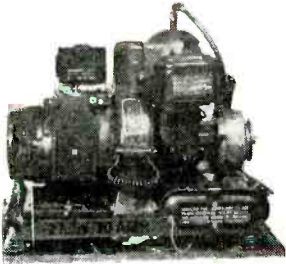

**(HRU) DC POWER SUPPLY**

E2A9 24-28 V. at 70 amp. 2000 watts gasoline engine generator with electric starter. Power supply which can be used to operate 24-28 V. equipment, start airplane engines, charge batteries, as a welding machine, lighting system, or for amateur radio station. 21 1/2" x 17 1/2" x 24 3/4". Wt. 115 lbs. **\$89.50**

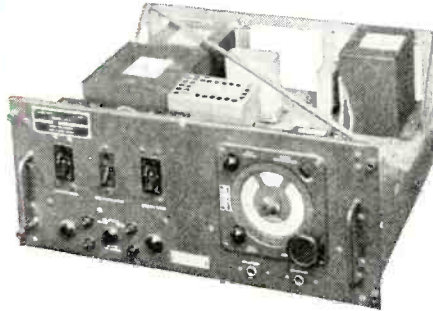

INDICATOR I-221-A. Contains several 110 V. 60 cycle transformers such as 1 multi transformer with two 6.3 V. filament windings, 1-5 V. 6.5 amp. filament winding and 1-220 V. 50 Ma. high voltage winding. Another 117 V. to 423 V. autoformer, 1-6400 V. high voltage transformer. Also contains 110 V. selsyn and numerous switches, circuit breakers, condensers and other items. Less tubes ..... **\$15.00**

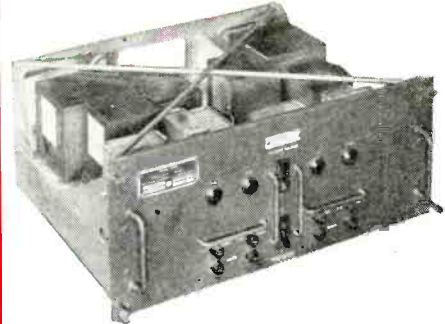

RA105-A POWER SUPPLY. Contains various high voltage filter condensers such as .2 mfd. 5000 V. and 7 mfd. 600 V. along with associated 110 V. 60 cycle transformers, chokes, circuit breakers, etc. Less tubes ..... **\$15.00**

COLLINS AN/ART-13 TRANSMITTER. A compact, lightweight, modern, high-powered transmitter. Frequency range 2-18.1 Mc. on any of its 11 auto-tune crystal controlled or master osc. channels. Dec. 1947 "Radio News" gives conversion data for convert. 24 V. DC operation to 110 V. AC. Are in exceptionally fine condition. Tested in our labs., with dynamotor. .... **\$234.50**

**ATTENTION AIRLINES! BC-348 COMMUNICATIONS RECEIVER**



E1H4 BC-348 COMMUNICATIONS RECEIVER. 6 bands, 200-500 Kc. and 1.5-18 Mc. 2 stages RF, 3 stages IF, BFO, crystal filter, manual or AVC. Complete with tubes and 24 V. dynamotor. These receivers have been thoroughly checked in our work-shop and found in excellent condition ..... **\$149.50**  
Converted to 110 V. AC 60 cycle .. **80.00**

A must for the radio man for the much needed 110 V. DC source. 110-120 V. AC input, 110-135 V. DC output at .75 amp. Connect in parallel for highest current requirements. Sizes 3 1/8 x 2 5/8 x 1 3/4 inches. **\$1.25**  
PRICE—New .....

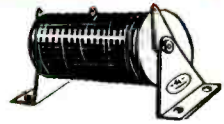

**ESSE WILL BUY ANYTHING ELECTRONIC**

Some of the equipment listed below is urgently needed by our company to meet the demands of customers and we will pay the highest cash prices. Send letter with full description describing condition and quote price. We will immediately answer and if we can use your equipment, we will authorize you to send it to us COD. We are dealers in surplus electronics and we are

interested in anything dealing with radio or television. We are especially interested in large quantities of surplus and anything that can be bought at a bargain price. Please don't hesitate to write us immediately. Quote us prices on what you have and give us a full detailed description. We will not answer any letter unless description and price is quoted.

**WE NEED AT ONCE!**

- BC-348 Receivers, AC or DC models
- BC-312 Receivers BC-221 Frequency Meters
- SCR-522 Transmitters & Receivers
- Hallcrafters BC-610 Transmitters
- Any factory built transmitters and receivers such as Hallcrafters, National, Temco, Collins, RCA, RME, Hammerlund, Millen, Meck, Harvey-Wells, Meissner, Sonar, McMurdo-Silver, Gonset, Stancor, Bud, etc.
- Amateur or commercial sets
- Large stocks of tubes
- Large stocks of transformers
- Large stocks of condensers
- Large stocks of resistors
- Large stocks of speakers
- BC-224 Receivers
- BC-312 Receivers
- Police type VHF transmitters and receivers for mobile application

- Collins ART-13 Transmitters ART-13 Dynamotors
- APS-13's
- SCR-269F or G Fairchild or Bendix ADF's
- Headphones in quantity lots
- Microphones in quantity lots
- Field telephones Sound-powered telephones

We are especially interested in any factories, dealers or other outlets giving us a list of surplus electronic equipment that is for sale so that we may submit our bid.

**ESSE'S GUARANTEE**

If not satisfied with any equipment purchased from us—you pay transportation both ways and return within 5 days for cheerful refund.



**Radio Co**  
40 W. South St.  
Indianapolis 4, Ind.

Unless Otherwise Stated, All of This Equipment Is Sold As Used  
**CASH REQUIRED**  
**WITH ALL ORDERS**  
Orders Shipped F.O.B. Collect

(Continued from page 54)

The drain from the 900-volt section must be held down to the very low value of from approximately 50 to 100  $\mu$ a.

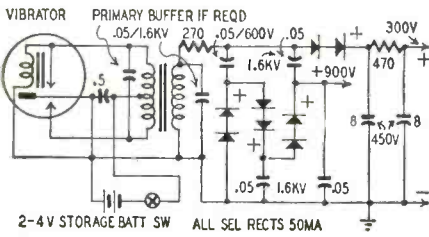

Fig. 4—Dual supply for Geiger counters. Blocking-oscillator supply

Two simple high-voltage power supplies employing the principle of the blocking oscillator are shown in Figs. 5 and 6. These supplies are suitable for applications requiring a very small current. The supply shown in Fig. 5 is for a.c. operation and uses a 3-to-1 audio transformer with a 6K6 or 6V6 and a 2X2. The two transformers should be adequately insulated to withstand surges. It is a good idea to dip them in insulating varnish and bake in an oven as an added precaution. If a cold-cathode rectifier such as the Raytheon CK-1013 is available, it may be used in place of the 2X2 and will require no filament transformer.

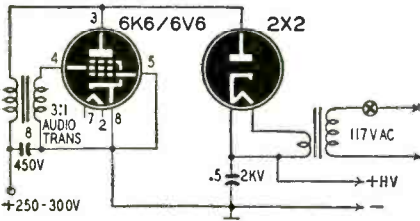

Fig. 5—Circuit uses blocking oscillator.

The battery-operated circuit of Fig. 6 works on the same principle and is good primarily for driving a G-M tube at about 900 volts from a small 67½-90-volt, portable B-battery. The 1T4 tube will withstand voltages up to 1,500 without breaking down. The small 3-to-1 audio transformer is not critical. Some 1T4 tubes may be unsuitable and break down internally at the high operating voltage but the performance of most will be satisfactory. This makes a very compact, lightweight assembly that is simple to build. The most expensive part is the CK-1013 rectifier. For those who wish to try this circuit without using the CK-1013, a 1T4 may be used as in Fig. 7. The only disadvantage to using the 1T4 as a rectifier is the separate 1.5-volt filament bat-

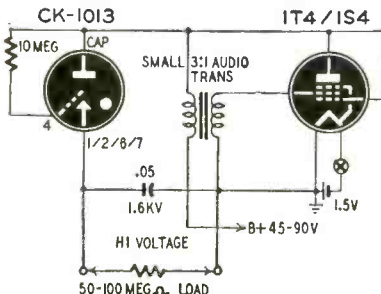

Fig. 6—Cold-cathode rectifier used here.

*NOW, you can tell your Customers*  
*it covers TELEVISION, too!*



The famous RAYTHEON Bonded Electronic Technician Certificate now covers Television as well as Radio. And the aggregate cash protection of each registered dealer certificate has been increased to \$400.00.

Think of it... your 90-day guarantee on TV and Radio repairs and replacement parts — backed by American Mutual Liability Insurance Company's assets of close to \$100,000,000.00.

Here's the one, sure way to win and hold customer confidence, and it's

**FREE — to qualified service dealers**

If you're not yet a Raytheon Bonded Electronic Technician get in touch with your Raytheon Tube Distributor at once. It costs you nothing but it puts you first in line toward better volume and profit from your television and radio service work.



**ACT NOW!** Ask your Raytheon Distributor how to become a BONDED ELECTRONIC TECHNICIAN

**RAYTHEON**

**RAYTHEON MANUFACTURING COMPANY**

*Excellence in Electronics*

Radio Receiving Tube Division  
Newton, Mass., Chicago, Ill., Atlanta, Ga., Los Angeles, Calif.

RADIO AND TELEVISION RECEIVING TUBES, CATHODE BAY TUBES, SPECIAL PURPOSE TUBES, TUBEMINIATURE TUBES, MICROWAVE TUBES

Over 43,000 Technicians Have Learned  
**HOW TO GET THE MOST OUT OF BASIC TEST EQUIPMENT**  
Why Not You, Too?

**SERVICING by SIGNAL SUBSTITUTION**  
A BEST SELLER FOR OVER 9 YEARS! (NEW, UP-TO-DATE, 11TH EDITION)

The Simple, Modern, Dynamic Speed Approach To Receiver Adjustment and Alignment Problems, AM-FM-TV.

- Nothing complex to learn
- Universal — non-obsolete
- No extra equipment to purchase
- Employs Only Basic Test Equipment

Ask for "S.S.S." at your local Radio Parts Jobber or order direct from factory.

PRECISION APPARATUS COMPANY, INC. • 92-27 Horace Harding Blvd., Elmhurst 4, N. Y.

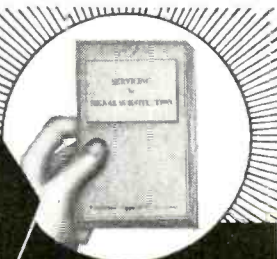

*only 40¢*

100 pages. Invaluable information that will help you re-double the value of your basic test equipment.

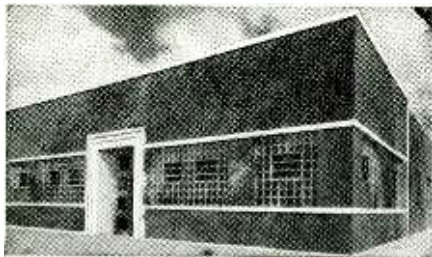

# KEEPING PACE

with RADIO,  
SERVICE - DEALER NEEDS

Our new plant's expanded manufacturing and technical facilities enable us to serve you even better . . . faster. A modern equipped plant and laboratory; latest production methods, and trained technicians provide a more systematized and complete operation. Products are constantly being developed to offer you the latest and best in electronic equipment.

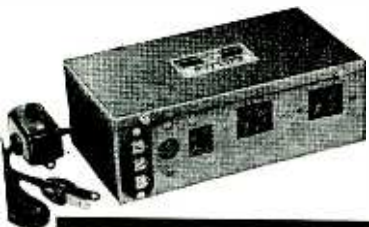

CONVERT BATTERY RADIOS  
to AC ALL-ELECTRIC

**Battery Eliminator, Model "S"** converts dry battery radio into dependable hum-free AC receiver. The Model "S," with selenium rectifier, operates any 1.4 volt 4, 5 or 6 tube battery radio from 115 volt, 60 cycle source. Eliminates fading and noise that accompanies battery reception. Eliminates Batteries, saves money. Easily Installed, just slips into place. Low Operating Cost, uses only 11 watts. On-off Switch for simple operation. Standard Battery Plug. Sockets provided. Blue Hammerloid Finish, handsome, durable.

MANY MODELS AVAILABLE  
Unmatched QUALITY and PRICE!

Model "P"—Same as Model "S" except has tube rectifier. Cost less. Also available for 220 volt use.

Model "F"—Operates 2 volt, 4 to 7 tube battery radio from 115 volt 60 cycle source. (0.5 amp. filament max.)

Model "FH"—Same as Model "F," but supplies 650 milliamperes filament current.

See Your Distributor or Write



Pioneer Manufacturers of Battery Eliminators  
**ELECTRO PRODUCTS LABORATORIES**  
4507 N. Ravenswood Avenue Chicago 40, Illinois

tery required and the complicated switching involved because it is in the high-voltage end of the circuit.

## Neon-tube supply

Another circuit suitable for use with a Geiger counter or similar device is given in Fig. 7. A small neon lamp used as a relaxation oscillator drives the 1T4 tube, and high-voltage surges appear across the plate choke. A "sub-ouncer" hearing-aid-type audio transformer or choke coil may be tried. It should have about 50,000 ohms impedance for best results. Output voltage may be adjusted by altering the B-voltage or varying the load. The load must be in the 50-100-megohm range to secure satisfactory voltage output. A Raytheon CK-1013 may be substituted for the 1T4 rectifier with savings in switching and filament-circuit complications, but the voltage drop is greater and cost of the cold-cathode tube is a factor to consider. Adjusting the padder will change the neon oscillator frequency and permit tuning the circuit to resonance with the choke for maximum output. The padder shown is a standard mica-insulated unit with screwdriver adjustment. Some 1T4 tubes may not function satisfactorily in this circuit.

While the current output from the power supplies in Figs. 5, 6, and 7 is

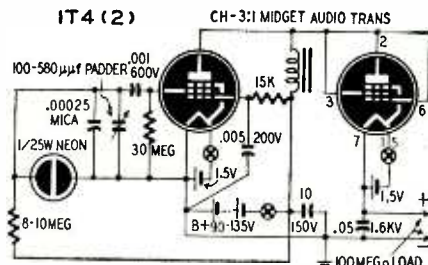

Fig. 7—The neon high-voltage supply.

low, they can give you a painful shock. Use proper precautions when working with them and avoid trouble. They will charge up a large capacitor to a dangerously high voltage in a very short time. Always discharge the capacitor in the high-voltage output before touching or working on any part of the supply. A good way to check these capacitors is with a high-resistance voltmeter. Then you can actually watch the discharge take place and know exactly when they are entirely safe to handle.

**IRE National Convention**  
GRAND CENTRAL PALACE  
and  
HOTEL COMMODORE  
New York

**RADIO - ELECTRONICS MAGAZINE**  
March 6-9 1950

SEE US at BOOTH K

# YOU SAVE TIME & MONEY

## With this Assembled VACUUM TUBE VOLTMETER

At Less Than Kit Prices!

Save plenty! Don't bother building one, here's a laboratory designed and calibrated VACUUM TUBE VOLTMETER at less than the cost of the kit.

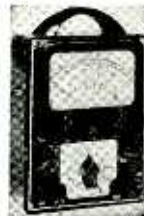

- Etched panel permanent markings.
- Buy direct from the maker.
- Technically designed and tested.
- Guaranteed by the manufacturer.

Only \$23.50

For AM/FM Radio and Television

THESE FEATURES INVITE COMPARISON: Includes a new type stabilized bridge circuit with a 200 microampere 4" alnico magnet meter; 15 megohm input, 3 to 1,500 volt ranges on AC or DC. Ohmmeter ranges to 1,000 megohms. Complete unit is mounted on an aluminum, permanently deep etched panel . . . markings won't wear off . . . and set in a bakelite case; 5 5/16" width, 7 7/8" height, 2 1/4" depth. Fully Guaranteed—same as RMA!

Big Savings!  
HIGH VOLTAGE PROBES . . . 15,000 volts. Designed for use on the ELLIOTT VACUUM TUBE VOLTMETER. Worth twice as much . . . Your cost, only \$3.95

Write today for FREE literature and more details about other ELLIOTT LABORATORIES precision built instruments offered at great savings.

ORDER TODAY! Send check or Money Order for full amount or enclose 25% with C.O.D. orders. WE PAY postage and C.O.D. fees if you send full amount . . . save even more!

**Elliott Laboratories**

140 LIBERTY STREET  
NEW YORK 7, N. Y. BARCLAY 7-4239

**FREE** it's yours for the asking

**SENCO'S**  
New . . . 1950  
RECEIVING TUBE  
INTERCHANGEABILITY  
CHART

Lists over 150 tube types that are directly interchangeable. Saves you time . . . save you money.

NOTHING TO BUY . . . Just Fill In Coupon . . . MAIL TODAY!

NAME .....

ADDRESS .....

CITY..... ZONE..... STATE.....

**SENCO RADIO INC., Dept. S**  
73 West Broadway, New York 7, N. Y.

Radio Man Who Know  
**SAVE AT SENCO**

RADIO-ELECTRONICS for

**YOU BUILD 'EM  
IN ONE EVENING  
BUT...**

**THEY LAST A LIFETIME!**

**SAVE 50% WITH**

**LABORATORY  
PRECISION**



**INSTRUMENTS  
& KITS**

**SENSATIONAL NEW  
EICO Model 360-K TV-FM SWEEP  
SIGNAL GENERATOR**

• Crystal marker oscillator with variable amplitude. • Covers all TV and FM alignment frequencies between 500 kc. and 228 mc. • Sweepwidth variable from 0-30 mc. with mechanical inductive sweep. • Extremely wide sweepwidth allows gain comparison of adjacent RF TV Channels. • Provides for injection of external signal generator marker. • Phasing control included. • Large, easy-to-read dial is directly calibrated in frequencies. • Vernier Tuning Condenser. • Comes complete with all tubes (including new, high-frequency miniature types): 6X5GT, 12AU7, two 6C4's. Crystal not included. 10"x8"x8 3/4". 5 Mc. Crystals available for above, each \$3.95. **FACTORY-WIRED AND TESTED \$39.95**  
Model 360. Ready to use Sweep Signal Generator. See it at your local jobber!

**\$29.95**

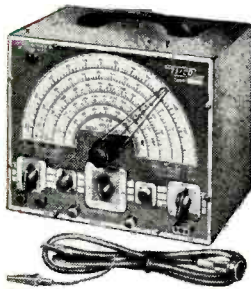

**ANYONE  
CAN BUILD  
THEM!**

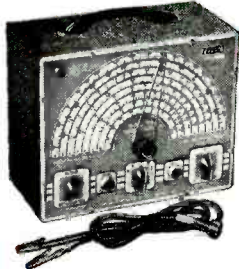

**NEW! MODEL 320-K  
SIGNAL GENERATOR**

For FM, AM alignment and to provide TV marker frequencies. Highly stable Hartley oscillator has range of 150 kc. to 102 mc. with fundamentals to 34 mc. Colpitts audio oscillator supplies pure 400 cycle sine wave voltage for modulation. Vernier Tuning Condenser. Use audio oscillator voltage to test distortion in audio equipment, bridge measurements, etc. **FACTORY-WIRED AND TESTED \$29.95**  
Model 320. Ready to use. . . .

**\$19.95**



**VERSATILE MULTI-  
SIGNAL TRACER**

Model 145-K. High gain—high frequency. Self-contained test speaker permits audible signal tracing of RF, IF, FM, audio and video circuits. Provision for visual tracing with VTVM. Response is well over 200 mc. 3-color hammerstone panel. 110-125 V. AC. Size: 10"x8"x4 3/4". Comes complete with tubes and diode probe in kit form. **FACTORY-WIRED AND TESTED \$28.95**  
Model 145. Ready to operate. . . .

**\$18.95**

**NEW PUSH-PULL 5"  
TV OSCILLOSCOPE  
Model 425-K Kit**

ALL-NEW Laboratory precision scope has Push-Pull deflection and .05 to .1 volts per inch sensitivity. Wide-range. Flat from 5 cps to 500 kc. with full gain setting, useful to 2 1/2 mc. Wide-range, multi-vibrator, sweep circuit from 15 cps to 75,000 cps. Direct connection to plates of CRT available at rear of cabinet. Z axis intensity modulation feature included. Size: 8 1/2"x17" x 13 1/2" high. Complete with 3-6SN7s, 2-6J5s, 2-5Y3s, and 5HP1 CRT.

**FACTORY-BUILT OSCILLOSCOPE \$69.95**  
Model 425. Fully wired and tested

**\$39.95**



**HIGH PRECISION  
VACUUM TUBE  
VOLTMETER  
Model 221-K**

Tops in workbench versatility—15 different ranges! AC and DC ranges: 0/5/10/100/500/1000 volts. Electronic ohmmeter ranges from .2 ohms to 1000 megs in 5 steps. New features include Zero Center for TV discriminator alignment, 25 Meg. DC input impedance. Accurate, 4 1/2" meter cannot burn out. Double triode balanced bridge circuit assures guaranteed performance. Sturdy portable steel case with etched hiroof panel. 110-130 V. AC 50-60 cycle. Size: 9 7/16"x6"x3 7/8".

**FACTORY-WIRED AND TESTED \$49.95**  
Model 221. Same, but completely wired, calibrated, and tested. . . .

**\$23.95**

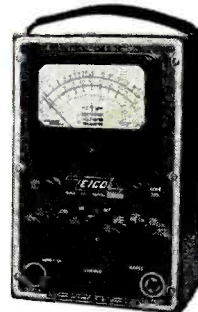

**Model HVP-1 HIGH FREQUENCY RF PROBE**

Model P-75K germanium crystal probe for visual RF signal tracing and measurements to over 200 megacycles. Can be used with models 221 or 113A Eico instrument (state which when ordering). 6 1/2" long, 1/2" O.D., with wire, plugs, and all components. **\$3.75**  
IN KIT FORM. . . . . **\$3.75**  
Model P75K same as above, but for oscilloscopes; in kit form. . . . . **\$3.75**  
Models P75 or P76 similar to above but factory wired, ready to operate. Each. . . . . **\$7.50**

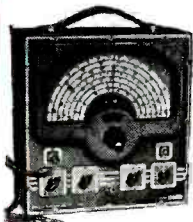

**DELUXE SIGNAL  
GENERATOR  
MODEL 315**

Completely wired, ready-to-use Signal Generator with 1% accuracy! A wonderful instrument with dozens of expensive features. Frequency range: 75 kc to 150 mc. Has microcycle band-spread vernier tuning for FM, AM, and TV. Voltage regulator. Write for full details. **\$59.95**

Model 511-K. A "Must" for every serviceman! Small, handy instrument used a thousand times a day. Large 3" meter, beautifully etched panel. A perfect kit for beginners. Simple to assemble. Ranges: DC-0/5/50/250/500/2500 volts. AC-0/10/100/500/1000 volts. Output—0/10/100/500/1000 v. DC Ma.—0/1/10. DC Amps.—0/1/10. Ohm meter—0/500/100,000 ohms/0/1 meg. DB meter—8 to +55 Db. **\$14.95**  
**ASSEMBLED—READY TO USE \$17.95**  
Model 511—Completely wired, tested, and assembled at the factory. Rugged, built for heavy duty. . . . .

**VOLT-OHM  
MILLIAMMETER  
Complete Pocket Kit**



**\$14.95**

**WRITE FOR NEW CATALOG C**



**HIGH VOLTAGE PROBE**

Complete top-quality Voltage Test Probe Measures up to 30,000 Volts. Special Helical-Wound Ceramic HV Multiplier Resistor adaptable to most VTVM's and all 20,000 ohms per volt meters with 1000 or 5000 volt scales. Lucite head, plywood bakelite handle, large flashguards for additional safety. Specify your instrument. Complete, ready to use. . . . **\$6.95**

**SEE THEM—TRY THEM—  
AT YOUR LOCAL JOBBER!**

EICO Instruments and Kits are on display at your local jobber—the nationally advertised kits which you can see and use before you buy. You take no chances with EICO!

Prices Higher on West Coast

**EASY-TO-FOLLOW SCHEMATIC & PICTORIAL DIAGRAMS**

Come complete with every EICO Instrument Kit. Each kit fully guaranteed to operate perfectly when assembled according to our simple instructions!

**EXCLUSIVE LIFE-TIME REPAIR SERVICE:** For a nominal charge, we will repair and service your EICO instrument, regardless of its age!



**ELECTRONIC INSTRUMENT CO., INC.**  
276 Newport Street, Brooklyn 12, N. Y.

# HOW TO CONSTRUCT INVENTORY RACKS

for the modern service shop . . .  
in the MARCH issue of:



The MARCH issue is on sale at your jobber's counter.

Complete instructions, plans, diagrams and parts list for constructing efficient, convenient inventory racks. These racks are custom-designed to fit your needs . . . they will simplify your stock problems . . . speed your daily work . . . save you time and make servicing easier. Everything about these racks has been specially designed also to be economical and easy to construct and install in your shop. These racks would cost many times the cost of parts and your working time if they were ordered elsewhere . . . Get the March issue of RADIO & TELEVISION MAINTENANCE at your jobber now! This is just one of the many valuable features in the magazine. Why not send in your subscription today?

## DON'T MISS ANY OF THE FORTHCOMING ISSUES!

Subscribe today at the new low price of \$1.00 for one year

Here is a list of future construction articles:

How to make receiving dollies for incoming radios  
How to construct a truck interior for efficient field work  
Building an auxiliary bench for tube testing, minor repairs, operating observation, etc.  
Construction of cathode-ray tube holder for servicing chassis when tube is separately mounted  
Shop planning and layout for steps, time and money saving

Auxiliary HV power supplies for operating tests on picture tube

Design and arrangement of a portable parts, tool and test box for servicing

Design and construction of TV antenna location tester

These are in addition to the regular content of technical articles on TV-FM and AM receivers, test equipment tools, etc.—news articles on current happenings, trends of the industry, new products and new literature.—sales methods and advertising programs.—business methods

# 30,000

radio servicemen buy RADIO & TELEVISION MAINTENANCE regularly—PROOF of its value to the trade!

Don't miss any of these issues. Send in your order at the new low price of \$1.00 for one year!

BOLAND & BOYCE INC. RES  
MONTCLAIR, N. J.  
Send me RADIO & TELEVISION MAINTENANCE for one year for only \$1.00

NAME \_\_\_\_\_

ADDRESS \_\_\_\_\_

CITY \_\_\_\_\_ ZONE \_\_\_\_\_

STATE \_\_\_\_\_

MONEY ENCLOSED  BILL ME LATER\*

I am in a  radio sales & service business  
 sales only  
 service only  
 other (explain) \_\_\_\_\_

(check one)  
I am  owner  
 manager  
 employee

FULL REFUND WITHIN 90 DAYS IF NOT COMPLETELY SATISFIED

\* If money is enclosed, thus eliminating billing expense, we will add one extra issue FREE.

## MULTIPURPOSE TESTER

By P. F. EGERTON, JR.

Included in this test instrument are a signal generator, a.f. oscillator, phono oscillator, a.f. preamplifier, a.f. and r.f. signal tracer, and radio tuner.

The r.f. signal generator is modulated by the signal from a neon-type a.f. oscillator when the modulation control is advanced. The tuning capacitor is from a small superhet with antenna and cut-plate oscillator sections connected in parallel. The r.f. coil is wound with No. 30 enamel wire on a 1½-inch form. There are 90 turns on the grid winding and 30 turns on the tickler. Both windings are close-wound and spaced approximately ¼ inch apart. This coil covers from 450 to 1500 kc. Plug-in coils can be used to cover other ranges.

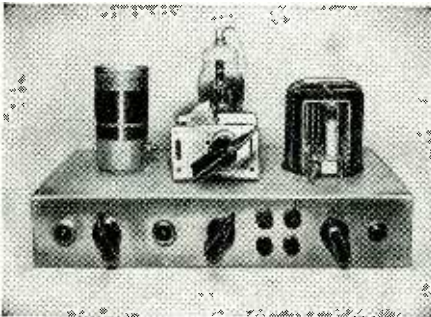

The tester is several instruments in one.

The a.f. oscillator can be used as a code-practice set by replacing the jumper with a key across the key terminals. Pitch of the a.f. signal is varied with the 2- to 5-megohm con-

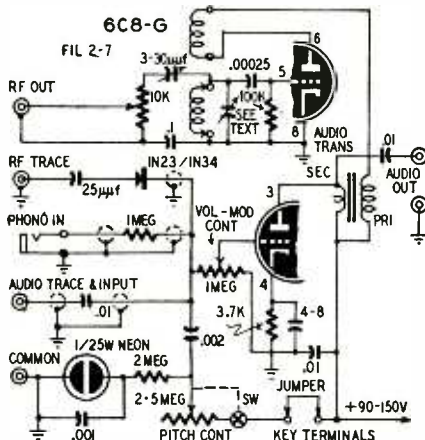

Only one tube and a neon lamp are needed.

control in series with the neon lamp and B-plus.

Short shielded leads are used for a.f. and r.f. signal-tracing probes. The r.f. probe should be not longer than 2 feet.

To use the unit as a phono oscillator, connect a pickup to the a.f. input terminals and adjust the volume to a suitable level with the 1-megohm control. It may be necessary to connect a short piece of wire to the r.f. output terminal.

Connect a coil, capacitor, and antenna to the r.f. tracer terminal and you have a simple r.f. tuner. The signal can be taken off the a.f. output ter-

## TECH-MASTER "Super 16"

BETTER THAN EVER

### the Model 630-TK TV Kit

with Voltage Doubler  
and KEYED A.G.C.

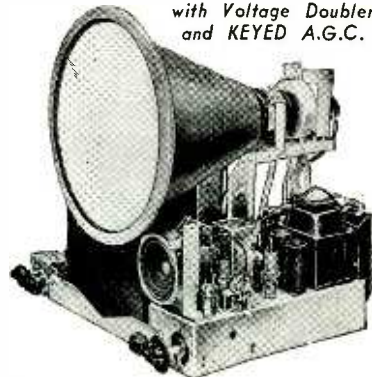

Circuit is the exact duplicate of the RCA 630TS, PLUS Voltage Doubler and Keyed Automatic Gain Control. All components mounted, ready to wire over a weekend.

Complete, less Kinescope \$179.50  
At your distributor—Write  
Dept. RE-3 for literature.



TECH-MASTER PRODUCTS CO.  
443-445 Broadway, New York 13, N. Y.

More leading engineers and technicians have built Tech-Master for their own use than any other Television Kit.

## Stop listening to DISTORTED MUSIC

The connoisseur of music listening wants to recognize the clear brilliance of symphonic sound and

## BROOK All Triode High Quality AUDIO AMPLIFIER

Gives It To Him

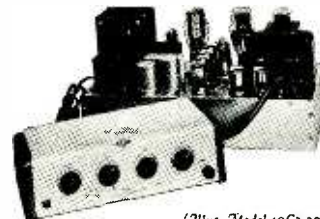

(Illus. Model 10C3-30 watts)  
Also available: Model 12A3-10 watts.

with

- Distortion and intermodulation at a new low.
- Reduction of listening fatigue.
- Brilliant, clear tone.
- Separate controls—stepped-for Bass and Treble.
- Extremely low volume without any loss of quality.

Write TODAY for FREE Technical Bulletin  
and Detailed Distortion Analysis

**BROOK ELECTRONICS, Inc.**  
Sales Agent  
Dept. EC-0, 34 De Hart Place, Elizabeth, N. J.

# When is a dot not a dot?

Look carefully at the pictures on this page, to see how television creates an image

No. 2 in a series outlining high points in television history

Photos from the historical collection of RCA

● As parlor magicians say: "The hand is quicker than the eye!" But modernize the statement so that it becomes: *Television magic is quicker than the eye*—and that's why you see a photographic image in motion . . . where actually there is only a series of moving dots!

To explain this to laymen, ask them to examine a newspaper picture through a magnifying glass.

Surprisingly, few people know that newspaper pictures are masses of tiny dots "mixed" by the eye to make an image. Even fewer know that the same principle creates a television picture . . . and, when picture after picture comes in rapid succession, the eye sees motion.

Devising a successful way to "scan" an image—to break it into dots which could be transmitted as electrical impulses—was one of television's first basic problems. Most of the methods dreamed up were *mechanical*, since electronics was then a baby science. You may remember some of the crude results transmitted mechanically.

Television as we now know it, brilliant images on home receivers, begins with the invention of the *iconoscope* tube by Dr. V. K. Zworykin of RCA Laboratories. First all-electronic "eye" of the television camera, this amazing tube scans an image—"sees" it even in very dim light—translates it into thousands of electrical impulses which are telecast, received,



Felix the Cat was the "stand-in" when this 60-line image was made mechanically in tests at NBC's first experimental television station.



Improved definition is obvious to anyone in this all-electronic 120-line image of Felix—transmitted in the early days of NBC television.



By increasing the number of scanning lines to 441 lines in each picture frame, RCA scientists gave us a sharper, clearer television image.



And here you see the deep blacks, clear whites, and subtle halftones as transmitted by NBC with our present 525-line scanning system.

and re-created as sharp, clear pictures in black-and-white—on the phosphorescent screens of today's home television receivers.

And, just as the first flickering "30-line" pictures—produced mechanically—eventually became our present sharp 525-line images, so the iconoscope itself was improved until it became today's super-sensitive RCA image orthicon television camera. All-electronic, the image orthicon peers deep into shadows, needs only the light of a candle to see and transmit dramatic action.

But every single television development made by scientists at RCA Laboratories depends, in the end, on a basic physiological fact: When the human eye sees a series of swift-moving dots on a television screen, it automatically "mixes" them into a moving photographic image!



**Radio Corporation of America**  
WORLD LEADER IN RADIO—FIRST IN TELEVISION

# NEW TELEKITS NOW \$49.95

Jobbers: Write for Confidential Price Information

NEW TELEKITS  
10-B \$69.95  
7-B \$49.95  
LESS TUBES

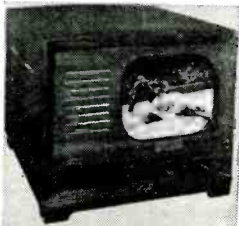

Sparkling new Telekit 10-B has 52-inch screen. Brand new compact lay-out has video tube mounted on chassis. Big illustrated easy-to-follow instruction book guides you step by step through easy assembly. No special knowledge of television is required. All you need is a soldering iron, pliers, and screw driver. 10-B Kit can be used with 12½, 15, 16-inch tubes. Telekit 10-B, \$69.95. 10-B Telekit cabinet, \$15.95 and \$24.50. Satisfactory Telekit Performance Guaranteed by Factory Service Plan.

Write for catalog listing 10-B and 7-B Telekits. New 7-B Telekit for 7-inch tube, \$49.95. 7-B cabinet \$15.95 and \$24.50.

TELEKIT BOOSTER \$12.95



If you live in a fringe area this fine Telekit booster will bring in TV signals bright and clear. There is a 20 to 30 times signal boost on all channels. NOT A KIT. Completely assembled with tubes. Works with Telekit or any other TV receiver.

13 CHANNEL TUNER \$12.95

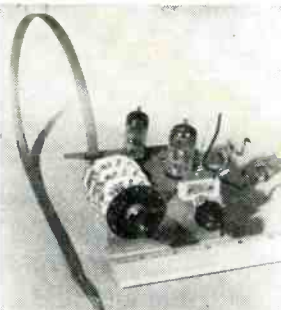

NEW 13 CHANNEL TUNER is a small compact unit with stage of R.F. Tunes all TV channels. Made to conform with Telekit or any other TV set having video I.F. of 25.75 Mc. Complete with tubes, pre-wired pre-aligned; only four connections to make. See your jobber, or write to us for information. Your cost, \$12.95.

Write for catalog of Telekit antennas, boosters, television kits, tuners, television parts and tubes.

# TELEKIT

ELECTRO-TECHNICAL INDUSTRIES  
1432 N. BROAD ST. DEPT. B PHILADELPHIA 21 PA.

minals and fed to phones or an a.f. amplifier.

The unit shown in the photo was constructed on a 6 x 10 x 2-inch chassis and mounted in a small metal cabinet. Its power can be taken from almost any source which will deliver 90 to 150 volts d.c. and 6.3 volts a.c.

From left to right, the controls and terminals are: r.f. output, r.f. output control, r.f. tracer input, volume and modulation control, a.f. input, audio output, pitch control and power switch, and phono input pack. Key terminals and power are on rear.

## Z-AXIS INPUT FOR SCOPE

By TED LADD

THE utility of an oscilloscope can be increased considerably by adding an intensity-modulation (Z-axis) input terminal to the instrument. A textbook on oscilloscope operation will reveal the many uses for this input. The terminal may be added easily.

The schematic shows the connections to be made. The 1-megohm isolating resistor R1 must be connected between the No. 1 grid of the oscilloscope (intensity electrode) and the intensity (brilliance) control, if R1 is not already in the regular circuit. The Z-axis input circuit consists of coupling capacitor C, resistor R2, and the insulated binding post or pin jack J. The Z-axis lead must be covered with grounded shield braid throughout its length. The binding post must be installed in the rear of the oscilloscope case as close as possible to the oscilloscope tube socket.

A signal applied to the Z-axis input while another signal is being observed on the scope screen will modulate the intensity of the pattern on the screen. If the Z-axis input consists of sharp positive pulses, bright dots will be spaced along the trace of the pattern.

OSCILLOSCOPE TUBE IN CIRCUIT

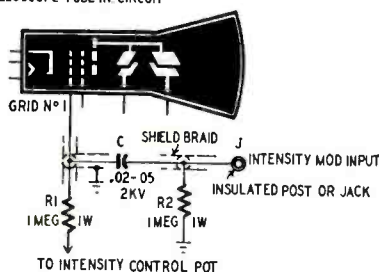

If the pulses are negative, blanked-out spots or spaces will be present instead of dots. If the frequency of the Z-axis input is known, these dots or blanks may be used for timing purposes. When a positive sine or square wave is applied to the Z-axis input, the pattern will be broken up into a series of bright lines along the trace, their number and length depending upon the frequency of the Z-axis signal. All negative Z-axis signals blank out portions of the trace. Intensity modulation is very useful in the establishment of "dot wheel" patterns for a.f. comparisons.

## HERE IS A TERRIFIC VALUE!

### 3 TUBE PHONO AMPLIFIER



- Designed for use with all types of Records—2½
- Watt output—Complete—wired with full range tone control. Only \$2.39
- In lots of three \$2.19 each.
- Set of Tubes for above ..... \$1.25
- 50L6 Output Transformer for above ..... 1.35
- 5" PM Speaker Alnico V ..... 1.15
- 6" PM Speaker Alnico V ..... 1.55
- Hi-Volt Phono Pickup ..... 1.79
- Hi-Volt Phono Cartridge ..... 1.69
- Medium Volt Phono Pickup ..... 1.59
- Medium Volt Cartridge ..... 1.49
- 78 RPM Motor & Turn Table ..... 2.49
- Dual Speed 33½, 78 RPM. M. & T.T. .... 3.89
- 3 Speed 33½, 45, 78 RPM. M. & T.T. .... 4.95
- Hi-Fidelity Phono Pickup with turnover Cartridge and 2 Needles for all records ..... 4.95

### JEWEL TIPPED PERMANENT NEEDLE

- PRECISION FINISHED "TRUE FIDELITY RUBY TIP"—List \$2.50 ..... 95c ea.
- SAPPHIRE TIP—List \$5.00 ..... 1.75 ea.
- Lots of 12 65c ea.
- Lots of 12 1.25 ea.
- All needles individually boxed.

### TELEVISION SPECIAL

- RCA type 630 chassis w/volt. doubler for 16" 31 tubes, factory wired and aligned for perfect reception ..... \$164.50
- 22 Tube type 630 Jr. Chassis for 16" ..... 124.50
- 22 Tube Same type Chassis for 12½" ..... 119.50
- 16HP4 Tube (1 yr. guarantee) ..... 44.50
- 12½" Tube ..... 29.50

Write Dept. RE1 for Descriptive Literature. All Prices F.O.B. New York. 25% Deposit required on all orders. Minimum Order \$5.00.

THE ROSE COMPANY 98 Park Place  
New York 7, N. Y. (Corner Greenwich St.)

## NEW!

### Color Tone on your Television!

Simply attach TELECOLOR FILTER to front of your set, and enjoy favorite programs in a glorious color tone, instead of dull black and white. 'TELECOLOR' Filter is one of the latest discoveries. It has a special formula fluorescent coloring, that gives brilliant pleasing color tone. You will find new happiness in the enjoyable color depth, reduced glare, fog, snow and less eye strain.

Everyone is talking about and waiting for 3 color Television costing hundreds of dollars.

For a small sum you can enjoy color toning now.

TELECOLOR FILTER is a wonderful gift to friends or relatives who own sets.

- 10 inch tube—\$3.00
- 12½ " " —\$4.00
- 16 " " —\$6.00

HARVARD LABORATORY  
Dept. RE3, 659 Fulton St., Brooklyn 1, N. Y.

### Build Your Own Geiger Counter

(See Radio-Electronics—Oct. 1949) \$9.87  
1B9B GAMMA COUNTER TUBES. Only.....

### SURPLUS EQUIPMENT Trouble Shooting Manuals (Include Schematics)

- BC-348—J, N, Q SCR-522 1.00
- BC-779 BC-610 each

- RCA Sound Power Unit. Use as mike or receiver ..... \$2.22 pr.
- Coaxial Cable—RG8/U ..... 6c ft.
- FL-8A Filter ..... \$1.37
- RCA Navy Head & Chest set \$14.88 ea.; \$28.00 pr.
- 1-82 Selsyn Indicator, 5" dia.—Brand New. \$3.95
- Selsyn Transmitter for above (used) ..... \$1.60
- G. E. 2J1G1 Selsyns—Brand New. .... \$1.16
- Connectors for 2J1G1 Selsyns ..... 39

### Command Receivers

- BC-453 190-550 kc—New Orig. Cartons. .... \$12.95
- BC-455 6-9 mc—New-Orig. Cartons ..... 6.95
- Hayden 4 RPM Synchronous Motor ..... \$1.79
- BC-1206 "Q-FIVER"—New (Orig. Cartons) ..... \$5.95
- AN/APS-13, Exc. Cond. .... \$14.95

### Brand New Sound Power Phones

- TS-10 Hand set. .... \$8.92 ea.; \$17.60 pr.
- Include Postage with Orders
- Send for FREE Monthly Bulletin

ELECTRONIC RESEARCH LABS.  
1021-E Callowhill St. Phila. 23, Pa.



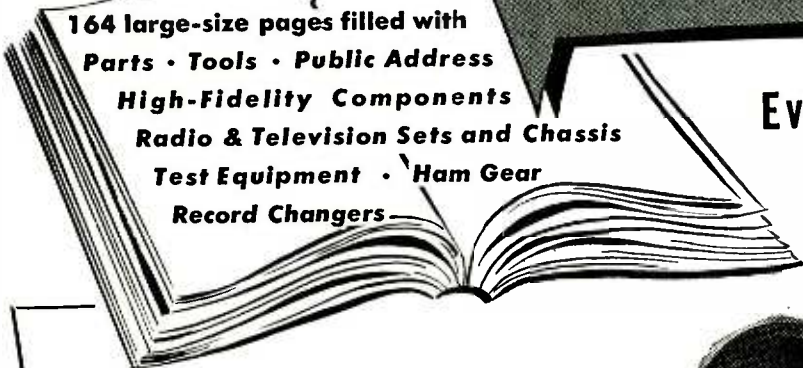

164 large-size pages filled with  
**Parts • Tools • Public Address  
 High-Fidelity Components  
 Radio & Television Sets and Chassis  
 Test Equipment • Ham Gear  
 Record Changers**

**Everything in Radio  
 and Television at the  
 Lowest "Net" Prices!**

Check these spec's—  
 then look at the price!  
**LAFAYETTE-ENGINEERED  
 FM-AM CHASSIS**

- 11 tubes plus rectifier
- Pre-amplifier for variable reluctance pick-up
- 10-watt push-pull beam-power output

**only \$59.50**

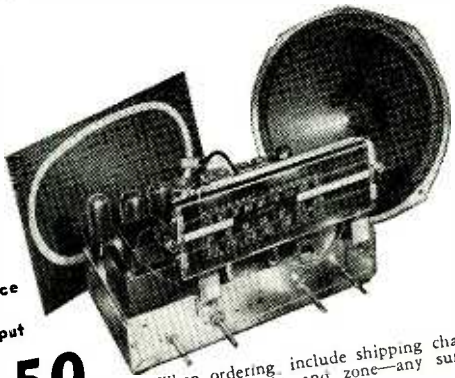

(When ordering, include shipping charges based on weight and zone—any surplus will be refunded.)

**INCLUDING THE MATCHED 12" PM SPEAKER!**

This is, without question, Lafayette's greatest chassis value in 10 years. For \$59.50 you get a chassis that compares favorably in performance with sets that have been selling as high as \$300 or more. Look at these excellent features: Latest 11-tube circuit, plus rectifier. Push-pull beam power output. Rated at 10 watts, undistorted. Built-in pre-amplifier for variable reluctance pick-up. Automatic volume control. Equipped

with phono input jacks for low and high impedance inputs. Full-range tone control. Slide rule dial, indirectly illuminated. Receives 88-108 MC FM band, 550 to 1700 KC broadcast band. 105-125 volts, 60 cycles. AC only. Chassis dimensions: 13 x 9 x 9 1/2. Shipping weight: 25 lbs. Complete with tubes, dial escutcheon, two indoor antennas (folded dipole for FM, loop for AM), and matching 12" PM speaker: \$59.50.

**DON'T** just take our word for it. Invest a penny postcard and send for your copy of the great new 1950 Lafayette Catalog. Then sit down with a pencil and paper and make a price comparison test yourself. Check the famous-make equipment, model for model, and see if Lafayette doesn't save you anywhere from a few pennies to a few dollars on most every item.

And remember—Lafayette gives you the service of a *national organization*, with 2 great centrally-located mail order centers and 6 strategic outlets for personal shopping. That means you save more money on postage, and get the parts you need a couple of days sooner.

So if you're a service man, experimenter, ham, hi-fi bug, engineer, or set-builder—send for your new 1950 Lafayette Catalog now. It's one of the biggest things in America you can get "for free"!



**Lafayette**  
**RADIO**

2 Great Mail Order Centers:  
 NEW YORK: 100 Sixth Avenue, New York 13  
 CHICAGO: 901 W. Jackson Blvd., Chicago 7



6 Outlets for Shopping in Person:

- NEW YORK: 100 Sixth Ave. and 542 E. Fordham Road (Bronx)
- ATLANTA: 265 Peachtree St.
- BOSTON: 110 Federal St.
- CHICAGO: 901 W. Jackson Blvd.
- NEWARK: 24 Central Ave.

**LAFAYETTE RADIO, DEPT. JC-50**  
 901 W. Jackson Blvd., Chicago 7, Ill.  
 or 100 Sixth Avenue, New York 13, N. Y.

Check here for FREE 1950 Catalog. (Please don't check if you have already received your catalog.)

Please rush the Lafayette FM-AM chassis (including speaker) at the reduced price of \$59.50. I enclose \$\_\_\_\_\_ in postal note, money order or check. Please include shipping charges based on weight and zone. (Any surplus will be refunded.)

Name \_\_\_\_\_

Address \_\_\_\_\_

City \_\_\_\_\_ Zone \_\_\_\_\_ State \_\_\_\_\_

**PASTE COUPON ON PENNY POSTCARD**



MODEL 1X-BD  
Bi-Directional Hi-Gain  
Conical "V" Beam



- TRUE CONICAL PERFORMANCE  
WITHOUT BULKY METAL CONES
- THE ONE ANTENNA FOR  
ALL CHANNELS PLUS FM
- NO HIGH FREQUENCY HEAD NEEDED
- HIGHEST GAIN — CONSTANT CENTER  
IMPEDANCE ALL CHANNELS
- BETTER THAN 12 DB FRONT TO  
BACK RATIO ALL FREQUENCIES
- ALL ELEMENTS MADE OF HIGH  
STRENGTH DURAL
- MODELS FOR HIGH BUILDING,  
CONGESTED AND FRINGE AREAS

TO BE SURE IT'S A CONICAL "V" BEAM  
... LOOK FOR THE TELREX TRADEMARK

**"These features are the reason we install  
TELREX antennas exclusively in our area"**

We know from experience that genuine Telrex Conical Antennas will do the job right—every time. Whether it's a high signal or fringe area installation on roof, chimney, sidewall or apartment window, Telrex means a better picture and a lasting installation. Since we started using Telrex exclusively, our service callbacks due to antenna failure have been eliminated. Our selling area has been broadened, also. Many of our customers are getting excellent pictures with sets \*200 miles from the transmitter.

**\*TV paths over land. On all-water paths, TELREX antennas are performing satisfactorily over distances up to 300 miles.**

QUALITY ACCESSORIES  
FOR CHIMNEY, ROOF  
SIDEWALL MOUNTING

**Telrex INC.**  
**CONICAL ANTENNAS**

Ask your distributor  
for complete data or write  
for illustrated catalog.

Telephone—ASBURY PARK 2-7252

AMERICA'S  
OUTSTANDING  
TELEVISION  
BEAM

ASBURY PARK 10, N. J.

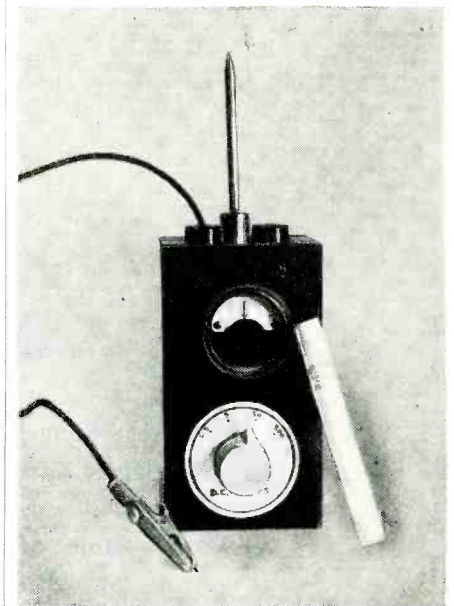

Case height is comparable to cigarette.

### MINIATURE TESTER USES 1-INCH-DIAMETER METER

By Rufus P. Turner, K6AI

THE new 1-inch-diameter, zero-center, d.c. milliammeters (manufactured by International Instrument, Inc., formerly MB Mfg. Co., Inc.) make it possible to construct a unique pocket-sized, multi-range, d.c. voltmeter having 2,000 ohms per volt sensitivity, with the entire instrument in the probe handle. The author employed a slender plastic box as the handle (see photo). It is small enough to be grasped comfortably in the operator's hand as the prod tip is touched to voltage points in a circuit under test.

The voltmeter has the additional advantage that no polarity switching or shifting of leads is necessary. Zero is at center-scale: the meter reads volts up-scale when the test prod is touched to a positive point, and volts down-scale

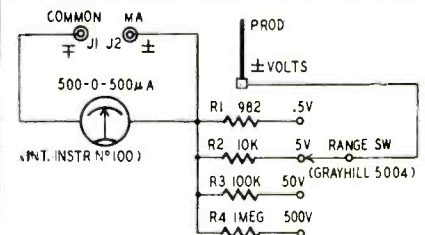

Only very few components are required.

when the prod is touched to negative point. The instrument may be connected semipermanently into a circuit for long-period tests, or it may be used intermittently, as in trouble shooting.

The instrument is shown ready to be picked up and used for testing. The removable test prod extends from the top of the case, which acts as the prod handle. A cigarette gives an idea of its small size.

In use, the voltmeter is handled just as if its small case were the handle of an ordinary test prod. One of its pin jacks is connected to the common terminal of the voltage source (such as

RADIO-ELECTRONICS for

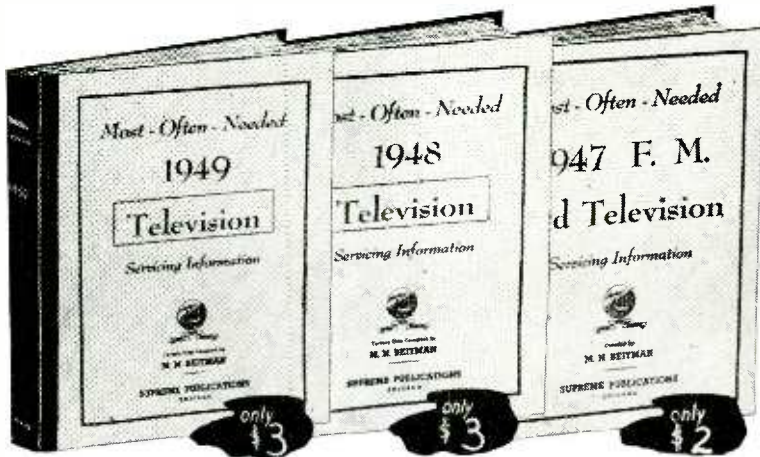

# Amazing SUPREME Values in New TELEVISION Manuals

All three giant Television Manuals shown at the left are available to you for only \$3, total cost, nothing else for you to pay, nothing else to buy, and we will even prepay the shipping charges. (Or you can buy these manuals separately at only \$3, \$3, and \$2.) Take advantage of this amazing *Supreme* offering to step into Television at a tremendous saving. For over 16 years, radio servicemen expected and received remarkable values in *Supreme Publications* service manuals. And now, the three-volume Television and F.M. series beats all previous bargains. Only a publisher who sold over one million of various radio manuals can offer such bargain prices based on stupendous volume-sales.

### New 1949 TELEVISION

Use this new giant handbook of television servicing as your guide to quick fault finding and repair of any modern T-V set. Easy-to-understand description of circuits, pages of test patterns, response curves, alignment facts, waveforms, voltage charts, service hints, hundreds of diagrams many in the form of giant double-spread blueprints. Here you have approved factory data on every popular T-V set. Large size: 8½x11", 192 pages + 9 blueprints 11x15", manual style. Amazing *Supreme* value for only \$3.

### 1948 T-V MANUAL

In this mammoth volume you have practical factory service data on all popular 1948 T-V sets of all makes. Let this manual show you how to make needed tests, guide you in carrying out adjustments, point to probable trouble spots, indicate location of all parts, trimmers, and controls. Includes hundreds of charts, waveforms, photographs, and many large 11x16" blueprints. Use coupon below to order; your special price only \$3.

### 1947 T-V & F.M.

Here is your manual of instructions for troubleshooting, repairing, and alignment of all popular 1947 F.M. and TELEVISION sets. The F.M. data covers tuners, AM-FM combinations, and all other types of F.M. circuits. Most complete information on various methods of F.M. alignment. A great deal of material on popular T-V sets including RCA 630-TS. Data on 192 large pages, 8½x11 inches. Sturdy manual-style binding. Price only \$2.

### FIND—FIX ALL TELEVISION FAULTS

Use these timely television manuals as your guide to quick fault finding and repair of any television set. Eliminates guesswork—tells you just where to look and what to do. Cuts hour-wasting jobs to pleasant moments. Use test patterns for quick adjustment, or look up probable cause of trouble in the pages of hints after simply observing fault in video picture. No equipment needed with these tests. Or use your voltmeter and compare values with many voltage charts included. With an oscilloscope you can get waveforms similar to hundreds illustrated using test points suggested and in a flash locate what used-to-be a hard-to-find fault. These manuals will give you the know-how of a television expert and will repay for themselves with time saved on the first TV job. Order at our risk for a 10-day trial. Use coupon below.



### NEW 1949 DIAGRAM MANUAL

Use this newest *SUPREME* radio manual to repair quickly all modern 1949 radio receivers. In this big single volume, you have clearly-printed, large schematic diagrams, needed alignment data, replacement parts lists, voltage values, and information on stage gain, location of trimmers, and dial stringing for almost all recently released sets. A worthy companion to the 8 previous volumes used by over 128,000 shrewd radio servicemen. Like the previous volumes illustrated above, it sells at a give-away price and gives you a whole year of radio diagrams for a couple of dollars total cost—nothing else to buy the rest of the year, nothing else to pay. Giant size: 8½x11 inches. Includes index. Manual style binding. Available at your jobber, or send coupon, price only \$2.50.

### SENSATIONAL LOW PRICE

Be money ahead with *SUPREME* Manuals. For the remarkable bargain price (only \$2 for most volumes) you are assured of having in your shop and on the job, needed diagrams and other essential repair data on 4 out of 5 sets you will ever service. These manuals pay for themselves with time saved on a couple of jobs, after that you use them FREE. Don't spend large sums for bulky, space-wasting manuals of other publishers, don't buy additional drawings every few weeks. Be wise, use *SUPREME* Manuals to get the most in diagrams for smallest cost.

### AMAZING SUPREME BARGAIN IN DIAGRAMS AND SERVICE DATA

Here is your low-priced money-saving source of radio diagrams and service data for all popular sets. Above is a photograph of these giant-size manuals—available to radio servicemen at only \$2 for most volumes. Let these easy-to-use manuals guide you to quick fault finding and simplified repair of any radio. Eliminate guesswork, cut hour-wasting jobs to pleasant moments. These manuals cover every popular radio of all makes, from old timers to new 1949 sets. Clearly printed circuits, parts lists, alignment data, and helpful service hints are the facts you need to be more expert in radio servicing. There are nine volumes in all as illustrated above. Each manual is 8½x11 inches, sturdy manual style binding, average manual has 194 pages of diagrams and practical service data. Use coupon below to order on 10-day no-risk trial or see these manuals at your jobber.



Compiled by M. N. Beltman, radio engineer, teacher, author & serviceman.

### Record Changers

**Post-War Manual**  
Service expertly all modern (1945-1948) record changers. Includes every popular make. Just follow simplified factory instructions to make needed adjustments and all repairs. Hundreds of photographs and exploded views. Large size: 8½x11 inches. 144 fact-filled pages. Available at your radio jobber, or sent post-paid, price only \$1.50.

### Radio Servicing Course-Book

Here is your practical radio course of 22 easy-to-follow lessons. Review fundamentals, learn new servicing tricks, all about signal tracing, oscilloscopes, recording, P.A., test equipment, and T-V. Just like a \$100.00 correspondence course. Everything in radio servicing. With self-testing questions and index. Large size: 8½x11" \$2.50. Price postpaid, only \$2.



New 1949 Edition

### NO RISK TRIAL ORDER COUPON

SUPREME PUBLICATIONS, 3727 W. 13th St., Chicago 23, ILL.

Ship the following manuals on 10-day trial under your guarantee of satisfaction.

- New 1949 Television Manual... \$3.00
- 1948 Television Manual... 3.00
- 1947 F.M. and Television... 2.00
- Post-War Record Changers... 1.50
- Radio Servicing Course-Book... 2.50

**Most-Often-Needed Radio Diagram Manuals**

- New 1949 Manual, \$2.50
  - 1948
  - 1947
  - 1946
  - 1942
  - 1941
  - 1940
  - 1939
  - 1926-1938—\$2.50
- PRICED AT ONLY \$2 EACH**

- I am enclosing \$... send postpaid.
- Send C.O.D. I am enclosing \$... deposit.

Name: .....  
Address: .....



Sold by all Leading Radio Jobbers

MARCH, 1950



# OHMITE

## Little Devil

### INSULATED COMPOSITION RESISTORS

In critical television applications, Little Devil Resistors can be depended on for longer, trouble-free service. These tiny, rugged units give quiet performance and are ideal for sensitive RF circuits. Moreover, they are available in  $\pm 5\%$  as well as  $\pm 10\%$  tolerances — in  $\frac{1}{2}$ , 1, and 2-watt sizes; standard RMA values.

### SERVICEMEN



### "Little Devil" RESISTOR ASSORTMENT IN All-Plastic CABINET

Designed for the serviceman!

Three assortments to choose from— $\frac{1}{2}$ -watt, 1-watt, 2-watt sizes. Each includes 125 most frequently used Little Devils, in 40 values, from 10 ohms to 10 megohms. Packed in rugged plastic cabinet—you pay only for the resistors! Prices:  $\frac{1}{2}$ -watt, \$12.50; 1-watt, \$18.75; 2-watt, \$25.00.

SEND NOW for Catalog No. 21

OHMITE MFG. CO.

4895 Flournoy St., Chicago 44

Be Right with...

# OHMITE

RHEOSTATS • RESISTORS • TAP SWITCHES

a receiver or amplifier chassis) with a clip lead. The instrument is picked up by its case, and the protruding test prod touched to any circuit point.

The test prod screws into a small, threaded brass block on the top of the case, and may be removed when the instrument is placed in the operator's pocket. The block will also take a threaded banana plug or similar phone-tip plug, the long prod then not being needed. This brass block is visible in both photographs.

The voltmeter has four ranges: 0-0.5,



Switch and resistors complete the tester.

0-5, 0-50, and 0-500 volts. Ranges are switched with another interesting sub-miniature component—a  $\frac{3}{4}$ -inch-diameter Grayhill No. 5004 single-pole, four-position, nonshorting, rotary selector switch. Two input jacks are connected directly to the meter terminals to permit an additional range of 0-0.5 ma (0-9 millivolts).

The voltmeter is housed in a colored plastic case, one of a new line manufactured especially for applications of this type.

### Circuit features

The circuit schematic of the miniature voltmeter is simple.

The multiplier resistors R1 to R4 may be ordinary carbon units selected carefully for exact values. The only really critical resistor is R1, which should have a resistance of 982 ohms for best accuracy on the 0-0.5-volt range. This odd value allows for the internal meter resistance of 18 ohms. A quantity of regular 10%-tolerance, 1,000-ohm resistors may be checked to find one with the 982-ohm value; or, if the builder does not object to an error of approximately 2%, he may use a 1,000-ohm resistor for R1. The other resistor values are so high as not to require subtraction of the meter resistance.

In ordinary use of the voltmeter, jack J1 is connected to the common voltage point (such as chassis) by a short, flexible lead terminated by an alligator clip. The test prod then is touched successively to the voltage points. When reading current (up to 0.5 ma) or millivolts (up to 9 mv), use both jacks J1 and J2 and remove the test prod if it is in the way.

The rear view shows the arrange-

# SNAP!

YOUR ANTENNA IS ASSEMBLED

## THE OAK RIDGE 6

FM and TV ANTENNAS

FEATURING THE AMAZING SNAP-LOCK\*

\*Pat. Pending

- Revolutionary four-second assembly.
- Just snap it out and it's fully assembled.
- Extremely rugged— $\frac{1}{2}$  inch aluminum elements.
- Completely pre-assembled—No loose hardware.
- We manufacture a full line of quality FM and TV antennas, including Hi-Lo's, Conicals, In-lines, Vee's, Stacked Arrays.
- Ask your local jobber for a demonstration. Inquiries invited.

### OAK RIDGE ANTENNAS

239 East 127th Street, New York 35, N. Y.  
Manufacturing Division of Video Television, Inc.

WRITE FOR CATALOG E-1

### MICROWAVE

WRITE FOR FLYERS OF NEW PLUMBING JUST RECEIVED FROM DEMORNAY BUDD AT SURPLUS PRICES.

10CM ECHO BOX CABY 14ABA-1 of OBU-3, 2890 MC to 3170 MCS direct reading micrometer head. Ring prediction scale plus 9% to minus 9%. Type "N" input. Resonance indicator meter. New and Comp. w/access. Box and 10 CM Directional Coupler ..... \$350.00

3 CM RECEIVER. SO-3. Complete with W.G. Mixer Assy (723-A/B). Reg. Fil. Power Supply 6 stages IF (6AC7) ..... \$99.50

10 cm. horn assembly consisting of two 5" dishes with dipoles feeding single type "N" output. Includes UG28/U type "N" "T" junction and type "N" pickup probe. Mfg. cable. New ..... \$15.50

10 cm. cavity type wavemeters 6" deep,  $\frac{6}{16}$ " in diameter. Coax. output. Silver plated ..... \$64.50 ea.

10 cm. echo box. Part of SFI Radar W/115 volt DC tuning motor Sub Sig 1118AO .... \$47.50

THERMISTOR BRIDGE: Power meter 1-203-A. 10 cm. mfg. W.E. Complete with meter, interpolation chart, portable carrying case \$72.50

W.E. 1138. Signal generator, 2700 to 2900 Mc. range. Lighthouse tube oscillator with attenuator & output meter. 115 VAC input reg Pwr. supply. With circuit diagram ..... \$150.00



3 cm. wavemeter. Ordnance type micrometer head New: Absorption type ..... \$85.00  
9000-9500 MCS Transmission type ..... \$92.50

SL. wavemeter. Type CW60ABM ..... \$125.00

TS 89/AP Voltage Divider. Ranges 100:  $\frac{1}{2}$  for 2000 to 2000v. 10:1 for 200 to 2000v. Input Z 2000 ohms. Output Z 4 meg ohms flat response 150 cy to 5 meg cy ..... \$42.50

AS14A/AP—10 cm Pick up Dipole with "N" Cables ..... \$4.50

TS 235 UP Dummy Load ..... \$87.50

10 cm Wavemeter. WE type B 435490 Transmission type. Type N Fittings. Veeder Root Micrometer dial, Gold Plated W/Calib. Chart. P/o Frea. Meter X66404A. New \$99.50

### SEND FOR FLYER OF RADIO PARTS

Send M.O. or CHK. Mds. Guard. Shpg. Charges Sent C.O.D. Price F.O.B. N.Y.C. Phone Di. 9-4124

COMMUNICATIONS EQUIPMENT CO.

131 Liberty St., Dept. C3 New York City 7, N. Y.

ment of the components inside the meter housing.

The range scale (see picture of front) is a 1 3/8-inch disc of stiff white drawing paper on which the numbers are drawn with black India ink. After the lettering is completed, the disc is cemented to the instrument panel, covered with transparent celluloid to prevent soiling, and is further secured by the shank nut of the selector switch. The knob is a standard 5/8-inch-diameter item commonly employed on mid-get radios and test instruments.

The block into which the test prod is screwed is of brass, 3/8-inch in diameter and 3/8-inch high. It is drilled straight through its center and threaded for a 6-32 screw. The block is held to the top of the case by a short 6-32 screw extending a short distance into its bottom. The test prod is threaded into the top of the block when needed in testing. The prod is a 2-inch length of stiff 1/8-inch brass rod, ground to a point at one end and threaded (6-32) at the other so that it will screw into the block.

## Calibrating Frequency Bridge

By I. QUEEN

THE Wien bridge and the parallel-T network are useful frequency-selective circuits. Either type can be used as a wave filter (like the heterofil), as the inverse feedback path for an R-C oscillator, or to measure frequency. If a.c. is applied to the input terminals (Fig. 1), the output progressively decreases as the frequency approaches  $f = 1/\omega RC$  from either direction. At  $f$  the output is zero.

The resistors or capacitors may be adjustable to control the frequency of a Wien bridge or parallel-T network. For convenience the variable elements are ganged. Where wide range and compactness are important, the resistors should be the ganged and variable elements. The Wien bridge requiring only a dual-gang resistor (or capacitor),

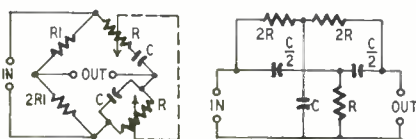

Fig. 1—Wien bridge and parallel T.

it is more often used of the two. However, the parallel-T can give better results.

The frequency equation shows that the calibration will not be uniform when the variable resistor (or capacitor) has a linear variation. The lows are well-spaced and the highs closely crowded, making it difficult to secure accurate calibration outside the lab or

factory. Each calibration point should be made individually since interpolation can cause considerable error.

An easier calibration method is herewith suggested. As has been shown, the

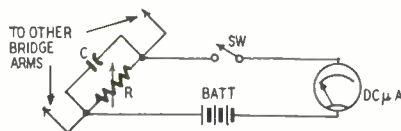

Fig. 2—Meter measures resistor current.

frequency is inversely proportional to resistance in the Wien bridge and the parallel-T network. We all know that in a simple series circuit, current flow is also inversely proportional to resistance. Therefore, a meter in series with a battery and resistance could measure frequency (Fig. 2).

When the switch is closed, current flows from the battery through R and the meter. The indication is proportional to  $1/R$  and, therefore, to the frequency. With proper choice of meter scales, the indications could be direct-reading. If the calibration is made correct at one point, it becomes correct throughout, disregarding error in the meter or discrepancy in the frequency network itself.

A spring return switch in the measuring circuit is advisable. When it is depressed, the frequency is read off; and when it is released, the frequency network functions normally.

## Turntable Speed Checker

THE increased popularity of three-speed phonographs has made necessary a simple method of checking the speed of the turntable. A stroboscopic type of checker is perhaps the simplest and easiest to use. It consists of a cardboard or plastic disc cut to fit over the turntable spindle. There are a number of bars, lines, or dots around the circumference of the disc. If the turntable speed is correct, these appear to stand still when viewed under a neon or fluorescent light. (Incandescents usually work nearly as well.—Editor)

The number of lines or dots in the pattern depends on the line frequency of the voltage applied to the lamp and the speed of the turntable in revolutions per minute. The formula for the number of points in the pattern is:

$$120 \times \frac{\text{line frequency (c.p.s.)}}{\text{turntable speed (r.p.m.)}}$$

For 60-cycle lines, there are 92, 160, and 216 bars or dots to a circle for turntable speeds of 78, 45, and 33 1/2 revolutions per minute respectively. —Mark A. Heald

## These Men are Getting PRACTICAL TRAINING



## IN RADIO-TELEVISION

ON REAL TELEVISION SETS RADIO RECEIVERS F.M. RECEIVERS IN THE GREAT SHOPS OF COYNE

Big opportunities are waiting for men who know the practical and technical end of Radio and Television. That's what you get at COYNE—besides practical Shop Training in F.M., Electronics and other branches of this giant field. Remember, Television is the fastest growing opportunity field today, and Radio is one of the biggest.

### NOT "HOME STUDY" COURSES

All Coyne Training is given in our ma-mouth Chicago training shops. We do not teach by mail. You train on actual equipment, under friendly instructors. Previous experience unnecessary. Hundreds of firms employ Coyne trained men.

### OLDEST, LARGEST, BEST EQUIPPED SCHOOL OF ITS KIND IN AMERICA

Come to the Great Shops of Coyne in Chicago. Established 1899—now in our 51st Year. Fully approved for G.I. training. Finance plan for non-veterans.

### MAIL COUPON FOR FREE BOOK

Send today for big new book packed with large pictures taken in Coyne Shops. No obligation. No salesman will call. Get the facts now!

**COYNE** B. W. COOKE, Pres.  
ELECTRICAL, RADIC & TELEVISION SCHOOL  
500 S. Paulina St., Dept. 30-08  
Chicago 12, Illinois



B. W. COOKE, Pres.  
COYNE Electrical, Radio & Television School  
500 S. Paulina Street, Dept. 30-8H, Chicago 12, Ill.

Send FREE BOOK and full details on Radio-Television Course.

NAME.....  
ADDRESS.....  
CITY.....STATE.....

# TV Service Tips

from **SPRAGUE**

WATCH OUT for overhead power lines whenever you install masts and antennas. Be especially careful that the top of the antenna does not become entangled with one power line and pull it into the companion power line.



DON'T DISCARD old picture tubes or leave them lying around! Either break the vacuum or, better yet, pack old tubes in their original cartons, and shatter them by hitting the carton a heavy blow with an iron bar.



PLAY SAFE by wearing safety goggles, gloves and a heavy smock when handling picture tubes. A tube that implodes may spread shattered glass in more directions than you want it to.



MAKE SURE that insulation on high voltage wires is not worn. To avoid grabbing a "hot" wire, it is a good idea to work with only one hand. Keep the other hand behind you, or in your pocket. Stand on a rubber doormat.

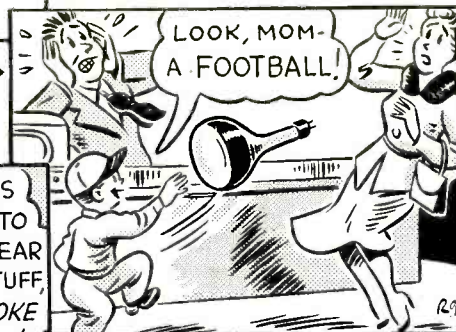

DON'T TAKE CHANCES ON ORDINARY REPLACEMENT CAPACITORS FOR TELEVISION SERVICING EITHER.

USE **SPRAGUE MOLDED TELECAPS®**

Actual records prove these phenolic-molded paper tubulars eliminate nine out of ten failures caused by ordinary capacitors in TV and other tough applications. Available in ratings from 200 to 12,500 volts.

**ATOM® AND TWIST-LOK® 'LYTICS**

These extremely small, metal-encased, 185°F. (85°C.) dry electrolytics are specifically designed for TV... are more widely used by leading TV makers than any other brand BECAUSE THEY STAND THE GAFF!

★Trademark

Write for catalog or see your Sprague jobber today.

**SPRAGUE PRODUCTS COMPANY** 81 Marshall Street, North Adams, Mass.

## MICROWAVE MODULATION

Patent No. 2,489,855  
Charles H. Brown, Baldwin, N. Y.  
(Assigned to Radio Corp. of America)

A cavity resonator has very high Q and can transmit only a very narrow band of frequencies, the resonant frequency being determined by its physical dimensions. This patent discloses how the dimensions of a cavity may be varied in accordance with a modulating voltage. This results in frequency modulation of a microwave carrier.

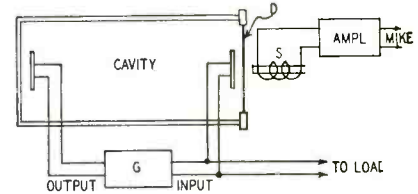

One end of the resonator is constructed of magnetic material which can vibrate as a diaphragm D. It is actuated by the solenoid S, which is excited by the amplifier. Therefore sound at the microphone causes D to vibrate, changing the dimensions and resonant frequency of the cavity. Input and output of a microwave generator G are coupled through the cavity by means of dipoles. Feedback occurs through the cavity at its resonant frequency, which is controlled by the audio input to the solenoid and therefore changes in accordance with the modulation.

## RADIOLOGICAL MEASUREMENT

Patent No. 2,476,810  
Eugene M. Brunner, El Cerrito, and  
Edwin S. Mardock, Berkeley, Calif.

Fast-moving neutrons move freely through heavy elements but are slowed and scattered by hydrogen and other light elements. This is a useful property for investigating liquids and gases containing hydrogen. Neutrons possess no charge, however, and cannot be detected directly by the usual Geiger counter or similar methods.

This patent notes that neutrons cause temporary instability of atoms of silver and manganese. These elements give off beta particles as they return to their normal state.

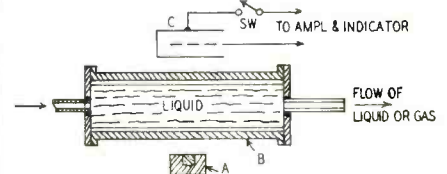

In the figure, A is a source of neutrons, which may be a radium-beryllium mixture. The radium gives off alpha particles which bombard the beryllium and cause it to emit neutrons. The fast neutrons pass freely through the metal enclosure B but are slowed down and scattered by hydrogen atoms in the liquid within. Some of the particles bombard the Geiger counter C, which has a cathode made of silver or manganese.

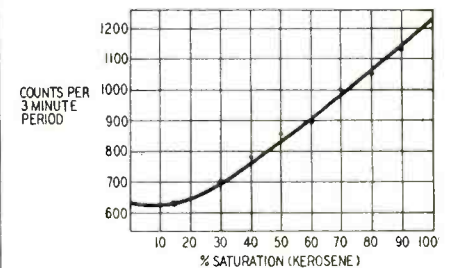

After a short neutron bombardment (with SW left open) A is removed and the switch closed. The silver or manganese cathode now emits beta particles which are detected by the Geiger counter.

The total count within a fixed period of a few minutes is a measure of the hydrogen content of the liquid or gas whose characteristics are being evaluated.

RADIO-ELECTRONICS for

*If your  
Pictures  
look like this* →



# YOUR TELEVISION WILL BE IMPROVED WITH A WARD OUTDOOR AERIAL

*Pictures like this* →



*The modern miracle of pictures by air can be a most satisfying means of entertainment. But be satisfied only with a picture comparable to a class "A" motion picture—on every station in your area. It is unnecessary to compromise!*

**HERE'S WHY:** Television waves are like light beams — solid objects reflect and refract them, making it impractical to pick up all stations from an indoor aerial. That is why you get double images on some stations.

In addition, indoor aerials have poor signal pickup making it difficult to get good pictures on all stations.

**FURTHERMORE:** Your indoor antenna may have a high noise level which increases the amount of interference as you advance the contrast control to bring up a weak picture. All of these technical difficulties are eliminated by a WARD outdoor aerial installed by a competent radio serviceman. In every case, a Ward outdoor antenna will improve reception over an indoor aerial. Also, Ward aerials are so well designed, they are attractive on a house. *It is unnecessary to compromise!*

*WARD is the largest and oldest exclusive maker of television and auto radio aerials.*

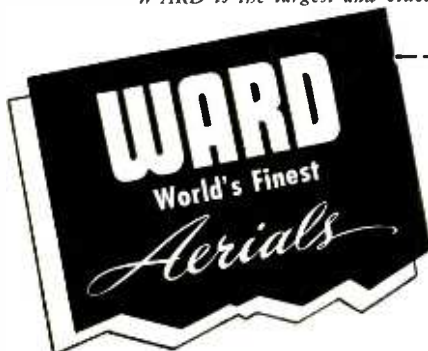

Does the antenna on your automobile need repair? Replace it with  
WARDS'S 8-BALL — world's largest selling auto aeria .

**WARD PRODUCTS CORPORATION**

1523 E. 45TH STREET, CLEVELAND, OHIO

*Division of the Gabriel Company*



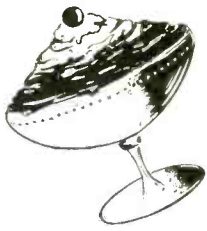

# 'the proof of the PUDDING!..

Impartial and exhaustive tests prove that the new **MODEL IT4-SUPER SONIC TV/FM AMPLIFIER** delivers a higher usable gain with full bandwidth and higher signal to noise ratio than other leading brands at any price!



model  
**IT4**

## SUPER SONIC TV/FM AMPLIFIER

**\$32.50**  
List

- Improves TV reception in weak signal areas, with or without outdoor antenna.
- Continuous tuning of all 12 TV channels, also FM with ONE knob control.
- Reduces electrical, diathermy interferences and minimizes "ghosts and snow" effects.
- Frequency range: 50 mc to 220 mc, continuously tuned.
- Bandwidth: 6 mc. minimum all channels.
- Insertion gain: Minimum of 18 db at any frequency with 300 input and output impedances.
- Highest signal to noise ratio.
- Input and Output Impedances: 300 ohm balanced to ground and 72 ohms unbalanced.
- Inductances wound with PURE SILVER wire.
- All moving contacts heavily silver plated.

**CHOICE TERRITORIES STILL AVAILABLE**

Write for Free Brochure to Dept. RC1

# SONIC INDUSTRIES INC.

"MANUFACTURERS OF DUOSONIC PHONOGRAPHS"

221 WEST 17th STREET, NEW YORK 11, N. Y.

### SAFETY CONTROL

Patent No. 2,490,679  
Allen R. Davidson Erie, Pa.  
(Assigned to Reliable Radio, Inc.)

The operator of a molding press must be careful not to come too close to his machine while it is in motion. Since the most experienced operator can make a mistake, a safety control should be used. This circuit automatically shuts off equipment if the operator comes too close.

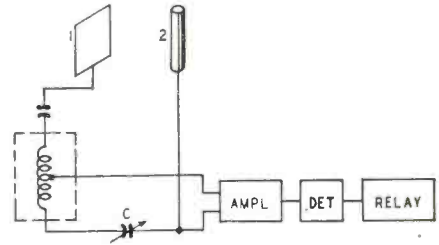

The upper half of the tank coil (which is the output coupling of an r.f. generator), the fixed capacitor, and the capacitance between electrodes 1 and 2 constitute half of a bridge circuit. The other half is formed by the lower portion of the coil and the variable capacitor C. C can be adjusted to balance the bridge so that no input is applied to the amplifier.

The electrodes 1 and 2 maintain an r.f. field near and between the platens of the press.

If the hand or body of the operator disturbs the r.f. field, the bridge is unbalanced and a voltage is amplified and detected. The relay operates to prevent possible accident.

### TELETYPE MODULATOR

Patent No. 2,474,261  
Frank A. Leibe, Quakertown, Pa.  
and Benjamin B. Mahler, Newark, N. J.  
(Assigned to Federal Tel. & Radio Corp.)

In teletype circuits, characters are transmitted by a code using combinations of two different audio frequencies. Known as "space" and "mark" frequencies, they are separated by about 200 cycles. The space and mark combinations are formed automatically as the keyboard is operated.

This modulator converts the "space-mark" switching operation to a corresponding frequency change. The figure shows a phase-shift oscillator with four sections. The circuit oscillates when the total phase shift equals 180°. The frequency may be increased by adding a shunt across one of the resistors, for example R2.

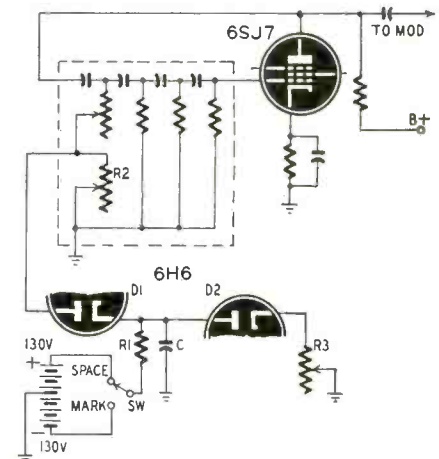

As the teletype keyboard is operated, SW is switched rapidly between the two contacts. When it touches the "mark" terminal, a negative bias appears on the cathode of D1 which conducts and shunts R2. In this position a higher frequency is generated. When SW is thrown to the left, a positive bias is placed on the D1 cathode and the diode blocks. Since R2 is no longer shunted, the oscillator frequency is now lower. In this way the space and mark frequencies are transmitted.

D2 is added for symmetrical charging and discharging of C. Regardless of the switch position, one diode is conducting and the other is blocked. If R2 is made equal to R3, the current through R1 has the same magnitude whether it flows in one direction or the other. The filter R1-C minimizes key clicks.



**BUFFALO  
RADIO SUPPLY**  
219 Genesee St.  
Buffalo 3, N.Y.  
Dep't RE-3

**274N COMMAND SET  
MADE BY WESTERN ELECTRIC**

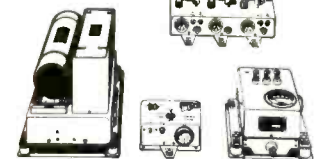
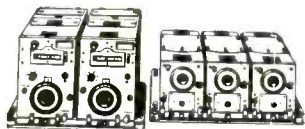

A mountain of valuable equipment that includes 3 separate Communications Receivers, covering up to 9 M.C., 2 separate 40 watt Transmitters including crystals, 4.28V Dynamotors (easily converted to 110V AC operation), Transmitter and Modulator, 2 Tuning Control Boxes, and 1 Antenna Coupling Box complete with R.F. Ammeter, 29 tubes supplied in all Receivers and Transmitters instantly detached from mounting racks for use in separate locations. Removed from unused aircraft and in guaranteed electrical condition. A super value at \$59.95 complete.

**CO-AXIAL CONNECTORS**

Army No. PL 259 or Amphenol 85-15P  
Army No. SO-259 or 83-1E  
Army No. PL 258 or 83-1J  
Army No. M-359 or 83-1AF  
39c ea.—in lots of 10 assorted 39c ea.

**\$12.95 FOR BIG BARGAIN "V"  
(All 3 items listed below)**

- 1. SENSATIONAL, FASCINATING, MYSTERIOUS SELSYNS.** Brand new Selsyns made by G. E. Company. Two or more connected together work perfectly on 110V AC. Any rotation of the shaft of one Selsyn and all others connected to it will rotate exactly as many degrees in the same direction, following unerringly as if the units were connected together by shafting instead of wire. This is true whether you twist the shaft of the master unit a fraction or a revolution or many revolutions. Useful for indicating directions of weather, vanes, rotating directional antennas, or controlling innumerable operations from a distance. Complete with diagram and instructions. Per Matched pair \$4.95.
- 2. ALUMINUM GEAR BOX 1826X7** that contains two powerful electric motors and two matched gear trains, 62 gears in all varying in size from 1/2 to 4 inches in diameter. This unit is readily converted to rotate a beam antenna or any other similar use. \$5.00
- 3. HOME WORKSHOP AT BARGAIN PRICE.** Accurate and precise 2 speed guaranteed hobby lathe, the essential machine for the home workshop. Sturdy enough for light production work or factory standby service. Supplied with 56" of belt for connecting to any available electric motor or power take-off. Also included in this unbelievable offer are such accessories as a 1/2" drill chuck with specially hardened tool steel jaws, a 4" electric furnace high speed grinding wheel, a cotton buffing wheel and a large supply of buffing compound, and a 4" steel wire scratch brush. Your cost \$6.00. Sole export agent. Distributor inquiries invited.

**AC-DC POCKET TESTER**

This analyzer, featuring a sensitive repulsion type meter housed in a bakelite case, is the result of 15 years achievement in the instrument field by a large company specializing in electronic test equipment. Specifications of the AC-DC Model Volt-Ohmmilliammeter: AC and DC Volts—0.25, 50, 125, 250. Milliampers AC—0-50. Milliampers DC—0-50. Ohms Full Scale—100,000. Ohms Center Scale—2400. Capacity—05 to 15 Mfd. Total price, prepaid anywhere in the USA—\$7.00. Similar DC Meter, lacking AC operated ranges of above, \$5.50 prepaid.



**SIGNAL GENERATOR**

Genuine Laboratory-type precision signal generator. Manufactured and sold for \$68.00 each in large quantities during the war by Northeastern Engineering Corp., one of the top manufacturers of electronic equipment for the U. S. Gov't. Five fundamental bands starting at 150 K.C. Strong signals up to 120 M.C. Five step ladder type attenuator as well as potentiometer output control. Regular 1000 cycle audio oscillator using vacuum tube, set a cheap neon sawtooth audio oscillator. Audio output available separately. Weight without packing material 16 lbs. Complete with fused plug and coaxial output lead. Super Special... **\$38.75**

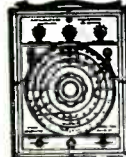

**MICROPHONES**

Super Special—Highest quality all chrome bullet shaped CRYSTAL MIKE of top-flight nationally known brand—\$5.95. Bullet DYNAMIC MIKE — \$7.95. MIKE Jr — 60c.

**"P.M. SPEAKERS"**

Latest type PM Speaker in a fully-enclosed finished metal cabinet. This speaker and case match communication receivers, and in addition make perfect intercom remote stations. Our price \$4.50. Including output transformer... \$4.95

**SPEAKERS**—These PM speakers are the finest that are available. All have heavy oversize Alnico V magnets

3 1/2"	\$1.15	6 for \$6.60
4"	\$1.15	6 for \$6.60
5"	\$1.10	10 for \$9.50
6"	\$1.50	6 for \$8.70
6"x4" Oval	\$2.10	6 for \$10.80
7" (Car Radio Size)	\$4.50	6 for \$21.50
8"	\$3.10	6 for \$18.60
8"	\$4.95	6 for \$29.70
10"	\$5.50	6 for \$33.00
12"	\$7.95	6 for \$47.70



**FCC AUTHORIZES  
RADIO FOR  
PRIVATE SERVICE!**

(The FCC announced that effective June 1, any American over 18 years of age is eligible for a 5 year station permit. In the "Citizens" band, neither code test nor technical knowledge is necessary.)

**GENERAL ELECTRIC 15 TUBE TRANSMITTER-RECEIVER SET.** This brand new 15 tube transmitter-receiver was designed for mobile storage battery powered service. It will operate in the "Citizens" band where no amateur license to transmit is necessary. It's a cinch for any experimenter to connect this unit for 110 V AC operation by following the instructions and diagrams supplied, which cover numerous applications, including television. For those intending to use on car or boat, a new dynamotor, exactly as originally supplied, costs only \$15.00. Don't fail to write for FREE descriptive bulletin. Order our RT-1248 for only \$29.95, or two for \$53.90.

**PORTABLE AIR  
COMPRESSOR \$14.50**

Portable air compressor and storage tank. Ruggedly built of best materials using lifetime-lubricated ball bearing on connecting rod and oil-impregnated main bearing on shaft. Unusual design forever eliminates valve trouble. PATENTED unique air intake system increases efficiency tremendously over other compressors. Will deliver approximately 3500 cu. in. of air per minute at maintained pressure of 50 lbs. Comes complete with 100 lb. gauge. Finger-tip adjustment allows setting of output pressure at any value, which is automatically maintained. Works from any 1/4 H.P. motor. Useful for spraying paints or lacquers, disinfectants, insecticides, annealing or brazing with natural gas, inflating tires, etc. Price \$14.50 prepaid anywhere in the U.S. Efficient, completely adjustable siphon type spray gun complete with 12 ft. of 100-lb. tested hose available for only \$7.75 with pint container, also prepaid. 25% required on all C.O.D. orders.



**SUPER SPECIAL**

**FAIRCHILD bombsight POWER UNITS. BRAND NEW.** Each unit contains 9 tubes which alone have a value of \$15.00; 8 electric motors or generators, 6 of which are the permanent magnet field type; relays; and 20 valuable precision resistors plus a multitude of the ordinary kind, in addition to many condensers and potentiometers. All for only \$14.95.

**NO ROOFTOP CLIMBING**

The BUFRAD Model BRS portable indoor antenna adjusts easily to any channel and any station direction. Base has felt base to prevent scratching furniture. Can also be readily installed attached to ceiling with base up, 300 ohm line furnished. Your cost \$1.80. In lots of 12 \$15.00 each.

**DE LUXE AC-DC RADIO KIT**

Extra high quality standard production line radio in kit form with complete instructions. Features 2 gang condenser, 2 iron core I.F. transformers, and polystyrene insulated edge-wise wound antenna loop. Tubes include 12A7, 6, 12BA6, 12BE6, 50B5 & 35W4. Receives broadcast band from 550 to 1700 KC. Kit form \$8.75 or 2 for \$17.00. Assembled, wired & tested \$12.95 or 2 for \$25.00.

**WORLD WIDE  
MAIL ORDER  
SERVICE**

**AUDIO AMPLIFIER**

Brand new, dual triode amplifier having 2 of the valuable and scarce octode type audio transformers that sell for \$12.80 apiece. Neat aluminum case, fully enclosed (largest dimension 6 in.). Perfect for intercom systems, phono amplifiers, mike amplifiers, or signal tracer amplifier for testing radio sets. A sensational bargain at only **\$3.40** each.

**TWIN COAXIAL CABLE  
at a Sensational Price**

Two No. 12 stranded conductors within a copper shielded, vinyl jacketed, polyethylene core. Can handle over 5 KV. of R.F. power. The ideal TV leadin for the most exacting installations such as apartment house antenna systems. Perfect for any twinax use calling for cable within the range of 70 to 95 ohm nominal impedance. Regular price 71c per ft. Your cost \$15.00 per hundred feet. Ask for RG-57U.

RG-59U 72 Ohm Coax. The most popular TV type. Regular price 17c per ft. Your cost 56c per ft. or \$4.50 per C.

**NEW!** FOR FIELD OR BENCH WORK ...

**OAK RIDGE miniatures**

work like **GIANTS** for You!

EASIER, FASTER, MORE PROFITABLE  
TV-FM SERVICING... at lowest cost!



**OAK RIDGE 10-in-1 MINIATURE TV-FM SIGNAL GENERATOR**

Pinpoints any signal failure from antenna to CRT or speaker in 2 minutes flat! Incorporates 3 separate tuning bands and modulation output and attenuator for TV & FM. Generates a signal to perform as complete . . .

- RF, OSC, and Mixer (1st Det.) Tester • Video IF Tester • Audio IF Tester • Video & Audio 2nd Detector Tester • Video & Audio Amplifier Tester • Sound Trap Aligner or Tester • Adjacent Picture Trap Aligner or Tester • Marker Generator • Antenna Orientation Tester • Antenna Sensitivity Tester.

You get **ALL TEN IN ONE** with this extremely adaptable, precision-made Model 103! Size: 5 1/4 x 4 x 2 1/4". Dealer's Net \$29.95.

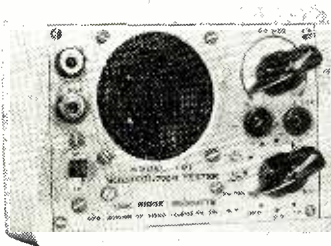

**OAK RIDGE 7-in-1 MINIATURE TV-FM-AM SUBSTITUTION TESTER**

Which of these Servicing Aids do You Need Most?

- Test Speaker Without Transformer • Test Speaker With Transformer
- Paper Condenser Substitutor • Electrolytic Condenser Substitutor
- Fixed Resistor Substitutor • Variable Potentiometer Substitutor
- Audio Signal Tracer for Video, Audio & Sweep Circuits in TV, FM, AM, Audio Amplifiers, etc.

You get **ALL SEVEN IN ONE** with the versatile, precision-made Model 101! Size: 5 1/4 x 4 x 2 1/4". Dealer's Net \$16.25.



**OAK RIDGE 3-in-1 MINIATURE TV HIGH VOLTAGE TESTER**

Accurately checks all high voltages in any direct-view or projection TV set. Has precision 10,000 ohm/volt movement, three scales: 0-500V, 0-15KV, 0-30KV. Complete with special high voltage test lead. Size: 5 1/4 x 4 x 2 1/4". Dealer's Net \$14.95.

Boost your efficiency and earnings! Ask your parts jobber for these amazing new MINIATURES today! Write for free Catalog T-E.

**OAK RIDGE PRODUCTS**  
239 EAST 127th STREET NEW YORK 35, N. Y.  
Manufacturing Division of VIDEO TELEVISION, INC.  
Makers of the famous OAK RIDGE Patented SNAP-LOCK TV-FM Antennas and Accessories.

**ELECTRONIC COUNTER**  
Patent No. 2,490,243  
Joseph C. Tellier, Penn Wynne, Pa.  
(Assigned to Philco Corporation)

This clever arrangement for counting alternate half-cycles of an input wave uses a number of stages, each including a capacitor and a rectifying diode. The stages are operated in order by successive half-cycles. If 10 stages were used, the last one would operate at the completion of five full cycles or 10 half-cycles.

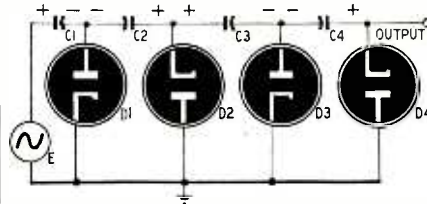

Originally all capacitors are discharged. At the first positive half-cycle, C1 is charged by current flowing through D1. Therefore the capacitor is charged to E volts with polarity as shown. D1 being effectively a short, the following stages are not affected. When the input goes negative, -2E is applied at the D1 plate. Therefore this diode is blocked. However, because this potential has the correct polarity to operate D2, the second capacitor C2 is charged with polarity as shown. The following stages are not affected because of the low resistance of D2.

When the wave goes positive a second time, the voltage across D1 is the sum of E (input) and -E (the potential across C1), which is zero. D2 is blocked because of the positive voltage on its cathode. Therefore the charge on C2 is applied across C3 and D3 in series. This diode conducts and charges capacitor C3 with polarity as shown.

The step-by-step process continues. At the nth half-cycle, the nth diode conducts and the nth capacitor is charged. All preceding diodes are blocked (note sign of potentials across them). All following diodes are unaffected because of the low resistance of the nth diode.

The voltage on the last capacitor may be used to operate a relay or another electronic circuit. The network can be used to divide frequency.

**PULSE WIDTH CONTROL**  
Patent No. 2,490,026

John A. Buckbee, Fort Wayne, Ind.  
(Assigned to Farnsworth Research Corp.)

This invention controls the width of pulses such as TV sync signals or pulse modulation signals. The pulses originate in a sine-wave or sawtooth generator. The generator is connected to a pair of rectifiers with means to bias them.

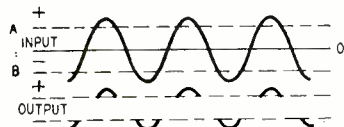
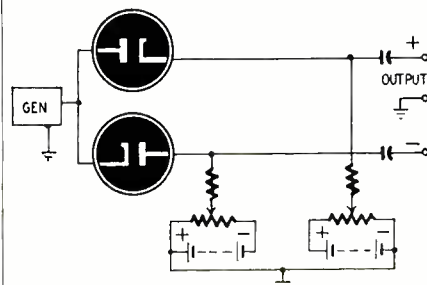

Positive pulses can flow through the upper rectifier when the input voltage exceeds the positive bias. For illustration, the graph shows how the bias (dotted line A) permits only peaks to be transmitted through the rectifier. As the bias is adjusted, more or less of the peak is passed. Therefore the width of the pulse is also changed. Negative pulses can pass through the lower rectifier only when the input voltage exceeds the negative bias. This is shown by the dotted line B. As before, the pulse width is controlled by the bias.

The variable positive or negative pulses are available at the corresponding output terminals.

**TECH-MASTER**  
*Blue Ribbon*

**TELEVISION KIT**  
featuring **AGC**  
(Keyed automatic gain control)

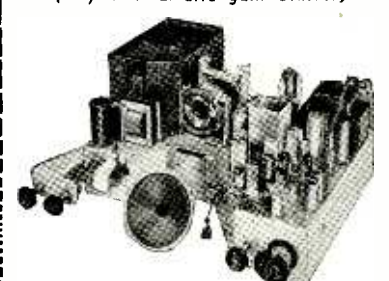

for 10" or 12" KINESCOPES

Four-stage video IF—4Mc band width. Completely assembled . . . ready to wire. Factory tested parts of finest make. Trouble-free wiring diagrams permit wiring in a week-end.

Complete with all tubes, less Kinescope **\$119.95**  
At your distributor, or write Dept. RE-3 for literature

**TECH-MASTER PRODUCTS CO.**  
443-445 Broadway, New York 13, N. Y.

More leading engineers and technicians have built Tech-Master for their own use than any other Television Kit.

**25 POWER PRECISION MICROSCOPE**  
POCKET



Compound Optical System—4 Precision Lenses—Aluminum case—5 inches long A professional instrument. Ideal for Machinists • Hobbyists • Photographers Engineers • Students • Naturalists, etc. Satisfaction Guaranteed or Money Back Postpaid

**MICROSCOPE & LENS CO.**  
168E Nassau Street, New York 7, N. Y.

If you don't receive our **FREE RADIO CATALOGS** you're losing money!

**VIDEO HANDBOOK**—Latest printing of Boland and Boyce famous Video "Bible", now available, postpaid **\$5.00**

**RADIO DATA HANDBOOK**, also \$5.00. Combination library of the two books, \$9.00

**RADIONIC EQUIPMENT CORPORATION**

Tribune Theater Entrance  
E170 Nassau Street, New York 7, N. Y.  
Worth 2-0421 • Open daily 9 to 6—Saturday 9-5

**FREE! MAIL TODAY!**

GET YOUR COPY AT ONCE!  
of RADIONIC'S Bargain Catalogs, Radio & Television Sets—Parts—Accessories, Unbeatable Values!

RADIONIC EQUIPMENT CORP., Dept. 103  
E170 Nassau Street, New York 7, N. Y.

Please rush Free Copy of your latest Bargain Catalog of Radio and Television Sets, Parts, Tubes and Accessories.

NAME \_\_\_\_\_  
ADDRESS \_\_\_\_\_ STATE \_\_\_\_\_  
CITY \_\_\_\_\_

**WILCOX-GAY A-52**

When this receiver is dead except for a faint hum from the speaker, check the .004- $\mu$ f, 600-volt capacitor between the plate of the 42 and ground. Replace this capacitor with a 1,000-volt unit. Check the output transformer to make sure that it has not been damaged by the excess current which passed through it because of the shorted capacitor.—*V. D. Kinard*

**OLDSMOBILE 1941 MODELS**

If the set stops playing a few seconds after it starts to operate, try replacing the OZ4 rectifier. This tube may check good in standard testers and yet fail to operate properly when used under conditions like those encountered in the power pack of an auto radio.—*F. Byrne*

**INTERCARRIER BUZZ**

A consistent overmodulation buzz on one channel was cured by placing a 100- $\mu$ f variable capacitor across the 300-ohm lead-in at the set. The hum could be tuned out and the picture improved on other channels by adjusting this capacitor.

I believe that this capacitor attenuates the video carrier so that the video or i.f. amplifiers will not be driven to cutoff by the white or sync signals.—*John C. Strole*

**MIDWEST 20-38**

If the filter capacitors will not hold up any length of time, the trouble may be caused by excessive B-voltage or by improper capacitor replacements. It is advisable to use 600-volt wet electrolytics if they are available. Check to see if one side of the push-pull a.f. section is inoperative because this can cause the B-supply voltage to rise to higher-than-normal values.—*Peter J. Foradas*

**HALLICRAFTERS 5-20R**

Severe distortion in the Sky Champion is almost invariably caused by a bad 6SQ7 cathode resistor. This resistor changes its value and shifts the operating bias. Replace it with a high-quality unit of the same value. A higher-wattage unit will guard against future failures.—*Gerald Samkofsky*

**PHILCO 48-1001**

The complaint was that the horizontal hold control was critical to adjust and the picture would jump out of sync at irregular intervals.

Tests with a Variac showed that a 1- or 2-volt drop in line voltage would cause the picture to jump after approximately 20 seconds. The horizontal multivibrator tube was replaced with one having reserve emission. The selection was made on the basis of satisfactory operation as the line voltage was reduced. With a good tube, these sets will operate without adjustment as the line voltage is varied between 135 and 90 volts. The picture goes from almost black to a washed-out white, but the sweeps don't even quiver.—*Gray Trembly*



**Use STANCOR EXACT DUPLICATE TRANSFORMERS**

Every call-back you make means lost time and profits. Why take a chance with transformers that "almost fit?" You're sure of a good job and a satisfied customer when you use Stancor *Exact Duplicate* transformers for TV servicing. These units meet the exact specifications, electrically and physically, of the original components. Representative types are listed below.

**Vertical Blocking - Oscillator Transformer.** Stancor Part Number A-8121. Exact duplicate of RCA type 208T2. For generation of 60 cps required to drive grids of vertical discharge tubes.

**Plate and Filament Transformer.** Stancor Part Number P-8156. Exact duplicate of RCA type 201T6 used in model 630TS receiver.

**Deflection Yoke.** Stancor Part Number DY-1. Exact duplicate of RCA type 201D1. For use with direct viewing kinescopes such as 7DP4 and 10BP4.

**Focus Coil.** Stancor Part Number FC-10. Exact Duplicate of RCA type 202D1. For use with magnetically focused kinescopes such as RCA type 10BP4.

**Horizontal Deflection Output and HV Transformer.** Stancor Part Number A-8117. Exact duplicate of RCA type 211T1. For use with direct viewing kinescopes, such as types 7DP4 and 10BP4.

For complete specifications and prices of these and other Stancor TV replacement components, see your Stancor distributor or write for Television Catalog 337.

**JUST PUBLISHED**—Ask your Stancor distributor or write for your free copy of the **New STANCOR TV COMPONENTS REPLACEMENT GUIDE**, Bulletin 338C. Lists Stancor replacement components for two-hundred and fifteen models and chassis made by forty-three leading receiver manufacturers.



**STANDARD TRANSFORMER CORPORATION**

3592 ELSTON AVENUE • CHICAGO 18, ILLINOIS

**RADIO AMATEUR NEWCOMER**

Ideal for those just getting started (or interested) in radio. You need no other book to get your license and get on the air. How-to-build simple equipment for a complete station; operating instructions; simple theory; study questions needed to pass license exams; U.S.A. Amateur radio regulations. **WRITTEN BY THE EDITORS OF "RADIO HANDBOOK."**

**\$1.00**

AT YOUR DEALER — On mail orders from us, \$1.10 postpaid. Add sales tax in California.

**EDITORS AND ENGINEERS, Ltd.**  
1345 KENWOOD ROAD • SANTA BARBARA, CALIF.

**YORK RADIO & REFRIGERATION**

265 W. MARKET ST.  
York, Pa.

HAS THE SENSATIONAL NEW  
**LEICO** 425-K  
5" Scope Kit  
**IN STOCK!**



\$39.95

**BE YOUR OWN BOSS!**

**MAKE MORE MONEY**



\$1.00 VALUE

**25¢**

**40,000 WORDS IN TEXT**

**NO ADS ALL "MEAT!"**

In "CASH IN" you now get THE real money-makers — dozens of profitable tested mail order plans, confidential business secrets, dozens of practical tested formulas, successful tested schemes — actual experiences of men who have started on a shoestring—with less than \$10 capital. 25¢ a copy postpaid. Send U. S. stamps, money order, or coin.

**Money Back Guarantee.**

**NATIONAL PLANS COMPANY**  
1966R BROADWAY, NEW YORK 23, N. Y.

## PHOTOFACT BOOKS HELP YOU 4 WAYS!

1. SAVE TIME 2. SAVE WORK

3. EARN MORE 4. LEARN MORE



### PHOTOFACT TELEVISION COURSE

The book bought and studied by thousands. Gives you a clear understanding of TV principles, operation and practice. Complete coverage of all phases. 216 pages; profusely illustrated; sturdily bound, 8½ x 11".  
Order TV-1.....Only \$3.00

### TELEVISION ANTENNAS

All you need to know about TV antennas—describes all types, tells you how to select, how to install, how to solve troubles. Saves time; helps you earn more. 166 pages; illustrated; handy pocket size.  
Order TAG-1.....Only \$1.25

### THE RECORDING & REPRODUCTION OF SOUND

A complete, authoritative treatment of the entire subject, written by Oliver Read, editor of Radio News. Covers all phases of recording and amplification. 364 pages. 6 x 9", cloth binding.  
Order RR-1.....Only \$5.00



### 1948 RECORD CHANGER MANUAL

Covers 45 models made in 1948, including LP and dual-speed changers, plus leading wire recorders. Entirely original data based on actual analysis of the equipment. Over 400 pages; de luxe bound, 8½ x 11".  
Order CM-2.....Only \$6.75

### AUTO RADIO MANUAL

Complete PHOTOFACT Service data on more than 100 post-war auto radio models. Complete, accurate, uniform information. Makes auto radio servicing easier and more profitable. Over 350 pages. Sturdy binding, 8½ x 11".  
Order AR-1.....Only \$4.95

### NEW! DIAL CORD STRINGING GUIDE

New Volume 2, covering receivers produced from 1947 through 1949. The only book that shows you the one right way to string a dial cord in thousands of receivers. Handy pocket size.  
Order DC-2.....Only \$1.00

## HOWARD W. SAMS & CO., INC.

Order from your Parts Jobber Today, or write direct to HOWARD W. SAMS & CO., INC., 2201 E. 46th St., Indianapolis 5, Ind.

My (check) (money order) for \$.....enclosed. Send the following books:

TV-1       RR-1       AR-1  
 TAG-1       CM-2       DC-2

Name .....

Address .....

City .....Zone.....State.....

### CHEVROLET RADIO 986240

Some of these sets are intermittent because of failure in the oscillator circuit. I have traced this fault to the oscillator coil. These coils are wound with wire covered with an almost invisible nylon insulation. In some cases the insulation is not sufficiently removed to permit a well-soldered connection at the coil terminals. Unsolder the leads, carefully clean them, and resolder.—*Frederick Roser*

### HALLICRAFTERS S-38

If the cabinet is hot enough to give a nasty shock even when the set is turned off, look for a direct contact between the chassis and cabinet, which are insulated from each other by two rubber grommets and screws at the bottom. Loosening the screws sometimes removes the short and clears up the trouble.

If the line polarity makes the chassis hot, the cabinet will also be hot because of the 0.25- $\mu$ f capacitor C-36 between them. Remove this capacitor and connect the cabinet to a good external ground.—*P. T. Narasimhan*

(It is advisable to connect a 1-ampere fuse in each side of the a.c. line to protect the set in the event of a short circuit between the chassis and the grounded cabinet.—*Editor*)

### CROSLEY 9-403 and 9-413

When tube replacement and horizontal discriminator alignment do not cure intermittent horizontal tear-out, try replacing the 120- $\mu$ f coupling capacitor C-60 between the sync separator and horizontal oscillator. This capacitor may check good on a bridge and still break down in the circuit. This trouble is hard to locate because all voltages are normal.—*Ralph E. Hahn*

### PHILCO 48-1000 and 48-1001

If these sets break down in the high-voltage section, check the lead between the plate cap of the 6BG6-G and the terminal board. If the lead is too near the metal shield of the high-voltage compartment, current will arc through the insulation to ground. Replace the lead and dress it away from the shield. Check the 6BG6-G because it is likely to have shorted if the set was left on too long after the arc-over occurred.—*Harry Ashby*

### RCA MODEL 6T5

This set and a number of other pre-war models have terminal boards on the rear of the chassis for connecting phono pickups. These terminal boards have a link or jumper which must be removed when playing records. Many users fail to tighten the screws with a screwdriver when replacing the link. When the link gets dirty and corrodes, the high-resistance contact causes intermittent fading and blaring.

Cleaning the link and screws will effect a temporary cure. I prevent this trouble by installing a small s.p.s.t. switch across the terminals and throwing the link away.—*Joseph Domankos, Jr.*

## Technical Bulletins

EACH \$1.00 Postpaid Foreign \$1.25

Simplified technical information on many subjects of everyday usefulness, written in simple, easy-to-understand language. They contain no complicated mathematics, chemical and electrical theories, and are not based on the assumption that the reader has had a technical training.

(102) **Cleaning Products for Many Purposes**—Over 35 effective chemical cleaners that you can make and sell.

(110) **Electroplating Non-Metallic Objects**—Includes wood, leather, plaster, glass, flowers, insects, fabrics. Complete directions.

(114) **Thermostats Easily Made**—Designing and making automatic control units of many types for maintaining uniform temperatures, automatic furnace regulation, safety controls to prevent overheating, etc.

(115) **Glue Molds for Casting Novelties**—Making flexible glue molds for casting small objects, using plastics, magnesite.

(119) **Electroplating with Alloys**—Bronze, brass and cadmium-silver. Improves finish and provides durable coating.

(123) **Mirror Silvering**—Make money resilvering old mirrors and making new ones. Colored, front-surface, transparent and photo mirrors.

(124) **Soldering All Metals**—Includes aluminum and die-cast alloys. Secrets of using the right flux and correct technique.

(125) **Buffing & Polishing**—All details on correct polishing. How to select the right abrasive for different kinds of metal. Gives wheel speeds, types and sizes of motors for best results.

(129) **Coloring Metals Chemically**—Tested formulas and directions to produce durable finishes in many colors on brass, copper, iron, aluminum and their alloys by chemical processes.

(130) **Glass-Working Technique**—How to cut, drill, grind and mount glass correctly; includes cutting of circles and internal openings.

(132) **Working with Plastics**—Covers all details of cutting, tooling, bending, cementing and polishing. Enumerates various kinds. Shows how to design articles. Includes using liquid plastics.

(139) **Rubber Molds for Casting Novelties**—Used for same purpose as glue molds but where greater elasticity is required.

(141) **Recording Thermometer**—How to make device to record room temperatures over 12-hour periods on a disk. Has alarm-clock mechanism.

(146) **Simplified Casting Methods**—Making small castings of soft metals without use of sand molds. For novelties, toys, etc.

(147) **Drills and How to Use Them**—How to use drills in different metals, plastics and other materials. How to sharpen correctly. Includes charts giving speeds and rate of drilling.

(149) **Electroplating with Copper, Nickel, Chromium, Zinc, Lead and Cadmium**—Enables anyone to do this fascinating work on a small scale.

(156) **Home-Maintenance Formulas & Repairs**—Includes a large number of simple, effective solutions for everyday household problems.

## TECHNIFAX, 110 N. Franklin St. Chicago, Ill.

Enclosed find \$..... for which send the following Technical Bulletin at \$1.00 each (Foreign \$1.25) as indicated by numbers:

.....  
.....  
.....

Name .....

Address .....

City & State .....

RE-3

**POSTWAR PHILCO COMBINATIONS**

Some of these sets have a voltage doubler which is connected so there is a high potential difference between the heater and cathode of the 7C6 detector and first a.f. amplifier. A heater-to-cathode short in this tube will cause the rectifier tube to burn out. One set had an intermittent short in the 7C6, and we burned out two rectifiers before we spotted the trouble.—*DeLoss Tanner*

**RCA MODEL Q-10**

If this set motorboats at low frequencies, try replacing the 12SA7. Some of these tubes will cause motorboating in some sets, even though they may work perfectly in others and check good on a tube tester.—*Migues Vega Vazquez*

**ZENITH 4G800**

Low volume and severe distortion may be caused by low screen-grid voltage on the 1S5. The 4.7-megohm screen dropping resistor has been found to have a much higher value in several of these sets. Replace it with a high-quality 4.7-megohm resistor.—*Andrew Pidog, Jr.*

**TRUETONE AUTO RADIO—D4842**

Several cases of intermittents in this model have been cured by replacing the 10,000-ohm resistor R3 in the plate circuit of the 6BA6 r.f. amplifier. If this resistor is intermittent, it is likely to check good on a meter; replace it and save time if the trouble seems to be in this part of the circuit.—*Sidney S. Goodkin*

**TRIPLE YOUR TV SALES!**

**TENNA-TRAILER SAVES TIME AND MONEY IN "ON THE SPOT" ONE MAN INSTALLATIONS**

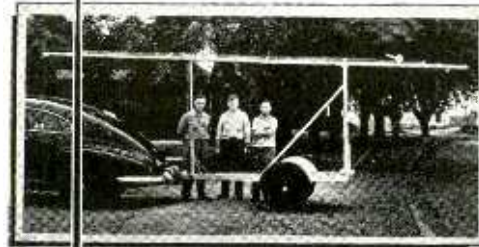

The new Price Tenna-Trailer will put you way out front of your competition. It enables you to quickly raise a 51 foot mast. One man can set the versatile unit in position, crank up telescoping mast, rotate for best signal — all in a matter of minutes. You'll be thrilled with its ingenious, sturdy construction!

**MAST AVAILABLE SEPARATELY**

With adaptor kit, Tenna-Trailer Mast becomes versatile means for permanent rotatable TV installations on ground or side of house.

Trailer is ruggedly constructed of steel, tires are excellent retreads. Standard trailer coupler with ball included. Unit trails easily, stands rigid in highest winds, yet is the lowest price portable mast in the field!

Write for illustrated folder for full details. Don't delay. You, too, can get the jump on your competition with the Price Tenna-Trailer.

**Complete, Trailer with Mast, Net .....\$225.00**  
**Mast Only, List.....\$99.50**

**PRICE TENNA-TRAILER CO.**  
**WATSEKA, ILLINOIS**

**BIG MONEY IN RADIO and TELEVISION NOW!**

See **COYNE'S Brand New 5 Volume Set "APPLIED PRACTICAL RADIO-TELEVISION" FREE!**

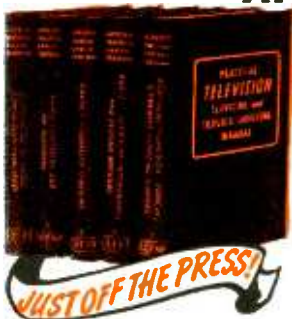

Here is a BRAND NEW Set of books written for men who want to "go places" in TELEVISION and RADIO . . . men who know how much a PRACTICAL working knowledge helps to get the BIG MONEY. Over 1500 pages, 5000 subjects of the latest Radio and Television "know how" . . . easy to understand with hundreds of crystal-clear illustrations. It's ALL here! EVEN COLOR TELEVISION AND UHF. How to install, service, align, balance ALL radio and TV sets . . . how to use new and old testing instruments for TV service . . . latest data on adapters, converters and more, more, MORE. You name it and COYNE'S GOT IT, in this amazing new money-making 5-Volume Radio-Television Library.

**Color Television Is Here!**

Set contains most complete section ever published on Color Television and UHF, adapters and converters. FULLY ILLUSTRATED AND PRINTED IN 4 COLORS.

**PRACTICAL!  
 CLEAR!  
 COMPLETE!**

5 fact-packed volumes — 1000 illustrations and diagrams with step-by-step photographs which "break down" the equipment to show what makes it "tick". Up-to-the-minute, complete, easy to follow.

**Act Now and Get FREE Book**

Now you can see these new Coyne books for 7 days without cost and get Coyne's book of 150 Radio and Television Diagrams FREE. It's free just for examining the new 5-Volume Set. Full details of this sensational Coyne "prove it" offer are given below. Mail the coupon at once.

**SEND COUPON—SEE SET FREE FOR 7 DAYS**

You must SEE these new books to know how easy it is to prepare for the big jobs in radio and television. Here's our special offer:—we'll send the complete 5-volume set for your 7-Day FREE Examination. And with it, we'll include our valuable, new guide for all radiomen, "150 New Radio-Television Diagrams Explained", absolutely FREE! If you keep the 5-volume Set all you pay is \$3.00 within 7 days after the books arrive and \$3.00 per month until \$16.50 is paid—or you can pay \$15.00 cash price. If you don't want the set, return it and you OWE NOTHING. But either way you keep "The Radio and Television Diagrams Book" as a gift. That book is ABSOLUTELY FREE.

**SEND NO MONEY** Coupon is just a request to see Set free and get FREE BOOK. Offer limited—act now.

**COYNE Electrical and Radio-Television School**  
 Dept. 30-T1, 500 S. Paulina St., Chicago 12, Ill.

**Mail This Coupon NOW**

Educational Book Publishing Division  
 COYNE ELECTRICAL & RADIO-TELEVISION SCHOOL  
 Dept. 30-T1, 500 S. Paulina St., Chicago 12, Ill.

O.K. Send me postpaid, your new 5-volume set, "Applied Practical Radio-Television", on 7 days Free Trial per your offer. Be sure to include as a gift the book of 150 Radio-Television Diagrams absolutely FREE.

NAME \_\_\_\_\_ Age \_\_\_\_\_

ADDRESS \_\_\_\_\_

TOWN \_\_\_\_\_ ZONE \_\_\_\_\_ STATE \_\_\_\_\_

Where employed \_\_\_\_\_



**AC-DC MULTITESTER**

MODEL 447A

**\$17.95**

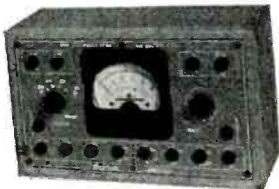

These units are in a class with other makes of testers that sell for considerably more. A 3" square D'Arsonval meter is used, having an accuracy of 2%. Ring type shunt circuits are employed. Accuracy of AC voltage measurements are kept to closer tolerance by use of a new gold plated copper oxide rectifier with excellent current density characteristics.

**RANGES**

DC Voltmeter: 0-5-50-250-500-2500 Volts at 1000 Ohm per Volt.  
 AC Voltmeter: 0-10-100-500-1000 Volts.  
 Output Voltmeter: 0-10-100-500-1000 Volts.  
 DC Milliammeter: 0-1-10-100-1000 MA.  
 DC Ammeter: 0-1-10 Amperes.  
 Ohmmeter: 0-10-1000 Ohms—1 Megohm—10 Megohms Ext.  
 Decibel Meter: -8 to +55 decibels.  
 Model 447A—Open face instruments supplied in hardwood case. Size 5" x 8 1/2" x 3". Weight 21 oz. Complete with batteries, ready to operate.

**TUBE TESTER**



Model 322A

Only **\$37.95**

A tube tester downright easy to operate. This is one of the lowest priced tube testers anywhere. Yet it permits accurate checking of the widest variety of old or new tubes—equipped with the new sub-miniature tube socket.

**CHECK THESE FEATURES**

- This tube tester has provisions for checking individual sections of multi-purpose tubes as well as miniature and subminiature receiving tubes.
- Closer tolerances are easily obtained due to special Alnico A.C. meter and extremely low test circuit voltage drop.
- Convenient jack is provided for head-phone noise test to check noisy swinging, or high resistance internal tube connections.
- Neon lamp for rapid short and leakage tests between elements.
- Compact, sturdy construction.
- Operates on 100-130 volt, 50/60 cycle A.C. power supply. Open-face in new hammertone grey finish steel cabinet with sloping panel. Size 5 3/4" x 12 1/2" x 8". Weight: 11 lbs.

Send for Bulletin No. 3RE  
 BUY IT AT YOUR LOCAL DEALER

**RADIO CITY PRODUCTS CO., INC.**

152 West 25th St. New York 1, N. Y.

**WRINKLE FINISHES**

Although the wrinkle-finish enamel used on radio equipment is extremely durable, it will gradually chip, scuff, and wear thin under hard usage. A good way of restoring the original finish is to brush over the scuffed surface with a quick-drying lacquer of the same color. Use a minimum of lacquer on the brush, brush hard, and spread the lacquer as thinly as possible. This thin layer of lacquer will preserve the wrinkle finish and restore the original appearance or something very near it.

—Henry Zave

**SOLDERING HINTS**

If you are annoyed by stray drops of solder sticking to a chassis which you are wiring, try rubbing the areas likely to be so damaged with a wax crayon or piece of candle before starting.

If, on the other hand, you have trouble making rosin core solder stick to a chassis, try Kester or some other brand of aluminum solder.—John W. Winder

**OVERLOAD PROTECTION**

By installing an overload switch in series with the a.c. line to my workbench, I have saved many a.c.-d.c. sets from possible damage through short circuits to ground or test instruments. The switch I used was made for an Easy washing machine and can be purchased from appliance supply stores for a few dollars. It breaks the power as soon as the overload occurs. Power is restored by merely throwing the switch.—Don Tsuboi

**MAKING SPECIAL CONTROLS**

Nonstandard shafts have been used on volume and tone controls on a number of receivers. On some sets, the dial string runs around a pulley which is centered on the volume control shaft and held in place by retaining rings. On others, the control shaft may be turned to two diameters for operating an indicator or to fit a special knob. Such controls are annoying to service technicians, particularly when replacements for the control are no longer available.

Some types of control shafts can be turned down without a lathe. A breast drill is locked in a bench vise so its handle and chuck are free to turn. Put the control shaft in the chuck and tighten it. Turn the drill with one hand while the other holds a pair of gas pliers which are used as a cutting tool. The depth of the cut is regulated by the pressure on the pliers. If it is necessary to notch the shaft for a retaining ring, cutting pliers can be used for this purpose.

This type of turning is limited to the soft metals used for shafts on many controls. Precision turning cannot be done by this method, but it will serve when other tools are not available. The process does not harm the pliers because they are made of metal much harder than most control shafts.—Wilbur J. Hantz

**Leotone** FACTORY SPEAKER REPAIRS SINCE 1927

1 1/2 V. "A" BATTERIES (similar Ever. 712) 2 3/4" sq. x 4". Not currently dated, but PLENTY OF SERVICE LIFE!  
 Box of 5 (shpg. wt. 9 lbs.)..... **59c**

DPDT ANTI-CAPACITY SWITCH—ea. 39c. 3 for 1.00  
 SLIDE SWITCH S.P.D.T.—1 1/2". 3/4 A/125V. 15c  
 6 VOLT TELEGRAPH KEY & BUZZER (W.E.) 1.25  
 NEON BULBS NE-48 ..... ea. 19c. 10 for 1.75  
 HIGH FIDELITY CRYSTAL MICROPHONE. Sensitive diaphragm. Imped. 15. O.D.D. 1/2" (deep). Rubber shock-mtd. Less housing  
 Aluminum Housing for crystal mike ..... 15c  
**98c**

RADIO HARDWARE TREASURE. FULL POUND OF NUTS, SCREWS, WASHERS, LUGS, ETC. All in handy SELF-SEALING HINGED LID CAN. Shpg. wt. 2 lbs. **49c**

65-400 V. OIL CONDENSERS ..... ea. 10c. 12 for 1.00  
 MICRO-SWITCH ..... SPST ..... N.O. Pin type ea. 39c  
 SELECTOR SWITCH ..... 3 pt. D.P. 2 deck. 1/4" shaft. .... ea. 39c  
 1/2" PILOT ASSEMBLY. Red faceted Jewel. Plated. With 28V. min. bay. bulb. .... ea. 29c. 4 for 1.00  
 STEEL MAST SECTIONS ..... MS-53, screw together to any length. .... ea. 39c. 3 for 1.00

MORE RADIO PARTS FOR LESS!!! LEO-TONE'S "JUMBO RADIO PARTS KIT" 17 FULL POUNDS of choice new & dismantled Radio & Electronic components: COILS, TRANSFORMERS, RESISTORS, CONDENSERS, WIRE, HARDWARE, SPEAKER ACCESSORIES, ETC. All these (shpg. wt. 21 lbs.) and MUCH, MUCH MORE for only **2.95**

**SERVICERS' BARGAIN KITS!!**

R.F. ANT. & OSC. COILS Kit of 10 asstd. .... .98  
 MOULDED BAKELITE CONDENSERS (Mica-mold) 00001 to 2 mfd. 200-600VV. Kit of 50 asstd. .... 2.49  
 DIAL SCALES, Airplane & slide-rule. Acetate & glass. Kit of 25 asstd. .... 2.49  
 KNOBS ..... Wood & bakelite. Spring, setscrew & push-button. Kit of 25 asstd. .... .98  
 WAFER SOCKETS ..... 4 to 8 prong. Kit of 12 ..... .25  
 MICA PADDERS & TRIMMERS (incl. ceramic). Kit of 15 ..... .69  
 WIRE-WOUND RESISTORS ..... 5 to 20 watt. Kit of 15 ..... .98  
 MIN. ORDER \$2.00 20% Deposit Req. on all COD's  
 Please add sufficient postage—excess refunded.  
 Full remittance of foreign orders.

**LEOTONE** RADIO CO. 67 Dey Street, New York 7, N. Y.

**HIGH FIDELITY ENTHUSIASTS**

Have you sent for literature on the revolutionary development in amplifier design that can be used with any input device, past, present or future—and is guaranteed against obsolescence FOR LIFE? Also features ABSOLUTE FIDELITY\* circuit! New noise suppressor! Volume expander! Designed by A. C. Shaney, of course. Write today for full specifications on ACA-100-VV (Double "V" for Very Versatile). \*Trade Mark Registered

**AMPLIFIER CORP. OF AMERICA**

398-10 Broadway New York 13, N. Y.

SEE RADIO-ELECTRONICS

AT THE

**NEW YORK IRE SHOW**

March 6-9

Booth K

**GREYLOCK RADIO TUBE BARGAINS!**

GT. Glass and Miniature Types  

1A4P	1U5	6BA6	6SQ7GT
1A6	3A4	6BA7	6U7G
1CG	3Q	6BE6	6V6GT
1F4	3V4	6BM6	6X4
1R5	6AG5	6CSGT	6X5GT
1SE	6A05	6J6	12AB6
1T4	6AT6	6K6GT	12A6
1U4	6AU6	6SK7GT	12AT6

**\$3295** per 100 asstd.

Also available in smaller quantities at 39c each.



**SPEAKER SPECIALS!**

3", 4", or 5" PM. less output. Alnico 5, each ..... .97c  
 In cartons of 30, each ..... .87c  
 8" x 9" Oval PM. Alnico 5, 3.16 oz. magnet, each ..... \$2.50  
 In cartons of 24, each ..... \$2.39

TERMS: Net C.O.D., F.O.B. NYC.

MINIMUM ORDER \$10.00.

Write for terrific CR tube prices and Bargain Catalog C-3

**Greylock Electronics Supply Co.**  
 30 Church Street New York 7, N. Y.

RADIO-ELECTRONICS for

**QUICK TEST FOR AUTO SETS**

The vibrator transformer of a battery-operated receiver or amplifier can be checked quickly and simply with a 6.3-volt filament transformer and an a.c. voltmeter. Remove the vibrator and plug the filament leads into the correct holes on the vibrator socket. Measure the voltage between ground and each plate pin on the rectifier socket. The voltage should be equal between each plate pin and ground; however, some transformers work satisfactorily with a 15-20-volt variation across the halves of the secondary.—C. F. Beard

**NOVEL DEMAGNETIZER**

Watches, small tools, and small pieces of ferrous metal can be demagnetized with a Weller soldering iron. Plug in the iron, hold it near the item to be demagnetized, and pull the trigger. The field around the tip is strong enough to do the job very effectively.—Frank E. Palcek

**STANDOFF INSULATORS**

Those red plastic towel-rod brackets that sell in dime stores at two for a nickel make fine standoff insulators and mounting brackets for coils and capacitors in ham transmitters.

Fig. 1 shows a bracket as it comes from the store. Saw off the cup and file the top of the post smooth with a fine file. As shown in Fig. 2, the end

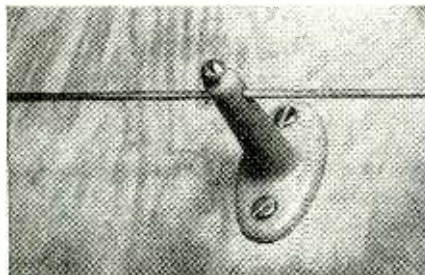

Screw in top holds wire or bus firmly.

of the post is bored with an undersize drill to a depth of about 3/8 inch, and a 6-32 by 1/2-inch round-head brass machine screw is twisted into the hole, threading the hole as it goes in. Now back up the screw and bore a 3/16-inch hole through the post at right angles to the screw hole.

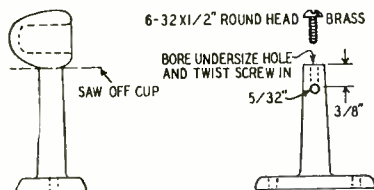

Fig. 1 (left)—Insulator comes with cup at top to take towel rod. Begin conversion by sawing off cup as indicated. Fig. 2 (right)—Twist a half-inch screw into a slightly undersized hole bored in the top; then bore a transverse hole to pass the wire through the new insulator.

In use, the wire is passed through the hole and held fast by the setscrew, or, if you wish, place a washer under the head of the screw and use the unit as a conventional standoff insulator.—Arthur Trauffer

MARCH, 1950

**\* 630 TV PARTS...TOP QUALITY...LOW PRICES**

**FOR KIT BUILDERS, REPLACEMENTS AND EXPERIMENTERS**

The following television parts list comprises all the components needed to build the famous #630 television chassis plus added features. PRICES UNLESS MARKED PER SET ARE PER ITEM. Parentheses indicate amounts of parts needed in lots of two or over. THE PRICES SPEAK FOR THEMSELVES

RCA FRONT END TUNER, complete w/ tubes	\$26.67
STANDARD TURRET TUNER, com. w/tubes	26.67
ESCUTCHEON PLATE, for either tuner	.69
COMPLETE SET OF KNOBS, w/ decals	.98
POWER TRANSFORMER, 295ma, 201T6	9.97
VERTICAL OUTPUT TRANS. 204T2	2.69
VERTICAL BLOCKING TRANS. 208T2	1.32
HORIZONTAL OUTPUT TRANS. 211T1	1.95
HORIZONTAL OUTPUT TRANS. 211T3	2.49
HORIZONTAL OUTPUT TRANS. 211T5	3.69
FOCUS COIL, 247 ohms, 201D2	2.29
FOCUS COIL, 470 ohms, 202D2	3.42
DEFLECTION YOKE, 201D1	2.97
DEFLECTION YOKE, 70° deflection, 206D1	3.98
SOUND DISCRIMINATOR TRANS. 203K1	1.12
1st PIX I.F. TRANSFORMER, 202K2	1.08
2nd PIX I.F. TRANSFORMER, 202K3	1.08
1st & 2nd SOUND I.F. TRANS. (2) 201K1	1.02
HORIZONTAL DISCRIM. TRANS. 208T8	1.49
FILTER CHOKE, 62 ohms	1.47
CATHODE TRAP COIL, 202K4	1.08
WIDTH CONTROL COIL, 201R1	.44
WIDTH CONTROL COIL, 201R4	.48
HORIZONTAL LINEARITY COIL, 201R3	.39
HORIZONTAL LINEARITY COIL, 201R5	.49
3rd & 4th PIX COILS, (2) 202L1	ea. .39
FILAMENT CHOKES, (5) 204L1	ea. .09
VIDEO PEAKING COIL, 203L1	.18
VIDEO PEAKING COIL, 203L2	.18
VIDEO PEAKING COILS, (2) 203L3	ea. .18
VIDEO PEAKING COILS, (2) 203L4	ea. .18
ION TRAP BEAM BENDER, 203D1	.79
ION TRAP BEAM BENDER, 203D3	.98

PUNCHED CHASSIS PAM, cadmium plated	\$4.87
HI VOLTAGE CAGE ASSEMBLY, complete	3.73
VOLT. DIVIDER SHIELD & COVER	1.79
ELECTROLYTIC COND. SUB-CHASSIS	.94
SPEAKER MOUNTING BRACKET	.59
DEFLECTION YOKE BRACKET	.29
DEFLECTION YOKE MOUNTING HOOD	.59
FOCUS COIL BRACKETS	per set .49
CATHODE TRAP COIL SHIELD	.39
CHASSIS MOUNTING BRACKETS	per set .44
HOLD CONTROL BRACKET	.59
SOUND DISCRIM. TRANS. SHIELD	.19
WIDTH CONTROL BRACKET	.39
630-KIT, screws, nuts, rivets, washers	1.69
TERMINAL STRIPS, 4-LUG	set of 11 .48
TERMINAL STRIPS, 3-LUG	set of 2 .08
TERMINAL STRIPS, 2-LUG	set of 2 .06
TERMINAL STRIP, 1-LUG	.02
ANTENNA TERMINAL STRIP	.19
3-SCREW TERMINAL STRIP	.19
CORONA TERMINALS	set of 2 .09
CORONA RING	.16
TUNER SHIELD	.22
TUBE SHIELDS	set of 2 .14
SPRING CLIPS, for tube shields	set of 2 .08
MINIATURE WAFER SOCKETS (10)	ea. .07
MINIATURE MOLDED SOCKETS (2)	ea. .12
OCTAL WAFER SOCKETS (13)	ea. .07
CATHODE RAY TUBE SOCKET	.39
H. V. RECT. SOCKET ASSEMBLY	.79
H. V. KINESCOPE LEAD, with clip	.39
TV 6' LINE CORD, w/ bch safety plugs	.29
SAFETY MALE CONNECTOR, for AC input	.19
OVAL PM SPEAKER, 5" 7"	2.97
12" PM SPEAKER, heavy Alnico #5 magnet	5.63
AUDIO OUTPUT TRANSFORMER (6K6)	.69
12 1/2" CRT MOUNTING BRACKET SET	1.98
16" CRT MOUNTING BRACKET SET	2.92
PLASTIC SLEEVE, for insulating 16" CRT	1.88
PLASTIC RING, for insulating rim 16" CRT	1.97

**VOLTAGE DOUBLER PARTS**

LUCITE SUB-CHASSIS, formed & drilled	3.94
3 - 20K H.V. FILTER CONDENSERS	set 2.22
2 - LOW LOSS MOLDED SOCKETS	set .32
7 - SPECIAL RESISTORS	set .59
2 - SPRING CONNECTORS	set .09

(Add the doubler system to the standard 630 circuit with these parts plus the 16" bracket kit, the plastic sleeve and ring a 1B3 and 211T5. Easy to follow instructions included)

**VOLUME CONTROLS**

PICTURE & SOUND, 10K ohms 1 meg. & switch	1.14
VERTICAL & HORIZ. 50K ohms 1 meg.	1.04
BRIGHTNESS CONTROL, 50K ohms	.44
HORIZ. CENTERING, wirewound, 20 ohms	.96
HEIGHT CONTROL, 2.5 megohm	.48
VERTICAL LINEARITY, 5000 ohms	.44
VERTICAL CENTERING, wirewound, 20 ohms	.96
FOCUS CONTROL, wirewound, 1500 ohms	.98
HORIZONTAL DRIVE, 20K ohms	.44

**MICA CONDENSERS—85° C OPERATION**

270 MMFD—500 W.V. (7)	.12
390 MMFD—500 W.V.	.12
470 MMFD—500 W.V.	.12
680 MMFD—500 W.V.	.16
4700MMFD—500 W.V.	.29
500 MMFD—10K W.V. H.V.—FILTER COND.	.59

**ELECTROLYTIC CONDENSERS—85° C**

40-10-80MFD — 450-450-150 VOLTS	1.37
40-40-10MFD — 450-450-450 VOLTS	1.49
80-50MFD — 450-50 VOLTS	1.49
40-10-10MFD — 450-450-350 VOLTS	1.37
20-80MFD — 450-350 VOLTS	1.49
250-1000MFD — 10-6 VOLTS	.98

**TUBULAR CONDENSERS—85° C**

.002 —600V	.09	.005 —400V (3)	ea. .07
.0025 —600V (2)	.09	.01 —400V (5)	ea. .09
.004 —600V	.11	.015 —400V (2)	ea. .11
.005 —600V	.11	.05 —400V (5)	ea. .12
.01 —600V (2)	.12	.1 —400V (2)	ea. .14
.05 —600V (6)	.15	.001 —1000V	.14
.1 —600V	.17	.004 —1000V (2)	ea. .14
.25 —400V (2)	.21	.035 —1000V	.18
		.05 —1000V	.18

**GERMIC TUBULAR CONDENSERS**

10 MMFD, 10% Tolerance	.12
51 MMFD, 10% Tolerance	.12
56 MMFD, 10% Tolerance	.12
82 MMFD, 10% Tolerance (2)	.12
1200 MMFD, not less than rated capacity	.12
1500 MMFD, not less than rated capacity (2)	ea. .12
6800 MMFD, not less than rated capacity	.12

**WIREWOUND RESISTORS**

5000 ohms, 5 watts	.22
VOLTAGE DIVIDER, 1360/250 ohms, 17/10 w	.74
VOLT. DIVIDER, 5300/2-500 ohms, 20/2/2 w	.89
VOLT. DIVIDER, 6750/12/93 ohms, 3.2/1/2/4 w	.72

**CARBON RESISTORS**

1/2 WATT, 5% TOLERANCE, 10, 150(5), 3900, 4700, 5600, 10K(2), 18K, 680K(2), 820K OHMS, 1.2 & 1.5 MEG	ea. .08
1/2 WATT, 10% TOLERANCE, 3.3, 39(3), 330, 560(3), 680, 1800, 2700(2), 3300, 4700, 6800(4), 8200(4), 10K(3), 22K, 27K(2), 47K, 56K, 100K(3), 150K, 270K, 470K(3) OHMS, 1(2), 22(2), 4.7, 6.8 MEG	ea. .06
1/2 WATT, 20% TOLERANCE, 100(2), 1000(9), 3300, 22K(3), 100K, 150K, 220K(2), 330K, 470K(3), 1(3), 10 MEG	ea. .04
1 WATT, 5% TOLERANCE, 2.2, 39K, 47K OHMS	ea. .12
1 WATT, 10% TOLERANCE, 1800, 3300, 4700(2), 10K(2), 18K, 22K, 27K, 39K OHMS, 1 MEG	ea. .09
1 WATT, 20% TOLERANCE, 10K OHMS	ea. .07
2 WATT, 10% TOLERANCE, 100, 270 OHMS	ea. .14
2 WATT, 20% TOLERANCE, 2200(2)	ea. .10

**# 630 TV TUBES—STANDARD MAKES**

6J6	R.F. Amplifier	.69
6J6	R.F. Oscillator	.69
6J6	Converter	.69
6BA6 (2)	1st and 2nd Sound I.F.	ea. .78
6AU6	3rd Sound I.F.	.69
6AL5	Sound Discriminator	.69
6AT6	1st A.F. Amplifier	.69
6K6GT	Audio Output	.59
6AG5 (4)	1st, 2nd, 3rd, 4th Pix I.F.	ea. .59
6AL5	Pix. Det. & DC restorer	.69
6AU6	1st Video Amplifier	.78
6K6GT	2nd Video Amplifier	.59
6SK7	1st Sync. Amplifier	.49
6SH7	Sync. Separator	.29
6SN7	2nd Sync. Amp. & Hor. Dis	.69
6J5	Vert. sweep osc. dis.	.49
6K6GT	Vertical sweep output	.59
6AL5	Hor. Sync. Discriminator	.69
6K6GT	Hor. Sweep Oscillator	.59
6AC7	Hor. Sweep Osc. Control	.79
6BG6	Horizontal Sweep Output	1.59
5V4G	Reaction scanning	.98
1B3/8016	High Voltage Rectifier	1.39
5U4G (2)	Power Supply Rectifier	ea. .69
10BP4	10" Kinescope	19.97
12LP4	12 1/2" "	28.89
16AP4	16" " metal	44.89
16CP4	16" " glass	39.82
19AP4	19" " metal	82.97
19GP4	19" " glass	79.64
16XP4	16" " Rectangular	44.85

**BROOKS RADIO DISTRIBUTING CORP.**

80 VESEY ST. (Dept. A) NEW YORK 7, N. Y. COrtlandt 7-2359

WHERE TO BUY IT . . .

**WHOLESALE RADIO**

of Baltimore

**NEW LOW PRICE ON TECHMASTER BLUE RIBBON TELEVISION KIT!**

**With Keyed A. G. C.**

22 Tube Chassis

For 10" or 12" Kinescope

**\$119.95**

Complete with all tubes less kinescope

All parts mounted on chassis. Four-stage video IF-4 mc band width. Factory tested parts of finest make. Trouble free wiring diagrams permit wiring in a week end. Order now!

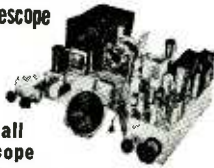

**SENSATIONAL NEW EICO 360-K KIT TV-FM SWEEP SIGNAL GENERATOR**

Crystal marker oscillator with variable amplitude. Covers all TV and FM alignment frequencies between 500 kc. and 228 mc. Sweep width variable from 0-30 mc. with mechanical inductive sweep. Extremely wide sweep-width allows gain comparison of adjacent RF TV channels. Provides for injection of external signal generator marker. Phasing control included. Large easy-to-read dial is directly calibrated in frequencies. Complete with all tubes—6X5GT, 12A U7, two 6C4's plus schematic and pictorial diagrams. Crystal not included.



**\$29.95**

**Sensational Antenna Buy! SNYDER HI-LO ARRAY**

Complete With Mast Sections Model TV 21



**\$5.95**

We don't believe you'll find a finer antenna anywhere near this low price. Two folded dipoles (High and Low) with reflectors. Complete with two 3/4 ft. mast sections, guy ring, stand-off insulators. Ready for easy, quick installation. \$5.75 in Lots of 8 or More.

**The New SUPERIOR TV-10 TUBE TESTER \$39.50**



Tests all tubes including 4,5,6,7, Octal, Lock-in, Peanut, Bantam, Hearing Aid, Thyatron, Miniaturs, Sub-Miniaturs, Novals, etc. Individual sockets for each type of tube. Tests by the well-established emission method. Operates on 105-130 volt 6 cycles AC. Built-in roll chart provides complete data for all tubes. Comes housed in a beautiful hand-rubbed oak cabinet complete with portable cover. Size 6" x 11 1/2" x 12". Shipping Weight 14 lbs.

cabinet complete with portable cover. Size 6" x 11 1/2" x 12". Shipping Weight 14 lbs.

**Assures Best Picture in Fringe Area Anchor All Channel T.V. Booster**

Increases Signal 2 1/2 Times

Covers all T.V. Channels, Simultaneous iron core tuning of grid and plate circuits. Uniform response on all channels. Impedance matching to input.

**\$22.50**



ROSS BOOSTER-SP4 . . . . . \$22.50

PEROLD BOOSTER-TV-FM with match-a-tran. 22.50

WRITE FOR FREE MONTHLY "FYI" BULLETIN ADDRESS ORDERS TO DEPT. QR 21 OR PHONE MULBERRY 2134

**WHOLESALE RADIO PARTS CO., Inc.**  
311 W. Baltimore St.  
**BALTIMORE 1, MD.**

**THYRATRON TRIGGER CIRCUIT**

When thyratrons such as 2050's, 2051's, and 2D21's are used to discharge capacitors in timing and trigger circuits, their cathode current sometimes exceeds manufacturer's specifications for the tube. This shortens the life of the tube and makes its operation erratic. Connecting two tubes in

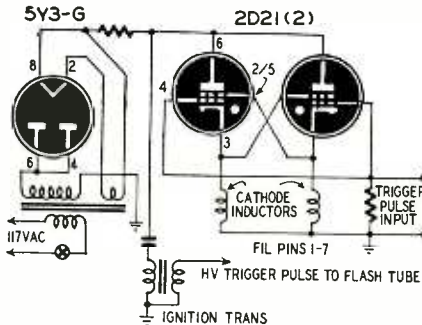

parallel does not ordinarily provide a solution to the problem because slight differences in tube characteristics will cause one to fire first, with the result that the anode voltage on the other will be lowered and it will not fire.

This circuit, described in *The Review of Scientific Instruments*, is designed to fire parallel-connected thyratrons simultaneously. The scheme, shown in the diagram, was used in an electronic photoflash circuit. The shield grid of each tube is connected to the cathode of the other. The plates and control grids are in parallel. Inductors consisting of 20 turns of No. 26 wire on a 1/2-inch form are connected in each cathode return circuit. When a trigger pulse is applied to the control grids, one tube may fire first. The rush of cathode current will develop a positive pulse across its inductor. This pulse, being applied to the shield grid of the remaining tube, will cause it to fire. The firing delay is very small.

**BATTERY OSCILLATOR**

Experimenters and service technicians are sometimes asked to convert an a.c.-d.c. receiver for dry-battery operation. Since most a.c.-d.c. sets use tapped oscillator coils, the installation of a filament-type oscillator tube may present no end of problems unless the coil is changed to the two-winding type.

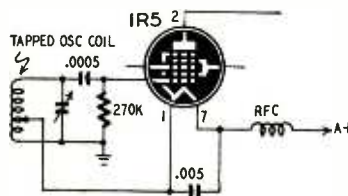

A method of using tapped oscillator coils with battery-type tubes was described in *The Radioman* (Delhi, India). The circuit shows the oscillator section of a 1R5. However, this circuit can be used with almost any battery-type oscillator tube. The positive side of the filament connects to A-plus through a low-resistance r.f. choke, and the negative side returns to ground

**NEW ODEGAARD ORIGINAL**

**NAIL POLYETHYLENE STANDOFF**

HIGHEST EFFICIENCY AT LOWEST COST!

for Ribbon or Coaxial Cable

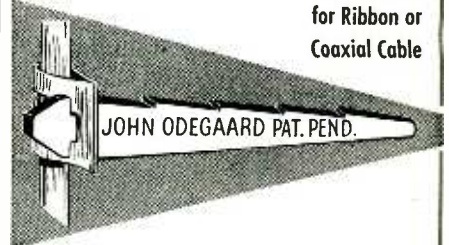

JOHN ODEGAARD PAT. PEND.

- Saves more labor, time and money than any other standoff!
- No drilling—just quick, easy hammer strokes
- Easily drives into wood, mortar, iron, aluminum, etc.
- Also excellent mast-coupler
- "Step"-locked, durable installation
- Cadmium-plated hardened high-carbon steel nail
- Specially punched lo-loss polyethylene

**SERVICEMEN:** For free sample and name of nearest distributor, write today to Dept. E.

**PARTS DISTRIBUTORS:** Choice protected territories still open. For full details write today to Dept. E.

**ODEGAARD MFG. CO.**

5416 Eighth Ave. Brooklyn 20, N. Y.

Copyright 1950, Odegaard Manufacturing Co.

**TELEVISION KITS**

FACTORY TO YOU - LOWEST PRICES!

10"-12 1/2"-16" Kit **\$84.50**  
Complete (Less Tubes)

Complete with All Tubes, Incl. C.R. Tube	
10" KIT	\$129.50
12 1/2" KIT	\$137.50
16" KIT	\$157.50

Any model wired up, tested, ready to play \$20.00 additional.

**MONEY BACK GUARANTEE FEATURING**

- AGC—Automatic Gain Control
- Picture and Sound Automatically Locked
- 12 Channel Tuner
- Electromagnetic Focus and Deflection
- Automatic Stabilized Synchro-Lock Circuit Holds Picture Steady

Money-Back Guarantee—Buy it, inspect it, if you don't think it's the best buy on the market—return unused within 5 days and your money will be refunded. All prices F.O.B. New York. 20% deposit with order. IMMEDIATE DELIVERY

**SOVEREIGN TELEVISION CO.**

5508 C New Utrecht Ave. Bklyn 19, N. Y.



**Every Seal You Buy HELPS**



or A-minus through the tap on the coil.

Although a 27,000-ohm grid resistor gives good results in most cases, other values may improve performance. The

capacitor across the filament may not be necessary in all circuits. The resistance of the r.f. choke should be not more than 2 or 3 ohms if excessive voltage drop is to be avoided.

**A NOVEL MILLIVOLTMETER**

A change as small as 1 mv in a 100-volt potential developed across a transformer winding or load resistor has been measured by this circuit. It can be used to measure the change in output of regulated power supplies when the load or line voltage is changed, and to show the effects of cathode temperature, grid bias, plate-supply voltage, and other factors on the output of an amplifier.

The measuring instrument consists of a peak-reading voltmeter with an adjustable bucking or compensating voltage. When properly adjusted, approximate peak values are read on a voltmeter across the compensating voltage, and precise voltage changes are read on a 100- $\mu$ a meter in series with the diode rectifier.

Close the switch to shunt the meter with the 10-ohm resistor; then connect the voltage to be measured across the input terminals on the instrument. Adjust the compensating voltage until the microammeter returns to zero. Open the switch and slowly adjust the compensating voltage until the meter reads approximately 10  $\mu$ a if you are expecting the voltage to rise, or to 50  $\mu$ a if you expect it to rise and fall while being metered. Approximate peak voltages are read on the voltmeter, and

fractions of a volt are indicated on the microammeter.

The microammeter must be calibrated for each setup because its accuracy depends on the internal resistance of the generator. Adjust the compensating voltage until the meter

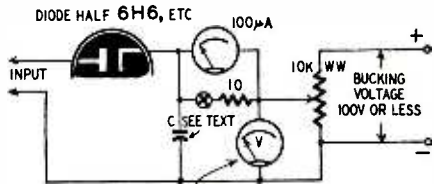

reads zero, then 100  $\mu$ a, noting the reading on the voltmeter for these two conditions. If the compensating voltage changes 0.2 volt as the current changes 100  $\mu$ a, each microampere represents .002 volt. The upper frequency limit depends on the wiring and rectifier capacitances and the lower on the size of capacitor C. When C is 1  $\mu$ f, the instrument will go down to approximately 10 cycles without too much loss in amplitude.

A germanium rectifier such as a 1N34 can be used in place of the diode, but the voltmeter will read approximately 20% low because of the low back-resistance of the germanium diode.—*Otto von Guericke*

**TELEVISION BOOSTER**

In this two-stage television booster, which works better than any other I have tried, the amplifiers and their tuned circuits are shielded from each other and coupled together through eight-turn coupling links.

The grid coils L2 and L6 are six turns of No. 18 enameled wire spaced

the diameter of the wire on  $\frac{3}{8}$ -inch, low-loss forms. Plate coils L3 and L7 have 19 turns of No. 18 enameled wire close-wound on  $\frac{3}{8}$ -inch forms. L1, L4, L5, and L8 are each eight turns of No. 30 s.c.c. close-wound over the ground ends of their respective tank coils.

Performance may be noticeably im-

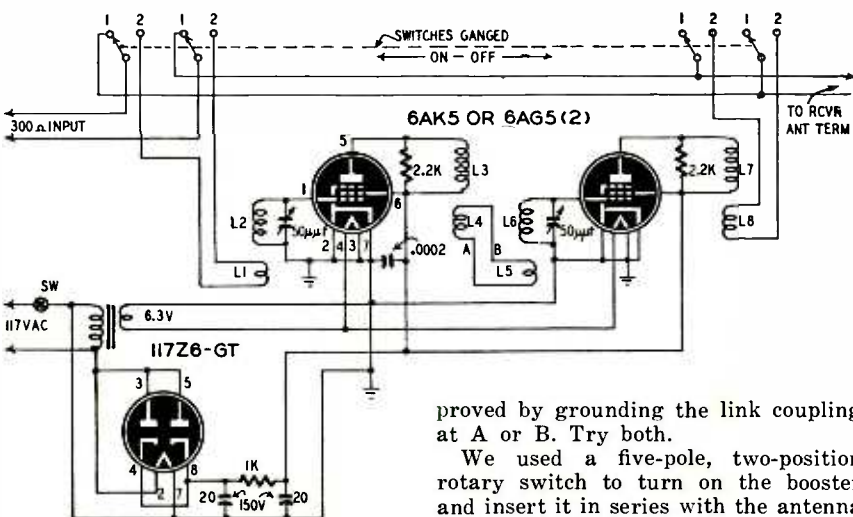

proved by grounding the link coupling at A or B. Try both.

We used a five-pole, two-position rotary switch to turn on the booster and insert it in series with the antenna lead-in.—*John Sager*

**Only SWEDGAL Can Offer These SENSATIONAL SAVINGS**

Fully Guaranteed **TUBES** At New Low Prices

All Brand New, Each in a Carton, For Immediate Delivery

SAVE MORE!

Order an assortment of 20 or more!!

Each 20 Asst.		Each 20 Asst.	
0Z4	57c	6S7GT	37c
1LN5	57c	6X5	37c
1R5	39c	12BA6	39c
1U4	37c	12SN7GT	37c
5Z3	49c	25L6GT	39c
5Z4	49c	25Z5	49c
6AG5	39c	35W4	37c
6AK5	39c	56	44c
6AL5	39c	76	37c
6AT6	37c	1625	39c
6BA6	37c	1632	44c
6BE6	37c	1642	44c
6CA	25c	205I	37c
6I6	37c	9002	39c
6K5	37c	9006	39c
6SA7GT	37c	VR90	54c
6SK7GT	37c	VR150	49c

**NEW! NEW! NEW! SPEAKERS**

First quality, fresh magnet, manufactured in 1950 by leading makers! Guaranteed perfect!

All Alnico V

	Ea.	Lots of 5
4" P.M. .68 oz.	\$.89	\$.85 ea.
4" P.M. 1 oz.	.99	.95 ea.
4" P.M. 1.47 oz.	1.05	.99 ea.
4" x 6" P.M. 1 oz.	1.49	1.39 ea.
5" P.M. .68 oz.	.89	.85 ea.
5" P.M. 1 oz.	.99	.95 ea.
5" P.M. 1.47 oz.	1.05	.95 ea.
6" P.M. 1 oz.	1.29	1.19 ea.
6" P.M. 1.47 oz.	1.39	1.29 ea.

**Automatic RECORD CHANGERS**

Changes automatically 12-10" and 10-12" records. Complete with crystal cartridge arm. AC, 110 V., 60 Cycle.

Latest SEEBURG Model "S" Only \$11.95 Complete  
WEBSTER Model 48 or 148 Only \$14.95 Complete  
WEBSTER Model 56 Reduced to \$16.45 Complete

**PINCH PENNIES ON**

7 ft. AC Line Cord with molded bakelite plug. 12c ea. Save! 10 for \$1.10  
6 ft. AC Line Cord with reinforced rubber plug. 14c ea. Save! 10 for \$1.25

**OUTPUT TRANSFORMERS**

3Q5 Output	34c ea.
50L6 Output	34c ea.
50L6 Push Pull Output	38c ea.
6V6 Output	38c ea.
6V6 Push Pull Output	49c ea.

**Precision Wound RADIO COILS**

Individually boxed, complete with easy wiring diagram

Medium Size 456 KC IF Transformer

Input..... 32c Output..... 32c

Also

175 and 262 KC. Output..... 32c ea.

Midget Iron Core 456 KC IF Transformer

Input..... 48c Output..... 48c

Astatic Nylon 1J FILTER CHOKE,  $\frac{3}{4}$ " Stack  
CRYSTAL CARTRIDGE 5 Henries @ 75 ma.  
\$2.25 49c

**COMPARE THESE SWEDGAL PRICES!**

CRYSTAL RADIO Pic-G-Graph Kit. Includes fully wound tuning slide-coil, crystal detector plus "cat's whisker." No Soldering. Complete with easy instruction sheet.....at only 88c

2" ROUND WESTON DC VOLTMETER. 0 to 600 and 0 to 15 DC Volts, 500 microamp movement. Order Now and Save!.....Only \$2.49

ANTENNA COIL covers from 535 to 1720 KC when used with a 365 mmfd tuning condenser. Perfect replacement for receiving sets.....25c  
RF Coil .25c Cathode Tap Oscillator Coil .19c

TO SPEED DELIVERY... Order Now! Minimum, \$2.50. For C.O.D. shipments enclose 25% deposit. Include adequate postage, excess will be returned. Orders without postage are sent express collect. All prices F.O.B., New York, N. Y.

WRITE TODAY for FREE listings of additional values that will save you many dollars!

Write to: Dept E-1

**Swedgal Radio, Inc.**  
96 Warren Street New York 7, N. Y.

# NOW! you can LEARN ELECTRIC MOTOR REPAIR

A good paying modern profession

...only \$5

## FOR THE COMPLETE TRAINING

Based on what can be learned quickly at home from this big **ELECTRIC MOTOR REPAIR** book, you can train for profitable installation, service, repair and complete rewinding of practically any electric motor. Every subject is clearly explained by text AND ALSO by more than 900 clear-cut illustrations. You not only read what to do. You actually SEE how to do it! Quick reference guides show how to handle specific jobs. When certain motors come in for repairs, just look them up. **ELECTRIC MOTOR REPAIR** tells what to do—and exactly how to do it.

## SPECIALIZE IN A FIELD THAT ISN'T CROWDED

Every day, more and more electric motors and control systems are being used in industry and home appliances. The expert who can install them and keep them working properly is a valuable man in this Electrical Age! **ELECTRIC MOTOR REPAIR** teaches you every step of the work—quickly and easily—at home—in spare time. Ideal for beginners or for bench use in busy shops. Thousands already in use in vocational schools, shops and, most important of all, for home study.



560 pages  
900 special illustrations . . .

**SHOWS HOW TO REPAIR MOTORS every step of the way**

The handiest reference book you've ever used!



ANSWERS TO 1,001 ELECTRICAL QUESTIONS . . . only \$2.50

## THE ELECTRICIANS' POCKET COMPANION

THE ELECTRICIANS' POCKET COMPANION handbook gives you a comprehensive selection of the important facts, figures and data modern electrical workers need to know about all sorts of jobs. It gives needed information based on the National Electrical Code and Underwriters' requirements. It covers the entire range of subjects from motors, meters and transformers to lighting, wiring, tools and equipment and literally hundreds of others. Contains hundreds of illustrations, charts, diagrams and data tables. The ideal book for easier, better and more profitable work on down-to-earth electrical jobs! Four different indexes give quick access to any needed fact. 442 pages, 4 1/2 x 7. Use coupon.

**ELECTRIC MOTOR REPAIR** is designed for use right at the bench. Unique Duo-Spiral Binding divides book into two sections so that both text and related pictures can be viewed together. An instructor standing by your side could hardly do better!

**EASY TO UNDERSTAND**  
It covers the entire motor field—including alternating—and direct-current motors and generators, etc., as well as mechanical, electrical and electronic control systems. Right down the line, it explains every detail of trouble diagnosing, repair, rewinding and maintenance in a way you can easily understand.

## FREE STUDY GUIDE

A big Study Guide of 500 practical motor study questions—sold separately for 25¢—is yours FREE with your request to examine **ELECTRIC MOTOR REPAIR** book. This is yours to keep, whether or not you decide to keep the book. Makes learning easier. Speeds up the work. Use coupon.

**PRACTICE FROM IT FOR 10 DAYS at our risk!**

## 10 DAY MONEY-BACK GUARANTEE

Dept. RE-30, Murray Hill Books, Inc., 232 Madison Ave., New York 16, N. Y.

Enclosed find \$..... for books checked; or  send C.O.D. (in U.S.A. only) for this amount and I will pay postman. If books are not satisfactory, it is understood I may return them in 10 days and you guarantee to refund my purchase price. (Cash only outside U.S.A., same return privilege.)

- ELECTRIC MOTOR REPAIR**, \$5 (\$5.50 outside U.S.A.) (Free Study Guide included)
- ELECTRICIANS' POCKET COMPANION**, \$2.50 (\$2.75 outside U.S.A.)

Name.....  
Address.....  
City, Zone, State.....

## Radio Thirty-Five Years Ago

In Gernsback Publications

### HUGO GERNSBACK

Founder

Modern Electrics.....	1908
Electrical Experimenter.....	1913
Radio News.....	1919
Science & Invention.....	1920
Television.....	1927
Radio-Craft.....	1929
Short-Wave Craft.....	1930
Television News.....	1931
Wireless Association of America.....	1938

Some of the larger libraries still have copies of **ELECTRICAL EXPERIMENTER** on file for interested readers.

## MARCH, 1916, ELECTRICAL EXPERIMENTER

The Future of Wireless, by Hugo Gernsback

The Tesla High Frequency Oscillator, by H. Winfield Secor

How to Organize and Conduct a Radio Club

New 500 Watt Military Radio Pack Set

New Electrolytic Interrupter Electrode

The Evolution of Wireless Telegraphy

The Use and Construction of a Decoder, by Milton B. Sleeper

How to Build a Photophone

Hook-up for Talking Wirelessly with Audion

## NEW TUBE DESIGNATIONS

RCA announces that dual type designations have been dropped from the 0A3/VR75, 0C3/VR105, and 0D3/VR150 voltage-regulator tubes, and the 6U5/6G5 electron-ray tube. They will henceforth be known as 0A3, 0C3, 0D3, and 6G5.

The VR numbers were easy to remember because they corresponded to the operating voltage of the regulator tubes. If you will remember that the letters A, B, C, and D correspond to operating voltages of 75, 90, 105, and 150, respectively, it will be easy to select the correct regulator tube.

## CORRECTIONS

There are an error and two omissions in the parts list for the video i.f. strip shown on page 35 of the January issue. Three .01- $\mu$ f capacitors are shown on the list; however, only one is needed in this part of the circuit. Add two .0001- and seven .001- $\mu$ f mica capacitors to the list.

Our thanks to Mr. Leo H. Wilkins for these corrections.

Alert reader Stephen Langenthal, of New York, N. Y., chides us for calling the 3" Pilot Candid TV (January 1950 page 44) an ac-dc. receiver instead of a transformerless receiver. He's right! There is a difference. All ac-dc. receivers are transformerless, but not all transformerless receivers are ac-dc. The Pilot Candid TV uses a pair of selenium rectifiers to supply positive and negative d.c. voltages. It is not designed for, nor can it be used on, the d.c. line.

There is an error in the table of sweep-generator characteristics on page 29 of the February issue. Mr. Harper Johnson, Jr. of Supreme, Inc., informs us that the Supreme model 675 sweep generator incorporates a separate crystal oscillator and has an external socket for marker crystals.

## 7 HARD TO GET ITEMS AT BIG SAVINGS TO YOU

### AMAZING BLACK LIGHT



250-watt ultra-violet light source. Makes fluorescent articles glow in the dark. Fits any lamp socket. For experimenting, entertaining, unusual lighting effects. Ship. wt. 2 lbs. ITEM NO. 87 **A SAVING AT \$1.95**

### LITTLE GIANT MAGNET

Lightweight 4 oz. ALNICO permanent magnet. 1 3/4" x 1 1/2". Lifts more than 20 TIMES ITS OWN WEIGHT! Ideal for hobbyists, experimenters. Shipping weight 3/4 lbs.



ITEM NO. 159 **BIG VALUE AT \$1.25**

### POWERFUL ALL PURPOSE MOTOR

Sturdy shaded pole A.C. induction motor. 15 watts, 3000 rpm, 3"x2"x1 3/4". 4 mounting studs; 3/8" shaft, 3/16" diameter; 110-120 volts. 50-60 cycles. A.C. only. When geared down, this unit can operate an 18" turntable with a 200 lb. dead weight. Use it for fans, displays, timers and many other practical purposes. Ship. wt. 2 lbs.

ITEM NO. 147 **UNUSUAL BUY \$1.95**

### WATTHOUR METER

Leading makes—completely overhauled, ready for service. 100-110 volts, 60 cycles, 2-wire A.C. Heavy metal case 8 1/2" x 6 1/4" x 5". Easy to install. Shipping weight 14 lbs.



ITEM NO. 33 **NOW ONLY \$4.45**

### WESTERN ELECTRIC BREAST MIKE

Lightweight 1 lb. carbon microphone. Aircraft type. Breastplate mounting, adjustable 2-way swivel. Easily fastened straps. For home broadcasts, communications etc. Complete with 6 foot cord, hard rubber plug. Sherardized plate, non-rusting finish. Ship. wt. 2 lbs.

ITEM NO. 152 **NEW LOW PRICE 95¢**

### TELEPHONE TRANSMITTERS

Genuine transmitters made by Kellogg, Western Electric, Stromberg Carlson. Work on two dry cells. For P.A. systems, intercoms, other practical uses. Shipping weight 1 lb.



ITEM 160 **REAL VALUE \$1.95**

### 250 POWER TELESCOPE LENS KIT

Make your own high powered 6 ft. telescope! Kit contains 3" diam., 75" focal length, ground and polished objective lens and necessary eye pieces. Magnifies 50x to 250x. Full instructions. Ship. wt. 1 lb. ITEM NO. 123 **YOU SAVE AT \$2.45**

**HUDSON SPECIALTIES CO.**  
40 West Broadway, Dept. RE-3-50,  
New York 7, N. Y.

I am enclosing full remittance for items circled below. Shipping charges included.  
OR, my deposit of \$..... MINIMUM C.O.D. ORDER \$5.00. Ship balance C.O.D.  
C.O.D. ORDERS ACCEPTED ONLY WITH 20% DEPOSIT INCLUDE SHIPPING CHARGES.  
Circle items wanted  
87 159 147 33 152 160 123  
Name..... Please Print Clearly  
Address.....  
City..... Zone..... State.....

RADIO-ELECTRONICS for

**ELECTRONIC LITERATURE**

Any or all of these catalogs, bulletins, and periodicals are available to you if you write to us on your letterhead (do not use postcards) and request them by number. It is necessary to send only the number of item you want. We will forward the request to the manufacturers, who in turn will send the literature directly to you. This offer void after six months.

**M-1—CONICAL TV ANTENNAS**

Two folders have been put out by Telrex. One describes their line of conical antennas and the other gives a technical explanation of their advantages.—*Gratis*

**M-2—TRANSFORMER CATALOG**

Catalog 1950-1 lists all transformers manufactured by Peerless. An insert on the special 20-20 line of high-quality audio units is included. The information is unusually complete, except that no prices are cited.—*Gratis*

**M-3—TV TRANSFORMER GUIDE**

A 20-page booklet, *Stancor Television Components Replacement Guide*, is now available to service technicians. It lists Stancor replacement transformers for 215 TV receivers and chassis made by 43 manufacturers. Both Stancor and the manufacturer's replacement parts numbers are listed.—*Gratis*

**M-4—METAL-TO-GLASS SEALS**

A folder containing specifications and illustrations of hermetically sealed terminals and gasket-type feed-through bushings is produced by Electrical Industries, Inc. These terminals and bushings are used on transformers, capacitors, crystals, and vacuum tubes.—*Gratis*

**M-5—BEACON ANTENNA BROCHURE**

A four-page brochure describes five new high-gain beacon antennas manufactured by The Workshop Associates, Inc. These vertical antennas are designed for use on the 144-152-, 152-162-, 162-174-, 450-460-, and 460-470-mc bands.—*Gratis*

**M-6—GEOPHYSICAL TRANSFORMERS**

Catalog No. GP-49, published by Triad Transformer Manufacturing Co., describes their line of Geofomers (transformers especially designed for use in geophysical exploration equipment).—*Gratis*

**M-7—TBA QUARTERLY REPORT**

A comprehensive summary of the television situation during July, August, and September, 1949, is given in Television Broadcasters Association's 40-page quarterly "Status of the Industry" report, which lists TV stations now in operation, network hookups, receiver specifications, receiver ownership figures, audience surveys, programming costs, and many other facts of interest to members of the industry.—*\$1.00 to Association nonmembers.*

MARCH, 1950

**"FAN MAIL"**  
for a Star Performer



2653 Int. 1, M. Nativida  
Manila, Philippines  
31 August, 1949

Gentlemen:

I am a user of a number of Turner Microphones and I know just the right mike for me. My job requires rugged performance because the Philippine climate is very rainy at times, then excessively humid, then hot . . . . If a wrong kind of microphone is used, it is very sure of not lasting long.

The Turner 99 solved for me the problem of the right microphone. I have a mike of this type which was caught several times in sudden showers and believe me, it is still excellent if not perfect. These microphones are the only types I can find suited to my requirements. I recommend Turner microphones for quality and the best performance.

Very truly yours,

TOMAS M. TAGULAO  
Co-Owner, Sterling "AA" Sound Systems

**TURNER  
MODEL 99**  
List Price  
**\$34.00**



Ask your dealer to show you the Turner 99  
*Write for Literature*



**THE TURNER COMPANY**

933 17th Street N. E., Cedar Rapids, Iowa

**IN CANADA:** Conodion Marconi Co., Ltd.  
Montreal, P. Q., and branches

**EXPORT:** Ad. Auriema  
89 Broad Street, New York 4, N. Y.

**Resistance and Capacitance Standards**

Mounted precision resistors 1, 10, 100, and 1000 ohms up to 1/20th of 1% accuracy. Mica capacitance standards .01 and .1 mfd up to 1/5th of 1% accuracy. Moderately priced so that every serious amateur, set builder and experimenter can now have his own basic precision laboratory standards. Write for circular RC-2.

The Greylin Co.—P.O. Box 258—Chicago 90, Ill.

**YORK RADIO & REFRIGERATION**  
265 W. MARKET ST.  
York, Pa.  
HAS THE SENSATIONAL NEW  
**EICO 221-K VTVM Kit**  
IN STOCK!  
\$23.95

**EASY TO LEARN CODE**

It is easy to learn or increase speed with an Instructograph Code Teacher. Affords the quickest and most practical method yet developed. For beginners or advanced students. Available tapes from beginner's alphabet to typical messages on all subjects. Speed range 5 to 40 WPM. Always ready—no QRM.

**ENDORSED BY THOUSANDS!**

The Instructograph Code Teacher literally takes the place of an operator-instructor and enables anyone to learn and master code without further assistance. Thousands of successful operators have "acquired the code" with the Instructograph System. Write today for convenient rental and purchase plans.



**INSTRUCTOGRAPH COMPANY**

4701 Sheridan Rd., Dept. RC, Chicago 40, Ill.

# For Greater Earnings... LEARN RADIO-ELECTRONICS

This fast-growing science of RADIO, TELEVISION, RADAR and ELECTRONICS, offers tremendous opportunities, and in no industry is RADIO-ELECTRONICS more important than in aviation. A skilled technician who *knows* the modern application of electronic devices, as used in the aircraft industry, is always in demand . . . not only in aviation, but in many other industries. Many large organizations call on Spartan regularly for graduates. Often, students are hired months before graduation.

Don't confuse the RADIO-ELECTRONICS course offered by SPARTAN with other courses, offered anywhere! As a graduate from this famous school you will know the application to industrial control devices; to the search for petroleum; and the important uses of radar, television and other electronic equipment.

SPARTAN offers two complete and thorough courses. You will work on the most modern and complete equipment. You will build equipment. You may join the SPARTAN "Ham" Club. Either course prepares you for Federal Communication Commission license tests — first class radio telephone, second class radio telegraph, or class "B" radio amateur.

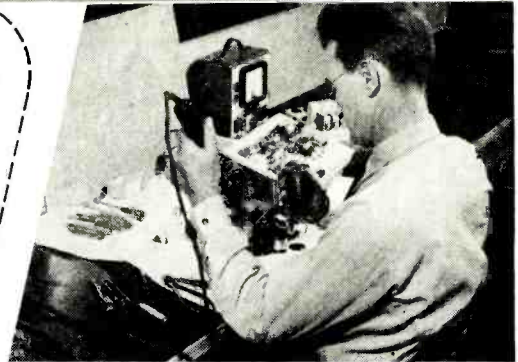

SPARTAN'S 21 years of teaching civilian and army personnel is your assurance of receiving the best possible training in the least possible time. You'll not need MORE than Spartan training — you cannot afford to take LESS.

## BIG CATALOG — Free

NAME \_\_\_\_\_ AGE \_\_\_\_\_

ADDRESS \_\_\_\_\_

CITY \_\_\_\_\_ STATE \_\_\_\_\_

Dept. RE-30

G. I. APPROVED — Write TODAY for Complete Information

## SPARTAN

SCHOOL OF RADIO AND ELECTRONICS

SCHOOL OF AERONAUTICS COLLEGE OF ENGINEERING  
MAXWELL W. BALFOUR, DIRECTOR ADDRESS DEPT. RE-30

TULSA, OKLAHOMA

**RCA** VOLTOHMYST  
ONLY **3950**  
AT TERMINAL

**SENSITIVE** — ideal for radio, TV and audio measurements of AVC, AFC and FM discriminator voltages!

**FULLY SHIELDED** — in metal case with enclosed battery power supply — ideal for accurate measurements in the powerful R.F. fields of transmitters!

**VERSATILE** — has polarity reversing switch, measures D.C. and A.C. volts, D.C. current and resistance!

**ACCURATE** — incorporates 1% tolerance precision resistors and 2% accuracy 4 1/2" meter in self-regulating, stable push-pull VTVM bridge circuit!

**SELF-CONTAINED** — completely independent of power line — use it anywhere! **LONG-LIFE BATTERIES** — last up to one year with normal use!

**RUGGED** — toughly made to withstand abnormal abuse, with electronic circuit-meter protected against burnout; unbreakable meter face!

**COMPACT** — size 9 1/2" high, 6 1/4" wide, 5 1/2" deep. Weighs 9 lbs., including batteries.

**It's Sensational!**  
RCA Battery Voltohmyst—vacuum tube voltmeter and volt-ohm-milliammeter combined — featuring self-contained long-life battery power supply!

The RCA WV-65A Voltohmyst is a highly accurate electronic voltmeter-ammeter-ohmmeter for laboratory and on-the-job testing! Supplied with 1-Meg. isolating shielded signal-tracing probe for measuring D.C. in presence of R.F.!

**RANGES**  
**D.C. VOLTS** — 0-3/10/30/100/300-1000 volts, input resistance 11 meg-ohms constant for all ranges  
**A.C. VOLTS** — 0/10/30/100/300/1000 volts @ 1000 ohms per volt

**RESISTANCE** — 0-1K/10K/100K/1 meg/10 meg/1000 megohms  
**D.C. CURRENT** — 0-3/10/30/100/300 milliamperes, 0-10 amperes

**RCA WV-65A Voltohmyst** complete with 1-Meg. D.C. dynamic test probe and test leads, less batteries **39.50**

**BATTERY KIT** — Two 45V and four 1 1/2V, factory-fresh! **2.58**

**WG-263** — RCA Crystal Probe, read R.F. voltages flat to 100 megacycles **8.95**

**WG-284** — RCA high-voltage probe, read D.C. volts to 30,000 volts **15.95**

### TERMINAL

RADIO CORPORATION  
Distributors of Radio & Electronic Equipment  
85 CORTLANDT STREET, NEW YORK 7, N. Y.  
WOrth 4-3311 • Cable: TERMRADIO

## COLOR TV STANDARDS

Color television standards must meet a number of conditions to be acceptable to the public and industry, stated David B. Smith of the Philco Corporation, during a recent FCC hearing. Most important of these conditions are:

1. The television viewer must be able to enjoy color or black-and-white with no loss of program either way.
2. Both color and black-and-white must be transmitted on a single set of standards, so that either can be received interchangeably on both color and black-and-white receivers.
3. Quality of television service must be at least as good as that now provided.
4. Continuity of existing television service to receivers owned by the public must be maintained.
5. There must be no experimenting at the expense of the public.

## NEW COLOR SYSTEM

A novel color television system requiring no light filters is proposed by Louis W. Parker of Jackson Heights, N.Y., in a patent assigned to the Federal Radio and Telephone Corporation. He first converts the radio waves to ultraviolet—instead of visible—light. The ultra-violet rays are then scanned by a rotating polygonal drum, each of whose faces fluoresces with a different color when excited by the ultra-violet light, producing a colored image.

## MEASURING TV GAIN AFTER ADJUSTMENTS

Video owners sometimes try to improve reception by varying the length or direction of the antenna, experimenting with stubs, etc. However, it is difficult to judge when optimum results have been reached.

A very good method of so doing is to turn down the gain control and (if nec-

essary) move the sync controls slightly until the picture just tends to move out of sync or to "tear." Then it is easy to tell when an improvement has been made because synchronization will be restored. Of course, if the change has been for the worse, the picture will show it.—Nathaniel Rhita

RADIO-ELECTRONICS for

PROJECTION OSCILLOSCOPE

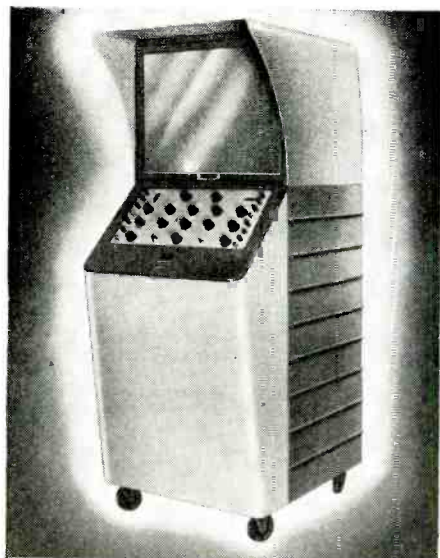

Called the Electronic Blackboard, Television Equipment Company's T-602 projection oscilloscope is designed to display patterns on 18 x 24-inch or 8 x 10-foot screens for viewing by large groups. It features driven and recurrent sweeps and Z-axis modulation in addition to the other functions of general-purpose oscilloscopes. The controls, mounted on a sloping panel, are convenient for the lecturer to operate. Casters make the entire scope movable.

ASSOCIATION ACTIVITIES

Officers of The Associated Radio-Television Servicemen of New York (New York City) for the 1950 term are: Max Liebowitz, president; Arthur Silverberg, vice-president; Jack Edel, treasurer; Jerry Maccherone, recording secretary; and Noel Payne, corresponding secretary.

The following members were elected to the board of directors: Sam Marshall, Louis Bennett, George Day, Henry Levine, John A. Bradley, Joseph Wolk, David Sohmer, H. A. Gibbs, Paul Abraham, Chester Kaplan, and John Wagony.

The Associated Radio and Television Servicemen of New York (New York, N. Y.) reports that 120 applicants have registered for the radio, electronics, and television courses offered by the Board of Education in cooperation with ARTSNY. Courses will cover elementary, industrial, advanced, and television subjects. If the first term is successful, a second term will be opened in the fall to continue the studies of the first-term graduates.

The Radio-Television Service Guild, Denver, Colo., elected officers for 1950 at its December meeting. Lee A. Martin, director of Western Radio Institute, was elected to the presidency. Bill Thoos was made vice-president, Harry Matsunaka secretary, and Donald R. Dixon treasurer. The technical portion of the meeting was a lecture and demonstration on audio given by Harold Wright of the Western Radio Institute instructional staff and William Oltersdorf of Sound Service.

MARCH, 1950

**HICKOK Leads!**

**WITH NEW TELEVISION VTVM**

**MODEL 209A**

**ELECTRONIC VOLT OHM CAPACITY MILLIAMMETER**

FEATURES

- Easy to read, long scale 9" meter.
- Zero-center DC scale for faster alignment.
- Resistance measurements as low as 1/10 ohm.
- New 1200 Volt AC range.
- Low capacity, high frequency probe. Peak-to-Peak or RMS — Flat frequency response to 300 megacycles.

• Now even more sensitive — Especially designed to save you time in television servicing. Measures any resistance, capacitance, voltage or current you would ever encounter in AM, FM or TV receivers.

New Peak-to-Peak voltage measurements — An absolute necessity for TV servicing. Zero-center DC scale increases speed and accuracy of TV and FM readings.

Model 209A is a quality instrument built to the high HICKOK standard, with lasting accuracy for years to come.

The most used instrument on the technicians bench, where top-quality is the most economical buy.

See the 209A at your jobber's or write for literature Today!

THE HICKOK ELECTRICAL INSTRUMENT COMPANY

10531 Dupont Avenue • Cleveland 8, Ohio

Send me full information on the New HICKOK Model 209A.

NAME \_\_\_\_\_

ADDRESS \_\_\_\_\_

CITY \_\_\_\_\_ STATE \_\_\_\_\_

**SAVE MONEY—BUILD YOUR OWN SPEED LIGHT EQUIPMENT FOR PROFESSIONAL AND AMATEUR**

Easy to follow . . . step-by-step Instructions  
Write for FREE list of complete Kits and Components

**CINEX, INC.**  
Dept. RE-3 165 W. 46th St., N.Y. 19, N. Y.

**\$10,000 REWARD**

Earn the government bonus by locating radium with a **P.R.I. GEIGER COUNTER**

The most sensitive portable Geiger Counters made.  
Weight only 2 lbs. Battery lasts a year. Prospecting book included free. Priced from \$49.50 complete.

**PRECISION RADIATION INSTRUMENTS, INC.**  
5478-R Wilshire Blvd. Los Angeles 36, Calif.  
Dealer Inquiries Invited

**TUBE SPECIALS**

IR-4	15c	6J5GT	29c
6H6GT	19c	5T4	29c
1A5GT	19c	36	29c
6C4	19c	2X2	49c
12K8	29c	OZ4	49c
6L6GA	29c		

**ALMO RADIO CO.**

Four Stores To Serve You

509 Arch St. Philadelphia, Pa.  
6205 Market St., West Phila., Pa.  
6th & Orange Sts., Wilmington, Del.  
4401 Ventnor Ave., Atlantic City, N. J.

# New Devices

## VOLTOHMMETER

Electronic Measurement Corp.  
New York, N. Y.

Model 104 Voltometer is a rugged and flexible 20,000-ohms-per-volt meter with a 4 1/2-inch-square case, 50-microampere



movement, and Alnico magnet. Weighing 2 lbs. 5 oz. and housed in a high-impact, round-cornered Bakelite case with carrying strap, it measures 5 1/4 x 6 3/4 x 7 7/8 inches.

It has five d.c. voltage ranges at 20,000 ohms per volt to 3,000 volts; five a.c. voltage ranges to 3,000 volts; three resistance ranges to 20 megohms. There are three a.c. and d.c. current ranges and five db ranges.

## 10-50-KV POWER SUPPLY

RCA Victor Division  
Radio Corp. of America  
Camden, N. J.

Type EME-2 is a highly regulated d.c. power supply, designed for any application requiring 10 to 50 kv with a maximum output-current requirement of 2 ma.

The unit is an ideal accelerating supply for cathode-ray tubes in experimental equipment or as a permanent setup for testing these tubes. It is also designed for use in nucleonics and laboratory test equipment.

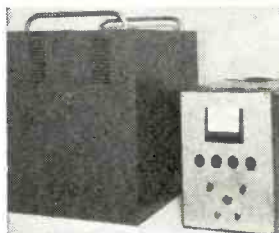

The supply, consisting of a driver unit and a rectifier unit, is available with either positive or negative ground. Four 6-foot cables between the units permit mounting of the driver on a convenient table-top or shelf and installation of the rectifier on the floor or in other out-of-the-way locations for the sake of convenience.

The final output voltage is taken from the rectifier unit and can be continuously varied between 10 and 50 kv. A meter on the front panel of the driver unit indicates output. Ripple is 5 volts maximum.

## CODE CALCULATOR

Sprague Products Co.  
North Adams, Mass.

A new capacitor code indicator makes it easy to decipher molded, paper, tubular capacitor color codings. The Sprague capacitor indicator consists of a pocket-size plastic device with rotating dials printed in full and



accurate colors. When flicked to the proper color bands, the dials instantly indicate capacitance, tolerance, and rated working voltage.

## V.T.V.M. KIT

Heath Co.,  
Benton Harbor, Mich.

In the new model V-4 vacuum-tube voltmeter kit, positive automatic meter protection on all functions is given by the electronic a.c. voltmeter and push-pull d.c. voltmeter circuit. The a.c. circuit incorporates a new balance control which allows complete elimination of contact potential, removes meter shift with various ranges, gives accurate readings on all ranges, and compensates for variations in tube elements. A 200- $\mu$ a meter uses an Alnico V magnet. One percent precision ceramic divider resistors are used. Twenty-four complete ranges are included. The meter pointer can be offset from zero for FM and TV alignment. The d.c. probe is isolated for making dynamic measurements of receiver voltages without disturbing receiver operation in any way.

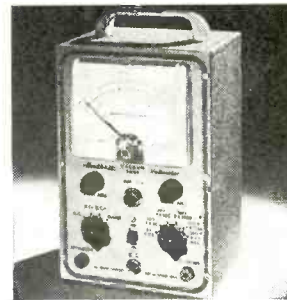

## TEST METER

Triplett Electrical Instrument Co.,  
Bluffton, Ohio

Model 630-A volt-ohm-milliammeter is a new laboratory-type meter with mirrored scales. Its greater accuracy is made possible through the use of special 1/2% resistors, each mounted in its own compartment. The long scales on the large 5 1/2-inch instrument are hand-drawn for greater meter accuracy at all scale points.

There are six d.c. volt ranges from 0 to 6,000, at 20,000 ohms per volt; six a.c. volt ranges from 0 to 6,000, at 5,000 ohms per volt; five d.c. current ranges; decibels; output; and resistance ranges from 0 to 100 megohms (compensated for greatest measurement accuracy).

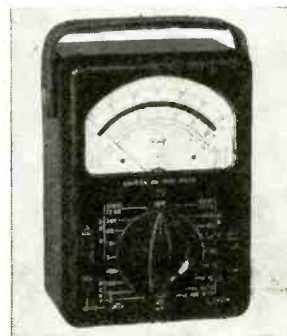

## SPIRAL-TYPE INPUTUNER

Allen B. Du Mont Laboratories,  
Inc.

E. Paterson, N. J.

A new 4-section Inputuner incorporating the latest Mallory-Ware spiral-type Inductuner is announced.

Its gain is double that of the previous Du Mont Inputuners, and it has greatly improved selectivity. The tuning range is continuous from 54 to 216 mc, covering TV channels 2 to 13 as well as the FM band. The new Inputuner, which requires only 5.9 turns of tuning motion, as against 10 turns for previous models, provides an improvement in the high-band spread, making exact tuning easier on channels 7-13.

Another notable refinement is efficient operation on either 300- or 72-ohm antenna systems, by means of an input transformer, connections to which may be altered for the desired impedance.

RADIO-ELECTRONICS for

"We have a much better picture than the neighbors. I think the serviceman was right when he said it's all because of our Amphenol INLINE\* Antenna."

This is the antenna they are talking about. It assures you the Best TV PICTURE

U. S. PATENT NO. 2,474,180

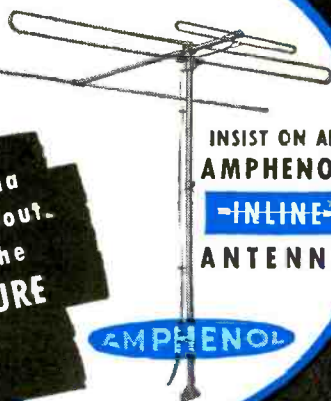

INSIST ON AN  
AMPHENOL  
-INLINE-  
ANTENNA

AMPHENOL

AMERICAN PHENOLIC CORPORATION  
1835 SO. 54TH AVENUE • CHICAGO 50, ILL. NOIS

## UTILITY TESTER

Superior Instruments Co.  
New York, N. Y.

This new pocket-size utility tester measures the current consumption of any appliance or utility, either a.c. or d.c., while the unit under test is in operation.



When the appliance is plugged into the front-panel receptacle, a reading in amperes is registered. A special pair of insulated clip ends is supplied for motors. The tester incorporates a sensitive, direct-reading resistance range for measuring all resistances commonly used in electrical appliances, motors, etc.

## ANTENNA ROTATOR

Alliance Mfg. Co.,  
Alliance, Ohio

Model DIR is a new deluxe model Tenna-Rotor featuring a directional in-



dicator control case. An indicator dial on the control case panel enables the television viewer to select and know the actual compass direction to which the antenna is pointed. The rotator is similar to the standard model ATR.

## TV ANTENNA

La Pointe Plascomold Corp.  
Unionville, Conn.

A new low-cost, four-bay, stacked array is known as the Challenger model HL Series, designed to meet the requirements of viewers in areas where both high- and low-channel reception is desired.

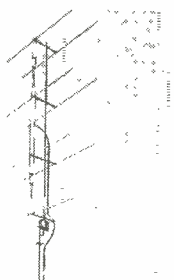

The antenna affords twice as much gain on the high channels as on the lows.

The Challenger comes custom-cut to favor any particular high channel desired, but because of its broad band characteristics is also a good performer on the lows. It matches 300-ohm line with negligible impedance variation throughout the TV spectrum. It is furnished with an integral 9-foot mast (1 1/2 inches o.d.) and will fit all rotators without special adaptors.

MARCH, 1950

## PREAMPLIFIER

Hermion Hosmer Scott, Inc.  
Cambridge, Mass.

A professional-type preamplifier for magnetic pickups which incorporates the new Scott Dynaural noise suppression circuits is now available for high-fidelity enthusiasts. It includes a variable turnover control to compensate for different recording characteristics as well as an adjustable distortion filter.

The preamplifier is completely remote-controlled, permitting the controls to be mounted at any convenient location.

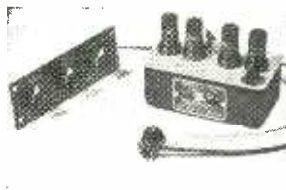

## INDOOR ANTENNA

Tricraft Products Co.,  
Chicago, Ill.

The Vidiette indoor TV antenna model 7007 requires no pushing and pulling of

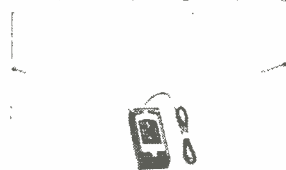

rods. Simply move the knob to the channel desired. The antenna is electrically tuned.

## TERMINAL LUGS

U. S. Engineering Co.  
Glendale, Calif.

New miniature terminal lugs have been designed to meet the trend toward lighter radio component parts and smaller size equipment. The miniature series, like the standard series, are silver-plated and specially treated to prevent corrosion.



## REPLACEMENT KIT

International Resistance Co.  
Philadelphia, Pa.

A packaged set of specially designed parts, Concentrikrit, allows radio technicians to assemble a variety of concentrics to meet over 90% of replacement requirements. Each Concentrikrit contains 11 IRC universal parts. These are combined with a selection of shaft ends and base elements—which are purchased separately—to provide maximum coverage of concentric dual replacements in home and auto radios as well as television sets.

Base elements supplied in conjunction with Concentrikrit are complete, with no loose parts. The blue molded base has element, collector ring, and terminals installed.



Presenting... NEW ADDITIONS TO THE

# Seletron

SELETRON RECTIFIER FAMILY

joining the more than 2,000,000 in service in Radio and Television!

Designed Especially for Power and Bias Supplies in Television

NOW SELETRON brings you these two new models ideally suitable in size and rating: No. 551 at 500 Mils — No. 8Y1, the "baby" of them all, measuring only 1/2" square and rated at 15 Mils, 130 volts. While these rectifiers are designed to meet television needs, engineers will find many applications for them in other electronic circuits. Other bias type rectifiers rated up to 250 volts will also be available.

A new leaflet on Bias Type 8Y1, describing its circuit possibilities is available. For a copy, write Dept. RS-25

SELETRON DIVISION  
**RADIO RECEPTOR COMPANY, INC.**  
Since 1922 in Radio and Electronics  
Factory: 54 North Street, Brookline 14, N. Y. • Sales Department: 351 West 131st St., New York 21, N. Y.

# RADIO - ELECTRONICS MAGAZINE LIBRARY

INGENIOUS, CUSTOM-BUILT STORAGE FILE... Another WALTER ASHE Value Scoop!

Only **25¢**

each plus 6¢ each to cover packing and postage (anywhere in U. S.)

Holds 12 complete issues of magazine in its present 82 to 98 page size. Measures 12" x 8 1/2" x 2 3/8"

Made of high quality Kraft fibre board, printed and constructed to look like a Buckram-bound book. Affords neat, orderly, flick-of-the-finger convenience. Handy Reference Index, printed on back, records the location of selected articles, wiring diagrams, etc. At the low price you'll want several of these so viceable, attractive Magazine Libraries.

Order now for immediate delivery

# FREE

NEW 1950 CATALOG

**Walter Ashe**  
RADIO CO.  
1125 PINE ST. • ST. LOUIS 1, MO.

# TELEVISION SCOPE

## SUPERIORITY AT A GLANCE!

The vertical response of this economy TV scope is usable to 5000 kc, not 50 kc. Response is flat to 750 kc, down 3 db at 1000 kc. Amplifier supplies a voltage gain of 20 at 5000 kc.



AR-3

Check this necessary feature before you buy any scope for TV use.

The R.S.E., AR-3 Scope has been built by Ross Armstrong to our rigid specifications. It's a complete unit that embodies standard horizontal amplifier and sweep circuits with normal sensitivity.

The case is 8" high x 5" wide x 14" long, attractively finished in "hammered" opalescent blue enamel. Operates on standard 110 volts—60 cycles—40 watts. Tubes, 3BP1-6AC7-6SJ7-6X5-5Y3-8B4. Instructions included. Complete specifications upon request. Satisfaction or your money back.

PRICE **\$49.95**  
AVAILABLE TO JOBBERS IN QUANTITY  
F. O. B. DETROIT

## INTERCOM & RADIO

AT A PRICE THAT CAN'T BE BEAT



6 tube superhet—3 tube intercom permits communication between radio-master and up to 4 sub-stations. **WHILE THEY LAST \$29.95**

Original cost \$64.50  
With 1 sub-station and 50 feet of cable Extra Sub-stations \$3.95 each

## PUSHBACK WIRE



25% BELOW MILL COST! 1st class, Essex or Lens, ALL SOLID tinned copper, double cotton serve, waxed finish.

SIZE	COLORS	100 feet	1000 feet	Production Reel
22	BLACK-BROWN	.39	3.79	3.65M
20	RED-WHITE-BLUE	.49	4.49	3.95M
18	BROWN	.69	5.98	



### ORDER INSTRUCTIONS

Minimum order—\$2.00. 25% deposit with order required for all C.O.D. shipments. Be sure to include sufficient postage—excess will be refunded. Orders received without postage will be shipped express collect. All prices F.O.B. Detroit.

Quantity and Export Orders Solicited

**RADIO SUPPLY & ENGINEERING CO., Inc.**  
85 SELDEN AVE. DETROIT 1, MICH.

### SIMPLE PROBLEM IN RESISTIVE NETWORKS

? Please find the battery voltage, line current, and the total resistance in the enclosed circuit and explain each step in the solution.—F. A. J., Buffalo, N. Y.

A. Your diagram is shown in the figure. The first step is to determine the line current. Because the voltage drop across the parallel combination of R3 and R4 is 200, we reduce this combination to its equivalent resistance by dividing the product of R3 and R4 by their sum, or  $100 \times 50 / 100 + 50 = 33.3$  ohms. (We carry the answers to only three significant figures, as greater accuracy is seldom useful.)

The line current flows through this 33.3-ohm network. The voltage drop across it is 200; the current is equal to the voltage divided by the resistance, or  $200 / 33.3 = 6$  amperes.

The 6-ampere line current flows through the combination of R1 and R2; however, since only 2 amperes flow through R1, 4 amperes must flow through R2. Because current varies inversely as resistance, the resistance of R1 must be twice that of R2, its

current being one-half that of R2. Therefore, R1 equals  $2 \times 65$  or 130 ohms.

R1 and R2 are in parallel and their equivalent resistance is

$$\frac{130 \times 65}{130 + 65} = 43.3 \text{ ohms.}$$

The voltage drop across the combination of R1 and R2 is the product of the line current and the equivalent resistance or  $6 \times 43.3 = 260$  volts.

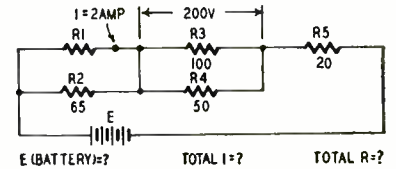

The drop across R5 is  $6 \times 20$  or 120 volts. The battery voltage is the sum of all the voltage drops or  $260 + 120 = 380$ .

The equivalent resistance in the circuit is the sum of the series resistances or  $43.3 + 33.3 + 20 = 96.6$  ohms.

### TROUBLES IN A POPULAR SIGNAL TRACER

? I constructed the signal tracer shown in Fig. 3 of the article "Signal Tracers Are Popular" in your November 1948 issue. The tracer motorboats when the a.f. gain control is advanced. It howls when the r.f. gain control is advanced beyond the half-way point. Can you suggest a remedy?—J. G. S., Hollywood, Calif.

A. To cure the motorboating, try using a large capacitor (20 to 40  $\mu\text{f}$ ) on the output of the power supply filter. If this does not help, try replacing the 0.1- $\mu\text{f}$  plate decoupling capacitors in the 6AC7 circuits with much larger values—8- $\mu\text{f}$  or larger—and increase the detector plate bypass to 0.5  $\mu\text{f}$ .

The howling seems to be caused by feedback between input and output cir-

cuits. Your parts layout diagram shows the two 6AC7's and a 6C5 placed close to the output transformer and the 6V6 placed some distance away from it. I would suggest that you use another parts layout. Confine the power supply and output circuit to one section of the chassis and the remaining stages to another. The r.f. input jack and the first 6AC7 should be as far as possible from the output transformer and speaker and the power supply components—including the choke. All grid and plate leads should be as short as possible and shielding should be used where necessary. Avoid shielding the wiring in the 6AC7 circuits if it is possible to do so. Be sure to ground the No. 1 pins on the 6AC7's and 6C5's solidly.

### 88 TO 108-MC TUNER FOR FM RECEIVER

? I am constructing an FM receiver and have completed a 10.7-mc i.f. strip and the a.f. amplifier. Please prepare a circuit and coil-winding data for an r.f. amplifier and mixer-oscillator. I would like to use 6.3-volt miniature tubes if possible.—E. E. P., Ames, Iowa

A. The circuit and winding data shown here were given in an article on an FM receiver in *Radiotronics* (Australia). The circuit and coil data are shown in the diagram.

The secondary of the antenna coil consists of  $1\frac{1}{2}$  turns of No. 18 enameled wire, wound 1 inch over-all, with 9/16 inch diameter. One end is connected directly to the stator plates of the antenna-tuning capacitor and the other to the a.v.c. terminal. The primary has  $1\frac{1}{2}$  turns of No. 18 tinned copper wire, wound 9/16 inch in diameter with  $1\frac{1}{4}$ -inch leads.

The primary and secondary coils are placed on a common axis and the pri-

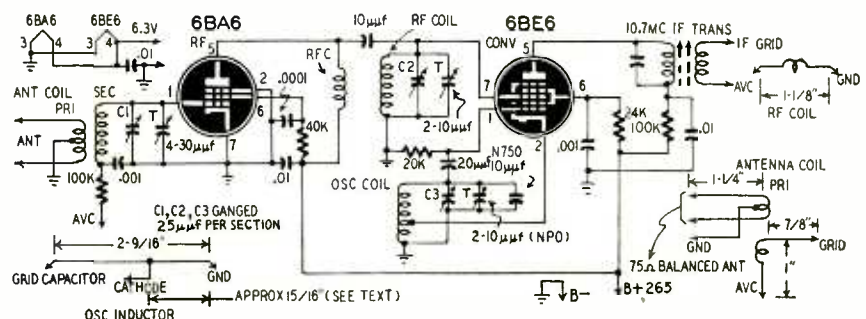



mary positioned for maximum output from the set. Locate the electrical center for the ground connection by connecting a short lead to ground and moving it along the primary until equal signal outputs are obtained when a signal is applied to either antenna terminal.

The r.f. coil consists of 1½ turns of No. 18 enameled wire, wound with an inside diameter of 9/16 inch. Its overall length, including leads, is 1½ inches. The r.f. choke in the plate circuit of the 6BA6 has 6¼ turns of No. 22 enameled wire, spaced to a ¾-inch winding length. The lead on the plate end should not exceed 1½ inches, and the lead to the .01-µf bypass capacitor and B-plus should be not longer than 1 inch.

The oscillator inductor is a 29/16-inch length of No. 18 tinned copper wire bent into an arc and soldered directly across the plates of the tuning capacitor. Because the cathode tap should be as short as is physically possible, the coil was bent to allow soldering directly to the cathode pin on the tube socket. The position of the tap is determined by connecting one end of a short piece of flexible wire to the cathode pin and moving the other end along the coil until the best signal-to-noise ratio is obtained.

**RECEIVER FOR WWV**

? I have an a.c.-d.c. broadcast receiver using a 12SA7-GT converter tube and 455-kc i.f. amplifiers. Please show how this receiver can be converted to a crystal-controlled receiver to tune in WWV on 5 mc.—A. F., Emeigh, Penna.

A. The antenna and oscillator circuits can be rewired as illustrated for 5-mc reception. The oscillator section of the 12SA7-GT is converted to a Pierce oscillator for use with a 4,545- or 5,455-kc crystal. The antenna coil or loop antenna must be replaced by a 2- to 6-mc antenna coil, and the tuning

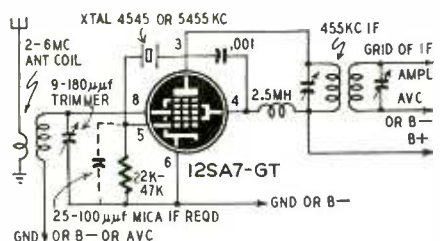

capacitor replaced by a 9- to 180-µmf trimmer. If the oscillator is sluggish, try shunting a small mica capacitor across the oscillator grid resistor. Values between 25 and 100 µmf should be about right.

The antenna trimmer should be adjusted for the strongest signal from WWV. Correct tuning will be indicated by an increase in a.v.c. voltage. Peak the i.f. transformers for maximum signal.

WWV's 2.5- and 10-mc transmissions may be received by switching in suitable antenna coils, tuning capacitors, and crystals. Use 2,045- or 2,955-kc crystals for 2.5 mc and 9,545- or 10,455-kc crystals for 10 mc.

MARCH, 1950

**CIRCLE X ANTENNA**

**ENGINEERED TO PROVIDE CLEAR SHARP PICTURES ON ALL CHANNELS**

**COMPARE CIRCLE-X TO ANY OTHER TV ANTENNA**

No other antenna combines all the mechanical and electrical features engineered into the Circle-X.

The high gain of the Circle-X is equal to stacked arrays. It is made of light weight corrosion resistant aluminum alloys that stand up in all atmospheric conditions.

When you use Circle-X you stock only one type of antenna for all jobs. It has one wire lead-in and weighs only 2½ lbs.

We urge you to compare Circle-X TV Antennas to any other TV antenna on the market.

Use Circle-X on your next tough TV installation. It may save you a lot of "no profit" call backs.

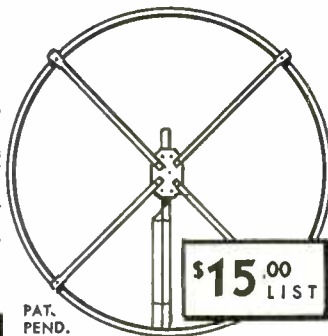

PAT. PEND.

DEALERS: Air Express or Parcel Post Special Delivery direct from factory to you through your jobber, if he cannot supply you with the Circle-X from his stock.

**CIRCLE-X ANTENNA CORP.**  
509 MARKET ST., PERTH AMBOY, N. J.



**TV SCOOPS!**

**FOR HAMS— DON'T BE BLAMED FOR TV!**

Tests have proven that the new Low-Pass Filter Kit\*, developed by W2GX, attenuates all frequencies above 40 MCS. This "M" derived filter for 160 through 10 meters prevents TVI while



you're operating. Eliminates all frequencies above 40 MCS at 60 DB or better, passes all frequencies below 40 MCS. Fits any 52-72 ohm feeders. Insertion loss less than 1/60th of 1 DB. Full directions included.

Cat. No. C-279

**\$4.99**

plus 25c shipping charges in U.S.

**FOR SERVICEMEN— SOUND POWERED PHONES**



Talk up to 10 miles without batteries with these sound powered phones. No loss in power when paralleled. Ample volume, excellent type rubber-cushioned ear phones. Type "Q" has swing-away mi-

M.I.—2454 Type "Q" Catalog No. C-299

**\$9.95** each

crophone. Type "O" has mike on chest set. Adjustable headband. Push-to-talk. 22 ft. of live rubber cord and plug on both types. Unit consists of 1 pr. phones, mike, cord and plug as illustrated.

M.I.—2475 Type "O" Catalog No. C-300

**\$4.95** each

plus 25c shipping charges in U.S.

**FOR TV SET OWNERS— BANISH INTERFERENCE**



**BLEEP BLOOP BLAP**

Niagara's new Hi-Pass Filter Interference kit\* is positive protection against amateur and other high frequency RF interference such as diathermy, ignition, etc. Fits any 300 ohm antenna feed line. No loss in pictorial brightness. Easily assembled. Full instructions included.

Cat. No. C-281.

**\$1.95**

plus 15c postage and handling in U.S.

\*Hi and Low Pass Filters manufactured by a division of Niagara Radio Supply Corp. Dealer inquiries invited.

Send for latest catalog C and tube price list. **IMPORTANT NOTICE:** Please include 20¢ deposit with C.O.D. orders, unless rated. Orders received without postage will be shipped railway express collect. Send us your inquiries today. We correspond in English, Spanish, French, Italian, Polish, Rumanian, Hebrew, German, Portuguese, etc. Prices subject to change without notice. All stock subject to prior sale. All merchandise f.o.b. N.Y.C. Minimum order \$2.00.

**Niagara Radio Supply Corp.**  
Dept. C30  
160 Greenwich Street, New York 6, N. Y.  
Phone Dlgby 9-1132-3-4

*three decades of radio-television "know-how"*

**TELEVISION and FM ACCESSORIES**

**LIGHTNING ARRESTER**  
NO 6112

**TURNBUCKLES**  
NO 6150

**GUY WIRE CLAMP**  
NO 6144

**INSULATED MAST STAND-OFFS**  
3 1/2" and 7" lengths for twin lead or coaxial cable

**ANTENNA MAST SUPPORTS**  
NO. 6131 for wall  
NO. 6130 for chimney

**TELEVISION SERVICING TOOLS "Handi-Kit"**

Nine specially designed television servicing tools in a durable pocket-size leatherette case. All the tools needed for a complete servicing job.

**"KILOVOLT" MULTIPLIER PROBE**

Equipped with 15 K.V. range multiplier . . . will increase the range of a 5,000 volt range voltmeter to 20,000 volts per scale. Available in 5,000, 10,000 and 20,000 ohms per volt.

Illustrated are only a few of ICA's extensive line. Write Dept. RE for complete catalog.



**insuline CORPORATION OF AMERICA**

INSULINE BUILDING • 36-02 35th AVENUE • LONG ISLAND CITY, N. Y.  
West Coast Branch and Warehouse: 1335 South Flower Street, Los Angeles, Calif.  
Exclusive Canadian Sales Agents: CANADIAN MARCONI COMPANY, Montreal

B. K. V. (Ben) French has been appointed application engineer of the Electronic Parts Division of ALLEN B. DU MONT LABORATORIES, INC., at its East Paterson, N. J., plant.

French brings to Du Mont a background of 26 years of varied experience in radio engineering. While associated with P. R. Mallory Co. (1937-1946), he was instrumental in the development of the Mallory-Ware Inductuner now incorporated in the Du Mont Inputuner used in Du Mont and other makes of TV sets.



French was also responsible for the introduction of push-button station selection and wave-band switching. During the early part of the recent war, he served on the joint Army-Navy Standardization Board, and late in 1944 he became supervisor of Mallory research for the development of the mercury-type dry battery extensively used in Armed Forces radio equipment. In 1946, French joined the executive staff of Howard Sams in the presentation of Photofact radio service literature, and served as a consultant to Stupakoff Ceramics.

French began his active career in 1923 with Federal Telegraph & Telephone, as development engineer. Later, he was with American Bosch in its development of the first all-wave radio sets, auto radios, and personal receivers, with RCA's License Division Laboratory, and with Case Electric as chief engineer.

He is a Senior Member of IRE, member of the Radio Club of America, and a frequent contributor to radio publications.

Ralph V. L. Hartley, inventor of the Hartley oscillator and formulator of the Hartley law of information transmission, has retired from active duty as transmission research consultant for BELL TELEPHONE LABORATORIES, INC. Mr. Hartley first came to Bell in 1914, his oscillator was invented a year later.



Among the contributions Mr. Hartley made to communications was his now widely accepted theory, that people perceive direction of a sound source because of the phase difference between sounds received by the two ears. He was instrumental in developing the treatment of telegraph pulses by Fourier analysis so that a.c. measurements could be used. He is the originator of the frequency-inversion system which allows communication privacy. Broadly, however, according to Bell officials his main contribution was the intangible one of clarifying ideas and arranging them in a useful pattern.

**1950 PROGRESSIVE RADIO KIT ONLY \$14.75**

**ABSOLUTELY NO KNOWLEDGE OF RADIO NECESSARY. YOU NEED NO ADDITIONAL PARTS. EXCELLENT FOR BACKGROUND IN TELEVISION. BUILD 15 RADIOS. . . .**

The PROGRESSIVE RADIO KIT will help you, if you want an EDUCATIONAL AND INTERESTING HOBBY, or if you want to get into a WELL-PAYING BUSINESS, or if you want to INCREASE YOUR KNOWLEDGE OF RADIO.

Absolutely no knowledge of radio is necessary. The PROGRESSIVE RADIO KIT is the product of many years of teaching and engineering experience. The detailed instructions and quizzes are clearly written and illustrated, so that they can be understood by anyone between the ages of 12 and 80.

The PROGRESSIVE RADIO KIT is not merely a collection of radio parts accompanied by a radio diagram. IT IS PRACTICALLY A RADIO COURSE, offered at a mere fraction of its real value. You will be taught to build radios in a progressive manner. First, you will build a very simple 1-tube receiver. The next set is a little more advanced. Gradually you will find yourself constructing elaborate radio sets, and doing work like a professional radio technician. Every part is illustrated. EVERY STEP INVOLVED IN BUILDING THESE SETS HAS BEEN CAREFULLY PLANNED. YOU CANNOT MAKE A MISTAKE.

Each of the 15 radios you will build operates on 110-120 volts, AC or DC. These sets have been designed to teach you the PRINCIPLES OF RADIO. Therefore, you will build a variety of circuits. The PROGRESSIVE RADIO KIT IS EXCELLENT FOR LEARNING THE PRINCIPLES OF RECEIVER, TRANSMITTER, AND AMPLIFIER DESIGN. It is used in many Radio Schools and Colleges in U.S.A. and abroad. It is used by the Veterans Administration for veteran training.

Quizzes are provided as part of the PROGRESSIVE RADIO KIT. They will be corrected by our staff at no extra cost.



**FREE 1950 EXTRAS:**

- ELECTRICAL AND RADIO TESTER
- ELECTRIC SOLDERING IRON
- SCREWDRIVER
- ALIGNMENT TOOL
- BOOK ON TELEVISION
- SPOOL OF ROSIN CORE SOLDER
- GENEROUS HANK OF WIRE
- MEMBERSHIP IN RADIO-TV CLUB

ORDER YOUR PROGRESSIVE RADIO KIT TODAY, OR SEND FOR FREE "KIT-KATALOG" POSTAGE PREPAID ON CASH ORDERS. C.O.D. ORDERS ACCEPTED IN U.S.A.

**PROGRESSIVE ELECTRONICS CO. 497 Union Ave., Dept. RE-33  
Brooklyn 11, New York**

**HOW** Learn how to simplify radio repairs FREE! Send penny postcard for big 32-page illustrated FREE MANUAL. No Obligation.

**FEILER ENGINEERING CO., Dept. 3RC5  
1601 S. Federal St. Chicago 16, Illinois**

**YORK RADIO & REFRIGERATION**  
265 W. MARKET ST. York, Pa.

HAS THE SENSATIONAL NEW 145-K Signal Tracer Kit IN STOCK!

 \$18.95

Brig. General David Sarnoff, chairman of the board of RADIO CORP. OF AMERICA, was awarded a United Nations citation for his "notable cooperation in the development of public understanding of the work of the United Nations and for his contribution in the field of human rights through advocacy of concepts of Freedom to Listen and Freedom to Look as fundamental expressions of Freedom of Information."

Upon receiving the citation, General Sarnoff described the award as a "generous commentary and kind recognition... directed more to a principle than to a man." He said, "I had the privilege of discussing this principle on several occasions with President Roosevelt, President Truman, Secretaries of State Hull and Marshall, and with other high officials of our government. It was gratifying to see the creation of an international broadcasting service that disseminates information to the rest of the world and that is now so well known as the Voice of America."



"Shortly after the United Nations was organized, I presented to Mr. Trygve Lie and other ranking officers of the UN, a plan for international broadcasting that would be known as the Voice of UN. And it is encouraging to observe the steady growth of your broadcasting service."

"May these Voices continue to be heard over an ever-widening circle and bring hope to an anxious world."

Edward A. Malling has been appointed sales manager for component parts in the GENERAL ELECTRIC Receiver Division at Electronics Park, Syracuse, N. Y., according to an announcement by W. M. Skillman, manager of sales for the division.



A native of Cleveland, Ohio, Mr. Malling has been employed by General Electric since 1935 when he joined the Electric Refrigeration Department at Nela Park in Cleveland.

He was graduated from Miami University, Oxford, Ohio, in 1934 with a Bachelor of Science degree in business administration.

John D. Small has joined the EMERSON RADIO & PHONOGRAPH CORP., New York, as executive assistant to Benjamin Abrams, president of the corporation.

Irving L. Wilson has been named general sales manager of the cathode-ray-tube division of ARCTURUS ELECTRONICS, INC., Newark, N. J., tube manufacturer.

Previous to his appointment, he was commercial manager of the components division of the North American Philips Co.

## four channels from 40 miles clearly with new low-cost C-Series

# Tel-a-Ray



These pictures were taken of a 10" Crosley screen in Aurora, Ill., 40 miles southwest of Chicago. A C-Series antenna on a 15-foot mast was in use... bringing in clearly the four channels pictured above. No booster of any type was used. (All photos untouched. Documented evidence on file.)

Here is the antenna you want — for sharp images — wide range — easy assembly — low cost! Tel-A-Ray's C-Series is new... designed after extensive tests to give you the best performance possible at the lowest cost.

Tel-A-Ray antennas are durable... stainless steel hardware and Dural fittings. The C-Series can be assembled and erected in a few minutes, yet its electrical efficiency in simple arrangements is superb. Available in a complete Hi-Lo Channel Kit with mast, guy wire lead-in, and mounting for \$24.50 list.

WRITE TODAY FOR COMPLETE INFORMATION

**TEL-A-RAY ENTERPRISES, INC.**  
P. O. BOX 332, DEPT. C, HENDERSON, KY.

### UNIVERSAL ELECTRIC MOTOR

**OPERATES AS 110 VOLT 60-CYCLE MOTOR—AS A CAR SHAVER MOTOR OR AS A DYNAMOTOR!**



A truly multi-use motor. As a dynamotor, supplies 110 Volt DC (Approx. 15 Watts) from 6 Volt DC—for operating most types of AC-DC electric shavers or radios from your auto battery, and for many other power uses. It can be converted easily to a 110 Volt 60 cycle motor approx. 1/26 HP at 3500 RPM—to operate grinders, buffers, polishers, fans, models, etc. As a generator, will supply various voltages depending on rotation speed: as dynamotor 18 VDC input, output 450 V, 60 MA. DC. Motor is ball bearing, 7" x 4" size, with 1" x 3/16" shaft one end and 3/8" x 3/16" shaft other end. Instructions furnished. Order No. RE-M3 \$2.95

Motor—converted to 110 Volt 60 Cycle. Order #RE-3M \$3.50

**PHONOGRAPH MOTOR** only—110 Volt 60 cycle, 78 RPM for automatic record changers \$1.50

**GEAR TRAIN MOTOR**—Low inertia reversible type. Can be used to operate small displays, models, etc. Operates from 12 V. AC with use of condenser. Normally operates 26 Volt 400 cycle. Motor 588 RPM; low speed 14 RPM; separate gear 3/8 RPM. Complete motor, gear train, condenser, & instructions \$2.50

**MODEL MOTOR**—12 Volt AC-DC. 3/8" double end shaft. Motor size: 2 1/2" L x 2 1/2" W x 1 1/2" H. Price \$1.50

**HAND TOOL MOTOR**—12 Volt AC-DC 5600 RPM. Size: 3 1/4" L x 1 1/4" D with splined shaft 3/8" D x 3/8" L. Price \$2.95

**6 VOLT AC OR DC MOTOR**—Ideal for auto heaters, defrosters, fans, models, etc. Used by Govt. in aircraft. Shaft size: 3/8" x 3/8". Price \$1.50

### DYNAMOTORS AND INVERTERS

Write us and tell your requirements. We have big stock to select from.

**TRANSFORMERS—110 Volt 60 cycle Primaries:**  
Sec. 12 V. 1 amp. \$1.50 Sec. 24 V. 2 amps. \$2.25  
Sec. 24 V. 1 amp. 1.95 Sec. 24 V. .5 amp. 1.50  
Sec. 36 VAC. 2.5 amps. \$2.95  
Sec. 14-14 or 28 V. 7 1/2 or 15 amps 4.95

### SELSYN TRANSMITTER & INDICATOR SYSTEM

Ideal for antenna direction indicator to remote position. Complete with Autosyn Trans. 3" 1-81 Indicator, Transformer and instructions. Price \$6.75 Autosyn Trans. only: \$2.95 Plug 7/1-81: \$1.00

**CABLE CO-213**—7 cond. #20 AWG; 2 cond. separately shielded within outer shield for all cond. Insulated, rubber covered, 35 ft. length. \$1.25

**CABLE-4**—Conductor, shielded, 50 ft. length. \$2.00

Address Dept. RE • Prices F.O.B., Lima, Ohio • 25% Deposit on C.O.D.'s • Minimum Order \$2.00

### Sewing Machine Conversion Kit

It's easy to convert your treadle type home sewing machine to an up-to-date electric machine. This big value kit comes complete with motor, rheostat control, light, adapter bracket, and instructions. Brand New. Order Stock No. RE-320. Price—only \$12.95

### PM FIELD DYNAMOTORS: POWER SUPPLY

Completely filtered 12/24 Volt input; output 275 Volt 110 MA. & 500 Volt 50 MA. housed in a metal case 8" x 6" x 10". Contains: 2 PM Dynamotors (as listed below), 2 Switches, 12 Cond., Fuses, Light, Brushes, Chokes, Resistors, Plugs, etc. Shipping weight: 62 lbs. Order No. RE-#3 \$5.00

### PM FIELD DYNAMOTORS

12/24 V. input; output 275 V. 110 MA. \$3.95  
12/24 V. input; output 500 V. 50 MA. \$2.95

### WHIP ANTENNA EQUIPMENT MAST BASES—INSULATED:

MP-132—1" heavy coil spring, 2" insulator. Overall length: 11 1/2". Wt. 2 1/2 lbs. Price \$3.95  
MP-22—Spring action direction of bracket, 4" x 6" mounting. Price \$2.95

### MAST SECTIONS FOR ABOVE BASES:

Tubular steel, copper coated, painted, 3 foot sections, screw-in type. MS-53 can be used to make any length. MS-52-51-50-49 for taper. Any section. 50c Ea. BAG BG-56 1/2 carrying 5 sections. 50c

### MARK II B-19 TRANSMITTER & RECEIVER 15 TUBE SET 2-8 MC.; 240 MC.; AND INTERCOM. FOR MOBILE OR STATIONARY USE!

Set transmits and receives 2 to 8 MC. Phone, C W and M C W 25 Watt Master Oscillator Control. Transmits and receives 240 MC. Phone. Also an intercommunicating set. Comes complete with 15 Tubes, Headset, Micro., Antennas, Control Box, 12/24 Volt Power Supply, and instructions—ready to operate. Set size: 27" x 10" x 13 1/4". Price—USED (TESTED) \$39.50

### RECEIVERS:

BC-1206 Receiver 24 V. 200-400 KC. LN. \$6.95  
BC-1023 Marker Beacon Receiver w/Tubes. New. 4.50  
BC-357 Marker Beacon Receiver w/Tubes. Used. 3.95  
BC-301 Marker Beacon Receiver L/Tubes. New. 1.95  
BC-454 Receiver 3-6 MC. w/8 Tubes. Used. 4.95  
BC-455 Receiver 6-9 MC. w/8 Tubes. Used. 6.95  
BC-453 Receiver 190-550 KC. w/8 Tubes. Used. 11.95

**FAIR RADIO SALES** 132 SOUTH MAIN ST. LIMA, OHIO

# FACTORY-TO-YOU MIDWEST RADIO and TELEVISION



**EASY TERMS**  
**NEW GIANT 16" PICTURE TUBE**  
**30 DAYS TRIAL**  
**MIDWEST Model CX-26**  
**A Complete 16-Inch TELEVISION Chassis**

Here is Television at its best! . . . brought to you by Midwest, the world's oldest and largest Exclusive Factory-To-You radio and television manufacturer. For 1950 Midwest offers a complete line of Television Consoles and complete, ready-to-operate chassis (not kits) featuring the new giant 16-inch tube, clear, steady pictures, synchronized sound and pictures that a child can tune perfectly. Buy your Television direct from Midwest at Low Factory Prices, on Long EASY TERMS and 30 DAYS TRIAL. Send coupon for FREE 32 - page, 4 - color catalog TODAY.

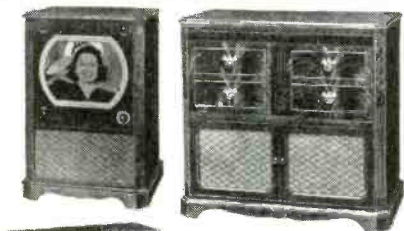

... Also a Complete New 1950 Line of  
**MIDWEST RADIOS**  
with new long distance  
FM Circuit and new  
3-Speed Phonograph.

**Read What Midwest Owners Say:**

**"I Am Amazed at the Clearness of the Picture"**  
Bayonne, N. J.—I am more than satisfied with my new Midwest "Constellation" Television Receiver. I really am amazed at the clearness of the picture, the fine reception, and the general attractiveness of the set. Midwest Television is everything you said it was, plus a whole lot more.  
**Charles Maraza, 661 Avenue "E"**

**"Midwest Television Is So Easy to Operate"**  
Port Clinton, Ohio—I received my Midwest Television set about a month ago and I want to tell you how pleased I am with its performance. I can get clear pictures from Toledo, Cleveland, and Detroit without moving the antenna. Midwest Television is so easy to operate, too. I am certainly very proud to own such a wonderful television set.  
**Harry W. Winnie, 217 Fulton St.**

**"My Midwest Television and Radio Are the Best I've Seen"**  
Wilkinsburg, Pa.—Recently I bought a Midwest Television Receiver Chassis to supplement my Midwest Series 16 AM-FM Radio and I am well pleased with both. In my estimation, my Midwest Television and Radio are the best I've seen. Please let me know if I can secure one of your large console cabinets to hold my complete outfit.  
**David M. King, 751 Ross Avenue**

**Write for FREE 32-Page, 4-Color Catalog or Paste This Coupon on 1c Post Card**

**Midwest Radio & Television Corp.**  
Dept. X-388, 909 Broadway, Cincinnati, Ohio  
Please send me your new FREE 1950 Midwest Catalog

Name \_\_\_\_\_  
Address \_\_\_\_\_  
City \_\_\_\_\_ Zone \_\_\_\_\_ State \_\_\_\_\_

**TV TOO PROMINENT**

Dear Editor:  
RADIO-ELECTRONICS? Nuts! "Television News" would be a more likely name for your publication. Rapid advances in this field or not—there's no excuse for such excessive, constant articles of this type. Gone are the days of meaty servicing and construction articles—of *Short-Wave Craft* and *Radio-Craft*. I have read your publications since 1930 and still have the copies since that time, but now I'm fed up! Too much television. Your December, 1949, copy is my last and you can bet I won't be purchasing your Annual Television Issue.

ART RADIO SERVICE  
Buffalo, N. Y.

**WELL BALANCED MAGAZINE**

Dear Editor:  
I feel that the magazine is quite well balanced. Since it is primarily a service technicians' publication, your recent emphasis on television is understandable, and those who criticize it must be very short-sighted.

My own hobby is experimenting with audio equipment; hence I enjoy Mr. Langham's articles. His knack for putting across a technical subject while keeping up the pretense of being a bumbling novice is unique. I would like to see more articles on high-fidelity audio equipment, distortion measurement, horn loudspeakers, and so on.

Month after month, RADIO-ELECTRONICS offers me the most for my money.

ALFORD E. ALLEN  
Sharon Hill, Pa.

**RAILWAY-STATION PA**

Dear Editor:  
I buy RADIO-ELECTRONICS primarily because of your stimulating editorials. In the December, 1949, issue, you called attention to the need for blast-proof mikes and PA systems for airplanes. Another audio problem that could be solved without too much work is the poor PA systems in railroad stations. The reflecting surfaces in the larger depots make the announcements unintelligible.

A possible simple solution is to place many small speakers with low power output around so that addition and subtraction of the present few speakers would be eliminated. Each small speaker would serve a small area and its power would be dissipated before it could interfere with the others.

WILLIAM L. MORRISON  
Wilmette, Ill.

**TUNABLE SIGNAL TRACER**

Dear Editor:  
I am writing to say how much I like RADIO-ELECTRONICS.

Please print a circuit for a tunable signal tracer. I have built a simple one but would like to try one of the others.

Keep up the good work and send along the same useful material you have in the past.

K. MYERS  
East Liverpool, Ohio

**SIX TUBE SUPER**

Three Gang Condenser

**\$33.30 NET**  
Crowe Panel  
Kit Included

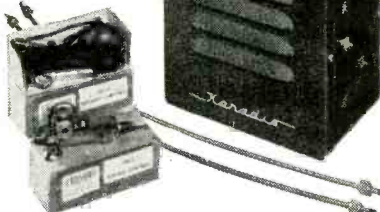

Panel kit to fit most all makes (Please specify make of car and year model). New up-to-date latest priced Catalog available to dealers.

**Bill Sutton's**  
Wholesale Electronics  
5th at Commerce Fort Worth, Tex.

**DROP US A CARD!**

**GET ON THE MAILING LIST FOR**



• LATEST, LOWEST QUOTATIONS ON  
*Standard & Surplus*  
**Radio-TV Equipment**  
**R&M RADIO CO.**  
2701 WILSON BLVD.  
ARLINGTON, VIRGINIA

**HOW**

**Learn How to Simplify Radio Repairs!**  
**FREE MANUAL**



Nothing complex to learn. no calculating. Used by beginners and experts. Send for FREE manual, "THE INSIDE STORY," today. 32 pages—illustrated—easy to read! Shows how obsolete methods prevent full use of your real ability. Explains use of NEW techniques. You owe it to yourself and your future to "get out in front" in your work.

**FEILER** SEND COUPON OR PENNY POSTCARD FOR FREE MANUAL TODAY!

FEILER ENGINEERING CO. Dept. 3-RC5  
1601 S. Federal St., Chicago 16, Illinois  
Please RUSH my FREE copy of "The Inside Story."  
Name \_\_\_\_\_  
Address \_\_\_\_\_  
City \_\_\_\_\_ Zone \_\_\_\_\_ State \_\_\_\_\_

**OPPORTUNITY AD-LETS**

Advertisements in this section cost 25¢ a word for each insertion. Name, address and initials must be included at the above rate. Cash should accompany all classified advertisements unless placed by an accredited advertising agency. No advertisement for less than ten words accepted. Ten percent discount six issues, twenty percent for twelve issues. Objectionable or misleading advertisements not accepted. Advertisements for March, 1950, issue, must reach us not later than January 24, 1950.  
Radio-Electronics, 25 W. Broadway, New York 7, N. Y.

**AMATEUR RADIO LICENSES. COMPLETE THEORY** preparation for passing amateur radio examination. Home study courses. American Radio Institute, 101 West 63rd St., New York City. See our ad in Page 94.

**"RAPID RADIO REPAIR"** now in preparation. Order now \$1.25 Postpaid or COD. Book reveals new, sure-fire technique, repair any set. "Well written . . . wealth of good practical information." —*Radio News*. Engler Weiss, Hickok Co., John 13, Burke, 168-08 90th Ave., Jamaica (NY) NY.

**MAGAZINES (BACK DATED)—FOREIGN, DOMESTIC,** arts, books, booklets, subscriptions, pin-ups, etc. Catalog, 10¢ (refunded). Cicerone's, 86-22 Northern Blvd., Jackson Heights, N. Y.

**FREE RADIO PARTS DICTIONARY,** Telegraph Code Instructions and Catalog of Kits priced from 90¢. Build your own receivers, transmitters, test equipment with our easy-to-assemble PICT-O-GRAPH instructions. Write Today! ELECTRONIC KIT CO., 326E Park Row Bldg., N. Y. 7.

**WE REPAIR ALL TYPES OF ELECTRICAL INSTRUMENTS,** tube checkers and analyzers. Hazleton Instrument Co. (Electric Meter Laboratory), 140 Liberty Street, New York, N. Y. Telephone—Barclay 7-4239.

**BARGAIN HUNTING? RADIO SERVICEMEN WRITE** Sensational catalog. Henshaw Radio Supply, 3619 Troost Kansas City 3, Missouri.

**HERMAN LEWIS GORDON, REGISTERED PATENT** Attorney. Patent Investigations and Opinions. Warner Building, Washington, D. C.

**SALE—STANDARD BRANDS RADIO TUBES, PARTS.** Send for our free listing. Joseph Kase Electronics, 245 Echo Place, Bronx 57, N. Y.

**TV ALL CHANNEL CONICAL ANTENNA WITH** Reflectors, less mast. Special \$6.65. 100-ft. 300 OHM wire \$1.95. Discount on quantity purchases. Joseph Kase Electronics, 245 Echo Place, Bronx 57, N. Y.

**LANCASTER, ALLWINE & ROMMEL, 436 BOWEN** Building, Washington, D. C. Registered Patent Attorneys. Practice before United States Patent Office. Validity and infringement Investigations and Opinions. Booklet and form "Evidence of Conception" forwarded upon request.

**RADIOMEN, SERVICEMEN, BEGINNERS—MAKE** more money, easily, quickly, \$250 weekly possible. We show you how. Information free. Merit Products, 216-32L 132nd Avenue, Springfield Gardens 13, New York.

**BEST DISTANCE RECORD CRYSTAL CIRCUIT,** crystal, catwhiskers, "Radiobuilder" and catalog—25¢. Laboratories, 578-B, San Carlos, California.

**PHONOGRAPH RECORDS 15¢,** Catalogue. Paramount TG-313 East Market, Wilkes-Barre, Penna.

**Five Element TV Yagi Beams,** High Band \$6.75, Low Band \$8.50. Aluminum Tubing, Etc. Willard Radcliff, Fostoria, Ohio.

All steel TV tower—Shipped direct from the factory at \$8.50 per 10' section. Easy to climb. Can be erected to 70' or more. The Youngstown Steel Towers, 1316 Wilson Avenue, Youngstown 8, Ohio.

**Print Your Own**  
Cards, Stationery, Advertising, Circulars and Titles. Save money. Print for Others. Good Profits; easy rules. Have home print shop. Raised printing like engraving, too. Sold direct from factory only. Write for free catalog of outfits and all details.  
KELSEY PRESSES, P-97, Meriden, Conn.

**NEW YORK'S RADIO TUBE EXCHANGE**  
We buy, we sell, we exchange. Write for lists.

**LIBERTY ELECTRONICS, INC.**  
135 LIBERTY STREET NEW YORK 6, N. Y.  
Phone WO 4-8262

**SATISFIED READER**

Dear Editor:

I am satisfied with RADIO-ELECTRONICS as it is. I especially liked the series on electronics in medicine.

What surprises me is the fact that there are so many who want only their own selfish interests served. In the letter by Robert O. Barg in the December issue, it seems that he is trying to cover up a lack of knowledge with a long gust of wind. I have seen a lot of television sets that were as good as any 16-mm movie and I suggest he look around a bit more.

EARL J. SHEFFES

Kansas City, Mo.

MARCH, 1950

**R-E NO HELP TO HIM**

Dear Editor:

I have been a reader of your magazine for a good many years. For the past two or three years, RADIO-ELECTRONICS hasn't been worth the paper it is written on and from now on I am not going to buy another issue of your very poor magazine. I just bought the July issue and read the letter from Mr. William Krider telling what he thinks about your publishing too many articles on television, taking space away from material devoted to sound radio.

I am in favor of him and his ideas. Out here in Oregon where there are no television transmitters and a person cannot receive any TV programs, television articles are no use. I like articles on the construction of radio receivers and the like. Television is O.K. and will be a grand thing, but that is for the future. I am studying television myself, but I still like just plain radio. I read the reply you wrote to Mr. Krider, and of course you try to defend yourself with a lot of bunk in favor of television. You people are on the East Coast where there are lots of TV programs to pick up. Try coming way out here to Oregon where such programs can be viewed only rarely.

To tell the truth, I haven't been able to get any help from your magazine in the construction line and I am going to do all I can to keep others from reading it. I intended to subscribe but will never do it.

If you like you can publish this letter word for word; but I don't think you will use it, as you won't want to let the people read what I and a lot of others think of your poor radio magazine (whew, what a smell).

HOWARD D. THOMPSON

Salem, Ore.

(Mr. Thompson is right; the above is not quite what he wrote us. We felt that good publishing practice required us to clean up most of the grammatical and typographical errors and to round out his incomplete sentences. We also omitted sentences about extraneous matters for reasons of space and clarity.

As accurate reporters we are unable to testify about the odor Mr. Thompson mentions, as we may have become acclimated. Our daily mailbag and mounting circulation figures, however, indicate that it is composed of printer's ink and melting solder in fairly satisfying proportions.

After sober reflection, Mr. Thompson may agree with us that, while continuing to publish construction articles on radio receivers and similar long-time favorite projects, we would be shirking our responsibilities if we failed to prepare him for the day—it's coming soon!—when television does invade Oregon. If reflection doesn't change his attitude, shock may—when the first TV transmitter starts percolating within his range and he suddenly finds himself out on a limb with a couple of dozen ailing TV sets staring him in the face. There are now more than a dozen TV stations on the West Coast.  
—Editor)

**AMPERITE**  
Studio Microphones  
at P.A. Prices

**Ideal for BROADCASTING RECORDING PUBLIC ADDRESS**

"The ultimate in microphone quality," says Evan Rushing, sound engineer of the Hotel New Yorker.

- Shout right into the new Amperite Microphone—or stand 2 feet away—reproduction is always perfect.
- Not affected by any climatic conditions.
- Guaranteed to withstand severe "knocking around."

Models  
RBG—200 ohms  
RBHG—Hi-imp.  
List \$42.00

"Kontak" Mikes  
Model SKH, list \$12.00  
Model KKH, list \$18.00

**Special Offer:** Write for Special Introductory Offer, and 4-page illustrated folder.

**AMPERITE Company, Inc.**  
561 BROADWAY • NEW YORK 12, N. Y.  
Canada: Atlas Radio Corp., Ltd., 580 King St. W., Toronto

**HOT**  
nails

HOT NAILS, INC. NEW

**SAVES YOU DOLLARS ON TV INSTALLATIONS**

Easily pierces brick, mortar between brick, most concrete. Acts as a mast coupler and stand-off insulator!

Write for FREE sample today!

**HOT NAILS, INC.**  
40 WEST 4TH STREET, NEW YORK 12, N. Y.

**PROSPECTIVE DX-ER**

Dear Editor:

Our city is 230 miles from the nearest television transmitter but a number of us are building our own receivers. Even though it is likely to be five years before we get a local station, we find we can learn a lot by building. I have monitored the sound signal of WBAP-TV in Fort Worth on an FM receiver and we are determined to pull in the picture as well. It may sound foolish, but the bug has hit us!

ROBERT G. ELLIOTT

San Angelo, Tex.

*Enter a dynamic profession! Become an*  
**ELECTRICAL ENGINEER**



- MAJOR IN POWER OR ELECTRONICS
- B. S. DEGREE IN 36 MONTHS

Look at the powerful trends which influence your future in these fields.

Men specializing in *Electronics* enter a science of tremendous, growing value—in communications, radio, television, broadcasting, high-frequency heating, power system control, printing and other fields.

Men specializing in *Power* become equipped to serve the electrical power industry, which must face an 80% expansion of its generating capacity by 1960.

This 47-year-old Technical Institute and College offers important advantages to the young man preparing for these opportunities. He saves a valuable year by gaining his B. S. degree in 36 months of continuous study. He receives extensive technical laboratory experience on modern equipment. This is integrated, in each successive term with fundamental education in engineering and the humanities.

The World-famous course in Power covers 24 technical specialty subjects in Electrical Power, including 8 in Electrical Design.

**MILWAUKEE SCHOOL of ENGINEERING**  
 Founded 1903 by Oscar Werwath



Over 35,000 alumni and 1,555 students. Faculty of 85 specialists.

Practical, military or academic training evaluated for advanced credit. Preparatory programs also available.

TERMS OPEN JULY, OCT., JAN., APRIL

**V RADIO ENGINEERING**  
**FM—Television—Broadcast**  
 Police Radio, Marine Radio, Radio Servicing, Aviation Radio and Ultra High mobile applications. Thorough training in all branches of Radio and Electronics. Modern laboratories and equipment. Old established school. Ample housing facilities. 7 acre campus. Small classes, enrollments limited. Our graduates are in demand. Write for catalog.  
 Approved for Veterans  
**VALPARAISO TECHNICAL INSTITUTE**  
 Dept. C VALPARAISO, INDIANA



The Electronics Course covers 19 technical specialty subjects in Electronic Engineering, including four in Electronic Design.

In One Year of Study, Become an **ELECTRONIC TECHNICIAN**—This certificate is yours after 12 months of study in the Electrical Engineering (Electronics) course.

Prepare Here for a Career in **RADIO TELEVISION**—In 18 months you can become a Technician, trained for receiver and transmitter testing, servicing, sales and production.



Send coupon or letter today for this free, helpful guidance literature (see below).

**MILWAUKEE SCHOOL OF ENGINEERING**  
 Dept. RE-350—1020 N. Broadway, Milwaukee, Wis.  
 Without obligation send  48-page pictorial bulletin, "Your Career";  110-page 1950 catalog.

I am interested in ..... course.  
 Name..... Age.....  
 Address.....  
 City.....Zone.....State.....  
 Check if World War II Veteran

**TV ELECTROMAGNETIC SERVICING COURSE**  
 Practical Shop and Laboratory Training at Largest Resident TV School in the East!  
 Also RADIO SERVICE & REPAIR, F-M & TELEVISION Preparation for F. C. C. LICENSE EXAMS  
 ★ Approved for Veterans ★  
**DELEHANTY SCHOOL of TELEVISION**  
 105A EAST 13th STREET • NEW YORK 3, N. Y.

**BLISS Electrical Training**  
 Intensive 32 weeks' residence course in fundamentals of industrial electrical engineering, including radio and electronics. Extensive laboratory, shop work, drafting. Prepares for electrical technician and engineering aides in communications, power, manufacturing, business machines, sales, servicing. G.I. approved. 57th year. Enter March 6, Sept 5. Catalog.  
**7543 TAKOMA AVENUE, WASHINGTON 12, D. C.**

**RADIO SCHOOL DIRECTORY**

**JOBS in TELEVISION**  
 TELEVISION TECHNICIANS NEEDED AT ONCE  
 QUALIFIED MEN ONLY • GOOD PAY  
 STEADY WORK • GOOD FUTURE

**AMERICAN RADIO INSTITUTE**  
 CAN TRAIN YOU FOR THIS JOB  
 New York 2010 B'way (68th St.)  
 Mt. Vernon, N. Y. 174 Gramatan Ave.  
 Syracuse, N. Y. 131 Shonnard St.  
 Free Employment Service—GI Approved

**TELEVISION**  
 Laboratory and theoretical instruction under the guidance of experts, covering all technical phases of Radio, Frequency Modulation and Television. Prepares for opportunities in Broadcasting, Industry or Own Business.  
 MORNING, AFTERNOON or EVENING SESSIONS. Licensed by N. Y. State. Free Placement Service. APPROVED FOR VETERANS.  
 ENROLL NOW FOR NEW CLASSES  
 Apply Daily 9-9: Sat. 9-2  
 VISIT, WRITE or PHONE  
**RADIO-TELEVISION INSTITUTE**  
 Pioneers in Television Training Since 1938  
 480 Lexington Ave., N. Y. 17 (46th St.)  
 PLaza 9-5665 2 blocks from Grand Central

**C.T.I. TRAINED MEN ARE AVAILABLE!**  
 Each month C.T.I. graduates ambitious young men who have completed an intensive course in Radio and Television maintenance and repairing. Their training has been practical. They've learned by working on modern equipment under personal, expert supervision. If you need a trained technician, we invite you to write for an outline of our course, and for a prospectus of the graduate. (No fees, of course.) Address:  
 Placement Manager, Dept. P108-3  
**COMMERCIAL TRADES INSTITUTE**  
 1400 GREENLEAF CHICAGO 26

**SHORT CUT** **CODESPEED**  
 Be an Expert  
 Learn to be a Telegrapher or Radio Operator. Thousands of men needed. Intensely interesting work—good pay. Learn at home or wherever you are, quickly, easily, with the famous Candler Code Speed System. Quality for amateur or commercial license. Book of particulars Free.  
**FREE BOOK**  
 CANDLER SYSTEM CO.  
 Dept. 3-C, Box 928 Denver 1, Colo.

RADIO-ELECTRONICS for

**Make Your Career  
RADIO and TV**

In no other industry does the future hold brighter financial promise and security than in AM and FM Radio, Television. These fields need and want men trained as announcers, script writers, disc jockeys, and radio technicians. It will pay you to investigate the Don Martin School of Radio Arts, established in 1937. Complete day and night classes . . . the latest equipment . . . and a staff of 30 nationally known instructors. Over 97% of the combination men graduates are placed on jobs immediately through the free placement service. Approved for veterans.

FREE—Write for Free Booklet "Your Future in Radio."

**Don Martin School of Radio Arts**

1655 No. Cherokee, Hollywood, Calif. HUdson 23281



**RADIO COURSES**

Preparatory Mathematics, Service, Broadcast, Television, Marine Operating, Aeronautical, Frequency Modulation, Radar.

Classes now forming for the Summer term June 1st Entrance exam. May 22nd.

**Veterans. Literature.**

**COMMERCIAL RADIO INSTITUTE**  
(Founded 1920)  
38 West Biddle Street, Baltimore 1, Md.

**RADIO ENGINEERING!**

Complete Radio Engineering course incl. Telev., U.H.F., and F.M. B.S. Degree Courses also in Civil, Elect., Mech., Chem., and Aero. Eng.; Bus. Adm., Acct. Visit campus, see well equipped labs. Low cost. Prep. courses. Personalized instruction. Grads successful. Founded 1884. Enter March, June, Sept., Jan. Write for Catalog.

DEGREE IN 27 MONTHS

**TRI-STATE COLLEGE** 2430 College Ave. ANGOLA INDIANA

**AUDIO ENGINEERING SCHOOL**

Practical engineering training in Audio fundamentals. Disc. Film, Magnetic Recording, and Audio frequency measurements. Studio training simulates Broadcast, Motion Picture, Television, and Commercial Recording work. Approved for Veterans

**HOLLYWOOD SOUND INSTITUTE, Inc.**  
1040-E North Kenmore, Hollywood 27, Calif.  
Correspondence Courses Available  
Specify if Veteran or Non-Veteran

**TRAIN FOR ALL TYPES  
FCC (RADIO OPERATOR) LICENSES**

Complete Raytheon AM and FM broadcast transmitters and studio control equipment. Also TV camera chain unit. 30th anniversary year. Please send for catalog R.

**MASS. RADIO SCHOOL**  
271 Huntington Ave., Boston 15, Mass.  
Lic. by Comm. Mass. Dept. Ed.



**RADIO and TELEVISION**

Thorough Training in All Technical Phases

APPROVED FOR VETERANS

RCA GRADUATES ARE IN DEMAND  
For Free Catalog Write Dept. RC-50

**RCA INSTITUTES, Inc.**  
A Service of Radio Corporation of America  
350 WEST 4TH STREET NEW YORK 14, N. Y.

**LEARN RADIO!**

PREPARE FOR A GOOD JOB!  
COMMERCIAL OPERATOR (CODE)  
RADIO SERVICEMAN  
TELEVISION SERVICING  
BROADCAST ENGINEER

V.A. Furnishes Books and Tools  
SEND FOR FREE LITERATURE

**BALTIMORE TECHNICAL INSTITUTE**  
1425 Eutaw Place, Dept. C, Baltimore 17, Md.

**VIDEO HANDBOOK**, by Morton G. Scheraga and Joseph J. Roche. Published by William F. Boyce, Montclair, N. J. 5 x 7 inches, 892 pages. Price \$5.

The pages of this volume contain the most complete (though not always the most thorough) description of the television system this reviewer has seen to date. Starting with a chapter on the history and the present status of television, the book goes on to explain the entire process from camera tube to viewing screen. The material on C-R tube construction is not new but is unusually full. Camera tubes are treated in detail and station transmission standards are listed. A large section on the TV station includes many diagrams.

The television receiver has a 174-page section to itself, in which its operation is discussed from beginning to end. The treatment is, of course, less exhaustive than would be possible in a book devoted solely to receivers. Other receiver material, however, includes a section describing typical commercial receivers in some detail, another outlining installation methods, and a third on servicing. A 24-page section discusses test equipment.

One interesting feature is a set of instructions for building a televiser. Schematic diagrams and some drilling templates are given, but it is doubtful that the instructions are sufficiently complete to make the project practicable for any but advanced technicians.

Some information perennially hard to find is in the book—data on remote TV pickup equipment, microwave relays, and other broadcast-station practices. A data section gives a sample service contract, a list of channel assignments in 150 cities, and characteristic and basing charts for 29 C-R tubes. The final sections are a glossary of TV terms and a bibliography of books on television.—R. H. D.

**TELEVISION FOR RADIOMEN**, by Edward M. Noll. Published by the Macmillan Co., N. Y. 6 1/4 x 9 1/2 inches, 595 pages. Price \$7.

Designed as a course in television for those who expect to do service work on receivers, this book gives very complete information on receiving circuits. The parts dealing with service procedures use actual sets as examples. A final chapter on television mathematics is included for those who wish to do more advanced work; the earlier sections contain almost no mathematics.

**25 WATT AUDIO AMP. KIT**  
P.P. 61.6 Output. The best buy on the market to-day. Make up an amplifier worth \$50. Powerful enough for auditoriums. Separately controlled Mike and Phono inputs. All parts—drilled chassis—hdwr.—etc. MATCHED OUTPUT XPMR \$1.49—Set of New Tubes \$3.95. **\$11.95** less tubes

**TWO-WAY INTERCOM KIT**  
NOTHING ELSE TO BUY—2 spkrs.—3 tubes—chassis—hdwr.—everything to make a fine system for the home, office, school, shop, ideal "baby-sitter" . . . **\$9.95**

**CODE PRACTICE OSC. KIT \$5.95**  
(all prices f.o.b. our plant)

Send Name & Address For Our Mailing List

**Universal/general corp**  
365 J CANAL ST. N. Y. 13,  
Walker 5-9642

**Everybody's  
Talking about  
the EMC**

**\*VOLOMETERS**

\*Reg. Trade Mark for Volt-Ohm-Milliammeter

**MODEL 102**  
(1000 ohms per volt meter)

- 3" SQUARE METER
- 3 AC CURRENT RANGES (0-30/150/600 ma.)
- Same zero adjustment for both resistance ranges (0-1000 ohms, 0-1 meg-ohms)
- 5 DC & 5 AC Voltage Ranges to 3,000 Volts. Also 4 DC Current Ranges. **\$13.90**



**MODEL 103**  
(1000 ohms per volt meter)

- 4 1/2" SQUARE METER
- 3 AC CURRENT RANGES (0-30/150/600 ma.)
- Same zero adjustment for both resistance ranges (0-1000 ohms, 0-1 meg-ohms)
- Same Ranges as Model 102. Also 5 DB Ranges. **\$17.50**



Model 103-S with plastic carrying strap . . . \$17.95

**MODEL 104**  
(20,000 ohms per volt meter)

- 4 1/2" SQUARE METER (50 micro-amperes—alnico magnet)
- Includes carrying strap
- 5 DC Voltage Ranges to 20,000 ohms/volt to 3,000 V. 5 AC Voltage Ranges to 3,000 V. 3 Resistance Ranges to 20 megs. Also 3 AC & DC Current Ranges. **\$24.95** & 5 DB Ranges.



All of the above have round cornered, bakelite, molded cases.

Export Dept., 303 W. 42nd St., N.Y.C.  
Write Dept. B-3 for Free Catalog

**EMC**

Gives More Measurement Value per Dollar!

**ELECTRONIC MEASUREMENTS CORP.**

423 BROOME STREET, NEW YORK 13, N. Y.

**RADIO COURSES**

- RADIO OPERATING • CODE
- RADIO SERVICING • ELECTRONICS
- F.M. TELEVISION
- REFRIGERATION SERVICING

Write for Catalog TE and Picture Brochures

**Y.M.C.A. TRADE & TECH. SCHOOL** 229 W. 44 St., N. Y. 23 INdicoff 2-8117

**PEN-OSCIL-LITE**

Extremely convenient test oscillator for all radio servicing; alignment • Small as a pen • Self powered • Range from 700 cycles audio to over 600 megacycles u.h.f. • Output from zero to 125 v. • Low in cost • Used by Signal Corps • Write for information.

**GENERAL TEST EQUIPMENT**  
38 Argyle Ave. Buffalo 9, N. Y.

### THE FINEST 16" TELEVISION SET EVER DESIGNED!

Now you can have the finest 1950 model *Voltage Doubler* Giant Screen Television Set ever designed. Custom built and improved with unusually high brilliance which will give you thousands of hours of fine entertainment during day or evening hours. A bright, clear steady picture is assured by the most famous television set ever produced, the RCA designed 630 type chassis. This identical type TV set is used by more Radio & TV Engineers than any other set ever manufactured!

The 30 tube circuit is more sensitive than any of the cheaper sets having less tubes and the new Standard Tuner has a pentode RF stage which acts as a *built-in high-gain Television Booster on all channels*. Also featured is an automatic frequency control system that keeps the picture steady and makes tuning easier.

Factory wired and tested, ready to operate. Shipped complete with tubes, less 16" picture tube **\$149.50**  
 Extra-Clear 16" glass picture tube—**\$39.50** guaranteed for one year—

#### SPECIAL!

Super-Giant 19" Television Set. 630 type similar to above, but modified to provide a whopper-sized picture. Factory-wired and tested, ready to operate. Shipped complete with tubes, less 19" picture tube. Price \$169.50

Extra-Clear 19" glass picture tube—**\$79.50** guaranteed for one year—

12 1/2" 630 chassis—\$149.50;

12 1/2" tube—1 year guarantee—\$24.95

### DE LUXE TELEVISION CABINETS

Beautifully designed to match the 630 chassis without any cutting or drilling. Solidly constructed like the finest furniture with a satiny piano finish. Shipped complete with mask and protective glass window.

16" Table Model—Mahogany or Walnut **\$39.95**

19" Table Model—Mahogany or Walnut **\$44.95**

16" Console—with drop panel to conceal knobs when desired. Mahogany or Walnut **\$69.50**

Blonde..... **\$79.50**

19" Console—with drop-panel as above—Mahogany or Walnut **\$79.50**

Blonde..... **\$89.50**

### 4-TUBE AC/DC TELE-BOOSTER

#### CHECK THESE FEATURES

- Uses 4 type 6AK5's in an extremely stable and efficient wide-band amplifier circuit. • Self-contained power supply. • Covers all television channels in use. • Eliminates need for outdoor antennas in many locations. • Will actually make difference between "Flat" and very bright pictures on weak stations. • Improves receiver immunity to off-channel interference. Can be tuned to boost weak station or turned off to provide normal reception. • Simple to install and operate, requires only external connection to receiver. • Operates on 110 volts AC or DC. **ONLY \$16.95**

### TWO STATION INTER-COMMUNICATION SYSTEM

Radiomen—provide yourself with an additional source of income by selling and installing these high quality—low cost intercoms. Selling Features: • For the nursery (baby sitting) or sickroom. • In private homes—room to room—garage to house—basement to attic, etc. • Busy businessmen • Ideal for use in television antenna installation and servicing—instead of unhandy earphones • Simple installation—only 2 wires to connect • Housed in an attractive walnut case, 1 master and 1 slave station, complete with tubes.

Price..... **\$10.95**

Extra for 50 feet twin-lead cable..... \$1.00

For complete listings of special buys for experimenters, radio technicians, laboratories, schools and engineers. Write for catalog T3.

**RADIO DEALERS SUPPLY CO.**  
 154 GREENWICH ST. NEW YORK 6, N. Y.

## ADVERTISING INDEX

Allied Radio Corporation	49
Almo Radio	85
American Electrical Heater Company	8
American Phenolic Corporation	86
Amperite Company	93
Amplifier Corporation of America	78, 96
Walter Ashe Radio Company	87
Bell Telephone Laboratories	Inside Front Cover
Boland & Boyce, Inc.	62
Boyce-Rache Book Company	53
Brook Electronics	62
Brook's Radio Dist. Corporation	79
Buffalo Radio Supply	73
Capitol Radio Engineering Institute	7
Cinex Incorporated	85
Circle X Antenna Corporation	89
Cleveland Institute of Radio	22
Communications Equipment Company	68
Coyne Electrical School	69, 77
DeForest's Training, Inc.	11
Editors and Engineers	75
Electro Products Laboratories	60
Electro-Technical Industries	64
Electronic Instrument Company, Inc.	61
Electronic Measurements Corporation	95
Elliott Laboratories	60
Esse Radio Company	56, 57, 58
Fair Radio Sales	91
Feiler Engineering Company	90, 92
General Electronic Dist. Company	51
General Test Equipment Company	95
Greylin Company (The)	83
Greylock Electronic Supply Company	78
Harvard Laboratory	64
Heath Company	13, 14, 15, 16, 17, 18, 19, 20
Herbach & Rademan	96
Hickok Electrical Inst. Company	85
Hot Nails	93
Hudson Specialties Company	82
Hytro Radio & Electronics Corp.	12
Instructograph Company	83
Insuline Corporation of America	90
Kelsey Company (The)	93
Lafayette Radio Co.	65
Electronic Research Laboratories	64
Leotone Radio Corporation	78
Liberty Electronics	93
McGraw-Hill Book Company, Inc.	96
Macmillan Company (The)	97
Midwest Radio Corporation	92
Murray Hill Books, Inc.	82
National Company	4
National Plans	75
National Radio Institute	3
National Schools	5
Niagara Radio Supply	89
Oak Ridge Mfg. Company	68, 74
Odegaard Manufacturing Company	80
Ohmite Manufacturing Company	68
Opportunity Adlets	93
Pitman Pub. Co.	97
Precision Apparatus Company	59
Precision Radiation Inst., Inc.	85
Price Tenna-Trailer Company	77
Progressive Electronics Company	90

### RADIO SCHOOL DIRECTORY

(Pages 94-95)

American Radio Institute	Hollywood Sound Institute
Baltimore Technical Institute	Massachusetts Radio School
Bliss Electronic School	Milwaukee School of Engineering
Candler System Company	RCA Institutes
Commercial Radio Institute	Radio Television Institute
Commercial Trades Institute	Tri-State College
Delehanty Institute	Valparaiso Technical Institute
Don Martin School of Radio Arts	YMCA Trade & Technical Schools
RCA Victor Division Radio Corporation of America	6, Back Cover
R & M Radio Company	92
Radio City Products	78
Radio Corporation of America	63
Radio Dealers Supply Company	96
Radio Receptor Company, Inc.	87
Radio Supply & Engineering Co.	88
Radionic Equipment Corporation	74
Raytheon Mfg. Company	59
Rose Company (The)	64
Sams & Co., Inc., Howard W.	9, 76
Senco Radio, Incorporated	55
Simpson Electric Company	72
Sonic Industries	80
Sovereign Television Company	84
Spartan School of Radio Electronics	70
Sprague Products Company	80
Sprayberry Academy of Radio	Inside Back Cover
Standard Transformer Corporation	75
Supreme Publications	67
Bill Sutton's Wholesale Electronics	92
Swedgal Radio, Inc.	81
Sylvania Electric Products	21
Tech-Master Products Company	62, 74
Technifax	76
Tel-A-Ray Enterprise	91
Telrex, Incorporated	66
Terminal Radio Corp.	84
Turner Company (The)	83
Universal General Corporation	95
York Radio Co.	75, 83, 90
Ward Products	71
Wells Sales	98
Wholesale Radio Parts Co., Inc.	80

49 OF ENGINEERS EVERYWHERE

## TWIN-TRAX\* TAPE RECORDER

Available to you direct from the factory at savings that make TWIN-TRAX the only professional-type recorder in the popular-price field. More than a dozen model variations for portability, long-play, continuous operation, etc. For a better tape recorder that combines professional quality with operating ease and trouble-free construction, it's TWIN-TRAX. Write today for complete literature. \*Trade Mark Registered

**AMPLIFIER CORP. OF AMERICA**  
 398-10 Broadway • New York 13, N. Y.

Latest Information

## RADIO & ELECTRONICS

You'll want

### HERBACH & RADEMAN'S

complete 16 page catalog of radio and electronic equipment every month

**ABSOLUTELY FREE**

Just send your name and address to Dept. R.E.

### HERBACH & RADEMAN, INC.

522 Market Street Phila. 6, Pa.

Now . . . shortcut your mastery of the best

## TELEVISION SERVICING TECHNIQUES



Here is an up-to-the-minute manual covering TV receiver installation and servicing. You get a detailed picture of both AM and FM circuits, operation, and servicing. Everyday TV receiver jobs go faster with the understanding of fundamentals you get in this down-to-earth manual.

Elaborate trouble-shooting charts show symptoms, causes and cures for over 50 common TV receiver problems. Simplified diagrams, schematic drawings, and photographs help show you what to do and how to do it.

## BASIC TELEVISION PRINCIPLES AND SERVICING

By **BERNARD GROB**  
 Instructor, RCA Institutes  
**592 pages, 6 x 9, over 400 tables, charts, illustrations \$6.50**

This new book combines well-rounded self-instruction in basic TV principles with practical, ready-reference receiver trouble-shooting guidance. Each block of receiver circuits is discussed separately to ensure clear understanding of all details. You get more than enough material to qualify for the FCC's added FM and TV requirements for the 1st class license test.

- #### COVERS
- Oscilloscope operation
  - Ratio detector system and intercarrier sound receivers
  - Automatic synchronizing control and synchronous system
  - Projection systems
  - Sequential, simultaneous color TV
  - Picture tubes from 3NP4 to 20BP4
  - Power supplies
  - Brightness control
  - Separation of synchronizing signals, etc., etc.

### 10 DAYS FREE EXAMINATION

MrGraw-Hill Book Co., 330 W. 42nd St., NYC 18  
 Send me Grob's BASIC TELEVISION Principles & Servicing for 10 days' examination on approval. In 10 days I will remit \$6.50, plus few cents for delivery, or return book postpaid. (We pay for delivery if you remit with this coupon; same return privilege.)

Name.....  
 Address.....  
 City..... Zone..... State.....  
 Company.....  
 Position..... RC-3-50

RADIO-ELECTRONICS for



*It's clear!*  
*It's complete!*

**NOW!** A complete radio reference library in one volume. Covers clearly and concisely the whole field of radio communications, including telegraphy, telephony, television, transcription and facsimile.



# Radio TECHNOLOGY

by  
**Ernest J. Vogt**

Formerly marine inspector (radio) Part of New York. Has held every class radio license ever issued. Now acting as private radio engineering consultant and assistant chief engineer, Aerojet Engineering Corp.

**REFER TO IT REGULARLY!**  
Depend On It  
For Technical Information!

**RADIO TECHNOLOGY** presents a complete technical picture of the radio-television field with all higher mathematics eliminated! A single chapter reviews all the mathematics necessary to understand fully the material discussed in this informative volume.

### TABLE OF CONTENTS (Abbreviated)

BASIC ESSENTIALS: The Atomic Theory . . . Electricity . . . Magnetism . . . Terminology. RADIO MATHEMATICS: Elementary Algebra . . . Trigonometry. CHEMICAL PRODUCTION OF ELECTRIC CURRENTS. DIRECT-CURRENT THEORY. BASIC ALTERNATING-CURRENT THEORY. MOTORS AND GENERATORS. INDUCTANCE. CAPACITANCE: Effects of Capacitance . . . Capacitive Reactance . . . The Electrolytic Capacitor . . . Parallel Capacitance . . . Series Capacitance. ADVANCED ALTERNATING-CURRENT THEORY. THE VACUUM TUBE. THE VACUUM-TUBE OSCILLATOR. RECEIVING-CIRCUIT PRINCIPLES. TRANSMITTING-CIRCUIT PRINCIPLES. SOUND CONVERSION. ANTENNAS: The theory of Wave Propagation . . . Antenna Resistance . . . Antenna Circuits . . . Skip Distance . . . Transmission Lines . . . Coupling Methods. RADIO AIDS TO NAVIGATION: The Radio Direction Finder . . . The Airway Radio Beacon. MEASUREMENTS IN RADIO. STUDIO AND CONTROL EQUIPMENT. TELEVISION AND FACSIMILE: Television . . . Radio Facsimile. APPENDIX.

### SEND NO MONEY!

Mail this coupon NOW! We will rush you a copy of **RADIO TECHNOLOGY** on approval! If you are not satisfied, return the volume to us without obligation.

Pitman Publishing Corp.  
2 West 45th Street, New York 19, N. Y.

Please send me **RADIO TECHNOLOGY**. Within 10 days I will either return the book and owe nothing, or I will send you \$6.00.

NAME .....

ADDRESS .....

CITY ..... STATE .....

(If you send the \$6.00 with this coupon, we will pay the postage. Same return privilege and refund guarantee.)

**INTERNATIONAL RADIO TUBE ENCYCLOPAEDIA**, edited by Bernard B. Babani. Published by Bernards (Publishers) Ltd., London. 8 x 10 inches, 410 pages. Price \$6.50. Distributed in U.S.A. by Terminal Radio Corp., N.Y.C.

With technical matter and instructions presented in 15 languages (Czech, Danish, Dutch, English, French, German, Hebrew, Italian, Norwegian, Polish, Portuguese, Russian, Spanish, Swedish, and Turkish), this master tube manual contains operating characteristics and pin connections for over 15,000 different types of radio tubes manufactured all over the world.

Separate sections are devoted to radio receiving tubes; triode transmitting tubes; transmitting tetrodes, pentodes, and other transmitting tubes having more than five elements; rectifiers; thyratrons; regulator and control tubes; tuning indicators; cathode-ray tubes; photo tubes; and rare tubes and their equivalents. A 24-page supplement includes data on tubes not included in preceding sections, diagrams of tube bases, and names and addresses of tube manufacturers.—*R.F.S.*

**ELECTRONICS: EXPERIMENTAL TECHNIQUES**, by W. C. Elmore and Matthew L. Sands. (National Nuclear Energy Series, Los Alamos Project V-1). Published by McGraw-Hill Book Co., New York, N.Y. 6½ x 9¼ inches, 417 pages. Price \$3.75.

The authors have prepared a book which may well serve as a workbook or manual for students and engineers engaged in electronic and nuclear research and development. It contains a wealth of information on circuits of such devices as regulated power supplies; wide band amplifiers; oscilloscopes; electronic counters; sweep, timing, and pulse generators; and numerous other types of testing and calibrating equipment.

Complete circuits are given with full step-by-step descriptions of their operation without recourse to graphic or mathematical analysis. In this newborn age of nuclear and electronic research, this book has a place on the bookshelf of every student and engineer who may have need for special circuits for laboratory work.—*R.F.S.*

**PRACTICAL TELEVISION SERVICING AND TROUBLE-SHOOTING MANUAL**. Published by Coyne Electrical & Radio-Television School, Chicago. 5½ x 8½ inches, 392 pages plus index. Price \$4.25.

The most remarkable thing about this book is the final chapter. Printed in 4 colors, its 45 pages are devoted to explanations of CBS, NBC, and other systems of color television.

The greater part of the book is intensive instruction for the practical service technician, based on service-shop procedure, with the first two chapters outlining service methods and instruments. Throughout, the text abounds with definite instructions to "do this" in a given case and "do that" in another. The "practical" in the book's title is no misnomer.—*R. H. D.*

## WHAT IS YOUR PROBLEM?

You will find the answer in

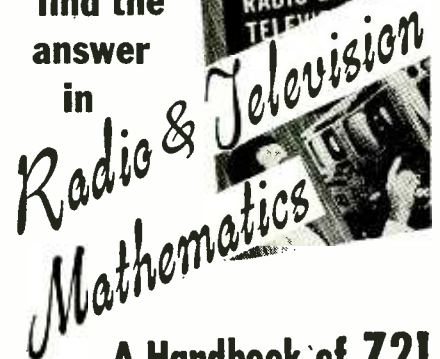

**A Handbook of 721 problems AND SOLUTIONS**

*Save time and trouble.* Arranged under radio and electronic headings and completely indexed for quick reference, these problems give you step-by-step solutions to every problem commonly arising in work on receivers, power supplies, antennas, amplifiers, tubes, transmitters, etc. If you are ever "stuck" on a calculation; if you need a check on your figuring; or if you want to refresh your memory on the formulas to use for a certain problem—you will find your answer *quickly and easily* in this book.

*Good practice for your FCC exams.* This book shows you how to solve every problem requiring mathematics in the FCC STUDY GUIDE for licenses of all classes. You will find no better handbook for practice in solving problems with ease, speed and accuracy. \$6.00

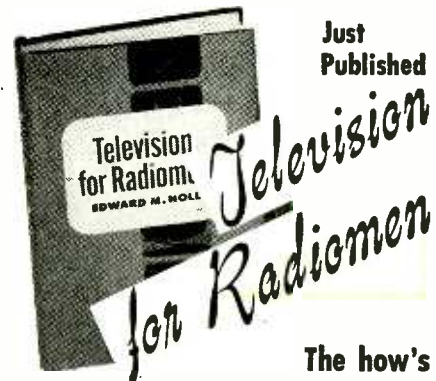

Just Published

The how's AND WHY'S in the practical terms of operation & servicing

This book explains the *theory* as well as the techniques of television construction, operation, and servicing in the clearest, most practical terms. It gives the radioman all the basic information he needs to meet the increasing demand for skilled television technicians. It shows how and *why* all modern equipment operates; includes all the essential mathematics and especially good material on antennas. \$7.00

### SEE THEM FREE

The Macmillan Co., 60 Fifth Ave., New York 11

Please send me a copy of the books checked below. I agree to remit in full or return the books within ten days without further obligation.

- Radio & Television Mathematics, \$6.00
- Television for Radiomen, \$7.00

Signed.....

Address.....

# SAVE on Miniature and Toggle Switches at WELLS

## Miniature Switches

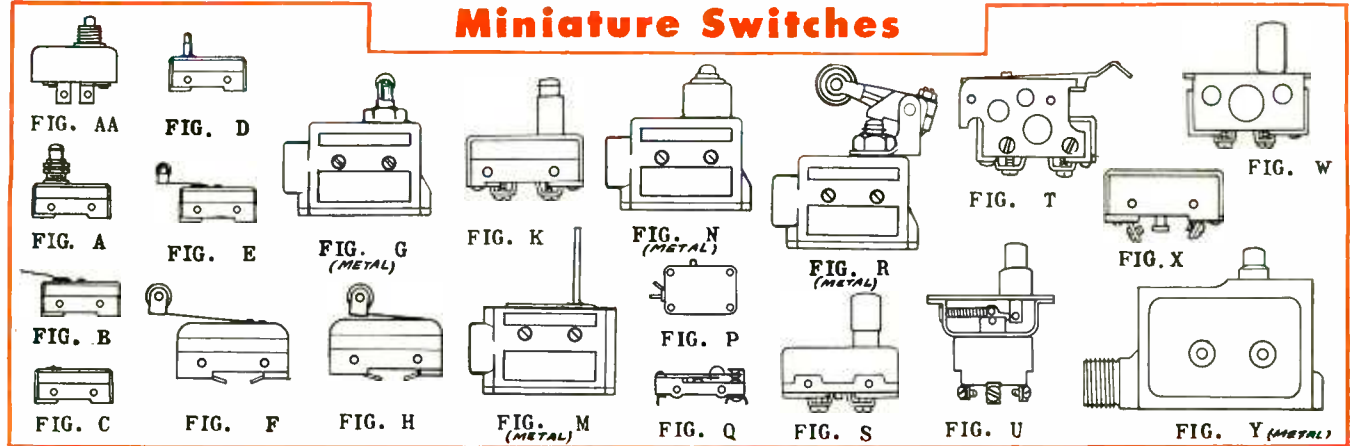

STOCK NUMBER	MANUFACTURER	MFR. TYPE NO.	CONTACTS	ILLUSTRATION	PRICE EACH	STOCK NUMBER	MANUFACTURER	MFR. TYPE NO.	CONTACTS	ILLUSTRATION	PRICE EACH
305-10	Microswitch	WP3M5	N.C.	FIG. AA	\$0.40	311-116	Microswitch	SW0186	N.C.	FIG. D	.63
305-160	Microswitch	WP-5M3	N.C.	FIG. AA	.40	303-49	Microswitch	YZ2YST	SPDT	FIG. D	.68
307-210	Microswitch	YP3A	N.O.	FIG. AA	.50	309-93	Microswitch	BRS36	SPDT	FIG. D	.68
L309-75	Microswitch	YZ-RQ1	N.O.	FIG. A	.92	370-17	Microswitch	QRS	SPDT	FIG. D	.75
303-67	Microswitch	YZ7RA6	N.O.	FIG. A	.71	PH-112	MU-Switch	MBW	SPDT	FIG. E	.72
PH-100	Acro	RO1P2T	N.O.	FIG. A	.71	305-64	Microswitch	WZR12	N.C.	FIG. E	.65
301-46	MU-Switch	MLB-321	SPDT	FIG. B	.85	311-25	MU-Switch	CUN24155	N.C.	FIG. E	.85
301-93	Microswitch	YZ-2YLTC1	SPDT	FIG. B	1.01	370-10	Acro	RO2M12T	N.O.	FIG. E	.70
301-30	MU-Switch	RO2M	SPDT	FIG. B	.95	303-32	Microswitch	YZ-3RW2T	N.O.	FIG. F	.65
301-78	MU-Switch	Green Dot	SPDT	FIG. B	.75	306-10	Microswitch	BZE-2RQ9TM1	SPDT	FIG. G	2.48
303-79	Microswitch	BZ-RL32	SPDT	FIG. B	.75	309-101	Microswitch	BZ-2FW221	SPDT	FIG. H	.95
303-85	MU-Switch	MLB329	SPDT	FIG. B	.67	PH-113	Microswitch	RZBQT	SPDT	FIG. K	.58
305-154	Acro	XD4-5L	SPDT	FIG. B	.78	L306-1010	Acro	RO7-8586	N.O.	FIG. K	.55
311-130	Acro	—	SPDT	FIG. B	.70	370-18	Acro	HRO71P2TSF1	N.O.	FIG. K	.60
PH-101	Microswitch	BRL18	SPDT	FIG. B	.78	370-19	Microswitch	YZRQ41	N.O.	FIG. K	.65
PH-102	Microswitch	YZRL812	N.O.	FIG. B	.65	370-40	Cutler Hammer	—	N.O.	FIG. K	.75
PH-103	MU-Switch	Blue Dot	SPDT	FIG. B	.68	370-8	Microswitch	RN-11-H03	SPDT	FIG. M	1.50
PH-104	Microswitch	YZ3RLTC2	N.O.	FIG. B	.64	309-157	MU-Switch	—	N.C.	FIG. N	1.15
PH-105	Microswitch	YZR31	N.O.	FIG. C	.53	370-15	MU-Switch	AHB203	SPDT	FIG. N	1.25
PH-106	Microswitch	R-R36	N.C.	FIG. C	.53	370-7	Microswitch	WZE-7RQTN	N.C.	FIG. N	1.35
PH-107	Microswitch	G-R36	N.C.	FIG. C	.53	305-11	Acro	2M031A	N.O.	FIG. P	.37
PH-108	Microswitch	WZ-2RT	N.C.	FIG. C	.71	305-71	Acro	2MD41A	SPDT	FIG. P	.37
305-161	Microswitch	YZ3R3	N.O.	FIG. C	.71	305-50	Microswitch	Open Type	SPDT	FIG. Q	.35
311-115	Microswitch	WZR31	N.C.	FIG. C	.60	370-28	Microswitch	YZE-RQ22	N.O.	FIG. R	2.75
311-123	Microswitch	WZ-7R	N.C.	FIG. C	.60	303-84	Acro	HRO7-4PST	N.O.	FIG. S	.50
311-126	Acro	HRRCT.1A	N.C.	FIG. C	.50	303-83	Microswitch	YZ-RQ4	N.O.	FIG. S	.50
311-125	Acro	HRR07.1A	N.O.	FIG. C	.53	PH-114	Microswitch	WZR-31	N.C.	FIG. T	.65
311-121	Microswitch	WZ7RTC	N.C.	FIG. C	.50	PH-115	Cutler Hammer	8905K564	DPDT	FIG. U	.65
311-128B	Microswitch	YZ	N.O.	FIG. C	.53	PH-116	Microswitch	WZRQ41	N.O.	FIG. W	.60
370-6	Microswitch	X757	N.C.	FIG. C	.45	PH-118	Microswitch	BZRQ41	SPDT	FIG. W	.60
PH-109	Microswitch	RRS13	N.C.	FIG. D	.45	311-128A	Microswitch	YZ-RTX1	N.O.	FIG. X	.90
PH-110	Microswitch	BRS36	SPDT	FIG. D	.53	PH-117	MU-Switch	Z	N.C.	FIG. Y	1.35
PH-111	Microswitch	GRS	N.O.	FIG. D	.49						

## Toggle and Push Switches

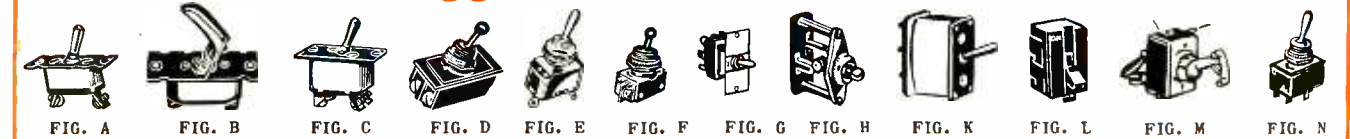

STOCK NUMBER	FIG.	CONTACT ARRANGEMENT	MANUFACTURER & NUMBER	PRICE EACH	STOCK NUMBER	FIG.	CONTACT ARRANGEMENT	MANUFACTURER & NUMBER	PRICE EACH
PH-500	A	SPDT	B1B	.35	305-174	C	DPDT CENTER OFF MOM 1 SIDE	AN-3023-5	.50
PH-501	A	SPDT	AN3022-3B	.35	305-177	C	DPDT CENTER OFF MOM EACH SIDE	C-3	.50
PH-502	A	SPST MOMENTARY	B10	.30	305-176	C	DPDT CENTER OFF MOM EACH SIDE	AN-3023-7	.50
PH-503	A	SPDT CENTER OFF MOM EACH SIDE	B11	.32	305-173	C	DPDT	8710K3	.55
PH-504	A	SPDT CENTER OFF	B14	.35	305-175	C	DPDT CENTER OFF MOM EACH SIDE	3712K3	.50
PH-505	A	SPDT MOMENTARY	B21	.30	305-179	C	DPDT CENTER OFF MOM EACH SIDE	8732-K2	.50
PH-505	A	SPST	AN-3022-2B	.30	309-163	C	DPDT CENTER OFF MOMENTARY	CH C-11	.55
PH-506	A	SPDT CENTER OFF	AN-3022-1	.35	309-162	C	DPST	CH C-1	.45
PH-507	A	SPDT CENTER OFF MOM EACH SIDE	AN-3022-7B	.32	309-164	C	DPST MOMENTARY	CH 8711K3	.40
PH-508	A	SPST MOMENTARY	AN-3022-8	.28	370-31	C	DPDT	CH C-1B	.55
PH-513	A	SPDT CENTER OFF	CH AN-3022-1B	.38	305-87	D	1 SIDE DPST MOM 1 SIDE SPST	AH & H	.95
PH-514	A	SPST	CH B-5 A	.35	305-111	E	SPST MOMENTARY	CH 8817K2	.28
LT-104	A	SPDT 1 SIDE MOMENTARY	CH 8905K568	.35	305-153	E	SPDT CENTER OFF	CH AN-3021-1B	.35
309-168	A	SPST	168553	.30	LT-100	F	SPST	CH	.22
309-171	A	SPDT CENTER OFF MOM 1 SIDE	CH 8209K5	.35	LT-101	F	SPST MOMENTARY	AH & H W/LEADS	.20
370-1	A	SPST MOMENTARY	CH AN-3022-8B	.25	301-51	G	4PDT MOMENTARY	CH 8905K12	.75
370-4	A	SPDT CENTER OFF	CH B-9A	.35	305-140	H	DT NO MAKE EACH SIDE	OPEN FRAME	.25
370-14	A	SPDT CENTER OFF 1 SIDE MOM.	CH B-7A	.30	309-161	K	SPST	CH 8781K3	1.95
370-25	A	SPST MOMENTARY	CH B-6B	.25	305-76	L	DPST	AH & H OPEN FRAME	.75
305-171	A	SPDT CENTER OFF MOM 1 SIDE	8209K5	.32	311-77	L	DPST	AH & H	1.25
309-169	B	SPST MOMENTARY	CH B-19	.35	301-12	M	DPST	AH & H SPECIAL FOR HANDY	.40
PH-509	C	DPST	AN-3023-2B	.45	LT-107	N	DPST	AH & H TALKIE	.25
PH-510	C	DPDT MOMENTARY	CH 8715K2	.50					
PH-511	C	DPDT MOMENTARY	CH 8715K3	.50					
PH-512	C	DPST CENTER OFF	CH 8720K1	.55					
303-65	C	DPST	CH AN-3023-2	.45					

Distributors: Our standard distributor arrangement applies on these items.

Many More Types in Stock. Send Us Your Requirements.

**JUST OUT: CATALOG H500** Manufacturers, Distributors and Amateurs write for the brand new Wells Electronic Catalog H500. Full of tremendous values in highest quality components.



Order directly from this ad or through your local parts jobber—

**320 N. LA SALLE ST. DEPT. Y, CHICAGO 10, ILL.**

**YOU** Need My PRACTICAL Training to Make Money in

# TELEVISION- RADIO and ELECTRONICS!



I'll Send You  
**8 BIG KITS** of  
Radio Parts and Equipment . . .

Learn at  
**HOME**  
IN YOUR  
SPARE TIME

**NOW IS THE TIME To Get Into This Fast Growing Industry—Prepare For A Fine Paying Job Or Your Own Business!**

If you want to get into Radio-Television and Electronics . . . you owe it to yourself to get the facts about my training. I have trained hundreds of men to become outstanding service technicians—and I'm ready to do the same for you. Whether your goal is a fine paying job in one of Radio's many branches—or a successful Radio and Television business of your own—you need the kind of training I offer! My training is practical and down to earth. **YOU NEED NO PREVIOUS EXPERIENCE.** You'll be astonished at your rapid progress. I start you with basic fundamentals and give you plenty of practical shop-bench training with many kits of parts I send you. This is the training that sticks with you and makes money for you on the job!

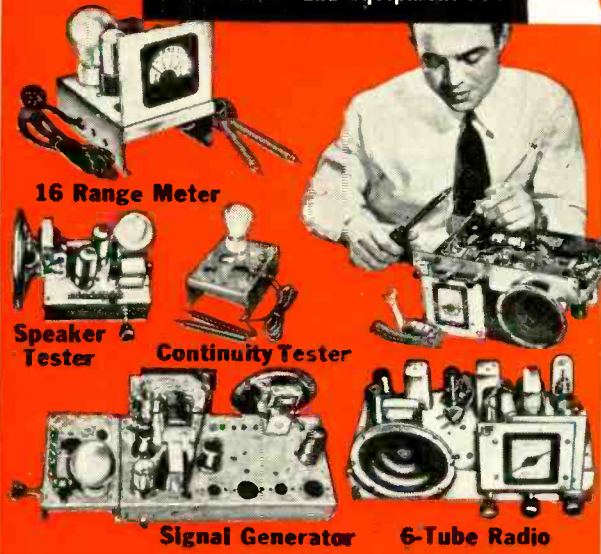

16 Range Meter

Speaker Tester

Continuity Tester

Signal Generator

6-Tube Radio

## Get Paid For Spare Time While Learning

Soon after you start training I send you my famous **BUSINESS BUILDERS** that show you how to make money in spare time doing interesting Radio jobs. Look at the useful and valuable equipment you get while training with me (illustrated at left)—I send you these 8 big kits of Radio parts and equipment and help you build step-by-step a powerful 6-tube superhet radio, a 16-range test meter, plus other mighty, useful equipment for Radio and Television servicing. You will perform over 175 fascinating experiments while training. You will learn about Television—so that you will be qualified to step into this fast growing, profitable field. I also send you many valuable service manuals, diagrams and my book telling exactly how to set up your own Television and Radio shop. *I want you to learn all about my training*—and that is why I urge you to clip and mail the coupon below for my two big **FREE** Radio hooks. I employ no salesmen—and nobody will call on you. The important thing is to act now and get the facts.



## HAVE A BUSINESS OF YOUR OWN

A profitable Radio and Television Service Shop may be started with little capital. I will show you how to get started and how to build your small business. At left is pictured one of my graduates, Mr. Merrit C. Sperry of Fairmont, Minnesota in his own shop. The way is also open for you to build a good **SERVICE BUSINESS FOR YOURSELF.**

## ALL KITS ARE YOURS TO KEEP

Each of the hundreds of Radio parts and other items I send my students is theirs "for keeps." You may use this equipment in your Radio and Television service work and save many dollars by not having to buy expensive "ready-made" test equipment. Each of my 8 kits will help you advance and learn important steps in Radio and Television servicing.



**CALVIN SKINNER** of New Orleans, La. tells us he makes \$5 to \$10 in spare time repairing radios. He is now also working with his own Television set.



**LOREN D. SAUCIER** of Coloma, Mich. reports that my training has made it possible for him to repair large numbers of Radio and Television receivers.

## RADIO AND TELEVISION INDUSTRY BOOMING

You couldn't pick a better time to get into Radio-Television and Electronics. New Television stations are going on the air to serve every major city—hundreds of new AM and FM Radio broadcasting stations are also on the air to serve practically every community in America. All this creates new and bigger opportunities for the trained man who knows Radio-Television and Electronics. Good Radio and Television service men are needed **NOW!**

## VETERANS

**THIS TRAINING AVAILABLE TO YOU UNDER THE G. I. BILL**

My Training Includes:  
**Radio Servicing**  
**Television**  
**FM Frequency Modulation**  
**Public Address and High Frequency Applications**



These Two Big **FREE!** Radio Books

Just mail coupon for a **FREE** sample Sprayberry Lesson and my big **FREE** book, "How To Make Money In Radio-Television and Electronics." Learn why my really *practical* training is best of all for you. Discover what's ahead for you in the fast moving Radio-Television and Electronics industry. No obligation. Don't delay—the future is too important to you. Mail the coupon now—and count on me for fast action.

## RUSH COUPON Today!

**SPRAYBERRY ACADEMY of RADIO, Dept. 20-G 111 North Canal St., Chicago 6, Ill.**

Please rush my **FREE** copies of "How To Make Money In Radio-Television and Electronics" and "How To Read Radio Diagrams and Symbols."

Name.....Age.....

Address.....

City.....State.....

**SPRAYBERRY ACADEMY OF RADIO**  
111 N. CANAL, DEPT. 20-G CHICAGO 6, ILL.

( ) Check here if you are a Veteran.

*Built for Service...* **SINCE 1915**

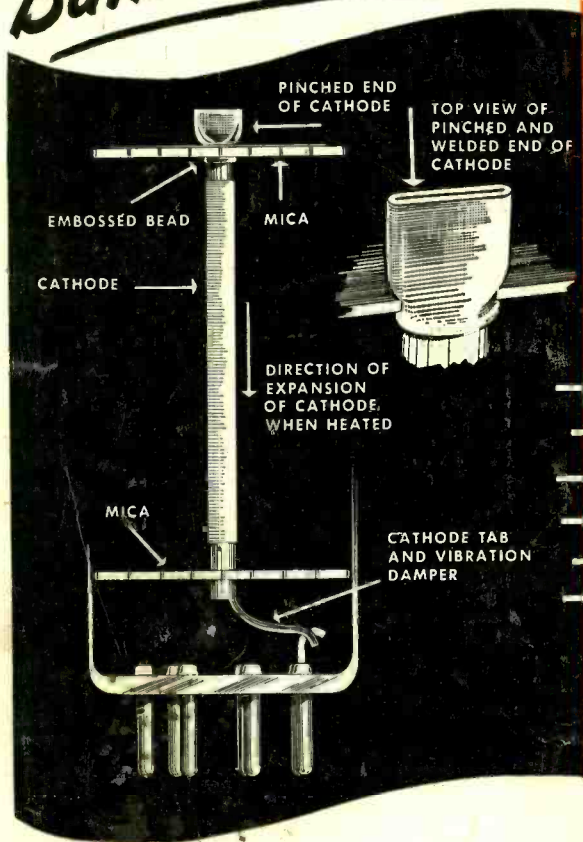

## The inside story of

# Cunningham quality

### 1. How Cunningham "Inverted" Pinched Cathodes Minimize Microphonics

Engineering progress is part and parcel of Cunningham quality. For instance . . . unlike most tubes Cunninghams use "inverted" *pinched cathodes* to minimize microphonics by preventing cathode vibration or displacement.

These important features are achieved by clamping the mica firmly between the embossed bead and the pinched top end of the cathode. This arrangement holds the upper end of the

cathode rigidly, but permits the heated cathode to expand freely downward through the bottom mica without producing cathode strain. The lower end of the cathode is prevented from vibrating by means of the damping tab connected between the cathode and a stem lead.

The "inverted" pinched cathode is only one of the many improvements which account for the *first-line* quality of Cunningham tubes. It serves to explain why experienced servicemen use Cunninghams consistently.

ALWAYS KEEP IN TOUCH WITH YOUR CUNNINGHAM DISTRIBUTOR



**RADIO CORPORATION of AMERICA**  
ELECTRON TUBES HARRISON, N. J.