

# RADIO — ELECTRONICS

2" SCOPE - 30 K

TV Front End 39

HUGO GERNSBACK, Editor

formerly

**RADIO  
CRAFT**

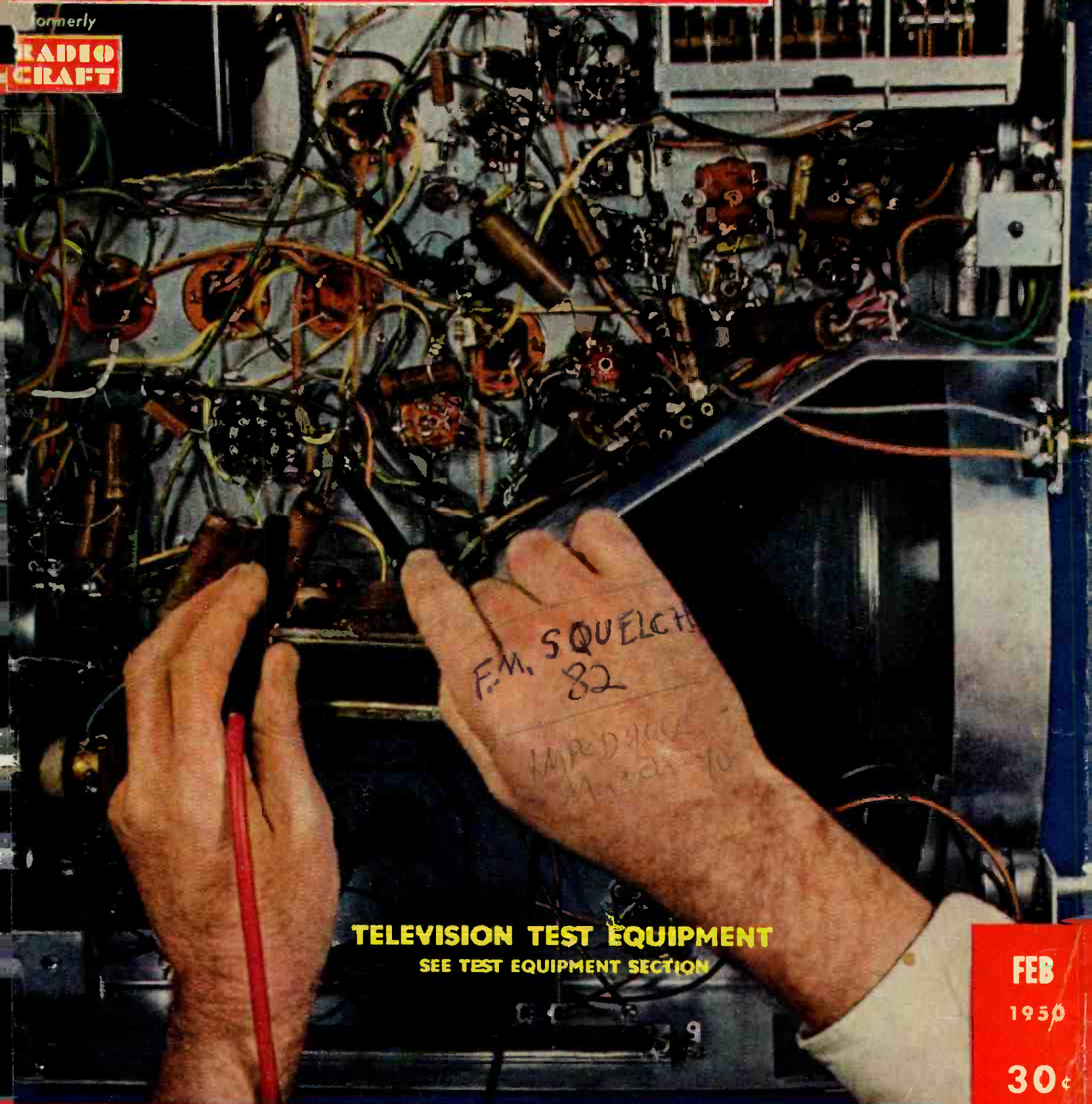

**TELEVISION TEST EQUIPMENT**

SEE TEST EQUIPMENT SECTION

**FEB**

1950

**30¢**

U. S. and  
CANADA

**LATEST IN RADIO — ELECTRONICS — TELEVISION**

# A clear selling



# field



You can sell **MORE RCA Batteries** because...

RCA BATTERIES give you a clear selling field—they're distributed primarily to the radio trade!

You have less competition from non-radio neighborhood stores. Sell RCA Batteries and repeat sales stay with *YOU!*

RCA Batteries are *radio-engineered* for extra listening hours. The completely rounded line covers virtually all renewal requirements.

Closely co-ordinated production meets seasonal demand, assures fresh stock always.

RCA provides the greatest array of battery selling aids in the industry—all geared to the *radio trade*.

Smart packaging, competitive prices and "the greatest name in radio" are compelling reasons why RCA Batteries are your best buy by far.

See your RCA Battery Distributor for fast, reliable service.



**RADIO CORPORATION of AMERICA**  
**RADIO BATTERIES** **HARRISON, N. J.**

## You Practice COMMUNICATIONS

I Send You Parts To Build This Equipment

As part of my new Communications Course I send you parts to build your own Transmitter. Conduct actual procedure demanded of Broadcast Station Operators, practice many interesting experiments and tests, learn how to put a transmitter on the air.



**NEW**

# BE A RADIO-TELEVISION TECHNICIAN

## You Practice Radio SERVICING

On This Modern Radio You Build With Parts I Send

As part of my Servicing Course, I send you the speaker, tubes, chassis, transformer, loop antenna, EVERYTHING you need to build this modern Radio Receiver that brings in local and distant stations. You use it to conduct many tests and experiments.

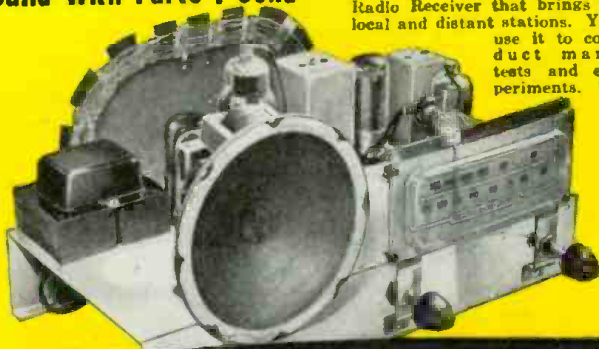

Learn Servicing or Communications by Practicing in Spare Time

with MANY KITS OF PARTS I Send

**YOU BUILD** this Tester as part of my Servicing Course. It soon helps you earn \$5, \$10 and more a week EXTRA MONEY fixing neighbors' Radios in spare time while learning.



**YOU BUILD** this Power Pack as part of my new Communications Course. Use it to conduct fascinating experiments with frequency amplifiers and multipliers, buffer stages, etc.



**YOU BUILD** this Superheterodyne Receiver Circuit and conduct Frequency Modulation experiments and many other tests as part of my Servicing Course.



**YOU BUILD** this Signal Generator as part of my Servicing Course for more valuable experience. It provides amplitude-modulated signals for many interesting tests and experiments.



## VETERANS

GET THIS TRAINING WITHOUT COST UNDER G. I. BILL MAIL COUPON

**YOU BUILD** this Wavemeter as part of my new Communications Course. Use it with Oscillator you also build that furnishes basic power to transmitter and determines transmitter frequency.



J. E. SMITH, President National Radio Institute

Want a good-pay job in the fast-growing Radio and Television industries or to be boss of your own money-making Radio and Television shop? I've trained hundreds of men with no previous experience to be Radio technicians. I can do the same for you! Or now, for the first time, enroll in my new practical course in Radio-Television Communications—learn to be a Broadcasting and Communications technician. You learn Radio and Television principles from clear, illustrated lessons. You get practical Radio experience with MANY KITS OF PARTS I SEND in my train-at-home method. All equipment yours to keep.

### MAKE EXTRA MONEY IN SPARE TIME

As part of my Radio Servicing Course, I send EXTRA MONEY booklets, starting the day you enroll. Use your know-how to make \$5, \$10 and more a week EXTRA MONEY fixing Radios in spare time while training. The next step is your own Radio shop or a good-pay Radio servicing job. Or, if you prefer, get into Government, Police, Aviation or Marine Radio, Broadcasting, Radio Manufacturing or Public Address Work.

### BRIGHT FUTURE IN TELEVISION

Think of the present and future opportunities in the fast-growing Television field. New stations are going on the air every month. Television manufacturers are producing over 100,000 sets a month. It's a fast-growing field and the man who knows Television will be in demand.

### GET ACTUAL LESSON AND BOOK FREE

Send now for my special DOUBLE FREE OFFER. Get actual lesson on Radio Repairing short-cuts absolutely free. Also get 64-page book, "HOW TO BE A SUCCESS IN RADIO-TELEVISION—ELECTRONICS." See how quickly, easily you can start. J. E. SMITH, President, Dept. OBX, National Radio Institute, Pioneer Home Study Radio School, Washington 9, D. C.

## I TRAINED THESE MEN AT HOME



Good Job in Radio Station  
"Am Chief Engineer of Station WORD, in charge of four men. Owe all I know about Radio to NRI."—CLYDE J. BURDETTE, Spartanburg, South Carolina.



Makes Extra Cash in Spare Time  
"Earned enough spare time cash to pay for my time I graduated. NRI training is tops!"—ALEXANDER KISH, Carteret, New Jersey.



Operates Own Radio Business  
"Now have two Radio shops servicing about 200 sets a month. Have largest service establishment in Southeast Missouri."—A. B. LEY STUDYVIN, DeSoto, Mo.

MAIL COUPON! FIND OUT ABOUT THIS TESTED WAY TO BETTER PAY

## Good for Both—FREE

MR. J. E. SMITH, President, Dept. OBX National Radio Institute, Washington 9, D. C.

Mail me FREE Sample Lesson and 64-page book about how to win success in Radio and Television—Electronics. (No salesman will call. Please write plainly.)

Name..... Age.....

Address.....

City..... Zone..... State.....

Check if Veteran

APPROVED FOR TRAINING UNDER G. I. BILL



# RADIO — ELECTRONICS

formerly RADIO-CRAFT

Incorporating  
 SHORT WAVE CRAFT • TELEVISION NEWS •  
 RADIO & TELEVISION  
 \*Trademark registered U. S. Patent Office

Lee Robinson  
 General Manager

G. Alique  
 Circulation Manager

John J. Lamson  
 Sales Manager

Robert Fallath  
 Promotion Manager

Hugo Gernsback, Editor-in-Chief  
 Fred Shunaman, Managing Editor  
 M. Harvey Gernsback, Consulting Editor  
 Robert F. Scott, W2PWG, Technical Editor  
 R. H. Dorf, W2QMI, Associate Editor  
 I. Queen, W2OUX, Editorial Associate  
 Angie Pascale, Production Manager  
 Wm. Lyon McLaughlin,  
 Technical Illustration Director

## Contents — February, 1950

Editorial (Page 23)	
Safeguarding Your Invention.....	by Hugo Gernsback 23
Test Instruments (Pages 24-32)	
Television Test Equipment (Cover Story).....	by Walter R. Jones 24
Small Signal Tracer.....	by Homer L. Davidson 27
Test Equipment for Television.....	by Robert Stang 28
Making a 2-Inch Scope.....	by Charles Welch, W5MHK 30
Using a Voltmeter as a Precision Resistor.....	by John T. Bailey 32
Television (Pages 33-41)	
Television Dictionary (continued).....	by Ed. Bukstein 33
Television "Sight Effects".....	by H. W. Secar 34
Theory and Practice of Intercarrier TV, Part II	by Seymour D. Uslan 36
More Television Queries.....	by David Gnessin 37
A De Luxe Televiser, Part II.....	by Charles A. Vaccaro 38
Television DX Reports.....	41
Construction (Pages 42-43)	
One-Tube Loudspeaker Receiver.....	by Sanford Miller 42
Theory and Engineering (Pages 44-45)	
Power Pack Design.....	by P. E. Leventhal 44
Audio (Pages 46-52)	
Custom-Built Phonograph.....	by Richard H. Dorf 46
Placing a Speaker in the Home.....	48
Contralling Sound Liveness.....	49
FM Phonograph Pickup.....	by Arthur Trauffer 50
Magnetic Tape "Contact Prints".....	52
Servicing (Pages 56-68)	
Fundamentals of Radio Servicing, Part XII—Vacuum-Tube Characteristics	by John T. Frye 56
Voltmeter Measures Current.....	by J. T. Cataldo and S. J. Richard 62
Handy Tools for Servicing.....	by H. Leeper 64
Review of Recently Issued Tubes.....	68
Amateur (Pages 69-75)	
Code Practice Outfit.....	by Harry C. Aichner 69
How to Become a Ham, Part V—The Factors That Count in Designing Transmitter Output Tanks.....	by George W. Shuart, W4AMN 70
Foreign News (Pages 84-86)	
European Report.....	by Major Ralph W. Hallows 84
Departments	
The Radio Month.....	8
Radio Business.....	10
New Devices.....	76
New Patents.....	77
Miscellany.....	78
Technotes.....	80
Radio-Electronic Circuits..	82
Try This One.....	87
Question Box.....	89
People.....	91
Communications.....	92
Book Reviews.....	95

ON THE COVER: Voltage check on the underchassis of a television receiver. Kodachrome by Avery Slack.

# For YOU! from SPRAGUE



## New Booklet to BUILD BETTER SERVICE BUSINESS

- Gives customers a new appreciation of your service facilities
- Helps you avoid "cut-throat" price competition

"Your Money's Worth in Good Radio and Television Service" is the title of this new 16-page booklet now made available by the makers of Sprague Capacitors and Koolohm Resistors for distribution to your service customers and prospects *under your own name!*

Profusely illustrated, finely lithographed in two colors, the booklet will help you win customers, justify fair service prices and meet "cut throat" competition that is springing up on all sides. It tells set owners about the complexities of today's radio and television equipment and about the extensive service facilities needed to keep receivers in first class working order.

In short, it is a book designed to win confidence for you by showing customers how complicated the work really is and by proving to them exactly how and why good service work commands a fair price.

Write for  
**FREE SAMPLE**

Sprague Products Company,  
 81 Marshall Street,  
 North Adams, Mass.

Please rush free sample of the new booklet "Your Money's Worth in Good Radio and Television Service" and tell me how I can obtain additional copies for distribution to my service customers.

Name \_\_\_\_\_  
 Address \_\_\_\_\_  
 City, Zone, State \_\_\_\_\_

RADIO-ELECTRONICS, February, 1950, Volume XXI, No. 5. Published monthly. Publication Office: Erie Ave. 7 to G Street, Philadelphia 32, Pa. Entered as second class matter September 27, 1948, at the post office at Philadelphia, Pa., under the Act of March 3, 1879. SUBSCRIPTION RATES: In U. S. and Canada, in U. S. possession, Mexico, South and Central American countries, \$2.50; \$6.00 for two years; \$8.00 for three years; single copies 50c. All other foreign countries \$4.50 a year, \$8.00 for two years, \$11.00 for three years. Allow one month for change of address. When ordering a change please furnish an address stencil impression from a recent wrapper. RADCRAFT PUBLICATIONS, INC. Hugo Gernsback, Pres.; M. Harvey Gernsback, Vice-Pres.; G. Alique, Sec'y. Contents Copyright, 1950, by RADCraft Publications, Inc. Text and illustrations must not be reproduced without permission of copyright owners.

EDITORIAL and ADVERTISING OFFICES, 25 West Broadway, New York 7, N. Y. Tel. REctor 1-9090. BRANCH ADVERTISING OFFICES: Chicago: 388 W. Washington Street. Telephone Randolph 6-7863. Los Angeles: Ralph W. Harker, 1127 Wilshire Blvd., Tel. MA. 4-1271. San Francisco: Ralph W. Harker, 592 Market St., Tel. GARfield 1-2481.

FOREIGN AGENTS: Great Britain: Atlas Publishing and Distributing Co., Ltd., London E.C.4. Australia: McGill's Agency, Melbourne. France: Brentano's, Paris 2e. Holland: Trilectron, Haarstede. Greece: International Book & News Agency, Athens. S. Africa: Central News Agency, Ltd., Johannesburg; Capetown; Durban. Natal. Universal Book Agency, Johannesburg. Middle East: Steimatzky Middle East Agency, Jerusalem. India: Sunit Gupta (Distributors) Co., (Circular Road) Broadway News Centre, Dadar, Bombay #14. K. L. Kannappa Mudaliar, Madras 2. Pakistan: Paradise Book Stall, Karachi 2.

Editorial and Executive Offices:  
 25 West Broadway, New York 7, N. Y.



MEMBER  
 AUDIT BUREAU OF CIRCULATION



Get Into

# RADIO, TELEVISION and ELECTRONICS

## Master ALL Phases

**YOU Build This Superheterodyne**

You receive complete standard equipment, including latest type High-Mu Tubes, for building various experimental and test units. You progress step by step until you build a complete Superheterodyne Receiver. It is yours to use and keep.

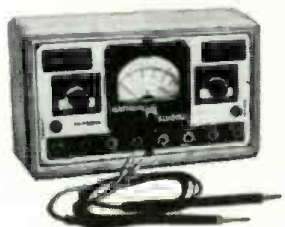

### YOU RECEIVE THIS PROFESSIONAL MULTITESTER!

You will use this professional instrument to locate trouble or make delicate adjustments—at home—on service calls. You will be proud to own this valuable equipment. Complete with test leads.

You construct the Transiron Signal Generator shown here, demonstrating Transiron principles in both R.F. and A.F. stages. You study negative type oscillators at firsthand.

### SIGNAL GENERATOR

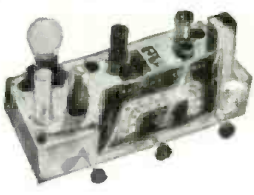

### AUDIO OSCILLATOR:

An electronic device, which produces audio-frequency signals for modulating R.F. (radio frequency) carrier waves, testing A.F. (audio frequency) amplifiers, speakers, etc.



### T.R.F. RECEIVER

You build several T.R.F. Receivers, one of which, a 4-tube set, is shown here. You learn construction, alignment, make receiver tests, and do trouble shooting.

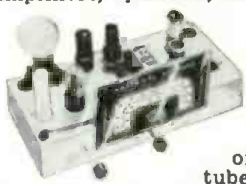

**Get Complete Training. You Receive and Keep All Tubes, Equipment, Parts and Lessons. No Extra Charges.**

**GOOD PAY and Unlimited Opportunities in JOBS LIKE THESE:**

Business of Your Own  
Radio Manufacturing, Sales, Service  
Broadcasting, Telecasting  
Television Manufacturing, Sales, Service  
Laboratories: Installation, Maintenance of Electronic Equipment, Electrolysis, Call Systems  
Garages: Auto Radio Sales, Service  
Sound Systems and Telephone Companies; Oil Well and Drilling Companies; Engineering Firms  
Theatre Sound Systems, Police Radio

And scores of other good jobs in many related fields

### YOU CONDUCT MANY EXPERIMENTS LIKE THESE!

Checking action of condensers  
Experiments with AF and RF amplifiers  
Experiments with resonance  
Producing beat frequencies  
Calibrating oscillators  
Experiments with diode, grid-bias, grid-leak and infinite impedance detectors  
Practical experience in receiver trouble shooting  
Application of visual tester in checking parts and circuits  
Experiments with audio oscillators  
Advanced trouble-shooting  
... and many, many others

### Complete Training by Practical Resident Trade School, Est. 1905

The same highly trained faculty, instruction materials and methods used here in our large, modern resident school, are adapted to your training in your own home. Shop Method Home Training has been proved by hundreds of successful graduates.

**Both Resident and Home Study Courses Offered**

### YOU LEARN BY DOING

You receive special laboratory experiment lessons to show you how to build with your own hands various experimental units such as those shown at left, and how to conduct many tests.

You will find all lessons easy to understand because they are illustrated throughout with clear diagrams and step-by-step examples that you work out yourself. Every piece of the equipment and complete lesson material we send you is yours to keep and enjoy, including the multitester, experimental equipment, all parts of the Superheterodyne, tube manual, radio dictionary, and complete, modern Television texts. All parts are standard equipment.

### Shop Method Home Training ... Earn While You Learn

With our practical resident Shop Method Home Training, you study in your spare time. You receive Spare Time Work Lessons, which show you how to earn while you learn. Service neighbors' radios and TV receivers, appliances, etc., for extra money and experience. Many National students pay all or part of their training with spare time earnings!

### DON'T DELAY! The Radio-Television Industry needs trained men NOW!

**APPROVED FOR VETERANS!**  
Check coupon below!

For quick action, mail coupon today and we'll rush you full information.

**Free!**  
NEW, ILLUSTRATED OPPORTUNITY BOOK AND SAMPLE LESSON SHOW YOU HOW WE TRAIN YOU ... SEND FOR THEM TODAY! NO COST. NO OBLIGATION.



### NATIONAL SCHOOLS

LOS ANGELES 37, CALIF. • EST. 1905

### FIND OUT NOW ... MAIL COUPON TODAY

National Schools, Dept. RE-2  
4000 South Figueroa Street  
Los Angeles 37, California

Mail in envelope or paste on penny postal.





Send me your FREE book "Your Future in Radio" and the sample lesson of your course. I understand no salesman will call on me.

NAME \_\_\_\_\_ AGE \_\_\_\_\_

ADDRESS \_\_\_\_\_

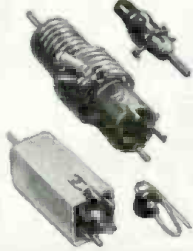
CITY \_\_\_\_\_ ZONE \_\_\_\_\_ STATE \_\_\_\_\_

Check here if Veteran of World War II

<p>Picture and Sound IF and Video Coils—Kit #204X1 containing 15 coils for picture and sound if stages, and video circuits.</p>		<p>Type 208T2 Vertical Blocking-Oscillator Transformer—Generates 60-cps pulses to drive vertical-discharge tubes.</p>		<p>Type 204T2 Vertical Deflection Output Transformer—For vertical-deflection circuits using RCA-201D1, 201D3, or 201D12 Deflecting Yoke.</p>	
	<p>Type 203R1 Horizontal Oscillator and Synchronizing Control Coil—Permeability tuned center-tapped oscillator coil.</p>		<p>Types 201D1, 201D3, and 201D12 Deflecting Yokes—For RCA kinescopes 10BP4, 12LP4, and 16AP4.</p>		<p>Type 202D1 Focusing Coil—For kinescopes such as the RCA-10BP4 operating at anode potentials up to 10 kilovolts.</p>
<p>Type 203D3 Ion-Trap Magnet—For use with kinescopes which utilize ion-trap guns and operate with anode potentials of 7 to 14 kilovolts.</p>		<p>Type 211T5 Horizontal-Deflection-Output and High-Voltage Transformer—For pulse operated power supplies up to 13.5 kilovolts.</p>		<p>Type 208T3 Horizontal Blocking Oscillator Transformer—Designed to drive the grids of the horizontal discharge tubes.</p>	
	<p>Picture IF Transformers—Type 202K5 to 202K11—Seven coils for stagger-tuned IF systems such as used in RCA TV receiver models 8T241, 8T243, 8T244.</p>		<p>Type 201R4 Width Control—For controlling picture width in receivers using RCA-16AP4 kinescopes.</p>		<p>Type 203L5 Video-Circuit Trap—A 4.5-megacycle video-circuit trap designed to operate in the plate-circuit of the first video amplifier.</p>

# Original

## RCA TV COMPONENTS COST NO MORE

THEY CUT DOWN SERVICE RETURNS, AND INSURE SUPERIOR PERFORMANCE

RCA television components are "Originals," developed by famed RCA television engineers, and specifically designed to work with the tube types and circuits used in the top television receivers in the field. Millions of RCA TV Components are in use today. Play safe... replace with RCA "Originals." Use them in *your* shop.

GET YOUR FREE COPY OF THIS COMPONENT DIRECTORY

Tells at a glance the type numbers of RCA TV Components for replacement in 214 television sets of 38 manufacturers. Only guide of its kind! Get yours today from your RCA Distributor. (Specify Form SP-1006.)



**RADIO CORPORATION of AMERICA**  
ELECTRONIC COMPONENTS

HARRISON, N. J.

RADIO-ELECTRONICS for

# Are You Prepared for a Good Paying Job in Television?

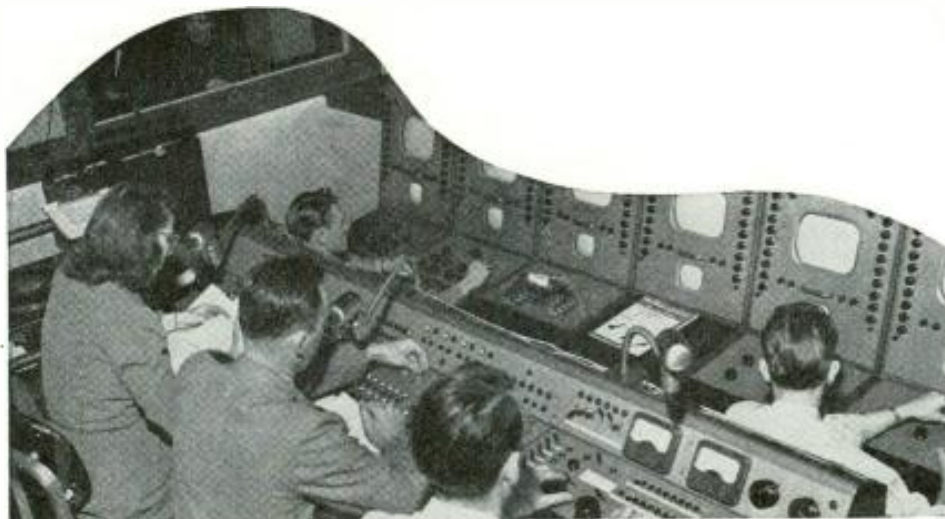

Television technicians are in demand—in stations, factories, research labs; in installation and trouble-shooting jobs. And the opportunities are increasing daily.

**The future belongs to those who prepare for it. This school gives you up-to-date technical training required to help you step ahead!**

By  
**E. H. RIETZKE**  
President CREI

**Y**OUR future success can best be assured by the steps you take today to prepare for it. No field offers a properly qualified young man greater opportunity than Television. But it takes technical training to land the good-paying jobs. Authorities are agreed that the *one sure way* to acquire this training is from a good school.

How can a young man select a "good school?" By its reputation in the industry . . . the professional standing of its faculty . . . the quality of its courses . . . the personalized help it offers . . . the length of time it has been in existence . . . and its accomplishments.

CREI invites investigation and comparison. An accredited technical institute founded in 1927, CREI's home-study graduates today fill important engineering, research, and radio-TV posts throughout the industry. While CREI makes no job promises to its graduates, the CREI Placement Bureau generally has on hand more requests than it can fill. During the war CREI trained thousands of technicians for the Army,

Navy and Coast Guard. Hundreds of thousands of special CREI technical texts were used in the Navy's own training program. Leading industrial firms—RCA Victor, United Air Lines, TWA, Pan American Airways, All-America Cables & Radio, Inc., Sears Roebuck & Co., to name only a few—have CREI group training programs now in operation.

CREI, through home study, offers practical technical training, starting with basic principles, going step-by-step through the more advanced subjects of TV and its related fields. Each student receives continuous attention and assistance to meet his special needs. You learn about Optics; Pulse Techniques; Deflection Circuits; RF, IF, AF and Video Amplifiers; FM;

Receiving Antennas; Power Supplies; Cathode Ray, Iconoscope, Image Orthicon and Projection Tubes; UHF Techniques, TV Test Equipment, etc. SEND FOR FREE SAMPLE LESSON and see for yourself how interesting it is to study at home and increase your income. Mail the coupon below and receive "The Orthicon and Image Orthicon." This lesson describes the development, theory and operation of the orthicon and image orthicon TV camera tubes.

**Veterans:** CREI Training Available Under G.I. Bill. For most veterans July 25, 1951, is the deadline. Act now!

**The Three Basic CREI Courses:** Practical Radio Engineering (fundamental course in all phases of radio-electronics); Practical Television Engineering (specialized training for professional radiomen); Television and FM Servicing (streamlined course for men in "top third" of field). Also available as Residence School Courses.

#### CAPITOL RADIO ENGINEERING INSTITUTE

Dept. 142B, 16th & Park Rd., N. W. Washington 10, D. C.

Gentlemen: Send me FREE SAMPLE LESSON and booklet, "Your Future in the New World of Electronics," together with details of your home study training, CREI self-improvement program and outline of course. I am attaching a brief resume of my experience, education and present position.

Check the Field of Greatest Interest:  PRACTICAL TELEVISION ENGINEERING.  PRACTICAL RADIO ENGINEERING.  TV, FM & ADVANCED AM SERVICING.  AERONAUTICAL RADIO ENGINEERING.  BROADCAST RADIO ENGINEERING (AM, FM, TV).  RADIO-ELECTRONICS IN INDUSTRY.

NAME \_\_\_\_\_ AGE \_\_\_\_\_  I am entitled to training under G.I. Bill.  
ADDRESS \_\_\_\_\_  Send details on Residence School.  
CITY \_\_\_\_\_ ZONE \_\_\_\_\_ STATE \_\_\_\_\_

# YOUR KEY

to better  
**RADIO and TELEVISION**  
servicing!

## TEE VEE 90 OSCILLOSCOPE

Combines two essential instruments needed in TV testing—alignment—service. A complete oscilloscope and a complete sweep generator that can be used independently. Oscilloscope also has its own variable linear sweep. Sinusoidal sweep with phasing control for use with internal RF sweep generator when testing band pass characteristics. Synchronization provision for either internal positive, external or line frequency. External jack provided for trace blanking. Requires 10 volts of negative pulse to blank a normal intensity level trace.

Independent sweep generator has a center frequency range of 1.5 to 45 megacycles giving a choice of any IF frequency desired. The band width can be varied continuously from 0.5 KC to 7 MC. Attenuation of RF is continuously variable from 0 to 500 millivolts and the output is applied through low loss coaxial cable.

Traveling detector probe is included for observing signal at any point of the RF circuit under test. 105-130 v. 50-60 cy. Wt. 25 lbs. Size 14 x 8 x 12 1/2 inches. Finished in hammertone grey. Supplied with tubes, probe, coaxial output cable and operating instructions ready to operate.

Net Price \$127.50



## NEW DYNATRACER

MODEL  
777A

\$41.50  
NET PRICE

### —The One Outstanding Signal Tracer

The answer to speedy accurate Trouble Shooting

New Model 777A dynatracer is such a masterpiece in engineering design that it is sweeping the nation in enthusiastic acceptance.

New design ultra sensitive instrument permits detecting signal and any distortion or variation with either or both meter and speaker at any point in any receiver or electronic circuit. Traces what happens at any and every point from antenna, through each stage of r.-f.—i.-f.—a.-f. to speaker. No switching or changing channels. The best and simplest way to solve problems of INTERMITTANTS—NOISE—OPENS—SHORTS—LEAKS—DISTORTION, ETC.

Frequency Range—Up to 160 Megacycles.  
Gain measurements made by accurate meter indications instead of uncalibrated magic eye indicators. Negligible outside pick up of noise and hum negligible disturbances to circuit—input capacity only 3 micromicrofarads.  
Attenuation—10,000 to 1 with ladder attenuator and a vernier control.  
Sensitivity—10,000 microvolts for full scale deflection of meter or 200 microvolts per division.

Tubes—6AU6—6AT6—6AQ5—6X4 and 1N34 crystal rectifier

Alnico 5 magnet speaker.  
MICROPHONES and PICKUPS tested through special jack provided.

Automatic control switch—either speaker or meter—both or standby.

Beautiful hammertone grey steel panel and case with new design probe. A high quality instrument in every detail. For 105-135 volts operation 50-60 cycles. Size 8 1/2" x 8 1/2" x 11". Weight 9 1/2 lbs.

Buy it from your jobber.

WRITE FOR CATALOGUE ZRC

**RADIO CITY PRODUCTS CO., INC.**

152 West 25th St. New York 1, N. Y.

**RADIO RELAY LINKS** are being used to send television network programs to central and northern New York cities, the Long Lines department of the American Telephone and Telegraph Co. announces. The programs are carried from New York to Albany by co-axial cable and take to the air from there. Four radio relay stations have been constructed between Albany and Syracuse—at Rotterdam, Cherry Valley, Deerfield, and Sullivan. These buildings are of square, concrete design and are 60 feet in height. At their tops are the 10-foot-square horn-shaped antennas which receive and beam the video signals along the path.

Syracuse-bound telecasts will be channeled to the Long Line offices in the New York Telephone Company's Albany building at 158 State Street by the co-axial cable. They will then be beamed on a line-of-sight path by antennas which have been installed on a 60-foot tower on top of the building, to Rotterdam, which is located 21 miles away.

After the Albany-Rotterdam hop, a thirty-two-mile jump lies ahead to Cherry Valley. Close to 33 miles separates Cherry Valley from Deerfield and the distance between there and Sullivan is 40 miles. Slightly over twelve miles lie between Sullivan and Syracuse. Schenectady is served out of Rotterdam by a seven-mile link and Utica out of Deerfield by a three-mile jump.

**IONIC ENERGY** is being used to produce winds of formerly unheard-of velocities in a wind tunnel at the University of Michigan, *Science News Letter* reported last month.

The equipment consists simply of an electric arc generated between a copper cylinder and a surrounding copper ring. Application of a strong magnetic field causes the arc to rotate like a wheel. The rotating motion of the arc causes the air in the tunnel to revolve at extremely high speeds as it is dragged around with the arc.

This ionic tunnel can produce winds with velocities five to ten times the speed of sound (normally about 760 miles per hour at sea level). A small model is at present in use and a larger one will be built shortly. It will be used with artificially reduced pressure to simulate conditions in the earth's upper atmosphere.

**TELEVISION TRADE SHOW** and fifth annual "Television Institute" will be held in New York City February 6 through February 8. The event, which will be held at the Hotel New Yorker, is expected to attract 50,000 persons, according to Irwin A. Shane, general chairman.

Panel speakers will include industry leaders, sponsors, advertising men, film and program producers, engineers, and educators. Some 500 representatives of the film industry will also be present for the annual Television Film Conference, which, though combined with the Television Institute, will hold its own sessions February 8.

**HIGH-DEFINITION TV** broadcasts began last month in Paris. The 819-line standard (described in the March 1949 issue of *RADIO-ELECTRONICS*) is being used. The power of the new transmitter will gradually be stepped up to serve a larger area as more and more of the necessary receiver converters become available.

**ELECTRON MICROSCOPES** may be subjecting their users to dangerous doses of X-ray radiation. This discovery was made recently at the University of California at Los Angeles by Drs. Louis B. Silverman, Sylvia B. Elliot, and M. A. Greenfield, in the course of a general radiation survey of the atomic energy project at the medical school.

Detection instruments showed radiation at the intermediate viewing port of 70 milliroentgens per hour. The maximum radiation exposure permitted at the atomic energy project is only 50 mr per day. The scientists report that the radiation is caused by the electron beam striking metal parts of the instrument and the accidental use of ordinary instead of lead glass in the viewing ports of a few of the instruments.

They suggest that other electron microscopists survey the radiation from their instruments to determine whether X-ray intensity is above the biological safety level.

**MAGNETIC SOUND TRACKS** were used by Universal Pictures last month to make the first full-length feature ("Confidential Squad") ever recorded on magnetic tape. Heretofore, the sound had been recorded optically on film, a high-cost, delicate process. The recordings for the new picture were made on 35-mm film coated with magnetic material, then dubbed (after editing) to standard film.

**NEW ELECTRONIC COMPUTER** was revealed last month by the Boeing Airplane Co. It will be used to study the probable flight of war missiles. The new machine is an analog computer which shows its results as a series of rapidly moving dots on an oscilloscope screen. A high-speed motion-picture camera photographs the dots, the film then becoming a permanent record for retention.

**V.H.F. RADIO** will be used to communicate with an elevator in the new British television station at Sutton Coldfield, near Birmingham, England. The elevator will run inside the station's 750-foot mast, between ground and the 600-foot level.

The station, England's second, which started operation December 17, 1949 will cover the British Midlands, serving an estimated 6,000,000 people. Its vision transmitter has a power output of 35 kw and works on 61.75 mc, while the sound transmitter works on 58.25 mc with a radio-frequency power output of 12 kw.

A third television transmitter, to serve the north of England, is under construction.



**IRE OFFICERS** for 1950 are Raymond F. Guy, president, and Sir Robert Watson-Watt, vice-president, the Institute announced recently.



Raymond F. Guy

Mr. Guy is currently manager of radio and allotments engineering for the National Broadcasting Co. and is one of the industry's first broadcast engineers. He became a member of the staff of WJZ, the country's second licensed broadcast station, in 1921, when it started operations. He has been with the National Broadcasting Co. since 1929, and has participated in many international radio conferences.

Sir Robert Watson-Watt is one of the world's outstanding workers in the field



Robert Watson-Watt

of radar, and has been deputy chairman of the radio board of the British cabinet as well as scientific adviser on telecommunications for the British Air Ministry. He was the recipient in 1947 of the IRE Fellow Award for his "early contributions to radio and his pioneering work in radar."

The IRE Directors for 1950-51 are William H. Hewlett of Hewlett-Packard, and James McRae of Bell Telephone Labs, directors-at-large; and regional directors Professor Herbert J. Reich of Yale University, North Atlantic region; Professor Ferdinand Hamburger, Jr., Johns Hopkins University, Central Atlantic region; John D. Reid, Crosley Division of Avco Mfg. Corp., Central region; Professor Austin Eastman, University of Washington, Pacific region.

**HARBOR RADAR** was inaugurated in the port of Baltimore December 13th last, making Baltimore the first United States Atlantic coast port to have radar as an aid to merchant shipping. It was preceded only by Long Beach, Calif. (RADIO-ELECTRONICS, January, 1949, page 95) and the world's first civilian harbor radar installation at Liverpool, England (RADIO-ELECTRONICS, December, 1948, page 22).

The Baltimore installation will have more advanced features than the first two stations. It will work with a radio-telegraph station and the ship-to-shore phone, all in one building. Besides aiding ships to dock in foggy weather and advising them as to objects in their immediate vicinity, it will help to find convenient anchorages.

**OVERLOADED POWER LINES** during popular program periods is a new television complaint. The additional drain of large numbers of tele receivers in certain areas and housing projects already running close to the load limit is sufficient to reduce voltage appreciably. The television pictures come down in size proportionately. One housing project resident reports, "Between 5 and 9 pm I get a fine 7-inch picture on my 10-inch screen."

### RADAR PROBES HUMAN BODY

A new technique developed at the Naval Medical Research Institute in Washington, D. C., uses a radar-like device to detect gallstones, bullets, shell fragments, bits of glass or wood, or other foreign matter in the human body.

Ultrasonic energy is transmitted by a crystal transducer into the body by placing the transducer against the skin. The waves are reflected by bones and by anything else whose acoustical properties are different from those of surrounding tissues. The reflected waves are fed to an oscilloscope. A foreign body which may or may not be visible by X-ray appears on the screen as an "echo," very much like the pip caused by an aircraft in radar detection. The distance of the echo pip from the incident pip shows the depth of the object.

**CONGRESS BY TELEVISION** was proposed last month by Senator Alexander Wiley, Wisconsin Republican, as a method of decentralizing government in case of atom-bomb attack. Under the proposal, senators and representatives would disperse to 30 or 40 points at which television receiving and transmitting apparatus would permit them to vote and participate in discussions.

**JAPANESE** radio receivers have reached an all-time high of 7,592,625, the Broadcasting Corp. of Japan announced last month. There were almost this many in 1944 but bomb destruction reduced the number by a little over 2 million. The present number of receivers means that about 42% of Japan's 16 million households are "radio homes."

# SERVICEMEN!

## We'll Prove You'll Save Time & Earn More with PHOTOFACT!



We'll send you absolutely

# FREE

any PHOTOFACT Folder  
listed in the Photofact Cumulative Index

NOW—learn for yourself—at our expense—how PHOTOFACT makes your service work quicker, easier, more profitable! Examine an actual PHOTOFACT Folder. Use it. You'll learn first-hand why this indispensable service data is used daily by over 35,000 successful service technicians. You'll discover quickly that no other service gives you PHOTOFACT's outstanding advantages: *completeness, accuracy, uniformity* and *ease-of-use* at the lowest cost to you! PHOTOFACT alone is the only radio service data prepared from laboratory analysis of the actual equipment. Nothing in the field equals PHOTOFACT. Know the facts—get your FREE Folder now. Examine it—use it—compare it—learn why no modern service shop can afford to be without PHOTOFACT!

**NOTE:** This FREE offer is limited to Service Technicians. Attach coupon below to your letterhead and mention the name of your jobber. If you have no letterhead, send coupon to your jobber. Experimenters and others may obtain the Photofact Folder by remitting 50c.

HOWARD W. SAMS & CO., INC.  
2201 E. 46th St., Indianapolis 5, Ind.

- Send FREE Photofact Cumulative Index
- Send Full Easy-Pay Details

I am a Service Technician:

- Send FREE Folder for set model. . . . .

I am an Experimenter:

- Send Folder for set model. . . . .  
(50c enclosed)

Name . . . . .

Address . . . . .

City . . . . . Zone . . . . . State . . . . .

**NEW!** FOR FIELD OR BENCH WORK ...

**OAK RIDGE** miniatures

work like **GIANTS** for You!

EASIER, FASTER, MORE PROFITABLE  
TV-FM SERVICING... at lowest cost!



**OAK RIDGE 10-in-1 MINIATURE  
TV-FM SIGNAL GENERATOR**

Pinpoints any signal failure from antenna to CRT or speaker in 2 minutes flat! Incorporates 3 separate tuning bands and modulation output and attenuator for TV & FM. Generates a signal to perform as complete .

• RF, OSC, and Mixer (1st Det.) Tester • Video IF Tester • Audio IF Tester • Video & Audio 2nd Detector Tester • Video & Audio Amplifier Tester • Sound Trap Aligner or Tester • Adjacent Picture Trap Aligner or Tester • Marker Generator • Antenna Orientation Tester • Antenna Sensitivity Tester.

You get ALL TEN IN ONE with this extremely adaptable, precision-made Model 1031 Size: 5½x4x2¼". Dealer's Net \$29.95.

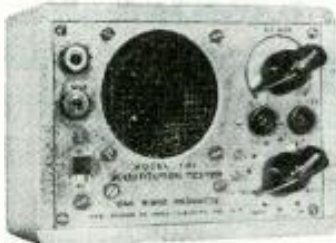

**OAK RIDGE 7-in-1 MINIATURE  
TV-FM-AM SUBSTITUTION TESTER**

Which of these Servicing Aids do You Need Most?

• Test Speaker Without Transformer • Test Speaker With Transformer  
• Paper Condenser Substitutor • Electrolytic Condenser Substitutor  
• Fixed Resistor Substitutor • Variable Potentiometer Substitutor  
• Audio Signal Tracer for Video, Audio & Sweep Circuits in TV, FM, AM, Audio Amplifiers, etc.

You get ALL SEVEN IN ONE with the versatile, precision-made Model 1011 Size: 5½ x 4 x 2¼". Dealer's Net \$16.25.



**OAK RIDGE  
3-in-1  
MINIATURE  
TV HIGH  
VOLTAGE  
TESTER**

Accurately checks all high voltages in any direct-view or projection TV set. Has precision 10,000 ohm/volt movement, three scales: 0-500V, 0-15KV, 0-30KV. Complete with special high voltage test lead. Size: 5½ x 4 x 2¼". Dealer's Net \$14.95.

Boost your efficiency and earnings! Ask your parts jobber for these amazing new MINIATURES today! Write for free Catalog T-8

**OAK RIDGE PRODUCTS**

239 EAST 127th STREET NEW YORK 35, N. Y.  
Manufacturing Division of VIDEO TELEVISION, INC.

Makers of the famous OAK RIDGE Patented  
SNAP-LOCK TV-FM Antennas and Accessories.

RCA Victor, Harrison, N. J., has developed an electron-tube carton which features an ingenious new sleeve insert to provide greater protection against handling damage.

The new "snug-fit" tube carton, in addition to "preserving the quality built into the tube at the factory," the company said, "permits easier shelf identification of tube types and presents a more attractive appearance."



The carton-insert is a cone-shaped cardboard sleeve into which the tube is inserted by hand. The wide ends of the sleeve fold inward to lock the tube in place. To extract the tube, the folded ends are simply flicked outward. The tubes are held so securely that even a vigorous shaking will not cause movement or rattling of the tubes in the carton. For quick identification and selection of tubes, type numbers are printed in large figures on the outside flap of the new carton. The new snug-fit sleeve will be used for conventional glass and metal types. A corrugated sleeve will be used as the insert in the new carton for miniature types.

The Parts Distributors Show of 1950, to be held in Chicago, May 23, 24, and 25, will feature a three-day conference and clinic on sales and merchandising.

Nationally known keynote speakers on each of the three days will be followed by other authorities on each topic, selected from the electronics industry.

Tuesday afternoon, May 23, the program will feature sales and merchandising. It will be in charge of LES A. THAYER, of Belden Mfg. Co., Chicago, and JACK A. BERMAN of Shure Bros., Inc., Chicago.

On Wednesday afternoon, a program on inventory control will be in charge of JOHN F. RIDER of John F. Rider Publisher, New York, and H. L. DALIS, of H. L. Dalis, Inc., New York.

Financial management will be the topic of the Thursday afternoon program, under the direction of WILLIAM O. SCHONING, Lukko Sales, Chicago, and HOWARD W. SAMS, of Howard W. Sams & Co., Indianapolis.

Portfolios of material to supplement the daily discussions will be provided for all distributors attending the meetings, it was announced.

A detailed practical discussion of every phase of merchandising, sales,

inventory control, and financing of interest to distributors is on the agenda. Case histories and actual experiences of distributors will be analyzed as illustrations, with a questions-and-answers period to follow each talk. Charts, films, and animated scale models will be used to demonstrate problems in display and inventory control.

Hytron Radio and Electronics Corporation of Salem, Mass., reported for the six months ended June 30 a net profit of \$247,977, equal to 43 cents a share. For the same period of last year, the net profit was \$47,598, or 8 cents a share.

The Radio Manufacturers Association, Washington, D. C., reported that sales of cathode-ray tubes for television receivers during the first nine months of 1949 were nearly double the value of such sales during the entire year of 1948. Sales of picture tubes totalled 2,129,210 units valued at \$62,525,446 in the first three quarters of 1949, compared with 1,309,176 units valued at \$33,459,554 in the full year of 1948.

The sharp trend toward larger pictures in television receivers was revealed in the breakdown of sales to equipment manufacturers. In the third quarter 65% of the picture tubes sold to set manufacturers were 12 inches or larger, whereas in 1948 they represented only 6% of sales to set manufacturers.

RMA member-companies reported shipments of 503,352 television receivers to 49 cities and a few unspecified areas during the third quarter of 1949. At the beginning of October, 2,209,724 television receivers had been shipped.

Third-quarter shipments brought total TV set shipments by RMA members for the year 1949 to 1,255,346. The RMA reports represent about 80% of total industry shipments of television receivers.

John F. Rider Publisher, Inc. of New York announces *Rider Manual Volume XX*, the latest volume in the series of manufacturers' authorized data, as a January, 1950, publication.

Manufacturers' servicing data on AM, FM, and auto receivers and record changers give complete coverage as of the publication date. A "How It Works" book with cumulative index for Volumes XVI through XX is another prominent feature.

All pages are filed in their proper places, making the volume available for immediate use on the service bench.

Built-in TV Antennas are not efficient and work in only a minority of locations, according to a survey of dealers in three cities, Chicago, Philadelphia, and New York, conducted by *Retailing Daily*. Dealers report that the public has responded to advertising, but that their own experiences show that the safer course is to steer customers toward conventional installations when possible. Even the usual indoor antennas appear to give better and more consistent performance than built-ins.

RADIO-ELECTRONICS for

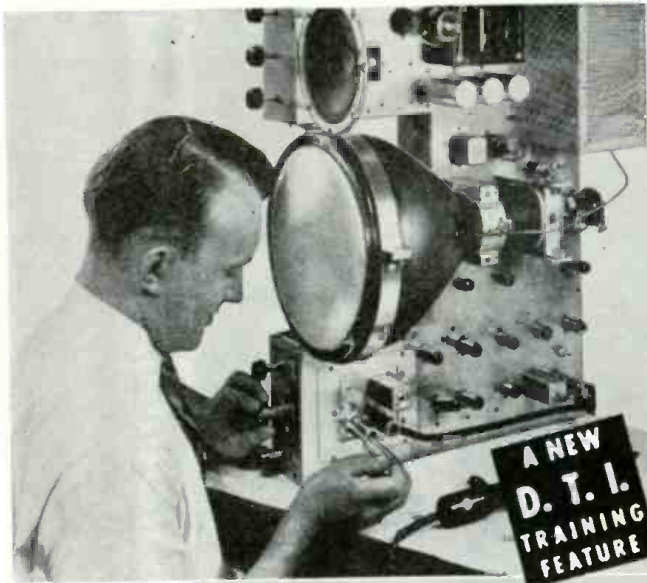

**NOW!** Build and Keep  
Big Screen Top Quality  
Television Receiver at Home  
as You Prepare for a  
Profitable job in  
**TELEVISION  
RADIO-ELECTRONICS**

**Choice of 10, 12½ or 16 inch picture tube**

Now you can get this amazingly practical aid for learning Television at home, to help you get started toward **FASCINATING WORK . . . GOOD MONEY . . . a THRILLING FUTURE**—in a real job, or your own sales and service business. When you complete our regular home training—described below—you can build and keep a top quality commercial-type Television Re-

ceiver. Standardized chassis is adaptable for a 10, 12½ or 16 inch direct view tube that gives big, bright, sharp, steady pictures. This is an optional training advantage—designed to provide the utmost in practical “learn-by-doing” home training in Television. Mail coupon for complete details. See why you owe it to your “Television Future” to enroll for DeForest’s Training, Inc.



**Mail Coupon NOW for FREE Information!**

See how D. T. I.’s amazingly effective methods help start you toward a **GOOD JOB** or your **OWN BUSINESS** in one of America’s most promising fields—including Television, F.M. Radio, Aviation, Train, and Taxi Radio, Broadcast Radio, Industrial Electronics. Get modern lessons . . . plus 16 shipments of Radio-Electronic parts. Work over 300 experiments and projects—including building of (1) commercial-type **OSCILLOSCOPE** for practical

T-V circuit training, (2) double-range R-F **SIGNAL GENERATOR**, (3) jewel-bearing **MULTIMETER**, (4) quality 6-tube **SUPERHET RADIO**. Then build and keep that big new Television Receiver. Here’s **EVERYTHING YOU NEED** for real laboratory type training . . . **AT HOME!**

*You also build and keep this Professional Type Equipment!*

**Modern Chicago Laboratories**

\* If you prefer, you can get **ALL** your preparation in our new, Chicago training laboratories . . . one of the finest of its kind. Ample instructors . . . modern equipment. Write for details!

**Employment Service**

\* When you complete your training, our effective Employment Service helps you get started toward a real future in Television—Radio—Electronics.

**You also use HOME MOVIES!**  
a D. T. I. Exclusive!

D. T. I. alone includes the modern, visual training aid . . . **MOVIES** . . . to help you learn faster, easier at home. See electrons on the march and other fascinating “hidden action”—a remarkable home training advantage that speeds your progress.

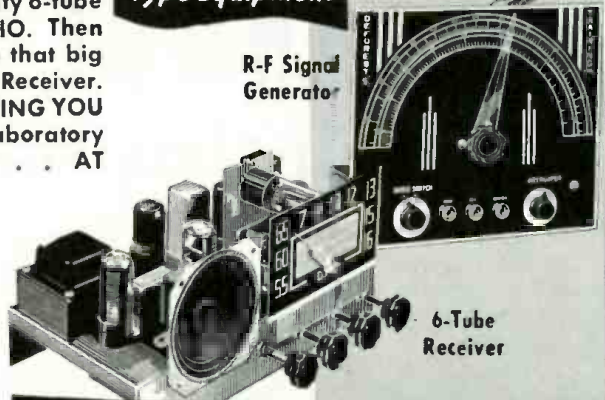
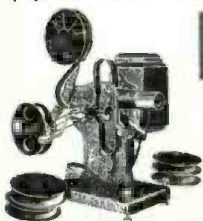

**MAIL THIS COUPON NOW!**

**DeFOREST’S TRAINING, INC.**  
2533 North Ashland Avenue, Dept. RC-G-1  
Chicago 14, Illinois

Without obligation, give me complete facts showing how I may make my start in Television-Radio-Electronics.

Name..... Age.....  
Street..... Apt.....  
City..... Zone..... State.....

**DeFOREST’S TRAINING, INC.**

CHICAGO 14, ILLINOIS  
A DE VRY Institution

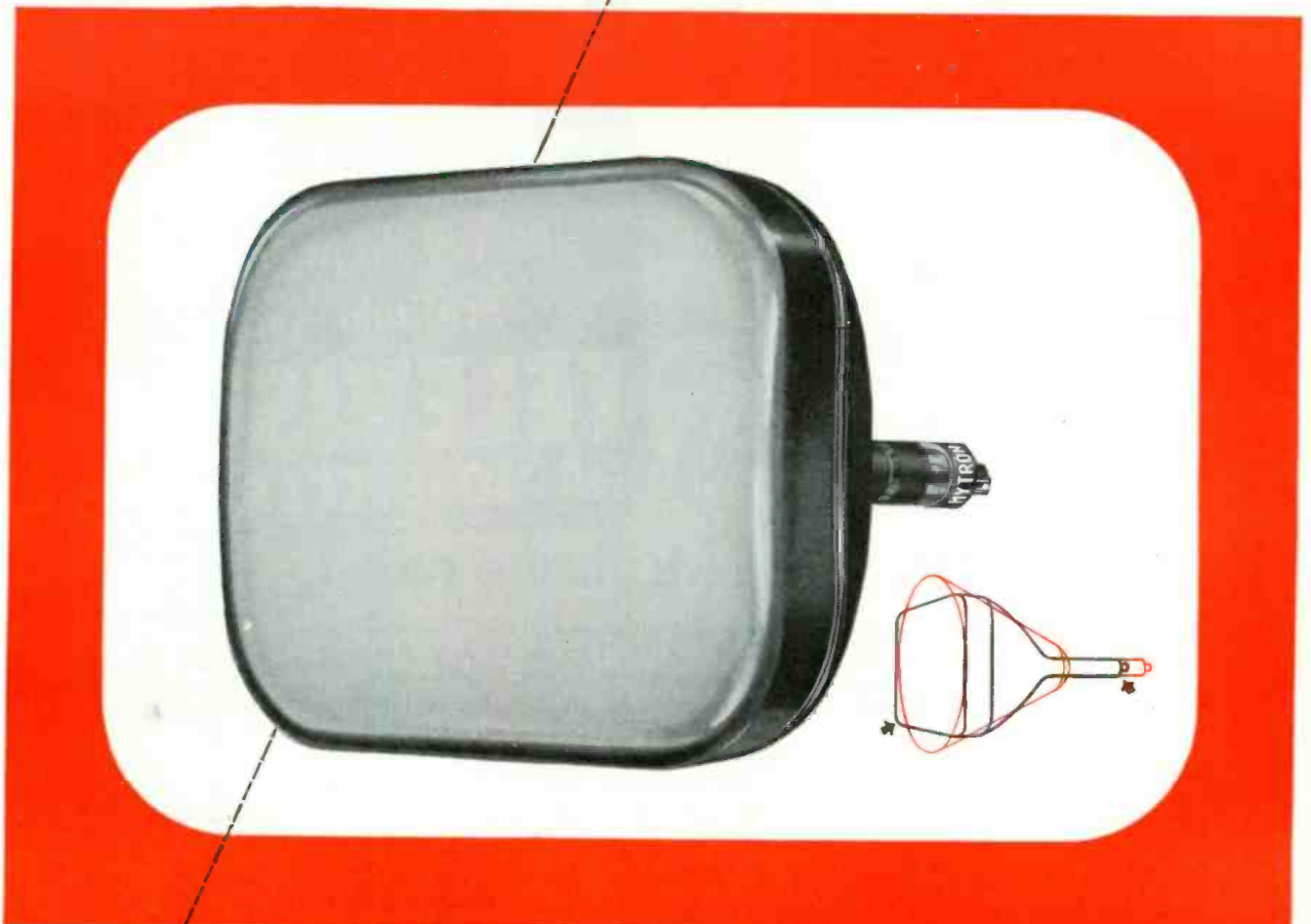
ANOTHER **HYTRON FIRST** YOU'LL BE BUYING SOON

## NEW HYTRON RECTANGULAR all-glass 16RP4

Meet Hytron's space and money saver. The new Hytron 16RP4. Revolutionary 16-inch rectangular picture tube. Takes approximately same cabinet space as 12LP4. Automatically sets the pace for more compact and economical TV set design. You'll be seeing it . . . buying it . . . soon.

The new 16RP4 is latest in a long series of Hytron firsts. Including: The GT tube. Over 50 GT types. The subminiature. Many new miniatures. Special low-cost TV deflection-circuit tubes: 1X2, 6BQ6GT, 6U4GT, 25BQ6GT. Check the 16RP4's many features. Watch for it. Buy the best by the leader. Buy Hytron!



OLDEST MANUFACTURER OF RECEIVING TUBES  
**HYTRON**  
RADIO AND ELECTRONICS CORP.

MAIN OFFICE: SALEM, MASSACHUSETTS



With old-style round tube, you lose the corners.



With Hytron 16RP4, you see the picture just as transmitted.

### Features of HYTRON 16RP4

- 1 Rectangular shape permits smaller, less costly cabinets.
- 2 Also just as short as 12LP4.
- 3 Weight is approximately two-thirds that of 16-inch, all-glass round tube.
- 4 Easy to mount. Can't roll or twist.
- 5 No high-voltage isolation of tube required.
- 6 Neutral gray face . . . increases contrast ratio.
- 7 Large viewing screen. You get the entire transmitted picture; no lost corners. Gives picture (with standard 3 by 4 aspect ratio) 10½ inches by 13½ inches.

Write for Bulletin E-147 giving complete data.

Study  
THE  
Features

# Heathkits ARE THE QUALITY LINE OF TEST EQUIPMENT KITS



## 1 MODERN STYLING

Heathkits have brought a new conception of beauty to laboratories and service benches.

Many organizations have standardized on Heathkits to make their shops appear attractive and uniform.

The panels are produced in grey and maroon and the modern streamline aluminum handles give the instruments a pleasant, professional appearance.

There is no waste space or false effort to appear large in Heathkits—space on service benches is at a premium and the size of Heathkit instruments is kept as small as is consistent with good engineering design.



## 5 COMPLETE KITS

When you receive your Heathkit, you are assured of every necessary part for the proper operation of the instrument.

Beautiful cabinets, handles, two-color panels, all tubes, test leads where they are a necessary part of the instrument, quality rubber line cords and plugs, rubber feet for each instrument, all scales and dials ready printed and calibrated. Every Heathkit is 110V 60 cy. power transformer operated by a husky transformer especially designed for the job.

## BEST OF PARTS

You will find many famous names on the parts in your Heathkit. Mallory switches and filter condensers, Chicago Transformer Corporation and Electrical Assembly Transformers, Centralab Potentiometers, Belden Cable, IRC and Allen Bradley resistors, G.E. tubes, Cinch and Amphenol sockets with silver plated contacts, Defiance variable condensers, Eby binding post and many other quality parts. The finest of parts are used to assure long trouble-free service from Heathkits.



## 2 PRECISION PARTS

Wherever required, the finest quality 1% ceramic resistors are supplied. These require no aging and do not shift. No matching of common resistors is required. You find in Heathkit the same quality voltage divider resistors as in the most expensive equipment.

The transformers are designed especially for the Heathkit unit. The scope transformer has two electrostatic shields to prevent interaction of AC fields.

These transformers are built by several of the finest transformer companies in the United States.

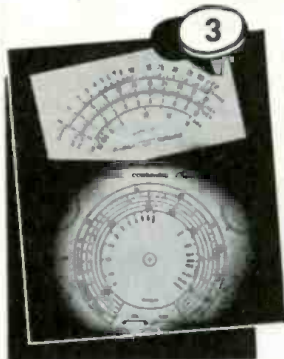
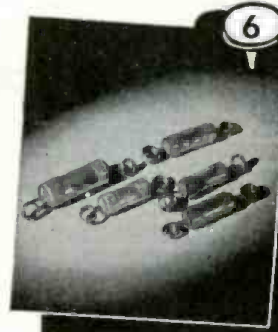

## 3 LARGE EASILY READ CALIBRATIONS

No charts or calculations are necessary to use any Heathkit properly. All scales are simple and plainly marked.

The operator instantly knows the proper use of the instrument and can proceed confidently. No multiplication is required as each scale is calibrated independently of the others.



## 7 COMPLETE INSTRUCTION MANUALS

Everyone is pleased at the thorough instructions covering the assembly of each Heathkit instrument. Every detail of the assembly is covered, together with sections on the use of the instrument and trouble shooting instructions in case of difficulty. Actual photos of the assembled instrument enable fast and accurate assembly, clear schematics and pictorial diagrams of the confusing parts such as rotary switches, enable the wiring to be completed quickly.

## KITS THAT FIT

Heathkit chassis are precision punched to fit the quality parts supplied. The grey crackle aluminum cabinet and the two-color panels are die punched to assure proper fitting.

Many builders have written marveling at the ease with which assembly can be accomplished.

The chassis are specially engineered for easy assembly and wiring—there are no small, tight corners which cannot be reached—the ends of the chassis are left open in order that installation of parts and soldering can be done with both hands.



## 4 IDEAL FOR SCHOOLS

Heathkits have been adopted as standard equipment of many of the largest universities and colleges. The low cost plus the fact that the students learn by actual assembly make them ideal training mediums. Many high schools and small colleges are finding that they too can have a modern physics and electronics laboratory by using Heathkits.

Some of the largest technical schools recommend Heathkits to their students as the best means of securing the necessary equipment to start their own shops.



EXPORT DEPT.  
13 East 40th St.  
NEW YORK CITY (16)  
CABLE: ARLAB-N.Y.

The **HEATH COMPANY**

... BENTON HARBOR 20, MICHIGAN



Heathkits are engineered in one of the most completely equipped laboratories for instrument development in the United States.

# Heathkits ARE LABORATORY ENGINEERED ...

## The NEW V-4 Heathkit VACUUM TUBE VOLTMETER KIT

### Features

- Meter scale 17% longer than average 4 1/2" meter.
- Modern streamline 200 ua meter.
- New modern streamline styling.
- Burn-out proof meter circuit.
- 24 Complete ranges.
- Isolated probe for dynamic testing.
- Most beautiful VTVM in America.
- Accessory probes (extra) extend ranges to 10,000 Volts and 100 Megacycles.
- Uses 1% precision ceramic divider resistors.
- Modern push-pull electronic voltmeter circuit.
- Electronic AC circuit. No current drawing rectifiers.
- Shatterproof plastic meter face.

The new Heathkit Model V-4 Vacuum Tube Voltmeter has dozens of improvements. A new modern streamlined 200 microampere meter has Alnico V magnet for fast, accurate readings. The new electronic AC voltmeter circuit incorporates an entire new balance control which eliminates contact potential and provides greater accuracy. New simplified switches for quicker assembly. New snap-in battery mounting is on the chassis for easy replacement.

The Heathkit VTVM is the only kit giving all the ranges. Check them — DC and AC full scale linear ranges of 0-3V, 0-10V, 0-30V, 0-100V, 0-300V, 0-1000V and can be extended to 0-3000V and 0-10,000V DC with accessory probe at slight extra cost. Electronic ohmmeter has six ranges measuring resistance accurately from .1 ohm to one billion ohms. Meter pointer can be offset to zero center for FM alignment.

The DC probe is isolated for dynamic measurements. Has db scale for making gain and other audio measurements.

The new instruction manual features pictorial diagrams and step-by-step instructions for easy assembly. The Heathkit VTVM is complete with every part — 110V transformer operated with test leads, tubes, light aluminum cabinet for portability, giant 4 1/2" 200 microamp meter and complete instruction manual.

Order now and enjoy it this entire season. Shipping weight 8 lbs., Model V-4



# \$24.50

THE FINEST VTVM KIT AVAILABLE FOR THIS PRICE.

Accessory: 10,000V high voltage probe, No. 310, \$4.50.

Accessory: RF crystal diode probe kit extends RF range to 100 Mc., No. 309, \$6.50.

## New Heathkit HANDITESTER KIT

### Features

- Beautiful streamline Bakelite case.
- AC and DC ranges to 5,000 Volts.
- 1% Precision ceramic resistors.
- Convenient thumb type adjust control.
- 400 Microampere meter movement.
- Quality Bradley AC rectifier.
- Multiplying type ohms ranges.
- All the convenient ranges 10-30-300-1,000-5,000 Volts.
- Large quality 3" built-in meter.

A precision portable volt-ohm-milliammeter. An ideal instrument for students, radio service, experimenters, hobbyists, electricians, mechanics, etc. Rugged 400 ua meter movement. Twelve complete ranges, precision dividers for accuracy. Easily assembled from complete instructions and pictorial diagrams. An hour of assembly saves one-half the cost. Order today. Model M-1. Shipping wgt., 2 lbs.



# \$13.50

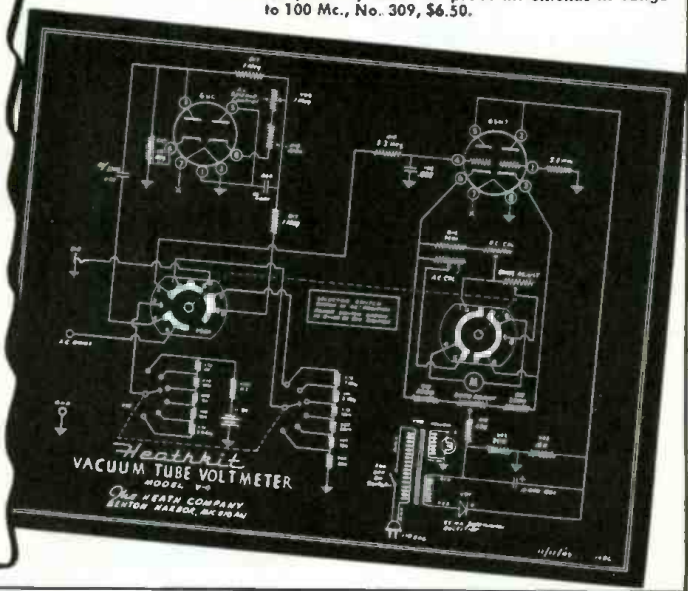

EXPORT DEPT.  
13 East 40th St.  
NEW YORK CITY (10)  
CABLE: ARLAB-N.Y.

# The HEATH COMPANY

... BENTON HARBOR 20, MICHIGAN

# TEST INSTRUMENT KITS



Only  
**\$39<sup>50</sup>**

## Heathkit PUSH-PULL EXTENDED RANGE 5" OSCILLOSCOPE KIT

### Features

- The first truly television oscilloscope.
- Tremendous sensitivity .06 Volt RMS per inch deflection.
- Push-pull vertical and horizontal amplifiers.
- Useful frequency range to 2 1/2 Megacycles.
- Extended sweep range 15 cycles to 70,000 cycles.
- New television type multivibrator sweep generator.
- New magnetic alloy shield included.
- Still the amazing price of \$39.50.

The new 1950 Push-Pull 5" Oscilloscope has features that seem impossible in a \$39.50 oscilloscope. Think of it—push-pull vertical and horizontal amplifiers with tremendous sensitivity only six one-hundredths of a volt required for full inch of deflection. The weak impulses of television can be boosted to full size on the five-inch screen. Traces you couldn't see before. Amazing frequency range, clear, useful response at 2 1/2 Megacycles made possible by improved push-pull amplifiers. Only Heathkit Oscilloscopes have the frequency range required for television. New type multivibrator sweep generator with more than twice the frequency range. 15 cycles to 70,000 cycles will actually synchronize with 250,000 cycle signal. Dual positioning controls will move trace over any section of the screen for observation of any part. New magnetic alloy CR tube shield protects the instrument from outside fields. All the same high quality parts, cased electrostatically shielded power transformer, aluminum cabinet, all tubes and parts. New instruction manual now has complete step-by-step pictorials for easiest assembly. Shipping weight, 25 lbs. Model O-5

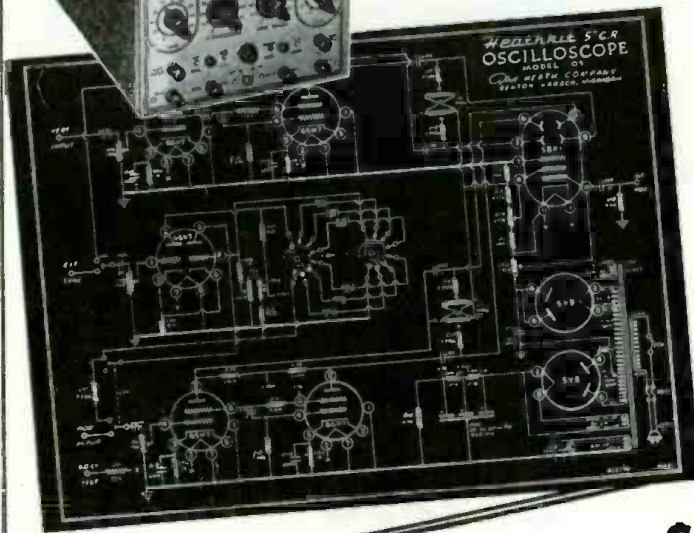

**\$34<sup>50</sup>**

## Heathkit

### ELECTRONIC SWITCH KIT

DOUBLE THE UTILITY OF ANY SCOPE

An electronic switch used with any oscilloscope provides two separately controllable traces on the screen. Each trace is controlled independently and the position of the traces may be varied. The input and output traces of an amplifier may be observed one above the other or one directly over the other illustrating perfectly any change occurring in the amplifier. Distortion-phase shift and other defects show up instantly, 110V. 60 cycle transformer operated. Uses 5 tubes (1 6X5, 2 6SN7's, 2 6SJ7's). Has individual gain controls, positioning control and coarse and fine switching rate controls. The cabinet and panel match all other Heathkits. Every part supplied including detailed instructions for assembly and use. Shipping weight 11 lbs. Model S-1

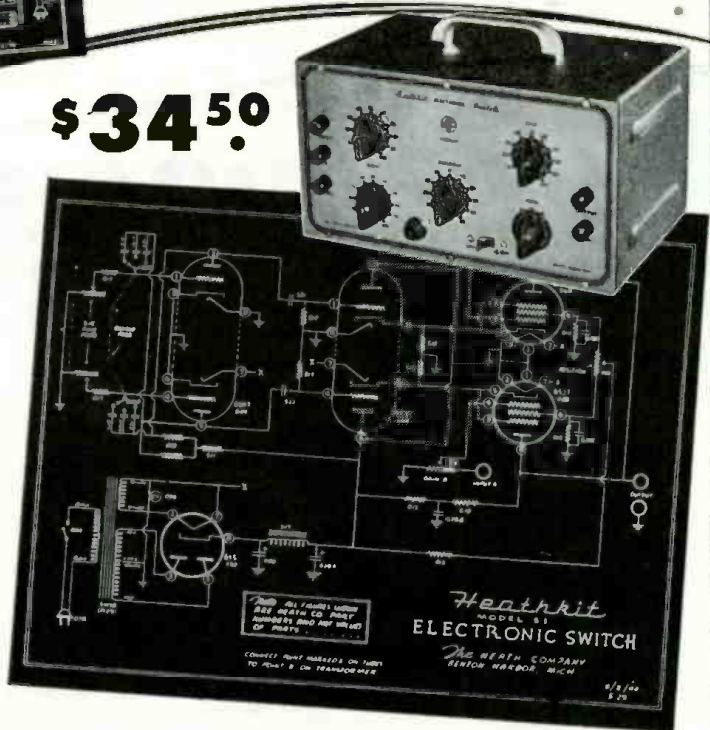

EXPORT DEPT.  
13 East 40th St.  
NEW YORK CITY (16)  
CABLE: ARLAB-N.Y.

The **HEATH COMPANY**

... BENTON HARBOR 20, MICHIGAN



By assembling your own laboratory equipment, you control the quality of workmanship and learn the entire story of the instrument.

# Heathkits ENABLE THE BUILDER

## New 1950 VERNIER TUNING RF Heathkit SIGNAL GENERATOR KIT

### Features

- New 5-to-1 ratio vernier tuning for ease and accuracy.
- New external modulation switch — use it for fidelity testing.
- Covers 150 Kc. to 34 Mc. on fundamentals and calibrated strong harmonics to 102 Mc.
- 400 cycle audio available for audio testing.
- Most modern type R.F. oscillator.
- New precision coils for greater output.
- Cathode follower output for greatest stability.

The most popular signal generator kit has been vastly improved — the experience of thousands combined to give you the best. Check the features in this fine generator and consider the low price \$19.50. A best buy for any shop, yet inexpensive enough for hobbyists. Everyone can have an accurate controlled source of R.F. signal voltage.

The new features double the value — think of being able to make fidelity checks on receivers by inserting a variable audio signal. Internal 400 cycle saw-tooth audio oscillator modulates R.F. signal and is available externally for audio testing. The new 5-to-1 ratio vernier drive gives hairline tuning for maximum accuracy in scale settings. The coils are already precision wound and calibrated. Uses turret type coil and switch assembly for ease of construction. The generator is 110V. 60 cycle transformer operated and comes complete in every detail — cabinet, tubes, beautiful two color calibrated panel and all small parts — new step-by-step pictorial diagrams and complete instruction manual make assembly a cinch even for novices. Why try to get along without a signal generator when you can have the best for less than a twenty-dollar bill. Better order it now. Shipping weight, 7 lbs. Model G-5.

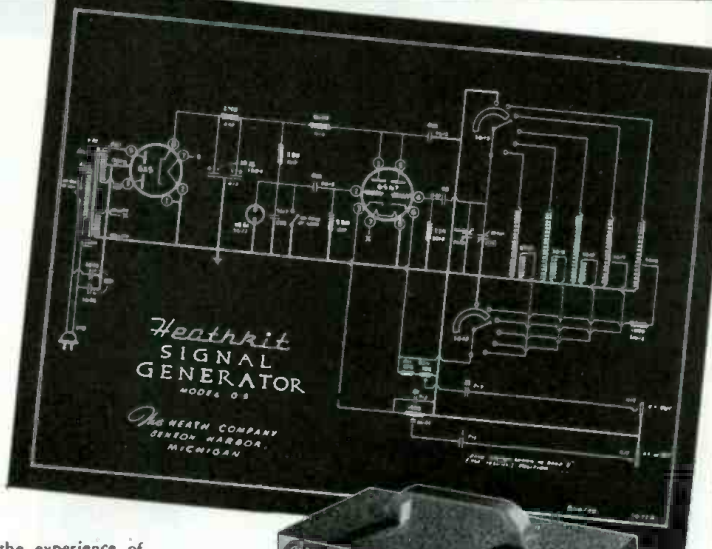

**\$19.50**



**\$34.50**

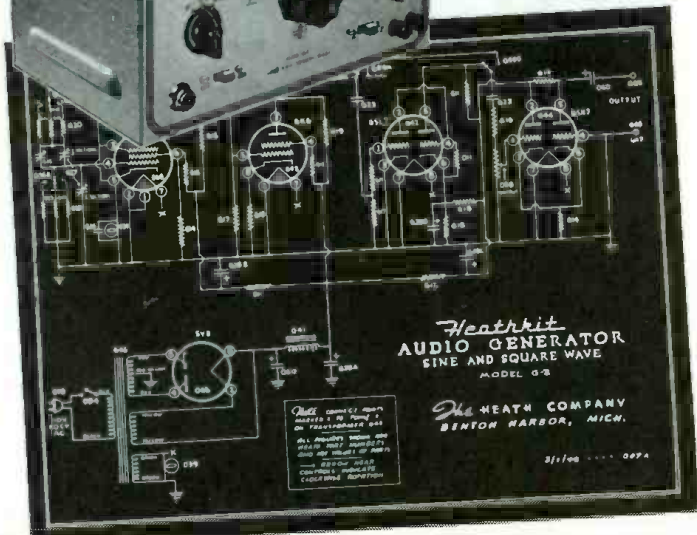

### Heathkit

## SINE AND SQUARE WAVE AUDIO GENERATOR KIT

Experimenters and servicemen working with a square wave for the first time invariably wonder why it was not introduced before. The characteristics of an amplifier can be determined in seconds compared to several hours of tedious plotting using older methods. Stage by stage, amplifier testing is as easy as signal tracing. The low distortion (less than 1%) and linear output ( $\pm$  one db) make this Heathkit equal or superior to factory built equipment selling for three or four times its price. The circuit is the popular RC tuning circuit using a four gang variable condenser. Three ranges 20-200, 200-2,000, 2,000-20,000 cycles are provided by selector switch. Either sine or square waves instantly available at slide switch. All components are of highest quality, cased 110V. 60 cycle power transformer. Mallory F.P. filter condensers, 5 tubes, calibrated two-color panel, grey crackle aluminum cabinet. The detailed instructions make assembly an interesting and instructive few hours. Shipping weight, 12 lbs. Model G-2.

Nothing ELSE TO BUY

EXPORT DEPT.  
13 East 40th St.  
NEW YORK CITY (16)  
CABLE: ARLAB-N.Y.

The **HEATH COMPANY**

... BENTON HARBOR 20, MICHIGAN



# TO USE THE *Best* OF WORKMANSHIP

## Heathkit TUBE CHECKER KIT

### Features

1. Measures each element individually.
2. Has gear driven roller chart.
3. Has lever switching for speed.
4. Complete range of filament voltages.
5. Uses latest type lever switches.
7. Uses beautiful shatterproof full view meter.
8. Large size 11" x 14" x 4" complete.
9. Checks new 9 pin miniatures.

Check the features and you will realize that this Heathkit has all the features you want. Speed, simplicity, beauty, protection against obsolescence. The most modern type of tester — measures each element — beautiful Bad-Good scale, high quality meter — the best of parts — rugged oversize 110V. 60 cycle power transformer — finest of Mallory switches — Centralab controls — quality wood cabinet — complete set of sockets for all type tubes including blank spare for future types — fast action gear driven roller chart uses brass gears to quickly locate and set up any type tube. Simplified switching cuts necessary time to minimum and saves valuable service time. Short and open element check. No matter what arrangement of tube elements, the Heathkit flexible switching arrangement easily handles it. Order your Heathkit Tube Checker today. See for yourself that Heath again saves you two-thirds and yet retains all the quality — this tube checker will pay for itself in a few weeks — better build it now.

Complete with detailed instructions, all parts, cabinet, roller chart, ready to wire up and operate. Shipping weight, 12 lbs. Model TC-1.

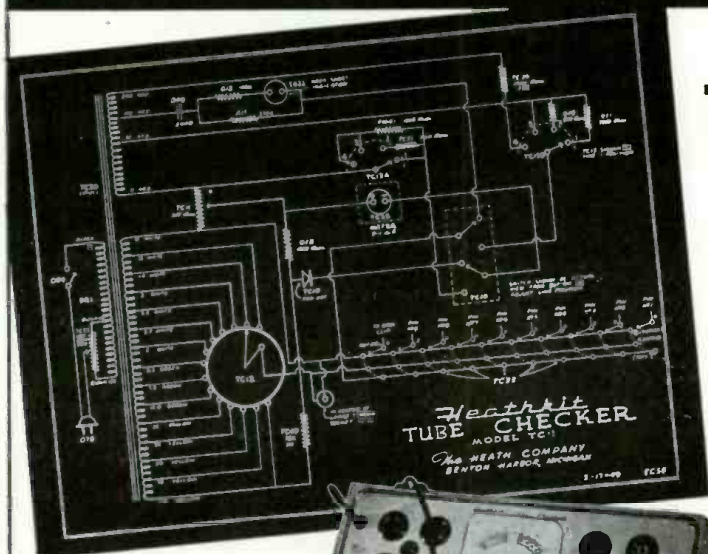

Heathkit  
TUBE CHECKER  
MODEL TC-1

The HEATH COMPANY  
BENTON HARBOR, MICHIGAN  
2-11-49 TC-1

Nothing  
ELSE  
TO BUY

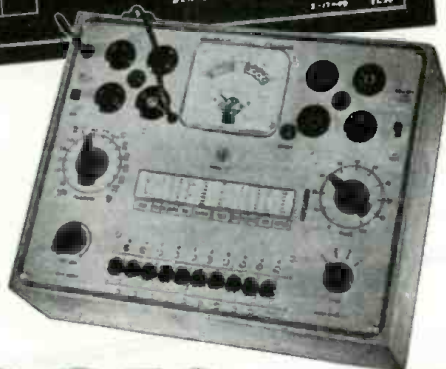

Only \$29<sup>50</sup>

## Heathkit BATTERY ELIMINATOR KIT

Now a bench 6 Volt power supply kit for all auto radio testing. Supplies 5 - 7½ Volts at 10 Amperes continuous or 15 Amperes intermittent. A well filtered rugged power supply, uses heavy duty selenium rectifier, choke input filter with 4,000 MFD of electrolytic filter. 0 - 15 Volt meter indicates output. Output variable in eight steps. Excellent for demonstrating auto radios. Ideal for servicing — can be lowered to find sticky vibrators or stepped up to equivalent of generator overload — easily constructed in less than two hours. Complete in every respect. Shipping wgt., 19 lbs.

Model BE-1

Nothing ELSE TO BUY

\$22<sup>50</sup>

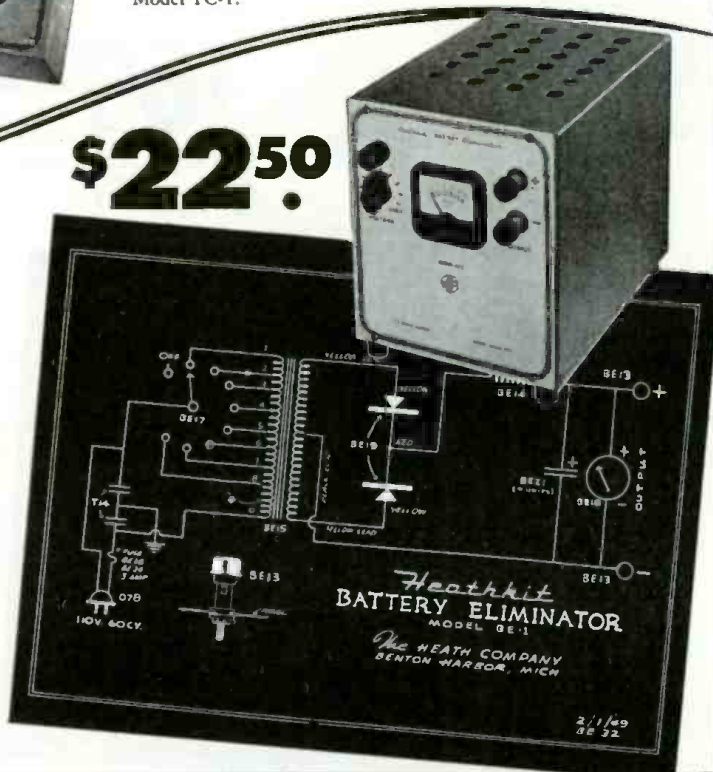

Heathkit  
BATTERY ELIMINATOR  
MODEL BE-1

The HEATH COMPANY  
BENTON HARBOR, MICHIGAN  
2-11-49  
BE-1

EXPORT DEPT.  
13 East 40th St.  
NEW YORK CITY (16)  
CABLE: ARLAB-N.Y.

The **HEATH COMPANY**

... BENTON HARBOR 20, MICHIGAN

# Heathkits ELIMINATE

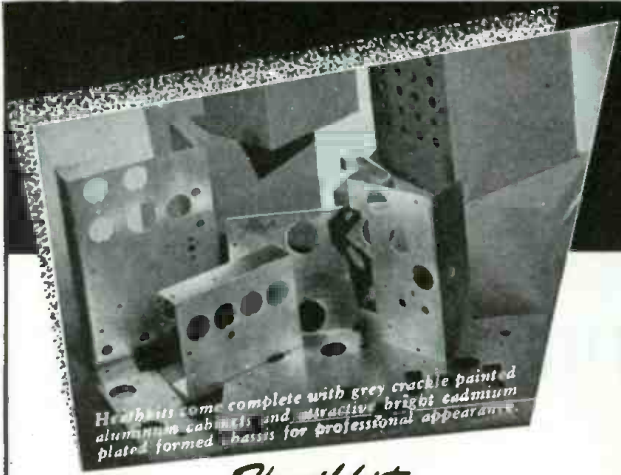

Heathkits come complete with grey crackle painted aluminum cabinets and attractive bright cadmium plated formed chassis for professional appearance.

## Heathkit TELEVISION ALIGNMENT GENERATOR KIT

Everything you want in a television alignment generator. A wide band sweep generator covering all TV frequencies 0 to 46 — 54 to 100 — 174 to 220 Megacycles, a marker indicator covering 19 to 42 Megacycles, AM modulation for RF alignment — variable calibrated sweep width 0-30 Mc. — mechanical driven inductive sweep. Husky 110V/60 cycle power transformer operated — step type output attenuator with 10,000 to 1 range — high output on all ranges — band switching for each range — vernier driven main calibrated dial with over 45 inches of calibration — vernier driven calibrated indicator marker tuning. Large grey crackle cabinet 16 1/4" x 19 3/8" x 7.3/16". Phase control for single trace adjustment. Uses three high frequency triodes plus 5Y3 rectifier — split stator tuning condensers for greater efficiency and accuracy at high frequencies — this Heathkit is complete and adequate for every alignment need and is supplied with every part — cabinet, calibrated panel, all coils and condensers wound, calibrated and adjusted, tubes, transformer, test leads — every part with instruction manual for assembly and use. Actually three instruments in one — TV sweep generator — TV AM generator and TV marker indicator.

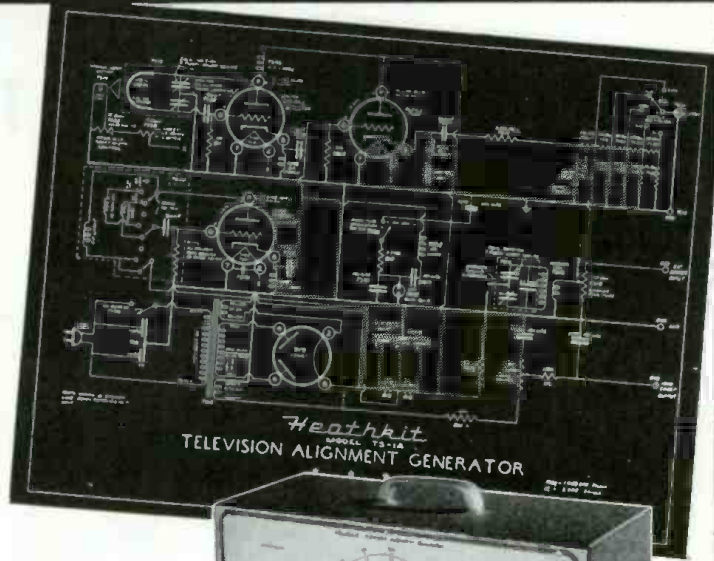

**\$39.50**

Shipping weight 20 lbs.  
Model TS-1A



**\$69.50**

Shipping weight 15 lbs.  
Model IB-1

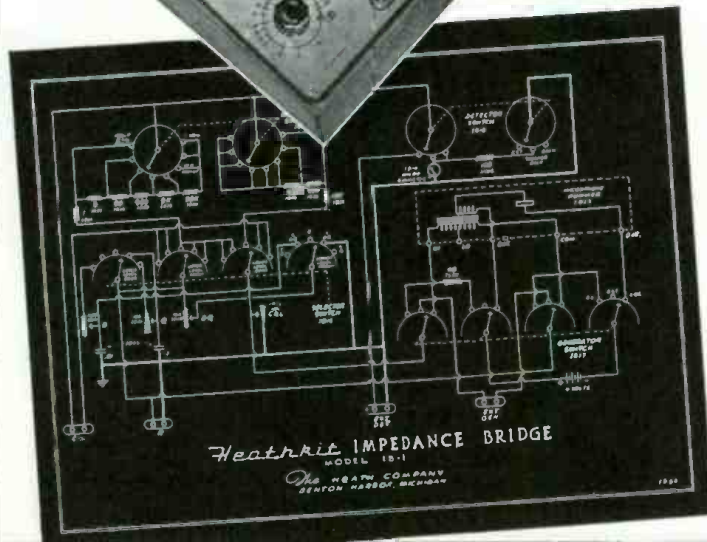

## New Heathkit

# IMPEDANCE BRIDGE KIT

A LABORATORY INSTRUMENT NOW WITHIN  
THE PRICE RANGE OF ALL

Measures inductance from 10 microhenries to 100 henries capacitance from .00001 MFD. to 100 MFD. Resistance from .01 ohms to 10 megohms. Dissipation factor from .001 to 1. "Q" from 1 to 1000.

Ideal for schools, laboratories, service shops, serious experimenters.

An impedance bridge for everyone — the most useful instrument of all, which heretofore has been out of the price range of serious experimenters and service shops. Now at the lowest price possible. All highest quality parts. General Radio main calibrated control. General Radio 1000 cycle hummer. Mallory ceramic switches with 60 degree indexing — 200 microamp zero center galvanometer — 1/2 of 1% ceramic non-inductive decade resistors. Professional type binding posts with standard 3/8" centers. Beautiful birch cabinet. Directly calibrated "Q" and dissipation factor scales. Ready calibrated capacity and inductance standards of Silver Mica, accurate to 1/2 of 1% and with dissipation factors of less than 30 parts in one million. Provisions on panel for external generator and detector. Measure all your unknowns the way laboratories do — with a bridge for accuracy and speed.

Internal 6 Volt battery for resistance and hummer operation. Circuit utilizes Wheatstone, Hay and Maxwell circuits for different measurements. Supplied complete with every quality part — all calibrations completed and instruction manual for assembly and use. Deliveries are limited.

EXPORT DEPT.  
13 East 40th St.  
NEW YORK CITY (16)  
CABLE: ARLAB-N.Y.

The **HEATH COMPANY**

... BENTON HARBOR 20, MICHIGAN

RADIO-ELECTRONICS for

# DIFFICULT METAL FABRICATION.....

## NEW *Heathkit* SIGNAL TRACER AND UNIVERSAL TEST SPEAKER KIT

The popular Heathkit Signal Tracer has now been combined with a universal test speaker at no increase in price. The same high quality tracer follows signal from antenna to speaker, locates intermittents, defective parts quicker, saves valuable service time, gives greater income per service hour. Works equally well on broadcast, FM or TV receivers. The test speaker has assortment of switching ranges to match push-pull or single output impedance. Also tests microphones, pickups, PA systems; comes complete—cabinet, 110V. 60 cycle power transformer, tubes, test probe—all parts and detailed instructions for assembly and use. Shipping Wt., 8 lbs. Model T-2.

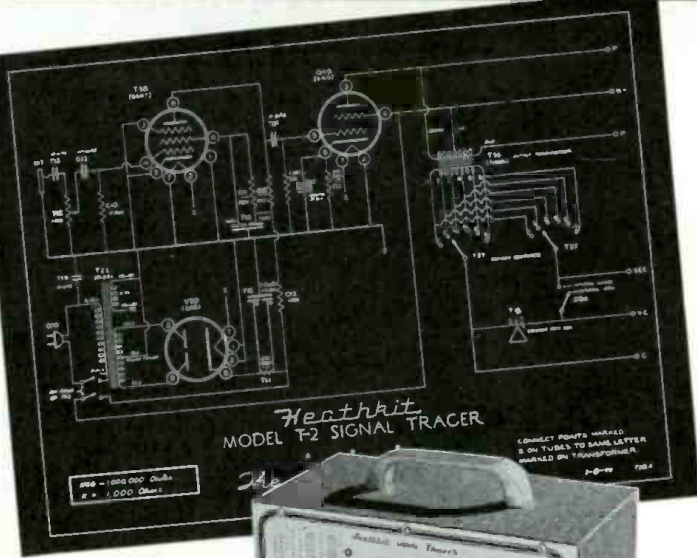

**\$19.50**

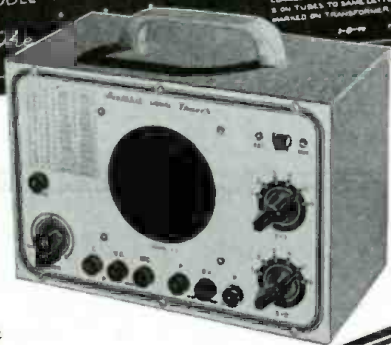

*Nothing*  
ELSE TO BUY

**\$19.50**



## *Heathkit* CONDENSER CHECKER KIT

### *Features*

- Power factor scale
- Measures resistance
- Measures leakage
- Checks paper-mica-electrolytics
- Bridge type circuit
- Magic eye indicator
- 110V. transformer operated
- All scales on panel

Checks all types of condensers, paper-mica-electrolytic-ceramic over a range of .00001 MFD. to 1000 MFD. All on readable scales that are read direct from the panel. NO CHARTS OR MULTIPLIERS NECESSARY. A condenser checker anyone can read without a college education. A leakage test and polarizing voltage for 20 to 500 volts provided. Measures power factor of electrolytics between 0% and 50%. 110V. 60 cycle transformer operated complete with rectifier and magic eye tubes, cabinet, calibrated panel, test leads and all other parts. Clear detailed instruction for assembly and use. Why guess at the quality and capacity of a condenser when you can know for less than a twenty dollar bill. Shipping weight, 7 lbs. Model C-2.

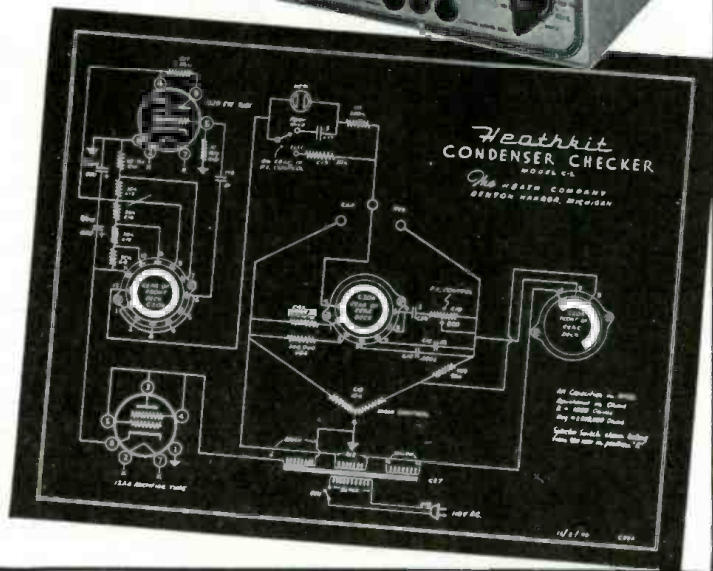

EXPORT DEPT.  
13 East 40th St.  
NEW YORK CITY (16)  
CABLE: ARLAB-N.Y.

*The* **HEATH COMPANY**

... BENTON HARBOR 20, MICHIGAN

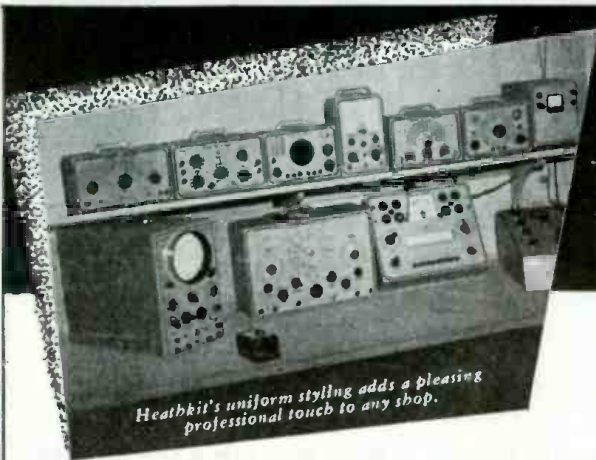

*Heathkit's uniform styling adds a pleasing professional touch to any shop.*

# Heathkit's PROVIDE PROFESSIONAL LABORATORY APPEARANCE

*New Heathkit*

## BROADCAST AND 3 BAND SUPERHETERODYNE RECEIVER KIT

**BROADCAST MODEL BR-1**  
550 to 1600 Kc.

**\$19<sup>50</sup>**

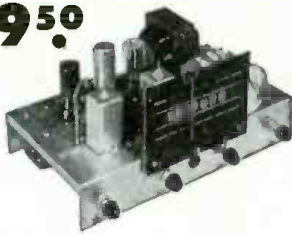

Two new Heathkit Superheterodynes featuring the best of design and material. Beautiful six inch slide rule dials — 110 V. 60 cy. AC power transformer operated—metal cased filters—quality output transformers, dual iron core metal can IF transformers — two gang tuning condenser. The chassis is provided with phono-radio switch—110 V. outlet for changer motor and phono pickup jack. Each kit is complete with all parts and detailed instruction booklet. Pictorial diagrams and step-by-step instructions make assembly quick and easy.

**3 BAND MODEL AR-1**  
550 Kc. to 20 Mc.

**\$23<sup>50</sup>**

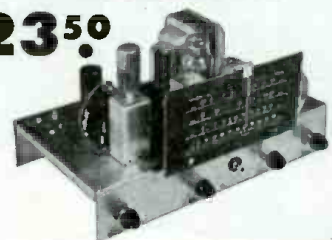

Ideal AC operated superheterodyne receiver for home use or replacement in console cabinet. Comes complete with attractive metal panel for cabinet mounting. Modern circuit uses 12K8 converter, 12SH7 input IF stage, 12C8 output IF stage and first audio 12A6 beam power output stage, 5Y3 rectifier. Excellent sensitivity for distant reception with selectivity which effectively separates adjacent stations.

The husky 110 V. cased power transformer is conservatively rated for long life. The illuminated six inch slide rule dial is accurately calibrated for DX reception. Enjoy the pleasure of assembling your own fine home receiver. Has tone, volume, tuning and phono-radio controls. Chassis size 2 1/4" x 7" x 12 1/2". Comes complete with all parts including quality output transformer to 3.4 ohm voice coil, tubes, instruction manual, etc. (less speaker). Shipping Wt., 10 lbs. No. BR-1 Receiver \$19.50.

No. 335 Communications Type Table Model Metal Cabinet.....\$4.50  
No. 320 High Quality 5" PM Speaker for above..... 2.75

Enjoy the thrill of world wide short wave reception with this fine new AC operated Heathkit 3 band superheterodyne — amazing sensitivity 15 microvolt or better on all bands. Continuous coverage 550 Kc. to over 20 Mc. Easy to build with complete step-by-step instructions and pictorial diagram. Attractive accurately calibrated six inch slide rule dial for easy tuning. Six tubes with one dual purpose tube gives seven tube performance. Beam power output tube gives over 3 watts output.

Separately assembled coil turret with band switch eliminates difficult construction. Conservatively rated 110 V. power transformer supplies full operating voltages to all tubes for maximum reception. Has band switch, tuning, volume, tone and phono-radio controls. Chassis size 2 1/4" x 7" x 12 1/2" — supplied complete — punched chassis — tubes — controls — transformers (quality output to 3.4 ohm voice coil) — all small parts — hardware and instructions (less speaker). Shipping Wt., 10 lbs. No. AR-1 Receiver \$23.50.

No. 335 Communications Type Table Model Metal Cabinet.....\$4.50  
No. 320 High Quality 5" PM Speaker for above..... 2.75

*Heathkit*

### PUSH-PULL HIGH FIDELITY AMPLIFIER KIT



**\$12.50**

Build this high fidelity push-pull amplifier and save two-thirds the cost—has two pre-amplifier stages, phase inverter stage and push-pull beam power output stage. Comes complete with six tubes—quality output transformer (to 3.4 ohm voice coil) tone and volume controls—varnish impregnated cased 110V. power transformer and detailed instruction manual and all small parts. Six watt output with output flat within 1 1/2 db between 50 and 15000 cycles.

Build this amplifier now and enjoy it for years.  
Shipping Wt. 7 lbs. Model A-4  
12" PM Speaker for above.....\$6.95

## ORDER BLANK

<b>HEATH CO.</b> BENTON HARBOR MICHIGAN		FROM _____		SHIP VIA	
		_____		___ Parcel Post	
		_____		___ Express	
		_____		___ Freight	
		_____		___ Best Way	
Quan.	DESCRIPTION	Price	Total		

ENCLOSED FIND  CHECK . . .  MONEY ORDER FOR \_\_\_\_\_  
PLEASE SHIP C.O.D. . . . POSTAGE ENCLOSED FOR \_\_\_\_\_ POUNDS

EXPORT DEPT.  
13 East 40th St.  
NEW YORK CITY (16)  
CABLE: ARLAB-N.Y.

# The HEATH COMPANY

. . . BENTON HARBOR 20, MICHIGAN

RADIO-ELECTRONICS for

**YOUR SYLVANIA TUBE  
CARTONS ARE WORTH 2¢  
IN TRADE!**

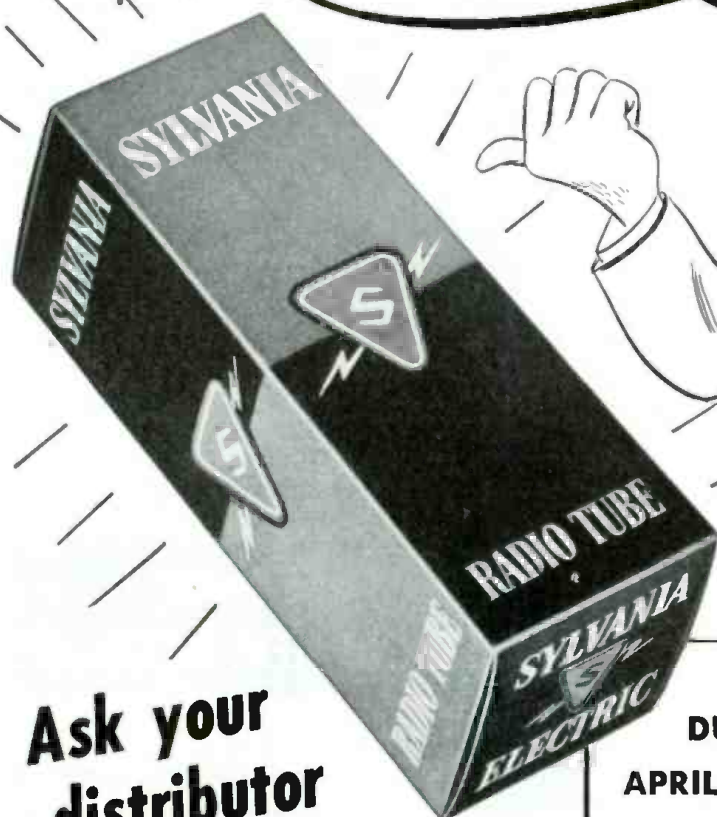

**Ask your  
distributor  
TODAY—  
about Sylvania's  
big tube carton  
trade-in deal!**

**DURING FEBRUARY, MARCH AND  
APRIL YOUR EMPTY SYLVANIA CAR-  
TONS ARE WORTH 2¢ EACH AT YOUR  
DISTRIBUTOR'S when applied against  
the purchase of...**

- SYLVANIA ADVERTISING MATERIAL
- MORE SYLVANIA TUBES
- SYLVANIA TEST EQUIPMENT

**SYLVANIA  ELECTRIC**

RADIO TUBES; CATHODE RAY TUBES; ELECTRONIC DEVICES; FLUORESCENT LAMPS, FIXTURES, WIRING DEVICES, SIGN TUBING; LIGHT BULBS; PHOTOLAMPS

FEBRUARY, 1950



## WANT YOUR FCC COMMERCIAL LICENSE IN A HURRY?

Add Technical Training to Your Practical Experience and Get Your "Ticket" in a FEW SHORT WEEKS. It's EASY When You Use CIRE Simplified Training and Coaching AT HOME in SPARE TIME

Thousands of new jobs are opening up—FM, Television, Mobile Communication Systems. These are only a few of the radio fields which require licensed radio technicians and operators. Get your license without delay. Let Cleveland Institute prepare you to pass

FCC license examinations, and hold the jobs which a license entitles you to, with CIRE streamlined, post-war methods of coaching and training.

### Your FCC Ticket is Always Recognized in ALL Radio Fields as Proof of Your Technical Ability

More than ever before an FCC Commercial Operator License is a sure passport to many of the better paying jobs in this New World of Electronics. Employers always give preference to the license

holder, even though a license is not required for the job. Hold an FCC "ticket" and the job is yours!

#### CIRE Job-Finding Service Brings Amazing Offers of Jobs!

"Have found and accepted a position at KWAD in Wadena, Minn. I am indebted to CIRE for I secured this position through the help of the CIRE Job Finding Service. I had six other offers from stations receiving my employment application and CIRE reference. I am sincerely under obligation to you."  
Student No. 2760 AT

"I am working at WRJM as transmitter engineer, and I received this position in response to one of the employment applications sent me upon completion of my course and the receiving of my Diploma. I received my 1st class Radiotelephone License on March 2, 1949. I want to express my sincere appreciation to the staff of CIRE."  
Student No. 2608 AT

"Thanks for the Application for Employment you recently prepared for me. I found satisfactory employment. I submitted 57 letters, enclosing the resume you supplied. I received 17 letters indicating my application was filed for future reference; 3 telephone calls, and one letter requesting personal interviews. As a result, I am employed in a development engineering capacity."  
Student No. 4235 NB

"I now hold ticket Number P-10-3787, and holding the license has helped me to obtain the type of job I've always dreamed of having. Yes, thanks to CIRE. I am now working for CAA as Radio Maintenance Technician, at a far better salary than I've ever had before. I am deeply grateful."  
Student No. 3319N12

### Look At The Job Opportunities You Will Have When You Get Your FCC Ticket!

- |                            |                        |
|----------------------------|------------------------|
| Forestry and conservation  | Bus and truck fleets   |
| Ambulances and hospitals   | Police and fire depts. |
| Gas and electric utilities | Telephone companies    |
| Gas and oil pipe lines     | Merchant marine        |
| Private automobiles        | Highway Patrol         |
| Street railways            | Railroads              |
| Taxicab fleets             | Airlines               |

### LOOK AT THESE AVERAGE PAY SCHEDULES FOR BROADCAST JOBS (Reported by FCC Nationwide Survey)

Position	Big Stations	Little Stations
Transmitter Engineer	\$4800	\$3000
Studio Engineer	5000	3650
Chief Engineer	7700	4300

Other jobs requiring FCC commercial licenses pay similar salaries.



1. Tells of Thousands of Brand-New Better Paying Radio Jobs Now Open to FCC License Holders.
2. Tells How We Guarantee to Train and Coach You Until You Get Your FCC license.
3. Tells How Our Amazing Job-FINDING Service Helps You Get The Better Paying Radio Job Our Training Prepares You To Hold.



Mail Coupon At Once  
**GET ALL 3 FREE**

Approved for Veteran Training under "G. I. Bill of Rights"

**CLEVELAND INSTITUTE OF RADIO ELECTRONICS** (Address to Desk No. to avoid delay)  
Desk RE-14, 4900 Euclid Bldg., Cleveland 3, Ohio

I want to know how I can get my FCC ticket in a few short weeks by training at home in spare time. Send me your amazing new FREE booklet "Money Making FCC License Information", as well as a FREE sample FCC-type exam and FREE booklet "How to Pass FCC License Examinations (does not cover exams for amateur license).

Name .....

Address .....

City ..... Zone ..... State .....

Veterans check for enrollment information under G. I. Bill!

RADIO-ELECTRONICS for

# Safeguarding your Inventions

... Documentary evidence is vital for inventions ...

By HUGO GERNSBACK

**R**EADERS of this magazine send us a continuous stream of letters asking advice how to proceed to safeguard new inventions, how to patent and how to sell them.

Practically every inventor is suspicious of his fellow man. Everybody—he feels—is out to steal his invention and to do him out of a fortune. He is suspicious even of a patent attorney and is loath to discuss his idea even with him. Yet he wishes to sell his invention to some big corporation and wants to collect royalties.

Most new inventors who have not had much experience with inventions and patents fall into this pattern. Here is a random example:

“Editor, RADIO-ELECTRONICS:

“Your editorial in the December issue sets out needed improvements in airplane public address systems. O.K., I have that problem solved, as well as several others in the electrical or electronic fields, but when I contact those who might be, or should be interested in buying such inventions they invariably try every way in the cards to steal the idea, and will not go into contract beneficial to me, even though I do guarantee each and every claim, etc.”

H. L.  
West Plains, Missouri

Certain elementary things *must* be observed to safeguard an invention. The most important of these is *documentary evidence*. Every inventor should put the elements of his invention on paper, preferably typewritten, or at least written in ink. Explanatory sketches made in ink should be on the same page. If the inventor knows he has a valuable idea, the piece of paper which now is the original conception of the invention, should be dated and signed before one or two witnesses, who should also sign their names on the same sheet of paper. It is not necessary that the witnesses know the contents of the invention, *they merely witness the inventor's signature*.

For further safeguarding, the document should be taken to a notary public and officially signed and stamped with date, notary public's name, etc.

Such a document often is worth more than a patent. It can be used in court as evidence and indeed has been so used in many court actions.

Edison, Lee de Forest, Tesla, and many other inventors of note have always used this system. It has paid big dividends.

One day on a visit to the late Edison, the writer noted that Edison always had before him a yellow paper scratch pad, size 4 x 6 inches. He personally made copious notes of anything that occurred to him during his work day. His secretary dated each sheet

of note paper every day. Once a month these sheets were bound into a book. These books later were used in patent suits by Edison and were admissible evidence as to actual conception dates of his inventions.

The same was the case in the famous audion suits where Lee de Forest finally established his claims on the invention of regeneration.

Most inventors have little money. It is the exceptional inventor who is so fortunate that he can patent every invention and every important idea that he has. Patents are expensive—but in the end the good ones usually pay out.

The inventor should always be cognizant of the fact that it is one thing to invent something, but a totally different thing to protect the invention legally with a patent. The average inventor little realizes that *to have a valuable patent he must also anticipate various improvements that someone else could make on his original idea*. That is the reason why all patents, if they are good, are granted a number of important “claims” by the patent office. It is the number and scope of these claims that make a patent valuable.

But the average inventor, knowing nothing about legal phraseology and practice is not competent to draft such claims. A good patent attorney will foresee the improvements that someone else could make on the original idea and will, therefore, try to obtain as many claims—anticipating such improvements—as he possibly can. These claims act like a ring of fortresses around a beleaguered city. Without them the invention becomes a prey to clever imitators.

Big corporations, as a rule, never appropriate inventions outright. What they do, however, often is improve on the original device, so much so that frequently the original inventor hardly recognizes his brainchild.

It is for this reason that it is never safe for an inventor to deal with commercial interests unless he has at least applied for a patent. It is better in most instances to wait until the patent has been issued.

Many inventors have tried to sell inventions by submitting photostats of their original documentary evidence sheets. Some have succeeded, most have not.

Large concerns dislike to buy inventions from mere documentary evidence—unless the invention is a very important one and fits into the company's operations. In no case does an inventor fare as well when selling his invention from an original document as from an actual patent. Thousands of successful inventions have been patented even if the inventor had no money at all. This has usually been accomplished by the inventor in taking some moneyed friends into his confidence. By showing them the document and perhaps a model of the invention he then sells a share in the invention to his friends in return for money used to patent the invention. This has always been a safe and sane means for handling new inventions.

# TELEVISION TEST EQUIPMENT

● HOW MUCH IS NEEDED AND HOW TO USE IT

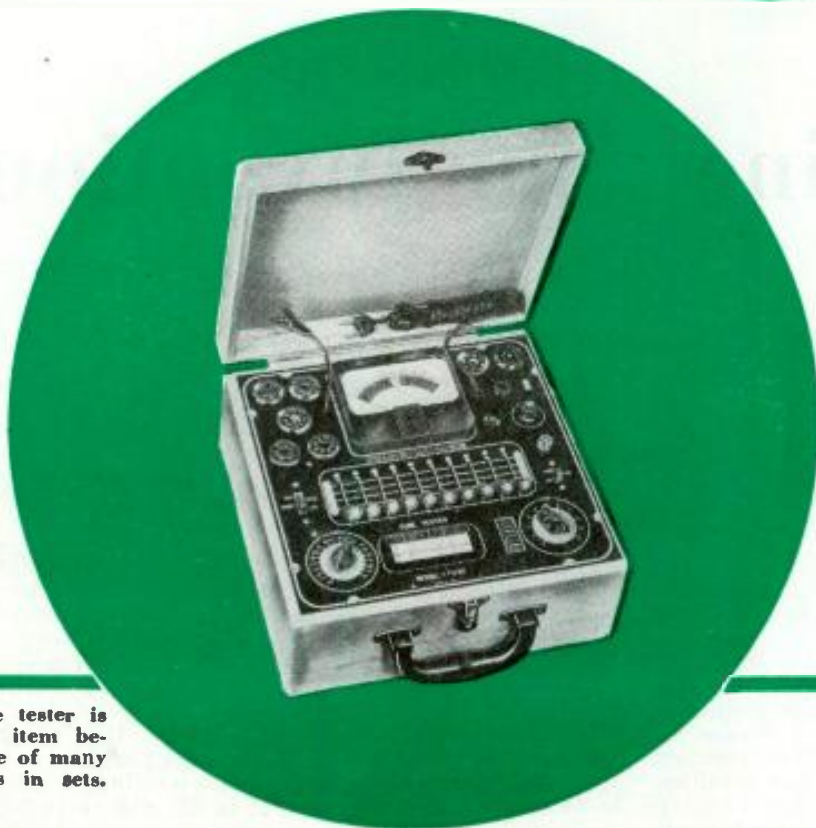

Tube tester is vital item because of many tubes in sets.

BY WALTER R. JONES\*

**T**HE rapid increase in the number of television receivers in operation has made life increasingly complicated for the radio technician. Not only are the problems of installation greatly aggravated; the customer must be educated in order to reduce to a minimum the number of unjustified complaints. In addition, the service technician must determine how much money he can afford to spend on test equipment and just what equipment he really needs. The confusion is in no way reduced as he examines test-equipment literature and encounters such terms as crosshatch generators, genescopes, signal alignment generators, dynatracers, markers, signal tracers, sweep generators, and field-strength meters. The problem can be eased, however, by reviewing what must be done and then deciding how to do it.

First, let us review the over-all problem. Two signals must be received, the picture and the sound. They are always separated by 4.5 mc as shown in Table I. The over-all bandwidth of each channel is 6 mc. Fig. 1 shows how the adjacent channels can cause trouble if traps are not properly tuned and any or all of the circuits improperly aligned.

Channel frequencies run from 54-88 mc and from 174-216 mc. The r.f. and mixer stages must operate in these ranges while the oscillator operates at frequencies spaced above or below the r.f. by the intermediate frequency. At present there is no real standardization of intermediate frequencies. They

range from 15.2-37.3 mc for video with the sound i.f. 4.5 mc away (the 4.5-mc separation is, of course, common to all receivers).

For purposes of simplification a television receiver may be broken down into five sections based on the signals handled:

1. R.f.;
2. Sound;
3. Video or picture;
4. Sweep;
5. Power supply.

The technician should automatically break down the schematic into these sections. This can be done with red pencil right on the schematic diagram itself.

The most important part of servicing any equipment is to locate the source of trouble. Isolation of the difficulty to one of the sections listed is the first step.

Since the low-voltage power supply is common to all sections, that is the

logical place to start. There are several ways to check it without using specialized equipment. The simplest check is to see whether the sound section is operating; if so, the low-voltage power supply is delivering voltage. If the picture tube shows a raster, the high-voltage supply is working. If either of these indications is not present, then a voltmeter with an insulated case will serve to check the voltages delivered by each supply. (A special, insulated probe is usually necessary for the high voltage.)

If the power supplies are satisfactory, the technician can start signal tracing. A modulated signal can be applied to the input and a crystal rectifier probe used to detect the passage of the signal through the various stages. Once the defective stage has been located, the difficulties can be found with other test equipment. The procedure just mentioned can be tabulated as follows:

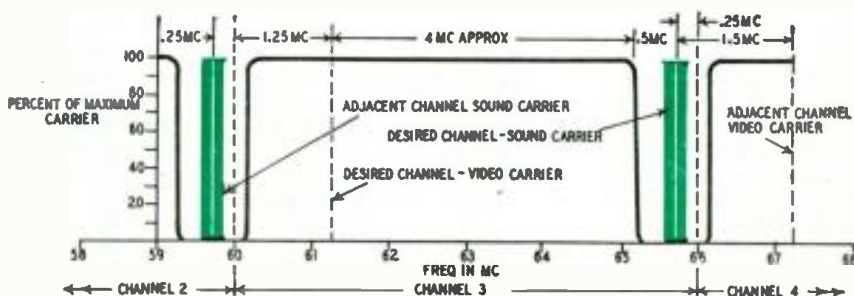

From Photofact Television Course, © Howard W. Sams, Inc.

Fig. 1—Adjacent channels can cause trouble if a set is not aligned correctly.

RADIO-ELECTRONICS for

\* Television Technicians Lecture Bureau.



**TEST EQUIPMENT REQUIRED**

1. Check low-voltage supply      20,000-ohm/voltmeter or v.t.v.m.
2. Check high-voltage supply      20,000-ohm/voltmeter or v.t.v.m. with high-voltage probe
3. Trace signal      Modulated signal generator; 1N34 crystal detector probe
4. Check components in defective stage      Voltmeter, ohmmeter, or v.t.v.m.
5. Sweep circuit      Oscilloscope

Thus we find necessary, or at least extremely useful: a high-resistance voltmeter, preferably a v.t.v.m.; a modulated signal generator; signal-tracing equipment including a 1N34 crystal detector probe; an ohmmeter; and an oscilloscope.

After the receiver is operating again it may be necessary to check alignment. *This should be done only if necessary.* One of the greatest temptations when one has new alignment equipment is to try it out on the first television receiver that comes in. Use good common sense and a little restraint.

For television r.f., i.f., and oscillator alignment a sweep generator, signal and marker oscillators, crystal calibrator, and scope are necessary.

**The tube tester**

In all stages of a television receiver the tube tester may be useful. More service calls are ultimately traced to bad tubes than any other cause.

As most service technicians have found out in their nontelevision work, the only reliable test for a tube is to put it in the circuit with which it must ordinarily work and see whether it actually functions. The same is true to an even greater degree in television. If a tube is suspected, a new tube should be substituted if at all possible.

The technician familiar enough with his tube tester to distrust it, can, however, often make intelligent judgments based on what the tester tells. Obviously, for instance, if the tube does emit (emission-type testers) or does amplify (mutual-conductance testers), there must be some good in it; though whether it is good for the circuit in which it belongs or in some other is still open to question. If, however, it does neither, it can be thrown away.

To summarize: if the tube tester says "bad," the tube is almost certainly

bad. If it reads "good," it may be either good or bad in its circuit.

**Voltohmmeters**

Table II shows the resistance which the voltmeter places across the circuit being measured, depending upon which scale is employed and the sensitivity of the meter movement. If one has a 1,000-ohm-per-volt meter, it is obvious that only on the higher scales is it likely to be useful other than as a device for measuring *relative* values of voltage. The effect of using the meter may be to alter the circuit conditions seriously.

Measurements of high voltages must be made only after considering the effect of the meter on the circuit. The drain on these circuits is usually very

Current meters: Often it is desirable to read the current flowing in a circuit so that the voltage across part of it can be calculated without the upsetting influence of a voltmeter. A good example is the oscillator circuit of a receiver. If we were to place a voltmeter across the grid leak, we would probably stop its oscillation. By opening the low side of the grid leak and inserting a microammeter in the break, we can read the current flowing, provided the leads at the chassis are bypassed. This is one way to get around some of the problems mentioned. The voltage developed will be the product of the current times the resistance.

**Vacuum-tube voltmeters**

Table II indicates that the influence

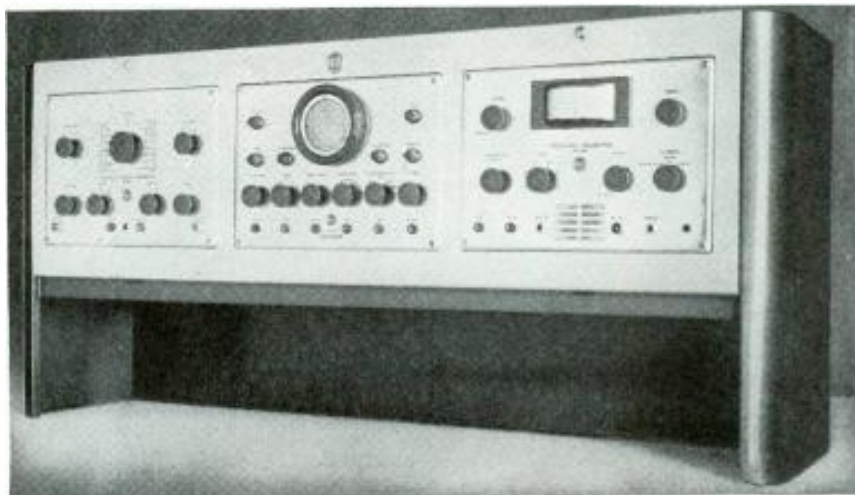

A unitized collection of television test instruments like this RCA rack will save time for technicians who can afford to make the necessary original investment.

low, and the meter resistance, unless a 20,000-ohm-per-volt unit is employed, may seriously affect the readings. A special probe and special insulation are required to make the measurements safely. Study the service manual on the test instrument before attempting high-voltage measurements.

**Ohmmeters**

The values of the various resistors encountered in service run from a fraction of an ohm to 10 megohms with an occasional value even higher. A survey of the components of a TV set indicates that this part of the volt-ohmmeter is likely to see plenty of use. The scales should be clear and easy to read.

of a voltmeter, even with 20,000 ohms per volt, may seriously affect some readings. A vacuum-tube voltmeter has a high-resistance input which is nearly constant for all ranges. In an instrument of this type the meter will usually not be damaged if the wrong scale is used, as would be the case with a regular volt-ohmmeter.

There are other upsetting influences besides input resistance on some circuits. The capacitance of the meter and its leads may, in many circuits, cause a false reading. A probe having a 1-megohm resistor at its tip serves very well to reduce this effect.

Some v.t.v.m.'s are provided with circuits which will permit reading capacitances from 1.5  $\mu$ f to 100  $\mu$ f or more. This is very useful, as many capacitors are employed in the average receiver.

V.t.v.m.'s can be employed for peak-

TABLE I

Channel Number	Channel Freq. (Mc)	Picture Carrier Freq. (Mc)	Sound Carrier Freq. (Mc)
2	54-60	55.25	59.75
3	60-66	61.25	65.75
4	66-72	67.25	71.75
5	76-82	77.25	81.75
6	82-88	83.25	87.75
7	174-180	175.25	179.75
8	180-186	181.25	185.75
9	186-192	187.25	191.75
10	192-198	193.25	197.75
11	198-204	199.25	203.75
12	204-210	205.25	209.75
13	210-216	211.25	215.75

TABLE II  
VOLTMETER RESISTANCE

Range	Resistance 1,000 ohms/volt	Resistance 20,000 ohms/volt	V.t.v.m.
0-2.5	2,500	50,000	10 meg
0-10.0	10,000	200,000	10 meg
0-50.	50,000	1 meg	10 meg
0-250	250,000	5 meg	10 meg
0-1,000	1 meg	20 meg	10 meg
0-5,000	5 meg	100 meg	10 meg

to-peak voltage measurements; but, since the waveform is likely to be anything but a sine wave, there will be no fixed relation between the peak and average values. In making these measurements, the input loadings, resistive and capacitive, are still very important because they can radically affect the waveshape. The manual supplied with the v.t.v.m. indicates precautions to be taken with the meter, and also shows its limitations.

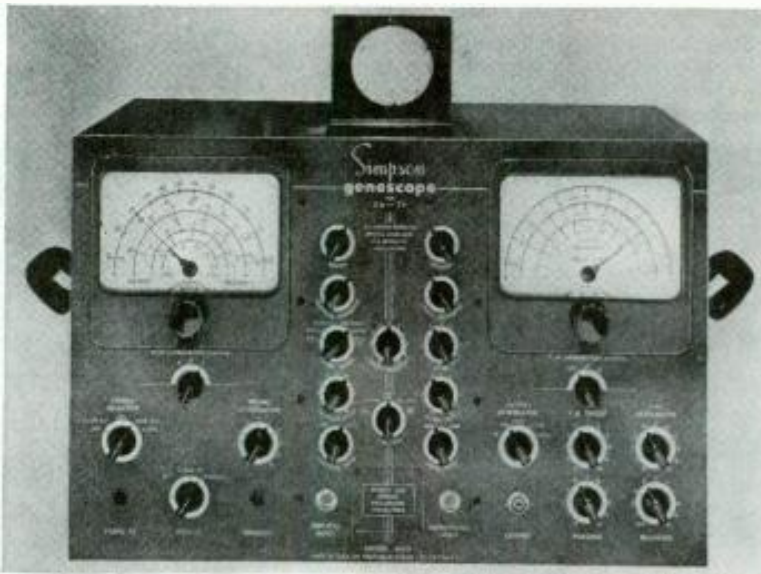

Some instruments combine two functions. This is scope and generator.

### Cathode-ray oscilloscopes

There are times when it is desirable to look at the waveform in addition to measuring its peak value. The cathode-ray oscilloscope makes that possible. The vertical amplifier in the scope must neither distort or change the shape of the waveform, or the results will not be of much value. If the amplifier response is flat up to at least 300 kc, the scope can be used for measurement of video, sync, and sweep signals. The low-frequency response must also be good.

If the horizontal sweep gain is reduced to zero, then the vertical trace may be used as a voltmeter which can be calibrated for various positions of the vertical gain control. The loading of a circuit by the scope must be taken into consideration. The vertical amplifier circuit has an input resistance of approximately 1 megohm, whereas the input capacitance may vary from 20 to 100  $\mu\text{f}$ . The shielded cable adds considerable additional capacitance; the total may be close to 200  $\mu\text{f}$ . There are many points in the receiver at which this amount of capacitance will disturb the circuit sufficiently to change the waveshape radically. A special probe is usually supplied to reduce the loading of the circuit under test to a few micromicrofarads. To achieve this reduction, an attenuation of signal of the same order as the capacitance reduction will take place. This will amount to as much as a 6-to-1 reduction in signal voltage; but the signals

to be measured usually being on the order of 10 volts, this will not be serious, and readable signals will still be obtained if the scope has reasonable vertical amplifier gain.

To obtain maximum usefulness, connections to the plates of the cathode-ray tube should be brought out to terminals so that the scope amplifiers—either vertical or horizontal—can be bypassed if the signal is large enough to show on the screen. The amplifiers

must have minimum phase distortion if a true reproduction of the waveform is to be obtained.

### Alignment generators

A television alignment signal generator is a piece of equipment which many service technicians have not as yet acquired.

The problem of alignment can be broken down into such steps that the requirements of the equipment can more readily be determined. The suggested order is as follows:

1. I.f. sound traps;
2. Adjacent-channel traps;
3. I.f. amplifiers;
4. Sound channel;
5. Oscillator;
6. R.f. amplifier.

The chief difference between a conventional signal generator and a television alignment generator lies in the width of sweep required to show the response curve on the oscilloscope. The sweep width should be 10 mc or more wide so that the trap settings may be checked.

The generator must be capable of covering the entire TV band either by fundamentals or harmonics. Since intermediate frequencies as low as 5 to 7 mc may be encountered in older TV receivers, the generator must be able to tune to at least these frequencies.

To determine that the i.f. response curve has been properly adjusted, an auxiliary piece of equipment known as the marker oscillator must be employed.

Often this is built in with the alignment generator. This marker oscillator must be accurately calibrated and should cover the range from 20 to 30 mc. This will enable the user to make certain that, not only is the response curve shape of the receiver correct, but the shape is correct at the proper frequency points. Provision is usually made to modulate this oscillator with an audio signal. It can thus be used for tuning traps as well as adjusting stagger-tuned receivers.

### Using test equipment

All test equipment together with the receiver under test should be placed on a metal-top bench. The ground connections for each piece of equipment should then be tied to the bench top with short lengths of  $\frac{1}{2}$ -inch braided-copper ribbon. If a metal bench top is not available, the equipment must be bonded together with short lengths of braided-copper ribbon. The effectiveness of this bonding can be checked during alignment by placing the hand on the metal chassis being aligned and on the metal cases of the various pieces of test equipment. If the response pattern or meter reading changes, the grounding must be improved before the circuits are aligned.

In using test equipment for radio and television receivers, perhaps the most important factor which should be emphasized is that it is necessary to understand fully the limitations and capabilities of the equipment. If one purchases the best piece of test equipment available and neglects to learn its exact utility, that person is not taking full advantage of the investment he has made; and the results he will obtain with this equipment will certainly not be comparable with those obtained by a competitor using the same equipment and familiar with its correct usage. Unless one is willing to invest sufficient time to understand his test equipment very thoroughly, it is probably unwise to purchase it at any price. On the other hand, if one is willing to spend the time necessary to learn what the equipment will and will not do, the investment becomes worth many times the original expenditure.

After the equipment has been purchased and is ready to be used, it is equally important to understand the manufacturer's instructions regarding its use in servicing a *specific* television receiver. Unless one takes the pains to utilize service data which usually is available from the manufacturer himself or from other services who make this information available, a great deal of time will be wasted without actually solving the customer's problem.

A collection of service data is indispensable to the television receiver technician. In the final analysis, the only purpose of a test instrument is to determine whether a circuit is operating in accordance with the manufacturer's specifications. If the specifications are not known, the test instrument loses a great deal of its value.

# Small Signal Tracer

**Portable test instrument fits in metal card-file container**

By HOMER L. DAVIDSON

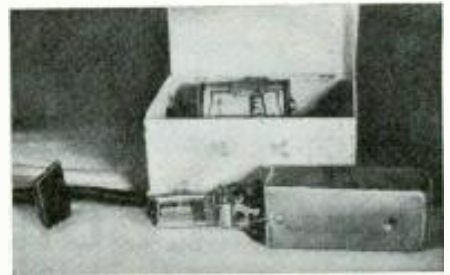

Tracer and probe.

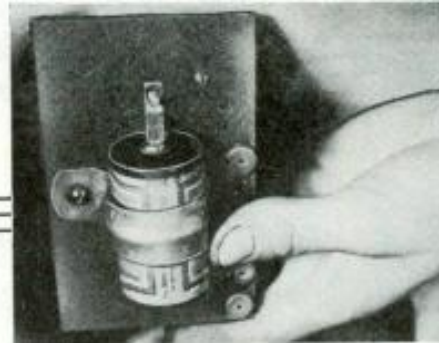

Filament battery is held by cable clamp.

**T**HIS small, portable signal tracer is constructed inside a 3x5 index-file box. A 67.5-volt B-battery furnishes plate and screen voltages, while a flashlight cell lights the filaments of the two miniature tubes. The B-battery lies flat on the bottom of the box, with enough space left above it for a 1S4 amplifier stage. The probe is homemade.

The circuit, given in Fig. 1, is fa-

was rather difficult. Finally the small probe was built inside a small i.f. can, as Fig. 2 shows. The probe needle itself is a solderless prod tip. The insulation core was tapped; a screw going through a hole in the top of the can holds it tightly. The lead from the 100- $\mu$ mf mica capacitor is placed through one of the trimmer holes and screwed up tightly on the prod tip.

A small mounting bracket was

some receiver. Surprising results were obtained. It located weak stages, defective tubes, bad coupling capacitors, open coils, and almost any condition one could name.

One of the tracer's biggest advantages is that no line isolation transformers have to be used. Moreover there is no bothersome a.c. interaction between it and the receiver. Fasten the alligator clip to the common negative or ground of any receiver and touch the grid cap of the first r.f. stage or the antenna coil, and a local station can easily be heard in the phones. Always tune in a local or powerful station while checking the first r.f. stage because the r.f. energy here is very small. Now try placing the probe on the plate of this first r.f. amplifier and notice the volume. From this stage on through the rest of the receiver, the probe doesn't necessarily have to touch the soldered contacts but can be held close to the wire carrying the signal. When checking the last one or two audio stages, it is best to have the volume turned way down on the receiver, for the signal has been amplified quite a few times and is

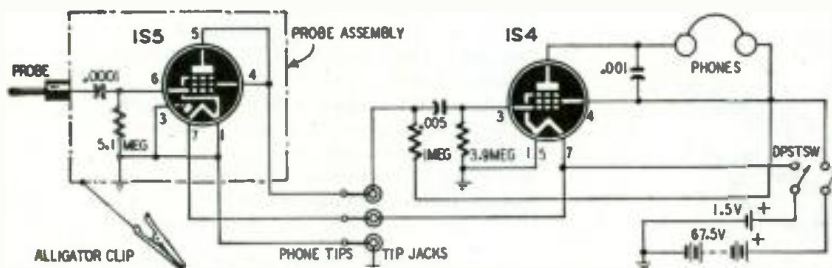

Fig. 1—Complete signal-tracer diagram. The 1S4 and its circuits are in the box.

miliar. With screen and plate of the 1S5 in the probe tied together, this tube functions as a triode detector and amplifier. Several small tubes were experimented with, but the 1S5 gave greatest pickup gain and least distortion.

The chassis is cut from a piece of Masonite. The filament cell is mounted with the aid of a cable clamp, as the photo indicates. Five small, colored tip jacks at the edge are for the probe leads and the phones. A 1/8-inch metal bracket is tightly wrapped around the miniature tube socket and bolted to the chassis. The chassis fits snugly in the index box. Two small metal screws go through the thin metal and come out just above the chassis and hold it down snugly against the flat 67.5-volt B-battery.

Making a probe that would allow the miniature tube to stand rough knocks

drilled to take the 1S5 tube socket, two holes being drilled and tapped in it. Before this strap is screwed to the metal can, it is best to place the 1S5 in its socket and place a rubber sponge around it to reduce microphonics and prevent damage from rough handling.

Three colored leads in a rubber-covered cable come from the probe. It is a good idea to paint the corresponding colors near the tip jacks on the Masonite chassis, assuring correct connections.

Another piece of Masonite is cut and drilled to be fastened to the open end of the i.f. can with the two mounting lugs already on the can. The three-wire cable is held in place by wrapping a few turns of steel wire around it tightly and then looping one end over one of the lugs.

After the small signal tracer was constructed, it was tried on a trouble-

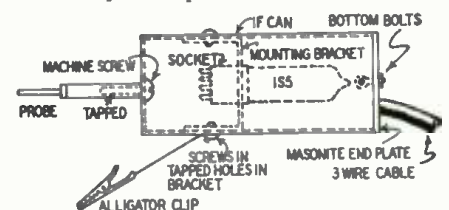

Fig. 2—Probe and 1S5 are in i.f. can.

sometimes rather hard on the user's ears.

This small audible signal tracer is inexpensive to build, but it is mighty effective for tracking down signals. If you don't desire to build it in an index file box, it can easily be made part of your regular service panel or can be placed in any other container.



# Test Equipment for Television

by  
**ROBERT A. STANG\***

**T**HERE has been a dearth of comparative data on television test equipment. With this in mind this survey has been compiled to give the prospective buyer an opportunity to make an objective, informed comparison of available commercial equipment. The survey has been limited to television sweep generators and oscilloscopes, these two instruments being the most important in television servicing.

The general list of sweep generator and oscilloscope characteristics is followed by a tabulation specifically describing various commercial units to aid the reader in determining what to look for in making his purchase.

## Television sweep generators

**Frequency coverage:** For use on present TV bands, should cover from as low as possible to 216 mc. A generator which starts at 2 mc will complement your present AM generator for over-all broadcast coverage.

**Fundamental range:** The use of fundamentals throughout minimizes spurious-signal interference and insures adequate power output on the higher bands.

**Sweep width:** Should be adjustable up to 12 mc. A linear sweep produces a

\* Blair-Steinberg Co.—395 Broadway, New York City.

SWEEP GENERATORS

	Precision E400	Hickok 610A	Jackson TVG-1	RCA WR59A	McMurdo Silver 911	Simpson 479 480 <sup>4</sup>	U.S. Tel. TVFM	Triplet 3434	RCP TV-75	Supreme 675	GE ST-4A	Kay Mega-sweep	Philco 7008 <sup>1</sup>
Freq. coverage	2-480 mc	10-250 mc	2-216 mc	18 fixed freqs.; 5-216 mc	2-226 mc	2-260 mc	0.5-110 mc	0-240 mc	5-270 mc uncalibrated	18 fixed freqs.; 4.5-216 mc	4-110 mc; 170-220 mc	50 kc-1,000 mc	2-260 mc
Fund. range	2-195 mc 5 bands	10-125 mc 3 bands	2-216 mc 6 bands	ditto	2-177 mc 1 band	2-260 mc 2 bands	0.5-110 mc 1 band	0-120 mc 2 bands	5-270 mc 1 band	ditto	ditto 2 bands	50 kc-1,000 mc	4-260 mc
Sweep width	0-1 mc 0-15 mc	0-15 mc	0-0.1, 0.2, 0.5, 1, 2, 6, 12 mc	1.5-10 mc	0-10 mc	0-15 mc	0.2-10 mc	0.5-12 mc	0.1-10 mc	0-10 mc	0.5-15 mc	0-30 mc	0-15 mc
Fund. marker range	sockets for four xtals. no var. osc.	20-40 mc	4-54 mc	none	fixed 1 mc and 5 mc xtals. no var. osc.	5 mc xtal 3.2-8 15-38 75-125 mc	1 mc and 10 mc xtals. no var. osc.	19.5-40 mc	2.5 mc and 5 mc xtals.; 5-125 mc 3 bands	19-50 mc	none	none	3.2-250 mc
Phasing control	yes	yes	yes	yes	yes	yes	yes	yes	yes	yes	yes		yes
Number of tubes	6 plus rect. and volt. reg.	6 plus rect.	6 plus rect. and volt. reg.	5 plus rect.	3 plus rect.	7 plus rect.	5 plus rect.	5 plus rect. and volt. reg.	3 plus rect. and volt. reg.	6 plus rect.	3 plus rect.	9 plus 2 rect.	10 plus 3 rect.
External xtal. provision	yes	yes	yes	yes	no	no	no	yes	yes	no	no	no	no
Price	\$124.75	\$195.00	\$220.00	\$325.00	\$78.50	\$245.00	\$295.00	\$149.50	\$89.50	\$179.50	\$379.50	\$395.00	\$395.00

true response curve picture and avoids the necessity of interpretation. A sweep adjustment in steps including several narrow sweeps is useful when aligning the sound i.f. strip and discriminator. Crystals: Provision for crystal insertion at the panel is very useful in adjusting adjacent-channel and other traps where an accurate signal source is required. Phasing: This is a knob-controlled device for shifting the phase relation of the trace and retrace patterns so a single pattern is observed. Useful in alignment. General: Many aspects cannot be covered in an article of this type, two of the most important being radiation and frequency stability. Radiation, if excessive, will operate the a.g.c. circuits and prevent optimum alignment. It can be

prevented only by careful internal shielding and r.f. wavetraps in the a.c. line of the generator. Stability can be obtained only by careful design including voltage regulation. These characteristics should be carefully investigated before making a purchase, and price alone should not be the determining factor.

Oscilloscopes

Vertical amplifier bandwidth: Not critical for observing i.f. response curves because here only the low-frequency modulation pattern is viewed. Broad band (over 2 mc) important for viewing fast-rising patterns such as sweep circuit and sync-pulse waveshapes. Valuable, if over 4 mc wide, for signal tracing when used with a crystal probe.

In this latter case, a scope can be used as a valuable signal tracer instead of only as an indicator.

Deflection sensitivity: Minimum output from the signal generator should always be used to keep below the a.g.c. threshold. This requires good scope amplifier sensitivity to produce a visible pattern. Better than .05 v/in. is desirable.

Cathode-ray tube size: Not critical but the 5-inch tube seems to be most popular.

Sweep range: Not critical. For TV use, 25 cycles to 30 kc is adequate for all usual applications.

Grid modulation: Useful when using an external return-trace blanking oscillator or for some techniques which require a Z-axis-modulated pattern.

OSCILLOSCOPES

	Precision ES-500	Hickok 195B	Jackson CRO-1	RCA WO5BA	Dumont 304	Triplet 3440	RCP TV-90	Reiner 508	Supreme 660	GE ST-2A	Sylvania 131	Transvision 450A	Philco 7008 <sup>1</sup>
Vert. amp. band width	10 c.p.s. -1 mc	30 c.p.s. -1 mc	20 c.p.s. -4.5 mc	5 c.p.s. -2 mc	d.c. amp. 0-100 kc a.c. amp. 5 c.p.s. -100 kc	20 c.p.s. -1 mc	5 c.p.s. -200 kc	2 c.p.s. -100 kc	5 c.p.s. -5 mc	20 c.p.s. -1 mc	10 c.p.s. -100 kc	20 c.p.s. -450 kc	
Vert. amp. def. sensit. (v/in.)	.02	.03	.018	0.5 peak to peak built-in volt-meter	.01 built-in volt-meter	.02	0.285	.01	0.1	.015	0.5	0.5	.025
C/R tube size (in.)	5	5	5	5	5	5	3	5	5	5	3	5	3
Sweep range	10 c.p.s. -30 kc	10 c.p.s. -25 kc	20 c.p.s. -50 kc	10 c.p.s. -100 kc	Sine or sawtooth 2 c.p.s. -30 kc	10 c.p.s. -60 kc	10 c.p.s. -45 kc	2 c.p.s. -50 kc	7 c.p.s. -100 kc	10 c.p.s. -100 kc	15 c.p.s. -40 kc	20 c.p.s. -50 kc	60 c.p.s.
Provision for grid modulation	yes	yes	no	no	yes	yes	yes	yes	yes	no	no	yes	
Price	\$149.50	\$156.00	\$195.00 <sup>1</sup>	\$345.00	\$285.00	\$189.50	\$127.50 <sup>2</sup>	\$265.00	\$276.80	\$279.50	\$69.50	\$99.50	\$395.00

NOTES—<sup>1</sup> Signal-tracing probe \$9.95.

<sup>2</sup> Has built-in 0.5-45-mc generator.

<sup>3</sup> Instrument is combination generator and scope.

<sup>4</sup> Model 479 plus built-in scope. Price \$375.

# Making a 2-Inch Scope

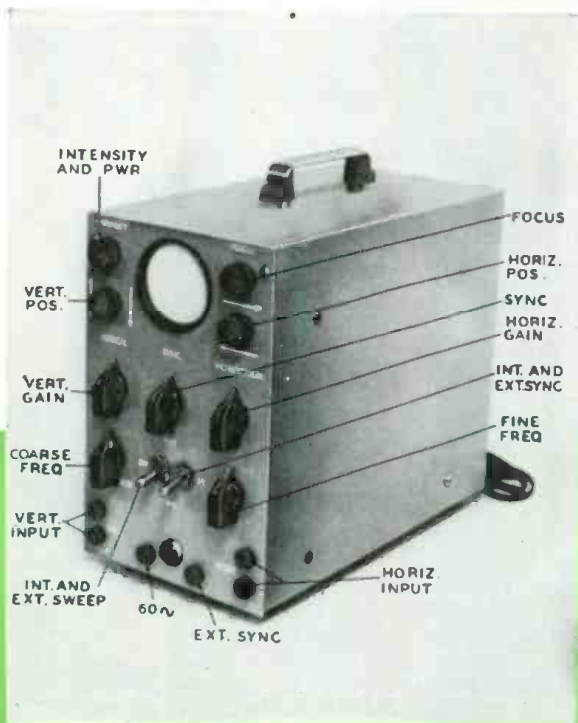

The complete 2-inch oscilloscope in its metal case.

**Construction data for  
a scope complete with  
amplifiers and sweep**

**BY CHARLES W. WELCH, W5MHK\***

**T**HERE is a very real and very wide gap between the inexpensive cathode-ray modulation-checker, with its extremely limited usefulness as a test instrument, and the elaborate and expensive test oscilloscopes on the market. The oscilloscope described in this article attempts to bridge that gap.

Its most obvious feature is its small size, which was not gained at the expense of versatility; full-sized components are used throughout. The 2-inch tube, while not large enough for a laboratory instrument, shows large, brilliant figures bright enough for photographing and certainly bright enough for viewing. Its other features are:

1. Vertical and horizontal amplifiers flat over the audio range.
2. High sensitivity which permits convenient viewing of 1 volt or less. Even the direct output of crystal pickups and microphones can be viewed.
3. Internal sweep oscillator with frequency variable in five steps, plus vernier fine-frequency control.
4. All usual oscilloscope features and functions.
5. Low cost.

## The foundation unit

The complete oscilloscope is built on a foundation unit assembled from two commercial chassis plus a panel and a few simple parts cut from sheet metal. It measures roughly 5 x 8 x 9½ inches. All these parts, including the chassis,

should be made of steel or other ferrous metal, as nonferrous metals do not have good magnetic shielding qualities. By using a steel chassis 5 x 9½ x 1½ inches and a sheet-iron panel and case, with the power supply mounted on the lower chassis, no magnetic shield is required on the cathode-ray tube itself.

The panel is cut out and drilled. You can use the photos as guides. It should then be lacquered the desired color and labeled.

The two chassis should be drilled and cut out, again referring to the photos. Transformers and chokes should be mounted on the lower chassis and as far to the rear as possible, to minimize magnetic interference. Do not cut any large holes in the upper chassis which might allow magnetic flux to cause trouble at the cathode-ray tube.

The lower chassis is mounted ¼ inch above the bottom of the panel, with ¼ inch of panel sticking out on either side of the chassis. It is fastened to the panel by angle brackets which bolt to the chassis and fasten under the mounting nuts of the input jacks on the panel.

The upper chassis is inverted, as shown in the photographs, so that the side flanges turn up. It is fastened to the panel with angle brackets, mounted with the bottom 2½ inches below the top of the panel, and centered so that ¼ inch of panel extends on both sides of the chassis. The rears of the two chassis are fastened together with a sheet-metal spacer strip. The distance between the two mounted chassis should

be about four inches to permit the 884 tube to be inserted in its socket.

In the upper chassis the four controls are mounted on sheet-metal brackets to the rear of the 2AP1 socket. Shaft extensions are of insulating material.

## The power supply

The high voltage for the cathode-ray tube in this scope is supplied by the same receiver-type transformer which feeds the other stages. It is obtained by taking the a.c. off one side of the high-voltage secondary winding, rectifying, and then boosting it by the action of the electrolytic capacitor C1. Note that the high-voltage rectifier 6X5-GT and C1 are reversed from normal polarity, because the high voltage must be negative. Be careful in mounting and insulating C1 not to ground the high-voltage power supply.

The output of the high-voltage section is a little over 500 volts. In choosing a power transformer, do not select one which has a lower output voltage than specified, as the 2AP1 is rated at 500 volts *minimum*. While this voltage is adequate, it cannot be reduced very much without serious effects.

## Scope and controls

The next step is wiring the cathode-ray tube with its controls. The intensity control, which has the a.c. line switch on the back of it, is mounted so that its knob is brought out to the upper left side of the panel. The focus control comes out on the upper right side of the panel. The two holes just

\* Transmitter Engineer WNAD AM/FM.

below these are for the two centering controls. The controls are identical electrically, but common practice places all vertical controls on the left-hand side of the panel.

The resistor network of which the centering controls are a part is the centering system of the scope. The resistors are arranged to give about 100 volts with the slider at full travel one way, zero in the center, and 100 volts at opposite polarity when the slider is at the other end of its travel. The spot can be moved entirely off the screen of the tube in either direction. When the network is completed, it may be necessary to juggle the fixed resistors slightly to get the right voltages, because of slight variations in power transformers.

Two jacks and plugs are mounted on an angle bracket behind the cathode-ray tube. An opening is cut in the rear of the case to make them readily accessible from the back of the 'scope. They permit disconnecting all controls from the deflection plates to apply r.f. voltages directly to the plates.

Now turn on the a.c. and let the filaments warm up. Set the centering controls to approximately mid-travel, and advance the intensity and focus controls. If no spot appears on the screen, try various positions of the centering controls. Frequently a 'scope works, but the positioning controls push the spot clear off the screen so that nothing is visible. If no spot can be found, check wiring until the trouble is located.

When the spot is located, retard the focus and intensity controls until the sharpest possible spot is obtained. Note that these controls work together with considerable interaction, which is normal. When the spot is as sharp as the controls will make it, look it over carefully. Any unusual shape or a large, sharp spot which cannot be focused down to a reasonable diameter, probably indicates magnetic interference coming from the power supply. If this is not too serious, don't worry about it for the present, but continue wiring the scope. The metal case which is put over the chassis will help eliminate it.

Amplifiers and sweep

The horizontal amplifier should be located on the right-hand side, using the tube, gain control, and jacks on that side. The amplifier is reasonably straightforward, except for what may be considered unusual bypassing. The amplifiers were built and rebuilt and modified, in the attempt to get them flat without the use of peaking inductances. They are perfectly flat from 100 to 12,000 cycles, and rough tests indicate that they are reasonably flat over the rest of the audio range.

If it is decided that the range should be extended further, or if the high frequencies are down in the finished amplifiers, the range can be increased with peaking inductances. In calculating such inductances, it should be kept in mind that this circuit has unusually high stray capacitance, because the in-

put capacitance of the 2AP1 and its wiring must be considered as well as the output capacitance of the 6AC7. The screen bypass C2 should be grounded to the ground end of C3, the cathode-bypass capacitor.

The gain of the amplifiers as shown is as high as will be needed in normal use. When the amplifier is finished, put an audio voltage into the input and advance the horizontal gain control with the position and focus controls properly set. The spot on the screen should

oscillates. When it is hooked up correctly and switch S1 is in the INTERNAL position, advance the horizontal amplifier gain control. A horizontal trace should appear on the screen; there is nothing tricky about getting a gas-triode oscillator to "take off." Try all the positions of the frequency controls, to make sure they are working.

There is little in the construction of the vertical amplifier which is not identical with the horizontal amplifier. The only difference is that the sync circuit takes a small amount of the output of the vertical amplifier and feeds it into the grid of the oscillator to make it lock in and hold the figure steady on the screen of the 2AP1. The sync voltage is taken off the amplifier plate through R and C4.

Testing

The 'scope is now ready for the final testing. Curves are run on the two amplifiers with an audio oscillator, carefully measuring the input to keep it constant, measuring the length of the trace on the screen of the scope, and plotting the output curve. It is best to make this test with only the output of the amplifier under test on the screen, so that you get a straight line to measure, rather than a figure. When the two amplifiers have been tested this way, test the sawtooth generator.

Two things demanded of the sawtooth generator are linearity and short flyback time. The test for length of flyback time is to apply a sine voltage to the vertical input and adjust the sweep frequency to stop several cycles on the screen. Then observe the return trace. If it is too bright, the flyback time is too long. The object, of course, is to make the flyback time as brief as pos-

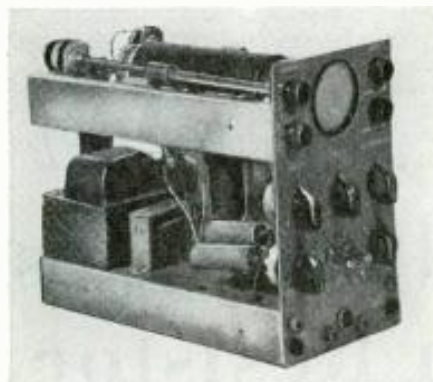

Parts mount on two chassis and a panel.

spread out into a streak. If the trace is not horizontal, rotate the 2AP1 socket until it is properly oriented—unless, of course, it is nearly vertical, in which case check to see that you have the amplifier hooked up to the right deflection plate.

The next step is wiring the sweep oscillator. It is a simple gas-triode circuit, described in every radio handbook, so we will not go into the theory of it here.

For the present, testing the sweep oscillator will simply be to see that it

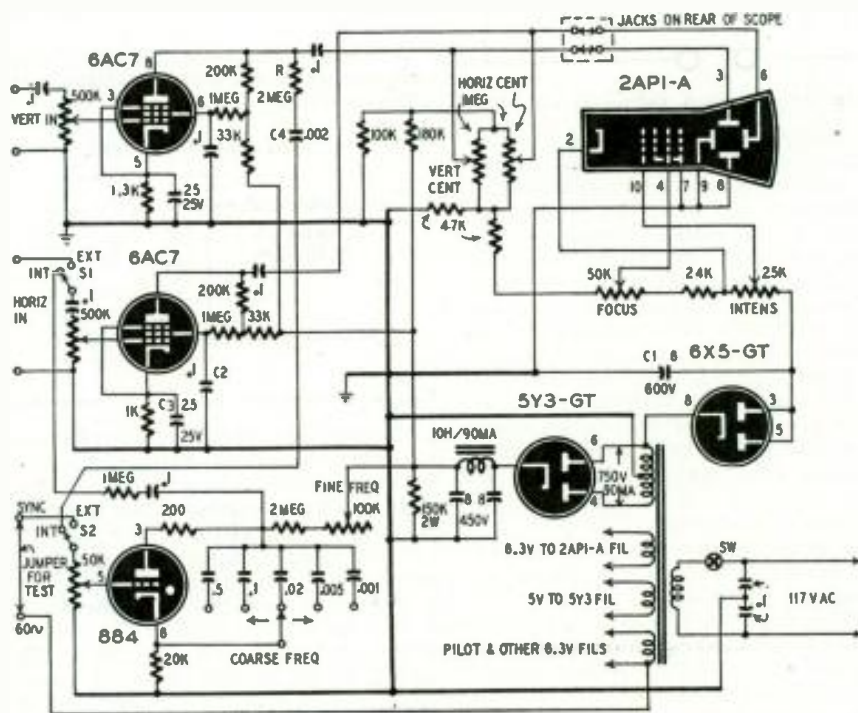

Complete schematic of the 2-inch oscilloscope. A 2AP1 or 902 may also be used.

sible, so that the return trace disappears altogether or at least is dim enough not to confuse the desired pattern. This test can be applied only to the finished scope.

The best check for linearity is viewing the output of the oscillator on another scope, and seeing if the sawtooth wave is perfectly straight-backed. Another scope is also useful in checking flyback time. In the absence of another scope, however, the linearity may be checked by the new scope.

Again apply a sine voltage to the vertical input and set the sweep frequency to show two or more complete cycles on the screen. Stop these with the fine-frequency and sync controls, and adjust the gain of the amplifiers until the pattern does not take up much more than a inch on the screen. Then measure the peak to peak distance hori-

zontally on the trace. These distances should be the same. If they start wide and narrow down in succeeding cycles, the sweep oscillator may not be linear. One note of caution: Due to the "stacking effect" which occurs when the electron stream passes near the positive, grounded deflection plate in the tube, the pattern will crowd up near one end of the screen. Therefore, the gain should be adjusted to keep the pattern small and near the center of the screen before deciding that the oscillator is or is not linear. "Stacking" is perfectly normal in an oscilloscope when single-ended deflection is used.

Keep in mind, too, that the amplifiers are sensitive and overload easily. Severe distortion will then occur. Very little input is required—a volt or less—though somewhat higher voltages can be accommodated by keeping the ampli-

fier gain-control knob turned well down.

The final check of the circuits should be made to see that the various switches and controls function properly. It being always advisable to use as little sync as possible, the sync voltage on this scope has been made rather small. In locking the oscillator in, the trace should be as nearly stopped as possible by the fine-frequency control, then finally synchronized with the sync control, advancing it only as necessary.

### Constructing the case

The case is made after the scope is finished. It, too, should be made of ferrous metal, and dimensioned to slip over the chassis, sliding up to position behind the  $\frac{1}{16}$  inch of panel left all the way around the chassis. The panel and the case should not be made of galvanized iron if other iron is available, as it is difficult to make paint or lacquer stick to a galvanized surface. However, if it must be made of galvanized metal, a primer made especially for the purpose will work nicely (ordinary automobile body primer will not). Provide for ventilation, because the tubes generate considerable heat. Ventilated plugs in the rear of the chassis are a satisfactory method. Don't forget that the case is a necessary part of the magnetic shielding and should not be cut up any more than can be helped.

After the case has been installed and fastened by self-tapping screws into the side flanges of the chassis, the scope should be checked again for any persisting magnetic deflection. If the case has not helped, a shield may be made from iron pipe, covering as much of the tube as the amplifier wiring will permit. Shielding about two-thirds of the way up from the base and grounding at the socket end will suffice. This should be necessary only in extreme cases. It was used in the oscilloscope pictured, but *only as an added refinement*. The trace before the addition of the shield was as fine as that of most commercial scopes; with the shield it is possible to get a trace that is finer than the line made by the average pen.

Certain interactions in this scope may, at first glance, appear to be bad, such as that between the intensity and the focus controls and certain characteristics of the sync circuit. These are perfectly normal and occur in any unit, commercially built or otherwise; they do not hinder the operation, once the operator is familiar with them.

### MATERIALS FOR OSCILLOSCOPE

**Resistors:** 1—200, 1—1,000, 1—1,300, 1—20,000, 1—24,000, 2—33,000, 2—47,000, 1—51,000, 1—100,000, 1—180,000, 2—200,000 ohms, 3—1, 2—2 megohms,  $\frac{1}{2}$  watt; 1—150,000 ohms, 2 watts; 1—25,000, 1—50,000, 1—100,000, 2—500,000 ohms, 2—1 megohm potentiometers.

**Capacitors:** 1—.002  $\mu$ f, mica; 1—.001, 1—.005, 1—.02, 10—0.1, 1—0.5  $\mu$ f, 400-volt, paper; 2—25  $\mu$ f, 25 volts, 2—8  $\mu$ f, 450 volts, 1—8  $\mu$ f, 600 volts, electrolytic.

**Switches:** 2—s.p.s.t. toggle, 1—1-circuit, 5-position rotary, 1—s.p.s.t. for attachment to intensity potentiometer.

**Inductors:** 1—power transformer, 750 volts center-tapped at 90 ma, 6.3 volts at 3 amps., 5 volts at 2.5 amps; 1—10-henry, 90-ma choke.

**Tubes:** 1—2AP1-A, 1—5Y3-GT, 2—6AC7, 1—6X5-GT, 1—884.

**Miscellaneous:** 2—chassis, 5 x  $9\frac{1}{2}$  x  $1\frac{1}{2}$  inches; 1—iron panel, 5 x 8 inches; tube sockets; miscellaneous hardware.

# Using a Voltmeter as a Precision Resistor

By JOHN T. BAILEY

THE common multirange voltmeter is a handy source of precision resistors which can be used for calibration work without removing them from the voltmeter. When the multimeter is switched to read d.c. volts, the circuit consists of a simple series arrangement of meter

meters have an accurate, temperature-compensated, swamping resistor in series with the meter coils, as in Fig. 2. This resistor is in the order of a few thousand ohms for a 150-volt meter, usually the meter carries the resistance value on the data nameplate. The meter will read on d.c. or a.c., and thus can be an indication of when a safe current value has been reached when it is used for resistance purposes.

Because the resistance value given for both meters includes the resistance of the meter coils, no correction need be made.

A vacuum-tube voltmeter is not suitable for this use since it operates on a different principle.

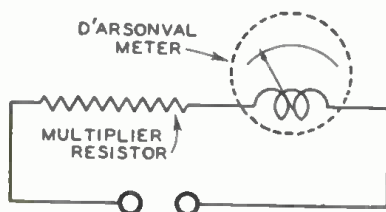

Fig. 1—Common voltmeter circuit

and multiplier resistor as shown in Fig. 1. This series circuit is connected to the test leads for convenient use. The total resistance of the series circuit is determined by the voltage range and the meter sensitivity. It can be computed quickly simply by multiplying the voltage range by the ohms-per-volt rating of the multimeter. For instance, if the sensitivity is 1,000 ohms per volt and the 30-volt range is used, the resistance is 1,000 times 30 or 30,000 ohms. This will be accurate to  $\pm 1\%$  for the average instrument. If two multimeters are available, they may be connected in series or parallel to increase the combinations of resistors.

Pay no attention to any reading that may occur on the meter unless, of course, it goes off scale.

This method may be used on a.c. work without any damage to the meter since it cannot follow the cyclic fluctuations of the alternating current.

Laboratory electro-dynamometer volt-

Fig. 2—Swamping resistor is accurate.

Uses for precision resistors include voltmeter multipliers, reference resistors for checking ohmmeters, bridge arms, calibration resistors for checking instrument dials, and others.

When using a meter as a precision resistor, it is always an excellent idea to make a few calculations beforehand to find the voltage that will be placed across the meter and multiplier. Be sure it is not greater than the maximum reading of the scale you plan to use.

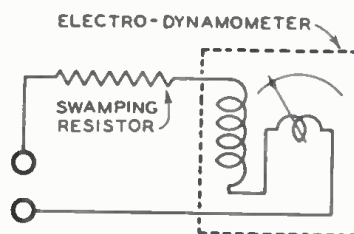



# Television Dictionary

(Continued from page 64 of the January issue)

**Centering**

The process of shifting the trace on an oscilloscope or the image on a television tube so that it is centered on the screen.

**Centering control**

An adjustment for shifting the pattern on the screen of a cathode-ray tube. The vertical centering control moves the pattern up or down, and the horizontal centering control moves it to either side. The pattern is centered by varying the d.c. potential applied to the deflection plates (electrostatic deflection) or by varying the d.c. current through the deflection coils (electromagnetic deflection).

**Channel**

A band of frequencies. Twelve channels have been assigned by the Federal Communications Commission for commercial television broadcasts.

Channel	Freq. (mc)
2	54-60
3	60-66
4	66-72
5	76-82
6	82-88
7	174-180
8	180-186
9	186-192
10	192-198
11	198-204
12	204-210
13	210-216

Each channel is 6 mc wide. The audio carrier is 0.25 mc from the

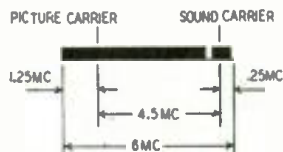

high-frequency end of the channel. The picture carrier is 1.25 mc from the low-frequency end. The picture and sound carriers are separated from each other by 4.5 mc. The diagram shows one TV channel.

**Chromatic aberration**

See Aberration.

**Clamper**

A circuit which establishes the d.c. level of a waveform (the baseline of an a.c. wave with a d.c. component). Clampers are also known as d.c. restorers.

**Clamping**

The process of establishing the d.c. level of a waveform. This may be done with a diode tube in series with a capacitor, as indicated. On

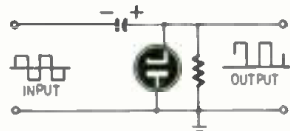

the negative alternations of the input signal, the diode conducts current and charges the capacitor. The capacitor adds its charge in series with the signal on the positive alternation.

By ED BUKSTEIN

**Clipper**

A circuit designed to remove all of a waveform above or below a given level. (See Amplitude separation.)

**Clipping level**

The amplitude level at which a waveform is clipped.

**Color**

The visual sensation produced when light enters the eye. The color perceived depends on the wavelength of the light. A wavelength of 4,000 Angstrom units is perceived as violet and a wavelength of 7,000 Angstrom units produces the sensation of red. All other color wavelengths are between these limits.

**Color disc**

A rotating disc containing red, blue, and green windows, placed in front of the television camera or C-R tube in the CBS color TV system.

**Complementary colors**

Two colors which, when properly combined, produce white light. A red light and a green light of proper intensity will combine to produce white light. Yellow and blue are also complementary colors.

**Composite signal**

The complete television signal containing the picture information and the synchronizing and

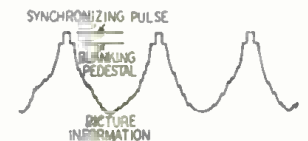

blanking pulses. Typical composite waveforms appear in the drawing above.

**Concave mirror**

A reflecting surface of such shape that it causes the rays of light striking it to focus upon a point on the principal axis, the concave mirror is also referred to as a spherical mirror. (See Center of curvature.)

**Contrast**

The total range of light intensities between the darkest and brightest portions of an image on the television screen.

**Contrast control**

An adjustment for increasing or decreasing the range of light intensities of an image by varying the amplitude of the picture signal. Contrast control in the television receiver corresponds to gain control in a sound receiver.

Often the contrast control varies

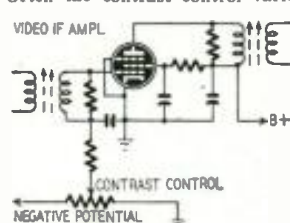

the gain of a remote-cutoff tube in the video i.f., as in the figure.

**Converging lens**

A lens which causes the light passing through it to converge to a point. (See Convex lens.)

**Convex lens**

A converging lens which is thick-

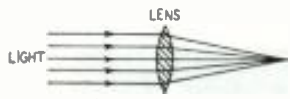

est through its center and thinner toward the edges.

**Counter**

A circuit whose output frequency is a submultiple of the input frequency. The counter circuit, also called a frequency divider, produces a stair-step waveform. (See Frequency divider.)

**Critical viewing distance**

The ratio between the distance at which the line structure of a television image is indiscernible and the height of the image.



**Damping tube**

A diode connected across the horizontal deflection coils to prevent shock-excited oscillations when the magnetic field collapses.

**D.c. reinsertion**

The process of establishing the d.c. level or baseline of a waveform. (See Clamping.)

**D.c. restoration**

Same as d.c. reinsertion and clamping.

**D.c. transmission**

Transmission of the d.c. level of a television signal. The d.c. level determines the background intensity of the image.

**Definition**

That quality of a television image which enables an observer to distinguish fine detail.

**Deflection**

The process of bending or altering the path of the electron stream in a cathode-ray tube.

**Deflection coils**

Coils placed around the neck of a cathode-ray tube to deflect the electron stream. The magnetic field created by the flow of current through the deflection coils causes the electron stream to deviate from its normal path. This system is electromagnetic deflection.

**Differentiator**

A circuit whose output waveform represents the rate of change of the input waveform. As the figure shows, a square or pulse waveform fed into a differentiator produces a narrow, peaked wave in the out-

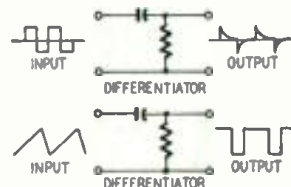

put. A sawtooth fed into a differentiator produces a pulse in the output. A differentiator is sometimes used in an oscilloscope to blank out the retrace. The sawtooth produced by the sweep circuit is fed into the differentiator, and the negative pulse produced in the output is used to bias the cathode-ray tube to cutoff.

**Dioptric**

The name applied to an optical system employing lenses but no mirrors.

**Direct-view**

The name applied to a television receiver in which the image is viewed on the face of the cathode-ray tube. This feature distinguishes it from the indirect-view or projection-type receiver, in which the image is optically projected from the cathode-ray tube to a special viewing screen.

**Discharge tube**

A tube so operated that it is normally cut off and made to conduct at periodic intervals. A capacitor connected in parallel with such a tube charges from the plate-voltage supply when the tube is cut off and discharges through the tube when it conducts. The voltage across the capacitor is sawtooth in form. A discharge tube is often used in a blocking oscillator.

**Dispersion**

The separation of white light into its component colors, as in a prism. Light passing through a prism is refracted to an extent dependent upon its wavelength.



The different wavelengths are separated in passing through a prism because they are refracted by different amounts. The result appears above.

(To be continued)

# Television "Sight Effects"

Radio has its sound effects and television its "sight effects." This article tells how unusual scenes are produced on your TV receiver screen

By H. W. SECOR

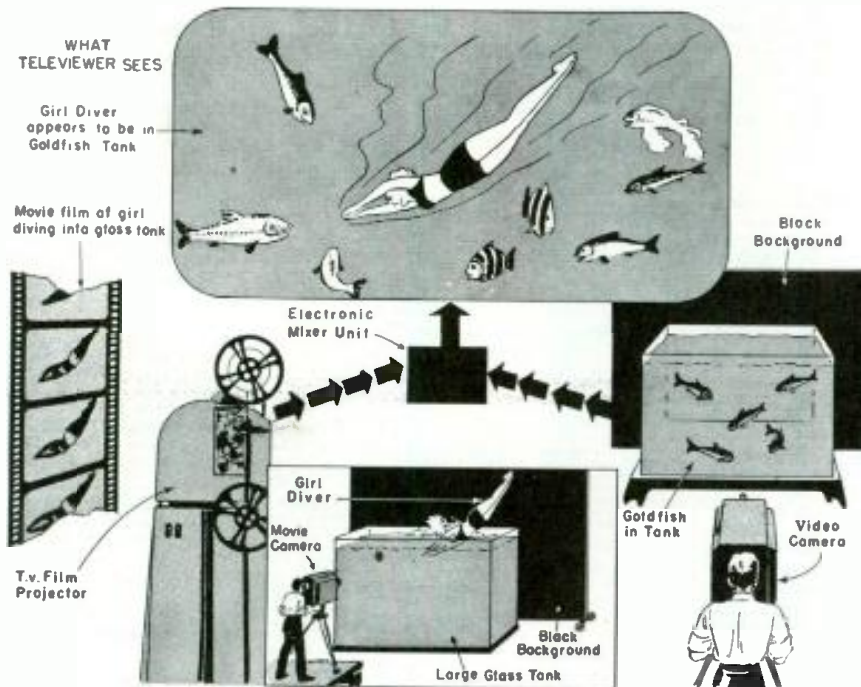

Fig. 1—How movie projector and camera squeeze girl swimmer into fishbowl.

commercials, where the sponsor's name and a picture of his product appear to float above a baseball field.

Squeezing a girl into a goldfish bowl looks like an impossible feat until you take a look at Fig. 1. The diver did her stuff in a giant glass tank while a motion-picture camera took pictures of the act. At the television studio the film was run off through a projection camera which passed the image to the mixing board. At the same time, another camera was trained on a real goldfish bowl. The control operators superimposed the two pictures so that viewers saw both at once. At the top of Fig. 1 you see what the viewers saw: a young lady in a bathing suit playing tag with the goldfish!

Have you ever sat home on a Saturday afternoon listening to a radio description of a ball game? Time for the commercial announcement comes around, and the announcer begins to tell you about El Ropo cigars. Right in the middle of his sales talk you hear the crack of a bat in the background and a great roar from the crowd. You're aching to know what's going on—but you have to wait for the end of the commercial before you find out.

In television it's different. The baseball game stays right on the screen. But you'll see a picture of the sponsor's product or a printed message superimposed on the picture. Often it

THE directors and producers of television plays and other programs are finding that TV is much more than an "instantaneous movie." Because pictures are transformed into electrical signals, they can be mixed, faded, and made to produce the most unexpected effects. That is why the average viewer is no longer

surprised—though he may be mystified—when he sees a lissome young lady swimming around in a goldfish bowl. Cleverly controlled electrons are responsible, too, for some of the trick



Fig. 2—Blurb appears above field.

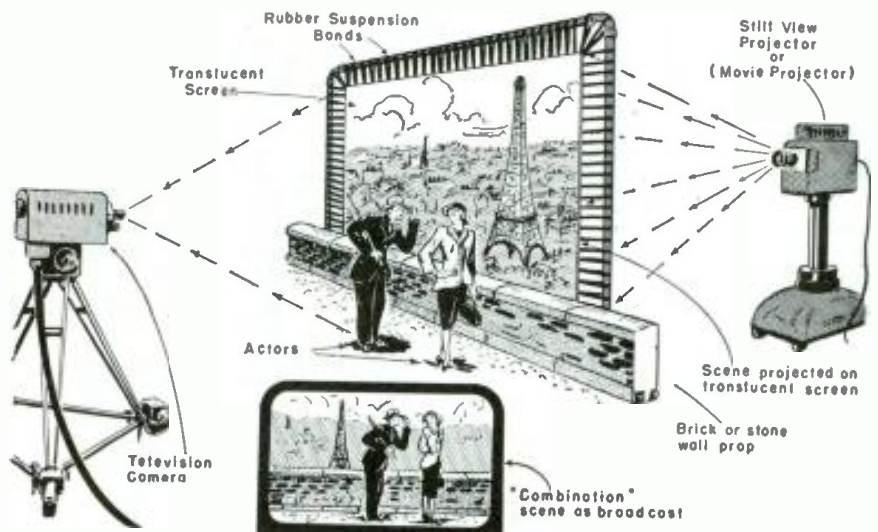

Fig. 3—Still picture projected from rear provides background for Paris short.

looks like sky-writing, or as if a gigantic transparent frame with drawings were suspended over the playing field.

Once again it's the mixers that do it (see Fig. 2). One camera picks up the ball game, and another is aimed at a live or pictured advertisement. Outputs of the two cameras go to a mixer where just the right amount of signal from each is sent on to the transmitter.

**Unusual studio tricks**

Not all television's effects are produced electronically. For instance, you may see a pair of actors standing on a Paris roof with the Eiffel Tower looming in the background. To paint a backdrop or build a set would cost more money and take more time than the scene is worth. But to find a small picture and use a magic lantern is the work of a few minutes.

As Fig. 3 shows, the actors stand on a small imitation rooftop with a white, translucent screen behind them. In back of the scene a still picture projector flashes the Paris view on the translucent screen. The audience sees the picture as a whole—the actors apparently looking at the tower.

The same technique has been used in railroad-train scenes. The action takes place inside the train, but through the window you can see the telephone poles go by and trees and fields appear in the background. This time a movie projector is used instead of a magic lantern. Pictures taken from a train window are projected on a translucent screen set in the window frame.

At present, only CBS is using rear projection. The projected scene must be very bright and powerful lamps are used—one, for example, rated at 5,000 watts. Storm and cloud effects are but one of the myriad possibilities. The screen is a special one, using a plastic-type material with fine metallic particles in it.

One of the most dramatic devices for heightening suspense and tenseness in a play is thick fog. TV producers don't wait for a bad night and shoot the scene outdoors; they make the fog to order. Fig. 4 shows how.

The air in a small box is saturated with titanium chloride mixed with castor oil. In the bottom of the box is a pan of water cooled with dry ice. When the smoke created by the sprayed mixture passes over the cold water, it becomes very thick and billowy. As it comes out the slot on the other end of the box, a fan directs it to the desired places.

**Cartoon figures walk and talk**

One of the cleverest versions of television's puppetry is Du Mont's Magnetoons, produced by J. M. Seiferth Productions. Small figures slide across a painted scene, moving arms and legs and gesturing realistically. These animated cartoons are operated by small magnets. The figures are made of cardboard.

board and a magnet is fastened to each of several strategic places. A like-shaped cutout is against the plastic scenery behind the figure, and it, too, is fitted with magnets.

Fig. 5 shows how the Magnetoons work. As live actors give voices to the characters, an operator behind the scenes moves the magnets. The figure on the front of the screen follows.

All kinds of startling things happen. Characters appear out of nowhere, balls suddenly drop into sight or disappear. Not only do the characters move around, but jaws open and close as words are spoken and the cardboard

actors swing their arms up and down to emphasize their points. To keep perspective as it should be, several cardboard replicas of each figure are used, each in a different size.

Television's heyday is just beginning—but already producers and engineers are outdoing each other in ingenuity. When a little more time has gone by, you may expect to see productions with effects exceeding those possible even in the movies—and with that sense of immediacy which helps to make television programs more enjoyable than even the best of "canned" entertainment.

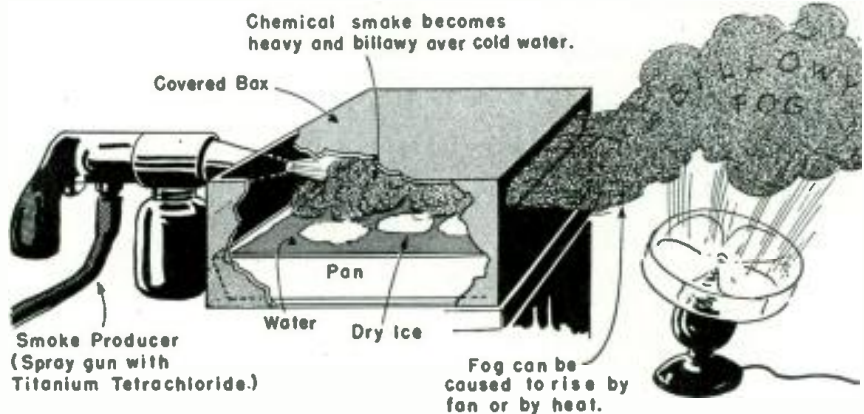

Fig. 4—Spray gun, cooling box, and fan produce a thick, billowy fog in studio.

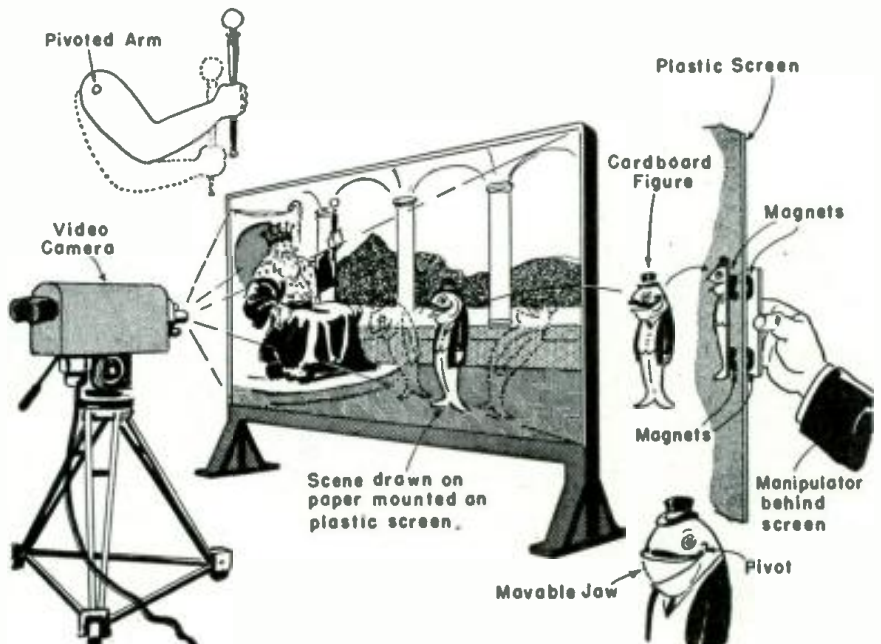

Fig. 5—In Magnetoons productions, cardboard cartoon figures are the actors.

# Theory and Practice of Intercarrier TV Part II

By  
**SEYMOUR D. USLAN\***

**M**ANY television receivers today utilize the intercarrier sound system. The combined i.f. circuits of these receivers up to the video detector are not much different from each other or for that matter from the conventional receiver, except as pointed out in the first part of this article. Overcoupled or staggered i.f.'s are primarily employed to obtain the necessary bandwidth. Adjustment of these i.f.'s for the proper intercarrier response shaping does not require changing the i.f. design greatly. The primary difference among intercarrier receivers is the method of 4.5-mc sound i.f. takeoff. Let us study a few 4.5-mc sound takeoff circuits in typical intercarrier TV receivers.

Fig. 1 is the sound takeoff circuit arrangement employed in the Delco model TV-201 receiver. The output signal from the video detector is fed to the first video amplifier through a high-frequency compensating network. This coupling circuit should be peaked to the point at which its bandwidth will also pass the 4.5-mc beat note. In the plate circuit of the video amplifier is a series-resonant circuit C16-L14, sharply tuned to 4.5 mc. The grid circuit of the first sound i.f. amplifier is connected to the junction of these two components. In other words, the grid-to-cathode circuit of the sound i.f. amplifier is across the inductance of the tuned circuit. Since, in a series-tuned circuit, the voltage across either reactive component is maximum at resonance, then a maximum 4.5-mc signal is applied to the sound section of the receiver.

Fig. 2 is the 4.5-mc sound takeoff circuit used in the Admiral 19A1 chassis. The 4.5-mc signal takeoff is also from the plate of the first video amplifier. However, a parallel-tuned, 4.5-mc

takeoff circuit L1-C1 is employed, connected directly across the grid-to-cathode circuit of the first sound i.f. amplifier. The voltage across a parallel-tuned circuit being maximum at resonance, a maximum 4.5-mc signal is applied to the sound section of the receiver.

One other common type of 4.5-mc sound takeoff unit used is a double-tuned transformer. In Fig. 3 we see two typical circuits employing such transformers. In Fig. 3-a the parallel-tuned primary is in the plate circuit of the video amplifier, while the tuned secondary is in the grid circuit of the sound i.f. amplifier. In Fig. 3-b the primary of the 4.5-mc transformer is in the *screen-grid* circuit of the video amplifier stage rather than the plate circuit.

After the point of 4.5-mc takeoff the video signal must be coupled to the picture tube without any 4.5-mc sound signal being present, as this would distort the picture. Consequently the video coupling circuits *after* the 4.5-mc sound takeoff points should not be peaked to pass any 4.5-mc signal. In like manner the 4.5-mc sound takeoff resonant circuits should be so sharply tuned that no video signal finds its way into the sound section of the receiver.

## Advantages of intercarrier

The major advantages of the intercarrier system over the conventional TV system are:

1. In the conventional receiver a fine-tuning control is almost always needed because of local oscillator drift, which causes the sound i.f. signal to move away from the resonant frequency of the sound i.f. tuned circuits.

In intercarrier systems oscillator drift will not produce such defects. Any drift in the local oscillator results in the same frequency drift in both video and sound i.f. carrier outputs from the mixer tube. Thus, if the oscillator increases in frequency, say by 50 kc, the carriers of the resulting video i.f. and sound i.f. also increase by the same 50 kc. The final sound i.f. signal (4.5 mc) is dependent upon the *difference* between the video and sound i.f. carriers, not their absolute values. Thus, even when the oscillator drifts, the difference remains the same and the resultant beat note is always 4.5 mc.

Many intercarrier receivers do, of course, have a fine-tuning control.

2. Disturbances of the local oscillator in any receiver that cause it to change in frequency at a specific rate actually make the oscillator output an FM signal. This defect can easily be caused

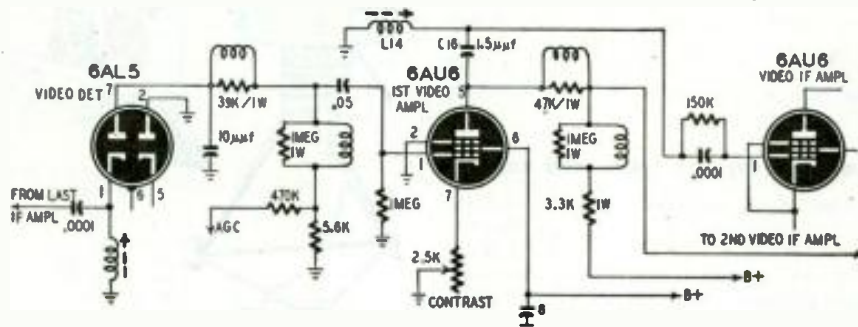

Fig. 1—Diagram of portion of Delco TV-201. Trap is also the takeoff coupler.

\* Chief Technical Editor, John F. Rider Publisher, Inc.

by microphonism. Frequency modulation of the oscillator signal can also be caused by hum from the power supply. In both types of TV receivers this undesired frequency modulation is imparted to the sound and video i.f. signals. In the conventional receiver the sound i.f. signal has no way of getting rid of it; it is detected along with the desired FM and appears in the audio output.

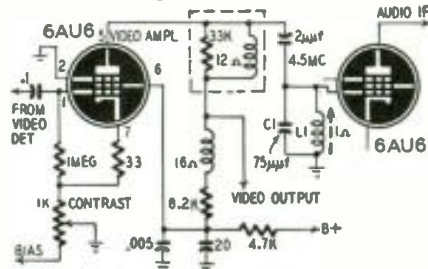

Fig. 2—A different trap-type takeoff.

In the intercarrier receiver, FM of the local oscillator will not reach the sound output. The frequency deviations of the video and sound i.f. signals are in phase. The 4.5-mc difference remains the same, and the undesired FM effects cancel out.

3. Amplification of the sound i.f. signal by the combined i.f. amplifiers and of the 4.5-mc signal by the video amplifiers adds greatly to over-all amplification of the signal input to the sound section of the intercarrier re-

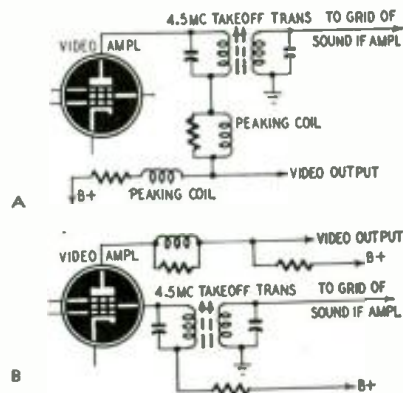

Fig. 3—Tuned-transformer takeoffs.

ceiver. Economically, this is highly advantageous because fewer stages are needed for the sound signals alone. Only one is usually employed in today's receivers.

4. In intercarrier receivers the local oscillator can be tuned above the incoming signal for the lower channels and below it for the upper channels, because the sound and video i.f. carriers will always be the required 4.5 mc apart. This possible tuning system, although considered very advantageous, has not been used very much at the present. It allows the over-all tuning range of the oscillator to be cut down.

**Disadvantages**

There are two chief disadvantages of the intercarrier system, both of which originate at the video transmitter, not the receiver. This is significant because

it means that any major correction work will have to be done to the relatively few transmitters rather than to the thousands of intercarrier receivers.

The two disadvantages each result in distorted sound and are caused by defects of the video carrier signal. The sound output distorts when the video carrier is overmodulated or near-overmodulated and also when it is phase- or frequency-modulated beyond a certain degree.

When the video carrier is overmodulated, there is no signal present during the periods of overmodulation. When this happens in the intercarrier receiver, there is no video i.f. carrier for the sound i.f. signal to beat against in the video detector, and hence no audio output from the speaker.

Since the overmodulation is usually repetitious at the frame rate (it is ordinarily caused by a bright object in the picture), the repeated loss acts as an additional frequency change in the

4.5-mc signal and is therefore demodulated by the FM detector as a 60-cycle buzz.

Most carrier signals of AM transmitters undergo a certain amount of phase or frequency modulation due to transit-time effects and other causes. In most cases this does not cause any trouble. It is not objectionable in the conventional TV system because the video detector will detect changes only in amplitude and not in frequency; but it is objectionable in the intercarrier type system since it means a periodic change in the difference between the sound and picture carriers. The changes in frequency are demodulated by the sound detector. Undesired phase and frequency modulation of the video carrier is greatest in those transmitters operating on the higher-frequency channels because transit-time effects at high frequencies cause greater degrees of frequency modulation of the carrier signal than at the lower frequencies.

# More Television Queries

By DAVID GNESSIN

## Climbing Pix

*I own a 7-inch Hallierafter set. When the picture is first put on, it is quite normal; but after an hour the picture tends to grow in height. Adjusting the height in back, I find that it grows upward, forcing me to move the picture down also. After about 3 hours of use, the picture has grown up so much that I cannot move it down any further and I can fill only the top two-thirds of the screen. Can you suggest a cure for this annoying condition?—J. C., Detroit, Michigan.*

A. Fortunately, Jack Luck of Columbus, Ohio, who has had the same trouble, forwards the following solution: The two horizontal blocking capacitors—.0005 μf at 6000 volts—and the two vertical blocking capacitors—.03 μf at 6000 volts—become leaky, causing

this pix growth. Since you have vertical growth trouble, you probably have one or two leaky vertical blocking capacitors. I recommend replacing all the four described above. See diagram.

## Vertical Problems

*Receiver is a General Electric Model 811. Two or three wide, faint gray bands appear on the face of the picture tube. These bands are about 1½ inches wide and roll upward very slowly. They appear with or without a station on the air, on blank channels such as Channel 8, and with the antenna disconnected from the receiver. Any suggestions?*

Also, how does one center the picture vertically on this receiver?—W. W. G., Briarcliff Manor, New York.

A. With the symptoms you describe, I'll take a shot in the dark and say they're due to unstable high voltage. In that case, check the h.v. supply and 500-μmf filter capacitor. You might replace the 470,000-ohm filter resistor as a check. A new 1B3-GT might help. Clean the 1B3-GT socket and assembly with carbon tetrachloride.

For your last question: Centering adjustment (as taken from *Sams Photo-facts*): Centering adjustments are made by two circular magnets mounted on the focus and deflection assembly. The assembly may be turned the necessary direction, and the amount of correction may be changed by rotating the large magnet with respect to the smaller one and by sliding the two magnets together or apart. Maximum effect is with the two magnets close together and aligned. Minimum effect is achieved by turning the large to oppose the small magnet.

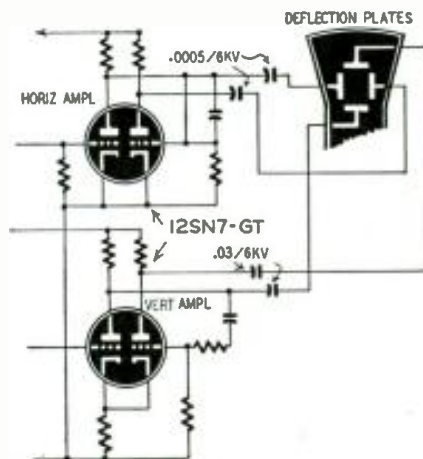

The .0005-μf capacitors may be leaky.

# A De Luxe Televiser

**Part II—The r.f. tuner is designed to cover any 9 of the 13 TV channels**

By  
**CHARLES A. VACCARO**

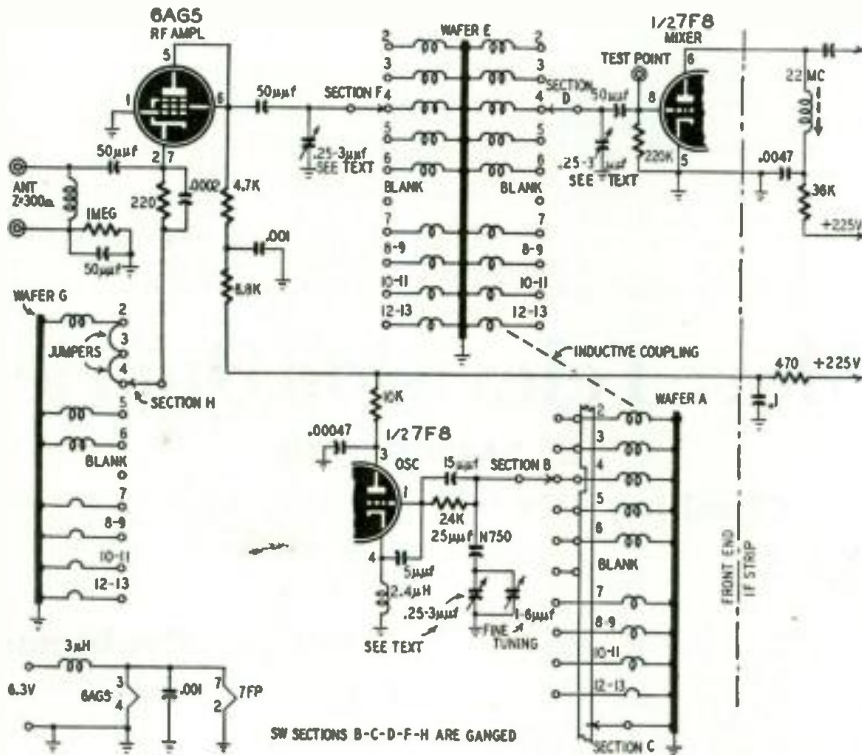

Fig 7.—The complete schematic diagram of a nine-channel television front end.

LAST month we described the construction of two standard video i.f. strips, either of which can be used in constructing this deluxe TV receiver or to modernize obsolete sets. This installment will discuss the construction of the tuner or front end. Designed to cover any nine of the existing twelve TV channels, this tuner can be used in constructing TV field-strength meters, and remote tuners.

A schematic of the tuner is shown in Fig. 7. The 6AG5 is a grounded-grid r.f. amplifier, and the 7F8 is the oscillator and mixer.

### The tuner circuit

The antenna signal is applied across a 300-ohm input consisting of a high-pass coil in parallel with an inductance in the cathode circuit of the 6AG5, which is a high-gain, triode-connected, grounded-grid amplifier. The cathode inductance is switched for various frequencies to maintain the proper termination for the antenna. The r.f. amplifier is transformer-coupled to the mixer section of the 7F8 by overcoupled r.f. transformers which are switched for each channel. The other half of the 7F8 is a modified Colpitts oscillator. The coils are switched for each channel and a small variable capacitor is used for fine tuning. The oscillator output is inductively coupled to the mixer input because the oscillator, mixer, and r.f. coils are wound close together on the same axis. See Fig. 8. The mixer output contains both the audio and video i.f. signals. A 25-μf capacitor, Erie type N750, stabilizes the oscillator against changes in frequency with heat. Three 0.25- to 3-μf variable capacitors compensate for differences in tube interelectrode capacitances when it is necessary to change tubes. If these were not used, all the coils in the circuits of the tube or tubes changed would probably have to be realigned. With these three capacitors installed, it is necessary only to adjust them for one high-frequency station and the rest of the channels automatically fall back into alignment. Construction of these variable capacitors will be described later in this article.

### Constructing the tuner

Figs. 8, 9, 10, and 11 show the construction of the channel-selector switch, which consists of five switch wafers and three metal shield plates. Switches D, F, H, and I are single-pole, 10-position wafers mounted with their terminals facing the rear of the switch

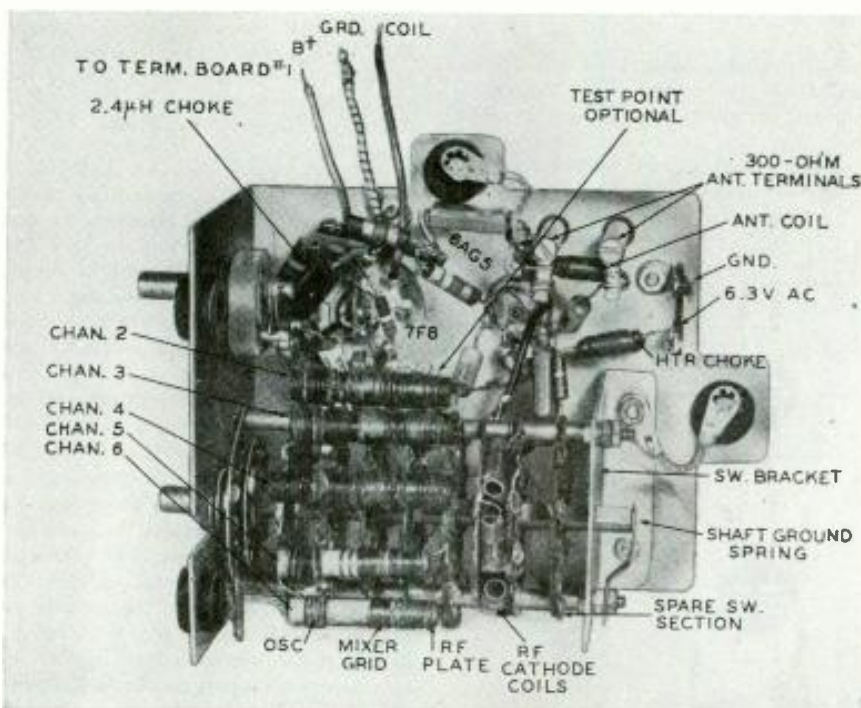

Fig. 8—Underchassis view of the tuner, with the main points and parts indicated.

frame. Switch sections B and C are mounted back-to-back on a single wafer mounted on the frame so that section B is on the front of the wafer. Section B is a single-pole, 10-position switch, and C is made from a shorting-type switch having a circular wiper which shorts all except one of its 10 contacts as it is rotated through its positions. Wafers with two switch sections back-to-back are not normally available; therefore, contacts and wiper were taken from a 10-position, shorting-type switch and mounted on the back of the wafer of switch section B.

Take care in selecting wafers for this switch because some available types have too much inductance in the contacts and others are difficult to convert for sections B and C. (Greenwich Sales Co., 59 Cortlandt Street, New York, N. Y. has three-deck rotary switches having two 10-position wafers and one shorting-type wafer which are suitable for use on the channel-selector switch.) Three of these switches will supply all the wafers needed.

Disassemble one of the shorting-type wafers by drilling out the eyelets which hold the contacts. Loosen the circular wiper by pinching its nibs together on the opposite side of the rotor. Remove it by prying evenly with a knife blade, being careful not to bend the wiper or damage the contacts during these operations.

Remove the contacts from positions allotted to channels 2, 3, 4, 5, 6, and the blank position on the wafer selected

for sections B and C. Do this by cutting through the folded-over section of the eyelets in five or six places with a sharp knife or wood chisel. Remove the rotor. Mount the wiper from the shorting-type switch on the back of the rotor just removed so that its open section is opposite the circuit-closing contact on the front. Anchor it in place by spreading the nibs with a screwdriver.

Insert the rotor in the wafer, making

sure that the contact for section B is toward the front. Place a contact and eyelet in position from the side of the wafer; turn the rotor until it engages the contact. This leaves section C open and its contact can be placed over the eyelet. Fold over the eyelet with a punch and put a little solder on both sides to insure a good connection between contacts. Add the other five contacts in the same way.

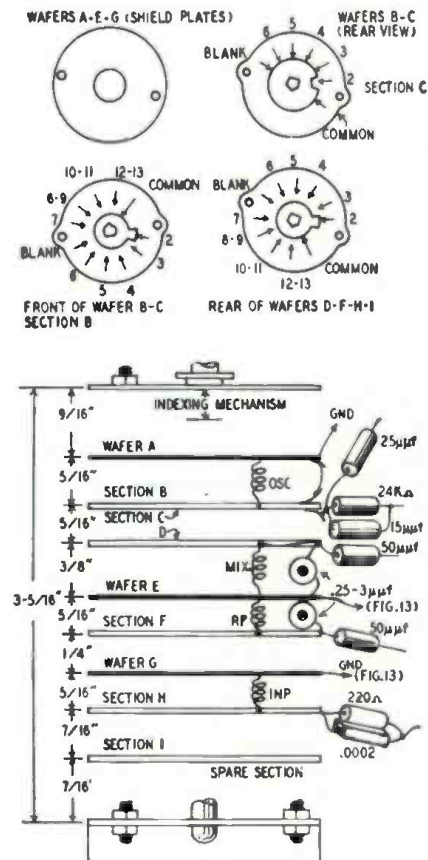

Fig. 9—Construction of the channel-selector switch is shown in the drawings.

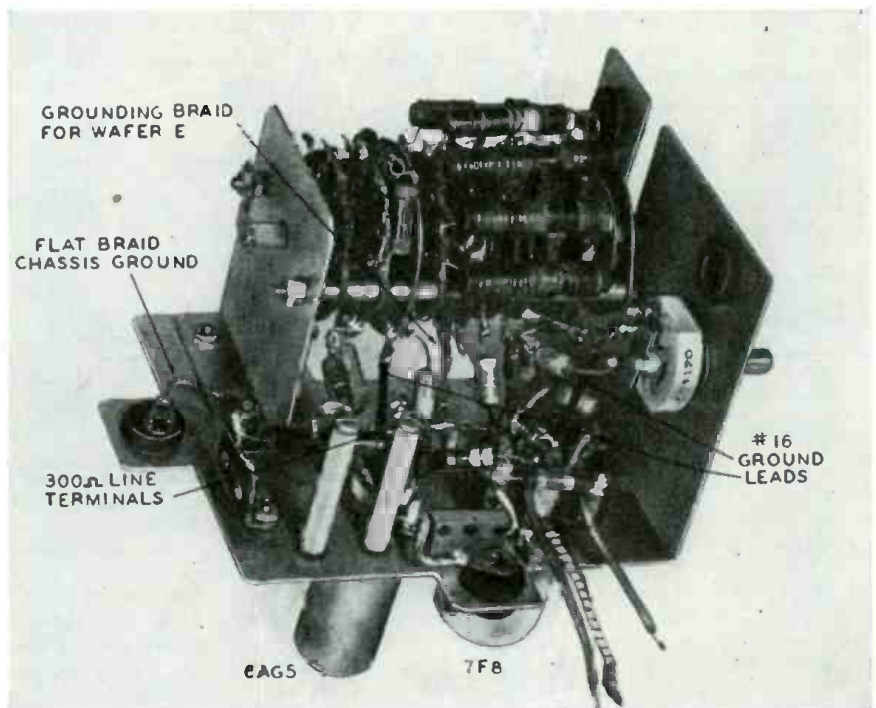

Fig. 10—The chassis from another angle. Look it over well for construction hints.

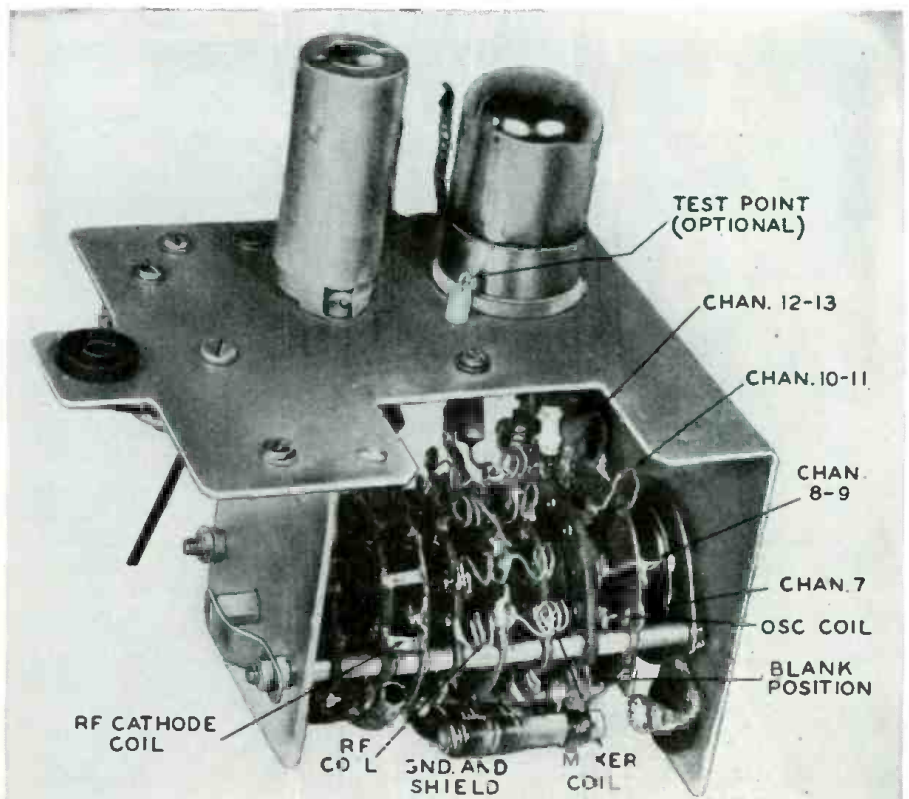

Fig. 11—The high-band coils show up in this view. Note the cathode inductors.

Section C shorts the unused low-band coils to prevent them from resonating with the high-frequency circuits. The high-band coils are not long enough to cause trouble.

Cut out and drill the three shield plates from 20-gauge copper, brass, or tin. Their exact size will depend on the sizes of the wafers and frame used. Cut spacers so the wafers are spaced as shown in Fig. 9; then reassemble the switch. The rear section is not used. It has been installed for possible future

The tuner chassis and switch support are cut to the correct dimensions (Fig. 12) from .05-inch, half-hard aluminum sheet. Drill the holes and bend to shape. Install the tube sockets, fine-tuning capacitor, tie points, etc., using internal-tooth lockwashers under each screw and nut. Leave out the switch until later. Wire in all components and wires, except those leading to the switch. Follow very carefully the layout (Fig. 13) and photographs (Figs. 8, 10, and 11). This is very important

to solder some of the high-band coils to the switch prior to installing it.

Refer to Fig. 14 for the data on all the coils and r.f. chokes. Note that all coils for the same channel are wound in the same direction. The winding length and spacing between coils was measured after all channels were aligned and should be a help in pre-setting them. Mixer and r.f. coils for channels 2 through 6 are closewound rather loosely around the form so they can be spread out easily after they are added to the switch. Later each coil turn will be held in place with soft wax. The oscillator coils can be wound fairly tight around the forms as they consist of only a few turns and do not have to be spread very much. All the coils for channels 2 through 6 are wound with Formex or Formvar-insulated wire or tubular forms. Those for channels 7 through 13 are No. 22 bare, tinned wire and are self-supporting. The cathode coils for these channels are made from .005 x 1/8-inch copper strips connected directly between the points on wafers G and H as shown in Fig. 11. The high-frequency coils are so critical that two lengths are given, a length to cut the wire, and the length to be used. Cut a piece of the bare wire to the "cut" length given in Fig. 14; then bend the two ends so that the "use" length is between the two bends. Form the coils as shown in the drawings and photos, and solder to the switch so that the solder covers the bent ends only up to the bends.

The r.f. amplifier cathode chokes or coils are close-wound on 3/16-inch Textolite or insulating paper tubing for the low channels. These are cemented when finished as they are very broad in response and require no adjustments. The cathode coil for the h.f. channels consist of bare wire soldered directly across the switch terminals.

Solder the two sets of coils for channels 12-13 and 10-11 to the switch, and then slide the switch back down the slot into the front-end assembly. Fasten the switch and its mounting, and complete the connections to the switch. Now add the coils for the rest of the channels, and finish by spreading them to the dimensions indicated on the coil data. The three variable capacitors that compensate for the variation in interelectrode capacitances of different tubes are easily made. (See Fig. 14). Use a piece of 3/16-inch (outside diameter), low-loss paper or Textolite tubing with walls thin enough to allow an 8-32 screw to slip in and out. Wind the six turns of No. 20 tinned, solid copper wire at one end. Remove it from the tubing, tighten the turns and then replace it. Flow in enough solder to produce a solid band of metal; let cool long enough so that the rosin from the solder forms a bond between the resulting metal band and the tubing.

Closewind four turns at the other end of the tubing in a counterclockwise direction, place a 7/8 or 1-inch cadmium- or chrome-plated 8-32 screw

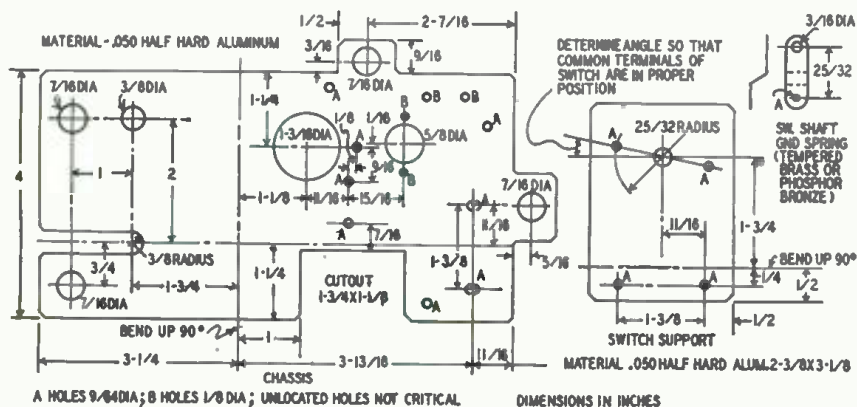

Fig. 12—Layout guide for the chassis and support for the selector switch.

use for antenna switching, station indicators, or preamplifiers. Install stops on the front of the switch to cover the 10 positions.

If the stops on the switch are not movable and are in the wrong positions, bend them back and install new ones where required by drilling holes and screwing in small self-tapping

because changes from this layout can make the coil data useless.

Fasten the switch to its rear mounting bracket and slide the switch down the slot in the front of its panel and into position (do not fasten it down yet). Solder the components and ground leads which go to the switch at the tube socket end, using the switch for

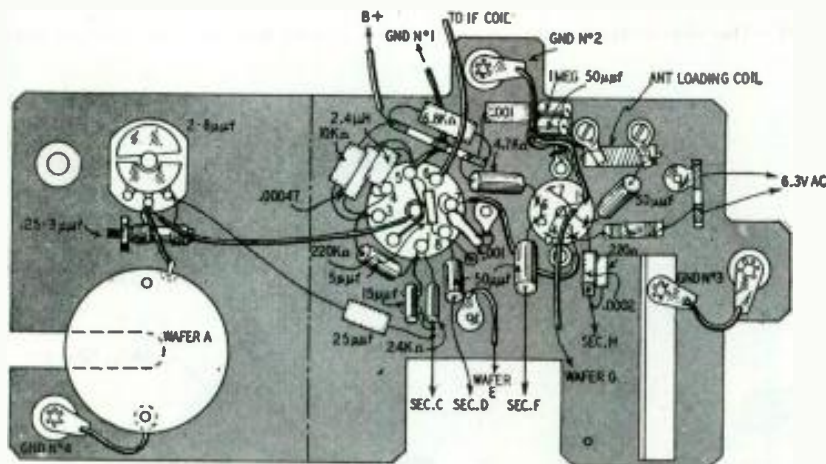

Fig. 13—A partial pictorial diagram of the tuner. The selector switch was omitted from the drawing for clarity as were two compensating capacitors.

screws. Let them project just far enough to stop the rotor without interfering with the indexing springs.

Note that the shafts on this switch and the fine-tuning control are short (about 3/4 inch long) and are connected with an extension shaft in the final assembly. This facilitates installation and removal of the tuner from the chassis and also is used to advantage during the alignment of the h.f. channels. All of the switch reworking as outlined above is much easier than it sounds and can be completed in a couple of evenings.

positioning. Use No. 16 stranded wire for the ground leads except for the 1/8-inch flat copper braid from shield section E directly to the chassis. At the switch end, pass the wires and leads through the proper switch terminals but do not solder yet. Make these leads just long enough to pass through the switch terminals so that the switch can be removed easily for servicing if necessary. Now pull the leads away from the switch and slide it out of the slot. Although all the coils can be soldered to the switch after it is installed, it is much easier



TELEVISION DX REPORTS

THE incoming mail in response to our requests for long-distance television reception reports discloses at least one interesting fact. Over 75% of all the letters reporting true dx reception (many listed only fringe-area results) logged reception of KLEE-TV in Houston, Tex., at least once. All the reports were from four closely grouped states, Illinois, Michigan, Iowa, and Indiana. No other station was mentioned in more than two letters.

Here's the list of those who reported receiving KLEE-TV:

Howard X. Anderson, Rockford, Ill. Nov. 16, 1949; G-E 821 receiver, Amphenol 114-005 antenna.

John B. Sevec, Joliet, Ill. Nov. 16, 1949; Amphenol dipole antenna.

Tom Bromeling, Albion, Mich. Nov. 16, 1949; RCA 8TZ41 receiver, two-bay Amphenol antenna, and booster.

Larry Shaw, Port Huron, Mich. July 15, 1949; Hallcrafters T-54 receiver, Taco double-doublet antenna.

Leo Yarusinsky, Streator, Ill. Nov. 17, 1949; RCA-type receiver, two-stack conical antenna.

Clifford R. Butler, Burlington, Iowa. Nov. 16, 1949; Westinghouse receiver, two-bay Amphenol antenna.

Arnold Zarek, Lafayette, Ind. Nov. 16, 1949; Emerson 611 receiver, two-stack conical antenna. (Mr. Zarek also received WOAI in San Antonio on the same day.)

Lewis R. Ronk, Port Clinton, Ohio. April 27, 1949. Philco 1002 receiver, Amphenol 114-302 antenna. Mr. Ronk reports that many viewers in his area picked up a baseball game on KLEE-TV at the same time he did and that the *Toledo Blade* wrote an article about it on April 28. He picked up KLEE-TV again on May 7 and May 21, as well as WKY-TV in Oklahoma City, Okla., on July 13, 1949. Mr. Ronk is on an island and has excellent overwater reception from many distant stations.

A letter from B. Waters of Oneida, Tenn., reports reception of WBAP in Ft. Worth, Tex., and WBZ, Boston, Mass., intermittently. Mr. Waters apparently believes in television although he is about 150 miles from the nearest station (Louisville). He owns two receivers, an Admiral at home and a Motorola VT-71 in his service shop. He, as well as many other correspondents, reports consistent reception over this and larger distances, indicating that even fringe areas extend over much more territory than anyone used to think possible.

G. Hampton Allison of Richmond, Va., reports receiving stations in New York and points slightly south on a Pilot TV-37 with a modified Yagi-type antenna.

Many other letters were received, too many to quote here. They reported reception up to 200 or 300 miles; there was enough of this, in fact, to make one wonder if reception at 200 miles might not be called almost normal.

about half-way in the tubing and wind the additional five turns around the screw. The wire size has been selected so that the last five turns form the threads for the screw. Remove the screw and the turns of wire from the tubing, tighten them slightly and replace. Now flow the solder into the four turns that are on the tubing, again using enough heat to allow the rosin in the solder to flow down to the tubing. Apply only enough solder to the turns over the screw to form a solid band. Turn the screw continuously while the solder is cooling so that neither the solder nor the rosin will set the screw. Again let it cool until the rosin sets against the tubing. The resulting variable capacitor is a compact unit with leads that are solid enough to keep it rigid and self-supporting in the wiring. Adjust the screw so its bottom is approximately even with the inside edge of the lower band and lock it in place with a hex nut or round battery nut, using only hand pressure. These capacitors need no further adjustment and should be left in this position until it is necessary to replace either the 6AG5 or the 7F8 after the receiver has been aligned.

Solder two of these capacitors to the switch with the screw side of the capacitors connected to the grounded shield and with the screws up, away from the chassis so that they will be easily accessible. Solder the third one across the fine-tuning capacitor, connecting the screw end of the capacitor to the grounded side of the tuning capacitor.

Now check the wiring of the front-end against the schematic and the layout.

There are numerous applications for small variable capacitors like the ones just described. For example; some home-made TV and FM boosters take off and oscillate at the slightest provocation. These circuits can be stabilized by installing small variable capacitors between plate and grid using any of the standard neutralizing schemes.

Gimmicks or twisted insulated leads are commonly used to couple the output of the b.f.o. to the second detector in communications-type receivers. Sometimes the b.f.o. is too strong to give a good beat with a weak signal. Furthermore, a strong b.f.o. will cause the a.v.c. voltage to rise and reduce the sensitivity of the receiver. This trouble can be cured by using one of these home-made variables to replace the gimmick. You can make the screw longer so it protrudes through the panel where it can be used as a b.f.o. injection control.

These low-capacitance variables can be used to neutralize the plate-to-grid capacitance of low-power transmitting tubes like the 6L6, 3E29, 3C24, and 807. Capacitors for medium-power tubes can be made in the same manner. Use thin-wall ceramic tubing and adjust the length of the screw and windings for the desired capacitance range and breakdown voltage.

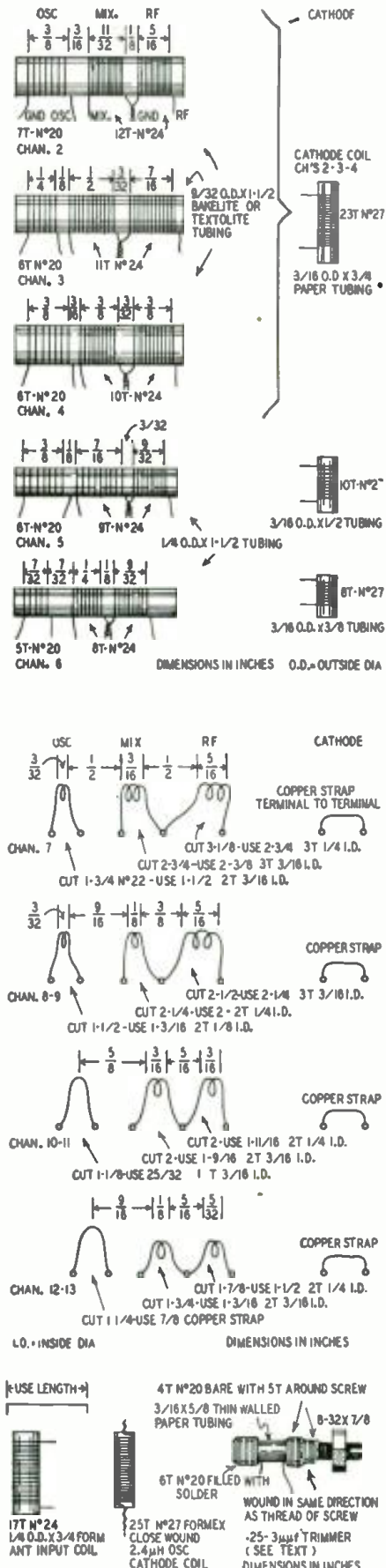
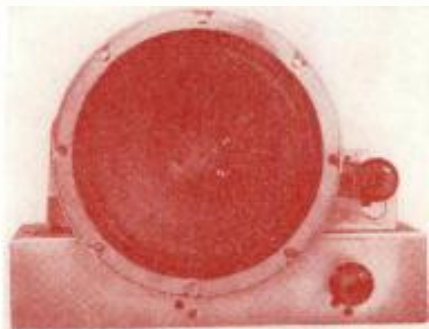

Fig. 14—These drawings show the construction of the inductors and the special low-capacitance capacitors which compensate for differences in the tubes.

# One-Tube Loudspeaker Receiver



The set gives good loudspeaker results.

A single-coil permeability tuner, a duo-triode, and two batteries give speaker-volume reception

by SANFORD MILLER

**T**HE one-tube loudspeaker receiver has long been the goal of constructors and experimenters. This one combines low cost and good volume without sacrificing sensitivity. Adding a small capacitor and a telegraph key makes it an excellent code-practice oscillator.

The set was designed during a search for a simplified, basic receiver. The crystal set was ruled out because of low selectivity and sensitivity and limitation to headphones. The superhet is too complicated for a simple receiver. Ordinary regenerators are undesirable because of radiation and the skill required to operate them properly. But

grid-leak detectors are most sensitive, and enormous gain can be obtained by regeneration, the incoming signal being amplified many times over.

The choice was narrowed down to the circuit shown in the figure, a special type of ultraudion with a certain amount of superregeneration. When components are carefully selected and permeability tuning used, regeneration is automatic. No manual regeneration control is necessary, and no tickler winding is required on the coil. Regeneration is provided by the ultraudion connection of the first triode.

The 24- $\mu$ f coupling capacitor was chosen as a happy medium. A larger

capacitor requires more feedback or regeneration and a smaller one reduces the volume, though it improves the selectivity. An adjustable trimmer can be used here, the best value for local conditions being chosen.

The detector plate bypass capacitor, shown as .0025 $\mu$ f in the diagram, is critical. Too little capacitance causes oscillation and too much reduces the volume. Various capacitors should be tried until one is found that permits tuning over the whole range without oscillation but with the detector very close to the "squeal point." If a very small capacitor is required here, the Q of the tuning circuit is low. A tuner that operates best when this capacitor is large probably has high gain and low losses. Choose a tuner that has stranded litz instead of solid wire for the coil. One with a universal (honeycomb) winding is usually much better than a plain solenoid.

Though not nearly as critical, other parts may be varied to meet special conditions. In locations near powerful stations, reducing the grid leak from 10 megohms to 3—or even 1—will minimize overloading on strong signals. Increasing the plate bypass capacitor will make operation smoother. Since sensitivity is not required, the set need not be run near the point of oscillation. In places remote from powerful stations, this capacitor should be as small as possible without causing signal-distorting oscillation, and the grid-leak resistance should be high.

The second half of the 3B7 is the audio amplifier, which is resistance-coupled to the detector plate through an 82,000-ohm resistor and .02- $\mu$ f capacitor. The 390,000-ohm grid leak connects to the negative end of a 1,000-ohm bias resistor, putting just enough negative bias on the grid to make it operate at minimum distortion. All these

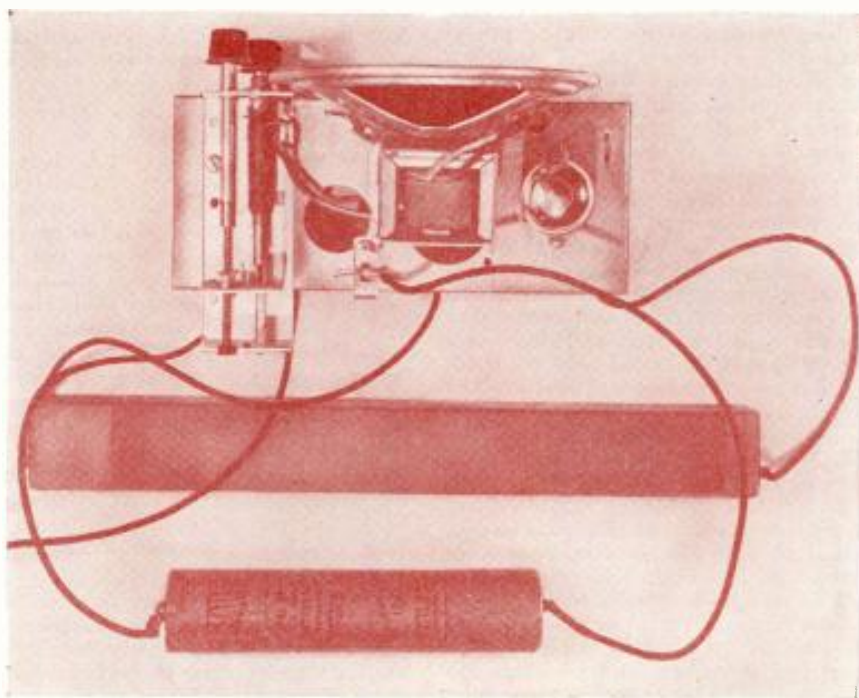

The permeability tuner is at the left. The batteries are special surplus types.

RADIO-ELECTRONICS for

values are uncritical. The coupling resistor may be increased to as much as 150,000 ohms (if the detector plate bypass capacitor is selected to give best results at that value) and grid leak values between 220,000 and 1 megohm will work. Higher values of either resistor may increase sensitivity, though the present values were considered—after some experiment—to be the best all-around combination.

Since only one tube is used, battery operation is simplest and most economical. It is also safest, if the set is built or used by a beginner. The A-battery can be made by paralleling two flashlight cells. The B-battery in the photograph is a surplus 103½-volt surplus unit. Two ordinary 45-volt batteries in series can be used instead. Current requirements being low, battery life is long.

An outdoor antenna is recommended for proper operation. Antenna length should be fitted to the needs of the location. Near powerful broadcast stations 25 to 50 feet should be sufficient, but in remote rural areas at least 100 feet flat-top, hung as high as possible, will be needed.

A weak A-battery causes low volume and broad tuning. Keep a flashlight cell handy to check it by the substitution method.

All components are cheap and easy to obtain, though high quality is needed to produce best results. The volume control is a 2,000-ohm, wire-wound unit. The inductance of the wire winding appeared to be of value, and a carbon type is not recommended. The tuner was actually a superhet permeability tuner with the oscillator coil and trimmer capacitors removed. If loudspeaker reception is to be obtained, a good speaker, and most especially, a good output transformer, will be required.

To use the receiver as a code-practice oscillator, a 100-µmf capacitor may be soldered to pin No. 2 of the tube socket. Connect the other end of the capacitor with a short wire to a telegraph key, and the key's other terminal with a short wire to pin No. 6. Audio growl with the key up if it occurs, may be removed by connecting a 100-µmf or larger capacitor between the output plate and ground.

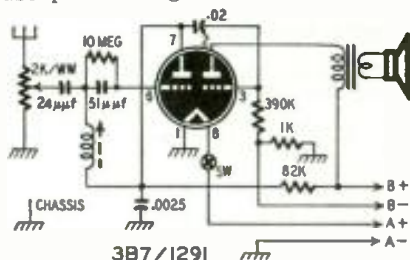

One-tube set is ultraaudion regenerator.

**MATERIALS FOR RECEIVER**

- Resistors: 1—1,000, 1—82,000, 1—390,000 ohms, 1—10 megohms, ½-watt; 1—2,000 ohms, wirewound potentiometer with switch.
- Capacitors: 1—24, 1—51 µmf, 1—.0025, 1—.02 µf.
- Miscellaneous: 1—permeability tuner; 1—3B7/1291 tube; 1—output transformer, 25,000 ohms to voice coil; 1 octal tube socket; chassis and miscellaneous hardware; 1—1.5-volt A, 1—90-103.5-volt B batteries; 1—PM loudspeaker.

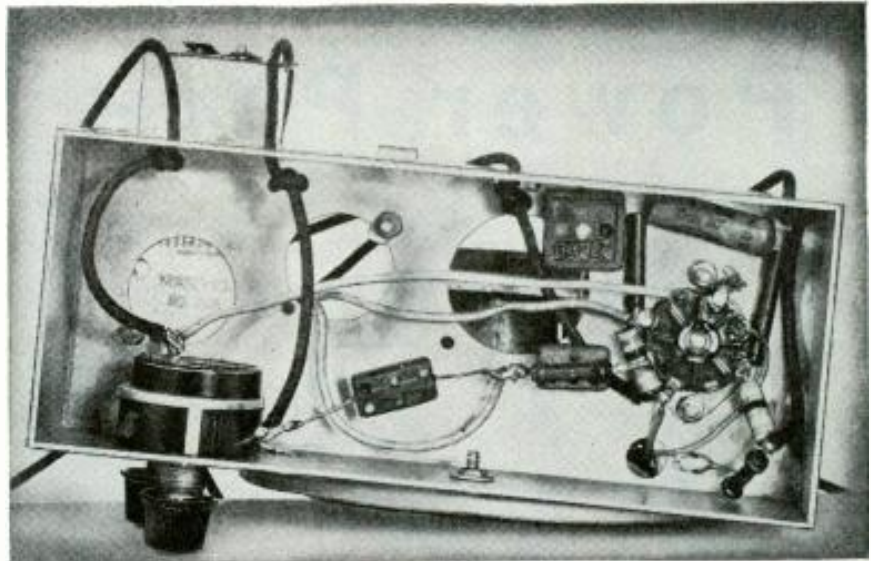

Receiver has few parts, is easily built. Much smaller chassis could be employed.

## Relay Timing Test Circuit

Many types of telephone central-office equipment include timing circuits, the accuracy of which must be high. Some depend on slow-acting relays, others on vacuum-tube circuits with R-C time-constant delays. Checking the equipment to see that the time intervals are as specified is important to smooth and faultless operation. This job can be done with a direct-reading instrument designed by E. R. Morton, described in the *Bell Laboratories Record*.

The heart of the instrument is a vacuum-tube voltmeter. This measures the voltage of a capacitor C which is allowed to charge only during the action time of the circuit under test. The charge at the end of any given time will indicate the time itself.

A bias of -13 volts is ordinarily applied (by another circuit unimportant to this discussion) to the grid of the tube V1. That is enough to cut off the tube. Switch SW is closed to discharge C. At the start of the timing cycle to be measured, SW is opened. The -13 volts is removed from the grid of V1, and ground is substituted. The operator has set the test key at OPR.

Now, while the positive end of the B-battery is connected to the plate of V1, the negative end is connected to the cathode only in series with capacitor C. The tube is so biased and the screen voltage set so that reasonable changes in plate voltage do not appreciably change the plate current. From the time the cutoff bias is removed, therefore, until full conduction, the plate current is constant.

The plate current passes through C, charging it, the charge increasing with time. The voltage across the capacitor at any given time is equal to its charge Q (in coulombs) at that time divided by the capacitance:  $E=Q/C$ . If the charging current is constant, as in this case, the charge is determined by the current and the time during which it

has flowed:  $Q=IT$ . Substituting  $IT$ , the equivalent of Q, for Q in the first equation, the voltage of any given time is

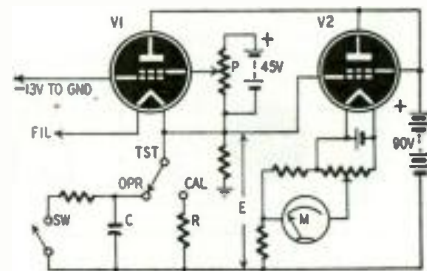

equal to the charging current multiplied by the time it has flowed, divided by the capacitance:  $E=IT/C$ . The current I and capacitance C are fixed, so the voltage E across capacitor C depends solely on the time T allowed for the charge. The voltage increases directly as time.

The grid of V2, the v.t.v.m. tube, is connected to the cathode side of C; therefore, the voltage developed across C by its increasing charge is indicated on the meter. While the meter effectively measures this voltage, it is calibrated in terms of time (which is directly related to the voltage, as shown). As the voltage across C depends not only on time but also on capacitance, four different time ranges may be measured by substituting different values of capacitance. The ranges are 0-20, 0-100, 0-500, and 0-5,000 milliseconds.

Potentiometer P calibrates the instrument. When the test key is switched to CAL, resistor R is substituted for capacitor C. The resistor's value is such that the voltage drop across it is the same as the charge would be on C when the maximum time for the scale in question (100 milliseconds, for instance) is being measured. P is then adjusted for a full-scale reading on the meter.

# Power Pack Design

*How to choose transformer and input capacitor values to obtain required voltage*

By P. E. LEVENTHAL

POWER supplies, particularly capacitor-input filters, are usually built on a system of hit-or-miss guesswork. There seems to be great difficulty in deciding the correct value of the input or reservoir capacitor. The amateur generally regards the power supply as the least important part of his equipment and simply wires up the standard full-wave circuit, using any capacitors on hand.

This is an unfortunate state of affairs, for a power pack is required for practically every piece of apparatus in the station and may give rise to many troubles, from intolerable hum in a re-

servoir capacitor charges up to this peak value. The charging ceases when the peak is passed, and the capacitor begins to discharge through the load until the voltage across the capacitor becomes lower than the rising voltage of the next half-cycle (or full cycle in the case of a half-wave rectifier), when the charging begins again. It is clear that the capacitor acts as a reservoir which is partially emptied and refilled during each half-cycle.

The smaller the charge and discharge with respect to the total charge on the capacitor, the less will be the fluctuation or ripple of the voltage. That is,

arranged to show the filter capacitor required for given output voltage when a.c. peak, load current, and ripple frequency are known,  $C = 1/2f(E_{peak} - V)$ .

The equations may be used as they stand to give most of the information necessary in the design of a power supply, but the author has constructed a nomogram which greatly simplifies the task.

## Using the nomogram

The nomogram may be used to find the value of the reservoir capacitor necessary for a required output from a given transformer, to determine the transformer necessary to give a stated output using a specified capacitor, or to find the output obtained using a specified transformer and capacitor.

Constructed for full-wave rectification of 50-cycle a.c., the nomogram may be used for half-wave rectification or any other frequency by multiplying the values of capacitance on the left-hand scale A by 100/f, where f is the lowest-frequency component of the ripple (120 cycles for a full-wave rectifier and a 60-cycle supply, for example).

It is necessary to calculate the value of  $E_{peak} - V$ , where  $E_{peak}$  is 1.4 times the rated r.m.s. voltage of the transformer secondary (or of half the secondary for a full-wave rectifier), and V is the required d.c. output voltage. To simplify matters to the utmost, a "yardstick" has been provided to convert r.m.s. values to peak values. Its range may be increased by multiplying both sides by 10 or 100 as required.

## Sample calculations

A receiver requires a power supply of 300 volts at 120 ma. The rectifier is of the full-wave type, connected to a 50-cycle supply. If the input capacitor of the filter (reservoir capacitor) is 8  $\mu\text{f}$ , what is the required a.c. voltage?

Place a straightedge between 120 on the load scale B and 8 on the capacitance scale A. The straightedge then intersects scale C at 80 volts. Therefore the peak a.c. input required is  $300 + 80 = 380$  volts. Converting this to r.m.s. values, we have 271 volts.

Hence a 275-0-275-volt transformer capable of supplying 120 ma would be suitable.

In another case, given a transformer

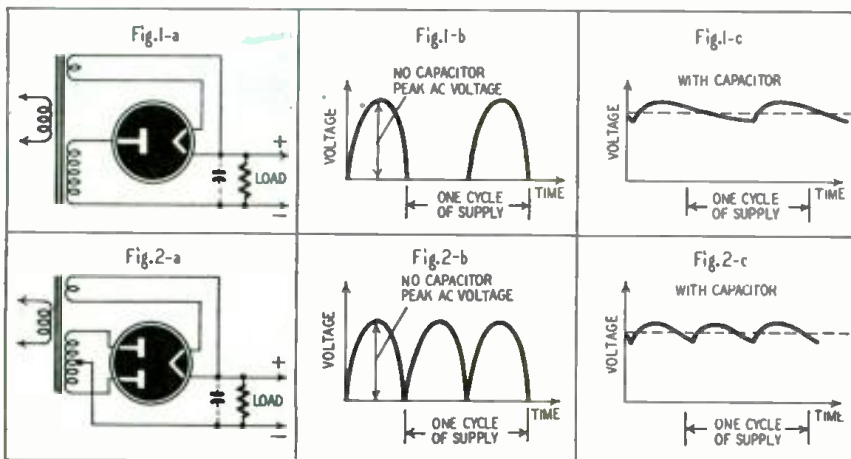

Fig. 1—The half-wave rectifier, with output waveforms with and without capacitor. Fig. 2—Higher ripple frequency of full-wave output makes it easier to filter.

ceiver to frequency creep in a transmitter.

The waveform of the output voltage across the resistance load of a simple half-wave rectifier system (Fig. 1-a) is shown by the graph, Fig. 1-b. The waveform which results when a capacitor is placed across the load is shown by the solid line in Fig. 1-c. The corresponding figures for full-wave rectification are shown in Figs. 2-a, 2-b, and 2-c. The dotted line represents the d.c. output voltage while the thick line is the superimposed ripple voltage.

The ripple voltage, or hum, has twice the frequency of the supply in the full-wave case and is therefore more easily filtered off.

Each rectifier conducts fully only during a part of each cycle when the applied voltage is near its peak, and the

the larger the capacitor for a given current drain, the less the ripple or the better the smoothing.

The d.c. voltage across the capacitor equals the peak a.c. voltage minus the average ripple voltage. Since the ripple decreases as the value of the reservoir capacitor increases, it is evident that increasing the size of the capacitor increases the effective d.c. voltage up to the limit at which the ripple is negligible, and the d.c. voltage across the capacitor (or load) equals the peak value of the applied a.c. voltage.

A simple analysis shows that  $V = E_{peak} - (\pi IX)$ , where V is the d.c. voltage across the reservoir capacitor,  $E_{peak}$  is the peak value of the applied a.c. voltage, I is the load current in amperes, and X is the reactance of the capacitor at the ripple frequency. Re-

with a secondary delivering 350 volts r.m.s. each side of the center tap, what size input capacitor is required to obtain a d.c. supply of 480 volts at a load of 5 ma?

The peak a.c. voltage is  $350 \times 1.4$  (or from the "yardstick") = 490 volts. Therefore, peak a.c. — required d.c. =  $490 - 480 = 10$  volts. A straightedge placed between 10 on scale C and 5 on scale B intersects scale A at 2.5  $\mu\text{f}$ ; this is the capacitance required.

Another problem: a 500-volt transformer used on 50-cycle a.c. is to have its output half-wave-rectified. What will be the resulting d.c. output at 200 ma if an 8- $\mu\text{f}$  capacitor is used at the filter input?

The peak a.c. is 700 volts (from the "yardstick"). Since the fundamental ripple frequency is now 50 cycles, we must multiply all numbers on scale A by 100/50, or 2. The original 4- $\mu\text{f}$  mark now becomes 8  $\mu\text{f}$ . Placing a straightedge between 4 on scale A and 200 on scale B, we have an intersection at 250 volts on scale C. Therefore the d.c. voltage output equals peak a.c. —  $250 = 450$  volts.

If the resistance of the smoothing choke following the reservoir capacitor is known, the voltage drop across it may be found by Ohm's law and added to the required d.c. voltage. If the rectifier tube is a mercury-vapor type, an extra 15 volts may be added for the drop across the tube. A tube handbook must be consulted for the drop across a vacuum tube.

The nomogram may be employed for all values of load current from 1 ma to 1 ampere. It may be used for all voltages, since the value  $E_{\text{peak}} - V$  does not depend at all on the absolute value of  $E_{\text{peak}}$ .

**The filter circuit**

The smoothing filter is another piece of apparatus which, though very important, is often imperfectly understood.

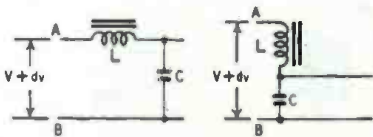
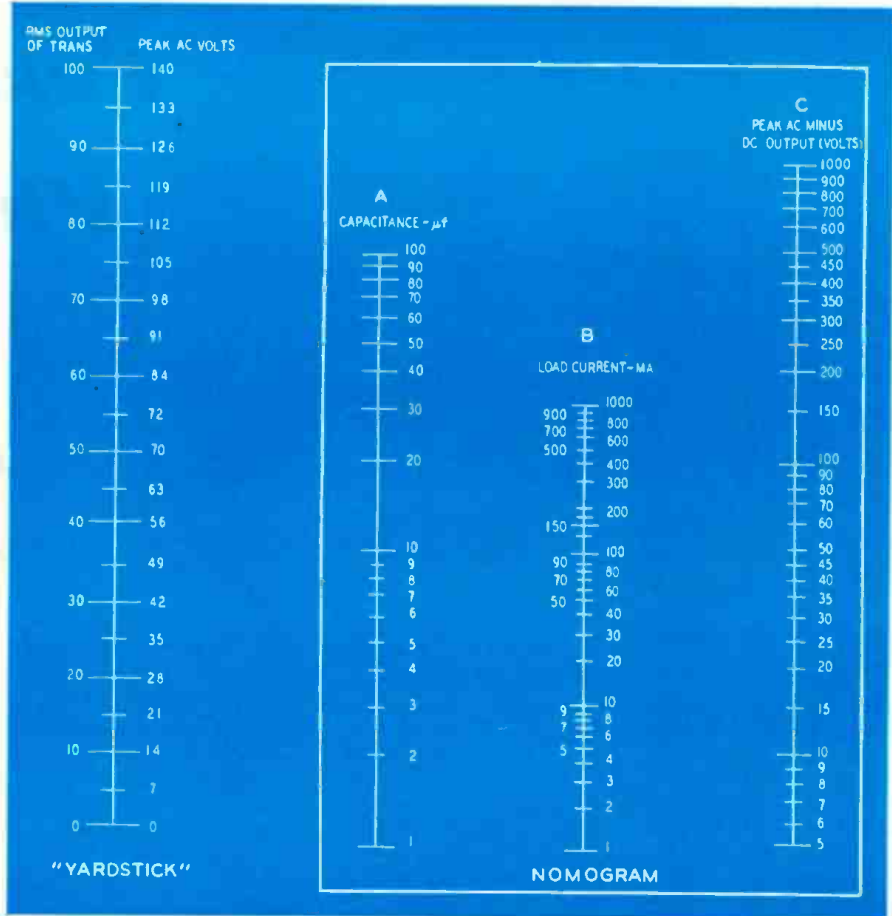

Fig. 3—Filter drawn as voltage divider.

Fig. 3 represents the ordinary type of filter circuit used by amateurs, terminals A and B being connected across the reservoir capacitor. The input to A and B, therefore, consists of a steady voltage V, with a superimposed ripple voltage dV.

If the filter circuit is redrawn in the form shown at right, its operation at once becomes apparent, as it is no more than a voltage divider or potentiometer.

As far as the d.c. component V is concerned, the capacitor presents an infinite impedance to this and the total d.c. voltage is obtained across the capacitor, minus only the ohmic loss due to the resistance of the wire in the choke.



Nomogram is for 50-cycle supply. Text explains its use for other frequencies.

The ripple component (which is a.c.) fares differently. The choke presents a high impedance to the ripple frequency, while the capacitor acts almost as a short circuit. Thus, the greater part of the ripple voltage appears across the choke and only a very small part across the capacitor with the d.c. component. In this way, the filter performs its operation of smoothing the rectified supply.

Attenuation of the ripple depends upon the values of L, C, and f (the ripple frequency), the ripple becoming smaller as these are increased. Therefore, to obtain good smoothing, use full-wave rectification (f = twice supply frequency), and make L and C as large

as possible. It is, of course, necessary to see that the working voltage of the capacitors is not exceeded and that the chokes can pass the required current. The resistance of the chokes must be such that they do not cause too great a voltage drop at the required load current.

(Thanks are due to the British *Short Wave Magazine* for permission to reprint this article. Note well that the nomogram and the calculations are based on a 50-cycle line frequency, common in Britain and in other countries. Instructions are given in the text for converting capacitance values for other frequencies such as the 60 cycles common in the U. S.—Editor)

**Meter Measures Coil Q**

A simple Q-meter which consists of a calibrated oscillator and a simple v.t.v.m. is shown. V1 is the oscillator tube, and V2 is the v.t.v.m. The meter

has a 2-ma scale with 20 equally spaced divisions.

With the switch set at A, adjust the meter to zero. Throw the switch to B and adjust the regeneration control until the meter reads 10 (half-scale). Connect the coil to be measured to the test terminals, throw the switch to C, and adjust C1 to resonance as indicated by a maximum reading on the meter. A coil having a Q between zero and 200 can be read on the meter. The accuracy of the instrument is not affected by losses through the 10-megohm resistor and through capacitor C1.

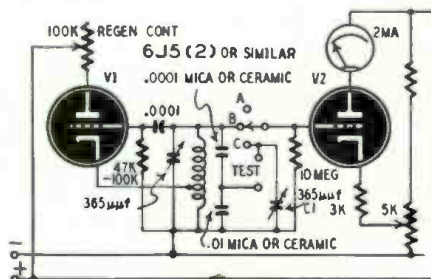

J. Kober



# Custom-Built Phonograph

**Optimum-quality LP-  
standard reproducer**

By RICHARD H. DORF

HAVE always felt that if you really want to hear recorded music at its very best, you have to build or assemble your own equipment. You can get a standard radio-phonograph console that will sound as good as one you build; but of the \$500 to over \$1,000 you'll pay for it, a shockingly high percentage will go into fancy cabinetwork. While many people like to have beautiful furniture in their living rooms, lots more have only a limited amount of money and they'd like to spend it on sound, not furniture.

My brother—and sister-in-law are such people. They are discriminating listeners to good music. But when they went the rounds of the radio stores, they found that the only record players they could afford had boomy bass or no treble or screechy highs or noisy turntables or record-chipping changers or some combination of these and other faults. Some expensive units sounded

fine (though most had inadequate tone controls), but looking over the sets showed that much of the price was tied up in solid mahogany cabinets and electrical doodads like shortwave bands, push-button tuning, dynamic noise suppressors, and turnover record changers, none of which they needed or wanted.

So we decided to *build* an instrument. We determined on an instrument like this:

1. A phonograph only. To provide for future use of a good AM-FM tuner, a special input jack would be included on the phonograph amplifier.

2. The instrument had to play both 78- and 33 $\frac{1}{3}$ -r.p.m. (long-playing) records.

3. There was to be no compromise on audio quality at any point.

4. A changer was unnecessary—undesirable, in fact, because few if any changers can give the best audio quality (to say nothing about the fact that most tend to wear the center-holes of the records).

5. Both high- and low-frequency treble and boost controls should be included, with a calibrated flat position for each.

## Selected components

The success of the finished phonograph is due to the selection of good, standard parts and to the straightforward, gimmickless design of the amplifier.

A pickup was needed that would play standards and microgrooves: the Astatic FL-33 filled the bill. It's fashionable nowadays to distrust crystals when looking for optimum quality, but this crystal (with its FL filter, which removes a resonant peak in the high range) is flat within a fraction of a decibel to 10,000 cycles with LP's. Its output being about 0.5 volt from LP's, a preamplifier is not needed. Changing styli isn't a mere matter of throwing

a lever, but changing the cartridge is something even a child can learn to do and takes only about 3 seconds.

There are better turntables than the General Industries DR selected. But they are bigger and cost a good deal more. This one has steady speed, simple lever speed change, and more torque than I've ever seen in a motor in its price class before. There is some rumble, but, even with the good bass response of this system, it isn't annoying.

The speaker is a General Electric S-1201-D. The maker claims 50-13,000 cycles on it. Listening to a harpsichord record through it (the plucked sound has high-level, high-order harmonics) is a thrilling experience. And it has enough good, clean bass to give your stomach a healthy push.



Parts must be mounted so as not to interfere with the turntable motor above.

To house the turntable assembly and amplifier, a case made for Webster changers was used. The speaker cabinet is a bass-reflex unit. Both were obtained from Terminal Radio Corp., New York, N. Y. Together, they accounted for only \$30 of the total \$120 cost of the whole instrument.

RADIO-ELECTRONICS for

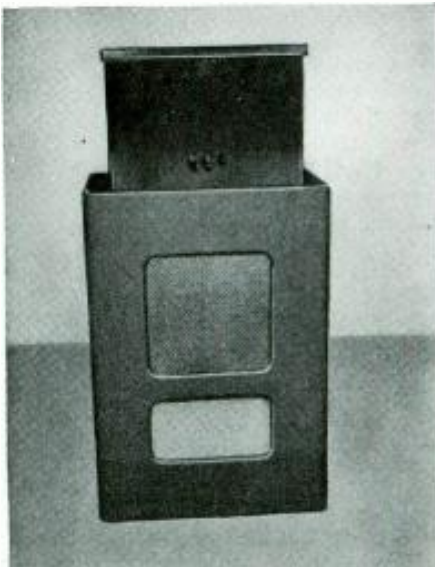

The bass-reflex speaker enclosure with player on top make a compact phono.

**The amplifier**

The schematic diagram of the amplifier reveals its simplicity. Essentially, it's a single voltage-amplifier triode, a "self-balancing" phase inverter, and a push-pull triode output stage. The tone control circuit has separate continuous bass and treble controls, each giving either boost or attenuation. It was adapted from a circuit in the June, 1949, issue of *Audio Engineering*. A second triode amplifier was included to make up for the 20-db loss in the tone control.

The most important feature of the amplifier is the feedback. Before inserting the feedback resistor R (at the suggestion of Harvey Gernsback—see his article in the August, 1949, issue of *RADIO-ELECTRONICS*) the response drooped off above about 8 kc, as expected with the UTC CG-16 output transformer. With feedback, the needle of the output meter—connected across the voice coil, not a resistive load—doesn't waver from the lowest to the highest point at which my test oscillator will percolate. In addition, it *sounds* 100% better—cleaner, more natural.

The motorboard circuit appears in the diagram with the amplifier. J1 and P1 are a two-prong, shielded jack-and-plug assembly. Through it, the TUNER-PHONO toggle switch (at the right rear of the motorboard in the photo) connects either the pickup or the tuner jack on the rear chassis apron to the volume control.

Note the Astatic FL filter. This is essential to eliminate a peak in the crystal response.

**Building the phonograph**

The motorboard can be made from 3-ply wood or from linen-filled bakelite obtained in a surplus store. (If the latter, put a thin sheet of asbestos on the bottom so it doesn't conduct heat so well.) Mount the turntable with the motor as near the front as possible, but scribe a 12½-inch circle around the centerpin location to be sure there will be room for 12-inch records. Locate the table as near the front left of the board as you can.

Screw and glue wooden supports for the board to the inside walls of the case, making them high enough to have the pickup on its rest just clear the top of the cabinet. That will leave the maximum room below, between the chassis and the motorboard. In my job, the top surface of the motorboard is 2⅞ inches from the top of the case. Since the inside height of the cabinet is 10 inches, that leaves about 4½ inches to play with above the chassis. If you don't use the same cabinet I did, don't forget to do some measuring before you buy transformers!

The turntable being higher than usual, the pickup cannot be mounted on the motorboard. I got a shiny pipe escutcheon at a plumbing supplier's store. You can see how the pickup is mounted in it to raise the arm high enough. Follow the instructions that come with the

FL-33 pickup to the letter—there's a mounting template, so you shouldn't have any trouble.

Locate the arm rest as near the right side of the board as possible, but far enough away so the user can get his fingers around the head to remove the cartridge. Be sure the rest leaves the pickup head at or above the level of the record surface. Glue a small cotton-lined container for the unused cartridge to the motorboard.

Get a 10 x 14 x 3-inch chassis—of aluminum unless you're ambitious for hard work. Before laying out the components on it, mark out the area above which the motor will be, as you can't put anything but J2 in that area.

The photo shows the parts layouts. Variations are possible, but the layout shown seemed most suitable for keeping the power supply away from low-level stages. Because of their height, 6A5-G's must be submounted. Get some long screws, put them through the socket-mounting holes on the chassis, and fill them up with nuts to make very rigid mountings for the sockets underneath. Don't forget to make the holes large enough for the bases of the 6A5-G's. These tubes, by the way, are similar to 2A3's but have a 6-volt filament and a cathode, which cuts down hum. They aren't made by RCA, but are made by Sylvania and perhaps others. The filament centers are tied to cathode internally, as shown; therefore, *be sure you don't ground either side or the center tap of the filament winding*. The arrangement puts the filaments of all tubes a few volts above ground.

**Adjustments**

The first adjustment is the feedback. Start off by leaving out R; see that everything works normally. Then insert R and listen for squeals. If there are none, put a low-range (3-volt) a.c.

meter across the voice coil and watch for an indication *with no input to the amplifier*. If the meter rests contentedly on zero, you're away. If not, increase the value of R by slow degrees until the meter is at zero.

If you get squeals or the output of the amplifier increases when R is connected, reverse either the primary or the secondary connections to the output transformer (not both). Then sound should decrease when R goes in, and you can go ahead with the instructions in the last paragraph. I got approximately 11.5 db of feedback with the

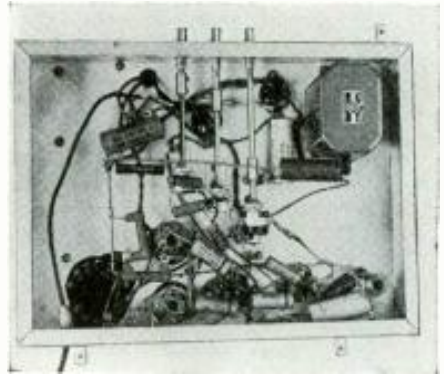

Extension shafts allow the controls to be put in the most convenient positions.

output transformer used. With a slightly different layout or another transformer, you may not be able to use so much; but you'll still get enough for a very fine amplifier. The higher the resistance of R, of course, the less feedback.

With the 11.5-db feedback, maximum output volume is, of course, cut down. It is more than plenty for the average living room, but nothing like the 10 watts at which the 6A5-G's are rated. The extra available power from the 6A5-G's insures against overloading on peaks. If you want to use this amplifier for PA work, add another triode voltage amplifier between the 6SN7-GT

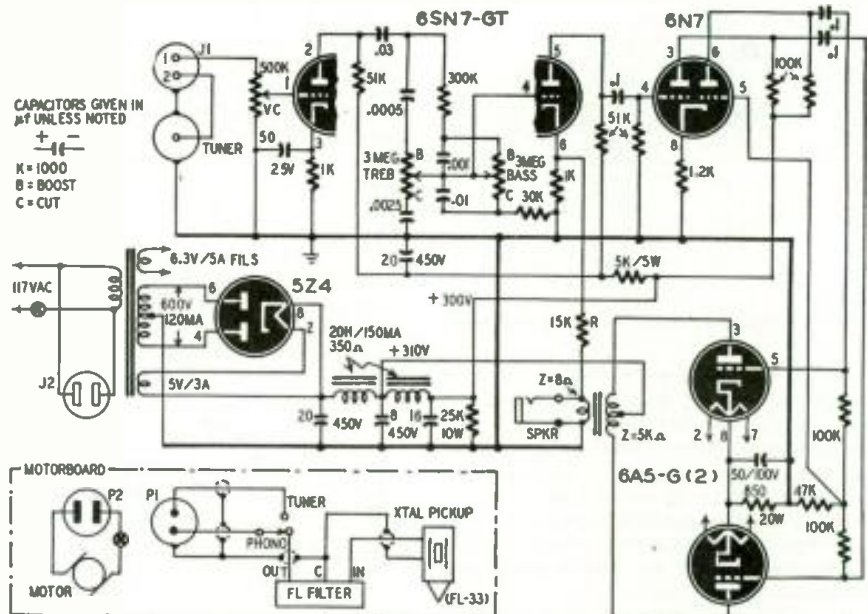

Push-pull 6A5-G amplifier with feedback (resistor R) gives wide-range output.

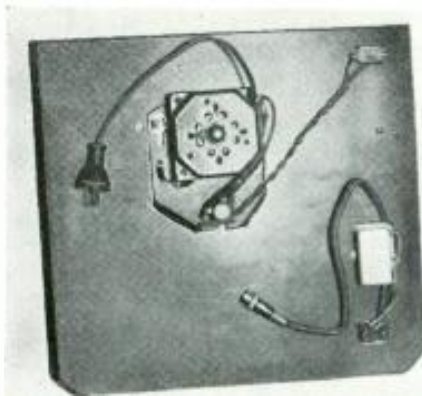

FL filter mounts under the motorboard.

and the 6N7 and raise the value of R to prevent too much feedback.

The tone controls should give flat response with the knobs pointing up. To guarantee this, install the amplifier in the case, connect an audio oscillator to the tuner jack and an output meter (a nonfrequency-sensitive one—v.t.v.m. preferred) across the voice coil of the speaker.

Set oscillator and volume control for any convenient meter reading at 1,000 cycles. Then set the oscillator to about 8,000 cycles and adjust the TREBLE control for the same meter reading. Go down to about 70 cycles and set the BASS control for the same reading. Leaving all controls alone, take a run; the output should be flat from approximately 40 or 50 cycles to higher than you can hear.

You may get either a bump or a dip in the bass range. If it's a hump, add a small amount of capacitance across the .01- $\mu$ f capacitor associated with the BASS control. If it's a dip, do the same with the .001. Experiment till all is flat. Then install the knobs pointing straight up. Make marks on the cabinet front at the maximum- and minimum-rotation points of both controls so the knobs can be put back right if they're removed or loosened. Clockwise rotation should boost in each case; swap connections to the outside lugs of the controls if it doesn't.

Tack a piece of the padding material that comes with the speaker cabinet to

each side and two pieces to the rear cover (inside, of course) to prevent sound bounce. Run as long a lead as needed of rubber-covered lamp cord to a phone plug.

When you plug the speaker cord into the chassis jack and connect the amplifier to the a.c. line, put on a record and listen. For \$120 you'll have a phonograph your friends will rave about and your customers will want to buy!

#### MATERIALS FOR PHONOGRAPH

Resistors: 2—1,000; 1—1,200; 1—15,000; 1—30,000; 1—47,000; 3—51,000; 4—100,000; 1—300,000 ohms, 1/2 watt; 1—25,000 ohms, 10 watts; 1—850 ohms, 20 watts; 1—500,000 ohms; 2—3-megohm potentiometers.

Capacitors: 1—500  $\mu$ mf, mica; 1—.001; 1—.0025, 1—.01, 1—.03, 3—0.1  $\mu$ f, 400 volts, paper; 1—50  $\mu$ f, 25 volts, 1—50  $\mu$ f, 100 volts, 1—98, 1—16, 2—20  $\mu$ f, 450 volts, electrolytic.

Inductors: 1—power transformer, 600 volts center-tapped at 120 ma, 5 volts at 3 amps, 6.3 volts at 5 amps; 2—filter chokes, 20 henries, 150 ma; 1—output transformer, 5,000-ohm push-pull plates to 8-ohm voice coil.

Tubes: 1—5Z4, 2—6A5-G, 1—6N7, 1—6SN7-GT. Connectors: 1—male and female 2-pin, shielded; 1—1-pin, shielded microphone connectors; 1—male and female (chassis-mounting) 2-prong, 117-volt connectors; 1—single-circuit, nonshorting phone jack and plug.

Player assembly: 1—Astatic LP-33 pickup with standard and microgroove cartridges; 1—Astatic FL filter; 1—2-speed motor and turntable.

Miscellaneous: Chassis, hardware, cabinetry, and loudspeaker as described in text.

## Placing A Speaker in The Home

ONE of the problems encountered by the owner of a composite high-fidelity reproducing system is where to place the speaker. The owner of a standard console radio-phonograph has no choice, since his speaker is already placed a few inches above the floor, within the cabinet. Buying separate components and assembling them, however, affords the possibility of a better location for the reproducer with a consequent improvement in sound.



Fig. 1—Speaker hole in a closet wall.

Since most live sounds originate at a height of 4 to 6 feet above the floor, raising the speaker to this level seems to increase presence. Enclosing the back of the speaker in a closed air chamber of at least 6 to 10 cubic feet is necessary to insure genuine reproduction of the bass notes, except where special enclosures (such as the bass-reflex) are used.

In a booklet of instructions for installing home-music-system components, the

Altec Lansing Corporation makes some excellent suggestions on placing speakers to satisfy both acoustical and esthetic requirements. These are shown in the drawings on this and the following page.

In Fig. 1 a hole is made in a wall which forms one side of a clothes closet. The closet furnishes the required closed air space behind the speaker. The enclosure should be deadened—made sound absorbent—and the clothes that are normally hung in the closet absorb sound excellently.

A somewhat similar idea is shown in Fig. 2. Here, however, the enclosure is the space under the stairs. In most homes this is either a closet or a stairway to the cellar. In either case, it can easily be coated with sound-absorbent material. The speaker should be placed where it is 4 to 6 feet above the floor and far enough along the stairway so that it is under the steps and out of the way.

The mountings of Figs. 1 and 2 are suitable only for those at liberty to make holes in walls. This is usually not possible in an apartment or a rented house. A mounting suitable for rented premises is shown in Fig. 3. Here the

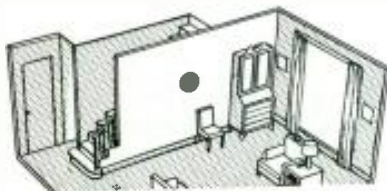

Fig. 2—Mounting speaker under stairs.

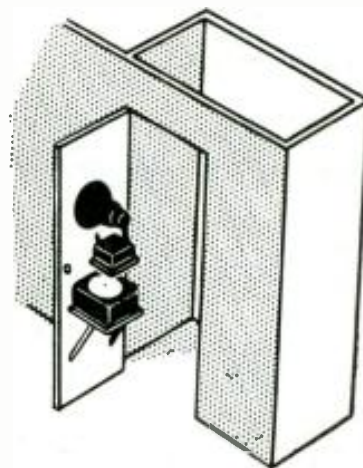

Fig. 3—Entire assembly on closet door.

door of a closet is removed (and carefully stored away for the landlord) and a new, stronger door substituted. A hole is cut out of the door and the speaker mounted in it. When the door is closed the closet forms an excellent sound chamber. As the illustration indicates, the amplifier and record changer may also be mounted on the inside of the door.

Many homes include a set of book cases built along one wall by either the owner or the tenant. A section of these can be altered for use as a speaker enclosure, as in Fig. 4. Since the volume of this enclosure is not likely to be very great, it may have to be used as a bass-

(Continued on page 49)



# Controlling Sound Liveness

**A** VERY interesting article on "Binaural Amplifiers" appeared in the October, 1948, RADIO-ELECTRONICS. It described binaural pickup and reproduction for public address. The same method would not be practical in broadcasting because two separate channels are required. However, a clever technique has been developed for attaining somewhat similar results merely by proper placement of the microphones used for the broadcast.

With this technique, *liveness* rather than loudness is controlled by the studio engineer. A nondirectional mike is used for general pickup. One or more directional mikes are used in accentuate desired sounds, for example, a solo. By balancing these sounds it is possible to give a remarkable illusion of actual "presence" in the studio or auditorium. In fact, it is claimed in the original article on the subject\* that the listener can be "placed" anywhere in the hall, from the front row to the rear, at the discretion of the studio engineer at the controls.

Since this mike technique permits greater liveness or apparent reverberation, the sounds appear to be louder at the receiver. A gain of up to 6 db may be obtained without an increase of transmitted power.

The useful range of liveness for different types of programs is listed in the Liveness Table. When a value near the lower limit is used, the reproduced sounds appear to originate just beyond the loudspeaker. When the value is near the upper limit of its range, the

\* Western Electric Oscillator, January, 1947.

sound appears to come from a much greater distance because of the increased reverberation.

The distance of the general-pickup mike in feet is determined by the equation

$$D = \frac{\sqrt{LV}}{T}$$

where L is the liveness value, V the

LIVENESS TABLE

Type of sound	Liveness range
Piano	4-16
Symphony orchestra	5-20
Small orchestra	3-12
Solo violin, cello, etc.	1-4
Solo singing	1/2-3
Speech	1/6-2/3

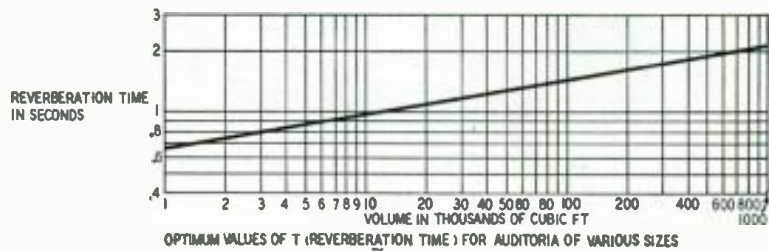

Fig. 1—This graph shows optimum liveness values for various-sized halls.

room volume in thousands of cubic feet, and T the reverberation time of the room. Optimum values of T are given in Fig. 1. The distance of an accentuation mike is 1.7 times greater than that of the general-pickup mike as given by the above equation.

Liveness values given in the table apply to over-all liveness. Since the general-pickup unit is in the circuit at the same time as the accentuation mike, the liveness values for each are calculated as follows:

For the general-pickup mike multiply the liveness value (from the table) by 1.5. This allows for loss due to the other mike. For the accentuation mike, multiply by 0.67 to allow for the gain

due to the general-pickup microphone.

In a practical case it is better to plot the distance-*vs*-liveness equation for both mikes. Then no further calculations are needed for that particular auditorium. If the graph is made on log-log paper with D measured horizontally and L vertically, it comes out a straight line making an angle of 60

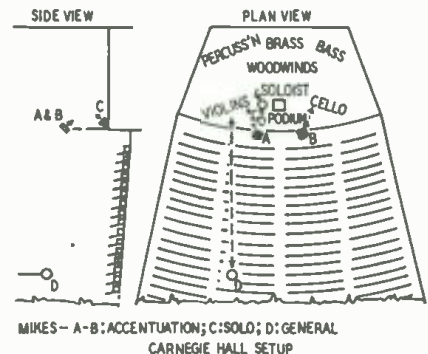

Fig. 2—Setup for Philharmonic broadcast.

degrees with the horizontal. Therefore, it is necessary to calculate only one point for each graph, and draw the straight line.

The correct mike balance is determined by starting with the general-pickup mike alone and gradually fading in with the other. If in doubt, less accentuation is preferable because the average living room may add some liveness.

Liveness control technique has been used by CBS to broadcast the New York Philharmonic Symphony Orchestra. Fig. 2 shows the approximate arrangement of microphones to broadcast these Sunday afternoon concerts. Favorable comment was received from many listeners who were unaware that a new pickup technique was being used at the time.

## PLACING A SPEAKER IN THE HOME

(Continued from page 48)

reflex cabinet and a port should be cut in it for that purpose.

There are many variations on these schemes. Speakers may be mounted in real or false fireplaces (after cautioning everyone concerned to refrain from building fires in the future). They have been placed in transoms, over corner cupboards, in boxes built to conceal

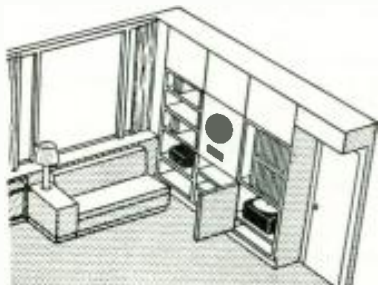

Fig. 4—Bookcase is bass-reflex baffle.

vertical steampipes in a corner of the room, and in other likely and unlikely places.

The drawings show the speakers as black circles for clarity, but they should be covered with very porous grille cloth to protect them and for the sake of appearance.

As a matter of protection against careless people who may lean on the cloth or kick a hole in it if it is near the floor, the cloth should be underlaid with a piece of quarter-inch-mesh galvanized screen, as heavy and stiff as possible. If that is not available, ordinary copper window screen can be used, but be sure to stretch it tight across the hole and tack it down solidly all around. Do not depend on the tack bodies placed through the mesh to hold it, but tamp the tack heads (upholstery nails are even better) down against the screening.

# FM Phonograph Pickup



The oscillator needed for the FM pickup is fastened to the rear of the cabinet.

## *How to build a transducer of unusually high a.f. quality*

By ARTHUR TRAUFFER

FASCINATED by the superior phono record reproduction possible with the FM capacitance pickup, the writer has spent many happy hours building and rebuilding them and figuring out various circuits for them. This much neglected pickup, if well designed, has the lowest distortion and the most linear response over the widest range of any phono pickup ever conceived. An invention of Benjamin F. Miessner, the capacitance pickup generates no voltage; it simply frequency-modulates a low-power oscillator. The r.f. signal is then detected and passed into an audio amplifier.

The mechanism consists of a free-moving needle, with a stationary metal plate mounted beside it. The plate is insulated from the needle, and there

is a small air space between them. As the needle follows the grooves in the record, it vibrates from side to side, in accordance with the modulation, which results in a variation of capacitance between the needle and the stationary plate. When the two are connected across the tank circuit of an oscillator, the mean frequency of the oscillator is shifted from side to side by the small changing capacitance, in accordance with the waveforms in the grooves. Since the only work required of the needle is to follow the waveforms, the response is linear (assuming the bearings are satisfactory) regardless of whether the needle moves once in 24 hours or 20,000 times per second!

Though far from beautiful the sim-

ple and economical capacitance pickup shown in the illustrations does work excellently and it will give the experimenter something to start with. The complete pickup cost about \$1.50 to build.

### Pickup construction

The arm assembly (shown in Fig. 1) should be made up first. The pivot was removed from a cheap crystal pickup arm and attached to a new arm made from hardwood. (The objection to using a metal arm is its bad effects on the pickup's capacitance.) The shape of the wooden arm can be copied from that of the original metal one, or, for better results, copy the shape of some fairly long transcription arm. Leave a little overhang at the rear for counterweighting if necessary. Sand the arm well, and cut grooves in its sides for the pickup leads. Keeping them far apart reduces the capacitance between them. The paint I used had some metal content, so I left the underside of the head—where the pickup is attached—unpainted. The arm is  $\frac{5}{8}$  inch thick.

There are only three parts to the pickup proper: the needle chuck, the needle, and a metal plate. The needle and plate form the capacitance which is connected across the tank of an oscillator to frequency-modulate it.

The chuck was taken from an As-tatic L-26-A crystal cartridge, though any similar cartridge will do. Fig. 2 shows how these cartridges are made with rubber trunnion bearings. Don't use an old one in which the rubber may have dried out and hardened.

Saw through the cartridge just behind the needle-chuck housing, as indicated by the vertical dashed line in Fig. 2. Then, with screws through the two mounting holes, fasten the housing to the underside of the arm.

Fig. 3 shows the copper plate which is mounted near the needle to act with the needle as a capacitor. *The copper must be heavy enough to prevent its vibrating.* Any vibration of the plate will swing the frequency of the FM oscillator at the vibration rate and will ruin reproduction. Fig. 4 is a head-on view of the pickup showing how the copper plate is fastened to the side of the arm so that the lower tab is parallel to the needle and very close to it.

### Wiring precautions

The wire connections should be made to the copper and to the needle-chuck housing. The leaf for the plate can be soldered to it, but *don't solder to the chuck housing.* The heat may soften and ruin the rubber trunnion bearings. Clamp this lead to the housing by end-

ing it in a lug clamped under one of the mounting screws. No direct connection to the needle or chuck is necessary, as the capacitive coupling between it and the housing through the bearings is sufficient. Run the leads to the rear of the arm in the grooves cut in the sides. Use rubber-insulated, flexible leads, gluing or cementing them in the grooves. Mount a piece of plastic to the underside of the arm as a handle, which can be seen plainly in the photo of Fig. 5.

**The needle**

The most critical part of the whole assembly is the needle or stylus. While the compliance, which limits the top frequency, is controlled by the rubber trunnion bearings, a needle which is mechanically resonant will produce a bad peak in the response somewhere in the upper audio range. When a resonant needle is used in a crystal pickup, the resonance is noticeable enough; but cheap crystals have poor response, generally, as well as peaks of their own. In a capacitance pickup, however, with its nearly perfect response to every fluctuation of the needle, resonances stand out like a house on fire! (The once disadvantage of a capacity pickup seems to be the complete lack of electrical damping, which is very much present in modern magnetic cartridges and to at least some degree in crystals. If a resonant needle in the capacitance pickup is shock-excited at its natural frequency—by a sharp transient in the music or by a piece of grit in the record—it is likely to generate a long damped-wave train which not only distorts the reproduction badly but also increases the surface noise greatly.—*Editor*)

The needle should have the lowest possible amount of mechanical resonance. Curved, offset, hollow, or tubular needles are poison. The shank should be straight, solid, and preferably of soft metal of uniform cross section. The needle in use now is a Pfanstiehl straight-shank unit with a precious-metal tip. The needle has very low resonance in spite of a thin part in the shank, which you can see in Figs. 4 and 5. If you want to play micro-groove discs, you can have a .001-inch tip ground on the needle at the factory (Pfanstiehl Chemical Co., 104 Lake View Ave., Waukegan, Ill.).

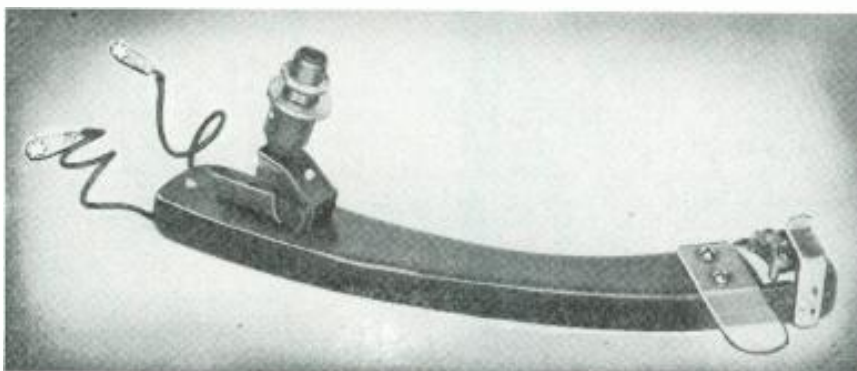

Fig. 1—The complete pickup. The swivel was taken from a cheap phono arm.

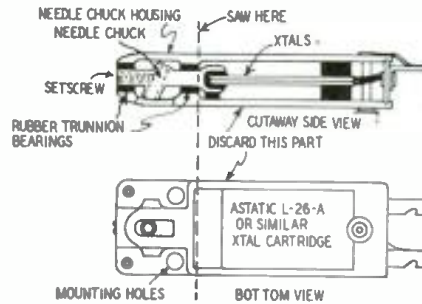

Fig. 2—The needle chuck housing is removed from a crystal pickup with a saw.

**Circuits**

Fig. 6 is a diagram of the simple Hartley oscillator used in most of the experiments. It is completely battery-powered to deliver a humless carrier.

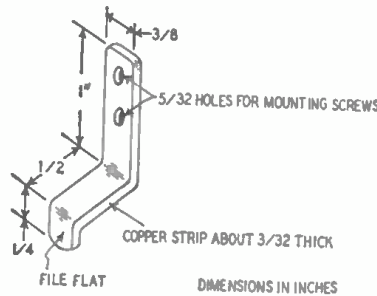

Fig. 3—Copper strip, mounted next to the needle, acts as capacitor plate.

Its output can be picked up and slope-detected on a standard receiver.

Choice of frequency is a matter of compromise: the lower the frequency, the more stable the oscillator; the higher the frequency, the more deviation the pickup causes. I work mine on



Fig. 4—This head-on view shows separation of the needle and copper strip.

about 160 meters (just above the broadcast band), using a commercial coil

1 inch in diameter and having about 98 closewound turns, with a 100- $\mu$ f shunt tuning capacitor.

With the unshielded capacitance pickup, the metal-to-metal contact of the turntable shaft and its socket creates an annoying noise, which can be killed at the source by replacing the metal

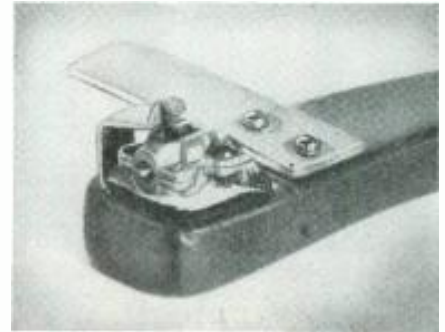

Fig. 5—A handle made of clear plastic helps prevent hand-capacitance effects.

turntable shaft with a plastic or fiber duplicate. I took the original to a machine shop and had the mechanic turn out a duplicate from a piece of polystyrene rod. Both appear in Fig. 7. The price was low (only \$1) and the job well worth doing.

The Hartley oscillator will produce audio without a demodulator if a pair of phones is placed between plate and B-plus. The phones can be replaced with a high-quality audio transformer and the signal fed to an amplifier. In either case, it isn't the FM that counts, but the AM caused by absorption modulation. Output obtained in this way is very low.

You can also make a simple crystal tuner by placing a tuned coil in series with a 1N34. If the coil is close to the oscillator coil and is tuned to a frequency near it, the crystal tuner will slope-detect, and you can feed the detected audio signal to an a.f. amplifier and loudspeaker.

Another good circuit is diagrammed in Fig. 8. The tanks C1-L1 and C2-L2

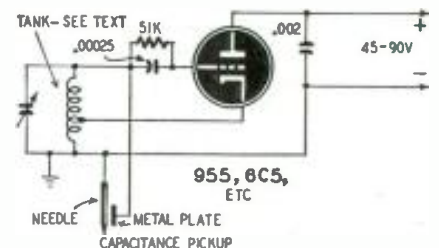

Fig. 6—Output of this frequency-modulated oscillator can be slope-detected.

are tuned to the same frequency. The secondary of L2 is connected to a standard Foster-Seeley or ratio detector. For slope detection, detune C2 slightly and feed the secondary to an ordinary AM detector. Contrary to popular opinion, slope detection can give very fine quality if the frequency swing stays within the straight part of the slope curve. With this circuit you can adjust for best conditions with

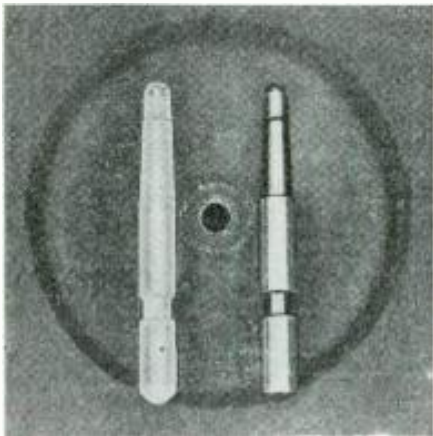

Fig. 7—Polystyrene turntable shaft at left was made cheaply by a machinist.

C2 and by varying the distance between the needle and the metal plate on the pickup (and, of course, by selecting the right frequency on which to operate the oscillator).

There are several other ways of recovering the audio, but experimenters will think of them all and probably improve them, too. In general, the method of Fig. 6 is probably the easiest, though not the kindest to the neighbors, as it may interfere with their radio reception. It is best, for a permanent unit, to make a demodulator of some kind and put a shield around it and the oscillator so that as little r.f. as possible is sprayed into the surrounding air to interfere with the neighbors' radio reception.

It's really surprising that with such

simple equipment and so little work you can make such a fine pickup. When

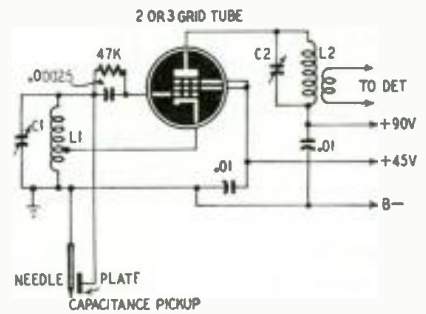
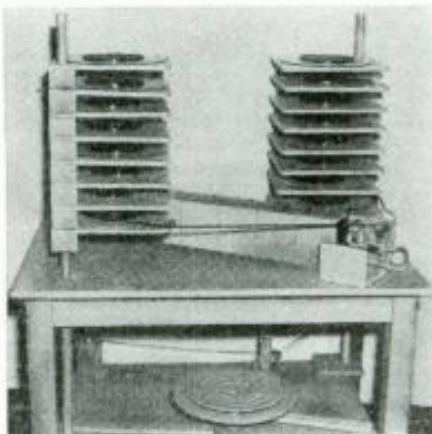

Fig. 8—Output of this circuit can be fed to either an FM or AM demodulator.

better records are made, the FM player will be waiting for them!

## Magnetic Tape "Contact Prints"



This experimental duplicator can turn out 960 hours worth of program daily.

**M**AGNETIC recording has a number of advantages over disc recording and, conversely, several disadvantages. One of its most serious drawbacks is the relative difficulty of duplicating recordings. Disc records are printed by the hundreds from a metal master disc. Tape records have been reproduced by re-recording, a much slower and more expensive process.

The announcement of a magnetic method of printing magnetic tapes by a process similar to that used for discs may herald a new advance in the acceptance of this new recording medium. A duplicating machine can turn out eight 1-hour reels every 2 minutes (using double-track tape and running the tape at a speed of 10 feet per second). A machine of this type has a conservative output of 960 hours of recording per day, the equivalent of well over 10,000 4-minute discs.

The process is actually very simple. A recorded tape and a blank one are held in contact with each other and passed through a high-frequency magnetic field, called the "transfer field," which produces a distortionless mag-

netization of the copy tape. See Fig. 1. Frequency of the transfer field current may be as low as 60 cycles and higher than 100 kc, though in practice frequencies close to those used in regular tape recording have been best.

It has long been known that, if a blank tape is held in close contact with a magnetized one, it will pick up the magnetic pattern. But the recording so picked up is very weak, and its level does not vary linearly with that of the "master." The transfer field changes all that. Level is within a few decibels of the master, and distortion is low.

The master tape is made of durable

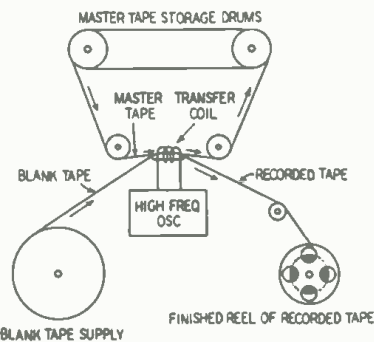

Fig. 1.—Master tape contacts copy in a magnetic field set up by transfer coil.

material having high magnetic retentivity. Mechanical ruggedness is essential, as it may have to make thousands of copies. The requirement of high retentivity is due to the transfer field. If this field is strong, there is a tendency to demagnetize the master tape. Yet it is in just such a strong field that the best record is made on the copy tape. Thus the easier it is to magnetize the copy, the more likely it is that the master will be harmed. Good results are obtained with a copy tape of easily magnetized material and a transfer field held just below the point at which it demagnetizes the master.

The copy is a mirror image of the

master. This caused no difficulty in single-track tapes, but an attempt to play back some of the increasingly popular double-track and stereophonic recordings resulted in the copy's always playing backward. To avoid this difficulty, the master record runs backward, producing copies which play correctly on a standard machine.

In a practical machine, such as the one in Fig. 2, the beginning and end of the master tape are spliced together to form an endless belt. The extra length of long tapes can be handled by winding around drums or in a number of other ways. The tape is then run through a number of copying heads, each with its own transfer field, to produce as many recordings as desired. The process is continuous, and the master tape itself is not affected by the copying (except as noted above).

The process was developed independently but almost simultaneously by Marvin Camras of the Armour Research Foundation and Robert Herr of Minnesota Mining and Manufacturing Co. The information above draws on both those sources. The illustrations, however, are all from Armour.

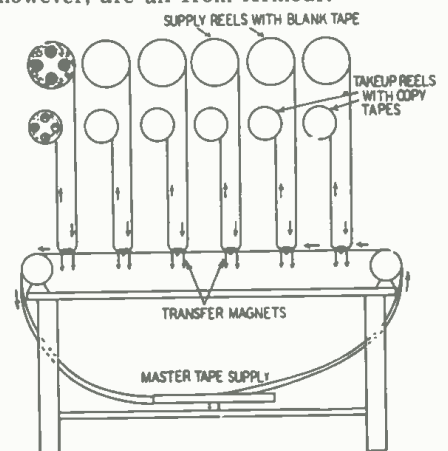
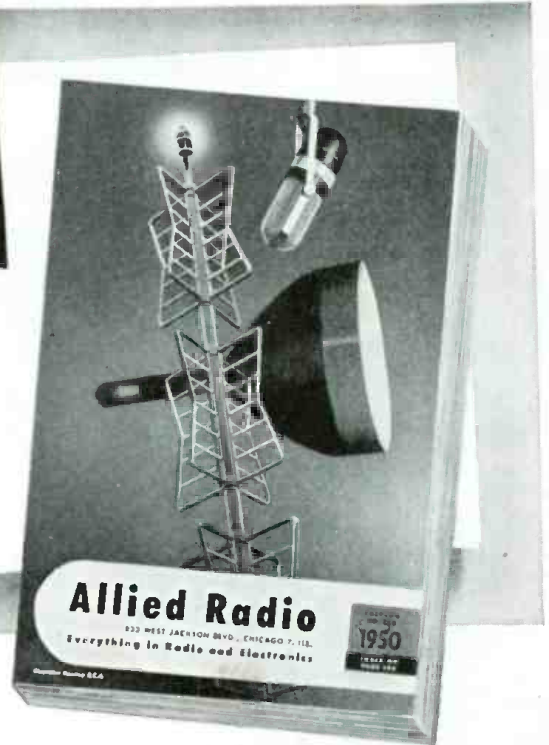

Fig. 2—In the practical setup several copy tapes are made at the same time.

# There's Only ONE COMPLETE CATALOG that Brings You EVERYTHING IN RADIO, TELEVISION & ELECTRONICS

IT'S YOUR **FREE**  
**ALLIED** 196-PAGE  
 VALUE-PACKED CATALOG!

**SEND FOR IT TODAY**



## Get Radio's Leading Buying Guide

Here's the Buying Guide to *everything* in radio for *everyone* in radio! It's the *one complete* catalog, preferred in the field because it fills *every* TV, Radio, and Electronic supply need. It's packed with the world's largest selections of quality equipment at lowest money-saving prices. See the latest in TV, AM and FM receivers; radio-phonos; new Sound Systems, P.A. equipment and high-fidelity sound components; recorders and accessories; full selections of newest Amateur receivers and station gear; test instruments; builders' kits; huge listings of parts, tubes, tools, books, diagrams.

ALLIED gives you every buying advantage: speedy delivery, expert personal help, lowest prices, assured satisfaction—plus the most liberal Time Payment plan in radio. Get the 1950 ALLIED Catalog—it will save you time and money. Send today for your FREE copy!

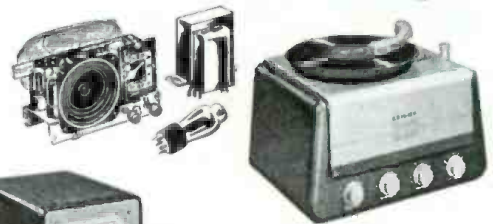

## WORLD'S LARGEST STOCKS

*Radio Parts Unlimited  
 Test Instruments—All Makes  
 Television & Home Radios  
 P. A. and Hi-Fi Equipment  
 Amateur Station Gear  
 Experimenters' Supplies*

**QUICK, EXPERT SERVICE**

## ALLIED IS YOUR TELEVISION HEADQUARTERS



You keep up with TV when you depend on ALLIED! Count on us for the latest releases and largest stocks of picture tubes, component parts, antennas and accessories—plus the latest in TV receivers, tuners and kits. If it's anything in TV—we have it in stock! So remember—for TV—it's ALLIED First!

# ALLIED RADIO

THE WORLD'S LARGEST RADIO SUPPLY HOUSE

*Everything in Radio, TV and Electronics*

Send for Radio's Leading Buying Guide

**FREE**

ALLIED RADIO CORP.  
 833 W. Jackson Blvd., Dept. 2-B-0  
 Chicago 7, Illinois

Send FREE 196-page 1950 ALLIED Catalog.

Name .....

Address .....

City..... Zone..... State.....

# I'LL HELP YOU LEARN TO EQUIPMENT EVER MADE

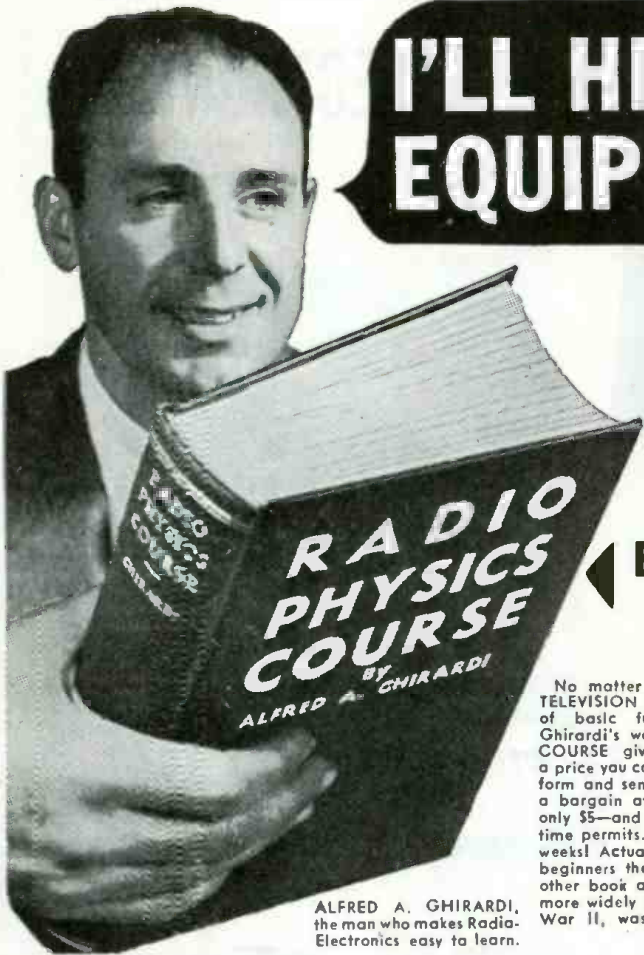

ALFRED A. GHIRARDI, the man who makes Radio-Electronics easy to learn.



A few nights of **THIS**

Can pave the way to a **THIS** prosperous future of

## EASY-TO-LEARN BASIC RADIO-ELECTRONICS TRAINING FOR BEGINNERS

36 Big Courses in One...only \$5 complete

No matter what part of ELECTRONICS-RADIO-TELEVISION work you plan to enter, a knowledge of basic fundamentals is absolutely essential. Ghirardi's world-famous 972-page RADIO PHYSICS COURSE gives exactly the training you need—at a price you can afford to pay! If broken into "course" form and sent as monthly lessons, you'd regard it as a bargain at \$50 or more! Instead, you buy it for only \$5—and you progress as fast as spare reading time permits. Many have completed it in only a few weeks! Actually, this big 4 lb. book has given more beginners their start in Radio Electronics than any other book or course! RADIO PHYSICS COURSE is more widely used for home study and, during World War II, was more widely used for Signal Corps

and Navy training than any other book of its kind.

### ASK THE MEN WHO KNOW!

Ghirardi's RADIO PHYSICS COURSE starts your training at the very beginning—with Basic Electricity. Then it takes you step by step through the entire field of RADIO-ELECTRONICS. Nothing is omitted or condensed. Everything is explained as simply as A-B-C. You can understand every word of it without previous radio training of any kind. Ask any Radio-Electronics man. He'll know the book—because he probably trained from it himself! Get started now in Radio! Get started right! Our 10-day MONEY-BACK GUARANTEE offer is your absolute protection. If you don't like RADIO PHYSICS COURSE you don't need to keep it. You cannot lose!

### LEARN FAST!—LEARN RIGHT!

Here are a few of the things about which RADIO PHYSICS COURSE teaches you:

Sound, Speech, Music  
Electron Theory  
Electric Current  
Electric Circuits  
Resistance  
Batteries  
Electromagnetism  
Electromag-Induction  
Condensers, Coils

Alternating Currents  
Transformers  
Filters  
Measuring Instruments  
Radio Waves  
Vacuum Tubes  
Detector & Amplifier Tube Action  
Radio-Frequency Amplifiers  
Superheterodynes

Audio Amplifiers  
Power Supplies  
Loud Speakers  
Auto & Aircraft Radio  
Aviation Radio  
Public Address Systems  
Phototubes, Cathode Ray Tubes  
Sound Pictures, etc., etc.

## A. A. Ghirardi's RADIO PHYSICS COURSE

972 pages; 508 clear illustrations; 856 self-test review questions that make study doubly easy!

## Here's how to train at home to be A PROFESSIONAL SERVICE EXPERT

Don't be a mere "screw driver mechanic!" Learn scientific service methods—at home — for only \$5!

There's a real future for you in servicing—and A. A. Ghirardi's MODERN RADIO SERVICING is just the book to start you on it without delay. And remember: Radio itself only represents the beginning of this big book's usefulness to you. What it teaches you about Radio Servicing, Test Instruments and Modern Scientific Technical Procedure is exactly the training you need to fit you to "grow up" with the fast-expanding Electronics profession in all of its servicing phases. Actually, it gives a COMPLETE MODERN EDUCATION in truly professional service work of the kind that will be your "Open Sesame!" to the real opportunities in RADIO-ELECTRONIC servicing springing up on every side.

### ALL ABOUT INSTRUMENTS—TROUBLESHOOTING—REPAIR

Read from the beginning, MODERN RADIO SERVICING is a complete servicing course from A to Z. Used for reference, it is an invaluable refresher course on any type of work that puzzles you. Explains test instruments used in Radio-Electronic service work—also how, when, why and where to use each one; how to make preliminary trouble checks and perform circuit analyses; how to repair or replace parts or make substitutions—and literally hundreds of additional subjects, including How to Start and Operate a Successful Service Business of Your own. Only \$5. Our 10-day MONEY-BACK guarantee protects you absolutely. Use coupon. See MONEY-SAVING OFFER!



## A. A. Ghirardi's MODERN RADIO SERVICING

1300 pages; 706 helpful illustrations; 720 self-test review questions.



## REPAIR HOME AND AUTO RADIOS FASTER with Ghirardi Gadgets

Ghirardi Gadgets help you troubleshoot radio sets with lightning speed. Just flip a card, and there before you are the "tests" and "remedies" for almost any trouble.

**HOME RADIO GADGET**—Spots 400 different troubles in Power Units, Receiver Circuits Proper, Tubes, Loudspeaker, Antenna, Ground, Batteries, etc. Covers such symptoms as "Hum," "Weak," "Noisy," "Inoperative," "Intermittent Reception," "Fading," and many more. Tells what tests to make. Suggests the remedy for each trouble. Only 50c.

**AUTO-RADIO GADGET**—Spots 444 special auto-radio troubles in all possible trouble-sources for 11 common symptoms including "Hum," "Weak," "Noisy," with and without car and engine at rest, "Noisy" when car is coasting with ignition off, "No Reception," "Intermittent," "Fading," "Distortion," and "Oscillation." Only 50c.

# GHIRARDI TRAINING SAVES YOU TIME AND MONEY

RADIO-ELECTRONICS for

# REPAIR ANY RADIO-ELECTRONIC

... and, to PROVE IT, I'll send any of these great books for 10 days' examination!

## THIS 4¼ lb. HANDBOOK SHOWS EXACTLY HOW TO REPAIR OVER 4,800 RECEIVER MODELS

Cuts Service and Test Time in Half on Literally Thousands of Jobs—Only \$5

Whether you repair radios for a living or work with them only occasionally, Ghirardi's RADIO TROUBLESHOOTER'S HANDBOOK will help you do literally thousands of jobs better and TWICE AS FAST. Eliminates useless testing! Saves time—helps you make more money!

### TELLS YOU WHAT TO DO—EXACTLY HOW TO DO IT!

Actually, this giant, 744-page, manual-size Handbook is a definite, dependable guide for diagnosing, locating and repairing the common troubles in over 4,800 receiver and record-player models of 202 leading manufacturers. When a receiver comes in for repair, simply turn to the 404-page Case History section. Look up the notes on that make and model. Chances are, you'll find EXACTLY the information you require. The Handbook tells what the trouble is—how to remedy it. Ideal for training and speeding up the work of new service helpers—handling tough jobs in half the usual time—repairing cheap sets rapidly.

### NOT A "STUDY" BOOK

The tabulations on hundreds of additional pages give you invaluable data on Color Codes, Tubes, I-F alignment and transformer troubles, tube substitutions, etc., and the literally dozens of charts, graphs, diagrams, data and helpful hints will save you money every day you use them! "Thanks to Ghirardi's Handbook, I repaired my radio in one hour after it had been returned as 'unrepairable' from a local shop," writes J. L. Fizzell, Kansas City, Mo.

### "WORTH 10 TIMES THE PRICE!"

"I would not take ten times the price my Handbook cost me," says C. E. Daniels of Florida.

"Started to work for me the first day I bought it. The Case Histories take you right to the trouble and save headaches and hours of testing," says Julius Siske, Jr., Curtis Bay, Maryland.

Try it for 10 days on our money-back guarantee offer. See Money-Saving offer in coupon.

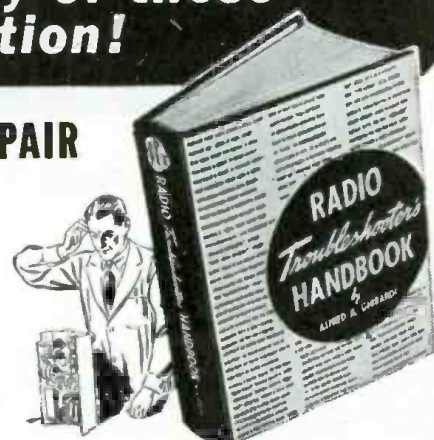

## A. A. Ghirardi's RADIO TROUBLESHOOTER'S HANDBOOK

744 big, manual size pages

## Cash in on TELEVISION SERVICE PROFITS!

### PRACTICAL TELEVISION SERVICING

By J. R. Johnson and J. H. Newitt  
375 pages, 6x9, over 230 illustrations  
Only \$4.00

Get where the big servicing money is—in television! Now is the time to prepare for this fast-growing business—and here is the book to help you do it. PRACTICAL TELEVISION SERVICING is a complete, down-to-earth guide that tells you step by step what to do and exactly how to do it.

### MAKES TV SERVICE EASY TO LEARN

PRACTICAL TELEVISION SERVICING isn't a book of theory and mathematics. It is a practical how-to-do-it handbook by two well known engineers who actually owned and operated a TV service shop. Besides telling how television differs from radio, they explain TV troubleshooting and service procedure from installations to synchronizing units; from erecting and orienting antennas to remedying image distortion. Case histories of actual television service jobs plus descriptions of common TV troubles and their remedies make the book doubly helpful and easy to understand.

### MONEY SAVING TIPS

Also included are dozens of time- and money-saving tips on testing for intermittent peaking coils or transformers; improving picture linearity; geying masts; getting a signal over a mountain; checking video response with a square wave; using mica capacitors to replace other types; choosing components; wiring techniques... and dozens of other vital TV subjects. Use coupon today!

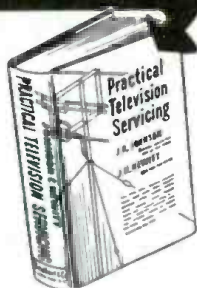

Here are the subjects covered:

1. Television is Here
2. Fundamentals of the Television System
3. Radio-frequency; Intermediate-frequency and Detector Sections
4. Video Amplifiers
5. Cathode Ray Tubes
6. Synchronizing and Sweep Circuits
7. Power Supplies
8. Antennas and Wave Propagation
9. Television Receiver Installation
10. Test Equipment and Alignment
11. Wiring and Repair Techniques
12. Common Troubles in Television Receivers
13. Troubleshooting
14. Servicing Hints and Case Histories
15. Color Television
  - A. Intermediate Frequencies of Standard Receivers
  - B. Receiver Layout Diagrams
  - C. Glossary

## LEARN ELECTRIC MOTOR REPAIR!

Train at home for good pay in an uncrowded field

There's big money in motor repair work! Prices are good. The field is not crowded. The home appliance repair business is a vast one and motor service is a highly important part of it. ELECTRIC MOTOR REPAIR by Robert Rosenberg is the book that will train you easily and quickly—for only \$5 complete!

### NO OTHER HOME TRAINING BOOK LIKE IT!

ELECTRIC MOTOR REPAIR explains every detail of motor trouble diagnosing, repair and rewinding. Covers a-c and d-c motors, synchronous motors and generators and BOTH mechanical and electrical control systems. Quick reference guides show exactly how to handle specific jobs.

Based on what can be learned from this big book alone, you can train quickly for PROFITABLE motor repair service. Ideal for beginners. Unexcelled for actual bench use in busy shops. Every type of work is demonstrated VISUALLY by more than 900 easily-understood diagrams. Unique Duo-Spiral Binding arrangement divides book into two sections. BOTH text and related pictures can be seen AT THE SAME TIME. Lies open flat on the bench while you work. Only \$5 complete.



### Robert Rosenberg's ELECTRIC MOTOR REPAIR

560 pages; over 900 diagrams and pictures. \$5

USE COUPON! Practice from it 10 days at our risk!

## 10 DAY MONEY-BACK GUARANTEE

Dept. RE-20, Murray Hill Books, Inc.,  
232 Madison Ave., New York 16, N. Y.

Enclosed find check or money order for \$..... for which please rush books indicated; or, send C.O.D. (in U.S.A. only) and I will pay postman this amount plus postage. In either event, if unsatisfactory, it is understood I may return the books in 10 days and you guarantee to refund my purchase price.

RADIO PHYSICS COURSE \$5 (\$5.50 outside U.S.A.)

MODERN RADIO SERVICING \$5 (\$5.50 outside U.S.A.)

RADIO TROUBLESHOOTER'S HANDBOOK \$5 (\$5.50 outside U.S.A.)

MONEY SAVING OFFER: Make your radio service library complete! Get Ghirardi's MODERN RADIO SERVICING and RADIO TROUBLESHOOTER'S HANDBOOK at special price of only \$9.50 for the two (\$10.50 outside U.S.A.)

Ghirardi HOME RADIO GADGET 50¢

Ghirardi AUTO RADIO GADGET 50¢

ELECTRIC MOTOR REPAIR \$5 (\$5.50 outside U.S.A.)

PRACTICAL TELEVISION SERVICING \$4 (\$4.50 outside U.S.A.)

Name.....  
Address..... State.....  
City & Zone..... (Please print or write plainly)

... Helps you learn at home EASIER, BETTER, FASTER!

FEBRUARY, 1950

# Fundamentals of Radio Servicing

## Part XII—Vacuum-tube characteristics

By JOHN T. FRYE

THE story of a vacuum tube can be told only very superficially in words. We can say how many pins it has, what kind of an envelope, the filament voltage, the number of elements, and the interelectrode capacitances. But that doesn't give much of an idea of what to expect from the tube when we use it in a circuit. The real questions are:

1. How much amplification (or in some cases, how much power output) can you get under a certain set of conditions?

2. How much voltage (a.c. and d.c.) should be applied to each element?

3. What impedances should be connected to the elements? (RADIO ELECTRONICS, December, 1949, page 52, second column.)

These three points are important because they alone determine how the tube will perform electrically, whether it will do a specific job, and how the circuit elements must be chosen for best results in a particular case. They are not easily summed up in a single statement, for they are interdependent; change any one of them and the others change, too.

The best way to show interdependent and variable quantities is in a graph. That is how most tube data is given in manuals.

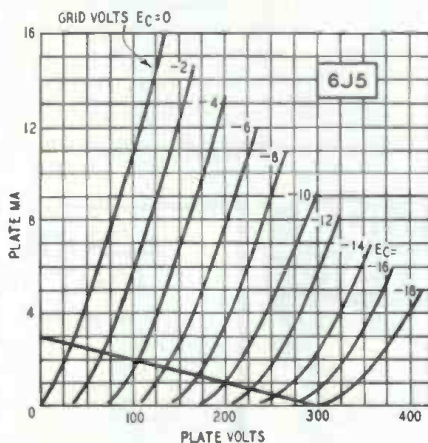

Fig. 1—Family of plate curves shows performance of the tube graphically.

The usual tube book gives a set of curves like those in Fig. 1 for each tube. Plate current is plotted here against plate voltage with a separate curve for each value of grid voltage.

All voltages are direct. The test circuit used in plotting the curves appears in Fig. 2. Filament and grid voltages are held constant while the plate voltage is varied. At each plate voltage value the plate current is read. Then the grid voltage is changed and the plate-voltage changes are gone through again and plotted.

To obtain the curves of Fig. 1, for instance, the grid voltage was set at zero (grid grounded) with the potentiometer, the plate voltage set at various values and the plate current measured at each voltage. Dots were made at these points and the curve drawn. Then the grid voltage was raised to  $-2$  and the same procedure followed with the new grid voltage. Several of these curves form a *plate family*. The same thing is done with tetrodes and pentodes, with fixed screen voltages. Often screen current is plotted on the same graph, using dashed lines to distinguish it from plate current.

The same information can be given in a slightly different way. Plate current plotted against grid volts, with a separate curve for each value of plate voltage, forms a *transfer* or *mutual characteristic* graph, which gives essentially the same information as a plate family.

We learned in Chapter X that the *amplification factor*, or " $\mu$ ", of a tube is simply a number telling how many times more effective grid voltage is than a plate voltage change in producing a change in plate current. For example, look at the  $-4$ -volt curve of Fig. 1. At one convenient point the plate voltage is 105 and plate current 2 ma. Now look at the  $-6$ -volt curve. At 105 volts the current is only about 0.2 ma. To get the 2-ma plate current again (keeping grid voltage  $-6$ ) we have to go to approximately 145 plate volts. A 40-volt change in plate current is necessary to restore to its original value a current that was varied by a 2-volt grid change in the opposite direction. The  $\mu$  is  $40/2$ , or 20, just as you will find in the book (RCA Tube Manual RC 15) if you look up the 6J5's ratings.

The plate resistance of a tube is found by dividing a small change in plate voltage by the change in plate amperage it causes. For example, if we check a number of the curves on Fig. 1,



The basic tools of the circuit designer—tube handbook, slide rule, scratch paper.



**MONEY BACK GUARANTEE** — We believe units offered for sale by mail order should be sold only on a "Money-Back-If-Not-Satisfied" basis. We carefully check the design, calibration and value of all items advertised by us and unhesitatingly offer all merchandise subject to a return for credit or refund. You, the customer, are the sole judge as to value of the item or items you have purchased.

**A COMBINATION  
20,000 OHMS PER VOLT MULTI-METER  
and TELEVISION KILOVOLT METER**

The New Model TV-20



**Added Feature:** Includes an Ultra High Frequency Voltmeter Probe with a frequency range up to 1,000 MEGACYCLES. When plugged into the Model TV-20, the V. H. Probe converts the unit into a Negative Peak-Reading H. F. Voltmeter.

**\$39.95** NET

The Model TV-20 operates on self-contained batteries. Comes housed in beautiful hand-rubbed oak cabinet complete with portable cover. Built-in High Voltage Probe, H. F. Probe, Test Leads and all operating instructions

**Specifications:**  
9 D. C. Voltage Ranges: (At 20,000 ohms per Volt)  
0-2.5/10/50/100/250/500/1,000/5,000 / 50,000 Volts)  
8 A. C. Voltage Ranges: (At 1,000 ohms per Volt)  
0-2.5/10/50/100/250/500/1,000/5,000 Volts  
5 D. C. Current Ranges  
0-50 Microamperes  
0-5/50/500 Milli-amperes  
0-5 Amperes  
4 Resistance Ranges:  
0-2,000 / 20,000 ohms. 0 - 2/20 Megohms  
7 D. B. Ranges: (All D. B. ranges based on  $ODb = 1 Mv.$  into a 600 ohm line)  
- 4 to + 10 db  
+ 8 to + 22 db  
+ 22 to + 36 db  
+ 36 to + 42 db  
+ 36 to + 50 db  
+ 42 to + 56 db  
+ 48 to + 62 db  
7 Output Voltage ranges:  
0 to 2.5/10/50/100/200/500/1,000 Volts

The New Model TV-10 **TUBE TESTER**



The Model TV-10 operates on 105-130 Volt 60 Cycles A.C. Comes housed in a beautiful hand-rubbed oak cabinet complete with portable cover.

**\$39.50** NET

**Specifications:**

- ★ Tests all tubes including 4, 5, 6, 7, Octal, Lock-in, Peanut, Bantam, Hearing-aid, Thyatron, Miniatures, Sub-Miniatures, Novals, etc. Will also test Pilot Lights.
- ★ Tests by the well-established emission method for tube quality, directly read on the scale of the meter.
- ★ Tests for "shorts" and "leakages" up to 5 Meg-ohms.
- ★ Uses the new self-cleaning Lever Action Switches for individual element testing. Because all elements are numbered according to pin-number in the RMA base numbering system, the user can instantly identify which element is under test. Tubes having tapped filaments and tubes with filaments terminating in more than one pin are truly tested with the Model TV-10 as any of the pins may be placed in the neutral position when necessary.
- ★ The Model TV-10 does not use any combination type sockets. Instead individual sockets are used for each type of tube. Thus it is impossible to damage a tube by inserting it in the wrong socket.
- ★ Free-moving built-in roll chart provides complete data for all tubes.
- ★ Newly designed Line Voltage Control compensates for variation of any line voltage between 105 Volts and 130 Volts.

The New Model 200

**AM and FM SIGNAL GENERATOR**

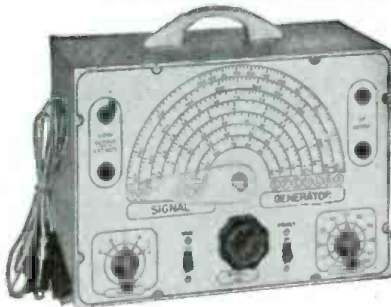

The Model 200 operates on 110 Volts A.C. Comes complete with output cable and operating instructions.

**\$18.85** NET

**R.F. FREQUENCY RANGES:** 100 Kilocycles to 150 Megacycles.  
**MODULATING FREQUENCY:** 400 Cycles. Also available separately.  
**ATTENUATION:** The constant impedance attenuator is isolated from the oscillating circuit by the buffer tube. Output impedance of this model is only 100 ohms. This low impedance reduces losses in the cable.  
**OSCILLATORY CIRCUIT:** Hartley oscillator with cathode follower buffer tube. Frequency stability is assured by modulating the buffer tube.  
**ACCURACY:** Use of high-Q permeability tuned coils adjusted against 1/10th of 1% standards assures an accuracy of 1% on all ranges from 100 Kilocycles to 10 Megacycles and an accuracy of 2% on the higher frequencies.

The New Model TV-30

**TELEVISION SIGNAL GENERATOR**

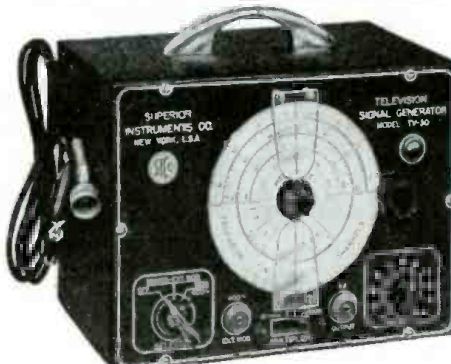

Model TV-30 comes complete with shielded coaxial lead and all operating instructions.

**\$29.95** NET

Enables alignment of Television I. F. and front ends without the use of an Oscilloscope

**Specifications:**  
**Frequency Range:** 4 Bands —No switching. 18—32 Mc. 35—65 Mc. 64—98 Mc. 160—250 Mc. Audio Modulating Frequency: 400 cycles (Sine Wave). Attenuator 4 Position.  
ladder type with constant impedance control for fine adjustment. Tubes Used: 6C4 as Cathode follower and modulated buffer. 6C4 as R.F. Oscillator. 6SN7 as Audio Oscillator and power rectifier.

The New Model 670

**SUPER METER**



**A Combination VOLT - OHM - MILLIAMMETER plus CAPACITY REACTANCE, INDUCTANCE and DECIBEL MEASUREMENTS.**

**D.C. VOLTS:** 0 to 7.5/15/75/150/750/1500/7500. **A.C. VOLTS:** 0 to 15/30/150/300/1500/3000 Volts. **OUTPUT VOLTS:** 0 to 15/30/150/300/1500/3000. **D.C. CURRENT:** 0 to 1.5/15/150 ma.; 0 to 1.5 Amps. **RESISTANCE:** 0 to 500/300,000 ohms. 0 to 10 Megohms. **CAPACITY:** 100 to 2 MFD. 1 to 4 MFD. (Quality test for electrolytics.) **REACTANCE:** 700 to 27,000 Ohms; 13,000 Ohms to 3 Megohms. **INDUCTANCE:** 1.75 to 70 Henries: 35 to 8000 Henries. **DECIBELS:** -10 to +18, +10 to +38, +30 to +58.  
The model 670 comes housed in a rugged, crackle-finished steel cabinet complete with test leads and operating instructions. Size 5 1/2" x 7 1/2" x 3".

**\$28.40** NET



The New Model 770—An Accurate Pocket-Size

**VOLT-OHM MILLIAMMETER**

(Sensitivity: 1000 ohms per volt) Compact-measures 3 1/4" x 5 3/8" x 2 1/4". Uses latest design 2% accurate 1 Mil. D'Arsonval type meter. Same zero adjustment holds for both resistance ranges. It is not necessary to readjust when switching from one resistance range to another. This is an important time-saving feature never before included in a V.O.M. in this price range. Housed in round-cornered, molded case. Beautiful black etched panel. Depressed letters filled with permanent white. Insures long-life even with constant use.  
**Specifications:** 6 A.C. VOLTAGE RANGES: 0-15/30/150/300/1500/3000 volts. 6 D.C. VOLTAGE RANGES: 0-7 1/2/15/75/150/750/1500 volts. 4 D.C. CURRENT RANGES: 0-1 1/2/15/150 Ma. 0-1 1/2 Amps. 2 RESISTANCE RANGES: 0-500 Ohms. 0-1 Megohm.

The Model 770 comes complete with self-contained batteries, test leads and all operating instructions.

**\$13.90** NET

20% DEPOSIT REQUIRED ON ALL C.O.D. ORDERS

**GENERAL ELECTRONIC DISTRIBUTING CO.** Dept. RC-2, 98 PARK PLACE NEW YORK 7, N. Y.

# COMPLETE WIRING DIAGRAM

for the 1950 Modern Bench Design  
in the FEBRUARY issue of:



the FEBRUARY issue is on sale at your  
jobbers' counters

Complete instructions, schematics and working drawings on how to wire the 1950 MODERN BENCH design quickly—easily—at low cost! Don't miss this article on how to have the most efficient, profitable and up-to-date working system for your shop or lab. This is Number 2 of 12 big construction articles in the 1950 RADIO & TELEVISION MAINTENANCE

## DON'T MISS ANY OF THE FORTHCOMING ISSUES!

Subscribe today at the new low price of \$1.00 for one year.

Here is a list of future construction articles:

How to make receiving dollies for incoming radios  
Planning and constructing inventory racks for AM, FM AND TV

How to construct a truck interior for efficient field work  
Building an auxiliary bench for tube testing, minor repairs, operating observation, etc.

Construction of cathode-ray tube holder for servicing chassis when tube is separately mounted

Shop planning and layout for steps, time and money saving

Auxiliary HV power supplies for operating tests on picture tube

Design and arrangement of a portable parts, tool and text box for servicing

Design and construction of TV antenna location tester

There are in addition to the regular content of technical articles on TV-FM and AM receivers, test equipment tools, etc.—news articles on current happenings, trends of the industry, new products and new literature,—sales methods and advertising programs,—business methods

# 30,000

radio servicemen buy RADIO & TELEVISION MAINTENANCE regularly—PROOF of its value to the trade!

Don't miss any of these issues. Send in your order of the new low price of \$1.00 for one year.

BOLAND & BOYCE INC. RE 2  
MONTCLAIR, N. J.  
Send me RADIO & TELEVISION MAINTENANCE for one year for only \$1.00

NAME \_\_\_\_\_  
ADDRESS \_\_\_\_\_  
CITY \_\_\_\_\_ ZONE \_\_\_\_\_  
STATE \_\_\_\_\_

MONEY ENCLOSED  BILL ME LATER\*  
(check one)

I am in a  radio sales & service business  
 sales only  
 service only  
 other (explain) \_\_\_\_\_

(check one)  
I am  owner  
 manager  
 employee

FULL REFUND WITHIN 90 DAYS IF NOT COMPLETELY SATISFIED

\* If money is enclosed, thus eliminating billing expense, we will add one extra issue FREE.

selecting parts where they are straightest, we find that changing the plate voltage by 10 or a little less, with grid voltage unchanged, produces a change of 1 ma in plate current. The plate resistance is then 10/.001 (ampere) or 10,000 ohms. The book gives values between 7,000 and 8,000, so we are a little high. A bigger graph would read more accurately.

Control-grid-plate transconductance or simply transconductance or mutual conductance (it's called more names than a baseball umpire) is abbreviated  $g_m$  and is probably the best value by which to judge how good a tube is as an amplifier. It is defined as "the small change in plate current divided by the

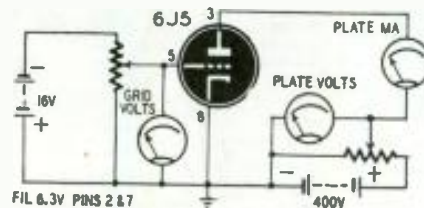

Fig. 2—Test circuit for making chart.

small change in grid voltage required to produce it." All other voltages are supposed to remain the same. Since our smallest divisions of grid voltage are a full 2 volts, we cannot readily make this measurement on the chart, though it could be done easily on the actual test setup.

As an example, if a grid shift of 1 volt produces a change of 2.5 ma in the plate current, the transconductance is equal to .0025/1, or .0025 "mhos." The *mho* (ohm spelled backward) is the basic unit of conductance—which is the reciprocal or opposite of resistance.

A handier, pocket-size unit is the *micromho* or millionth of a mho. The transconductance of the 6J5 under typical operating conditions may run between 2,500 and 3,000 micromhos. See how close you can come to it using the graph.

### Dynamic characteristics

The measurements and curves you have seen so far are *static* characteristics, made under standing-still conditions. You get about as much useful information from them as you would out of watching a new driver maneuvering a car in a large deserted lot. By watching him in the lot, you can tell whether he knows what the pedals are for and if he has the strength to turn the steering wheel (and in the right direction!). But none of that information and ability is useful until he gets out on the road and reacts to different—and *changing*—conditions that he will encounter there.

The same is true of the tube. Used in an amplifier circuit, it will encounter impedances not present in the tests; it will deal with a.c. voltages and currents; it will have to adapt itself to changing conditions. A little simple calculation, using ruler, pencil, and paper, will tell us what the tube will do under *dynamic*—moving—conditions, when it

is in useful operation as an amplifier.

Suppose we are to use the 6J5 in the simple voltage-amplifier circuit of Fig. 3. We choose the value of R1 (which, as we saw in the December issue, makes it possible to pass the amplified voltage to another tube) at 100,000 ohms. C1 is merely a blocking capacitor preventing d.c. from passing into the following stage. A grid resistor in series with the bias battery permits us to place a negative (d.c.) voltage on the grid without any likelihood of shorting out incoming signals.

What will happen with the values for R1 and the bias and B-voltages we have chosen? What values are needed to obtain the amplification we want? If we know the answer to the first of this pair of questions, the second question answers itself.

If the bias does not cut off the tube, the plate current causes a d.c. voltage drop in R1; therefore, the plate has *less* than 300 volts on it. The static curves in Fig. 1 no longer tell the whole story, for, if we choose a certain grid voltage, the chart shows that the plate current depends on the plate voltage—but with R1 in the circuit we don't know what the plate voltage is!

The solution is to draw a *load line* on the graph to show just what the plate voltage is for each value of grid voltage, with R1 in circuit.

It's a simple matter of reasoning. If the voltage at the plate is really 300 volts in the circuit of Fig. 3, there is no drop across R1, which means that plate current must be zero. On the graph, we place a dot at the intersection of 300 plate volts and zero current.

If the plate voltage is zero, the tube must be effectively a dead short between cathode and plate, and *all* the B-voltage is across R1. This never happens in practice (unless the tube has shorted elements, in which case, watch things burn!), but it is useful as a piece of brainwork. If all the B-voltage is across the resistor, we can easily figure the current:  $I = E/R = 300/100,000 = .003$  ampere or 3 ma. That means that if the plate voltage approaches zero, plate current approaches 3 ma; and we can dot the appropriate intersection on the graph. Joining the two dots with a line will show the true dynamic characteristic of the tube when it is placed in its circuit.

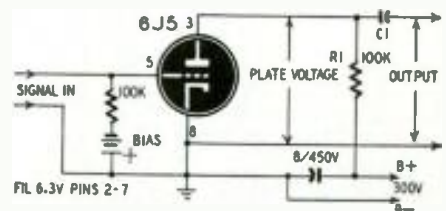
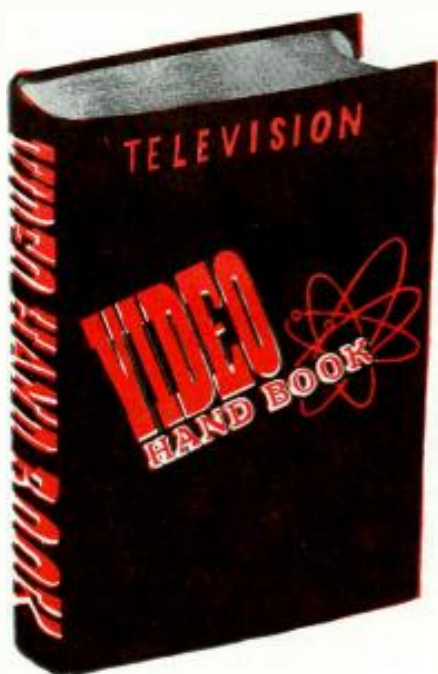

Fig. 3—A typical 6J5 voltage amplifier.

Note that the value of R1 and the B-voltage determined the placement of the *load line*. Other values would give other lines. The static plate family, on the other hand, is a set of curves that remain the same no matter how the tube is used. We can define dynamic

# RADIO & TELEVISION'S GREATEST BOOKS!



Make every operation easier . . . get all information in condensed, easy to read form in the RADIO DATA and the VIDEO HAND BOOK! These books give you all facts, data and techniques for engineers, technicians, students. They provide complete reference, text, charts, data and thousands of pictures: drawings, photographs, diagrams, schematics, sketches, etc. Complete set of test patterns illustrated in the Video Hand Book. All text and charts in easy-to-understand, non-mathematical style. These books are best sellers in the radio and television field. The first printings of 30,000 are sold out . . . second printings are going fast! Make sure you get your copies now . . . order both, you'll profit by the valuable information they contain!

Get them at your favorite dealer. If he cannot supply you, order direct using coupon below.



## THE VIDEO HAND BOOK

- How Television Works, Basic . . . through advanced.
- How to Troubleshoot and Repair Television, Safety procedures.
- How to Select and Install a Television Antenna.
- How to Create a Television Show.
- How to Build an Operating Television Receiver, Complete instructions.
- How to Select a Television Receiver.

The VIDEO HANDBOOK is designed to give you the practical . . . answers to all your questions on television—the complete, detailed procedures on all phases of television work—step-by-step explanations for everyday problems. This book provides the ready information to make your television education complete.

The VIDEO HANDBOOK will save you time—improve your efficiency and make your work easier. It provides the knowledge that means more profit for you. Every page adds to your background for greater prestige and income. Here is the means for everyone in television—employed and executive—to increase his value to his firm.

This book is more than a source of information and interesting reading—it is an investment in your future in television.

**\$5.00**

Handsomely bound in DuPont Fabrikoid . . . over 900 pages . . . 14 sections . . . over 800 illustrations—photographs, charts, diagrams, schematics.

Section 1. Television: Past, Present & Future. Section 2. Fundamentals of electronic Television. Section 3. The Television Station. Section 4. The Television Receiver. Section 5. Television Antenna Systems. Section 6. Creating a Television Show. Section 7. Descriptions of Modern Television Receivers. Section 8. Installing Television Receivers. Section 9. Servicing Television Receivers. Section 10. Television Test Equipment. Section 11. Building a Television Receiver. Section 12. Data Section. Section 13. Television Terms. Section 14. Bibliography.

## THE RADIO DATA BOOK

Plan every operation in radio and electronics with the *Radio Data Book*. This new radio bible will be your lifelong tool . . . you will use it every day, on the board, at the bench, in the field! Use it for engineering, construction, troubleshooting and testing. The RADIO DATA BOOK will be your invaluable aid in design, experiment and in layout. It will help make your production better, faster and easier. In any and every operation in radio and electronics, you will use the RADIO DATA BOOK!

The RADIO DATA BOOK is a work of complete authority, prepared by engineers with many years of practical experience. They have been assisted by the Boland & Boyce staff of editors skilled in preparing electronics manuals for the U. S. Signal Corps for many years. These men have worked for several years gathering material for this book . . . all the knowledge of radio principles and operation . . . all the statistics . . . all the newest developments in electronics . . . every possible angle and detail. Eighteen months were spent digesting this material into the most concise, the clearest, and the most readable form. The result is this invaluable manual . . . The RADIO DATA BOOK. Whether you use this book for general reference, for scientific instruction, or for education, one thing is certain—the practical help, the daily usefulness you will derive from it will prove to be worth many, many times its astonishingly low price.

**\$5.00**

Section 1: FUNDAMENTALS (complete introduction to electricity, current, radio theory, vacuum tubes, radar, sonar, AM, FM, and all electronic equipment); 2: BASIC CIRCUITS; 3: TEST EQUIPMENT; 4: TESTING, MEASURING and ALIGNING; 5: ANTENNAS; 6: RECORDING; 7: SOUND SYSTEMS; 8: CHARTS, GRAPHS, CURVES; 9: CODES, SYMBOLS, STANDARDS; 10: 50 TESTED CIRCUITS; 11: DICTIONARY; 12: TUBE CHARTS.

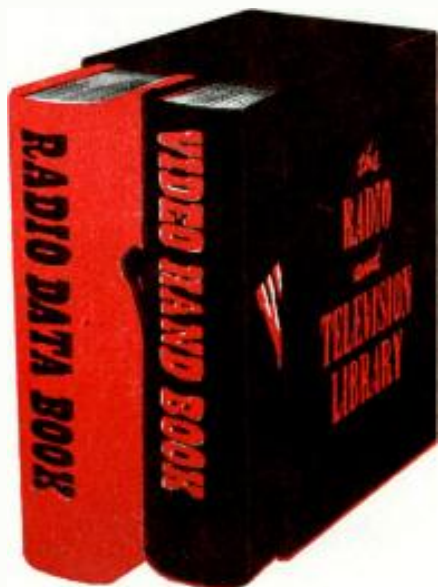

Order both . . . save money! the RADIO DATA BOOK and the VIDEO HAND BOOK combined in handsome slip case: THE RADIO and TELEVISION LIBRARY Complete Only **\$9.00**

**FREE** The Boyce-Roche Book Co. handles ALL Radio and Electronic books. Immediate shipment. Send stamp for FREE CATALOGUE.

### MAIL THIS COUPON TODAY:

BOYCE-ROCHE BOOK CO., MONTCLAIR, N. J. RE-2

Send me the books listed below.

Radio Data Book \$5.

Video Handbook \$5.

Radio and TV Library \$9.

I will pay postman for books plus few cents postage on delivery

I enclose payment, send books postpaid

Name \_\_\_\_\_

Address \_\_\_\_\_

City \_\_\_\_\_ Zone \_\_\_\_\_

State \_\_\_\_\_

ADMIRAL • ARVIN • BELMONT • BENDIX • CAPEHART  
 CROSLY • DEWALD • DUMONT • EMERSON • FADA  
 FARNSWORTH • GAROD • HALLICRAFTER • MOTOROLA • OLYMPIC  
 PHILCO • PILOT • P... SENTINEL  
 SPARTON • STROMBERG-  
 CARLSON • TELE-TONE  
 TRAVELER • WESTINGHOUSE • ZENITH

**It's smart to use the Television Tubes**  
**TV Set Manufacturers choose . . .**

**RAYTHEON**  
*Quality*  
**Television Tubes**

characteristics, therefore, as the characteristics of the tube in the actual circuit and under the actual conditions in which it is used.

The load line tells us what the plate voltage, plate current, and grid voltage really are at any time while the tube is working. We need know only one to find the other two. If we have a grid voltage of -10, for example, the plate current is 1 ma and the plate voltage is 200.

These values are dynamic—they apply just as much to a.c. as to d.c. Suppose we connect an audio generator to the input terminals. Assume for the moment that the bias battery is shorted. The audio signal has a peak amplitude of 10 volts. At its 10-volt negative peak, the tube's plate voltage is 200; when the audio is at zero, plate voltage is 35. The tube's plate voltage has changed during the half-cycle by 200-35 or 165 volts. Since the change is at an audio rate, it goes through C1 and appears at the output terminals as an enlarged replica (more or less perfect) of the input signal. The enlargement is easy to figure: the input signal was 10 volts peak; the output was 165 volts peak. The magnification, *amplification*, or *voltage gain*, was 165/10 or 16.5 times. Note that the voltage gain, like other dynamic characteristics, depends on the circuit used.

The dynamic characteristics are too important to be brushed over thus lightly here; we will discuss them more thoroughly later in relationship to amplifiers.

Meanwhile, note that the three main tube characteristics are related to each other, as would be expected. Multiply the transconductance (mhos) by the plate resistance to get the amplification factor, or:  $g_m = \frac{\mu}{r_p}$ , to recast the equation.

Thus, if we know two of these characteristics, we can always find the third one.

Each major tube manufacturer publishes a tube manual in which all of the above characteristics, as well as many other items of useful information, are given for the tubes he produces. Such a book is as important and necessary to the radio technician as a cookbook to a career-girl bride. You will realize why when future chapters refer to and use over and over the tube characteristics to which you have just been formally introduced. If you have not already done so, this is the time to latch onto a tube manual and give it a good look-through.

Television servicemen minimize their tube-to-tube variation bugaboo by using the same TV tubes leading set manufacturers use — Raytheon Quality Television Tubes. The wealth of experience Raytheon gained in the development and manufacture of tubes for video amplifiers in Radar applications, is proving invaluable in the production of high efficiency tubes for modern TV receivers. Raytheon instantly recognized that the normal industry test tolerances of many tubes being used in video applications were not close enough for perfect performance

in today's television receivers. A new, stricter set of test tolerances and more rigid quality standards were introduced with the result that Raytheon Quality TV Tubes save many a headache for manufacturer and serviceman.

Save time and trouble — save money — safeguard customer goodwill — standardize on Raytheon Quality Television Tubes.

**RAYTHEON CATHODE RAY TUBES** come in all the most popular types. For peak video performance, specify Raytheon Television Picture Tubes as well as all other Raytheon Television Type Tubes.



**RAYTHEON**

**RAYTHEON MANUFACTURING COMPANY**

Radio Receiving Tube Division

Newton, Mass., Chicago, Ill., Atlanta, Ga., Los Angeles, Calif.

*Excellence in Electronics*

RADIO RECEIVING TUBES, TELEVISION TUBES, CATHODE RAY TUBES, SPECIAL PURPOSE TUBES, MINIMATURE TUBES, MICROWAVE TUBES

**HOW TO GET THE MOST**  
 from only  
**BASIC TEST EQUIPMENT**

**Servicing by Signal Substitution**  
 The Simple, Modern, Dynamic Speed approach to receiver alignment and adjustment problems, FM-AM-TV.

- Nothing complex to learn
- No extra equipment to purchase
- Universal — non-obsolete
- Employs only Basic Test Equipment



**S-S-S tells HOW — in simple, direct language.**

New 9th edition now off the press. 100 pages of valuable information.

Available from all leading radio parts and equipment distributors or directly from factory at only 40c per copy.

PRECISION APPARATUS COMPANY, Inc. • 92-27 Horace Harding Blvd., Elmhurst 4, N. Y.



RADIO-ELECTRONICS for

# When Mickey and Felix were our leading “TV” stars . . .

Those celebrated “movie actors”—  
Mickey Mouse and Felix the Cat—were  
pioneer helpers in television research

No. 1 in a Series Tracing the High  
Points in Television History

Photos from the historical collection of RCA

● Strange though it seems, two toys had much to do with television as you now enjoy it! As “stand-ins” during television’s early days, Mickey Mouse and Felix the Cat helped RCA scientists and engineers gather priceless information.

Choice of this pair was no accident. Their crisply modelled black-and-white bodies were an ideal target for primitive television cameras. The sharp contrast they provided was easy to observe on experimental kinescopes.

Would living actors have done as well? No, for what RCA scientists were studying—as they trained their cameras on the two toys—was the effect of changes and improvements in instruments and telecasting techniques. With living actors it could never have been absolutely certain that an improve-



Felix the Cat and Mickey Mouse were, during television’s experimental period, the most frequently televised actors on the air. Using them as “stand-ins,” RCA engineers gathered basic data on instruments and techniques.

ment in the televised image came from an improvement in equipment and techniques—or from some unnoticed change in an actor’s appearance, clothing, make-up. Mickey and Felix provided a “constant,” an unchanging target which led to more exact information about television . . .

Problem after problem was met by RCA scientists, with the results you now enjoy daily. For example: In the “Twenties” and early “Thirties,” there were still people who argued for *mechanical* methods of producing a television image, despite the obvious drawbacks of moving parts in cameras and receivers. Then Dr. V. K. Zworykin, now of RCA Laboratories, perfected the iconoscope, to give television cameras an all-electronic “eye”—without a single moving part to go wrong. Today, this same all-electronic principle is used in the RCA Image Orthicon camera, the supersensitive instrument which telescopes action in the dimmest light!

Also developed at about this time, again by Dr. Zworykin, was the *kinescope*. It is the face of this tube which is the “screen” of your home television receiver, and on its fluorescent coating an electron “gun”—shooting out thousands of impulses a second—creates sharp, clear pictures in motion. Those who may have seen NBC’s first experimental telecasts will remember the coarseness of the image produced. Contrast that with the brilliant, “live” image produced by the 525-line “screen” on present RCA Victor television receivers!

Credit RCA scientists and engineers for the many basic developments and improvements which have made television an important part of your daily life. But don’t forget Mickey Mouse and Felix. They helped, too!

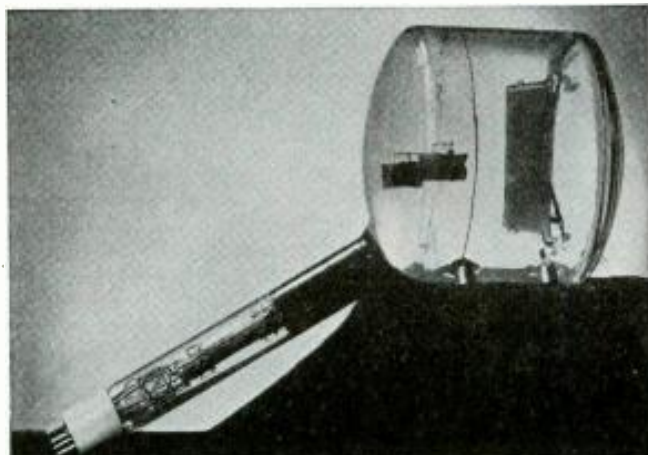

The iconoscope, electronic “eye” of television, invented by Dr. V. K. Zworykin, of RCA Laboratories.

FEBRUARY, 1950



**Radio Corporation of America**  
WORLD LEADER IN RADIO—FIRST IN TELEVISION

## SOLDERING IS A CINCH

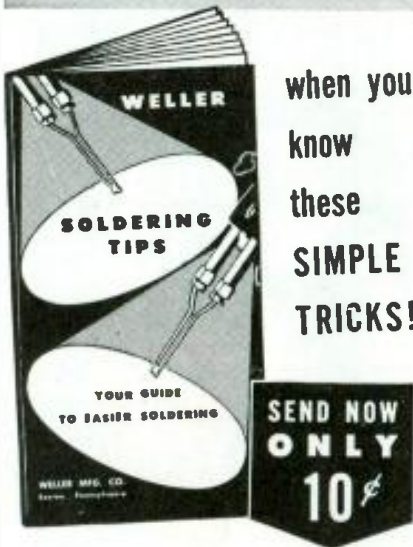

when you know these SIMPLE TRICKS!

SEND NOW ONLY 10¢

No matter how much you know about soldering, there's always a trick that will make it easier. This little 20-page pocket guide is crammed full of such time-and-trouble savers.

Without wasting words, it covers the whole soldering operation—points out DO's and DON'T's—refreshes your memory on difficult points—suggests methods that help you work faster. Yet there's no hard studying, no tough technical talk. Every word is plain everyday English and every point is made clear by easy-to-understand illustrations.

Get this handy Soldering Guide today, and keep it on your bench for ready reference. It's a real handbook of professional soldering—not a catalog. Just mail the coupon with 10c in coin and we'll send your copy at once.



When you send for your Guide to Easy Soldering, be sure to ask about the New Weller Soldering Guns. They're a handful of convenience, better from tip to grip.

**WELLER**  
MANUFACTURING COMPANY

Weller Mfg. Co., 828 Packer St., Easton, Pa.

Enclosed find ten cents (10c) for which please send my copy of the Weller "Soldering Tips".

I am also interested in the new Weller Soldering Guns. Please send Catalog Bulletin.

Name \_\_\_\_\_

Address \_\_\_\_\_

City \_\_\_\_\_ State \_\_\_\_\_

# Voltmeter Measures Current

By J. T. CATALDO\* and S. J. RICHARD†

IN troubleshooting a radio it is frequently necessary to determine whether a circuit current is normal. However, current readings are difficult since it is necessary to open the circuit by unsoldering components, insert a milliammeter, make the measurement, and then resolder the components. If many measurements are to be made, much time and patience is required.

Voltage and resistance measurements are easier to make since it is not usually necessary to disturb the circuit.

According to Ohm's law,  $I = E/R$ , you can find the current through a circuit by measuring the voltage across a resistor of known value through which the current is passing. However, ohms are very small quantities in radio work, and amperes are very big ones. It is better to use the following units:  $E =$  volts,  $I =$  milliamperes,  $R =$  thousands of ohms (K-ohms).

To illustrate, assume a typical a.c.-d.c. five-tube radio set employing a 50L6 output tube, as in Fig. 1. The question is whether the cathode current of the output tube is normal. The bias resistor is 150 ohms (determined with an ohmmeter or otherwise). When the set is turned on, a voltmeter placed across the resistance indicates 7.5 volts. Applying Ohm's law,  $I = E/R$ , or  $17.5/150,000 = .05 = 50$  ma, which is normal for a 50L6 biased with 150 ohms. Here is one case where ohms and amperes are easier, though the equation could have read  $7.5/.15 = 50$ .

Referring again to Fig. 1, assume that we want to determine the plate current of the triode section of the 12SQ7. The plate load resistor is 500,000 ohms and a voltmeter across it indicates 60 volts. Again applying Ohm's law,  $I = E/R$ , or  $60/500 = 0.12$  (ma), which is normal for this type of tube. The input resistance of the voltmeter should always be at least 10 times the resistance across which it is connected. In this case, a v.t.v.m. must be used.

This method may also be used for higher-current circuits, a.c. or d.c. This is convenient since the average multimeter usually has a.c. voltage ranges but seldom has a high milliamperage or an ampere range. Suppose the current drain of a radio receiver is to be found. The receiver must be connected as shown in Fig. 2, with a 1-ohm, 10-watt resistor in series with the line. A 1-ohm resistor is chosen because the current drawn through it will be numerically equal in amperes to the drop in volts across it.

\* General Research Laboratories  
† Radio Div., Delehan Institute

The authors wired the resistor in a box with a female receptacle on one end and a plug and line cord at the other end. Terminals connected across the resistor were provided on the top of the box.

Using the gadget, the receiver under test is plugged into the female receptacle, and the line cord of the tester is plugged into the 117-volt line. The voltmeter is, of course, across the resistor

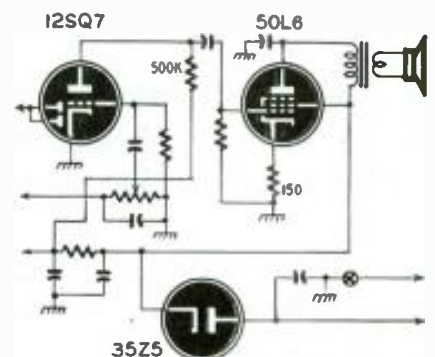

Fig. 1—Portion of a standard receiver. An a.c. receiver generally draws about half its final current right away; then the current rises slowly to the final value. A transformerless receiver has an initial heavy surge which drops immediately, then the current rises to the final value.

The power drawn by most receivers is indicated on a chassis label or can be found in the servicing diagram. Since  $P = EI$ , the power drawn is equal to the line volts times the amperes through the resistor, which is numerically equal to the voltmeter reading. With a 120-volt line, a 1-volt

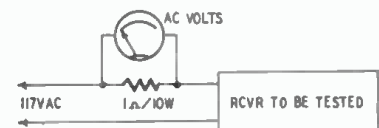

Fig. 2—Simple device checks power. reading indicates 120 watts, but, for quick figuring, you can assume that the wattage is about the same as the voltmeter reading multiplied by 100.

If the receiver mentioned above is rated at 100 watts, the reading should rise gradually to around 0.5 volt, then slowly increase to a little less than 1 volt. But if it continues rising past 1 volt, pull the power cord quickly; you can bet your bottom dollar the set has short-circuited filter or bypass capacitors.

A.c.-d.c. receivers usually pull 35-40 watts, with voltmeter readings around 0.3 to 0.4. If the reading goes past about 0.5, disconnect in a hurry and investigate.

**YOU BUILD 'EM  
IN ONE EVENING  
BUT...**

**THEY LAST A LIFETIME!**

**SAVE 50% WITH**

**LABORATORY  
PRECISION**



**INSTRUMENTS  
& KITS**

**SENSATIONAL NEW**

**EICO Model 360-K TV-FM SWEEP  
SIGNAL GENERATOR**

• Crystal marker oscillator with variable amplitude. • Covers all TV and FM alignment frequencies between 500 kc. and 228 mc. • Sweep-width variable from 0-30 mc. with mechanical inductive sweep. • Extremely wide sweepwidth allows gain comparison of adjacent RF TV Channels. • Provides for injection of external signal generator marker. • Phasing control included. • Large, easy-to-read dial is directly calibrated in frequencies. Comes complete with all tubes (including new, high-frequency miniature types): 6X5GT, 12AU7, two 6C4's. Crystal not included. 10"x8"x6 3/4". 5 Mc. Crystals available for above, each \$8.95.

**\$29.95**



**FACTORY-WIRED AND TESTED \$39.95**  
Model 360. Ready to use Sweep Signal Generator. See it at your local jobber!

**ANYONE  
CAN BUILD  
THEM!**

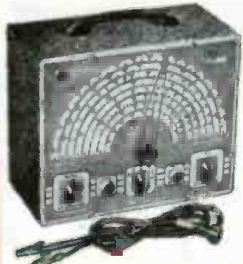

**NEW! MODEL 320-K  
SIGNAL GENERATOR**

For FM, AM alignment and to provide TV marker frequencies. Highly stable Hartley oscillator has range of 150 kc. to 102 mc. with fundamentals to 34 mc. Colpitts audio oscillator supplies pure 400 cycle sine wave voltage for modulation. Use audio oscillator voltage to test distortion in audio equipment, bridge measurements, etc.

**FACTORY-WIRED AND TESTED \$29.95**  
Model 320. Ready to use.....



**VERSATILE MULTI-  
SIGNAL TRACER**

Model 145-K. High gain—high frequency. Self-contained test speaker permits audible signal tracing of RF, IF, FM, audio and video circuits. Provision for visual tracing with VTVM. Response is well over 200 mc. 8-color hammettone panel. 110-125 V. AC. Size: 10"x8"x4 3/4". Comes complete with tubes and diode probe in kit form.

**\$18.95**

**FACTORY-WIRED AND TESTED \$28.95**  
Model 145. Ready to operate.....

**NEW EICO PUSH-PULL WIDE  
RANGE HIGH-  
SENSITIVITY TV  
5" OSCILLOSCOPE  
Model 425-K**

ALL-NEW laboratory precision scope has Push-Pull deflection and .05 to .1 volts per inch sensitivity. Wide range, flat from 5 cps to 500 kc. with full gain setting, useful to 2 1/2 mc. Wide-range, multi-vibrator, sweep circuit from 15 cps to 75,000 cps. Direct connection to plates of CRT available at rear of cabinet. Z axis intensity modulation feature included. Size: 8 1/2"x17"x13" high. Complete with 3—6SN7a, 2—6J5a, and 5BP1 CRT.

**FACTORY-BUILT OSCILLOSCOPE \$69.95**  
Model 425. Fully wired and tested

**\$39.95**



**HIGH PRECISION  
VACUUM TUBE  
VOLTMETER  
Model 221-K**

Top workbench versatility—15 different ranges! AC and DC ranges: 0/5/10/100/500/1000 volts. Electronic ohmmeter ranges from .2 ohms to 1000 megohms in 5 steps. New Zero Center for TV discriminator alignment. 26 Meg. DC input impedance. Accurate, 4 1/2" meter cannot burn out. Double triode balanced bridge circuit assures guaranteed performance. Steel case sturdy and rubproof panel etched. 110-130 V. AC 50-60 cycle. Size: 9 7/16"x6"x5".

**FACTORY-WIRED AND TESTED \$49.95**  
Model 221. Same, but completely wired, calibrated, and tested....

**\$23.95**



**DELUXE SIGNAL  
GENERATOR  
MODEL 315**

Completely wired, ready-to-use Signal Generator with 1% accuracy! A wonderful instrument with dozens of expensive features. Frequency range: 75 kc to 150 mc. Has microcycle hand-spread vernier tuning for FM, AM, and TV. Voltage regulator. Write for full details. **\$59.95**

Model 511-K. A "Must" for every serviceman! Small, handy instrument used a thousand times a day. Large 3" meter, beautifully etched panel. A perfect kit for beginners. Simple to assemble. Ranges: DC-0/5/50/250/500/2500 volts. AC-0/10/100/500/1000 volts. Output—0/10/100/500/1000 v. DC Ma.—0/1/10. DC A m p s.—0/1/10. Ohmmeter — 0/500/100,000 ohms/0/1 meg. DB meter —8 to +55 Db. **\$14.95**

**ASSEMBLED—READY TO USE \$17.95**  
Model 511—Completely wired, tested, and assembled at factory. Rugged, built for heavy duty.....

**VOLT-OHM  
MILLIAMMETER  
Complete Pocket Kit**



**\$14.95**



**HIGH VOLTAGE PROBE**

Complete top-quality Voltage Test Probe Measures up to 30,000 Volts. Special Helical-Wound Ceramic HV Multiplier Resistor adaptable to most VTVM's and all 20,000 ohms per volt meters with 1000 or 5000 volt scales. Lucite head, plywood bakelite handle, large flashguards for additional safety. Specify your instrument. Complete, ready to use... **\$6.95**

**SEE THEM—TRY THEM—  
AT YOUR LOCAL JOBBER!**

EICO Instruments and Kits are on display at your local jobber—the nationally advertised kits which you can see and use before you buy. You take no chances with EICO!

Prices Higher on West Coast

Model HVP-1

**HIGH FREQUENCY RF PROBE**

Model P-75K germanium crystal probe for visual RF signal tracing and measurements to over 200 megacycles. Can be used with models 221 or 113A Eico instrument (state which when ordering). 6 1/2" long, 1/2" O.D., with wire, plugs, and all components. **\$3.75**  
IN KIT FORM..... **\$3.75**  
Model P78K same as above, but for model 400 Oscilloscope; in kit form..... **\$3.75**  
Models P75 or P76 similar to above but factory wired, ready to operate. Each... **\$7.50**

**EASY-TO-FOLLOW SCHEMATIC &  
PICTORIAL DIAGRAMS**

Come complete with every EICO instrument kit. Each kit fully guaranteed to operate perfectly when assembled according to our simple instructions. **EXCLUSIVE LIFE-TIME REPAIR SERVICE:** For a nominal charge, we will repair and service your EICO instrument, regardless of its age!



**ELECTRONIC INSTRUMENT CO., INC.**  
276 Newport Street, Brooklyn 12, N. Y.

# HANDY TOOLS FOR SERVICING

Every service technician needs certain special test instruments and tools, but a little ingenuity converts many ordinary items to valuable radio-repair implements. A practical repairman illustrates some of his own ideas. You will think of many more.

By H. LEEPER

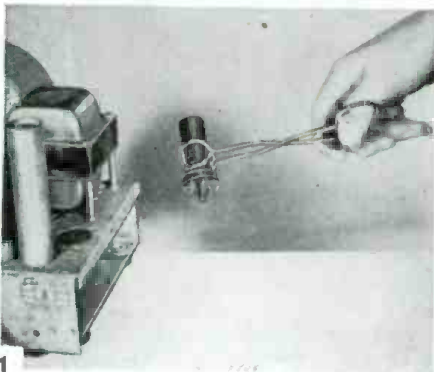

**Photo 1.** Start with a trip to your local department store to pick up a pair of kitchen tongs like those in the photograph. If you've ever tried to pull a red-hot metal tube out of its socket for replacement (and what service technician or experimenter hasn't), you will appreciate the cool comfort of removing the tube with the tongs. It's as good as a regular tube puller but costs less.

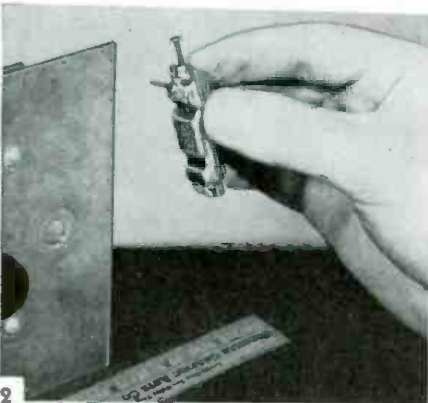

**Photo 2.** Everyone knows that all you need to scribe out markings on radio chassis and panels is a piece of metal with a sharp point; and you must have thought often that a phonograph needle would be ideal if there were only some way to hold it. Why not use an old crystal cartridge?

**Photo 3.** Suppress your embarrassment and buy one of those small hair-curling kits at the dime store, one with those convenient split, metal, rubber-tipped curlers. Clip them to chassis to keep the chassis from falling over or use them to anchor test leads to chassis or terminals.

**Photo 4.** Ever find yourself needing two hands for a job, when one of them is already holding a hot soldering iron—and not a stray ashtray in sight to rest it on? The book says you should have a regular iron holder; maybe it's hiding from you. Take a tip and keep a few of the large, old-style tube shields around the bench instead of in the junk box. They're fine iron holders!

**Photo 5.** A 4½-inch chrome reflector—you can find them at the camera store—keeps light out of your eyes and adds many lumens to the brightness of your probe lamp. Slip the upper part of the probe through the hole in the reflector and tighten the fit with tape.

**Photo 6.** No good repairman has holes in his pocket knowingly; but what he doesn't know may hurt him, especially if he carries small screwdrivers or alignment tools in the pocket. A metal toothbrush carrier like the one shown carries the tools neatly and requires a much bigger hole for loss.

**Photo 7.** When you want to concentrate a stream of liquid, you use a funnel. Why not do the same when you want a little spot of light for a delicate job? Tape the funnel over a flashlight lens. The holder in the photo was made from a clamp sold for holding flashlights to

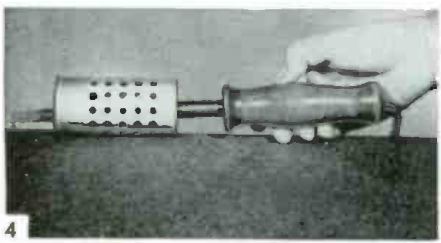
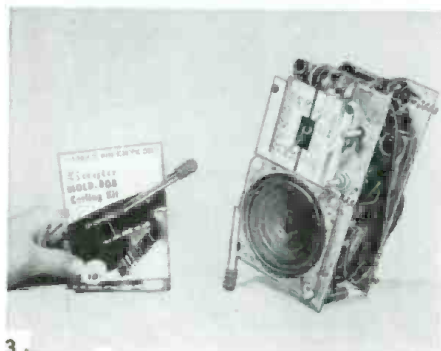
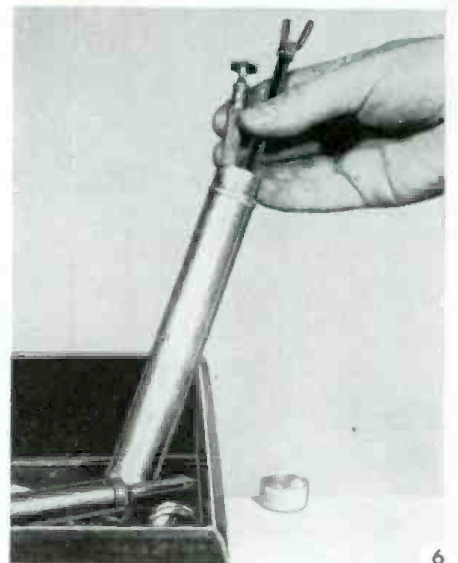
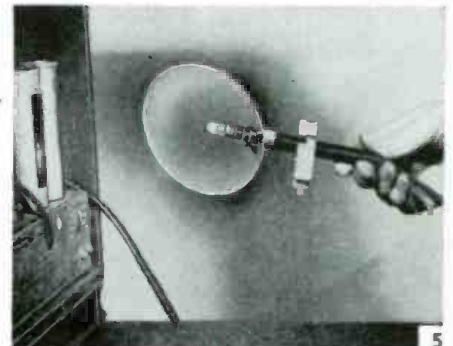





# To tell the **TRUTH\*** you'll find the **GREATEST BUYS at NIAGARA!**

## FAMOUS UTAH

15 and 25 Watt Potentiometers

Body: 2-11/16" dia., 27/32" depth behind panel. Bushing: 7/16" dia., 3/8" long. Shaft: 1/8" dia., 7/16" long from bushing. Effective rotation 300 degrees. Mounts in 7/16" hole. 15 W "PW" type wirewound on bakelite strip. 25 W "SW" type wire-wound on asbestos-covered steel strip, for greater heat dissipation. PV type has 3 terminals, no off position. SW type has 2 terminals with off position.

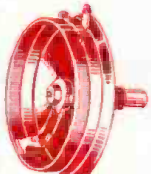

15W Stock No.	Resistance in Ohms	25W Stock No.	Resistance in Ohms
PW-100	100	SW-1	1
PW-150	150	SW-2	2
PW-200	200	SW-3	3
PW-250	250	SW-6	6
PW-300	300	SW-10	10
PW-400	400	SW-15	15
PW-500	500	SW-20	20
PW-800	800	SW-30	30
PW-3M	3000	SW-40	40
PW-5M	5000	SW-50	50
PW-7500	7500	SW-60	60
		SW-75	75
		SW-100	100
		SW-150	150
		SW-200	200
		SW-250	250
		SW-300	300
		SW-400	400

Stock No. PW-15 watt. ALL SIZES \$1.50. SPECIAL **39c**  
 Stock No. SW-25 watt. ALL SIZES \$1.75. SPECIAL **49c**

## TERRIFIC PRICE SLASH! BRAND NEW TUBES

TRANSMITTING		RECEIVING	
E1148	\$ .34	1H5GT	\$.50
2C26	.28	3A4	.27
5BP1	1.70	3B7	.29
10Y	.28	3D6	.29
211	.28	6C4	.20
603	3.63	6AR5	.54
805	3.63	6DS	.42
813	6.90	8K7GT	.43
815	1.37	69M7	.27
843	.38	68S7	.53
954	.18	7C4	.28
955	.18	12A6	.15
957	.18	12H6	.22
958A	.18	12K7GT	.49
1619	.18	12SH7	.29
1625	.18	12SR7	.29
1626	.18	28D7	.29
7193	.48	35L6GT	.48
9004	.18	50B5	.48
9006	.18	50L6GT	.48

ALL QUANTITIES LIMITED



### HEART OF THE BC-221 FREQ. METER

This VFO Sub-Assembly, used in BC-221 Freq. Meter, is ideally suited for home construction of:  
 1—Amateur V.F.O.      3—Portable Transmitter  
 2—Freq. Mtr. Foundation      4—Replacement for BC-221  
 Unit contains two temperature & moisture compensating coils, wafers switch, 3 variable condensers, carbon resistors, & silver mica condensers. FULLY WIRED & mounted on sturdy aluminum sub-chassis, ready for installation. Brand new—in original packing. N-276 Very special. **\$6.95**

### BT CUT 1000 KC XTAL

When used in above assembly, will make a fully self-contained harmonic generator from 125 KC to N-189 Special **\$4.95**

**IMPORTANT NOTICE:** Please include 20% deposit with C.O.D. orders, unless rated. Orders received without postage will be shipped railway express collect. Send us your inquiries today. We correspond in English, Spanish, French, Italian, Polish, Rumanian, Hebrew, German, Portuguese, etc. Prices subject to change without notice. All stock subject to prior sale. All merchandise f.o.b. N. Y. C. Minimum order \$2.00.

## MORE BARGAINS IN SURPLUS EQUIPMENT

1—2 or 3 of each • Check every line!

- Wilcox CW-3-110V Superbat Iterr. New... \$75.00
- Antenna Rotating Motor—RL-42A Reel Exc. 4.95
- W.E. XMTR MOD Comp. w/controls spares—New 225.00
- MN 260 Radio Compass—New 32.00
- MN260 Radio Compass—Used 26.95
- 733D Localized Receiver—Exc. 9.95
- AN-APN-1 Altimeter—L.N. 18.95
- APS-13 Receiver—Exc. 12.95
- TG-10 Code Keyer—L.N. 14.95
- 274N Modulator BC456A w/tubes Exc. 2.65
- 274B Modulator BC456A Pair less tubes 1.68
- SCN 322 Receiver BC624 Exc. less tubes 7.95
- SCR522 XMTR-BC625 Exc. less tubes 11.95
- BC 1000A Transceiver New 300.00
- BC 604 FM XMTR Exc. 14.95
- BC603 FM RCVR. Exc. 14.95
- BC 645 Transceiver. Contr. Box. Dyn. Instruction book. New 47.95
- T-17 Handmike 200 Ohm Imp. Exc. .69
- T-24 Handmike—7 Ft. Cord—Noise Filter—Plug—New 1.19
- PE 94 24V. DYN. for SCR522 Used L.N. 2.95
- Surplus Radio Conv. Manual Vol. 1 or 2 2.50
- BC 610 Tank Coll.—New 1.50
- BC 654 80 Meter XMTR & RCVR w/tubes & XTAL 34.95
- Collins 32 RA-7 XMTR VT GD. 125.00
- Telex Code Machines (Less tapes) Exc. 18.95
- ASD Radar Set Complete—New (Price on Request)
- ASD Parabolic Antenna—Rotable—L.N. (Price on Request)
- 2601A Parabolic Rot. Ant.—L.N. (Price on Request)
- R784 APS 15A Electronic Camera (Price on Request)
- Sig. Gen. Ferris #16C (Price on Request)
- BC221 Freq. Mtr. w/XTAL & Callb. Book L.N. 90.00
- LM Freq. Mtr. w/XTAL, Book, Mod. Exc. 90.00
- TBY Navy 6 & 10 Mtr. Bat. Transceiver 39.95
- RME69 RCVR. w/SPKR—VY. GD. 69.00
- BC-375 Tuning Units New—cased. 4.95
- BC-375 Tuning Units New—cased. 3.95
- GE 25 Watt Phone XMTR Model GF4A Pow. Sup. Exc. 29.95
- ATO 50 Watt XMTR New. 49.95
- JQ Navy 6V. Port. Audio Ampl. w/VIB. Sup. VY. GD. 9.95
- Gibson Girl Emergency XMTR. New 2.89
- BC 614 Speech Amplifier For BC610 L.N. 55.00
- W1252 Electronic Wavemeter 22-30 Mcs. Exc. 44.95
- BC 939 Ant. Tuner for BC610 L.N. 59.90
- Nat'l 1-10A RCVR. w/coils less Pow. Sup. L.N. 39.95
- BC 342 Navy Comm. RCVR. Exc. 69.95
- McMurdo Silver RCVR. Mod. 801 G-80 Mtrs. w/tubes L.N. 29.95
- Gen-Set 50-54 Mc. Conv. L.N. 24.95
- Beach 80 Meter VFO New. 19.95
- Handy 28.5-29.7 Mc. Conv. New 24.95
- BC-347C Interphone Amplif. L.N. 2.95
- Dynamator SA 5088 Imp. 18V./Out P. 150V. 4.95
- GP7 Tuning Units—New—cased. 4.95
- GP7 Tuning Units—Used—cased. 3.95
- GP7 Tuning Units—Used—no case. 2.95
- BC 376 W Model XTAL. Test Onc. Exc. 14.95
- BC-610 plug in tuning unit. new 3.50

## NIAGARA'S GOLD-PLATED SPECIAL!

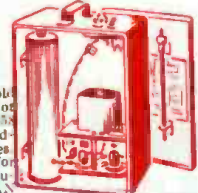

An ultra-high freq. Gold Plated Carly Resonator with a range of 234 Mcs. Fully wired. Including two 955 acorn tubes. Designed by the navy for use as a portable modulated test oscillator. **NEVER USED AS A MODULATED SIGNAL GENERATOR.** Battery compartment is large enough to house speech element and power supply. Making it a desirable portable UHF Transmitter for Ham use. Complete with tuning wrench, tubes, whip antenna, and circuit diagram on inside cover. Black wrinkle finished cabinet measures 9 1/4" x 8 1/4" x 6 3/4". *The Buy of a Lifetime!* Cat. No. N-257 **\$3.95** Special

## WAVE TRAPS

Traps consist of two slug-tuned all-verized coils and two ceramic condensers. All mounted on a cadmium plated bracket conveniently drilled and ready for mounting. May be used to eliminate FM sound bars in TV sets, eliminate amateur interference (shock excitation) in TV Herts. Match Hi-Lo TV antennas, and dozens of other uses too numerous to mention. They're going fast, so order yours today.



Cat. No. N-128 **3 for \$1.00** Special

## DOES YOUR TV SET DROOP FROM INTERFERENCE BLOOP?



## BANISH INTERFERENCE with New NIAGARA HI-PASS FILTER!

Positive protection against interference from amateur transmitters, ignition noises, duotherapy and all other devices generating RF interference. Designed to fit any 300 ohm antenna feeder. Absolutely no loss in brightness or clarity. Easily assembled. Complete instructions. FCC findings under actual test included.

anywhere in U.S.A. plus 15c post- age and handling. **\$1.95** per kit

## ATTENTION AMATEURS!



Don't be blamed for TVL. FCC tests have proven that Niagara's NEW LOW-PASS filter attenuates all frequencies above 40Mc. Skillfully engineered Modified Filter for 10, 20, 40, 80 and 160 meters prevents TVI while you're operating. Eliminates all harmonics above 30MC at 60DB or better, passes all frequencies below 30MC. Complete, nothing else to buy. FCC report included. **\$4.99** plus 25c shipping charges in U.S.

No. N-279

## BARGAINS IN NEW METERS

- 2" RD. Weston 0-2 RF Amps. \$3.49
- 2" RD. Westinghouse 0-5 A.C.V. 2.40
- 2" RD. Westinghouse 0-9 RF Amps. 4.95
- 2" RD. G.E. 0-10 DC Amps. 1.96
- 3" RD. Ass'd Brands 0-4 KV DC 1.96
- 2" RD. Ass'd Brands 0-1 R.F. Amps. 1.96
- 2" RD. W. Electric 50-50 Yos. Test. Sec. (0-1 MA) 2.95
- 3" RD. G.E. 0-30 KVD.V. 2.95
- 3" RD. — to +100 DB. (0-1 MA Basic-Illum) 3.65

**WRITE FOR NEW CATALOG "C"**

# Niagara Radio Supply Corp.

Phone Dlgby 9-1132-34

Dept. C20

160 Greenwich Street, New York 6, N. Y.

FOR A NEW HIGH IN  
**HIGH FIDELITY!**

**University**  
MODEL 6201  
**COAXIAL SPEAKER**



**CUTAWAY  
VIEW**

showing coaxial arrangement of rugged 12" cone and full size tweeter with cobra horn, built-in LC frequency dividing network and new super-efficient W shaped Alnico 5 magnet.



**CONTINUOUS POWER:**  
20 watts of integrated program material

**NOMINAL IMPEDANCE:**  
6-12 ohms

**FREQUENCY RESPONSE:**  
45 to 15,000 cycles

**Leading again in  
PRICE AND QUALITY!**

**ECONOMY**—The Model 6201 is one of the greatest coaxial speaker values ever offered. Despite its economical price, it offers no compromise in efficiency, response, or power handling capacity. A listening test in comparison with higher priced competitive speakers is the most convincing demonstration we can suggest to substantiate these claims.

**MANY NEW FEATURES**—These include an oversize woofer 2" voice coil capable of extreme excursion for perfect low frequency response, a professional driver—driven tweeter

unit with "cobra" shaped horn for clean, wide angle projection of the highs, and a built-in LC type frequency dividing network with a variable attenuator.

**UNIVERSAL REPLACEMENT**—The self-contained features of the Model 6201 permit rapid, easy replacement of any standard speaker for conversion to high fidelity reproduction. Only two wires to connect and the job is complete. Ample cable is provided for mounting the attenuator control in any convenient location.

WRITE DEPT. D FOR ILLUSTRATED CATALOG



**University**  
**LOUDSPEAKERS INC**  
80 SO. KENSICO AVE., WHITE PLAINS, N. Y.

Famous World-Wide for LOUDSPEAKERS • DRIVER UNITS • TWEETERS • PORTABLE POWRMIKES

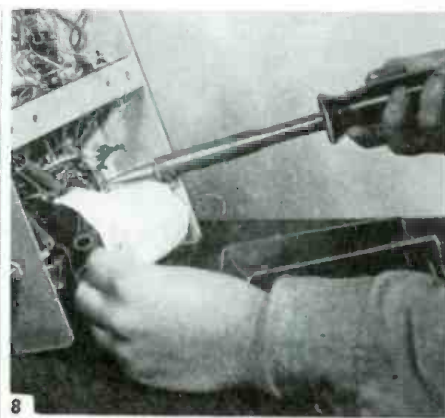

the steering columns of automobiles. **Photo 8.** A piece of asbestos paper may easily be worth several times its weight in burned capacitors and insulation. Before you stick your soldering iron in a tight place, cover the surrounding components with the asbestos.

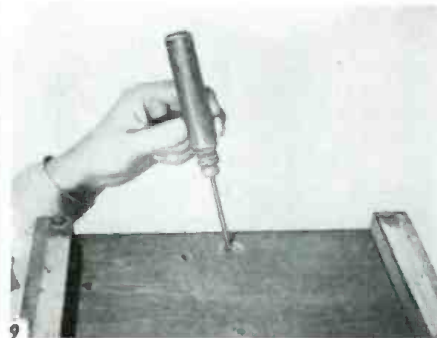

**Photo 9.** A radioman without an ice pick is like a painter without a brush. Use it to line up chassis holes with those in the cabinet, pick bits of solder out of unlikely places, strip shield braid from microphone cable, poke holes through solder-filled terminals—you could exhaust a ball-point pen writing down all its virtues!

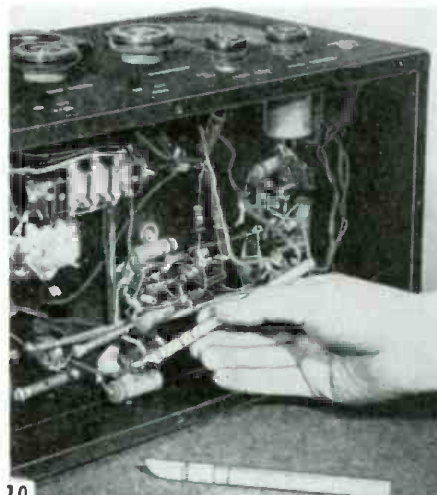

**Photo 10.** There are lots of tight places where you have to strip off insulation. When there isn't room to pull it off, you have to slice. When you try your jack-knife, you wish you had a surgeon's scalpel. Next best is a modelmaker's knife like the two in the photograph, X-actos or similar.

RADIO-ELECTRONICS for

# Order your **EICO** Test Instrument Kits NOW

## SAVE UP TO 50%

by building your own precision laboratory test instruments!  
Easy to build in one evening — They last a lifetime

from  
**ALLIED**

**\$19<sup>95</sup>**

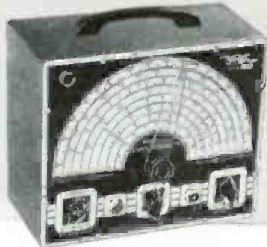

**\$23<sup>95</sup>**



**\$39<sup>95</sup>**

### SIGNAL GENERATOR

**Model No. 320-K.** An invaluable test unit for service, laboratory and school use. Highly stable Hartley oscillator has range of 150 kc to 102 mc with fundamentals to 34 mc. Ideal for quick alignment of FM-AM receivers; provides TV marker frequencies. Also supplies 400-cycle audio output from a Colpitts oscillator. Audio oscillator voltage can be used for testing distortion in audio equipment, bridge measurements, etc. Complete with tubes, portable case, etched panel, all parts, knobs, wire, shielded cable, instructions, diagrams, and operating manual. Size: 10 x 8 x 4 3/4". For 110-120 volts, 60 cycle AC. Shpg. wt., 10 lbs.

83-154. Only ..... **\$19.95**

### VACUUM TUBE VOLTMETER

**Model No. 221-K.** An easy-to-build, sensitive VTVM for making measurements in high-resistance circuits. 15 different ranges, with DC input resistance of 26 megohms. 4 1/2" meter is protected against burnout. Includes zero center for alignment of FM and TV discriminators. Double-triode balanced bridge circuit assures top stability. Ranges: AC-DC volts, 0.5-10-100-500-1000; resistance, 0-1000 ohms and 0-1-10-100-1000 megohms. With tubes, all parts, portable case, etched panel, wire, instructions, diagrams and operating manual. Size: 6 x 9 1/4 x 5". For 110-120 volts, 60 cycle AC. Shpg. wt., 10 lbs.

83-152. Only ..... **\$23.95**

### NEW 5-INCH OSCILLOSCOPE

**Model No. 425-K.** A sensational scope with all new features at amazing low price! With Push-Pull deflection! A precision instrument for TV, FM and AM alignment. Extra sensitive: .05 to .1 volts per inch. Wide range, flat from 5 cps to 500 kc, useful to 2 1/2 mc. Wide range sweep circuit from 15 cps to 75,000 cps. Direct connection to plates of CRT tube available at rear of cabinet. Complete with tubes (3-6SN7, 2-6J5, 5BP1, 2-5Y3 rect.), portable case, etched panel, all parts and knobs, wire, instructions, diagrams and operating manual. Size: 8 3/4" x 13 1/2" x 17" deep. For 110-120 volts, 60 cycle AC. Shpg. wt., 30 lbs.

83-155. Only ..... **\$39.95**

**\$14<sup>95</sup>**

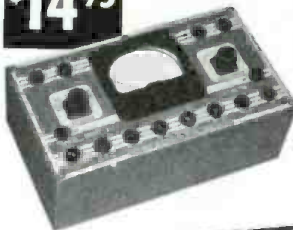

### VOLT-OHM-MILLIAMMETER

**Model No. 511-K.** A pocket-size reliable VOM. 3" meter. Germanium crystal for AC. Ranges: DC v., 0-5-50-250-500-2500; AC and output v., 0-10-100-500-1000; DC current, 0-1-10-100 ma, 0-1-10 amps; res., 0-500-100,000 ohms, 0.1 meg; decibels, -8 to +55. Complete kit, ready to assemble. Shpg. wt., 3 1/2 lbs.

83-153. Only ..... **\$14.95**

### SWEEP SIGNAL GENERATOR

**Model No. 360-K.** For visual alignment at TV and FM frequencies between 500 kc and 228 mc. For use with any scope. Sweep width variable from 0-30 mc. Crystal marker with variable amplitude. Provision for injection of external marker. Phasing control. Vernier dial calibrated in frequencies. Complete with tubes (2-6C4, 1-12AU7, 6X5GT rect.), all parts, shielded cable, portable case, panel, wire, instructions and operating manual. Less crystal. Size: 10 x 8 x 6 3/4". For 110-120 v., 60 cycle AC. Shpg. wt., 12 lbs.

83-159. Only ..... **\$29.95**

**\$29<sup>95</sup>**

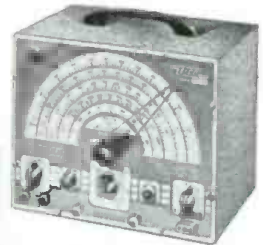

**FREE** SEND FOR YOUR 196-PAGE 1950 **ALLIED CATALOG** Radio's Leading Buying Guide

Get the only complete Radio Buying Guide in the field—the one book that fills all of your Radio, Television and Electronic supply needs! Get every buying advantage at ALLIED—world's largest stocks of quality equipment at lowest money-saving prices—speedy, expert shipment, personal attention, complete satisfaction on every order. Get your FREE ALLIED Catalog today!

**ALLIED RADIO**

Complete with Easy-To-Follow Diagrams and Instructions

### WE STOCK ALL EICO EQUIPMENT

Model T45-K Multi-Signal Tracer. 83-158. Only ..... **\$18.95**  
Model P-75K High-Frequency Probe Kit. 83-156. Only .. **3.75**  
Model P-76K H-F Probe Kit. 83-157. Only ..... **3.75**  
Model HVP-1 High Voltage Probe. 83-160. Only ..... **6.95**

(All Prices Net F. O. B. Chicago)

**ALLIED RADIO CORP., Dept. 2-BB-O**  
833 W. Jackson Blvd., Chicago 7, Illinois

Ship the following EICO equipment: .....

Enclosed \$ .....  Full Payment  
 Part Payment (Balance C.O.D.)

Send FREE 196-Page ALLIED Catalog

Name .....

Address .....

City ..... Zone ..... State .....

# Review of Recently Issued Tubes



At the left, 12AY7; at right, the 6BC5.

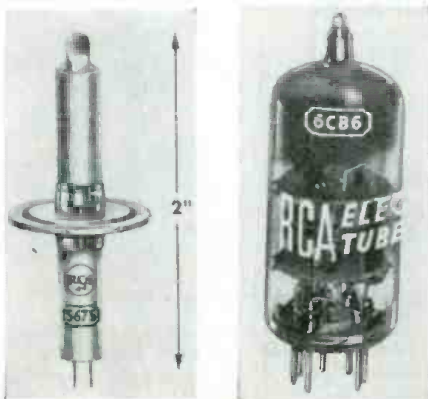
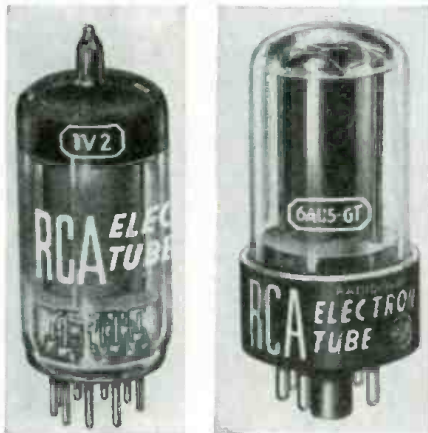

The new 16RP4 rectangular Pix

SEVERAL new tubes were announced last month. Three, by Sylvania, include the 12AY7, a miniature medium-mu duo-triode especially suitable for the first stage of audio amplifiers where noise and microphonics would be bothersome. A center-tapped heater provides for 6.3 or 12.6-volt operation.

Sylvania's 6BC5 r.f. amplifier is a sharp-cutoff miniature pentode with high mutual conductance, designed for r.f. and i.f. use in TV receivers. It is equivalent to the 6AG5 but has higher gain.

The other Sylvania type is the 6BQ6-GT, a horizontal deflection amplifier for TV. It is intended for transformer-operated sets where high peak interelectrode voltages are encountered.

RCA announces four types. The 6AU5-GT is a high-perveance beam-power amplifier. Its features include low mu, high plate current at low plate voltages, and a high ratio of plate to screen current. It is designed for use in horizontal deflection circuits where the plate voltage is supplied partly by the circuit and partly by the low-voltage supply of the receiver. One 6AU5-GT will fully deflect a 10BP4, 12LP4, or similar tube having a deflection angle up to 60 degrees and up to 12 kv anode voltage.

Type 1V2, also by RCA, is a high-voltage half-wave rectifier, a nine-pin miniature. When used in a doubler circuit transformer-coupled to a horizontal deflection circuit employing the 6AU5-GT, the 1V2 is especially suited to rectify the high-voltage pulses for the picture-tube anode.

The RCA 5675 is a new, "pencil-type," medium-mu triode for use in grounded-grid circuits at frequencies as high as 3,000 mc. As a local oscillator, it is capable of giving a power output of 475 mw at 1,700 mc and about 50 mw at 3,000 mc.

The 5675 utilizes "pencil-type" construction for minimum transit time, low lead inductance, and low interelectrode capacitances. Other features are small size, light weight, low heater voltage, good thermal stability, and convenience of use in circuits of the co-axial-cylinder, line, or lumped-circuit type. In grounded-grid circuits, the grid flange permits effective isolation of the plate circuit from the cathode circuit.

The "pencil-type" design employs a co-axial-electrode, double-ended structure in which the plate cylinder and the cathode cylinder, each only  $\frac{1}{4}$  inch in diameter, extend outward on opposite sides of the grid flange. The overall length of the structure is only  $2\frac{3}{8}$  inches.

The 6CB6 is a miniature sharp-cutoff RCA pentode designed especially for video i.f. amplifier service at around 40 mc. It is also well suited for use as an

r.f. amplifier in v.h.f. television tuners. Featured in the 6CB6 is very high transconductance combined with low interelectrode capacitances, and separate basepin terminals for grid No. 3 and cathode. The separate terminals permit the use of an unbypassed cathode resistor to minimize regeneration.

Hytron announces the 16RP4, the first commercially available rectangular television cathode-ray tube. The face of the all-glass tube has the standard 4-to-3 aspect ratio so that the entire screen is used for television pictures. Required cabinet space is approximately the same as that for a 12-inch round tube. Weight of the 16RP4 is about two-thirds that of round 16-inch glass tubes. The face has a neutral gray tint to increase contrast. Magnetic focus and deflection are used.

General Electric announces a new miniature, the 6BC5, designed principally for r.f. and i.f. service in television receivers. It is a higher-transconductance version of the 6AG5, with which it is interchangeable.

G-E has also put into production two miniatures for use in altimeters, radio compasses, control equipment, and high-frequency aircraft receivers and transmitters. These are the GL-5814 and the GL-5751. The former is a heater-cathode, medium-mu twin triode; the latter is a high-mu twin triode. Heater voltages are 6.3 at 350 ma or 12.6 at 175 ma. Maximum plate voltage is 330.

Eitel-McCullough has redesigned the 4E27 pentode for longer life, simpler cooling, and increased plate dissipation rating. The tube is rated at 125 watts plate dissipation in v.h.f. service.

Tung-Sol's new 5687 is a twin triode miniature for 6.3-volt, 900-ma, or 12.6-volt, 450-ma operation. Amplification factor of each section is 16.5 to 18, transconductance 4,100 to 11,000  $\mu$ mhos.

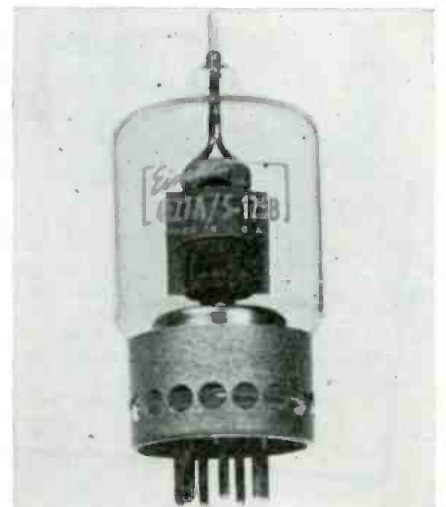

The newly redesigned Eimac 4E27A.

**CODE PRACTICE OUTFIT**

BY HARRY C. AICHNER, JR.

IT'S sure-fire! And you can take that literally. The compact, inexpensive, one-tube code-practice oscillator described here will take any except crystal headphones. In fact, you can use several sets of headphones and keys, or even PM speakers, for the unit will operate with almost any reasonable impedance as a load.

The oscillator was constructed on a piece of sheet metal, measuring 4 x 5 inches for easy mounting within the case of a commercial tape code-practice machine. Actually, the physical layout of the circuit is not important, and you could build your unit in a standard 3 x 4 x 5-inch cabinet and use it as an ordinary code-practice outfit.

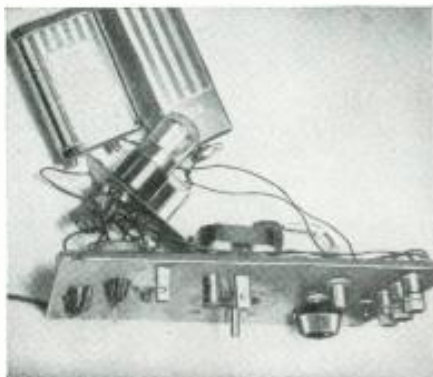

In the circuit proper, a 6J5 triode tube and a 3-to-1-ratio audio inter-stage transformer are employed to set up the required oscillations. Pitch of the signal is controlled by the .01- $\mu$ f paper capacitor and the three variable resistances.

Operating power is supplied by a 45-volt B-battery and a 6-volt A-battery. The latter lasts longer than it normally would because of the 10-ohm rheostat in the filament circuit. Most 6J5 and similar tubes do not need full 6.3 volts for their filaments in this circuit, so cutting down on battery use saves power.

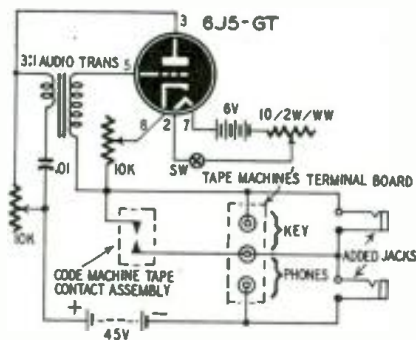

For convenience, standard phone jacks were installed in addition to the binding post terminals already on the tape machine panel.

A final word about the versatility of this oscillator. The author applied various impedance loads from 450 ohms to 10,000 ohms. At no point within this range did the unit refuse to oscillate!

FEBRUARY, 1950



**Loudspeakers  
are  
gaining**

*preference* **BECAUSE of**



Model PM-10G

1. Finer tone amplification with better aluminum voice coils that dissipate heat faster.
2. Stronger construction—a 3" speaker supports 300 lbs.l.
3. Non-fluttering because of vulcanized cones and spiders.
4. Fully weather-proof—(will even play when fully submerged in water).
5. Millions are chosen each year by the most expert radio technicians.
6. The Cletron line is complete with an Alnico 5 or E.M. speaker for every need.
7. Beautiful blue-grey Hammerloid finish, infra-red baked.
8. Individually packed in sturdy corrugated cartons.

**Cletron** Radio and TV loudspeakers handle greater power without distortion or overheating. No warping. No buckling. No corrosion.

Write or wire now for your best buy in Speakers. It's CLETRON.

**CLEVELAND ELECTRONICS, INC.**

6612 EUCLID AVENUE • CLEVELAND, OHIO

MORGAN EXPORTING CORP. • 458 Broadway Avenue • New York, New York

*Cletron The Choice of Expert Radio Technicians.*

**30-44 Megacycles FM**

**PR-30 Receiver For  
MOBILE CALLS**

Emergency thrills . . . hear "news in the making" . . . as it happens.

6 Tube superheterodyne, 115 volts, AC or DC. Now you may enjoy . . . **\$44<sup>95</sup>**  
 • POLICE • MARITIME  
 • FIRE • FORESTRY  
 • HIGHWAY TELEPHONE  
 LIST PRICE

PR-7 POLICALARM tunes 152-162 mc. \$39.95

See your dealer or write Dept. RE-3



**★ POLIC<sup>FM</sup> ALARM**

**RADIO APPARATUS CORP.**  
 303 FOUNTAIN SQ. THEATER BLDG.  
 INDIANAPOLIS 3, INDIANA

# FACTORY-TO-YOU MIDWEST RADIO and TELEVISION



**EASY TERMS**  
30 DAYS TRIAL  
The MIDWEST "CONSTELLATION"  
16-Inch Picture TELEVISION Console

Here is Television at its best! . . . brought to you by Midwest, the world's oldest and largest Exclusive Factory-To-You radio and television manufacturer. For 1950 Midwest offers a complete line of Television Consoles and complete ready-to-operate chassis (not kits) featuring the new giant 16-inch tube, clear, steady pictures, synchronized sound and pictures that a child can tune perfectly. Buy your Television direct from Midwest at Low Factory Prices, on Long EASY TERMS and 30 DAYS TRIAL. Send coupon for FREE 32-page, 4-color catalog TODAY.



Also a Complete New 1950 Line of  
**MIDWEST RADIOS**  
with new long distance FM Circuit and new 3-Speed Phonograph.

**Read What Midwest Owners Say:**

**"I Am Amazed at the Clearness of the picture!"**  
Bayonne, N. J.—I am more than satisfied with my new Midwest "Constellation" Television Receiver. I really am amazed at the clearness of the picture, the fine reception, and the general attractiveness of the set. Midwest Television is everything you said it was, plus a whole lot more.  
Charles Marzsa, 661 Avenue "E"

**"Midwest Television is So Easy to Operate"**  
Port Clinton, Ohio—I received my Midwest Television set about a month ago and I want to tell you how pleased I am with the performance. I can get clear reception from Toledo, Cleveland and Detroit without moving the antenna. Midwest Television is so easy to operate, too, I am actually very proud to own such a wonderful television set.  
Harry W. Winnie, 217 Fulton St.

**"My Midwest Television and Radio Are the Best I've Seen"**  
Wilkes-Barre, Pa.—Recently I bought a Midwest Television Receiver Chassis to supplement my Midwest Series 15 A.M.-P.M. Radio and I am well pleased with both. In my collection my Midwest Television and Radio are the best I've seen. Please let me know if I can secure one of your large console cabinets to hold my complete outfit.  
David M. King, 751 Rose Avenue

Write for FREE 32-Page, 4-Color Catalog or Paste This Coupon on 1c Post Card

Midwest Radio & Television Corp.  
Dept. X387, 909 Broadway, Cincinnati 2, Ohio  
Please send me your new FREE 1950 Midwest Catalog

Name \_\_\_\_\_  
Address \_\_\_\_\_  
City \_\_\_\_\_ Zone \_\_\_\_\_ State \_\_\_\_\_

# How to Become a Ham

## Part V—The factors that count in designing transmitter output tanks

By GEORGE W. SHUART, W4AMN

**B**ECAUSE you, the faithful follower of this series of articles, are probably well on the way toward earning that coveted amateur radio operator's license you have been preparing for, it is time to consider some factors in the design of the transmitter you will soon be building.

Reactance, impedance, and phase—though they may be important to the beginner—we will leave to handbooks and textbooks which are able to cover the subjects in greater detail.

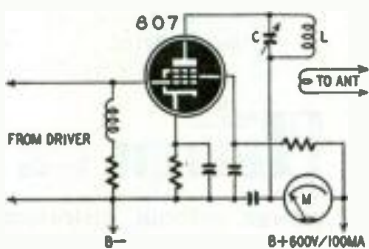

Fig. 1—The 807 r.f. output amplifier.

Every tuned circuit—your transmitter will probably have several—has capacitance (C) and inductance (L). There are almost endless combinations of L and C which will tune (resonate) at a given frequency. Regardless of the specific values of inductance and capacitance which will resonate at a given frequency, the product of the inductance in microhenries (μh) and capaci-

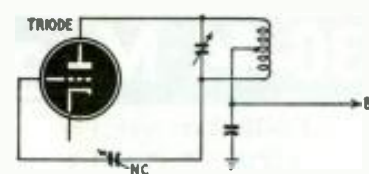

Fig. 2—Tube is across half of the tank.

tance in micromicrofarads (μmf) will always be the same for that frequency.

The product of LC for any frequency can be found from the formula:

$$LC = 25,330/f^2, \quad (1)$$

where L is in μh and C in μmf, and f is the frequency in megacycles. When the capacitance is large, we have a high-C circuit. A large value of inductance gives us a low-C circuit.

While there are many combinations

of capacitance and inductance which will tune to a given frequency, the efficiency of the circuit will be governed by the ratio of capacitance to inductance. (L/C).

Because of factors which we need not take up at this time, the Q of a plate tank circuit should be neither too high nor too low in class-C amplifiers. As a result, designers compromise and select a Q of 12 as the design factor. Because the total capacitance in the tank plays a large part in determining the Q of the circuit, we can use the formula

$$C = \frac{300 \times Q \times I_p}{f \times E_p} \quad (2)$$

to determine the total capacitance needed in the circuit. I<sub>p</sub> is the d.c. plate current in ma, E<sub>p</sub> is the d.c. plate voltage, f is the frequency in mc, and Q is 12.

Varying the capacitance is the most common method of tuning a circuit. Every variable capacitor has a capaci-

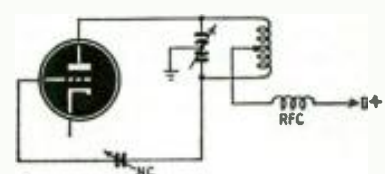

Fig. 3—Split-stator capacitor is used.

tance ratio which is C<sub>max</sub>/C<sub>min</sub>. For every tuned circuit, there is a similar ratio (F<sub>max</sub>/F<sub>min</sub>) between the maximum and minimum frequencies. This ratio of frequencies, called the tuning ratio, is equal to the square root of the capacitance ratio. Conversely, the relationship between capacitance and tuning ratios may be written

$$\frac{C_{max}}{C_{min}} = \frac{f_{max}}{f_{min}}^2 \quad (3)$$

Let us apply what we have learned thus far to the design of a tank circuit for a transmitter to cover the 80-meter band (3,500 to 4,000 kc or 3.5 to 4 mc). The frequency ratio of the tank circuit is 4.0/3.5 or 1.143. The capacitance ratio is (1.143)<sup>2</sup> or 1.3.

Our transmitter will have an 807 beam tetrode connected as shown in (Continued on page 72)



**164 large-size pages filled with**  
**Parts • Tools • Public Address**  
**High-Fidelity Components**  
**Radio & Television Sets and Chassis**  
**Test Equipment • Ham Gear**  
**Record Changers**

**FREE!**  
**THE GREATEST CATALOG**  
**FROM LAFAYETTE IN**  
**29 YEARS**

**Everything in Radio**  
**and Television at the**  
**Lowest "Net" Prices!**



This is, without question, Lafayette's greatest single bargain offer in ten years. It's our famous 11-tube (plus rectifier) FM-AM chassis. TODAY—priced at only \$59.50, and it includes a fine 12" PM speaker to match! Check the high-fidelity specifications shown above (11 tube circuit, tone control, phono pre-amplifier, push-pull 10 watt output). See if the performance of this high-fidelity chassis doesn't compare favorably with sets that have been selling as high as three hundred dollars or more! Remember: this is not a discontinued model but a chassis with proven circuits, delivering superb high-fidelity performance in thousands of custom installations!

Rush us your order for the high-fidelity buy of a lifetime. We don't expect our present supply to last long at this low price.

**NOTE:** Order the above chassis together with the new Webster 3-speed variable reluctance cartridge record-changer—and you have everything you need for a complete high-fidelity radio-phonograph custom installation!

Phono connector plug supplied at no extra charge when chassis and record-changer are ordered together.

**SALE!**

**LAFAYETTE'S FAMOUS FM-AM HIGH-FIDELITY CHASSIS. 11 TUBES plus RECTIFIER. Includes PRE-AMPLIFIER for variable reluctance pick-up.**

**PRICE NOW:**  
**\$59.50**

**INCLUDING MATCHED 12" PM SPEAKER!**

- Receives 88-108 MC FM band, 550 to 1700 KC broadcast band.
  - Latest 11-tube circuit plus rectifier.
  - Push-pull beam power output.
  - Rated at 10 watts, undistorted.
  - Automatic volume control.
  - Equipped with phono input jacks for low and high impedance inputs.
  - Full-range tone control.
  - Slide rule dial, indirectly illuminated.
  - Supplied with 2 indoor antennas (folded dipole for FM, loop for AM).
  - 12" PM speaker.
- 105-125 volts, 60 cycles, AC only. Chassis dimensions: 13 x 9 x 9 1/2. Shipping weight: 25 lbs. Complete with tubes, dial escutcheon, two antennas and matching 12" speaker: \$59.50

**DON'T** just take our word for it. Invest a penny postcard and send for your copy of the great new 1950 Lafayette Catalog. Then sit down with a pencil and paper and make a price comparison test yourself. Check the famous-make equipment, model for model, and see if Lafayette doesn't save you anywhere from a few pennies to a few dollars on most every item.

And remember—Lafayette gives you the service of a *national organization*, with 2 great centrally-located mail order centers and 6 strategic outlets for personal shopping. That means you save more money on postage, and get the parts you need a couple of days sooner.

So if you're a service man, experimenter, ham, hi-fi bug, engineer, or set-builder—send for your new 1950 Lafayette Catalog now. It's one of the biggest things in America you can get "for free"!

**Lafayette**  
**RADIO**

**2 Great Mail Order Centers:**  
**NEW YORK: 100 Sixth Avenue, New York 13**  
**CHICAGO: 901 W. Jackson Blvd., Chicago 7**

**29<sup>th</sup>**  
**ANNIVERSARY**

**6 Outlets for Shopping in Person:**

- NEW YORK: 100 Sixth Ave. and 542 E. Fordham Road (Bronx)
- ATLANTA: 265 Peachtree St.
- BOSTON: 110 Federal St.
- CHICAGO: 901 W. Jackson Blvd.
- NEWARK: 24 Central Ave.

**LAFAYETTE RADIO, DEPT. JB-50**  
**901 W. Jackson Blvd., Chicago 7, Ill.**  
**or 100 Sixth Avenue, New York 13, N. Y.**

- Check here for FREE 1950 Catalog.  
 (Please don't check if you have already received your catalog.)
- Please rush the Lafayette FM-AM chassis (including speaker) at the reduced price of \$59.50. I enclose \$\_\_\_\_\_ in postal note, money order or check, which includes shipping charges based on weight and zone. (Any surplus will be refunded.)

Name \_\_\_\_\_  
 Address \_\_\_\_\_  
 City \_\_\_\_\_ Zone \_\_\_\_\_ State \_\_\_\_\_

**PASTE COUPON ON PENNY POSTCARD**

**RUSH COUPON**

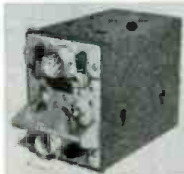

**PERMANENT MAGNET FIELD DYNAMOTORS—POWER SUPPLY:**

**POWER SUPPLY:**

12 or 24 Volt DC Input; output 275 Volt 110 MA.; 50 Volt 50 MA. Completely filtered and housed in metal case. These units were originally used with MARK II No. 19 radio sets and cost Govt. \$150.00. The dynamotors will operate on 6 VDC at approx. half the voltage, thereby giving you a good motor for car shaver or AC-DC radio operation and a power supply for your mobile receiver from 6 Volt auto battery. This power supply contains all of the items listed in the column to the right. Size: 8" H. 4" W x 10" D. Shipping weight: 62 lbs. Complete unit—Order No. **\$5.00** EFS #3.

**EACH UNIT CONTAINS THE FOLLOWING PARTS WHICH MAY BE PURCHASED SEPARATELY:**

- 1—Dym. 12/24 Input; output 275 V 110 MA. .... \$3.95
- 1—Dym. 12/24 Input; output 500 V 50 MA. .... 2.95
- 8—1 500 V Oil Tubular Cond. .... 1.00
- 2—1 1000 V Oil Tubular Cond. .... .50
- 2—15 MFD; 400 V DC Elec. Cond. .... .80
- 1—DPST 15 A. Toggle Switch. .... .40
- 1—3PDT 20 A. Toggle Switch. .... 1.00
- 2—Fuses Hlders & ¼ A. Fuses. .... .30
- 1—Pilot Light 12 V & Holder. .... .20
- 1—Flament & RF Chokes. .... 1.00
- 1—Spare Brush Kit. .... 1.00
- Also—Resistors, Plugs, Panel Chassis, Cable, Case, and Grill. .... 3.00

**WHIP ANTENNA EQUIPMENT MAST BASES—INSULATED (PICTURED AT RIGHT)**

- A. MP-132—1" heavy coil spring. 2" Insulator. Overall length: 11½". Weight: 2½ lbs. \$3.95
- C. MP-57—2" heavy coil spring. 5" Insulator. Price. .... \$3.95
- E. MP-37—2" heavy coil spring. 8" Insulator. Price. .... \$3.95
- B. MP-22—Spring action direction of bracket. 4" x 6" mounting. Price. .... \$2.95
- D. MP-48—2" heavy coil spring. 3" Insulator. Price. .... \$2.95
- F. MP-47—3" heavy coil spring. 9" Insulator. Price. .... \$5.95

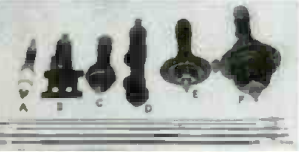

**BC-645-A TRANSCEIVER—ALSO 110 VOLT TRANSFORMER AND CHOKE**

15 Tube Transceiver ideal for conversion to 460 MC. Frequency coverage 435 to 500 MC. With conversion instructions. Price—NEW and BOXED. .... \$14.95  
**TRANSFORMER** for BC-645-A—110 Volt 80 cycle input; output 400 Volt 150 MA after filter. EH-9, and 5 V AC. 4 amps and 5 V. 3 amps. No. EH-645 \$6.95  
**CHOKE**—15 Hvy. 150 MA. No. EH-646. .... \$2.95

**SELSYN TRANSMITTER & INDICATOR SYSTEM**

Ideal for antenna direction indicator to remote position. Complete with Autosyn Trans. 3" 1-81 Indicator, Transformer, and instructions. Price \$6.75 Autosyn Trans. only. \$2.95. Plug 7/1-81: \$1.00  
**SELSYN #V**—110 V. 80 cycle C-78248 & Instr. Pair. .... \$5.95  
**SELSYN 2JIG1**—With CAPS & Instructions. Pair. .... \$3.00  
**FT-237** Mounting Base 1/BC-604-800's and 1/BC-684-800's. Prices: USED—\$7.00. NEW \$9.95  
**CABLE CO-213**—7 cond. #20 AWG; 2 cond. separately shielded within outer shield for all cond. Insulated, rubber covered. 35 ft. length. .... \$1.25  
**CABLE**—4 Conductor, shielded. 50 ft. length. .... \$2.00  
 Address Dept. RE • Prices F.O.B. Lima, Ohio • 25% Deposit on C.O.D.'s • Minimum Order \$2.00

**MAST SECTIONS FOR ABOVE BASES:**

Tubular steel, copper coated, painted, 3 foot sections, screw-in type. MS-53 can be used to make any length. MS-52-51-50-49 for taper. Any section. .... 50c Ea.  
 BAG BG-56 /carrying 5 sections. .... 50c

**DYNAMOTORS AND INVERTERS:**

Write us and tell your requirements. We have big stock to select from.

**BC-223 TRANSMITTER:** 30 Watt Trans. with crystal 30 M O control on 3 pre-selected channels. 2000 to 5200 KC. by use of 3 plug in coils. 5 Tubes. 2-801, 3-46. W/TU-17 Tuning Unit 2000 to 3000 KC & cable—NEW: \$24.95—USED: \$19.95.

**TUNING UNITS:** TU-18 3-4.5 MC. TU-25 4.5-5.2 MC. Either—NEW: \$9.50—USED: \$2.50

**PE-125 Power Supply 1/BC-223 Trans. 12/24 V. Input; output 300 V. 150 MA. NEW: \$9.95—USED: \$7.95** Cable only. Trans. to P.S. \$1.75

**TRANSFORMERS—110 Volt 60 Cycle Primaries:**  
 Sec. 12 V. 1 amp. .... \$1.50 Sec. 24 V. 2 amps. .... \$2.25  
 Sec. 24 V. 1 amp. 1.95 Sec. 24 V. .5 amp. .... 1.50  
 Sec. 36 VAC. 2.5 amps. .... \$2.95  
 Sec. 14-14 or 28 V. 7½ or 15 amps. .... 4.95

**BC-1206 RECEIVER—5 Tubes. 24-28 VDC. 200-400 KC IF Freq. 135 KC. Size: 4"x4"x6". LN \$6.95**

Fig. 1. We will operate it with a plate voltage of 600 and a current of 100 ma. Substituting our known values in Equation 2, the total tank circuit for resonance at 3,500 kc (3.5 mc) is

$$300 \times 12 \times 100 = 3.5 \times 100$$

or approximately 170 µf. Note that this is close to 2 µf per meter.

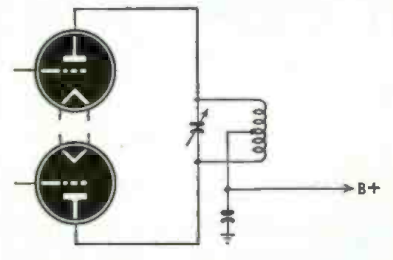

Fig. 4—A standard push-pull amplifier.

From the tube manual we find that the output capacitance of the 807 is 7 µf. Stray capacitance due to leads will probably double this value. Subtracting this 14 µf from 170 µf shows that we will have to add 156 µf to the circuit to tune it to 3.5 mc. When we mount our variable capacitor near the metal chassis, we greatly increase the fixed minimum capacitance and add to the over-all capacitance. Therefore we can use a capacitor smaller than 156 µf. A standard 150-µf capacitor will be about right.

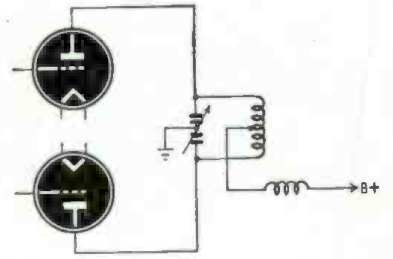

Fig. 5—Push-pull and split-stator unit.

Because a total capacitance of 170 µf is required to tune to 3.5 mc, and because the capacitance ratio is 1.3, the capacitance required to tune to 4 mc is 170 µf/1.3 or approximately 130 µf. This is well within the range of the 150-µf unit we will use.

Next we will need an inductor or coil for the tank circuit. Transposing the factors in Equation 1 we have:

$$L = \frac{25,330}{f^2 \times C}$$

where L is in µh, f in mc, and C in µf. Substituting in this equation, we have:

$$L = \frac{25,330}{4^2 \times 130}$$

$$L = 12.7 \mu h \text{ (approx.)}$$

Various formulas for winding coils having a specific inductance are given in a number of texts and handbooks and will not be discussed here. The type A Lightning Calculator published by A.R.R.L. is a circular slide-rule which will give winding data for almost any type of coil. Coil-winding instructions are also given in construction articles in amateur radio handbooks, of which you should have more than one by now.

If you don't care to wind your own (Continued on page 74)

**FAIR RADIO SALES 132 SOUTH MAIN ST. LIMA, OHIO**

**SAVE WITH SOVEREIGN!**

**\$84.50**

LESS TUBES

**COMPLETE WITH ALL TUBES INCL. C.R. TUBE**

- 10" KIT ..... \$129.50
- 12½" KIT ..... \$137.50
- 16" KIT ..... \$157.50

**THE "ALL PURPOSE" TELEVISION KIT 10" — 12½" — 16" MONEY BACK GUARANTEE**

- FEATURING**
- Latest Type of Circuits
  - AGC—Automatic Gain Control
  - Picture and Sound Automatically Locked
  - Sound Cannot Drift
  - Non-Microphonic
  - Stagger Tuned I.F. for Max. Gain and Ease of Alignment
  - 12 Channel Tuner
  - Electromagnetic Focus and Deflection
  - Automatic Stabilized Synchro-Lock Circuit Holds Picture Steady
  - Voltage Regulated Circuit for Stability
- Large clarified stage-by-stage pictures and schematics to insure ease of construction. Guaranteed to work. Money-Back Guarantee—Buy It, Inspect It, if you don't think it's the best buy on the market—return unused within 5 days and your money will be refunded. All prices F.O.B. New York. 20% deposit with order. IMMEDIATE DELIVERY. Any model wired up, tested, ready to play! \$20.00 additional.

**SOVEREIGN TELEVISION CO. 5508C New Utrecht Ave. Bklyn 19, N. Y.**

**EASY TO LEARN CODE**

It is easy to learn or increase speed with an Instructograph Code Teacher. Affords the quickest and most practical method yet developed. For beginners or advanced students. Available tapes from beginner's alphabet to typical messages on all subjects. Speed range 5 to 40 WPM. Always ready—no QRM.

**ENDORSED BY THOUSANDS!**

The Instructograph Code Teacher literally takes the place of an operator-instructor and enables anyone to learn and master code without further assistance. Thousands of successful operators have "acquired the code" with the Instructograph System. Write today for convenient rental and purchase plans.

**INSTRUCTOGRAPH COMPANY**

4701 Sheridan Rd., Dept. RC, Chicago 40, Ill.

**IT'S IN HERE!**

**THE MAGNETIC TAPE RECORDER YOU WANT**

Get the most complete tape recorder catalog ever compiled. Describes specialized models for every engineer, entertainer, businessman, recordist, etc. Exclusive new features, new recorders, new accessories. Big 16 page book. Write for your free copy.

**AMPLIFIER CORP. OF AMERICA**

398-10 Broadway New York 13, N. Y.



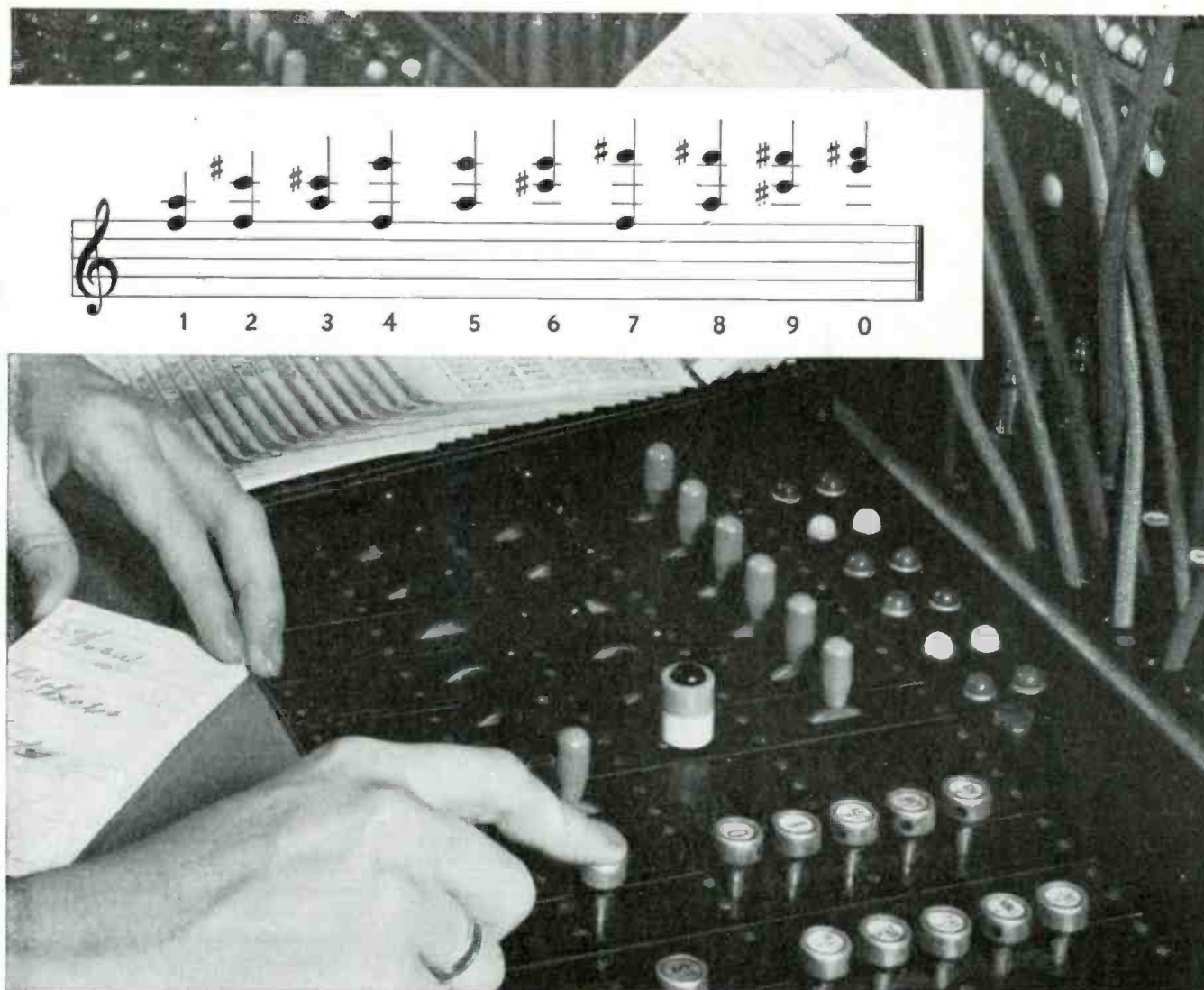

Above is the Bell System's new "musical keyboard." Insert shows the digits of telephone numbers in musical notation, just as they are sent across country.

## *Playing a tune for a telephone number*

Before you talk over some of the new Bell System long distance circuits, your operator presses keys like those shown above, one for each digit in the number of the telephone you are calling. Each key sends out a pair of tones, literally setting the number to music.

In the community you are calling, these tones activate the dial telephone system, to give you the number you want. It is as though the operator reached clear across the country and dialed the number for you.

This system, one of the newest developments of Bell Telephone Laboratories, is already in use on hundreds of long distance lines radiating from Chicago, Cleveland, New York, Oakland and Philadelphia, and between a number of other communities.

It will be extended steadily in other parts of the country — a growing example of the way Bell Telephone Laboratories are ever finding new ways to give you better, faster telephone service.

**BELL TELEPHONE LABORATORIES**

Exploring and inventing, devising and perfecting, for continued improvements and economies in telephone service





A MESSAGE TO  
**Service-Dealers:**  
**WORRIED ABOUT**  
**COMPETITION?**  
 Become the  
**TV SALES**  
 and **SERVICE**  
**CENTER**  
 IN YOUR COMMUNITY

- Beat competition at a profit.
- Stop being undersold — by anybody!

Here's a real opportunity to MAKE MONEY in Television. If you can qualify, you can become the Transvision Television Center in your community — and BUY TV and RADIO PARTS AT JOBBER PRICES. Practically no investment required. This offer is open only to service-dealers in territories where we do not have an authorized distributor. CONTACT US today!

**Now...16" WIRED TV CHASSIS**

Completely wired and aligned by TRANS-VISION. Specify: MODEL W16RS TV CHASSIS. List price, less C.R. Tube ..... **\$139**

Also available as a KIT which can be completed in ONE DAY. Specify: Model W16RS TV Kit; list price, less C.R. Tube ..... **\$119**

FILL OUT AND MAIL THIS COUPON NOW!

**TRANSVISION, INC.**  
 NEW ROCHELLE, N. Y.

Please ship THROUGH YOUR NEAREST LOCAL OUTLET: RE 2-50

I am enclosing 10% DEPOSIT in the amount of \$..... balance C.O.D. ( ) Send details of TV CENTER PLAN.

Name ..... (please print)

Address .....

City & State .....

coils, you will find that they are made for most amateur frequencies by such firms as Barker & Williamson, E. F. Johnson Co., James W. Millen, National Co., Inc., and a number of others.

Let's take another look at tank capacitors. The value we selected will work nicely for Fig. 1, but suppose that we had selected a triode which required neutralization. The circuit would then look like Fig. 2 or 3. In these circuits, the tube is connected across only one half of the tank circuit; therefore, the capacitance must be reduced to one-quarter of its calculated value C. Had we elected to use a split-stator capacitor as in Fig. 3, each section would

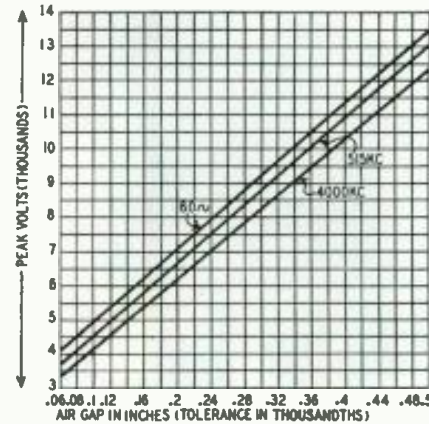

Fig. 6—Capacitor breakdown voltages.

have had to be 1/2 C for a total capacitance of 1/4 C. The coil inductance would then have to be increased four times (Equation 1).

Suppose that we had a push-pull amplifier. Its circuit would look like that in Fig. 4 if we used a single capacitor or like Fig. 5 for a split-stator tuning unit. In both these circuits, the effective capacitance must be 1/4 C.

We know what capacitance we need, but how shall we select the proper unit for the job? Capacitors are made in all sizes and shapes. Some have the plates very close together; you can push your finger between the plates of others. The peak voltage between the stator and rotor is the factor which determines the spacing between these elements. If we use a circuit from Figs. 1, 2, or 4, the d.c. voltage is applied to both sides of the capacitor and the only thing we need worry about is the peak-to-peak r.f. voltage, which equals the d.c. voltage in these circuits. To use a circuit from Fig. 3 or 5, we must select a capacitor having a breakdown rating of at least twice the d.c. plate voltage. If we plan to modulate this amplifier (use phone), capacitors in Figs. 1, 2, and 4 should be rated at twice the d.c. voltage while those in Figs. 3 and 5 should withstand four times the d.c. voltage.

Fig. 6 shows the peak arc-over voltage for capacitors having different air gaps. The ratings are for capacitors with 0.025-inch plates with polished surfaces and rounded edges. Thinner plates reduce the voltage rating by approximately 8% and square-edge plates reduce the arc-over rating by as much as 20%.

**MICROWAVE** WRITE FOR FLYER OF SURPLUS PLUMBING AND ACCESSORIES

- 10 CENTIMETER**  
 WAVEGUIDE TO 7/8" RIGID COAX "DOOR-KNOB" ADAPTER, choke flange and SILVER PLATED BROAD BAND ea. \$19.50  
 WAVEGUIDE DIRECTIONAL COUPLER, 27db Navy type CABV-47AAN, with 4 in. slotted section 32.50  
 SQ. FLANGE to rd choke adapter, 18 in. long OA 1 1/2 in. x 3 in. guide type "N" output and sampling probe 27.50  
 RIGHT ANGLE BEND 3" radius E or H Plain Circular flanges 17.50

- 3 CENTIMETER**  
 723 A/B KLYSTRON MIXER SECTION with crystal mount, choke flange and iris flange output 22.50  
 90 DEGREE TWIST, 6 inches long 8.00  
 2 WAY WAVEGUIDE DIRECTIONAL COUPLER, type N fitting 1 1/4" x 1/2" guide 28DB 18.50  
 "X" BAND PREAMPLIFIER, consisting of 2-723 A/B local oscillator-beacon feeding waveguide and TR/ATR Duplexer sect. incl. Pre Amp 67.50  
 5 FT. SECTIONS CHOKE TO COVER, Silver plated 10.00

- 1.25 CENTIMETER**  
 "K" BAND FEEDBACK TO PARABOLA HORN, with pressurized window 30.00  
 MITRED ELBOW cover to cover 4.00  
 TR/ATR SECTION choke to cover 4.00

- TEST EQUIPMENT**  
 MODEL TS-268/U Test set designed to provide a means of rapid checking of X-tal diodes IN21, IN21A, IN21B, IN23, IN23A, IN23B. Operates on 1 1/2 V dry cell battery 5267 35.00  
 3 CM. WAVEMETER Ordnance type micrometer head, NEW, Absorption type 85.00  
 9000-9500 Transmission type 82.50  
 10 CM. WAVEMETER W.E. type B-435490 Transmission type, Type N fittings, Veeder root micrometer dial, Gold plated, with calibration chart, P/o freq. meter X66401A, New 99.50  
 T889/AP VOLTAGE DIVIDER, Ranges 100-% for 2000 to 20,000 V, 10:1 for 200 to 2000 V. Input Z 2000 ohms. Output Z 4 meg. ohms. Flat response 150 cy to 5 mc. 42.50

- IN21 \$1.00 ea. \$ 8.30 for 10 CRYSTAL  
 IN22 1.50 " 14.00 " " DIODES  
 IN23 1.50 " 14.00 " "  
 IN26 3.00 " 27.50 " "

SEND FOR FLYER OF RADIO PARTS Rated Concerns Bend P.O.  
 Send M.O. or CHK. Mdse. Guardt. Shpg. Charges Sent C.O.D. Price F.O.B. N.Y.C. Phone DI. 9-4124  
**COMMUNICATIONS EQUIPMENT CO.**  
 131 Liberty St., Dept. C2 New York City 7, N. Y.

**SIX TUBE SUPER**

Three Gang Condenser

**\$33.30**  
 NET  
 Crowe Panel  
 Kit Included



Panel kit to fit most all makes (Please specify make of car and year model). New up-to-date latest priced Catalog available to dealers.

**Bill Sutton's**

Wholesale Electronics  
 5th of Commerce Fort Worth, Tex.



**"RADIO-TELEVISION Questions and Answers"**

A separate book for each element of the study guide questions pertaining to the various classes of commercial U.S.A. radio operator licenses. You need buy only those elements required for the license you want.

Element 2: Basic Theory and Practice  
 Element 3: Radiotelephony  
 Element 4: Advanced Radiotelephony

**85¢** AT YOUR DEALER — On mail orders from us, \$1 EACH postpaid for one, or 90¢ each for two or more.

**EDITORS AND ENGINEERS, Ltd.**  
 1305 KENWOOD ROAD SANTA BARBARA, CALIF.

RADIO-ELECTRONICS for

20-METER SCR-274-N

THIS data is strictly for hams. The schematic diagram shows the p.a. plate tank of the SCR-274-N transmitter. (Use either the 7-9.1-mc unit or the 5.3-7-mc transmitter set returned for 40 meters.) Open the lead from the stators of the parallel variable tuning capacitors. A good place to break the line is where the wire is soldered to the lug on the tank coil. Solder a midget three-plate capacitor (C in the diagram) on the tank-coil lug, making it self-supporting.

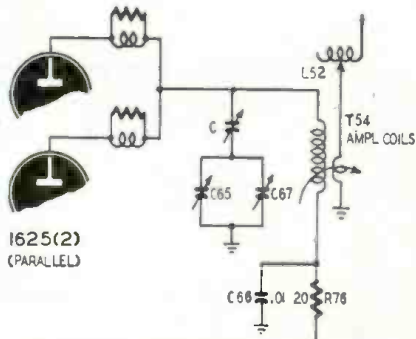

Using an insulated screwdriver, adjust the midget condenser while the transmitter is fired up, watching a resonance indicator. (A pilot bulb in series with a 3-inch-diameter closed loop will do fine; hold it near the tank coil.) When the bulb lights to maximum brilliance, showing resonance, you're through. Your 40-meter transmitter will now transmit on 20 meters with no further adjustments. What's more, the tracking between oscillator and p.a. stage is still correct, so that the dial calibration can be used.

If you're bothered about what you did—relax. The oscillator output contains harmonics, predominantly second and third. They are ordinarily insignificant in the output. Inserting the midget condenser and peaking it tunes the tank circuit to the second harmonic.

The assumption is that the harmonic being amplified is the second—thus doubling from 40 meters to 20. It could be the third. Better check before sending out a CQ.—Earle E. Greer, W8ZYH

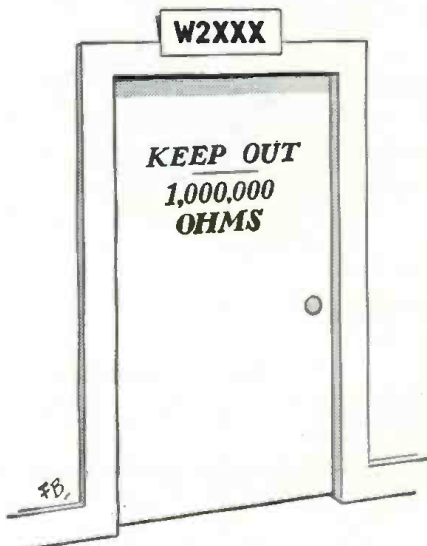

Suggested by V. B. Eupla, Yellow Springs, Ohio



Fits in the Palm of Your Hand!

A complete Transmitter and Receiver Kit for 75-80 meter C.W., incorporating these features—3 latest multipurpose tubes—Crystal controlled transmitter—Improved regenerative receiver—Built-in A.C. 110 V. power supply—Plug-in coil for receiver frequency change—Single control operates transmitter or receiver—Same antenna for transmitting or receiving. The "Mitey Mite" is ideal as a beginner's project or as an auxiliary for the old-timer. Tests have shown remarkably gratifying results. Get on the air with the "Mitey Mite," while rebuilding the main rig! Tube Line-up: 12 BA6 Det., 50B5 Xtal Osc.—Audio Amp. 35W4 Rect. Xmitter Pwr Impl. 4.5 W. Overall Dimensions: 7" x 5" x 3 1/2". Shipping Weight—3 1/2 lbs.

Immediate Delivery  
**ORDER NOW!**  
25% DEP. BAL. C. O. D.

**Complete MITEY-MITE Kit \$9.95**

(less key and headset)

**\*SCR-522 V.H.F. TRANSMITTER-RECEIVER** 100-156 Mc 10 tube receiver and 7 tube xmitter, rated at 8 to 10 watts output. Used extensively by Hams, Cabs, Busses, C.A.P., etc. Complete with tubes, Exc. condition. Shpg. Wt. Approx. 60 Lbs. **\$39.50**

**\*BC-604 FM TRANSMITTER** 25 W. output @ 100% modulation. Good condition, used. Less tubes, crystal and dynamotor. Shpg. Wt. Approx. 60 Lbs. **\$6.95**

**\*BC-423 MODULATOR** A sturdy and beautifully built RF Osc., variable: 125 to 210 Mc. (Approx.) pulse modulated at 4098 C.P.S. Uses 1-955, 2-6J7, 1-6F6 and 1-6W4. Operates at 115 V. 60 Cyc. May be modified for T.V. Generator, etc.

New with tubes. Shpg. Wt. Approx. 45 Lbs. **\$12.50**

**BUZZER PHONE (W.E.) EE1-A.** A complete unit consisting of a tone generator, buzzer, relay, key, headphone, switches, etc. Makes a very practical code practice set. Can be used in remote areas for signalling or communication. Housed in thick wooden case 3 1/2" L. x 6 3/4" H. x 6 1/4" W. Shpg. Wt. Approx. 16 Lbs. Like new with diagram. **\$4.50**

**\*TG-10 PHOTO ELECTRIC CODE KEYS** Used for code instruction. Uses 8 tubes: 1-923, 2-6J7, 2-6N7, 2-6L6 and 1-5U4G. Variable speed 115 V. 60 Cyc. motor. Housed in black wrinkled steel cabinet, 21" x 16" x 11 1/2". For 115 V. 60 Cyc. Less tubes, tapes and reels. Shpg. Wt. Approx. 110 Lbs. Very good condition. **\$14.50**

**\*BC-702 RADAR TRANSMITTER** Coaxial R.F. 2-R.E.L. #7 tubes, 4-2 x 2 Rect. tubes. Input: 115 V. 400 Cyc. and 12 or 24 V.D.C. Contains Blower motor assembly, 0-25 Ma. D.C. Meter and numerous other attractive components. Shpg. Wt. Approx 60 Lbs. New. **\$12.50.** Used. **\$9.50** with tubes.

**PERMEABILITY TUNERS**

For broadcast band. 3 slug tuned coils in one sturdily built assembly. R.F., Osc. and Mixer shielded. Two trimmers. New. 2 for **95c**

**METER SHUNT** Leeco-Neville. .005 Ohms 200 Amps. Mounted on Asbestos base and covered with perforated metal shield. New. Each **95c**

**\*MAGNIFIER REFLECTOR**

8" Dia. Parabolic. (Lancaster Lens) Metallic coated silver surface. Useful in photographic work. (Glass) Shpg. Wt. Approx. 1 1/2 Lbs. New—**\$1.95**

**ELECTRONICS SURPLUS PACKAGE**

A selection of parts, units and assemblies of varied description. A splendid value! 10 Lbs. **\$1.29**

**QUANTITIES LIMITED.** 25c packing charge on orders below \$2.00. Minimum deposit 25% on C.O.D. orders. Prices F.O.B. Chicago. **\$25.00** Minimum foreign order acceptable.

**JUST OUT!!!**

Write for our 1950 money saving flyer!!

**TRANSFORMERS, POWER TYPES, NEW, POPULAR MAKES**

- No. 103 510 V.C.T. @ 80 Ma. 5V. @ 4A. 6.3V. @ 3.8A. **\$1.69**
- No. 104 750 V.C.T. @ 110 Ma. 5V. @ 3A. 6.3V. @ 4.2A. **\$2.49**
- No. 105 750 V.C.T. @ 150 Ma. 5V. @ 3A. 6.3V. @ 5A. **\$3.39**
- No. 106 750 V.C.T. @ 220 Ma. 5V. @ 4A. 6.3V. @ 6.5A. **\$4.65**

**V.H.F. ANTENNA**

AT-59/TRC-7 Telescopic. Adjustable from 15 1/4" to 27 3/4". Mounts with standard coaxial male connector. Two sections. Locks at any setting. Light weight and low wind resistance. New—**\$1.39**

**RECORDING HEADS (SHURE)**

Magnetic. 4 Ohms at 400 cycles. With stylus screw. Finish slightly scratched. Otherwise good condition. Only **79c**

**V.H.F. TRANSCIEVER ASSEMBLY**

Has ceramic ins. 15 Mmf. tuning cond., 2 filament chokes, 1-acorn socket and filament bypass cond. Mounted on Poly. panel 1 3/4" X 3 1/2" X 1 1/4". Mounts upright with two 6-32 screws in bottom. New. Each **79c**, 2 for **\$1.50**



**DYNAMOTORS**

**DM 21-B DYNAMOTOR**—14 V. input. 235 V. @ 90 Ma. output. Completely shielded with filters. 5hpg. Wt.—5 Lbs. Brand new. Only—**\$2.49**

**MODEL DM-32-A DYNAMOTOR**—Input: 28V. @ 1.1 A. Output: 250 V. @ 60 Ma. For 274 N. Series Recvrs. With mounting. Shpg. Wt. Approx.—3 Lbs. New—**\$1.59**

**DM-33 DYNAMOTOR**—Input: 28V. Output: 540V. @ 250 Ma. Int. Shpg. Wt.—10 1/2 Lbs. New, in original cartons. Only—**\$2.69**, each.

**DM-34 DYNAMOTOR**—Input: 12V. @ 2.8 Amps. Output: 220 V. @ 80 Ma. With filters and plug. Shpg. Wt.—3 Lbs. Good Condition, used—**\$1.59**; Brand New—**\$2.19**

**MODEL DM-36-D (W.E.) DYNAMOTOR**—Input: 28V. @ 1.4A. Output: 220 V. @ 80 Ma. with filter. Used, in good condition. Shpg. Wt.—7 Lbs. Only—**\$1.29**

**NAVY TYPE DYNAMOTORS.** High efficiency PM. field units. May be used on 6 V.D.C. with 1/2 output voltage ratings. **MODEL #516 REC.**—Output: 275 V. @ 110 Ma. Input: 12 to 24 V.D.C. Shpg. Wt. 10 1/2 Lbs. Selling for—**\$2.50**; **MODEL #515 TRANS.**—Output: 500 V. @ 50 Ma. Shpg. Wt. 10 1/2 Lbs. Selling for—**\$3.50**

**FENWAL THERMOSWITCHES**

S-17. 115 V. 10 Amps. Set at 275 degrees, 3/8" D. X 4 1/4" L. Asbestos covered shielded leads. Variable from —100° to +400° F. at 90° per turn. New **95c**

**HARDWARE ASSORTMENTS**

No. 18 Solder lugs. All sizes and types. 3 Lbs. for **1.29**  
No. 19 Screws, Nuts, Washers, etc., 3 Lbs. for **1.29**  
No. 20 Aluminum Rivets. All sizes and types. 3 Lbs. for **1.29**

**FABRIC LOOM**

Weather-proof. Ideal for sieving on T.V. and FM antenna lead-ins, thru skylights and around corners. 1-D. 1/4", 1/2", 3/8". (Specify size) 50 feet, any size—**\$1.45**

**FILTER STRIP ASSEMBLY**

Bakelite strip contains 2-8 Mf. 450 V. PRS. type condensers, 1-6000 Ohm 20 Watt resistor and a few ceramics. New units, 3 for **\$1.00**



**\*TR-18 AIRCRAFT TRANSCIEVER**

Lear PXer. 6 tube unit. Receives and transmits in the 117 Mc. band. 195 Kc. to 405 Kc. Transmits on crystal freq. of 3105 Kc. Complete with tubes, mike, cables and power pack; 12 V.D.C. and instruction sheet. Ready to install. Guaranteed in excellent working condition. Total Wt. 15 Lbs. Ideal installation for small planes. **\$29.95**

**TUBE SOCKET AND SHIELD ASSEMBLY**

9 pin miniature, black Phenolic socket. New. Each—**25c**. 4 for **95c**

**RHEOSTATS**

Ohmite baked enamel wirewound. Air-cooled and shielded. Aircraft type. 90 Ohms at 1.35 Amps. Shipping weight—2 Lbs. New—**55c**

**CONDENSERS**

1 + 1 Mfd. 115 Vac.—**29c**; 3 Mfd. 330 Vac.—**49c**; 1 Mfd. 1000 V.D.C. Oil. 6 for **\$1.00**; 2 Mfd. 600 V.D.C. Oil. 6 for **\$1.00**; 1 Mfd. 2000 V.D.C. Oil. 3 for **\$1.00**; 3 Mfd. 2000 V.D.C. Oil. 2 for **\$3.45**; 3 Mfd. 2500 V.D.C. Oil. Each—**\$2.49**; 8 Mfd. 2500 V.D.C. Oil. Each—**\$8.50**

\* Shipped Railway Express or Freight. Only!

**UNITED SURPLUS MATERIALS**

314 SO. HALSTED ST.

CHICAGO 23, ILL.

**TAPE RECORDER**

Amplifier Corp. of America  
New York, N. Y.

A new continuous-play magnetic tape recorder, the Model 810-DV, eliminates the usual continuous tape loop. It will repeat any message from 1 second to 1 hour in duration.



Continuous repetition is achieved through double reversal of standard magnetic tape. Half the message is recorded on one sound track in forward tape travel, and the other half on the second sound track in reverse tape travel. Special solenoids reverse the direction of tape travel in both directions.

Intimate contact between the tape and the driving capstan of the recorder is secured with only 20 grams of pressure, thereby permitting 10,000 or more playbacks of a recording without noticeable drop in volume or wear in the tape. Another desirable feature is the presence of an auxiliary pair of contacts which provide a pulse for synchronization of auxiliary equipment such as slide projectors. Frequency response is 50 to 9,000 cycles at 7 1/2 inches per second of tape speed. An alternate model with a maximum message length of 30 minutes, operates at 15 inches per second with frequency response of 30 to 13,000 cycles. Cabinet dimensions are 13 3/4 inches high, 16 1/2 inches wide, and 14 1/2 inches deep. Net weight 47 lbs. Finish is grey leatherette.

**TELE TRANSFORMERS**

Standard Transformer Corp.  
Chicago, Illinois

The addition of three horizontal deflection output and high-voltage transformers to the Stancor line of television replacement transformers has been announced.

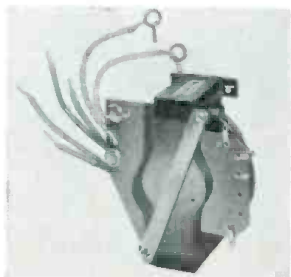

Included are the A-8119, an exact duplicate of RCA type 211T5, far use with the 16AP4 and similar kinescopes; the A-8127, an exact duplicate of RCA type 211T3 for use with the 10BP4; and the A-8128, designed to fill the need for a transformer between the 10 and 16-inch sizes and also for use in converting a smaller receiver to a 16-inch receiver.

**WIRE RECORDER**

Allied Radio Corp.  
Chicago, Ill.

The new Knight wire recorder plays 78-r.p.m. records and includes a phono oscillator. It records from microphone, records, or radio. A 5-tube amplifier and a PM speaker are built in.

**IMPEDANCE BRIDGE KIT**

Heath Co.,  
Benton Harbor, Mich.

The new Heathkit impedance bridge is an accurate instrument for measuring inductance, capacitance, resistance, Q, and dissipation factor. Ranges include inductance from 10  $\mu$ h to 100 h, capacitance from 10  $\mu$ uf to 1,000  $\mu$ f, resistance from .01 ohm to 10 megohms, dissipation factor from .001 to 1, and Q from 1 to 1,000. The main control and hummer are General Radio components. Ceramic, noninductive resistors of 0.5% accuracy, ceramic switches, and a zero-center, 200- $\mu$ a meter are other features. All parts, marked panel and case, and complete assembly instructions are furnished.

**TV SIGNAL GENERATOR**

Electronic Instrument Co., Inc.,  
Brooklyn, N. Y.

A crystal marker oscillator with variable amplitude is one of the features of the new model 360 TV-FM sweep signal generator.

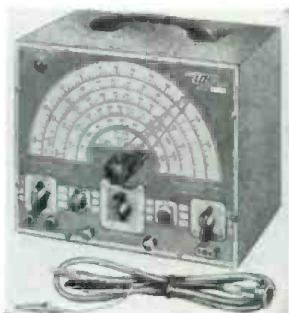

Available in either kit or wired form, model 360 covers all TV and FM alignment frequencies between 500 kc and 228 mc.

Other features are: sweep width variable from 0-30 mc with mechanical inductive sweep, gain comparison of adjacent RF TV channels, injection of external signal generator marker, phasing control, dial directly calibrated in frequencies, stable oscillator. Size is 10 x 8 x 6 1/4 inches. Tubes are 6X5GT, 12AU7, and two 6C4's.

**TELEVISION BOOSTER**

JFD Mfg. Co., Inc.,  
Brooklyn, N. Y.

The Video Beam, model TV10, is said to have flat response over the TV spectrum, with separate circuits for high and low bands. Fine tuning controls are provided for each band. The booster matches all television receivers.

**MINIATURE ELECTROLYTICS**

Aerovox Corp.,  
New Bedford, Mass.

Miniaturized electrolytic capacitors handling full-sized functions, known as the Bantam or type SRE, are announced.

Bantams are hermetically sealed in tubular aluminum cases with wax-impregnated cardboard insulating jackets. New stud terminals provide maximum creepage distances between terminals and can. Leads are No. 18 gauge finned copper.

**INDOOR ANTENNA**

Circle "X" Antenna Corp.,  
Perth Amboy, N. J.

The Circle X antenna described in the August, 1949, issue is now available in modified form as an indoor TV antenna. It covers the complete television band with little adjustment and has a high gain.

**MULTISECTION POTENTIOMETERS**

International Resistance Co.,  
Philadelphia, Pa.

This new product allows the service technician and experimenter to make up his own ganged potentiometer assemblies from a wide variety of types. Known as Multisections, the new units are complete control sections that can be added to standard miniature-type Q, PQ, or RQ controls, just as switches are attached. Each Multisection adds 19/32 inch to the basic control. As many as three can be added to make a quadruple control.

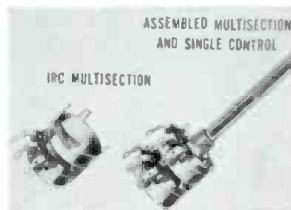

No special tools are required for assembly. Seventeen standard resistance values are available from 1,000 ohms to 10 megohms.

**YAGI TV ANTENNA**

Trio Mfg Co.,  
Griggsville, Ill.

A new Yagi-type antenna with a double folded dipole has been announced. It provides improved performance with light weight (5 pounds for channel 5). A model is available for each TV channel. Gain is 10 db on tuned channel, front-to-back ratio over 25 db. The pattern is sharply directional.

**GERMANIUM DIODES**

Sylvania Electric Products  
New York, N. Y.

Compact, moisture-proof, germanium crystal diodes enclosed in hermetically sealed glass cartridges are available in two types: IN34A, a general-purpose diode; and IN58A, a 100-volt diode.

Electrical characteristics, ratings, and prices of the new "glass"-type crystals are the same as those for corresponding "ceramic" types which have been marketed by Sylvania since the war.

**VOLTMETER PROBE**

Insuline Corp. of America  
Long Island City, N. Y.

A new multiplier probe for voltmeters, called the Kilovolt, adds 15,000 volts to the scale readings of



high-resistance voltmeters used in radio servicing. Three models are available, for 50-, 100-, and 200- $\mu$ a meter movements.

**RIBBON-LINE STRIPPER**

Holub Industries, Inc.,  
Sycamore, Ill.

Baring the ends of the 300-ohm ribbon lead so extensively used for television transmission lines is a nuisance at best. The Hi A-TV Stripper neatly removes insulation of both leads at the same time in one "squeeze." It will also cut the lead and strip other types of wire without changing blades.

**CRYSTAL MICROPHONE**

Electro-Voice, Inc.,  
Buchanan, Mich.

The Spherex is an omnidirectional crystal microphone with response from 60-7,000 cycles. Output level is -50 db. Net weight is 8 ounces.

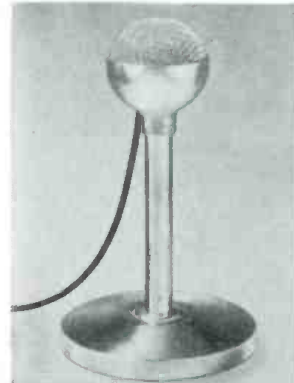
**FM/AM RECEIVER**

Collins Audio Products Co.,  
Westfield, New Jersey

The 44-B is a high quality FM/AM receiver embodying in one radio-chassis all the features for high quality listening. It uses 26 tubes, two of which are voltage regulators. Among its

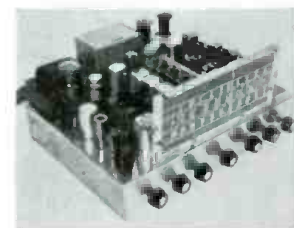

other features are a 12-tube FM circuit, push-pull triode amplifier, FM squeelch, broadband AM circuit, 10-microvolt sensitivity on FM, and an equalizer tube for magnetic phono cartridges.

**LINE STANDOFFS**

South River Metal Products Co.,  
South River, N. J.

Three new versions of standard line insulators for 300-ohm transmission line have been introduced. The first type may be fastened to the mast, the second is a nail-on, and the third has a screw base. Any of the three types may be had with dual insulators to handle a pair of lines.



# NEW TELEKITS

NOW **49.95**

Jobbers: Write for Confidential Price Information

NEW  
TELEKITS  
10-B \$69.95  
7-B \$49.95  
LESS TUBES



Sparkling new Telekit 10-B has 52-inch screen. Brand new compact lay-out has video tube mounted on chassis. Big illustrated easy-to-follow instruction book guides you step by step through easy assembly. No special knowledge of television is required. All you need is a soldering iron, pliers, and screw driver. 10-B Kit can be used with 12½, 15, 16-inch tubes. Telekit 10-B, \$69.95. 10-B Telekit cabinet, \$15.95 and \$24.50. Satisfactory Telekit Performance Guaranteed by Factory Service Plan.

Write for catalog listing 10-B and 7-B Telekits. New 7-B Telekit for 7-inch tube, \$49.95. 7-B cabinet \$15.95 and \$24.50.

TELEKIT  
BOOSTER  
\$12.95



If you live in a fringe area this fine Telekit booster will bring in TV signals bright and clear. There is a 20 to 30 times signal boost on all channels. NOT A KIT. Completely assembled with tubes. Works with Telekit or any other TV receiver.

13  
CHANNEL  
TUNER  
\$12.95



NEW 13 CHANNEL TUNER is a small compact unit with stage of R.F. Tunes all TV channels. Made to conform with Telekit or any other TV set having video I.F. of 25.75 Mc. Complete with tubes, pre-wired pre-aligned; only four connections to make. See your jobber, or write to us for information. Your cost, \$12.95.

Write for catalog of Telekit antennas, boosters, television kits, tuners, television parts and tubes.

**TELEKIT**  
ELECTRO-TECHNICAL INDUSTRIES  
1432 N. BROAD ST. DEPT. 8 PHILADELPHIA 21 PA.

## Radio Thirty-Five Years Ago

In Gernsback Publications

### HUGO GERNSBACK Founder

Modern Electrics .....	1908
Electrical Experimenter .....	1913
Radio News .....	1919
Science & Invention .....	1920
Television .....	1927
Radio-Craft .....	1929
Short-Wave Craft .....	1930
Television News .....	1931
Wireless Association of America .....	1908

Some of the larger libraries in the country still have copies of ELECTRICAL EXPERIMENTER on file for interested readers.

### IN THE FEBRUARY 1916 ISSUE OF ELECTRICAL EXPERIMENTER

Latest De Forest Radio Apparatus  
New French Radio Instruments  
American Optical Co. Installs Radio Time Set  
Dubilier Multiple Musical Tone Radio System  
The Electric Arc and Its Interesting Application, by Morton W. Sterns  
A Compact Radio Detector Cabinet  
Determining the Lag Between Arlington and Key West Radio Time Signals  
9,000-Mile Radio A New Record  
Construction of a Collin's Radiophone Arc, by H. Winfield Secor  
A Silicon "Tikker"  
A Novel Detector, by G. F. Exner  
1,000 Foot Collapsible Radio Mast

### REPAIR WHILE YOU WAIT

The Belmont Radio Service in Washington, D.C., has come up with an unusual idea in radio servicing. This neighborhood radio repair and appliance shop specializes in fixing receivers while the customer waits; from 75 to 90% of the store's business is done this way.

The owner, Bud Sickmen, who has been operating Belmont for almost a year, says that among other advantages is the fact that customers who watch the work being done lose some of the suspicious attitude people so often have about radio repairs.

### NO PERMANENT STYLI

So-called "permanent" phonograph needles are far from permanent, according to an article in the *Permo Reporter*, issued by Permo, Inc., producer of the Fidelitone styli. The writer points out that when two materials rub—record and stylus—there is inevitable friction and wear.

The point of a phonograph needle contacts the record groove with a pressure of 6,000 to 25,000 pounds per square inch. The friction-generated temperature is in the order of 1,000 to 2,000 degrees F. Both needle and record lose material. The jagged needlepoint that results then tears the record, so that the process is cumulative.

After the recent war, many cartridges were made with permanent points, replacement of which necessitated replacement of the entire unit. Manufacturers are now recognizing the stylus' impermanence and redesigning cartridges so the needle can be replaced.

### SMALLEST B-BATTERIES

The tiniest hearing-aid B-batteries ever produced commercially were introduced recently by Olin Industries, Inc., New Haven, Conn. Available in two voltages, the batteries are built up from interlocked midget plastic cells, each producing a potential of about 1.5 volts. The square cells are almost flat. Thus merely stacking them in "layer-built" fashion connects them; there is



no need for soldered connections, the breaking or corrosion of which often results in trouble in multicell batteries.

The photograph shows the two sizes. The 15-volt unit at the left is made of 10 stacked cells and measures about 5/8 inch square and 1 inch long. The 30-volt unit at the right is made of two 10-cell stacks and is approximately twice as large.

In the photo the plastic framework of one of the cells is shown on a man's finger, the aspirin tablet beside it illustrating its small size. The new batteries are expected to make possible hearing aids smaller than a package of cigarettes.

### RADAR AFFECTS BIRDS

Birds were observed recently to follow strange flight patterns in the vicinity of radar transmitters, the British publication *The Sphere* reported. The story mentioned American observations of the phenomenon early in the year, then told of what has been going on at a radar-equipped lighthouse in the English Channel. Swallows fly madly about the tower on which the antenna is mounted, finally falling into the sea in exhaustion.

Bird watchers will observe future flights with great interest, to see how new radar installations (especially the radar "fence" to be erected around the U. S.) will affect birds' seasonal migration habits.

### CORRECTION

A connection to the bias line was omitted from Fig. 2 of the article "Revamping a 630-Type TV Set," on page 39 of the January issue. Connect the junction of R1 and the 82,000- and 10,000-ohm resistors in the a.g.c. detector circuit to the -100-volt point in Fig. 1 on the same page.

RADIO-ELECTRONICS for

**ELECTRONIC LITERATURE**

Any or all of these catalogs, bulletins, and periodicals are available to you if you write to us on your letterhead (do not use postcards) and request them by number. It is necessary to send only the number of item you want. We will forward the request to the manufacturers, who in turn will send the literature directly to you. This offer void after six months.

**FY-1—PHONO NEEDLE CROSS-INDEX**

Jensen Industries, Inc., is introducing a replacement needle chart which lists replacement needles, needlepoint material, size, name of cartridge the needle is designed to fit, name of the phonograph using the cartridge, brief installation instructions, and the list price.—*Gratis*

**FY-2—OSCILLOGRAPH BOOKLET**

The new Du Mont type 304 and 304-H cathode-ray oscillographs are described in a 12-page booklet issued by Allen B. Du Mont Laboratories, Inc. The booklet contains simplified schematics and a description of the various circuits, as well as photographs of various patterns which may be viewed on the scopes.—*Gratis*

**FY-3—GUIDE TO HI-FI MUSIC**

A 12-page booklet of information for the layman, the "High-Fidelity Music Guide," prepared by David Randolph, music consultant for Lafayette Radio. It consists of a glossary of some of the terms used to describe audio reproducing equipment, a definition of high-fidelity, and descriptions of various pieces of commercial equipment which can be used in custom installations.—*Gratis*

**FY-4—THEATRE TV BOOKLET**

A 16-page booklet, "Theatre Television Facts Every Theatre Owner Should Know," (Form 2R6154) has been released by RCA Theatre Equipment Sales Division. It briefly describes the instantaneous projection and intermediate film methods of projection. The booklet answers a number of questions likely to be asked by persons interested in theatre television.—*Gratis*

**FY-5—CROSSOVER NETWORK DATA**

Racon Electric Co. has released a four-page bulletin of practical instructions and a wiring diagram for building a 1-kc cross-over network. A range of inductance, capacitance, and resistance values is given for speaker impedances from 4 to 16 ohms. Coil-winding data is given for the specified inductances. Information on installation of woofers and tweeters is also included.—*Gratis*

**FY-6—APPLIANCE CATALOG**

The latest catalog issued by the Sheldon Electric Co., division of Allied Electric Products, Inc., lists various types of line plugs, cube taps, low-voltage, high-current rectifiers for battery chargers, movie projectors, and similar applications, flood and spotlights, and fluorescent starters. Inserts giving electrical and mechanical specifications on 11 television picture tubes are also included.—*Gratis*

FEBRUARY, 1950

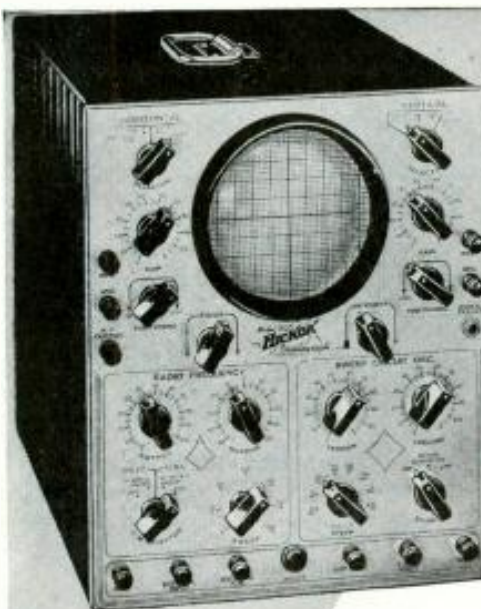

**5" Scopes**

for Television

and FM

by

**HICKOK**

**Model 505A Illustrated**

Contains built-in FM Oscillator for visual alignment. The only complete serviceman's 'Scope.

**Model 195B**

Another popular HICKOK 'Scope. Most practical sensitivity. An ideal companion for the HICKOK 610A TV Generator and the 288X FM-AM Generator.

**Greater Sensitivity—Higher Frequency**

The only complete Cathode Ray Oscilloscope. Contains new 5-UP 5" tube voted the most popular size for service work. Built with the famous HICKOK accuracy and providing the following HICKOK features:

- Wide band amplifiers—20 cycles to 1 m.c.
- Highest practical sensitivity
- Demodulator and phasing control
- Return eliminators
- Sinusoidal and linear sweep
- Built-in FM Oscillator (505A only)

Safeguard your service reputation with the highest quality equipment. Make your HICKOK equipment part of your sales talk—you'll build customer loyalty along with sound profits.

See your jobber or write for complete information today.

World Famous

For over 35 years... the finest in electrical and electronic instruments

**THE HICKOK ELECTRICAL INSTRUMENT CO.**

10531 DUPONT AVE.

CLEVELAND 8, OHIO

**FY-7—NEW RIDER TV MANUAL**

John F. Rider Publisher, Inc., announces that TV Manual Volume III is now available. A How It Works book and a cumulative index to the three TV manuals are supplied with the volume.—*Price \$21.00*

**FY-8—TV ANTENNA CATALOG**

Radiart Simpli-Flex television antennas are listed in this 8-page folder, which is punched for insertion in an 8½ x 11 binder. All the usual types of antennas are shown, with brackets, accessories, and so on.—*Gratis*.

**FY-9—TELEMETERING SYSTEMS**

General Electric's 19-page bulletin GEA-5233 describes the newest G-E telemetering equipment for electric

power distribution and industry. Detailed information is given on frequency, torque-balance, and photoelectric systems, with diagrams of typical installations.—*Gratis*

**FY-10—COIL CATALOG**

An 8-page catalog lists all FM and TV coils made by Stanwyck Winding Co., Newburgh, N. Y. Exact replacements are given for RCA and Transvision receivers as well as universal types. Schematics are shown of the circuits for which the coils are designed.—*Gratis*

**FY-11—WIRE MARKERS**

An 11-page booklet (Bulletin 349) describes the uses of E-Z code wire markers in considerable detail.—*Gratis*



## Radio Servicemen

FREE 1949-50  
CATALOG

Wards Electronic Equipment Catalog contains nationally known test instruments for the radio serviceman. Has everything from pocket-size meters to large oscilloscopes, including new models for servicing FM, AM and television.

Also features high quality Sound Systems, television sets and accessories, amateur gear, and high fidelity radio components for home installations.

ALL MERCHANDISE AVAILABLE ON  
WARDS MONTHLY PAYMENT PLAN

Pay Only 10% Down

Mail coupon for your free Catalog

MONTGOMERY WARD, Dept. RE-2, Chicago, Ill.  
Please send my free copy of Wards new 1949-50  
Electronic Equipment Catalog.

Name \_\_\_\_\_  
(Please PRINT Name and Address plainly)

Street Address \_\_\_\_\_

Or Route \_\_\_\_\_ Box \_\_\_\_\_

Post Office \_\_\_\_\_ State \_\_\_\_\_

### MOTOROLA 7-INCH TV

The vertical sweep drifted until it was impossible to hold the picture after the set had operated continuously for an hour or more. We removed the .05- $\mu$ f, 600-volt capacitor from the vertical multivibrator and replaced it with one having a higher voltage rating. Tests on the unit removed showed its leakage resistance to be more than 1,000 megohms cold and approximately 50 megohms when slightly warmed with a soldering iron. The leakage tests were made at 600 volts.

This trouble can occur in almost any set having multivibrators in the sweep circuits.—*Gray Trembly*

### HALLICRAFTERS TV-505

If the picture is out of focus and is not correctable with the focus control, look for an open resistor in the bleeder of the high-voltage supply.

When the raster is intermittent and the sound is OK, check the adjustment of the high-voltage oscillator. If this stage is not properly adjusted, the oscillator will be intermittent.—*Charles F. Otto*

### ADMIRAL 20A1, 20B1 and 21A1

Audio output of early production runs of sets using these chassis can be increased by adjusting slug A9 (L106) on the tuner. Turn the slug while watching the picture to make sure that picture quality does not decrease with an increase in sound level. If this adjustment does not bring the sound up to a satisfactory level, replace the second sound i.f. transformer with part No. 72B86-2. Remove the 27,000-ohm resistor (R203 across the secondary of the second sound i.f. transformer) and use it to replace the 47,000-ohm resistor (R303 in the a.g.c. network). Realign all 21.25-mc sound i.f. and ratio detector circuits.

In later production runs the aforementioned changes have been made and the inductance of L105 increased to raise the a.f. level. The later chassis are marked with the run number 15 or higher and blue dots on top of the tuner near L106 and on top of T201.—*Service Division of Admiral Corp.*

### ZENITH 12A58

Cross-talk or cross-modulation which causes a strong local broadcast station to blanket the short- and longwave bands is traceable to oxidized contacts on the bandswitch. Cleaning the contacts with carbon tet or alcohol restores the set to normal operation.

Advise the set owner that the contacts will not oxidize if the set is turned off before changing bands.—*Baron von Huenc*

### FIX ANYTHING ELECTRICAL!

Insure against hard times with amazing new electrical appliance repair method. Even beginners can fix electrical appliances double quick. At sensational low price, you get training course and new simplified electrical tester. Send postal card for details. No obligation.

**FEILER ENGINEERING CO.**  
Dept. 2RC5E, 1601 S. Federal St., Chicago 16, Ill.

## Technical Bulletins

EACH \$1.00 Postpaid Foreign \$1.25

### Electrical Design and Construction

These bulletins give you easy, accurate, dependable methods of designing and building electrical equipment. You just follow simple charts, tables and step-by-step instructions that tell how to figure correct size units to meet specific requirements.

**106 Rewinding Electric Motors**—Enables anyone without electrical training to locate trouble, repair and rewind a.c. or d.c. motors and generators of all kinds; how to figure wire size and wind coils.

**111 Transformers**—How to design and build all types and sizes of transformers including specials for Neon tubes and ultraviolet lamps. Easy methods of determining core dimensions and wire size.

**152 House Wiring**—Safe, approved way to wire new and old buildings. Shows many different circuits. Explains how to use latest type of materials including fittings, fixtures. Also gives estimating methods.

**101 Resistance Wire**—How to use Nichrome and similar wire in heating devices, rheostats and resistance coils. Figuring wire size and length; how to wind elements and test. Also supply directory.

**113 Solenoids & Plunger Magnets**—How to make these a.c. and d.c. magnets having movable plungers to control other equipment. How to figure dimensions, plunger stroke, wire size, etc.

**112 Electromagnets**—How to design and build all types and sizes for a.c. and d.c. How to figure lifting power, wire size.

**148 Relays**—Designing and building a.c. and d.c. relays of any size for various purposes where small currents and voltages must control heavy circuits. Includes control systems for motors and machines.

**137 Meters**—Designing and building ammeters, voltmeters, wattmeters, for a.c. and d.c. Includes complete information on calibrating.

**127 Small Electric Light Plants**—Easy-to-build, low-cost installations for cottages, camps, etc. Includes a 110-volt, seven 25-watt-lamp system; also a 6-volt system using auto generator.

**151 Electric Power from Streams**—How to survey streams, estimate requirements and available power, design and build dams, select and install the control system and electrical equipment.

**161 Burglar Alarms & Time Switches**—Dependable types for various purposes. Time switches made for alarm clocks and arranged to control lights, sprinkler systems, motors and other devices.

**144 Choke Coils**—How to design and build for many different purposes. How to use these instead of rheostats for voltage control, safely and with much less loss of electricity

**131 Remote Control of Electrical Devices**—Circuits and applications. How to use telephone dial and Stroger switch. For experimenters and model-railroad switching purposes.

**134 A.C. Electrical Experiments**—Fascinating, harmless experiments for education and entertainment. Also practical uses.

**TECHNIFAX,** 110 N. Franklin St.  
Chicago 6, Ill.

Enclosed find \$\_\_\_\_\_ for which send the following  
Technical Bulletins at \$1.00 each (Foreign \$1.25) as  
indicated by numbers:

\_\_\_\_\_  
\_\_\_\_\_  
\_\_\_\_\_  
Name \_\_\_\_\_  
Address \_\_\_\_\_  
City & State \_\_\_\_\_

RE-2-50

RADIO-ELECTRONICS for



# BARGAIN SLEUTHS!

HERE IS YOUR CLUE TO LOWER PRICES!



### AC-DC POCKET TESTER

This analyzer, featuring a sensitive repulsion type meter housed in a bakelite case, is the result of 15 years achievement in the instrument field by a large company specializing in electronic test equipment. Specifications of the AC-DC Model Volt-Ohmmilliammeter: AC and DC Volts—0-25, 50, 125, 250. Milliamperes AC—0-50. Milliamperes DC—0-50. Ohms Full Scale—100,000. Ohms Center Scale—2400. Capacity—.05 to 15 Mfd. Total price, prepaid anywhere in the USA—\$7.00. Similar DC Meter, lacking AC operated ranges of above, \$5.50 prepaid.



### AUDIO AMPLIFIER

Brand new, dual triode amplifier having 2 of the valuable and scarce oncer type audio transformers that sell for \$12.80 apiece. Neat aluminum case, fully enclosed (largest dimension 6 in.). Perfect for Intercom systems, phono amplifiers, mike amplifiers, or signal tracer amplifier for testing radio sets. A sensational bargain at only **\$3.40** each.

### MODEL 592 SPEEDTESTER

MADE BY  
SUPREME INSTRUMENT CORP.  
WAS \$58.95

NOW **\$48.95**



The finest multimeter money can buy. "Tops" in quality, accuracy, complete coverage, and speed of operation. 44 ranges at your fingertips. 1 Microampere to 14 amperes. Either 1000 ohms per volt or 25,000 ohms per volt meter sensitivity. Instantly available. 0.1 to 1400 D.C. Volts. 1/4 ohm to 50 megohms. No removal of test leads necessary—1 pair pln jacks for all ranges. In beautiful oak case. Regularly \$58.95, we are offering these brand new testers for a limited time only for \$48.95.

### SIGNAL GENERATOR

Genuine Laboratory-type precision signal generator. Manufactured and sold for \$68.00 each in large quantities during the war by Northeastern Engineering Corp., one of the top manufacturers of electronic equipment for the U.S. Govt. Five fundamental bands starting at 150 KC. Strong harmonics up to 120 MC. Five step ladder type attenuator as well as potentiometer output control. Regular 1000 cycle audio oscillator using vacuum tube, not a cheap neon sawtooth audio oscillator. Audio output separately available externally. Weight without packing material 16 lbs. which should show what a world of difference exists between this signal generator and the ordinary cheap oscillator used by the average serviceman. Complete with fused plug and coaxial output lead. Super Special \$38.75.



### AUTO PILOT AMPLIFIERS

Now only **\$9.95**

RT1463 7 tube amplifiers containing 3-7F7, 1-7Y4, 3-7N7, 4 potentiometers, numerous resistors, filter and bypass condensers, filter chokes, power and audio transformers, and six sensitive plate relays. A military development that provided amazing stepless control proportional to correction required for altimeters, rudder and elevator. In the original application. A control amplifier of the ordinary type would deflect the rudder by some arbitrary amount when the ship was blown off the course to port or starboard. The result would either be that the correction was insufficient and the plane continued off course, or the correction would be too great, starting a series of tacklings and would greatly increase fuel consumption and elapsed time in reaching the objective. This phenomenal unit, with its 3 amplifiers and six 5000 ohm relays in bridge circuits, will accurately control any 3 operations, related or unrelated, in minutely adjustable uniquely quantitative variations in either forward or reverse directions. 9"x7"x8" black crackle aluminum case. Brand new in original carton. \$9.95.

### "DRILLMASTER" ELECTRIC DRILL

Ideal for hobbyists. Complete with sander, buffers, grinding wheels, etc. This is bankrupt stock! Only a few available. A real bargain at \$9.95. Satisfaction guaranteed or money refunded if returned prepaid within 5 days.



### HEAT GUN

Streamlined pistol grip heat gun. Vivid red housing. 20 Cu. Ft. per min. of hot air at 160°F. Lifetime-lubricated AC-DC motor of the rugged vacuum cleaner type. Produces a hurricane of hot or cold air. Blow out dust from radio chassis. Dry ignition system. Heat carburetors. Quick-dry paint. Blow out radiators or water pipes. Will dry your wife's hair in half the time of ordinary hair dryer. Also good for drying stockings or clothing, or defrosting refrigerator instantly. Only \$12.95. Satisfaction guaranteed or money refunded if returned prepaid within 5 days.



### CUT RATE BUYS

3 gang broadcast band PERMEABILITY TUNER, was \$3.50, NOW \$1.50

Push-pull AUDIO AMPLIFIER with hypersil core A. F. transformers— \$30.00 value, now \$3.40

LINE FILTER—Dual 14 mfd. oil condensers. High Inductance 50 Amp. Choke. Connectors included. \$17.00 value for \$1.98

Super Special highest quality all chrome Bullet shaped CRYSTAL MIKE of top-flight nationally known brand. Was \$15.00, now \$5.95

DYNAMIC MIKE .. formerly sold for \$14.50, now \$6.95

Push - to - talk Mike with switch on handle, was \$1.69, now 98¢

### BUFRAD WILL BUY ANYTHING ELECTRONIC

WE NEED AT ONCE:

- SCR 284, BC 654S, PE 103's
- BC-348 Receivers, AC or DC models
- BC-312 Receivers
- BC-221 Frequency Meters
- SCR-522 Transmitters & Receivers
- Hallicrafters BC-610 Transmitters
- Amateur or commercial sets
- Large stocks of tubes
- Large stocks of transformers
- Large stocks of condensers
- Large stocks of resistors
- Large stocks of speakers
- BC-224 Receivers
- BC-342 Receivers
- Collins ART-13 Transmitters
- Headphones in quantity lots
- Microphones in quantity lots
- Field telephones
- Sound-powered telephones

We are especially interested in large quantities, but will buy one to a thousand. Factories, dealers or other outlets please submit to us a list of surplus electronic equipment on sale so that we may submit our bid.

### 1000 CYCLE AUDIO FILTERS

Navy PD52010-1 low pass audio filters as mentioned in the "Peaked Audio" article in June CQ, and designated by the above number, are the exact electrical and physical equivalent of commercial audio filter units selling for \$35.00 wholesale. They are infinitely better than the surplus "Radio Range Filters" being sold for reducing QRM, and at 2 KC off resonance for example, a 2 section filter using PD52010-1 is capable of twice the selectivity available through the use of the QR-er. (the BC453 section of the 274N which has provided the amateurs' previous highest standard of interference elimination) EXTRA SPECIAL—NAVY PD52010-1 with diagram—\$2.00.

BANDSWITCHING TUNING TURRET made by Western Electric. Covers 4 bands, above 100 MC. All coils wound with No. 14 silver-plated wire. Complete with tuning condensers and powerful electric driving motor. Diagram included. ONE OF OUR MOST TERRIFIC VALUES—ONLY \$2.95.

**BUFFALO RADIO SUPPLY**  
219 Genesee St.  
Buffalo 3, N.Y.  
Dep't RE-2

### DON'T MISS THIS 3 FOR 1 BARGAIN • \$ 7.00 TAKES 'EM ALL

Aluminum Gear Box 18x 8x7 contains 2 powerful electric motors and 2 matched gear trains. 62 gears in all, varying in size from 1/2 to 4" in diameter. Readily converted to rotate a beam antenna or any other similar use. \$5.00.

Relay Box 730A Signal Corps Inter-connector Relay Box. This unit, made by Bell (BC818) in aluminum case 8 1/2 x 5 1/2 x 2 1/2, contains 150 mfd. of condenser capacity, sensitive relays, resistors and terminal strips. Order several at this giveaway price of only \$1.95.

Remote Control Aluminum case 4x3x2 contains revolution counter, 2 potentiometers, triple pole switch, 4 knobs, phone jack and gear mechanism. Includes 8 prong JAN connector to fit box—\$1.39.



WORLD WIDE MAIL ORDER SERVICE!

WHERE TO BUY IT . . .  
**WHOLESALE RADIO**  
 of Baltimore

**PIONEERS IN RADIO AND TELEVISION!**

Our Reputation Is Your Guarantee of Quality

**NEW SIMPSON MODEL 303 VACUUM TUBE VOLT-OHMMETER For TV Servicing**



Ranges DCV.—1.2—12—60—300—1200 (30,000 with hi-voltage probe) ACV ranges wider than any other similar instrument.—1.2—12—60—300—1200, OHMS—1000—100,000—1 megohm—10 megohms—1000 megohms. Size 5 1/4" x 3 1/4". Wt. 4 lbs.  
 Model 303 inc. DCV probe, ACV, \$58.75  
 Ohms probe and ground lead  
 Model 303RT with roll top case \$64.75  
 Hi-Frequency probe 7.50  
 Hi-Voltage Probe 14.85

**G. E. PICTURE TUBES**  
 Far Less Than You'd Expect To Pay  
 For Famous GE Quality

7JP4 . . . . . \$16.88	12JP4 . . . . . \$36.25
8AP4 . . . . . 16.50	12KP4 . . . . . 36.45
10BP4 . . . . . 26.00	12LP4 . . . . . 32.50
10FP4 . . . . . 29.56	12AP4 . . . . . 55.80

Here's High Quality At A Low Price  
**THE NEW JACKSON 106 SIGNAL GENERATOR**  
 For Radio and TV



Standard amplitude modulated type oscillator for test, big AM radios and FM sets. Also as a marker generator for AM, FM and TV sweep generators. Full dial range frequencies from 100 KC to 54 MC. Harmonics 54 MC to 216 MC. Two circuit attenuator for controlling signal strength. Has 400 cycle modulated signal or straight CW. Accuracy, 1/4 of 1% on all ranges.  
**\$49.50**

Save Time . . . Money! Increase Profits!

**WELLER SOLDERING GUNS**

NO WAITING  
 5 second heating  
 saves time and power!

Single heat 200 watts <b>\$12.95</b> WS-200	Dual heat 200/250 <b>\$14.95</b> WD-250
--	--

Operates on 115 V. 60 cycles

**Sensational Antenna Buy! SNYDER HI-LO ARRAY**  
 Complete With Mast Sections  
**Model TV 21**



We don't believe you'll find a finer antenna anywhere near this low price. Two folded dipoles (High and Low) with reflectors (complete with two 3 1/2 ft. mast sections, guy ring, stand-off insulators). Ready for easy quick installation.  
**\$5.95**  
 \$5.75 in Lots of 6 or More.

WRITE FOR FREE MONTHLY "FYI" BULLETIN  
 ADDRESS ORDERS TO DEPT. QR 105  
 OR PHONE MULBERRY 2134

**WHOLESALE RADIO PARTS CO., Inc.**  
 311 W. Baltimore St.  
**BALTIMORE 1, MD.**

## AUTOMATIC FM SQUELCH CIRCUIT

Automatic squelch or silencing circuits are used in FM communications receivers which may be turned on for long periods of time while no signal is being received and in some FM broadcast receivers to silence the set while tuning between channels.

The double-action FM squelch shown in the diagram was described in *Electronics*. V1 and V2 are direct-coupled cascade limiters working into a discriminator. Note that the grid resistor and capacitor combination C1-R1 is returned to the plate of V1 rather than to ground, thus placing a positive bias on the grid of V2. At low- or no-signal levels, the bias causes V2 to conduct heavily; therefore its plate voltage drops to a low level. When the tube is

voltage across R2 is applied to a voltage divider consisting of R3 and R4. The a.f. amplifier is a zero-bias triode with the lower end of its grid resistor R5 returned to the junction of R3 and R4 so its grid is biased positive. The cathode is biased more positive than the grid; therefore the tube is cut off with no signal input. When the signal increases, the voltage rises across R2 and R4 and the a.f. amplifier immediately begins to conduct.

The time constant of C2-R5 should be short to have the a.f. amplifier conduct at the instant a signal is received. This allows the receiver to be used for fast break-in operation and also helps to avoid passing over a station while tuning the receiver.

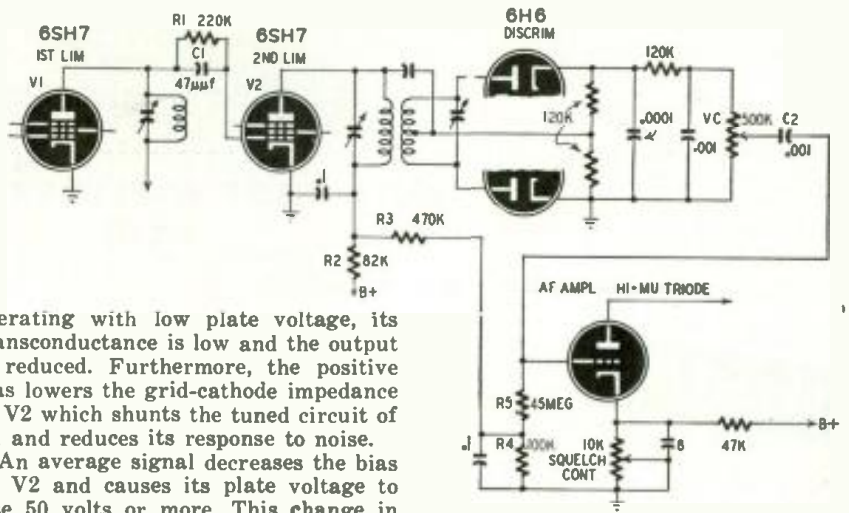

operating with low plate voltage, its transconductance is low and the output is reduced. Furthermore, the positive bias lowers the grid-cathode impedance of V2 which shunts the tuned circuit of V1 and reduces its response to noise.

An average signal decreases the bias on V2 and causes its plate voltage to rise 50 volts or more. This change in

## DIRECT-COUPLED PHASE INVERTER

A most interesting phase inverter was used in an amplifier circuit which appeared in catalog TR-49 published by Triad Transformer Mfg. Co. The speech amplifier, phase inverter, and power amplifier circuits are shown in the diagram.

Note that the input grid of the 7N7 phase inverter is direct-coupled to the plate of the 7C7 speech amplifier. The

put section. Output signals are taken from both cathodes of the 7N7 phase inverter tube.

The circuit is so connected that any incoming signal which makes the 7C7 conduct more heavily will cause the input half of the 7N7 to draw less current. Therefore its cathode and the grid of the upper 6L6 will be driven in a negative direction. Because the grid

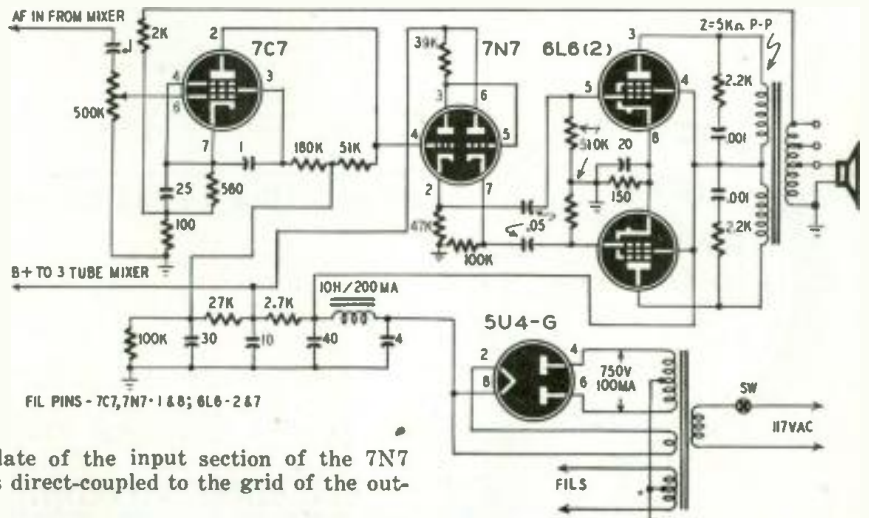
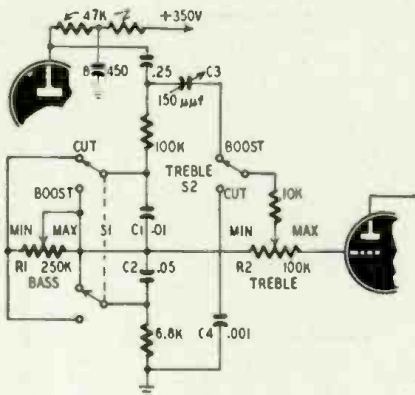

plate of the input section of the 7N7 is direct-coupled to the grid of the out-

of the second section of the 7N7 is direct-coupled to the plate of the first, its grid will become more positive, thereby driving its cathode and the grid of the lower 6L6 in a positive direction.

**WIDE-RANGE EQUALIZER**

A versatile tone control or equalizer for boosting or attenuating bass and treble notes was described in *Wireless World*. The circuit shown in the diagram was designed for use between two triode-connected EF37 voltage amplifier stages. (The EF37 has an amplification factor of 28 and plate resistance of 10,000 ohms when used as a triode with 150 volts on the plate and screen, which are tied together at the socket.)



The controls are two potentiometers with individual BOOST-CUT switches. When the BASS control R1 is set to minimum resistance (counterclockwise position), low-frequency response is flat below 1,000 cycles. When S1 is set to BOOST accentuation begins at 1,000 cycles and increases to slightly more than 20 db at 10 cycles when R1 is turned to its maximum resistance position. The low-frequency rolloff begins at approximately 500 cycles and is -12 db at 10 cycles when R1 is at maximum. Increasing the value of C1 lowers the frequency at which rolloff begins and increasing C2 lowers the starting point for low-frequency boost.

Treble response is flat from 1 to 20 kc when R2 is set at minimum resistance. The highs rise gradually to 18 db at 20 kc when R2 is at maximum and S2 is set to BOOST. Rolloff begins at 1,000 cycles and is down 18 db at 20 kc when R2 is at maximum and S2 is set to CUT. Decreasing C3 makes treble boost begin at a higher frequency, and decreasing C4 raises the high-frequency rolloff point.

**\$3.00 FOR CARTOON IDEAS**

RADIO-ELECTRONICS prints several radio cartoons every month. Readers are invited to contribute humorous radio ideas which can be used in cartoon form. It is not necessary that you draw a sketch, unless you wish.

Address  
RADIO CARTOONS, RADIO-ELECTRONICS  
25 West Broadway, New York 7, N. Y.

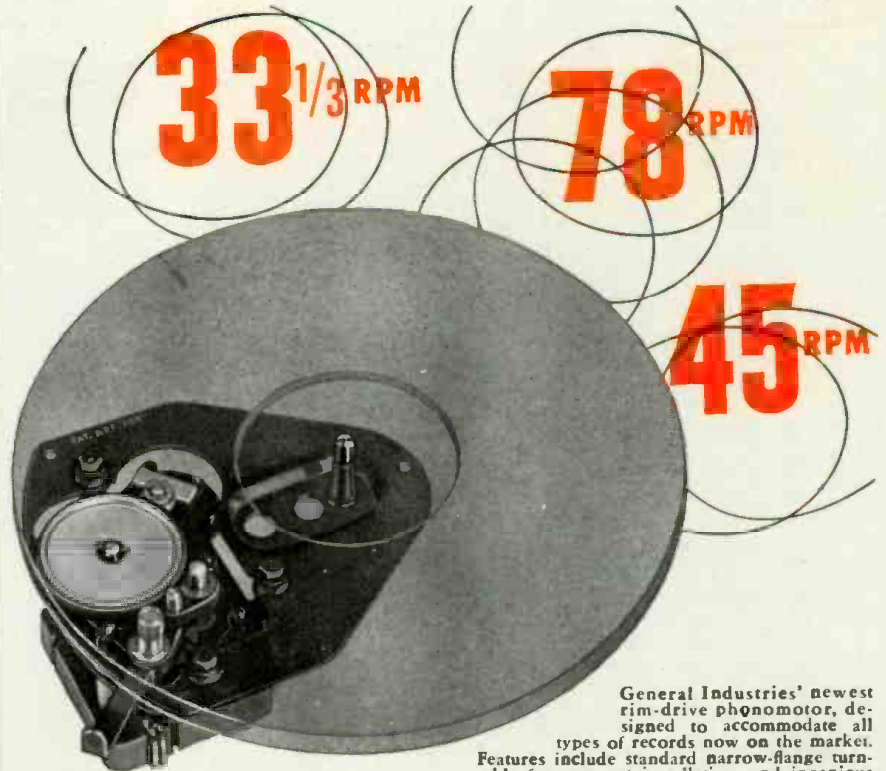

This model for manual operation. Many variations are available to record-changer manufacturers.

General Industries' newest rim-drive phonomotor, designed to accommodate all types of records now on the market. Features include standard narrow-flange turntable for compact installation, and ingenious speed-change mechanism with external shift lever.

**GI MODEL TS ( ALL THREE SPEEDS )**

Here's the turntable that puts you right in the middle of the profitable market for consoles, table models and portable phonographs that will play all three types of records. Simple and fool-proof in operation, the Model TS incorporates all of the advanced engineering features which have long distinguished GI's complete line of Smooth Power phonomotors, recorders and record-changer recorders.

Quantity price quotations, specifications and blueprints mailed immediately upon request. Write today to:



**The GENERAL INDUSTRIES Co.**

DEPARTMENT C • ELYRIA, OHIO

**SUB-MINIATURE**

**PRINTED ELECTRONIC CIRCUITS**

on ceramics, plastic and paper bases from your schematics. Special attention given to small orders. All service and correspondence held strictly confidential.

Write for full details and our latest bulletins on printed circuit components and assemblies available from stock.

**PLASTICS & ELECTRONICS COMPANY**  
272 Northland Ave. Buffalo 8, New York



Jensen Industries, Inc., 329 S. Wood St., Chicago 12, Ill.

**GOVERNMENT SURPLUS!  
WORLD'S LOWEST PRICE**

**PHOTO FLASH EQUIPMENT**



COMES COMPLETE WITH  
**4** EDGERTON  
FLASH TUBES  
& REFLECTORS



EASY TO  
CONVERT INTO  
A 2-WAY PHOTO  
FLASH UNIT  
OPERATES ON 110V. AC & 12V. BATTERY

Brand new at a fraction of original cost. Contains finest component parts available. All necessary parts and complete instructions included. After conversion, works on 110V AC or 12V battery by a flick of a switch.

Immediate delivery on all mail orders  
**\$68. COMPLETE**  
CINEX, INC., 165 W. 46th St., N. Y. 19, N. Y., Dept. RE 2

# Federated Announces ... SENSATIONAL REDUCTION on RCA BATTERY VOLTOHMYST

TYPE WV-65A

Was \$87.50 NOW \$39.50

Now Federated makes it possible for you to own world-renowned RCA's push-pull VTVM for \$48 less than you would have paid only a short time ago! This battery Volt Ohmyst measures voltage, current and resistance and operates on a self contained power supply. You'll find it's useful beyond all expectation for radio, television, lab and service work.

Please include 25% deposit with order.  
Balance C.O.D. Dept. 28-C



### Specifications

D.C. Voltmeter  
Six Ranges... 0/3/10/30/100/300/1000  
Volts  
Input Resistance... 11 megohms constant for all ranges  
Sensitivity (max.)... 3.7 megohms per volt on 3-volt range  
A.C. Voltmeter  
Five Ranges... 0/10/30/100/300/1000  
Volts  
Sensitivity... 1000 ohms Per volt  
Ohmmeter  
Six Ranges... 0/1000/10,000/100,000  
ohms; 0/1/10/1000 megohms  
D.C. Ammeter  
Six Ranges... 0/3/10/30/100/300  
milliamp. and 0/10 amp.  
Voltage Drop... 450 mv. for full scale deflection.

**Federated Purchaser**  
INCORPORATED  
NEW YORK CITY ALLENTOWN, PA.  
80 PARK PLACE 1115 HAMILTON ST.  
Digby 9.3050 Allentown 3-7441

# EUROPEAN REPORT

By MAJOR RALPH W. HALLOWS

SOME of you who use fluorescent lighting in your homes may have experienced a very annoying kind of interference with radio and television reception. I write "may have experienced" because it by no means follows that you are bound to have interference when a fluorescent tube is in use. Till a short time ago the whole business was rather puzzling, but recent research has given some interesting answers. It has been found that the trouble is caused by only a small proportion (about 5%) of new tubes, though others, which were blameless in their youth, may become interference producers after considerable service.

It is as a rule quite easy to discover whether or not a particular fluorescent tube is responsible for either radio or television interference. Switch on the fluorescent light while the set is working, noting the time. If the tube is to blame, interference will be noticed from 5 to 15 minutes later. Switch off the fluorescent tube. If the trouble ceases instantly, the tube is guilty. It is, in actuality, falling into oscillation and radiating fairly strongly. When you have a tube that behaves this way, take a look at the heaters through the narrow areas of clear glass (if any) at the ends. On the coating of one of the heaters you will find a bright spot.

Tap the tube sharply and the spot will disappear, together with the interference. Both, however, return after a time. So far, tube manufacturers do not know exactly how or why the condition is caused, or how to prevent it from happening. They attribute it to local "poisoning" in the heater coating. One firm, specializing in interference suppression has brought out a small

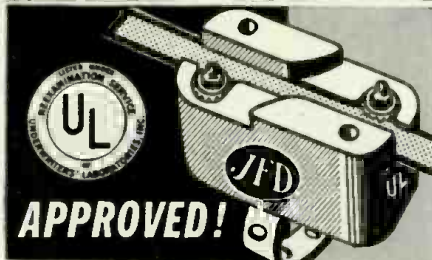

**APPROVED!**  
for OUTDOOR-INDOOR USE  
**JFD SAFE TV GUARD**  
Twin Lead  
**Lightning Arrester**

Protects Television Sets Against Lightning and Static Charges **\$225** LIST

The ONLY Twin Lead Lightning Arrester Approved by UL for Outdoor-Indoor Installation.

SIMPLE TO INSTALL... attaches to any grounded object—pipe, radiator, roof, wall—at any position between antenna and the set, indoor or outdoor.

NO WIRE STRIPPING or CUTTING or SPREADING of lines necessary. 300 ohm Impedance... does not unbalance line.

One Dozen To Package with FREE Self-Selling Display Card. No. AT102-12

Advertised In Consumer Publications To Help Your Sales

©1950. JFD MFG. CO., Inc.

**JFD** MANUFACTURING CO., Inc.  
6101 16th Avenue  
Brooklyn 4, N. Y.  
BEST IN TELEVISION ANTENNAS AND ACCESSORIES

## Stop listening to DISTORTED MUSIC

The connoisseur of music listening wants to recognize the clear brilliance of symphonic sound and

## BROOK All Triode High Quality AUDIO AMPLIFIER Gives It To Him



(Illus. Model 10C3-30 watts)  
Also available: Model 12A3-10 watts.

- Distortion and intermodulation at a new low.
- Reduction of listening fatigue.
- Brilliant, clear tone.
- Separate controls—stepped-for Bass and Treble.
- Extremely low volume without any loss of quality.

Write TODAY for FREE Technical Bulletin and Detailed Distortion Analysis  
**BROOK ELECTRONICS, Inc.**  
Sales Agent  
Dept. EB-0, 34 De Haré Place, Elizabeth, N.J.

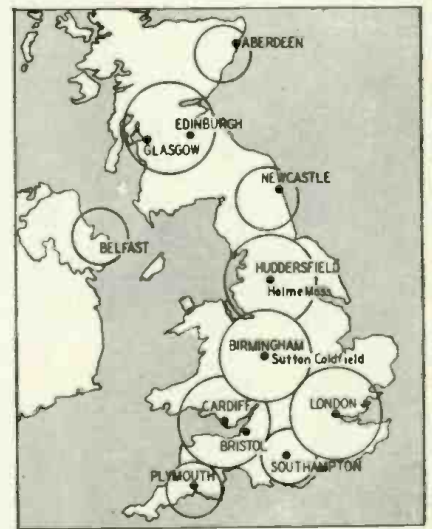

A television coverage map of Britain.

RADIO-ELECTRONICS for

# RADIOMEN! BIG PAY FOR YOU IN TELEVISION



NEW  
•  
COMPLETE  
•  
PRACTICAL  
•  
FULLY  
ILLUSTRATED

**BIG SECTION  
ON COLOR TV  
AND UHF**

400 pages  
only  
**\$4.25**

**MAIL  
COUPON  
TODAY**

## PARTIAL CONTENTS

Color Television  
Ultra High Frequencies  
Alignment of  
Sound Section  
Television Tuners  
Video-Detector  
The Sync Section  
Picture Tube Service  
**OTHER NEW VITAL FACTS!**

## HERE'S THE "KNOW HOW" YOU NEED

Here's the easy way to get in on the ground floor of profitable Television Servicing! Get this amazing new book and you have *all* the answers. Covers Television from A to Z, up-to-the-minute, packed with successful ideas used by leading television manufacturers and service men, boiled down for quick, easy reference on the job and elsewhere. Edited by COYNE TV experts for the radioman who wants to CASH IN NOW on the big pay Television service and Installation field.

### 1001 FACTS—INCLUDES COLOR TELEVISION

It's all here! 400 pages of easy-to-follow diagrams, photos, circuits, etc., on PRACTICAL TELEVISION SERVICING. Shows you, step-by-step, how to repair, adjust, align, service all makes . . . how to use new testing instruments. Use it on the job to spot and correct trouble by latest short-cut methods. Large section on COLOR TELEVISION and UHF, printed in 4 colors. Shows actual converters, explains how to change present sets to receive color television and UHF channels. Get your copy today!

### INSPECT 7 DAYS AT OUR RISK

Mail handy coupon now for your copy. On arrival, pay postman only \$4.25, plus C.O.D. postage. You must be 100% satisfied, or return volume in 7 days for cash refund. No risk, so ACT NOW!

## SEND COUPON FOR 7-DAY TRIAL

Educational Book Publishing Division  
COYNE Electrical & Radio School, Dept. 20-T1

500 South Paulina Street, Chicago 12, Illinois

YES! Rush me PRACTICAL TELEVISION SERVICING AND TROUBLE-SHOOTING MANUAL for 7-day trial inspection. I will pay postman \$4.25, plus C.O.D. postage, on guarantee of 100% satisfaction or money back in 7 days.

Name \_\_\_\_\_

Address \_\_\_\_\_

City \_\_\_\_\_

Zone \_\_\_\_\_

State \_\_\_\_\_

**SAVE MONEY!**

Enclose \$4.25 and COYNE pays postage.  
Same guarantee.

EDUCATIONAL BOOK PUBLISHING DIVISION

**COYNE** ELECTRICAL AND  
RADIO SCHOOL

500 S. PAULINA ST., DEPT. 20-T1, CHICAGO 12, ILL.

device which completely eliminates the interference caused by an oscillating fluorescent tube. Cylindrical in shape and measuring about 2¼ inches by 1 inch in diameter, it is easily fitted inside the casing of the ballast unit. Its cost is just over \$1.00. I can speak of its effectiveness from personal experience, but there is much weightier evidence than mine available.

At Radiolympia hundreds of fluorescent tubes were in use, but there was no interference in any of the audio or vision demonstration rooms—not after the first day, that is. Rather surprised, I made some inquiries and learned that the Radio Industry Council had insisted that every fluorescent lamp in the show be fitted with the gadget described. On the opening day there was some interference, whose source was soon traced to one stand. Suppressors had been fitted to all its lamps, but examination showed that the electrician had done the job according to his own ideas and with a nonchalant disregard of the makers' simple instructions. When the connections had been made properly, there was no further interference anywhere.

Here are some particulars of the latest television receiver to appear in England. It is the first television product of the English Electric Company, with which the Marconi Wireless Company is now tied up. The design is the work of L. H. Bedford, one of the big men of the times in all that concerns

the cathode-ray tube. The receiver is a console type, with a 15-inch cathode-ray tube and a 120-square-inch picture. Besides ordinary sound and vision reception, it can be switched to FM reception on the 88-108-mc band.

One of its outstanding features is its unit construction. There are three separate (and easily removable) sub-chassis in the vision part: the receiver, time-base (sweep) and power units. All have plug-and-socket connections. The technician is thus able to deal in remarkably quick time with any breakdown that may occur. Having traced it to a fault in, say, one of the time-base (sweep) circuits, he removes the complete time-base unit by disconnecting a plug from a socket, plugs in a replacement unit, and has the set in action again. He either repairs the faulty time-base unit in his own workshop, or, for a fixed price, sends it to the manufacturers' repair center covering the area in which his business is situated. The results are satisfactory to all concerned. The customer's broken-down televisor is as good as new in almost a matter of minutes. The service technician makes his rightful profit, for he knows just what his costs will be for the job. The price of this receiver is about \$265 at the present rate of exchange, exclusive of purchase tax.

There is much to be said for designing, not only televisers, but ordinary broadcast receivers, on the socket-plug

unit system. Servicemen would be saved a heap of time and trouble if they could whip out and replace, say, r.f., i.f., a.f., or power units in customers' homes and do all the serious repair jobs in their own workshops.

### TV network planned

The accompanying map shows how Britain's television chain has been planned. The larger circles represent the service areas of the five big stations of 17 to 35 kw; the smaller are the five of from 2 to 5 kw, which are classed as low-powered. I imagine that the service area of the 35-kw stations is going to turn out to be considerably greater than predicted, largely because the great height of the transmitting antennas and the careful siting of them. The Birmingham antennas, for instance, are at the top of a 750-foot mast which is at the summit of a 600-foot hill.

All the English, Scotch, and Welsh stations seen on the map will be interconnected by both co-ax and radio links. Any television center will be able to work both inward and outward; that is, it will be possible for it to relay programs from other stations and to supply its own programs to them. Thus very few of the big events, sporting or otherwise, that occur in any part of Britain will be out of television range of the rest of the country.

(Continued on page 86)

**Ridiculous**

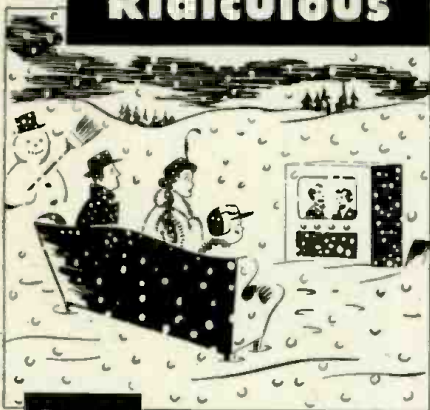

**but**

**NO WORSE THAN**



**SNOW INSIDE**  
on your TV Screen

WITH a properly engineered antenna, you can generally eliminate the effect of snow in your television picture. It strengthens the signal without amplifying the noise factor. Snow, after all, is just visual noise . . . the result of electrical disturbances which overpower the strength of the signal. Even though your set is located in an area where there is a high incidence of random noises, much of this visual noise can be eliminated with a high gain VEE-D-X antenna.

**send for FREE BULLETIN**

If your television forecast is snow, send coupon below for latest bulletin on Snow Removal issued by the VEE-D-X Television Laboratory. VEE-D-X antennas are nationally famous for fine performance and long distance reception. When you have a VEE-D-X . . . you have the finest.



**VEE-D-X**

**VEE-D-X means video distance**

LA POINTE PLASCOMOLD CORP., Unionville, Conn.  
Send me the VEE-D-X free bulletin, "Eliminating Snow in TV Reception."

Name \_\_\_\_\_  
Company \_\_\_\_\_  
Street \_\_\_\_\_  
City \_\_\_\_\_ Zone \_\_\_\_\_ State \_\_\_\_\_

If all goes well, the plan will be carried out within four years. Even should the service areas prove (as is most unlikely) to be no bigger than those shown on the map, the television system will then make reception available to nearly 90% of our whole population. My own prediction is that, with the possible exception of those who dwell in the more mountainous parts of Wales and Northern Scotland, the percentage will be much nearer 100 than 90. The rather larger bit of country eastward of areas 1, 2, and 3, may seem to be nobody's baby. But I believe it will be well covered, for most of it is nearly as flat as a pancake and it is only a very few feet above sea level.

**A new pickup**

The British Cosmocord Company decided to approach the problems of the high fidelity pickup from a new angle when working out their latest G.P.20 type of instrument. Their idea was to produce a pickup which would require no equalizing when used to play most ordinary records.

Using the crystal system, the stiffness of the assembly was first of all reduced until it would track commercial discs with a weighting of only 5-7 grams. As a compromise, to provide for warped records, the weighting was deliberately increased to 15 grams (or about 1/2 ounce), still an extremely low pressure.

Next, the vertical compliance was decreased until it was slightly less than the lateral. This was found to reduce needle talk, tracking distortion, as well as distortion due to pinch effects.

The desired frequency response was ingeniously obtained by giving the crystal assembly what is virtually the form of a terminated transmission line and so arranging the terminating section that it provides pre-emphasis of about 6 db per octave above 1,000 cycles, giving the pickup a constant-velocity characteristic.

The resulting characteristic is flat to 250 cycles, drops 6 db between 250 and 1,000 cycles, and is flat from that frequency to the upper limiting frequency of 10,000 cycles, above which the response falls at the rate of 6 db per octave.

The tone arm is pivoted on a single needle point, which means important reductions in vertical and lateral friction.

The output is said to be 5 to 20 times as great as that of comparable magnetic models.

**CORRECTION**

Captions were interchanged on the tables for cathode- and plate-loaded amplifiers in the third column, page 43, of the article "Design of Class-B Drivers" in the November 1949 issue. Data for plate-loaded amplifiers is in the top table and cathode-loaded amplifiers in the bottom one. We thank the author, Mr. W. H. Anderson, for this correction.

**HARD-TO-GET PARTS**

**POWERFUL ALL-PURPOSE INDUCTION MOTOR**

**IDEAL FOR EXPERIMENTERS—101 USES**  
Sturdily constructed to precision standards, this self-starting shaded pole A.C. induction motor is powerful enough for a number of uses. Some of these are: Automatic Timing Devices, Current Interrupters, Electric Fans, Electric Chimes, Window Displays, Photocell Control Devices, Electric Vibrators, Small Grinders, Buffers and Polishers, Miniature Pumps, Mechanical Models, Sirens, and other applications.

Consumes about 15 watts of power and has a speed of 3,000 r.p.m. When geared down, this sturdy unit will constantly operate an 18-inch turntable loaded with 200 lbs. dead weight—THAT'S POWER!

Dimensions 3" high by 2" wide by 1 3/4" deep; has 4 convenient mounting studs; shaft is 7/8" long by 3/16" diameter, and runs in self-aligning oil-retaining bearings. Designed for 110-220 volts, 50/60 cycles, A.C. only. Shp. Wt. 2 lbs.

ITEM NO. 147  
YOUR PRICE . . . . . **\$1.95**

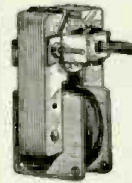

**ULTRA MAGNET**

LIFTS MORE THAN 20 TIMES ITS OWN WEIGHT

**LITTLE GIANT MAGNET**  
Lifts 5 lbs. easily. Weighs 4 oz. Made of ALNICO new high-magnetic steel. Complete with keeper. World's most powerful magnet ever. The experimenter and hobbyist will find hundreds of excellent uses for this high quality permanent magnet. Measures 3/4" x 1 1/2". Shp. Wt. 3/4 lb.

ITEM NO. 159  
YOUR PRICE . . . . . **\$1.25**



**GENUINE MICROPHONE TRANSMITTERS**

Regular telephone transmitters taken from a large telephone supply company's stock. Work perfectly on 2 dry cells. Can be used on P.A. systems, call systems, inter-communications sets, short-line telephone circuits, house-to-house or farm-to-farm phone lines, also to talk through your own radio or an concealed dictaphone pick-up. Useful replacements on battery-operated rural telephone lines.

**THESE ARE GENUINE TRANSMITTERS, MADE BY CARLSON, excellent in appearance and operation. A remarkable value and one seldom offered in these times. Shp. Wt. 1 lb.**

ITEM NO. 160  
YOUR PRICE . . . . . **\$1.95**



**WATT HOUR METER**

Completely overhauled and ready for immediate service. Designed for regular 100-110 volt, 60 cycle 2-wire A.C. circuit. Simple to install. 2 wires from the line and 2 wires to the load. Sturdily constructed in heavy metal case. 6 1/2" high, 6 1/4" wide, 3" deep. Westinghouse, G. E., or other available make. Shp. Wt. 14 lbs.

ITEM NO. 32  
YOUR PRICE . . . . . **\$4.45**



**AMAZING BLACK LIGHT!!!**

Powerful 250-Watt Ultra-Violet Source

The best and most practical source of ultra-violet light for general experimental and entertainment use. Makes all fluorescent substances brilliantly luminescent. No transformers of any kind needed. Fits any standard lamp socket. Brings out beautiful ornamental lines in various types of materials. Swell for amateur parties, plays, etc.; to obtain unique lighting effects.

Bulb only. Shp. Wt. 2 lbs.

ITEM NO. 87  
YOUR PRICE . . . . . **\$1.95**



**WESTERN ELECTRIC BREAST MIKE**

This is a fine light-weight aircraft carbon microphone. It weighs only 1 lb.

Mike comes with breastplate mounting and has 2-way swiveling adjustment so that it can be adjusted to any desired position. There are 2 woven straws: one ties around neck, the other around chest. Straws can be snapped on and off quickly by an ingenious arrangement.

This excellent mike can be adapted for home broadcasting or private communication systems. By dismounting breastplate, it can be used as desk mike.

Comes complete with 8-foot cord and hard rubber plug. Finished in spherulized plate, non-rustable. Shipping weight, 2 lbs.

ITEM NO. 152  
YOUR PRICE . . . . . **\$9.95**



HUDSON SPECIALTIES CO.  
40 West Broadway, Dept. RE-2-50, New York 7, N. Y.

I have enclosed below the number of the items I'm ordering. My full remittance of \$\_\_\_\_\_ (which includes shipping charges) is enclosed (NO C.O.D. ORDERS UNLESS ACCOMPANIED WITH A DEPOSIT.) OR my deposit of \$\_\_\_\_\_. My order is enclosed (20% down) and I'll pay the balance C.O.D. for balance. NO C.O.D. ORDERS FOR LESS THAN \$5.00. BE SURE TO INCLUDE SHIPPING CHARGES.

Circle Item No. wanted:

147	159	160	87	152	33
-----	-----	-----	----	-----	----

Name \_\_\_\_\_  
Address \_\_\_\_\_  
City \_\_\_\_\_ State \_\_\_\_\_

Please Print Clearly

**HIGH-VOLTAGE CONTROL**

Recently a high-wattage volume control was needed for setting the volume levels of two speakers connected across the output of a 100-watt amplifier. From the resistance wire of a heating element, I cut off a piece having a resistance equal to the output imped-

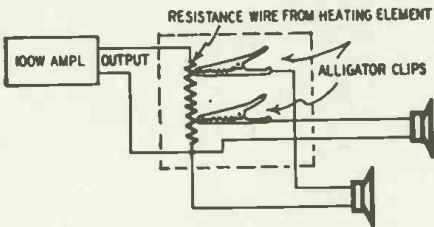

ance of the amplifier. The resistance wire was then stretched between terminal strips mounted on an asbestos-covered block of wood. The speakers were connected to correct points on the wire with clips.—*Deloss Tanner*

**ADJUSTABLE TV TRAP**

An adjustable indoor TV antenna can be used as a variable trap to eliminate interference or to tune the transmission line for the best picture on any

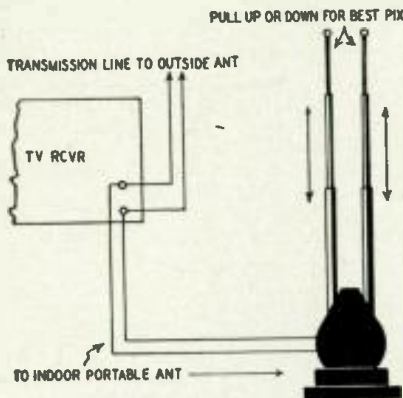

channel. Connect the indoor antenna in parallel with the transmission line from the outdoor antenna, as shown in the drawing. Increase or decrease the length of the elements of the indoor antenna for the best picture.—*Melvin G. Claude*

**SAFE A.C.-D.C. EQUIPMENT**

Serious shocks and fireworks can be avoided if you make sure that the B-minus side of all a.c.-d.c. circuits is connected to the grounded side of the power line. This is particularly true when the equipment is used near radiators, pipes, and metal benches.

To check the polarity of the equipment, insulate one contact on a small neon lamp and place your finger over it. If the lamp glows when the uninsulated contact is touched to the chassis, the chassis is hot. Reverse the plug on the line cord.—*Henry Wong*

**HIGH-VOLTAGE INDICATOR**

A burned-out 2X2 rectifier can be used safely as an indicator of voltages up to 5,000. Connect one high-voltage test lead to a filament pin (No. 2 or 7) and another to the cap of the tube. High voltage is indicated by a purple glow in the tube.—*Hyman Herman*

**GREYLOCK RADIO TUBE BARGAINS!**

GT. Glass and Miniature Types

1A4P	1U5	6BA6	6SQ7GT
1A6	3A4	6BA7	6U7G
1C6	3Q4	6R7A	6V6GT
1F4	3V4	6BM6	6X4
1R5	6AQ5	6CSGT	6X5GT
1S5	6AQ5	6J6	12AR6T
1T4	6AT5	6K6GT	12AG6
1U4	6AU6	6SK7GT	12AT6

**\$32.95** per 100 asstd.

Also available in smaller quantities at 39¢ each.



**SPEAKER SPECIALS!**  
3", 4", or 5" P.M. lens output. Alnico 5, each . . . . .97c  
In cartons of 30, each . . . . .27c  
6" x 9" Oval P.M. Alnico 5, 3.16 oz. magnet, each . . . . .\$2.50  
In cartons of 30, each . . . . .\$2.39

TERMS: Net C.O.D., F.O.B. NYC.  
MINIMUM ORDER \$10.00.  
Write for terrific CR tube prices and Bargain Catalog C-2  
**Greylock Electronics Supply Co.**  
30 Church Street New York 7, N. Y.

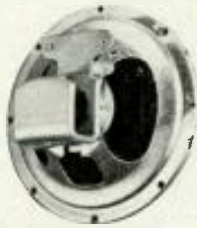

*only*  
**QUAM**  
*offers you this PLUS value*

Among all the radio speakers made today there's only one that's different.

Only Quam has the adjustable voice coil, permitting accurate centering after assembly, and virtually eliminating rubbing voice coil trouble!

Only Quam has the U-Shaped Coil Pot, providing an unbroken path for the magnetic flux, thus producing a stronger magnetic field, greater efficiency and better performance.

Only Quam has these plus values, only Quam is different.

Specify Quam for all replacements!  
Mail this coupon for free catalog.



QUAM-NICHOLS CO.  
521 E. 33rd Place  
Chicago 16, Illinois

Please send me Quam catalog.

Name .....

Address .....

City..... State.....

**TELEVISION SCOPE**



**SUPERIORITY AT A GLANCE!**

The vertical response of this economy TV scope is usable to 5000 kc, not 50 kc. Response is flat to 750 kc, down 3 db at 1000 kc. Amplifier supplies a voltage gain of 20 at 5000 kc.

AR-3

Check this necessary feature before you buy any scope for TV use.

The R.S.E., AR-3 Scope has been built by Ross Armstrong to our rigid specifications. It's a complete unit that embodies standard horizontal amplifier and sweep circuits with normal sensitivity.

The case is 8" high x 5" wide x 14" long, attractively finished in "hammered" opalescent blue enamel. Operates on standard 110 volts—60 cycles—40 watts. Tubes, 3BP1-6AC7-6SJ7-6X5-5Y3-884. Instructions included.

Complete specifications upon request. Satisfaction or your money back.

PRICE  
**\$49.95**

AVAILABLE TO JOBBERS IN QUANTITY

F. O. B. DETROIT

**INTERCOM & RADIO**

AT A PRICE THAT CAN'T BE BEAT



6 tube superhet—3 tube intercom permits communication between radio-master and up to 4 sub-stations.

WHILE THEY LAST  
**\$29.95**

With 1 sub-station and 50 feet of cable Extra Sub-stations \$3.95 each

Original cost \$64.50

**PUSHBACK WIRE**



25% BELOW MILL COST!

1st class, Essex or Lens, ALL SOLID tinned copper, double cotton serve, waxed finish.

SIZE	COLORS	100 feet	1000	Production Foot
22	BLACK-BROWN	.39	3.79	3.65M
20	RED-WHITE-BLUE	.49	4.49	3.95M
18	BROWN	.69	5.88	

**ORDER INSTRUCTIONS**  
Minimum order—\$2.00. 25% deposit with order required for all C.O.D. shipments. Be sure to include sufficient postage—excess will be refunded. Orders received without postage will be shipped express collect. All prices F.O.B. Detroit.

**RADIO SUPPLY & ENGINEERING CO., Inc.**  
85 SELDEN AVE. DETROIT 1, MICH.

## THE PRICES SPEAK FOR THEMSELVES

RADIO & TV TUBES			
RCA, KENRAD, GENERAL ELECTRIC, SYLVANIA, HYTRON, RAYTHEON, ETC.			
6C4	.16	6X5	.49
46	.19	6SA7	.49
37	.26	6SK7	.49
6H6	.29	6SQ7	.49
1LD5	.29	12SK7	.54
77	.33	12SJ7	.54
78	.33	12AT6	.54
1LN5	.39	J2BA6	.54
6F5	.39	12BE6	.54
35W4	.39	6K6	.54
35Z5	.39	6J7	.54
6G6	.39	0Z4	.55
80	.39	35L6	.55
5Y3	.44	50L6	.55
14A7	.44	50B5	.55
14B6	.44	12SA7	.55
14Q7	.44	12SG7	.55
5Y4	.49	24A	.59
25Z6	.49	43	.55
1Q5	.49	45	.59
6SC7	.49	47	.59
6S17	.49	6A7	.55
12SQ7	.49	6Q7	.59
5U4G	.55		
3Q4	.59		
3Q5	.69		
3V4	.55		
117Z3	.59		
6A8	.65		
6SN7	.65		
6AC7	.69		
6SL7	.65		
6V6	.69		
1A7	.69		
1H5	.69		
1N5	.65		
117Z6	.69		
25L6	.65		
35A5	.69		
50A5	.69		
6AG5	.69		
6J6	.69		
6AL5	.69		
5V4G	.92		
1B3	1.25		
6BG6	1.85		
50¢ BOTTLE PHILCO FURNITURE POLISH . . . \$ .09			
\$5.00 CENTURY SAPPHIRE PHONO NEEDLE . . . .69			
100-ASSORTED PILOT LIGHTS, 46, 47, 49, 51 . . . 3.97			
500-ASSORTED TUBE CARTONS, 5 sizes . . . .4.69			
100-ASST. CONDENSERS, .001 to .02, 600V. . . 3.75			
ONE POUND ROSIN CORE SOLDER . . . . .49			
UL APPROVED ZIP CORD, 20 gauge, 500 feet . . . 6.98			
RG59U COAXIAL CABLE, 72 ohms, 100 feet. . . 3.97			
TWIN LEAD-IN, 20 gauge, 300 ohms, 100 feet . 1.39			
STANDARD 16" CATHODE RAY TUBE, (glass) . . . . .45.79			
RCA #9T246 TELEVISION CABINET, (10") . . . 17.97			
GENUINE LUCITE 15" TELEVISION MASK . . . 3.97			
TV NO-GLARE FILTERS, 10" .69¢, 12 1/2" .97¢, 16" 1.89			
TV ALL-CHANNEL ANT., including 8" mast. . . 7.98			
COMPLETE CHIMNEY ANT. MOUNT KIT. . . 1.39			
UNIV. OUTPUT TRANS., matches any tube. . . .89			
FAMOUS RIM-DRIVE PHONO MOTOR w/T.T. . . 2.89			
STANDARD PICK-UP ARM, quality crystal. . . 2.89			
REPLACEMENT CRYSTAL CARTRIDGE. . . . 1.44			

### AUTOMATIC 1949 & 1950 CUSTOM BUILT AUTO RADIOS

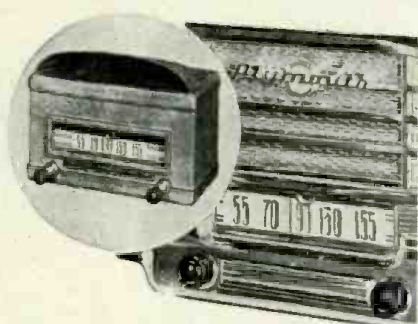

The perfect factory look of the Plymouth (illustrated) is equally as nice on the Ford, Dodge or Chevrolet. Simple to install . . . fully guaranteed.

#### FEATURES

- 6-Tube Superheterodyne (8-tube performance)
- Beam Power Output & Automatic Volume control
- 3 Gong Condenser—Large Dynamic Speaker

FORD	.....	\$29.75
DODGE	.....	34.97
PLYMOUTH	.....	34.97
CHEVROLET	.....	36.49

UNDER DASH 6-TUBE AUTO RADIO, complete, fits any car .....\$29.47

**BROOKS RADIO DISTRIBUTING CORP.**  
80 VESEY ST. (DEPT. A) NEW YORK 7, N. Y.

### CLEANING LITZ WIRE

The ends of pieces of Litz wire are usually burned in a flame to remove the insulation. This often results in a number of the small wires fusing or breaking.

This will not happen if about one inch of the wire is compressed into a small ball about 1/8 inch in diameter, heated in a flame until red hot, then quenched in alcohol. The wire comes out clean without a trace of enamel and none of the small wires are broken. —Van Klaveren

### A SIMPLE 10-METER ANTENNA

Unable to find two points suitable for suspending my 10-meter folded dipole, I constructed the mounting shown in the diagram. The antenna, a piece of 300-ohm ribbon line approximately 16 feet 3 inches long, is suspended between the bowed-up ends of a 17-foot piece

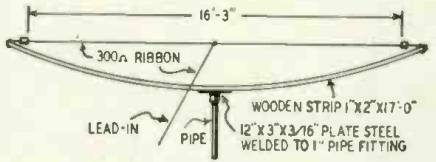

of 1 x 2-inch lumber. It is bolted to a 12 x 3 x 3/16-inch steel plate welded to a 1-inch pipe fitting. The mast is a length of 1-inch pipe fastened to the side of the house with brackets normally used in erecting FM and TV antennas.—Leon S. Heesacker

### FLEXIBLE TEST CLIPS

A flexible clip-type test lead can be made from a metal cable release of the type used on cameras. Two small metal clips, alligator type, are soldered to the ends of the cable. The outsides of the clips may be coated with insulating lacquer to avoid short circuits. Jaro Kober

### SPEAKER FIELD SUPPLY

I had a number of 15-inch electrodynamic speakers with 3,200-ohm field coils. To furnish field current, I made up several supplies like those shown in the figure. Ordinary selenium rectifiers

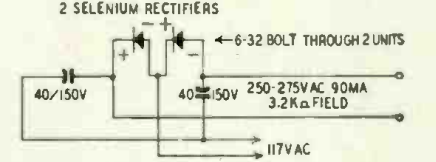

are used in a standard voltage-doubler circuit, providing 250 to 270 volts a.c. from a 117-volt a.c. line.—Franklin W. Young

### LIGHT FOR RECORDERS

A low-wattage incandescent night light that comes with a plug base and a little rotatable hood is ideal for illuminating the turntable of a disc recorder. Pass the plug prongs through a pair of holes drilled in the motor-board, then set the assembly in place with Duco cement. You can rotate the little hood to get the light where you need it.—R. A. Nelson

### 25 POWER PRECISION MICROSCOPE

Compound Optical System—4 Precision Lenses—Aluminum Case—5 inches long  
A professional instrument. Ideal for Machinists • Hobbyists • Photographers • Engineers • Students • Naturalists, etc.  
Satisfaction Guaranteed or Money Back  
**MICROSCOPE & LENS CO.** Postpaid  
1168 Nassau Street, New York 7, N. Y.

**\$2.79**

If you don't receive our **FREE** RADIO CATALOGS you're losing money!

VIDEO HANDBOOK—Latest printing of Boland and Boyce famous Video "Bible", now available, postpaid **\$5.00**  
RADIO DATA HANDBOOK, also \$5.00. Combination library of the two books, \$9.00

## RADIONIC EQUIPMENT CORPORATION

Tribune Theater Entrance  
D170 Nassau Street New York 7, N. Y.  
WOrth 2-0421 •• Open daily 9 to 6—Saturday 9-5

**FREE! MAIL TODAY!**

GET YOUR COPY AT ONCE!  
of RADIONIC'S Bargain Catalog, Radio & Television Sets—Parts—Accessories. Unbeatable Values!

RADIONIC EQUIPMENT CORP., Dept. 102  
D170 Nassau Street, New York 7, N. Y.

Please rush Free Copy of your latest Bargain Catalog of Radio and Television Sets, Parts, Tubes and Accessories.

NAME .....

ADDRESS .....

CITY .....

STATE .....

### QUICK, EASY WAY TO READ TUBULAR CAPACITOR CODING



Having trouble deciphering the color coding on tubular molded capacitors in new TV and Radio sets? There's no need to consult complicated wall charts or tables!  
The Sprague Capacitor Indicator gives you the needed data in a jiffy. Just flick the dials to the color bands and read the capacitance, tolerance, and voltage directly.  
This slick plastic service help fits your pocket. Always on hand, it saves time and avoids mistakes . . . and it's only 15¢. Ask for one at your Sprague distributor today!

### SPRAGUE PRODUCTS COMPANY

Distributors' Division of the Sprague Electric Co.  
NORTH ADAMS, MASS.

### RADIO MINDED????

LEARN CODE NOW!!  
A complete code oscillator, plug in and use. AC or DC. Small compact chassis. Variable tone. Operates phones or small speaker. With tube and key. **\$3.45** Guaranteed



FOB-NY Rated firms 10 days quantity discounts  
**GREENWICH SALES CO.**  
59 Cortlandt St. New York City 7





# distinct images from 200 miles away with *Tel-a-Ray*

## Reception-master antenna . . .

Here is the antenna that television users have been demanding — Tel-a-Ray . . . with maximum reception ability . . . reasonably priced . . . interference free.

For the antenna with all the important features — including razor-sharp directivity, absolute corrosion resistance and quick trouble-free assembly — write to Tel-a-Ray Enterprises, Inc., Henderson, Ky.

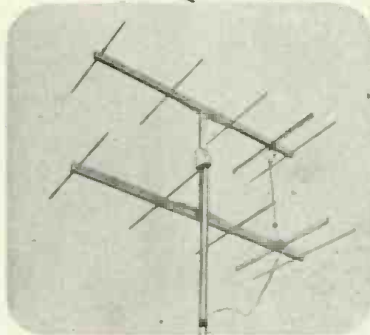

Tel-a-Ray model TD, expressly designed for adverse conditions and low signal areas. Gain 25 times basic dipole, 14 db Power gain, 7.25 db front-to-back ratio.

**distributors:** *You'll find Tel-a-Ray antennas easy to sell . . .*

. . . because the same fine quality is found in the 22 lower priced Tel-a-Ray models as in the most elaborate stacked arrays. Each antenna has been developed to meet a specific television or FM problem. Distributorships in many cities are still available. Write today for complete information.

**TEL-A-RAY ENTERPRISES, INC.**  
P. O. BOX 332A, HENDERSON, KENTUCKY

### D.C. VACUUM-TUBE VOLTMETER

? I have a 400-microampere d.c. meter which I want to use in a direct-current v.t.v.m. having 5, 10, 50, 100, 250, and 500-volt scales. Do you have a circuit which I can use? It should include a method of voltage regulation.—E. H., Petawawa, Ont.

A. In this simple v.t.v.m. circuit the

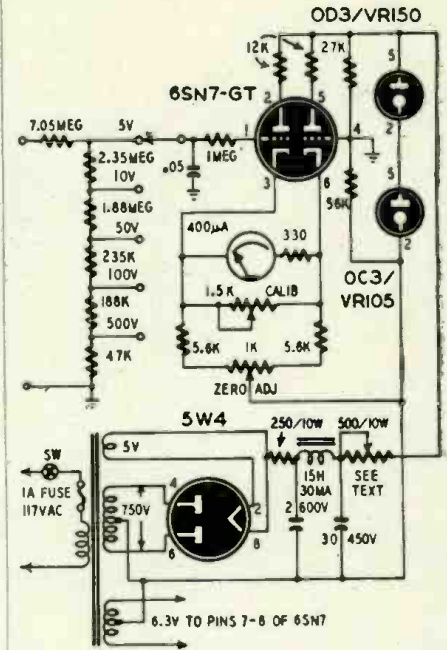

voltage divider should be made up of precision resistors or standard resistors which have been measured on a bridge. You may have to parallel two resistors to get the correct values. The calibration control may be mounted behind the panel because it need not be touched after the initial adjustment, except when the 6SN7 is replaced. The zero adjust control is mounted on the panel. Set the slider on the 500-ohm, 10-watt resistor so the voltage-regulator tubes glow with medium brilliancy.

### TV ANTENNA MATCHING

? My TV booster has an output impedance of 300 ohms. How can I match this to my receiver, which is designed for use with a 72-ohm antenna? Can I use transmission line for matching?—J. G., Canton, Ohio

A. All you need do is connect a quarter-wave length of 150-ohm ribbon line between the output of the booster and the antenna terminals on the receiver. Length of the matching stub in feet

$$\text{is found from the formula } \frac{246}{f} \times V$$

where  $f$  is the frequency in megacycles and  $V$  is the velocity of propagation (77% for Amphenol type 14-079 150-ohm Twin-Lead or equivalent). It is recommended that the matching stub be cut to the frequency of the weakest station. In other words, the frequency of your weakest station (in megacycles) would be substituted for  $f$  in the formula.

RADIO-ELECTRONICS for

# HOT nails

**SAVES YOU DOLLARS ON TV INSTALLATIONS**  
Easily pierces brick, mortar between brick, most concrete. Acts as a most coupler and stand-off insulator!

Write for **FREE** sample today!

**HOT NAILS, INC.**  
40 WEST 4TH STREET, NEW YORK 12, N. Y.

**DROP US A CARD!**

GET ON THE MAILING LIST FOR

# R&M Monthly BARGAIN BULLETIN

• LATEST, LOWEST QUOTATIONS ON Standard & Surplus

## Radio-TV Equipment

**R&M RADIO CO.**  
2701 WILSON BLVD.  
ARLINGTON, VIRGINIA

**\$10,000 REWARD**  
Earn the government bonus by locating Radio-Active Areas with a

## P.R.I. GEIGER COUNTER

Weight only 2 lbs. Priced from \$49.50 complete. The most sensitive portable Geiger Counters made.

**PRECISION RADIATION INSTRUMENTS, INC.**  
912R. S. Spaulding Ave. Los Angeles 36, Calif.  
Dealer Inquiries Invited

### CODE PRACTICE OSCILLATOR

KIT complete ready to build **\$5.49** FOB

A complete kit with two tubes, key and  speaker or  phones (specify which)—simple easy-to-follow instructions enclosed—**NOTHING ELSE TO BUY.**

### MONOTUBE SPEAKER—RADIO KIT

As described in Dec. issue of Radio-Electronics—complete ready to build. **\$5.95** FOB

Two-way Inter-com. kit—  
comp. — 2 tubes — 2 spkrs. **\$9.95** FOB

**Universal/general corp**  
365 J CANAL ST. N. Y. 13,  
WALKER 5-9642

The American taxicab industry now has nearly \$30 million invested in radio equipment FCC Commissioner George Sterling announced recently. More than 2,700 taxi radio systems have been authorized to date.

**Joseph T. McNaney**, formerly with Consolidated Vultee Aircraft Corp. as a design engineer, has been appointed principal engineer in the communication and navigation engineering department of Bendix Aviation Corp., Baltimore, Md.

Mr. McNaney is the inventor of the Electrontype method of communication using the Charactron cathode-ray tube, described on page 87 of the December, 1949, issue of RADIO-ELECTRONICS.



**Erling G. Fossum**, an employee of STEWART-WARNER CORP. since 1926, has been appointed general manager of Stewart-Warner Electric, the company's radio and television division. This was announced by James S. Knowlson, president and board chairman of Stewart-Warner.

Fossum's appointment as division head, effective November 1, fills the vacancy created by the recent resignation of Samuel Insull, Jr. In his new position, Fossum will be responsible for all phases of engineering, production, and marketing of radio, television and other electronic products of Stewart-Warner Electric. He has been assistant to the president for the past year. He was formerly service manager of the Alemite, instrument and heater division.

**R. T. Capodanno** has been appointed director of engineering at EMERSON RADIO and PHONOGRAPH CORP., it was announced by *Dorman D. Israel*, executive vice president.

Mr. Capodanno comes to Emerson after eleven years with Philco, where he was active in government projects and in developing home, auto, and export radio receiver designs. Prior to this, he was connected with the University of Illinois, Physiological-Psychology Department, as engineering adviser on technical devices for the hard-of-hearing, brainwave studies, and spinal work, as well as engineering and construction of laboratory equipment for medical work.

**Max M. Lee** has joined the research staff of the NATIONAL BUREAU OF STANDARDS as chemist. In this capacity, he will investigate the applications of high polymers to electronics development projects in the Bureau's ordnance laboratory.

Before coming to the Bureau, Mr. Lee was a senior research chemist with the Hercules Powder Co., studying the application of plastics and plasticizers to rocket development.

**Karl Hassel** has been elected secretary of ZENITH RADIO CORP. of Chicago. With Zenith since its organization in 1923, is also a director and assistant vice president.

**Harry J. Deines**, of New York, an advertising executive with nearly 20 years' experience in the electrical manufacturing field, has been named manager of advertising and sales promotion for the WESTINGHOUSE ELECTRIC CORP., Pittsburgh, Pa.

Mr. Deines will direct the development of advertising and sales promotion in conjunction with sales departments. His responsibilities also include the development of sales training programs as well as staff supervision over the application of such programs.

**Anthony H. Lamb** has been appointed vice president of the WESTON INSTRUMENT CORP., Newark, N. J., it was announced by *Earl R. Mellen*, president.

Lamb, who has been with the corporation since 1924 as acting chief engineer, will assume responsibility for

# RADIO-ELECTRONICS MAGAZINE LIBRARY

INGENIOUS, CUSTOM-BUILT STORAGE FILE... Another **WALTER ASHE** Value Scoop!

Only **25¢**

each plus 6¢ each to cover packing and postage (anywhere in U. S.)  
Holds 12 complete issues of magazine in its present 82 to 98 page size. Measures 12" x 8 1/2" x 2 3/8"

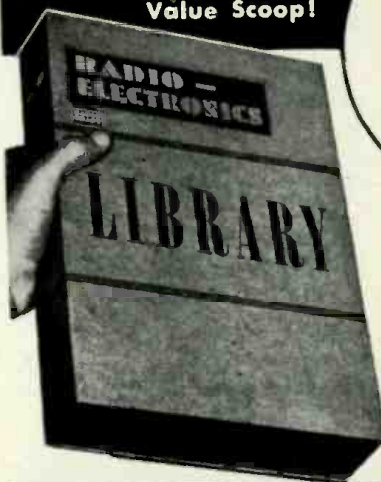

Made of high quality Kraft fibre board, printed and constructed to look like a Buckram-bound book. Affords neat, orderly, flick-of-the-finger convenience. Handy Reference Index, printed on back, records the location of selected articles, wiring diagrams, etc. At the low price you'll want several of these serviceable, attractive Magazine Libraries.

Order now for immediate delivery

**Walter Ashe**  
RADIO CO.  
1125 PINE ST. • ST. LOUIS 1, MO.

**FREE**  
NEW  
1950  
CATALOG

the TAGLIABUE division, which was purchased in 1948 by Weston.

**Frank M. Folsom**, president of RCA, received an award for his many years of service to humanitarian causes at a testimonial dinner in his honor sponsored by the National Jewish Hospital at Denver.

In presenting the bronze plaque award, John B. Kelly, chairman of the dinner, pointed out that Mr. Folsom "typifies the men of broad vision, patience, understanding, and charity, who have made democracy work." He told the guests that they are "providing the means to carry on the fight against tuberculosis—a fight which has been so well advanced by the National Jewish Hospital at Denver."

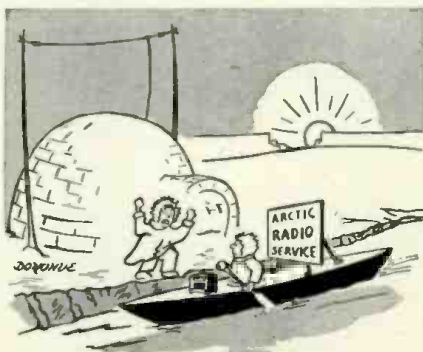

"And you promised me overnight service almost six months ago!"

## HEADQUARTERS FOR ELECTRONIC TUBES IN ALL QUANTITIES

5000 Magnetrons, 1000 Klystrons, 500,000 other tubes. Consult Electronics Magazine for our Many Bargains.  
**LIBERTY ELECTRONICS, INC.**  
135 LIBERTY STREET NEW YORK 6, N. Y.  
PHONE WORTH 4-8262

# HOW

Learn How to Simplify Radio Repairs!  
**FREE MANUAL**



Nothing complex to learn, no calculating. Used by beginners and experts. Send for FREE manual. "THE INSIDE STORY," today, 32 pages—illustrated—easy to read! Shows how obsolete methods prevent full use of your real ability. Explains use of NEW techniques. You owe it to yourself and your future to "get out in front!" in your work.



SEND COUPON OR PENNY POSTCARD FOR FREE MANUAL TODAY!

FEILER ENGINEERING CO. Dept. 2-RC3  
1601 S. Federal St., Chicago 16, Illinois  
Please RUSH my FREE copy of "The Inside Story."

Name.....  
Address.....  
City..... Zone... State.....

## DON'T BUILD ANY TELEVISION KITS!

16" - 630 Chassis With  
31 Tubes & Voltage Doubler

—When you can get a factory wired and tested 630TV Television Set, complete with tubes, ready to operate—at the same price as a kit!—Why fuss or have headaches?

This is the famous RCA type 630TV chassis which has proved to be superior to anything yet developed. We need not describe the 630-TV chassis—you already know about it. The design and operation is excellent—and it's fully guaranteed! Complete with tubes, less 16" Picture Tube.

Ready To Play  
LESS CABINET **\$159.50**

Extra for Glass 16" Tube..... **\$44.95**

### TELEVISION CABINETS

Fine quality cabinets, superbly finished in Walnut and Mahogany, designed especially to take the RCA 630 chassis, but can be ordered blank to fit any other make. Solidly reinforced, the cabinets are with built in mask for 15" or 16" tubes. Table Model, beautiful modern design. Specify 15" or 16" tube. .... **\$39.95**

Standard Television Console, **\$59.50**

Designed for custom-built installations

### V-M Model 406TRI-O-MATIC

Completely automatic operation, all records, all speeds, all sizes DISCRIMINATING MUSIC LOVERS form a ready market for this custom-styled version of the V-M Tri-O-Matic Changer. Smooth flowing lines readily adapt themselves to either modern or period cabinets.

ADJUSTMENTS ELIMINATED—All moving parts in Tri-O-Matic Changers are factory adjusted—insuring years of trouble-free performance. Actually only two adjustments are ever needed, needle height and set-down—and both are accessible from ABOVE the base plate. .... **\$32.22**  
Changer also available with GE Variable Reluctance Cartridges only **\$3.92** additional.

### WIRELESS AUTOMATIC RECORD PLAYER

A fortunate purchase has permitted us to offer these high quality single post automatic record changers AT LESS THAN FACTORY COST.

Nothing to connect, simply plug into wall outlet, load up a stack of records and turn on any radio within 50 feet. The record player will take ten 12" or twelve 10" standard records. The built-in wireless oscillator consists of two tubes in a stable high-quality circuit which can be easily adjusted for operation in any quiet spot on the radio. Mounted on an attractive leatherette covered base and sold complete, ready to operate.

Order today—while they last. **\$12.95**

### SPECIAL

Mammoth assortment of radio & electronic parts of such items as transformers, chokes, condensers, resistors, wire, coils, hardware, etc. of not less than 10 pounds. Price ..... **\$1.25**

For complete listings of special buys for experimenters, radio technicians, laboratories, schools and engineers. Write for catalog R2.

**RADIO DEALERS SUPPLY CO.**  
154 GREENWICH ST. NEW YORK 6, N. Y.

### QUESTIONS SURVEY

Dear Editor:

Although I'm not now working as a service technician, I feel moved to write regarding your survey to determine what your readers want regarding television articles (November, 1949, issue, coupon on page 52 and editorial, page 19).

According to your own statement, a survey made several years ago showed that 50% of readers were connected with servicing. How accurately does an old survey apply to the needs of 1949-50? On page 48 of the November issue, Commander Freedman gave a list of 25 new fields in radio-electronics. Only two of the 25 listed were in TV. Personnel working in the other 23 fields (I'm in research) also want to read and study RADIO-ELECTRONICS. Too many articles on TV or any other one subject could cause many readers to drop R-E in favor of other magazines which do not stress TV so much.

My own opinion is that the November issue represents a well-balanced magazine—there was something in it for everyone.

E. V. SCHWARTZ

Culver City, Calif.

(It was, of course, the fact that conditions have changed greatly during the past couple of years that inspired us to put out our questionnaire—a small-scale survey in itself. Our thanks for your kind comment on our November issue.—Editor)

### TRAINING FOR FUTURE

Dear Editor:

I believe your present television presentations are very satisfactory. Although we do not have television in this area, I have had considerable training on the subject and realize it is to my advantage to further my education along those lines. I also appreciate good audio circuits and latest radio developments.

NORMAN HOEFS,  
Service Manager,  
Meyers-Taube Co.

Fargo, N. D.

### NOT FOR SALE

Dear Editor:

I, too, say you put too much TV in your mag. I'd rather see you publish a radio magazine and a TV magazine. I doubt if you'd sell many of the latter, but at least you'd keep faith with those of us who are looking for a radio magazine.

If you don't change policy soon, I'll buy the darned rag and hire a new editor!

DEV DETSON

Lincoln, Nebr.

### WANTS FULL TV DIAGRAMS

Dear Editor:

If any subject warrants a lot of space, it certainly is television in this day and age.

I found the most welcome schematic of the Motorola VT73 receiver in this

**NOW** — IN KIT FORM!

EMC MODEL 300

VACUUM TUBE

Volt-Ohm-Capacity

METER

**\$23.95**



- Hammertone Metal Carrying Case
- DC VOLTS—6 ranges to 1000 volts!
- AC VOLTS—5 ranges to 1000 volts!
- RESISTANCE—6 ranges to 1000 meg-ohms
- CAPACITY—4 ranges (1.00025 mfd to 20 mfd)
- ZERO CENTER POSITION
- INCLUDES LEADS

Completed Unit ..... **\$39.50**  
CAPACITY RANGES and ZERO CENTER POSITION are features not available in competitive VTVM kits.



EMC Model 120  
20,000  
ohms-per-volt  
VOLTMETER

**\$22.95**

Portable Model Illustrated \$26.95  
The ONLY 20,000 ohms-per-volt instrument that gives you

- 6 D.C. Volt ranges at 20,000 ohms/volt to 6000 volts
  - 6 A.C. Volt ranges at 10,000 ohms/volt to 4000 volts
  - 5 current ranges to 6 amps
  - 4 resistance ranges to 300 megs
- Completed Unit (open face) . . . **\$29.95**  
Completed Unit (portable) . . . **\$34.95**

EMC MODEL 500K

R. F. SIGNAL  
GENERATOR

**\$18.75**



- Employs electrostatically shielded transformer for 115V 60 cycle operation
  - All coils not in use are automatically shorted out.
  - Provision for external modulation.
  - Att-active 3 color panel.
  - Covers range from 150KC to over 30 megacycles on fundamentals—over 100 megacycles on harmonics
  - 400 cycle internal modulation available.
- Export Dept., 303 W. 42nd St., N. Y. C.  
Write Dept. B-2 for Free Catalog

Gives More Measurement Value per Dollar!

**EMC** ELECTRONIC MEASUREMENTS CORP.  
423 BROOME STREET, NEW YORK 13, N. Y.

### BE YOUR OWN BOSS!

### MAKE MORE MONEY



In "CASH IN" you now get THE real money-makers—dozens of profitable tested mail order plans, confidential business secrets, dozens of practical tested formulas, successful tested schemes—actual experiences of men who have started on a shoe-string—with less than \$10 capital—25¢ a copy postpaid. Send U. S. stamps, money order, or coin.

**Money Back Guarantee.**

NATIONAL PLANS COMPANY  
1866 BROADWAY, NEW YORK 23, N. Y.

RADIO-ELECTRONICS for

month's (October) issue. I hope that this is a trend and that there will be a schematic of a different TV set each month.

WALTER J. WOJICH

Chicago, Ill.

**A NEW FM PROBLEM**

The following letter was received with a clipping announcing that WBRC-FM, Birmingham, was closing down permanently. The problem posed is serious. In spite of the merits of FM, and its undoubted acceptance by an ever-increasing number of listeners, a number of factors—chief of which is probably preoccupation with TV on the part of both listeners and broadcasters—are tending to squeeze it out. The clipping referred to stated that "plans for the expansion of WBRC-TV facilities will be announced later."

Dear Editor:

"I am inclosing a clipping from a local newspaper in regard to the suspension of one of our FM radio stations. This is one of our newest and most powerful stations with a power of 546,000 watts and an antenna 1,280 feet in height. It covers a radius of over a hundred miles. We have three other FM stations here but only one broadcasts programs direct from the FM studio; the other two offer AM duplicate programs.

"Is FM broadcasting going out as short wave did several years ago, or is this just a local condition?

"I have bought over \$200 worth of high-fidelity equipment consisting of amplifier, co-axial speaker, bass reflex inclosure, and FM tuner which it seems I won't need.

"People here don't seem to appreciate high fidelity and look irritated when you tune in a program or play a record that goes up above 4,000 cycles. Most people seem to like a program with more natural bass than they do high notes."

HARRY RANDALL

Bessemer, Alabama

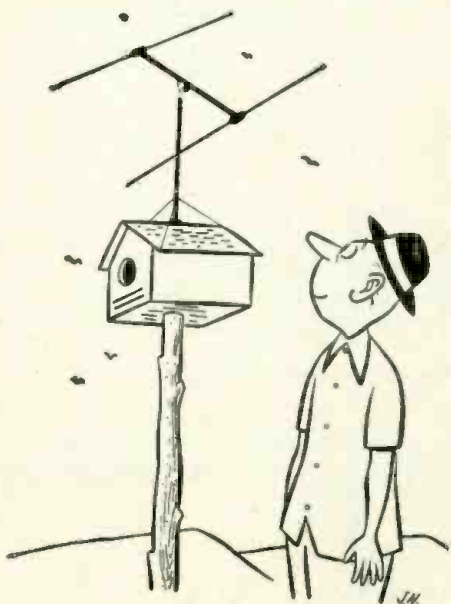

Suggested by John Norment, New York, N. Y.

FEBRUARY, 1950

**1950 PROGRESSIVE RADIO KIT ONLY \$14.75... ABSOLUTELY NO KNOWLEDGE OF RADIO NECESSARY. YOU NEED NO ADDITIONAL PARTS. EXCELLENT FOR BACKGROUND IN TELEVISION. BUILD 15 RADIOS.**

The PROGRESSIVE RADIO KIT will help you, if you want an EDUCATIONAL AND INTERESTING HOBBY, or if you want to get into a WELL-PAYING BUSINESS, or if you want to INCREASE YOUR KNOWLEDGE OF RADIO.

Absolutely no knowledge of radio is necessary. The PROGRESSIVE RADIO KIT is the product of many years of teaching and engineering experience. The detailed instructions and quizzes are clearly written and illustrated, so that they can be understood by anyone between the ages of 12 and 80.

The PROGRESSIVE RADIO KIT is not merely a collection of radio parts accompanied by a radio diagram. IT IS PRACTICALLY A RADIO COURSE, offered at a mere fraction of its real value. You will be taught to build radios in a progressive manner. First, you will build a very simple 1-tube receiver. The next set is a little more advanced. Gradually you will find yourself constructing elaborate radio sets, and doing work like a professional radio technician. Every part is illustrated. EVERY STEP INVOLVED IN BUILDING THESE SETS HAS BEEN CAREFULLY PLANNED. YOU CANNOT MAKE A MISTAKE.

Each of the 15 radios you will build operates on 110-120 volts, AC or DC. These sets have been designed to teach you the PRINCIPLES OF RADIO. Therefore, you will build a variety of circuits. The PROGRESSIVE RADIO KIT is EXCELLENT FOR LEARNING THE PRINCIPLES OF RECEIVER, TRANSMITTER, AND AMPLIFIER DESIGN. It is used in many Radio Schools and Colleges in U.S.A. and abroad. It is used by the Veterans Administration for veteran training.

Quizzes are provided as part of the PROGRESSIVE RADIO KIT. They will be corrected by our staff at no extra cost.

**FREE 1950 EXTRAS:** ELECTRICAL AND RADIO TESTER SCREWDRIVER BOOK ON TELEVISION GENEROUS HANK OF WIRE  
ELECTRIC SOLDERING IRON ALIGNMENT TOOL SPOOL OF ROSIN CORE SOLDER MEMBERSHIP IN RADIO-TV CLUB

ORDER YOUR PROGRESSIVE RADIO KIT TODAY, OR SEND FOR FREE "KIT-KATALOG" POSTAGE PREPAID ON CASH ORDERS. C.O.D. ORDERS ACCEPTED IN U.S.A.

**PROGRESSIVE ELECTRONICS CO.**

497 Union Ave., Dept. RE-32  
Brooklyn 11, New York

**WANTED TO BUY**

Large and small quantities of new or used electronic government or manufacturers' surplus tubes and equipment. Highest prices paid. State quantity, condition and best price in first letter.

Box No. F-2 c/o Radio Electronics

25 West Broadway  
New York 7, N. Y.

**SAVING TECHNOTES**

Dear Editor:

The Technotes published in RADIO-ELECTRONICS are of permanent value and ought to be saved. I put mine right in the service data binder with the sets they refer to.

I take a piece of white paper as tall as the binder and about 3 inches wide. The edge is pasted on the inside edge of the first page referring to the set. Then I cut out the Technotes as they are published and paste them on the paper. Next time you have trouble with a set, look in the data book.

DAVID GNESSIN

Columbus, Ohio

**SATISFIED CUSTOMER**

Dear Editor:

I am writing to say how much I like RADIO-ELECTRONICS. I have subscribed to it now for some time. Like everything else written or done by man, it has some deficiencies; but, then, that is why they put erasers on pencils, is it not?

I wish you would print a circuit of a tunable signal tracer. I built a simple one but would like to try one of the other type.

K. MYERS

East Liverpool, Ohio

**Leotone**

FACTORY SPEAKER REPAIRS SINCE 1927

- "POWER-PACKED" . . . 2 5 N.P. UNIVERSAL MOTOR (G.E.—3BA50LJ1) . . . 115V. AC/DC. REVERSIBLE 3000 RPM. Shaft 2 1/2" x 5/8". Overall: 7" x 4 1/2". Shpg. wt. 12 lbs. . . . \$5.95
- 8"-10" SPEAKER BAFFLE . . . Walnut veneer. Stone front. Sapp. wt. 4 lbs. . . . \$1.59
- "DICK TRACY WRIST RADIO" . . . NO BATTERIES! NO TUBES! Uses crystal diode; built-in phone. WEAR IT LIKE A WRIST WATCH! Requires aerial \$2.98 in lots of 12 only . . . \$2.00
- S.P.S.T. 115V. DC G.E. RELAYS (CR-2701) . . . .59
- VARIABLE CONDENSERS . . . 2 gang, Super. or TRF . . . .49
- TV GLARE FILTERS . . . INCREASE CONTRAST—REDUCE EYE STRAIN . . . 7" \$1.49; 10" \$1.79; 12" \$1.29; 12 1/2" \$1.39; 15" \$1.98; 16" \$2.29; 20" \$2.98

STOP! LOOK!! & SAVE!! . . . with LEOTONE'S "JUMBO RADIO PARTS KIT" . . . 17 FULL POUNDS of choice new & dismantled Radio & Electronic parts: COILS, TRANSFORMERS, WIRE, SPEAKERS, ACCESSORIES, RESISTORS, CONDENSERS, ETC. ETC. ALL THESE (shpg. wt. 21 lbs.) . . . \$2.95 AND MUCH, MUCH MORE!

- 8C-986A IFF TRANSCEIVER . . . Like new. \$12.95 Shpg. wt. 36 lbs. . . . A STEAL AT 5 for \$1.00
- 83-1AP CO-AX ANGLE PLUG (M-359) . . . ea. 5.23 5 for \$1.00
- ALNICO MAGNET KIT . . . Bar, Block, "U" . . . \$1.98 Ring. Kit of 10 ass'd. Shpg. wt. 2 lbs. . . .
- 09V. DC PANEL METER . . . 2 1/2" SQ. NEW. . . \$1.29
- PUNCHED CHASSIS & COVER FOUNDATION (5 tube) . . . Cad. plated steel. Overall: 11" x 9 1/2" x 4 3/4". Shpg. wt. 6 lbs. . . . .98
- 4 WAY CONNECTOR SET . . . PL-179 plug & cable jack—both . . . .49
- GRILLE CLOTH—12"x14" . . . Hvy. cardboard mg.; hole cut for 10" or 12" shkr. Rich Wine color—ea. . . .59
- TU-17 TUNING UNIT (BC-223 XMTR). 2.3 Mc. Like new . . . .2.49
- ARMY TANK PERISCOPES . . . Reflector type. BRAND NEW . . . .1.49
- STEEL MAST SECTIONS . . . MS-49, 50, 51, 53 or 54—ea. 5.39 . . . .3 for 1.00

RADIO HARDWARE TREASURE . . . FULL POUND OF NUTS, SCREWS, LUGS, WASHERS, etc. All in HANDY, SELF-SEALING HINGED LID . . . 49c CAN. Shpg. wt. 2 lbs. . . .

- SPONGE RUBBER PHONE CUSHIONS—pair \$25; 5 pr. for . . . \$1.00
- EXPERIMENTAL TUBES . . . for Servicemen, Experimenters, Students. Fil. tested. KIT of 20 ass'd. rcvg. types . . . .1.00

MIN. ORDER \$2.00 20% Deposit Req. on all COD's Please add sufficient postage—excess refunded

**LEOTONE RADIO CO.**  
67 Day Street,  
New York 7, N. Y.

**PEN-OSCIL-LITE**

Extremely convenient test oscillator for all radio servicing; alignment • Small as a pen • Self powered • Range from 700 cycles audio to over 600 megacycles u.h.f. • Output from zero to 125 v. • Low in cost • Used by Signal Corps • Write for information.

**GENERAL TEST EQUIPMENT**  
38 Argyle Ave. Buffalo 9, N. Y.

**BLISS ELECTRICAL SCHOOL**

Intensive 32 weeks' residence course in fundamentals of industrial electrical engineering, including radio and electronics. Extensive laboratory, shop work, drafting. Prepares for electrical technician and engineering aides in

communications, power, manufacturing, business machines, sales, service. G.I. approved. 57th year. Enter March 6, Sept. 5. Catalog. 7542 TAKOMA AVENUE, WASHINGTON 12, D. C.

Disc. Film. Magnetic recording, and audio frequency measurements. Studio training simulates Broadcast, Motion Picture, Television, and Commercial Recording work. Approved for Veterans  
**HOLLYWOOD SOUND INSTITUTE, Inc.**  
1040-E North Kenmore, Hollywood 27, Calif.  
Correspondence Courses Available  
Specify if Veteran or Non-Veteran

# Build Your Career! Become an ELECTRICAL ENGINEER

# RADIO SCHOOL DIRECTORY

96

**RCA**  
**VOLTOHMYST**  
**ONLY 3950**  
**AT TERMINAL**



**SENSITIVE** — ideal for radio, TV and audio measurements of AVC, AFC and FM discriminator voltages!  
**FULLY SHIELDED** — in metal case with enclosed battery power supply — ideal for accurate measurements in the powerful R.F. fields of transmitters!  
**VERSATILE** — has polarity reversing switch, measures D.C. and A.C. volts, D.C. current and resistance!  
**ACCURATE** — incorporates 1% tolerance precision resistors and 2% accuracy 4 1/2" meter in self-regulating, stable push-pull VTVM bridge circuit!  
**SELF-CONTAINED** — completely independent of power line — use it anywhere! **LONG-LIFE BATTERIES** — last up to one year with normal use!  
**RUGGED** — toughly made to withstand abnormal abuse, with electronic circuit-meter protected against burnout; unbreakable meter face!  
**COMPACT** — size 9 1/2" high, 6 1/4" wide, 5 1/2" deep. Weighs 9 lbs., including batteries.

**It's Sensational!**  
 RCA Battery Voltohmyst—vacuum tube voltmeter and volt-ohm-milliammeter combined — featuring self-contained long-life battery power supply!

The RCA WV-65A Voltohmyst is a highly accurate electronic voltmeter-ammeter-ohmmeter for laboratory and on-the-job testing! Supplied with 1-Meg. isolating shielded signal-tracing probe for measuring D.C. in presence of R.F.!

**RANGES**  
 D.C. VOLTS — 0-3/10/30/100/300-1000 volts, input resistance 11 megohms constant for all ranges  
 A.C. VOLTS — 0/10/30/100/300/1000 volts @ 1000 ohms per volt

**RESISTANCE** — 0-1K/10K/100K/1 meg/10 meg/1000 megohms  
**D.C. CURRENT** — 0-3/10/30/100/300 milliamperes, 0-10 amperes  
**RCA WV-65A Voltohmyst complete with 1-Meg. D.C. dynamic test probe and test leads, less batteries 3950**  
**BATTERY KIT — Two 45V and four 1V2V, factory-fresh! 2.58**  
**WG-263 — RCA Crystal Probe, read R.F. voltages flat to 100 megacycles 8.95**  
**WG-284 — RCA high-voltage probe, read D.C. volts to 30,000 volts 15.95**

**TERMINAL**  
 RADIO CORPORATION  
 Distributors of Radio & Electronic Equipment  
 85 CORTLANDT STREET, NEW YORK 7, N. Y.  
 WOrth 4-3311 • Cable: TERMRADIO

## ADVERTISING INDEX

Allied Radio Corporation	53, 67
Amplifier Corporation of America	72, 89
Walter Ashe Radio Company	91
Bell Telephone Laboratories, Inc.	73
Boland & Boyce, Inc.	58
Boyce-Roche Book Company	59
Brook Electronics	84
Brooks Radio Dist. Company	88
Buffalo Radio Supply	81
Capital Radio Engineering Institute	7
Cimex, Incorporated	83
Cleveland Electronics, Inc.	69
Cleveland Institute of Radio	22
Communications Equipment Company	74
Coyne Electrical School	85, 89
DeForest's Training, Inc.	11
Editors and Engineers	74
Electronic Instrument Co., Inc.	63
Electronic Measurements Corporation	92
Electro-Technical Industries	78
Fair Radio Sales	74
Federated Purchaser	84
Feller Engineering Company	80, 91
General Electronic Dist. Co.	57
General Industries	83
General Test Equipment Co.	93
Greenwich Sales Company	88
Graylock Electronic Supply Co.	87
Heath Company	13, 14, 15, 16, 17, 18, 19, 20
Hickok Electrical Inst. Company	79
Hot Nails	90
Hudson Specialties Company	86
Hytron Radio & Electronics Corp.	12
Instructograph Company	72
JFD Mfg. Co.	84
Jensen Industries, Inc.	83
Jersey Specialty Company	97
The Kelsey Company	96
Lafayette-Concord	96
La Pointe-Plascomold Corp.	86
Electronic Research Laboratories	96
Leotone Radio Corporation	93
Liberty Electronics	91
McGrow-Hill Book Co., Inc.	97
The Macmillan Company	97
Midwest Radio Corporation	70
Murray Hill Books, Inc.	54, 55
National Radio Institute	3
National Schools	5
Niagara Radio	65, 93
Oak Ridge Mfg. Company	10
Opportunity Adlets	96
Plastics & Electronics Company	83
Precision Apparatus Company	60
Precision Radiation Inst., Inc.	90
Progressive Electronics Company	93

## OPPORTUNITY AD-LETS

Advertisements in this section cost 25¢ a word for each insertion. Name, address and initials must be included at the above rate. Cash should accompany all classified advertisements unless placed by an accredited advertising agency. No advertisement for less than ten words accepted. Ten percent discount six issues, twenty percent for twelve issues. Objectionable or misleading advertisements not accepted. Advertisements for March, 1950, issue, must reach us not later than January 24, 1950.  
 Radio-Electronics, 25 W. Broadway, New York 7, N. Y.

**AMATEUR RADIO LICENSES. COMPLETE THEORY** Preparation for passing amateur radio examination. Home study courses. American Radio Institute, 101 West 63rd St., New York City. See our ad in Page 94.

**MAGAZINES (BACK DATES)—FOREIGN, DOMESTIC,** art. Books, booklets, subscriptions, pin-ups, etc. Catalogs, 10¢ (refunded), Cleorone's, 86-22 Northern Blvd., Jackson Heights, N. Y.

**FRANK COTTON—OMAK, Wash.** has McMurdo Silver Test Instruments for sale. Reasonable.  
 Art reproductions exchanged for radio parts and books. Harry Cutler, 38, Tornay House, Hackney, London, E9, England.

**WE REPAIR ALL TYPES OF ELECTRICAL INSTRUMENTS,** tube checkers and analyzers. Hazleton Instrument Co. (Electric Meter Laboratory) 140 Liberty Street, New York, N. Y. Telephone—BARclay 7-4230.

**BARGAINS: NEW AND RECONDITIONED HALL-**crafters, National, Collins, Hammarlund, Meissner, RME, other receivers, tuners, television receivers, transmitters, etc. Wholesale prices. Terms. Shipped on trial. Liberal trade-in allowance. Write: Henry Radio, Butler, Missouri and 11240 West Olympic, Los Angeles, California.

**BAIGAIN HUNTING? RADIO SERVICEMEN WHITE** Sensational catalog. Henshaw Radio Supply, 3619 Troost Kansas City 3, Missouri.

**HERMAN LEWIS GORDON, REGISTERED PATENT** Attorney. Patent Investigations and Opinions. Warner Building, Washington, D. C.

**LANCASTER, ALLWINE & ROMMEL, 436 ROWEN** Building, Washington, D. C. Registered Patent Attorney, Practice before United States Patent Office. Validity and infringement investigations and opinions. Booklet and form "Evidence of Conception" forwarded upon request.

**MAGAZINES—radio, electronic, etc.** sold and bought. Landa, 157b Leveritt, Boston-14, Mass.

Young Englishman would like to contact Americans with view to exchanging Radio Magazines, parts etc. Is there anything you want from England? Jack McNamee, 91 Green Lane, Blackburn, Lancs, England.

**WANTED—SALES AGENT.** Important nationally known manufacturer has developed lowest cost paging and alarm system now produced. Suitable for all medium sized factories, offices, hospitals, retail stores, restaurants, banks, etc. Our own salesmen cannot handle this product because they cover different trade. Exclusive agent appointments will be made at once—prefer man with small sales organizations now covering above mentioned outlets. Liberal commission and special discounts on samples. Write fullest qualifications to President, NuTone, Inc., Dept. SA-9, Madison & Redbank Roads, Cincinnati 27, Ohio.

**SNIPERSCOPE & SNOOPERSCOPIES** wanted. Any construction. Needed immediately. Box F1, Radio-Electronics, 25 W. Broadway, New York 7, N. Y.

**PHONOGRAPH RECORDS** 15¢. Catalogue, Paramount TG-913 East Market, Wilkes-Barre, Penna.

**TELEVISION—Bright and clear.** Adjust present aerial. Build low-cost Precision antennae. Instructions, charts, diagrams, dimensions, plans. Free—Television stations, kilowatts, tower heights. ProPson Company, Lumberton, N. J.

Five Element TV Yagi Beams, High Band \$6.75. Low Band \$8.50. Aluminum Tubing, Etc. Willard Radcliff, Fostoria, Ohio.

**URANIUM ORE!! (CARNOTITE)** approximate 1/4 lb. \$5.00. Rozsak, Hermlin, Pa.

All steel TV tower—Shipped direct from the factory at \$8.50 per 10' section. Easy to climb. Can be erected to 70' or more. The Youngstown Steel Towers, 1316 Wilson Avenue, Youngstown 8, Ohio.

## SURPLUS EQUIPMENT

Trouble Shooting Manuals  
 (Include Schematics)  
 BC-348—J, N, Q SCR-522 **1.00**  
 BC-779 BC-610 **each**  
**Build Your Own Geiger Counter**

(See Radio-Electronics—Oct. 1949)  
 1898 GAMMA COUNTER TUBES. Only.....\$9.87

RCA Sound Power Unit. Use as mike or recvr. ....\$1.11 ea.; \$2.22 pr.  
 FL-8A Filter .....\$1.37  
 RCA Navy Head & Chest set \$14.88 ea.; \$28.00 pr.  
 I-82 Selsyn Indicator, 5" dia.—Brand New...\$3.95  
 G.E. 2J1G1 Selsyns—Brand New.....\$1.16

**Command Receivers**  
 BC-453 190-550 kc—New Orig. Cartons.....\$12.95  
 BC-454 3-6 mc—New—Orig. Cartons..... 6.95  
 BC-455 6-9 mc—New—Orig. Cartons..... 6.95

**Brand New Sound Power Phons**  
 TS-10 Hand set.....\$8.92 ea.; \$17.60 pr.  
 Include Postage with Orders  
 Send for FREE Monthly Bulletin  
**ELECTRONIC RESEARCH LABS.**  
 1021-E Callowhill St. Phila. 23, Pa.

## Handi-Chest So Handy...

Home-Office-Shop  
 Stamps-Pins-Buttons-Washers  
 Bolts-Nuts-Nails-Screws—  
**METAL CABINET ALUMINUM DRAWERS**  
 No Extras To Buy!

**PRICES**  
 96 9" DRAWER \$8.75  
 192 9" DRAWER \$15.75

**WE PAY ALL POSTAGE**  
 WE'VE THE ROCKY MOUNTAINS  
 AND FOREIGN COUNTRIES ADD 10%  
 OHIOANS ADD 3% SALES TAX  
 No C.O.D.'s Please  
 Send check or money order to  
**TIBBITS MFG. CO.**  
 Dept. 3-B-38100, Ohio

SIZES	DESCRIPTION
32 Drawer 6"-17 1/2"-15 1/2"	BEAUTIFUL HARMONIZED ENAMEL FINISH REMOVABLE DIVIDERS IN DRAWERS
64 Drawer 6"-24 1/2"-19 1/2"	INDEX CARDS SPOT WELDED STEEL CABINET
Drawer Size (all sizes) 14"-23 1/2"-5 1/2"	ROBUST FEET WON'T WAVE

**Money Back Guarantee!**

## RADIO SCHOOL DIRECTORY (Pages 94-95)

American Radio Institute	
Baltimore Technical Institute	
Bliss Electronic School	
Candler System Company	
Commercial Radio Institute	
Commercial Trades Institute	
Delehanty Institute	
Don Martin School of Radio Arts	
Hollywood Sound Institute	
Massachusetts Radio School	
Milwaukee School of Engineering	
RCA Institutes	
Radio-Television Institute	
Tri-State College	
Valparaiso Technical Institute	
YMCA Trade & Technical Schools	
Quam-Nichols	87
RCA Victor Division Radio Corporation of America	6, Inside Front Cover, Back Cover
R & M Radio Company	90
Radio Apparatus Corporation	69
Radio City Products	8
Radio Corporation of America	61
Radio Dealers Supply Company	92
Radio Supply and Engineering	87
Radianic Equipment Corporation	88
Roytheon Mfg. Company	60
Howard W. Sams & Co., Inc.	9
Senco Radio, Incorporated	77
Sovereign Television Company	72
Sprague Products Company	4, 88
Sprayberry Academy of Radio	Inside Back Cover
Bill Sutton's Wholesale Electronics	74
Sylvania Electric Products	21
Technifax	80
Tel-A-Ray	90
Terminal Radio Corporation	96
Tidbits Mfg. Co.	96
Transvision	74
United Surplus Materials	75
Universal General Corporation	90
University Loudspeakers	66
Montgomery Ward & Company	80
Weller Mfg. Company	62
Wells Sales	98
Wholesale Radio Parts Co., Inc.	82

**Print Your Own**  
 Cards, Stationery, Advertising, Circulars and  
 Notes. Save money. Print for Others. Good Profit  
 easy rules. Have your own print shop. Raised printing like  
 never before. No. Sold direct from factory only. Write  
 for free catalogue of outfits and all details.  
**KELSEY PRESSES, P-97, Meriden, Conn.**

**TELEVISION**

300 Ohm T.V. twin lead  
Transmission Wire  
at World's Lowest Price

**SUPER DISTRIBUTORS  
WANTED!**

Who are now covering  
Dealers and Installers.

**Valuable EXCLUSIVE**

Territories still available  
To Live organizations  
To act as our Super  
Representatives in many States  
To sell to Distributors and Jobbers

**Jersey Specialty Co.**

Manufacturers of Wire Products  
Little Falls, N.J.

Phones: L.F. 4-0784-1404-1405

Just out! New 10th Edition!

**RADIO OPERATING  
QUESTIONS and ANSWERS**

—to help you meet NEW  
F.C.C. Study Guide  
Requirements



By J. L. Hornung

Supervisor, Radio Electronics  
Walter Hervey Junior College  
539 pages \$5.00

HERE is the information you need to help you pass any class of commercial radio operator's examination; the correct answers to the approximately 1500 new examination questions listed in the FCC Study Guide, Elements 1, 2, 3, 4, 5 and 6, revised July 1, 1948, and element 7, effective Jan. 3, 1950. PLUS the answers to the FCC supplementary listing, including the new element 7 for aircraft radiotelegraph operator's license.

**Just Published  
BASIC  
TELEVISION**

By Bernard Grob  
Instructor, RCA Institute  
An A-to-Z manual for everyone concerned with TV receiver installation and servicing. Elaborate trouble-shooting charts show symptoms, and cures for over 50 common TV receiver problems. Simplified diagrams, drawings and photographs illustrate every topic. 592 pages, \$6.50.

**CONTENTS**

- Basic Radio Laws • Basic Theory and Practice
- Radiotelephone • Advanced Radiotelephony
- Radio Telegraph
- Advanced Radiotelegraphy • Aircraft Radiotelegraphy

**SEE THEM 10 DAYS FREE**

McGraw-Hill Book Co., 330 W. 42 St., N. Y. C. 18

Send me book(s) checked below for 10 days' examination on approval. In 10 days I will send remittance, plus few cents for delivery, or return book(s) postpaid. (We pay for delivery if you remit with this coupon; same return privilege.)

- Hornung's RADIO OPERATING Q. & A. \$5.00
- Grob's BASIC TELEVISION \$6.50

Name .....

Address .....

City ..... Zone ..... State .....

Company .....

Position .....

This offer applies to U. S. only RC-2-50

**FUNDAMENTALS OF ELECTRIC WAVES**, second edition, by Hugh Hildreth Skilling. Published by John Wiley & Sons, Inc., New York, N. Y. 6 x 9½ inches, 245 pages. Price \$4.00.

Students of radio have long been aware of a gap between the nonmathematical or slightly mathematical technical text and the one which assumes that the reader has become suddenly well grounded in Maxwell's equations and proceeds to deal with propagation theory on that assumption. Here at last is a book that bridges that gap. Written for the use of senior electrical engineering students, it is so planned as to meet the requirements of those who have no previous knowledge of electromagnetic theory, but have a good grounding in college mathematics and physics. Conversely, it will be extremely useful to the radioman who has discovered that a knowledge of calculus does not prepare him to understand radio propagation theory.

Such heretofore esoteric terms as "curl" and "divergence" are explained and illustrated with drawings.

The earlier part of the book deals with electrostatic and electromagnetic fields, leading up to Maxwell's hypothesis (in chapter VII). Chapters IX to XIV are given over to plane waves, reflection, radiation, antennas, wave guides, and waves in the ionosphere. The mks system of units is used.

**RADIO TUBES**, by E. Aisberg, L. Gaudillat, and R. de Schepper. Published by the Societe des Editions Radio (Paris, France.) 8¼ x 5¼ inches, 156 pages. Price 385 francs.

A novel work, this little book is really a tube manual (though the authors are careful to point out that it should be considered complementary to, rather than superseding, standard manuals).

The book consists of 858 schematic diagrams, each showing a standard European or American tube in a circuit suited to it. All pertinent voltages are given, together with currents when considered expedient. Maximum input and output signal voltages are often included. Characteristics such as plate resistance, amplification factor, and the like are included in a little table in an upper corner of each schematic. Typical values of plate, cathode, and other resistors are also given in the schematics. Most tubes are illustrated with one diagram, but some with widely differing applications have two, and the 6L6 has five.

Written in the international tongue of the schematic diagram, the text of the book is understandable to all readers. Explanatory prefaces in five languages are included.

While the exact field likely to be covered by the new book is not entirely clear, it is certain to be in demand by the experimenter (for its more than 800 circuits, if nothing else); the engineer, who can compare applications at a glance and also by service technicians and others who have to deal with equipment using European tubes.

**WHAT IS YOUR PROBLEM?**

You will find the answer

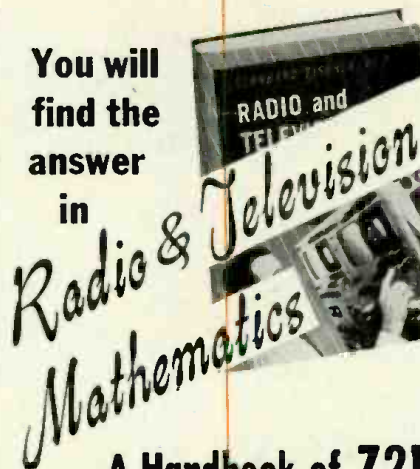

**A Handbook of 721 problems AND SOLUTIONS**

Save time and trouble. Arranged under radio and electronic headings and completely indexed for quick reference, these problems give you step-by-step solutions to every problem commonly arising in work on receivers, power supplies, antennas, amplifiers, tubes, transmitters, etc. If you are ever "stuck" on a calculation; if you need a check on your figuring; or if you want to refresh your memory on the formulas to use for a certain problem—you will find your answer quickly and easily in this book.

Good practice for your FCC exams. This book shows you how to solve every problem requiring mathematics in the FCC STUDY GUIDE for licenses of all classes. You will find no better handbook for practice in solving problems with ease, speed and accuracy. \$6.00

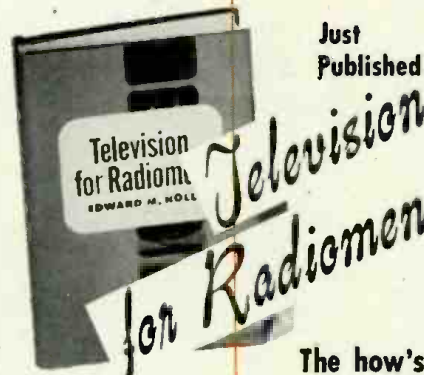

Just Published

**The how's AND WHY'S in the practical terms of operation & servicing**

This book explains the theory as well as the techniques of television construction, operation, and servicing in the clearest, most practical terms. It gives the radioman all the basic information he needs to meet the increasing demand for skilled television technicians. It shows how and why all modern equipment operates; includes all the essential mathematics and especially good material on antennas. \$7.00

**SEE THEM FREE**

The Macmillan Co., 60 Fifth Ave., New York 11

Please send me a copy of the books checked below. I agree to remit in full or return the books within ten days without further obligation.

- Radio & Television Mathematics, \$6.00
- Television for Radiomen, \$7.00

Signed.....

Address.....

# RADIO-ELECTRONIC Components by the Thousands!

## 6 OUTSTANDING VALUES FROM WELLS' FAMOUS STOCK

### B-L Auto Radio Filterpac and Battery Eliminator

Replaces storage battery for auto radio test bench or for sales demonstration. Supplies 10 amps D.C. continuous or 15 amps D.C. intermittent at 6 volts. Long life B-L Selenium Rectifier. Brand new. 115 V. A. C. Save on our low price of only \$32.00.



### Heavy Duty Blower

Centrifugal type blower for cooling your transmitter or dark room. Adjustable air control. Capacity 100 CFM. 115 VAC. Price only \$12.95.



Junior Centrifugal Blower with 25 CFM capacity—\$6.95.

### S Meter

Add an S meter to your receiver at low cost. High grade 5 mil movement. 2 inch bore. Only \$1.25.



### Servo Amplifier

Beautiful 7 tube amplifier complete with 6 relays for servo system operation. Parts alone worth several times our low price. New in original packing—only \$11.95.

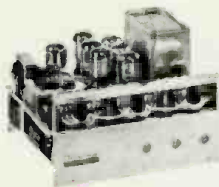

### Fractional H. P. Motor

Perfectly built, silent running motor originally built for ART/13 tuner. 3900 RPM. 1/20 HP. Instructions for operating on 115 VAC. Makes a fine sewing machine motor. Priced very low at \$7.95.



### Circuit Breaker

25 Ampere circuit breaker protects your equipment in case of overload. Ideal for replacing household fuse boxes. Price only \$1.95.



## WELLS TUBE DEPARTMENT

Brand new, standard make tubes by the thousands are ready for immediate delivery at the lowest prices in our history. Check this list for exceptional values.

TYPE	PRICE EACH	TYPE	PRICE EACH	TYPE	PRICE EACH	TYPE	PRICE EACH
0A4G	\$.095	6B4G	.95	28D7	.40	714A Y	3.90
01A	.45	6B7	.80	30	.75	715B	9.75
1A5GT	.55	6B8	.95	30 (VT-67) Walkie	.75	717A	.85
1B22	4.35	6BE6	.55	23 (VT-33) Talkie	.75	721A	3.75
1B23	7.50	6C4	.40	34	.35	723AB	14.95
1B42	5.25	6C6	.70	RK-34	.45	724A	4.25
1C5GT	.65	6C21	19.25	35Y4	.65	724B	4.25
1D8GT	.95	6D6	.60	36	.40	725A	9.95
1E7GT	1.95	6E5	.70	37	.40	726A	17.45
1E7G	1.95	6F6	.60	38	.40	730A	10.95
1G6	.65	6G6G	.80	39/44	.35	801	.50
1L4	.75	6H6	.45	45 Spec.	.50	801A	.70
1LC6	.75	6J5	.45	46	.75	803	8.25
1N5GT	.45	6J5GT	.45	EF50/VT250	.45	804	9.95
1N21 (Crystal Diode)	.65	6J6	.90	56	.65	805	5.95
1N21A (Crystal Diode)	.95	6J7GT	.70	70L7	1.05	807	1.25
1N21B (Crystal Diode)	.95	6J8G	.72	72	1.75	808	1.55
1N23 (Crystal Diode)	.80	6J9G	.95	RKR-73	1.25	811	2.35
1N23A (Crystal Diode)	.85	6K6GT	.55	76	.55	812	7.85
1N27 (Crystal Diode)	.85	6L7	.75	77	\$.055	814	3.75
1N29 (Crystal Diode)	.85	6N7	.75	VR-78	.65	815	2.85
1Q5GT	.85	6R7G	.75	60	.45	826	.75
1R4/1294	.65	6SA7	\$.065	FG-81A	2.95	829B	4.95
1S5	.70	6SC7GT	.70	83V	.90	830B	3.95
1T4	.75	6SF5	.65	89Y	.40	834	5.75
2A3	1.05	6SH7	.65	VR-90	.65	837	1.65
2A7	.65	6SJ7GT	.60	VR-92	.65	838	\$ 3.25
2B7	.75	6SK7GT	.60	100R	2.75	841	.50
2B22/GL559	3.75	6SL7GT	.60	FG-105	9.75	843	.50
2C22/7193	.35	6SN7GT	.80	VR-105	.85	851	39.00
2C26	.35	6SQ7GT	.60	VU-111-S	.55	860	2.40
2C26A	.45	6SR7	.60	1148	1.20	861	29.25
2C34	.55	6SR7	.60	11723	.55	864	.45
2J21A	11.45	6T7G	.85	VT-127 British	.35	865	2.55
2J22	9.85	6V6GT	.75	VT-127-A (Triode)	2.95	866A	1.30
2J26	8.45	6Y6G	.75	VR-150	.50	869	19.95
2J27	12.95	7-7-11 Ballast	.35	VT-158	14.95	869B	27.25
2J31	9.95	7A4	.60	FG-172	19.75	872A	2.45
2J32	14.85	7A7	.60	205B	1.45	874	1.95
2J33	18.95	7B4	.60	211 (VT4C)	.60	878	1.95
2J34	17.50	7C4/1203A	.40	215A	1.75	930 Photo Tube	1.00
2J37	13.85	7E6	.60	221A	2.10	954	.45
2J38	6.95	7F7	.70	231D	1.20	955	.55
2J48	12.95	7H7	.70	268A	2.95	956	.50
2J61	27.50	7H7	.70	304TH	5.75	957	.45
2Y3G	1.20	7L7	.70	304TL	1.75	958	.45
2X2/879	.65	7N7	.70	307A	4.25	991 (NE-16)	.30
3A4	.35	7Q7	.60	316A	.75	1005	.35
3B22	2.65	10	.45	350B	\$ 2.55	1149	.35
3B24	1.75	10T1 Ballast	.50	354C	14.95	1201	.75
3BP1	3.75	10Y	.45	371A	.95	1203A/7C4	1.05
3C24/24G	.50	12A6	.25	371B	.85	1616	1.25
3D6/1299	.65	12A6GT	.25	388A	3.95	1619	.45
3E29	4.95	12AH7GT	1.10	393A	4.65	1624	1.25
3FP7	2.95	12B8	.50	MX408U	.40	1626	.45
3FP7A	4.95	12F6GT	.65	417A	14.50	1629	.40
3CP1	4.50	12H6	.40	434A	3.40	1630	3.95
3HP7	2.95	12J5GT	.40	446A	1.58	1638	.90
3Q5	.90	12J7GT	.70	450TH	17.95	1641/RK-60	.75
3S4	.75	12K8	.65	471A	2.55	2051	.75
REL-5	14.95	12SF7	.70	527	9.95	7193	.30
5AP1	3.95	12SG7	.65	530	9.95	8011	2.25
5BP1	2.75	12SH7	.40	531	12.95	8012	3.25
5BP3	3.95	12SK7	.60	532A/1B32	3.55	8020	3.25
5CP1	3.75	12SL7GT	.60	GL-559	3.75	8025	6.75
5D21	24.75	12SQ7GT	.60	KU-610	7.45	9001	.65
5FP7	3.25	12SR7	.60	HY-615	1.05	9002	.45
5HP1	4.95	12X825-2-amp.		700B	7.95	9003	.60
5HP4	4.75	Tungar	2.10	700C	7.95	9004	.40
5J22	13.45	13-A Ballast	.35	700D	2.95	9006	.40
5J29	13.45	14B6	.95	702A	7.95	9006	.40
5R4GY	.95	15R	1.20	703A	3.95	38111A	.45
6-4	.35	REL-21	2.75	704A	1.75		
6-7	.35	23D4 Ballast	.45	705A	2.65	NEON BULBS	
6A3	.95	RK24	1.75	707A	17.50	NE-11	\$0.24
6A6	.75	24A	.75	707B	19.50	NE-16	.24
6AB7	.95	25Z6GT	.55	708A	\$ 4.95	NE-20	.06
6AC7	.90	26	.65	710A	2.45	NE-21	.24
6AK5	.80	27	.50	713A	1.55	NE-48	.24
6AK6	.80						

### JUST OUT! CATALOG H500

Manufacturers, Distributors and Amateurs write for the brand new Wells Electronic Catalog H500. Full of tremendous values in highest quality components.

Distributors: Our standard distributor arrangement applies on these items.



Order directly from this ad or through your local Parts Jobber.

320 N. LA SALLE ST., DEPT. Y, CHICAGO 10, ILL.



**YOU** Need My PRACTICAL Training to Make Money in

# TELEVISION- RADIO and ELECTRONICS!



*I'll Send You*  
**8 BIG KITS of**  
Radio Parts and Equipment . . .

Learn at  
**HOME**  
IN YOUR  
**SPARE TIME**

**NOW IS THE TIME To Get Into This Fast Growing Industry—Prepare For A Fine Paying Job Or Your Own Business!**

If you want to get into Radio-Television and Electronics . . . you owe it to yourself to get the facts about my training. I have trained hundreds of men to become outstanding service technicians—and I'm ready to do the same for you. Whether your goal is a fine paying job in one of Radio's many branches—or a successful Radio and Television business of your own—you need the kind of training I offer! My training is practical and down to earth. **YOU NEED NO PREVIOUS EXPERIENCE.** You'll be astonished at your rapid progress. I start you with basic fundamentals and give you plenty of practical shop-bench training with many kits of parts I send you. This is the training that sticks with you and makes money for you on the job!

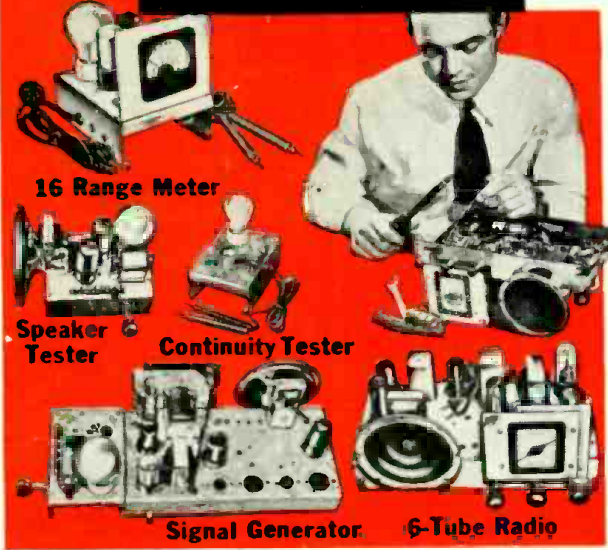

## Get Paid For Spare Time While Learning

Soon after you start training I send you my famous **BUSINESS BUILDERS** that show you how to make money in spare time doing interesting Radio jobs. Look at the useful and valuable equipment you get while training with me (illustrated at left)—I send you these 8 big kits of Radio parts and equipment and help you build step-by-step a powerful 6-tube superhet radio, a 16-range test meter, plus other mighty, useful equipment for Radio and Television servicing. You will perform over 175 fascinating experiments while training. You will learn about Television—so that you will be qualified to step into this fast growing, profitable field. I also send you many valuable service manuals, diagrams and my book telling exactly how to set up your own Television and Radio shop. *I want you to learn all about my training*—and that is why I urge you to clip and mail the coupon below for my two big **FREE** Radio books. I employ no salesmen—and nobody will call on you. The important thing is to act now and get the facts.

## HAVE A BUSINESS OF YOUR OWN

A profitable Radio and Television Service Shop may be started with little capital. I will show you how to get started and how to build your small business. At left is pictured one of my graduates, Mr. Merrit C. Sperry of Fairmont, Minnesota in his own shop. The way is also open for you to build a good **SERVICE BUSINESS FOR YOURSELF.**



## ALL KITS ARE YOURS TO KEEP

Each of the hundreds of Radio parts and other items I send my students is theirs "for keeps." You may use this equipment in your Radio and Television service work and save many dollars by not having to buy expensive "ready-made" test equipment. Each of my 8 kits will help you advance and learn important steps in Radio and Television servicing.



**CALVIN SKINNER** of New Orleans, La., tells us he makes \$5 to \$10 in spare time repairing radios. He is now also working with his own Television set.



**LOREN D. SAUCIER** of Coloma, Mich., reports that my training has made it possible for him to repair large numbers of radio and Television receivers.

## RADIO AND TELEVISION INDUSTRY BOOMING

You couldn't pick a better time to get into Radio-Television and Electronics. New Television stations are going on the air to serve every major city—hundreds of new AM and FM Radio broadcasting stations are also on the air to serve practically every community in America. All this creates new and bigger opportunities for the trained man who knows Radio-Television and Electronics. Good Radio and Television service men are needed **NOW!**

## VETERANS

**THIS TRAINING AVAILABLE TO YOU UNDER THE G. I. BILL**

My Training Includes:  
**Radio Servicing**  
**Television**  
**FM Frequency Modulation**  
**Public Address and High Frequency Applications**



These Two Big **FREE!** Radio Books

Just mail coupon for a **FREE** sample Sprayberry Lesson and my big **FREE** book, "How To Make Money in Radio-Television and Electronics." Learn why my really practical training is best of all for you. Discover what's ahead for you in the fast moving Radio-Television and Electronics industry. No obligation. Don't delay—the future is too important to you. Mail the coupon now—and count on me for fast action.

## RUSH COUPON Today!

**SPRAYBERRY ACADEMY of RADIO, Dept. 20-F 111 North Canal St., Chicago 6, Ill.**

Please rush my **FREE** copies of "How To Make Money in Radio-Television and Electronics" and "How To Read Radio Diagrams and Symbols."

Name . . . . . Age . . . . .

Address . . . . .

City . . . . . State . . . . .

**SPRAYBERRY ACADEMY OF RADIO**  
111 N. CANAL, DEPT. 20-F CHICAGO 6, ILL.

( ) Check here if you are a Veteran.

THE QUALITY OF RCA TUBES IS UNQUESTIONED



934  
12  
1468  
984  
11808  
5900

$$1\lambda = \frac{984}{F} \text{ IN FEET}$$

ANOTHER MILESTONE IN

# Television Progress

...the new RCA-16GP4 short  
metal-cone kinescope with  
"Filterglass" face plate

UNCEASING RESEARCH in television tubes by RCA engineers is responsible for the development of the new, short 16GP4 metal kinescope.

This 16-inch-diameter tube is actually  $\frac{5}{16}$ " shorter than the 10BP4 . . . nearly 5" shorter than the 16AP4. Thus, greater flexibility and compactness is made possible in receiver and cabinet design.

Also, a superior picture is realized from the RCA "Filterglass" face plate. Picture contrast is improved by minimizing the effects of reflected room light, and of light reflections within the face plate itself.

RCA's engineering leadership adds *value beyond price* to the RCA tubes you sell. And you benefit directly from this *continued* research by the new enterprises which it creates.

*Always keep in touch with your RCA Tube Distributor*



**RADIO CORPORATION of AMERICA**  
ELECTRON TUBES HARRISON, N. J.