

ANNUAL TELEVISION NUMBER

HUGO GERNSBACH, Editor

RADIO — ELECTRONICS

CHOOSING A TV

formerly

**RADIO
CRAFT**



**MASS PRODUCTION
TELEVISION TESTS**
SEE TELEVISION SECTION

JAN

1950

50¢

U. S. and
CANADA

LATEST IN RADIO — ELECTRONICS — TELEVISION

"TV+FM+AM . . . We're making sure that we get all of this business . . ."

"We don't propose to let even one customer walk out of our place. If it's a TV, AM or FM set that needs servicing, we're making sure that we can handle the job satisfactorily. And one way of making sure is by constantly using our reference library of Rider Manuals."

— Says Mr. I. Zwickel
Signal Radio Hospital
Brooklyn, New York



For Greater Efficiency... For More Information... For More Value For Your Money

Place Your Order Now for the **NEW RIDER TV MANUAL VOL. 3**

Larger Page Size! 12" x 15" All Pages in Place! Easier to Use!

**Order Now From Your Jobber
New RIDER MANUAL
VOL. XX**

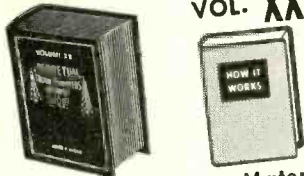

**New Material! More Material!
New Profit-Possibilities!**

Reliable, authentic, factory-authorized servicing information covering the latest AM, FM radio, Auto Receivers, Record Changers, etc. . . . Complete in every respect, but with the added advantage of text and double spreads assembled in position.

**FREE! Eye-Stoppers For
Service Shop Windows**

A very clever Rider Display Idea, 14 x 17 inches, captioned "Which One Is The Phony?". It shows two greatly enlarged photos of postage stamps, one genuine, one a known counterfeit, with identifying characteristics and means of recognizing the forgery. This Display is a real traffic-stopper, and will help build more business for you. 2 Displays are issued each month, and you can get them FREE of CHARGE from your Jobber.

NOTE: Are you receiving your copy of "Successful Servicing"? It's Rider's own publication of interest to every Serviceman. Write for it... it's FREE!

Here is accurate, authentic, reliable servicing information direct from 74 TV receiver manufacturers. New, enlarged page size, 12 x 15 inches, with all pages filed in position. Giant pages have been retained . . . but now have only one fold for greater convenience and durability. There's more ease in using, too, because there are fewer pages to turn and because diagrams and related text are more closely positioned. Order now from your jobber.

\$21⁰⁰
Complete

Equivalent of Approximately 2032 Pages (8 1/2 x 11"), Plus Cumulative Index Volumes 1, 2 and 3, Plus the Famous "How It Works" Book

RIDER MANUALS

- Television Manual Volume 3 (Plus "How It Works" Book and Index)..... \$21.00
- Television Manual Volume 2 (Plus "How It Works" Book and Index)..... \$18.00
- Television Manual Volume 1 (Plus "How It Works" Book and Index)..... \$18.00
- Volume XIX \$19.80
- Volume XVIII \$19.80
- Volume XVII \$16.50
- Volume XVI \$ 8.40
- Volume XV \$19.80
- Volume XIV to VII (each volume)..... \$16.50
- Volume VI \$12.50
- Abridged Manuals I to V (one volume) \$19.80
- Record Changers and Recorders \$ 9.00
- Master Index, Covering Manuals, Vols. I to XV \$ 1.50
- PA Equipment Manual, Vol. I \$18.00

FM TRANSMISSION and RECEPTION

by John F. Rider and Seymour D. Usilan

A "must" book for the radio serviceman who looks to FM and television as an important part of his future earnings. Covers all types of frequency modulation systems employed in TV, radio, amateur radio, railroad, aviation, marine, police, point-to-point and mobile receivers. 416 pages, profusely illustrated. **\$3⁸⁰**

TV PICTURE PROJECTION and ENLARGEMENT

by Allan Lytel

Timely . . . Complete . . . Authoritative and well-organized explanation of the fundamentals of light, optics and optical systems as employed in home television receivers, with emphasis on projection types and front lens enlargement. 192 pages; 119 illustrations, charts. **\$3⁸⁰**

BUSINESS HELPER

by Leslie C. Rucker (Rucker Radio Wholesalers)

Written by a successful business man who started from scratch and worked his way up to a chain of 3 stores. Any one of his many worthwhile ideas can mean fifty times the cost of this book in your pocket. 144 pages; 22 chapters. **\$2⁰⁰**

JOHN F. RIDER PUBLISHER, Inc., 480 Canal Street, New York 13, N. Y. • Export Agent: Rocke International Corp., 13 E. 40th St., N.Y.C., Cable, ARLAB.

RIDER MANUALS mean SUCCESSFUL SERVICING

NOTE: The Mallory TV Service Encyclopedia, 1st TV Edition, makes reference to only one source of TV receiver schematics—Rider TV Manuals.
NOTE: The Mallory Radio Service Encyclopedia, 6th Edition, makes reference to only one source of radio receiver schematics—Rider Manuals.
NOTE: The C-D Capacitor Manual for Radio Servicing, 1948 Edition No. 4, makes reference to only one source of receiver schematics—Rider Manuals.

LEARN RADIO-TELEVISION

BY PRACTICING AT HOME
IN SPARE TIME WITH
THESE AND OTHER KITS
I SEND YOU



**I WILL TRAIN YOU AT HOME FOR
GOOD PAY - SUCCESS
A BRIGHT FUTURE**
in America's Fastest-Growing Industry



J. E. SMITH, President
National Radio Institute

I TRAINED THESE MEN

"N. R. I. helped qualify me for position as Radio Mechanic with United Airlines. Have my Radiotelephone 2nd Class License."—L. M. Hauger, San Bruno, Calif.

"Work only spare time at Radio and average about \$40 a month. Knew nothing about Radio before enrolling with N. R. I."—Samuel T. DeWald, St. Clair, Pa.

"I am operating a Radio Sales and Service business. With FM and Television in the offing, we have a very profitable future."—Albert Patrick, Tampa, Florida.

Want a good-pay job in the fast growing RADIO-TELEVISION Industry? Want a money-making Radio-Television shop of your own? Here's your opportunity. I've trained hundreds of men to be successful Technicians . . . MEN WITH NO PREVIOUS EXPERIENCE. My tested and proved train-at-home method makes learning easy. You learn Radio-Television principles from illustrated lessons. You get practical experience building, experimenting with MANY KITS OF PARTS I send. All equipment yours to keep.

MAKE EXTRA MONEY IN SPARE TIME

The day you enroll, I start sending SPECIAL BOOKLETS that show you how to make \$5, \$10 a week or more EXTRA MONEY fixing neighbors' Radios in spare time while learning. From here, it's a short step to your own shop or a good-pay Radio-Television servicing job. Or be a licensed Radio-Television Operator or Technician. The number of Radio Stations has nearly tripled in the last few years—and within three years, experts predict there will be 1000 Television stations on the air. Then add developments in FM, Two Way Radio, Police, Marine, Aviation, Microwave Relay Radio! Think what this means! New jobs, more jobs, good pay for qualified

men. The man who prepares now will reap rich rewards;

MAIL COUPON FOR BOOKS FREE

Act now! Send for my FREE DOUBLE OFFER. Coupon entitles you to actual lesson, "GETTING ACQUAINTED WITH RECEIVER SERVICING." It shows you that learning at home is easy, practical. You also get my 64-page book, "HOW TO BE A SUCCESS IN RADIO-TELEVISION." It tells what my graduates are doing and earning, how quickly you can be on your way to good pay, success, a bright future. Send coupon in envelope or paste on penny postal. J. E. SMITH, President,

Dept. OAX,
National Radio
Institute, Pioneer
Home Study Radio
School, Washington 9, D. C.

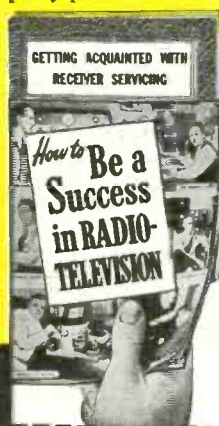

Good for Both - FREE

MR. J. E. SMITH, President, Dept. OAX,
National Radio Institute, Washington 9, D. C.

Mail me Sample Lesson and 64-page Book about
How to Win Success in Radio-Television—both FREE.
(No Salesman will call. Please write plainly.)

Name.....Age.....

Address.....

City.....Zone.....State.....

Check if Veteran Approved under G. I. Bill

VETERANS

GET THIS TRAINING
WITHOUT COST
UNDER G. I. BILL

RADIO — ELECTRONICS

formerly RADIO-CRAFT

Incorporating
SHORT WAVE CRAFT • TELEVISION NEWS •
RADIO & TELEVISION
*Trademark registered U. S. Patent Office

Lee Robinson G. Aliquo
General Manager Circulation Manager
John J. Lamson Robert Fallath
Sales Manager Promotion Manager

Hugo Gernsback, Editor-in-Chief
Fred Shunaman, Managing Editor
M. Harvey Gernsback, Consulting Editor
Robert F. Scott, W2PWG, Technical Editor
R. H. Dorf, W2QMI, Associate Editor
I. Queen, W2OUX, Editorial Associate
Angie Pascale, Production Manager
Wm. Lyan McLaughlin,
Technical Illustration Director

Annual Television Number

Contents — January, 1950

Editorial (Page 23)	
Television in 1975.....	by Hugo Gernsback 23
Television (Pages 24-79)	
The Problem of Color TV.....	by Dr. Lee de Forest 24
Industrial TV Applications.....	by Dr. Allen B. Du Mont 26
Television in Color.....	by Fred Shunaman 28
Mass Production Television Tests (Cover Feature).....	31
A De Luxe Televiser, Part I.....	by Charles A. Vaccaro 32
TV Interference Problems.....	by William L. Kiser 36
Revamping a 630-Type TV Set.....	by M. Harvey Gernsback 38
Theory and Practice of Inter-carrier TV, Part I.....	by Seymour D. Uslan 41
Transmission Line Constants.....	by Robert F. Scott 42
Television in Every Room.....	by Martin Clifford 44
Illustrated TV Station List.....	48
Choosing a TV Receiver.....	by Sol D. Prenskey 55
Electronic Magnification for Existing Receivers.....	by Wilbur J. Hantz 57
Interesting Television Circuits.....	58
TV-Guided Missile.....	59
TV Trouble Shooting.....	by Murray Barlowe 60
Finding and Curing Unusual TV Troubles.....	by Irving Dlugatch 62
Television Dictionary.....	by Ed. Bukstein 64
Adjusting TV Linearity Without a Test Pattern.....	by Matthew Mandl 65
British TV News.....	by Ralph W. Hallows 67
Soap Bubbles and Television.....	by E. Aisberg 69
Television Antennas.....	70
Overhead Planes Cause TV Flutter.....	by Nathaniel Rhita 71
Directory of TV Receiver Characteristics.....	72
Electronics (Pages 80-82)	
Making Large Electrets.....	by Victor H. Laughter 80
Servicing (Pages 84-98)	
Fundamentals of Radio Servicing, Part XI—The Pentode Vacuum Tube	by John T. Frye 84
Radio Set & Service Review (RCA Victor's 45 r.p.m. Changer)	by Richard H. Dorf 92
Audio (Pages 100-105)	
Record Changers—Bah!.....	by James R. Langham 100
Construction (Pages 106-109)	
D. F. Receiver for Yachts.....	by T. W. Dresser 106
Time-Delay Circuit.....	by Otto L. Wooley, WØSGG 109
Amateur (Pages 110-116)	
How to Become A Ham, Part IV.....	by George W. Shuart, W4AMN 110
New Design (Page 117)	
French Radio Developments.....	by E. Aisberg 117
Foreign News (Pages 119-121)	
European Report.....	by Major Ralph W. Hallows 119
Departments	
Radio Month.....	8
Radio Business.....	10
New Devices.....	118
New Patents.....	122
Radio-Electronic Circuits.....	124
Question Box.....	126
Technotes.....	128
Try This One.....	130
Association News.....	132
Miscellany.....	136
People.....	137
Communications.....	139
Book Reviews.....	143

ON THE COVER: Final tests on a televiser nearing the end of the assembly line at RCA's Camden, New Jersey, factory.

RADIO-ELECTRONICS, January, 1950, Volume XXI, No. 4. Published monthly. Publication Office: Erie Ave., P. O. Box 32, Philadelphia 32, Pa. Entered as second class matter September 27, 1948, at the post office at Philadelphia, Pa., under the Act of March 3, 1879. SUBSCRIPTION RATES: In U. S. and Canada, 1n U. S. possessions, Mexico, South and Central American countries, \$2.50; \$6.00 for two years; \$8.00 for three years; single copies 30c. All other foreign countries \$4.50 a year, \$8.00 for two years, \$11.00 for three years. Allow one month for change of address. When ordering a change please furnish an address stencil impression from a recent wrapper. RADCRAFT PUBLICATIONS, INC. Hugo Gernsback, Pres.; M. Harvey Gernsback, Vice-Pres.; G. Aliquo, Sec'y. Contents Copyright, 1949, by RADCraft Publications, Inc. Text and illustrations must not be reproduced without permission of copyright owners.

EDITORIAL and ADVERTISING OFFICES, 25 West Broadway, New York 7, N. Y. Tel. REctor 2-9690. BRANCH ADVERTISING OFFICES: Chicago: 309 W. Washington Street. Telephone RAndolph 6-7363. Los Angeles: Ralph W. Harker, 1127 Wilshire Blvd., Tel. MA 6-1271. San Francisco: Ralph W. Harker, 582 Market St., Tel. GArdfield 1-2481. **FOREIGN AGENTS:** Great Britain: Atlas Publishing and Distributing Co., Ltd., London E.C.4. Australia: McGill's Agency, Melbourne, France: Brentano's, Paris 2e. Holland: Trilectron, Heemstede. Greece: International Book & News Agency, Athens. So. Africa: Central News Agency, Ltd., Johannesburg. Capetown: Durban, Natal, Universal Book Agency, Johannesburg. Middle East: Steimatzyk Middle East Agency, Jerusalem, India: Sunit Gupta (Distributors) Co., Calcutta. Broadway News Centre, Dadar, Bombay #14. K. L. Kannappa Mudaliar, Madras 2. Pakistan: Paradise Book Stall, Karachi 3.

Editorial and Executive Offices:
25 West Broadway, New York 7, N. Y.



MEMBER
AUDIT BUREAU OF CIRCULATION



Every
SPRAGUE
TV
dry electrolytic
is processed

FOR **185°F** (85°C.)
OPERATION!

Sprague leads again with the largest, most complete line of replacement electrolytic capacitors for television receivers. Each type is engineered especially for tough video applications and will stand up under the high temperatures, high ripple currents and high voltage surges encountered in TV equipment. *Every Sprague TV capacitor rated at 450 d-c working voltage or less has been processed for 185°F. (85°C.) operation.* Send postcard for special TV Bulletin.

SPRAGUE PRODUCTS CO.
33 Marshall Street
NORTH ADAMS • MASS.



**YOU
Build This
Superheterodyne**

You receive complete standard equipment, including latest type High-Mu Tubes, for building various experimental and test units. You progress step by step until you build a complete Superheterodyne Receiver. It is yours to use and keep.

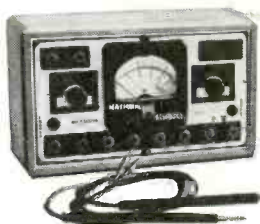

YOU RECEIVE THIS PROFESSIONAL MULTITESTER!

You will use this professional instrument to locate trouble or make delicate adjustments—at home—on service calls. You will be proud to own this valuable equipment. Complete with test leads.

SIGNAL GENERATOR

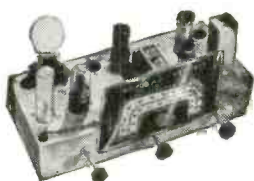

You construct the Transatron Signal Generator shown here, demonstrating Transatron principles in both R.F. and A.F. stages. You study negative type oscillators at firsthand.

AUDIO OSCILLATOR:

An electronic device, which produces audio-frequency signals for modulating R.F. (radio frequency) carrier waves, testing A.F. (audio frequency) amplifiers, speakers, etc.



T.R.F. RECEIVER

You build several T.R.F. Receivers, one of which, a 4-tube set, is shown here. You learn construction, alignment, make receiver tests, and do trouble shooting.

Get Into **RADIO, TELEVISION** and **ELECTRONICS** Master ALL Phases

Get Complete Training. You Receive and Keep All Equipment, Parts and Lessons. No Extra Charges.

GOOD PAY and Unlimited Opportunities in JOBS LIKE THESE:

Business of Your Own
Radio Manufacturing, Sales, Service
Broadcasting, Telecasting
Television Manufacturing, Sales, Service
Laboratories: Installation, Maintenance of Electronic Equipment,
Electrolysis, Call Systems
Garages: Auto Radio Sales, Service
Sound Systems and Telephone Companies; Oil Well and Drilling Companies; Engineering Firms
Theatre Sound Systems, Police Radio

And scores of other good jobs in many related fields YOU CONDUCT MANY EXPERIMENTS LIKE THESE!

Checking action of condensers
Experiments with AF and RF amplifiers
Experiments with resonance
Producing beat frequencies
Calibrating oscillators
Experiments with diode, grid-bias, grid-leak and infinite impedance detectors
Practical experience in receiver trouble shooting
Application of visual tester in checking parts and circuits
Experiments with audio oscillators
Advanced trouble-shooting
... and many, many others

Complete Training by Practical Resident Trade School, Est. 1905

The same highly trained faculty, instruction materials and methods used here in our large, modern resident school, are adapted to your training in your own home. Shop Method Home Training has been proved by hundreds of successful graduates.

**Both Resident and Home Study
Courses Offered**

YOU LEARN BY DOING

You receive special laboratory experiment lessons to show you how to build with your own hands various experimental units such as those shown at left, and how to conduct many tests.

You will find all lessons easy to understand because they are illustrated throughout with clear diagrams and step-by-step examples that you work out yourself. Every piece of the equipment and complete lesson material we send you is yours to keep and enjoy, including the multitester, experimental equipment, all parts of the Superheterodyne, tube manual, radio dictionary, and complete, modern Television texts. All parts are standard equipment.

Shop Method Home Training ... Earn While You Learn

With our practical resident Shop Method Home Training, you study in your spare time. You receive Spare Time Work Lessons, which show you how to earn while you learn. Service neighbors' radios and TV receivers, appliances, etc., for extra money and experience. Many National students pay all or part of their training with spare time earnings!

DON'T DELAY! The Radio-Television Industry needs trained men NOW!

**APPROVED
FOR
VETERANS!**
Check coupon below!

For quick action,
mail coupon
today and we'll
rush you full information.

Free!

**NEW, ILLUSTRATED
OPPORTUNITY
BOOK AND SAMPLE
LESSON SHOW YOU
HOW WE TRAIN
YOU ... SEND FOR
THEM TODAY! NO
COST. NO
OBLIGATION.**

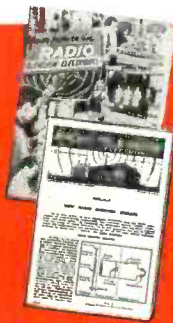

NATIONAL SCHOOLS

LOS ANGELES 37, CALIF. • EST. 1905



FIND OUT NOW ... MAIL COUPON TODAY

National Schools, Dept. RE-1
4000 South Figueroa Street
Los Angeles 37, California

Send me your FREE book "Your Future in Radio" and the sample lesson of your course. I understand no salesman will call on me.

NAME.....AGE.....

ADDRESS.....

CITY.....ZONE.....STATE.....

Check here if Veteran of World War II

Mail in envelope
or paste on
penny postal.

NATIONAL
 **TELEVISION**

Presents
**2 ALL-NEW
 1950 MODELS**

**YOU'LL BE
 SOLD ON** *Sight*

Place these two new 1950 National Television receivers side by side with any other television receiver. Compare the large (12½") screen—compare the chassis—compare the picture quality—compare the cabinet styling. Because National Television is custom assembled—not mass-produced—there just is no comparison! Yet it costs no more.



Model TV-1201
 Striking modern mahogany veneer table model with 12½" tube and 2 six-inch oval speakers.
\$269.95



Model TV-10W
 Genuine mahogany veneer table model with 10" screen and 2 six-inch oval speakers.
\$229.95



Model TV-7W
 Unbeatable TV dollar value. 7" screen with twin speakers. NC enlarging lens available, \$16.95.
\$129.95



Model TV-7M
 Metal cabinet version of TV-7W. Ideal as "second set" for playroom, den or bedroom.
\$119.95



Model TV-1225
 A 12" picture tube and a 10" speaker in a handsome mahogany console.
\$299.95

(1) Latest flyback high voltage supply gives clear, bright pictures even in fringe areas. (2) Automatic frequency control locks picture in place. (3) Exceptionally wide video band-width for beautiful clarity of detail. (4) Front-of-panel focus control. (5) Coil switching assures equivalent of separate, high-Q tuned circuits for each channel. (6) Automatic gain control. (7) 3-stage 37 mc IF minimizes picture interference caused by other radio services. (8) Double-tuned RF bandpass circuits improve selectivity and image ratio. (9) Automatic Station Selector and fine tuning control.

Prices Slightly Higher West of the Rockies

National

NATIONAL COMPANY, Inc.
 MALDEN, MASSACHUSETTS

RADIO-ELECTRONICS for



Can You See Your Future in TV?

CREI Practical Training Shows You the Way to Greater Earnings in TELEVISION & FM SERVICING!

TODAY THE CATHODE RAY TUBE can be the crystal ball that forecasts your future. Is the picture clear and bright—or is it fuzzy and out of focus?

Are you going to learn *now* how to install and service all types of TV and FM receivers? There can be no doubt that TV is the important field for greater earnings: 83 stations on the air (many more authorized); two million new sets in 1949; twelve million predicted by 1953; practically every area in the nation soon to be in range of a TV station. Technicians with specialized TV-FM training will inevitably have the inside track installing and maintaining all these sets.

CREI offers just the specialized training you need. It's a streamlined course for the top third of the men in the field—thorough and complete. It gives practical answers to the technical problems you run into

while servicing today's intricate TV and FM equipment. It is up to date, constantly revised to cover new developments as they are adopted by the industry.

Start your training now and apply your knowledge immediately. The profitable work, passed up yesterday because it was over your head, can be yours tomorrow. Make this year the turning point in your TV career! Write today for complete FREE information. The cost is popular, the terms easy. (Veterans: CREI training is available under the G.I. Bill. For most veterans, July 25, 1951 is the deadline. ACT NOW!)

SAMPLE FREE! "Television & FM Trouble Shooting" LESSON devoted to live, "dollar - and - cents", practical practice based on day-to-day servicing problems. Read this interesting lesson! See for yourself how CREI training can help you. Mail coupon for sample lesson, free booklet and details.

THE THREE BASIC CREI COURSES:

- ★ **PRACTICAL RADIO ENGINEERING**
Fundamental course in all phases of radio-electronics
- ★ **PRACTICAL TELEVISION ENGINEERING**
Specialized training for professional radiomen
- ★ **TELEVISION AND FM SERVICING**
Streamlined course for men in "top-third" of field
ALSO AVAILABLE IN RESIDENCE SCHOOL COURSES

CAPITOL RADIO ENGINEERING INSTITUTE

An Accredited Technical Institute Founded in 1927

Dept. 141-B, 16th Street & Park Road, N. W.
Washington 10, D. C.

Branch Offices:

New York (7) 170 Broadway • San Francisco (2) 760 Market St.

JANUARY, 1950



FREE BOOKLET
plus
SAMPLE LESSON

CAPITOL RADIO ENGINEERING INSTITUTE

Dept. 141B, 16th & Park Rd., N. W. Washington 10, D. C.

Gentlemen: Send me FREE SAMPLE LESSON and complete details of the TV and FM Servicing home study course. Also send brochure that explains the CREI self-improvement program and gives complete details and outline of course. I am attaching a brief resume of my experience, education and present position.

- Check the Field of Greatest Interest
- | | |
|--------------------------|--|
| <input type="checkbox"/> | TV, FM & ADVANCED AM SERVICING |
| <input type="checkbox"/> | PRACTICAL TELEVISION ENGINEERING |
| <input type="checkbox"/> | PRACTICAL RADIO ENGINEERING |
| <input type="checkbox"/> | AERONAUTICAL RADIO ENGINEERING |
| <input type="checkbox"/> | BROADCAST RADIO ENGINEERING (AM, FM, TV) |
| <input type="checkbox"/> | RADIO-ELECTRONICS IN INDUSTRY |

I AM ENTITLED TO TRAINING UNDER G.I. BILL.

NAME _____ AGE _____

ADDRESS _____

CITY _____ ZONE _____ STATE _____

SEND DETAILS ON RESIDENCE SCHOOL.

TELEVISION'S HANDBOOK

for engineers,
technicians and
students.

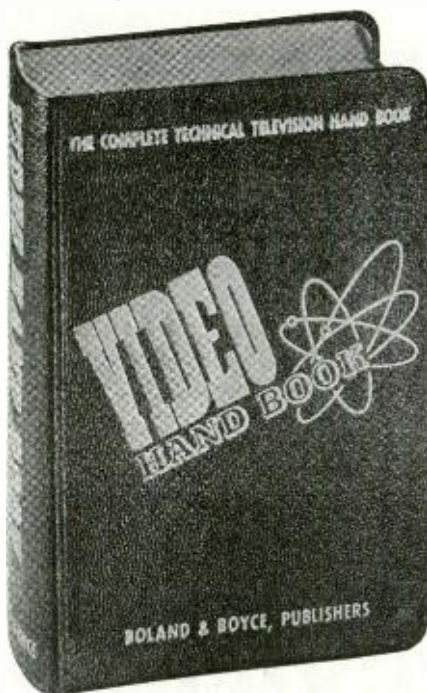

Now in one great book—all the essential knowledge of television for laboratory technician—experimenter—serviceman . . . everyone interested in or working at television! Complete, up-to-the-minute information arranged for quick reference—easy to read . . . no mathematics. Over 900 pages . . . more than 800 photographs, diagrams and drawings. Here are some of the subjects covered: Fundamentals, the TV station, the receiver, antennas, programming, installation, service, test equipment, data, terms, etc. etc. **\$5.00**

RADIO DATA BOOK



The only radio handbook of its kind! Covers everything in Radio for lab technicians—experimenters—servicemen—everyone and anyone! Over 900 pages, 12 big sections with hundreds of drawings and diagrams. Some of the subjects covered are . . . Testing, Measuring and Alignment . . . All about Antennas . . . Sound Systems . . . Recording . . . Complete Test Equipment Data . . . Complete Tube Manual . . . Charts, Graphs and Curves . . . 50 Tested Circuits . . . Codes,

Symbols and Standards . . . 150 Basic Circuits . . . Dictionary of Radio Terms . . . etc., etc.

THE RADIO & TELEVISION LIBRARY

A complete library covering everything in Radio and Television in over 1800 pages, completely illustrated! Two handsomely bound books (contents described above) in attractive slip case . . . compact, concise, complete!



Over 1800 Pages **\$9.00**

Coming Soon—

RADIO & TELEVISION MAINTENANCE MAGAZINE'S construction handbook for the radio technician. Complete How-To-Do-It information on constructing power supplies, test equipment, radio test and laboratory bench, etc., etc.

All products of
BOYCE-ROCHE BOOK COMPANY
Montclair 3, N. J.

are available at your
local distributor's counters. Order now!

BOYCE-ROCHE BOOK COMPANY

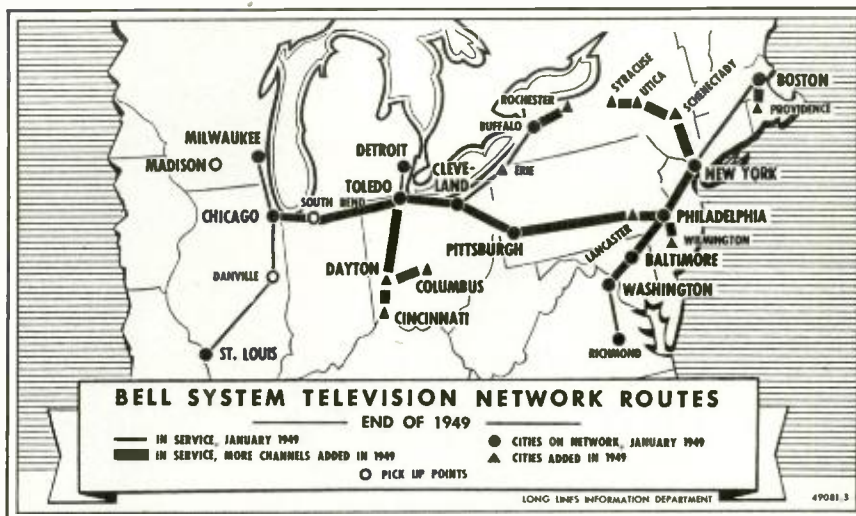

Map above shows the spread of television via co-axial cable network routes.

FREE TELEVISION in hotels was instituted last month in the Shelton Hotel, New York. According to William J. Knott, president of the owner corporation, the hotel is the first to offer TV to guests without charge. An RCA master antenna system is used, with individual antennas for each channel. The receivers were designed by Admiral and the installation was made by Tele-Ho-Tele Corp.

THE TELEVISION CONTEST

We received three tentative entries in our Simple Television Receiver Contest (announced in our May, 1949 issue), plus a few drawings and progress reports from persons who did not feel their work had reached the point where an entry would be possible.

The three entrants were invited to submit their receivers for inspection. Only one of them was actually forwarded, however. While its circuits were interesting, the picture it produced was definitely below entertainment level under New York conditions.

We are therefore forced to call off the contest for lack of suitable entries.

TVI-BURDENED AMATEURS will be aided by a new film announced last month by George Grammer, technical director of the American Radio Relay League. The film depicts corrective measures the amateur may take to eliminate bad effects on neighboring TV sets caused by his transmitter. Interference from other sources is pictured as well. Distribution will be through the more than 600 ARRL-affiliated radio clubs throughout the country. The film was made entirely under amateur auspices as part of a long-term program of cooperation among viewers, technicians, and amateurs conducted by ARRL.

AUSTRALIAN TELEVISION will operate with a 625-line standard. Under the present plan, television will be a government service, with stations to be erected first in the capital city of each of the six Australian states.

VIDEO-BROADCAST FILMS are not subject to review by a state censor, according to a decision rendered last month by the United States District Court against the Pennsylvania Board of Censors. Chief Judge William H. Kirkpatrick ruled that interference by the state would infringe on interstate commerce, a field covered by federal statutes. The ruling means that a film banned from the local theatres may still be shown to a much larger audience via the local television station. Provided the film is not profane, obscene, or indecent, no legal power exists to prevent the station from showing it, since federal law does not permit censorship.

HUGE RADAR CHAIN is being built by Canada, the government announced last month. The system will give warning against a possible attack by air against Canada's principal cities and on other important targets. The stations are expected to cost between 2.5 and 3.5 million dollars each.

BRITISH TELEVISION transmitting equipment is now being offered for sale to American television stations. Demonstrations of cameras, control equipment, and film projectors made by Pye, Ltd., were held in three major American cities last month. The equipment is made to RMA standards. B. J. Edwards, technical director of the British company, said that the firm wished to get the orders of the small portion of the market which cannot be served by American producers because of the large demand.

MOST POWERFUL RADIO in the world will be built by the U. S. Navy, according to a recent Defense Department announcement. Situated at Jim Creek, Wash., it will use its 1-megawatt output on low frequencies principally to send weather information to Navy units and installations throughout the Pacific area. The antenna will be suspended from one mountain top to another.

ELECTRONIC SIGHT may be a reality some day for the blind, reported Prof. Wendell J. S. Krieg of Northwestern University Medical School last month. Electrodes placed in or on the brain may be able to stimulate the motor points of muscles to make the lame walk and the seeing and hearing points to make the blind see and the deaf hear. To create sight the electrodes would have to be distributed in a prearranged pattern and some scanning method similar to that used in television probably would be necessary. It was emphasized that much remains to be done in basic research on the subject but that essentially the realization of practical results will merely be a technological step which, however, may take several years.

TRANSIT RADIO was called "an immoral, unwarranted invasion of personal liberty and privacy" last month in Washington, D. C., by R. A. Seeling, president of the local Transit Riders Association. The Public Utilities Commission was holding a hearing on radio receivers in trolleys and buses, which now operate under an arrangement with WWDC, a Washington radio station. A canvass of bus riders revealed mixed, but very much less strong, reactions.

WEATHER FORECASTS will be made with the aid of radar, the Army Signal Corps announced last month. A new radar station located at Fort Monmouth, N. J., will be able to predict the arrival of storms six to eight hours in advance. The equipment consists of a steel tower for the antenna and a ground building to house the storm detector scope and the remainder of the equipment.

E. E. SHUMAKER, former president of RCA Victor, died at his home in Merchantville, N. J., on November 2. At the time of his death he was vice-president of Electrical Research Products Co. and head of ERPI Classroom Films, Inc., both Western Electric subsidiaries. He was president of Victor Talking Machine Co. in 1930 when it merged with RCA and continued with the new company until 1932.

GUIDED MISSILES have been fired "by the scores," the Air Force announced last month after two years of secrecy. Two kinds of rockets are being used, the "GAPA," which is fired from the ground, and the "Firebird," designed to be launched from a plane to attack another aircraft. The missiles are being fired at Alamogordo, N. M. They are faster than the speed of sound and are radio-controlled. An Air Force spokesman said that this type of weapon was the "only foreseeable defense against the atomic bomb." W. E. Beall, vice-president of Boeing Aircraft, which makes the "GAPA," said that the developments might have far-reaching effects on future peace-purpose aircraft.

INSURED SERVICE POLICIES are now available to television service organizations, it was announced last month by M. C. Feldman & Co., New York insurance brokers. The dealer or service organization may issue renewal policies to set owners. The policies are insured to protect the customers, and the dealer pays the insurance company for each contract. The company requires the dealer to deposit 70% of his receipts from contracts in an escrow bank account, from which the bank usually turns back one twelfth of the amount per month. Careful scrutinies and continuing surveillance of the dealer's financial status are made by the insurer. The present arrangement does not take in small dealers and service companies, as the insurer requires a minimum of 500 policies. However, other insurance companies may enter the field and may be willing to set smaller minimums.

DR. FRANK BALDWIN JEWETT, former president and chairman of the board of Bell Telephone Laboratories, died on November 18 at the age of 70. For more than 40 years he had been an outstanding inventor and researcher for A. T. & T. and its affiliates.



Dr. Jewett joined the company's engineering staff in 1904 and subsequently became chief engineer, then a vice-president of A. T. & T. and of Western Electric. From 1925 to 1940 he served as president of Bell Telephone Laboratories and as board chairman from 1940 to 1944, when he retired. From 1939 to 1947 he headed the National Academy of Sciences, the first engineer ever to be elected its president. Dr. Jewett had just been awarded the 1950 medal of the Industrial Research Institute, Inc.

FELLOWSHIPS for graduate and internships for undergraduate students are offered by the Bureau of Standards to outstanding students. The Bureau's program permits the student to alternate periods of full-time study with practical experience in his chosen field.

TWO BEVATRONS, the world's most powerful atom smashers, have been ordered by the Atomic Energy Commission, it was announced last month. The magnets alone will have a 110-foot diameter and the accelerating chamber will be 400 feet around. One of the machines will be installed at the University of California radiation laboratory and the other at Brookhaven National Laboratory.

FIRE broke out last month in the Washington offices of the FCC resulting in the destruction of many documents. The fire was in the top three stories of the building.

American Beauty

ELECTRIC SOLDERING IRONS

are sturdily built for the hard usage of industrial service. Have plug type tips and are constructed on the unit system with each vital part, such as heating element, easily removable and replaceable. In 5 sizes, from 50 watts to 550 watts.



TEMPERATURE REGULATING STAND

This is a thermostatically controlled device for the regulation of the temperature of an electric soldering iron. When placed on and connected to this stand, iron may be maintained at working temperature or through adjustment on bottom of stand at low or warm temperatures.

For descriptive literature write

AMERICAN ELECTRICAL HEATER COMPANY
DETROIT 2, MICH., U. S. A.

POWER- PACKED

FOR HEAVY DUTY



SOLDERLITE
STREAMLINED

5-SECOND
HEATING
RIGID-TIP
LONGER REACH

DUAL HEAT

—single heat
200 watts,
dual heat
200/250 watts,
115 volts,
60 cycles

New WELER 250-watt Soldering Gun

Heavy jobs and light jobs—the new 250-watt Weller Soldering Gun speeds them all. Chisel-shaped RIGID-TIP provides more soldering area for faster heat transfer. New “over-and-under” terminal design gives bracing action to tip. Your Weller Gun does delicate or heavy soldering with equal efficiency; compact and lightweight, it gets into the tightest spots.

Weller Guns actually pay for themselves in a few months. Fast 5 second heating means no time lost. Trigger-switch control means no current wasted—no need to unplug gun between jobs. Prefocused spotlight and longer length let you see the job and reach the job with ease. No other soldering tool offers so many time-and-money-saving features. Order your new 250-watt Weller Gun from your distributor today, or write for bulletin direct.

SOLDERING GUIDE

Get your copy of “SOLDERING TIPS”—new fully illustrated 20 page booklet of practical soldering suggestions. Price 10c at your distributor's or order direct.



WELER

MANUFACTURING COMPANY

828 Packer Street, Easton, Pa.

Radio Corp. of America reported in a consolidated statement of income for the third quarter of 1949 and the first nine months of the year, with comparative figures for the corresponding period of 1948, as follows:

Total gross income from all sources amounted to \$275,673,666 in the first nine months of 1949, compared with \$256,968,537 in the same period of 1948, an increase of \$18,705,129.

Net income, after all charges and taxes, was \$14,095,186 for the first nine months of 1949, compared with \$15,128,783 in 1948.

After payment of preferred dividends, net earnings applicable to the common stock for the first nine months of 1949 were 84½¢ per share, compared with 92¢ per share in the first nine months of 1948, a decrease of \$1,033,597.

Motorola, Inc., Chicago, reported sales of \$51,795,564 for the first nine months of 1949, against \$39,848,775 for the same period of 1948. Net profit for the 1949 period amounted to \$2,672,613, equal to \$3.34 a share, compared with \$2,215,914, or \$2.77 a share, last year.

Net profit for the third quarter of the current year amounted to \$764,377, or 96c a share, in sales of \$17,973,196, against a net profit of \$565,874, or 71c a share in sales of \$12,930,235, a year before.

Electro Products Laboratories, Inc., has moved to its new plant at 4501 N. Ravenswood Avenue, Chicago, Ill.

These pioneer manufacturers of Electro battery eliminators for radios have recently introduced a new-type, d.c. power supply with conduction cooling. Expanded production facilities also offer improved delivery on the Pressuregraph and Syncromarker for accurate measurement and recording of dynamic and static pressures in engines and pumps, and the Dynamic Micrometer for accurately measuring dynamic or static displacement vibration or movement of any metal body.

Raytheon Mfg. Co. has transferred the merchandising of Raytheon mobile radiophones from its Belmont Radio Division, Chicago, to Raytheon's main plant at Waltham, Mass. The entire mobile radiophone operation will be under the direction of RAY C. ELLIS, vice president in charge of Raytheon's Equipment Sales Division. Production and service will continue at the Chicago plant until the equipment is in full production at Waltham. Delivery schedules and full service to all customers will be assured during the transfer period.

Although this move was planned several months ago, recent developments have proved that it will be most advantageous for both Raytheon and users of the equipment. Belmont Radio can now concentrate on the manufacture of its 1950 line of television receivers. Also, during recent months, Raytheon has expended over \$1 million in improving its engineering, production, and testing facilities at the Waltham location.

International Resistance Co. of Philadelphia, played host to 65 sales representatives at a three-day sales conference in Hershey, Pa. By car, train, and plane, sales representatives from Canada and all over the United States journeyed to the Chocolate Town's famous Hershey Hotel for fun, games, and a thorough indoctrination in IRC's new products and sales plans.

Following the three-day conference, the entire conclave traveled by special bus to the IRC factory in Philadelphia for luncheon and a guided tour of the plant. Final activity of the sales session was a farewell party in Philadelphia's Broadwood Hotel.

Sylvania Television expanded to Western video markets with appointments of distributors in six major cities. C. K. “LARRY” BAGG, sales manager, started a Western business tour to set up distributorships in Los Angeles, San Francisco, Denver, Salt Lake City, Portland, and Seattle. More than 15 Eastern cities already have Sylvania distributors.

Sylvania Television sets are manufactured by Colonial Radio Corp., Buffalo, a wholly owned subsidiary of Sylvania Electric Products, Inc., New York. Nine Sylvania models in 10-, 12½-, and 16-inch table, console, and console combinations, the latter with three-speed record changers, all with built-in antennas, were already introduced in all the important east-coast television markets.

The Parts Distributors Show of 1950 announces that the show will be held on May 23, 24, and 25 at the Stevens Hotel in Chicago.

Show Manager PRINCE emphasized that there is to be no exclusive time in Exhibition Hall for any one group of distributors and that the hall is to be open from 10 am to 6 pm for all distributors who do business with exhibitor companies.

In keeping with show regulations, service technicians, hams, and the general public will not be admitted to the exhibition.

Emphasis at this year's show will be on a comprehensive educational program for radio parts distributors, including seminars and discussion sessions on such subjects of jobber interest, ways and means of stimulating sales, market research, cost accounting, and inventory control.

Radio Inventions, Inc., has announced that its president, JOHN V. L. HOGAN, has moved his office from 730 Fifth Avenue to 155 Perry Street, New York, and is devoting his full time and energy to the supervision of research and development work. To identify all the activities of the organization as closely as possible with him, the name of the corporation was changed as of September 21, 1949, to Hogan Laboratories, Inc. Personnel, location, telephone numbers, and corporate organization all remain just as they were before.

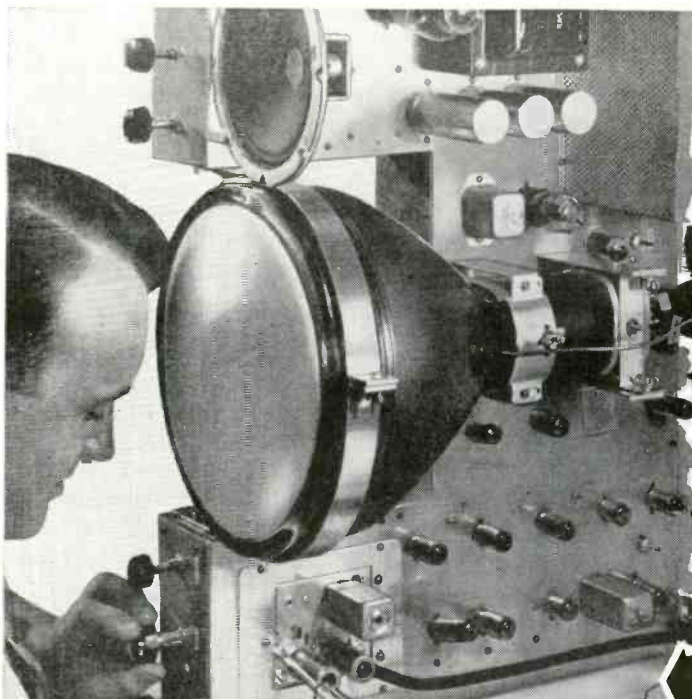

Only D.T.I.
offers you the
"BIG 5"
TELEVISION
RADIO-ELECTRONICS
Laboratory Type
HOME TRAINING

Build and Keep 10, 12½ or 16 inch Picture Tube Quality
TELEVISION RECEIVER as you prepare for a Profitable Future



Here is everything you need to prepare you at home for FASCINATING WORK, GOOD MONEY and a THRILLING FUTURE in one of America's most promising fields.

This includes the opportunity to build and keep the top quality Television Receiver shown above—with choice of a 10, 12½ or 16 inch picture tube that gives big, bright, sharp, steady pictures. Get the complete facts. This is an optional feature — available when you complete your training described below. See how D.T.I.'s wonderfully practical "BIG 5" method meets industry's needs. No previous experience needed. Mail coupon today!

16 Big Shipments of Parts — Plus Lessons
Work over 300 electronic experiments and projects from 16 big shipments of parts. This includes building and keeping all test equipment and radio set shown at left side of page. Modern easy-to-read lessons with handy fold-out diagrams simplifies your entire training.

You Also Use Home Movies
D.T.I., alone, includes the modern, visual training aid . . . MOVIES to help you learn faster, easier at home. See electrons on the march and other fascinating "hidden action"—a remarkable home training advantage that speeds your progress.

EMPLOYMENT SERVICE
When you complete your training, our effective Employment Service helps you get started toward a real future in Television-Radio-Electronics.

Modern Laboratories
If you prefer, you can get ALL your preparation in our new, Chicago training laboratories . . . one of the finest of its kind. Ample instructors . . . modern equipment. Write for details!

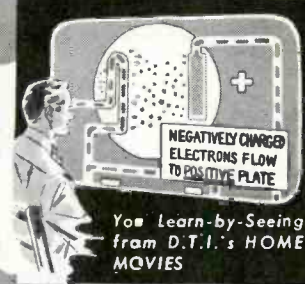
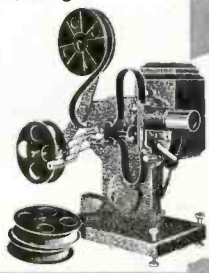
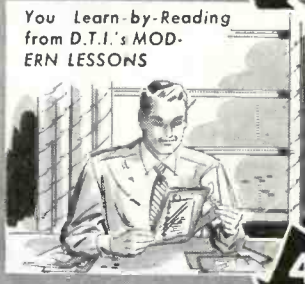
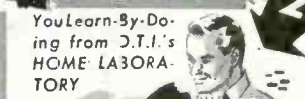

1 OPTIONAL FEATURE

2

3

4

5

DeFOREST'S TRAINING, INC.
Chicago 14, Illinois
A DeVry Institution

MAIL THIS COUPON TODAY!

DeFOREST'S TRAINING, INC.
2533 North Ashland Avenue, Dept. RC-G-1.
Chicago 14, Illinois.

Without obligation, give me complete facts showing how I may make my start in Television-Radio-Electronics.

Name _____ Age _____
Street _____ Apt. _____
City _____ Zone _____ State _____



Your telephone uses **ceramics, too!**

Five thousand years ago, potters were making household vessels of clay. As skill grew, grace of shape and ornament were added. The beauty of fine china has been recognized by every civilization, while the availability, ease of manufacture and durability of other ceramics have given them wide use.

Your telephone, too, uses ceramics. Behind its dial is a metal plate, glazed as carefully and in much the same manner as this fine piece of pottery. It carries the letters and numbers you dial, so it must resist both fading and abrasion. You will find other ceramics as insulators, supporting wires on pole lines; in eighty thousand miles of underground conduit, where fired clays defy decay and corrosion.

Today at Bell Telephone Laboratories scientists utilize ceramics in ways undreamed of in ancient times. Thermistors, made of a ceramic, provide automatic controls for electric current, to offset fluctuations in temperature and voltage. One kind of ceramic makes low-loss insulation at high frequencies, while another supplies controlled attenuation for microwaves traveling in waveguides.

Each use demands a special composition, scientifically controlled and processed. Basic studies in the chemistry and physics of ceramics have shown how to utilize their versatile properties in electrical communication. And research continues on ceramic materials as well as on every other material which promises better and cheaper telephone service.

BELL TELEPHONE LABORATORIES



EXPLORING AND INVENTING, DEVISING AND PERFECTING, FOR CONTINUED IMPROVEMENTS AND ECONOMIES IN TELEPHONE SERVICE.

RADIO-ELECTRONICS for

Study THE Features **Heathkits ARE THE QUALITY LINE OF TEST EQUIPMENT KITS**

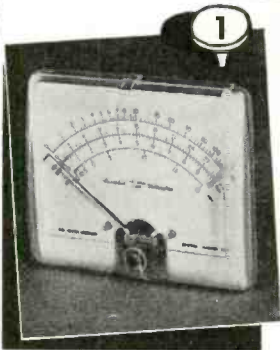

1 MODERN STYLING

Heathkits have brought a new conception of beauty to laboratories and service benches. Many organizations have standardized on Heathkits to make their shops appear attractive and uniform. The panels are produced in grey and maroon and the modern streamline aluminum handles give the instruments a pleasant, professional appearance. There is no waste space or false effort to appear large in Heathkits—space on service benches is at a premium and the size of Heathkit instruments is kept as small as is consistent with good engineering design.

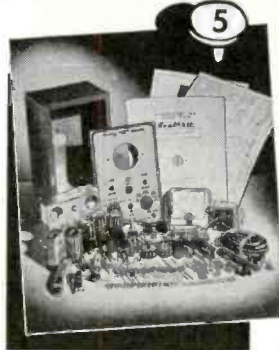

5 COMPLETE KITS

When you receive your Heathkit, you are assured of every necessary part for the proper operation of the instrument. Beautiful cabinets, handles, two-color panels, all tubes, test leads where they are a necessary part of the instrument, quality rubber line cords and plugs, rubber feet for each instrument, all scales and dials ready printed and calibrated. Every Heathkit is 110V 60 cy. power transformer operated by a husky transformer especially designed for the job.

BEST OF PARTS

You will find many famous names on the parts in your Heathkit. Mallory switches and filter condensers, Chicago Transformer Corporation and Electrical Assembly Transformers, Centralab Potentiometers, Belden Cable, IRC and Allen Bradley resistors, G.E. tubes, Cinch and Amphenol sockets with silver plated contacts, Defiance variable condensers, Eby binding post and many other quality parts. The finest of parts are used to assure long trouble-free service from Heathkits.



2 PRECISION PARTS

Wherever required, the finest quality 1% ceramic resistors are supplied. These require no aging and do not shift. No matching of common resistors is required. You find in Heathkit the same quality voltage divider resistors as in the most expensive equipment. The transformers are designed especially for the Heathkit unit. The scope transformer has two electrostatic shields to prevent interaction of AC fields. These transformers are built by several of the finest transformer companies in the United States.

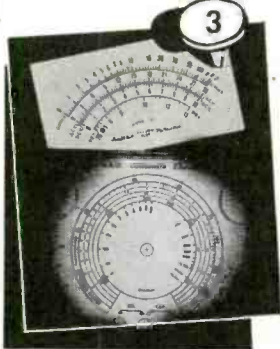
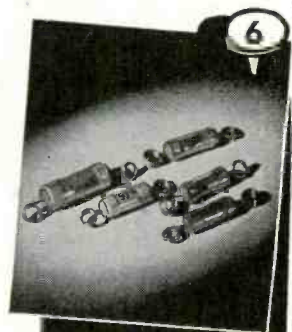

3 LARGE EASILY READ CALIBRATIONS

No charts or calculations are necessary to use any Heathkit properly. All scales are simple and plainly marked. The operator instantly knows the proper use of the instrument and can proceed confidently. No multiplication is required as each scale is calibrated independently of the others.



7 COMPLETE INSTRUCTION MANUALS

Everyone is pleased at the thorough instructions covering the assembly of each Heathkit instrument. Every detail of the assembly is covered, together with sections on the use of the instrument and trouble shooting instructions in case of difficulty. Actual photos of the assembled instrument enable fast and accurate assembly, clear schematics and pictorial diagrams of the confusing parts such as rotary switches, enable the wiring to be completed quickly.

KITS THAT FIT

Heathkit chassis are precision punched to fit the quality parts supplied. The grey crackle aluminum cabinet and the two-color panels are die punched to assure proper fitting. Many builders have written marveling at the ease with which assembly can be accomplished. The chassis are specially engineered for easy assembly and wiring—there are no small, tight corners which cannot be reached—the ends of the chassis are left open in order that installation of parts and soldering can be done with both hands.



4 IDEAL FOR SCHOOLS

Heathkits have been adopted as standard equipment of many of the largest universities and colleges. The low cost plus the fact that the students learn by actual assembly make them ideal training mediums. Many high schools and small colleges are finding that they too can have a modern physics and electronics laboratory by using Heathkits. Some of the largest technical schools recommend Heathkits to their students as the best means of securing the necessary equipment to start their own shops.



EXPORT DEPT.
13 East 40th St.
NEW YORK CITY (16)
CABLE: ARLAB-N.Y.

The **HEATH COMPANY**
... BENTON HARBOR 20, MICHIGAN

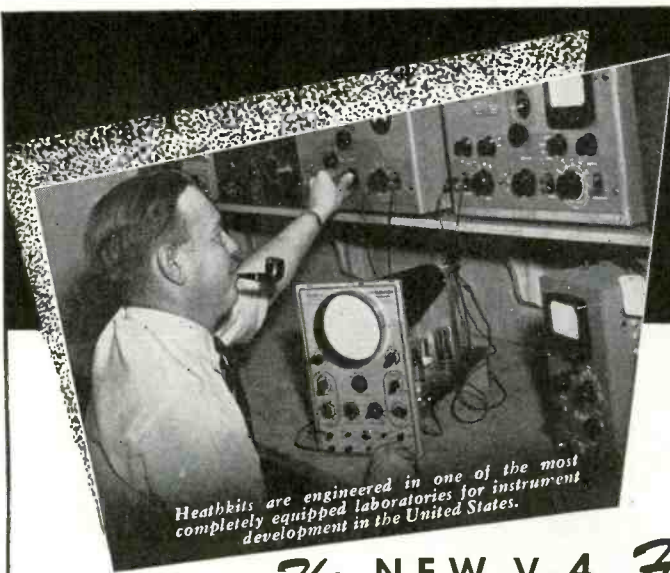

Heathkits are engineered in one of the most completely equipped laboratories for instrument development in the United States.

Heathkits ARE LABORATORY ENGINEERED...

The NEW V-4 Heathkit VACUUM TUBE VOLTMETER KIT

Features

- Meter scale 17% longer than average 4 1/2" meter.
- Modern streamline 200 ua meter.
- New modern streamline styling.
- Burn-out proof meter circuit.
- 24 Complete ranges.
- Isolated probe for dynamic testing.
- Most beautiful VTVM in America.
- Accessory probes (extra) extend ranges to 10,000 Volts and 100 Megacycles.
- Uses 1% precision ceramic divider resistors.
- Modern push-pull electronic voltmeter circuit.
- Electronic AC circuit. No current drawing rectifiers.
- Shatterproof plastic meter face.

The new Heathkit Model V-4 Vacuum Tube Voltmeter has dozens of improvements. A new modern streamlined 200 microampere meter has Alnico V magnet for fast, accurate readings. The new electronic AC voltmeter circuit incorporates an entire new balance control which eliminates contact potential and provides greater accuracy. New simplified switches for quicker assembly. New snap-in battery mounting is on the chassis for easy replacement.

The Heathkit VTVM is the only kit giving all the ranges. Check them — DC and AC full scale linear ranges of 0-3V, 0-10V, 0-30V, 0-100V, 0-300V, 0-1000V and can be extended to 0-3000V and 0-10,000V DC with accessory probe at slight extra cost. Electronic ohmmeter has six ranges measuring resistance accurately from .1 ohm to one billion ohms. Meter pointer can be offset to zero center for FM alignment.

The DC probe is isolated for dynamic measurements. Has db scale for making gain and other audio measurements.

The new instruction manual features pictorial diagrams and step-by-step instructions for easy assembly. The Heathkit VTVM is complete with every part — 110V transformer operated with test leads, tubes, light aluminum cabinet for portability, giant 4 1/2" 200 microamp meter and complete instruction manual.

Order now and enjoy it this entire season. Shipping weight 8 lbs., Model V-4



\$24.50

THE FINEST VTVM KIT AVAILABLE
FOR THIS PRICE.

Accessory: 10,000V high voltage probe, No. 310, \$4.50.
Accessory: RF crystal diode probe kit extends RF range
to 100 Mc., No. 309, \$6.50.

New Heathkit HANDITESTER KIT

Features

- Beautiful streamline Bakelite case.
- AC and DC ranges to 5,000 Volts.
- 1% Precision ceramic resistors.
- Convenient thumb type adjust control.
- 400 Microampere meter movement.
- Quality Bradley AC rectifier.
- Multiplying type ohms ranges.
- All the convenient ranges 10-30-300-1,000-5,000 Volts.
- Large quality 3" built-in meter.

A precision portable volt-ohm-milliammeter. An ideal instrument for students, radio service, experimenters, hobbyists, electricians, mechanics, etc. Rugged 400 ua meter movement. Twelve complete ranges, precision dividers for accuracy. Easily assembled from complete instructions and pictorial diagrams. An hour of assembly saves one-half the cost. Order today. Model M-1. Shipping wgt., 2 lbs.



\$13.50

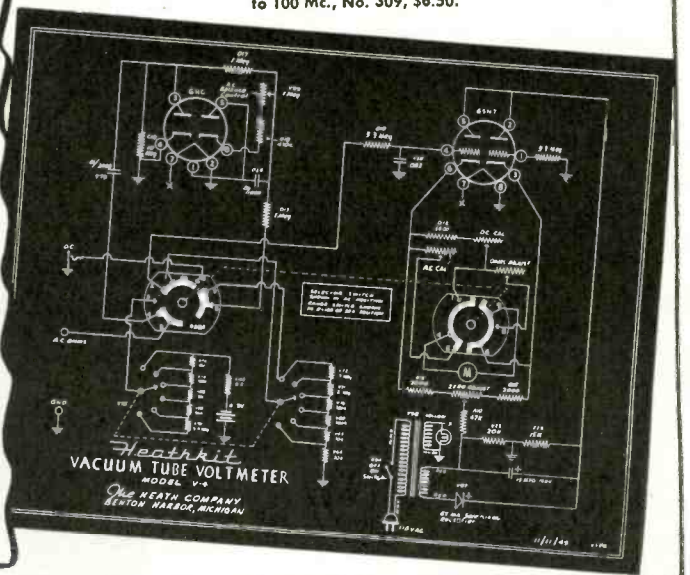

EXPORT DEPT.
13 East 40th St.
NEW YORK CITY (16)
CABLE: ARLAB-N.Y.

The **HEATH COMPANY**
... BENTON HARBOR 20, MICHIGAN

TEST INSTRUMENT KITS

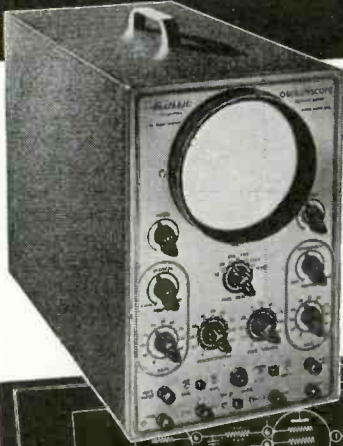

Only
\$39⁵⁰

Heathkit
**PUSH-PULL EXTENDED RANGE
5" OSCILLOSCOPE KIT**
Features

- The first truly television oscilloscope.
- Tremendous sensitivity .06 Volt RMS per inch deflection.
- Push-pull vertical and horizontal amplifiers.
- Useful frequency range to 2½ Megacycles.
- Extended sweep range 15 cycles to 70,000 cycles.
- New television type multivibrator sweep generator.
- New magnetic alloy shield included.
- Still the amazing price of \$39.50.

The new 1950 Push-Pull 5" Oscilloscope has features that seem impossible in a \$39.50 oscilloscope. Think of it—push-pull vertical and horizontal amplifiers with tremendous sensitivity only six one-hundredths of a volt required for full inch of deflection. The weak impulses of television can be boosted to full size on the five-inch screen. Traces you couldn't see before. Amazing frequency range, clear, useful response at 2½ Megacycles made possible by improved push-pull amplifiers. Only Heathkit Oscilloscopes have the frequency range required for television. New type multivibrator sweep generator with more than twice the frequency range, 15 cycles to 70,000 cycles will actually synchronize with 250,000 cycle signal. Dual positioning controls will move trace over any section of the screen for observation of any part. New magnetic alloy CR tube shield protects the instrument from outside fields. All the same high quality parts, cased electrostatically shielded power transformer, aluminum cabinet, all tubes and parts. New instruction manual now has complete step-by-step pictorials for easiest assembly. Shipping weight, 25 lbs. Model O-5

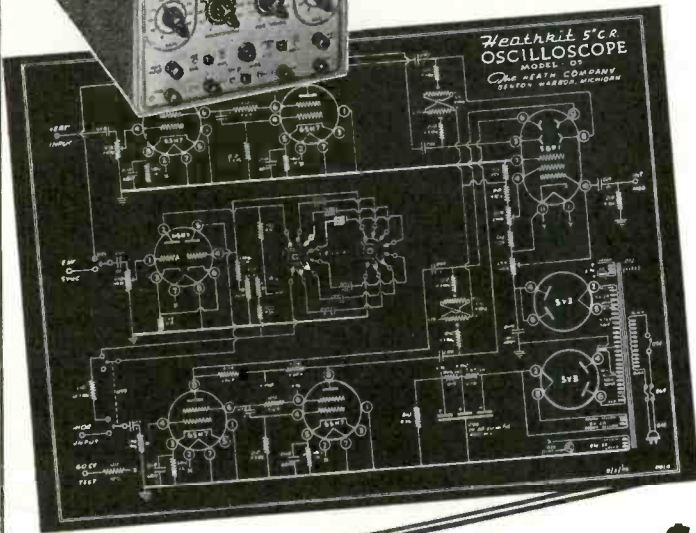

Heathkit
**ELECTRONIC
SWITCH KIT**

DOUBLE THE UTILITY OF ANY SCOPE

An electronic switch used with any oscilloscope provides two separately controllable traces on the screen. Each trace is controlled independently and the position of the traces may be varied. The input and output traces of an amplifier may be observed one above the other or one directly over the other illustrating perfectly any change occurring in the amplifier. Distortion-phase shift and other defects show up instantly, 110V. 60 cycle transformer operated. Uses 5 tubes (1 6X5, 2 6SN7's, 2 6SJ7's). Has individual gain controls, positioning control and coarse and fine switching rate controls. The cabinet and panel match all other Heathkits. Every part supplied including detailed instructions for assembly and use. Shipping weight 11 lbs. Model S-1

\$34⁵⁰

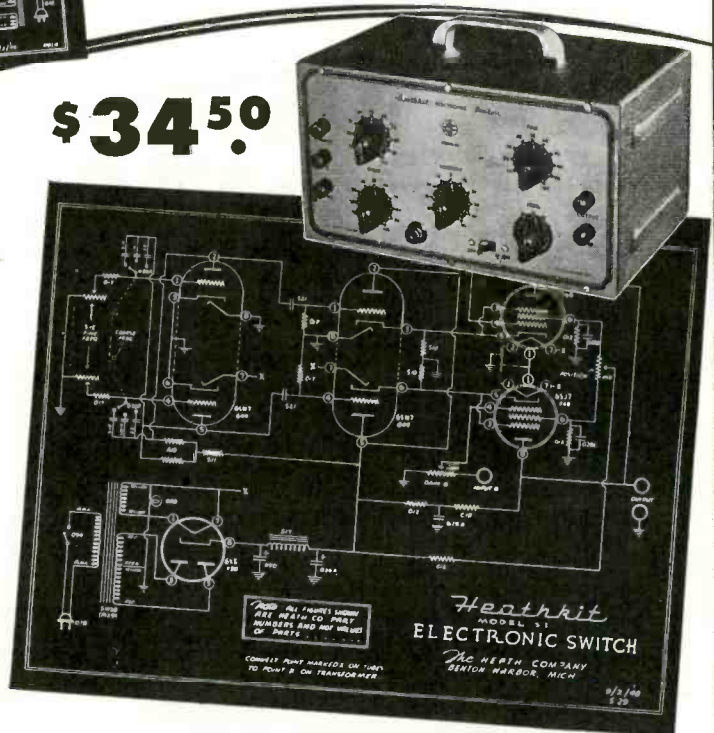

EXPORT DEPT.
13 East 40th St.
NEW YORK CITY (16)
CABLE: ARLAB-N.Y.

The **HEATH COMPANY**

... BENTON HARBOR 20, MICHIGAN



By assembling your own laboratory equipment, you control the quality of workmanship and learn the entire story of the instrument.

Heathkits ENABLE THE BUILDER

New 1950 VERNIER TUNING RF Heathkit SIGNAL GENERATOR KIT

Features

- New 5-to-1 ratio vernier tuning for ease and accuracy.
- New external modulation switch — use it for fidelity testing.
- Covers 150 Kc. to 34 Mc. on fundamentals and calibrated strong harmonics to 102 Mc.
- 400 cycle audio available for audio testing.
- Most modern type R.F. oscillator.
- New precision coils for greater output.
- Cathode follower output for greatest stability.

The most popular signal generator kit has been vastly improved—the experience of thousands combined to give you the best. Check the features in this fine generator and consider the low price \$19.50. A best buy for any shop, yet inexpensive enough for hobbyists. Everyone can have an accurate controlled source of R.F. signal voltage.

The new features double the value—think of being able to make fidelity checks on receivers by inserting a variable audio signal. Internal 400 cycle saw-tooth audio oscillator modulates R.F. signal and is available externally for audio testing. The new 5-to-1 ratio vernier drive gives hairline tuning for maximum accuracy in scale settings. The coils are already precision wound and calibrated. Uses turret type coil and switch assembly for ease of construction. The generator is 110V. 60 cycle transformer operated and comes complete in every detail—cabinet, tubes, beautiful two color calibrated panel and all small parts—new step-by-step pictorial diagrams and complete instruction manual make assembly a cinch even for novices. Why try to get along without a signal generator when you can have the best for less than a twenty-dollar bill. Better order it now. Shipping weight, 7 lbs. Model G-5.

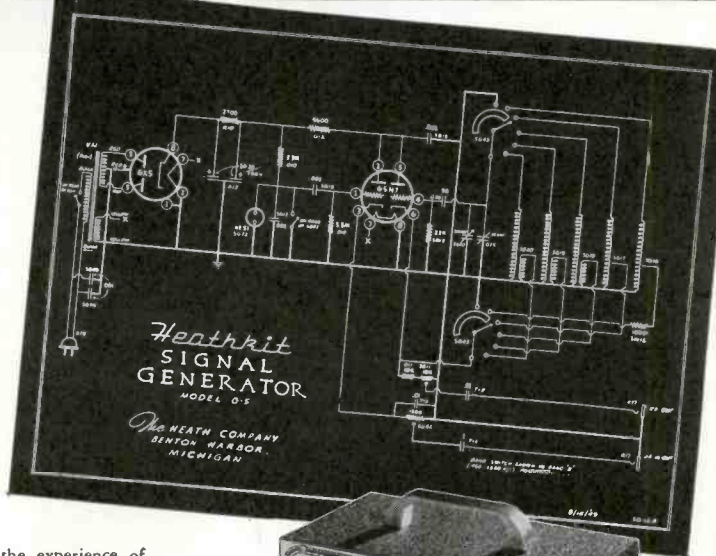

\$19.50



\$34.50

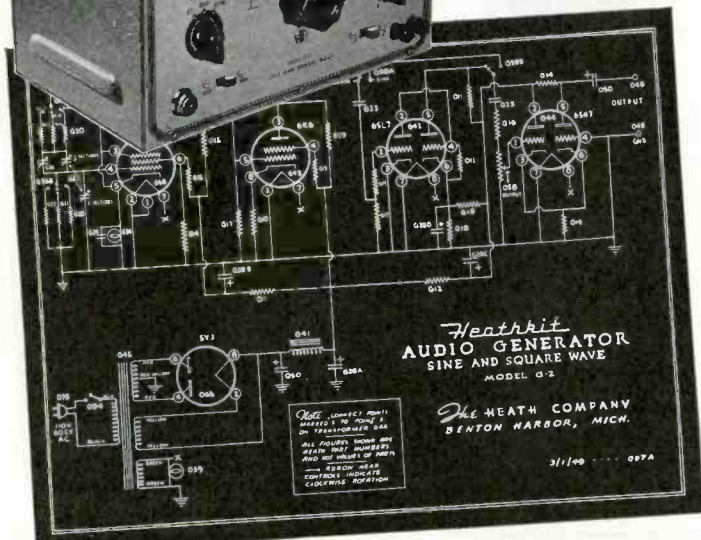

Heathkit

SINE AND SQUARE WAVE AUDIO GENERATOR KIT

Experimenters and servicemen working with a square wave for the first time invariably wonder why it was not introduced before. The characteristics of an amplifier can be determined in seconds compared to several hours of tedious plotting using older methods. Stage by stage, amplifier testing is as easy as signal tracing. The low distortion (less than 1%) and linear output (\pm one db) make this Heathkit equal or superior to factory built equipment selling for three or four times its price. The circuit is the popular RC tuning circuit using a four gang variable condenser. Three ranges 20-200, 200-2,000, 2,000-20,000 cycles are provided by selector switch. Either sine or square waves instantly available at slide switch. All components are of highest quality, cased 110V. 60 cycle power transformer. Mallory F.P. filter condensers, 5 tubes, calibrated two-color panel, grey crackle aluminum cabinet. The detailed instructions make assembly an interesting and instructive few hours. Shipping weight, 12 lbs. Model G-2.

Nothing ELSE TO BUY

EXPORT DEPT.
13 East 40th St.
NEW YORK CITY (16)
CABLE: ARLAB-N.Y.

The HEATH COMPANY

... BENTON HARBOR 20, MICHIGAN

TO USE THE *Best* OF WORKMANSHIP

Heathkit TUBE CHECKER KIT

Features

1. Measures each element individually.
2. Has gear driven roller chart.
3. Has lever switching for speed.
4. Complete range of filament voltages.
5. Uses latest type lever switches.
7. Uses beautiful shatterproof full view meter.
8. Large size 11" x 14" x 4" complete.
9. Checks new 9 pin miniatures.

Check the features and you will realize that this Heathkit has all the features you want. Speed, simplicity, beauty, protection against obsolescence. The most modern type of tester — measures each element — beautiful Bad-Good scale, high quality meter — the best of parts — rugged oversize 110V, 60 cycle power transformer — finest of Mallory switches — Centralab controls — quality wood cabinet — complete set of sockets for all type tubes including blank spare for future types — fast action gear driven roller chart uses brass gears to quickly locate and set up any type tube. Simplified switching cuts necessary time to minimum and saves valuable service time. Short and open element check. No matter what arrangement of tube elements, the Heathkit flexible switching arrangement easily handles it. Order your Heathkit Tube Checker today. See for yourself that Heath again saves you two-thirds and yet retains all the quality — this tube checker will pay for itself in a few weeks — better build it now.

Complete with detailed instructions, all parts, cabinet, roller chart, ready to wire up and operate. Shipping weight, 12 lbs. Model TC-1.

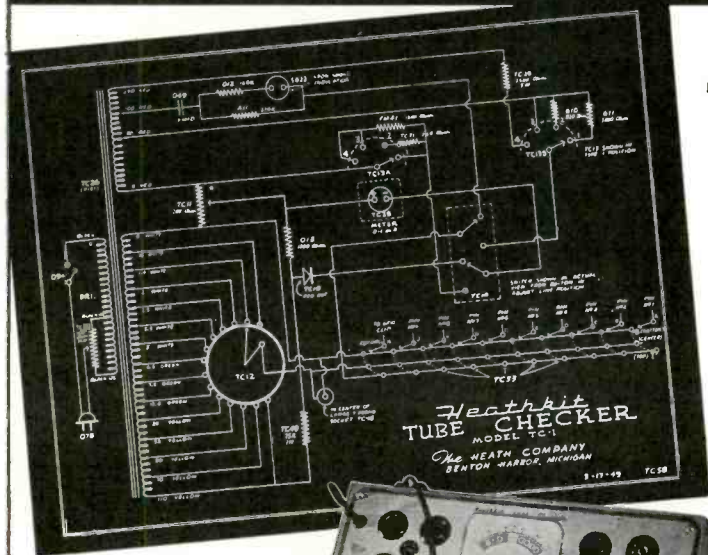

Nothing
ELSE
TO BUY

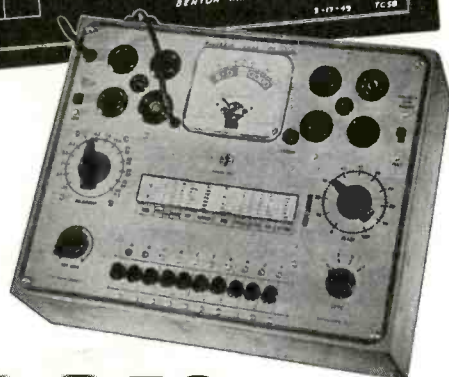

Only \$29⁵⁰

Heathkit BATTERY ELIMINATOR KIT

Now a bench 6 Volt power supply kit for all auto radio testing. Supplies 5 - 7½ Volts at 10 Amperes continuous or 15 Amperes intermittent. A well filtered rugged power supply, uses heavy duty selenium rectifier, choke input filter with 4,000 MFD of electrolytic filter. 0 - 15 Volt meter indicates output. Output variable in eight steps. Excellent for demonstrating auto radios. Ideal for servicing — can be lowered to find sticky vibrators or stepped up to equivalent of generator overload — easily constructed in less than two hours. Complete in every respect. Shipping wgt., 19 lbs.

Model BE-1

Nothing ELSE TO BUY

\$22⁵⁰

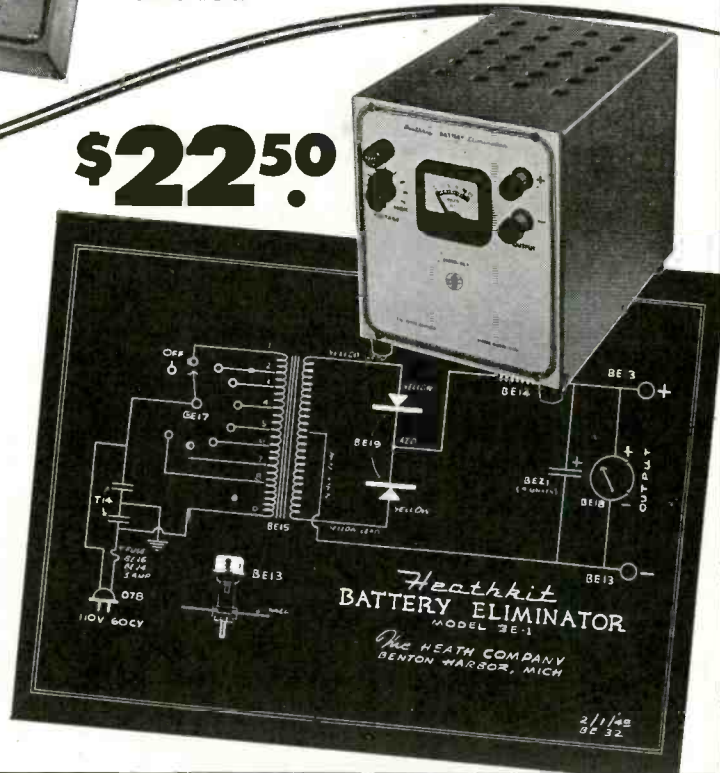

EXPORT DEPT.
13 East 40th St.
NEW YORK CITY (16)
CABLE: ARLAB-N.Y.

The **HEATH COMPANY**

... BENTON HARBOR 20, MICHIGAN

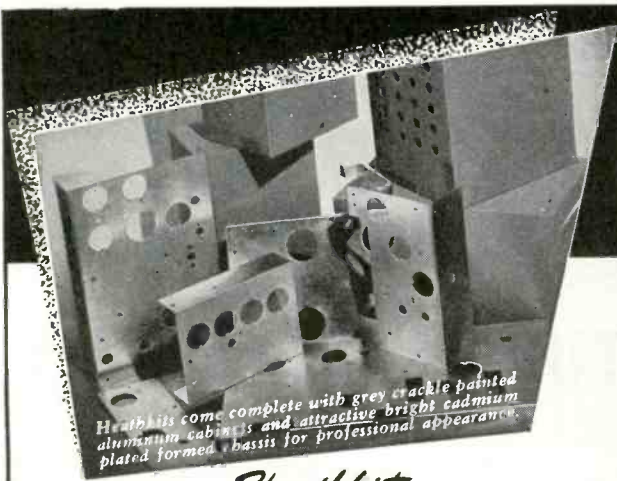

Heathkits come complete with grey crackle painted aluminum cabinets and attractive bright cadmium plated forms on basis for professional appearance.

Heathkits ELIMINATE

Heathkit TELEVISION ALIGNMENT GENERATOR KIT

Everything you want in a television alignment generator. A wide band sweep generator covering all TV frequencies 0 to 46 — 54 to 100 — 174 to 220 Megacycles, a marker indicator covering 19 to 42 Megacycles, AM modulation for RF alignment — variable calibrated sweep width 0-30 Mc. — mechanical driven inductive sweep. Husky 110V. 60 cycle power transformer operated — step type output attenuator with 10,000 to 1 range — high output on all ranges — band switching for each range — vernier driven main calibrated dial with over 45 inches of calibration — vernier driven calibrated indicator marker tuning. Large grey crackle cabinet 16 1/8" x 10 3/8" x 7-3/16". Phase control for single trace adjustment. Uses three high frequency triodes plus 5Y3 rectifier — split stator tuning condensers for greater efficiency and accuracy at high frequencies — this Heathkit is complete and adequate for every alignment need and is supplied with every part — cabinet, calibrated panel, all coils and condensers wound, calibrated and adjusted, tubes, transformer, test leads — every part with instruction manual for assembly and use. Actually three instruments in one — TV sweep generator — TV AM generator and TV marker indicator.

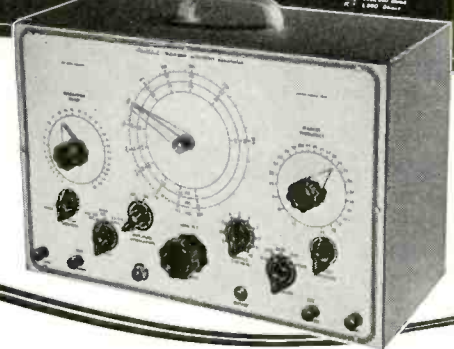
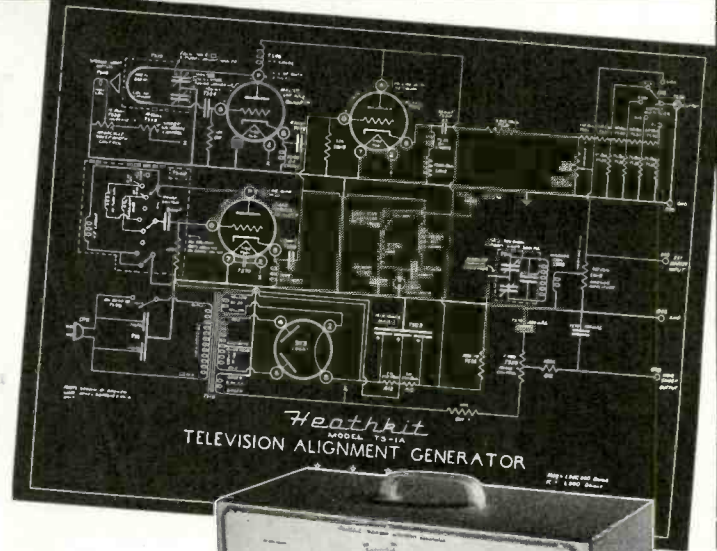

\$39⁵⁰

Shipping weight 20 lbs.
Model T5-1A

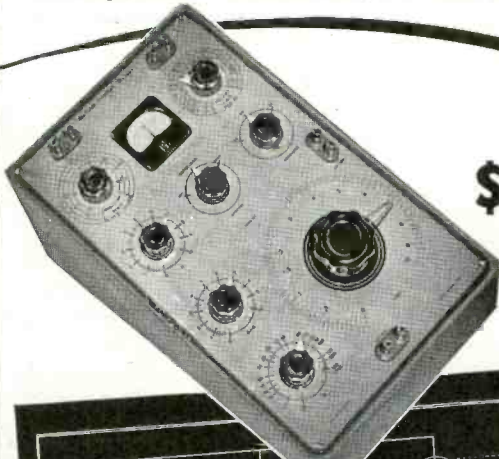

\$69⁵⁰

Shipping weight 15 lbs.
Model 1B-1

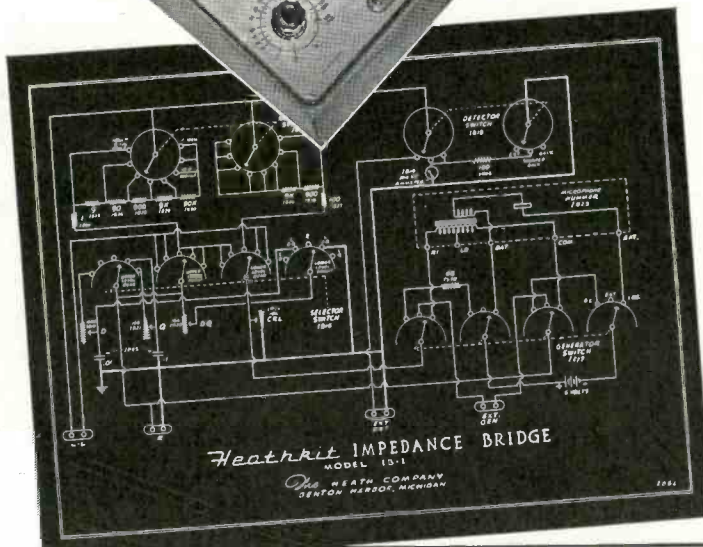

New Heathkit

IMPEDANCE BRIDGE KIT

A LABORATORY INSTRUMENT NOW WITHIN
THE PRICE RANGE OF ALL

Measures inductance from 10 microhenries to 100 henries capacitance from .00001 MFD. to 100 MFD. Resistance from .01 ohms to 10 megohms. Dissipation factor from .001 to 1. "Q" from 1 to 1000.

Ideal for schools, laboratories, service shops, serious experimenters.

An impedance bridge for everyone — the most useful instrument of all, which heretofore has been out of the price range of serious experimenters and service shops. Now at the lowest price possible. All highest quality parts. General Radio main calibrated control. General Radio 1000 cycle hummer. Mallory ceramic switches with 60 degree indexing — 200 microamp zero center galvanometer — 1/2 of 1% ceramic non-inductive decade resistors. Professional type binding posts with standard 3/4" centers. Beautiful birch cabinet. Directly calibrated "Q" and dissipation factor scales. Ready calibrated capacity and inductance standards of Silver Mica, accurate to 1/2 of 1% and with dissipation factors of less than 30 parts in one million. Provisions on panel for external generator and detector. Measure all your unknowns the way laboratories do — with a bridge for accuracy and speed.

Internal 6 Volt battery for resistance and hummer operation. Circuit utilizes Wheatstone, Hay and Maxwell circuits for different measurements. Supplied complete with every quality part — all calibrations completed and instruction manual for assembly and use. Deliveries are limited.

EXPORT DEPT.
13 East 40th St.
NEW YORK CITY (16)
CABLE: ARLAB-N.Y.

The **HEATH COMPANY**

... BENTON HARBOR 20, MICHIGAN

DIFFICULT METAL FABRICATION....

NEW *Heathkit* SIGNAL TRACER AND UNIVERSAL TEST SPEAKER KIT

The popular Heathkit Signal Tracer has now been combined with a universal test speaker at no increase in price. The same high quality tracer follows signal from antenna to speaker, locates intermittents, defective parts quicker, saves valuable service time, gives greater income per service hour. Works equally well on broadcast, FM or TV receivers. The test speaker has assortment of switching ranges to match push-pull or single output impedance. Also tests microphones, pickups, PA systems; comes complete—cabinet, 110V. 60 cycle power transformer, tubes, test probe—all parts and detailed instructions for assembly and use. Shipping Wt., 8 lbs. Model T-2.

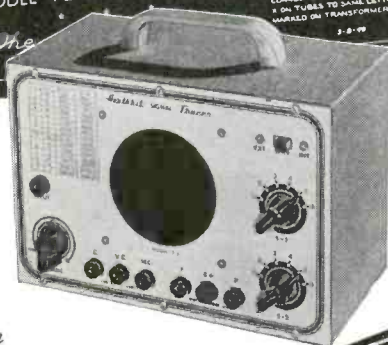
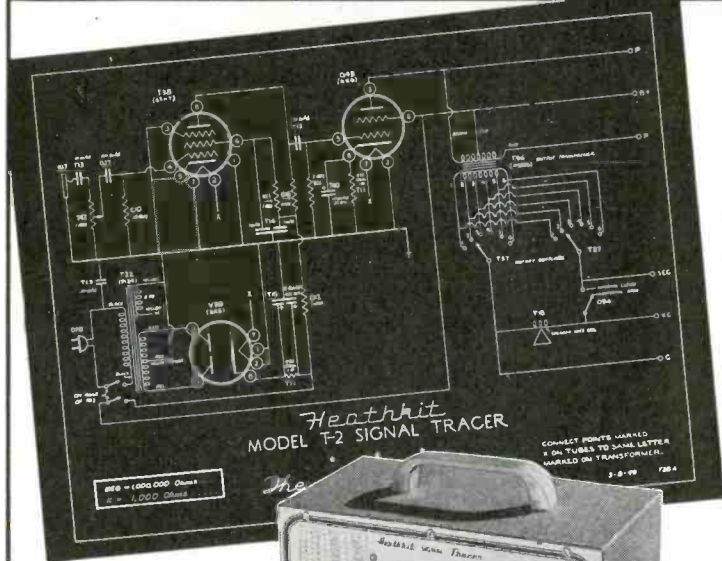

\$19.50

Nothing ELSE TO BUY

\$19.50



Heathkit CONDENSER CHECKER KIT

Features

- Power factor scale
- Measures resistance
- Measures leakage
- Checks paper-mica-electrolytics
- Bridge type circuit
- Magic eye indicator
- 110V. transformer operated
- All scales on panel

Checks all types of condensers, paper-mica-electrolytic-ceramic over a range of .00001 MFD. to 1000 MFD. All on readable scales that are read direct from the panel. NO CHARTS OR MULTIPLIERS NECESSARY. A condenser checker anyone can read without a college education. A leakage test and polarizing voltage for 20 to 500 volts provided. Measures power factor of electrolytics between 0% and 50%. 110V. 60 cycle transformer operated complete with rectifier and magic eye tubes, cabinet, calibrated panel, test leads and all other parts. Clear detailed instruction for assembly and use. Why guess at the quality and capacity of a condenser when you can know for less than a twenty dollar bill. Shipping weight, 7 lbs. Model C-2.

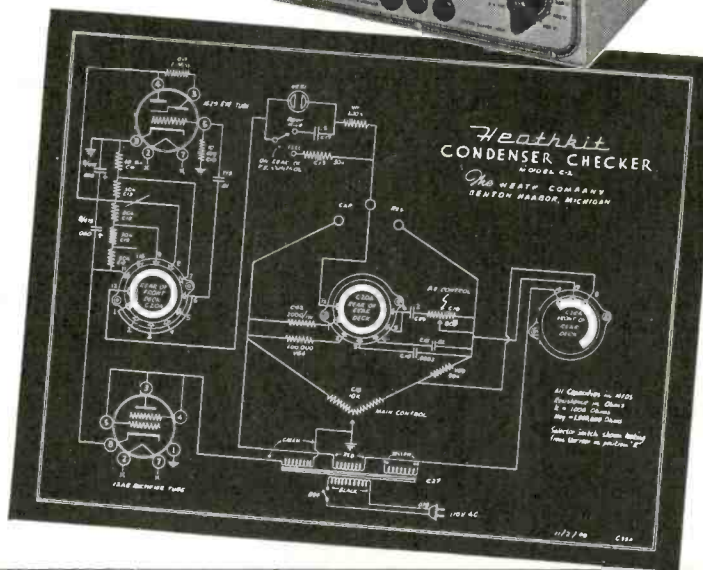

EXPORT DEPT.
13 East 40th St.
NEW YORK CITY (16)
CABLE: ARLAB-N.Y.

The **HEATH COMPANY**
... BENTON HARBOR 20, MICHIGAN

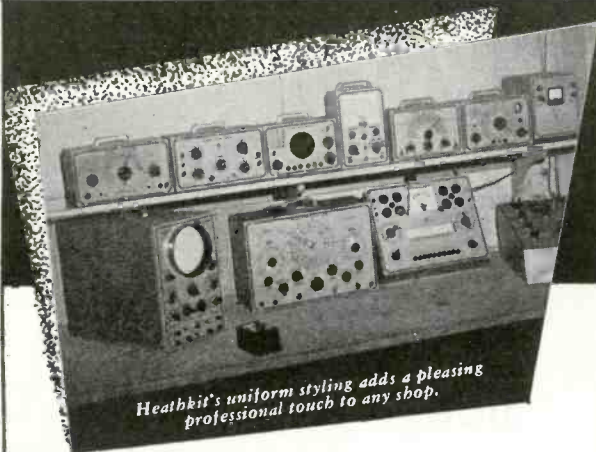

Heathkit's uniform styling adds a pleasing professional touch to any shop.

Heathkits PROVIDE PROFESSIONAL LABORATORY APPEARANCE

New Heathkit BROADCAST AND 3 BAND SUPERHETERODYNE RECEIVER KIT

BROADCAST MODEL BR-1
550 to 1600 Kc.

\$19.50

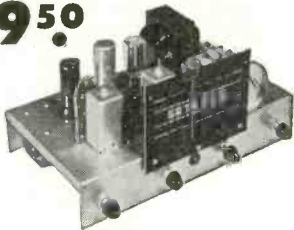

Two new Heathkit Superheterodynes featuring the best of design and material. Beautiful six inch slide rule dials — 110 V. 60 cy. AC power transformer operated—metal cased filters—quality output transformers, dual iron core metal can IF transformers — two gang tuning condenser. The chassis is provided with phono-radio switch—110 V. outlet for changer motor and phono pickup jack. Each kit is complete with all parts and detailed instruction booklet. Pictorial diagrams and step-by-step instructions make assembly quick and easy.

Ideal AC operated superheterodyne receiver for home use or replacement in console cabinet. Comes complete with attractive metal panel for cabinet mounting. Modern circuit uses 12K8 converter, 12SH7 input IF stage, 12C8 output IF stage and first audio 12A6 beam power output stage, 5Y3 rectifier. Excellent sensitivity for distant reception with selectivity which effectively separates adjacent stations.

The husky 110 V. cased power transformer is conservatively rated for long life. The illuminated six inch slide rule dial is accurately calibrated for DX reception. Enjoy the pleasure of assembling your own fine home receiver. Has tone, volume, tuning and phono-radio controls. Chassis size 2 1/4" x 7" x 12 1/2". Comes complete with all parts including quality output transformer to 3.4 ohm voice coil, tubes, instruction manual, etc. (less speaker). Shipping Wt., 10 lbs. No. BR-1 Receiver \$19.50.

- No. 335 Communications Type Table Model Metal Cabinet..... \$4.50
- No. 320 High Quality 5" PM Speaker for above..... 2.75

3 BAND MODEL AR-1
550 Kc. to 20 Mc.

\$23.50

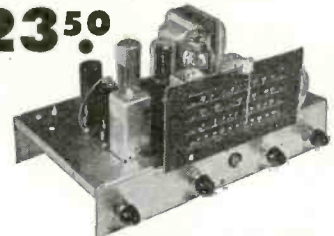

Enjoy the thrill of world wide short wave reception with this fine new AC operated Heathkit 3 band superheterodyne — amazing sensitivity 15 microvolt or better on all bands. Continuous coverage 550 Kc. to over 20 Mc. Easy to build with complete step-by-step instructions and pictorial diagram. Attractive accurately calibrated six inch slide rule dial for easy tuning. Six tubes with one dual purpose tube gives seven tube performance. Beam power output tube gives over 3 watts output.

Separately assembled coil turret with band switch eliminates difficult construction. Conservatively rated 110 V. power transformer supplies full operating voltages to all tubes for maximum reception. Has band switch, tuning, volume, tone and phono-radio controls. Chassis size 2 1/4" x 7" x 12 1/2" — supplied complete — punched chassis — tubes — controls — transformers (quality output to 3.4 ohm voice coil) — all small parts — hardware and instructions (less speaker). Shipping Wt., 10 lbs. No. AR-1 Receiver \$23.50.

- No. 335 Communications Type Table Model Metal Cabinet..... \$4.50
- No. 320 High Quality 5" PM Speaker for above..... 2.75

Heathkit PUSH-PULL HIGH FIDELITY AMPLIFIER KIT



\$12.50

Build this high fidelity push-pull amplifier and save two-thirds the cost—has two pre-amplifier stages, phase inverter stage and push-pull beam power output stage. Comes complete with six tubes—quality output transformer (to 3-4 ohm voice coil) tone and volume controls—varnish impregnated cased 110V. power transformer and detailed instruction manual and all small parts. Six watt output with output flat within 1 1/2 db between 50 and 15000 cycles.

Build this amplifier now and enjoy it for years. Shipping Wt. 7 lbs. Model A-4 12" PM Speaker for above..... \$6.95

ORDER BLANK

HEATH CO. BENTON HARBOR MICHIGAN		FROM _____	SHIP VIA <input type="checkbox"/> Parcel Post <input type="checkbox"/> Express <input type="checkbox"/> Freight <input type="checkbox"/> Best Way	
Quan.	DESCRIPTION	Price	Total	

ENCLOSED FIND CHECK . . . MONEY ORDER FOR _____
PLEASE SHIP C.O.D. . . . POSTAGE ENCLOSED FOR _____ POUNDS

EXPORT DEPT.
13 East 40th St.
NEW YORK CITY (16)
CABLE: ARLAB-N.Y.

The HEATH COMPANY
... BENTON HARBOR 20, MICHIGAN

RADIO-ELECTRONICS for

THE EYE IS QUICKER THAN THE EAR

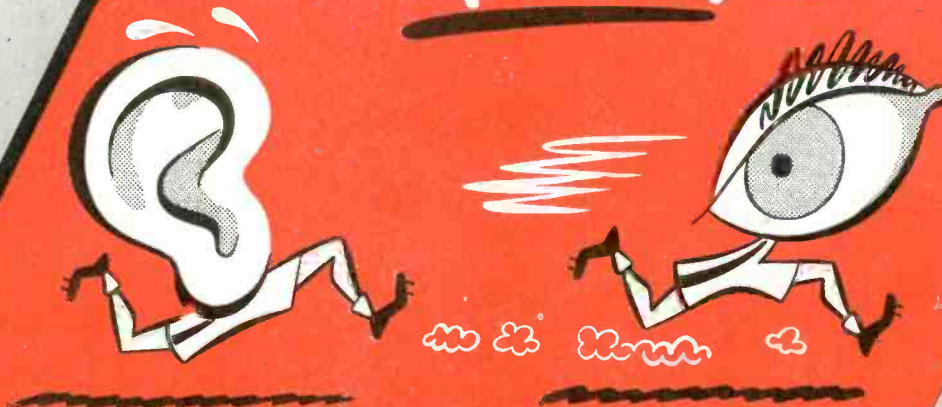

IF you service TV, you know this. Customers are quick to *see* imperfections. Much slower to *hear* them. Therefore *premium-quality* Hytron receiving tubes for the tougher TV jobs. *At no extra cost!* You gain also: Through fewer expensive service call-backs. Better customer satisfaction and confidence. More profits.

How does Hytron do it? By working closely with leading TV set manufacturers. By endless striving to better already superior performance. By improved design . . . processing . . . inspection . . . testing.

Try Hytron TV receiving tubes: 1X2, 6AG5, 6AL5, 6AU6, 6BG6G, 6BQ6GT, 6J6, 6SN7GT, 12SN7GT, etc. You pay no more for Hytron. But *see* the difference yourself . . . on the TV screen . . . on your cash register.



OLDEST MANUFACTURER SPECIALIZING IN RECEIVING TUBES

HYTRON

RADIO AND ELECTRONICS CORP.

MAIN OFFICE: SALEM, MASSACHUSETTS



49c net

OUR APOLOGIES! We knew these Hytron shop tools would be popular . . .

because they are designed "by servicemen, for servicemen." But we didn't dream they would be so popular. That you needed them so badly. First production runs of both Soldering Aids and Tube Lifters melted away like snow in the red hot demand. New, more adequate production facilities had to be rushed into action.

NOW YOU CAN HAVE THEM

Sorry, if you were one of the unlucky ones who had to wait. Your Hytron jobber should now have both Soldering Aids and Tube Lifters in stock. If he hasn't, please drop us a line.



15c net

ALSO AT YOUR HYTRON JOBBER'S . . .

TUBE TAPER 5c net



9-PIN MINIATURE STRAIGHTENER 55c net



7-PIN MINIATURE STRAIGHTENER . . . 55c net



AUTO RADIO TOOL 24c net



Which Do You Want?



Better Pay



A Nice Home



A New Car

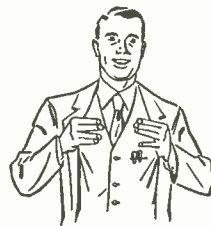

Greater Security



Happy Vacations and Travel

Get Your FCC Ticket
Jobs leading to
\$3,000 to \$7,500
 (Average Pay Reported by FCC
 Nationwide Survey)
are opening up
right now for
FCC Licensed
Radiomen

Add Technical Training to Your Practical Experience and

Get Your FCC

COMMERCIAL RADIO OPERATOR LICENSE

in a Few Short Weeks



It's EASY if you use CIRE Simplified Training and Coaching AT HOME in SPARE TIME

Get your license easily and quickly and be ready for the jobs open to ticket holders that lead to \$3000 to \$7500. CIRE training is the only planned course of coaching and training that leads directly to an FCC license.

YOUR FCC TICKET IS ALWAYS RECOGNIZED IN ALL RADIO FIELDS AS PROOF OF YOUR TECHNICAL ABILITY

CIRE Job-Finding Service Brings Amazing Offers of Jobs

"Have found and accepted a position at KWAD in Wadena, Minn.

I am indebted to CIRE for I secured this position through the help of the CIRE Job-Finding Service. I had six other offers from stations receiving my employment application and CIRE reference. I am sincerely under obligation to you."

Student No. 2760 AT

"I am working at WRJM as transmitter engineer, and I received this position in response to one of the employment applications sent me upon completion of my course and the receiving of my Diploma. I received my 1st class Radiotelephone License on March 2, 1949.

I want to express my sincere appreciation to the staff of CIRE."

Student No. 2608 AT

"I now hold ticket Number P-10-3787, and holding the license has helped me to obtain the type of job I've always dreamed of having. Yes, thanks to CIRE, I am now working for CAA as Radio Maintenance Technician, at a far better salary than I've ever had before. I am deeply grateful."

Student No. 3319N12

CLEVELAND INSTITUTE OF RADIO ELECTRONICS
 Desk RE-13 4900 Euclid Bldg. Cleveland 3, Ohio
 Approved for Veteran Training under "G.I. Bill of Rights"



GET THIS AMAZING NEW BOOKLET

1. Tells of Thousands of Brand New Better-Paying Radio Jobs Now Open to FCC License Holders.
2. Tells How We Guarantee to Train and Coach You Until You Get Your FCC License.
3. Tells How Our Amazing Job-FINDING Service Helps You Get the Better-Paying Radio Job Our Training Prepares You to Hold.

Get All 3 FREE Send Coupon Now!

CLEVELAND INSTITUTE OF RADIO ELECTRONICS

Desk RE-13, 4900 Euclid Building, Cleveland 3, Ohio
 (Address to Desk No. to avoid delay.)

I want to know how I can get my FCC ticket in a few short weeks by training at home in spare time. Send me your FREE booklet "Money Making FCC License Information," as well as a sample FCC-type exam and FREE booklet, "How to Pass FCC License Examinations," (does not cover exams for Amateur License).

Name

Address

City Zone State

Veterans check for enrollment information under G. I. Bill.

Television in 1975

. . . *What progress will television make during the next 25 years?* . . .

By HUGO GERNSBACK

AS we round the half-century mark we can use this important milestone as a vantage point from which to speculate on what the next quarter century will mean to the progress of television.

Looking back, we are struck with the fact that there have been very few actually new developments during the past 25 years televisionwise. All the elements we have in television today were—with few exceptions—known 25 years ago.

The cathode-ray tube and all-mechanical televisions were both well advanced at that time. A tremendous amount of work, of course, had to be done to coordinate and make practical the theoretical knowledge which had been accumulated over the years. We in television, 25 years ago, had a pretty good idea what television could and would do by 1950. We knew that its realization was merely a matter of engineering and ironing out a multiplicity of "bugs". All these difficulties have been solved brilliantly.

How far will the television receiver of 1975 have advanced? I believe a fairly good estimate can be made from our 1950 vantage point, profiting by our past experience.

COLOR: It is a safe bet that every 1975 television receiver will have color. At present engineers mainly are concerned with the three-color system. Our opinion is that color television 25 years hence will be either the so-called electronic-color or an optical-electronic color system. It is doubtful that it will be of the mechanical type.

It is quite possible also that by that time we will have *four-color television* instead of the present three colors used. Anyone who has seen a magazine cover produced both in three colors and by a four-color process—such as is used, for instance, on the front cover of this magazine—knows the much greater color definition achieved.

THREE DIMENSIONAL PICTURES: The pictures on your television screen today are uniformly flat and without depth. If you look at a baseball game or other sports, it is sometimes hard to see what is going on. In boxing or wrestling, for instance, it may be impossible to tell in what part of the ring the contestants move. This is because the television picture has no perspective. That is what is missing in present-day television reproduction.

We know now that three-dimensional television is possible. It is also known that it is a much less difficult problem than, for instance, three-dimensional movies. We believe that the 1975 receiver will be fully three-dimensional, making all the figures stand life-like out in space.

AERIALS: We are now at just the beginning of practical television—at what some engineers face-

tiously call the crystal-detector-headphone stage of television. One of the handicaps of today's receivers is, of course, the outdoor aerial. These aerials, not only disfigure houses (whether private or apartment), but are expensive. They must be looked after frequently because of poor connections, and a heavy rain or snow storm often plays havoc with the installation. You may rest assured that the 1975 television installation will not require an outdoor antenna. The sensitivity of the receiver will have been increased vastly, and the television antenna (whatever it is at that period) will be right in the set itself. Television receiver history will be merely repeat radio set history. In radio, too, we started out with outdoor aerials, but today almost every receiver has its own built-in antenna.

Incidentally, television receiver cabinets in the next 25 years will become considerably smaller and lighter than they are today. Our present television sets, particularly table models, are much too cumbersome, much too heavy, and consequently expensive.

GHOSTLESS SETS: Present-day television receivers are bedeviled with a multiplicity of ghosts. In some locations this condition is particularly bad and, on some channels, almost impossible to eradicate. We may think of these exasperating ghosts merely as children's sicknesses—simply another nuisance that we are even now beginning to eradicate. When it comes to ghosts *in color*, the situation becomes even worse. We may be sure, therefore, that in 1975 television ghosts will be only a memory. By that time *automatic electronic ghost* elimination will be standard in all sets. Just as FM radio eliminated static and other extraneous noises in our radio sets, so the television set of 1975 will have found an electronic answer to the ghost problem.

CONTROLS: Television sets of today remind us forcibly of the radio sets of the early 1920's which sometimes had as many as 15 knobs on the front panel. The multiplicity of controls on the present-day television set reflects the comparative youth of television. It is possible even now to build a television receiver with a single knob although high production costs make it commercially impractical as yet. The 1975 television set, it is safe to predict, will also have a single knob for off-and-on and for sound control; perhaps by pushing the knob in or pulling it out you can vary the brilliance and contrast of the picture to the desired degree.

Incidentally, the average table model of 1975 will probably have 12 tubes or fewer. It will perhaps have both FM and AM reception if desired. In that case we would, of course, have more than one control.

THE PROBLEM OF COLOR TV

By LEE de FOREST

COLOR television, as an idea and aspiration, is almost as old as mechanical television itself. That grand old TV pioneer, John Logie Baird demonstrated in England a crude form as early as 1928. He employed, of course, the whirling disc with two color filters, one red and the other a combination of green and blue colors.¹

A year later Dr. Herbert E. Ives of the Bell Telephone Laboratory, also using a perforated disc, demonstrated a somewhat similar color television system.²

In 1931 a German engineer, Ahronheim, devised a color system using a 12-color filter disc in conjunction with a scanning disc.³

In February, 1930, a patent on color television was issued to Ray D. Kell, assigned to the General Electric Co. It also employed a double, spiral, scanning disc and only two colors instead of all three primaries.⁴

In the early thirties the electron beam swept all such mechanical whirling dervishes into the discard, and would-be TV colorists began to devise ways and means for tinting monochromous monochrome kinescope pictures with all the hues and shadings of the rainbow.

Today's colorists

Until today the question paramount in the minds of all television-minded citizens, owners (or prospective owners) of kinescope sets, is COLOR! How soon will color TV be available and at what retail cost? Opinions differ widely. CBS is vociferous in its claims that it has thoroughly demonstrated the merits of its mechanical, sequential, subtractive color system; and a dozen TV-set or gadget manufacturers announce their readiness to supply the public with motor-driven tricolor discs at low prices for CBS-type polychrome reception.

RCA has recently given some remarkable demonstrations of its all-electronic color system before the FCC and selected guests. The writer has witnessed these and has gone on record as saying that in fidelity of colors of every hue and shade when seen on direct-view screens, it leaves nothing to the imagination. Projected images,

1A description of Baird's arrangement appears in *Television Simplified*, by Milton Kiver.

2March-April, 1931, issue of *Television News*.

3July-August, 1931, *Television News*.

4November-December, 1931, *Television News*. The same issue contains an article by Wolf S. Pajes on a color TV system using electronic light valves.

however, lack as yet desirable brilliance.

The system of Color Television, Inc., of San Francisco, like that of RCA, uses three separate pickup devices, all in a single camera, combining at the receiver the color images by optical projection from three separate cathode-ray tubes with different phosphors, red, green, and blue.

All three of the above color systems

Some straightforward views on an important decision the FCC must soon make, written by the "Father of Radio"

now operate within the 6-mc band, as required last year by the Federal Communications Commission, so all are applicable to our existing v.h.f. television channels. In the 1946 demonstrations both CBS and RCA systems required bands of 12 mc or more, thereby restricting their proposed operations to the u.h.f. channels not yet authorized by FCC.

Both organizations now claim that their present 6-mc-bandwidth pictures are essentially as satisfactory as those demonstrated in 1946. This has been questioned. In view of the fact that the widespread successful commercial employment of the proposed u.h.f. channels has not yet been proven (and in the minds of many experts will never be satisfactory in many localities and during certain seasonal and weather conditions), the wisdom of FCC in stipulating that color must fit existing v.h.f. channels is clear and is generally approved.

The Radio Manufacturers Association has recently laid down requirements for any future acceptable color television system; these are carefully

thought out, clearly logical, and designed for the greatest benefit to the television industry and the public now and in the future.

Compatibility a must

Foremost of their *sine qua non* conditions, a positive must, is that of compatibility. This simply means that whatever system of color is finally to receive the green light from FCC must be one whose color telecasts can be received on any existing standard black-and-white receiver, and must be equal in quality to any monochrome TV picture today. Any color system that cannot comply with this fundamental requirement should not be authorized. If the introduction of color telecasting means that any number of today's 3,000,000 TV receivers cannot receive a particular program (in monochrome), the television viewing audience will be reduced by just that number of receivers.

The potential prosperity of the television industry, broadcasters, and set manufacturers alike, demands that the television audience be built up as fast as possible. We cannot wisely permit anything which will compel any fraction of the existing audience to switch off their sets. Only the inferior quality of a program's content itself should induce a viewer to turn to some other channel! He should not be forced to do so by the technical limitations of his present TV set. *Any other policy will spell disaster to this growing industry.*

We cannot afford, in the interests of a small favored minority who can afford to purchase converters for color, to penalize others less favored, or to reduce the number of available programs for that vast majority who, for one cause or another, are not equipped for color viewing.

The logic of this position of RMA is unassailable. I think I can speak authoritatively on this topic. For the past two years I have been quietly at work on a mechanical television system, requiring no color wheel which limits the service as does the CBS system to 7- or 10-inch kinescopes. In place of the outlandishly large color wheel and the requirement of circuit changes to provide a frame frequency of 144 (instead of 30) per second and a reduced number of lines, I place before any kinescope face, even of 16-inch diameter, a three-color mosaic screen. It oscillates in an orbital, circular movement less than 1 inch in

diameter, 30 times per second, so that each picture element is viewed through one of the three prime colors on the mosaic filter screen every $\frac{1}{30}$ second. Nothing could be more simple or cost less than such a color adapter, readily slid in front of the kinescope face for color viewing and withdrawn for monochrome programs. The mosaic shuttle must, of course, oscillate or circulate in synchronism with a similar one properly located in the light beam from the image to the pickup camera (flying-spot or image-dissector type). This requirement is readily met; the small driving motors are of only 10 watts power.

But this system, like the mechanical system of CBS, was not, at the time of the FCC hearings, compatible. Used with a black-and-white receiver tuned to the color transmission, a rapidly shifting veil or pattern appeared, superimposed over the monochrome picture from the color transmitter. This has since been eliminated by a device which is quite simple, whereby the image may be seen on a black-and-white kinescope, like any present monochrome-transmitted picture. Therefore it was not submitted, in the form it had at that time, to the Federal Communications Commission at the recent color television hearings in Washington.

Politics and pressure

It is highly regrettable that politics has pushed its ugly head into the color-television picture; nor is it too difficult to imagine just why certain solons have taken it upon themselves to attempt to force FCC into a premature, ill-considered decision authorizing any particular existing color TV system for early commercial introduction and exploitation. (As logically should the Western Union seek a ruling by FCC that only the new zirconium spotlight, admittedly superior, should be used as the accepted illuminant in all television studios!)

Color television should not be forced upon the industry, nor on the public. As is admitted by all proponents of this or that color system (with one single exception), the fruit is not yet ripe on the tree of knowledge. Let us have more time to perfect this highly complex facility—to iron out a mess of wrinkles and imperfections. The industry has only now struck its stride. Much of it is yet deeply in the red, financially. We need at least three years more of growth and unimpeded prosperity while the wizards of electrons and circuitry are dressing up their polychrome babies.

I think no fixed time for color-system acceptance should now be placed on any calendar. Let us wait until black-and-white market saturation has been reached. Then will be the proper time to introduce to an eager, accepting audience of at least 5,000,000 set owners an RMA-standardized color television system—one which is absolutely compatible and one which will not reduce the viewing audience by a single set

nor by a single hour of employment or enjoyment. Also the color-television receiver should cost little more than the better class of monochrome sets, or color converters should be available at the very minimum of expense. Then, and not until then, let us have color television.

One thing is clear: no color adapter should be limited to 7- or 10-inch kinescopes, nor to projection types of receivers. For the past year the trend has been increasingly toward the larger direct-view sets, 12-, 16-, 19-inch kinescopes. Any color system limited to smaller tubes or to dim projected images should not be considered, for obviously they will have scant public acceptance. Owners of the larger sets must not be debarred from color nor

More rather than less emphasis should be placed on compatibility, as month by month more hundred-thousands of receivers roll off the assembly lines. Did I not sincerely believe this, I would be emphatically advocating the advantages of my own color system over all others in evidence today. But RCA, at least, has proven the practicability of compatibility. Let other aspirants do the same. We want no brake applied to the television chariot, today or tomorrow.

Color television in 6 mc must proceed upon a lasting foundation of proper standards, excellent performance, and complete compatibility with existing receivers, *with no changes in their chassis for black-and-white reception of color programs.*

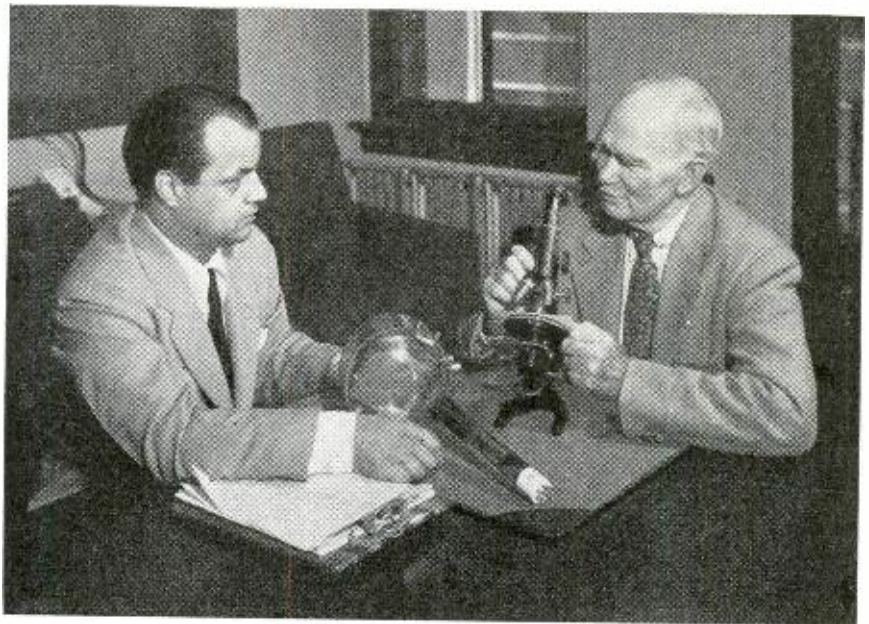

The author, Dr. Lee de Forest, with U. A. Sanabria of American Television, Inc.

compelled to buy completely new receivers for color television enjoyment.

Such logical considerations will render abortive the high-pressure methods now so evident, seeking to force a half-sized or midget color system upon industry and public. The simple fact that a certain system "is operative today" by no means rules out the obvious fact that some other color system may be operative in a far better fashion two or three or four year or more from now.

Hurry vs delay

Delay in immediate acceptance of any system today would, we are told, "result in a double loss for the public, because millions more of black-and-white receivers lacking provision for adaption and conversion will have been purchased." But why increase the cost of our present chassis and cabinets for the purpose of converting to any one system which may, probably will, be obsolete and discarded within the next three years? Public loss will be safeguarded by watchful waiting—not by jumping into a 10-inch bag be it ever so colorful.

The RCA color system is a triumph of clever electronic engineering. (It is described elsewhere in this issue.—*Editor*) At present, however, RCA color receivers are too costly compared to monochrome, and their converters are scarcely less so. The engineers are hard at work to simplify and cheapen these devices, and it is reasonable to expect revolutionary improvements and drastic cost cuts during the next two years. Other systems may do the same, or better. By all means, then, let us control our natural impatience to view color perfection on our screens. Delay today will pay rich dividends, in color and costs, tomorrow, or possibly day after tomorrow.

And in the meantime, let the FCC at once lift its arbitrary "freeze" on further extension of v.h.f. video transmitters so that every section of the country may enjoy as rapidly as possible the immeasurable benefits of television reception. The duty of the Commission to act speedily in this is incomparably more imperative than to decree that color television shall be quickly commercialized.

JANUARY, 1950

tions, whereas heretofore only a mere plots in penetrating deep into enemy homes.

JANUARY, 1950

A CBS converter. The color wheel in the housing at left is slid over tube face.

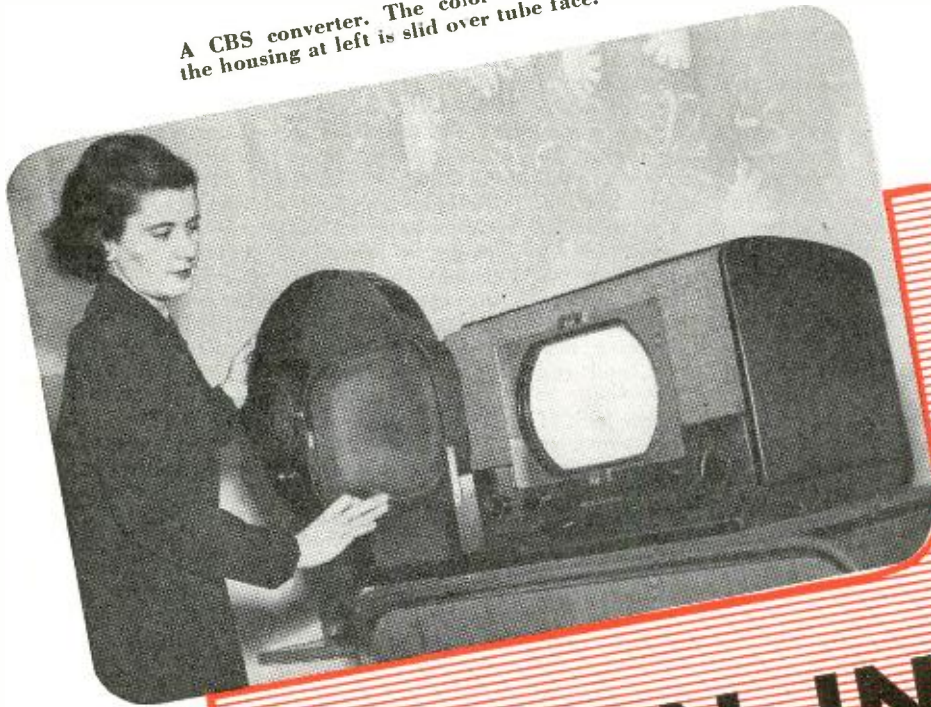

TELEVISION IN COLOR

By FRED SHUNAMAN

Is color television a rainbow-hued mirage or a reality already visible on the horizon? When and how will it be achieved? There is little agreement among experts on the first question. To answer the second, a number of organizations and individuals have proposed or demonstrated systems which they hold to be the most practical. Probably the most important are those of the Columbia Broadcasting System and the Radio Corporation of America. Both are modifications of color systems demonstrated to the FCC a few years ago.¹

CBS uses a mechanical system of whirling color wheels. A transparent disc divided into segments of the three primary colors—red, green, and blue—revolves in front of the television camera. When the red segment comes between the scene and the camera, the lens picks up chiefly the red light. The same is true of the other two primary colors.

A similar disc whirls in front of the receiver screen. (See Fig. 1 and the photo at the head of this article.) The receiver disc is synchronized with that at the transmitter: when, for example, the red field is being received, the red section of the disc is ahead of it. The image seen by the viewer is then red.

The successive primaries are flashed on the eye at the rate of 144 per second, and persistence of vision

blends them into one full-color picture. All color being made up of these three primaries, a color between red and blue, for example, transmits some red and some blue light; the mixture of the two in the eye of the viewer reproduces the original color because of persistence of vision.

The practical realization² is not as simple as that, of course. Problems of interlacing, flicker, and fringing, among others, arise.

CBS has obtained its best results with 48 complete pictures (144 color fields) per second. The number of

permit operation on 525 or 405 lines.

The RCA approach

RCA uses a camera with three lenses and three electronic systems—in effect three cameras in one—to pick up the reds, greens, and blues. To transmit over an r.f. band not more than 6 mc wide, each color in the new system “shares time” with the others. Red, green, and blue are transmitted in turn over a video band approximately 4 mc wide. Fig. 2 is a block diagram of the system.

The time-sharing feature of the

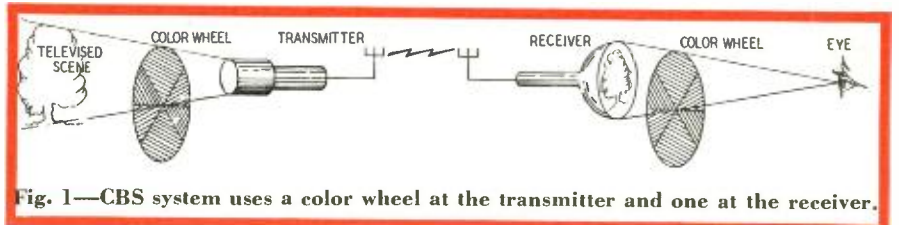

Fig. 1—CBS system uses a color wheel at the transmitter and one at the receiver.

scanning lines per picture is 405, instead of the 525 in standard black-and-white receivers. This feature was considered necessary to reduce the transmitting bandwidth to the standard 6 mc, but makes the system “incompatible” with today’s black-and-white receivers, which require modification to receive transmissions in both color and black-and-white. Slight alteration of the sweep circuits is sufficient, and a simple switch can be installed to

new system is made possible by *sampling*, a method originally developed for multiplex pulse communications systems.

The sampling system works like this: As the scanning spot swings across the subject, the output of each of the three color cameras is “tapped” 3,800,000 times per second. Each of these sampling periods is so short that it produces a narrow d.c. pulse whose voltage represents the strength of that

color at the exact spot being televised (Fig. 3-a).

The electrical pulse representing each color sample goes to a low-pass filter. This filter broadens these sharp d.c. pulses into a displaced (Fig. 3-b) alternating current (a.c. with a d.c. component), which flows in one direction twice as long as in the other. Thus the alternation whose peak voltage is the same as that of the pulse occupies two-thirds of the cycle. The filter cuts off all frequencies above 2 mc.

The three color samples in b, d, and f of Fig. 3 are combined in the composite wave of Fig. 3-h. This composite signal looks like a single sine wave from which retrieving the three color components would seem a hopeless task. But a look at b, d, and f reveals that, at the instant each color wave is at its peak (the instant of sampling), the other two are passing through zero. Neither red nor blue can affect the green signal at the green peak, so a sample of the composite wave taken at that instant gives the exact strength of the green signal.

The great advantage of the composite wave is that it can be of the same bandwidth as the sampling signal. Thus we get three 3.8-mc signals on a single 3.8-mc channel, instead of on one three times as wide. In a 525-line picture, each color is sampled more than 7,000 times per line. These samples are staggered so that when the second line is scanned, the sample of each color is taken midway between the samples of that color on the line above.

Bypassed mixed highs

To this composite wave is added the fine-detail modulation between 2 and 4 mc, which has been picked up in parallel from all three cameras and passed on together in what RCA calls the bypassed mixed-highs system. The complete signal then goes through the low-pass (4-mc) filter and is applied to the modulator of a conventional v.h.f. or u.h.f. transmitter. Fig. 4 gives an excellent—though quantitatively inexact—picture of the video signal as it leaves that filter, and illustrates how a secondary color like yellow is made up of pulses from two primaries. Fine-detail modulation from the mixed highs is also present but has been omitted because of the difficulty of representing it in a diagram.

The receiving system

The receiver is standard right up to the video detector (Fig. 5). At that point a sampler synchronized with the one at the transmitter takes short samples of the composite signal at the instants of red, green, and blue peaks, passing each color to its own video amplifier.

Color is restored by using three kinescopes whose phosphors glow in the three primary colors. Their outputs are mixed—either for direct viewing as in Fig. 6 or projection as in Fig. 7—with the help of dichroic mirrors. These are plates of glass on which a

microscopically thin metallic film has been deposited to make them reflect one primary color and pass another.

The scanning is interlaced, with 60 fields per second, as in standard black-and-white. Fig. 8 illustrates the method by showing a few lines of each field.

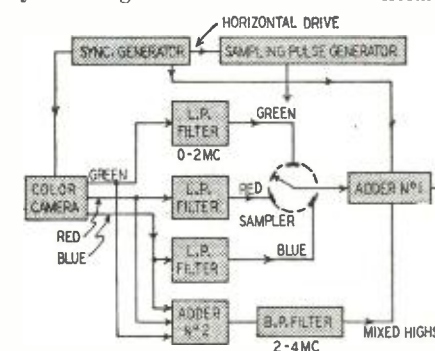

Fig. 2—Block diagram shows how the RCA system operates at the transmitter end.

The colored "dots" represented by the letters are actually short colored dashes which overlap each other about 50%. Lines 1, 3, 5, etc., are scanned in the first field. Then the even-numbered lines are scanned, with the dots so displaced as to fall halfway between those of the same color in the line above them. The odd and even lines are again scanned in the third and fourth fields, with the dots filling in the spaces left in the first and second scanings. (Note the absence of G in the initial space of lines 2 and 3 in the top half of Fig. 8, and its presence in the same spaces in the lower half of the figure.)

Four fields are required for a complete picture, instead of two as in black-and-white. Thus there are 15 pictures per second.

The interlaced scanning permits greater definition than would otherwise be possible. The finest detail which would affect the image would be one which would be a peak value at one dot and zero at the next dot of the same color. This would represent a frequency of half 3.8, or 1.9 mc. But since the second line scans points halfway between those of the first line, detail which goes from maximum to zero in half the distance between successive color dots is reproduced. This is made clear in Fig. 9. The solid lines represent the three colors as they are distributed over a small part of line 1, and the dotted lines the same colors in line 2. The overlap of color is well illustrated in this figure.

Fine detail is reproduced by the bypassed mixed-highs system, first developed several years ago without the bypass feature for the older simultaneous system. Fine detail (frequencies between 2 and 4 mc) is taken from all three of the camera sections, bypassed around the sampler, and added to the sampled signal (Fig. 2). It is detected in the receiver, then bypassed around the sampler and added to the red and green video signals, experience having proven that the eye is more sensitive to these colors than to blue. While these mixed

highs cannot be said to be color-sensitive, in actual practice they add to the fine definition without subtracting noticeably from the color fidelity. Receivers constructed to use the mixed highs are like those of Fig. 5, with the addition of low-pass 0-2-mc filters

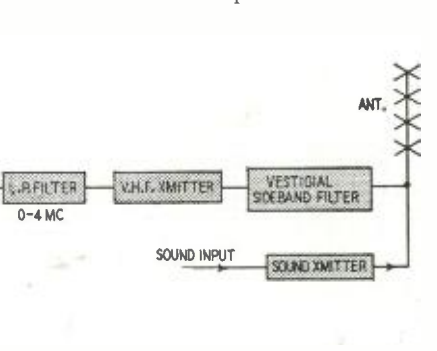

in each color video circuit, a 2-4-mc band-pass filter for the mixed highs, and adders in the green and red video circuits.

Other systems

A few other contenders have entered claims, but so far have not demonstrated their systems to the FCC. Chief

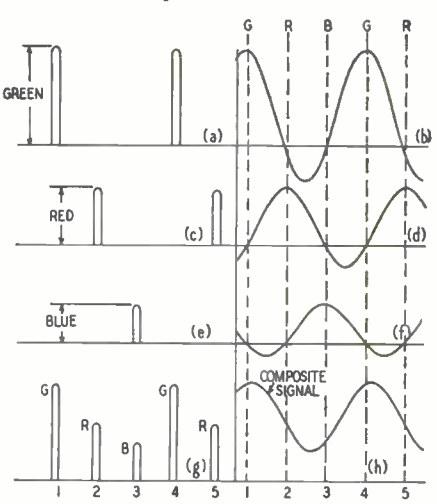

Fig. 3—The sampling system takes pulses of each color, integrating them.

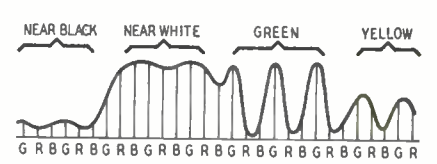

Fig. 4—Signal after passing through 4-mc filter. This is applied to modulator.

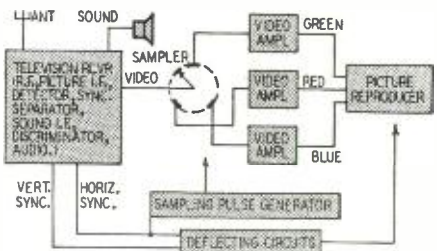

Fig. 5—The receiver contains synchronized sampler and three kinescope tubes.

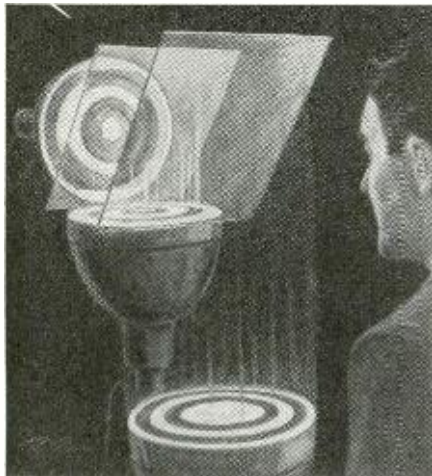

Fig. 6—A direct-view RCA color system.

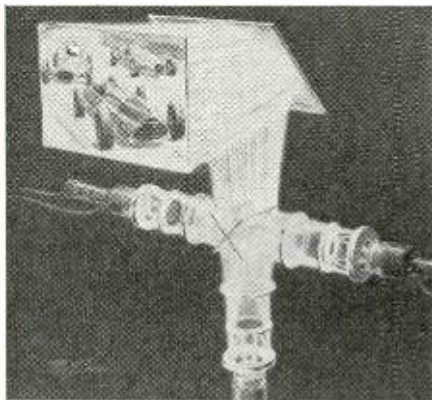

Fig. 7—Three-tube projection receiver.

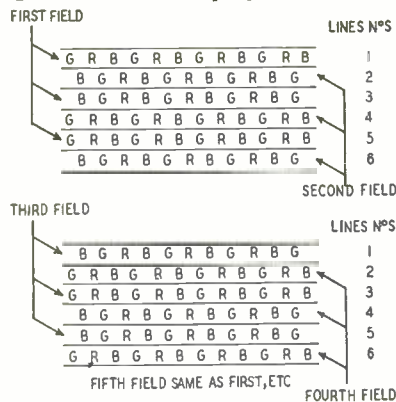

Fig. 8—How three colors are interlaced.

of these is Color Television, Inc., of San Francisco. Based on patent No. 2,200,285, issued to R. Lorenzen, and Nos. 2,389,645 and 2,389,646, granted to George E. Sleeper, its colors "share space" on the transmitting and receiving tube screens, instead of sharing time or spectrum width.⁴ Three lenses and three color filters are placed in front of the pickup tube (Fig. 10) which may be an ordinary image orthicon. These are so positioned that three separate primary-color images of the scene being televised are formed, as in the blocks A, B, and C of Fig. 10. Scanning in the transmitting and receiving cathode-ray tubes is the same as in black-and-white, with one-third of each scanning line in a different color field. The kinescope may be a special tube with the three picture

areas coated with red, green, and blue phosphors, or it may be a white-light tube. If a white-light tube, filters are again placed ahead of each section to transmit only the correct primary. In any case, the three images are combined with lenses and projected as a single picture.

A somewhat similar system called Thomascolor was described a few years ago, but has not been heard from during the present color hearings.

"Subtractive" color

Skiatron Corp., which has a large-screen system operating with an ultrasonic cell, points out that the rotating-disc color system "can easily be applied to the Skiatron and supersonic methods⁵, and the disc can be made very small by inserting it near the optical imaging system where the whole light energy is restricted to a small cross section." Fig. 11 shows such a setup, with the color picture projected on a large screen. The same system could be used with the Skiatron tube, which also modulates a beam of light from a local source. According to Dr. Rosenthal, inventor of the tube, the Skiatron is also adapted to a "subtractive" color system, in which the light is projected through three Skiatron-tube screens (whose opacity rather than brilliance is varied by the signal). The screens are lined up so the light goes through them *in series*, and each screen carries an opacity picture corresponding to one field of a three-color system (minus red, minus green, and minus blue). This method, which will have to wait for further development of the Skiatron tube, should make for greater optical efficiency in color projection. Dr. Rosenthal points out that Kodachrome and Technicolor

both use subtractive methods and that additive systems have been partially abandoned in the photographic field.

Still another method, known as the Geer system, also from California, has put forward its claims. The details released on it are somewhat reminiscent



Fig. 9—Overlap of colors is shown here of the Du Mont Trichroscope⁶, a tube with three electron guns and a face made up of minute three-sided pyramids, each side of which is coated with a phosphor in one of the three

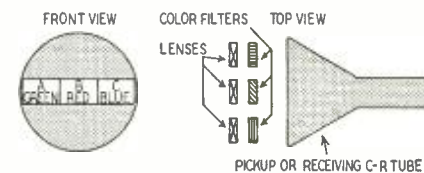

Fig. 10—Three separate images on tube. primary colors. This tube would reproduce a picture in full color right on the cathode-ray tube screen, with no mixing.

Other systems of color television have been suggested—or hinted at—but whether for reasons of insufficient development or patent protection, few details have been given.

References

- 1 Color Television. Harry W. Secor, *Radio-Craft*, Part 1, June, 1947, page 20. Part 2, July, 1947, page 24.
- 2 PPM—New Technique. Fred Shunaman, *Radio-Craft*, February, 1946, page 314. Pulse Code Modulation, Fred Shunaman, February, 1948, page 28.
- 3 Simultaneous Color Television. Kell, Sziklai, Ballard, Schroeder, Wendt and Fredenall, *Proceedings of the I.R.E.*, September, 1947, page 864.
- 4 Color Television, *Radio-Craft*, July, 1947, page 24.
- 5 Television Projection Methods, Dr. A. H. Rosenthal, *Radio-Electronics*, March, 1949, page 36.
- 6 Color Television. *Radio-Craft*, July, 1947, page 24.

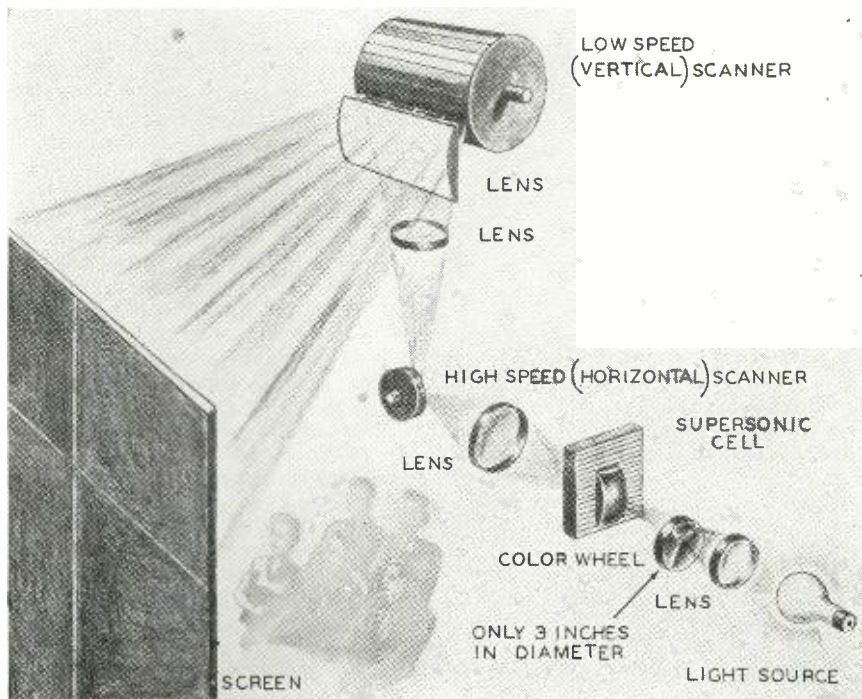

Fig. 11—Skiatron Corp. proposes adaptation of CBS color wheel to its projector.

Mass Production Television Tests

MORE than 1,000 parts, assembled with rivets, screws, and more than 500 crimping and soldering operations, go into the average television receiver, according to officials at RCA Victor's Camden, N. J., plant, where our cover picture was taken. Receivers flow off the production lines as steadily and relentlessly as the tides. Yet, despite the complexity of each set, faulty receivers are rarities. Television service technicians have been impressed with the dependability of *good* television sets over relatively long periods of use. A set several times as complicated as a standard radio, theoretically should break down several times as often, but in practice this ratio is not even approached.

The reason is thorough and consistent production testing, say the RCA men. The very practical basis for this policy is recognition that faults can be corrected far more easily while the set is in production than after it has been completed and shipped and put into operation.

Master signals, generated by special equipment comparable to two complete television transmitters and valued at more than \$200,000, are sent to individual test positions by some 40 miles of specially shielded co-axial cable strung through the Camden plant. This equipment, probably the world's largest signal generator, is capable of supplying every type of signal required in television testing. More than 200 oscilloscopes and about the same number of VoltOhmysts are also used in the various tests.

Testing, however, must begin even before the material going into the receiver reaches the production lines. The purchasing department's Quality Control Section sample-checks every batch of parts, reel of wire, or shipment of solder received. *The easiest place to catch trouble in a receiver is before the defective part is installed.*

Eight inspectors seated among the production workers on each chassis assembly line inspect for mechanical defects every part of each partially completed receiver as it flows past. In this mechanical inspection, every receiver coming off the chassis production line is gone over twice by the inspecting personnel.

As the chassis move along the assembly line, they are slid off into the booths of the *circuit checkers* for the



Partially completed television receivers travel down the factory production line.

first test on the completed receiver. Here all circuits and components are checked with the aid of VoltOhmysts for continuity of wiring and electrical values of components.

The next phase of the inspecting and checking routine through which every receiver passes is the *hot check* or preliminary operation test. In it the set produces a test pattern on an auxiliary oscilloscope connected to the receiver circuits with clips. The testers inspect the test pattern for faults which might indicate a defective set.

In the *alignment test*, the i.f. and r.f. circuits are aligned and checked for proper waveshape response and sensitivity. Here all variable controls are adjusted—there are 42 specific circuit adjustments to be made. A *deflection* test checks deflection adjustments to make sure that all picture characteristics meet the required technical standards.

The characteristics studied and brought into line include focusing, spot size, linearity, resolution, distribution, centering, size, and over-all sensitivity. The picture characteristics of the television image are checked as exactly as a photographer checks the

characteristics of his masterpieces.

Mechanical inspection is not forgotten in these finished receivers. The service technician, used to checking microphonic tubes, is quick to note the large rubber hammer with which all chassis are struck smartly to make certain that solder joints are secure and the set is not noisy under vibration.

Not until the chassis has successfully gone through this entire routine is it permitted to go on down the line to the point where the picture-tube face is cleaned and it is fitted into its cabinet and sent to the final operating test.

Separate quality-control testers are continually at work sampling the output and putting selected receivers through rigorous examinations. At least 10% of the output is checked by the quality-control testers.

"Quality must be the watchword" is the slogan continually expounded to the testing staff by the plant manager. "Not only the reputation of the brand name, but the very strength of the industry depends on thoroughness of inspection. Viewed from this light, it is an investment in the continuity and growth of television operations—as wise an investment as can be made."

A De Luxe Televiser

Part I

Entire sections or single components of this televiser can be used to improve the performance of kits and obsolete receivers

By
CHARLES A. VACCARO

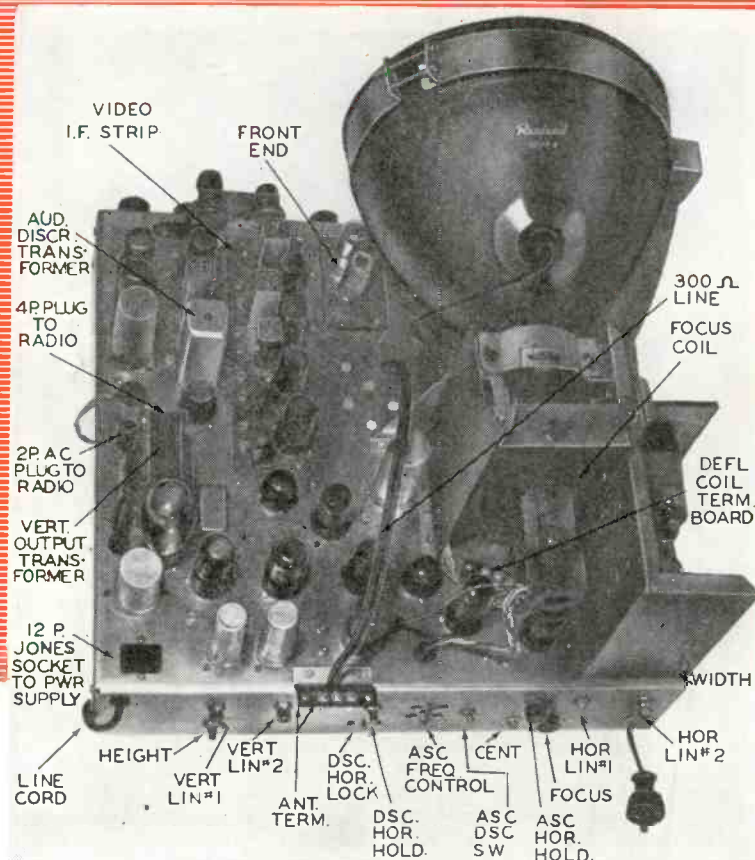

Top view of completed 10-inch TV receiver. Position of major parts is shown.

DO you want to make a discriminator transformer to convert the detector of your TV receiver from a slope detector to a true FM discriminator? Or a 12-channel front-end for the receiver that has provisions for only 5 channels? Perhaps you only want to make a small trimmer capacitor that can hang in the wiring where you need it, or know how to stabilize your present horizontal multivibrator, or go the limit and build a complete quality TV receiver. This information, plus much more, will be included in a series of articles covering the construction, adjustments, and alignments of a 10-inch TV receiver. This receiver can be constructed with a little extra time over that required to assemble and wire a kit.

Complete data will be supplied for the construction of all r.f. and i.f. coils and transformers, subassemblies, resistor-capacitor boards, etc.

It is not my intention to convince the reader that building this receiver will save money, because the saving (even though it is considerable compared to the cost of good commercial models) is small compared to the amount of work involved. However, for those who want the best possible picture and sound quality, the resulting receiver will be more than gratifying.

Besides receiving all of New York City stations with excellent results, this receiver pulls in WFIL-TV and WPTZ in Philadelphia, Pa., WNHC in New Haven, Conn., and on several occasions it has received WNBW in Washington, D. C., WMAR-TV in Baltimore, Md., and WRGB in Schenectady, N. Y., when connected to a simple folded dipole oriented toward New York City—25 miles to the south.

The receiver is intended as a console model; however, other variations will be covered later. A separate power

supply chassis is used to facilitate handling of the receiver chassis and for other reasons to be described. The audio amplifier drives a 12-inch PM speaker. Provisions have been made in the chassis for the inclusion of an AM-FM-phono chassis or any combination of these functions in the console cabinet. Sturdy tubes have been selected and the circuits designed to give long and reliable service.

The photos show methods of wiring and construction. The use of hookup wire is confined almost exclusively to the heater and plate-supply circuits. Most of the components are mounted on terminal boards which are used in all stages except the front end to insure uniform results. It should not be necessary to "de-bug" the set if directions and layouts are followed.

Other than the usual construction and wiring tools, it will be helpful to have access to a 3- or 4-inch vise,

RADIO-ELECTRONICS for

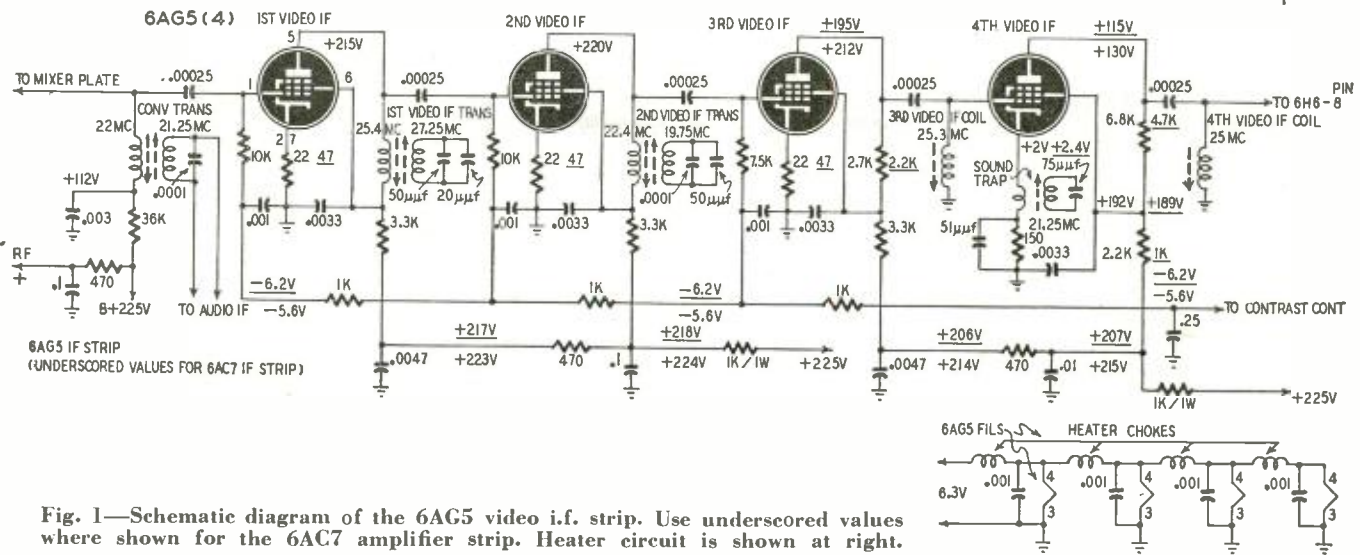

Fig. 1—Schematic diagram of the 6AG5 video i.f. strip. Use underscored values where shown for the 6AC7 amplifier strip. Heater circuit is shown at right.

socket punch, small eyelet punch, circle cutter, electric drill, two steel or angle-iron bars, and a couple of C-clamps which can be used with the vise for bending aluminum.

The alignment data to be given will be based on the assumption that the builder has access to an ordinary AM signal generator capable of delivering modulated and accurately calibrated r.f. up to 28 mc (preferably on fundamentals), and some type of output meter such as a high-resistance voltmeter, v.t.v.m., or scope. Additional alignment data will also be presented for use with sweep generator and scope.

Video i.f. strip.

The video i.f. strip is the heart of the picture. If this is not good, there is not much that can be done preceding or following it to produce a good picture. The schematic diagram, Fig. 1, gives a good idea of the circuit function. The mixer coil is the first on the i.f. strip. Across it are both the audio i.f. and video i.f. frequencies. The audio i.f. is inductively coupled to it by a circuit tuned to 21.25 mc, while the video i.f. is capacitance-coupled to the first video i.f. amplifier tube. Capacitance coupling is used between all the video i.f. stages; stagger-tuned, partially loaded, coils are used to help reproduce the full bandwidth of the transmitted picture signal. Traps are included to remove adjacent-channel audio and video interference and a 21.25-mc cathode trap prevents any of the audio i.f. signal riding through and interfering with the picture.

Gain of the i.f. strip (and picture contrast) is controlled by varying the bias to the first three amplifiers.

Two interchangeable video i.f. strips will be described. One uses 6AG5 and the other 6AC7 tubes. The 6AC7 amplifier has more gain but the miniature 6AG5's may have to be used if additional space is needed for the coils. obtainable. The 6AG5 i.f. strip is shown in Fig. 1. Underscored values and voltages are for the 6AC7 strip. The 6AC7 i.f. strip will be shown in the complete schematic later in the series.

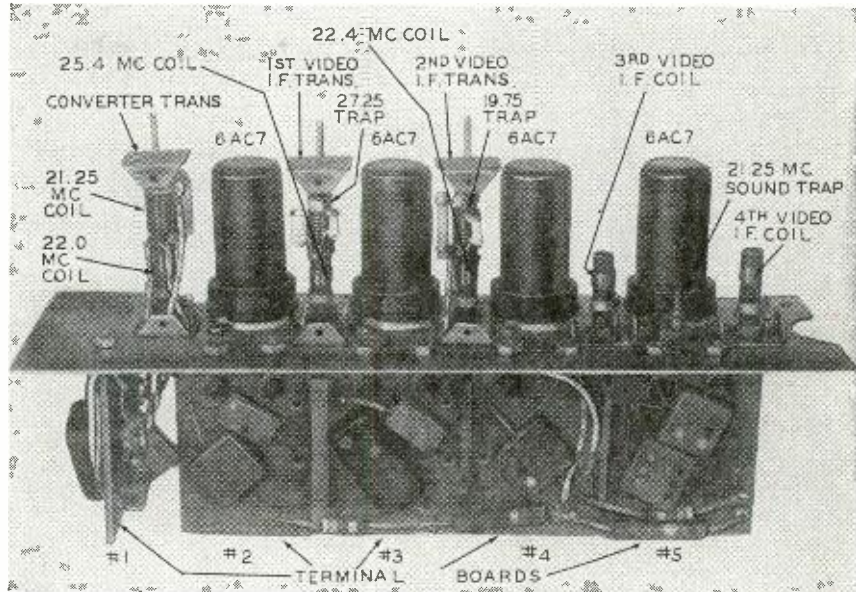

Fig. 2—Top view of 6AC7 video i.f. strip shows construction of transformers.

Because the size of the coils may be the deciding factor as to which of the i.f. strips will be constructed, they will be covered first.

The video i.f. coils and transformers

shown in Figs. 2 and 3 were made from surplus coils remodeled to suit my purpose. When purchased, they contained a ceramic coil form 1 3/4 inches long, but otherwise appeared the same

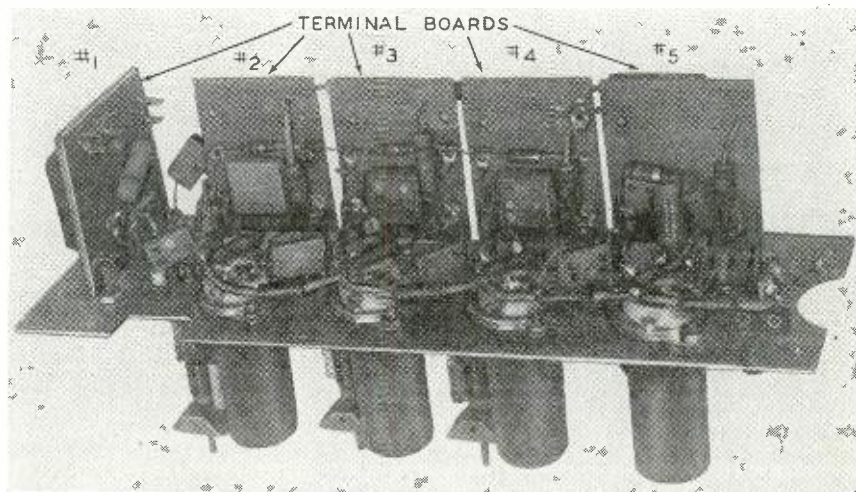

Fig. 3—Neat wiring with short leads reduces trouble in video i.f. strips.

as the double-tuned coils in the photos. The ceramic form and all the parts cemented to it were removed by soaking the assembly in lacquer thinner. All the parts were used except the ceramic form which was replaced by a 5/32-inch bakelite tube cut to the dimensions indicated in Fig. 4.

Drill a 5/16-inch hole through the cen-

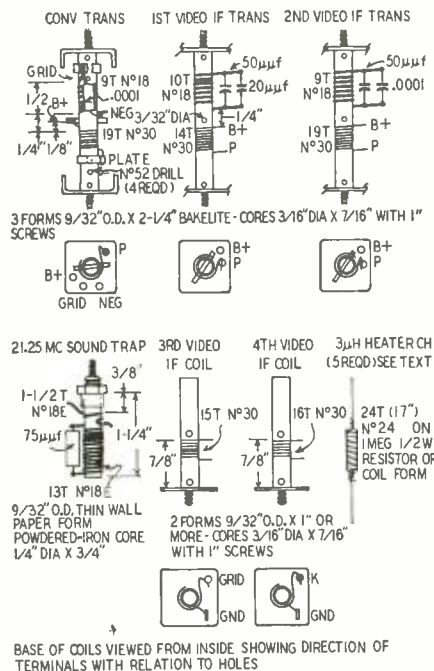

Fig. 4—i.f. transformers and coils are wound as indicated in drawings.

ter of each of the forms. Then cut five pieces of 3/32-inch bakelite rod 3/4-inch long and force these through the 5/16-inch holes so they project equally on

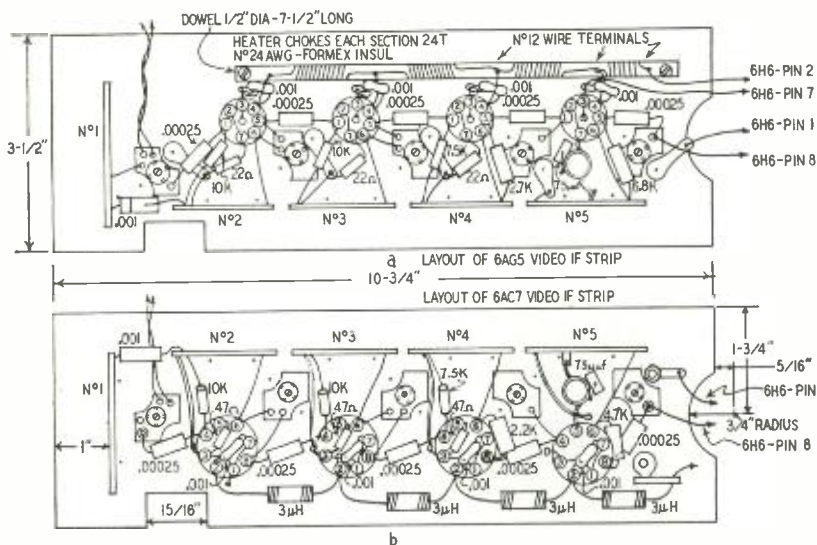

Fig. 5—Pictorial diagrams of 6AG5 and 6AC7 strips. Latter is at the bottom.

each side of the form. Additional holes can be drilled near the ends of the bakelite forms to help the cement get a better hold and also 3/8-inch from each end to allow for inspection of the powdered-iron core. The mounting plate

for some of the coils will require additional holes. These are drilled just large enough for the stranded insulated leads to pass through.

Replace the terminal clamps on the forms; coat the ends of the forms with cement and push them into the bottom mounting plates so that they line up as indicated in Fig. 4; then let the cement dry.

Use Formex insulated wire for all the coils. All the lower (plate-circuit) windings on the coils are started by first stripping and tinning approximately 1 inch of the wire. Wrap the wire around one side of the center bakelite rod, and then flow in some solder to form a solid terminal for the flexible lead to be added later. Finish winding the lower coil, following accurately the turns specified and the dimensions given from center and fasten the free end to the lower terminal clamp.

Wind the heavier No. 18-wire trap coils on a form slightly smaller than 9/32 inch in diameter. Then transfer the windings to the coil forms. Slip on the upper terminal clamp and solder the top end of the coil to it. Spread the coil out to the proper dimension and solder the capacitor to it. The bottom end of this coil is then self-supporting. Solder stranded, insulated wire, leads to the terminals as required to extend 2 or 3 inches beyond the lower edge of the coil mounting. Coat the coils with coil dope or with Duco household cement, and they are now ready for installation.

It does not matter which direction you wind the coils except that the two on each form must agree. In other words, if the top end of the lower coil is started around the form in one di-

rected except that a Palnut-type coil fastener is used at each end of the tubing to fasten the cores and for mounting. A round hole is then drilled in the i.f. strip plate instead of the semi-rectangular type and additional holes are drilled for the wires on the side of the larger hole. Terminal clamps are made of soft, lead-coated metal and the rest of the coil follows the same pattern as for those previously described. The third type is a one-hole-mounting, single-core type similar to the sound trap coil. Any of these may be used if the diameter and length dimensions are not changed.

The sound trap is wound on 3/32 O.D. thin-wall paper tubing. Extend the tubing to the proper length; then round off a 5-40 nut to give a snug fit in the upper end of the form. Screw the powdered-iron core into the nut and cement the nut into the top of the form. Another nut and lockwasher are used to provide enough tension to lock the core in place after adjustments are made.

Each of the 3-μh heater-circuit r.f. chokes for the 6AC7 strip consists of 17 inches of No. 24 AWG Formex insulated wire wound as tightly as possible on a 1-megohm, 1/2-watt resistor or an equivalent form. The wire is soldered to the pigtail at each end and the coil coated with coil dope or cement. Make five of these as one will be used in the front end. If you use 6AG5's in the i.f. amplifier, four of the chokes can be wound on a single form as shown on Fig. 5-a.

Making the terminal boards

Cut out the five boards from 3/32-inch, laminated bakelite and drill holes as shown in Figs. 6-a, -b, -c. Note that double-eyelet type terminals were used. Where only a single-eyelet type was needed, one side was clipped off. Single-eyelet terminals can be used, but having all the wires on one post may be inconvenient. If a rivet punch of the size required for the terminals is not available, a suitable substitute can be made by filing the end of a blunt round punch or any other piece of metal. The terminals are applied by fastening the home-made punch in a vise, holding the terminal board with the terminal in the hole in the direction required, and tapping with a hammer until the eyelet folds over on the other side. The terminals being flat, bend their ends up 90 degrees with a wood chisel or sharp screwdriver after mounting them.

Wire the components to the boards as shown in Figs. 6-d, and -e. Note that boards Nos. 2, 3, 4, and 5 for the i.f. strip using 6AC7's are mounted on the opposite side from that illustrated using 6AG5's. The holes are drilled in the same places, but the terminals and components that are shown on the near side in Figs. 8-e are mounted on the far side and those shown on the far side are mounted on the near side for the strip using 6AC7's. Components such as the 1,000-ohm resistors shown from board to board are not connected to the circuit until the boards are in-

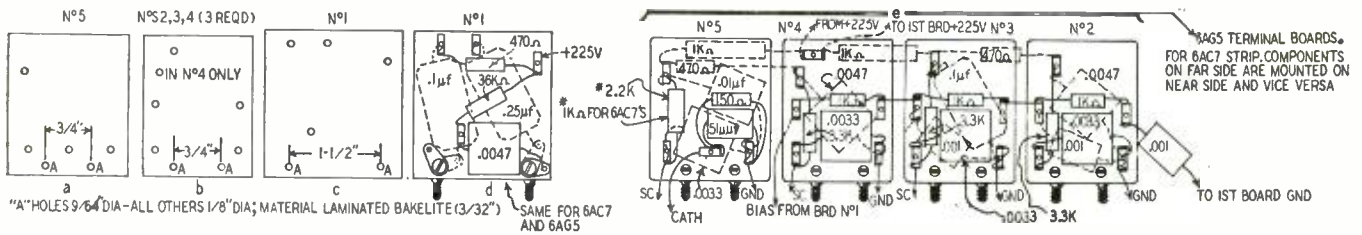

Fig. 6—Terminal boards are cut and drilled as shown. This method of construction makes trouble shooting easy.

stalled on the i.f. strip. After the components are wired on the boards, fasten two spade bolts to the bottom of each, using 3/16 x 6-32 machine screws and 6-32 nuts and lockwashers. Place a 6-32 nut on each of the spade bolts, and the boards are ready for installation.

Cut the i.f. strip plate 3 1/2 x 10 3/4 inches from .050 ST aluminum, as indicated in Fig. 5-a for the 6AG5's or Fig. 5-b for the 6AC7's. This plate can be polished to give it a neat appearance after drilling is completed by using a very fine emery cloth or a piece of

crocus cloth. Now assemble the tube sockets, terminal boards, etc., to the plate, but leave out the i.f. coils. Solder in the resistors, capacitors, heater chokes, and jumpers, following closely the partial layouts and referring to the schematic. Solder the decoupling resistors and capacitors on the rear from board to board, continuing until the wiring is completed. Wire in the cathode trap, install and wire the leads from the i.f. coils, and the i.f. strip is complete. Recheck the wiring and soldered connections.

The two-tube tuner will be described in the next installment of this series of articles.

Parts list for I.F. Strip

- Resistors: 1—36,000, 5—1,000 ohms, 1 watt; 2—10,000, 1—7,500, 1—6,800 3—3,300, 1—2,700, 1—2,200, 3—470, 1—150, 3—22 ohms, 1/2 watt.
- Capacitors: 1—.025, 2—.01, 3—.01 uf, 450 volts, paper; 2—.0047, 4—.0033, 1—.003, 5—.00025 uf, mica; 1—.00002, 2—.00005, 1—.000051, 1—.000075 uf, ceramic.
- Miscellaneous: 4—sockets (octals for 6AC7 or 7-pin miniatures for 6AG5 i.f. amplifier); sheet of 3/16-inch laminated bakelite, permeability-tuned coil forms, spade lugs, eyelet-type soldering lugs, hookup wire, etc.

NEW FLAT PLASTIC LENS

A new thin, flat plastic lens for enlarging the television image on home receivers is the latest accessory for TV fans. It operates on the Fresnel principle of magnification and is known as the Magna-Screen. Weighing but a few pounds, it is easily attached to any type of receiver by means of brackets supplied with the lens. It is adjustable and can be quickly changed to give any desired degree of magnification within its scope. The Magna-Screen is free from edge distortion and provides glareless viewing of the image at a reasonably wide angle.

The lens operates on a principle similar to the Fresnel lens used in lighthouses. Its magnifying power is based on the fact that carefully designed optical prisms or ridges are impressed in the plastic from a master die, each prismatic line corresponding to a segment of the curved surface of a thick glass lens of the usual type.

How the rays of light are refracted through the successive ridges or prisms in the lens is shown in the diagram. As the circular ridges or prisms approach the outer edge of the lens their angle becomes steeper, whereas toward the center of the lens the prismatic ridges flatten out until they are nearly flat. In this manner the lens is able to pick up rays of light from all angles and redirect them beyond the lens to form an enlarged (virtual or apparent) image, which is viewed by the observer.

The magnifying element of the screen is formed from a sheet of thin plastic, into which hundreds of the prismatic grooves are pressed. In the assembly there is a green filter which eliminates glare, together with protective outer sheets of plastic (Plexiglas), the whole

unit being sealed at the edges. When used with a 10-inch television tube, the image can be enlarged up to the size normally received on a 16-inch-diameter tube.

Plastic lenses of this type are made by cutting ridges into a brass or other suitable metal mold, which is heated and pressed into the plastic sheet. The grooves are very fine in some parts of the lens, running as high as 200 or more to the inch. The circular rings or grooves can be seen when looking at the screen; but when placed in front of a TV picture tube, the lines are not visible, because of the smoothing out or resolving effect of the overlapping rays of light.

These new flat plastic lenses are designed for gathering the light from a given source, such as the bright image on a TV picture tube, and are not suited for use as projection lenses. They do have the valuable property of spreading the light evenly across the field of vision. A defect met with in many simple lenses, that of spherical aberration, is thus practically eliminated in the new thin plastic lenses.

The Magna-Screen is mounted in a neat wooden frame and comes in three sizes: 8 x 10 inches for sets with 7-inch tubes, 9 x 12 inches for 7- and 10-inch tubes, and 11 x 16 1/2 inches for sets with 10- and 12-inch tubes. The brackets supplied with the lens permit using it on any table set, and it is available mounted on a floor stand for use with console TV receivers.

The Magna-Screen is made of Rohm & Haas Plexiglas, an optically-clear, extremely strong, light-weight acrylic plastic, by the Plastic Division of the Willson Camera Co.

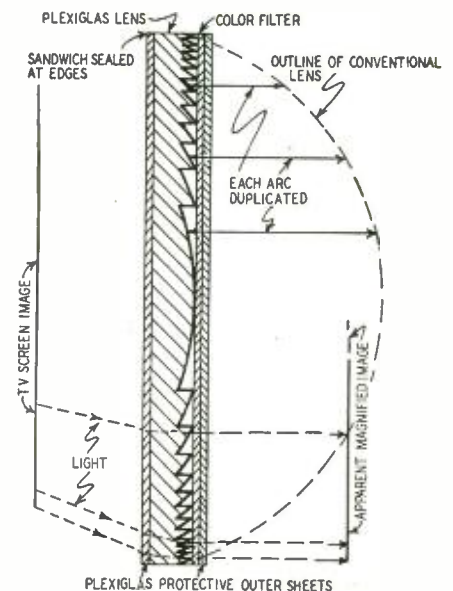

Construction of the Magna-Screen is shown in this cross-section drawing.

TV INTERFERENCE PROBLEMS

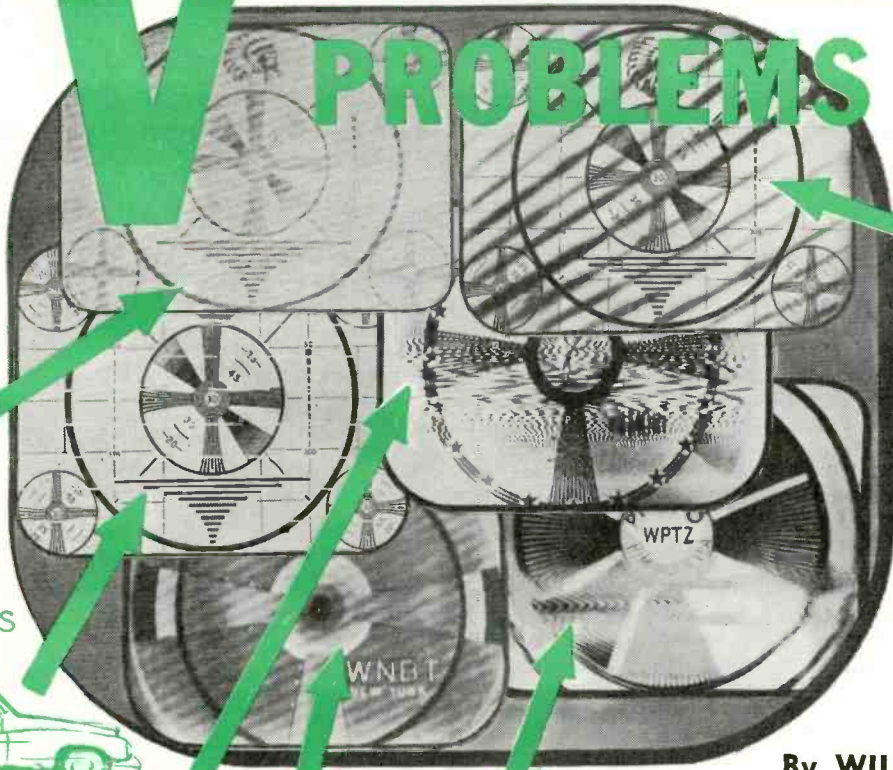

WIRELESS TELEGRAPHY



FM IMAGES



AUTOMOBILE IGNITION



INDUSTRIAL INTERFERENCE



OTHER TV RECEIVERS



DIATHERMY

By WILLIAM L. KISER*

THERE are many excellent television installation and maintenance crews, technically qualified and having the necessary equipment for finding the causes of interference. On the other hand, there are service technicians who merely advise the consumer that the interference is due to "outside r.f. radiation" and advise him to communicate with the Federal Communications Commission.

A large number of letters received by the Commission state that the complaint is being made on the advice of a service technician. Some add that they are doubtful as to the technician's qualifications and ability. These doubts are confirmed when the FCC engineer investigates the case and the technician is called back—on the engineer's advice—to install a wavetrap or make some other modification which removes the interference.

The consumer cannot avoid the correct conclusion that the technician should have been able to diagnose the condition and correct it, and feels, justifiably, that he is paying for inferior servicing.

From a long-range view, this type of servicing does not benefit the television industry nor does it encourage set owners to renew servicing contracts.

Except in extreme cases, it is the responsibility of the service technician to clear interference. If he is not able to do so, the matter should be referred

* Radio Engineer, Federal Communications Commission, New York, N. Y.

direct to the receiver manufacturer.

Two types of interference to television reception cause difficulty for the service technician. These are interference of the *same* frequency as that on which the program material is televised, and interference of a frequency *different* from that of the television carrier.

In the first type, the interference can be cleared only by suppressing or eliminating it at the source. In the second type, the interference can be cleared only by modification of the set.

Most complaints received at the New York Federal Communications Commission office are due to the second variety.

I.f. and image interference

As in all superheterodyne circuits, there are three frequencies to contend with: the frequency to which the receiver is adjusted (and the only frequency in which the user is interested), the image frequency, and the intermediate frequency. The latter two sometimes prove to be a headache in design and service.

For instance, the image frequency for channel 2 on most receivers is between 102 and 107 mc. Frequencies between 88 and 108 mc are assigned exclusively to FM broadcasting stations.

Point-to-point radiotelegraph services are assigned to frequencies in the lower part of the i.f. band. If the receiver is insufficiently shielded, these signals may cause interference.

Interference due to poor image re-

jection is continuous and is observed only on certain channels. Interference due to poor i.f. rejection may be continuous or intermittent and can be observed on all channels.

A mistake made by many technicians is taking the receiver back to the service shop. Not only is it a waste of time and money, but the receiver rarely can be correctly adjusted to reject interference unless the adjustment is made while the interference is taking place. A communications receiver capable of tuning through the intermediate frequencies is of great assistance to the technician when servicing a receiver which is being interfered with because of poor i.f. rejection. First, it will tell him whether or not the interfering signal is in or near the i.f. band, and, second, whether the receiver requires i.f. traps or added shielding, if the signal causing the interference is being transmitted on or near the i.f.

Poor locations

The service technician who agrees to service receivers installed in close proximity to the transmitting sites of point-to-point radiotelegraph stations is in for a lot of trouble, since some of the transmitters at these sites are operating on frequencies in the lower part of the i.f. band and have power outputs ranging between 1 and 50 kw. Special shielding and trapping often help, and a highly efficient antenna and well matched transmission line are necessities. Trapping is rarely completely effective, however, because most of these transmitters use beamed transmission and change power output or shift frequency at unannounced intervals to take advantage of propagation conditions. Reception in such areas is hardly ever perfect, despite all precautions.

Interference from signals on the television station frequency may be due to radiation from the local oscillators of nearby television receivers or to harmonics of FM receiver oscillators. Industrial r.f. heating apparatus and medical diathermy equipment can give trouble in this way too, but those signals are rapidly disappearing into one of the three assigned "noise" bands.

Ideally no receiver should radiate, but nearly all do, some more than others. Since the worst interference from other sets occurs in thickly populated areas, especially in apartment houses, this type of interference might be classified as resulting from a poor location.

The problem of eliminating it is one for the manufacturer, not ordinarily for the technician. However, it usually saves time and confusion if the technician at least locates the source of the trouble for his customer. The offending set can usually be identified by making simple on-off tests with nearby receivers. Sometimes a slight reorientation of the antenna helps.

The "amateur alibi"

The first thought of many technicians and set owners who know of an amateur in the neighborhood is to blame

all interference on him. It cannot be overemphasized that the amateur is to blame only when he is transmitting excessive harmonics or other spurious emissions that are on the same frequency as a local television station and thereby cause harmful interference when the complainant's receiver is tuned to that frequency.

In spite of this, amateurs with 60 and 70 db of harmonic attenuation are being taken to task every day. It has been the observation of Commission engineers that most amateurs are willing to cooperate with both the consumer and the service technician. However, in some cases, this cooperation is precluded when the consumer is informed by the serviceman that the interference is due entirely to the operation of the amateur station. Investigations by Commission engineers, have time and again proven conclusively to the set owner that the amateur is operating within his rights and that the apparent interference is due to inadequate design features in the television receiver.

The first TVI complaint may serve to inform the amateur of his rights. In a typical case, a TV antenna 10 feet from a 10-meter ham antenna carried TVI down to the receiver. The ham was notified. He and the service technician got together. With transmitter on-off tests the technician found that most of the interference could be eliminated with a high-pass filter attenuating all frequencies below the TV bands. Addition at the receiver of a trap adjusted to the amateur's fundamental frequency completed the job. The amateur will usually cooperate with technicians investigating complaints in nearby receivers. But he knows that *the responsibility is not his* if he has reduced harmonics and spurious emissions from his transmitter to the extent that they do not cause interference on the same frequency as that of a local television station. He is *not obliged* to conduct further tests. Nor is he to be blamed if his irritation at the number of future unfounded accusations causes him to lose patience and refuse any aid at all. That is one excellent reason for making a genuine investigation of the interference source and not jumping at the nearest "easy" solution.

Some service technicians attempt to analyze the causes of interference by telephone conversations or calling at the customer's home at times when the interference is not observed. The only way to make a proper analysis is to observe the interference while the receiver is installed in the consumer's home. This may involve working evening hours in some cases, but it will certainly reduce the number of future service calls during the day.

Some conclusions

A very large part of the whole interference problem lies right in the lap of the manufacturers. It is not a matter of "blame" as such, for few receivers have been deliberately designed poorly. By the standards of other types

of home radio equipment, TV sets in general are well made. But interference makes a much bigger impression on the eye than it does on the ear—a fact that calls for higher future standards.

It is possible to design a receiver that will reject all interference not on the same frequency as the desired station. For reasons of cost and because the amount and degree of interference was perhaps underestimated, manufacturers have erred somewhat on the side of insufficient rejection. That this is recognized by the manufacturers themselves is evident in the improvements in receivers during the last year.

There are upward of 1,000,000 television receivers in the United States, and there will probably be twice this number in another year. This is a tremendous field for television sales and service and to service television receivers properly will require fast and efficient servicing personnel.

It is hoped that the interference problem may be alleviated to some extent by the tremendous and continued improvement in receiver design made by certain companies on their later models as compared to the receivers on the market a year or so ago.

TELEVISION DX REPORTS

Apparently propagation conditions have not been favorable to long-distance television reception. Just three letters reporting genuine dx have appeared in response to our queries in the November issue.

One is a copy of a report written by H. A. Wenzel of Quincy, Ill., to KPIX, San Francisco, Calif., reporting reception on the evening of May 20, 1949. The signal from KPIX was almost as strong as that from KSD-TV in St. Louis, Mo., about 100 miles from Quincy, which Mr. Wenzel watches regularly. Other distant stations were also unusually strong on that night, but none could be identified. The receiver was a Motorola VT-107.

Paul O. Kirikamm, WNBK video engineer, Columbia Station, Ohio, sent in a log showing frequent reception of stations over 100 miles away and of two over 1,000 miles distant. Both of the latter were heard on May 21, 1949. One was KLEE-TV, Houston, Tex., 1,325 miles away; the other was WKY-TV in Oklahoma City, Okla., at a distance of about 1,200 miles. Reception was good to fair in both cases. The antenna was a picture-wire folded dipole on a wooden crossarm, 50 feet above ground. Interestingly, Mr. Kirikamm adds a note that he installed a commercial folded dipole and reflector in July, after which about 90% of his former dx reception disappeared! His receiver is a 10-inch Emerson.

A report from W. W. Wilcox in Richmond, Va., tells us that he picked up WKY-TV, Oklahoma City, Okla., on June 22, 1949. A Western Auto antenna was used with a Truetone receiver. He reports, too, reception of WMCT, Memphis, Tenn., and stations in Baltimore, Washington, D. C., and Pennsylvania.

Revamping a 630-Type TV Set

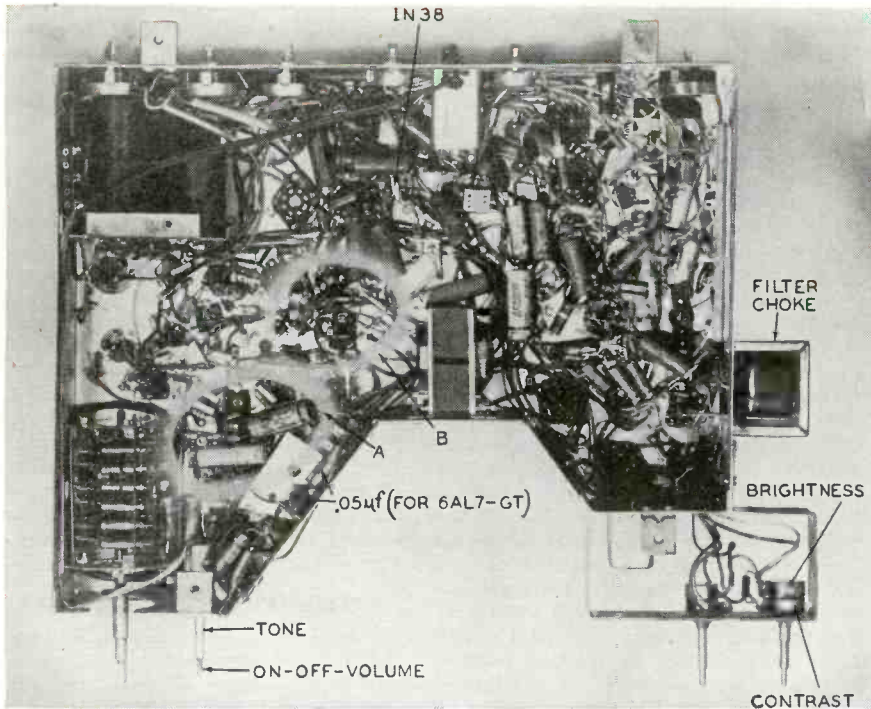

Photo of the parts under the chassis with some of the major parts pointed out.

LIKE so many experimenters I've never been completely satisfied with standard radio sets. Every one I've ever bought wound up with numerous "improvements," some of which actually improved and others—well, they were fun doing. Television hasn't changed things for me. After having used a TV set of the 630 type for several weeks, that old feeling returned. I had to make improvements!

Before muttering "gilding the lily," let's take a look at the 630. It's a good set, no doubt about it. But it has some weaknesses.

First of all, the 10-inch tube is a

little too small for viewing comfort. So we decided to replace it with a 16AP4. This meant 12,000 to 13,000 volts in place of the existing 9,000-volt high-voltage supply. It also meant modification of the vertical and horizontal sweeps to produce a picture with a maximum size of 14½ by 11 inches.

Another bad omission in the 630 is automatic gain control (in effect, automatic contrast control) the video equivalent of sound radio's a.v.c. Automatic gain control (a.g.c.) means less fiddling with the contrast control as you tune from station to station and a great reduction in flickering or blinking of

How to add a larger tube, a.g.c., and a better a.f. section

By M. HARVEY GERNSBACK

the picture when airplanes are flying nearby—an effect caused by reflection of TV waves from the plane's surface. We decided to add a.g.c. to our set.

A third shortcoming of the 630 (like most TV sets) is its audio amplifier. The sound output is little better than that of an a.c.-d.c. table radio. We decided to add a 12-inch speaker and revamp the audio stages to incorporate a large amount of negative feedback. This would bring the audio system up to the capabilities of the FM sound i.f. and discriminator circuits of the 630.

As a final touch we decided to add a 6AL7-GT tuning indicator tube to make proper setting of the fine tuning control easy.

Adding the 16AP4

There are several ways to raise the high voltage to 12,500 volts. Several parts manufacturers make horizontal output transformers for this purpose. Some require the use of an extra 1B3-GT high-voltage rectifier in a voltage-doubler circuit. We decided to use one of the newer units which develop the high voltage without the use of a doubler and its extra rectifier. The unit (a Guthman 77J1) is a new development in powdered-iron-core transformers. Although the manufacturer pro-

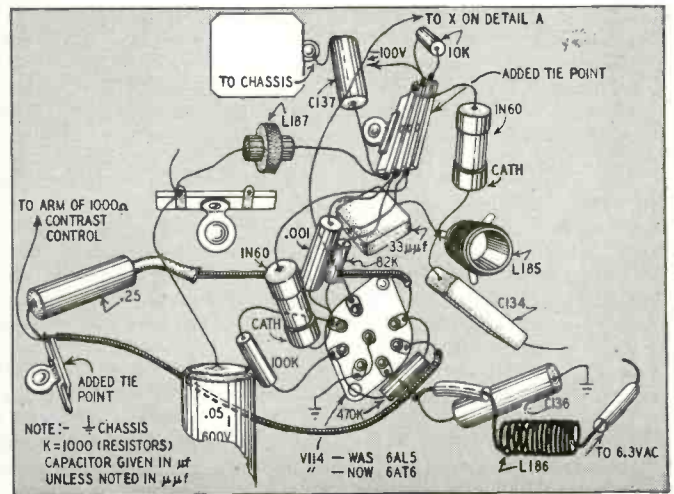
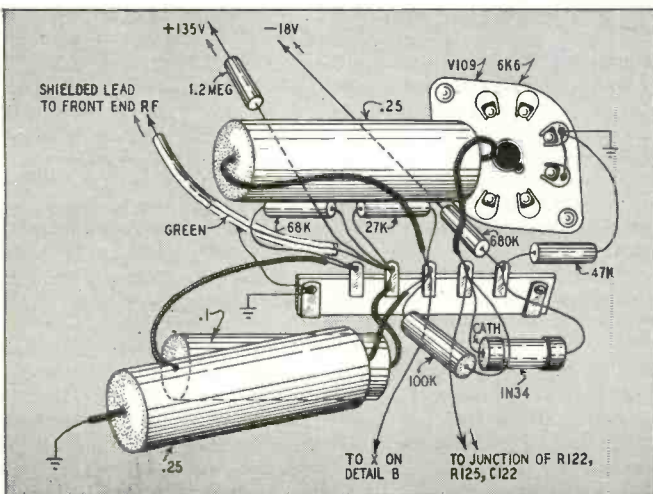

These are drawings of sections A and B in the photo of the underchassis above. They show where the parts are placed.

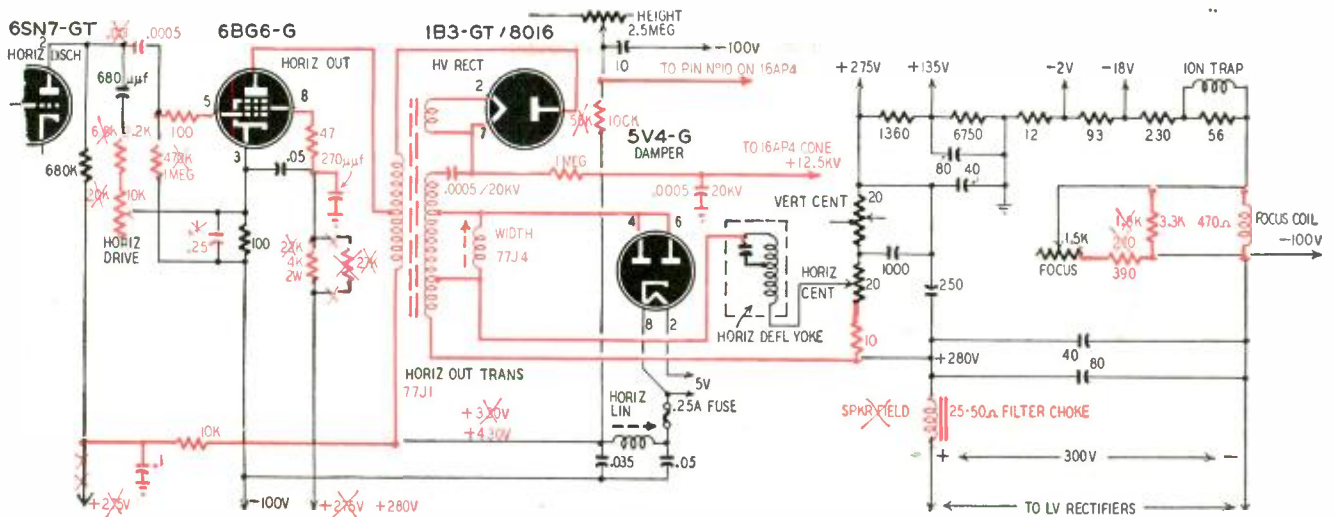

Fig. 1—This diagram shows the changes made in the horizontal sweep, high-voltage, and focusing circuits of the 630.

vides an instruction sheet for connecting this unit, other circuit changes had to be made to get the proper high voltage and sufficient horizontal sweep. The revised circuit is shown in Fig. 1. The changes are indicated in color in the diagram. Where values have been changed, the old is shown crossed out and the new printed in color. The value of the 680-µmf capacitor in the horizontal drive control circuit is critical. Small changes affect horizontal linearity at the edges of the picture and also have a considerable effect on the maximum value of the high voltage. In my set the proper value was found to be 600 µmf. The 10-ohm resistor in series with the horizontal centering potentiometer permits proper horizontal centering. Replacing the old 20-ohm potentiometer with a 30-ohm unit will have the same effect. However, it is difficult to remove the old unit.

The 16AP4 uses the same socket as the 10BP4. The only change in socket wiring is to return the lead from pin 10 to the slider on the height control as shown in Fig. 1. The 12.5-kv lead con-

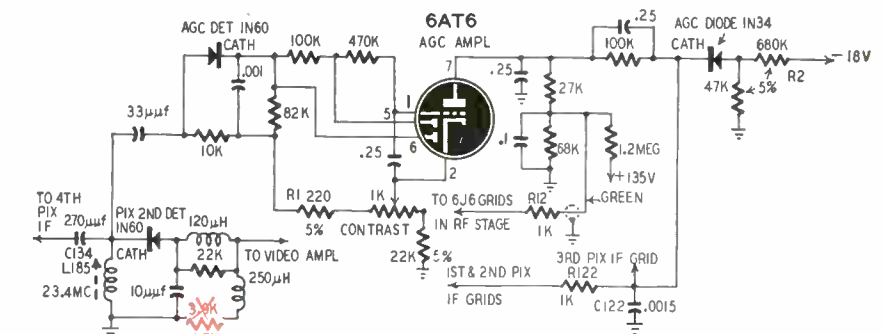

Fig. 2—This a.g.c. circuit improves the performance of 630-type chassis.

nnects to the metal cone of the 16AP4 at its lip. If you use one of the vinyl insulating sleeves made to cover the tube, connect the high voltage to the snap-on connector on the sleeve and fold the sleeve contact strip over the lip of the tube. The tube may be mounted on the chassis by using one of several special brackets made for the purpose.

The new horizontal output transformer will not work with the old width control coil. A special matching width

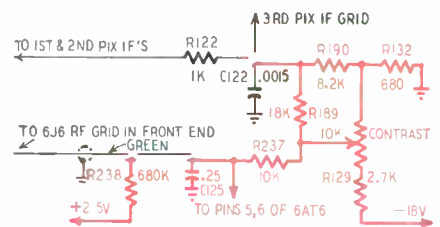

Fig. 3—Revisions for contrast control circuit. Colored parts were eliminated.

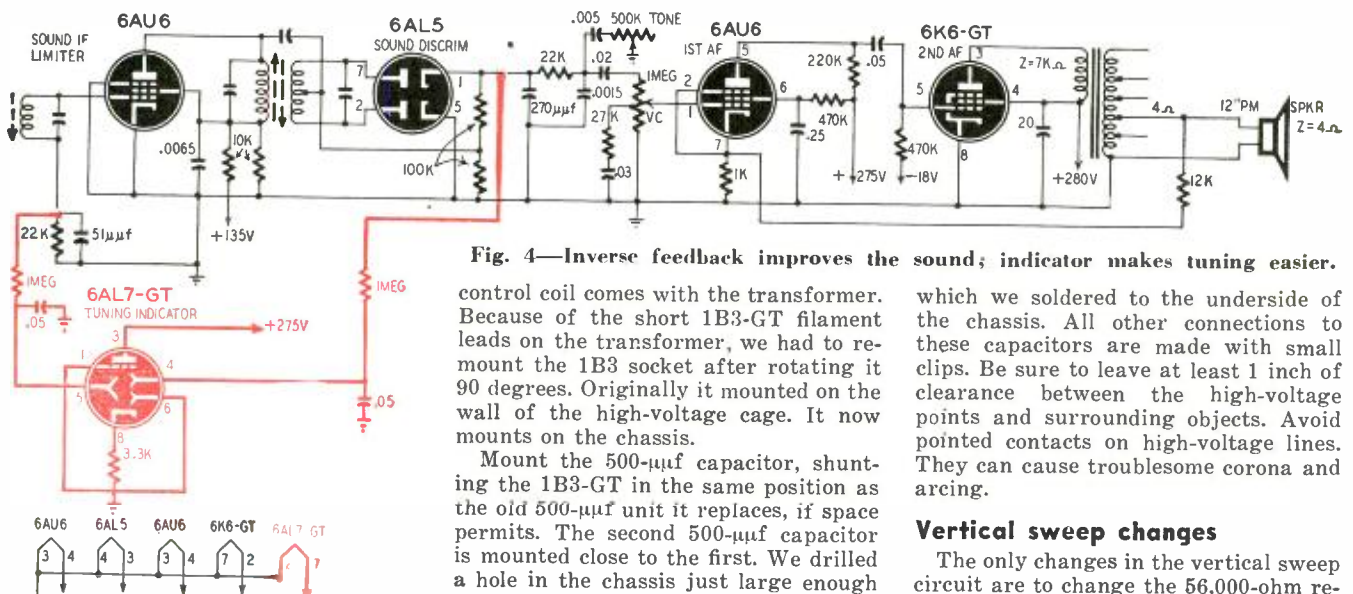

Fig. 4—Inverse feedback improves the sound; indicator makes tuning easier.

control coil comes with the transformer. Because of the short 1B3-GT filament leads on the transformer, we had to re-mount the 1B3 socket after rotating it 90 degrees. Originally it mounted on the wall of the high-voltage cage. It now mounts on the chassis.

Mount the 500-µmf capacitor, shunting the 1B3-GT in the same position as the old 500-µmf unit it replaces, if space permits. The second 500-µmf capacitor is mounted close to the first. We drilled a hole in the chassis just large enough to insure a tight fit for its rod terminal,

which we soldered to the underside of the chassis. All other connections to these capacitors are made with small clips. Be sure to leave at least 1 inch of clearance between the high-voltage points and surrounding objects. Avoid pointed contacts on high-voltage lines. They can cause troublesome corona and arcing.

Vertical sweep changes

The only changes in the vertical sweep circuit are to change the 56,000-ohm resistor in series with the height control

to 100,000 ohms (see Fig. 1), the 2,700-ohm (1,800 in some sets) fixed cathode bias resistor of the 6K6 vertical output tube to 1,500-ohms, and the 10,000-ohm 6K6 plate dropping resistor to 1,000 ohms.

The 16AP4 requires a more powerful focusing coil. Use one similar to the RCA 202D2 which has a d.c. resistance of 470 ohms. See Fig. 1 for changes in resistors associated with the focus coil circuit.

The A.G.C. system

The a.g.c. system (Fig. 2) is a modification of the circuit used by RCA in more expensive versions of the 630 (the 8TV41 and the 648PTK). The carrier amplitude of a TV transmitter varies with changes in picture content, so an ordinary a.g.c. operating to maintain a constant carrier amplitude (as in radio a.v.c. systems) is not suitable. However, the peaks of the synchronizing pulses which accompany all TV transmissions are at a uniform maximum amplitude level corresponding to 100% modulation (the so-called blacker-than-black level of video signal). These peaks can therefore be used to operate a video a.g.c.

Part of the video i.f. is tapped off the second video detector and rectified by the 1N60 crystal which operates as a peak rectifier at the horizontal sync frequency (15,750 cycles). Its rectified output is thus proportional to the peak carrier amplitude of the received signal. If the signal fades, the rectified output decreases; if it increases in strength, the rectified voltage increases. This rectifier will also rectify the peaks of noise pulses in the same way. Thus a noise burst could cause the a.g.c. to function, reducing gain and blanking out the picture. To reduce this effect the diodes of the 6AT6 are connected as a two-stage noise limiter or clipper. To further protect against noise pulses the rectified d.c. goes through an integrating network (in effect a low-pass filter) made up of the 470,000-ohm resistor and the 0.25- μ f capacitor in the grid circuit of the 6AT6. The d.c. output from the integrator is too small to be used to control the i.f.-r.f. gain. In addition, the voltage becomes more positive with increasing signal strength. For a.g.c. it is amplified and inverted by direct coupling to the 6AT6 triode grid. The 6AT6 operates with its cathode at about -100 volts and its plate between 0 and -33 volts, depending on received carrier strength. This voltage is used to control grid bias of the r.f. and i.f. amplifiers.

With a weak signal the 6AT6 cathode bias causes it to operate with almost no plate current. Consequently there is little voltage drop across the 68,000- and 27,000-ohm plate load resistors and the plate is nearly at zero potential. The available r.f.-i.f. bias control voltage is also nearly zero. In the presence of a strong signal the rectified output of the 1N60 opposes the 6AT6 fixed bias, causing plate current flow and a voltage drop across the plate load resistors. The 6AT6 plate goes increasingly negative

as signal strength increases. This negative voltage is applied to the grids of the r.f. and i.f. amplifier tubes to control gain.

The r.f. amplifier uses a 6J6 triode while the i.f. video amplifier uses 6AG5 variable-mu pentodes. Because the control-grid characteristics of these two types are not the same, the bias voltages applied to them must be different. For maximum signal-to-noise ratio on weak signals, the r.f. bias should be held at zero for all signals below the level which causes overloading of the first i.f. amplifier. This is the reason for the inclusion of the 1N34 and the connection of the r.f. bias return to B-plus (135 volts) through the 1.2-megohm resistor. This resistor establishes a bucking delay-bias voltage on the r.f. bias bus which holds the r.f. grid at zero until the signal has increased a.g.c. bias sufficiently to overcome the delay voltage. Thereafter the r.f. bias increases with the drop across the 6AT6 plate load. The i.f. bias bus is connected in the 1N34 circuit. On weak signals the 1N34 cathode (which is at the same potential as the 6AT6 plate) is positive with respect to its plate and does not conduct. The i.f. bias then follows the variations in 6AT6 plate voltage. When the received signal exceeds a certain value, the 1N34 cathode becomes more negative than its plate. The 1N34 then conducts, causing a voltage drop in the series 100,000-ohm resistor. This drop limits the maximum value of i.f. bias developed to about -3 volts at even the strongest signal inputs. The r.f. bias is not limited in this way and increases with increasing signal strength to a maximum of about -6 volts. Fig. 3 shows the 630 contrast control circuit *before* the modification with removed parts shown in color.

Germanium diodes are used in the a.g.c. circuit to avoid adding another tube socket to the set and to eliminate additional heater current drain on the set. The pictorial details A and B show placement of the new wiring and parts for the added a.g.c. circuit. Since the 6AT6 a.g.c. amplifier is an extra tube, one tube had to be eliminated from the original 630. The 6AL5 video detector and d.c. restorer was replaced by two germanium diodes. Two 1N34's can be used with little reduction in performance although we used a 1N60 detector and a 1N38 d.c. restorer.

The old dual volume-contrast control is converted to a volume-tone control (an RCA dual control No. 74048 from a 9T270 receiver is the replacement). The single brightness control is replaced with a dual contrast-brightness control (another RCA replacement part, No. 71971 from a 648 PTK receiver). If these controls are not available, use individual controls. The values of R1 and R2 are critical. If possible, measure voltages with a v.t.v.m. after wiring is completed. With the set operating, but no signal coming in, r.f. bias should be about -23 volts with contrast at minimum and zero with contrast at maximum. The i.f. bias should be -6.8 and

-1 volts and 6AT6 plate voltage -33 and -0.3 volts at minimum and maximum settings, respectively, of the contrast control.

L185 must be realigned after the alterations are completed. If a sweep generator and 'scope are not available, feed in an AM signal of exactly 23.4 mc at the antenna terminals with selector set for channel 13. Connect a v.t.v.m. across the 4,700-ohm load of the 1N60 video detector. Adjust L185 for maximum output.

The audio system

The revised audio amplifier is shown in Fig. 4. Power output is unchanged; but frequency response is flattened to within 1 db from 100 to 12,000 cycles, and distortion is reduced by a factor of 10 to 1 through use of 20 db of negative feedback between the speaker voice coil and the first a.f. stage cathode. The large amount of feedback reduces audio gain to one-tenth of its original value. To make up the lost gain, the 6AT6 first audio stage is replaced with a 6AU6 pentode using cathode bias. (Save the 6AT6 for the a.g.c. amplifier.) The values of coupling capacitors and grid resistors are also changed to improve frequency response.

A new and larger output transformer (a Peerless S-472-X) was added to improve tone quality. The unit was a compromise between a high-quality transformer and a cheap replacement type. If the audio amplifier squeals after the rewiring is completed, reverse the primary leads of the output transformer to change the phase of the feedback. The original speaker was replaced with a 12-inch, permanent-magnet speaker with a 4-ohm voice coil. The field coil of the old speaker had been used as the set's filter choke. A heavy-duty, 25-ohm, open-frame choke mounted on one wall of the chassis replaced it. The last change in the a.f. system was to eliminate the two parallel 2,200-ohm resistors in the 6K6 B-plus line and return the B-plus line to the low-voltage side of the filter choke instead of to the 5U4-G cathodes. This change reduced hum markedly. An optional addition is the tone control shown in the schematic. This is a simple high-cut affair.

While the improved audio is not a high-fidelity system, it's flattened frequency response and greatly reduced distortion puts it in the "near high-fidelity" class within the limits of its 2 watts of output. And it's a tremendous improvement over the original.

Tuning eye

As a final touch we added a 6AL7-GT tuning-eye tube to the sound i.f. system (see Fig. 4). This tube gives visual indication when the fine-tuning control is properly adjusted for best sound. The tuning indicator is in the sound channel because sound tuning is sharper than video tuning.

With all these changes, the old 630 can stand up to most 1950 receivers and look down on the audio channels of many.

TODAY'S television receivers have two principal systems of obtaining a sound i.f. The older (and still conventional) method is to beat both sound and video carriers against the local oscillator signal and obtain separate intermediate frequencies, each to be amplified by its own i.f. strip. From the mixer on, in other words, there are really two separate receivers.

The newer intercarrier system offers a saving in the total number of stages in the set and greatly reduces the bad effects of oscillator drift. It is based on the fact that all channels have video and sound carriers exactly 4.5 mc apart. The principle is to treat the video i.f. carrier as a "local oscillator" and to beat the audio i.f. carrier against it to obtain a 4.5-mc difference frequency. Since the 4.5-mc interval is wholly controlled by the expensive and precise circuits of the transmitter (of which the FCC requires great accuracy), the 4.5-mc beat is always exactly 4.5 mc; and, provided the receiver is accepting the television signal at all, it is impossible to detune the audio by local-oscillator drift or mis-handling of controls.

The diagram of Fig. 1 compares the two systems in convenient block form. For illustration, let us assume the receiver is tuned to channel 2.

The 55.25-mc video carrier and the 59.75-mc sound carrier enter the receiver, go through the r.f. amplifier, and enter the mixer, where they beat with the local oscillator. So far, both receivers are alike, which is shown by placing the similar stages outside the dashed enclosure.

In both receivers two beat frequencies are obtained, the difference between the sound carrier and the oscillator, and that between the video carrier and the oscillator. In the conventional set (upper diagram), these two beats are sent into separate i.f.-amplifier strings, one tuned to 25.75 mc and the other to 21.25 mc. From the first i.f. amplifier on, each section, sound and picture, is treated as a separate receiver.

The intercarrier scheme

The intercarrier receiver is a double-superheterodyne as far as the sound signal is concerned. The two r.f. signals pass through the r.f. amplifier and mixer, just as in the standard set, and beat against the local oscillator to produce the two i.f. signals. But here the big difference begins.

Refer to the lower block diagram of Fig. 1. Instead of entering two separate i.f. strips, the two i.f. signals enter a single i.f. amplifier. Its band width is 6 mc (ideally) so that it can accept both signals and all the desired sidebands. The two i.f. signals are still exactly 4.5 mc apart.

*Chief Technical Editor—John F. Rider, Publisher, Inc., N.Y. Co-Author of *FM Transmission and Reception*, *Television—How it Works*, and other books.

Theory and Practice of Intercarrier TV

Part I—An explanation of how intercarrier operates

By SEYMOUR D. USLAN*

After amplification, the two signals reach the second detector. This is called the video detector in conventional receivers, since it deals with the video i.f. only; but in intercarrier it deals with the sound signal as well, and is often called simply the second detector.

This diode detector rectifies the two signals and passes them to the video amplifiers. The video i.f. is an AM signal, so the detected result is the composite picture signal, ready for amplification and application to the C-R-tube grid and the sync separators. The sound i.f. is FM, however; therefore, rectifying it yields no audio signal.

A detector and a mixer are similar, both being nonlinear circuit elements. The two frequencies passing through the second detector, the sound i.f., and video i.f., mix and produce a beat note equal to their difference, 4.5 mc. This 4.5-mc signal is frequency-modulated exactly the same as the original sound r.f. and i.f. signals were. The frequency of the beat at any instant depends on the frequency of the video i.f. (constant at 25.75 mc) and of the sound i.f. (21.25 mc, frequency-modulated ± 25 kc).

A 4.5-mc trap removes the new 4.5-mc sound i.f. signal from the video fed

to the picture tube. The trap is usually a double-tuned transformer, the secondary of which carries the 4.5 mc FM to a sound i.f. amplifier, after which it is detected and the audio amplified for the loudspeaker. Any small amount of AM remaining on the sound FM signal as the result of the mixing in the second detector is removed by the FM detector.

Carrier amplitude relationship

The most important point about this system is the required amplitude relationship between the video i.f. and the sound i.f. carriers at the input to the video detector. The amplitude of the FM sound i.f. carrier must be *much less* than that of the video i.f. carrier to have the 4.5-mc beat note contain mostly FM and very little video (AM) modulation.

When two unmodulated r.f. signals are mixed and detected, the resultant signal has frequency equal to the difference between the two *and an amplitude equal to that of the smaller signal*.

Now suppose we mix an AM signal and an unmodulated r.f. signal. This is the heterodyning process used in AM superheterodynes, where the local oscillator is the unmodulated signal. The

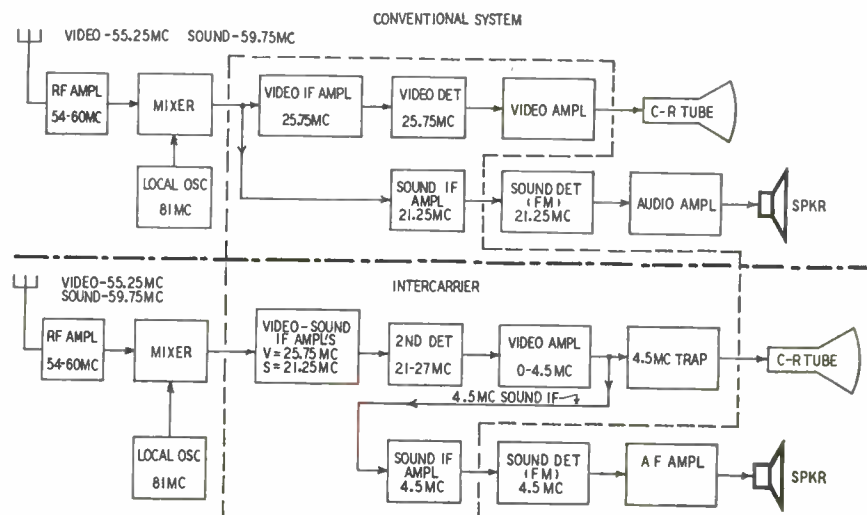

Fig. 1—Block diagrams compare two systems. Receivers are tuned to channel 2.

oscillator signal must be much stronger than the input r.f. if the i.f. is to contain approximately the same degree of modulation as the r.f. carrier did. If the oscillator is weak, the modulation percentage of the resultant i.f. is low. If the oscillator is very weak, the i.f. may contain practically no amplitude modulation at all.

In mixing an FM signal and unmodulated r.f. the situation is very different. No matter what the relative strengths of the signals, the beat note is frequency-modulated to the *same degree* as the input FM signal. That means that variations in frequency of any one signal in a mixing process will result in the same frequency variations in the beat. The amplitude of the beat is, however, mainly dependent upon the *weaker* of the two input signals,

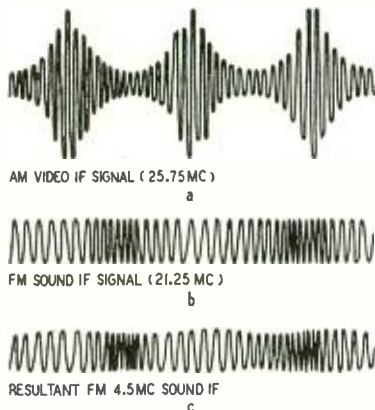

Fig. 2—Video and sound i.f.'s (a and b) mix in the second detector to produce the 4.5-mc FM signal shown at c.

no matter which one is frequency-modulated.

We now come to the process of mixing the AM video i.f. and the FM sound i.f. in the second detector. The first object is to obtain a beat note which is frequency-modulated to the same degree as the original r.f. and the 21.25-mc sound i.f. As demonstrated a few paragraphs back, the only re-

quirement is that the video i.f. frequency remain constant, so there is no problem here.

The second object is to keep the 4.5-mc beat note as free of AM as possible. The answer to this problem is to keep the amplitude of the 21.25-mc sound i.f. *low* compared with that of the video i.f. At the second detector of an intercarrier receiver, the sound i.f. is the equivalent of a local oscillator signal and the video i.f. is the equivalent of an AM signal in a broadcast set. To reproduce the amplitude modulation, the oscillator signal (or the sound i.f. in this case) must be much stronger than the incoming AM signal (the video i.f. here). The sound i.f. is actually made *much weaker*. As a result, little or none of the AM appears in the 4.5-mc beat. The FM is still there, of course, so the beat can be amplified and detected as a simple low-frequency FM carrier.

Fig. 2 gives a rough picture of the waves with which we are concerned. At *a* appears the video-modulated AM i.f. At *b* is the FM sound i.f., whose amplitude is much lower. At *c* is the 4.5-mc beat note. It is frequency-modulated like the wave at *b*, and its amplitude is approximately equal to that at *b*, following the rule that the amplitude of a beat depends on the strength of the weaker of the two original signals. Notice that while the beat at *c* has some AM, there is not very much. What there is will be washed out in the discriminator or ratio detector.

I.f. response curves

Fig. 3 is a drawing of standard and intercarrier over-all i.f. responses. The right side slopes in the usual manner and accounts for the video i.f. signal and its vestigial sideband. This is the same for both receiver types.

Curve 1 at the left is found in the video i.f. response of standard receivers. Traps tuned to the sound i.f. frequency remove the unwanted signal from the video channel, and curve 1 shows a sharp dip at the sound fre-

quency as a result of the traps. The small peak at the left appears in most receivers using traps.

Curve 2 is the standard intercarrier response, in which the sound i.f. frequency is greatly attenuated by the slope of the response, but not trapped

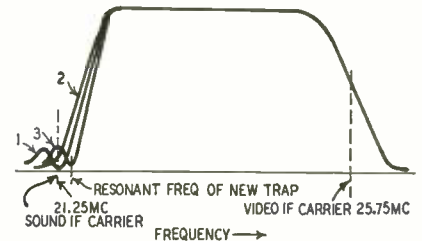

Fig. 3—Standard receiver i.f. response (1) and two for intercarrier (2 and 3).

out entirely. Standard i.f. transformers need be broad-banded only a little more than usual to include the sound frequency, especially as its level must be kept low to prevent the 4.5-mc, second-detector beat from being amplitude-modulated.

Curve 2 has the disadvantage that it is not symmetrical on either side of the center frequency of the sound i.f., so that the FM is slope-detected, with resulting distortion of both sound and picture. To prevent distortion, the sound i.f. amplitude must be limited to from 5 to 7.5% of the picture i.f.

Curve 3 cures this fault by providing a peak at the sound i.f. frequency. Though the peak looks narrow, the swing of the FM is only 50 kc, about 1% of the video bandwidth; therefore, the peak effectively provides a flat-top response for the sound signal. The peak is obtained by inserting in the i.f. amplifiers, a trap tuned slightly *above* the sound i.f. The trap slightly below trap resonance results from the same tuned-circuit action that produces the peak in curve 1. The amplitude of the sound carrier can now be increased to about 15% of the picture signal without distortion, and the FM detector can take care of the resulting AM on the 4.5-mc sound beat.

TRANSMISSION-LINE CONSTANTS

By ROBERT F. SCOTT

SOLID-DIELECTRIC co-axial and polyethylene-ribbon transmission lines are rapidly replacing open-wire types used in connecting antenna systems to receivers and to transmitters running up to 1 kilowatt input. These types of lines are used almost exclusively on television and FM receiving antennas. This is particularly true where the slight increase in transmission loss is overshadowed by ease of installation and added flexibility. They are also used as filters, wavetraps, impedance-matching devices, delay lines, and attenuating circuits.

Commercial transmission lines are currently available, with impedances of 35, 50, and 70 ohms in single-conductor types; 75, 90, and 300 ohms for twinax and twisted-pair types; and 75, 150, and 300 ohms for ribbon types.

The characteristics or surge impedance of a single-conductor co-ax or ribbon line is determined by its inductance and capacitance. Both these factors are governed by the diameters of the conductors and the spacing between them. The impedance of twinax or two-conductor types is much more complex because the diameters of the inner con-

ductors, the diameter and dielectric constant of the insulating material, the center-to-center spacing of the inner conductors, the ratio of the dielectric diameter to conductor spacing, and the ratio of the conductor spacing to conductor diameter are all governing factors.

Electromagnetic waves are slowed down from their normal 186,000 miles-per-second velocity when they pass through solid dielectrics. Therefore, a single cycle of a given frequency will not travel as far on an insulated transmission line as it would on a line in

free space during the same period of time. For this reason, one wavelength at any given frequency will be shorter on an insulated transmission line than on a line in free space. Because it is often necessary to cut a transmission line to a given wavelength, we must

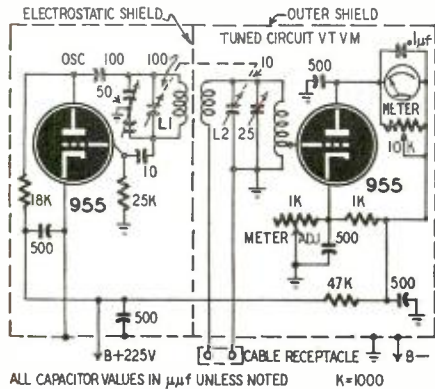

This circuit measures velocity factor.

know the relationship between actual physical wavelength and the electrical wavelength. Manufacturers of various types of transmission lines have simplified calculations for the user by comparing the velocity of electromagnetic waves through the dielectrics they use to the velocity of waves in free space. This ratio, expressed as a percentage, is called the *velocity factor* or *velocity of propagation*.

The circuit shown in the diagram was developed for measuring velocity of propagation (V.P.) in transmission lines. This device, described in detail in the July, 1946, issue of *Electronics*, consists of a 95-105-mc oscillator and a v.t.v.m. resonance indicator. The oscillatory circuit consists of L1 and its shunt capacitors. The indicator has a similar tuned circuit ganged to that of the oscillator. The bottom end of L2 is open and connected to a receptacle for the transmission line to be tested. The circuits are designed to track but they do not do so until the lower end of L2 is returned to ground by shorting the receptacle. When a transmission line is connected to the receptacle, it will have negligible impedance when it is an odd number of quarter-wavelengths long at the oscillator frequency. The velocity factor V.P., in percent, is then equal to $2/3f$, where f is the test frequency. For example: If a $1\frac{1}{2}$ -meter length of coaxial line resonates at 97.5 mc, $V.P. = \frac{2}{3} \times 97.5 \text{ mc} = 65\%$.

According to Bach ("The Trombone T," *CQ*, March and April, 1947), the electrical and actual physical wavelengths are equal when the currents in the two conductors are in phase; as in a folded dipole. When they are out of phase, as in a matching stub or trap, the electromagnetic field passes through the dielectric and the physical length is reduced by the velocity factor.

Because insulated transmission lines are becoming more popular as new devices are developed and new applications found, two tables have been prepared giving pertinent characteristics

of most of the available types of cables. Table I lists characteristics of the RG-/U co-axial cables. The velocity-of-propagation factor is 65% for RG-21/U attenuating co-ax and 65.9% for the others. Capacitance ratings in micro-microfarads per foot and attenuation in decibels for each 100-foot length will prove valuable in selecting cable for a particular job. Conductor and outside diameters are given as an aid to identifying unmarked cables. The color of the jacket may be a useful factor in identifying unmarked co-axial cable. Black jackets are used on RG-5/U, -8/U, -11/U, -13/U, -15/U, -22/U, -34/U, -57/U, -58/U, -58A/U, -59/U, and -62/U; grey on RG-6/U, -9/U, -9A/U, -10/U, -12/U, -14/U, -17/U, -18/U, -19/U, -20/U, -21/U, -42/U, and -74/U; while RG-29/U, 54A/U, -55/U, and -71/U have brown or natural polyethylene outer jackets. Table II covers the popular types of ribbon-type lines.

Most observers have probably wondered why some polyethylene insulation is almost clear or milky-white and other types are dark brown. We found the answer in the July, 1949, issue of *Amphenol Engineering News*. Ultra-violet rays from the sun cause natural polye-

thylene to become suntanned so it begins to crack and break up. After blue, red, black, brown, and orange pigments were used, the present brown was found to have the lowest power factor and will stand up better than the other types tested, for a period of approximately $15\frac{1}{2}$ months. After this time, the line begins to crack and should be replaced. Natural polyethylene has a lower power factor than the brown type when it is first put into service, but the brown is better after two or three months and remains so for its life span of approximately 16 months.

The choice of co-axial or ribbon-type transmission lines depends on a number of factors. For example, co-axial lines are recommended as TV lead-ins when the line passes through a high-noise area. The type of cable matters little in strong-signal areas so long as its impedance is correct. In fringe areas it will be necessary to select the cable with the lowest attenuation factor. Obviously, if it is necessary to insert a specified amount of loss in a 52-ohm line, all you need do is insert a length of RG-21/U cut to give the desired amount of attenuation at the center frequency.

TABLE I

Imp. (Ohms)	RG-/U	Cap. Ft. (uuf)	Center cond.	O.D. (inches)	Loss in Decibels Per 100 Feet								
					Megacycles								
					1	4	8	30	60	100	200	400	
35	83	35	#10	0.450									
51	9.9A	30	7-21	0.420	0.130	0.295	0.450	1.000	1.50	2.10	3.30	4.50	
52	10	29.5	7-21	0.475	0.130	0.295	0.450	1.000	1.50	2.10	3.30	4.50	
52	8	29.5	7-21	0.405	0.130	0.295	0.450	1.000	1.50	2.10	3.30	4.50	
52	14	29.5	#10	0.545	0.80	0.180	0.290	0.635	1.00	1.40	2.15	3.35	
52	17	29.5	0.188	0.975	0.038	0.100	0.155	0.380	0.60	0.85	1.30	2.10	
52	18	29.5	0.188	0.945	0.038	0.100	0.155	0.380	0.60	0.85	1.30	2.10	
52	19	29.5	0.250	1.120	0.030	0.078	0.122	0.300	0.49	0.70	1.10	1.75	
52	20	29.5	0.250	1.195	0.030	0.078	0.122	0.300	0.49	0.70	1.10	1.70	
52	58A	28.5	7-29	0.195									
52	74	29.5	#10	0.615	0.080	0.180	0.290	0.635	1.00	1.40	2.15	3.35	
52	5	28.5	#16	0.332	0.200	0.440	0.650	1.370	2.00	2.65	3.85	5.60	
53	21 ¹	29.0	#16N	0.332	1.300	2.650	3.800	7.800	11.60	14.00	20.00	34.00	
53	5	29.5	#20	0.184	0.240	0.560	0.860	1.950	3.00	4.10	6.20	9.50	
53	55	28.5	#20	0.206	0.240	0.560	0.860	1.950	3.00	4.10	6.20	9.50	
53	58	28.5	#20	0.195	0.240	0.560	0.869	1.950	3.00	4.10	6.20	9.50	
58	54A	26.5	7-0152	0.250									
71	34	21.5	7-21	0.625	0.115	0.270	0.410	0.940	1.40	1.90	2.85	4.35	
72	****	21.5	#9	0.870	0.020	0.058	0.100	0.275	0.46	0.70	1.15	2.00	
73	59	21	#22CW	0.343	0.260	0.590	0.880	1.900	2.80	3.75	5.60	8.30	
74	13	20.5	7-28T	0.420	0.115	0.270	0.410	0.940	1.40	1.90	2.85	4.35	
75	11	20.5	7-26T	0.405	0.115	0.270	0.410	0.940	1.40	1.90	2.85	4.35	
75	12	20.5	7-26T	0.475	0.115	0.270	0.410	0.940	1.40	1.90	2.85	4.35	
76	6	20	#21CW	0.332	0.200	0.440	0.650	1.370	2.00	2.65	3.85	5.60	
76	15	20	#21CW	0.545	0.080	0.200	0.310	0.730	1.10	1.50	2.40	3.65	
93	62	13.5	#22CW	0.242	0.280	0.570	0.810	1.600	2.30	3.05	4.40	6.30	
93	71	13.5	#22CW	0.250	0.280	0.570	0.810	1.600	2.30	3.05	4.50	6.30	
95	22	16.0	***	0.405	0.220	0.500	0.750	1.700	2.50	3.40	5.20	8.30	
95	57	17	**	0.645	0.180	0.410*	0.620	1.400	2.13	2.90	4.60	7.30	

All cables have velocity factor of 65.9% except RG-21/U. Notes: 1—Special attenuating cable. Velocity factor 65%. CW—Copperweld. ****—Amphenol number 21-125. N—Nichrome conductor. T—Tinned copper. ***—Twin conductors; each seven strands of .0152-inch copper. **—Twin conductor; each seven strands of No. 21.

TABLE II RIBBON-TYPE TRANSMISSION LINES

Imp. (Ohms)	Amphenol Number	V.P. %	Max. Width	Loss in Decibels Per 100 Feet								
				Megacycles								
				3.5	7.0	14.0	28.0	50.0	100	144	200	400
75 ¹	14-080	68	9/64	0.37	0.64	1.10	1.90	3.00		6.8		
75 ²	14-023	71	5/16	0.29	0.49	0.82	1.40	2.10		4.8		
150 ¹	14-079	77	3/16	0.20	0.35	0.60	1.00	1.60		3.5		
150	14-279			0.24	0.35	0.52	0.76	1.05	1.55	1.90	2.59	3.38
300 ¹	14-056	82	13/32	0.19	0.28	0.43	0.61	0.85	1.25	1.52	1.82	2.70
300 ³	14-076	84		0.155	0.23	0.34	0.50	0.69	1.00	1.24	1.48	2.18
300 ⁴	14-271	84		0.19	0.28	0.43	0.61	0.85	1.25	1.52	1.82	2.70

Notes: 1—7-28 copper conductors. 2—7-21 copper conductors. 3—7-26 copper conductors, tubular transmitting cable. 4—7-28 copper conductors, tubular transmitting cable.

Television in Every Room

Parts from the junk collection put together to make a pair of remote television viewing units

By Martin Clifford*

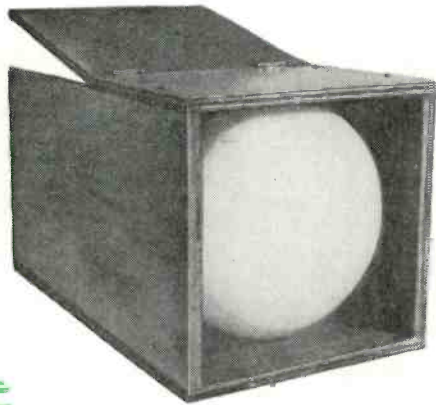

The 9LP7 in a plywood housing.

RADIOMEN are junkmen. Every radioman worthy of the name has cached away boxes full of radio parts—some new, some old, but none of which are going to be thrown out, not if he has anything to say about it. Those parts are valuable! But, when we received an ultimatum from the “better half” that closets are meant for storing clothes, not as a repository for useless broken-down radio parts, something drastic had to be done. The parts took up the larger part of only three closets, but women are so unpredictable. We had to do something to justify their existence—something big and important to impress a certain unappreciative person with just what could be done with “junk” . . . something like television in every room, operated by a master control.

That was it! Master-slave television (it even *sounded* good) with the master unit in the livingroom bookcase and remotely controlled 12-inch sets all over the house.

Of course there was a hitch, right at the beginning, as there is in all ambitious projects. To have master-slave television you have to have a master unit, a complete television receiver in good working order. To avoid wholly unnecessary arguments, we decided not to touch the existing TV receiver, but to buy an economical TV set that would be light in weight, small in size, yet capable of supplying a strong composite video signal. The Pilot 3-inch a.c.-d.c.

Candid TV fitted this description admirably. The video signal was in excess of 35 volts peak-to-peak, enough to swing a projection tube. The front end was continuous tuning, with a switching arrangement to avoid the FM bands.

The first raid on our precious collection of miscellaneous parts, maligned by the name “junk,” yielded a derelict Ansley, minus the front end and completely innocent of picture or sound stages. There was a yoke, but no focus coil.

Let’s inventory just what we did have. There was a low-voltage supply (Fig. 1) mounted on its own chassis. Also, as we see in Fig. 2, a separate chassis holding the vertical oscillator and output stage, horizontal oscillator and horizontal output, and, thank goodness, the high-voltage supply in working order. And now the big problem—how to tie all this stuff together and make it work to produce pictures.

The first obvious solution was to connect the low-voltage supply to the rest of the slave unit. Since these units were on separate chassis, they could easily be connected by cables using octal male and female plugs. To be able to add more circuits if desired, a small chassis (that junk box again) of the type shown in Fig. 3 was used. Octal sockets were mounted on all four sides, and all socket pins of the same number tied together (pin No. 1 of socket No. 1 to pin No. 1 of socket No. 2 to pin No. 1 of socket No. 3, etc.). This was repeated with all the pins, ad nauseam. It looked like a crow’s nest, but came in mighty handy. A high-impedance focus coil

was shunted across the power supply through a 5,000-ohm wire-wound pot (Fig. 1).

We decided to proceed with caution. The entire slave unit (still not connected to the master) was turned on and some random voltage checks taken. These were far, far from manufacturer’s recommendations. The meter

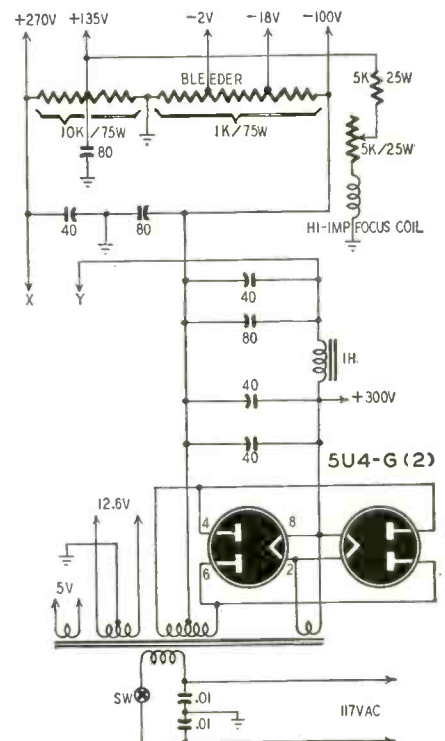

Fig. 1—Low-voltage plate power supply.

*Instructor, Pierce School of Radio & Television, New York, N. Y.

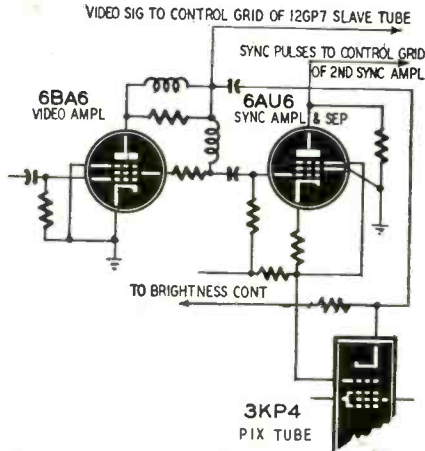

Fig. 4—A portion of the Pilot receiver.

Reversing the crystal gave us correct picture phase, but wrong pulse polarity again. Back went the sync take-off to the plate of the 6AU6.

Now the slave unit worked well, but not quite well enough. The picture would run vertically, and sometimes slip horizontally, especially on weak signals. This time that junk box was attacked with vim and vigor. Out came a chassis, miscellaneous resistors and capacitors, a few tubes. An additional sync amplifier and clipper had been born. (See Fig. 5.) Now the slave worked as it should. We had master-slave TV with only one drawback. The plug and cable department had become somewhat complex, as a look at Fig. 3 will prove!

A second remote unit

But that was just *one* slave unit. As long as luck and the junk box held out, more slaves could be built. Packed at the top of the closet was a 12-inch electrostatic radar tube. Maybe something could be done with that and a little auxiliary equipment.

The second slave called for only a

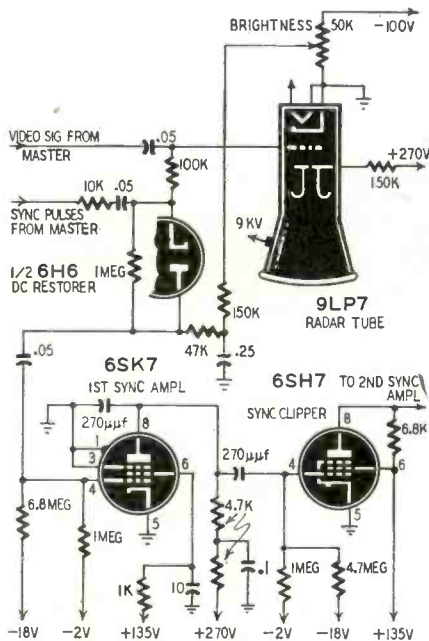

Fig. 5—The sync amplifier and clipper.

modest expenditure of cash for r.f. power supply. All the rest of the unit was made of parts that had never expected to see the bottom of a chassis again.

circuit, few changes being necessary. The electrostatic slave, the final circuit for which is in Fig. 6, proved once again, and very definitely, that there is a vast difference between reading tele-

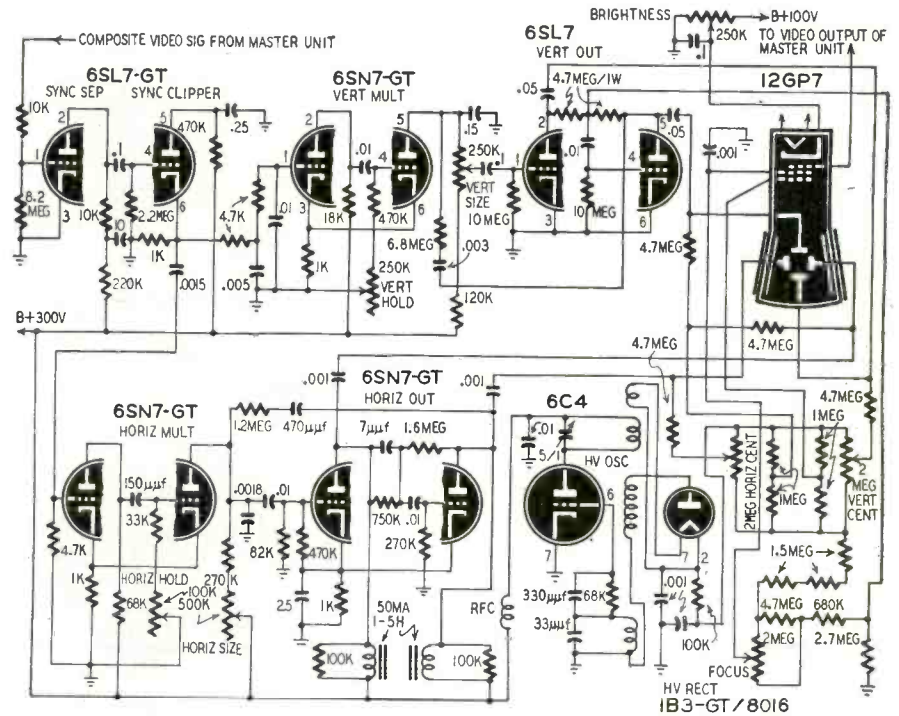
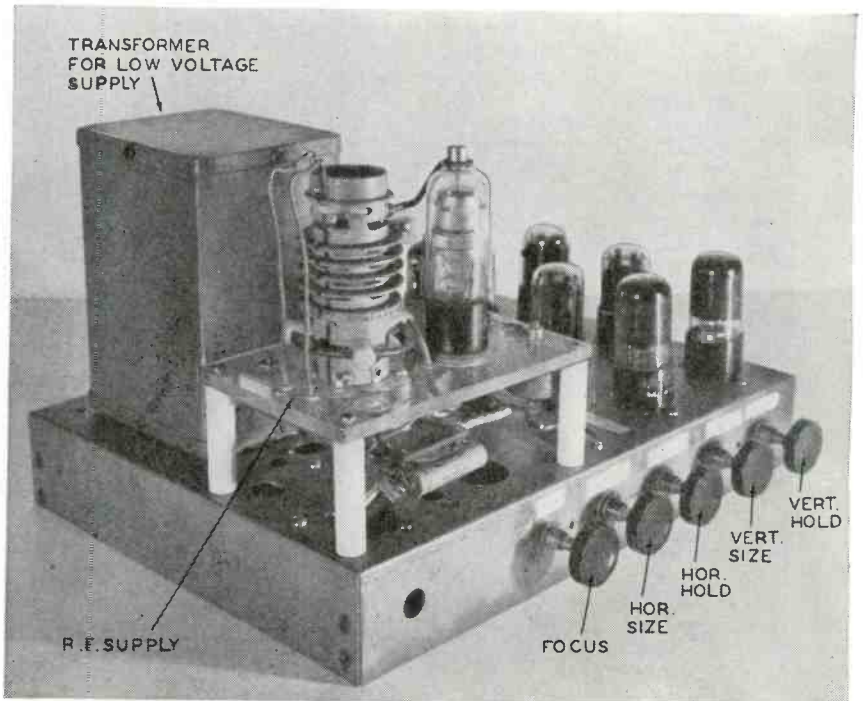

Fig. 6—Final circuit of the slave using the electrostatic 12GP7 cathode-ray tube.

Some experimenting was done on an original circuit, which began to approach that of one of the Belmont models so closely that finally the pencil drawings were thrown away and the original features drawn in on the schematic diagram of a standard Belmont

vision theory and applying it. Not that the electrostatic slave didn't work. It did. Surprisingly, that's what the trouble was. The first pattern received produced the famous "venetian-blind" effect, typical indication of lack of horizontal sync. Varying the horizontal hold



This chassis contains the circuits for the electrostatic slave diagrammed above. The r.f. power supply is built on a small plastic chassis for good insulation.

control gave us the first sight of a test pattern—running vertically. Adjusting the vertical hold control cured that. All that remained was to adjust the focus control to get a nice, clear, sharp, and—here was the gimmick—very, very small picture.

Small? That picture looked positively lost! There it was, modestly confining itself to the tiniest possible space when it had the entire area of a 12-inch screen to play around in. We could have substituted a 7-inch electrostatic tube, but the thought of the caustic comment it would arouse prevented taking the easy way out. The picture had to be made bigger, and not by a magnifying lens either.

The problem was precise, and so were the answers. To get a bigger picture, the sawtooth voltage from the balanced deflection amplifiers had to be made bigger, lots bigger, without sacrificing linearity. That was just the first step. Next on the agenda was reducing the high voltage on the C-R tube from about 8 to 6 kv. This meant loss of brilliance, but it also meant a beam that wasn't so stiff and could be moved across and up and down with greater ease.

The vertical deflection amplifier was tackled first. The best we could hope for was to *approach* the amplification factor of the tube we used originally, a 6SN7 with a μ of 20. This called for increasingly larger values of plate load resistor. The quarter-megohm units originally used in the plate circuits of the 6SN7 vertical amplifier were removed and replaced with 1-megohm resistors. This was fine, except for one thing. The plate voltage on the tube had almost disappeared. A (v.t.) voltmeter check showed practically the entire supply voltage across the plate load. More voltage was needed. Fortunately the high-voltage bleeder was available, giving us up to 6 kv if we wanted it. We stopped at approximately 1,200 volts up the bleeder. The picture was still not quite big enough. The plate load resistors were increased until we hit almost 5 megohms. Still the picture wasn't big enough, not even with 1,200 volts supply and 5-megohm plate load. A quick check with the tube manual showed that a 6SL7 had an amplification factor of 70 compared to 20 for the 6SN7. Only a few minor circuit changes were needed to accommodate the 6SL7, and the pix on the screen became large as life—but not as natural. The aspect ratio favored the vertical side far too much.

Now all we had to do (so we thought!) was to make the same changes in the horizontal deflection amplifier, and then everything would be wonderful. It just didn't work out that way. The picture expanded horizontally all right, horizontally and horribly. The horizontal sawtooth was being amplified, and greatly distorted in the process. New tactics were called for. The final solution for large horizontal sawtooth voltage on the plates of the 6SN7 balanced load resistors with small receiver-type

chokes. The low d.c. resistance of the chokes put almost the full supply voltage on the plates of the 6SN7 balanced horizontal deflection amplifier. We had our cake and could eat it too. At the horizontal frequency of 15,750 c.p.s., the plates of the 6SN7 thought they were looking into a very respectably sized impedance—the choke coils, whose inductance probably approached 5 henries. The d.c. drop across the choke-resistor plate load was small, but the sawtooth voltage developed across it was large.

Next step—to devise cathode-follower coupling units and separate the slaves from the master. (We also thought of widely spaced open-wire lines at high impedance.) But that step was never taken though we may do it yet.

Of course, with the master and *two* slaves working, the total number of connecting wires, cables, metal braid,

did make things seem a bit sloppy. But to have built two slaves (and successfully, too) and then to be told, "It still looks like a pile of junk to me. Just keep that mess out of the livingroom." And after all that hard work, physical and mental! Women are so unpredictable!

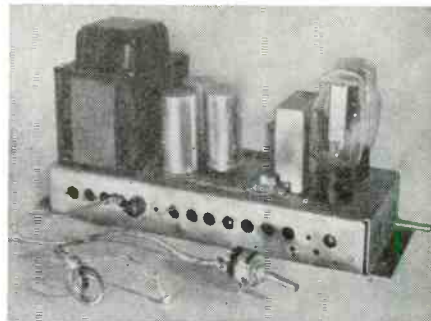

This is the power supply which furnishes low plate voltages for the tubes.

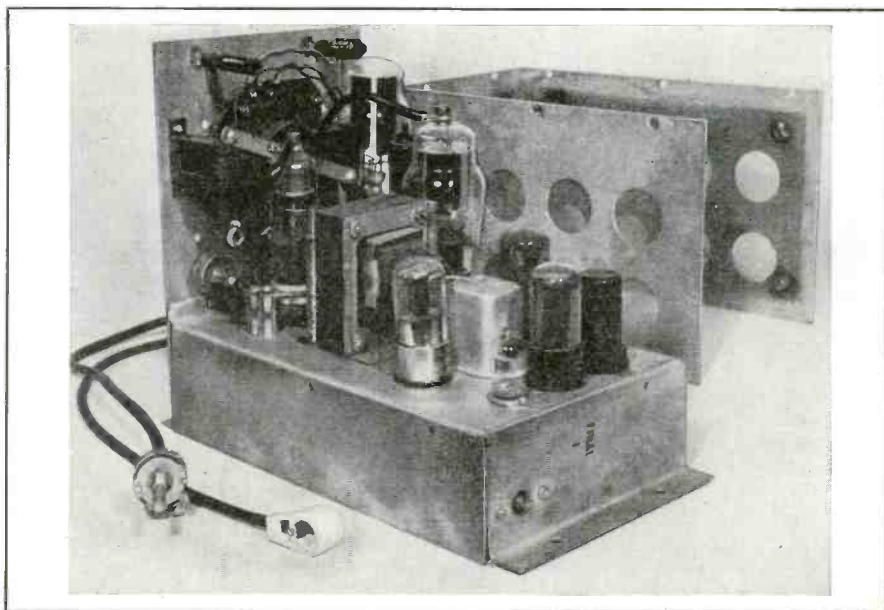

The derelict Ansley unit was modified as described in text for the 9-inch slave.

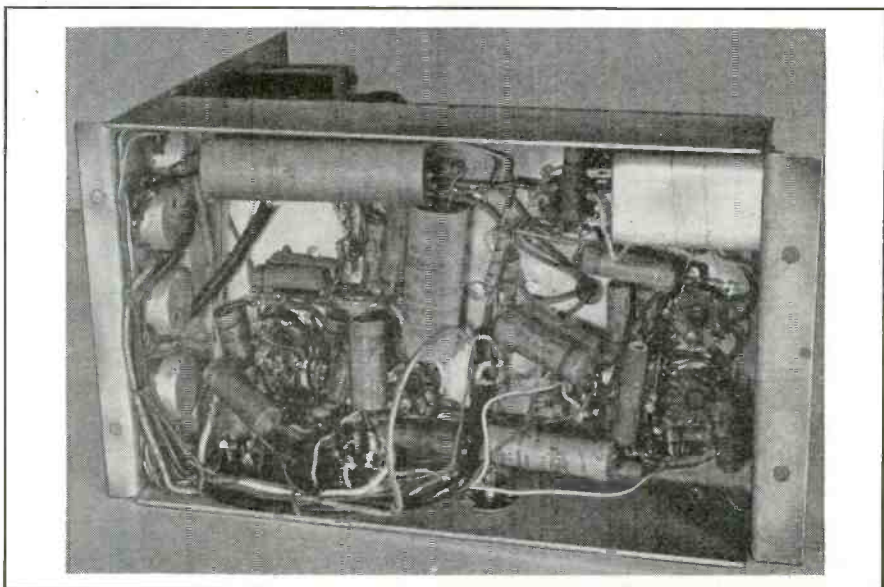

This view of the Ansley chassis after surgery is unimpressive—but it works!

Illustrated TV Station List

**Complete roster of operating stations.
The identification-pattern photographs
should be especially helpful to dx-ers**



Note 1



Note 2

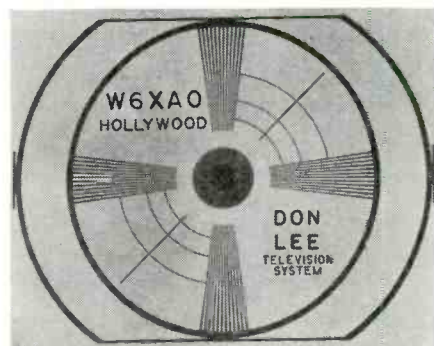

Note 3



Note 2



List corrected to November 15, 1949



Note 2

ARIZONA		
*Phoenix	KPHO-TV	
CALIFORNIA		
Los Angeles	KFI-TV	9
Los Angeles	KLAC-TV	13
Los Angeles	KNBH	4
Los Angeles	KTLA	5
Los Angeles	KTSL	2
Los Angeles	KTTV	11
Los Angeles	KECA-TV	7
San Diego	KFMB-TV	8
San Francisco	KGO-TV	7
San Francisco	KPIX	5

* Stations not yet operating at time list was compiled.



RADIO-ELECTRONICS for

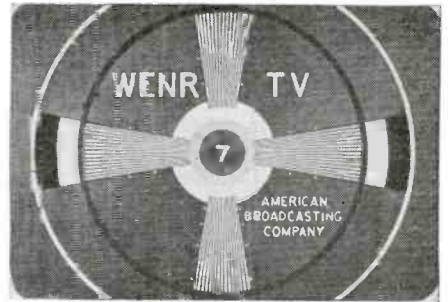
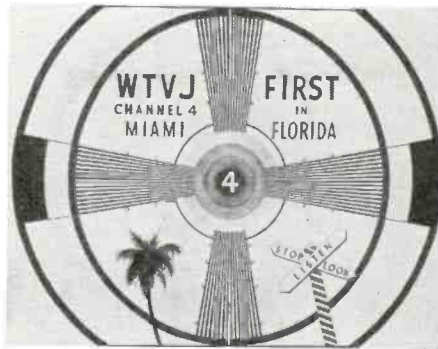
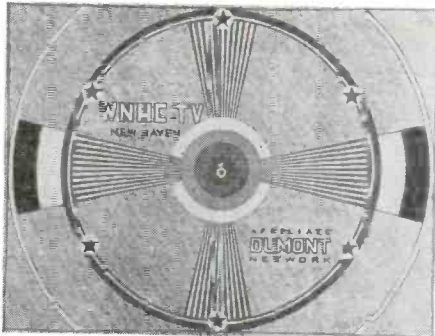

Note 5

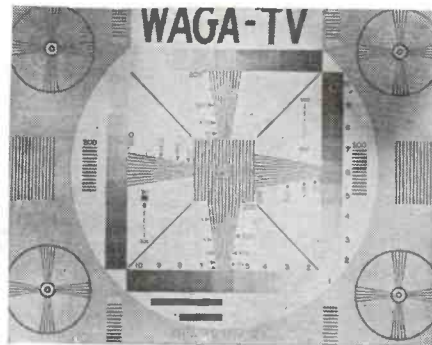
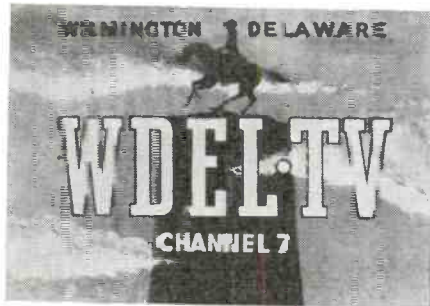

Note 4

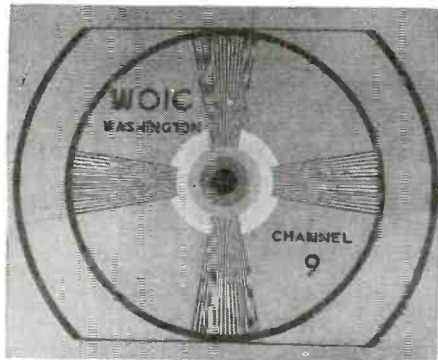
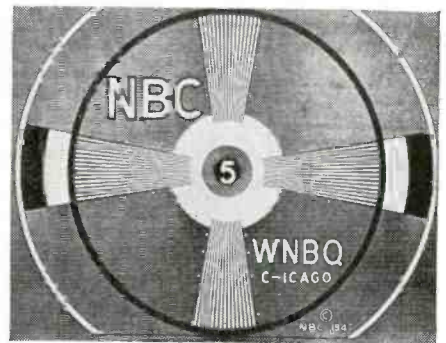
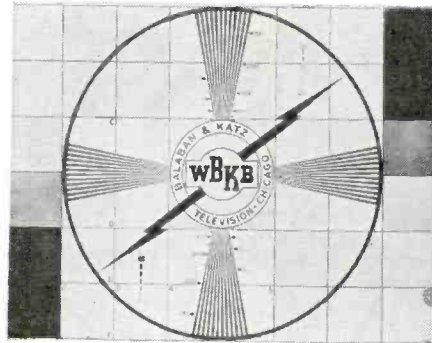

- San Francisco **KRON-TV** 4
- CONNECTICUT**
- New Haven **WNHC-TV** 6
- DELAWARE**
- Wilmington **WDEL-TV** 7
- DISTRICT OF COLUMBIA**
- Washington **WMAL-TV** 7
- Washington **WNBW** 4
- Washington **WOIC** 9
- Washington **WTTG** 5



- FLORIDA**
- Jacksonville **WMBR-TV** 4
- Miami **WTVJ** 4
- GEORGIA**
- Atlanta **WAGA-TV** 5
- Atlanta **WSB-TV** 8
- ILLINOIS**
- Chicago **WBKB** 4
- Chicago **WENR-TV** 7
- Chicago **WGN-TV** 9
- Chicago **WNBQ** 5

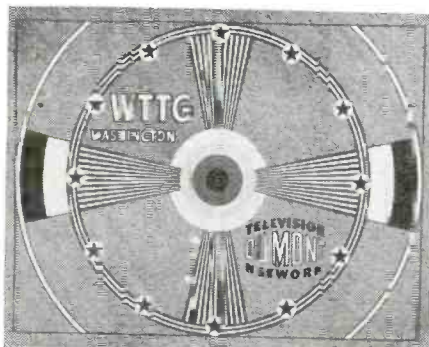

- INDIANA**
- *Bloomington **WTTV** 10
- Indianapolis **WFBM-TV** 6
- IOWA**
- Davenport **WOC-TV** 5
- KENTUCKY**
- Louisville **WAVE-TV** 5

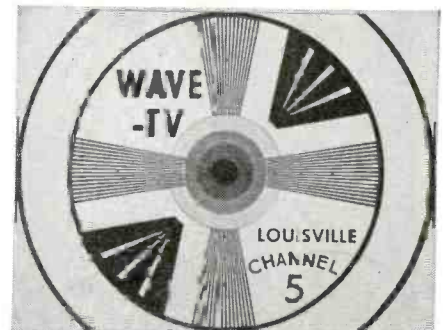

* Stations not yet operating at time list was compiled.

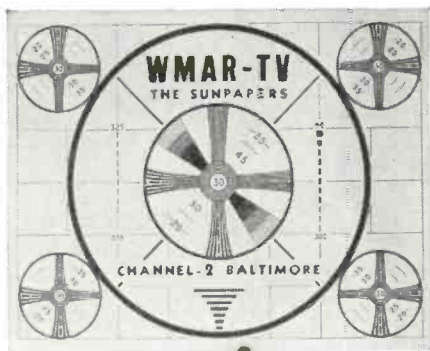
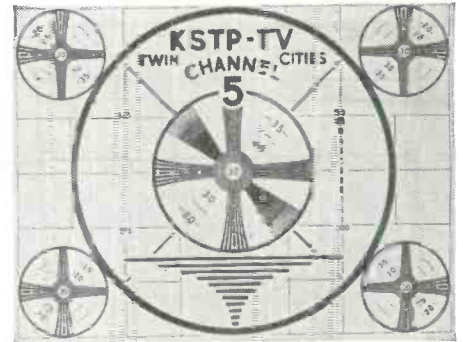
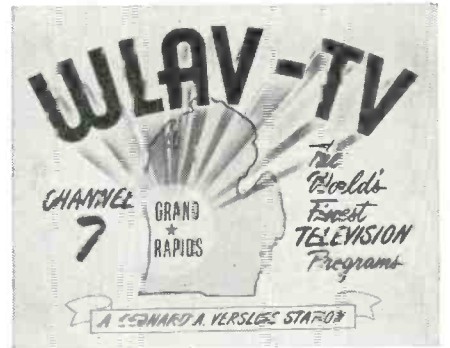
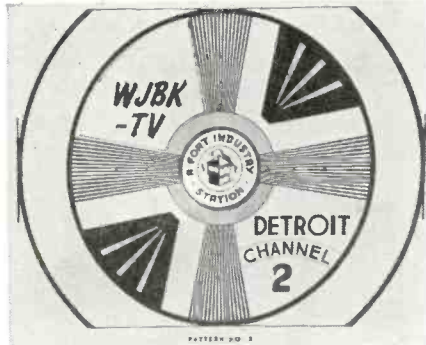

LOUISIANA
New Orleans WDSU-TV 6

MARYLAND
Baltimore WAAM 13
Baltimore WMAR-TV 2
Baltimore WBAL-TV 11

MASSACHUSETTS
Boston WBZ-TV 4
Boston WNAC-TV 7

MICHIGAN
Detroit WJBK-TV 2
Detroit WWJ-TV 4
Detroit WXYZ-TV 7
Grand Rapids WLAV-TV 7

MINNESOTA
Minneapolis KSTP-TV 5
Minneapolis WTCN-TV 4

MISSOURI
Kansas City WDAF-TV 4
St. Louis KSD-TV 5

NEBRASKA
Omaha WOW-TV 6
Omaha KMTV 3

NEW JERSEY
Newark WATV 13

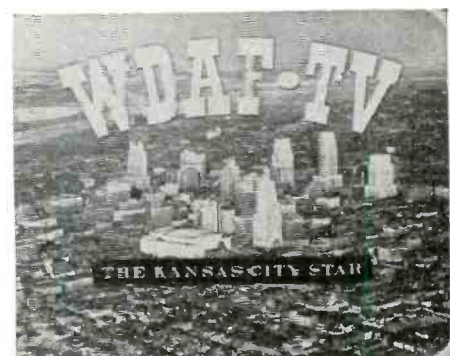
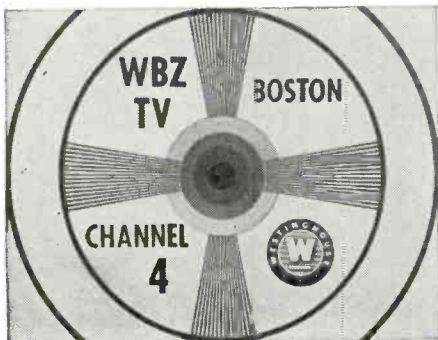

RADIO-ELECTRONICS for

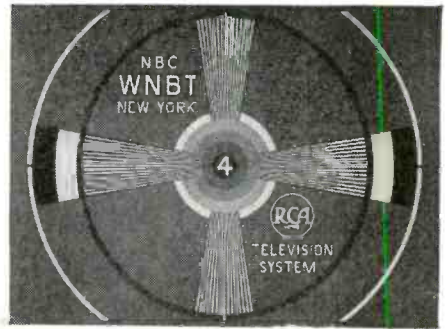
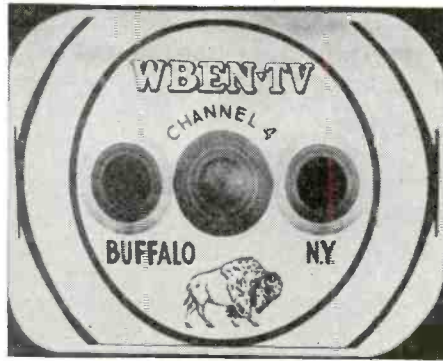

Reproduced by Permission of NBC, Inc.

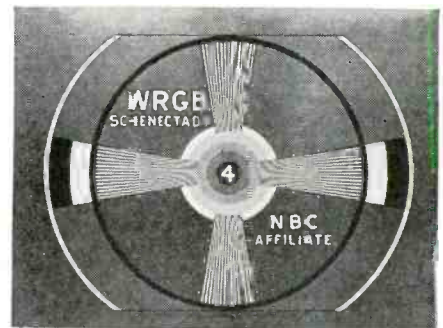
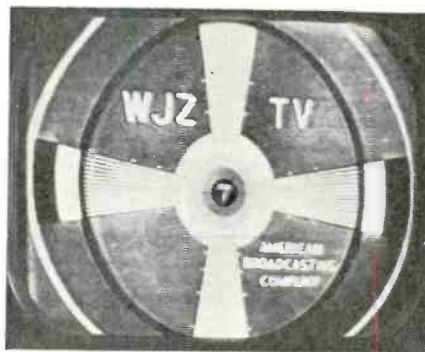
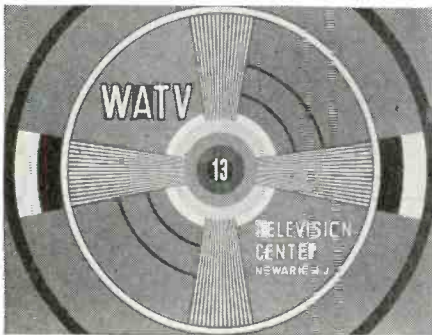
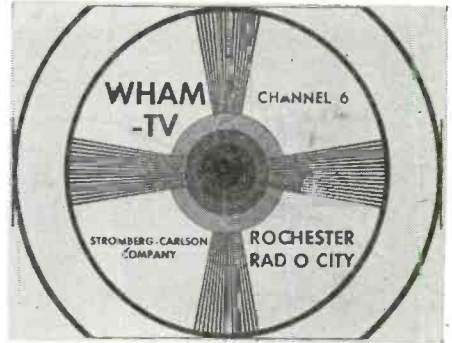
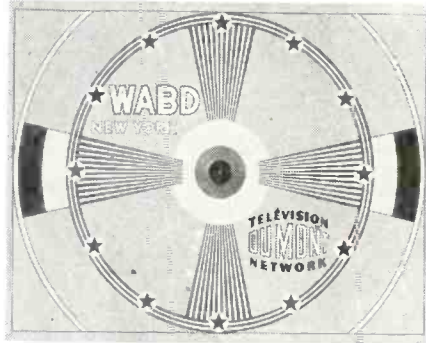
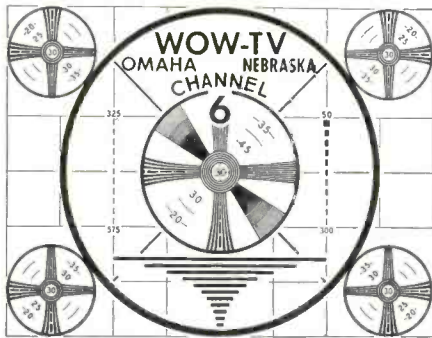
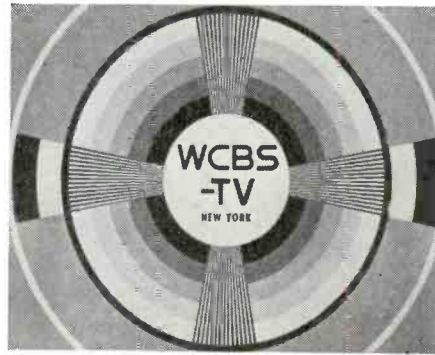
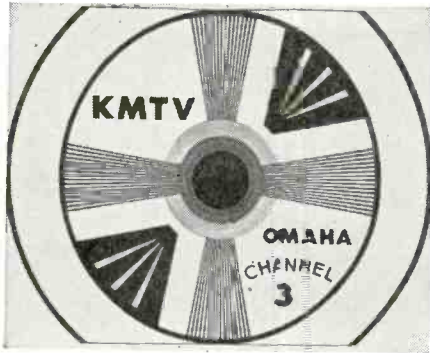

Note 7

NEW MEXICO		
Albuquerque	KOB-TV	4
NEW YORK		
*Binghamton	WNBF-TV	12
Buffalo	WBEN-TV	4
New York City	WABD	5
New York City	WCBS-TV	2
New York City	WJZ-TV	7
New York City	WNBT	4
New York City	WOR-TV	9
New York City	WPIX	11
Rochester	WHAM-TV	6
Schenectady	WRGB	4
Syracuse	WHEN	8

* Stations not yet operating at time list was compiled.





Note 8

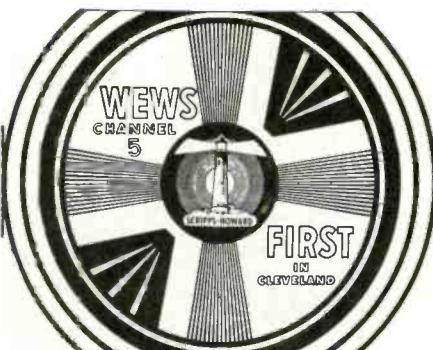
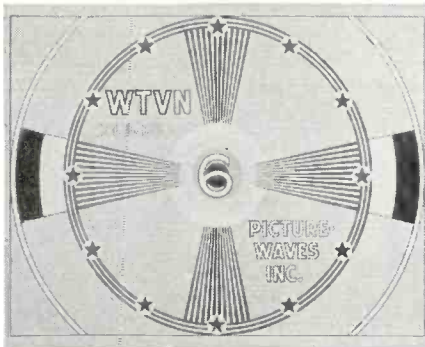
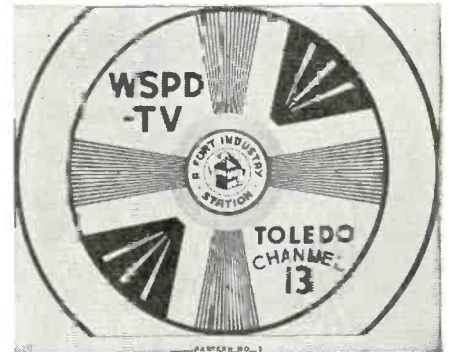
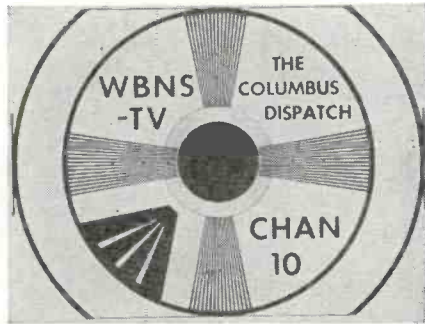
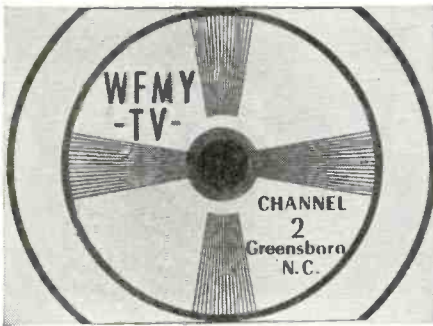

*Utica	WKTV	
NORTH CAROLINA		
Charlotte	WBTV	3
Greensboro	WFMY-TV	2
OHIO		
Cincinnati	WCPO-TV	7
Cincinnati	WKRC-TV	11
Cincinnati	WLW-T	4
Cleveland	WEWS	5
Cleveland	WNBK	4
Cleveland	WXEL	
Columbus	WBNS-TV	10
Columbus	WLW-C	3
Columbus	WTVN	6
Dayton	WHIO-TV	13
Dayton	WLW-D	5
Toledo	WSPD-TV	13

* Stations not yet operating at time list was compiled.

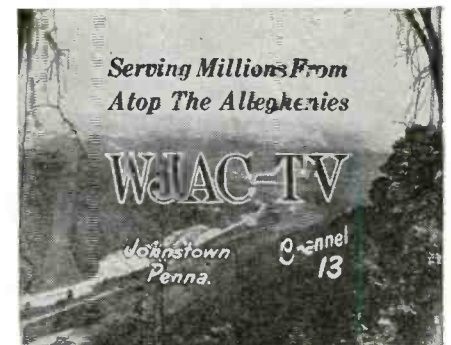

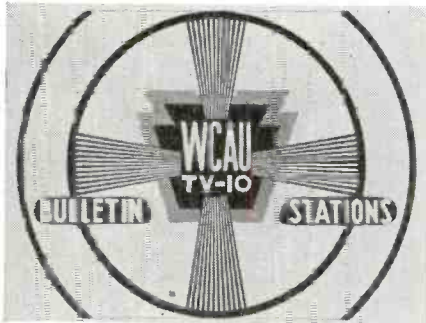
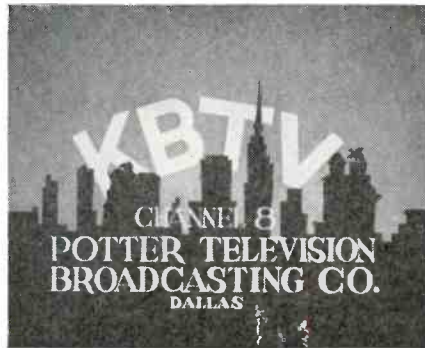

Note 9

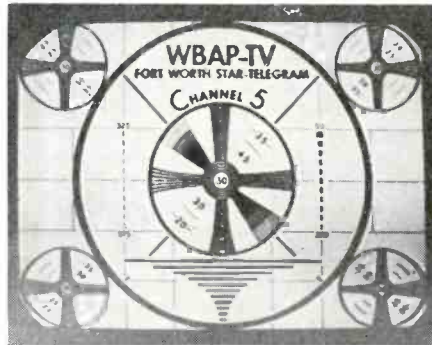

OKLAHOMA

Oklahoma City	WKY-TV	4
Tulsa	KOTV	6

PENNSYLVANIA

Erie	WICU	12
Johnstown	WJAC-TV	13
Lancaster	WGAL-TV	4
Philadelphia	WCAU-TV	10
Philadelphia	WFIL-TV	6
Philadelphia	WPTZ	3
Pittsburgh	WDTV	3

RHODE ISLAND

Providence	WJAR-TV	11
------------	---------	----

TENNESSEE

Memphis	WMCT	4
---------	------	---

TEXAS

Dallas	KBTW	8
*Dallas	KRLD-TV	4
Fort Worth	WBAP-TV	5
Houston	KLEE-TV	2
*San Antonio	WOAI-TV	4

UTAH

Salt Lake City	KDYL-TV	4
Salt Lake City	KSL-TV	5

VIRGINIA

Richmond	WTVR	6
----------	------	---

WASHINGTON

Seattle	KING-TV	5
---------	---------	---

WEST VIRGINIA

Huntington	WSAZ-TV	5
------------	---------	---

WISCONSIN

Milwaukee	WTMJ-TV	3
-----------	---------	---

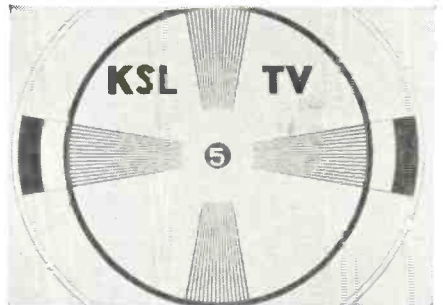

Note 10



Note 9



Note 11

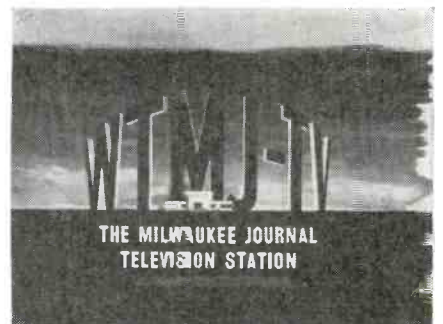
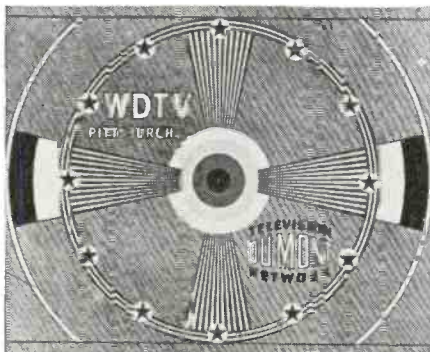

* Stations not yet operating at time list was compiled.

IDENTIFICATION NOTES

1. Birmingham, Ala.
2. Los Angeles, Calif.
3. Changed to KTSL, Hollywood, Calif.
4. Atlanta, Ga.
5. Chicago, Ill.
6. Albuquerque, N. M.
7. New York, N. Y.
8. Charlotte, N. C.
9. Philadelphia, Pa.
10. Salt Lake City, Utah
11. Richmond, Va.

Television Queries Answered

Waves on Co-ax

? *RADIO-ELECTRONICS* has published many suggestions for using stubs or tinfoil strips to tune or detune TV antenna leads. They're probably fine for 300-ohm lines. But what about those of us with 72-ohm co-axial lines? In my noisy location I have to use co-ax. How can I tune out standing waves on my line? Or shall I assume that co-ax doesn't have standing waves?—A. D., Miami Beach, Florida.

A. You're quite correct in your assumption that standing waves may exist to some extent on co-axial cable. Coupling methods would have to be quite perfect for every trace of standing waves to be eliminated. There is a simple aid for that particular type of installation. (See Fig. 1.) At the antenna binding

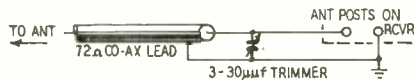

Fig. 1—"Matching stub" for co-ax lead.

post, connect between the inner conductor and outside braid a small 3-30- μ fd ceramic trimming capacitor. Leave it permanently attached to the antenna terminals if you tune only one station with trouble.

Tune in that station properly, then adjust the trimmer for brightest picture. This automatically indicates optimum impedance match with consequent minimum standing waves on line. The trimmer setting won't help the condition on other channels, so reserve it for the worst channel, or make a compromise adjustment.

Open Line or Co-ax

? *There's been so much advice to switch to co-axial lead-in to reduce noise that I tried it on my TV set. It is no better. If anything, the noise is worse. Why?*—F. C., Alameda, Cal.

A. There might be several things wrong. First, the impedance match must be correct. Co-ax is generally of less than 100 ohms impedance, while twin is usually in the order of 300 ohms. You will lose efficiency if you connect a 75-ohm line to a 300-ohm antenna. Likewise you will suffer when connecting a 75-ohm line to a 300-ohm receiver input. Provision must be made for a correct impedance match, both at the antenna and at the receiver.

Theoretically, this could be done at the antenna end by using a quarter-wave matching section (see *RADIO-ELECTRONICS*, April, 1949, page 50, for full details). Practically, this would be of little value if you are receiving several channels. Instead use an antenna

By DAVE GNESSIN

In the August, 1949, issue of *RADIO-ELECTRONICS* we ran a feature "Television Queries Answered," by Dave Gnessin, comprising representative queries on general TV subjects. The response from the readers shows sufficient demand for extension of that type of information, so we are presenting a second group of questions and answers.

Remember that these are not regular Question Box inquiries, which are covered in our regular department. The questions in this article are unique on two counts: they deal only with television; and they are of a general nature, of interest to many others than the reader submitting them.

whose impedance is correct for the lead-in (a straight instead of a folded dipole for 75-ohm line, for instance).

At the receiver end most sets have a connection for 300-ohm line, balanced to ground. This means that the antenna coil is tapped and grounded at the center. In that case, simply ground the outer shield of the co-ax, or, better still, disconnect one of the leads from the end of the coil and run it from the antenna post of the set to the grounded center of the coil instead of the end (as in Fig. 2-a). Half a 300-ohm coil will have an impedance of about 75 ohms. If the antenna coil has no ground tap, tap it about the middle and hook up a circuit as in Fig. 2-b. Secondly, the outside conductor of the co-ax must be

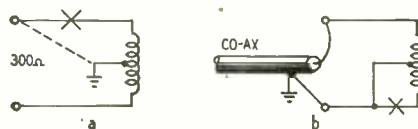

Fig. 2—Attaching co-ax to TV receiver.

positively grounded, at least to the chassis of the set; otherwise the outside braid becomes a regular conductor.

Try to discover whether the noise is being picked up by the lead-in, however. The most perfect co-ax in the world won't help you if the antenna itself is in the noise field. While a small TV set on the roof itself is the only perfect way of finding out, analyze the types of noise you are getting and apply a lot of common sense.

Finally, the inevitable attenuation of the signal due to inherent losses in the co-ax might cause such weak output as to make reception worse than originally available with Twin-Lead. Consequently co-ax should be used mostly in zones of comparatively strong signals. Obviously this method of impedance match-

ing cannot be used on receivers having a balanced, push-pull r.f. amplifier like that used in the RCA 630TS and similar sets.

Optical Distortion

? *My television set is a Philco 48-2500 (projection type). It's rather expensive, and I don't want to have it repaired unless absolutely necessary. My complaint is that there are dull shadows on the lower right and left corners of the screen. These shadows are present even when only a test pattern is sent. None of the front or rear panel controls seem to have an effect. Is there a remedy?*—N. T., Los Alamos, N. M.

A. Checking with the factory I find this classified as optical difficulty rather than electrical. The adjustments on the optical housing will have to be aligned. Be careful to avoid touching the mirror faces. This is a job for a qualified technician.

Wrong Aspect Ratio

? *I have a 630TS RCA receiver. The raster covers about one-third of the mask vertically. The aspect ratio is about 6 to 2. The width operates perfectly. What can I do to make the height and linearity control make the raster cover the mask vertically?*—M. G. F., Leesville, Louisiana.

A. It's quite obvious your trouble is in the vertical circuit, somewhere between 6J5 vertical oscillator discharge stage, through vertical output 6K6-GT to vertical deflection yoke. This includes only the two tubes mentioned, two transformers, one yoke, and miscellaneous capacitors and resistors (Fig. 5). Try the following:

Check the height and linearity controls (disconnected). They should be 2.5 megohms and 5,000 ohms, respectively, with smooth resistance transition throughout. Then check the two tubes.

This next step is most important, since I'll give you two to one that this is your trouble: Check the vertical output transformer (entirely disconnected) for leakage between windings, and to case. In each case the resistance should be infinite. If no cure has been found thus far, then each resistor and capacitor in the circuit described should be checked against the diagram for value and leakage. Finally (Heaven help you) the yoke should be checked. This is normal correct servicing procedure.

(Readers are invited to submit questions on TV addressed to Television Forum, *RADIO-ELECTRONICS*, 25 West Broadway, New York 7, N. Y. Those of general interest will be answered in future forum articles as space permits and interest demands.)

Choosing a TV Receiver

What to seek for and what to avoid in a televiser

By SOL D. PRENSKY*

THE ordinary citizen who decides that the time has come to buy a television receiver finds plenty of types from which to choose—his big problem is trying to make up his mind as to just which model of which brand is ideal for him. The usual set buyer is not willing to plunge into the technical mysteries of TV; he has neither the time nor the background, to say nothing of the inclination. To make matters even more confusing, he is beset by a clatter of exaggerated advertising blurbs shouting about this “miraculous” feature or that “magical wonder” of a particular receiver. And he is often led in wrong—and conflicting—directions by outright misstatements made by ignorant or dishonest salesmen.

There is only one really good way to decide which receiver you want, and that is to observe and try out a number of them, preferably right in your own locality. But to make a really sound decision one must know what to look for; and that is what we shall point out in this article. In addition, we'll try to clear up a few of the misconceptions that have been repeated so often they are beginning to sound plausible.

Picture size, picture quality, accuracy of tuning, reserve sensitivity, your chances for good installation and service—all these are important points to keep in mind when looking around for a good television receiver.

Picture size

One of the major selling points of receivers, and rightly so, is the size of the picture, because large pictures can be more comfortably viewed than small ones. There has been much confusion, however, over this apparently simple point because manufacturers have tended lately to measure picture size in square inches and to give different square-inch figures for sets with the same size viewing tube.

Even when the simpler figure of tube diameter is used for size, there are still as many as nine different sizes of picture tubes in commercial use at present, having diameters of 7, 8, 10, 12, 12½, 15, 16, 19, and 20 inches.

To arrive at a sensible basis for comparing picture size, another point

* Co-author, with Ricardo Muniz, of forthcoming book “Electronic Test Equipment for AM, FM and TV Circuits” (Van Nostrand).

should be kept in mind: the face of the viewing tube is circular, while the transmitted TV picture is rectangular—like a standard motion picture. This means that, if a square-corner rectangular mask is used, as Fig. 1-a shows, a good deal of the tube-face area is wasted. Note, however, that the entire transmitted picture is seen.

A larger picture may be shown on the same tube if the electronic circuits are adjusted to enlarge the image. Note in Fig. 1-b that the tube size is the same as in Fig. 1-a, but that there is less wasted space. The picture has been blown up, and the mask in front of the tube has rounded corners. The picture may be blown up more if desired (and if the receiver circuits permit it), until the entire tube face is covered with picture, leaving no wasted area. The picture in Fig. 1-c appears circular.

But, whenever the picture is blown up to fill more of the screen area than is the case in Fig. 1-a, parts of the picture are lost. Many receivers are made with round-corner masks like that in Fig. 1-b, and, therefore, only unimportant corners are lost. Circular-screen receivers give a bigger picture with any size of tube, but Fig. 1-c shows you how much of the picture you can't see.

This explains why two receivers may have, say, a 10-inch tube, but one may have a “52-square-inch” picture and the other a “60-square-inch” screen. Sixty sounds like a bigger figure—but you pay the price of missing some of the televised action. You are getting no bargain when you buy a “wide-screen” receiver or one with a “big circular screen.”

When comparing picture sizes, it is helpful to think of the various tube diameters as falling into five main groups, the 7-inch group (the smallest practical and including 7 and 8-inch tubes); the 10-inch group; the 12-inch group (including 12 and 12½-inch tubes); the 15-inch group (including 15-inch and 16-inch tubes); and the largest direct-view, the 19-inch group (including 19 and 20-inch tubes).

Whether you would rather have a large picture and miss some of the scene, or a smaller picture but see it all, is, of course, up to you. Obviously, if cost doesn't matter much, simply choose a set with the largest size pic-

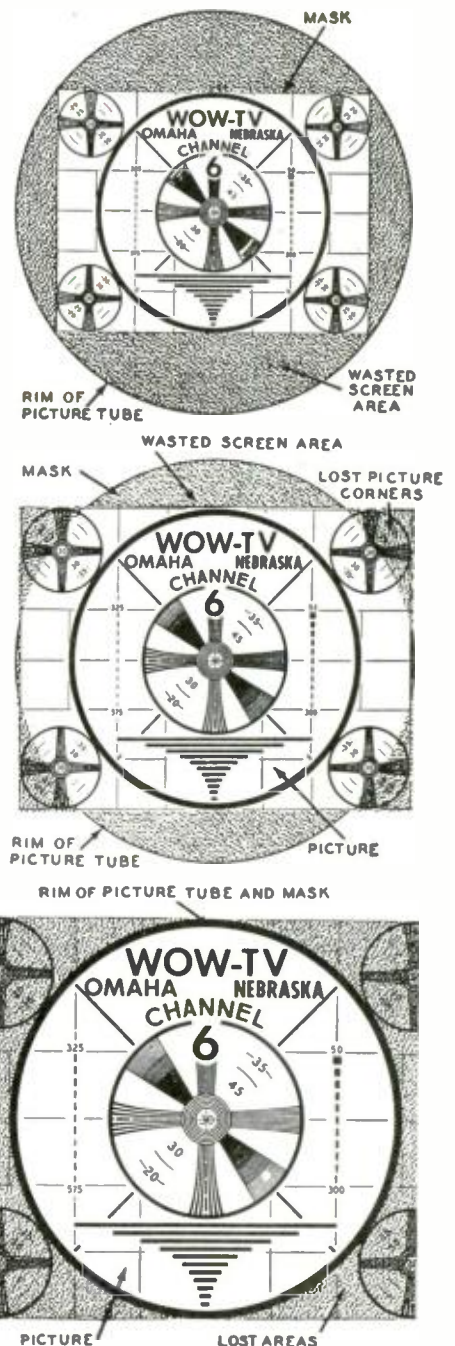

Fig. 1—Rectangular mask (a) shows entire pictures; rounded corners increase image size (b). Circular mask (c) gives large image but blanks much of border.

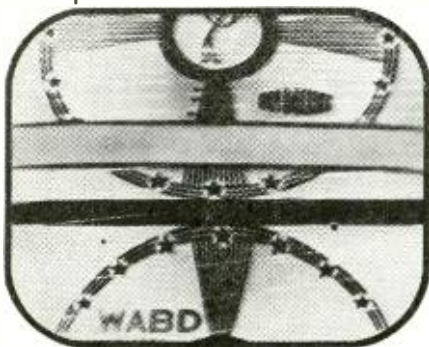

Fig. 2—Improper setting of vertical hold control or poor vertical stability.

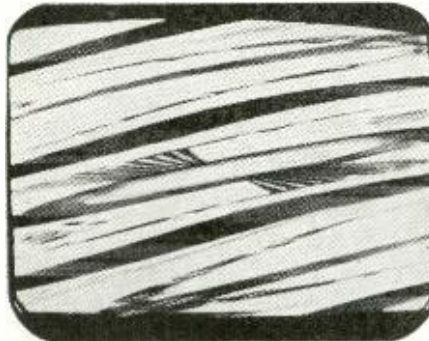

Fig. 3—Poor horizontal stability causes picture to shift to right or left.

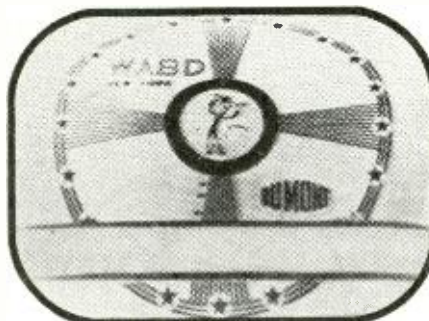

Fig. 4—Poor linearity causes distortion of circle and unequal wedge length.

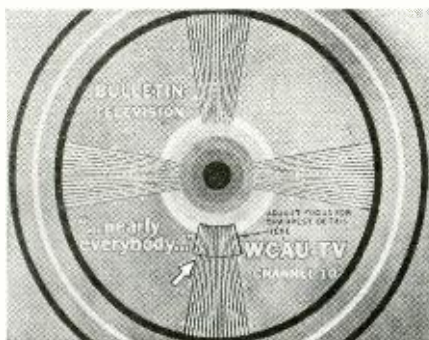

Fig. 5—Check receiver resolution by length of individual lines in wedge.

ture and see both a large picture and all of it. In any case, however, keep your eye on the actual tube diameter as the price-determining factor in picture size.

Picture quality

Three factors are foremost in judging how pleasing the picture is. First of all, the image should stand still—it should not “jitter” or move from side to side or up and down. Second, it should not be distorted—a straight line

should look straight and a circle should look circular rather than oval. And third, you should be able to see almost as much detail as in a 16-mm movie.

Steadiness will come only when the controls are adjusted correctly. If the VERTICAL HOLD and HORIZONTAL HOLD controls are on the front panel, adjust them until the picture does not move after first adjusting the FINE TUNING control, if any, for the loudest and clearest sound. Let the set operate for a while; then switch to another channel. Immediately switch back to the original channel and readjust the FINE TUNING control if necessary. The picture should be steady again—if it moved when you switched, retuning should have made it jump back into its proper position and stay there. On a good receiver, the HOLD controls should not have to be adjusted oftener than once per sitting—sometimes not more than once every week or so, if that often.

Fig. 2 shows a test pattern on a set with an incorrectly adjusted VERTICAL HOLD. The image moves upward or downward or may stand still in the position shown. Fig. 3 shows a receiver that needs HORIZONTAL HOLD adjustment. If these controls are set and the picture doesn't stay put for long periods of time, the receiver probably isn't acceptable.

Picture distortion is best judged when a test pattern is on. Fig. 4 shows one that is badly distorted. The circle looks like an egg and the vertical wedges, which should have the same height, are quite different. All receivers have rear-chassis adjustments that should be able to clear up distortion, but don't buy a set until you see it or an identical one properly adjusted so there is no distortion. Don't mind too much, however, if some of the station test patterns have circles that are slightly egg-shaped. If the receiver is adjusted for a perfect circle on one station, others may not look perfect because of slight differences in station equipment. An out-of-true circle is the easiest thing to detect; where the circle is only slightly out-of-round, chances are the deviation will not noticeably affect the quality of an ordinary program.

To check detail clarity (also called *resolution*), tune in a station and adjust the FOCUS control (if on the front panel) for best sharpness near the center of the screen. If there is a test pattern on, look at the black and white lines that make up the vertical wedges. You should be able to see the lines distinctly as they come closer together, down to within a small fraction of an inch of the end of each wedge. The critical area is outlined in Fig. 5. Notice also the corresponding areas on the horizontal wedges.

If you are watching a program, notice small familiar objects and the eyes of the characters to get an idea of the picture's clarity. Compare the clarity of details on various sets and don't be satisfied with anything but the best.

Many people say that one set is more “powerful” than another—meaning that it pulls in weak stations better.

The correct term for this “pulling power” is *sensitivity*. Sets do vary in sensitivity, and you must select one that will fit your needs.

The signals broadcast from a television transmitter may arrive at your location either strong or weak. Just as the light from a lamp gets weaker as you go farther away from it; so does the signal from the station, so you may therefore need a sensitive receiver. Like light, the waves can be blocked by intervening buildings and hills. If you are behind such a barrier, you will consequently get a weak signal. If, on the other hand, your receiving antenna is close to the transmitter (within, say, 5 miles or so) and there are no obstructions between it and the transmitting antenna, you won't have to worry much about sensitivity.

The antenna or aerial is very important. A sensitive set with a poor antenna will usually not pick up weak signals as well as an average receiver with a good antenna. *Indoor antennas in general are poor antennas.* They may suffice in very good locations, but they are never as effective as even a simple outdoor antenna. Don't let anyone sell you a receiver if you can't put up an outdoor antenna—unless you know there are other sets in your location that work well with indoor aerials. In any case, try to choose a sensitive receiver for use with an indoor antenna.

It's very hard to judge receiver sensitivity because results depend so much on your location and the kind of antenna used. If, however, your neighbor gets good reception—a clear picture without little dancing white spots (“snow”) all over it—probably the same kind of receiver and antenna will give you good results too.

Installation and service

Some television receivers nowadays are said to need no installation—you just plug them in and turn them on. In a very good location it may be possible to do just that, but don't count on it. Such sets have built-in antennas. A built-in antenna may not work as well as the indoor type because it can't be positioned for best results without moving the receiver itself. Don't forget that in any but excellent locations, you may need an outdoor antenna with any set. If your landlord will not permit an antenna on the roof, you must, of course, be satisfied with one of the indoor models. But if you can have an outdoor aerial, by all means use one!

When you buy a set, you are usually offered a contract for installation and a year's service. On the whole, these contracts are a good idea and may save a lot of money if you have frequent trouble. More and more independent service technicians are qualifying themselves for TV work, and you may well elect to “pay when served”—have an independent shop make your installation and do your repairs, paying each time for the work done. However, it is probably more economical to buy a service contract with your set, for you

Electronic Magnification for Existing Receivers

By WILBUR J. HANTZ

will probably pay less over the first year than if you depended on independent technicians.

Not all service contractors do perfect installation jobs. Most contracts allow you to call for service whenever something is wrong, but ordinarily *no more than one antenna installation is allowed* without extra charges. For that reason, be on hand when the installation men come; when they are finished, request them to demonstrate the set. Make sure you are satisfied with the reception and *don't take any excuses if the picture is poor on any channel*. If the installers will not remedy poor reception, refuse to sign any set receipt or work certificate. Call or write the contractor *immediately*. If you are told a certain station simply cannot be received well in your locality, check at once with several set-owning neighbors; if any of them can receive it, the statement is false. Insist on your right to a good installation job!

'Tain't so!

There are some points on which so many people are misinformed that fiction seems more plausible than truth. Here are some typical ones.

Can large-screen sets give the same picture detail as small-screen receivers? Yes. If the receiver's circuits are correctly designed, a big screen will produce just as fine a picture as a small one. You must sit farther away from it, however, to make the picture elements blend together and give you the effect of a continuous whole.

Do all TV receivers tune in FM broadcasts? No. Television sound is itself of an FM character, but so-called FM stations can be heard only if the TV receiver has additional elements for the purpose. Most do not. If you want to receive FM broadcasts, buy a set with an "FM band" on it.

Has there been any revolutionary new development in TV recently that should be part of any receiver I buy? No. Certain features like metal picture tubes, circular screens, built-in antennas, "daylight" screens, and so on, have certain advantages, either in cost reduction or in performance. None of them are "revolutionary." You can judge whether they add to performance, by comparing with sets that don't have them.

Will u.h.f. television obsolete my set? No. If u.h.f. bands are used in your locality, you will be able to get a converter; and if v.h.f. (Channels 2-13) is used in your area, it will remain in use.

Will color TV obsolete my set? No. Despite the present furor over color, experts predict it will take several years to establish it commercially.

Will an indoor antenna give me as good reception as a full-priced outdoor installation? Positively no, despite advertising claims to the contrary, unless you live very close to the transmitter and the receiver is placed in a particularly fortunate position in the room—and even then it may not give satisfactory results.

A NUMBER of technicians have asked if they can add "electronic magnification" to existing sets. Many recent commercial television receivers have made it an important feature in their advertising, and attachments have been marketed which are intended to "zoom" the picture up to more than double size.

In electronic magnification, the horizontal and vertical amplification is increased so that the transmitted image is larger than the tube. The whole screen is then covered with a circular picture. Corners are lost; but the part that does appear is much larger than before, and none of the screen area is wasted. A switch permits the viewer to select either the standard picture or the electronic "closeup."

Most standard receivers can be modified to include electronic magnification. Fig. 1 shows a typical horizontal sweep circuit (the one in the General Electric model 803). The deflection amplifier is a single 6BG6-G; it is coupled through a matching transformer to the deflection coils of the 10-inch cathode-ray tube. The 6AS7-G damps out the small oscillations caused by the return trace's shock-exciting the coils. The linearity control in the 6AS7-G grid circuit varies the shape of the sweep-voltage wave.

The width of the picture is adjusted by the variable-iron-core inductor L, which is normally set for less than the maximum possible horizontal sweep voltage so that the picture stays within the mask. If we place a s.p.s.t. switch across the inductor to short it out, maximum voltage will reach the deflection coils and the picture width will increase to fill the entire screen horizontally. (Some receivers may not have enough horizontal sweep output for this. A refinement on those that do would be to switch in a second width-control inductor, which could be adjusted to optimum for the expanded picture.—*Editor*)

Fig. 2 shows a typical vertical sweep. The 6SN7-GT is a multivibrator, the output of which (and therefore the sweep voltage) is varied by the height-control potentiometer, which varies the applied B-voltage. The voltage applied to the screen of the 6V6 vertical amplifier is varied as well.

If resistor R is shunted across the height-control potentiometer, the net resistance decreases; more B-voltage is applied to the circuit and the vertical sweep increases, covering the entire

height of the tube. (Again, if the maximum output of the particular receiver is sufficient.—*Editor*) The 51,000-ohm value worked with the G-E receiver, but experiment will determine the cor-

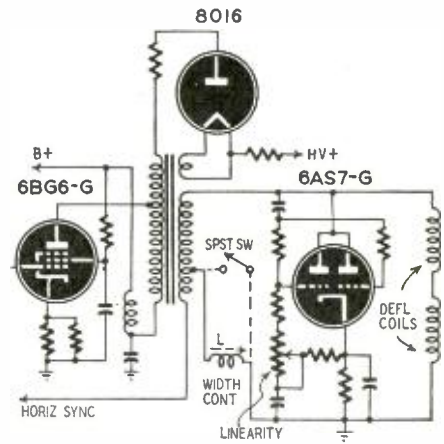

Fig. 1—Modification of the horizontal sweep circuits of General Electric 803.

rect value for others. Making R variable will give an auxiliary height control for use with the expanded picture.

The two switches should, of course, be combined into a single d.p.s.t., or—as in some receivers—a relay can be used, with its energizing current con-

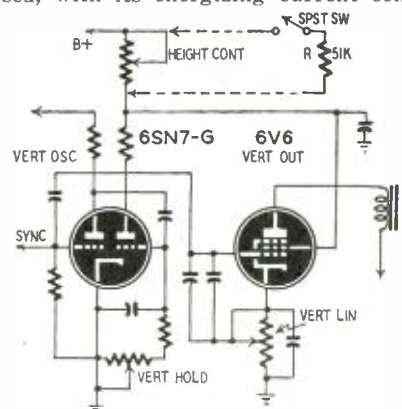

Fig. 2—Shunting a resistor across the height control to increase the height.

trolled by a switch at the end of a piece of lamp cord, permitting control of the picture from the viewer's chair.

The same system can be used with electrostatic-deflection receivers if there is enough drive.

For best results, the rectangular mask should be removed from the receiver.

Interesting Television Circuits

The newer television receivers feature a number of circuits not present a year ago

A NUMBER of improvements and modifications have appeared in TV receivers during the past year. One of these is a new type of automatic gain (contrast) control. This circuit is commonly called "keyed a.g.c.," although some prefer to call the system *pulsed* or *gated* a.g.c. The circuit shown in Fig. 1 is that of a

age developed across the resistor is filtered by the 0.5- μ f capacitor and fed to the grids of the a.g.c. controlled tubes. Direct coupling is used between the video detector and video amplifier, and between the video amplifier and the a.g.c. tube so that the sync pulses will have a d.c. component.

The contrast control is removed

with the amplifier's grid return, any voltage developed across it will unblock the amplifier and permit it to amplify the a.f. signal and feed it to the grid of the 6V6-GT power amplifier. When no signal is being received, the voltage across R-74 is zero, the amplifier is cut off, and the set is silent. The values of R-72 and R-73 are chosen so the amplifier cuts off shortly after the signal becomes unusable.

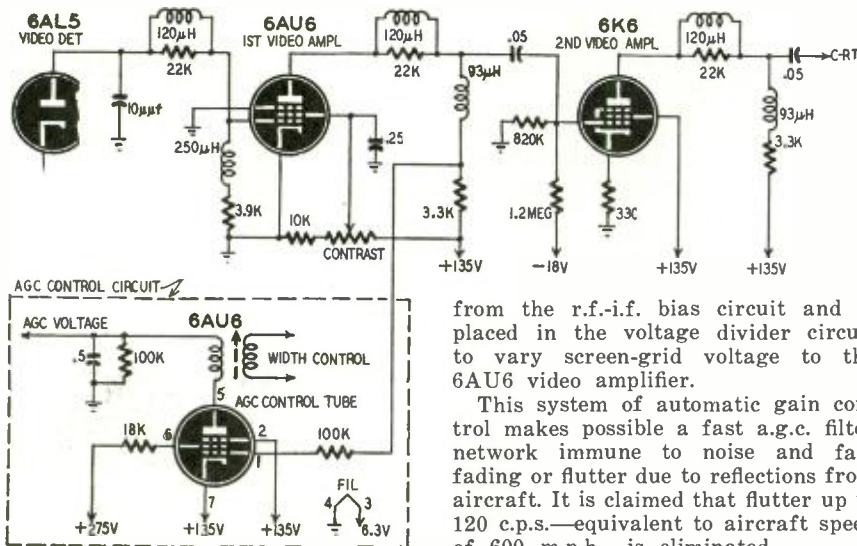

Fig. 1—Circuit of Tech-Master's a.g.c. adapter kit for 630-type TV chassis.

keyed a.g.c. adapter kit made by Tech-Master for installation in 630-type TV receivers. Similar circuits are used in the Radio Craftsmen model RC 100, Admiral 20A1, 20B1, and 21A1; and in other makes and models. The Tech-Master adapter components are enclosed in broken lines; the other components are in the 630 chassis.

The a.g.c. control tube develops a negative control voltage whose value is determined by the amplitude of the transmitted sync pulse level. The grid of this tube is fed with positive sync pulses from the plate circuit of the first video amplifier.

A second winding on a special width control is the source of 300-volt, 15,750-cycle pulses which are applied to the plate of the a.g.c. control tube. This tube remains cut off except during the positive half-cycles. Therefore noise cannot disturb the circuit except during this conductive period or approximately 5% of the total time. When the tube is conducting, the current through it and voltage drop across the 100,000-ohm 6AU6 plate load resistor are determined by the amplitude of the sync pulses. The negative volt-

from the r.f.-i.f. bias circuit and is placed in the voltage divider circuit to vary screen-grid voltage to the 6AU6 video amplifier.

This system of automatic gain control makes possible a fast a.g.c. filter network immune to noise and fast fading or flutter due to reflections from aircraft. It is claimed that flutter up to 120 c.p.s.—equivalent to aircraft speed of 600 m.p.h.—is eliminated.

Interstation squelch control, automatic picture-size stabilization, and interlace stabilization are new features of the Motorola 12VK15 and 16VK7 TV

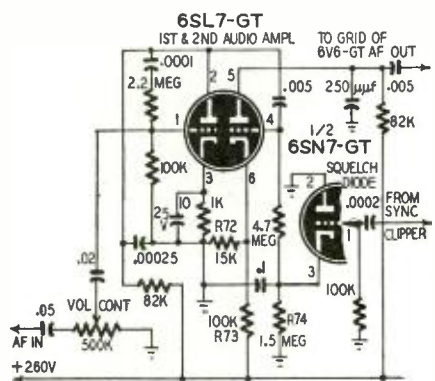

Fig. 2—Motorola's interstation squelch.

receivers using the TS-16 and TS-30 chassis.

The interstation squelch control circuit is shown in Fig. 2. When a signal is tuned in, sync signals are fed to the squelch diode where an average of 12 volts is developed across the 1.5-megohm cathode resistor R-74. The second a.f. amplifier is normally biased to cutoff because its cathode returns to a sufficiently positive point on voltage divider R-72-R-73. R-74 being in series

A voltage regulator

The picture stabilization circuit (Fig. 3) is actually an electronic voltage regulator at the output of the high-voltage power supply. The high-voltage output being constant for loads between zero and 200 microamperes, the voltage does not rise when the picture changes from light to dark. This also prevents the voltage from rising and causing arc-over, corona discharges, or filter failure when the C-R tube is out of its socket.

The usual combination high-voltage power and horizontal output transformer is not used. Instead, high-impedance deflection coils are direct-coupled to the plates of the parallel 6Y6-G horizontal output tubes.

The horizontal damper tube, a 35Z5-GT, has its heater voltage fed through a three-winding isolation transformer. The third winding is connected to the grid of a 6BG6-G pulse amplifier which drives a flyback-type, high-voltage transformer.

Triode V-10B, the high-voltage regulator tube, has its grid connected across a 68,000-ohm resistor R-133 in the negative leg of the high-voltage supply. The plate of this tube gets its voltage from the 6BG6-G screen supply. When the C-R tube draws more current, its second anode voltage usually drops. In this circuit, the increased C-R tube current makes greater the drop across R-133 so that the grid of the regulator tube goes more negative and its plate draws less current. This raises the screen voltage of the 6BG6-G and causes the tube to develop a higher voltage across the primary of the high-voltage transformer.

The interlace stabilizer (Fig. 4) is designed around a high-level vertical blocking oscillator. The feedback winding on the transformer is so tuned by a .005- μ f capacitor that the retrace time is equal for successive cycles. High output voltage was obtained by selecting such values for C-106 and R-90 that their combination would result in a short time constant. The short-time integrating network R-86,

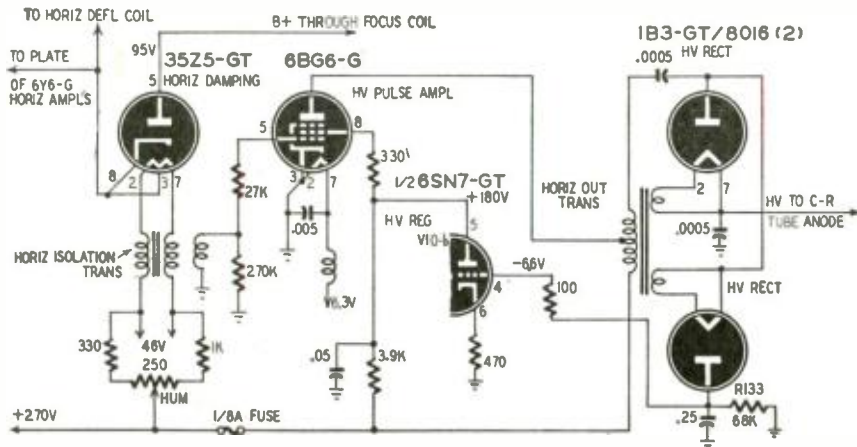

Fig. 3—Voltage regulation of the high-tension power supply stabilizes picture.

C-103, C-102, R-85, and C-104 is an additional aid to perfect vertical timing.

The 110-volt distorted output of the blocking oscillator is linearized and reduced to a 30-volt sawtooth by R-91, R-92, and C-107 between the blocking oscillator and vertical output stages. An unbypassed cathode resistor in the output circuit further improves the shape of the sawtooth. This circuit so stabilizes the vertical deflection circuit that the hold and size controls have been placed on the back of the set.

Most television receivers have two or more low-voltage supplies to deliver voltages to the deflection, audio, r.f., and i.f. circuits. Philco has eliminated the usual 150-volt supply in their 50-1104, 50-1105, 50-1106, and other models by connecting the mixer, video i.f., and audio i.f. stages in series with the audio output stage across the 380-volt, low-voltage supply. The circuit is shown in Fig. 5. The circuit is stabilized by bleeder current through the paralleled 10,000-ohm resistors.

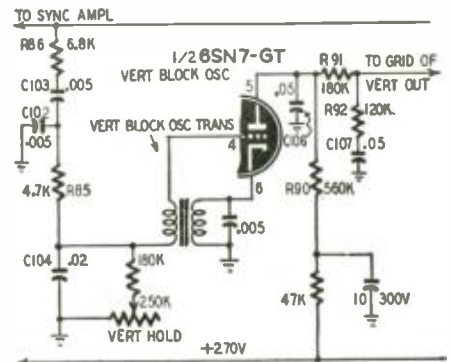

Fig. 4—An interlace stabilizer circuit.

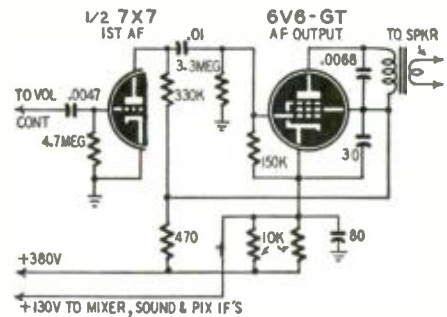

Fig. 5—Circuit eliminates one supply.

TV-GUIDED WAR MISSILE

A TELEVISION device very nearly resembling the human eye was built into a German guided missile, the *Technical Data Digest* (U. S. Air Forces magazine) reported in its issue of May 15, 1949. This television device had an eye that could move, a retina (iconoscope) on which the image was impressed, a system which selected wanted signals and used them, while rejecting unwanted ones, in a manner similar to the human brain, and electric nerves to the steering engine, which played the part of muscles.

Heart of the equipment is an iconoscope, which is scanned in a spiral. The spiral starts at the outside, and when it has reached the "dead area" near the center snaps back to the outside again, being blanked out during the retrace. (Fig. 1) The object at which the missile is aimed is centered in the "dead spot." While it remains there, the missile moves directly toward it. If part of it projects into the sensitive area, it creates a pulse which turns the missile slightly toward that quadrant, thus tending to bring the object back toward the center of the screen. The sensitive area is a narrow ring, which increases in size automatically as the missile gets nearer the target and therefore sees a bigger image of it. This ring-shaped sensitive area is a valuable aid in keeping the missile sighted on its proper objective, rather than other images.

is moved to keep the image in the center of the screen. In larger ones, it was

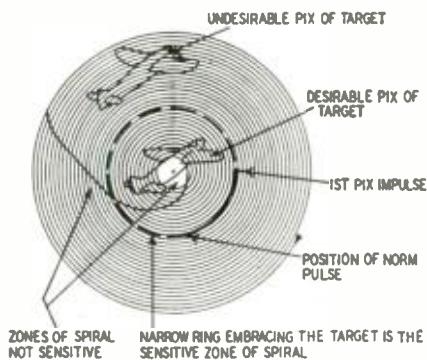
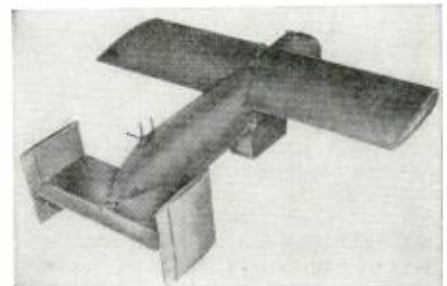

Fig. 1—Iconoscope is scanned spirally.

found better to use a movable mirror (see Fig. 2) on account of its small inertia. Then the mirror follows the target immediately, and the missile is brought around with a slight time lag, much like the action of the eye and body of a baseball player following a fly.

The motors permit steering in four quadrants: up, down, left, and right. If the target moves diagonally, it will first appear in one of the quadrants, then in the adjoining one, and the missile will first move (for example) to the right and up, to bring it back to center.

To sight the projectile, the pilot centers the image of the target on the screen or in the mirror and switches



on the automatic steering device. The missile's own computers take over from there and make all the necessary adjustments to keep it moving directly toward the target while the range is decreasing and possibly other disturbing objects are moving across its field of vision.

The photograph shows the smaller of two models which were completed just before the end of the war, but never put into action. About 3 feet long and 7 inches in diameter, it weighed approximately 12 pounds. Expected range was 2-4 miles, depending on the target size. The bombs were chiefly intended for aircraft use, to be launched from a position under the wings of the carrying craft after the pilot had sighted them on the target and set the automatic steering device.

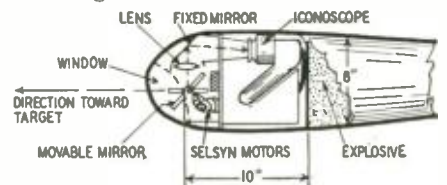

Fig. 2—Arrangement of components.

TV TROUBLE SHOOTING

A practical television man reveals causes and remedies for some of the set ills that may puzzle repairmen

By **MURRAY BARLOWE***

TELEVISION manufacturers' service notes usually contain excellent suggestions for trouble-shooting TV receivers. Checking the service notes of a few of the leading manufacturers reveals that most of the troubles listed are due to misadjustment of controls. These cases are obvious to the technician after he has worked on four or five modern receivers, but often there is need for help on troubles whose cures are not so obvious.

Here are the results of many hours of "blood, sweat, and tears" trying to unravel some of the mysterious symptoms which turn up during a day's work in maintaining this new menace to the sanity of the electronic technician.

Black vertical line

Case 1: Service tag reads, "Ragged, black vertical line about an inch from left-hand side of picture on channels 7, 11, and 13. Looks like running water." The condition is illustrated in Fig. 1.

The trouble is caused by high-frequency oscillations in the horizontal deflection amplifier tube (usually a 6BG6) and can occasionally be cured by replacing the tube. The tube amplifies the 15-kc sawtooth voltage which provides the horizontal sweep.

During part of the sweep cycle, the grid approaches zero volts with respect to the cathode. Maximum current flows in the plate circuit, and the plate voltage drops very low. Electrons leaving the cathode are attracted toward the screen, which has a comparatively high positive voltage. Most of the electrons

*Instructor, Radio Electronics School, New York

pass through it on their way to the plate, only to be slowed down by the low plate voltage, and attracted back to the screen. Again they pass through the screen, this time headed toward the cathode. There being no attraction for them at the cathode, they are again attracted toward the screen. This motion of the electrons oscillating back and forth within the tube at a very rapid rate is a burst of high-frequency energy. The oscillations, ranging in frequency from approximately 200 to 800 mc, are picked up by the r.f. section of the receiver, detected, amplified, and finally applied to the picture tube. The bursts are caused by the horizontal sweep, which accounts for the black spot's being in the same position on each horizontal line.

If replacing the tube doesn't cure the trouble, tape a small Alnico magnet to the side of the tube, as in Fig. 2-a, determining the best position experimentally. The magnet deflects the oscillating stream of electrons and prevents their following a repetitious path, thereby suppressing the high-frequency oscillations. If the high-voltage compartment has a cover, the magnet can be fastened to the inside of the cover close to the tube, as in Fig. 2-b.

Picture blooms and fades

Case 2: Service tag reads, "Picture intermittently blooms [loses brilliance and increases in size simultaneously]."

This symptom immediately points to trouble in the high-voltage supply. The loss of picture brilliance indicates a decrease in the second-anode voltage, and the increase in picture size con-

firms it. The increase in size is due to the fact that a low-velocity stream of electrons is more easily deflected than a high-velocity stream; the velocity of the electron stream in the c.r. tube is proportional to the second-anode voltage.

Some of the possible causes of trouble in the high-voltage supply are:

1. Intermittent breakdown of high-voltage button-type or ceramic filter capacitors;
2. Intermittent 1-megohm filter resistor;
3. Bad 8016 (high-voltage rectifier tube);
4. Arcing anywhere along the high-voltage lead from the supply to the second anode;
5. Internal short in the picture tube.

A situation closely allied to the complaint just described occurs when the picture blooms when the brightness control is turned up. Again there is a loss of high voltage, this time only when the brightness control is turned up. Brightness is controlled by varying

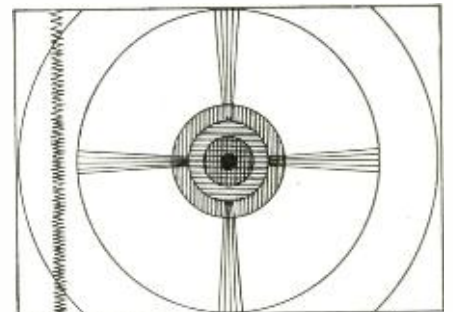

Fig. 1—Vertical black line in pattern.

the bias on the picture-tube grid. Less negative grid voltage results in an increased flow of electrons and consequently more brightness. Loss of high voltage with an increase in electron-beam current indicates poor regulation in the high-voltage supply. This may be caused by a high-voltage filter re-

sistor that has increased in resistance, a bad high-voltage rectifier tube, or, in the case of an r.f.-type supply, an incorrect setting of the trimmer capacitor in the oscillator circuit or a bad oscillator tube.

Narrow picture

Case 3: Service tag reads, "Insufficient width." That complaint is one of the most common, especially now with the popularity of the "expanded" picture. There are five or six routine checks suggested by the service manuals, which in many cases solve the problem. But there are always those few stubborn cases which seem to defy all of the logical solutions and turn

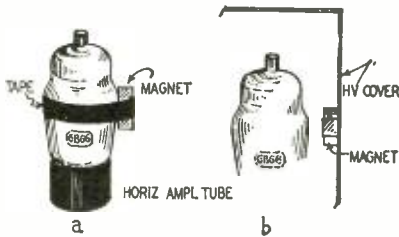

Fig. 2—The magnet damps oscillations.

out to be the most time-consuming jobs in the shop. After replacing tubes and checking voltages in the horizontal deflection circuits has failed to show up the defect, the following remedies will yield that extra quarter inch or so of picture to fill the mask:

1. Clip the leads which run from the width-control coil to the horizontal output transformer (A in Fig. 3). This allows maximum sweep. (The action of the width control when it is in the circuit is to reduce the sweep width below maximum.)
2. Increase the value of the damping resistor (this is R209 in the RCA 630-TS) in the output of the horizontal amplifier (B in Fig. 3).
3. Add a 10,000-ohm resistor in series with the arm of the horizontal drive control, at point C in Fig. 3.
4. Decrease the size of the 680,000-ohm resistor in the plate circuit of the horizontal discharge tube.
5. Increase the plate voltage to the discharge tube by obtaining it from the "boosted" B-plus available at the linearity control (connection D in Fig. 3) instead of from the 275-volt supply.
6. Increase or decrease the value of the 6BG6-G screen resistor. Increasing the screen voltage occasionally results in a decrease in width due to an increase in secondary emission. Also, the voltage on the screen of the 6BG6-G may be increased by obtaining it, too, from the "boosted" B-plus via connection E in Fig. 3.
7. Connect a mica or paper capacitor across those terminals of the horizontal output transformer to which the width control was originally connected (A in Fig. 3). Try various values from .001 μ f to about 0.1 μ f. The capacitor should be rated at least 600 working volts. It tends to decrease the amount of high voltage produced by the kickback type

of power supply. The larger the capacitance, the lower is the output voltage. A decrease in the picture tube's second-anode voltage reduces the speed of the electron stream; a lower-velocity beam can be more easily deflected, resulting in greater sweep width. The disadvantage of this method is that the brilliance is affected. However, the decrease in brilliance is very small for a slight increase in width and is usually justified.

Many of these modifications may result in a change in linearity as well as width. That usually calls for readjusting the linearity controls and possibly changing the values of some resistors. Variable resistors can be used and the effect of different values noted before the final fixed value is decided on.

Herringbone pattern

Case 4: Service tag reads, "Fine herringbone pattern all over picture on all channels." This usually is the result of an interfering signal which has managed to get through the i.f. stages. Often it is the result of image interference produced by an FM broadcast station when the set is tuned to one of the low-frequency television channels.

For example, when a typical set is tuned to channel 2 (54 to 60 mc), the picture carrier is 55.25 mc and the picture i.f. is 25.75 mc. The oscillator operates above the r.f. by an amount equal to the i.f. (55.25 plus 25.75), which is 81 mc. The image frequency is twice the i.f. plus the r.f. (51.5 plus 55.25), or 106.75 mc. An FM station operating at 106.75 mc beats against the local oscillator (81 mc) and produces a difference frequency (106.75—81) of 25.75 mc. This comes right through the i.f. stages and shows up as interference in the picture. It can be eliminated by resonant wavetraps at the antenna input, tuned to the interfering FM frequency.

Image interference is usually present on only one channel. If the pattern is visible on all channels, it probably is due, not to image interference, but rather to a different kind of "beat" interference. Its cause and cure may not be obvious, but such interference can be eliminated.

The sound carrier is always 4.5 mc above the picture carrier. In the receiver, these two carriers beat against

a local oscillator and produce sound and picture intermediate frequencies which are still 4.5 mc apart. Both signals may travel through a common i.f. stage and then be separated into their respective i.f. channels. After separation, trap circuits in the picture i.f. stages get rid of any sound signal which may remain, and prevent it from reaching the video detector.

Since all detectors are nonlinear, they mix as well as rectify. If any energy at the sound i.f. frequency gets through to the video detector, it and the sound i.f. heterodyne and a constant 4.5 mc beat signal are present at the output. This 4.5-mc signal is usually within the passband of the video amplifier and therefore is applied to the grid of the picture tube, along with the picture signals.

There are two methods of correcting the condition. The first is to properly align the sound traps.

If they are aligned and the pattern is still present and strong enough to be annoying, the second method usually serves.

Since the interfering signal is at a fixed frequency (4.5 mc) after the video detector, the logical step is to install a 4.5-mc resonant trap somewhere in the video amplifier. The best place is in the plate circuit of the first video amplifier tube. Use a discarded width control coil as a form.

Remove all the wire from the width control. Close-wind 40 turns of No. 32 enameled wire in a single layer. Connect a 50- μ f ceramic capacitor across the winding. Mount the coil close to the plate lead of the first video amplifier and wire it in series with the plate.

To adjust the trap, connect a modulated, 4.5-mc AM signal generator to the grid of the first video amplifier. Set the generator output to maximum, producing horizontal black and white bars on the face of the picture tube. Adjust the trap for minimum intensity of the bars. An alternate method is to tune in a signal and adjust the trap for minimum interference pattern.

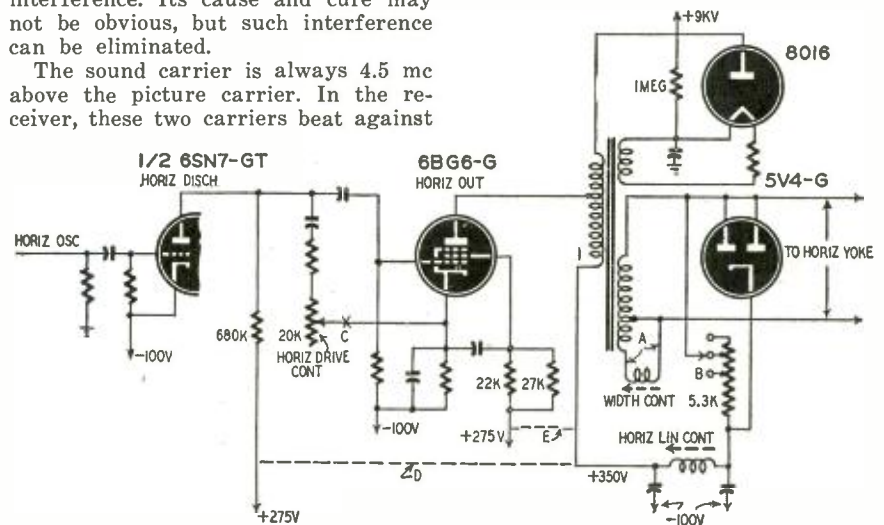

Fig. 3—Schematic of horizontal output circuit indicating the modifications.

Finding and Curing Unusual TV Troubles

By IRVING DLUGATCH

EVERYONE is familiar with "no output," "weak output," or "distorted output" in radio servicing. Television has its "no picture," "no sound," "no sweep," and "distorted picture." In either radio or television work, these ordinary troubles offer no problem to the expert even possessed of the simplest of equipment. Many a radio technician, however, owes his gray hairs to the puzzling intermittents and the "everything's perfect but—" What, then, of the television technician faced with a multiplicity of circuits, each capable of developing individual intermittents and unusual symptoms? Where does he begin using his elaborate service instruments?

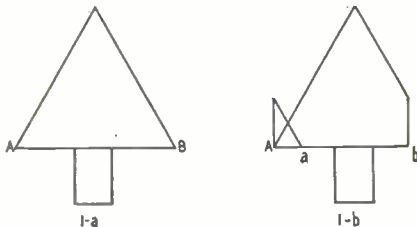

Fig. 1—Misplaced picture distorts tree.

The combination of an intermittent in some obscure circuit plus misalignment or maladjustment is enough to confound the most experienced technician. Too often, by his random twisting of controls and adjustments, he not only indicates his complete befuddlement, but manages to make matters worse. It is often much simpler to analyze the possible causes of the trouble and then proceed methodically with the proper equipment to track down the guilty component. Let's look into a few unusual problems.

The misplaced picture

The picture had a vertical slice cut off the right end and placed very neatly over the left side. In this way, it was possible to watch a ball game in which the pitcher stood behind the batter. He threw a ball off to the left where it disappeared. It reappeared at the right of the picture to fly toward the batter. Note, this is not a case of foldover where the picture is merely distorted at one side; nor is it horizontal slipping. Fig. 1-a shows the signal as trans-

mitted and 1-b shows the right side transposed to the left. Let's analyze this condition.

The slopes of the sides of the tree being equal and linear, there is no possibility of nonlinearity in the horizontal or vertical sweep circuits because nonlinearity causes sections of the pattern to be abnormally cramped or stretched. Fig. 2-a shows the deflection waveshape for a normal line in Fig. 1-a. The slicing off and transposition to the left of the received picture indicates that the receiver sweep oscillator was cutting off at b and starting a new line while the transmitter sweep continued to B. Thus the part of the picture between a and B appeared at the beginning of the lines instead of the ends where it belonged.

Obviously the receiver's horizontal sweep was somewhat faster than the transmitter's. By signal tracing in the sync circuits, the trouble was located in a sync coupling capacitor which had changed value.

Another type of deflection-circuit trouble is nonlinearity which causes crowding or stretching at the sides and top or bottom of the picture. Figs. 3-a

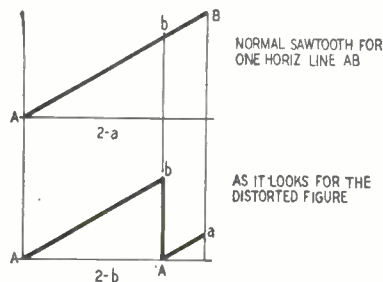

Fig. 2—Horizontal sweep is too fast.

and 4-a show nonlinear vertical and horizontal deflection voltages, while Figs. 3-b and 4-b show the resulting distortion in the picture.

When the vertical deflection wave curves, the downward sweep of the beam is slowed up, permitting more horizontal lines to be scanned in a given period and producing crowding or stretching. The center portion of the sweep is linear, and the lines are evenly spaced.

When the horizontal sweep is distorted, the picture elements are

crowded during the curved portions of the sweep and evenly spaced during the linear portion.

If nonlinearity is not correctable with the linearity controls or by standard servicing practices, look for 60- or 120-cycle hum in the deflection circuits. Fig. 5-a and b shows how hum or ripple adds to or subtracts from the amplitude of the horizontal scanning wave and makes corresponding lines longer or shorter. This causes over-all distortion with a sine-wave shape at the left edge of the raster. Ripple or hum in the vertical deflection circuits will cause cramping like that shown in Fig. 3-b.

Another trouble common to deflection circuits is failure of the damper tube. This is characterized by distortion or

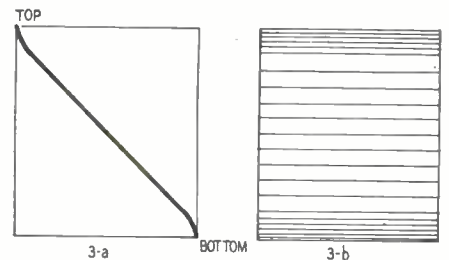

Fig. 3—A nonlinear sweep crowds lines.

foldover at the left side of the picture. This is understandable when we recall that the damper tube stops oscillations caused by the rapid change in deflection-coil current during the retrace period. Occasionally, only a single cycle of spurious oscillation is produced during each scanning cycle. The resultant is a single white bar with no other distortion in the picture.

Leftward tendencies

Sometimes one or more lines are shifted to the left without otherwise distorting the picture. Fig. 6 is exaggerated to show this condition, which is recognizable as a form of tearing—a condition usually caused by loss of sync. Deflection oscillators are usually designed to operate at frequencies somewhat lower than the 60- or 15,750-cycle synchronized rates. Naturally, they slow down to their designed frequency when sync is removed. The usual type of tearing occurs irregularly and over many lines. In this problem, the "slipping" is clean and covers comparatively few lines. Furthermore, the displacement occurs at the same place in the picture. This makes identification positive.

Suppose the receiver in question uses a.f.c. in the horizontal scanning circuit shown in Fig. 7. Capacitor C stores a charge which maintains the bias on the control grid of V1 for one frame, and the oscillator will stay locked in for this period, unless, of course R or C have undergone considerable changes in value. Checking the values of these components is the first step in finding the cause of the intermittent loss of sync.

Regardless of the type of horizontal sweep circuit involved, the trouble is not caused by an intermittent com-

ponent because the displacement is clean and occurs at regular intervals. Noise pulses can be eliminated because of their irregularity. A more likely cause is an unwanted signal which adds to or subtracts from the video signal so as to destroy the sync

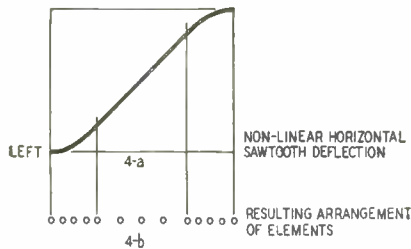

Fig. 4—Horizontal sweep is nonlinear. for a few lines. Obviously the unwanted signal must occur at a 60-cycle rate to produce this effect. By signal tracing, the trouble can be traced to stray pickup in the r.f. or i.f. circuits. The interference may be caused by parasitic oscillations, high-amplitude deflection voltages, or heterodynes.

The vanishing ghost

A true intermittent ghost or reflected image is not rare. It can occur any time the antenna sways or turns in the wind. The cure is a good antenna installation. We are more concerned with non-reflected streaks and intermittent shadows which appear in the picture. Con-

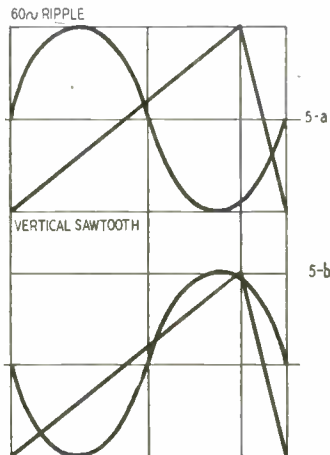

Fig. 5—Hum may cause nonlinearity.

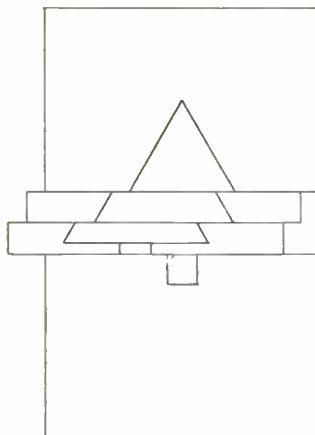
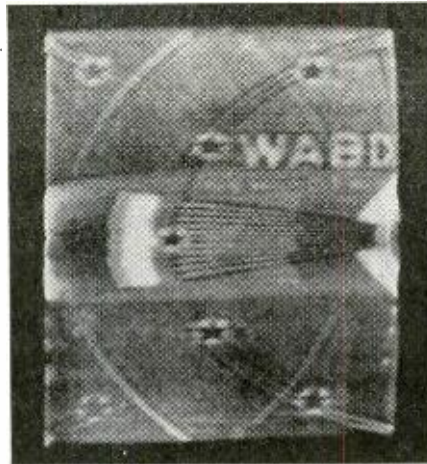

Fig. 6—Some lines shifted to side.



A pattern affected as shown in Fig. 1. sider what will happen to a picture when an unwanted signal appears in the video amplifiers. Fig. 8-a shows the video signal during one line, 8-b a part of the positive cycle of an unwanted signal, and 8-c shows how the sum of the video and interfering signals places the video signal nearer the white region. When the interference goes negative, the video signal goes closer to the black region. If the inter-

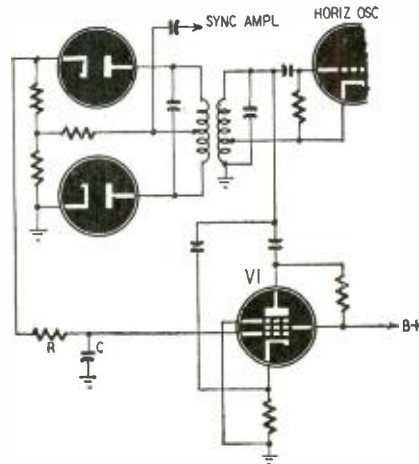

Fig. 7—A horizontal sweep with a.f.c. ference is a 60-cycle sine wave, half the picture will be brighter and half darker than normal.

If the interference is at a frequency higher than the line scanning rate, each line will be modulated with white or black dots and vertical lines will appear in the picture.

When sound gets into the picture, we see bars, streaks, or patches, depending on the amplitude, phase, frequency, and duration of the interfering signal.

These three types of interference are easily recognizable and methods for curing them are obvious.

1. Long, dark, horizontal streaks following a thin, horizontal, black object against a white background. This may be caused by misalignment of r.f. or i.f. circuits or by faulty peaking in the video amplifier circuits.

2. White streaks forming at the edges of white objects against a dark background. This is particularly no-

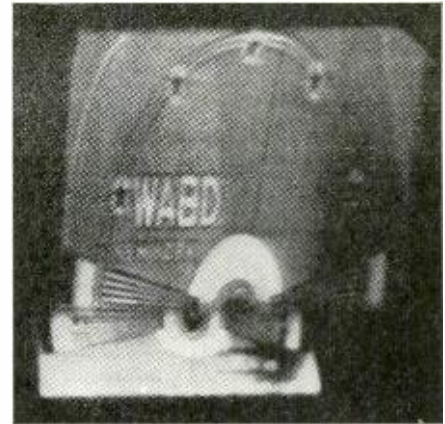

An actual photo of condition in Fig. 6.

ticeable at the hairline on an actor's face. This trouble is also traceable to faulty aligning or peaking.

3. Muddy, washed-out pictures and visible retrace lines can result from turning up the contrast control to compensate for low emission in the picture tube. Advancing the contrast control raises the gain of the i.f. amplifiers, which may alter the over-all response curve and cause smearing like that just described.

Weird sound

Most cases of distorted or missing sound are due to improper operation of the receiver's controls but some may be traced to excessive oscillator drift. A bad tube is usually at fault when poor front-end design is not evident. Misalignment of the r.f. and i.f. stages is an obvious cause of the same trouble. (A common mistake is to realign the picture i.f. rather than the sound stages. The sound i.f. bandpass is not as wide as that of the video i.f.; therefore the former is more critical.)

Mismatch between the antenna system and the tuner can alter the Q of the r.f. input circuits and distort the response curve so that the carriers do not peak simultaneously. Slight mistuning can eliminate one carrier by causing it to fall outside the passband of the r.f. circuit. This condition is

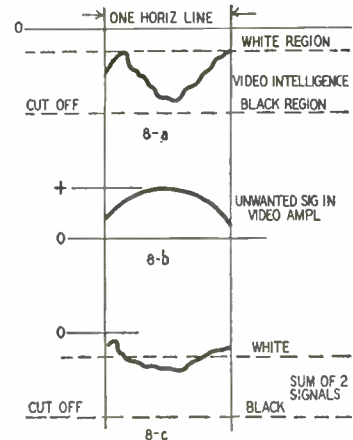

Fig. 8—How interference affects image.

cured by proper matching between the receiver and antenna.

Television Dictionary

Initial installment of a new A-to-Z dictionary of TV terms

By ED BUKSTEIN

A

Aberration

A defect of a lens or mirror. For instance, chromatic aberration is the tendency of a lens to separate



white light into its component colors and to focus different colors at different points.

Accelerator

The second anode of a cathode-ray tube. This anode, operated at a high positive potential with respect to the cathode, increases the velocity of the electron stream and is therefore referred to as an *accelerating anode*.

Accommodation

The ability of the eye to focus on objects either near or far.

Achromatic lens

A combination of two lenses, the curvature of the second lens being



such that it corrects the chromatic aberration of the first.

Afterglow

A fluorescent material glows when bombarded by electrons and continues to glow for a length of time after the bombardment ceases. This continued glow is referred to as *afterglow*, *persistence*, or *phosphorescence*.

Amplitude separation

The process of removing a portion of a waveform above or below a given level. In the figure a positive potential of 3 volts is applied to the cathode of the diode. The diode

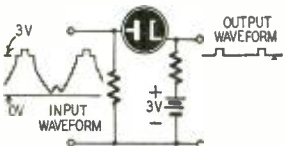

cannot conduct until the signal voltage on its plate becomes more positive than 3 volts. The output contains only that portion of the input waveform above the 3-volt level. This process is also referred to as *clipping*.

Angle of deflection

In a cathode-ray tube, the angle by which the electron stream deviates from the path it would follow if undeflected.

Angle of divergence

In a cathode-ray tube, every electron in the stream exerts a repelling influence on every other electron. Therefore, the stream tends to spread out or widen. The angle formed by the edge of the stream and a longitudinal line through its center is called the *angle of divergence*.

Angstrom unit

A unit of wavelength measurement. The Angstrom unit is equal to 10^{-10} meter. The wavelength of visible light is between 4,000 and 7,000 Angstrom units.

Aperture

A small opening or window. The term is also used to describe the cross-sectional area of the scanning beam in a television camera tube.

Aperture compensation

Reduction of aperture distortion by emphasizing the high-frequency components of the picture signal.

Aperture distortion

Attenuation of the high-frequency components of the picture signal due to the finite cross-sectional area of the scanning beam. When this area is large enough to cover several mosaic globules in the iconoscope simultaneously, aperture distortion results and the resolution of the image becomes poor.

Aquadag

The graphite coating on the inside of the glass envelope of the cathode-ray tube. The aquadag, which is electrically connected to the second anode, collects the secondary electrons knocked out of the fluorescent screen. It also provides shielding for the tube.

Aspect ratio

The ratio of the width to the height of a television picture. Under present television standards, the picture aspect ratio is 4 to 3.

Astigmatism

When the vertical and horizontal curvatures of a lens are unequal, part of the image is in focus while other parts are not. This defect of the lens is called *astigmatism*.

Automatic brightness control

A circuit which maintains fairly constant the average intensity or brightness of the television picture.

Automatic contrast control

A circuit which varies the bias on one or more variable- μ tubes in such a manner that the intensity and contrast of the television picture are maintained at a constant average level. Automatic contrast control is to the television receiver what automatic volume control is to the sound receiver. The manual contrast control fixes the average level of the picture, and the a.c.c. maintains this average even if video carriers of different peak amplitudes are tuned in.

B

Beam

In cathode-ray tubes, the stream of electrons passing from the cathode to the fluorescent screen.

Beam current

The current in the stream of electrons in the cathode-ray tube. The beam current rarely exceeds 250 μ a and is normally less than 100 μ a.

Black level

In the television receiver, the video signal is applied to the control grid of the cathode-ray tube. Portions of this signal drive the grid to cutoff and produce the black portions of the picture. Those portions of the video signal which drive the grid beyond cutoff are said to be below the black level.

Black-level control

A control for varying the amplitude of the portion of the video signal which produces the black parts of the picture.

Blacker-than-black region

That portion of the video signal below the black level. The synchronizing and blanking pulses are contained in this portion of the signal.

Blanking

The process of applying negative voltage to the control grid of the cathode-ray tube to cut off the electron beam during the retrace or flyback period.

Blanking pedestal

A voltage pulse used to drive the cathode-ray tube beyond cutoff during the time the spot is returning from right to left or from the bottom to the top of the picture. These blanking pedestals must be synchronized with the sweep circuits so that the beam is cut off at the right time.

Blanking pulse

Same as blanking pedestal.

Blocking oscillator

A vacuum tube so operated that it is continually driven back and forth from cutoff to saturation. If a capacitor is connected in parallel with such a tube, it will charge during the time the tube is cut off and discharge through the tube when it conducts. This process produces a sawtooth voltage waveform which may be used as sweep voltage for the cathode-ray tube.

Brightness

The intensity of the light produced at the screen of a cathode-ray tube.

Brightness control

In the television receiver, the adjustment which varies the average illumination of the picture by varying the bias on the cathode-ray tube grid.

Brilliance

Same as brightness.

Broadband Amplifier

An amplifier having flat response over a wide range of frequencies.

C

Caesium

A photosensitive material used in the mosaic of the iconoscope.

Camera

That component of a television transmission system which houses the iconoscope, orthicon, or image dissector tube. The scene to be televised is focused through a system of lenses upon a photosensitive surface. The camera breaks down the visual image into a large number of small picture elements, translating the light intensity of each element into its electrical equivalent.

Candlepower

A measure of the light-producing ability of a source. The standard 1-candlepower source produces a light flux of 12.57 lumens.

Catadioptric

The name applied to an optical system employing both lenses and mirrors.

Cathode-ray tube

An electron tube which converts electrical energy into light by projecting a beam of electrons upon a fluorescent screen. The screen glows at the point where the electrons strike it, producing a spot of light. By deflecting the electron stream, the spot may be made to trace a pattern corresponding to the deflection voltage.

Catoptric

The name applied to an optical system employing mirrors but no lenses.

Center of curvature

The point equidistant from all points on the surface of a spherical mirror. If the mirror is considered to be a segment of a complete sphere, the center of curvature

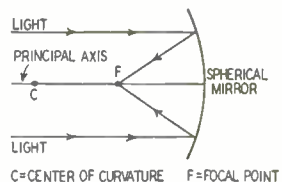

would be located at the center of the sphere. The center of curvature is located on the principal axis.

(Continued in February issue)

Adjusting TV Linearity

Without a Test Pattern

By MATTHEW MANDL

*Audio-modulated signal generator
produces parallel bars on screen*

THE most common method of adjusting linearity in television receivers is to tune in a station test pattern and adjust the horizontal and vertical linearity controls on the rear apron of the chassis. When the pattern circle is perfectly round, and the width and height controls are adjusted to mask the image properly, we can be reasonably sure that the receiver will not elongate, bend, or otherwise distort the subject material of subsequent television programs.

While this method is highly satisfactory, a test pattern is not always available when needed. The technician should become familiar with the procedures for adjusting linearity without it. The methods are not complex and require no equipment other than a signal generator and a simple audio oscillator. With them, vertical and horizontal linearity can be set, and sweep amplitude can be adjusted by the visible indication appearing on the tube.

Use a signal generator to produce vertical or horizontal lines (or both) on the face of a tube. These lines, which resemble the sound bars so often visible when the receiver traps are not adjusted correctly, are used as a basis for adjusting linearity. If, for instance, a frequency above the 15,750-cycle horizontal sweep rate is injected into the video stages, a series of vertical bars appears on the picture-tube face. The number of bars depends on how much the frequency of the injected signal exceeds 15,750 cycles. The bars will be perfectly spaced and of equal thickness only if the horizontal linearity is correctly adjusted.

If a frequency below 15,750 cycles is used, but above the 60-cycle vertical sweep frequency, a series of horizontal bars is visible, and their number depends upon how much higher than 60 cycles the injected frequency is. Again, the spacing and thickness of the bars indicate linearity—vertical in this case.

When an a.c. signal is applied to the grid of the picture tube, it alternately adds and subtracts from the bias already on the tube. If, for instance, we inject a frequency of 60 cycles (the

same as the vertical sweep rate), the bias is increased and decreased 60 times per second. Since the vertical sweep rate is only 60 cycles, half of the downward trace is blanked out and half is not. If a 480-cycle signal is injected, it blanks out and releases the beam at a more rapid rate—eight times per field, to be exact, since 480 divided by 60 equals 8. This means that approximately eight white and eight black horizontal bars will appear on the screen. Actually such division will not give the exact number of bars

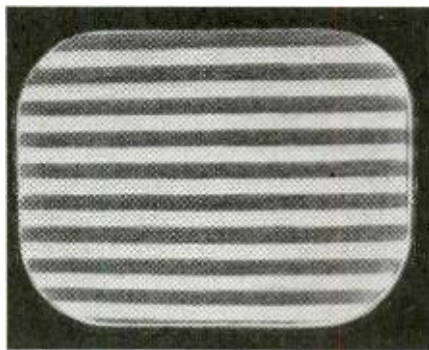

Fig. 1—Horizontal bars afford a check on linearity of vertical sweep source.

which appear on the screen because some are lost during the retrace time. However, more and more bars will appear on the screen as the frequency is raised to 15,750, the horizontal sweep rate. Fig. 1 is a photo of a screen with these bars on it.

When the frequency is above 15,750 cycles, it affects the horizontal lines, since its frequency is now high enough to blank out and release the beam during the horizontal sweep. If the injected frequency is, say, 315 kc (315,000 cycles), the electron beam is cut off 20 times and released 20 times (315,000 divided by 15,750). Almost 20 black and white vertical lines therefore will be visible on the screen. Fig. 2 shows a screen with vertical bars.

Any standard signal generator can be used to produce the vertical bars. It is preferable to use frequencies

above 300 kc to get a sufficient number of bars for good linearity adjustment.

Though many r.f. signal generators have a 400-cycle tone available for internal modulation purposes, they are not suitable for producing horizontal bars, since such a frequency would only produce about five lines. The bars would be fairly thick and their linearity rather difficult to determine. It is much more desirable to use a frequency between 800 and 2000 cycles so that from 10 to 30 bars will appear on the screen. If an audio oscillator is available, it can be used. However, audio oscillators having not been employed to any extent by service technicians, one may have to be built up.

Oscillator construction

Fig. 3 is a schematic of an oscillator using a 117L7-GT, which combines a rectifier with a beam-power amplifier. Utilizing the rectifier section for the power supply and the amplifier tube as a grid-blocking oscillator, we can construct a compact audio oscillator without the need for a separate power source. The frequency can be varied with the 500,000-ohm potentiometer, and the output is more than sufficient. It can also be used during regular servicing for signal tracing.

The parts can be mounted on a small chassis. A small tin baking pan makes an excellent chassis. Ground all terminals to the chassis, and

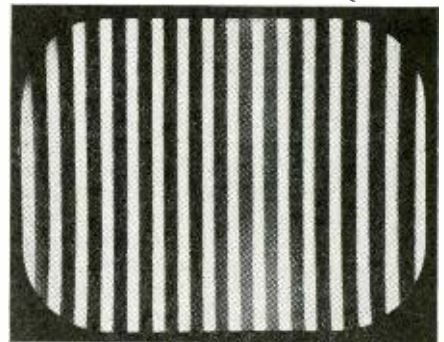

Fig. 2—Even spacing of vertical bars indicates horizontal sweep is linear.

use the isolation transformer indicated in Fig. 3. The isolation transformer is necessary, as otherwise the chassis of the oscillator would be "hot" and there would be danger of shorts and shocks. A small power transformer and tube designed for 250 volts on the plate can be used, of course, as can any oscillator which will produce a good waveform between about 1,000 and 2,000 cycles.

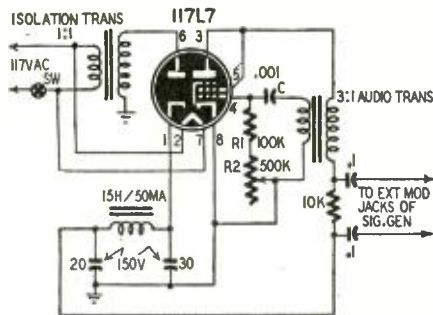

Fig. 3—Circuit of the audio generator.

Any audio interstage transformer will work in the tuned circuit. The unit can be tested for oscillation by placing a pair of phones across the output terminals. If there is no oscillation, reverse either the primary or secondary connections of the audio transformer, but not both. Make sure the secondary winding (the one having greater d.c. resistance) goes to the grid. If the oscillation frequency is too high or too low, change C, R1, or R2. Exact values for these cannot be given, since frequency range is also dependent on the transformer, the distributed capacitance, circuit wiring, etc. The frequency can, however, be altered by changing any of the values of C, R1, and R2.

Linearity testing

Both vertical and horizontal linearity can be checked and adjusted right in a customer's home. For adjusting vertical linearity the procedure is as follows:

1. Turn on the television receiver and allow it to warm up. Remove the antenna lead-in. Attach the audio oscil-

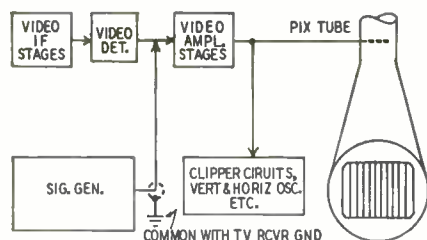

Fig. 4—Tie generator to a video grid.

lator to the EXTERNAL MODULATION jacks of the signal generator, turning off the internal modulation. Attach the output cable of the signal generator to the antenna terminal of the receiver. Set the receiver to the lowest channel.

2. Tune the signal generator to the channel frequency. Vary the signal-generator frequency slightly until bars appear on the screen. Adjust contrast

and brilliancy for satisfactory image. (The generator can also be set to the picture i.f. frequency.)

3. Adjust the vertical hold until the horizontal bars stand still. (Fine tuning may also be adjusted.) If more or fewer bars are desired, change the frequency of the audio oscillator. Vary the signal generator modulation control for the desired darkness of the black bars.

4. Adjust the vertical linearity control until there is no crowding of bars either at top or bottom of the screen. Height and vertical positioning controls may need slight retouching for proper centering and amplitude.

If the work is done when the chassis is on the workbench, the r.f. signal generator is not needed. Simply attach the output of the audio oscillator to the grid input of the first video amplifier. Turn the channel selector off a station, and start with step No. 3, above.

For horizontal linearity adjustments, where vertical bars are required, the signal generator output must be injected into the first video amplifier grid, as shown in Fig. 4. This can be done while the chassis is on the workbench, or it can be done in the cus-

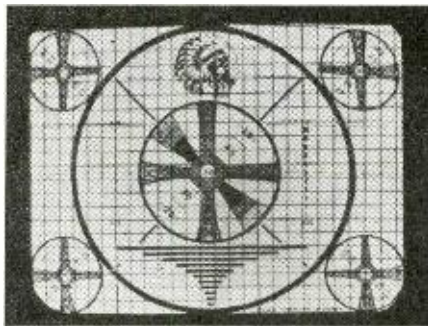

Fig. 5—RCA grating generator pattern.

tommer's home by removing the tube and bending a small piece of wire around the grid pin. The output from the signal generator is attached to this piece of wire, with the shield of the cable going to receiver ground. (Do not use a modulated signal.) This is also an alternate method for injecting the audio oscillator directly into the video amplifier without removal of chassis. This does away with the need for a signal generator during vertical adjustments. The procedure for horizontal linearity adjustment is:

1. Turn on the receiver and allow it to warm up. Set the channel selector so

no station is tuned in, or remove the antenna lead-in. Turn on the signal generator and set the frequency for approximately 300 kc. Vary the output and frequency until 20 or 30 vertical bars appear on the screen, as shown in Fig. 2.

2. Adjust contrast and brilliancy for a satisfactory image. Also vary the horizontal hold until the vertical bars are stationary.

3. Adjust the horizontal linearity until there is no crowding of bars at either side of the screen. Width and horizontal positioning controls may need slight retouching for proper centering and width.

Commercial equipment

Several commercial pieces of equipment are available which are so designed that the dark-line trace is thin, and both horizontal and vertical bars appear simultaneously.

The device used by RCA is called a *grating generator* (type WA-3A). The grating pattern appears in Fig. 5. This thin-line trace can be used against a station pattern as shown in the illustration, or it can be used to give the lines against a plain raster background. Improper adjustment of either vertical or horizontal linearity results in crowding or spreading of the bars at top and bottom or at the sides.

The Philco product, which produces the same type of vertical and horizontal bars, is known as a *crosshatch generator* (model 5072). It comes with an adapter harness, as shown in Fig. 6. Plate voltage, heater power, and synchronizing voltages are obtained from the television receiver.

The Philco crosshatch generator is adjusted at the factory to produce 12 horizontal and 16 vertical lines. The number and positions of the vertical lines, however, can be changed by a trimmer which is accessible through a hole in the bottom of the generator. Horizontal line adjustments can also be made.

Two other commercial types are the Hickok linearity-pattern television generator, model 620, and the Supreme composite video generator, model 665. The latter produces a dot modulation pattern. On the tube face a series of slightly elongated dots appears; and if receiver linearity is properly set, vertical and horizontal dot spacing is equal.

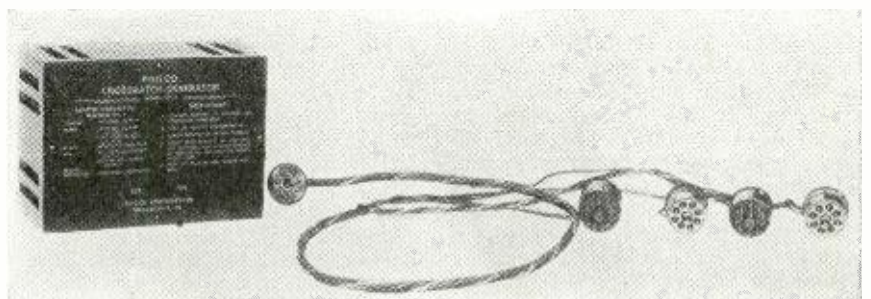
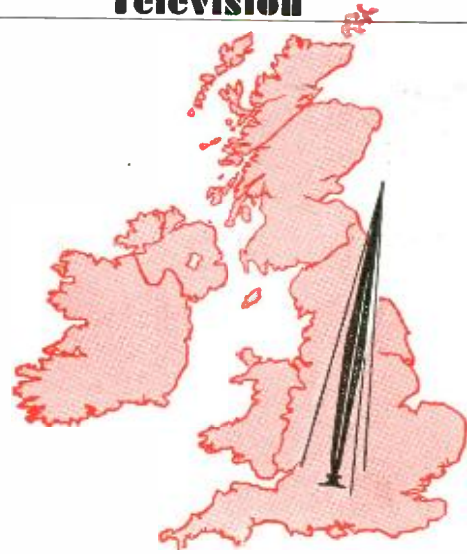

Fig. 6—The Philco crosshatch generator shown with its plug-and-wiring harness.

British TV News



By RALPH W. HALLOWS

BY the time that this article appears in print, Britain's second television station will be on the air in the Birmingham area. We're rather proud of it; for, with its vision output rated at 35 kw and its sound rated at 12, it's the most powerful thing of its kind in the world. Our population is so conveniently arranged from the TV point of view that one pair of stations, London and Birmingham, serves a good half of it. The third station is to be in the north; it will cover the thickly populated districts of Yorkshire and parts of Lancashire and should bring the total of potential viewers up to nearly three-quarters of the British people.

For all stations except the London transmitter, which is to remain unaltered, the BBC has decided to adopt the asymmetric sideband system illustrated in the drawing. This will allow five individual sound and vision channels to be fitted into the band, the transmitter on each channel radiating a video bandwidth of 2.75 mc with virtual freedom from amplitude or phase distortion.

This decision of the BBC's has had considerable effect on the design of televisers produced recently. The separation between the video carrier of any channel (except No. 1) and the sound band of the channel next above it is only 1.5 mc. A considerable degree of selectivity is thus essential, and this rules out the t.r.f. designs, which have been so popular in England because of their freedom from harmonic troubles.

All the new televisers are superhets. Next, single-sideband working is called for; rather the receiver should have ideally 100 per cent response to modulation frequencies 2.75 mc below that of the carrier, a similar response to those up to 0.75 mc above it, and then a sharp cutoff. At 1.5 mc above the carrier the attenuation of sensitive receivers must be 50 db or better.

One interesting trend is that toward lower prices. This cannot be done by incorporating a very small picture tube, for the public has shown in no uncertain manner that it will not accept at any price televisers providing an image smaller than about 7½ x 6 inches; and that means that the 9-inch tube is the absolute minimum size. Nor is there any future—or even any present—for the vision-only set without accompanying sound. It's a bit difficult to give you an idea of TV prices in Britain, because ordinarily all are quoted inclusive of purchase tax. Purchase tax is a variable for which the manufacturer has no responsibility. It may at any time go down; equally (and more likely) it may at any time be increased. What I've done, with the aid of such modest mathematical accomplishments as I possess, is to give you from now on the price as it would be were purchase tax not added to it, converted into dollars at the present rate of \$2.80 to the pound sterling. If you want the price including tax, add about one-third to the figures given.

The lowest priced, and in many ways one of our most interesting, small tele-

visers is the Baird *Everyman*, which registered a miniature atom-bomb effect when produced out of the bag on the opening day of Radiolympia. It has a 9-inch tube, has both sound and vision, is a very respectable performer, its appearance is attractive, its overall dimensions are less than a cubic foot, and its cost is about \$78. Very few beans have been spilt so far about its makeup, but I understand that it contains no more than ten tubes and two metal rectifiers in addition to its C-R tube. I need hardly say that with this small complement of tubes it is a short-range set—the sensitivity, in fact, is a pretty large fraction of a millivolt. But it should appeal strongly to the millions of folk who live in districts where television field strength is high.

Other examples of low-priced televisers are the H.M.V. model 1807 (10-inch tube) at \$97, and the Ambassador (10-inch tube) at \$88. These are table models. There are also quite a number of table receivers with 12-inch tubes. Ekco has two at about \$122 apiece, and there are 12-inch table models by Ambassador, Murphy, and Ultra at comparable prices.

I have mentioned that the small screen is not readily accepted. I'll go further and say that there is a noticeable swing in the direction of images of 80 square inches and upward. Consoles with 12-inch tubes are legion, those for television only being priced, on the average, at about \$150, and those with broadcast-band or all-wave

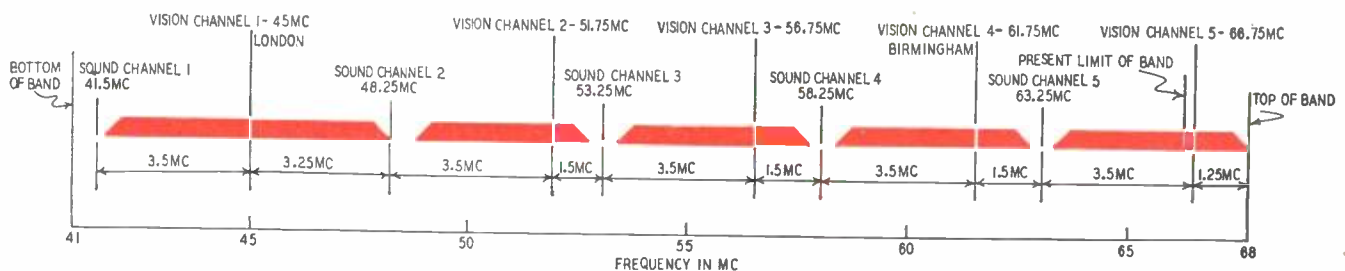

TV channel assignments in Britain. All except No. 1 have asymmetric sidebands. Channels 1 and 4 are those now employed.

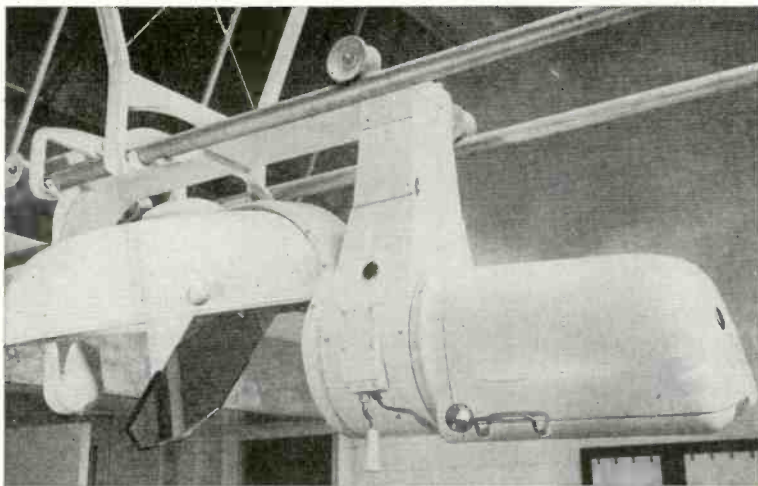

Camera in E.M.I. hospital unit travels on rails over operating table.

radio reception as well, running from about \$200 upward. I know of two models with 14-inch and a half dozen with 15-inch tubes. Most of these big fellows go in for expensive cabinetwork; prices therefore cover a wide field. There is, however, an Ekco 15-inch tube model with four selected broadcast-band "press-button" stations at \$256, and if you want a console housed in a beautiful cabinet and combining all-wave radio with a special high-quality audio end and TV, there's the Haynes at \$440.

Projection sets were numerous at Radiolympia; but I don't believe that more than a few of these will become firmly established on the market. Almost all use the Schmidt system. Many manufacturers are chary of offering a set containing a C-R tube requiring 25 kv, which may have a very short life and give a good deal of trouble. This is not unlikely to happen with some of the 2½-inch, high-voltage, superbrilliant projection tubes available; but the Philips-Mullard people seem confident of the ruggedness and

longevity of their newest tube of this kind, for which an average life of 1,000 hours is claimed.

Using this tube and a modified Schmidt assembly, the Philips big-screen televisor has been designed on novel lines. The cabinet contains the projector, but this throws the image on to a beaded-reflector home movie screen outside the instrument itself. The size of the picture varies, according to the length of the throw, from 16 x 12 inches to about 4 x 3 feet. The extraordinarily bright and clear images live up to the maker's claim that they are as good as those of 16-mm home movies. These sets can apparently be made inexpensively, for the price tentatively suggested for the 4 x 3-foot model is about £100, or \$280.

Speaking of C-R tubes, there are one or two other points I must mention. The newest aluminized Emiscope tubes give a very bright and contrasting picture. To make the most of them the high voltage must be 8 kv or more. Most sets, whether or not they have aluminized tubes, are now using line-flyback for generating the high-voltage EHT, and it is certainly the most satisfactory system where voltages getting into the neighbourhood of 10 kv are called for.

Two television systems specially designed and developed for the instruction of medical students in hospitals are giving most satisfactory results at the great London hospitals, Guy's and the Middlesex. I want to emphasize that these are not just ordinary TV

bits and pieces pressed into occasional service. The apparatus is specially designed for the job, and it is a permanent installation. In the E.M.I. system the transmitter unit incorporates the camera, a specially designed shadowless lamp, and the microphone. The apparatus is suspended from rails above the operating table and the image is delivered to the camera by way of a mirror, which can be tilted at the most suitable angle. The camera has a remotely controlled triple lens system, by means of which the screen can be made to cover a large area on a reduced scale, or to give a natural-sized image, or to give a magnified image of a small area. At the control desk there is a monitor tube and the switches and knobs necessary for making any adjustment that may be required from this remote point. The E.M.I. system is in monochrome, but good definition is obtained by the use of color filters. The Pye Co. has recently developed a system of color television for operating theatres, which gives admirable results.

The Cossor Co. has just introduced an interesting extension unit for TV receivers. I won't go into details as extension televisers are dealt with elsewhere in this issue. I'll just mention one or two of Cossor's striking points. It taps off the TV signal at the modulation terminal of the C-R tube; and it doesn't matter whether the tube is grid- or cathode-modulated, for a phase-reversing switch is provided at the extension. The preset variables of the extension have so wide a range that it is readily adjusted for 405-line, 50-frame-per-second, or 525-line, 60-frame-per-second reception. The price is to be from \$60 to \$70 for the model with 10-inch tube.

From some of the accompanying photographs you'll see what strides have been made in turning the once rather clumsy televisor cabinet into a beautiful piece of furniture. To me the corner model is specially attractive. Not only does it look well and save space, but it allows the TV receiver to be placed where it can do justice to both sound and vision programs.

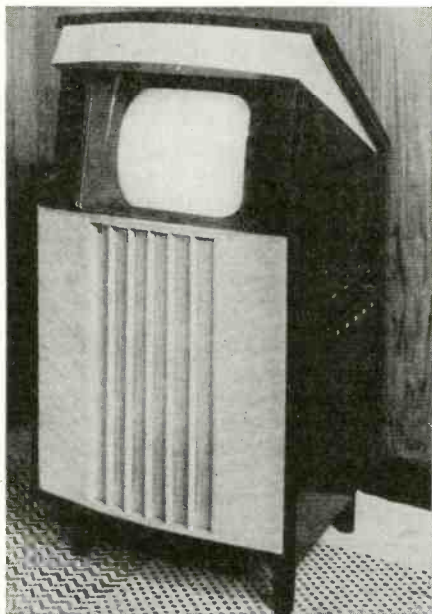

Ekcovision TSC113 has unusual cabinet.

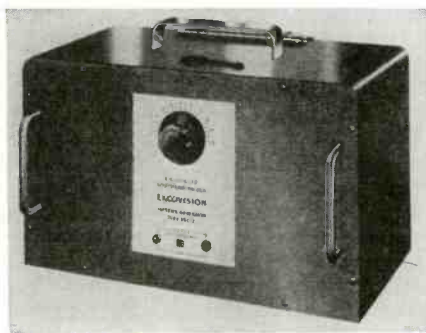

Ekco device generates a testing pattern.

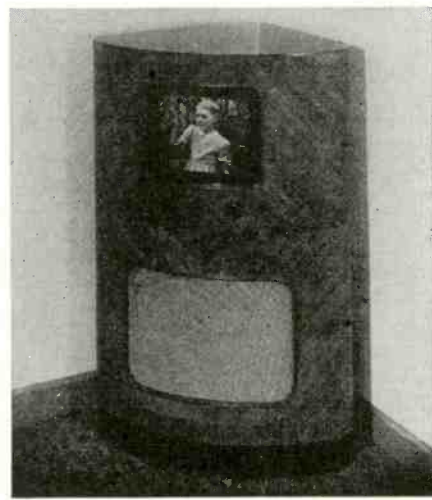

Receiver by Fitton stands in a corner.

Soap Bubbles and Television

By E. AISBERG*

ALL the color-television systems demonstrated or proposed up to the present are based on the trichromatic principle which has long been used in printing.

To reproduce an image in colors, three cuts are made by photographing through yellow, red, and blue filters. These cuts are then printed successively and in careful registry.

We proceed in the same manner in television, breaking the image up into the elementary colors with appropriate filters and transmitting the partial images either successively or simultaneously. These elementary colors are again combined into a color image at the receiver.

The principle is excellent, but it lacks by far the simplicity that characterizes the real solutions of the hardest problems. I do not believe it will be along this path that the best system of transmission in colors is to be found.

Why not imitate Nature, who resorts to the simplest means to produce her most beautiful hues? What can show more varied colors than a soapbubble? A drop of oil on a damp pavement exhibits more variegated colors than the plumage of the rarest of exotic birds. And speaking of birds, do you think the plumes of the peacock owe their iridescence to colored pigments? Then try to scrape them away with your knife. You will be left with nothing but a uniformly grayish-white substance.

All these instances are examples of the well-known phenomenon of the action of thin transparent layers. Our physics texts tell us that when such an exceedingly thin layer is illuminated, part of the light is reflected by the first (top) surface and that part of it penetrates the layer and is reflected by the second (bottom) surface.

The two reflected rays do not follow the same trajectory. That is, they are not at all times in phase. According to the wavelength of the light and the thickness of the layer, certain of the radiations oppose each other and are weakened or extinguished; others find themselves in phase and therefore are strengthened.

Consequently, if we illuminate our thin layer with white light, composed of all the visible wavelengths, only the radiations of certain colors will be visible after their reflection. (One might note, in passing, how much this phenomenon resembles both the fading of

*Editor, *Toute la Radio*, Paris (France)

radio waves and the "dead spots" of the u.h.f.'s.)

Thus, a thin transparent layer which itself is colorless (soapbubble, film of oxide on the surface of a metal, varnish, drop of oil or gasoline) reflects a colored light, the color of which depends solely on its thickness.

Without being able—at the present state of technique—to guess at the concrete means necessary to achieve that objective, I dare to affirm that the true solution of the color problem is offered by this phenomenon of thin transparent layers. And this applies in all the fields

of image reproduction: photography, printing, phototelegraphy, and television.

Television in color will be realized the day that the cathode-ray tube can modify the thickness of thin transparent optical layers on its screen. Then, illuminated by white light, it will produce a living image in complete color, an image which also can be projected easily onto a large screen.

Here, in my opinion, is the path which those researchers who seek to discover the true solution of color television might profitably explore.

(From *Toute la Radio*, October, 1949)

Rebalancing TV Set Inputs

REPRESENTATIVE of the many popular television receivers which use a balanced push-pull input system are the RCA 630TS and 8TS30, Admiral 30A1 chassis, Emerson models 571 and 606, Olympic TV-922, Capehart 501P, and many others.

This type of input is really efficient only when the arrangement is well balanced and when the shunt impedance of the input circuit matches the impedance of the transmission line.

A simple test shows unbalance. Tune in a strong station and disconnect the transmission line. Touch one wire of the line to one input terminal; then touch it to the other terminal. If the signal is stronger at one terminal than the other, there is unbalance. Remedying the situation is very simple; and, in view of the improvement you can expect, it is well worth doing even though it necessitates removing the chassis.

The load on the transmission line is the series value of R1 and R2, 300 ohms. L1 is a choke which acts as a high-pass filter, shorting low-frequency interfer-

ing signals but having a high reactance at TV signal frequencies. If either R1 or R2 changes value with age, one will be greater than the other, destroying balance. Even if both change equally, the impedances will not match. Check R1 and R2 on a good ohmmeter and replace with 150-ohm units if necessary.

The schematic shows that separate inductors are used to tune each plate circuit. If opposite numbers here are not matched, there will be unbalance. If the unbalance is not very bad, you can eliminate it without test equipment.

Tune in the highest-channel, high-band (channel 7-13) station in the area. Adjust the high-band tuning slugs L2 and L3 until the balance test (using the single transmission-line lead as before) shows good balance. Ordinarily both tuning-slug screws should project about equally from the tuning assembly.

Next, tune in the highest-channel station in the low band (channels 2-6) and adjust L4 and L5 for the best possible balance.—Matt Mandl

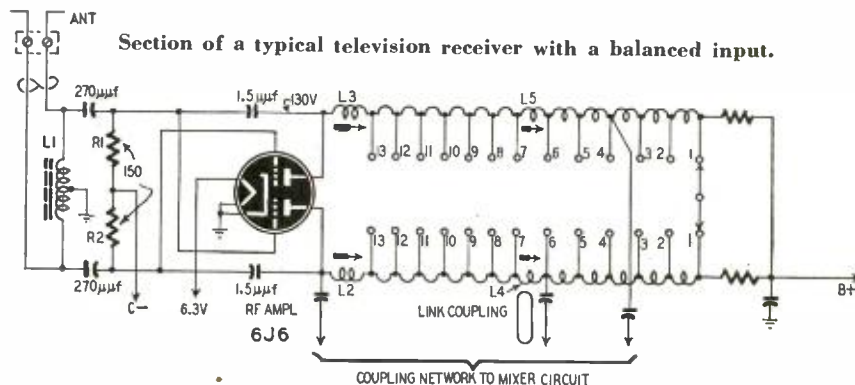

Television Antennas

Directory of manufacturers
and their antenna products

Aero Tower & Rotator Div.,
Knepper Aircraft Service
116 Linden St., Allentown, Pa.
Antenna masts of tubular steel,
built in triangular form, 10 to
198 feet high.

Alliance Mfg. Co.,
Alliance, Ohio
Antenna rotators, with or with-
out direction indicators.

Alprodo, Inc.,
Box 56F, Mineral Wells, Tex.
Aluminum antenna towers, as-
sembled or knocked down in 6-
foot sections. Bases for mount-
ing on vertical, horizontal, or
sloping surfaces.

American Phenolic Corp.,
1830 South 54th Ave.,
Chicago, Ill.
High-gain, multielement, folded
dipoles; one indoor unit. Four
antenna models. Masts, stand-
offs, brackets, transmission lines.

Astatic Corp.,
Conneaut, Ohio
Four-tube, all-channel booster.

Baker Mfg. Co.,
133 Enterprise St.,
Evansville, Wis.
Antenna towers, self-supporting
and guyed, up to 100 feet.

Best Vue Products
247 Centre St., New York, N. Y.
Conical-type antenna, adaptable
for high or low bands; single
or stacked arrays.

Brach Mfg. Co.,
200 Central Ave., Newark, N. J.
Wide- and narrow-lobe, high-
gain arrays, fans and conical
types; indoor V's. Twelve an-
tenna models. Lightning arrest-
ers. Twelve-receiver distribution
system.

Brooklyn Television Co.,
1630 St. Johns Place,
Brooklyn, N. Y.
Straight and folded dipoles; con-
icals. Wall and chimney mounts;
standoffs.

C & G Tool Manufacturers, Inc.,
39 Main Street, East Orange, N. J.
Antenna rotor; mast extenders;
chimney and wall mounts; cop-
per-plated ground rods.

Camburn Inc.,
62-40 57th St., Woodside, N. Y.
Dipoles, folded dipoles, and con-
icals, multielement, single- and
double-bay, high- and low-fre-
quency; indoor V's; window di-
poles. Brackets and mounts, guy
wire, mast extensions, lightning
arresters, ribbon transmission
line.

Channel Chief Co.,
37 Mall Drive,
North Plainfield, N. J.
Square, corner-reflector broad-
band, high-frequency antennas.

Channel Master Corp.,
Napanoch Road, Ellenville, N. Y.
Dipoles and folded dipoles with
reflectors; biconical and fan ar-
rays; in-line-types, three-ele-
ment beams; V's; lazy-H's;
masts. Thirty models.

Circle-X Antenna Corp.,
500 Market St., Perth Amboy, N. J.
Circular, high-gain, wideband
antennas, indoor and outdoor.
Two models.

Commercial Plastics Co.,
1198 Merchandise Mart, Chicago 54
Ethyl cellulose plastic clamp to
support 300-ohm ribbon line.

Communication Measurements Corp.,
120 Greenwich St., New York, N. Y.
Unequal-length folded dipoles
driven by phasing section, for
high, low, and both bands; nar-
row-band, three-element arrays;
pole-mounting antenna selector
switch.

Cornell-Dubilier Electric Corp.,
South Plainfield, N. J.
Single- and double-bay conicals
and folded dipoles with reflect-
ors. Rotators with direction
indicators.

Crown Controls Co.,
124 S. Washington St.,
New Bremen, Ohio
Antenna rotators with direction
indicators.

Delson Mfg. Co.,
126 11th Ave., New York, N. Y.
Dipole, folded-dipole, and con-
ical window antennas; indoor
V's. Six models.

Dielectric Products Co., Inc.,
125 Virginia Ave.,
Jersey City 5, N. J.
All-channel, unidirectional V's
for 72- or 300-ohm line; all-
channel dipoles, bidirectional on
low band, unidirectional on high
band. Twelve models.

Easy-Up Tower Co.,
3800 Kinzie Ave., Racine, Wis.
Prefabricated towers, 30 to 100
feet high.

Electro-Steel Products, Inc.,
112 N. 7th St., Philadelphia 6, Pa.
Indoor triple-loop antenna.

Garrett-Buckley Co.,
624 South Michigan Ave.,
Chicago, Ill.
No information furnished.

General Cement Mfg. Co.,
919 Taylor Ave., Rockford, Ill.
Towers 28 to 100 feet high;
indoor V antennas. Mounts,
brackets, clamps, insulators, and
all accessories. 300-ohm twin
line.

Gonset Co.,
Burbank, Calif.
No information furnished.

Hy-Lite Antennae, Inc.,
528 Tiffany Street, Bronx 59, N. Y.
Multielement conicals, Yagi ar-
rays, folded dipoles.

Industrial Television, Inc.,
359 Lexington Ave., Clifton, N. J.
Master antenna systems to feed
six receivers without, and more
with, amplification equipment.

Insuline Corp. of America,
36-02 35th Ave.,
Long Island City, N. Y.
Wideband biconicals, indoor and
window dipoles. Eleven models.

Jerrold Electronics Corp.,
121 N. Broad St., Philadelphia 7, Pa.
Master antenna system ampli-
fiers, lead-ins, matching net-
works.

JFD Mfg. Co., Inc.,
6101 16th Ave., Brooklyn 4, N. Y.
Multielement and multibay di-
poles, folded dipoles, and con-
icals, with special modifications,
and Yagi beams; window and
indoor antennas. Eighty-eight
antenna models. Masts, exten-
sions, brackets, arresters, and
other accessories.

La Pointe-Plascomold Corp.,
Unionville, Conn.
High-gain antennas, masts,
towers, and mounts, with acces-
sories; transmission lines and
arresters.

Lyte Parts Co.,
15 Washington Ave., Plainfield, N. J.
Ten high- and low-band antenna
models, multielement, multibay
folded dipoles and conicals. Ro-
tators and masts.

McKinney Steel & Sales Co.,
8 Madison St., Waukegan, Ill.
Swivel bases for antenna masts.

Metalac Corp.,
2101 Grand Concourse, Bronx 53, N. Y.
Twenty-four types of mounts for
antenna masts.

Nicholas Equipment Co.,
Bellevue, Ohio
Antenna rotator.

Oak Ridge Antenna,
239 East 127th St., New York, N. Y.
Multielement, multibay dipoles,
folded dipoles, and Yagi arrays;
indoor and window antennas.
Transmission line. Mounting ac-
cessories.

Walter E. Peck, Inc.,
2842 West 30th St.,
Indianapolis 22, Ind.
Six-element, folded-dipole Yagi
beams for low band; single- and
double-stacked, collinear, phased
dipoles and reflectors for high
band. Five models.

Peerless Products Industries,
812 North Pulaski Road,
Chicago 51, Ill.
Indoor telescoping V.

- Penn Boiler & Burner Mfg. Corp., Lancaster, Pa.**
Tripod-type towers in sections, usable to 120 feet; tower bases, turning caps, pole mounts, roof mounts.
- A. A. Peters, 231 North 7th St., Allentown, Pa.**
No information furnished.
- Philson Mfg. Co., Inc., 60 Sackett St., Brooklyn 31, N. Y.**
Wide- and narrow-band arrays; indoor dipoles; masts.
- Phoenix Electronics, Inc., Lawrence, Mass.**
No information furnished.
- Precision Plastic Products, Inc., 628 West Lake St., Chicago 7, Ill.**
Adjustable folded dipoles.
- Premax Products Division, Chisholm-Ryder Co., Inc., Niagara Falls, N. Y.**
Adjustable V-shaped dipoles (outdoor).
- Price Tenna-Trailer Co., 660 East Walnut St., Watseka, Ill.**
Trailer carrying telescoping mast for TV demonstration; telescoping masts for permanent installation.
- Progress Mfg. Co., 2165 Morris Ave., Union, N. J.**
Chimney mounts.
- Rad-El-Co Mfg. Co., 7580 Garfield Blvd., Cleveland 25, Ohio**
Broadband X-type, in-line, and folded-dipole-and-reflector arrays. Five models.
- Radiart Corp., 3571 West 62nd St., Cleveland 2, Ohio**
Single and multielement, single- and multi-stack, folded-dipole arrays for high and low bands; single and stacked conicals; indoor V's. Fifty-six models.
- Mounts, masts, and brackets. Antenna rotators.**
- The Radio Craftsmen, Inc., 1617 South Michigan Ave., Chicago 16, Ill.**
Adjustable indoor "slide-rule" antenna.
- Radio Merchandise Sales, 550 Westchester Ave., New York 55**
Single- and multibay dipoles, folded dipoles, conicals, and special V types; indoor and window antennas. Mounts and hardware. Twenty-five antenna models.
- Radion Mfg. Co., Inc., 1137 Milwaukee Ave., Chicago, Ill.**
No information furnished.
- Raytron Mfg. Co., 441 Summit, Toledo, Ohio**
Single- and double-stacked fans and conicals. Aluminum rods, Plexiglas insulators, and hardware for antenna builders.
- RCA Tube Department, 415 South 5th St., Harrison, N. J.**
Wide- and narrowband arrays, reversible beams, indoor dipoles, V attachments for increasing forward gain of wideband dipoles. Thirteen antenna models. Transmission line, mast mountings, couplings, guy rings.
- Norman N. Sewell, Inc., Susquehanna Ave. at Dearstine, Lansdale, Pa.**
No information furnished.
- Snyder Mfg. Co., 22nd & Ontario Sts., Philadelphia, Pa.**
Dipole, folded-dipole, and conical arrays; indoor antennas. Brackets, masts.
- South River Metal Products Co., Inc., South River, N. J.**
Chimney and wall mounts; standoffs.
- Spirling Products Co., Inc., 62 Grand Street, New York, N. Y.**
Indoor V antennas.
- Square Root Mfg. Co., 901 Nepperhan Ave., Yonkers, N. Y.**
No information furnished.
- Standard Coil Products Co., Inc., 2329 North Pulaski Road, Chicago 39, Ill.**
High-gain booster.
- Technical Appliance Corp., Sherburne, N. Y.**
Stacked and single-bay Yagis, conicals, lazy H's, and folded dipoles; indoor antennas. Forty-one models.
- Tel-A-Ray Enterprises, Inc., P. O. Box 332, Henderson, Ky.**
High-gain multielement dipole antennas.
- Telrex, Inc., 26 Neptune Highway, Asbury Park, N. J.**
Single-bay and multistack conicals.
- Television Laboratories, Inc., 542 N. Parkside Ave., Chicago 44, Ill.**
"Printed" antennas (conducting paint in the shape of a folded dipole on heavy paper).
- Tricraft Products Co., 1535 North Ashland Ave., Chicago 22, Ill.**
End-loaded dipoles, indoor and outdoor; single and stacked conicals.
- U.H.F. Resonator Co., 224 7th St., Racine, Wis.**
High-gain, highly directional, stacked, colinear arrays.
- Unimac Division, Marvin Radio-Television, Buckeye at 89th St., Cleveland, Ohio**
Universal, standard, and chimney mounts.
- Universal Products, 4100 Taylor Ave., Racine, Wis.**
Steel towers, conical antennas, masts. Eleven models.
- Veri-Best Television Products, Inc., 233 Spring St., New York, N. Y.**
Dipoles and folded dipoles with reflectors; indoor V's; mounting brackets.
- Walco Products, Inc., East Orange, N. J.**
Aluminum towers.
- Ward Products Corp., 1523 East 45th St., Cleveland, Ohio**
Single- and multistack, broadband folded dipoles. Fifteen models.
- Warren Mfg. Co., Inc., 250 East St., New Haven, Conn.**
Dipoles and folded dipoles, conicals, fans, and V's.
- J. M. Weaver Co., 267 Kings Road, Madison, N. J.**
All-channel folded dipoles and hardware.
- Western Coil & Electrical Co., 215 State St., Racine, Wis.**
Towers, telescoping masts, and accompanying mounts, guy rings, insulators, etc.
- Wincharger Corp., East 7th & Division Sts., Sioux City 6, Iowa**
Thirteen models of towers.
- Wind Turbine Co., East Market St. & Penna. R.R., West Chester, Pa.**
Ten models of towers.
- Workshop Associates, Inc., 66 Needham St., Newton Highlands, Mass.**
Narrowband arrays with three and twelve elements. Thirty-six antenna models. Masts, mounts, matching transformers, silver-plated connectors.

Overhead Planes Cause TV Flutter

DURING the war, it was a good thing that airplanes reflect high-frequency radio waves so well, radar being one of our most effective weapons. Now this reflecting property is a great annoyance. Many TV owners are bothered by picture flutter caused by passing planes. The TV signal, like a radar beam, is reflected to the receiving antenna by the moving aircraft. Here it adds or subtracts from the direct signal, giving alternately a brighter and darker picture.

The same effect, incidentally, is noticed on FM receivers, due to the high frequency on which they operate. It manifests itself as a rapid fading, and is not as troublesome as on television, partly because of the automatic volume control action and partly because the ear is not as critical as the eye.

It is difficult to experiment with this type of interference because it lasts only a few seconds each time. However, A. H. Cooper describes in *Wireless World* (London, England) his theoretic

investigations supplemented with actual observations (he lives near two airports).

The phase difference of an echo depends upon how much longer it has traveled than has the direct signal. This added time (or distance) is fixed only if the plane travels in an ellipse with receiving and transmitting antennas at the foci. There would be no flutter if a plane were to follow such a course. The picture would be strengthened or weakened by the echo, but it would remain steady.

Since a plane never does fly such an ideal course, flutter does result from an aircraft flying in the neighborhood. While the plane is still distant, the flutter frequency is high, probably more than 20 cycles per second. As the craft approaches, the frequency is reduced. In some cases the image may become completely blacked out for about a second, followed by an intensely brilliant screen for the next second. Then the frequency increases again until the plane disappears.

Flutter may be reduced by automatic gain control (a.g.c.). Unfortunately, this is not the whole solution. The echoes may be progressively swept across the screen, going positive and negative alternately. To make matters worse, these echoes may arrive in time to interfere with the sync pulses. Also echoes of the pulses may interfere with the picture. There are no known cures for these conditions.

Mr. Cooper offers partial solutions. A good directional antenna limits the directions from which echoes can be picked up. (Stacking increases the horizontal pickup at the expense of the vertical, greatly reducing such interference.—*Editor*.) Increased antenna height may also help by increasing the direct signal without greatly changing the reflection. He also finds that a.c. coupling between video amplifier and kinescope is preferable to direct coupling. With a.c. coupling the *average* brightness does not vary during a fade.

—*Nathaniel Rhita*

Directory of TV Receiver Characteristics

1	2	3	4	5	6	7	8	9	10	11	12	13	14	15	16	17	
Manufacturer	Model	Chassis number	Cabinet type	FM-AM-SW	CR tube type	CR tube anode kilovolts	Number of tubes (less rectifiers)	Number of rectifiers	Intercarrier sound	Tuner type	A.g.c. (RF or IF)	A.g.c. (RF or sweep)	AC, DC, Both	FM wave traps	Audio output (watts)	Speaker size (inches)	
Admiral Corp. 3800 Cortland St. Chicago 47, Ill.	4HI26A1, 4HI37A1	21A1	CO	AM-FM	16AP4	13	27	4	No	T	Both	Sweep	AC	No		12	
	17T11, 17T12	17T1	TA	No	73P4	5.5	16	2	Yes	T	Both	No	AC	No		5	
	20X11, 20X12	20X1	TA	No	10BP4	9	17	2	Yes	T	Both	Sweep	AC	No		5	
	20X122	20X1	CO	No	10BP4	9	17	2	Yes	T	Both	Sweep	AC	No		6	
	24A125	20A1	CO	No	10BP4	9	21	3	No	T	Both	Sweep	AC	No		6	
Air King Products Co., Inc. 170 53 St. Brooklyn, N. Y.	24C15, -16, -17	20B1	CO	No	12LP4	9	21	3	No	T	Both	Sweep	AC	No		6	
	25A15, -16, -17	21A1	CO	No	16AP4	13	21	4	No	T	Both	Sweep	AC	No		10	
	30F15, -16, -17	20B1	CO	AM-FM	12LP4	9	27	3	No	T	Both	Sweep	AC	No		10	
	1001A	499-3	CO	No	10BP4	10	19	1	Yes	T	Both	Sweep	AC	No		10	
	A1000	496	TA	No	10BP4	10	28	2	No	T	Both	Sweep	AC	No		2.5	
	A1001	496	CO	No	10BP4	10	28	2	No	T	Both	Sweep	AC	Yes		2.5	
	A1016	496-1	CO	No	16AP4	13.5	28	2	No	T	Both	Sweep	AC	Yes		2.5	
	A2000, A2010	499	TA	No	10BP4	10	18	2	Yes	T	Both	Sweep	AC	No		2.5	
	A2001	499-1	TA	No	12LP4	10	18	2	Yes	T	Both	Sweep	AC	No		2.5	
	A2002	499-2	CO	No	12LP4	10	18	2	Yes	T	Both	Sweep	AC	No		2.5	
Altec Lansing Corp. 1161 North Vine St. Hollywood 38, Calif.	A2012	499-1	CO	No	12LP4	10	19	1	Yes	T	Both	Sweep	AC	No		2.5	
	ALC-202	400	WC	No	12LP4	9	19	2	No	S	No	Sweep	AC	Yes		3.5	
	ALC-203	400	TA	No	12LP4	9	19	2	No	S	No	Sweep	AC	Yes		3.5	
	ALC-204	500	CO	No	12LP4	9.5	21	2	No	T	Both	Sweep	AC	No		3.5	
	ALC-205	516	WC	No	16DP4	13.5	21	3	No	T	Both	Sweep	AC	No		3.5	
Andrea Radio Corp. 27-01 Bridge Plaza North Long Island City 1 New York	ALC-206	516	CO	No	16DP4	13.5	21	3	No	T	Both	Sweep	AC	No		3.5	
	Carenia COVK161	VN15-16	CO	AM-FM	16-in.	13	27	3	No	C	No	Sweep	AC	No		12	
	Gramercy CVK1268	VK12	CO	AM-FM	12 1/2-in.	10.5	26	3	No	C	No	Sweep	AC	No		10	
	Ridgeway CVK1251	VK12	CO	AM-FM	12 1/2-in.	10.5	26	3	No	C	No	Sweep	AC	No		10	
	Saratoga TVK12	VK12	TA	AM-FM	12 1/2-in.	10.5	26	3	No	C	No	Sweep	AC	No		4.5	
	Sharron TVK1278	VK12	CO	AM-FM	12 1/2-in.	10.5	26	3	No	C	No	Sweep	AC	No		4.5	
	Winfield CVK1518	VK151	CO	AM-FM	15 1/2-in.	12.5	27	3	No	C	No	Sweep	AC	No		6.0	
	7061	703	CO	AM-FM	16-in.	13	26	4	No	T	No	Sweep	AC	Yes		8	
	717	P101	CO	No	3NP4 ¹⁰	26	30	6	No	T	No	Sweep	AC	Yes		3	
	718	P101	CO	No	3NP4 ¹²	26	30	6	No	T	No	Sweep	AC	Yes		3	
Ansley Radio and Television, Inc. 41 St. Joes Ave. Trenton 9, N.J.	7191	703	CO	AM-FM	16-in.	13	26	4	No	T	No	Sweep	AC	Yes		8	
	7201	702	CO	AM-FM	12 1/2-in.	9	26	3	No	T	No	Sweep	AC	Yes		8	
	721, 724	705	CO	No	16-in.	13	26	4	No	T	No	Sweep	AC	Yes		3	
	723	703	TA	No	16-in.	13	26	4	No	T	No	Sweep	AC	Yes		3	
	3100TM	703	CO	AM-FM	16-in.	13	26	4	No	T	No	Sweep	AC	Yes		6	
Arvin Radio and Television Noblit-Sparks Industries, Inc. Columbus, Ind.	3120CM	703	TA	No	10BP4	13.5	20	3	No	T	Both	Sweep	AC	No		2	
	3160CM	703	CO	No	12LP4	10	20	3	No	T	Both	Sweep	AC	No		2	
	3180CM	703	CO	No	16AP4	10	20	5	No	T	Both	Sweep	AC	No		2.5	
	3101CM	703	CO	No	10BP4	10	20	5	No	T	Both	Sweep	AC	No		2	
	160C	160C	CO	No	16-in.	13.5	25	4	No	S	Both	Sweep	AC	Yes		4	
Hace Television Corporation Green and Leuning St. 5001 N. Hackensack, N. J.	160TM	160TM	TA	No	16-in.	13.5	25	4	No	S	Both	Sweep	AC	Yes		4	
	190C	190C	CO	No	16-in.	13.5	25	4	No	S	Both	Sweep	AC	Yes		4	
	1500 (16-in. Club)	1500	TA	No	16-in.	12.5	31	2	No	S	Both	Sweep	AC	Yes		4	
	1501 (16 in. Remote)	1501	RE	No	16-in.	12.5	31	4	No	S	Both	Sweep	AC	Yes		4	
	2000 (20-in. Club)	2000	TA	No	20-in.	12.5	32	4	No	S	Both	Sweep	AC	Yes		4	
Bell Television, Inc. 552 West 53 St. New York 19, N. Y.	2001 (20-in. Remote)	2001	RE	No	20-in.	12.5	32	4	No	S	Both	Sweep	AC	Yes		4	
	No information supplied																
	Belmont Radio Co. Division Raytheon Mfg. Co. 59 1 West Dickens Ave. Chicago 49, Ill.	No information supplied															

Company	Model	T1, T2	TA	No AM-FM	10BP4	10	20	3	No	C.S	Both	No	Yes	3	4x6	
Bendix Radio-Television and Broadcast Receiver Division Bendix Aviation Corp. Baltimore 4, Md.	235B1, 235M1, 325M8 ³	T1-5, C11-1	TA	No	10BP4	10	20	3	No	C.S	Both	No	Yes	3	4x6	
	2001	T4-1	CO	AM-FM	10BP4	10	20	3	No	C.S	Both	No	Yes	3	12	
	2020	T4-2	TA	No	10BP4	7	14	2	Yes	T	Both	No	No	1.5	4x6	
	3001, 3002	T4-1	CO	No	12KP4	7.5	14	2	Yes	T	Both	No	No	1.5	4x6	
	Bowers Battery & Spark Plug Co. Reading, Pa.	TC-12		CO	No	10BP4	9	22	2	Yes	S	No	No	No	5	12
		TC-16		CO	No	16AP4	12.6	22	2	Yes	S	No	No	No	5	12
		TTM-10		TA	No	10BP4	7.5	22	2	Yes	S	No	No	No	5	6
		TTM-16		TA	No	16AP4	12.6	22	2	Yes	S	No	No	No	5	6
		812		TA	No	12LP4	9.2	18	2	Yes	S	Both	Sweep	No	No	5
		816		TA	No	16-in.	11	18	2	Yes	S	Both	Sweep	No	No	8
Brunswick Division Radio and Television, Inc. 244 Madison Ave. New York 16, N. Y.	8125		CO	No	12LP4	9.2	18	2	Yes	S	Both	Sweep	No	No	8	
	8165		CO	No	16-in.	11	18	2	Yes	S	Both	Sweep	No	No	10	
	462P12	C-276	CO	No	12 1/2-in.	12	32	2	No	S	Both	Sweep	Yes	5	12	
	661P10		CO	No	10-in.	12	27	2	No	S	Both	Sweep	Yes	5	12	
	B504P16 ⁴		CO	AM-FM	16-in.	12	40	3	No	S	Both	Sweep	Yes	12	12	
	3001 ⁶	CX30	TA	No	12 1/2-in.	12	19	3	No	S	Both	Sweep	Yes	5	6	
	3001-B, -M ⁵	C-272	TA	No	12 1/2-in.	12	19	3	Yes	C	Both	Sweep	No	5	6	
	3002 ⁶	CX30	CO	No	12 1/2-in.	12	19	3	Yes	C	Both	Sweep	No	5	8	
	3002-B, -M ⁵	C-272	CO	No	12 1/2-in.	12	19	3	Yes	C	Both	Sweep	No	5	8	
	3004 ⁶	CX31	CO	AM-FM	12 1/2-in.	12	30	2	No	T	Both	Sweep	No	12	12	
3004-M ⁵ , 4001-M ⁴	C-268	CO	AM-FM	12 1/2-in.	12	30	2	No	T	Both	Sweep	No	12	12		
3006 ⁷	CX31	CO	AM-FM	16-in.	12	30	2	No	T	Both	Sweep	No	12	12		
3006-M ⁵	C-274	CO	AM-FM	16-in.	12	30	2	No	T	Both	Sweep	No	12	12		
4001 ³	CX31	CO	AM-FM	12 1/2-in.	12	30	2	No	T	Both	Sweep	No	12	12		
504P16 ⁴	U12	CO	AM-FM	16-in.	12	40	3	No	T	Both	Sweep	No	12	12		
Cascade Television Co. 179-181 South St. Newark 5, N. J.	Cascade	F30	CO	No	16-in.	13	26	4	No	T	Both	No	Yes	5	12	
	Cascade Junior	125D	TA	No	15-in.	13	27	4	No	T	Both	No	Yes	5	5x7	
	Cascade Custom ²	F38-1X3	RE	No	5-in. 13	25	32	6	No	T	Both	No	Yes	5	12	
	Certified	48-10	K	No	7 1/2	3	16	2	No	S	No	No	No	2	4x6	
Sovereign Brooklyn 19, N. Y.	4920	K	K	No	10BP4 ¹⁴	10	18	2	Yes	T	Both	Sweep	No	2.5	4x6	
	520		CO	No	12LP4	9.5	20	2	Yes	S	IF	Sweep	Yes	3.5	12	
536		CO	No	16DP4	13.5	20	3	Yes	S	IF	Sweep	Yes	3.5	12		
Convertible Television, Inc. 630 5th Ave. New York 20, N. Y.	The Essex	10T149	TA15	FM16	10-in. 16		19	3	Yes	RT	Both	No	No	5	5	
	The Hampshire	16T170	TA15	FM16	16-in. 16		19	3	No	RT	Both	No	No	5	5	
	The Sussex	12C160	TA15	FM16	12 1/2-in. 16		19	3	No	RT	Both	No	No	5	5	
	9-403MA	227	TA	FM	10BP4	8.5	18	3	No	I	No	Sweep	No	3.5	7x5	
	9-404M ³ , 9-414B ³	228, 229	CO	AM-FM	10BP4	8.5	21	3	No	I	No	Sweep	No	4	10	
	9-409M Family Theater ³	226, 276	CO	AM-FM	12QP4	8.5	28	5	No	I	No	Sweep	No	4	10	
	9-419M Popularity ⁸	277	TA	FM	12LP4	8.5	23	4	No	I	No	Sweep	No	3.5	7x5	
	9-422M Master Showman ⁸	232	CO	FM	16AP4	11.5	24	5	No	I	No	Sweep	No	4	10	
	9-424B	270	CO	FM	10BP4	8.5	18	3	No	I	No	Sweep	No	4	10	
	9-425		PO	No	7 1/2	5.8	19	3	Yes	S	Both	No	No	1.8	5	
Delco, United Motors Service Division of General Motors Corp. General Motors Building Detroit 2, Mich.	TV-102 ⁹		TA	No	10BP4	8.5	21	2	Yes	S	Both	No	No	2	6 1/2	
	TV-121		CO	No	12LP4	11.5	21	2	Yes	S	Both	No	No	3	6 1/2	
	TV-122		CO	No	12LP4	11.5	21	2	Yes	S	Both	No	No	3	6 1/2	
	TV-160		CO	No	16AP4	10.5	21	2	Yes	S	Both	No	No	3	8	
DeWald Radio Mfg. Company United Scientific Laboratories 35-15 37 Avenue Long Island City 1, New York	BT-100		TA	No	10BP4	9.2	26	4	No	S	Both	Sweep	Yes	4	6 1/2	
	CT-101		CO	No	16AP4	10	26	4	No	S	Both	Sweep	Yes	4	6 1/2	
	CT-102, CT-103		TA	No	10BP4	9.2	19	3	No	S, T	Both	Sweep	Yes	3	6 1/2	
	CT-104, CT-120		TA	No	12LP4	10	19	3	Yes	S, T	Both	Sweep	Yes	3	6 1/2	
	CT-160		TA	No	16AP4	12	19	3	No	S	Both	Sweep	Yes	3	6 1/2	
	CT-2000		CO	No	3NP4 ¹³	25	29	8	No	S	Both	Sweep	Yes	4	12	
DTX-160, DTX-161		TA	No	16AP4	12	19	3	Yes	S	Both	Sweep	Yes	3	6 1/2		
Allen B. Du Mont Laboratories 85 Market St. East Patterson, New Jersey	Bradford ³	RA-108	CO	FM	19AP4	14	30	6	No	I	IF	Sweep	No	2.5	12	
	Club 20 ⁸	RA-106	CO	FM	20BP4	16	29	6	No	I	Both	Sweep	No	2.5	10	
	Colony ³	RA-105	CO	AM-FM	15AP4	10	34	7	No	I	Both	Sweep	No	8	12	
	Hastings ⁸	RA-104A	TA	FM	15DP4	8.5	25	5	No	I	No	Sweep	No	2.5	6	

1	2	3	4	5	6	7	8	9	10	11	12	13	14	15	16	17	
Allen B. Du Mont Labs. (cont'd)	Manchu ⁸ Ranson ⁸ Savoy ⁸ Sheffield ⁸ Sussex ⁸ Westwood ⁸	RA-106	CO	AM-FM	20BP4	16	35	7	No	I	IF	Sweep	AC	No	8	12	
		RA-103D	TA	FM	12QP4	8	25	5	No	I	No	No	Sweep	AC	No	2.5	6
		RA-108	CO	AM-FM	12JP4	8.5	30	4	No	I	No	No	Sweep	AC	No	2.5	10
		RA-103D	CO	FM	12QP4	8	25	5	No	I	No	No	Sweep	AC	No	2.5	10
		RA-105B	CO	FM	15DP4	12	29	6	No	I	IF	No	Sweep	AC	No	2.5	12
RA-110A	CO	FM	19AP4	8.5	25	5	No	I	No	No	Sweep	AC	No	2.5	12		
Electromatic Manufacturing Corp. 88 University Place New York 3, New York		500100	TA	No	10BP4	9	17	4	Yes	S	Both	Sweep	AC17	No	4	6	
		500100	TA	No	10BP4	9	17	4	Yes	S	Both	Sweep	AC17	No	4	6	
		500100A	TA	No	12CP4	9	17	4	Yes	S	Both	Sweep	AC17	No	4	6	
		500100B	TA	No	15CP4	11	17	4	Yes	S	Both	Sweep	AC17	No	4	6	
		7B	K	No	7JP4	6	16	3	No	S	S	IF	No	AC	No	5	5
Electro-Technical Industries 1432 North Broad Street Philadelphia 21, Pa.	Telekit 7B Telekit 10B Telekit 16B	10B	K	No	10BP4	9	16	2	No	S	IF	Sweep	AC	No	5	5	
		10B	K	No	16AP4	14	16	2	No	S	S	IF	Sweep	AC	No	5	6x8 6x8
		120103B	PO	No	7JP4	6	19	2	Yes	T	Both	Both	Sweep	Both ¹⁷	No	2	4
		120089B	CO	No	16AP4	13	22	7	Yes	T	Both	Both	Sweep	AC17	No	3	12
		120084B	CO	No	3NP4 ¹³	25	25	9	Yes	T	Both	Both	Sweep	AC17	No	5	12
		120110B	TA	No	10BP4	8	20	3	Yes	T	Both	Both	Sweep	AC	No	3	6
		120098B	TA	AM-FM	10BP4	8.5	25	3	Yes	T	Both	Both	Sweep	AC	No	3	6
		120088P	CO	AM-FM	10BP4	8.5	25	3	Yes	T	Both	Both	Sweep	AC17	No	3	12
		120104B	CO	No	16AP4	13	22	7	Yes	T	Both	Both	Sweep	AC17	No	3	12
		120107B	TA	No	12LP4	8	20	6	Yes	T	Both	Both	Sweep	AC17	No	3	6
		120099B	CO	AM-FM	12LP4	8.5	25	3	Yes	T	Both	Both	Sweep	AC	No	3	12
		120109B	TA	No	16AP4	13	22	4	Yes	T	Both	Both	Sweep	AC17	No	3	6
		120096B	CO	AM-FM	16AP4	13	25	4	Yes	T	Both	Both	Sweep	AC	No	3	12
		120087B	CO	No	10BP4	8	20	6	Yes	T	Both	Both	Sweep	AC17	No	3	6
		120109B	TA	No	7JP4	6	19	2	Yes	T	Both	Both	Sweep	Both ¹⁷	No	2	4
120113B	TA	No	12LP4	8	20	3	Yes	T	Both	Both	Sweep	AC	No	3	6		
Espey Manufacturing Company 528 East 72 Street New York 21, New York	TV3K	TV3K	K	No	3-in.	0.98	16	2	No	S	No	Sweep	AC	No	2	3	
Fada Radio and Electric Co., Inc. 525 Main Street Belleville, N. J.	TV30	TV30	TA	No	10-in.	8.5	26	4	No	S	No	Sweep	AC	Yes	5x7	5x7	
		880	CO	No	3NP4 ¹²	25	30	6	No	S	No	No	Sweep	AC	Yes	10	10
		895 ³	CO	AM-FM	12 $\frac{1}{2}$ -in.	9.5	27	3	No	S	No	No	Sweep	AC	Yes	10	0.5
		925	TA	No	16-in.	12.5	27	4	No	S	No	No	Sweep	AC	Yes	5x7 ¹	5x7 ¹
		930	TA	No	12 $\frac{1}{2}$ -in.	9.5	27	3	No	S	No	No	Sweep	AC	Yes	10	10
		940	CO	No	12 $\frac{1}{2}$ -in.	9.5	27	3	No	S	No	No	Sweep	AC	Yes	10	10
Federal Television Corp. 139 Duane Street New York 3, New York	Commodore ³ Dover ¹⁹ Essex ¹⁹ Manhattan ¹⁹ Mohawk New Yorker ¹⁹ Pacemaker	1600C	CO	AM-FM	16DP4	12.5	27	4	No	I	Both	Sweep	AC	No	4	12	
		1200D	CO	FM	12LP4	9	24	2	No	I	Both	Both	Sweep	AC	No	4	12
		1600E	CO	FM	16DP4	12.5	24	4	No	I	Both	Both	Sweep	AC	No	4	12
		1600M	TA	FM	16DP4	12.5	24	4	No	I	Both	Both	Sweep	AC	No	4	5x7
		1200N	TA	No	16DP4	12.5	23	4	No	I	Both	Both	Sweep	AC	No	4	5x7
		1600P	CO	FM	12LP4	9	24	2	No	I	Both	Both	Sweep	AC	No	4	12
Fisher Radio Corp. 41 East 47th Street New York, N. Y.	No information supplied																
Freed Radio Corp. 200 Hudson St. New York, N. Y.	No information supplied																
Garod Electronics Corporation 70 Washington Street Brooklyn 1, New York	10TZ20, 10TZ22 (Tele-Zoom) ²¹ 104Z (Headliner) ²¹ 12TZ20, 12TZ22 (Tele-Zoom) ²¹	98	TA ²⁰	AM-FM	10BP4	9	22	4	No	C	Both	Sweep	AC	Yes	2	6 ⁹⁶	
		94	TA	No	10BP4	8.5	16	3	Yes	C	Both	Sweep	AC	No	2	5	
		93	TA ²⁰	AM-FM	12LP4	9	22	4	No	C	Both	Sweep	AC	Yes	2	6 ⁹⁶	

Company	Model	TA	No. AM-FM	12LP4	8.5	16	3	Yes	C	Both	Sweep	AC	No. Yes	5
General Electric Company Receiver Division Electronics Park Syracuse, New York	1244 (Madison)	TA	No	12LP4	8.5	16	3	Yes	S	Both	Sweep	AC	No	5
	151Z24 (Tele-Zoom) ²¹	CO	No	15LP4	10	22	5	No	C	Both	Sweep	AC	Yes	10
	1546 (Newport)	TA	No	16LP4	10	16	3	Yes	C	Both	Sweep	AC	No	6
	1548 (Raleigh)	CO	No	16LP4	10	16	3	Yes	C	Both	Sweep	AC	No	10
	10C101	CO	No	10-in.	10.5	18	3	Yes	S	Both	Sweep	AC ¹⁷	Yes	10
	10T1, 10T4, 10T5	TA	No	10-in.	10.5	18	3	Yes	S	Both	Sweep	AC ¹⁷	Yes	4
	12C101, 12C102, 12C105	CO	No	12 1/2-in.	10.5	18	3	Yes	S	Both	Sweep	AC ¹⁷	Yes	12
	12K1 ¹	CO	No	12 1/2-in.	10.5	24	4	Yes	S	Both	Sweep	AC ¹⁷	Yes	12
	12T1	TA	No	12 1/2-in.	10.5	18	3	Yes	S	Both	Sweep	AC ¹⁷	Yes	4
	800	TA	No	10-in.	10.5	18	3	Yes	S	Both	Sweep	AC ¹⁷	Yes	4
Hallicrafters 4401 West Fifth Avenue Chicago, Ill.	600 ⁶	TA	No	10-in.	9	18	2	Yes	S	Both	Sweep	AC	No	1.5
	601, 602 ⁶	TA ²⁰	No	12 1/2-in.	12	18	2	Yes	S	Both	Sweep	AC	No	1.5
	603, 604 ⁶	TA ²⁰	No	16-in.	13	18	2	Yes	S	Both	Sweep	AC	No	1.5
	C610	TA	No	10BP4	9	22	2	No	T	Both	Sweep	AC	No	3
	C612	TA	No	12LP4	9	22	2	No	T	Both	Sweep	AC	No	3
	C912, C913 ²²	CO	No	16AP4	12.5	36	5	No	T	Both	Sweep	AC	No	15
	600	TA	No	10BP4	9	22	2	No	T	Both	Sweep	AC	No	3
	601	TA	No	12LP4	9	22	2	No	T	Both	Sweep	AC	No	3
	613	TA	No	12LP4	9	25	2	No	T	Both	Sweep	AC	No	3
	820, 821, 822	CO	No	12LP4	9	22	2	No	T	Both	Sweep	AC	No	3
Hoffman Radio Corporation 3761 South Hill Street Los Angeles, Calif.	826, 827, 828	CO	No	16AP4	12.5	23	4	No	T	Both	Sweep	AC	No	3
	830, 831	CO	No	16AP4	12.5	23	4	No	T	Both	Sweep	AC	No	3
	836, 837, 840	CO	No	19AP4	12.5	24	4	No	T	Both	Sweep	AC	No	3
	914, 915 ³	CO	No	12LP4	9	25	2	No	T	Both	Sweep	AC	No	3
	917, 918, 920 ³	CO	No	16AP4	12.5	26	4	No	T	Both	Sweep	AC	No	3
	Century 326 ²	CO	No	16FP4	14	30	5	No	T	No	Sweep	AC	Yes	12
	Century 821D	TA	No	12LP4	11	17	3	Yes	T	Both	Sweep	AC	Yes	3
	Century 921D	CO	No	12LP4	11	17	3	Yes	T	Both	Sweep	AC	Yes	3
	D-12	TA	No	12 1/2-in.	9	27	4	No	S	No	Sweep	AC	No	4 1/2
	D-16	CO	No	16-in.	14	27	4	No	S	No	Sweep	AC	No	4 1/2
International Television Corp. 238 William Street New York 7, New York	630TS	CO	No	19-in.	14	27	4	No	S	No	Sweep	AC	No	4 1/2
	No information supplied													
	Lytel & Co. 4721 N. Kedzie Avenue Chicago, Ill.													
	Magnavox Company, The Fort Wayne, Ind.													
	American Modern ³	CO	AM-FM	12KP4 ²³	12	22	3	No	S	Both	Sweep	AC	Yes ²⁶	18
	American Traditional ³	CO	AM-FM	12KP4 ²³	9	22	3	No	S	Both	Sweep	AC	No	4 ²⁸
	Brittany	CO	No	16AP4	14	22	4	No	S	Both	Sweep	AC	Yes ²⁶	4
	Constellation	TA	No	16AP4	14	22	4	No	S	Both	Sweep	AC	Yes ²⁶	4
	Contemporary, Normandy	CO	No	16AP4	14	22	4	No	S	Both	Sweep	AC	Yes ²⁶	4
	Embassy ⁵	CO	All	12KP4 ²³	12	22	3	No	S	Both	Sweep	AC	No	20
Embassy 150 ³	CO	All	16AP4 ²⁴	14	23	4	No	S	Both	Sweep	AC	No	15 ³⁰	
French Provincial ³	CO	AM-FM	12KP4 ²³	9	22	2	No	S	Both	Sweep	AC	No	4 ²⁹	
Hepplewhite ⁶	CO	AM-FM	12KP4 ²³	9	22	2	No	S	Both	Sweep	AC	No	4 ²⁸	
Modern Symphony	CO	No	12KP4 ²³	9	22	2	No	S	Both	Sweep	AC	Yes	4	
Modular	TA	No	12KP4 ²³	9	22	2	No	S	Both	Sweep	AC	No	4	
Windsor Bookcase ²⁵	TA	No ⁵	12KP4 ²³	12	22	3	No	S	Both	Sweep	AC	Yes	45	
Mars Television, Inc. 29-05 40th Road Long Island City, New York	631	CO	No	16HP4	13.5	27	4	No	T	Both	Sweep	AC	Yes	4
	Baldwin	TA	No	12RP4	10	27	4	No	T	No	Sweep	AC	Yes	4
	LaSalle ³¹	CO	No	16HP4	13.5	28	4	No	T	Both	Sweep	AC	Yes	4
	Princeton ³¹	TA	No	16HP4	13.5	28	4	No	T	Both	Sweep	AC	Yes	4
	No information supplied													
Mattison Television and Radio Corp. 220 Fifth Ave. New York 1, N. Y.	XD-704	TA	No	7JP4	4	19	4	Yes	S	Both	No	AC ¹⁷	No	2
	XE-705	PO	No	7JP4	4	19	4	Yes	S	Both	No	AC ¹⁷	No	2
John Meek Industries, Inc. Plymouth, Ind.														

1	2	3	4	5	6	7	8	9	10	11	12	13	14	15	16	17																																											
John Meck Industries, Inc. (Cont'd) Brooklyn 8, N. Y.	XM-751 XQ-776 XR-778 XS-786 XT-785	TA TA CO CO TA	No No No No No	10BP4 12LP4 12LP4 16DP4 16DP4	9 9 9 11 11	17 17 17 17 17	3 3 3 3 3	Yes Yes Yes Yes Yes	S S S S S	Both Both Both Both Both	Sweep Sweep Sweep Sweep Sweep	AC AC AC AC AC	No No No No No	2 2 2 2 2	5 5 10 10 5																																												
																Meissner Manufacturing Division Mt. Carmel, Ill.	TV-132 24TV32	TA WC	No No	12KP4 12KP4	9 9	22 22	3 3	No No	S S	No No	2 2	5 5																															
																													Motorola, Inc. 4545 Augusta Blvd. Chicago, Ill.	7VT2, 7VT5, 9VT1 10VT10-24, 10VK12-22 TS-14 TS-23 HS-19036 12VF43 12VK15 TS-80 16VK7 TS-1637 16VF83	TA33 TA35 TA35 CO CO CO CO CO CO	No No No AM-FM No No No AM-FM	7JP434 10BP4 12LP4 12LP4 13 13 13	6 10 10 10 24 24 24 24 32	15 18 18 24 24 24 24 32	3 3 3 543 544 544 638	Yes Yes Yes Yes Yes Yes Yes Yes	S S S S S S S S	IF Both Both Both Both Both Both	Sweep Sweep Sweep Sweep Sweep Sweep Sweep	AC17 AC87 AC87 AC AC AC AC AC	No No No No No No No No	1.5 1.5 1.5 1.541 2.6 2.6 2.645 1.242																
																																												Multiple Television Mfg. Co. 987 Hegeman Ave. Brooklyn 8, N. Y.	No information supplied	TA TA CO CO	No No No No	10BP4 12LP4 12LP4 16-in.	8 8 10 11	14 14 14 14	2 2 2 2	Yes Yes Yes Yes	T T T T	Both Both Both Both	Sweep Sweep Sweep Sweep	AC AC AC AC	No No No No	1.5 1.5 1.5 1.5	
																																																											Muntz T. V., Inc. 1785 Belmont Avenue Chicago, Ill.
National Company, Inc. 61 Sherman Street Malden 48, Mass.	NC-TV-7W, NC-TV-7M NC-TV-10W NC-TV-12T, NC-TV-12C NC-TV-1225	TA TA TA CO	No No No No	7JP4 10BP4 12LP4 12LP4	5 10 12 12	18 20 20 20	3 2 2 2	Yes Yes Yes Yes	S S S S	Both Both Both Both	Sweep Sweep Sweep Sweep	AC AC AC AC	No No No No	2 3 3 3																																													
															Nielsen Television Corporation Newton Ave. at Crawford Road Norwalk, Conn.	1018B 1018 1218 1618	CO TA TA CO	No No No No	10-in. 10-in. 12-1/2-in. 16-in.	8 8 9 11	27 27 27 27	3 3 3 4	No No No No	S S S S	Sweep Sweep Sweep Sweep	AC AC AC AC	Yes Yes Yes Yes	12 6 6 12																															
																													Pathe Television Co. 5302-98 Second Avenue Brooklyn 92, New York	12-1 12-10	TA CO	No No	12LP4 12LP4	10 10	18 18	2 2	Yes Yes	S, T S, T	Both Both	Sweep Sweep	AC AC	No No	2.5 2.5																
																																												Philco Corporation C and Troga Sts. Philadelphia 34, Pa.	702 11046 11056 1400, 1401, 14026 14308 14438 1477, 1478, 1479, 148146, 1482 148346 163046	TA TA TA TA CO CO CO CO	No No No No No AM-FM AM-FM	7JP4 10BP4 10BP4 12LP4 12LP4 12LP4 12LP4 16LP4	5 8 7 9 9 10 9 10	17 20 20 20 20 22 25 26 22	3 2 3 2 2 4 4 5	No No No No No No No No	S S S S S T T T	Both Both Both Both Both Both Both Both	Sweep Sweep Sweep Sweep Sweep Sweep Sweep Sweep	AC AC AC AC AC AC AC AC	No Yes No Yes Yes No No No	1.5 1.5 1.5 1.5 1.5 2.5 5 5 5	
																																																											Philharmonic Radio Corporation 119 West 57 St. New York 19, New York
Pilot Radio Corporation 97-06 36 St. Long Island City, New York	TV-37 TV-42 TV-47, TV-48 TV-1218 TV-9523	PO CO CO TA CO	No No No FM AM-FM	3KP4 3NP412 16AP4 12LP4 3NP412	2 25 15 10 25	17 30 30 22 4	3 4 4 3 4	Yes No No Yes No	C C C C S	No Both Both Both Both	No No No No No	Sweep Sweep Sweep Sweep Sweep	AC17 AC AC AC AC	0 8 5 3 3																																													
															Radio Corp. of America Front and Cooper Sts. Camden, New Jersey	9-PC-412 9-T-2468 9-T-2708 9-TC-2408 9-TC-2458 9-TC-247, 9-TC-2498 9-TC-272, 9-TC-2758 9-TW-3906	CO TA TA CO CO CO CO CO	No No No No No No No All	5TP447 10-in. 16-in. 10-in. 12-in. 12-in. 16-in. 16-in.	28 9 5 12 9 10 10 12 12	34 22 23 22 22 22 23 23	7 2 4 2 2 2 4	No No No No No No No	S S S S S S S	IF Both Both Both Both Both Both	Sweep Sweep Sweep Sweep Sweep Sweep Sweep	AC AC AC AC AC AC AC	Yes Yes Yes Yes Yes Yes Yes																															

Radio Craftsmen, Inc., The 1617 South Michigan Ave. Chicago 16, Ill.	RC 100	RC 100	WC	16-in.	13	25	4	No	T	Both	Sweep ¹³	AC	No	10 ¹⁰	No	
Regal Electronics Corp. 608 West 130 St. New York 27, N. Y.	1007	TA	No	10BP4	9.5	18	2	Yes	T	Both	Sweep	AC	No	3	4x6	
	1031	TA	No	10BP4	9.5	27	3	No	S	No	Sweep	AC	Yes	4	5x4	
	1207	TA	No	12LP4	11	18	2	Yes	T	Both	Sweep	AC	No	3	4x6	
	1208	CO	No	12LP4	11	18	2	Yes	T	Both	Sweep	AC	No	3	12	
	1230	TA	No	12LP4	11	27	3	No	S	No	Sweep	AC	Yes	4	5x7	
	1607	TA	No	16DP4	12.5	18	2	Yes	T	Both	Sweep	AC	No	3	4x6	
	16731	TA	No	16DP4	12.5	27	4	No	S	No	Sweep	AC	Yes	4	5x7	
	16736 ⁸	TA	AM-FM	16DP4	12.5	37	4	No	S	No	Sweep	AC	Yes	4	5x7	
	Remington Radio Corp. 80 Main St. White Plains, New York	Georgian, 80, 1606, 1950	CO ⁵⁰	FM	12-in.	11	23	2	No	I	Both	Sweep	AC	No	5	8
		130, 721, 1606-15	CO ⁵⁰	FM	15-in.	11	23	2	No	I	Both	Sweep	AC	No	5	10
		Night Watch	CO	FM	19-in.	11	24	2	No	I	Both	Sweep	AC	No	5	10
	Scott Radio Laboratories 4541 North Ravenswood Chicago 40, Ill.	400B	TA	No	3NP4 ¹³	25	27	6	No	S	Both	Sweep	AC	No	2.5	6
		800BT ⁸	CO	All	3NP4 ¹³	25	48	3	No	S	Both	Sweep	AC	No	20	15 ¹¹
		9T47 ³	CO	No	16-in.	11.5	50	10	No	S	Both	Sweep	AC	No	20	13 ¹¹
		9T48 ³	CO	All	16-in.	11.5	46	10	No	S	Both	Sweep	AC	No	20	15 ¹¹
12T		TA, WC	No	12LP4	9	28	3	No	T	IF	Sweep	AC	Yes	2.5	6	
Shevers, Inc., Harold 33 West 46 St. New York 19, N. Y.	16Q, 16CL, 16C, 16R, 16ET	CO ⁶⁵	No	16FP4	12.5	28	4	No	T	IF	Sweep	AC	Yes	2.5	12	
	12 ^{1/2} -S-4 ³⁷	TA	No	12 ^{1/2} -in.	11	21	2	Yes	C	No	Sweep	AC	Yes	4	8	
Sightmaster Corp. 385 North Ave. New Rochelle, N. Y.	12 ^{1/2} -D-4 ³⁷	TA	FM	12 ^{1/2} -in.	11	22	2	No	I	No	Sweep	AC	No	4	8	
	16-C-8 ⁹⁷	CO	No	16-in.	13.5	21	2	Yes	C	No	Sweep	AC	Yes	4	8	
	16-D-8 ⁹⁷	CO	FM	16-in.	13.5	22	2	No	I	No	Sweep	AC	No	4	8	
	16-S-8 ⁹⁷	TA	No	16-in.	13.5	21	2	Yes	C	No	Sweep	AC	Yes	4	8	
	19CD9 ⁵⁷	CO	FM	19-in.	14	27	4	No	I	Both	Sweep	AC	No	4	8	
	Auditorium ¹³	CO	FM	5TP4	30	34	4	No	I	No	No	No	AC	Yes	11	12
	Champion	TA	FM	12LP4	10	28	2	No	I	No	No	No	AC	Yes	4.5	5x7
Crusader	CO	No	12LP4	10	17	2	Yes	I	No	No	No	AC	No	4.5	8	
Spartan Radio Television 2400 East Ganson St. Jackson, Mich.	24TL10	CO	AM-FM	10BP4	10	25	2	No	S	Both	Sweep	AC	No	2.5	10	
	24TM10	CO	AM-FM	12LP4	10	25	2	No	S	Both	Sweep	AC	No	2.5	10	
	23TC10A	CO	No	12LP4	10	21	2	No	S	Both	Sweep	AC	No	2.5	10	
	4944 ³	CO	No	16AP4	12	25	2	No	S	Both	Sweep	AC	No	2.5	10	
	4950, 4951, 4952	TA	No	10BP4	10	25	2	No	S	Both	Sweep	AC	No	2.5	4x6	
	4954	TA	No	10BP4	10	21	2	No	S	Both	Sweep	AC	No	2.5	4x6	
	4960, 4961	TA	No	12LP4	10	21	2	No	S	Both	Sweep	AC	No	2.5	4x6	
	4900TV, 4901TV ³	CO	AM-FM	12LP4	10	25	2	No	S	Both	Sweep	AC	No	2.5	10	
	4939TV, 4940TV ³	CO	No	10BP4	10	25	2	No	S	Both	Sweep	AC	No	2.5	10	
	Starrett Television Corp. 601 West 26 St. New York 1, N. Y.	Adams ¹	CO	AM-FM	12 ^{1/2} -in.	9	32	3	No	S	Both	Sweep	AC	Yes	3.5	12
Ambassador		TA	No	16-in.	13	26	4	No	S	Both	Sweep	AC	Yes	3.5	5x7 ¹⁸	
Cleveland ¹ , John Hancock ¹		CO	AM-FM	16-in.	13	32	4	No	S	Both	Sweep	AC	Yes	3.5	12	
Cosmopolite ¹ , Washington ¹		CO	AM-FM	16-in.	13	38	5	No	S	Both	Sweep	AC	Yes	15	12	
Gotham ¹ , Lincoln ¹		CO	AM-FM	16-in.	13	38	5	No	S	Both	Sweep	AC	Yes	15	12	
Henry Hudson, Henry Parks		TA ²⁰	No	16-in.	11	19	2	No	S	Both	Sweep	AC	No	3.5	16 ⁶⁸	
Jefferson		CO	No	12 ^{1/2} -in.	9	17	2	Yes	S	Both	Sweep	AC	No	3	4x6	
King Arthur		TA	AM-FM	20-in.	13	32	4	No	S	Both	Sweep	AC	Yes	3.5	12	
Nathan Hale		TA	No	12 ^{1/2} -in.	9	17	2	Yes	S	Both	Sweep	AC	Yes	3	4x6	
Robert Fulton		CO	AM-FM	12 ^{1/2} -in.	9	23	3	Yes	S	Both	Sweep	AC	No	3	10	
Stewart-Warner Electric Div. 5, Stewart Warner Corp. 1826 Diversy Parkway Chicago 14, Ill.	9100J	TA	No	10BP4	9.5	21	3	Yes	T	Both	Sweep	AC	No	6	6	
	9109B ⁶	TA	No	12LP4	8	22	3	Yes	T	Both	Sweep	AC	No	6	6	
	9108C	CO	No	12LP4	8	22	3	Yes	T	Both	Sweep	AC	No	6x9	6	
	9104A ⁷	TA	AM-FM	12LP4	8	27	3	Yes	T	Both	Sweep	AC	No	6	6	
	9104B ^{1,5}	CO	AM-FM	12LP4	8	27	3	Yes	T	Both	Sweep	AC	No	6x9	6	
	9105A ^{1,6}	CO	AM-FM	3NP4 ¹³	20	30	6	Yes	T	Both	Sweep	AC	No	12	12	

1	2	3	4	5	6	7	8	9	10	11	12	13	14	15	16	17
Stromberg Carlson Co. 100 Carlson Rd. Rochester, N. Y.	Century TC-125-HM. Brentwood TC-125-LM ³ Chinese Classic TS-125-M5M ³ Dorset TS-125-HM Emperor TC-19-LM ³ Manhattan TG-10-H Monmouth TS-16-M1M ³ Somerset TS-16-PM ³ Weymouth TS-125-LM Yarmouth TS-16-L1M	TC-125 TS-125 TS-125 TC-19 TC-10 TS-16 TS-16-PM TS-125 TS-16	TA ²⁰ CO TA CO TA CO CO CO CO CO CO	No AM-FM AM-FM No No AM-FM AM-FM AM-FM AM-FM AM-FM	12QP4 12LP4 ⁶⁰ 12LP4 ⁶⁰ 19AP4 10BP4 16AP4 16AP4 12LP4 ⁶⁰ 16AP4	9 9 18 9 13 18 13 13	22 43 43 29 22 43 43 43 43	2 2 1 1 2 2 2 2	Yes No No Yes Yes No No No No	C C C C C C C C	Both Both Both Keyed Both Both Both Both	Sweep Sweep Sweep Sweep Sweep Sweep Sweep Sweep	AC AC AC AC AC AC AC AC	No No No No No No No No	3 10 8 3 5 10 12 8	8
Sylvania Television 1290 Main St. Buffalo, N. Y.	075 076 090 113 114 125 128 210		TA CO CO CO CO TA CO CO TA		10-in. 10-in. 16-in. 10-in. 12 1/2-in. 12 1/2-in. 12 1/2-in. 12 1/2-in.		24 28 24 24 24 24 24 28 24	3 3 5 3 3 3 3 3							5 1/4 10 10 8 8 5 1/4 12 5 1/4	
Tech Master Products Co. 443 Broadway New York, New York	930 1250 1530, 1530C 1631 1632 2031 BC1223 (Blue Ribbon)		All ⁵¹ All ⁵¹ All ⁵¹ All ⁵¹ All ⁵¹ All ⁵¹ All ⁵¹	No No No No No No No	10BP4 12LP4 15-in. 16-in. 16-in. 19-in. 12LP4	9 9 13 13 13 13 9	28 28 29 29 30 29 22	2 2 2 2 2 2 1	No No No No No No No	S S T.S T.S T.S T.S T	No No No Both Both Both	Sweep Sweep Sweep Sweep Sweep Sweep Sweep	AC AC AC AC AC AC AC	Yes Yes Yes Yes Yes Yes No	2.5 2.5 2.5 2.5 2.5 2.5 2.5	4 4x6 6 1/4 6 1/4 6 1/4 6 1/4 4x6
Tele King Corp. 601 West 26 St. New York 1, New York	510 616 712 816		TA CO TA ²⁰ TA	No No No No	10BP4 16CP4 12LP4 16CP4	8.5 13 8.5 13	16 16 16 16	3 4 3 4	Yes Yes Yes Yes	S S S S	Both Both Both Both	Sweep Sweep Sweep Sweep	AC AC AC AC	Yes Yes Yes Yes	3 3 3 3	4x6 8 4x6 10
Telegrip Radio Company 1901 South Washitena Chicago 8, Ill.	12 112 116 212 216		TA TA TA CO CO	No No No No No	12LP4 12LP4 16GP4 ⁵⁵ 12LP4 16GP4 ⁵⁵	8 9 9 9 9	17 17 17 17 17	1 1 1 1 1	Yes Yes Yes Yes Yes	S T T T T	Both Both Both Both Both	No Sweep Sweep Sweep Sweep	AC AC AC AC AC	No No No No No	2 2 2 2 2	4x6 4x6 4x6 6x9 6x9
Tele Tone Radio Corp. 540 West 58 St. New York 19, New York	TV 220 ⁶ TV 254, TV 255 ⁶ , 69 TV 284, TV 287, TV 288 TV 286	TK TT TH, TJ	PO TA TA ⁵⁶ CO	No No No No	7JP4 10BP4 12TP4 ³³ 16AP4	6.2 8.1 9.2 13.5	21 19 20 21	2 2 2 3	Yes Yes Yes Yes	S S S S	IF IF IF IF	No Sweep Sweep Sweep	AC ¹⁷ AC AC AC	No No No No	2 3.5 4 4.5	4x6 4x6 4x6 10
Televista Corp. of America 12-01 44 Ave. Long Island City, New York	Electra, Imperial, President, Trafton	104	WC ³⁸	No	16DP4	11.5	20	2	No	T	No	Sweep	AC	Yes	4	12
Trad Television Corporation 1001 First Avenue Asbury Park, New Jersey	13-E, 14, 15-E ² D-250		CO CO	FM No	5TP4 ¹³ 16AP4	27 11	33 27	3 4	No No	S S	No No	Sweep Sweep	AC AC	Yes Yes	5.6 3.4	12 12
Transvision Inc. 460 North Ave. New Rochelle, New York	1 2 3 4 5 6 10 13	WRS WRS WR WR WR A A	CO CO CO TA TA TA TA TA	No No No No No FM No	10BP4 12LP4 16DP4 10BP4 12LP4 16DP4 10BP4 12LP4	10 10 11 10 10 11 10 10	17 17 17 17 17 17 21 21	2 2 2 2 2 2 2 2	Yes Yes Yes Yes Yes Yes No No	C C C C C C S C	No No No No No No No No	No No No No No No Sweep Sweep	AC AC AC AC AC AC AC AC	No No No No No No No No	4.5 4.5 4.5 4.5 4.5 4.5 4.5 4.5	4x6 6x9 6x9 4x6 4x6 6x9 4x6 4x6

Model	Manufacturer	WHS	CO	No	16DP4	11	17	2	Yes	C	No	No	AC	No	4.5	6x9	
27	Traylor Radio Corp. 571 West Jackson Blvd. Chicago, Ill.	A	CO	No	16DP4	11	21	2	No	I	No	No	AC	No	4.5	6x9	
33		A	CO	FM	16DP4	11	21	2	No	I	No	No	Sweep	No	4.5	6x9	
633		A	CO	FM	16DP4	11	21	2	No	I	No	No	Sweep	No	4.5	6x9	
16AD ⁵⁹		A	K	FM	16DP4	11	21	2	No	I	No	No	Sweep	No	4.5	6x9	
16AS ⁵⁹		A	K	FM	16DP4	11	21	2	No	S	No	No	Sweep	No	4.5	6x9	
W12RS ⁵⁹		WRS	K	No	16DP4	11	17	2	2	Yes	C	No	No	AC	No	4.5	6x9
W16RS ⁵⁹	WRS	K	No	16DP4	11	17	2	2	Yes	C	No	No	AC	No	4.5	6x9	
12 TM	United States Television Mfg. Corp. 8 West 61 Street New York 23, New York	12 T	CO	No	12LP4	10	21	2	Yes	T	Both	Both	AC	No	1.5	6x9	
16 TM		16 T	CO	No	16AP4	12.5	22	2	Yes	T	Both	Both	AC	No	1.5	6x9	
C-12924 ⁸	Vidcraft Television Corporation 780 East 137 Street New York 54, New York		CO	No	12-in.	8	22	2	No	T	No	No	AC	No	6	12	
CFM-12824, CFM-15925, CFM-19930, KFM-19980 ⁸			CO	FM	15-in. 61	8.5 ⁿ	23	2	No	T,C	No	No	AC	No	6	12	
KRV-15993 ³			CO	AM-FM	10-in.	8.5	27	6	No	T	No	No	AC	No	8	12	
T-10824 ⁵			TA	No	10-in.	8	22	2	No	T	No	No	AC	No	6	5	
T-12924 ⁸			TA	No	12-in.	8	22	2	No	T	No	No	AC	No	6	5	
T-15925 ⁸			TA	No	15-in.	8.5	22	2	No	T	No	No	AC	No	6	5	
T-19980 ⁸		TA	No	15-in. 61	14.5	23	2	No	T,C	No	Yes	Yes	AC	No	10	12	
1200 ⁸	Vidcraft Television Corporation 780 East 137 Street New York 54, New York	1200	TA	FM	12 1/2-in.	7.5	21	3	No	T	Both	Both	AC	Yes	4	6	
1600 ⁸			TA	FM	16-in.	12	24	3	No	T	Both	Both	AC	Yes	4	8	
1601 ⁸			CO	FM	16-in.	12	24	3	No	T	Both	Both	AC	Yes	4	12	
1602 ¹			CO	AM-FM	16-in.	12	32	4	No	T	Both	Both	AC	Yes	4	12	
VS-160, VS-161 VS-166, VS-167, VS-168	Video Corporation of America 229 West 28 Street New York 1, New York		TA	No	16-in.	12	16	2	Yes	T	Both	Both	AC	Yes	4	8	
			CO	No	16-in.	12	16	2	Yes	T	Both	Both	AC	Yes	4	8	
H-600T16 ⁶	Westinghouse Electric Corporation Home Receiver Division 1354 Susquehanna Avenue Sunbury, Pa.	V-2150-61	TA	No	16JP4	12	25	3	Yes	S	Both	Both	AC	No	4.5	6	
H-601K12, H-602K12 ⁶			CO	No	12LP4	11	25	3	Yes	S	Both	Both	AC	No	4.5	10	
H-603C12, H-608C12 ³			CO	AM-FM	12KP4A	11	28	4	Yes	S	Both	Both	AC	No	11	10	
H-604T10 ⁶			TA	No	10BP4	9	23	2	Yes	S	Both	Both	AC	No	1.5	4	
H-630T12 ⁶⁴			TA	No	12RP4	11	25	3	Yes	S	Both	Both	AC	No	4.5	5	
9-302 9-400 9-422 9-462	Wilcox-Gay Corporation Charlotte, Mich.		WC ⁶²		12BP4	8	19	3	Yes	T	Both	Both	AC	No	3	12	
			WC ³⁰		10BP4	8	19	3	Yes	T	Both	Both	AC	No	3	12	
			WC ²⁰		12BP4	8	19	3	Yes	T	Both	Both	AC	No	3	12	
			WC ²⁰		12BP4	8	19	3	Yes	T	Both	Both	AC	No	3	12	
G2346R, G2340R, G2553R G2441R, G2442E, G2442R, G2448R ⁹ G2957R, G2958R ⁹ G3059R, G3062 ⁹	Zenith Radio Corporation 6001 Dickens Ave. Chicago 39, Ill.	23G22	CO	No	12UP4A	10	20	3	Yes	T	Both	Both	AC	No	3.5	7	
			24G22	CO	No	16EP4	12	21	3	Yes	T	Both	Both	AC	No	3.5	7
			23G23	CO	AM-FM	12UP4A	10	20	3	Yes	T	Both	Both	AC	No	3.5	12
			24G23	CO	FM-AM	16EP4	12	21	3	Yes	T	Both	Both	AC	No	3.5	12

Codes for TV receiver tabulation

- C Continuous
- CO Console or console
- I Input
- K Kit
- PO Portable
- S Separate cabinets.
- T Turret
- TA Table model
- WC Wired chassis
- 1 With 3-speed phono
- 2 Has remote control
- 3 With phono, type not specified
- 4 Has built-in antenna, 3-speed phono, Polatron picture tube
- 5 Has built-in antenna, Polatron picture tube
- 6 Has built-in antenna, phono switch and jack
- 7 Has built-in antenna, phono connections
- 8 Phono connections
- 9 Has electronic picture magnifier
- 10 36 x 48-inch picture (projection)
- 11 Co-axial speaker

- 32 Has extension speaker jack
- 33 Model 7VT5 is portable
- 34 Model 9VT1 has 8BP4 C-R tube
- 35 10VK12, 10VK22, 12VK11 are consoles
- 36 Also chassis 16LP4
- 37 Model 284 is console
- 38 Two of the rectifiers are selenium
- 39 Model 7TV5 has 6 1/2-inch speaker
- 40 8-inch speaker on Models 10VK12 and 12VK11, 6-inch on 10VK22
- 41 1-watt output on AM-FM radio
- 42 Also has a 5-inch speaker
- 43 Three of the rectifiers are selenium
- 44 One rectifier is selenium
- 45 3.8 watts output from AM-FM radio
- 46 With tunable built-in antenna and 3-speed phono except on Model 1477 which has a 2-speed phono
- 47 15 x 20-inch projection picture
- 48 8 watts output from AM-FM radio
- 49 Three volts into 500-ohm input of RC2 10-watt amplifier
- 50 1950 and 721 are table models
- 51 Except portable. Model 2031 except portable and table
- 52 Also 20-inch pictures
- 53 Vertical and horizontal sweep
- 54 Other speakers up to 10-inch available
- 55 Also uses 16LP4
- 56 Model 284 is console
- 57 Remote control optional
- 58 Also available as table models and in console cabinets
- 59 Remote control and phono optional
- 60 Also 12KP4 or 12QP4
- 61 Also available with 16-inch tube
- 62 Also table model
- 63 With built-in antenna, 3-speed phono, and electronic magnifier
- 64 With built-in antenna, electronic magnifier
- 65 Also wired chassis and table model with 4 x 6-inch speaker
- 66 10-inch speakers on consoles
- 67 Transformerless low-voltage supply with filament transformer
- 68 Some sets have 5 x 7-inch speakers
- 69 No built-in antenna on TV-254
- 70 H-608C12 also uses chassis V-2149-3
- 71 14.5 kv on CFM-19930 and KFM-19930

Making Large Electrets

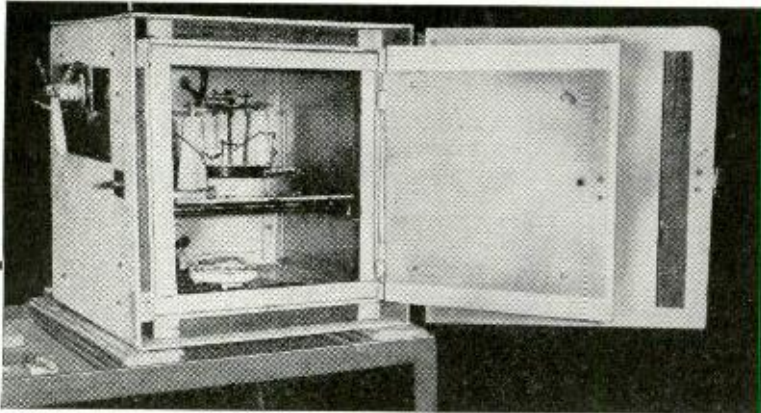

Fig. 1—Aluminum-walled angle-iron oven has Transite insulation.

SIMPLY stated, the electret is made by pouring melted wax between two metal plates to which a high direct voltage is applied. The voltage remains on until the mixture solidifies. When it cools, the wax disc has become electrostatically charged, with a positive and a negative surface. This charge remains.

Many materials will take on a temporary charge but M. Eguchi of Tokyo published the first reports on electrets of the so-called permanent kind. This type is made of equal parts carnauba wax and resin with 10% beeswax. When removed from the charging plates, it usually shows a minus charge where the plus plate touched it and a plus charge opposite the minus plate. Later the electret reverses polarity and the new charges are permanent.

Early work with electrets indicated that some method for rapid, though not necessarily highly accurate, means should be provided for making comparative measurements of electrostatic field strength. The device must also indicate polarity. The vacuum-tube voltmeter was naturally the answer. The first instrument used had an input impedance of 5,000 megohms and proved very satisfactory until summer weather arrived with high humidity. Erratic readings were traced directly to leakage paths. The obvious solution was to use a comparatively low-impedance meter, which meant increasing the output of the electret.

Past experience indicated that the output depends on the surface area, which should be increased until the electrostatic field would cause an indication on a standard 10-megohm-input vacuum-tube voltmeter (this instrument was free from humidity effects). A final diameter of 7 inches was selected as a good balance between output and manufacturing limitations.

The cooling oven

Fig. 1 is a photograph of the oven. A 14-inch-square framework of $\frac{3}{4}$ -inch

angle iron was built up. Two pieces of angle were mounted inside, about 5 inches from the bottom, as a shelf support. Five sides are covered with $\frac{1}{16}$ -inch aluminum sheet, and a door of aluminum provided. A 4 x 5-inch cutout on the left side about 3 inches from the top is covered with a sheet of Bakelite in which holes were drilled for the high-voltage leads. The metal box is covered with Transite, held about 1 inch from the metal surface by wood spacers.

A sheet of Bakelite measuring about 5 x 10 inches and $\frac{1}{8}$ inch thick was mounted over a cutout in the left side of the Transite. Next, two standoff insulators were mounted on a second 3 x 6-inch piece of which is attached to the first Bakelite, with 1-inch screws and nuts. Flexible leads run from the underside of the 1-inch screws, through

New 7-inch electrets supply enough output Voltage to energize a 2-watt neon lamp

By VICTOR H. LAUGHTER

the interior heat reaches about 400 degrees F. A thermometer projecting from the top left is a laboratory unit about 12 inches long. The thermometer bulb rests near the wax solution, but there is, of course, some difference between the indicated temperature and the exact heat of the solution. The heat of the wax is 5 to 10 degrees above that shown by the thermometer.

A metal grill of $\frac{1}{4}$ -inch iron rod is placed on the shelf angles to support the wax container.

The wax pan

Fig. 2 is a photo of the wax-holding assembly. One part is an aluminum plate 11 inches square and $\frac{1}{4}$ -inch thick, with two $4\frac{1}{2}$ -inch-high standoff insulators. The aluminum crossbar has a slot in each end to allow adjustment.

In the center of the crossbar is a

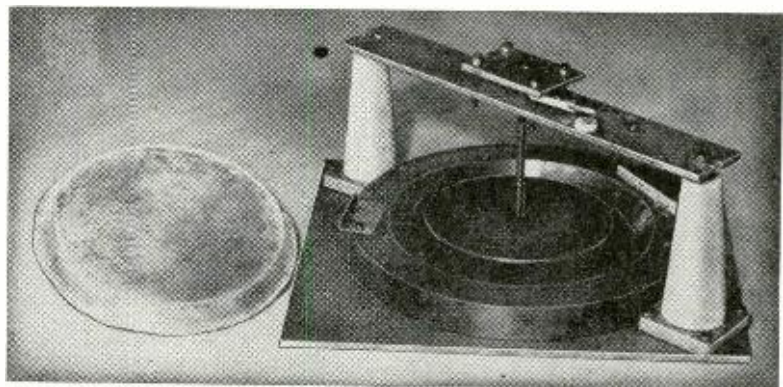

Fig. 2—Wax holder includes a pan and a crossbar for upper electrode.

holes in the Bakelite which covers the aluminum, to the inside of the oven. Short flexible leads with alligator clips at each end connect the outside ends of the 1-inch screws with the tops of the screws which mount the insulators.

A 600-watt heating element is at the bottom and another is at the top. Asbestos-covered line cords are used, as

brass ball that has been drilled and threaded. The ball is held in place by an aluminum top plate held to the crossbar with screws and compression springs. The brass ball is a swivel joint. A threaded brass rod is fastened to the ball at one end and to a $5\frac{1}{2}$ -inch-diameter disc at the other. The disc is the upper high-voltage plate, and the

RADIO-ELECTRONICS for

tracted from lignite. Hard, brittle, lustrous, it has a melting point of about 170 degrees F. Its color is brown.

Ouricury wax. This is obtained from leaves of the ouricury palm. Melting point is about 185 degrees F. It has a brown color.

Ethyl Cellulose. Viscosity 100, type N. A white granular powder. Melting point depends on the wax with which it is mixed.

TABLE I

Volts	Ma	Temp. (F)	Minutes
6,300	45	195	0
5,600	60	186	10
3,125	90	172	20
1,250	120	169	22
800	130	168	25
300	130	128	100
1,000	125	126	110
1,250	120	120	118
3,200	90	106	130
5,800	50	88	148
8,000	20	82	175
8,600	10	70	210

Electret mixtures

The basic mixture of equal parts carnauba and resin, with 10% beeswax, makes an excellent electret, when the diameter does not exceed 4 inches. A suitable mix for the 7-inch diameter is 3 oz. of carnauba, 1 oz. yellow beeswax, 1 oz. white refined beeswax, and 1.5 oz. of resin. Run the mix through a filter to remove foreign matter.

Table III gives the data for a typical run of the latter mixture. The temperature was 198 degrees F at the start and 100 degrees F when the last reading was taken.

The electret made from this mixture reverses immediately after removal from oven. It shows an excellent homo charge on both surfaces.

The addition of ethyl cellulose pro-

TABLE II

Volts	Ma	Temp. (F)	Minutes
6,800	35	175	0
6,950	32	150	33
7,500	28	142	68
8,000	20	126	83
8,700	10	116	123

duces a hard, high-gloss electret that will not crack under normal conditions, and raises the melting point according to the proportion of ethyl cellulose used. However, the cellulose tends to decrease the crystalline structure of the waxes which is proven in the finished electrets.

Candelilla wax makes an electret that gives a strong hetero charge which gradually reduces to a minus hetero surface of indefinite life. Five ounces of reworked candelilla and 1 oz. of Montan wax make an electret that will end up with a strong homo charge on the minus side and hold this final charge over a long period. The addition of the montan lifts the conductivity of the mixture to a maximum of about 300 ma from the usual 35-50 ma of candelilla alone. It is possible that the ad-

TABLE III

Volts	Ma	Minutes
1,800	115	0
3,750	90	37
4,900	70	54
5,900	50	71
7,500	30	103
8,600	10	116
8,700	08	143

dition of a small amount of montan wax would improve the charge of other electrets, as the greater conductivity may allow more perfect fibering. Candelilla and carnauba wax will not make a satisfactory electret. Electrets made from this wax act about the same as candelilla though they do not show the rising current of Table I.

Testing electrets

A vacuum-tube voltmeter may be used for testing electrets. A zero-center meter is best. A piece of 4 x 5-inch brass or phosphor bronze .01 inch thick, with a 1/2 inch portion at the long end bent up at right angles and punched, is attached to the voltmeter probe. The instrument is set on the 3-volt scale. The electret is laid on a piece of metal and the ground test lead connected to this piece. Swing the probe to the electret and the meter will indicate a positive or minus surface. Turn the electret over and it should read in the opposite direction. Generally the negative meter swing will be greater.

The readings are not indicative of the actual voltage values. The estimated potential near the surface of an electret is 20,000 volts. The electret has only a minute power output; therefore, when the probe begins to approach it, the power begins to dissipate through the load impedance of the meter; and only a small portion of the output is indicated. If the probe plate can be laid on the electret and then removed rapidly, a reading will be obtained opposite to that when approaching. H. Gernsback suggested the small neon glow lamp (Fig. 4) as an indicator of electret output. The neon lamp has all the necessary requirements as it offers infinite impedance until ionization begins. Immediately ionization begins, though, a short circuit is put across the electret and the ionization ceases.

The original small-size electrets gave a dim flash in complete darkness. The present 7-inch size flashes a G-E 2-watt NE34 neon in normal room light.

Turbulent action

A turbulence can be observed in the wax mixture, between the edge of the upper plate and the pan. Fig. 5 is a cross-section drawing of a portion of the plate and pan. The upper plate is positive and the pan negative. For viewing this effect a special wax mixture is used, 3 3/4 oz. of candelilla and 2 1/4 oz. of No. 1014 Halo wax.

In the perfect fluid state no action can be observed; but when the mixture begins to cool down, small particles of the Halo begin to move. Some particle takes on, say, a minus charge and starts in the direction of the upper, plus-charged plate. When near this plate, it becomes positively charged and is repelled, and is attracted by the minus lower charge. This action is repeated by the bottom plate, resulting in rotation. A nucleus 1/8 to 1/16 inch in diameter gathers at the center, and bands are formed around the circumference of the upper plate in broken sections. The nucleus rotates, windmill fashion, collecting and losing particles due to centrifugal action, as indicated in Fig. 5. The photograph of Fig. 6 shows the solution, the upper plate, and the lower pan. The white band around the solution is the nucleus. The details are not sharp enough to illustrate the rotating particles.

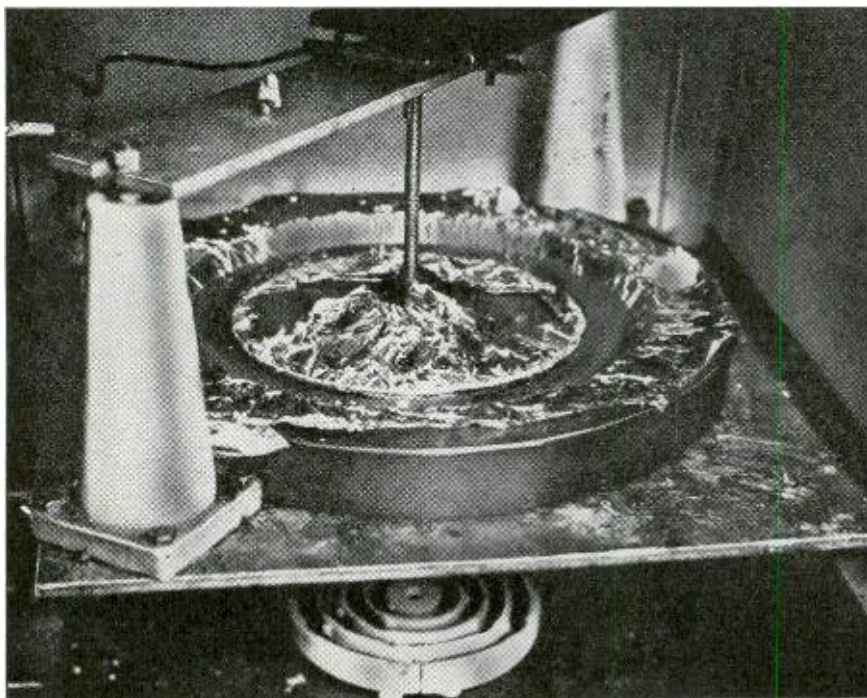

Fig. 6—Light-colored circle in liquid wax indicates turbulence noted in text.

There's Only ONE COMPLETE CATALOG that Brings You EVERYTHING IN RADIO, TELEVISION & ELECTRONICS

IT'S YOUR **FREE**
ALLIED 196-PAGE
 VALUE-PACKED CATALOG!

SEND FOR IT TODAY



Get Radio's Leading Buying Guide

Here's the Buying Guide to *everything* in radio for *everyone* in radio! It's the *one complete* catalog, preferred in the field because it fills *every* TV, Radio, and Electronic supply need. It's packed with the world's largest selections of quality equipment at lowest money-saving prices. See the latest in TV, AM and FM receivers; radio-phonos; new Sound Systems, P.A. equipment and high-fidelity sound components; recorders and accessories; full selections of newest Amateur receivers and station gear; test instruments; builders' kits; huge listings of parts, tubes, tools, books, diagrams.

ALLIED gives you every buying advantage: speedy delivery, expert personal help, lowest prices, assured satisfaction—plus the most liberal Time Payment plan in radio. Get the 1950 ALLIED Catalog—it will save you time and money. Send today for your FREE copy!

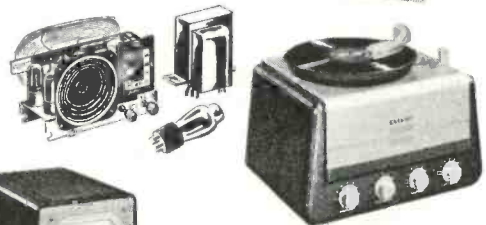

WORLD'S LARGEST STOCKS

*Radio Parts Unlimited
 Test Instruments—All Makes
 Television & Home Radios
 P. A. and Hi-Fi Equipment
 Amateur Station Gear
 Experimenters' Supplies*

QUICK, EXPERT SERVICE

ALLIED IS YOUR TELEVISION HEADQUARTERS



You keep up with TV when you depend on ALLIED! Count on us for the latest releases and largest stocks of picture tubes, component parts, antennas and accessories—plus the latest in TV receivers, tuners and kits. If it's anything in TV—we have it in stock! So remember—for TV—it's ALLIED First!

ALLIED RADIO

THE WORLD'S LARGEST RADIO SUPPLY HOUSE

Everything in Radio, TV and Electronics

Send for Radio's Leading Buying Guide

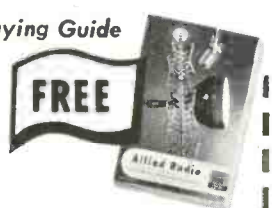

ALLIED RADIO CORP.
 833 W. Jackson Blvd., Dept. 2-A-0
 Chicago 7, Illinois

Send FREE 196-page 1950 ALLIED Catalog.

Name

Address

City Zone State

Fundamentals of Radio Servicing

Part XI—The Pentode vacuum tube

By JOHN T. FRYE

MORE than 20,000 miles a second! That's the speed at which an electron hits the plate of the tetrode described last month. No wonder that the terrific impact of the speeding electron knocks other electrons loose from the plate. It's like throwing an apple at an apple tree; if you throw it hard enough, a whole shower of fruit falls to the ground.

Up to now the only emission we had run into was that from the cathode, caused by heat, but now we have electrons emitted from the plate—and with-

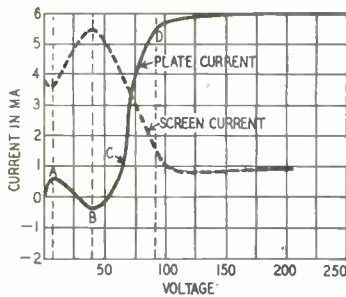

Fig. 1-a—Curves show tetrode behavior.

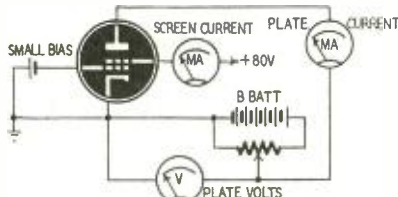

Fig. 1-b—Circuit for obtaining curves.

out any heat at all! This kind of knock-'em-loose emission is called *secondary emission* because it can't take place until a "primary" electron from the cathode comes along to do the knocking.

Secondary emission in a triode bothers no one. The plate is usually the only positive electrode in the tube and its irresistible fascination for the negative secondary electrons pulls them right back where they came from. The negative grid helps to shoo them on their way.

But the tetrode is a different story, for the screen is also positive, and some of the secondary electrons are attracted to it. The plate actually loses electrons to the screen. This wrong-way traffic is just about as upsetting inside our tube as it would be on a one-way street. Collisions occur between the "in reverse" electrons and those emitted

from the cathode; furthermore, electrons arriving from the cathode are repelled by the cloud of secondary electrons surrounding the plate.

The graph of Fig. 1-a shows these upsetting effects. The curves show how plate and screen currents vary when the plate voltage is changed. During the experiment, the screen is held at 80 volts. The test circuit appears in Fig. 1-b. Beginning with zero plate voltage (potentiometer arm at grounded end), plate current is zero. There is screen current, because the screen is 80 volts positive and acts like a plate.

Now we run up a little plate voltage, say about 10 volts. There is a little rise in plate current and a little drop in screen current because some of the electrons from the cathode are reaching the positive plate instead of going to the screen. The attraction of the plate is not great enough to make them travel really fast, so they dislodge no secondary electrons from the plate.

As the plate voltage rises above the 10-volt level, however, the electrons speed up and a few secondary electrons are knocked off the plate. Remember that the total plate current is made up of the electrons that reach it from the cathode *minus the secondary electrons grabbed by the screen*. As the plate voltage rises, the speed gets higher and higher, knocking off more and more secondary electrons for the screen to steal. As the graph plainly shows, the net plate current between voltages A and B actually gets *less* as the plate voltage rises, and the screen current increases! After a while, in fact, the impact of primary electrons is so great that each one of them knocks loose *several* secondary electrons from the plate. This is clearly a losing proposition—the plate is giving up more electrons that it is getting. So, as the solid curve shows, not only does the net plate current go down to zero, but it actually flows in the wrong direction. We indicate this topsy-turvy state of affairs by showing "negative" (wrong-direction) plate current.

As the voltage is increased beyond point B, the growing attraction of the plate begins to enable it to hold its own against the siren call of the screen. A higher percentage of the secondary electrons commence to fall back onto the plate instead of going to the screen

grid, and the plate current starts to increase again. At point D the plate has become positive enough to put an end to the screen's theft of its electrons, and it reclaims *all* of its emitted particles. From this point on, the plate current is little affected by the plate voltage. The screen and control grid voltages, determine the plate current, as we learned in Chapter X.

If the plate voltage always stayed in the region beyond point D; secondary emission would cause no trouble; but when a tube is working in a circuit, the plate current is constantly changing. By the same token, so is the plate voltage, because of the varying drop across the plate load resistance. (See last installment.) In fact, when the grid is driven strongly positive, the plate voltage may dip *below* the screen voltage.

When this happens, we have lost a good bit of our ability to control the plate current solely with the signal grid. For, as we have just seen, a change in the plate voltage in this lower-voltage region has a very decided effect on the plate current on its own hook. If we are to avoid the bad effects of this double control, we must either keep signal voltages very small so that the plate voltage will not swing down near the screen voltage, and thus sacrifice a large portion of the tube's ability to amplify; or we must use a very high plate voltage to insure the same thing even with increased ampli-

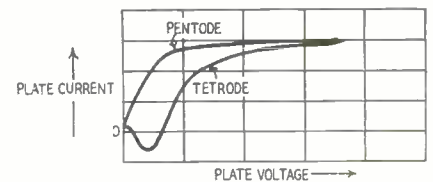

Fig. 2—Adding suppressor alters curve.

fication. What is really needed is some device that will put a stop to this dominance secondary emission gives to plate voltage over plate current.

Just such a device is the *suppressor grid*, which looks much like the control and screen grids, although the spacing between turns is usually greater. It is found between the plate and screen and is connected—often inside the tube—to the cathode. This is the fifth element added to our tube, so the family name of *pentode* (*pente* is Greek for five) is

SYLVANIA'S EXTENSIVE NATIONAL ADVERTISING IS Building business for *you* every minute!



LOOK FOR THIS SIGN OF DEPENDABLE RADIO SERVICE

If your television becomes a terrible vision, call the expert who displays the Sylvania service sign. He knows these complex sets inside out... has the "savvy" to make the delicate adjustments and repairs they sometimes need. He relies on super-keen Sylvania testing devices to detect and diagnose troubles accurately... Sylvania radio tubes, the proper television picture tubes and other custom parts to restore perfect sight and sound. Stop at the shop showing the Sylvania sign for top television and radio repairs.

SYLVANIA RADIO TUBES
PRODUCT OF SYLVANIA ELECTRIC PRODUCTS INC.



LOOK FOR THIS SIGN OF DEPENDABLE RADIO SERVICE

Whistling sounds in your set really give reception a black eye. Get rid of unwanted noises now by calling the radio serviceman who displays the Sylvania sign. He'll make you



LOOK FOR THIS SIGN OF DEPENDABLE RADIO SERVICE

Does your radio give out with squeals and grunts? Then call the serviceman who displays the Sylvania sign. Because your radio needs expert care, the kind this fellow is trained to give.

Sylvania ads especially prepared to boost your service are telling 15,500,000 people from coast to coast all about the *valuable service* and parts you're offering them. Readers of these magazines are attracted to the lively cartoon-type ads, three of which are reproduced above. They tell them to stop at the Sylvania sign

of dependable service... for the best radio and television repairs at the fairest prices!

Hundreds of these readers are your *potential customers*. These humorous ads, running in the cream of the nation's publications, help assure you a *steady stream of new customers* and greater profit.

There's Still Time To Cash In On The First 1950 Sylvania Service Dealer Campaign—Write Sylvania Electric Products Inc., Advertising Dept. R 1001, Enporium, Pa.

SYLVANIA ELECTRIC

RADIO TUBES; CATHODE RAY TUBES; ELECTRONIC DEVICES; FLUORESCENT LAMPS, FIXTURES, WIRING DEVICES, SIGN TUBING; ELECTRIC LIGHT BULBS; PHOTOLAMPS

SOLVE your hi-fidelity problems with

University TWEETERS

WIDEST SELECTION • BEST VALUE • HIGHEST QUALITY

SINGLE UNIT TWEETERS

MODELS 4408, 4409—600 CYCLE TWEETERS: Recommended for highest quality reproduction systems requiring a low crossover frequency. Cobra shaped horn results in perfect wide angle distribution. Frequency response 600 to 15,000 cycles. Model 4408 handles 6 watts and 4409 25 watts.

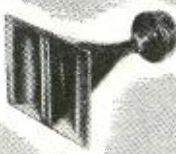

MODEL 4407 ADAPTER MOUNTS 4401 TWEETER IN ANY 12" CONE UNIT: Converts any 12" cone speaker into a wide-range coaxial reproducer in a few minutes. Installation is extremely simple and results in a dual speaker occupying little more space than the original cone speaker. Complete with 4401 tweeter.



MODEL 4401—2000 CYCLE TWEETER: An economical 6 watt unit for converting any good 10-15" cone speaker for extended response to 15,000 cycles. Wide Angle horn, compact design and low price bring excellent high fidelity well within the popular price range.



DUAL TWEETERS

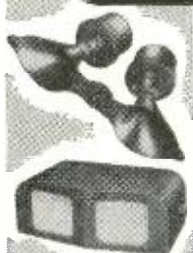

MODEL 4402, MODEL 4404: Model 4402 reproduces to 15,000 cycles. Crossover at 2000 cps. Horizontal dispersion 100°, Vertical 50°. Handles 12 watts. Compact design mounts in any radio, phono, or speaker cabinet. Model 4404 incorporates 4402 tweeter in handsome walnut cabinet complete with high-pass filter and high frequency volume control. Any one can install.

CROSSOVER NETWORKS



MODEL 4405 HIGH PASS FILTER: An effective and economical unit for preventing lows reaching the tweeter unit. Contains high frequency control to balance high and lows. Cutoff frequency 2000 cycles.

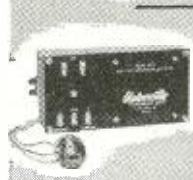

MODEL 4410, 4420 LC CROSSOVER NETWORK: Genuine LC frequency dividers for segregating highs and lows. Not to be confused with ordinary high-pass filters. Crossover frequencies: Model 4410 600 cycles, Model 4420 2000 cycles. Attenuator controls included and wired.

Write today for illustrated literature—address inquiries to Department D

University LOUDSPEAKERS • INC

80 SO. KENSICO AV., WHITE PLAINS, N.Y.

given to tubes with suppressor grids.

This suppressor grid being negative with respect to the plate, it sends secondary electrons right back to the plate instead of letting them pass through its turns to the screen. Control of the plate current is restored to the control grid, even under conditions where the instantaneous plate voltage dips below the screen voltage. In power output tubes, such as the 3V4 and the 6K6, this means higher power output with lower grid-driving voltage; in tubes used to amplify radio frequencies, such as the 6SJ7 and the 12SK7, signal voltages can be amplified tremendously without employing high plate voltages. Fig. 2 shows how adding a suppressor grid takes the dip out of the plate-voltage-vs.-plate-current curve of the tetrode. Remember that the effect of the suppressor grid on secondary emission is the same as that of a good kiss-proof lipstick: the act isn't prevented from taking place, but it is kept from causing any trouble!

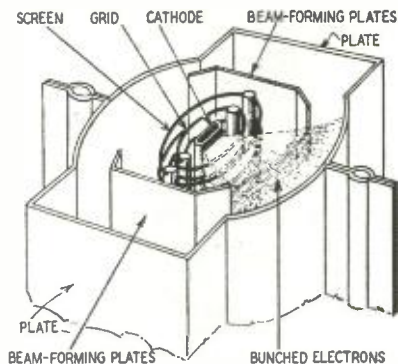

Fig. 3—Beam tube needs no suppressor.

One special kind of tube contains no suppressor but arrives at the same result as the pentode. Fig. 3 is a cutaway drawing of a beam tube, the 6L6. The beam-forming plates are connected to the cathode. The negative beam plates repel electrons so that they are all concentrated in a stream directed at the curved parts of the plate. The plates also prevent any secondary electrons from sneaking over to the screen by the side doors—outside the beam.

As the electron stream goes through the grid, the grid wires slice it up so that the beam is a stack of flat sheets.

The sheets pass between the wires of the screen, which are aligned with the grid wires. Since the electrons do not hit the screen wires directly, the screen takes very few of them and almost all go to the plate where they can do the most good.

The steady voltage on the screen may often be higher than the instantaneous plate voltage, while it is varying rapidly to amplify a signal; therefore, the screen is more attractive to the electrons than is the plate. After the electrons have passed through the screen, this greater attraction slows them up—they are not as anxious to get to the plate as they thought they were! Because of the "braking" action, the slowed-up electrons bunch up between screen and plate, as the heavier dashed lines in Fig. 3 show. The concentration of electrons results in a negative space charge, a "wall" between plate and grid, which prevents secondary electrons knocked out of the plate from getting to the screen just as effectively as a suppressor would.

We have by no means pumped the well dry on the subject of different types of electron tubes. There are literally hundreds of varieties on the shelves of any well stocked radio store. Many of the differences, though, are produced by mechanical variations in the filament structure, the basing arrangement, or the housing of a single basic type. For example, there are beam tubes with filaments that operate at 1.4, 6.3, 12, 25, 35, 50, 70, and 117 volts. Beam tubes come in small, medium, and large envelopes, and the envelope may be made of either metal or glass. If we look at the bases, we will find beam tubes with 7-prong miniature bases, with octal bases, and with loktal bases.

Another flock of types is produced by a kind of electronic grafting, in which two or more basic types of tubes are housed in the same envelope and are built around a common cathode. This method produces some fearsome sounding names, such as "duo-diode-hi-mu-triode;" but that name really describes nothing more awful than a hybrid tube in which two diodes and a high-amplification triode are all clustered around the same cathode inside one envelope.

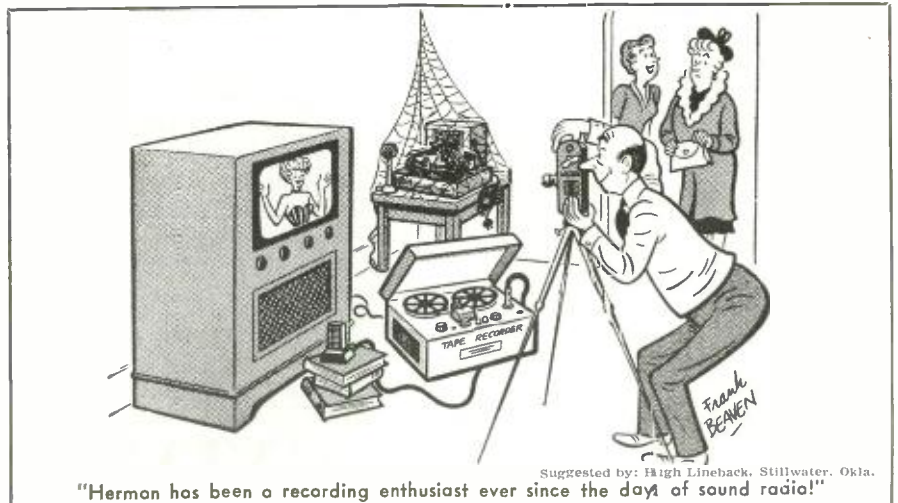

Suggested by: High Lineback, Stillwater, Okla.
"Hermon has been a recording enthusiast ever since the day of sound radio!"

5 Pages of TEST EQUIPMENT at prices every serviceman can afford!

MONEY BACK?

Every single unit described on this and the following pages is offered on a strict "money-back-if-not-satisfied-basis." No if's—no but's—no maybe's. Simply send your order for any unit

or units you select and try them out for 10 days. If not completely satisfied—return for refund in full. No explanation necessary. You are sole judge.

GUARANTEE?

Every instrument sold by us is covered by a one year guarantee. Guarantee registration card is included with shipment.

KITS?

We have discontinued advertising Test Equipment in kit form. After handling kits for a period of three months, we have come to the conclusion that it is impractical to successfully complete instrument kits at home without the expensive calibration standards and other equipment available when instruments are factory-pro-

duced. Also, even a minor variation in the placement or length of a connection often seriously affects the performance and accuracy of an instrument. We feel this "know how" cannot always be passed on, no matter how detailed the instructions.

TUBE TESTERS

THE NEW MODEL 247



Check octals, loctals, bantam jr., peanuts, television miniatures, magic eye, hearing aids, thyratrons, the new type H.F. miniatures, etc.

Features:

★ A newly designed element selector switch reduces the possibility of obsolescence to an absolute minimum.

★ When checking Diode, Triode and Pentode sections of multi-purpose tubes, sections can be tested individually. A special isolating circuit allows each section to be tested as if it were in a separate envelope.

★ The Model 247 provides a supersensitive method of checking for shorts and leakages up to 5 Megohms between any and all of the terminals.

★ One of the most important improvements, we believe, is the fact that the 4-position fast-action snap switches are all numbered in exact accordance with the standard R.M.A. numbering system. Thus, if the element terminating in pin No. 7 of a tube is under test, button No. 7 is used for that test.

\$29⁹⁰
NET

Model 247 comes complete with new speed-read chart. Comes housed in handsome hand-rubbed oak cabinet sloped for bench use. A slip-on portable hinged cover is indicated for outside use. Size: 10³/₄"x8³/₄"x5¹/₄". ONLY

THE NEW MODEL TV-10



Specifications:

★ Tests all tubes including 4, 5, 6, 7, Octal, Lock-in, Peanut, Bantam, Hearing-aid, Thyatron, Miniatures, Sub - Miniatures, Novals, etc. Will also test Pilot Lights.

★ Tests by the well-established emission method for tube quality, directly read on the scale of the meter.

★ Tests for "shorts" and "leakages" up to 5 Megohms.

★ Uses the new self-cleaning Lever Action Switches for individual element testing. Because all elements are numbered according to pin-number in the RMA base numbering system, the user can instantly identify which element is under test. Tubes having tapped filaments and tubes with filaments terminating in more than one pin are truly tested with the Model

TV-10 as any of the pins may be placed in the neutral position when necessary.

★ The Model TV-10 does not use any combination type sockets. Instead individual sockets are used for each type of tube. Thus it is impossible to damage a tube by inserting it in the wrong socket.

★ Free-moving built-in roll chart provides complete data for all tubes.

★ Newly designed Line Voltage Control compensates for variation of any line voltage between 105 Volts and 130 Volts.

The Model TV-10 operates on 105-130 Volt 60 Cycles A.C. Comes housed in a beautiful hand-rubbed oak cabinet complete with portable cover.

\$39⁵⁰
NET

TO ORDER—TURN TO PAGE 91 FOR RUSH ORDER FORM

GENERAL ELECTRONIC DISTRIBUTING CO.

DEPT. RC-1, 98 PARK PLACE

NEW YORK 7, N. Y.

1

WE KNOW THE PRICE IS UNBELIEVABLY LOW,

but that's not all! In addition, this finely engineered instrument provides a degree of accuracy never before attained in a unit selling for even double this price. Furthermore—in designing this unit, we took advantage of every recent improvement in components. For example, by using slug-tuned coils, we are able to efficiently adjust each instrument for

perfect accuracy. This feature will also enable you to recalibrate the model 200 periodically without having to return it to the factory. The use of a Noval tube (the 12AU7) with its extremely low inter-electrode capacity enabled us to reach a higher frequency range than was heretofore possible in a unit of this type.

THE NEW MODEL 200 AM and FM SIGNAL GENERATOR



SPECIFICATIONS

The Model 200 operates on 110 Volts A.C. Comes complete with output cable and operating instructions.

- ★ **R.F. FREQUENCY RANGES:** 100 Kilocycles to 150 Megacycles.
- ★ **MODULATING FREQUENCY:** 400 Cycles. May be used for modulating the R. F. signal. Also available separately.
- ★ **ATTENUATION:** The constant impedance attenuator is isolated from the oscillating circuit by the buffer tube. Output impedance of this model is only 100 ohms. This low impedance reduces losses in the output cable.
- ★ **OSCILLATORY CIRCUIT:** Hartley oscillator with cathode follower buffer tube. Frequency stability is assured by modulating the buffer tube.
- ★ **ACCURACY:** Use of high-Q permeability tuned coils adjusted against 1/10th of 1% standards assures an accuracy of 1% on all ranges from 100 Kilocycles to 10 Megacycles and an accuracy of 2% on the higher frequencies.
- ★ **TUBES USED:** 12AU7—One section is used as oscillator and the second is modulated cathode follower. T-2 is used as modulator. 6C4 is used as rectifier.

**\$18⁸⁵
NET**

2

TO ORDER—TURN TO PAGE 91 FOR RUSH ORDER FORM

GENERAL ELECTRONIC DISTRIBUTING CO.

DEPT. RC-1, 98 PARK PLACE, NEW YORK 7, N. Y.

The new model 770



AN ACCURATE POCKET-SIZE VOLT-OHM MILLIAMMETER

(SENSITIVITY: 1000 OHMS PER VOLT)

FEATURES

- ★ Compact-measures 3 1/8" x 5 7/8" x 2 1/4".
- ★ Uses latest design 2% accurate 1 Mil. D'Arsonval type meter.
- ★ Same zero adjustment holds for both resistance ranges. It is not necessary to readjust when switching from one resistance range to another. This is an important time-saving feature never before included in a V.O.M. in this price range.
- ★ Housed in round-cornered, molded case.
- ★ Beautiful black etched panel. Depressed letters filled with permanent white, insures long-life even with constant use.

The Model 770 comes complete with self-contained batteries, test leads and all operating instructions.

SPECIFICATIONS

- 6 **A.C. VOLTAGE RANGES:** 0-15/30/150/300/1500/3000 VOLTS
- 4 **D.C. CURRENT RANGES:** 0-1.5/15/150 MA. 0-1.5 AMPS.
- 6 **D.C. VOLTAGE RANGES:** 0-7.5/15/75/150/750/1500 VOLTS
- 2 **RESISTANCE RANGES:** 0-500 OHMS 0-1 MEGOHM

\$13.90
NET

The new model 670



SUPER-METER

A COMBINATION VOLT-OHM MILLIAMMETER PLUS CAPACITY REACTANCE INDUCTANCE AND DECIBEL MEASUREMENTS

SPECIFICATIONS:

- D.C. VOLTS:** 0 to 7.5/15/75/150/750/1,500/7,500 Volts
- A.C. VOLTS:** 0 to 15/30/150/300/1,500/3,000 Volts
- OUTPUT VOLTS:** 0 to 15/30/150/300/1,500/3,000 Volts
- D.C. CURRENT:** 0 to 1.5/15/150 Ma. 0 to 1.5 Amperes
- RESISTANCE:** 0 to 500/100,000 Ohms 0 to 10 Megohms
- CAPACITY:** .001 to .2 Mfd. .1 to 4 Mfd. (Quality test for electrolytics)
- REACTANCE:** 700 to 27,000 Ohms 13,000 Ohms to 3 Megohms

- INDUCTANCE:** 1.75 to 70 Henries 35 to 8,000 Henries
- DECIBELS:** -10 to +18 +10 to +38 +30 to +58

ADDED FEATURE:

The Model 670 includes a special GOOD-BAD scale for checking the quality of electrolytic condensers at a test potential of 150 Volts.

The Model 670 comes housed in a rugged, crackle-finished steel cabinet complete with test leads and operating instructions. Size 5 1/2" x 7 1/2" x 3".

\$28.40
NET

A COMBINATION 20,000 OHMS PER VOLT MULTI-METER and TELEVISION KILOVOLTMETER

The new model TV-20



SPECIFICATIONS

- 9 D. C. VOLTAGE RANGES: (At 20,000 ohms per Volt) 0-2.5/10/50/100/250/500/1,000/5,000/50,000 Volts
- 8 A. C. VOLTAGE RANGES: (At 1,000 ohms per Volt) 0-2.5/10/50/100/250/500/1,000/5,000 Volts
- 5 D. C. CURRENT RANGES: 0-50 Microamperes 0-5/50/500 Milliampers 0-5 Amperes
- 4 RESISTANCE RANGES: 0-2,000/20,000 ohms 0-2/20 Megohms
- 7 D. B. RANGES: (All D. B. ranges based on Odb = 1 Mv. into a 600 ohm line)
 - 4 to +10 db
 - + 8 to +22 db
 - + 22 to +36 db
 - + 36 to +50 db
 - + 42 to +56 db
 - + 48 to +62 db
- 7 OUTPUT VOLTAGE RANGES: 0 to 2.5/10/50/100/250/500/1,000 Volts

ADDED FEATURE:

The Model TV-20 includes an Ultra High Frequency Voltmeter Probe. A Silicon V. H. F. Diode together with a resistance capacity network provides a frequency range up to 1,000 MEGACYCLES. When plugged into the Model TV-20, the V. H. F. Probe converts the unit into a Negative Peak-Reading H. F. Voltmeter which will measure gain and loss in all circuits including F. M. and T. V.; check capacity and impedance; test efficiency of all oscillator circuits; measure bandwidth of F. M. and T. V.; etc.

The Model TV-20 operates on self-contained batteries. Comes housed in beautiful hand-rubbed oak cabinet complete with portable cover, Built-In High Voltage Probe, H. F. Probe, Test Leads and all operating instructions. Measures 4 1/2" x 10 1/4" x 1 1/2". Shipping Weight 10 lbs.

\$39.95
NET

TO ORDER TURN TO PAGE 91 FOR RUSH ORDER FORM

GENERAL ELECTRONIC DISTRIBUTING CO.

93 PARK PLACE

DEPT. RC-1

NEW YORK 7, N. Y.

3

The model CA-11



SIGNAL TRACER

SIMPLE TO OPERATE . . . BECAUSE IT HAS ONLY ONE CONNECTING CABLE—NO TUNING CONTROLS!

Introduced in 1939-1940 Signal Tracing, the "short-cut" method of Radio Servicing quickly became established as the accepted method of localizing the cause of trouble in defective radio receivers. Most of the pre-war testers (including ours) were bulky requiring a number of connections before the unit was "set for operation" and included a tuned amplifier which had to be "retuned" to compensate for signal shift.

The new Model CA-11 affords all the advantages offered by the pre-war models and only weighs 5 lbs. and measures 5"x6"x7". Always ready for immediate use without the necessity of connecting cables, this amazingly versatile unit has **NO TUNING CONTROLS.**

Essentially "Signal Tracing" means following the signal in a radio receiver and using the signal itself as a basis of measurement and as a means of locating the cause of trouble. In the CA-11 the Detector Probe is used to follow the signal from the antenna to the speaker—with relative signal intensity readings available on the scale of the meter which is calibrated to permit constant comparison of signal intensity as the probe is moved to follow the signal through the various stages.

FEATURES

- ★ **SIMPLE TO OPERATE**—only 1 connecting cable—**NO TUNING CONTROLS.**
- ★ **HIGHLY SENSITIVE**—uses an improved Vacuum Tube Voltmeter circuit. Tube and resistor-capacity network are built into the Detector Probe.
- ★ **COMPLETELY PORTABLE**—weighs 5 lbs. and measures 5"x6"x7".
- ★ **Comparative Signal Intensity readings** are indicated directly on the meter as the Detector Probe is moved to follow the Signal from Antenna to Speaker.
- ★ Provision is made for insertion of phones.

The Model CA-11 comes housed in a beautiful hand-rubbed wooden cabinet. Complete with Probe, test leads and instructions

\$1350
NET

The new model CA-12



SIGNAL TRACER

THE WELL KNOWN MODEL CA-12 IS THE ONLY SIGNAL TRACER IN THE LOW PRICE RANGE INCLUDING BOTH METER AND SPEAKER!!!

SPECIFICATIONS

- ★ Comparative Intensity of the signal is read directly on the meter—quality of the signal is heard in the speaker.
- ★ Simple to Operate—only one connecting cable—no tuning controls.
- ★ Highly Sensitive—uses an improved vacuum-tube voltmeter circuit.
- ★ Tube and Resistor Capacity Network are built into the detector probe.
- ★ Built-In High Gain Amplifier—Alnico V Speaker.
- ★ Completely Portable—weighs 8 pounds—measures 5 1/2" x 6 1/2" x 9".

MODEL CA-12 comes complete with all leads and operating instructions

\$2995
NET

The new model TV-30

TELEVISION SIGNAL GENERATOR

ENABLES ALIGNMENT OF TELEVISION I. F. AND FRONT ENDS WITHOUT THE USE OF AN OSCILLOSCOPE!



FEATURES

Built-in modulator may be used to modulate the R. F. Frequency also to localize the cause of trouble in the audio circuits of T. V. Receivers.
 Double shielding of oscillatory circuit assures stability and reduces radiation to absolute minimum.
 Provision made for external modulation by A. F. or R. F. source to provide frequency modulation.
 All I. F. frequencies and 2 to 13 channel frequencies are calibrated direct in Megacycles on the Vernier dial. Markers for the Video and Audio carriers within their respective channels are also calibrated on the dial.
 Linear calibrations throughout are achieved by the use of a Straight Line Frequency Variable Condenser together with a permeability trimmed coil.
 Stability assured by cathode follower buffer tube and double shielding of component parts.

SPECIFICATIONS

Frequency Range: 4 Bands—No switching; 18-32 Mc., 35-65 Mc., 54-98 Mc., 150-250 Mc.
 Audio Modulating Frequency: 400 cycles (Sine Wave). Attenuator: 4 position, ladder type with constant impedance control for fine adjustment.
 Tubes Used: 6C4 as Cathode follower and modulated buffer. 6C4 as R.F. Oscillator. 6SN7 as Audio Oscillator and power rectifier.
 Model TV-30 comes complete with shielded co-axial lead and all operating instructions. Measures 6" x 7" x 9". Shipping Weight 10 lbs.

\$2995
NET

TO ORDER TURN TO PAGE 91 FOR RUSH ORDER FORM

4

GENERAL ELECTRONIC DISTRIBUTING CO.

98 PARK PLACE

DEPT. RC-1

NEW YORK 7, N. Y.

Mr. Radio Serviceman
ADDITIONAL \$\$\$ FOR YOU EVERY WEEK
REPAIR ELECTRICAL APPLIANCES

with the aid of the New Model 50

UTILITY TESTER



Compact—Measures 3 1/8" x 5 7/8" x 2 1/4"

The Model 50 Utility Tester comes housed in a round cornered molded bakelite case. Complete with all test leads and operating instructions—

\$13⁹⁰
NET

A NEW KIND OF INSTRUMENT FOR TESTING ALL ELECTRICAL CIRCUITS AND APPLIANCES SUCH AS

- RANGES
 - SHAVERS
 - HEATERS
 - IRONERS
 - WASHERS
 - FANS
 - VACUUM CLEANERS
 - AIR CONDITIONERS
 - REFRIGERATORS
 - SUN LAMPS
 - CIRCUIT BREAKERS
 - LIGHTING SYSTEMS
- and MOTORS**

ALL MOTORS—single phase, multi-phase, universal, squirrel cage, induction, in fact every type of motor from fractional H.P. to 2 H.P.

THE MODEL 50 UTILITY TESTER:

- Will test Thermostats under *actual working conditions*.
- Is the ideal trouble-shooter as it will instantly locate opens, shorts and grounds.
- Will test all bulbs, radio tube filaments, pilot light lamps, all fuses including cartridge, screw, etc., fluorescent bulbs, etc.
- Will test condensers for both opens and shorts.
- Will accurately check and locate the exact cause of failure in 3 way heat control switches.
- Will check field coils for opens and shorts.
- Will indicate when one side of an appliance or motor connected to the line under test is "grounded".
- Will measure the *actual current consumption* of any appliance or utility either A.C. or D.C. and will measure it *while the unit is in operation*. The reading will be direct in amperes. The appliance or utility may be plugged directly into the front panel receptacle. A special pair of insulated clip-end leads is included for motors, etc.
- Incorporates a sensitive direct-reading resistance range which will accurately measure all resistances commonly used in electrical appliances, motors, etc. This range will enable continuity checks and tests for shorts and opens.
- Will indicate excessive leakage between a motor and a line up to 10 Megohms.
- Will indicate when a three phase motor is running erratically due to a "blown" fuse.
- Will measure the actual voltage and indicate whether the current is A.C. or D.C. and if the frequency is 25 cycles or 60 cycles.

GENERAL ELECTRONIC DISTRIBUTING CO.
 DEPT. RC-1, 98 PARK PLACE, NEW YORK 7, N. Y.

GENTLEMEN:

PLEASE RUSH THE MATERIAL LISTED BELOW:

QUANTITY	MODEL	PRICE

TOTAL

\$..... (Payment in Full Enclosed)

\$..... (Deposit Enclosed—Ship Balance C.O.D.)

SHIP TO:

Name

Address

City Zone State.....

**RUSH
 ORDER
 FORM**

**CUT
 OUT
 AND
 MAIL
 TODAY!**



Radio Set and Service Review

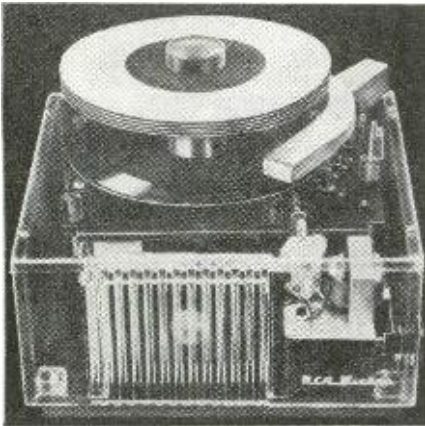

Changer in special transparent mount.

THE repair technician is going to see a lot of the new RCA Victor 45-r.p.m. record changers now that their price is so low. And for the same reason, he is going to have to service them at top speed to keep repair charges in reasonable proportion to original cost. If he knows how they *should* work, he is in a good position to find out quickly why a particular specimen *doesn't* work. Fortunately, the mechanism is simple enough to be described fully in these pages. The 9-JY record-player attachment was the particular model examined, but the same mechanism is used in all the RCA 45-r.p.m. players.

The turntable is a brass casting $5\frac{1}{4}$ inches in diameter. An underside view appears in Fig. 1. The shaft is a hollow metal tube (A in Fig. 1) which goes through hole B in the metal pillar attached to the metal panel that supports the changer mechanism (Fig. 2). Inside the hollow tube is the drive shaft C (Fig. 1) which is free to rotate independently. At the lower end of C is a star wheel (explained later and not shown in Fig. 1). At the upper end is a small drive gear, which appears in the cut-away drawing of Fig. 3. The assembly shown in the drawing is within the upper part of the $1\frac{1}{2}$ -inch-diameter spindle of the turntable.

Two small gears at the top of very short, hollow shafts fit over short rods set in holes in the spindle. Atop each gear is a small support shelf. Fig. 3 shows how the assembly is put together; note that the pins atop the right and left gears are mounted off center. The spring pushes the shelves apart so they normally extend outside the spindle.

When the drive shaft rotates in the direction of the arrow, the gears also rotate as shown. During the first half-revolution, the offset-mounted pins on the outside gears pull the support shelves inside the housing; during the second half, the spring pushes them out.

The separator blades are also mounted

RCA Victor's 45-r.p.m. changer is unusually small and uncomplicated

By RICHARD H. DORF

on the offset pins. During the first half-turn of the drive shaft, they project from the housing; during the second, they recede.

The events must have the sequence illustrated by Fig. 4, a cross section of a small part of the spindle. At first the shelves are out, supporting all records which are on the spindle (condition 1). As the change cycle begins, the separators emerge while the shelves are still out (condition 2). Then the shelves recede, allowing the lower record to fall (condition 3). The shelves emerge again (condition 4), and finally the blades recede (condition 5).

The action described takes place as the result of one revolution of the drive shaft. In the changer the drive shaft is actually made to stand still while the turntable goes through one revolution—which produces the same effect. Normally, the entire group rotates as a unit. The star wheel shown in Fig. 3 is attached to the drive shaft. When the change cycle begins, a lever in the main mechanism moves in and stops the star

wheel while the turntable keeps running. After a single revolution the lever moves away and the star wheel is released. Since the entire action takes place in the course of a single revolution, the change cycle requires only $\frac{1}{4}$ minute, or $1\frac{1}{2}$ seconds.

(Continued on page 94)

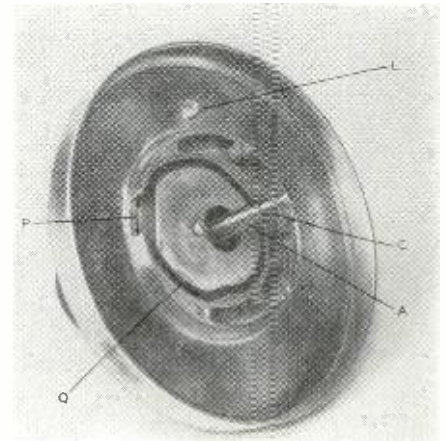

Fig. 1—The underside of the turntable.

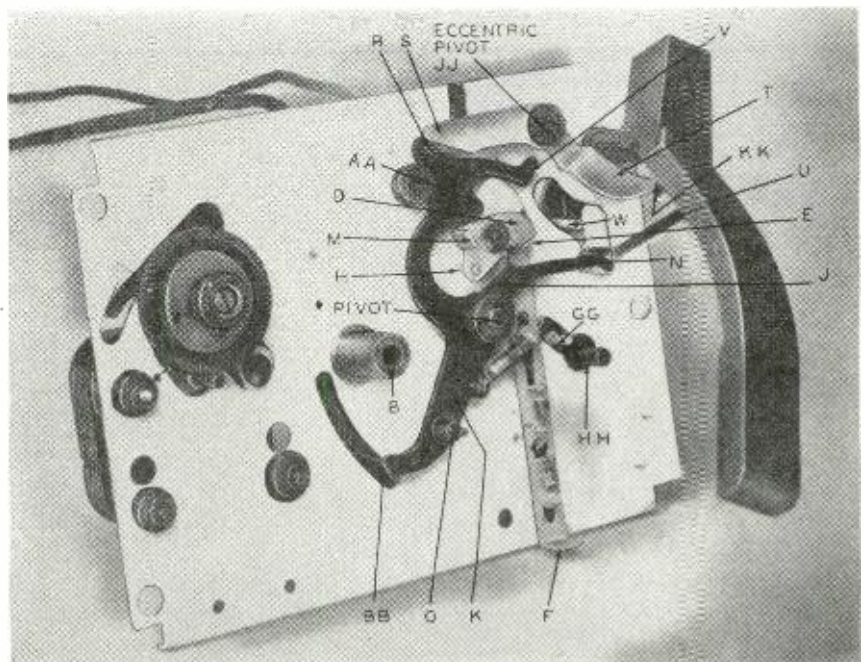
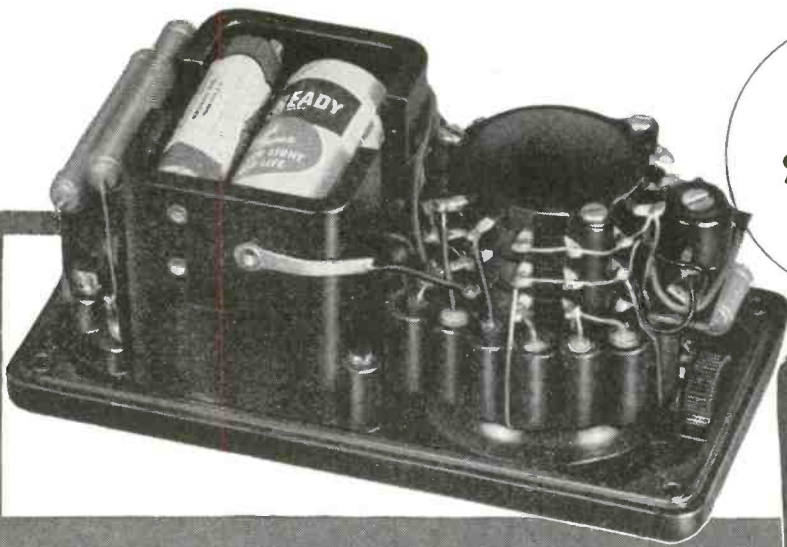

Fig. 2—Top of changer mechanism. Lettered parts are referred to in the text.



**MODEL
666-R
\$24⁵⁰**
U. S. A. Dealer Net

**A *New* TRIPLETT
POCKET-SIZE
VOLT-OHM-MIL-AMMETER
with self-contained Resistance
Ranges to 3 Megohms**



**Note the special
features of this New
handy-size tester**

- (1) **RESISTANCE RANGES** from 0-3000 Ohms (.5 Ohm low reading) to 3 Megohms, self-contained. Also A.C.-D.C. Volts to 5000, 10 ranges; and 3 Direct Current ranges.
- (2) **ENCLOSED SELECTOR SWITCH**, molded construction. Keeps dirt cut, and retains contact alignment permanently.
- (3) **UNIT CONSTRUCTION**—Resistors, shunts, rectifier, batteries are housed in a molded base integral with the switch. Direct connections without cabling. No chance for shorts.
- (4) **RESISTORS** are precision film or wire-wound types, each in its own compartment.
- (5) **BATTERIES EASILY REPLACED**—Positive grip coil spring assures permanent contact. Makes replacement of batteries a simple procedure.
- (6) **STREAMLINED STYLING**. Handsomely designed, pocket-size case. Only two controls, both flush with panel.

*For Detailed Information
See your Radio Parts Distributor or write . . .*

TRIPLETT ELECTRICAL INSTRUMENT COMPANY • BLUFFTON, OHIO, U.S.A.

In Canada: Triplett Instruments of Canada, Georgetown, Ontario

RANGES:

D.C. VOLTS: 0-10-50-250-1000-5000, at 1000 Ohms/Volt

A.C. VOLTS: 0-10-50-250-1000-5000, at 1000 Ohms/Volt

D.C. MILLIAMPERES: 0-10-100, at 250 Millivolts

D.C. AMPERES: 0-1, at 250 Millivolts

OHMS: 0-3000-300,000
..... (20-2000 at center scale)

MEGOHMS: 0-3
..... (20,000 Ohms center scale)

(Compensated Ohmmeter circuit for greatest accuracy over wide battery voltage variations.)

Precision first...to Last



RADIO SET & SERVICE REVIEW

(Continued from page 92)

SENCO'S
low--low
PRICES
ring the
bell

BRAND NEW IMMEDIATE DELIVERY TUBES INDIVIDUALLY CARTONED GUARANTEED

SPECIAL QUANTITY DISCOUNT OFFER. Order 25 or More Assorted Tubes and Deduct 5c from the Price of Each Tube.

15¢ Each	6CSGT 6C6 6F6G 6HG7	3B7 5AL5 6BJ6 6D7	6B8 6D6 6F8G 6L5G
2C26 2C34/RK34 1626 1644 7193/2C24 E1148 VT52	6K6GT 6K7GT 6N4 6SA7GT 6SD7GT 6S7 6S17 6SK7GT 6S7GT 6UG7 6VG7 6X4 6X5GT 12A06 12AV6 12AK7 12J5 12J7GT 12K7GT 12Q7GT 12S15 12S17GT 12S23 12S24 2SL6GT 32L7GT 35Y4 35Y4GT 43 6AB5G 6AB7 6AG5 6B4 6B6 6BG6 6BH6 6J6 6J8G 6W4 6W6 1A2 1C6G 1C7G 1D7C 1D8G 1E7G 1F4 1F5G 1G4G 1G5 1GG7 1H4G 1H6G 1J6G	6F5GT 6G6G 6F5GT 6K7GT 6SL7GT 6SN7GT 6S7GT 6V5 6Y6G 7A4/XXL 7A5 7B6 7E5/1201 7K7 12AT6 12AU7 12BA8 12BE6 12S17GT 12S23 12S24 2SL6GT 32L7GT 35Y4 35Y4GT 43 6AB5G 6AB7 6AG5 6B4 6B6 6BG6 6BH6 6J6 6J8G 6W4 6W6 1A2 1C6G 1C7G 1D7C 1D8G 1E7G 1F4 1F5G 1G4G 1G5 1GG7 1H4G 1H6G 1J6G	6T7Q 7A7 7C5 7E7 7Q7 12B06 12C8 14B6 50C5 50L6 20S1 350B 75 0A2 0Z4 1L44 1LC6 1LD5 1LE3 1LM4 1LN5 1MG 174 5V4G 6B4 6B6 6AG5 6B4 6B6 6J8G 6W4 6W6 1A2 1C6G 1C7G 1D7C 1D8G 1E7G 1F4 1F5G 1G4G 1G5 1GG7 1H4G 1H6G 1J6G
19¢ Each	1644 V99 X99	12AV6 12AK7 12J5 12J7GT 12K7GT 12Q7GT 12S15 12S17GT 12S23 12S24 2SL6GT 32L7GT 35Y4 35Y4GT 43 6AB5G 6AB7 6AG5 6B4 6B6 6BG6 6BH6 6J6 6J8G 6W4 6W6 1A2 1C6G 1C7G 1D7C 1D8G 1E7G 1F4 1F5G 1G4G 1G5 1GG7 1H4G 1H6G 1J6G	59¢ Each 0A2 0Z4 1L44 1LC6 1LD5 1LE3 1LM4 1LN5 1MG 174 5V4G 6B4 6B6 6AG5 6B4 6B6 6J8G 6W4 6W6 1A2 1C6G 1C7G 1D7C 1D8G 1E7G 1F4 1F5G 1G4G 1G5 1GG7 1H4G 1H6G 1J6G
29¢ Each	2A7 2K2 6C4 6SH7GT 6U7C 7Y4 12A6 12ASGT 12FSGT 12H6 26 36 956 957 8011/VT90 HY615 RK72 RKR72 RKR73 VT25	12AV6 12AK7 12J5 12J7GT 12K7GT 12Q7GT 12S15 12S17GT 12S23 12S24 2SL6GT 32L7GT 35Y4 35Y4GT 43 6AB5G 6AB7 6AG5 6B4 6B6 6BG6 6BH6 6J6 6J8G 6W4 6W6 1A2 1C6G 1C7G 1D7C 1D8G 1E7G 1F4 1F5G 1G4G 1G5 1GG7 1H4G 1H6G 1J6G	50¢ Each 1ASGT 1A2 1C6G 1C7G 1D7C 1D8G 1E7G 1F4 1F5G 1G4G 1G5 1GG7 1H4G 1H6G 1J6G
39¢ Each	1A3 1U4 1U5 1V 2A6 4A6 5U4G 5W4 5Y3GT 5Y4G 6AB4 6AH6 6AT6 6AUG 6BA6 6BE6	12AV6 12AK7 12J5 12J7GT 12K7GT 12Q7GT 12S15 12S17GT 12S23 12S24 2SL6GT 32L7GT 35Y4 35Y4GT 43 6AB5G 6AB7 6AG5 6B4 6B6 6BG6 6BH6 6J6 6J8G 6W4 6W6 1A2 1C6G 1C7G 1D7C 1D8G 1E7G 1F4 1F5G 1G4G 1G5 1GG7 1H4G 1H6G 1J6G	69¢ Each 6AC7/1852 6AG7 6AK5 117Z6GT
45¢ Each	1B5/255 1L4 1R5 1S4 1S5 1T5GT 2A5 2B6	12AV6 12AK7 12J5 12J7GT 12K7GT 12Q7GT 12S15 12S17GT 12S23 12S24 2SL6GT 32L7GT 35Y4 35Y4GT 43 6AB5G 6AB7 6AG5 6B4 6B6 6BG6 6BH6 6J6 6J8G 6W4 6W6 1A2 1C6G 1C7G 1D7C 1D8G 1E7G 1F4 1F5G 1G4G 1G5 1GG7 1H4G 1H6G 1J6G	89¢ Each 1B3GT/8016 6L6G 830B

MINIMUM ORDER \$2.50. Send 25% deposit for all C.O.D. shipments. Include sufficient postage, excess will be refunded. Orders without postage will be shipped express collect. All prices F.O.B. New York City.

1950 RECEIVING TUBE INTERCHANGEABILITY (CHART)

Very latest... complete data on direct interchangeability. It's SENCO'S way of greeting New Customers and thanking old ones... It's yours for the asking.

FREE

Nothing to Buy... Just fill in Coupon... MAIL TODAY!

NAME

ADDRESS

CITY ZONE STATE

Radio Men Who Know
SAVE AT SENCO

SENCO RADIO, INC., Dept. Q
73 West Broadway, New York 17, N. Y.

The change cycle

Fig. 2 is a photo of the metal chassis removed from its Bakelite housing and with the turntable removed. Fig. 5 shows the underside of the chassis. All parts appear in their normal positions while playing a record, except that in Fig. 2 the tone arm has been moved out and held up to reveal parts it would otherwise obscure.

The key component is the trip pawl D (Fig. 2). Its vertical, down-projecting tab E is pushed rearward, either by the reject lever F or by the inward travel of the pickup arm, through lever G under the chassis (Fig. 5). The short down-projecting pin H under trip pawl D now lies against point J on main lever K.

As the turntable rotates, a small projection L on the underside of the turntable (Fig. 1) hits the upward-projecting tab M on trip pawl D (Fig. 2), making M strike point J on main lever K. This pushes arm N of main lever K toward the front of the changer and upward-projecting pin O slightly toward the center of the turntable.

At this instant, opening P (Fig. 1) under the turntable is opposite pin O (Fig. 2), and pin O passes through the opening. As the turntable continues to rotate, pin O is caught in the cam groove Q under the turntable. The groove is so shaped that, during one revolution, pin O is pushed close to the turntable center, then outward again, finally escaping through opening P.

As pin O moves in, pin R (Fig. 2) travels to the right, pushing arm S of the lift lever rearward because of the

shape of the inner edge of arm S. Arm T then moves forward. Pin U, attached to the pickup arm, normally is close to arm T in the position shown. When arm T moves forward, it pushes against pin U, raising the pickup off the disc. At the end of the cycle, when pin O on the main lever has come back to its normal position as shown in the photo, the

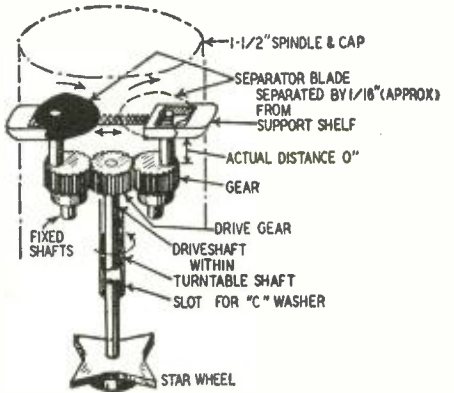

Fig. 3—The record-drop mechanism.

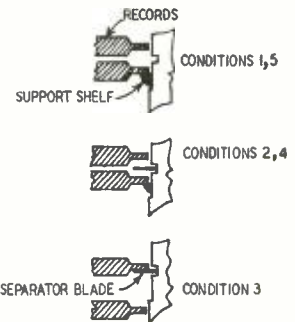

Fig. 4—Sequence of record-drop cycle.

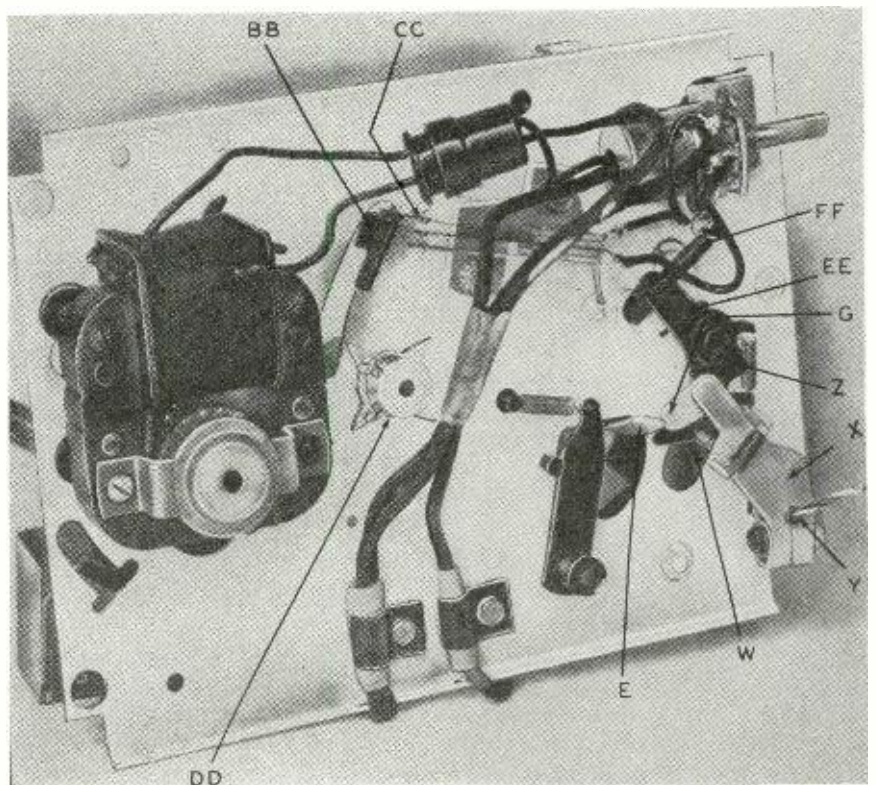
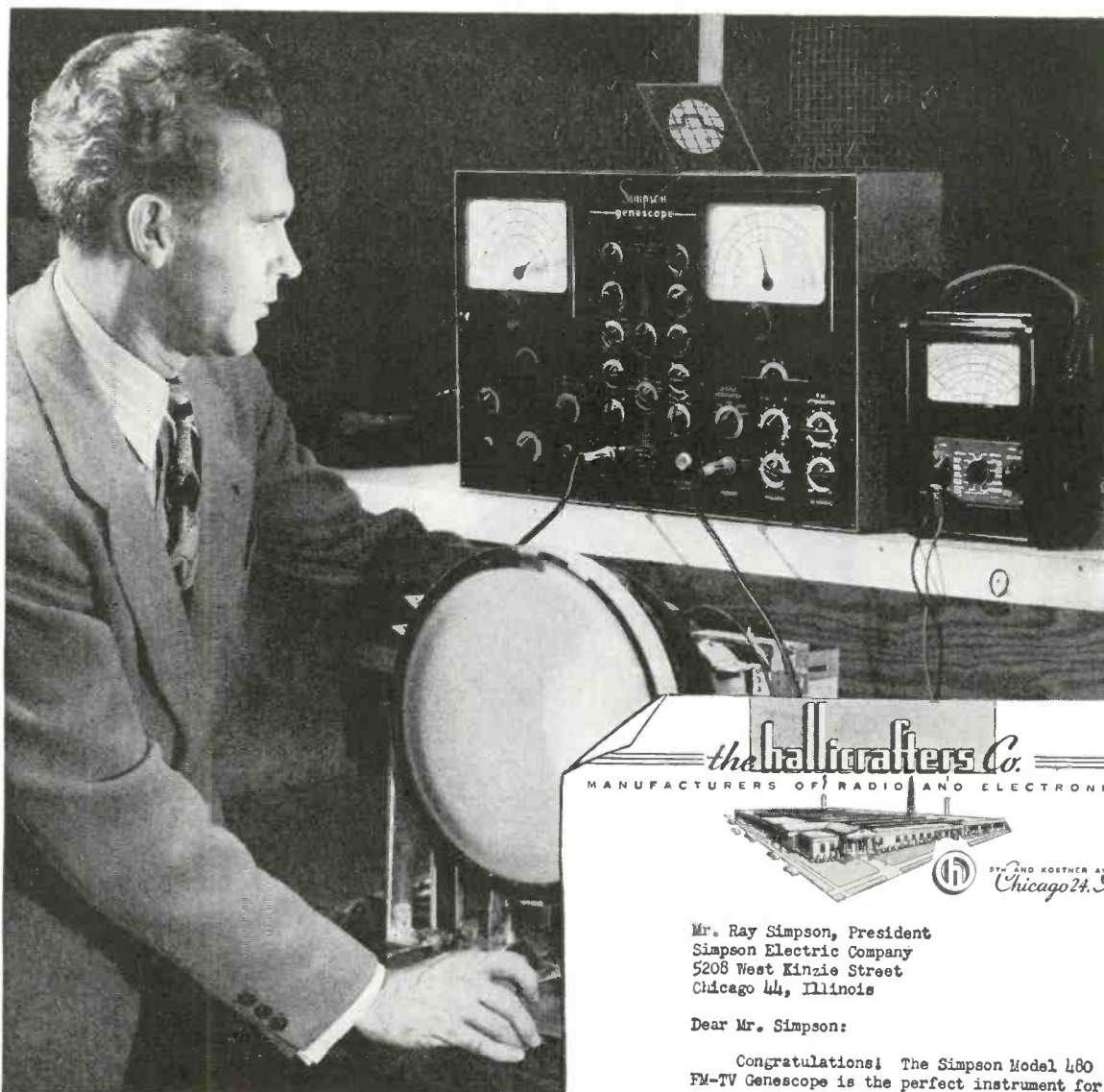



Fig. 5—Under changer chassis. Tab BB stops star wheel DD to start record drop.



the hallcrafters Co.
MANUFACTURERS OF RADIO AND ELECTRONIC EQUIPMENT



EST. AND BROTHER ARCHIVES
Chicago 24, Ill.

Mr. Ray Simpson, President
Simpson Electric Company
5208 West Kinzie Street
Chicago 44, Illinois

Dear Mr. Simpson:

Congratulations! The Simpson Model 480
FM-TV Genescope is the perfect instrument for
the proper alignment of all FM and TV receivers.

In addition to providing all necessary signal
sources, the new Simpson Genescope includes a

says EDWARD CROXEN

General Service Manager of Hallcrafters

In addition to providing all necessary signal sources, the new Simpson Genescope includes a high sensitivity oscilloscope of unique advanced design, complete in every detail. Sensitivity 25 millivolts per inch. Wide band response to 3 megacycles or more. Equipped with a high frequency crystal probe for signal tracing. AM and FM oscillator sections provided with large, easy to read dials with 20-1 vernier control and 1000 division logging scale. *Revolutionary, Ingenious, Exclusive* output termination provides for various receiver impedances, either direct or through an isolating condenser.

Step attenuator for control of output.

Size: 22"x14"x7 1/2". Weight 45 lbs. Shipping Weight 54 lbs.

DEALER'S NET PRICE complete with Test Leads and Operator's Manual \$375.00

CHECK THESE RANGES AND YOU WILL SEE HOW MUCH THE SIMPSON GENESCOPE CAN DO FOR YOU

RANGES
FREQUENCY MODULATED OSCILLATOR
Band A—2-120 megacycles
Band B—140-260 megacycles
Sweep width variable from zero to 15 megacycles
Sweep rate 60 cycles per second
Specially designed frequency sweep motor
Continuously variable attenuator
Crystal calibrator—5 megacycles ± .05%
Audio Oscillator 400 cycles

AMPLITUDE MODULATED OSCILLATOR
Band A—3.2-16 megacycles
Band B—15-75 megacycles
Band C—75-250 megacycles
30% modulation at 400 cycles or unmodulated
Continuously variable attenuator
Visual method of beat frequency indication

Modern FM and TV development and servicing requires the use of test equipment made to exacting standards. With this in mind Simpson offers you the Genescope with the assurance that everything possible has been done to make it the most accurate, flexible and convenient instrument available. The Genescope will render many years of uninterrupted service and always produce accurate results.

**HERE'S THE SIMPSON—MODEL 479
TV-FM SIGNAL GENERATOR**

Exactly the same circuits, ranges and functions as the Model 480, described above, with the exception of the oscilloscope.

Size 17"x14"x7 1/2". Weight 34 lbs.
Shipping Weight 40 lbs.

DEALER'S NET PRICE with Test Leads and Operator's Manual \$245.00

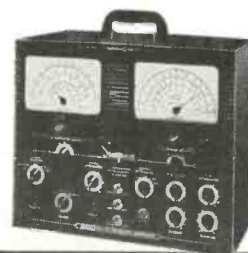

Simpson

INSTRUMENTS THAT STAY ACCURATE

SIMPSON ELECTRIC COMPANY

5200-5218 WEST KINZIE STREET • CHICAGO 44, ILLINOIS
In Canada: Bach-Simpson, Ltd., London, Ont.

LET THIS "AUTOMATIC TEACHER" show you exactly how to repair over 4800 RADIO MODELS without expensive test equipment!

GHIRARDI SAVES YOU TIME —HELPS YOU MAKE MONEY

Ghirardi's RADIO TROUBLESHOOTER'S HANDBOOK is the ideal manual to show you exactly how to repair radios at home in spare time—quickly and without a lot of previous experience or costly test equipment. It contains MORE THAN 4 POUNDS OF FACTUAL, time-saving, money-making repair data for repairing all models and makes of radios better, faster and more profitably than you may have thought possible!

NOT A "STUDY" BOOK

RADIO TROUBLESHOOTER'S HANDBOOK can easily pay for itself the first time you use it. You don't have to study it. Simply look up the make, model, and trouble symptom of the Radio you want to repair and go to work. No lost time! Clear instructions tell exactly what the trouble is likely to be—EXACTLY how to fix it. Actually, this big 744-page manual-size HANDBOOK brings you factual, specific repair data for the common troubles that occur in over 4800 popular models of Home and Auto radio receivers and Automatic record changers of 202 manufacturers! In addition, there are hundreds of pages of helpful repair charts, tube charts, data on tuning alignment, transformer troubles, tubes and parts substitution, etc., etc.—all for only \$5 (\$5.50 foreign). Read it for 10 days . . . at our risk! Use coupon.

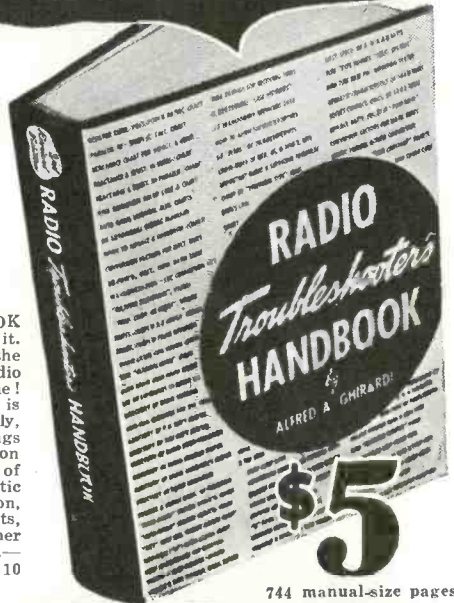

744 manual-size pages

Get a Complete RADIO-ELECTRONIC SERVICE EDUCATION AT HOME—WITHOUT AN INSTRUCTOR

COMPLETE DATA ON TEST INSTRUMENTS —TROUBLESHOOTING—REPAIR

A. A. Ghirardi's big 1300-page MODERN RADIO SERVICING is the finest, most complete instruction book on Radio-Electronic service work for either the novice or the professional Radio-Electronic serviceman—bar none! Read from the beginning, it is a COMPLETE COURSE IN SERVICING by scientific methods. Used for reference, it is an invaluable means of brushing up on any servicing problem. Gives complete information on all essential service instru-

ment types; how they work (with wiring diagrams), when and why to use them; how to build your own; preliminary trouble checks; circuit and parts analysis; parts repair, replacement, substitution; obscure radio troubles aligning and neutralizing; interference reduction — and hundreds of other subjects including How to Start and Operate a Successful Radio Electronic Service Business. 723 self-testing review questions help you check your progress EVERY STEP OF THE WAY. Only \$5 complete \$5.50 foreign).



1300 pages. 706 illus. 723 review questions

10 DAY MONEY-BACK GUARANTEE

Dept. RE-10, MURRAY HILL BOOKS, INC., 232 Madison Ave., New York 16, N. Y.

Enclosed find \$_____ for books checked below; or send C.O.D. (in U.S.A. only) for this amount plus postage. In either event, if books are not what I want, I may return them in 10 days and you guarantee to refund the purchase price.

- MODERN RADIO SERVICING \$5 (\$5.50 foreign)
- RADIO TROUBLESHOOTER'S HANDBOOK \$5 (\$5.50 outside U.S.A.)
- Special MONEY-SAVING COMBINATION Both Big Books for only \$9.50 (\$10.50 outside U.S.A.)

Name.....
Address.....
City, Zone, State.....
(Please print or write plainly)

You Can't Go Wrong on a Ghirardi Radio Book



MONEY-SAVING OFFER! Get BOTH big books — Radio's most famous Service Library — over 2030 pages — at a bargain combination price. See coupon.

reverse takes place and the pickup is lowered.

As pin O moves in, and after the pickup has risen somewhat, point V on the main lever strikes upward-projecting pin W. Pin W is part of lever X (Fig. 5), which is rigidly attached to the rear pickup-arm bearing Y, which projects down through the chassis and on which the arm swings. As point V (Fig. 2) pushes pin W rightward, the pickup arm is swung outward. The outward swing is limited by pin W's hitting a portion of lever Z (invisible in the photo but quickly understood when the actual unit is examined). In the second half of the cycle, when point V recedes leftward, the pickup remains at the outside limit which has been provided by a coil-spring arrangement on lever Z.

The trip pawl is reset by point AA on main lever K (Fig. 2). This hits the rear surface of tab E on the pawl, so that the pawl is rotated clockwise back to its initial position. It is then ready for the next cycle.

The record-change is caused by BB, the downward-projecting tab on main lever K. When this travels inward, it gets between the points of the star wheel DD (Fig. 5) and prevents it from turning, so that a new record is dropped as explained earlier. At the end of the cycle, the cam groove under the turntable pushes pin O (Fig. 2) outward and tab BB goes along with it, allowing the star wheel to turn with the table again.

In the playing position, BB rests against the leaf of the muting switch CC (Fig. 5) holding it open. When the cycle starts and BB begins to move in, the leaf is released, shorting the pickup leads, which are connected across the contacts, and muting the device to prevent audible clicks and thumps.

Adjustments

The set-down point for the pickup depends on the normal position to which arm EE (Fig. 5) of the limiting lever is pulled by spring FF. Pin GG (Fig. 2) projects upward from arm EE and hits an eccentric collar on screw HH. The travel limit of pin GG, and therefore the resting and set-down points of the pickup, can be altered by turning screw HH. This can be done without any disassembly. Adjust the screw so that the needle sets down about halfway between the first record groove and the record's outer edge. It will then move into the first groove smoothly.

The height to which the arm rises is controlled by the position of the pivot JJ of the lift lever. Turning the pivot screw moves the entire lever backward and forward through an eccentric mounting. Adjust this so that the arm does not hit the bottom-most of the records on the spindle during the change cycle. Bend lug KK (Fig. 2) so that the needle rests just high enough to clear the empty turntable when the mechanism is in the playing condition (not in the change cycle).

The record-drop mechanism in the turntable spindle must operate at the



Deep are their **roots**

With television, you see far beyond the horizon. Radio brings you sounds from around the world. Electron microscopes peer deep into the world of the infinitesimal.

These, and other "leaves" on our new tree of knowledge are rooted in creative research—as carried out at RCA Laboratories in Princeton, N. J. Here, research scientists seek new scientific principles, improve on old ones, or put them to new uses.

Already on their achievement list are hundreds of important and basic developments in electronics, television, radio, electron tubes, radar, and recorded music. RCA research works continually to give you better products.

Examples now working for you include: Today's sharp-eyed Image Orthicon television cameras, television picture tubes, compact portable radios made possible by tiny new RCA electron tubes, the 45-rpm record-playing system with the fastest record changer

ever devised and distortion-free records.

Research in your behalf: Creative research into new principles is another way in which RCA Laboratories work to improve your way of living. Leadership in science and engineering adds *value beyond price* to any product or service of RCA and RCA Victor.

Examples of the newest advances in radio, television, and electronics—in action—may be seen at RCA Exhibition Hall, 36 West 49th St., N. Y. Admission is free. Radio Corporation of America, Radio City, N. Y. 20.



RADIO CORPORATION of AMERICA

World Leader in Radio — First in Television

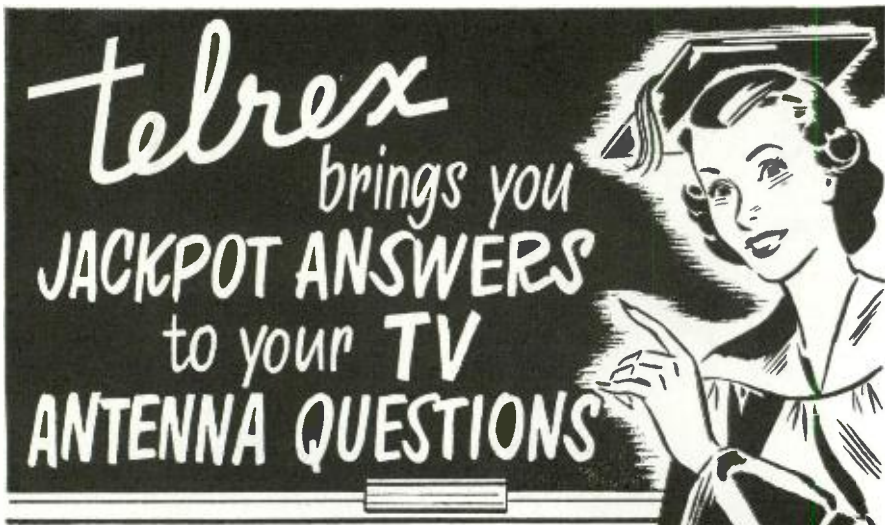

1. QUESTION—What's the one antenna that cuts installation troubles and service call-backs to the bone in all locations?

ANSWER—Telrex Conical Antennas, the conical "V" beams that cover all TV channels and FM, and afford best reception in every signal area. There's an engineer-designed, service-tested model for every TV location.

2. QUESTION—Why have Telrex Conical "V" beams replaced every possible combination of antennas for TV reception?

ANSWER—Because Telrex "V" beams are the only antennas offering true conical performance—top TV reception without bulky metal cones. For experience-designed models to meet every problem, workmanship that gives longer service . . . continue to look to Telrex!

3. QUESTION—Who has built 95% of all conical antennas installed today?

ANSWER—Telrex! Leadership in engineering and quality keeps Telrex out in front. The Telrex staff is ever seeking better methods, improved materials and design advancements. Supply a Telrex antenna on your next TV installation—you'll see the difference!

TELREX MODEL 2X-BD

- Bi-Directional Stacked Conical "V" Beam
- Low Vertical Angle
- Extremely High Signal to Noise Ratio
- Constant Center Impedance
- Uses 72, 150 or 300 Ohm Transmission Lines
- Universal Mounting Clamp

PATENTS PENDING
COPYRIGHT 1949

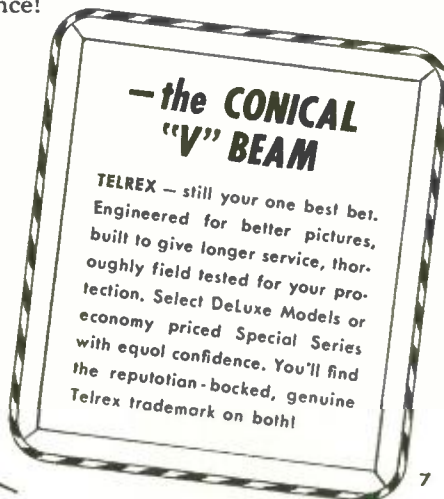

Telephone—ASBURY PARK 2-7252



correct time with respect to the action of the main mechanism. This is determined by the orientation of the star wheel on the drive shaft, which can be adjusted by loosening the wheel's two setscrews and turning it. We have found that the quickest way to adjust it is to position the wheel experimentally, hand-tighten a setscrew, and put the changer through a cycle, turning the table by hand, with a couple of discs on the spindle. When the star wheel's position is correct, the disc will drop at the right time and both setscrews can be tightened to keep it firmly in place.

The changer should trip immediately after the needle leaves the last close-spaced groove and enters the spiral. To make the trip occur sooner, bend tab E on the trip pawl (Fig. 5) to decrease the angle between the tab and the pawl body; to delay the trip, bend it the other way. *Do not bend it much in either direction or it will not trip at all.*

There is no way to adjust the speed at which the pickup falls on the record. The fall, when there are only one or two discs on the turntable, is hard enough to make the pickup bounce. This is a fault of the design. Recent models, however, are equipped with a pneumatic dashpot which stops the bounce.

REGULATED POWER SUPPLY

Experimenters frequently use tapped bleeders across power supplies. A system of this type will work as long as the current from all the taps remains at the level at which the taps were adjusted. Any change in current drain from one tap will change the voltage at all taps.

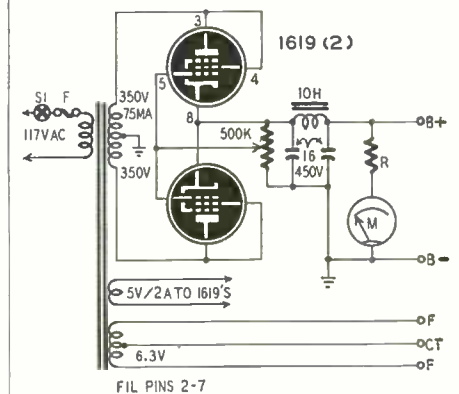

This circuit is a solution to the problem. The output voltage can be varied from approximately 50 to 225 volts under ordinary loads. The voltage and current ranges can be increased—within limits—by using a huskier transformer and choke. A pair of 1619's can be obtained from surplus stocks for about \$1.00. The control potentiometer should be one of the molded-element type to carry the current. If this type is not available, you may use a standard 1-megohm carbon potentiometer. Resistor R is the meter multiplier. Its resistance depends on the meter and voltage to be measured.—Charles J. Applegate

FREE! NEW RADIO CATALOG

Packed with bargains! Big, new 164-page catalog teeming with everything new in radio, television and electronic equipment — at prices you want to pay. Thousands of outstanding bargains of popular brand name merchandise, fully described and illustrated. It's a gold-mine of helpful information...a practical encyclopedia used by economy-minded servicemen, dealers and technicians throughout the world. Lafayette makes it easy for you to order from this complete "one-source" guide, guaranteed to save you money on every purchase. And best of all, it doesn't cost you anything to have a copy. Clip the coupon below, paste it on a penny postcard and mail it today. Lafayette's 29 years of "know-how" in the radio and electronic field is yours to command with this valuable buying guide.



LAFAYETTE SLASHES PRICES ON SUPREME TEST EQUIPMENT

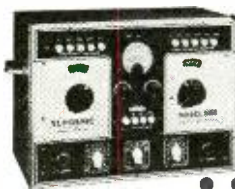

AF & RF OSCILLATOR

~~Was \$141.60~~ **NOW \$63.95**

Both AF and RF signals available at the same time — push button operated. Also has FM oscillator providing visual alignment of IF amplifiers of amplitude modulated receivers. 5 RF Ranges: 65/205 KC, 205/650 KC, 650/2050 KC, 2050/6500 KC, 6.5/20.5 MC. Harmonics above 60 MC. Frequency modulated 15 KC; rate 120 cps; 60-cycle time base. Range of AF oscillator: 15-15,000 cps. Output impedances: center tap transformer 50/500/5000 ohms. High impedance resistor 50,000 ohms. 110-125V., 50/60 cycles. Metal case 15½ x 11½ x 8¾". Shpg. Wt. 33 lbs. With Test Leads.

99A9633—Supreme Model 666..... **63.95**

All five ranges read on two basic scales, accurately calibrated at both ends, 65-205 KC; 205-650 KC; 650-2050 KC; 2050-6500 KC; 6.5-20.5 MC. Harmonics to 82 MC. 400-cycle audio; continuously variable voltage output. RF carrier modulated at 50% at 400 cycles; can be cut off to provide unmodulated signal. Jack for external audio modulation. Electron coupled circuit assures maximum stability. 110-125 volts, 50/60 cycles. Heavy steel case measures 9½ x 8¾ x 7-3/8". Shpg. Wt. 15 lbs.

99A9632—Supreme Model 661..... **32.95**

RF SIGNAL GENERATOR

~~Was \$72.50~~ **NOW \$32.95**



All ranges selected by push-button operation with exception of 14 ampere ranges. DC Ranges: 0/70/700 microamps; 7/35/140/350 ma; 0/1.4/14 amps. DC Volts: 7 ranges at 1000 ohms/V. and 7 ranges at 25,000 ohms/V. 0/3.5/7/35/140/350/700/1400. Ohms: 0/500/5000/50,000/500,000; 0/5/50 megs. All operated by self-contained battery. AC Volts & Output Ranges: 0/7/35/140/350/700/1400. 4 DB Ranges: 0 to +46. Size: 9-1/16 x 6¼ x 5¼".

99A9631—Supreme Model 592...Shpg. Wt. 9 lbs.... **29.95**
Battery Kit for above. (4) Burgess #1 & (1) M30
20A20621—#1 Cell, Each...6½¢ 20A20617—M30, Each...1.54

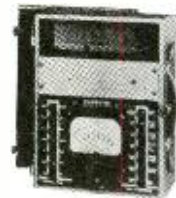

PUSH BUTTON SET TESTER

~~Was \$58.95~~ **NOW \$29.95**

Lafayette Radio

Lafayette's huge purchasing power makes bargains like these possible. Many other outstanding values are listed in our FREE CATALOG and also featured in our showrooms located in the following cities:

- NEW YORK.....100 Sixth Avenue
- BRONX.....542 E. Fordham Road
- CHICAGO.....901 W. Jackson Blvd.
- BOSTON.....110 Federal Street
- NEWARK.....24 Central Avenue
- ATLANTA.....265 Peachtree Street

MAIL THIS COUPON TODAY

LAFAYETTE RADIO, Dept. JA-50
100 6th Avenue, New York 13

- Check here for FREE CATALOG
- Ship 99A9633-Model 666 AF & RF Oscillator.....\$63.95
- Ship 99A9632-Model 661 RF Signal Generator.....\$32.95
- Ship 99A9631-Model 592 Push Button Set Tester...\$29.95
- Ship 20A20621 Burgess #1 Cells (4 needed @ 6½¢).....26¢
- Ship 20A20617-Burgess M30 Battery.....\$1.54

My postal note, money order or check includes shipping charges based on weight and postal zone.

NAME.....
ADDRESS.....
CITY.....ZONE.....STATE.....

PUZZLED?



TUBE TESTER?
BATTERY TESTER?
CONDENSER TESTER?
AM SIGNAL GENERATOR?
AUDIO OSCILLATOR?
FM SIGNAL GENERATOR?

Here's Your Answer Now

ALL IN ONE!

SERVISHOP MODEL 8573

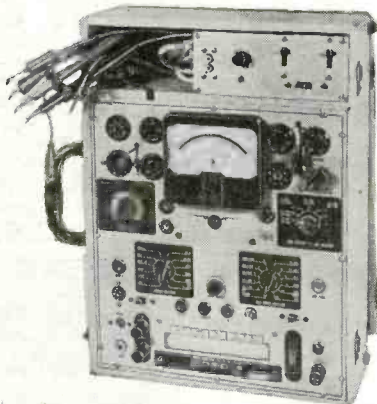

EQUIVALENT TO A COMPLETE SERVICE SHOP!

- TUBE TESTER
- SET TESTER
- BATTERY TESTER
- CONDENSER TESTER
- AUDIO R. F. - F. M. SIGNAL GENERATOR

\$99.95

Every square inch solid-packed with value! Look what you get in this phenomenally low-priced tester: (1) A complete tube tester with over 800 listings in its famous Rollindex roll chart, (2) a battery tester indicating actual voltage under rated load, (3) A capacitor tester, (4) A fixed point calibrated AM-FM signal generator, (5) An audio oscillator; and a dozen additional features.

Readable scale divisions on the ohm meter start at 0.05 ohm to 25 megohms.

DC Volts: 0, 2.5, 10, 50, 250, 1000, 5000
AC Volts: 0, 10, 50, 250, 1000, 5000
DC Milliamps: 0, .5, 2.5, 10, 50, 250, 1000
DC Amps: 0, 10
Ohms: 0, 250, 2500, 25000
Megohms: 0, 2.5, 25

Decibels: -8 to +15, 15 to 29, 29 to 49, 32 to 55
Output Voltmeter: 0, 10, 50, 250, 1000, 5000

Complete with tubes, batteries and test leads, output leads, etc., housed in natural finish oak case; hammertone gray panel. See this outstanding buy at your jobber today—or write for new catalogue J.C.

RCP INSTRUMENTS—BEST FOR EVERY TEST

RADIO CITY PRODUCTS CO., INC.

152 West 25th St.  New York 1, N. Y.

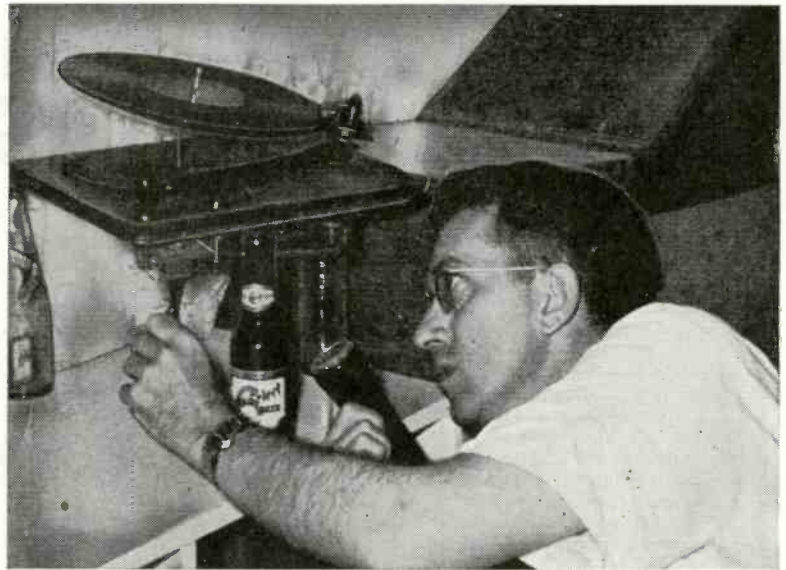

"... got underneath ... and began getting a crick in my neck."

Record Changers--Bah!

By JAMES R. LANGHAM

WE'VE all heard fantastic tales about record changers. And Lord knows they *can* be fantastic. George Price drew a very fine cartoon of one hurling a disc through the air and its owner saying, a trifle smugly, to a visitor: "Our record changer says if it isn't Bach, to hell with it." Fantastic, yes—but close enough to the truth to be funny.

Back in the days when I was doing general service work we didn't get many record changers. In the first place there weren't as many of them. In the second place those we had were a little better in quality and workmanship (though poorer in design) and so tended to go wrong less often.

I remember one brute I was called in on. All the thing needed was a new length of phosphor-bronze cable run through its complicated system of wheels and pulleys. It wore me down to trace it out and then string up a new one, so I charged the owner \$15 for the repair job. Looking back now, I wonder how I had the nerve to charge so much and why he accepted the charge without complaint. It certainly wasn't much of a job to thread it up once I discovered how it was supposed to go. It wasn't nearly as bad as the dial arrangement on some of the new all-band or communications receivers you run into.

I got into audio work just a little while after that, specializing more in design and construction than servicing. I didn't get to see many record

changers because both the XYL and I scorned them heartily. Hard on the records.

We had a neighbor once who kept a small hammer alongside his record changer. Every once in a while it would stop playing records and begin saying "wood chuck." It would just say it over and over: "Wood chuck wood chuck wood chuck." The owner would reach over and hit it with the hammer, and it would stop saying "wood chuck" and go back to playing records. He'd hit it right on the center of the turntable spindle. I haven't the faintest idea why. Sometimes he would have to hit it only a couple times an evening, and sometimes he'd cosh it about every fifteen minutes. Depended on the cosmic rays, maybe. He didn't mind it particularly—he was rather proud of it! It sort of set him off from other people. The XYL was all for my digging into it and removing its appendix or something but I shushed her. I didn't want any part of that fearsome affair.

Anyhow, a little over a year ago the XYL suggested that we buy a changer. She was almost apologetic about it. "It would be nice for the youngsters and for dancing, and we could put some Strauss waltzes on at mealtime and..."

I let her talk me into it, agreeing that it might be pleasant. Sucker! After all, loads of people have them. They probably have been exercised of evil spirits by now. Just about fool-proof.

So one morning we went down to the

RADIO-ELECTRONICS for

For the greatest selection of kits in the world PROGRESSIVE ELECTRONICS COMPANY

SIGNAL GENERATOR KIT

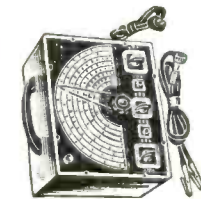

- 150 kc. to 34 Mc on fundamentals.
- Over 100 Mc on strong harmonics.
- 5 Bands on scale.
- 400 cycle Modulation.
- 400 cycle audio available without modulation.
- Provides markers for sweep generators.

• 110 volts . . . 60 cycles.
• Ideal for AM, FM, and TV Alignment.

Kit is complete with all parts and tubes necessary for construction and ready for assembly. Large dial. Convenient size and weight.

SIGNAL GENERATOR KIT COMPLETE . . . \$18.95

FREE GIFT: Book on Radio Test Instruments.

SWEEP GENERATOR KIT



A Sweep Generator is an absolute necessity for FM and TV servicing, alignment, and experimenting. We have designed our kit to give you the maximum performance in all three categories mentioned.

Operating and constructional features:

- Range . . . 2 Megacycles to 226 Megacycles
- AM or FM output.
- Variable sweep width up to 10 Megacycles.
- Variable PHASING control
- SWEEP OUTPUT for Oscilloscope.
- Miniature tubes used for best results.
- 110 volt . . . 60 cycle operation.
- Extra large calibrated scale.

SWEEP GENERATOR KIT COMPLETE . . . \$22.95

Free Television & FM Servicing Notes.

MULTI-TESTER KIT



A versatile, compact test instrument ideal for radio receiver servicing. Equipped with 3 1/2" round 0-1 Ma. EMPLOYING THE FOLLOWING RANGES:

- Volts . . . 500, 100, 50
- Milliamperes DC.
- Ohms: 0-5, -50, -150
- Ohms: 0-2000, -20,000, -200,000
- Internal source: 4 1/2 volts
- 1000 ohms X 1 with sensitivity.

MULTI-TESTER KIT COMPLETE . . . \$11.05

Free Book on Radio Test Equipment.

AMPLIFIER KIT



The PROGRESSIVE AMPLIFIER KIT is the Ideal Amplifier. Electricities musical instruments. Separate make tubes constant voltage supply. DC Heater supply. DC Heater supply. Whether used on AC or DC, provides humless operation by eliminating cathode heater leakage hum. Tone and volume controls completely variable. 5 watts output. Features 9 beam power amplifiers, 1 twin-triode phase inverter, and 1 voltage regulator.

AMPLIFIER KIT COMPLETE . . . \$15.00

Free Book on Amplifiers.

SIGNAL TRACER PROBE KIT



This Signal Tracer Probe Kit will allow you to locate trouble with your own Audio Amplifier or VTYM. Consists of a Germanium Crystal detector and associated RC network. A very hands, professional-looking probe, enclosed in a beautiful aluminum casing. The probe detects the trace in any stage of a circuit or audio amplifier. Can be wired in a few minutes. Simple, easy-to-follow instructions, pictorial and schematic.

SIGNAL TRACER PROBE KIT COMPLETE . . . \$5.75

Free Book on Radio Test Instruments.

FREQUENCY MODULATION (FM) RECEIVER KIT



Here is a complete, seven tube FM kit. • Front end section factory assembled at factory. • Uses 2 LF stages and 1 Discriminator. • Utilizes the Armstrong system of noise elimination: best for FM reception. • Complete with cabinet, tubes, pictorial, schematic, detailed instructions.

- Tubes: 1-12BE6, 3-12BA6, 1-12AU6, 1-19T8, 1-35B5.

FM RECEIVER KIT COMPLETE \$29.95

Free Gift: 50 Feet of Twin-Lead Transmission Line.

SIGNAL TRACER KIT

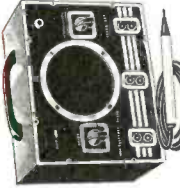

Engineered for audio tracing of video and audio circuits. Provides visual signal tracing, enabling actual stage-by-stage gain comparison. The Signal Tracer may also be used as a dress or intercom system. Handsome etched panel, sturdy steel case with 6S17, 6K6, and crystal probe.

SIGNAL TRACER KIT COMPLETE . . . \$18.95

Free Book on Radio Test Instruments.

TOOL KIT



Consists of 15 Watt Electric Soldering Iron, Combination Long Nose Pliers, Cutters, diagonal screw-driver, and supply of Rosin-Core Solder.

TOOL KIT COMPLETE . . . \$5.75

Free, 35 Watt Midsize Electric Soldering Iron and Supply of Hook-up Wire.

Only Progressive has the World Famous Progressive Radio Kit

NOW! BUILD 15 RADIOS \$14.75
COMPLETE KIT ONLY...

Absolutely No Knowledge of Radio Necessary. You Need No Additional Parts EXCELLENT FOR BACKGROUND IN TELEVISION . . .

Contains everything you need. Instruction book, metal chassis, tubes, condensers, resistors and all other necessary radio parts. The Instruction Book written by expert radio instructors and engineers teaches you to build radios in a professional manner. The circuits are designed to provide excellent performance. Each of the 15 radios you will build operates on 110-120 volts AC or DC. The PROGRESSIVE Radio Kit is excellent for learning the principles of Receiver, Transmitter and Amplifier design. It is used in many Radio Schools and Colleges in U.S.A. and abroad. It is used by the Veterans Administration for Veteran training.

FREE: ELECTRICAL AND RADIO TESTER, plus FREE Membership in the Progressive Radio & Television Club. You will be entitled to FREE expert advice and consultation service with licensed radio technicians. ORDER YOUR KIT NOW! PROGRESSIVE RADIO KIT COMPLETE \$14.75

OSCILLOSCOPE KIT

1. All controls on front panel
2. Horizontal sweep circuit range . . . 15 to 30,000 cycles
3. Frequency response flat from 50 cycles to 50 KC on both horizontal and vertical amplifiers.
4. Input impedance, 1 megohm and 50 micro-microfarads; excellent for I.F., R.F., F.M., video and audio circuits.
5. Ideal linear sweep utilizing Thyratron type tube #84.
6. Deflection sensitivity: 2.5V3: 1-884; 1-58P1 tubes
7. Deflection for external synchronization.
8. Provision for external synchronization.
9. Test voltage jack.
10. Luminosity modulation.
11. Detailed instructions for assembly and wiring.
12. Pictorial diagrams included.
13. The finest Oscilloscope Kit obtainable anywhere.
14. The finest Oscilloscope Kit COMPLETE . . . \$39.95

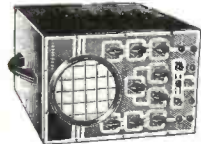

Free Book on Cathode-Ray Tube Oscilloscopes.

VACUUM TUBE VOLTMETER KIT

1. You can actually measure antenna voltage with this meter.
2. 0-500 micro ampere movement, the finest available.
3. Output Meter . . . You can measure DB gain or loss directly.
4. AC-300, 10000 volts . . . 5 separate scales covering 0-3, -30, -100, -10 meg. . . 5 separate ranges . . . 0-1000, -100,000, -1 meg, -10 meg. -1000 meg. (Shows slightest condenser leakage)
5. DC Input impedance . . . 11 megohms . . . perfectly linear movement.
6. AC Input impedance . . . 6.5 megohms . . . perfectly linear movement in accuracy.
7. Designed specifically for use in AM, FM, and Television work. \$23.95
8. VTYM KIT COMPLETE WITH SET OF PROBES . . . \$29.95



Free Gift: Book on Advanced Servicing Techniques.

FAMOUS #630 TV CHASSIS

Not in kit form, completely wired and ready to operate. A COMPLETE 16 inch TELEVISION CHASSIS, ready for custom bulb installation. Licensed by RCA. 16" brackets included. • 31 RCA tubes incl. rectifiers. • Automatic picture blifter. • RCA 13-channel tuner. • Long-range cruise reception. • New improved daylight viewing. • Dimensions W-21 1/2" H-10" D-16"

NO FINER RECEIVER AT ANY PRICE . . . \$179
Complete net price. Pictured (Less C-R Tube)

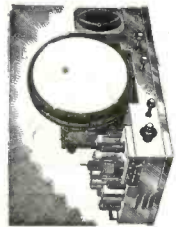

FREE GIFT WITH EACH KIT

PROGRESSIVE ELECTRONICS CO.

497 Union Ave. • Brooklyn 11, N. Y.

Phone: Evergreen 8-0054

2% DISCOUNT ON CASH ORDERS

C.O.D. Orders accepted in U.S.A.

Your **BEST BUY** is TV TEST EQUIPMENT by **SILVER**

Originally designed by McMurdo Silver . . . developed and constantly being improved by McMurdo Silver's staff of engineers. Manufactured of the highest quality, tested components by the trained electronic technicians in McMurdo Silver's modern factory. Compact! Low-priced! You can't beat the value that is built into every McMurdo Silver Laboratory Caliber Test Instrument!



Model 900-A "Vomax"

The new "VOMAX" makes TV, FM, and AM measurements accurately, at highest meter resistance. Giant meter, non-breakable glass; 45 ranges, new single probe for a.c., d.c., a.f., r.f., volts, ohms, db. and current measurements. "VOMAX" measures TV power supply potentials up to 30 Kilovolts when used with the High Voltage Adaptor Probe. A world-beater at only \$68.50 net.

Model 918 Multiplier Probe

Built for long life and hard usage, each probe has been thoroughly tested: assuring safety of operation on voltages up to 30,000 volts d.c. Plug-in tips make it readily attached to your VOMAX VTVM, Model 900 or 900A, on which direct meter readings can now be made from 1/10 volt to 30,000 volts d.c. Only \$9.95 net.

Model 915 Tubeless Grid Dip Adapter

Checks oscillators, antenna systems, transmitters, trap circuits, without mechanical coupling. Determines value of all coils and condensers. Requires no power supply or tubes; connects to any signal generator. Three calibrated plug-in coils cover 100 kc. to 300 mc. Equipped with phone jack for easy identification of oscillator frequencies. Model 915 is only \$34.95 net, including coils.

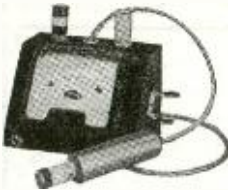

Model 906 FM-AM Signal Generator

Choice of the big engineering laboratories plus thousands of service technicians, 906 stands out as maximum value. 90 kc thru 210 mc. in 8 ranges, 1% accuracy; less than 1/2 microvolt, including strays to over 1 volt v.t.v.m.-metered output; multiple shielding; adjustable 0 to 100% amplitude modulation, adjustable 0 to 1000 kc. FM sweep. Price only \$116.50 net.



Model 905-A "SPARX"

Combining signal-tracer and universal test speaker, 905-A is amazingly sensitive yet free of usual tracer hum. Vacuum-tube prod with r.f. - a.f. switching; high-gain high-fidelity amplifier, 6" PM speaker; 18-watt output transformer gives wide choice of impedances. Two essential instruments in one, 905-A is a value far exceeding \$44.50 net



Model 911 TV/FM Sweep Generator

Here is an all-in-one TV service center. Continuous range of 2 thru 226 mc. Output from 0.1/2 volt, 1 and 5 mc. precision crystal markers insure pin-point setting of TV i.f. band width, and trap circuits. Phased 60 cycle sine and 120 cycle saw-tooth voltages for direct scope control. Sweep from 0-10 mc. An outstanding buy at only \$78.50 net.

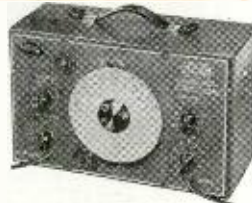

SEND COUPON TODAY

McMURDO SILVER CO., Inc.
1249 Main Street Hartford 3, Conn.

Date.....

Please send me — and bill through my jobber — the instruments I have checked below:

- | | |
|--|---|
| <input type="checkbox"/> 900-A "VOMAX" @ \$68.50 | <input type="checkbox"/> 906 FM-AM Signal Generator @ \$116.50 |
| <input type="checkbox"/> 918 Multiplier Probe @ \$9.95 | <input type="checkbox"/> 905-A "SPARX" @ \$44.50 |
| <input type="checkbox"/> 915 Tubeless Grid Dip Adapter @ \$34.95 | <input type="checkbox"/> 911 TV/FM Sweep Generator @ \$78.50 |
| | <input type="checkbox"/> Send Free catalog of Laboratory Caliber Test Instruments |

MY JOBBER IS: _____

Name.....

City.....

Address.....

Name.....

City.....

Address.....

McMurdo Silver Co., Inc.

wholesale house and asked to be shown. I'm a pretty good customer, and so they bent over backward and lined up a whole row for our inspection. We both hefted the tone arms and looked underneath with a technical air that probably fooled the clerk.

The first question was whether to choose a center-post changer or one with the two bladelike dinguses that hold the discs by the edges. We were inclining toward the two-blade affair when the XYL happened to wonder about some records being thicker than others.

The salesman assured us that it just wasn't so. All the records were the same size, he insisted.

The more we thought about it, the more we stalled, finally calling a moratorium on the purchase, and went to a record shop. It was our regular shop and the girl knew us, but this time we were in a hurry and didn't want to go through a whole bunch of explanations. We demanded a thick record.

"Uh—thick?" The girl wasn't sure. We nodded. "Preferably laminated. Columbia. A thick one."

The girl was very unhappy over the whole thing. It was a silly way to choose a record and our reputations took an awful drop. We finally went back to the wholesale house with a thick, laminated disc of Lanny Ross singing some tepid number. We slapped it on the changer.

The XYL's fears were true. Those knife-edges tried to go in between Lanny Ross. It stuck and kind of growled and grunted and then the record gave up. Lanny lost his first eight bars.

The salesman was humiliated and a bit resentful. We should have taken his word for it. "Any record shop will exchange a bad record like that."

The XYL smiled sweetly. "There may be quite a few like that in our library. We've had them for some years. Do you really think we could exchange them now? Let's look at the center-post changers."

The salesman shrugged in a resigned, hopeless manner. "What's the use? They'll wear out the center holes. You can't make an omelet without breaking eggs."

"We don't want an omelet, thank you. Also we don't want to have to sweep out the record chips every night."

Anyhow we finally got down to a choice between a most-popular American model and another, slightly higher, imported from Great Britain. We decided on the American model because of ease in getting replacement parts. I commented on Whitworth and S.A.E. threads. Also because the American model looked as though it had more bronze and less pot metal underneath it. Also it was cheaper. I was still a newborn babe. I found out afterward the bronze was paint, and there were only two or three screws in the whole thing.

Anyhow we took home a brand new changer all sealed in its carton. We

NEW for 1950

MIDWEST

Celebrates its 30th YEAR of FACTORY-TO-YOU Selling with a Sensationally NEW 1950 LINE of

TELEVISION

CONSOLES *and Complete* CHASSIS

New GIANT 16" PICTURE TUBE

Here is Television at its finest! . . . brought to you by Midwest, for 30 years a leader in the field of radio and electronics. Immense 151-square-inch screen on new 16" metal-glass tube . . . clear, steady, bright pictures . . . Synchronized sound and picture that a child can tune in perfectly . . . Highest quality FM sound . . . Big 12" Electro-Dynamic Panasonic Speaker. Available in beautiful Consoles or in complete chassis as illustrated (not a kit, but a complete Television receiver ready to plug in and play) to place in your own cabinet. And you can buy Midwest Television at Low Factory Prices, with Low Down Payment and Long Easy Terms — and on 30 Days Trial!

NEW LOW Down Payment Long EASY TERMS

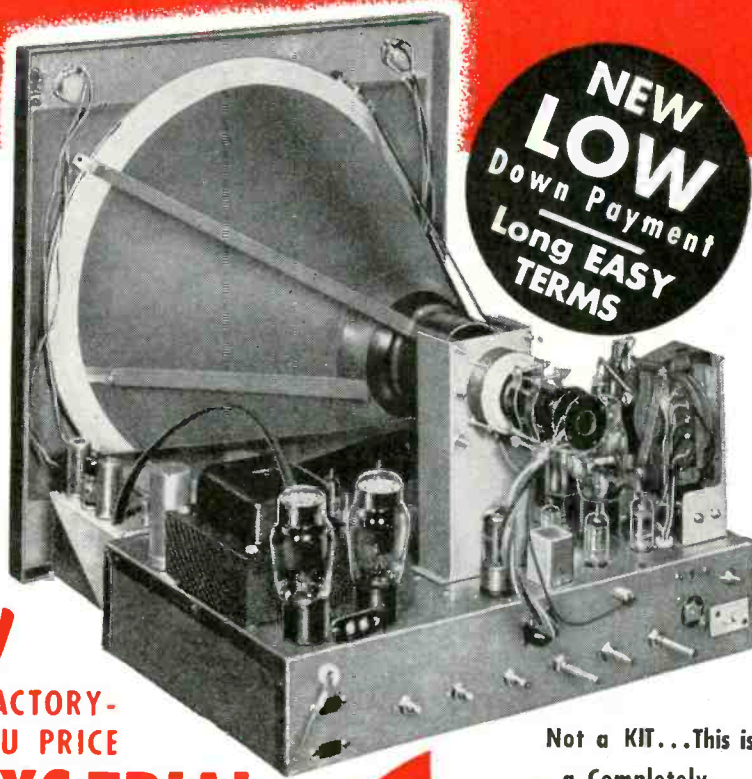

LOW FACTORY-TO-YOU PRICE 30 DAYS TRIAL

Not a KIT...This is a Completely assembled Receiver

...also a Magnificent Line of NEW 1950 **MIDWEST RADIOS** featuring the latest Improved FM Circuit and the New 3-SPEED RECORD PLAYER



Powerful new 1950 Series 16 and Series 12 AM-FM Radio in complete chassis. Also beautiful new Console models including the magnificent Symphony Grand Radio-Phonograph with latest FM circuit and new 3-Speed Automatic Record Player.

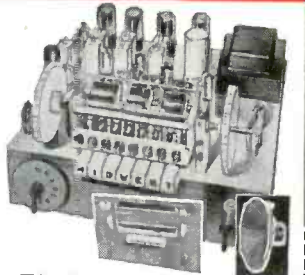

BUY DIRECT FROM THE MIDWEST FACTORY and SAVE! MIDWEST RADIO & TELEVISION CORP.

Dept. X386, 909 Broadway, Cincinnati 2, Ohio

SEND FOR FREE 32-Page Full Color CATALOG



Write in Name and Address (Please Print) on Coupon or 1c Postcard.

MIDWEST RADIO & TELEVISION CORP. Dept. X386, 909 Broadway, Cincinnati 2, Ohio Please send me your new FREE 1950 Catalog.

NAME _____ ADDRESS _____ CITY _____ ZONE _____ STATE _____

JFD Products Give Everybody A "Break"

Precision mass-produced to give your customers a "break" on servicing prices, and to give you a "break" on profits! Here are typical JFD values included in the most complete line in the world.

R5 Ranger "Economy" Array

Duo-Orienting Hi-Lo Folded Dipoles. First Choice for local signal areas. Channels 2 to 13 plus FM.

List ONLY **\$13⁷⁵**

JFD TA160 "D-Xer" All-Band Conical

Delivers higher DB gain and sharper directivity. Built to outsell and outperform!

List **\$13⁹⁵**

JFD TA161

Same as TA160 but 1/4 wavelength stacked for extra gain.

List **\$29²⁵**

JFD TA162

Same as TA161 but 1/2 wavelength stacked.

List **\$30⁹⁰**

Single "Adjusta" Stand-Offs For Twin Lead

UT350 (3 1/2") 19c List UT750 (7 1/2") 26c List
 UT550 (5 1/2") 25c List UT1200 (12") 46c List

Call on JFD first . . . "Headquarters for All types of screw eye insulators."

Write for Free JFD Catalog of TV Accessories No. TV100

More than a catalog, it contains installation and servicing data of interest to every serviceman.

Also FREE for the Asking—JFD Catalog of Radio Accessories No. 438.

JFD MANUFACTURING CO., Inc.

6101 18th Avenue
 Brooklyn 4, N. Y.

FIRST IN TELEVISION ANTENNAS AND ACCESSORIES

Copyright 1950 JFD Manufacturing Co., Inc.

felt smugly confident that we had done the RIGHT thing. Scientific method.

Then for a couple of days I wrestled with plywood to make a box for the thing. Inside dimensions, 14 x 14 inches. Nice fit. A flame finish went pleasantly with the playroom decor, and so I squirted the blow torch at it while the XYL stood by with trepidation and a fire extinguisher.

When I put the changer in, I noticed the flame finish on the outside had made the wood squeeze in a bit on each side. Not much. Just made it a nice push fit.

I had already equalized the crystal with it on manual with the changer standing on three beer bottles and had got it about right, so I now called the XYL and loaded up the changer with a nice stack of Sibelius. Then I pushed the button.

Man, it was funny! The changer walked right through that stack of records and never played a note. Just changed them all, one right after the other, as fast as it could. Fast cycle too!

"My," admired the XYL. "That was a quick symphony wasn't it? What did you say it was?"

Glaring at her, I set them up in the other alley. Same result. It wouldn't play a single bar of music. As fast as the tone arm set down on a record, the mechanism would go into another spasm. All ten records just like the little Indians. My loving helpmate giggled.

"Well, after all," I remarked. "You wanted a changer. It changes them. It just doesn't play them. We have a regular turntable to play them on. Speed is the catchword of modern progress."

She frowned. "I wonder where we could get a service technician?"

That was too much! I chased her out of the room, pried that fool changer out of its corsetlike box, and set it up on the three beer bottles again. Then I loaded it up, got underneath with a flashlight, and began getting a crick in my neck.

Like most items in a competitive economy this affair was made as cheaply as possible. The motor board is a stamped piece of sheet steel covered with bronzelike stain. The mechanism works with a series of little springs in different directions. The who-dad bumps on the dingbat and that releases the gimmick (if the tensions are right on the springs) that triggers the bull-sprocket, and so on.

That nice tight-fitting box was warping the light motor board so that the vector tensions of the springs were thrown slightly cattywampus. The box being my pride and joy and my blood and sweat, too, the answer was not to knock the box apart and rebuild it. The answer to me—then—was simply to adjust those little springs.

Those little springs were held by small tongues that were punched out of the sheet metal of the motor board. The little tongues were pushed up and the springs just looped over them. The only adjustment possible, of course,

was to bend those little tongues this way and that. My natural tendency seemed to be to bend them the wrong way at first and about seven times too far.

Progress was slow on it, too, because the only way of testing it each time was to push the thing down into the box again and, then, when it didn't work, pull it and pry it out and set it up on the bottles again.

Looking back on it now, I honestly think a regular record-changer repairman could have adjusted that thing within an hour or so. I even think I could do it now. But not then. It was bend and put it in the box and try it; pry it out and bend again; ad nauseum. Humiliating! Also slow.

After some hours the XYL called out something, and I just snarled at her. Still later she brought me a cheese sandwich and a glass of beer. Then she

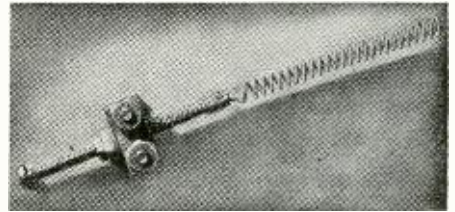

"... flattened the screws out and hooked the springs through the small holes . . ."

came down in her slippers and robe to say it was nearly three thirty and didn't I think I'd better stop for now?

I didn't and bent a tongue again. This time the little tongue broke off in my pliers, and the spring went "ANG-UH-Ang-uh-ang-uh." Something whizzed through the air and hit the speaker baffle.

At that point, I confess, I put my head down in my arms and wept. The XYL picked up the washer, turned out the lights, and led me off to bed.

The next morning I broke off the other two little tongues and failed to solder the first one on so that it would hold. The XYL came in and got the axe away from me just in time. I went for a long walk by the beach then and tried to commune with myself.

When I got back, I made up three little brass blocks and drilled them to clear 6-32 screws. These were bolted to the motor board. Then I made a longer 6-32 screw into a little hook and anchored the springs with the hooks. This longer screw was adjustable with a lock nut. The bullcog had bumps that fouled these hooks, so I flattened each screw out and put the springs through a small hole drilled through it. Still adjustable tension.

Then I got to work. I changed the tensions a little at a time and (of course) got it in less than an hour. I locked down the nuts and there it was. Adjustable and lockable. Then I put it back and, trembling, called the XYL.

This time it worked fine. It changed not only standard Victor, Columbia, and Decca discs but even some Telefunken records which are slightly smaller over-all and have no eccentric

grooves at the end of the cut. It even worked fine with acetate recordings although I don't recommend that practice—too rough on the acetate discs.

Since then I have become a sort of minor authority on the adjustment of record changers among a small circle of high-fidelity fans. I have had to make several machines work after various wives had seen ours working and made their husbands buy them. In each case I have installed at least one brass block for adjusting the spring tension. The most critical (and one is always more critical than the others) is generally the one toward the corner where the switch is.

Aside from this there's not an awful lot to go wrong with a record changer. The whole thing is mechanical and you can generally diagnose the trouble by inspection while it's going through its routine. Instead of beer bottles, I now have three threaded brass rods to stand the thing on.

Wear often seems to occur at the underside of the dog-leg arm that pushes the stack of records. The manual says to bend this arm so it won't go so far, but it is better to shim it with a piece of cardboard.

Impatient folk will try to stop a changer in its cycles sometimes, and then you do have a rebending job on the spindle or, on some changers, on the little sheet-metal finger that trips the trigger. Most of the changers have poor bearings, and, when they wear out, you either have to make new ones or buy them.

Those bull-gears with the knobs that look as though they are made of pot metal *are* made of pot metal, so watch your step and don't bump them! Sometimes they crumble if you breathe hard on them. I've had that trouble with three or four popular British changers, and I don't particularly like them for that reason.

As to fidelity, they aren't so hot if you want the finest. You don't get the results with them that you have a right to expect from a really nice pickup. In spite of the fad for reluctance heads right now, I personally prefer crystal units on changers. The reluctance heads require a lot of bass boosting and have low output anyhow, making it too easy to have your hum level up there so high the quiet passages can't be heard.

The crystals (as well as the reluctance cartridges) require equalization; I've never had a pickup yet that didn't need it. You can swap cartridges for another type, but don't try to switch arms. One chap converted an old Capeheart changer to swing a Brush PL-50 arm and head. He finally got it working, but took up absinthe shortly afterward and was never much good for anything again. Got to seeing everything green.

Changers do gouge the records more than a straight player but not an awful lot. You don't really expect records to last forever anyhow. They don't do as much damage in a dozen playings as some careless jerk who wipes the dust off the grooves with sweaty hands.



320K SIGNAL GENERATOR KIT \$19.95
Wired \$29.95



221K HIGH PRECISION VACUUM TUBE VOLTMETER KIT \$23.95
Wired \$49.95



400K 5" SCOPE KIT \$39.95
Wired \$69.95



315 DELUXE SIGNAL GENERATOR \$59.95
Wired only



145K MULTI-SIGNAL TRACER KIT \$18.95
Wired \$28.95



511K POCKET VOLT-OHM-MILLIAMMETER KIT \$14.95
Wired \$17.95



360K SWEEP SIGNAL GEN'R'R KIT \$29.95
Wired \$39.95



HI-FREQ PROBE KIT \$3.75
Wired \$7.50
HI-VOLTAGE PROBE
Wired only \$6.95

**SAVE TIME, SAVE MONEY—
LEARN WITH EICO KITS!**

By following the schematic and pictorial diagrams enclosed with your EICO Kit, you are certain of turning out a laboratory-type precision instrument. It's no trick at all to complete the job in one evening!

Build it yourself—save assembly labor cost—acquire invaluable electronic knowledge and experience.

FOLLOW THE LEAD of numerous schools, colleges, TV manufacturers, who specify EICO instruments and kits. Prepare yourself for TELEVISION—buy EICO instruments and kits. Ideally suited for TV: EICO VTVM goes to 30,000 volts and over 200Mc with our accessory probes—EICO Sweep Generator has TV channels marked on panel and crystal marker—new EICO 'scope has high sensitivity and Push-pull.

Write NOW for our new catalog "E".



ELECTRONIC INSTRUMENT CO., INC.
276 Newport Street, Brooklyn 12, N. Y.

DEWALD'S NEW 1950 LINE



**GIANT SCREEN TELEVISION
AM & FM RADIOS
THREE-WAY PORTABLES
RADIO-PHONO COMBINATIONS**

DeWald's reputation of a quarter of a century of proven quality ••• plus our prompt friendly service ••• is your assurance of satisfaction. Our policy, as authorized factory distributor, is to sell you only what you select ••• no package deals ••• no tie-in sales.

Attractive Dealer Prices ••• Write • Wire • Phone!

BROOKS RADIO DISTRIBUTING CORP.
80 VESEY ST. (Dept. A) NEW YORK 7, N. Y. COrtlandt 7-2359

FIX ANYTHING ELECTRICAL!

Insure against hard times with amazing new electrical appliance repair method. Even beginners can fix electrical appliances double quick. At sensational low price, you get training course and new simplified electrical tester. Send postal card for details. No obligation.

FEILER ENGINEERING CO.
Dept. 1RC5E, 1601 S. Federal St., Chicago 16, Ill.

CABINETS—CONSOLES

FOR
RADIO — TELEVISION

JACK CANTOR
171 A. Washington St., N. Y. 7

TRYLON

Announces

... THE FIRST
PRACTICAL,
EASY-TO-INSTALL,
LOW COST
TV MAST

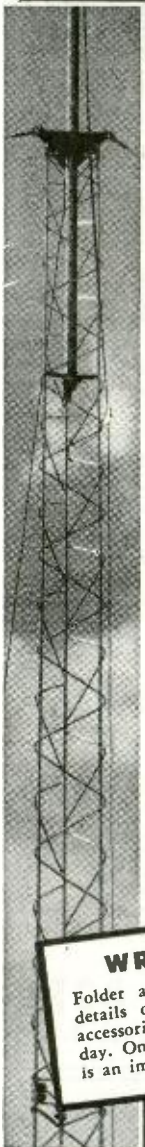

- Easy to handle—easy to climb
- Mounts any type of TV antenna
- 40' Trylon mast and antenna installed by 2 men in 3 hours or less—at mast cost of about \$1 per foot!

Now you can get all the height you want for TV antennas—at little more than the cost of makeshift mast devices—and twice as easily installed! Trylon TV Antenna Masts are made in handy 10' sections. They weigh only about 2 lbs. per foot! Sections can easily be joined for mast heights of 20', 30', 40', 50' or 60' as desired. Triangular in shape, formed of double-welded "serpentine" steel rod construction, they can be mounted on either flat or peaked roofs and climbed like a ladder. Clamp-on working platforms are available for installation or adjustment of antennas. Safe, durable, fully tested in numerous installations.

WRITE TODAY!

Folder and price list giving full details of Trylon TV Masts and accessories now available. Write today. One out of every 4 TV users is an immediate prospect!

WIND TURBINE CO.

Tower and Antenna Division

WEST CHESTER • PA.



D. F. Receiver For Yachts

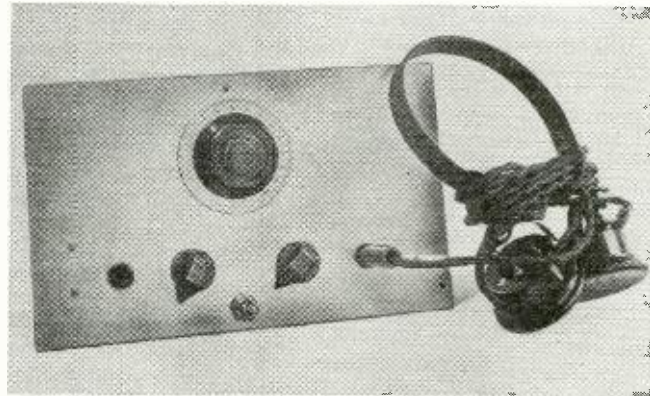

The little direction-finder receiver is simple and neat.

By T. W. DRESSER

IN THE average small sea-going yacht with a waterline length of 30 to 50 feet, space is at a premium. There simply is not room for elaborate direction-finding gear, even if the owner could afford it. A standard battery receiver with built-in loop may be used, but it does not give the sharp null required for accurate bearings.

The receiver described here does not have the great accuracy of elaborate commercial jobs, but it will furnish bearings with much less error than those usually obtained by amateur yachtsmen. The dimensions are so small that the gear can be stowed in a locker or fastened to a bulkhead without being obtrusive. The cost is very reasonable and maintenance requirements low. Although the equipment is primarily a navigational aid, it operates on the broadcast band as well as on the beacon band and can be used for entertainment.

To insure a clear null and good stability, the receiver, antenna, and connections must be effectively shielded. It is not possible to obtain an absolutely silent null point by shielding alone, as the capacitance to ground within the shield is not symmetrical. However, with a little practice, it is a simple matter to estimate the bearing

by taking the mean of two equal-signal-strength points either side of minimum. (An output meter would be very useful for this purpose in view of the notorious inaccuracy of the ear in judging the strength of any but the very lowest-level sounds.—Editor)

The receiver circuit, diagrammed in Fig. 1, is orthodox, with an r.f. amplifier followed by a regenerative detector and an audio output stage. To reduce the amount of iron in the vicinity of the loop assembly and compass, crystal headphones are used, with the output tube arranged as a voltage amplifier. There is, thus, no need for an output transformer or the field magnet of a speaker. Battery requirements are very modest—1.5 volts for the filaments and 45 volts for the plates. The chassis and case are both made of aluminum. Specifications for the tuning coil appear in Fig. 2.

In arriving at the size of the loop frame, the ratio of diameter to coil length (in this case width) is the determining factor. A high ratio contributes greatly to better geometrical accuracy in relation to the wavefront and also to alignment of the compass, which should be mounted on the antenna itself.

The old big-ship method wherein a

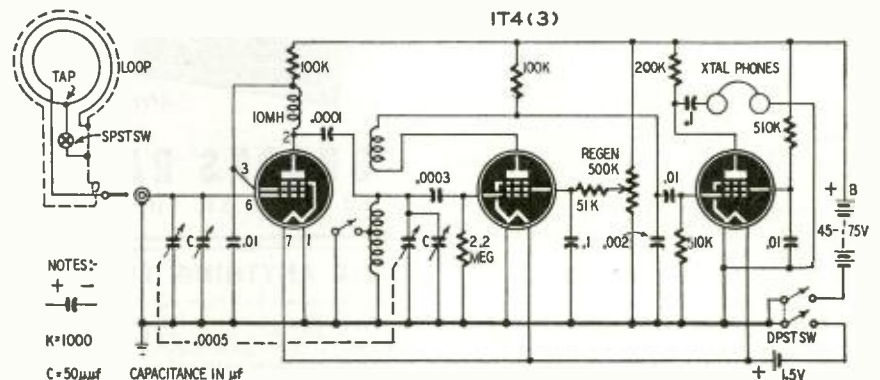

Fig. 1—Receiver is an ordinary regenerative battery unit with three tubes.

UNITED'S 1950 SPECIALS!



Fits in the Palm of Your Hand!

A complete Transmitter and Receiver Kit for 75-80 meter C.W., incorporating these features:—3 latest multipurpose tubes—Crystal controlled transmitter—Improved regenerative receiver—Built-in AC-DC 110 V. power supply—Plug-in coil for receiver frequency change—Single control operates transmitting or receiver—Same antenna for transmitting or receiving. The "Mitey Mite" is ideal as a beginner's project or as an auxiliary for the old timer. Tests have shown remarkably gratifying results. Get on the air with the "Mitey Mite," while rebuilding the main rig! Tube line-up: 12 BA6 Det., 50B5 Xtal Osc.—Audio Amp. 35W4 Rect. Xmitter Pwr Inpt: 4.5 W. Over-all Dimensions: 7" x 5" x 5 1/2". Shipping Weight—3 1/2 lbs.

Immediate Delivery
ORDER NOW!
25% DEP. BAL. C. O. D.

Complete MITEY-MITE Kit \$9.95
(less key and headset)

***SCR-522 V.H.F. TRANSMITTER-RECEIVER** 100-156 Mc 10 tube receiver and 7 tube xmitter, rated at 8 to 10 watts output. Used extensively by Hams, Cabs, Busses, C.A.P., etc. Complete with tubes, Exc. condition. Shpg. Wt. Approx. 60 Lbs. **\$39.50**

***BC-604 FM TRANSMITTER** 25 W. output @ 100% modulation. Good condition, used. Less tubes, crystal and dynamotor. Shpg. Wt. Approx. 60 Lbs. **\$6.95**

***PP-51-APQ9 POWER SUPPLY** 80-115 V. 1 ∅ 400-2600 Cyc. input. Complete with 4-5R4GY Rect. tubes, Shpg. Wt. 40 Lbs. Like New **\$6.50**

***BC-423 MODULATOR** A sturdy and beautifully built RF Osc., variable: 125 to 210 Mc. (Approx.) pulse modulated at 4098 C.P.S. Uses 1-955, 2-6J7, 1-6F6 and 1-5W4. Operates at 115 V. 60 Cyc. May be modified for T.V. Generator, etc.

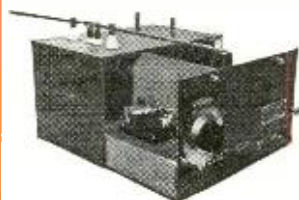

New with tubes. Shpg. Wt. Approx. 45 Lbs. **\$12.50**

BUZZER PHONE (W.E.) EEL-A. A complete unit consisting of a tone generator, buzzer, relay, key, headphone, switches, etc. Makes a very practical code practice set. Can be used in remote areas for signalling or communication. Housed in thick wooden case 9 1/2" L. x 6 3/4" H. x 6 1/8" W. Shpg. Wt. Approx. 16 Lbs. Like New with diagram. **\$4.50**

***TG-10 PHOTO ELECTRIC CODE KEYS** Used for code instruction. Uses 8 tubes: 1-923, 2-6SJ7, 2-6N7, 2-6L6 and 1-5U4G. Variable speed 115 V. 60 Cyc. motor. Housed in black wrinkled steel cabinet, 21" x 18" x 11 1/2". For 115 V. 60 Cyc. Less tubes, tapes and reels. Shpg. Wt. Approx. 110 Lbs. Very Good condition. **\$14.50**

***BC-702 RADAR TRANSMITTER** Coaxial R.F. 2-R.E.L. #77 tubes. 4-2 x 2 Rect. tubes. Input: 115 V. 400 Cyc. and 12 or 24 V.D.C. Contains Blower motor assembly, 0-25 Ma. D.C. Meter and numerous other attractive components. Shpg. Wt. Approx 60 Lbs. New. **\$12.50**. Used, **\$9.50** with tubes.

***BC-1023 MARKER BEACON RECEIVER** 12 V.D.C. 4 tube unit. Brand new, original cartons. With shock mounting base and complete instruction book. Shpg. Wt. Approx. 5 Lbs. **\$5.50**

METER SHUNT Leece-Neville. .005 Ohms 200 Amps. Mounted on Asbestos base and covered with perforated metal shield. New. Each **.95¢**

AC CURRENT TRANSFORMER Weston Type #880. Ratio 75:1. 50-133 Cyc. with mounting, Bracket. Shug. Wt. 1 Lb. New **\$1.95**

ANT. KNIFE SWITCH Square "D" S.P.D.T. 6" plated blade and contacts mounted on 2 1/2" ceramic pillars. Assembled on 2" x 1 1/2" x 8" Bakelite strip. Brand new **.69¢**

* Shipped Railway Express or Freight Only!



RELAYS

- (A) Type 8-9 Guardian S.P.D.T. 10 Amps. Time delay 200 Ohm coil. New. **79¢**
- (B) Guardian 3 P.D.T. 10 Amps. Coil 24 V. @ 200 Ma. Heavy duty. **69¢**
- (C) 324 D. D.P.D.T. 500 Ohm coil. Platinum contacts. Telephone type. **69¢**
- (D) Ant. changeover. 274-N type. May be used on 12 or 24 V. Silver contacts. Ceramic supports. New. **49¢**
- (E) Dynamotor or starter solenoid. 6 V.D.C. coil. Will carry heavy current. Completely shielded. **95¢**

CARTRIDGE THERMOSWITCHES

Fenwol S-17. 115 V. @ 10 Amp. A.C. 5/8" Dia. x 4 1/2" Long. Asbestos shielded leads. Variable—100° F to plus 400° F @ 90° per turn. New. **95¢** each.

CIRCUIT BREAKERS

Square "D" Type "M." 120-240 V.A.C. at 20 Amps. 2 Ckt. New. **\$1.75**
G.E. Type AF-1. 230 V.A.C. at 30 Amps. 2 Ckt. New. **\$1.95**



COAXIAL CONNECTORS

- (A) 10H/529. British elbow. Male to male. Each **35¢**, 3 for **\$1.00**
- (B) M-359-A. 90° elbow, male to female. RG8U, etc. Each **35¢**, 3 for **\$1.00**
- (C) UG-27/U. Pin 90° elbow, male to female. RG8U, etc. Each **75¢**
- (D) UG-21/U. Pin connector (Less PM) Ucinatc. Each **35¢**, 3 for **\$1.00**
- (E) PL-259. Cable Male for RG8U, etc. Each **35¢**, 3 for **\$1.00**
- (F) QA-49547. British to standard male adaptor. Each **75¢**
- (G) 10H/528. British, chassis male. Each **25¢**, 5 for **\$1.00**
- (H) SO-239. Chassis female for RG8U, etc. Each **19¢**, 3 for **55¢**

V.H.F. TRANSCIEVER ASSEMBLY

Has ceramic ins. 15 Mmf. tuning cond.; 2—filament chokes, 1—acorn socket and filament bypass cond. Mounted on Poly. panel 1 3/4" X 3 1/2" X 1/4". Mounts upright with two 6-32 screws in bottom. New. Each **79¢**, 2 for **\$1.50**



COILS—IF SHIELDED. NEW

- FM. 10.7 Mc. Slug tuned. 2 for **95¢**
- 265 Kc. Mica tuned; ceramic form. Each **39¢**, 3 for **\$1.00**
- 455 Kc. Standard replacement. Mica tuned. Each **39¢**, 3 for **\$1.00**
- 455 Kc. Diode. Clip Mtg. Mica tuned. Each **39¢**, 3 for **\$1.00**
- 465 Kc. Mica tuned ceramic form. Each **39¢**, 3 for **\$1.00**
- 20.7 Mc. Low loss ceramic and phenolic. Each **49¢**

OSC.

B.F.O. 1415 Kc. Air-tuned (274N) Each **29¢**, 4 for **\$1.00**

TRANSMITTING. 2-4.5 Mc. Ceramic form with cath. top. Slug tuned. 1 1/4" OD X 3 1/2" long. (No shield) **49¢**

100 W. Tank coil. 12-14.5 Mc. on National ribbed form, 2" Dia. X 5" L. Wound with #12 finned wire. Each **39¢**, 3 for **\$1.00**

6-10 Mc. Oso. Poly form. Cath. Top. Air tuned with A.P.C. Trim. Shld. Each **59¢**, 2 for **\$1.00**

*NAVY AIRCRAFT IFF

A VHF Xmitter and Receiver complete with 11 tubes, Dyna. (With gear train), Relays, etc. May be converted to citizens band. An exceptional parts buy! Excellent condition. Shpg. Wt. Approx. 40 Lbs. **\$9.95**

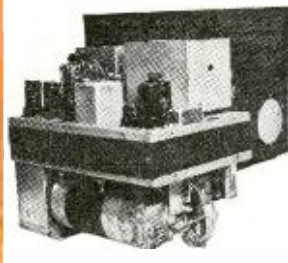

ELECTRONICS SURPLUS PACKAGE

A selection of parts, units and assemblies of varied description. A splendid value! 10 Lbs. **\$1.29 JUST OUT!!!!**
Write for our 1950 money saving flyer!!!

RELAYS

- (F) Plate circuit relay. S.P.D.T. coil 5000 Ohms. Oper. Cur. 1 Ma. fits 5 P. socket. With dust cover. Adjustable. **75¢**
- (G) P3 or #405 Miniature S.P.D.T. Size: 1" X 1" X 1". Coil: 1280 Ohms D.C. 3 for **\$1.00**
- (H) Switch board Nite Alarm Buzzer—24 V. S.P.S.T. Contacts. 3 for **\$1.00**
- (J) ZE-12. Switchboard alarm. S.P.S.T. Contacts 2 coils. Completely adjustable. 1000 Ohms per coil. **95¢**
- (K) Cook #818 3 P.D.T., plus 3 P.S.T. (Norm. Open) 12 Ohm coil telephone type. Platinum alloy contacts. **\$1.45**
- (L) Polarized Relay (WE) 239 FM. 500 Ohms 3 Ma. Op. Cur. Releases at 1 Ma. Soak current. .015 Amp. completely shielded. Adjustable **\$1.49**

*TR-1B AIRCRAFT TRANS-CEIVER

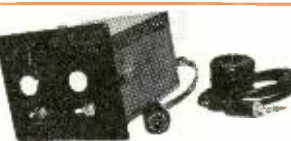

Lear PXer. 6 tube unit. Receives on weather band, 195 Kc.

to 405 Kc. Transmits on crystal freq. of 3105 Kc. Complete with tubes, mike, cables and power pack. 12 V.D.C. and instruction sheet. Ready to install. Guaranteed in excellent working condition. Total Wt. 15 Lbs. Ideal installation for small planes. **\$29.95**

AIRCRAFT CRYSTALS (All Tested and Guaranteed)

- (A) 3105 Kc. Mounted size: 5/8" X 1 1/8" X 1 3/4" Pin Spacing 3/4". **\$4.50**
- (B) 3105 Kc. Mounted size: 3/8" X 5/8" X 1". Pigtail leads. **\$1.95**

AIRCRAFT WIND GENERATOR

(Leat) Type 1030-A. Output: 12 V.D.C. @ 10 Amps. 4000 R.P.M. Less blade and end cover. Size Overall: 6 3/4" L. X 3 1/2" Diam. Excellent condition. Shpg. Wt. Approx. 5 1/2 Lbs. **\$5.95**



AIRCRAFT POWER PACKS

No. 858. Input: 12 V.D.C. Output: 250 V. @ 65 Ma. D.C. New. Complete with 0Z4G Tube, vibrator and cover. Size: 5 H. X 4 3/8" W. X 4 3/4" D. Shpg. Wt. Approx. 5 Lbs. **\$3.95**

No. 860. Input: 12 V.D.C. Output: 325 V. @ 125 Ma. New. Complete with 2-6X5GT tubes, vibrator, 2 relays and shock mounting base. Size: 9 1/2" L. X 5 1/2" X 4" H. Two octal plugs for input, control and output, Shld. Shpg. Wt. Approx. 9 Lbs. Ideal for small aircraft 2 way radio. New. Each—**\$7.50**

*PE-125BX VIBRO-PACK POWER SUPPLY

Electronic Industries. Heavy duty. Ideal for Mobile, Marine or Portable P.A. use. Input: 12 V. @ 15 A. or 24 V. @ 7.5 A. Output: 475 V. @ 200



Ma. Complete with two RK-60 Rectifier tubes and instruction book. Shpg. Wt. Approx. 55 Lbs. New **\$5.75**

QUANTITIES LIMITED. 25¢ packing charge on orders below \$2.00. Minimum deposit 25% on C.O.D. orders. Prices F.O.B. Chicago. **\$25.00** Minimum foreign order acceptable.

UNITED SURPLUS MATERIALS

312 S. HALSTED ST.

CHICAGO 23, ILL.

NOW!

All the Fundamentals of TELEVISION in one Up-to-the-Minute Book

Here at last is everything you need to know to succeed in television. This great new book, now in a new third edition, brings you a clear, authoritative picture of the entire field, including complete descriptions of all leading projection systems, and the methods of color television being considered right now by the F.C.C.

New Third Edition



TELEVISION SIMPLIFIED

by **MILTON S. KIVER**

Associate Instructor in Radio, U.S. Army Air Forces. Formerly Instructor in Radio, Illinois Institute of Technology.

You'll be delighted with the way this newly revised handbook covers each and every subject—video I. F. amplifiers of the various types; the latest d. c. reinsertion circuits; power supplies including selenium rectifiers and pulse-type high-voltage systems; the saw-tooth, sine-wave, and pulse methods of achieving automatic frequency control; and the new Inter-carrier sound television system. You'll be especially delighted with the way this new edition simplifies television-receiver servicing. Hundreds of illustrations, scores of fresh facts make this volume indispensable.

BRIEF OUTLINE OF CONTENTS

The Television Field; Ultra-high Frequency Waves and The Television Antenna; Wide-band Tuning Circuits; Radio-frequency Amplifiers; The High-frequency Oscillator, Mixer and Immediate-frequency Amplifiers; Diode Detectors and Automatic Gain-control Circuits; Video Amplifiers; Direct Current Reinsertion; Cathode-ray Tubes; Synchronizing-circuit Fundamentals; Deflecting Systems; Typical Television Receiver—Analysis and Alignment; Frequency Modulation; Inter-carrier Television Sound System; Servicing Television Receivers; Color Television; Glossary of Television Terms. Plus Other New Chapters and Expanded Sections.

EXAMINE THIS BOOK FREE

Let this practical book prepare you for your future in the expanding television field. Send for it NOW!

MAIL THIS COUPON

D. Van Nostrand Company, Inc.
250 Fourth Avenue, New York 3, N. Y.

Please send me "Television Simplified." Within 10 days I will either return the book and owe nothing, or I will send you \$2.00, plus a few cents postage, and \$2.00 for two months.

Name.....

Address.....

City..... State.....

(If you send the \$6.00 with this coupon, we will pay the postage. Same return privilege and refund guarantee.)

fixed scale indicates the bearing of the loop in relation to the fore-and-aft line of the ship (to make a correction, the course must be rated at the moment the bearing is taken) is cumbersome and liable to error in even the biggest of ships. In a small yacht with its quick motion and often an inexperienced crew, it is impossible; the advantages of having the compass right on the antenna are obvious.

Fig. 3 shows how the loop antenna is constructed. Two strips of plywood veneer are formed into circles (with the help of some steam). Hardwood blocks join the concentric circles and

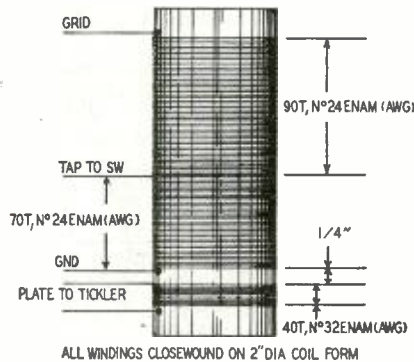

Fig. 2—Specifications for tuning coil.

wire is wound in slots sawed in the blocks. The switch shorts out some of the turns to make the coil tune the broadcast band. Copper foil is used to cover the loop frame for shielding purposes, but a gap is left at the bottom of the loop so the foil will not form a closed turn and absorb power.

The big-ship practice of mounting the loop rigidly on a deckhouse top is not recommended for small craft. Whereas a big vessel, even in the worst weather, is on an even keel at one point of her motion, which is sufficient to get a bearing, the smaller ship is frequently laid over for long periods in a stiff breeze and any bearings taken are hopelessly inaccurate. A better method is to support the antenna from the deck head by some flexible means so that it finds its own vertical, whatever the ship's motion may be. An old set of compass gimbals serves admirably as the flexible mount.

The choice of a compass can be left to the yachtsman, who will know that it should be dead-beat.

Operation

Bearings can be obtained on ordinary ship-to-shore stations, on beacon stations in the 900-1,000-meter range, or on seaboard broadcast stations. On ship-to-shore stations and beacon transmitters it may be advisable to advance the regeneration control until the receiver oscillates, and adjust the pitch of the note so that it stands out against the background of other stations on the same band. That makes it easier to concentrate on the one signal.

A swing of about 8 or 10 degrees will be enough to indicate points of equal signal strength each side of minimum. As there is only a single loop and no sensing antenna, there are two points of minimum signal 180 degrees apart. In coastwise and inshore sailing it is usually obvious which is correct.

Bearings taken beyond a distance of 100 miles should not be accepted as accurate if standard charts on Mercator's projection are used, since bearings on such a chart are Rhumb lines, while radio follows a great-circle route.

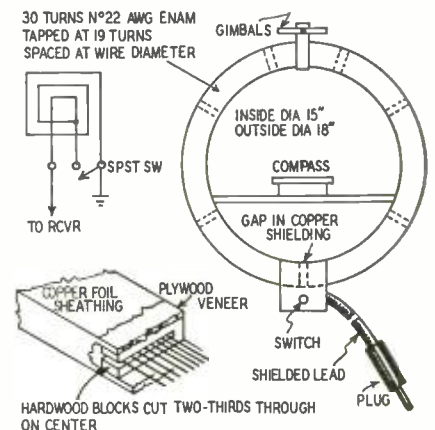
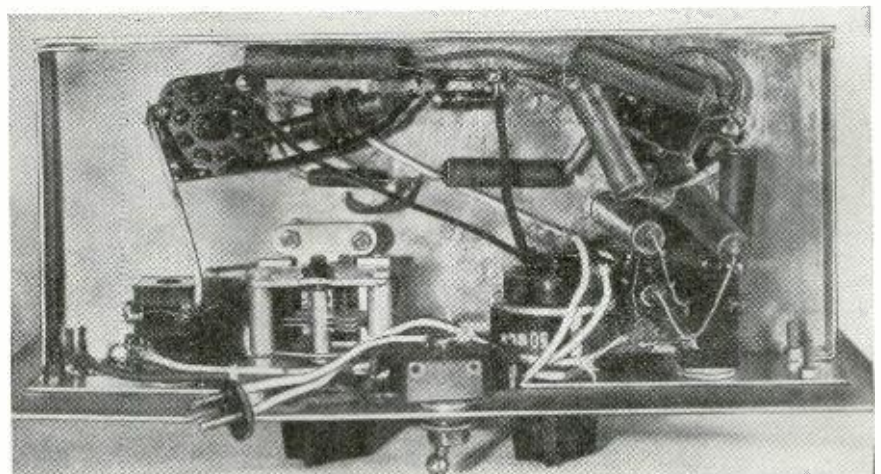

Fig. 3—The loop may be built as shown here or a surplus unit purchased.

Bearings taken over 50 miles at night are subject to skywave-path inaccuracies. Don't trust them.



Any amateur radioman can easily build this receiver. It has few components.

TIME-DELAY CIRCUIT KEYS AMATEUR RIGS

By OTTO L. WOOLEY, W9SGG

KEYING an amateur c.w. transmitter for best results on all bands involves a number of considerations. Oscillator keying allows complete break-in or semi-break-in on or near the operating frequency. However, above .7 mc this type of keying may easily produce a chirpy signal, so the final amplifier or a buffer stage is often selected for keying on the 14- and 28-mc bands. The disadvantage of this setup is obvious—the continuously running oscillator is a nuisance, prohibiting operation on the same frequency. Of course a manually operated switch may be employed to kill the oscillator during reception periods, but this adds a control and multiplies the chances of operational error.

The problem is to obtain a method which will turn the oscillator on instantly when a following stage is keyed, and keep it on at normal keying speeds. The system should then kill the oscillator after a predetermined time interval when keying ceases.

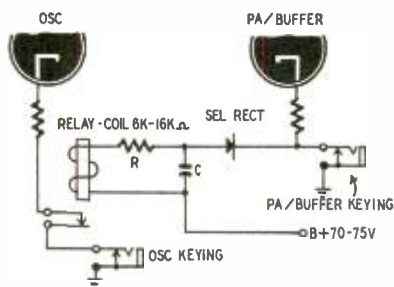

Relay stays closed between characters.

The circuit diagrammed fulfills these requirements and uses only a relay, small resistor, capacitor, and rectifier.

The schematic shows how the circuit operates. When the key is plugged into the oscillator keying jack, the oscillator is keyed in the usual manner, the relay being held shut by the current from B+ to ground through the closed-circuit amplifier keying jack.

If the key is plugged into the amplifier keying jack, the oscillator is inoperative because the relay contacts are open. However, the instant the key is depressed, current flow closes the relay, turning on the oscillator and charging capacitor C. As long as the amplifier is being keyed, the charge on C will keep the relay closed; but when keying ceases, the relay will open after the time interval required for C to discharge through the resistance of R and the relay coil in series.

This interval may be determined from the formula $t = RC$. When C is in microfarads and R is in megohms, t will be the number of seconds necessary for C to discharge to approximately one-third the charging voltage.

Equip for long faithful service

with a

TURNER MODEL 33

Choice of crystal
or dynamic



Over the years, thousands of sound men have discovered that dependable Turner Microphones gives smoother, more accurate performance than any other microphones in their price class. For all-around use, the Turner Model 33 is a long-time favorite. It combines up-to-the-minute styling, high output, wide range response, and utmost reliability under tough operating conditions. Has 90° tilting head for semi- or non-direction use. Complete with 20 ft. quick-change removable cable set.

Model 33X Crystal. List.....\$24.50
Model 33D Dynamic. List.....\$27.00

For top dollar-for-dollar value in microphones that fit any need Turn to Turner.

THE TURNER COMPANY

933—17th Street N.E., Cedar Rapids, Iowa

- IN CANADA: Canadian Marconi Co., Ltd., Montreal, P. Q., and Branches
- EXPORT: Ad. Auriema, Inc., 89 Broad Street, New York 4, N. Y.

Crystal licensed under patents of the Brush Development Company



For example, let us suppose a certain relay will open at 25 volts. We know from the formula that the charging voltage must be 75 volts, which may be obtained from a tap on the power-supply bleeder. Assume the relay coil resistance to be .008 megohm and R to be .047 megohm, with a capacitor of 2 μ f. Therefore, $(.008 + .047) \times 2 = 0.11$ second. This interval is about right for fairly fast keying.

The interval may be increased by using a larger capacitor, resistor, or charging voltage. In any case the constants will have to be adjusted to suit the operator's keying speed.

The relay contacts should be spaced very close to prevent clipping part of

the first character as the amplifier is keyed.

Capacitor C must be of good quality. A leaky capacitor will prevent satisfactory operation. Do not use an electrolytic. The relay is a sensitive unit with a coil resistance of 6,000-16,000 ohms.

The selenium rectifier prevents interaction between the relay and tube circuits when the key is up. Do not key any stage where the rectifier's inverse voltage rating will be exceeded.

Cathode keying of the oscillator is shown; however the circuit may be used with most forms of oscillator keying. As a matter of fact the system may be used to turn on and off an oscillator that is not satisfactory for keying.

TELEVISION SCOPE

SUPERIORITY AT A GLANCE!

The vertical response of this economy TV scope is usable to 5000 kc, not 50 kc. Response is flat to 750 kc, down 3 db at 1000 kc. Amplifier supplies a voltage gain of 20 at 5000 kc.



AR-3

Check this necessary feature before you buy any scope for TV use.

The R.S.E., AR-3 Scope has been built by Ross Armstrong to our rigid specifications. It's a complete unit that embodies standard horizontal amplifier and sweep circuits with normal sensitivity.

The case is 8" high x 5" wide x 14" long, attractively finished in "hammered" opalescent blue enamel. Operates on standard 110 volts—60 cycles—40 watts. Tubes, 3BP1-6AC7-6SJ7-6X5-5Y3-884. Instructions included. Complete specifications upon request. Satisfaction or your money back.

AVAILABLE TO JOBBERS
IN QUANTITY

PRICE
\$4995

F. O. B.
DETROIT

INTERCOM & RADIO

AT A
PRICE
THAT
CAN'T
BE BEAT



6 tube superhet—3 tube intercom permits communication between radio-master and up to 4 sub-stations.

Original cost \$64.50

WHILE THEY LAST
\$2995

With 1 sub-station and 50 feet of cable
Extra Sub-stations
\$3.95 each

PUSHBACK WIRE



25% BELOW MILL COST!

1st class, Essex or Lens, ALL SOLID tinned copper, double cotton serve, waxed finish.

SIZE	COLORS	100 feet	1000	Production Reel
22	BLACK-BROWN	.39	3.79	3.65M
20	RED-WHITE-BLUE	.49	4.49	3.95M
18	BROWN	.69	5.98	

ORDER INSTRUCTIONS



Demand This
Seal of Quality

Minimum order—\$2.00. 25% deposit with order required for all C.O.D. shipments. Be sure to include sufficient postage—excess will be refunded. Orders received without postage will be shipped express collect. All prices F.O.B. Detroit.

Quantity and Export
Orders Solicited

**RADIO
RADIO SUPPLY &
ENGINEERING CO., Inc.**
85 SELDEN AVE. DETROIT 1, MICH.

How to Become a Ham

Part IV—How to put together an excellent 1-tube converter

By GEORGE W. SHUART, W4AMN



Utility box encloses converter neatly.

ANYONE with a little technical knowledge can, in a matter of hours, put together a transmitter that will produce remarkable results. The receiver problem is different! It's a big problem no matter how you look at it, and the majority of amateurs have spent a lifetime trying to find the ideal receiver. It's our opinion that unless the reader is loaded with cash and buys the best on the market he'll never know what it is to be satisfied. It's a safe bet, too, that he'll

be satisfied only a few months at the most no matter what he buys.

Let's assume that the reader isn't loaded with cash, and that he is aware that the old-fashioned 2-tube just won't compete in the present-day crowded ham bands. A fairly good receiver will cost something less than two hundred dollars, and a good one will cost much more.

Since there seems to be no great disgrace in owning a "used automobile," there's no reason why the newcomer in ham radio can't economize by buying a good used receiver. Reliable dealers recondition their trade-ins, and thereby offer the opportunity to obtain top performance at a very reasonable cost. The surplus market has offered top value for little cash outlay, but of late the better buys are not so often seen, and prices are higher. There are still a number of receivers that cover one or more of the ham bands available at a low price. These usually operate on 28 volts but units to convert them to 120-volt a.c. operation are becoming available.

There are several very low-cost receivers which appeal to the beginners with little cash to spend, but they have several shortcomings which limit their effectiveness; for example, lack of a crystal filter and sufficient pre-selection.

(Continued on page 113)

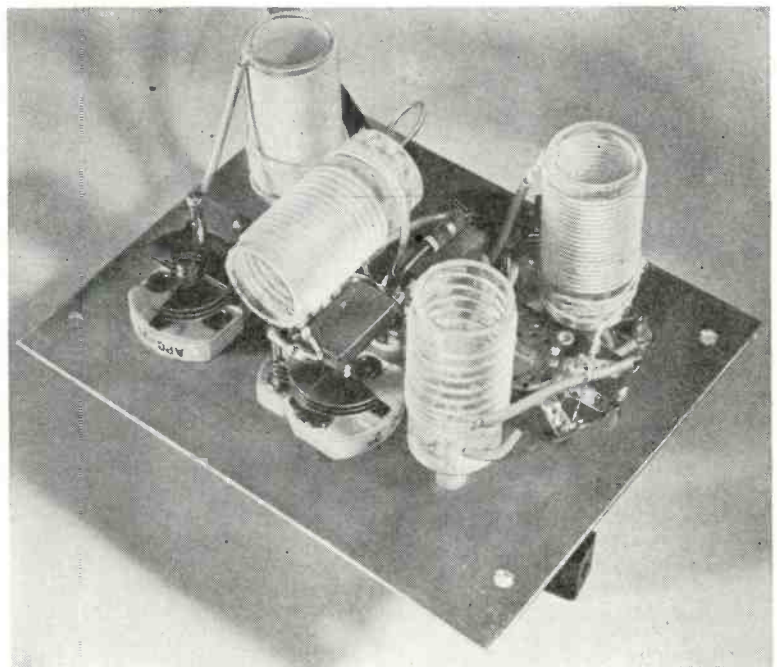

Converter parts are on metal panel. The coils are wound on polystyrene forms.

RADIO-ELECTRONICS for



NIAGARA is FIRST with the FINEST in TELEVISION & RADIO COMPONENTS!

NIAGARA TUBES - NIAGARA TUBES - NIAGARA TUBES - NIAGARA TUBES

Type	Price	Type	Price	Type	Price	Type	Price	Type	Price	Type	Price	Type	Price	Type	Price
0A2	1.69	1LN5	1.06	6AC7/1852	1.16	6J5GT	.54	6ST7	.88	7Y4	.72	14B8	.88	43	.66
0A3/VR75	.98	1N5GT	.80	6AD7G	1.28	6J6	1.16	6SV7	.88	7Z4	.72	14C5	.88	45	.60
0A4G	1.06	1P5GT	1.06	6AF6G	1.25	6J7	.80	6T7G	1.24	10	.69	14C7	.88	45Z3	.66
0B2	2.05	1Q5GT	1.06	6AG5	1.06	6J7GT	.80	6V5/6G5	.72	12A	.80	14E6	.72	45Z5GT	.72
0B3/VR90	.75	1R4	1.06	6AG7	1.28	6J8G	1.28	6U6GT	.72	12A6	.39	14E7	.88	46	1.03
0C3/VR105	.98	1R5	.80	6AH6	1.56	6K5GT	.96	6U7G	.72	12A8GT	.29	14F7	.88	47	.96
0D3/VR150	.75	1S4	.96	6AJ5	.99	6K6GT	.60	6V6/6V6G	1.28	12A7	1.28	14F8	1.06	49	.88
0Y4	.88	1S5	.72	6AK5	1.56	6K7	.66	6V6GT	.80	12A8GT	.80	14H7	.88	50	1.56
0Z4	.88	1T4	.80	6AK6	.96	6K7GT	.66	6W7G	.88	12A7GT	.88	14J7	1.06	50A5	.88
0Z4G	.88	1T5GT	1.06	6AL5	.80	6K8	.96	6X4	.80	12A15	.80	14N7	1.06	50B5	.66
0IA	.60	1U4	.72	6AL7GT	1.06	6K8GT	.96	6X5GT	.80	12A76	.60	14Q7	.88	50C5	.66
IA3	.72	1U5	.72	6AQ5	.80	6L5G	1.06	6Y6G	.88	12A77	1.16	14R7	.88	50L6GT	.66
IA4	1.28	1V	.88	6AQ6	.72	6L6	1.42	6Y7G	.88	12A78	.80	14S7	1.06	50Y6GT	.72
IA4P	1.56	2A3	1.28	6AQ7GT	.88	6L6G	1.16	6Z7G	1.28	12A79	.96	14W7	1.06	51	1.06
IA5GT	.72	2A5	.88	6AR5	.66	6L6GA	1.16	6ZY5G	.88	12BA6	.72	14X7	1.06	56	.72
IA5	1.28	2A6	1.06	6AS7G	4.95	6L7	.96	7A4/XXL	.72	12BE6	.72	19	1.28	57	.80
IA7GT	.80	2A7	1.06	6AT6	.80	6L7G	.96	7A5	.72	12C8	.69	19T8	1.56	58	.80
IB3GT	1.49	2B7	.88	6AU6	.80	6N6G	1.56	7A6	.72	12F5GT	.72	22	1.28	59	1.06
IB4	1.56	2V3G	1.98	6AV6	.80	6N7	.96	7A7	.72	12H6	.39	24A	.88	70L7GT	1.56
IB5/255	1.28	2X2A	1.25	6B4G	1.28	6N7GT	.96	7A8	.72	12J5GT	.39	25A6	1.06	71A	.80
IB7GT	1.06	3A4	.39	6B5	1.56	6P5GT	.96	7AD7	1.06	12J7G	.80	25A6G	1.06	75	.66
IC5GT	.88	3A5	1.49	6B6G	.88	6Q6G/6T7G	1.06	7AF7	.72	12J7GT	.80	25AC5GT	1.16	76	.66
IC6	1.28	3A8GT	1.98	6B7	1.28	6Q7	.80	7AH7	.88	12K7GT	.72	25L6GT	.66	77	.66
IC7G	1.28	3B7	.36	6B8	1.28	6Q7GT	.72	7B4	.88	12K8	.96	25Y5	1.16	83V	1.39
IC5GP	1.55	3D6	.36	6B8G	1.28	6R7	1.06	7B4	.72	12K8GT	.96	25Z5	.60	79	.88
ID7G	1.28	3LF4	1.28	6BA6	.80	6R7GT	1.06	7B5	.72	12Q7GT	.72	25Z6GT	.60	80	.46
ID8GT	1.56	3Q4	.88	6BE6	.72	6S7	1.28	7B6	.72	12SA7	.66	26	.72	81	1.56
IESGT	1.38	3S4	.96	6BF6	.66	6S7G	1.28	7B7	.72	12SA7GT	.66	27	.80	82	1.06
IE7G	1.56	3S4	.80	6B5G	1.28	6S8GT	1.06	7A7	.72	12SG7	.72	28D7	.39	83	1.06
IF4	1.06	3V4	.80	6BH6	.80	6SA7	.66	7C4/1203A	.88	12SW5	.80	31	.39	84/6Z4	.72
IF5G	1.06	5A74	.60	6BJ6	.80	6SA7GT	.66	7C5	.72	12SF5GT	.80	31	.39	84/6Z4	.72
IF6	1.56	5R4GY	1.15	6C4	.39	6SB7Y	.88	7C6	.72	12SF7	.80	32	1.28	85	.88
IF7G	1.56	5T4	1.28	6C5	.86	6SC7	.72	7C7	.72	12SF7GT	.80	32L7GT	1.26	89	.72
IG4GT	1.06	5U4G	.60	6CGT	.66	6SD7GT	.49	7E5/1201	1.66	12SG7	.72	33	.39	89Y	.39
IG5GT	1.06	5V4G	.96	6C6	1.28	6S7	.66	7E6	.72	12SH7	.39	34	.38	117L7GT	1.56
IH4G	.88	5W4	1.06	6C7	1.28	6SF5GT	.96	7E7	.88	12S17	.88	35/51	.80	117M7GT	1.56
IH5GT	.66	5W4GT	.66	6C8G	1.28	6SF7	.80	7F8	.88	12S17GT	.66	35A5	.72	117N7GT	1.56
IH6G	1.28	5X4G	.72	6D6	.66	6SG7	.80	7F8	1.06	12SK7	.66	35B5	.80	117P7GT	1.56
IH6GT	1.28	5Y3GT	.42	6D8G	1.28	6SH7	.39	7G7/1232	1.06	12SK7GT	.66	35L6GT	.66	117Z3	.60
IH6T	1.28	5Y4G	.60	6E5	.85	6S17	.66	7H7	.80	12SL7GT	.88	35W4	.46	117Z4GT	1.16
IH4	.80	5Z3	.72	6F5	.66	6S17GT	.66	7J7	1.06	12SN7GT	.80	35Y4	.72	117Z6GT	.96
IL4A	1.06	5Z4	1.06	6F5GT	.66	6S7	.80	7K7	1.06	12SW5	.80	35Z3	.72	FM-1000	1.28
IL6A	1.06	6A3	1.28	6F6	.80	6SK7GT	.66	7L7	.88	12SQ7GT	.60	35Z4GT	.60	UX120	1.38
IL84	1.06	6A6	1.06	6F6GT	.66	6SL7GT	.96	7N7	.88	12SR7	.39	35Z5GT	.50	UX200	1.28
ILC5	1.06	6A7	.80	6F7	1.06	6SN7GT	.88	7Q7	.72	12SR7GT	.39	36	.39	9001	.89
ILC6	1.06	6A8	.80	6F8G	1.28	6S9GT	.60	7R7	.88	12Z3	.88	37	.39	9002	.39
ILD5	1.06	6ASGT	.80	6G6G	1.06	6SQ7GT	.60	7S7	1.06	12X3	.98	38	.39	9003	.69
ILE3	1.06	6AB5/6N5	.88	6H6	.80	6SR7	.72	7V7	1.06	14A7/12B7	.88	39/44	.39	9004	.49
ILG5	1.06	6AB7/1B53	1.06	6H6GT	.60	6SR7GT	.72	7W7	1.06	14AF7/XXD	.88	41	.96	9005	.96
ILH4	1.06	6AC5GT	1.16	6J5	.54	6SS7	.66	7X7/XXFM	1.06	14B6	.88	42	.66	9006	.49

7" and 10" TV LENSES

New and improved TV lenses that make your TV picture really large without distortion. Magnifies up to 4 times original size. Made of oil filled plastic. A Precision magnifier—fully adjustable—fits all receivers with 7 or 10 inch picture tubes. Greatly increases the pleasure of television viewing. Precision-built by optical experts. Specifically designed for the new, small, low cost TV receivers.

CAT. NO. N-132 **7" lens**
YOUR COST **\$9.90**

CAT. NO. N-133 **10" lens**
YOUR COST **\$11.88**

CO-AX CABLE

RG-22-U 9c per Ft. 8 1/2c per 100 Ft.

RG-58-U 6c per Ft. 5 1/2c per 100 Ft.

RG-59-U 6c per Ft. 5 1/2c per 100 Ft.

200 Ohm KW. **TWIN LEAD** 8c per Ft. 7 1/2c per 100 Ft.

100 Ohm CO-AX **TWIN LEAD** 12c per Ft. 11 1/2c per 100 Ft.

FIRST TALL TALES WINNERS

will appear in the next issue of this magazine—watch for it. There's still time to compete. Send in your entry TODAY!

Does YOUR TV Set DROOP FROM INTERFERENCE BLOOP?

BANISH INTERFERENCE with New NIAGARA HI-PASS FILTER!

Positive protection against interference from amateur transmitters, ignition noises, diathermy and all other devices generating RF interference. Designed to fit any 300 ohm antenna feeder. Absolutely no loss in brightness or clarity. Easily assembled. Complete instructions. FCC findings under actual test **\$1.95** per kit included.

Cat. No. N-281 anywhere in U.S.A. plus 15c postage and handling.

ATTENTION AMATEURS! Don't be blamed for TVI.

FCC tests have proven that Niagara's NEW LOW-PASS filter attenuates all frequencies above 40Mc. Skillfully engineered M-Derived Filter for 10, 20, 40, 60 and 160 meters prevents TVI while you're operating. Eliminates all harmonics above 40Mc at 60DB or better, passes all frequencies below 40Mc. Complete, nothing else to buy. FCC report included. plus 25c shipping charges in U.S.

Cat. No. N-279

TELETRON

Magnetic Deflection Yokes for TV or Scope Application

NIAGARA carries the full TELETRON line of fine quality TV replacement components. Send us your requirements or write for TV replacement parts catalog.

Cat. Mfrs. Defl. Horiz. Vert. Overall Net No. No. Angle Induct. Induct. Length Price

N-263 DY-15 55° 5 MH. 19 MIL 25¢ 69.60
N-264 DY-2L 40° 5 MH. 22 MIL 33¢ 10.50
N-265 DY-4L 40° 1.5 MH. 45 MH. 3 1/2" 10.50

RCA TV YOKE MOUNTING HOOD TYPE 201x1

Hood holds deflection yoke 201D1 or 201D3. Improved rubber bumper provides safe support for picture tube. Spring contacts provide a ground for the coating on outside of the kinescope.

CAT. NO. N-121 YOUR COST **\$1.65**

WAVE TRAPS

Traps consist of two slug-tuned silverized coils and two ceramic condensers. All mounted on a cadmium plated bracket conveniently drilled and ready for mounting. May be used to eliminate FM sound bars in TV sets, eliminate amateur interference (shock excitation) in TV Rcvrs. Match Hi-Lo TV antennas, and dozens of other uses too numerous to mention. They're going fast, so order your today!

39c ea.

SPECIAL **3 for \$1.00**

Cat. No. N-128

IMPORTANT NOTICE: Please include 20% deposit with C.O.D. orders, unless rated. Orders received without postage will be shipped railway express collect. Send us your inquiries today. We correspond in English, Spanish, French, Italian, Polish, Rumanian, Hebrew, German, Portuguese, etc. Prices subject to change without notice. All stock subject to prior sale. All prices f.o.b. our N. Y. C. warehouse.

MINIMUM ORDER \$2.00

Niagara Radio Supply Corp.

Dept. C-10 160 Greenwich Street, New York 6, N. Y.

Phone Dlgby 9. 1132-3-4

HERE IT IS!

the first of twelve big construction articles . . .
which an overwhelming majority of our

30,000

readers have asked for!
BUILD IT YOURSELF!

THE 1950 MODERN BENCH DESIGN
complete plans, working drawings and instructions in the January issue of **RADIO & TELEVISION MAINTENANCE**

DESCRIPTION OF EDITORIAL CONTENTS AND BALANCE FOR 1950

Four general types of editorial material will appear in Radio & Television Maintenance Magazine. The description of the editorial coverage and emphasis has therefore been broken into four sections.

A. Technical articles. The articles in this group will fall into three categories as listed below.

- 1. Educational:** The purpose of these articles is to keep the reader informed of new technical developments from the standpoint of operating theory. *Examples:* New circuits appearing in current TV VM and AM receivers, new tools, test equipment.
- 2. Techniques:** These articles will deal with the practice of radio servicing. *They will cover—*troubleshooting, alignment repair, measurement, installation, etc.
- 3. Shop Planning, Construction and Supplies:** These articles will deal with the problems encountered in the operation of service organizations as a productive unit. *Subjects, such as* shop equipment, shop layout, keeping inventory, stock requirements, etc. will be covered under this grouping.

B. NEWS

The subject will be covered by a series of monthly columns as follows:

- 1. Current Happenings:** The Radio Industry Newsletter will cover current news. *It will consist of* two pages of short, concise news items with as few words and comments as possible. It will keep the reader informed with a minimum expenditure of his time.
- 2. Trends:** Electronically Speaking will analyze current news insofar as it affects the reader. *It will cover, in greater detail* news subjects which are beyond the scope of the Newsletter.
- 3. Products:** The Industry Presents will describe new products. *Included in this department* will be parts, tubes, test equipment, receivers, shop equipment, antennas, etc.
- 4. Literature:** Review of Trade Literature. *This short monthly column* will describe new manufacturer's literature and review new books.

C. SALES AND ADVERTISING

Articles in this group will fall into two categories:

- 1. Advertising programs:** These articles will cover the advertising of Service Replacement Parts, Receivers, Specialty Products and Accessories. A monthly department will be devoted to describing various types of display and advertising material such as manufacturer's packaged point of sales displays—how they can be used and what can be expected of them.
- 2. Sales Techniques:** These articles will cover handling the customer, in the home, in the store, closing, sales opportunities, etc.

D. BUSINESS METHODS

Typical subjects to be covered will be management, pricing, costing, taxes, systems, goals, banking, credit-bookkeeping, etc.

RADIO & TELEVISION MAINTENANCE

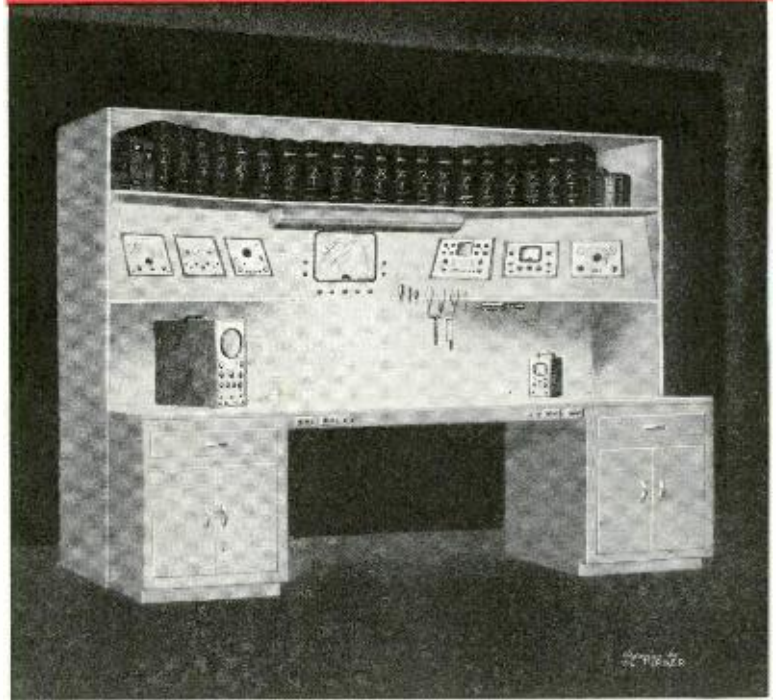

PLUS: 12 big new construction articles as follows:

How to build the 1950 TV service bench. (January, see cover proof enclosed herewith.)

Building power supplies for the service bench.

How to make receiving dollies for incoming radios.

Planning and constructing inventory racks (and how to stock economically).

How to plan and build efficient set-storage racks for AM, FM and TV.

How to construct a truck interior for efficient field work.

Building an auxiliary bench for tube testing, minor repairs, operating observation, etc.

Construction of cathode-ray tube holder for servicing chassis when tube is separately mounted.

Shop planning and layout for steps, time and money saving.

Auxiliary HV power supplies for operating tests on picture tube.

Design and arrangement of a portable parts, tool and test box for servicing.

Design and construction of TV antenna location tester.

Don't miss any of these issues. Send in your order for the special introductory offer of one year for \$2.00 (regularly \$3.00—you save one dollar). The January issue is on sale at your jobber's counters. Don't wait—get your **RADIO & TELEVISION MAINTENANCE** subscription in **TODAY**.

BOLAND & BOYCE INC.
MONTCLAIR, N. J.

SPECIAL OFFER COUPON

Send me **RADIO & TELEVISION MAINTENANCE** for one year for only \$2.00 (regularly \$3.00—I save \$1.00)

NAME _____

ADDRESS _____

CITY _____ ZONE _____

STATE _____

(check one)

MONEY ENCLOSED

BILL ME LATER

I am in a radio sales & service business

sales only

service only

other (explain) _____

(check one)

I am owner

manager

employee

MONEY BACK GUARANTEE

FULL REFUND WITHIN 90 DAYS
IF NOT COMPLETELY SATISFIED

RADIO-ELECTRONICS for

They are also less sensitive than the more costly models, and liable to be plagued with images.

Selectivity is becoming more important every day. Manufacturers are constantly improving the design of the i.f. amplifiers in their receivers, and informed hams will carefully scrutinize the actual shape of the selectivity curve of the receiver they intend purchasing. The steepness of the sides of the curve, and the width of the skirt are important. An ideal situation would be one where the sides were vertical. See Fig.

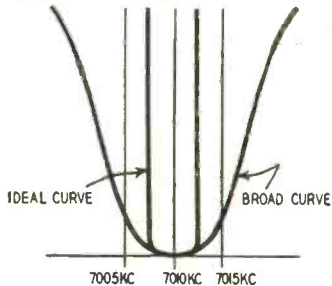

Fig. 1—I.f. selectivity is important.

1. Note that in an ideal receiver tuned to 7010 kc, stations on 7005 and 7015 would not be received at all, but in a cheap receiver might be received with almost as much volume as the desired signal.

Poor sensitivity and low image rejection can be simply overcome in a low cost receiver by the addition of a high-frequency converter to be operated ahead of the receiver's r.f. section. Such an arrangement will make a "double super" out of the simplest receiver. With the receiver proper tuned to something between 3 and 6 mc, the first stages act as an intermediate-frequency amplifier wherein images could be removed by some 6 to 12 mc—enough to just about eliminate "images" (signals as far below the oscillator frequency as the desired signal is above it) even though the new converter uses the simplest circuit.

Somewhere, at the beginning of this article, we said that the 2-tuber wouldn't compete in the crowded bands. However, many newcomers won't be satisfied unless they have a try at using one. For their benefit a circuit diagram and other data are supplied (Fig. 2).

The coils can be wound on polystyrene forms approximately an inch in diameter. Coil L1 should consist of about 15 turns of No. 24 d.c.c. wire, spaced to occupy one inch, and L2 of 6 turns of No. 24 or smaller wire, close-wound about 1/8 inch from the ground end of L1. This will cover the 20-meter band. About 30 turns for L1 and 10 turns for L2 will cover the 40-meter band. Experiment with the tickler coil (L2) especially, adding or taking off turns till regeneration is smooth.

Very loose antenna coupling produces best results. Two pieces of metal about half an inch square separated about a quarter of an inch should prove entirely satisfactory. The amount of coupling may be varied by bending the plates closer together or farther apart. Loose coupling reduces interference

JANUARY, 1950

ALPRODCO

TOWERS of "aircraft" ALUMINUM

ASSURES SPARKLING RECEPTION

for

Tv Fm A^M

- LIGHT
- INEXPENSIVE

ONLY

\$115

PER FOOT

IMMEDIATE DELIVERY

- Weight of one pound per foot assures safe, easy installations.
- Available in knocked down or factory assembled six foot sections.
- Attractive "life-time" beauty with no maintenance worries.
- Heights up to 120 feet may be safely used.
- Self-supporting (no guy wires needed) to heights of 24 feet.
- Aircraft Aluminum of spring tempered alloys is used exclusively in Alprodcu Towers.

WRITE FOR FREE LITERATURE

Part. No	Dealer net price
T-6 Standard 6' Tower (knocked down)	\$6.91
AT-6 Standard 6' Tower (assembled)	8.56
MK-1 Mast Kit, including top angles and mast bracket	1.80
B-1 Hinged Base Plate	2.10
S-4 4" Standoff Support Bracket	1.15
S-12 12" Standoff Support Bracket	1.70
GB-1 Guy Bracket, each	.07

SOLD THROUGH LEADING DISTRIBUTORS
IF YOUR TERRITORY IS NOT REPRESENTED ORDER FROM FACTORIES

- STRONG

ALPRODCO INC.

(B) Factories at either, Dept.-R, Mineral Wells, Texas, or Box 607-R West Lafayette, Indiana.

distinct images
 from 200 miles away
 with *Tel-a-Ray*

Reception-master antenna . . .

Here is the antenna that television users have been demanding — Tel-a-Ray . . . with maximum reception ability . . . reasonably priced . . . interference free.

For the antenna with all the important features — including razor-sharp directivity, absolute corrosion resistance and quick trouble-free assembly — write to Tel-a-Ray Enterprises, Inc., Henderson, Ky.

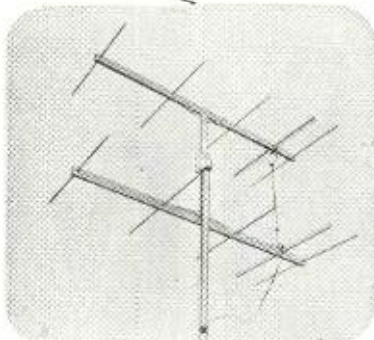

Tel-a-Ray model TD, expressly designed for adverse conditions and low signal areas. Gain 25 times basic dipole, 14 db Power gain, 7.25 db front-to-back ratio.

distributors: *You'll find Tel-a-Ray antennas easy to sell . . .*

. . . because the same fine quality is found in the 22 lower priced Tel-a-Ray models as in the most elaborate stacked arrays. Each antenna has been developed to meet a specific television or FM problem. Distributorships in many cities are still available. Write today for complete information.

TEL-A-RAY ENTERPRISES, INC.
 P. O. BOX 332A, HENDERSON, KENTUCKY

DON'T BUY!
 any tape recorder 'til you've learned all the facts about our **NEW PROFESSIONAL MODELS!**

We have more than 30 exciting models, 2-speed recorders, 24-hr. recorders, conference recorders and many others. Get the facts in our new 16-page catalog. Complete specifications given. Write today for your copy.

AMPLIFIER CORP. OF AMERICA
 398-10 Broadway New York 13, N. Y.

BOTH BOOKS FREE

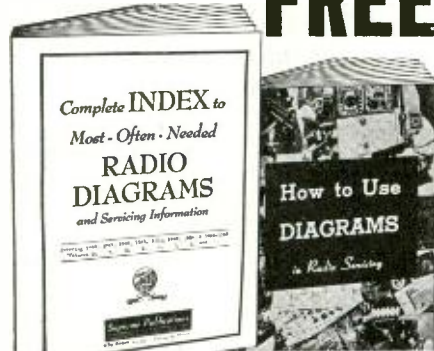

FREE to every reader of Radio-Electronics. No strings, nothing to buy. "How to Use Diagrams" gives hints, suggestions, short cuts on the use of diagrams in radio servicing. The 26-page INDEX will tell you just what models are included in SUPREME "Most- Often- Needed Radio Diagrams" manuals. If you need a circuit at any time, the INDEX will tell you where to get it. Get both books in 2-in-1 volume FREE. Just send stamp for postage.
SUPREME PUBLICATIONS 3727 W. 13th St. Chicago 23, ILL.

TELEVISION RECEIVER—\$1.00

Complete instructions for building your own television receiver. 16 pages—11"x17" of pictures, pictorial diagrams, clarified schematics. 17"x22" complete schematic diagram & chassis layout. Also booklet of alignment instructions, voltage & resistance tables and troubleshooting hints.—All for \$1.00.

CERTIFIED TELEVISION LABORATORIES
 Dept. C. 5507-13th Ave., Brooklyn 19, N. Y.



Learn How to Simplify Radio Repairs!
FREE MANUAL

Nothing complex to learn. no calculating. Used by beginners and experts. Send for **FREE** manual. "THE INSIDE STORY," today. 32 pages—illustrated—easy to read! Shows how obsolete methods prevent full use of your real ability. Explains use of NEW techniques. You owe it to yourself and your future to "get out in front" in your work.

FEILER SEND COUPON OR PENNY POSTCARD FOR FREE MANUAL TODAY!

FEILER ENGINEERING CO. Dept. I-RC5
 1601 S. Federal St., Chicago 16, Illinois
 Please RUSH my FREE copy of "The Inside Story."

Name

Address

City Zone State

from strong stations on adjacent channels. Close coupling results in dead spots in the tuning range due to absorption by the antenna system.

At this point it is understood that the reader has built, borrowed, bought, or stolen a receiver that is suitable for

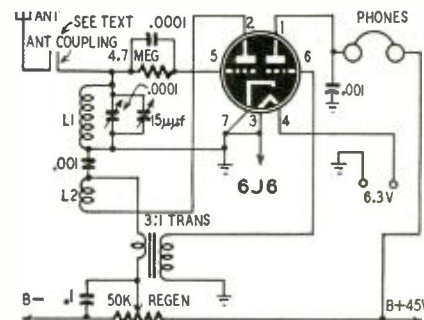

Fig. 2—Simple receiver you can build.

use in the ham bands. The converter illustrated in the photos and in Fig. 3 will produce amazing results. Its simplicity should be no measure of its effectiveness. One word of warning—do not connect this converter to an a.c.-d.c. receiver!

A 6J6 twin triode forms the basis for this converter. The circuit is by no means a new one. It has been used by many oldtimers. One section of the tube is employed as a grid-leak detector (especially well suited to weak-signal reception), and the other section is used as a plate-feedback oscillator. The circuit employs fewer components than any other we have ever used. The particular converter shown in the photo was an experimental model. Others which preceded it incorporated slight variations which in some cases may be desirable. For example, one had a direct tuning control, while the one shown here is fix-tuned.

Since the frequency band to be covered is quite limited the detector input circuit is broad enough to permit all tuning to be done by the receiver tuning control. This latter arrangement has

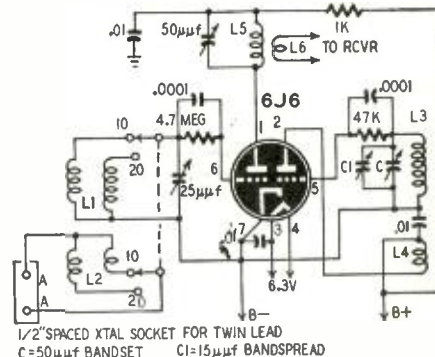

Fig. 3—A converter improves reception.

the advantage that all operating is done right at the receiver control panel. However, the one disadvantage lies in the likelihood of interference due to direct pickup by the receiver on this new so-called "high intermediate frequency." Where there is a separate tuning control on the converter, the receiver can be adjusted to a clear channel very close to the desired i.f. and all

tuning then done at the converter panel. All other units which were built covered a single ham band.

Because a signal may be received with the oscillator tuned to either the high or the low side of the detector, it was possible to cover two bands with a single oscillator coil, simply by using the high side for the low frequency band and the low side for the higher band. A slight readjustment of the oscillator is necessary, but that offers no problem. The unit shown in the photos is the fixed-tuned model for the 14-mc and the 28-mc bands. It is illustrated because it had the best layout of components. The same arrangement may be used to cover any other band. In fact, this unit will work very efficiently at the very high frequencies. The only change would be in the selection of a different i.f.; 10 mc should be satisfactory. Table I provides the various tuning ranges of the detector and oscillator circuits at the recommended i.f.'s. Normally a much higher i.f. would be used for the upper two ranges. Low-cost receivers with which this converter is to be used suffer from loss of gain above 10 mc. The 10-mc i.f. is a compromise.

The intermediate frequencies listed are not critical. Should the receiver perform better at a slightly different setting, then, by all means use the frequency that allows the lowest noise.

Noise, by the way, is the basic reason for adding a converter to a low-cost receiver. All receivers generate noise in the r.f. and converter stages. When a signal is weak due to losses in the receiver itself or to outside conditions, then noise (hiss) tends to override the signal. By operating a receiver at a relatively efficient point in its tuning range (where sensitivity is great and noise, therefore, not bothersome) and adding a high-sensitivity, low-noise

TABLE I

Band (mc)	Det. range (mc)	Osc. range (mc)	I.f (mc)
3.5	3.5-4	6.5-7	3
7	7-7.3	11-11.3	4
14	14-14.4	9-9.3	5
28	28-29.7	22-23.7	6
50	50-54	40-44	10
144	144-148	134-138	10
220	220-225	210-215	10

converter, signals can be made to override the noise by a substantial factor. The result is an extremely quiet receiver where the signals pop right out of an almost silent background. Of course, as we previously pointed out, the image problem is greatly reduced at the same time due to the higher i.f.

The converter illustrated in the photo is built in a 3 x 4 x 5-inch utility box. One cover of the box was discarded and an aluminum one was substituted for ease of working. The entire unit is mounted on the aluminum cover. Coils are wound on miniature 7/8-inch-diameter polystyrene forms in accordance with information given in Table II.

JANUARY, 1950

MICROWAVE WRITE FOR FLYERS OF SURPLUS PLUMBING AND ACCESSORIES

- 10 CENTIMETER**
 WAVEGUIDE TO 7/8" RIGID COAX "DOOR-KNOB" ADAPTER. CHOKE FLANGE. SILVER PLATED BROAD BAND ea. \$19.50
 WAVEGUIDE DIRECTIONAL COUPLER. 270b Navy type CABV-47AAN, with 4 in. slotted section 32.50
 SO. FLANGE to rd choke adapter, 18 in. long OA 1 1/2 in. x 3 in. guide type "N" output and sampling probe 27.50
 RIGHT ANGLE BEND 3" radius E or H plain Circular flanges 17.50
- 3 CENTIMETER**
 723 A/B KLYSTRON MIXER SECTION with crystal mount, choke flange and iris flange output 22.50
 TR-ATR SECTION for above with 724 ATR Cavity 8.50
 90 DEGREE TWIST, 6 inches long 8.00
 2 WAY WAVEGUIDE DIRECTIONAL COUPLER, type N fitting 1 1/2" x 3/4" guide 26DB 18.50
 CRYSTAL MOUNT in waveguide, 17.50
 3 cm. 90 BEND, 14" long 90° twist with pressurizing nipple 6.00
 TRANSITION 1 x 1/2 to 1 1/2 x 3/4, 14 in. 8.00
 "K" BAND PREAMPLIFIER, consisting of 2-725 A/B local oscillator-beacon feeding waveguide and TR/ATR Duplexer sect. incl. Pre Amp 67.50
 5 FT. SECTIONS CHOKE TO COVER, Silver plated 10.00
- 1.25 CENTIMETER**
 "K" BAND FEEDBACK TO PARABOLA HORN, with pressurized window 30.00
 MITRED ELBOW cover to cover 4.00
 TR/ATR SECTION choke to cover 4.00
- TEST EQUIPMENT**
 MODEL TS-268/U Test set designed to provide a means of rapid checking of X-tube diodes IN21, IN21A, IN21B, IN23, IN23A, IN23B. Operates on 1 1/2 V dry cell battery 3x6X7 35.00
 3 CM. WAVEMETER Ordnance type micrometer head, NEW. Absorption type 85.00
 9000-9500 Transmission type 92.50
 10 CM. WAVEMETER W.E. Type B-433490 Transmission type. Type N fittings. Feeder root micrometer dial. Gold plated, with calibration chart. P/O freq. meter X66404A. New TS89/AP VOLTAGE DIVIDER. Ranges 100:1/2 for 2000 to 20,000 V. 10:1 for 200 to 2000 V. Input Z 2000 ohms. Output Z 4 meg. ohms. Flat response 150 cy to 5 mc. 42.50
- SEND FOR FLYER OF RADIO PARTS RATED CONCERNS SEND PO
 Send M.O. or CHK. Mdse. Guard. Shpg. Charges Sent C.O.D. Price F.O.B. N.Y.C. Phone Di. 9-4124
COMMUNICATIONS EQUIPMENT CO.
 131 Liberty St., Dept. C1 New York City 7, N. Y.

TENASTUBS for BRIGHTER TV IMAGES ONLY \$1.00 PER SET

Simple impedance matching device snaps over 300-ohm line. Requires no tools to install. Send \$1.00 cash, stamps or money order at once to:

TENASTUBS

466 Third Ave. New York 16, N. Y.

More Leotone Specials!

- HIGH FIDELITY CRYSTAL MICROPHONE!!... Sensitive diaphragm, high-imped. type. (1 1/4" O.D., 3/4" deep). Rubber shock-mtd. Less housing 98c
 ALUMINUM HOUSING for crystal mike 15c
 P-23 HEADSETS. Hi-imped. 5 ft. cord & PL-55 1.49
- SPEAKER CONE KIT**... 12 asstd. popular sizes 4" to 12", moulded & free-edge, less voice coils. Kit of 12 1.98
SPEAKER REPAIR KIT... A PROFESSIONAL KIT TO SAVE YOU \$\$\$ Contains: 25 mg. rings, 10 spiders, 25 voice coil forms, 3 yds. felt strip, 20 chamolite leather segments, 16 shims, cement & INSTRUCTIONS. ALL FOR ONLY 2.49
SPECIAL OFFER!! BOTH "CONE & REPAIR KITS" for only 3.95
- MORE & MORE FOR YOUR MONEY!!** LEOTONE'S "JUMBO RADIO PARTS KIT"—17 FULL POUNDS of selected new & dismantled Radio & Electronic parts for every Radioman COILS, TRANSFORMERS, WIRE, HARDWARE, SPEAKER ACCESSORIES, SOCKETS, ETC. ALL these (shpg. wt. 21 lbs) AND MUCH MORE 2.95
- 4 TUBE AMPLIFIER FOUNDATION**... Black crackle cabinet & slide-in chassis & panel. Contains: power trans, condensers, resistors, sockets, etc. 8X4" x 3 1/2" Shpg. wt. 4 lbs. 95c
0-100 DC AMMETER... 2 1/2" sq panel with shunt. ONLY 98c
120" WHIP ANTENNA, 3 screw-in sects. with spring mtg. base. Shpg. wt. 4 lbs. 1.98
- RADIO HARDWARE TREASURE**... A FULL POUND OF SCREWS, NUTS, WASHERS, LUGS, ETC. All in HANDY SELF-SEALING HINGED LID CAN. Shpg. wt. 2 lbs 49c
- RADIO-AMPLIFIER STEEL CABINETS**... (from RCA coin radios). GLISTENING CHROME GRILLE & SLIDE TRIM. BEAUTIFIES ANY ELECTRONIC TEST, INDUSTRIAL or MEDICAL EQPT. 16 1/2" x 9 1/2" x 10 1/2". Shpg. wt. 12 lbs. BRAND 1.98
- NEW! ARMY FIELD WIRE**... Twisted pair, 7 strand, weatherproof. Avail. only in rolls 300-450 ft. ea. Shpg. wt. 4 lbs/100 ft. Perfect 1/2 FT. condition 29c
- SUPER TUBE VALUES!!**... TREMENDOUS SAVINGS NOW ON 90 DAY GUARANTEED TUBES. Unsealed cartons #01A, 27, 39, 77, 89, 6A4, 6K7 or 25L5, 5Y4, 6A8, 6BT, 6C5, 6E5, 6F5, #35, 80, 85, 1A7, 5Y4, 6A8, 6BT, 35L6 or 35Z3 39c
 #10, 24, 41, 42, 46, 50, 78, 84, 1L6A, 5T4, 5U4, 3Z4, 6A3, 6F6, 6J5, 6K6, 6SK7, 7A4, 7A7, 7A8, 7B6, 7C5, 7C6, 7G7, 7H7, 7V7, 12SA7, 12SB7, 50B5 or 50C5 49c
- "FACTORY SPEAKER REPAIRS SINCE 1927" MIN. ORDER \$2.00 20% Deposit Req. on all COD's Please add sufficient postage—excess refunded
- LEOTONE RADIO CO.**
 67 Day Street, New York 7, N. Y.

CODE PRACTICE OSCILLATOR

Kit complete ready to build \$5.49 FOB
 A complete kit with two tubes, key and speaker or phones (specify which)—simple easy-to-follow instructions enclosed —NOTHING ELSE TO BUY.

MONOTUBE SPEAKER—RADIO KIT

As described in Dec. issue of Radio Electronics—complete ready to build. \$5.95 FOB

Two-way Inter-com. Kit—

comp 2 tubes — 2 spkrs. \$9.95 FOB

Universal/general corp.

365 J CANAL ST., N. Y. 13, Walker 5-9642

ATTENTION

WE ARE PROUD TO ANNOUNCE A BASIC NEW DESIGN IN BROAD BAND—HIGH GAIN MULTI-CHANNEL TV & FM ANTENNAS

Write for particulars . . . State requirements

Amy Aceves & King, Inc. 11 West 42 St., N.Y.C.

Is Your Life Crowned With Success?

LEXIPOWER



WE THINK IN WORDS. THOUGHT IS POWER. Let this New Science show you how to WIN WITH WORDS—financially, socially, culturally. Develop a MASTERFUL VOCABULARY. Influence others, improve your personality, manifest your latent ability. You are judged and rated by every sentence you utter. Start using the POWER of LEXIPOWER after the first Lesson. Write NOW for FREE details about LEXIPOWER. Dime-a-day LESSON CLUB. LEXIPOWER COMPANY 517-K W. Deming Place, Chicago 14, Illinois

PEN-OSCIL-LITE

Extremely convenient test oscillator for all radio servicing; alignment • Small as a pen • Self powered • Range from 700 cycles audio to over 600 megacycles u.h.f. • Output from zero to 125 v. • Low in cost • Used by Signal Corps • Write for information.

GENERAL TEST EQUIPMENT 38 Argyle Ave. Buffalo 9, N. Y.

CIRCLE X ANTENNA

ENGINEERED TO PROVIDE
CLEAR SHARP PICTURES ON ALL CHANNELS
 COMPARE CIRCLE-X TO ANY OTHER TV ANTENNA

No other antenna combines all the mechanical and electrical features engineered into the Circle-X.
 The high gain of the Circle-X is equal to stacked arrays. It is made of light weight corrosion resistant aluminum alloys that stand up in all atmospheric conditions.
 When you use Circle-X you stock only one type of antenna for all jobs. It has one wire lead-in and weighs only 2½ lbs.
 We urge you to compare Circle-X TV Antennas to any other TV antenna on the market.
 Use Circle-X on your next tough TV installation. It may save you a lot of "no profit" call backs.



CIRCLE X
 ANTENNA CORPORATION

PAT. PEND.
 DEALERS: Air Express or Parcel Post Special Delivery direct from factory to you through your jobber, if he cannot supply you with the Circle-X from his stock.
CIRCLE-X ANTENNA CORP.
 509 MARKET ST., PERTH AMBOY, N. J.

It is recommended that the reader follow the exact arrangement of the untuned converter but add the extra tuning control to the opposite cover. Mount the dial (a small vernier) and the bandspread capacitor on the cover.

TABLE II

Band (meters)	Turns			
	L1	L2	L3	L4
10	8	3	8	2
20	20	4	8	2
40	30	5	19	4
80	40	10	32	5

Power for the converter may be taken directly from the receiver with which it is operated. The heater of the 6J6 should be connected in parallel with those in the receiver. Best results were obtained with about 60 volts on the plates of the 6J6. The current requirement at that voltage was between 12 and 13 ma. Plate voltage should be taken from a high-voltage point which feeds the i.f. stages in the receiver. Do not use the point that feeds the audio amplifier because that may not be sufficiently filtered. Employ Ohm's law to calculate the value of resistance needed to drop the receiver's voltage to 60 volts for the converter.

Antennas are important! We found that a folded doublet made of 300 ohm ribbon lead works very well. Cut it to resonate within the band in which you are working. The antenna coupling coil will vary with antennas. In general, close coupling works best with this converter. Where spacing permits, the antenna coil should be interwound with the B-minus end of the detector grid coil. In other cases wind it directly over the grid coil, at the same point, as follows:

Band	Ant.	Osc. plate.
3.5	10	5
7	5	4
14	4	3
28	3	2

All coils are wound in the same direction. The output coupling coil will depend on the receiver with which it is used. Some experimenting may be necessary but in all probability 10 or 12 turns will work satisfactorily. All wire No. 24 d.c.c. except that L1 uses No. 26 on 80 meters. All coils 1 inch long except L3 on 80 meters, which is close-wound. L5 is 50 turns No. 28 d.c.c. for 4-5mc; L6 is 10-12 turns.

Tuning is simple. Adjust the receiver to the desired i.f.; then adjust the oscillator bandsetting capacitor until a signal is heard at the low-frequency end of the band. The vernier bandspread capacitor should be set as maximum. After a signal is received adjust the detector for maximum signal strength, then adjust the output transformer. If the receiver has fairly accurate frequency calibration set it at the frequency to which the converter's oscillator should be tuned and adjust until the oscillator is heard in the receiver. Then make adjustments as previously outlined.

AMPERITE

Studio Microphones at P.A. Prices

Ideal for BROADCASTING RECORDING PUBLIC ADDRESS

"The ultimate in microphone quality," says Evan Rushing, sound engineer of the Hotel New Yorker.

- Shout right into the new Amperite Microphone—or stand 2 feet away—reproduction is always perfect.
- Not affected by any climatic conditions.
- Guaranteed to withstand severe "knocking around."

Models
 RBLG—200 ohms
 RBHG—Hi-imp.
 List \$42.00

"Kontak" Mikes
 Model SKH, list \$12.00
 Model KKH, list \$18.00

Special Offer: Write for Special Introductory Offer, and 4-page illustrated folder.

AMPERITE Company, Inc.
 561 BROADWAY • NEW YORK 12, N. Y.
 Canada: Atlas Radio Corp., Ltd., 560 King St. W., Toronto

New TECH-MASTER BLUE RIBBON TELEVISION KIT featuring AGC (automatic gain control)

for 10" or 12" KINESCOPIES

Four-stage video IF—4Mc band width. Completely assembled . . . ready to wire. Factory tested parts of finest make. Trouble-free wiring diagrams permit wiring in a week-end. Write for complete information on the "Blue Ribbon" and other Tech-Master TV products. Complete with all tubes, less Kinescope **\$119.95**

TECH-MASTER PRODUCTS COMPANY
 443-445 Broadway New York 13, N. Y.
 More leading engineers and technicians have built Tech-Master for their own use than any other Television Kit.

French Radio Developments

By E. AISBERG*

THE recent Paris Fair demonstrated that the French radio industry is back on its feet after the hardships and technical stagnation of the occupation years.

The appearance of receivers has changed drastically. Before the war cabinets were usually rectangular boxes with more or less fancy-work. Today, right angles and points are being replaced with curves in many designs.

One of the more novel receivers is the Super-Boom, shown in Photos 1 and 2. The chassis is a circle of sheet iron. As the photos indicate, the parts layout is quite different from that of an ordinary receiver.



PHOTO 1

Nonradio electrical devices in France have long gone unrepaired and unimproved with the result that man-made interference is a serious threat to good broadcast reception. To reduce noise pickup in receivers, the old loop antenna is being revived. Widely used between 1925 and 1930, the loop had been practically discarded before the war.

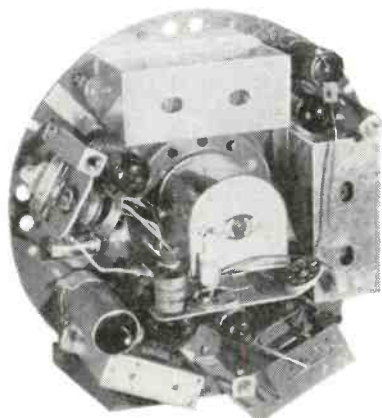

PHOTO 2

Loop antennas are available today both as separate units or, as shown in Photo 3, built into receivers. The loop itself is within the cylinder and is tuned by the receiver's variable capacitor. The wire wound around the cylinder is

grounded at one end and acts as a shield.

Some of the loops available as single units have an amplifier tube in the base to improve signal-to-noise ratio still more.

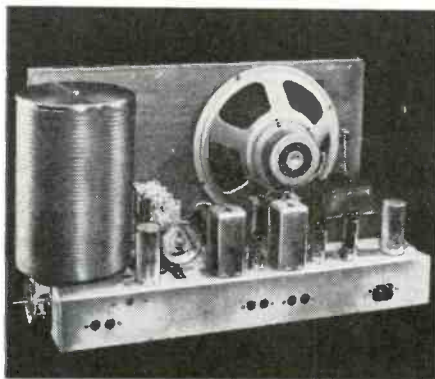

PHOTO 3

The American invention of the amplifying crystal, the transistor, made quite a stir in French technical circles. Engineers have been working on them enthusiastically and have come up with several interesting applications as well as an improved version of the transistor itself, known as the *transistron*.

The action of the germanium crystal, whether it is used in the ordinary role of rectifier or with extra electrodes added as a transistor (or transistron), is governed largely by a small amount of impurities in the germanium. French engineers have developed a method of

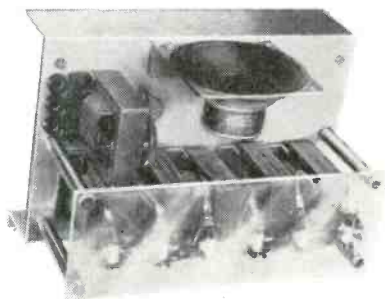

PHOTO 4

holding the amount of impurities to a closer tolerance than heretofore, with the result that the amplifying action is more stable and predictable.

Photo 4 shows a radio receiver which uses six transistrons and no tubes at all. Transformers are required between each two cascaded stages to take care of impedance matching.

The transistron, no longer a laboratory curiosity, may soon be put into



PHOTO 5

large-scale commercial production. Very soon repeaters using transistrons will be installed in the telephone circuit between Limoges and Paris. Photo 5 shows one of these.

NEW TELEKITS
NOW 49.95

Jobbers: Write for Confidential Price

Information

NEW TELEKITS
10-B \$69.95
7-B \$49.95
LESS TUBES



Sparkling new Telekit 10-B has 52-inch screen. Brand new compact lay-out has video tube mounted on chassis. Big illustrated easy-to-follow instruction book guides you step by step through easy assembly. No special knowledge of television is required. All you need is a soldering iron, pliers, and screw driver. 10-B Kit can be used with 12½, 15, 16-inch tubes. Telekit 10-B, \$69.95. 10-B Telekit cabinet, \$15.95 and \$24.50. Satisfactory Telekit Performance Guaranteed by Factory Service Plan.

Write for catalog listing 10-B and 7-B Telekits. New 7-B Telekit for 7-inch tube, \$49.95. 7-B cabinet \$15.95 and \$24.50.

TELEKIT BOOSTER
\$12.95



If you live in a fringe area this fine Telekit booster will bring in TV signals bright and clear. There is a 20 to 30 times signal boost on all channels. NOT A KIT. Completely assembled with tubes. Works with Telekit or any other TV receiver.

13 CHANNEL TUNER
\$12.95

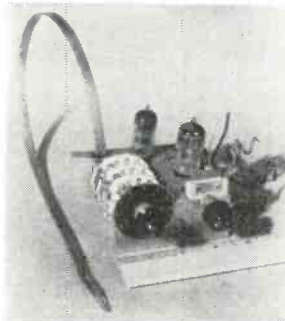

NEW 13 CHANNEL TUNER is a small compact unit with stage of R.F. Tunes all TV channels. Made to conform with Telekit or any other TV set having video I.F. of 25.75 Mc. Complete with tubes, pre-wired pre-aligned; only four connections to make. See your jobber, or write to us for information. Your cost, \$12.95.

Write for catalog of Telekit antennas, boosters, television kits, tuners, television parts and tubes.

TELEKIT

ELECTRO-TECHNICAL INDUSTRIES
1432 N. BROAD ST. DEPT. 8 PHILADELPHIA 21 PA.

* Editor, *Toute la Radio*, Paris

NEW RESISTORS

International Resistance Co.
Philadelphia, Penna.

Two recently announced miniature units are the IRC BTR and BTB. Type BTR at 1/3 watt meets JAN-RC10 specifications. Type BTB at 2 watts is equivalent to JAN type RC40.

BTR has a body length of only 13/32 inch and a diameter of 3/32 inch, while BTB has a body length of 1/4 inches and a diameter of 1/4 inch. Their construction features provide a resistor of extremely low operating temperature and excellent power dissipation in a compact, lightweight, fully insulated unit. Minimum resistance of each is 470 ohms, and maximum resistance 22 meg ohms. Available in $\pm 5\%$ and $\pm 10\%$ tolerances in RMA ranges.

Like all advanced-type BT's, the new resistors are protected against moisture by a phenolic resin housing molded at high pressure. Copper leads are securely anchored inside insulation—heavily tinned for easy soldering.

TELE GENERATOR

Superior Instruments Co.
New York, N. Y.

Model TV-30, a television signal generator, permits alignment of television i.f. and front ends without the use of an oscilloscope.



The model TV-30 permits alignment operation in the manner normally employed to align broadcast and short-wave receivers. Four frequency ranges are 18-32 mc.; 35-65 mc.; 54-98 mc. and 150-250 mc. without switching. Audio-modulating frequency is 400 cycles (sine wave).

Cabinet measures 6x7x9 inches. Shielded co-axial lead is supplied.

TV-FM ANTENNA KIT

J. M. Weaver Co.
Madison, N. J.

This TV-FM installation kit contains all the necessary essentials required for installing a TV or FM receiver, including a broadband all-channel folded dipole antenna, mounting bracket. 75 feet of lead, lightning



arrester, standoff insulators, hardware, and assembly instructions. The antenna is prefabricated, and it requires but a moment's time to complete the assembly. The dipoles are made from single lengths of tubing. This eliminates the usual connections between sections which are potential sources of trouble. The mounting bracket is of unique design and requires the use of only one hand for rotating the antenna for proper adjustment.

MARKER GENERATOR

Approved Electronic Instruments
New York, N. Y.

Marker generator model A-450 is a precision-built, tuneable oscillator pro-



viding a marker modulated or unmodulated, for indicating frequencies on a displayed frequency response of a television or any wideband i.f. amplifier, when used with a sweep generator and an oscilloscope.

The frequency range is 19.5 to 40 mc, accurate to 0.5%, or better. Accurate sound or video frequency spotting can be obtained using an external crystal of proper frequency.

The unit operates on 115 volts, 60 cycles.

SIGNAL TRACER

Radio City Products Co.
New York, N. Y.

Model 777A Dynatracer provides such exceptionally high amplifications that actual gain measurements may be made for receivers or other apparatus.



An accurate meter gives calibrated indications, which are not possible with magic-eye indicators.

Input capacitance is only 3 micromicrofarads. Attenuation is 10,000 to 1 by means of a ladder attenuator with vernier control. Sensitivity is 10,000 microvolts for full-scale deflection of meter or 200 microvolts per division.

Frequency range covers approximately 160 megacycles.

A jack is provided for testing microphones and pickups. An automatic control switch permits either speaker or meter to be used alone or together or standby.

Its tube complement is 6AU6, 6AT6, 6AQ5, and 6X4; its crystal rectifier, a 1N34. The speaker employs an Alnico 5 magnet.

TWIN-STYLUS CARTRIDGE

General Electric Co.
Syracuse, N. Y.

The new twin-stylus, variable-reluctance phonograph cartridge, model RPX-050, is capable of playing conventional and Microgroove records.

The twin-stylus assembly is replaceable as a unit with sapphire tips having 1- and 3-mil tip radii. Stylus pressure with either stylus is 8 grams.

The new cartridge is the same in size as present models having the replaceable stylus, and features increased



compliance and a very high signal-to-noise ratio. It shows a smooth, wide-range, frequency-response curve over a useful range of 40 to 10,000 cycles.

LIGHTNING ARRESTER

JFD Manufacturing Co.
Brooklyn, N. Y.

The safe TV guard is an Underwriters Laboratory approved lightning arrester for both outdoor and indoor use. It can be installed on the mast, on a grounded pipe, a wall, window sill, or other flat surface.

Charges are dissipated by contacts sealed in rare-gas tubes. The arrester does not affect the impedance of the 300-ohm line, which is passed through the groove on top of the arrester.

Toothed washers, tightened by nuts, bite through the insulation to make the contact. No cutting, stripping, or spreading of the line is needed.

**SIGNAL GENERATOR**

Electronic Measurements Corp.,
New York, N. Y.

The model 500K r.f. signal generator is now available in kit form. The generator covers 150 kc to over 30 mc on fundamentals, and harmonics are usable past 100 mc. Internal 400-cycle modulation is provided. All coils not in use are shorted.

TELEVISION UNITS

Quam-Nichols Co.
Chicago, Ill.

Two new television components—an ion trap and a focalizer unit—are in production.

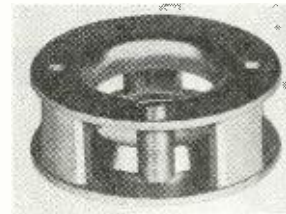

Simplified design of the Quam focalizer unit utilizes Alnico permanent magnets to replace the old-style, wire-wound focus coil and permits permanent precision focusing of the picture not affected by temperature or line-voltage changes.

The Quam ion trap also features an ingenious use of permanent magnets (see illustration).

GEIGER TUBE

Amperex Electronic Corporation
Brooklyn, N. Y.

The type 52N is a new, thin-metal-wall, radiation counter tube for beta and gamma detection.

This self-quenching tube features extremely rugged mechanical construction, unlimited life, unchanging characteristics with use, low operating voltage, and a long plateau.



The tube may be operated over a wide temperature range without affecting tube life or electrical characteristics. Accidental overvoltage will not harm it.

TELEVISION MIRROR

General Cement Mfg. Corp.,
Rockford, Ill.

The Service Mirror is designed for use by the television technician in adjusting receivers. While he sets the rear-panel controls, he can see the screen's reflection. The mirror is 10 x 12 inches in size and clamps easily to a chair, table, or other piece of furniture. It is made entirely of metal.

TV IMPEDANCE MATCHER

Jerrold Electronics Corp.,
Philadelphia, Pa.

The Match-A-Tran is a step-type variable-impedance transformer designed to match the antenna transmission line to the input of any television receiver. Connected between line and set, it

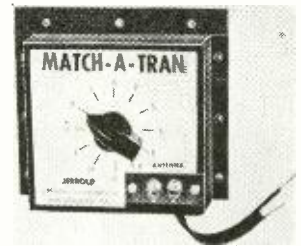

tunes out the reactance present and makes the line termination almost completely resistive, eliminating standing waves. This peaks the signal and reduces negative ghosts.

DIRECTIVE ANTENNA

Technical Appliance Corp.,
Sherburne, N. Y.

Type 900 Taco television antenna has four driven elements, two vertical and two horizontal instead of parasitic ones, giving better control of the field pattern and permitting lobe switching. It is possible with a diplexer network to eliminate entirely the co-channel interference present in many locations where two stations are on the same channel or adjacent channels, located about 180 degrees apart at the installation. It also makes possible reception from either direction without turning the antenna itself. Front-to-back ratio ranges up to 20 to 1.

The antenna is supplied with a diplexer, located at the receiver. The diplexer serves as a matching transformer between transmission line and receiver, eliminating any standing waves due to a mismatch. It also serves as a reversing switch for switching directivity lobes.

TV PREAMPLIFIER

Radio Merchandise Sales, Inc.
New York, N. Y.

Preamplifier model SP-4 is said to provide an average gain of four to six times over the entire TV range. It features individually shielded input, output, and power sections, with further



shielding around the whole unit. Input and output are iron-core tuned. Coils are wound with flat ribbon.

An isolation transformer eliminates shock hazard.

TV DISTRIBUTION SYSTEM

Electro Engineering & Mfg. Co.,
Detroit, Mich.

As many as eight television receivers may be operated from a single antenna without interaction with the aid of the TVD-8 Television Distribution System. Eight 6J6's are used as isolation stages. There is no amplification, but attenuation of the signal is lower than with resistive isolation systems. The unit covers all channels.

Input and output circuits are balanced, with 300-ohm impedances in both. The system is built on a chassis 18 1/2 x 6 1/4 x 6 1/2 inches.

RADIO-ELECTRONICS for

European Report

By MAJOR RALPH W. HALLOWS

THE outdoor antenna is disliked heartily by both broadcast listeners and viewers in Britain. They don't like the expense of putting up an outdoor antenna, they don't like the look of it, and not a few have (without any foundation) misgivings about it during thunderstorms. It is mainly for these reasons that the broadcast receiver with built-in antenna and that using the supply mains as antenna have become so popular. Those who have sets requiring an external antenna largely use indoor types, such as a length of wire stapled to the picture molding or slung from end to end of the attic. We have TV models using the supply mains as antenna, but the distance at which they can be used from the transmitter is usually quite short—and mains-borne interference is apt to be a nuisance.

The big demand for the indoor TV antenna is being met in a variety of ways. One type which gives good results is made of flexible wire molded into a plastic ribbon. It consists of two "arms" of equal length, the feed being taken from the mid-point between the arms (like some antennas described in American magazines). This antenna is designed for door-frame mounting: either tack one arm vertically up the side of the frame and the other along the skirting board to form an L, or run the horizontal arm along the top of the frame so that the L is inverted. Then there's the inverted V, made in rigid form and intended for installation in the attic, where it fits in very conveniently. These and some other types are all quite successful, so long as the field strength is high. I expect that there will be a big enough demand for indoor antennas to stimulate fresh developments when the 35-kw Birmingham station gets into its stride. At close quarters, in fact, the field strength of its transmissions is likely to provide some pretty problems in the design of attenuators.

For years past the H-shaped combination of dipole and reflector (remember our vertical polarization) has been almost the standard outdoor TV antenna in Britain. One sees a few reflectorless dipoles (can they be called I-shaped?), but they're not very common. One reason for the popularity of the H-type is that it has a front-to-back attenuation, with proper spacing of its two elements, of about 7 db. In areas where field strength is high, it can thus be oriented so as to use the reflector as a shield screen against in-

INTRODUCING NEW IRC PRECISTORS

Here is the precision resistor you've been hunting. IRC's new Deposited Carbon PRECISTOR combines accuracy, stability and economy!

PRECISTORS are principally designed for uses where carbon compositions are unsuited and wire wound precisions too expensive. They are excellent in television, voltmeter multiplier, and high frequency circuits. PRECISTORS are supplied in 2 sizes: Type DCF—200 ohms to 5 megohms and Type DCH—500 ohms to 20 megohms.

Your IRC Distributor has new PRECISTORS packaged in sturdy plastic cases . . . fully protected against scratches and jars. Characteristics are printed on the case, and range, type and tolerance are given on the resistor. Ask to see new IRC PRECISTORS when you visit your Distributor!

IRC also manufactures a complete range of Wire Wound Precision Resistors. 1% accuracy is standard, but closer tolerances to 1/10 of 1% are available at slightly higher prices. Highest quality materials combined with skillful winding technique make IRC Precision Wire Wounds the choice of leading instrument makers. International Resistance Co., 401 N. Broad St., Phila. 8, Pa. In Canada: International Resistance Co., Ltd., Toronto, Licensee.

INTERNATIONAL RESISTANCE CO.

Wherever the Circuit Says 



GUARANTEED
ACCURACY
1%

PLUS

STABILITY
OVER LONG
PERIODS

PLUS

LOW
COST

PLUS

WIDE RANGE
OF
VALUES

PLUS

PRECISION
PACKAGING
in tubular
plastic case

terference coming mainly from one direction. Very promising results have been obtained from a new X-shaped antenna, with which the front-to-back attenuation is nearly three times as great. The forward gain, too, may show an improvement of 2 db over that of the H-array.

In districts where low field strength makes reception chancy with the H antenna, better results have been obtained with an X arrangement. Still more promising are the Yagi arrays which are now becoming popular in fringe areas. One type coming increasingly into use has a dipole, a reflector, and two directors. I shall not be surprised to see more complex arrays coming along—say, dipole, reflector,

and from four to six directors or more—for the Yagi has proved itself to be, not only sensitive, but also highly directional. It can, therefore, be a powerful defense against interference. Further, it is adaptable to either polarization. What about a light TV Yagi array, designed for attic installation? It could make an effective indoor antenna where other types don't deliver the goods.

We're getting on

Although up to now we have had only one television station in service for the whole of the country, the monthly jumps in the number of receiving licenses have been spectacular. I reported that at the end of March

CONICAL TV RECORD BREAKER!!

LAZY X DOUBLE STACKED ANTENNA ARRAY ALL TV CHANNELS

T. V. Problems over in FRINGE AREAS!!

• Users Report up to 300 Mile Reception!!

• No Booster Required!

• Matches Any ohm Wire!!



YOUR COST
\$945 Lots of six
Each \$9.90

NO JOBBERS
BUY DIRECT
30 days rated accounts
20% dep. on C.O.D. orders.
IMMEDIATE DELIVERY

ATTENTION: DEALERS, STORES, SERVICE MEN,

sell complete in a box with all accessories, Guywire, Ring, 60' 300 ohm, peakmounting base, hookeyes, insulators 15' most. Lightning Arrestor. Instruction sheet. Everything you need. List \$39.95.

Your Cost \$16.00

We manufacture and sell all types of brackets, roof chimney, guy rings, U-bolts, masting, T. V. wire, etc.

WRITE—WIRE—CALL

HOUSEHOLD • 419 DORR STREET, TOLEDO, OHIO

1947, the license total was 18,000. At the end of August, 1949, just 30 months later, that figure had risen to 162,150. A nine-fold increase in that time is remarkable enough—and you have to remember that the total would have grown far more rapidly could manufacturers have kept pace with the demand. I'm willing to bet that within 12 months, the opening of the Birmingham station plus increased production of receivers will bring the number to at least 400,000. Growth would be even more rapid were it not that so much of our available manpower and electrical materials must still be devoted to making good the wartime damage to our power stations and distribution systems (it is little realized how great this was), and to catching up with the expansions and improvements in them which should have been made during the approximately six years that we were at war.

Room for both

One noteworthy fact is that the widespread interest in television is not killing the market for radio receivers. The definite slump in radio set sales during the earlier part of this year now appears to have been due largely to the fact that people were holding back for Radiolympia. There was no exhibition last year, and the average family felt that it would make do with the old set until the next show, when there were bound to be worth-while improvements shown. When Olympia opened, there were many who lamented that its organizers had allowed the TV side to eclipse radio. It looked rather like that, for the emphasis appeared to be largely on television and televisers. They were staged, rightly or wrongly, as the chief attraction, and visitors regarded them as such. But it was generally realized that the most important and most complete source of home entertainment for some years to come must be the radio receiver. The result (hardly hoped for, but very gratifying) was, first, that television didn't steal the show, and, second, that the business done in orders for radio receivers proved that there is a boom rather than a slump in this department. The underlying reason, I believe, is that our folks have not been oversold on television and that they are not holding back from radio through any falsely encouraged belief that TV at crystal and head-phone radio set prices, or even at five-tube radio set prices, is just around the corner for everyone.

Definition chaos

You don't need to be much of a prophet to foretell with certainty that if the television of, say, 10 years hence depends on scanning, it won't be limited to 405, 525, or indeed any three-figure number of lines. In the meantime we're limited to definition of those orders since, with any system we now know, the bandwidth of modulation frequencies depends approximately on the square of the number of lines. Even if there were room for the enormously wide

RADIO-ELECTRONICS for

ARROW "SUPER 16" CHASSIS

AN AMAZING BARGAIN

COMPLETE CHASSIS B10023

\$174.50 FOB

16" GLASS PICTURE TUBE

ONLY \$44.50

B1008 FOB

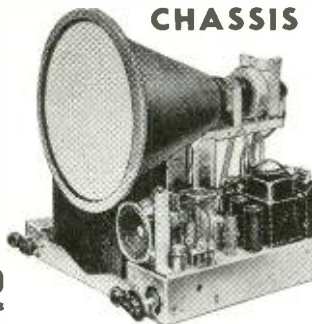

Here is the great 630 circuit with last minute improvements and modifications for using the 16" metal tube. Includes the added Voltage Doubler Circuit which produces a full 13,500 volts—the recommended output for optimum performance of the 16" tube. 16" mounting brackets are already built into the chassis. RCA type parts. The "Super 16" is completely wired, tested, and aligned, ready to provide Big Screen TV entertainment for many years to come. B10023, complete chassis, less picture tube... \$174.50

ARROW 630 - KIT BARGAINS

630-AGC KIT provides automatic gain control—eliminates airplane flutter, etc. Uniform brightness when tuning from channel. B10220.....\$3.18

RESISTOR KIT B10167.....\$3.80

KNOB KIT B10168.....\$1.49

ELECTROLYTIC CONDENSER KIT B10169.....\$5.95

VOLUME CONTROL KIT B10170.....\$6.48

CERAMIC CONDENSER KIT B10171.....\$3.71

MICA CONDENSER KIT B1072.....\$2.48

I.F. COIL KIT B103.....\$7.50

PAPER CONDENSER KIT B10174.....\$4.15

COMPLETE METAL PARTS KIT B10221

Including all brackets and chassis....\$19.50

WRITE FOR NEW FREE CATALOG J2

ARROW ELECTRONICS
INCORPORATED
82 CORTLANDT ST. N. Y. C. 7, N. Y.

PORTABLE POWER SUPPLY (Low drain)

AVA-126A, RCA mfg., for mobile, boats, planes. In grey crackle steel box 5" 6 1/2" 7" wt. 10-lbs. Operates from 6 or 12 V. DC source and delivers 320 V. DC at 110 Ma. with taps for revr. and transmitter. OZ4GT rectifier, 3 built-in relays, complete filters, 2 vibrators (6 and 12 V.), mtg. accessories, diagram.



NEW FOB \$14.95

Specialty Priced Transmitters from low to high power in models by Metzner, Collins, Hallicrafters, Western Electric, General Electric, Bendix and others. Complete listings on request.

COMMUNICATION DEVICES CO.
2331 TWELFTH AVENUE NEW YORK 27, N. Y.
Cable: Communidev Tel: AD-4-9277

ORDER NOW — LADDERS

FOR TELEVISION INSTALLERS



Heavy Duty Aluminum—Extension ladders, roof ladders and special ladders made to order. Sold direct. Write today!

• Heavy Duty - Lightweight
WAYNE F. SMITHERS CO.
Box 217 Stony Ridge, Ohio
DISTRIBUTORS

channels required by 1,000-line or 1,500-line systems, the cost of televisers capable of dealing with passbands of these widths would be prohibitive. Intensive work toward higher definition is going on, and one day it will come. Till that day dawns, we can't go much beyond the present American and British standards, which have proved amply that they provide pictures of real entertainment value.

For that reason it's a pity that there's not more of the get-together spirit. France is changing over to the British system, which means that we can exchange programs. And between our two countries there's more to it than that. France is committed to the adoption of 819 lines within five years, and we have agreed to explore the possibilities of developing our forthcoming high-definition system on the same standard. Quite a few European countries either have started in a small way (or are likely to start in the near future) transmissions of the 400-600-line order. If only some common standard could be agreed upon, long-range international relays and exchanges could take place over the great network of co-axial cables already in existence or nearing completion. These cables can carry television relays with a modulation-frequency range corresponding to 400-500 lines, but no more. Unhappily, each country seems to prefer to work on a standard of its own, thereby cutting itself off from the others. Holland, for instance, is developing 449 lines; the "iron curtain" countries, 625 lines; Italy, 441; and Denmark 657. It almost seems as if some of them were just being pernickety by working out systems which effectively prevent them from transmitting to or receiving from other countries! And that is just about the last thing that should be done in television or in any other variety of broadcasting.

The Birmingham station

Here's the very latest information about Britain's Birmingham station which is to go on the air with a full service on December 17, 1949. Its vision is on 61.75 mc; output power, 35 kw; sound, 58.25 mc; output power, 12 kw. Its antenna system is eight equally spaced vertical dipoles mounted on a mast 800 feet high and connected to the transmitters by devices which eliminate the possibility of interference between sound and vision signals. The antennas have each a de-icer and an arrangement preventing the accumulation of moisture from rain or snow. Should any adjustments or repairs be required, technicians can quickly reach the dipoles by means of an elevator inside the lattice mast. The Birmingham station is connected to the London studios by both co-axial cable and a chain of radio links. There are four of the latter, and it is not unlikely that in the future some of them may operate as unattended transmitters, thus greatly increasing the service areas of both Birmingham and London.

JANUARY, 1950

TWO Sensational
JACKSON
New Television Instruments

ONE! NEW TV SWEEP GENERATOR

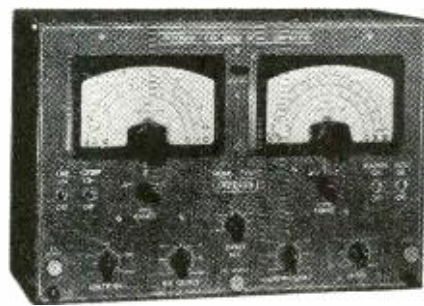

Model TVG-1 Net Price \$220.00

The ONE generator for accurate complete TV servicing. Look at these features:
Built-In Marker Generator. On fundamentals from 4 to 54 Mc. Harmonics readily usable to 216 Mc. Three ranges, accurately calibrated dial.
Crystal Calibrator. Jack provides means for calibrating Marker for any frequency within the range of the instrument.
Complete Sweep Generator. Provides frequencies from 2 Mc. to 216 Mc. in three ranges. Accurately calibrated dial with TV channels and FM band clearly indicated.
Adjustable Sweep width. Easily and quickly adjustable from 100 Kc. to a full 12 Mc. for FM and TV servicing.
400 Cycle Modulation. For use with Marker Generator.
Scope Timing. Provides a phased sinusoidal voltage for the Horizontal timing axis of the oscilloscope. Built-in phasing control assures a single pattern indication on the 'scope screen.

TWO! NEW 5" OSCILLOSCOPE



Model CRO-1 Net Price \$195.00
 Demodulation Probe . Net 9.95
 (For Signal Tracing)

Thanks to an amazing JACKSON discovery, this fine laboratory-type instrument gives you either wide band or high sensitivity. Check these features against any other oscilloscope.
Wide Band Amplifier. Vertical amplifier flat within plus or minus 1.5 db from 20 cycles to 4 1/2 Mc. Readily usable to full 5 Mc! Such band width is essential for accurate picture of TV sync pulses.
High Sensitivity. Vertical sensitivity .018 RMS volts-per-inch. Ideal for proper analysis of low voltage signals. Band width on High Sensitivity ranges is 20 cycles to 100 Kc.
Sweep Oscillator. Saw tooth wave 20 cycles to 50 kilocycles in 5 steps. Provision for external sweep.
Extra Features. Provision for direct connection of AC voltages. Internal and External Intensity Modulation. Synchronizing Input Control. Removable calibration screen. Height same as TVG-1 (above) for compact service-bench installation.

Get all the facts! Mail the coupon today!

JACKSON

"Service-Engineered"
Radio-Television
Test Equipment
 Dayton, Ohio

Jackson Electrical Instrument Co.
 16-18 S. Patterson Blvd.,
 Dayton 1, Ohio

Please rush complete information on the following Jackson instruments:

TVG-1 Television Generator Complete line of Jackson Test Equipment CRO-1 5-Inch Oscilloscope

NAME _____
 STREET _____
 CITY _____ ZONE _____ STATE _____
 MY DISTRIBUTOR IS _____

MULTICHANNEL BLOCKING SYSTEM

Patent No. 2,468,058
 Donald D. Grieg, Forest Hills, N. Y.
 (Assigned to Federal Tel. and Radio Corp.)

A method of accepting certain pulses and blocking others, such as patented here, is needed in multiplex signaling with pulse modulation. The pulses pass through a blocking stage after which they are squared and amplified.

oscillations until the next negative pulse arrives from the blocking stage.

The negative waves coming through C are squared and used to bias the blocking stage to cutoff. The duration of cutoff depends upon

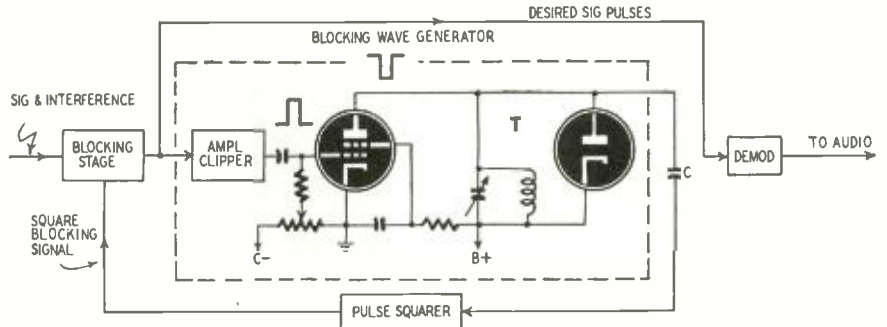

Then they appear as negative pulses across a high-Q resonant circuit T. As is known, such a circuit goes into oscillation at its resonant frequency when it is shock-excited by a pulse. The first half (negative) of the oscillation wave passes through C, but the following positive voltage is virtually shorted out by the diode. The energy is dissipated and there are no further

the width of the biasing square wave, which is governed in turn by the resonant frequency of T. The duration should be equal to or less than the interval between wanted pulses arriving at the receiver. This keeps the receiver blocked for all but the desired channel. Only the wanted pulses are transmitted to the demodulator which follows.

JANUARY TELEVISION SPECIALS! HIGH GAIN X TELEVISION ANTENNAS

Covers channels 2 to 13 without separate section. Constant non-varying center impedance. Better than 12Db front to back ratio. Can be used with 72, 150 or 300 ohm line. Works well in weak areas and gives a sharp conical beam. Price \$5.95 each less mast. Extra for 6 ft. mast \$1.35

FRINGE AREA ANTENNAS

Stacked X Antennas for extra gain in fringe areas including heavy 10 ft. mast. Price \$16.95

DON'T BUILD ANY TELEVISION KITS!

When you can get a factory wired and tested 16"-630 chassis with 31 tubes and voltage doubler, complete with tubes, ready to operate—at the same price as a kit!—Why fuss or have headaches? This is the famous RCA type 630TV chassis which has proved to be superior to anything yet developed. We need not describe the 630TV chassis—you already know about it. The design and operation is excellent—and it's fully guaranteed! Complete with tubes, less 16" Picture Tube.

Ready to Play **\$159⁵⁰**

LESS CABINET

Extra for Glass 16" Tube \$44.95

TELEVISION TABLES

Television Tables made exclusively for Table Model Television Sets. Beautifully yet simple styled, and massively built. Finished in Mahogany, Walnut or Blond Maple as desired. Solidly reinforced, and suitable for the heaviest cabinet; Cabinet base corners fit snugly in table top for solid fit. Fully adjustable to fit any size cabinet. Price \$12.95

Now—The All Channel 4 Tube AC/DC TELE-BOOSTER

Only **\$16⁹⁵**

CHECK THESE FEATURES

- Uses 6AK5's in an efficient wide-band amplifier circuit.
- Self-contained power supply.
- Covers all television channels in use.
- Eliminates need for outdoor antennas in many locations.
- Will actually make difference between "Flat" and very bright pictures on weak stations.
- Improves receiver immunity to off-channel interference. Can be tuned to boost weak stations or turned off to provide normal reception.
- Simple to install and operate, requires only external connection to receiver.
- Operates on 110 volts AC or DC.

MODEL NFRD—RADIO NOISE FILTER

if it doesn't work, send it back!!

We absolutely guarantee that our Model NFRD will eliminate all line noises when properly connected to radios, television sets, short wave sets, motors, electric shavers, refrigerators, vibrators, oil burners, transmitters, and all other sources of interference. This unit will carry up to 12 amperes or 1/4 KW of power and may be used right at the source of interference or at the radio. Small size only 3" x 1 1/2" x 7 1/2". Very low price only EACH \$1.95

SPECIAL

Mammoth assortment of radio & electronic parts of such items as transformers, chokes, condensers resistors wire, coils, hardware etc. of no less than 10 pounds. Price \$1.25

Satisfaction guaranteed on all merchandise.
 All prices F.O.B. New York City
 WRITE FOR FREE CATALOGUE T1

RADIO DEALERS SUPPLY CO.

154 Greenwich St. New York 6, N. Y.

ELECTRONIC SCALER

Patent No. 2,469,031
 Arthur E. Canfora, Brooklyn, N. Y.
 (Assigned to Radio Corp. of America)

This circuit counts positive pulses. The input square-wave signal is transmitted through C1 to the duo-diode V1. Negative pulses are bypassed to ground through the upper diode, positive pulses being rectified by the lower diode to charge C2.

at the grid of V4, blocking it.

The plate voltage on V4 rises abruptly to the value of the B-supply because there is no drop across the tube. This positive surge is transmitted through a capacitor back to the grid of V2.

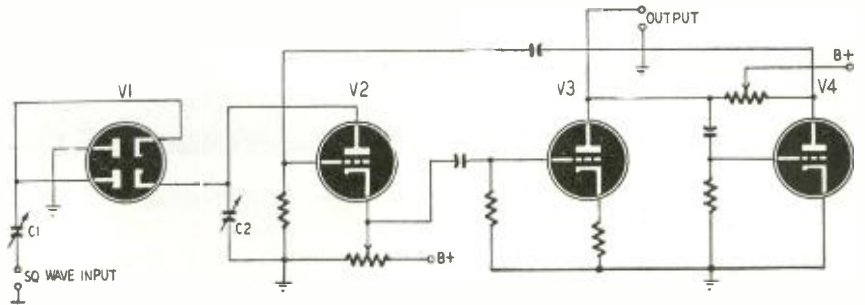

Tube V2 is normally cut off by cathode bias from the voltage divider across the B-supply. V4 normally conducts.

As the charge in C2 increases, the voltage across it reaches a critical value which permits V2 to conduct. The rise in cathode current results in a positive pulse at the grid of V3, which is amplified. The pulse is reversed in phase at the plate of V3, therefore a negative pulse appears

V2 becomes saturated, the charge on C2 is virtually short-circuited through it and C2 is ready for the next charge.

C1 and C2 are adjustable, thus making it possible to control the number of pulses which can accumulate on C2 before the critical potential is reached. For example, if this number is 10, the actual count is 10 times greater than the pulses across the output terminals.

GAIN AND POLARITY CONTROL

Patent No. 2,464,594
 John J. Mahoney, Jr., Lynbrook, N. Y.
 (Assigned to Bell Telephone Labs)

In this amplifier circuit a single potentiometer controls both volume and polarity of the output wave.

The two tubes V1 and V2 are cathode-biased by 160-ohm resistors R1 and R3. The two cathodes are connected by another 160-ohm resistor, R2. R2 and R3, in series across R1, constitute a voltage divider which places the cathode of V2 above ground by exactly half the voltage across R1. This is true for signal voltages only, since biases are controlled, not only by the resistor network, but by the plate currents through V1 and V2. V1 is a cathode-follower whose output appears across R1, the arm of which is coupled to the grid of V2.

Assume an input to the amplifier which produces a +1-volt pulse across R1. Due to the voltage divider R2-R3, +0.5 volt appears across R3. If the arm of R1 is at the top as in the figure,

+1 volt is coupled to the grid of V2. With the V2 cathode at +0.5 volt and the grid at +1, the

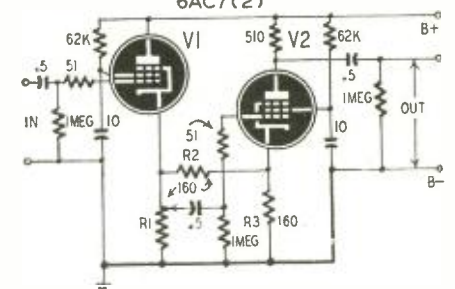

net grid voltage is +0.5 and a corresponding amplified negative pulse appears at the output terminals.

If the arm of R1 is at the bottom (grounded), grid voltage is zero. Since the signal appearing at the cathode of V2 is still +0.5 volt, the net grid voltage is -0.5 volt, equal in amplitude but opposite in polarity to that described before.

If the potentiometer arm is at exact center, grid voltage is +0.5 volt. With cathode also at +0.5 volt, net grid potential is zero and no output appears.

Varying the potentiometer arm between either end and center varies the output amplitude.

ADJUSTABLE TIME DELAY

Patent No. 2,467,857

John H. Rubel, Albany, and Roy E. Troell, Schenectady, N. Y. (Assigned to General Electric Co.)

A time delay is often needed when dealing with r.f. pulses. For example, it may be necessary to delay pulses applied to the plates of an oscilloscope until the sweep has started.

A transmission line made of insulated copper wire is wound around a semicircular core. Each turn of the line is insulated from all others, but a portion of each turn is exposed to the contact

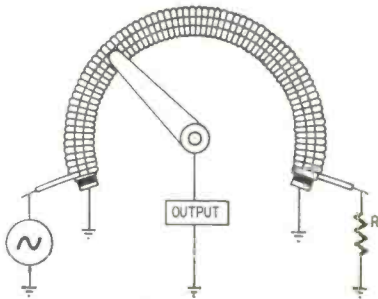

of a rotary arm. The core is made of Litz wires soldered together at each end and grounded.

This line has large capacitance and inductance and is the equivalent of a much longer conventional line. Therefore there is appreciable delay in transmitting a signal through it. In a typical case the core was 3/16 inch in diameter. The coil had 130 turns of wire, 28 to the inch. Inductance was 76.2 microhenries per inch and capacitance 78.7 µf per inch. The impedance was 1,200 ohms. The result was a time delay of about .07 microsecond per inch of coil.

Resistor R which terminates the transmission line should be equal to its characteristic impedance.

LECHER SYSTEM

Patent No. 2,475,198

Charles G. Reischmidt, Hempstead, N. Y. (Assigned to Bell Tel. Labs., Inc.)

The resonant frequency of a Lecher system is ordinarily controlled by changing its physical length, which is neither very convenient nor efficient if only slight frequency changes are required. The new trimmer arrangement is mechanically stable and permits fine tuning.

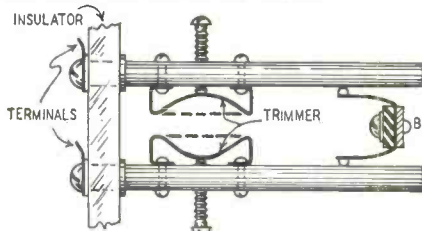

The two parallel conductors are insulated at one end, and terminals are provided for connecting them to the remainder of the circuit. At the other end a shorting bridge B is supported on an arm and arranged to slide along the conductors. The metal contacts short the conductors at desired points for coarse tuning.

The trimmers are made of spring-metal strips riveted to each piece of tubing. A screw passes through a tapped hole in each conductor and presses against the strips. As the metal pieces are forced closer together, the added capacitance between them partially shorts the parallel lines.

Dotted lines show the trimmers in position for maximum frequency.

ESSE RADIO COMPANY
INDIANAPOLIS INDIANA

To All Customers of Esse Radio Co.:

Esse Radio Company has tried for a long while to supply its many thousands of customers with the largest variety, and at the lowest prices, surplus gear and will continue to do that.

Now today and hereafter, as long as possible, we will supply to you radio tubes of any type listed below at 50¢ each. Most of these tubes will be in cartons with the "ESSE" name on each box but in any event will be unconditionally guaranteed against anything, except breakage, for 90 days from date of purchase. We will take your word for whether or not the tube is bad and will replace it free of charge if you will send the tube back to us. I don't think there is a better guarantee by anybody than ours. We want your business and your friendship and we want to continue to supply you with your needs in radio at the lowest possible prices. Make ESSE your headquarters. If you can use 100 or more at one time (mix up the types, we don't care), our price will be 45¢ each. If you can use 250 or more of any type (mixed-up), our price will be 42¢ each. If you can use 1000 or more, 38¢ ea. Here's our list.

Watch "CQ" for ESSE ads. We are possibly doing more advertising in "CQ" magazine, on surplus, than any other surplus dealer.

0Z4	5X4	6K8	7C4	19T8	76
1A5GT	5Y3GT	6L7	7C5	24A	77
1C6	5Y4G	6P5GT	7F7	25A6	78
1D8	5Z3	6Q6	7H7	25AC5	80
1G4	6A3	6Q7	7Y4	25L6	81
1H5	6A4	6R7	7Z4	25Z6	83
1H5GT	6A8GT	6S7G	10Y	26	84/6Z4
1J6	6AC5GT	6S8	12A6	30	85
1E4	6AF6G	6SA7	12A8	31	89
1LC6	6AG5	6SC7	12AT6	32L7	117P7
1LH4	6AK5	6SD7	12AT7	35	117Z3
1LN5	6AL5	6SG7	12AU6	35/51	117Z6
1R4	6AQ5	6SH7	12AU7	35B5	1619
1R5	6AT6	6SJ7	12AV6	35W4	VR150
1S5	6AU6	6SK7	12AX7	35Z5	182B
1T4	6AV6	6SL7	12BA6	36	482B
1T5	6B4G	6SN7	12BA7	37	483
1U4	6B8	6SQ7	12BE6	39/44	954
1U5	6BA6	6SR7	12BF6	40	955
1V	6BA7	6SS7	12C8	41	956
2A5	6BE6	6ST7	12F5	42	957
2A7	6BF6	6SU7	12J7	43	1005
3A4	6BH6	6T7	12K7	46	1625
3A5	6BJ6	6T8	12K8	47	1626
3B7	6C4	6U6G	12Q7	50	1629
3D6	6C5	6U7	12SA7	50B5	2051
3Q4	6C8G	6V6	1201/7E5	50C5	9003
3Q5	6D6	6W7	12S8	50Y6	CW931
3S4	6D8	6X4	12SF5	51	
3V4	6F8	6X5	12SH7	53	9001
5R4G	6H6	6Y6	12SJ7	56	9002
5T4	6J6	6Y7	12SN7	57	
5T4G	6J7	6ZY5	12SR7	70L7GT	
5V4	6K6	7A4	14X7	71A	
5W4G	6K7G	7B6	19	75	

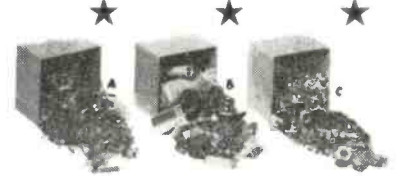

A—Resistor Kit composed of 150 or more assorted wattages. Containing various resistors of up to 10 megohms. Many with gold bands. An honest-to-goodness bargain. Box 2.65

B—Condenser Kit. Contains assortment of 25 various condensers including 2-2 Mfd. 600 V. filters, 1-1000 Mfd. 15 V. filter 4-1 Mfd. 400 V. paper by-pass, 3-3 gong midjet trimmers, etc. 2.65

C—Hardware Kit containing about 5 lbs. of radio hardware including nuts, bolts, washers, shafts, gears, grommets, lugs, screws, spacers. It is a gold-mine of invaluable parts. 1.95



E—Tube Socket Kit 25 or more assorted sockets having various usable sizes. 1.50

F—Switch Kit consisting of assortment of 10 rotary and toggle switches. Price. 1.25

NEW RESISTORS—CARBON

	per hundred
100 ohms, 1/2 watt	\$3.00
120 ohms, 1/2 watt	3.00
220 ohms, 1/2 watt	3.00
270 ohms, 1/4 watt	3.00
470 ohms, 1 watt	3.00
480 ohms, 1/4 watt	3.00
1200 ohms, 1/2 watt	3.00
6800 ohms, 2 watt	3.00
12,000 ohms, 2 watt	3.00
21,000 ohms, 1/4 watt	3.00
56,000 ohms, 1/4 watt	3.00
85,000 ohms, 1/4 watt	3.00
150,000 ohms, 1 watt	3.00
270,000 ohms, 1/2 watt	3.00
830,000 ohms, 1/4 watt	3.00
1,200,000 ohms, 1/2 watt	3.00
5,600,000 ohms, 1/4 watt	3.00

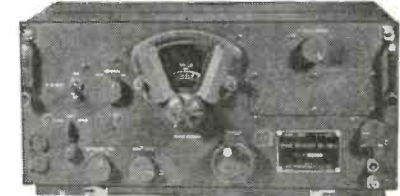

BC-348 RECEIVER 149.50
6 bands, 200-500 Kc. and 1.5-18 Mc. 2 stages RF, 3 stages IF, BFO, crystal filter, manual or AVC. Complete with tubes and 24 V. dynamotor. These receivers have been thoroughly checked in our work-shop and found in excellent condition.

TURNTABLE & MOTOR DRIVE

For small record player boxes. 78 rpm., 105/125 V. 60 cycle, 20.5 watts. 35 gram stylus force. Turntable -6 1/2" diameter. Brand new. \$4.00 ea.

MODEL "BA-301" HUSHATONE

A miniature, molded plastic extension speaker. Disc shaped (4 3/16" dia. x 1 1/16" thick). Tone quality comparable to cone-type speaker. Low power consumption (.01 watt). Hermetically sealed. Light weight BIMORPH crystal drive element insures uniform response and high sensitivity. No parts to wear, loosen, or become detached. Brand new, with 10 ft. cord and phone plug. \$2.50 ea.



TRANSMISSION LINE STANDOFF

(Patent Pending)

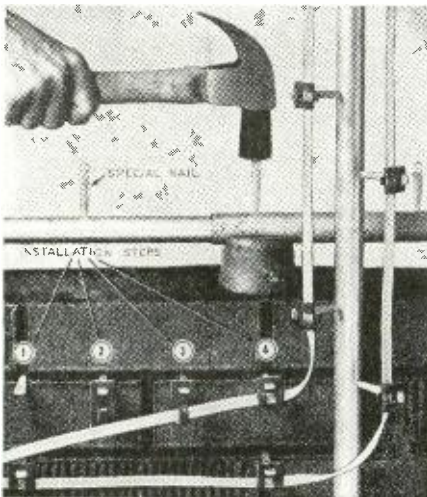

Assembly steps for the standoff are numbered

The transmission-line standoffs manufactured by John Odegaard, are novel in construction and unusually versatile and easy to use. Each consists of a cadmium-plated, hardened-steel, flat nail and a small piece of specially punched polyethylene similar to that of which ribbon transmission line is made.

The nail is shaped much like a flooring or horseshoe nail, with small "steps" along one edge. It may be driven into wood, the mortar between bricks, or iron or aluminum television antenna mast pipes. It may be used to join the antenna mast to an extension, as shown in the photo. A lead weight backs up the pipe in this case. No drilling is necessary; the nails may simply be hammered in and through.

The top row of standoffs in the wall (see photo) shows the sequence of operations. The nail is hammered in, then one of the slots in the polyethylene strip is forced over the head. The cable is placed beneath the flap and the strip is folded over the cable, the other slot going over the nail head.

OBTAINED THROUGH LEADING DISTRIBUTORS

ODEGAARD MANUFACTURING CO.

5416 Eighth Avenue
Brooklyn 20, N. Y. GEdney 5-0861

Latest Information

RADIO & ELECTRONICS

You'll want

HERBACH & RADEMAN'S

complete 16 page catalog of radio and electronic equipment every month

ABSOLUTELY FREE

Just send your name and address to Dept. B

HERBACH & RADEMAN, INC.

522 Market Street Phila. 6, Pa.

ALL-WAVE T.R.F. RECEIVER

Most regenerative shortwave receivers use 140- μ f or smaller tuning capacitors and seven coils or more in each stage for continuous coverage of the spectrum between 550 kc and 30 mc. A four-tube receiver described in *Radio and Hobbies* (Australia) uses 365- μ f tuning capacitors and five coils per stage to cover this range.

The circuit of the receiver is shown in the diagram. A 6SK7 or similar remote-cutoff pentode is the r.f. amplifier, and a 6SJ7 is the regenerative detector. The detector circuit is unusual in that oscillations take place between the grid and screen grid of the 6SJ7. The plate, being coupled to the detector through the electron stream, acts an a.f. amplifier to drive the 6V6 power

$\frac{1}{8}$ inch below the ground end of L2 and L4 on all except the 13-33-mc coil.

Band (mc)	L1 (turns)	L2 & L4 (turns)	L3 (turns)	L5 (turns)
0.55-1.6	15	110	25	62
1.5-4	11	35*	15	26
3-8	6	12 $\frac{1}{2}$ *	12	15
6-16	3	7*	6	8
13-33	1	3†	2	3*

*—No. 24 enameled wire. †—No. 19 enameled wire.

One turn of L3 is interwound with the bottom turn of L4 on this coil. L5 is spaced approximately $\frac{1}{8}$ inch above the grid end of L4 on all coils. It may be

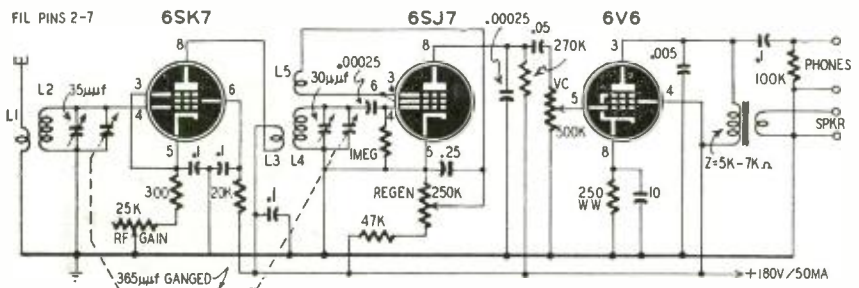

amplifier. The suppressor is tied to the screen grid to insure reliable oscillation up to 30 mc. Regeneration is controlled by the 250,000-ohm potentiometer in the screen circuit of the 6SJ7 and the r.f. gain by the 25,000-ohm control in the cathode return of the 6SK7 r.f. tube.

The antenna coils are wound on four-prong, $\frac{1}{4}$ -inch, low-loss, plug-in forms, and the detector coils are wound on six-prong forms of the same type. All coils are wound with No. 32 enameled wire except where noted. All windings are in same direction. Coils are wound as in the table below.

L1 and L3 are spaced approximately

necessary to vary the spacing between L4 and L5 for best results on each band. Be sure that the connections to L3 are reversed as per the diagram.

The 35- μ f capacitor across L2 is mounted on the panel to permit the r.f. stage to be peaked. The midget air or mica trimmer across L4 is normally set at approximately half capacitance. To make sure that the r.f. and detector stages track, tune in a signal and peak it with the r.f. trimmer. If the signal is loudest with the trimmer all the way in, add a fraction of a turn or more to L2. Remove a turn or fraction thereof if the stage peaks with the trimmer full open.

SHORTWAVE CONVERSION

I modified my automobile radio for 75-meter reception by adding a 75-meter coil and capacitor connected as shown. The coil and capacitor, any combination tuning the desired band, are switched in and out of the circuit with a d.p.d.t. switch. The second harmonic of the receiver oscillator is made to beat with the incoming 75-meter signal to produce the intermediate frequency. The receiver tuning control is used for shortwave tuning and logging, and capacitor C for peaking the signal. Tune in shortwave signals by setting the receiver tuning control to the frequency found from the equation

$$F_1 - F_2 = \frac{F_2}{2}$$

when F_1 is the frequency of the shortwave station and F_2 is the intermediate frequency of the receiver.

Assume, for example, that it is desired to tune in a 4000-kc signal on a

receiver with a 460-kc i.f. and its oscillator above the signal frequency. The receiver would have to be tuned to 1300 kc as shown by

$$4000 - 460 = 1310 \text{ kc.}$$

The same system can be used to provide 10-meter reception on receivers tuning to 18000 kc. Other bands can be covered by using the proper coil-capacitor combinations in the antenna circuit and using the harmonic of the receiver

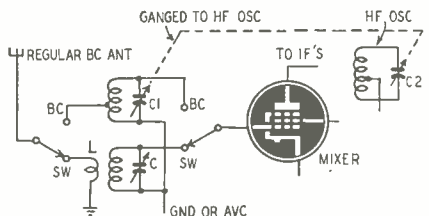

oscillator. The harmonic may be below or above the signal frequency. The third harmonic may be used to increase further the tuning range of a receiver. However, the added L-C combination must be sharp tuning (high Q) and the oscillator well shielded.—S. Beverage, *WIMGP*

GROUNDING-GRID OSCILLATOR

A novel grounded-grid triode oscillator designed for displacement measurement and control was described in *The Review of Scientific Instruments*. The circuit is shown in Fig. 1. Since the grid is grounded through C1, the plate and cathode are isolated and the positive feedback necessary for sustained oscillations must come from outside the tube. L2-C2 is the tuned frequency-determining circuit and L1 is the cathode feedback coil. If a thin metal vane

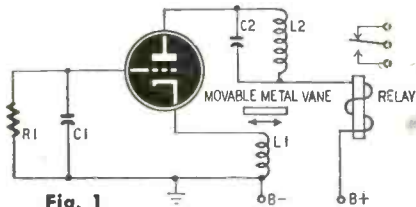

Fig. 1

is inserted between L1 and L2, it reduces the coupling to the point where feedback is insufficient to sustain oscillations. Therefore, the plate current is high and the relay closes. As the vane is withdrawn, the feedback increases and the tube breaks into oscillations and produces a sharp drop in plate current which opens the relay.

It is claimed that when L2-C2 is tuned to 30 mc, a vane displacement of .002 inch is enough to open or close the relay. Circuits of this type can be used to level elevators so the bottom of the car is even with the floor. The oscillator coils can be mounted on the wall of the shaft and the metal vane on the car. The circuit can be connected to stop the car when the vane passes between the coils.

A variation of this oscillator, Fig. 2, can be used as an 80-meter v.f.o. V1-a

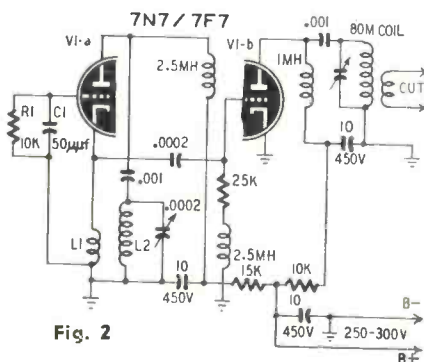
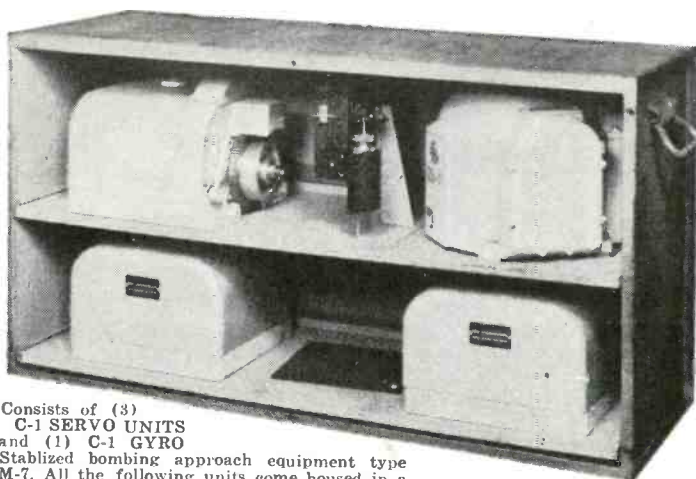

Fig. 2

is a 160-meter oscillator and V1-b is a doubler. The frequency stability depends on the values of R1 and C1. With the values shown, a 30-volt change in line voltage will change the output frequency but a few cycles. In this circuit, L1 is 11 turns of No. 22 enameled wire closewound 1/8 to 1/4 inch from L2, which has 25 turns of No. 20 enameled wire closewound on a 2 1/2-inch-diameter form.

ESSE RADIO COMPANY
INDIANAPOLIS INDIANA



Consists of (3) C-1 SERVO UNITS and (1) C-1 GYRO. Stabilized bombing approach equipment type M-7. All the following units come housed in a steel case, size 36" long x 17" high x 12" deep. Weighs approximately 160 lbs. net.

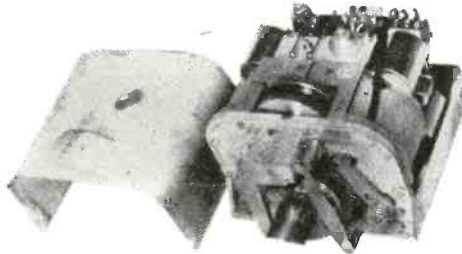

C-1 SERVO UNIT

Use to rotate beam antenna, actuate boat rudder control, etc. Contains 24 V. motor, clutch, relays, etc. Reversible. Size overall approx. 10 1/2" x 8 1/2" x 6 1/2".

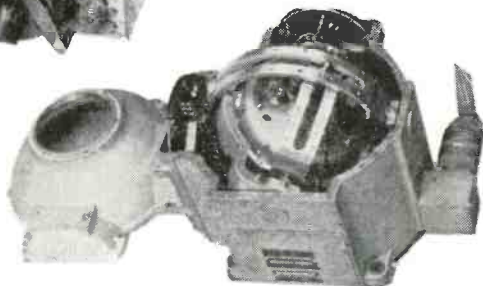

C-1 GYRO

Part of the C-1 Auto Pilot which is sold separate and may be used to conduct many interesting and amusing experiments. Operates from 24 V. DC or may be operated for short periods on 110 V. AC. Gyro will run for approx. 15 minutes after actuating. Size—approx. 8" x 8 1/2" x 8 1/2".

And 1 DIRECTIONAL PANEL with dashpot action (not pictured). All five of these units as described individually and as pictured at top, priced, brand new, at **\$35.00**

★
RECEIVER TUNING HEAD CRV-23253

Used with CRV-46151 Receiver for vernier tuning. Has beveled dial with hairline cursor. Bands are 200-560, 560-1600, 1600-4450, 4450-9050 Kcs. Each band spread over about 280 degrees of dial edge. Has provision for flexible tuning shaft or can be adapted for direct drive on any tuning shaft. Black crackle finish. Size 5" x 3" x 2" overall. Brand new... **\$1.50**

★
PILOTS CONTROL BOX TYPE CRV-23254

Used with CRV-46151 Receiver for remote control of volume, selection of any one of six frequency bands, as off/on switch or selection of C. W. and M.C.W. and M.V.C. or A.V.C. Black crackle finish. Size 2" x 2 1/2" x 5" high. Brand new. **\$1.50**

★
A TREMENDOUS BARGAIN Quartz Crystals without Holders

Get an assortment of these and grind to your own frequencies or use them as they are. .5X.6" B-cut lapped on faces and squared on edges (Ready to use). We will give you an assortment of these from approximately 13 thousandths of an inch to 24 thousandths of an inch whereby you can grind to frequencies desired. These crystals are now ground to the approximate following frequencies:

3500	4300	5600	6300	7306
3700	4600	5800	6700	7400
3900	4900	6000	6800	7500
4100	5300	6200	6900	7800
				7900

Formula for converting thicknesses of B-cut crystals to frequency is as follows: $F=98.4/T$ where F is frequency in kilocycles and T is thickness in inches. **AN ASSORTMENT OF 20 DIFFERENT THICKNESSES. \$1.50**

★
FIELD TELEPHONE WIRE

3 conductor, stranded, insulated and weather-proofed. Ideal for inter-communication systems, telephones, Selsyn indicators. Use it inside or out of doors. 525 foot roll. Brand new. Price..... **\$4.25 ea.**



T-17-B CARBON MICROPHONES

(Handmike) (New) **\$.175**

ESSE Radio Company
40 West South Street, Indianapolis 4, Ind.

unit can be constructed as compactly as possible. The projector uses a 921 phototube.—W.W., New York, N. Y.

A. Your needs should be met by this amplifier. The 6AU6's should provide sufficient amplification to drive the 6AQ5 output tubes to full output with normal signal input. The 5.1-megohm resistors between the plates of the 12AX7 and 6AQ5's may be omitted.

FOREIGN TUBES

? I have a European receiver using tubes made by Philips. Are replacements available in this country?—G.J.M., Keokuk, Iowa

A. Most of the tubes made by Philips are available from Philips Export Corp., 145 Palisade Street, Dobbs Ferry, N. Y. Write to them requesting information on the tubes you desire. All tubes are not stocked, so it may take about six weeks to fill your order.

OPPORTUNITY AD-LETS

Advertisements in this section cost 25c a word for each insertion. Name, address and initials must be included at the above rate. Cash should accompany all classified advertisements unless placed by an accredited advertising agency. No advertisement for less than ten words accepted. Ten percent discount six issues, twenty percent for twelve issues. Objectionable or misleading advertisements not accepted. Advertisements for February, 1950, issue, must reach us not later than December 24, 1949. Radio-Electronics, 25 W. Broadway, New York 7, N. Y.

AMATEUR RADIO LICENSES. COMPLETE THEORY preparation for passing amateur radio examination. Home study courses. American Radio Institute, 101 West 63rd St., New York City. See our ad in Page 143.

MAGAZINES (BACK DATES)—FOREIGN, DOMESTIC, arts, books, booklets, subscriptions, pin-ups, etc. Catalog. 10c (refunded). Cicerone's, 86-22 Northern Blvd., Jackson Heights, N. Y.

HERMAN LEWIS GORDON, REGISTERED PATENT Attorney. Patent Investigations and Opinions. Warner Building, Washington, D. C.

WE REPAIR ALL TYPES OF ELECTRICAL INSTRUMENTS, tube checkers and analyzers. Hazleton Instrument Co. (Electric Meter Laboratory), 140 Liberty Street, New York, N. Y. Telephone—BARCLAY 7-4239.

BARGAINS: NEW AND RECONDITIONED Hallcrafters, National, Collins, Hammarlund, Meissner, RME, other receivers, tuners, television receivers, transmitters, etc. Wholesale prices. Terms. Shipped on trial. Liberal trade-in allowance. Write, Henry Radio, Butler, Missouri and 11240 West Olympic, Los Angeles, California.

BAIGAIN HUNTING? RADIO SERVICEMEN WRITE Sensational catalog. Heushaw Radio Supply, 3619 Troost Kansas City 8, Missouri.

BEST DISTANCE RECORD CRYSTAL CIRCUIT, including Crystal, Catwhiskers, "Radiobuilder," Catalog—25c. Laboratories. 578-B, San Carlos, California.

LANCASTER, ALLWINE & ROMMEL, 436 BOWEN Building, Washington, D. C. Registered Patent Attorneys. Practice before United States Patent Office. Validity and infringement Investigations and Opinions. Booklet and form "Evidence of Conception" forwarded upon request.

MAGAZINES—radio, electronic, etc., sold and bought. Landa, 157b Leverett, Boston-14, Mass.

PHONOGRAPH RECORDS 15c. Catalogue. Paramount TG-313 East Market, Wilkes-Barre, Penna.

BRITAIN CALLING AMERICA! Britain's leading radio-television monthly, PRACTICAL WIRELESS AND PRACTICAL TELEVISION, contains exclusive articles by foremost British experts; latest British-European radio-television developments; newest transmitters and receivers fully analyzed. Send only \$1.50 made payable to our auto-typed agent Jeremy North—Bookseller (PW.46), "Friendship House," Jamestown, Rhode Island, for 12 consecutive issues sent direct to your address from London. Two Years \$2.75.

TELEVISION—Bright and clear. Adjust present aerial. Build low-cost precision antennae. Instructions, charts, diagrams, dimensions, plans. Free—Television stations, kilowatts, tower heights. Pronson Company, Lumberton, N. J.

FIVE ELEMENT TV YAGI BEAMS. HIGH BAND \$6.75, Low Band \$8.50. Aluminum Tubing, etc. Willard Rad-Int, Potosi, Ohio.

101 RADIO REPAIRING TIPS (BOOKLET). SEND 50 cents U.S. Radio. 135 E. 28 St., New York 18, N. Y.

All steel TV tower—Shipped direct from the factory at \$8.50 per 10' section. Easy to climb. Can be erected to 70' or more. The Youngstown Steel Towers, 1316 Wilson Avenue, Youngstown 8, Ohio.

Print Your Own Cards, Stationery, Advertising, Circulars and Titles. Save money. Print for Others, Good Profit; easy rules. Have home print shop. Raised printing like engraving, too. Sold direct from factory only. Write for free catalog of outfits and all details. KELSEY PRESSES, P-97, Meriden, Conn.

ESSE RADIO COMPANY
INDIANAPOLIS INDIANA
WILLARD BATTERIES

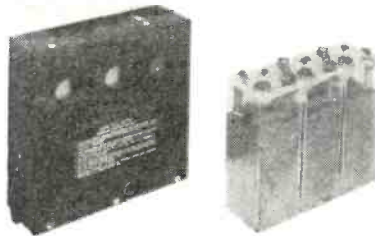

6 V. (New) (Dry-charged)..... \$3.00
6 V. (In metal carrying case) (Add electrolyte specific gravity 1.265) \$4.00
(Drugstore) Price

TELRAD 18-A FREQUENCY STANDARD



Checks signals in the range of 100 Kc. to 45 Mc. with a high degree of accuracy. Self-contained power supply is 110, 130, 150, 220, and 250 V. 25-60 cycle AC. Complete with tubes, dual crystal, and instruction book. Brand new.

Price \$29.50

(HRU) DC POWER SUPPLY

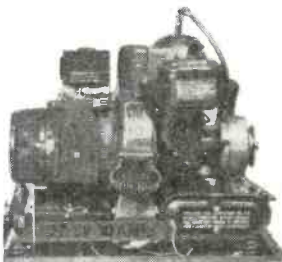

24-28 V. at 70 amp. 2000 watts gasoline engine generator with electric starter. Power supply which can be used to operate 24-28 V. equipment, start airplane engines.

charge batteries, as a welding machine, lighting system, or for amateur radio station. 21 1/2", 17 1/2" x 24". Wgt., 115 lbs. \$89.50

TURBO AMPLIFIER

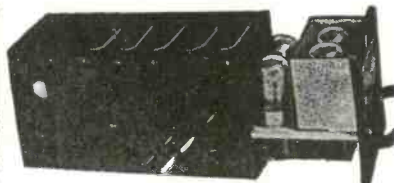

Used for parts—shipped complete with the following tubes: 2-7C5's, 1-7Y4, 1-7F7. Price \$1.50 ea.

CO-AXIAL CABLE

For high frequency low-loss, trouble-free, weather proof, durable service. Fully shielded, cut to length. Brand New. RG8/D-52 ohm (unmarked) \$5.95
Price—100 ft. for
RG29/U- ohm (marked) 4.95
Price—100 ft. for

Greatest Bargain Esse Has Ever Offered.

TELEVISION SWEEP GENERATOR

Made especially for the Sarkes Tarzian Co. at Bloomington, Indiana and reportedly cost them \$600.00 each. Channels 1-13. A beautiful instrument with sync. output connection. Esse's price while 26 of them last.

Brand new \$150.00
Used \$100.00

15 WATT POWER AMPLIFIER UNIT—BRAND NEW

Model F. Power Amplifier Unit Manufactured by Personal Music Company, Newark, New Jersey. Formerly sold to jobbers at \$129.50 each. Chassis size 11 1/2" x 17 1/2" x 2 1/2" high (with cover 11 1/2" x 17 1/2" x 7 1/2" high). Net weight about 50 lbs. Gray crackle finish. This amplifier delivers 15 watts of undistorted audio power with excellent frequency response. The tube line-up is 1-2D21, 1-6AL5, 1-6SJ7, 1-6SN7, 2-6L6G's, 1-5U4G. The total power drain is 300 watts from the 110 V. 60 cycle AC power source. Treble, bass, vernier volume and master volume controls are provided. This amplifier is beautifully designed and is sturdily constructed with the best of components. It can be used for continuous day and night service. Deluxe features such as high—low AC line switch, AC line fuse, and good ventilation of chassis and cover, external carrying handles, lock and key, and heavy duty AC line cord are provided. You can use this unit for microphone, phonograph, or radio input or fix it for combinations of such inputs. It will make an excellent foolproof and trouble-free unit for dance bands, lecture halls, school, sports events, for rental purposes, for inter-office communication. It will handle a number of loudspeakers.

OUR PRICE BRAND NEW—COMPLETE

- \$29.00
- I.F. Transformer 455 KC 1st I.F. Recommended with 6SK7 tube. Grid lead 4 3/8" long. Lug connection on bottom—mounted in .020 zinc can 1.375" sq.—3.30" high. \$.50
- I.F. Transformer—455 K.C. 2nd I.F. Lug connection on bottom—Recommended with 6SK7 tube. Mounted in .020 zinc can 1.375" sq.—3.30" high. \$.50
- I.F. Transformer Permeability tuned 10.7 M.C. 1st I.F. position—Recommended with 6BA6 tube. Lug connection on bottom. Mounted in can 1 1/4" sq.—2 9/16" high. \$1.00
- I.F. Transformer Permeability tuned 10.7 M.C. 1st position. Recommended with 6BX6 tubes. Mounted in can 1 1/4" sq.—2 9/16" high. \$.50
- Speaker—PM 2" x 3"—1 1/4" dap. Resonance 250-340 cycles per sec. 1.0 oz. Alnico V magnet 150 milliwatt power output. Voice Coil impedance 11 3/4 ohms. \$1.00
- Speaker—PM 8" Round—3 7/8" deep. Resonance 75-95 cycles per sec. 2.15 oz. magnet. 10 volt-ampere power. Voice Coil impedance—3.2 ohms. \$3.00
- Turntable & motor drive for small record player boxes. 78 RPM. 105/125 volts 60 cycles. 20.5 watts. 35 gram stylus force. Turntable—6 1/2" diameter. \$3.00
- Tube socket. Miniature 7 pin tubes Wafer type. Plated ground link. \$.05
- Rectangular 2 pin socket for .125 & .156 diam.—pins .468 apart 1" x 1 27/64" x 1 1/16" deep. \$.05
- Cable Assembly .125 pin type double contact plug—Cinch Cat. M-95. Connected to a two wire rubber tubing and braided shield covering 24" long. \$.25

ESSE Radio Company
40 West South Street, Indianapolis 4, Ind.

Add TONE & VOLUME to your TELEVISION with a BROOK High Quality AUDIO AMPLIFIER

ALL TRIODES

Attractive small remote control console for maximum convenience in operation and installation



Model 12A3-10 watts

For you who revel in fine music and abhor distortion—over radio, television, phonograph—the BROOK all-triode high quality AUDIO AMPLIFIER has been developed, after years of intensive engineering research. Now you can have "live" music in your own home . . . clean . . . clear . . . bright music through any good speaker. The use of triodes in all stages—together with Brook designed transformers—means amplification at its level best. For REALISM in critical music reproduction, hear this finest of amplifiers at your Brook Dealer's NOW!

ALL TRIODES

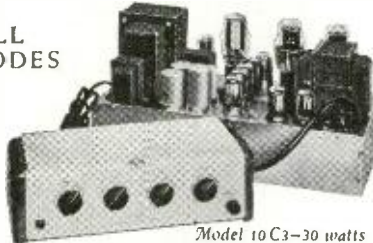

Model 10C3-30 watts

FOR BEST RESULTS — BROOK GIVES

- Extremely High Volume Without Any Loss of Quality
- Brilliant, Clear Tone
- Separate Controls — Stepped for Bass and Treble
- Minimum Distortion
- Reduces Listening Fatigue

Write TODAY for FREE Technical Bulletin and Detailed Distortion Analysis

Sales Agent

BROOK ELECTRONICS, Inc.
Dept. EA-O, 34 De Hart Place, Elizabeth, N.J.

ADMIRAL 30 SERIES CHASSIS

The a.f. output from the 30A, -B, -C, and -D series TV chassis can be increased by making the following changes:

1. Remove R620, the 150,000-ohm resistor, in the 4H1 (FM tuner) chassis.
2. Replace the 15,000-ohm ratio-detector load resistors R219 and R220 with 27,000-ohm units.
3. Remove the 6AG5 r.f. amplifier grid return from the arm of the contrast control and connect it to the junction of R305 and R307. This fixes the bias at approximately 1.25 volts and increases the sensitivity. If the receiver is located in an area where both strong and weak signals are received, the contrast control may not operate correctly on strong signals. If this happens, disconnect the video i.f. grid return from the junction of R304 and R305 and connect it to the arm of the contrast control. The r.f. grid return should then be moved to the junction of R304 and R305.
4. Realign the ratio detector transformer.
5. Check the 6AU6's in the audio i.f. amplifier to make sure they are good.
6. Replace the 6K6-GT power amplifiers with 6V6-GT's.

These changes will increase the a.f. sensitivity and output and are recommended where the complaint is low volume in fringe areas. However, it has been found that some TV stations do not deviate more than 7 or 10 of the permissible 25 kc; therefore their a.f. output will be low. If the station is the cause of low TV volume, these changes, while improving the output, may not produce more than room volume.—*Admiral Radio Service Bulletin*

INTERMITTENT PICTURE

If the picture on a TV receiver varies in intensity or disappears intermittently, look for arcing at the base of the high-voltage rectifier socket. This condition can best be checked in a dim light. If arcing is noted, lengthen the insulation path by bending the socket prongs and coating them with service cement or coil dope. Replace the socket if continuous arcing has charred it.—*John L. Johnson*

(This condition may exist at the socket of the C-R tube, particularly in sets using electrostatic deflection systems. The same remedy applies.—*Editor*)

STROMBERG-CARLSON TV-12

If the complaint is "no raster" with the sound operating OK, check the 680,000-ohm, 1-watt resistor between the 1B3 high-voltage rectifier and the anode of the C-R tube. If this resistor is open, replace it with a high-quality unit. Check the 500- μ f high-voltage filter capacitor, because the voltage is high when the load is removed by the open resistor.—*Wilbur J. Hantz*

RADIO-ELECTRONICS for



PERMANENT MAGNET FIELD DYNAMOTORS—POWER SUPPLY:

POWER SUPPLY:

12 or 24 Volt DC input; output 275 Volt 110 MA.; 500 Volt 50 MA. Completely filtered and housed in metal case. These units were originally used with MARK II No. 19 radio sets and cost Govt. \$150.00. The dynamotors will operate on 6 VDC at approx. half the voltage, thereby giving you a good motor for car shaver or AC-DC radio operation and a power supply for your mobile receiver from 6 Volt auto battery. This power supply contains all of the items listed in the column to the right. Size: 8" H x 6" W x 10" D. Shipping weight: 62 lbs. Complete unit—Order No. EPS #3. \$5.00

EACH UNIT CONTAINS THE FOLLOWING PARTS WHICH MAY BE PURCHASED SEPARATELY:

- 1—Dyn. 12/24 Input; output 275 V 110 MA. . . . \$3.95
- 1—Dyn. 12/24 Input; output 500 V 50 MA. . . . 2.95
- 8—1 500 V Oil Tubular Cond. 1.00
- 2—1 1000 V Oil Tubular Cond.50
- 2—15 MFD, 400 V DC Elect. Cond.80
- 1—DPST 15 A. Toggle Switch40
- 1—3PDT 20 A. Toggle Switch 1.00
- 2—Fuses Holders & ¼ A. Fuses.30
- 1—Pilot Light 12 V & Holder20
- 7—Flamert & RP Chokes 1.00
- 1—Spare Brush Kit 1.00
- Also—Resistors, Plugs, Panel Chassis, Cable, Case, and Grill 3.00

WHIP ANTENNA EQUIPMENT

MAST BASES—INSULATED (PICTURED AT RIGHT)

- A. MP-132—1" heavy coil spring, 2" insulator. Overall length: 11½". Weight: 2½ lbs. . . . \$3.95
- C. MP-57—2" heavy coil spring, 5" insulator. Price. . . . \$3.95
- E. MP-37—2" heavy coil spring, 8" insulator. Price \$3.95
- B. MP-22—Spring action direction of bracket, 4" x 6" mounting. Price \$2.95
- D. MP-48—2" heavy coil spring, 3" insulator. Price. . . . \$2.95
- F. MP-47—2" heavy coil spring, 9" insulator. Price. . . . \$5.95

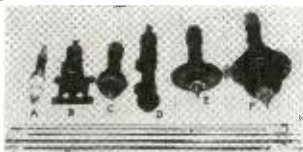

MAST SECTIONS FOR ABOVE BASES:

Tubular steel, copper coated, painted, 3 foot sections, screw-in type. MS-53 can be used to make any length. MS-52-51-50-49 for taper. Any section. 50c Ea. BAG BG-56 (carrying 5 sections. 50c

DYNAMOTORS AND INVERTERS:

Write us and tell your requirements. We have big stock to select from.

BC-223 TRANSMITTERS:

- WITH: NEW: USED:
- One Tuning Unit. \$24.95 \$19.95
- Three Tuning Units. 29.95 24.95

CABLE—Power Sup. to Trans. \$1.75
PE-125 Power Supply f/BC-223 Trans.

Prices: NEW . . . \$9.95 USED . . . \$7.95

TRANSFORMERS—110 Volt 60 Cycle Primaries:
Sec. 12 V. 1 amp. . . \$1.50 Sec. 24 V. 2 amps. . . \$2.25
Sec. 24 V. 1 amp. . . 1.95 Sec. 24 V. .5 amp. . . 1.50
Sec. 36 VAC. 2.5 amps. \$2.95
Sec. 14-14 or 28 V. 7½ or 15 amps. 4.95

BC-1206 RECEIVER—5 Tubes. 24-28 VDC. 200-400 KC. IF Freq. 135 KC. Size: 4"x4"x6". LN. . . \$6.95

Address Dept. RE • Prices F.O.B., Lima, Ohio • 25% Deposit on C.O.D.'s • Minimum Order \$2.00

FAIR RADIO SALES 132 SOUTH MAIN ST. LIMA, OHIO

TV SIGNAL SUBSTITUTION

The problem of isolating a defective stage in a TV receiver can be simplified by using another receiver as a signal source if both receivers have the same intermediate frequency. A length of 300-ohm transmission line and two .01- μ f capacitors are required.

Check power plug polarity to ground on both chassis if sets are transformerless.

Use one conductor of the transmission line to connect the two chassis; connect one capacitor to each end of the other conductor. Tune the operating receiver to a station, and connect one capacitor to the *output* of the video amplifier. Use the other capacitor as a probe and feed this signal into the *input* of the video amplifier in the defective set. If the video amplifier is good, you will get the same picture on both sets, assuming that the sweeps are in good order. Proceed in a like manner to the front end of the set or until the defective stage is isolated.

The good receiver can be used as a signal tracer by reversing the process. —*Ralph E. Hahn*

SHORTED C-R TUBE

A 5BP4 cathode-ray tube, used in an experimental TV receiver, developed a large brilliant spot on one side of the screen. Since this spot would not focus or take modulation, we suspected the tube. On checking it for interelement continuity, we found a low-resistance shunt between cathode and control grid.

Normally, this condition would have meant discarding the tube; however, as an experiment, we connected a 110-volt d.c. supply across the shorted elements. The foreign matter—whatever it was—was quickly burned out, restoring the tube to normal operating conditions—*David Gnessin*

RCA 630TS AND SIMILAR SETS

If the picture cannot be locked in with the horizontal hold control, check the adjustment of the frequency control on the rear of the chassis. Set this control so the picture is stable at both extremes of the hold control after the signal is momentarily removed and restored.—*Harry Ashby*

TELEVISION RECEIVERS

A number of the smaller TV receivers use 6SN7's or 12SN7's in the sweep and deflection circuits. In the event of oscillator failure, try switching the tubes between the sweep and deflection circuits. A tube which will not work as an oscillator may work as an amplifier. This is an emergency measure, so the defective tube should be replaced as soon as possible.—*G. J. Macheak*

HOWL IN TV RECEIVERS

If a set howls when a station is tuned in, the trouble may be traced to a microphonic high-frequency oscillator tube which is affected by vibrations from the speaker. Replace this tube with one which is not microphonic, taking care to select one having similar characteristics so the alignment will not be disturbed.—*William J. Wegge*



**JUST DOLLAR SAVING VALUES FOR YOU
YOU CAN'T AFFORD TO MISS
THESE BARGAINS!**

GET ON THE MAILING LIST • DROP US A CARD TODAY

■ The R & M BI-MONTHLY BULLETIN gives you the latest releases of rock-bottom prices on choice TV and Standard or Surplus Radio Equipment.

TV CONICAL STACKED DE LUXE

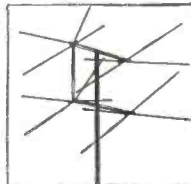

**ANTENNA
\$13.29**

Unexcelled—Good up to 125 miles for use with 72 or 300 ohms receivers. LESS MAST.

**All Band TV
ANTENNA \$5.29**

Pre-assembled for quick installation; highly efficient, easy to install; for 300 ohm sets. Less mast.

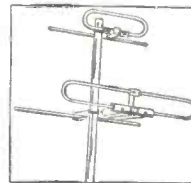

\$26.50 value

TV PICTURE TUBES



One full year guarantee (misuse or mishandling excepted)

7JP-4 \$16.88 | 10BP-4 \$24.75 | 10FP-4 \$26.80
12-KP-4 \$36.45 | 12LP-4 \$34.40 | 16AP-4 \$55.88

Horiz. Deflection Output & High Voltage



TRANSFORMER

Reg. \$6.90 R&M'S **\$3.29**
wholesale PRICE



CONDENSERS

SPRAGUE MOLDED	Mfd.	DC V	Price
Rugged, small size, heat resistant, non-inflammable and completely insulated.	.01	600	18c
	.05	600	24c
	.0005	6000	81c
	.001	6000	81c
	.005	6000	81c
	.0005	10000	90c

TERMS: F. O. B. Arlington, Va. Under \$10—cash with order. Over \$10—25% deposit, bal. C.O.D.



Stand Off 3 1/2"

INSULATORS 3 1/2c each

300 ohm; screw-type. 100\$2.75
1000\$24.75

300 ohm Chocolate Twin Lead
100 ft.\$1.29 1000 ft.\$9.95

5-ft. Steel Extension Masts75c

4-ft. Aluminum Extension Masts75c

12-ft. Heavy Duty Aluminum Mast \$3.49



CHIMNEY QUICK MOUNT \$1.45

Steel, heavily plated. Two complete easily mounted brackets supporting masts up to 1 3/8" diam. All strap and hardware included.



16-in.

TV deluxe KIT \$163.50

Complete with 31 matched RCA tubes. less picture tube

Kit as above, completely wired **\$197.50**

less picture tube

Build your own 1949 model television set—and save! The kit is complete—major components, all controls, all sockets and terminal strips mounted in place; ultra-simplified wiring diagrams furnished. RCA 13-channel front end tuner completely wired, aligned and tested; final adjustments can be made without additional test equipment.

R & M RADIO COMPANY

2701 WILSON BLVD. DEPT. E1 ARLINGTON, VA.

These Men are Getting PRACTICAL TRAINING



IN RADIO-TELEVISION

ON REAL TELEVISION SETS RADIO RECEIVERS F.M. RECEIVERS

IN THE GREAT SHOPS OF COYNE

Big opportunities are waiting for men who know the practical and technical end of Radio and Television. That's what you get at COYNE—besides practical Shop Training in F.M., Electronics and other branches of this giant field. Remember, Television is the fastest growing opportunity field today, and Radio is one of the biggest.

NOT "HOME STUDY" COURSES

All Coyne Training is given in our mammoth Chicago training shops. We do not teach by mail. You train on actual equipment, under friendly instructors. Previous experience unnecessary. Hundreds of firms employ Coyne trained men.

OLDEST, LARGEST, BEST EQUIPPED SCHOOL OF ITS KIND IN AMERICA

Come to the Great Shops of Coyne in Chicago. Established 1899—now in our 51st Year. Fully approved for G.I. training. Finance plan for non-veterans.

MAIL COUPON FOR FREE BOOK

Send today for big new book packed with large pictures taken in Coyne Shops. No obligation. No salesman will call. Get the facts now!



COYNE
ELECTRICAL, RADIO & TELEVISION SCHOOL
500 S. Paulina St., Dept. 10-8H
Chicago 12, Illinois

B. W. COOKE, Pres.
COYNE Electrical, Radio & Television School,
500 S. Paulina Street, Dept. 10-8H, Chicago 12, Ill.

Send FREE BOOK and full details on Radio-Television Course.

NAME.....
ADDRESS.....
CITY..... STATE.....

OUTPUT TRANSFORMER CHECKS

To check the primary impedance of an output transformer, connect a 400-cycle signal generator, v.t.v.m., and 25,000-ohm variable resistor to the transformer primary as shown in the diagram. Load the secondary with a resistor equal to the voice-coil impedance

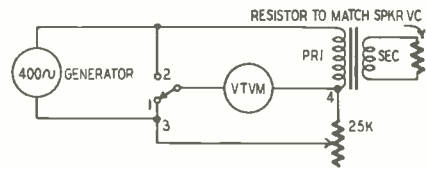

of the speaker you plan to use. Switch the v.t.v.m. between points 1 and 2, and adjust the variable resistor until both readings are equal; then measure the resistance between points 3 and 4. The result is the primary impedance of the transformer at 400 cycles.—G. F. Beard

NOTE TO CONSTRUCTORS

After completing a successful radio or electronic project, make a note of all operating voltages and currents. Should the unit become defective, a comparison of operating voltages will help localize the defect. The same method can be applied to commercial equipment where these measurements are not given in a manual. The information may be kept in a notebook or attached to the chassis.

If you record operating characteristics, repairs can be made with simpler equipment than would be required if voltage and current measurements were unavailable.—Gerald Samkofsky, W2Y-SF

TUNER FOR PA AMPLIFIER

Many PA amplifiers can be used to receive signals from strong local stations with the addition of a broadcast

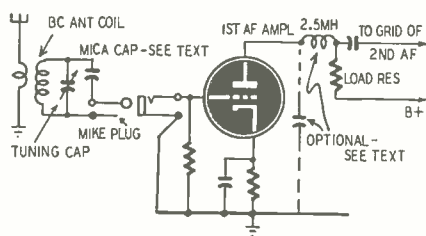

coil, tuning capacitor, mica capacitor, and a microphone plug, connected as shown. In this system, the first stage of the amplifier becomes a grid-leak detector. The mica capacitor should have a high a.f. and low r.f. reactance compared to the resistance of the grid resistor in the first a.f. stage of the amplifier. Experiment with values between 50 and 250 μf for best results.—Charles Erwin Cohn.

(The tuner may be improved by connecting a 2.5-mh r.f. choke and plate bypass capacitor as shown. The capacitor should be between .001 and .002 μf for triode amplifiers and 250 to 500 μf where the first stage is a pentode.—Editor.)

SUPPLIES 1 to 20 AMPS
6 Volts DC, Continuous Duty

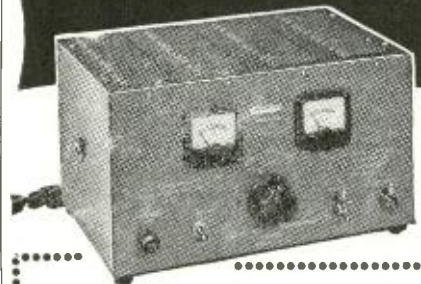

Patent Pending

Conduction Cooling Increases Rectifier Power Rating 1 1/2 Times

New Electro Model "B" costs no more than the conventional type. Completely different application of selenium rectifiers aided by conduction cooling, dissipates over 3 times the heat. The Electro Model "B" has proved itself the most efficient direct current source of power known. Gives instant readings, and offers ample power to operate any receiver. Peak instantaneous current rating of 35 amperes (from 50 to 60 cycle 115 volt power source), permits operation of two receivers with push button solenoids.

APPLICATIONS

Test or operate auto radios, relays, telephone circuits, laboratory instruments and many other low voltage requirements.

ONLY ELECTRO HAS ALL THESE FEATURES

- ★ 1 to 20 amperes at 6 volts continuous duty
- ★ Damped volt and ammeters (no wiggling) voltmeter 3% accuracy
- ★ Less than 3% A.C. ripple or hum
- ★ Heavy duty selenium rectifiers
- ★ 8 heavy duty power tap adjustments
- ★ Heavy duty transformer and choke
- ★ 6000 mfd. filter condenser

UNMATCHED NET PRICE \$43.50
See Your Distributor or Write To



Pioneer Manufacturers of Battery Eliminators

ELECTRO PRODUCTS LABORATORIES
4507 N. RAVENSWOOD AVENUE, CHICAGO 40, ILL.

RADIO-ELECTRONICS for

SWITCHES AND CIRCUIT BREAKERS

Heinemann circuit breakers
 110-15 amp. ----- 1.49
 110-20 amp. ----- 1.49
 110-5 amp. ----- .95

Aircraft ckt. breakers 24V.-20 amp.
 amp.—AN 3160—Square D Co.-----1.49

DPST 30 amp. toggle switch—bakelite
 case ----- .39
 DPDT 110V. slide switch ----- .19
 DPDT Toggle switch ----- .39

RELAYS

Potter & Brumfield OVERLOAD relay
 relay No. 1 is 5000 ohms, coil
 current 10 ma., relay No. 2 is 110V-
 60 cy. Ac coil. SPDT-----\$1.95

Telephone type, plate sensitive relay-
 7000 ohm, SPDT----- 1.95

Plate sensitive relay—5000 ohm coil
 contact DPST ----- 1.49

BK22-K relay—used in conjunction
 with SCR-269-F—contains 28V step
 relay, 5 deck, 6 pos. switch—12V-
 DPST ----- 2.95

RESISTORS and RHEOSTATS

POWER RHEOSTATS—25W-25 ohm—
 1 amp. max. ----- \$.69
 POWER RHEOSTATS—25W-25 ohm—
 1.7 amp. max. ----- .95
 75,000 ohm, 200W. bleeder ----- .95
 11,296 ohm, 100W. bleeder, IRC type
 tapped at 750-23-23-7500-3000 ----- .49
 1 Meg. multiplier, 1% tolerance ----- .89
 Thyrite discharge resistor type 5F
 HE 130V AC/DC ----- .95
 100 assorted 1/2 watt resistors in
 popular sizes ----- 1.49

SILVER CERAMIC CONDENSERS

500 W.V.D.C. 10c ea. 12 for \$1.00
 Available capacity (MFD's), 2, 3, 4, 5,
 7, 8, 8 1/2, 10, 11, 12, 15, 24, 25, 30, 40,
 100, 120, 125, 140, 232, 350, 375, 400, 470,
 45, 50, 51, dual 60, 70, 72, 75, 80, 81, 95,
 500, 1000 and 5000.

CAPACITORS

2MFD-6000 V. paper oil type ----- \$8.95
 2MFD-7500 V. paper oil type ----- 12.50
 1MFD-5000 V. paper oil type ----- 2.95
 1MFD-6000 V. paper oil type ----- 4.95
 .1 MFD-7000 V. Sprague tubulars ----- 1.95
 2 MFD-1000 V. ----- \$.89
 1 MFD-1000 V. ----- .44
 8 MFD-600 V. ----- .95
 4 MFD-600 V. ----- .69
 2 MFD-600 V. ----- .49
 20 MFD-2500VDC PK. Type No. 775,
 65W. Sec.-PHOTOFLASH ----- 9.95
 32 MFD-2500VDC PK. No. 777,
 100W. Sec.-PHOTOFLASH ----- 14.95
 .01 MFD 8000V, 16-20 Amps. Aerovox
 mica LS-217—1000-3000 KC ----- 4.95
 .002 MFD-3000 VDC Mica ----- .69
 3x.05-300VDC round can 1 1/2"x1 1/2"
 paper ----- Doz. 1.00
 50-30 MFD, 150V. tubular electroly-
 tics, well known brands ----- .49
 .008 Buffer 1600-V ----- .29
 Assorted micas ----- per one hundred 1.95

VARIABLE CAPACITORS

5 Gang variable, approx. 50 MMFD
 per sect.—Individual air tuned pad-
 ders—18 to 1 vernier drive—shield-
 ed ----- \$1.95
 6 Gang variable—silver plated—sec.
 1: 350 MMFD, sects. 2, 3, 4, 5;
 60 MMFD, sect. 6: 80 MMFD ----- .89
**BUTTERFLY WAVEMETER AND
 OSCILLATOR CONDENSERS**
 TN-2A 106-300 MC Antenna conden-
 ser—with acorn socket ----- \$3.95
 TN-20 76-300 MC oscillator ----- 3.95
 TN-3A 300-1000 MC Detector (uses
 1N29 XTAL ----- 2.95
 TN-30 135-485 MC Oscillator
 TN 300-1000 MC oscillator (uses
 368AS doorknob tube) ----- 3.95
 Ceramic silver padders—dual 3 to 12
 MMFD or 3 to 20 MMFD ----- .19
 Ceramic mica padder—single 5-20
 MMFD per doz. ----- .50

TRANSFORMERS

MODULATION & DRIVER XFMRs-
 RC 1206 mod. xfmr., 815 class AB2,
 56W. audio, RC1205 driver xfmr.
 6SN7 to 815, class AB-2 (com-
 panion to RC 1206). Both units for
 only ----- \$4.95
 SCOPE XFMR.—pri. 110V-60 cy.,
 sec. 4000V. at 10 ma., 6x4x3 1/2" ----- 3.95
 AUDIO OSC. XFMR. with FEED-
 BACK and OUTPUT windings ----- .95
 IF XFMR-5 MC with air trimmer-im-
 pedence coupled, mounted in Alum.
 shield can ----- .95
 DISCRIMINATOR XFMR. to match
 IF xfmr. above ----- .95
 FILAMENT XFMR. pri. 110-60 cy.,
 sec. 4 volts at 16 amps. and 2.5
 volts at 1.75 amps. INSULATED
 FOR 5000 volts. Ideal for 2x2 and
 826 tubes. Hermetically sealed,
 6x3 1/2 x 4 1/2" ----- 1.95
 IF XFMR., 30 MC, silver slugged ----- .35
 500 ohm to GRID matching xfmr.
 No. 81749 (used with T-17 mike) ----- .69

TUBES

304TL—Ideal for 1 KW final, Induc-
 tion heater or dielectric heater.
 Efficient operation at 1500-3000 V.
 —typical operation 2500V. at 400
 ma. ----- \$.75

CATHODE RAY TUBES

3 AP 1 ----- \$2.95
 3 BP 1 ----- 2.95
 5 FP 7 ----- 2.95
 7 BP 7 ----- 3.95
 9 LP 7 ----- 4.95
 5 BP 1 ----- 2.75
 5 GP 1 ----- 5.95
 3 GP 1 ----- 3.50

CE PHOTOCELL—for use in projec-
 tors or burglar alarm ----- .95
 PHOTOFLASH TUBE 12,000,000 lu-
 mens output. Ignition coil included
 on back of bulb. 10,000 flashes-
 diagrams furnished on request. ----- 5.95
 Complete Photoflash kits—Write for
 Information
 Complete Stock of GE Photoflash Tubes

PLUGS AND CONNECTORS

AN-3102-24-3P SK-C16-326
 PL-Q65 SK-C16-23
 AN-3106-36-1S 1/2 AC-AN
 AN-3108-36-15S M-359-A
 AN-3108-28-2S AN-3100-32-6P
 PL-Q7 10H-529
 AN-3106-24-2S AN-3057-24
 AN-3106-28-2P AN-3102-14S-1P
 AN-3057-16 PL-147
 AN-3057-8 AN-3106-32-101S
 UG-21/U AN-3102-18-20S
 PL-Q171-10H/414 U-16/
 AN-3108-14S-2S PL-112
 AN-3102-14S-2S PL-118
 AN-3108-40-1S AN-3102-20-27P
 PL-182-10H/258-S MC-136
 AN-3108-22-17P ARC-9589
 AN-3108-24-19P AN-3102-22-14P
 AN-3106-22-1S AN-3102-14S-75
 AN-3102-18-5S AN-3106-18-12S
 2255-26 AN-3106-16S-1P
 PL-419 AN-3057-S
 AN-3106-18-8S AN-3102-36-8P

45c each

BUILD YOUR OWN GEIGER COUNTER.
 Detects both Beta and Gamma rays.
 All parts, batteries, diagrams and
 instructions, nothing else to buy. This
 is the famous 49'er Geiger Counter.
 as described in Sept. Radio Electronics.
 \$49.50

DETROLA RECORD CHANGER, auto-
 matic changer for 12 10" or 10
 12" records ----- 9.95

AIRCRAFT COMPONENTS

A5 SPERRY DIREC. GYRO, part No.
 656029-115V., 400 cy., 3 ph. ----- \$9.95
 MK 18 Eastman Kodak gunsight ----- 2.95
 MK 4 Bank and Cilmgyro control
 head for MK 4 autopilot ----- 9.95
 A 5 Autopilot Servel, 100 lb. max. ----- 9.95

RADIO RADAR

RCVRS-XMTRS-COMPONENTS

BC 223 AX Transmitter—BRAND NEW—
 801 oscillators and 801 PA's, (2) 46
 mods. & (1) 46 speech amp. 4 xtal
 freqs. and master osc. on selector
 switch—tone voice or CW mod., 10-30
 W. output. Ideal for 80 meter band.
 Complete with 2 coils TU 17A 2000-3000
 kc, TU-25 3500-5250 kc.—black crackle
 case. Two extra cases to store coils.
 Freq. chart and tubes Incl., packed in
 orig. cases, less xtals. ----- \$39.95

BC-702 A HIGH FREQ. RADAR XTMR.
 (4) 2x2 tubes; squirrel cage blower, 12-
 24V.; 25MA, 2" meter; 02-8000V cond.;
 (2) .01-500V conds.; .001-9500V.
 cond. ----- \$14.95

BC-AR230 TRANSMITTER with 4 tubes
 and RF ammeter.

BC-AL229 RECEIVER with 6 tubes—air-
 craft equipment, both units ----- \$9.95

T85/APT-5 UHF NOISE-MODULATED
 JAMMING XTMR—With these tubes:
 (2) 6AC7, (1) 6L6, (2) 829, (1) 931A,
 (1) 6AG7, (1) 522 blower-cooled UHF
 oscillator tube. This unit contains a
 lecher-line tuned cavity, with tunable
 plate, grid, and cathode lines. Lecher
 line settings are read directly in CM on
 front panel with veeber type counters.
 Neon resonance indicator. Filaments
 operate from 115 VAC. No plate supply.
 Packed in orig. case with instruction
 book. Wt. 118 lbs. ----- \$95.00

BC-375 XTMR TUNING UNIT—Approx.
 65 MMFD cond., coils, RF chokes, dials,
 assorted micas, 25WVDC and many other
 parts ----- \$2.50

ARR7 AIRBORNE HALLICRAFTER
 VERSION OF SX-28A—Search rcvr.,
 complete with tubes, less power supply,
 in sealed cases ----- \$129.00

BC-620A-TRANSEIVER — 20-27.9 MC,
 dual channels, built-in fil. and plate
 meters, with tubes as follows: (3)
 1LN5, (1)LC6, (1) 1LH4, (2) 1291, (4)
 1299, (1) 1294—Ideal for use between
 boats, vehicles, etc. Used in good
 condition, less power supply. Wt. 38-lbs.
 Complete with carrying case and dia-
 grams.

GE CONTROL BC-1103—Contains fuse
 F301, indic. lamps 1301, 1301A, recep-
 tacles as follows: 3 pole Russell Stole
 No. 6852, 2 pole Hart and Hegeman
 No. F7723, 4 pole Russell Stole No.
 8087. Also relay 120V., 60a Struthers-
 Dunn No. AS8X1, Switch, Allen-Brad-
 ley cat. 2AS, and 250V. 10 amp. Inter-
 lock ----- \$4.95

SCR-625 Mine Detector, used ----- \$39.50

METERS and INDICATORS

Remote position indicator—1-82, 6-12V,
 400 cy., 5" indicator with 0-360 degree
 dial ----- \$4.95
 Azimut control MN-52H-360 degree dial
 60 to 1 ratio crank control—Ideal for
 antenna rotating indicator, used ----- .49
 Meter—3 1/2" cross pointer. Two 200 micro-
 amp movements, brand new ----- \$2.95
 METER, type DC-41, 0-1 mil. movement,
 scales 0-5 Kilo V. and 0-10MA
 DC ----- \$2.95

MISCELLANEOUS

BN IFF Antenna duplexer, 156-157
 MC ----- \$5.95
 BN IFF non directional doughnut an-
 tenna ----- 5.95
 Voltage REGULATOR, carbon pile,
 magnetic type, coil current 105 ma-
 max. 5 amps at 18.25 volts ----- .95
 THERMOSTAT, normally opens at
 95 deg. F., No. F85-1/H5 ----- .49
 BLOWER, 400 cy., 115 Volts Type
 FL, style No. I 171145C, 6700 RPM,
 Westinghouse ----- 1.95
 BLOWER, squirrel cage, 110/60 cy.
 AC, 2" outlet, silent oil lite bearing
 motor, with mtg. bracket ----- 7.95
 Eclipse 24 V. carbon pile type, GE
 Voltage REGULATOR, brand new,
 Co., 2 1/2 lbs. ----- .95

HERSHEL RADIO CO.

5249 GRAND RIVER DEPT. R. E. 12
 DETROIT 8, MICHIGAN
 All orders F.O.B. Detroit—Minimum order \$2.00—Michigan customers
 add 3% sales tax—20% payment must accompany all orders.

Free
 Catalog

WANTED

**GOOD LOOKING OLD CONSOLES
THAT NEED A NEW "HEART"**

install an
ESPEY AM/FM CHASSIS

and your favorite console is "right-up-to-date"

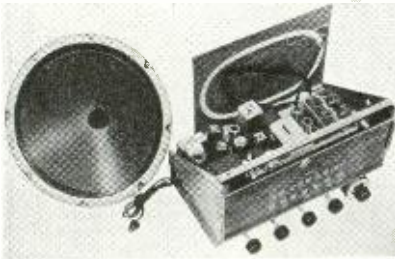

Rated on excellent instrument by America's foremost electronic engineers. Fully licensed under RCA patents. The photo shows the Espey Model 511, supplied ready to play. Equipped with tubes, antenna, speaker and all necessary hardware for mounting.

ATTENTION SERVICEMEN—Did you know there are over 19 million consoles waiting to have a modern AM/FM chassis installed? Here is a gigantic sales market just waiting for you to develop. Send for Espey Bulletin "19 million customers". It will tell you how to make real money!

Write for literature RC for complete specifications on Model 511 and others.

Makers of fine radios since 1928.



EMPIRE STATE FEDERATION MEETS

The Empire State Federation of Radio Technicians (ESFETA) held their regular meeting at Rochester, N. Y. November 13, 1949. Representatives from eight of the ten affiliated organizations were present.

Final amendments and corrections on the Federation's constitution and by-laws were approved and the secretary, Wayne Shaw, authorized to approve any further minor corrections.

Max Liebowitz reported on the progress of the New York City check-up campaign. Distributors, he reported, generally felt that a less busy month should be selected. The meeting concurred, and suggested February or August.

Other routine business included a report on the trends among organized radio technicians in Pennsylvania and discussion of local organization activities. The meeting adjourned till the annual meeting which will be held early in April.

NEW YORK HAS STATE-WIDE LECTURE COURSE

Empire State Federation of Electronic Technicians Associations reports an excellent reaction to the first of their series of 16 television lectures for New York State technicians, which began Sept. 7 (RADIO-ELECTRONICS, November, page 84). Four locations were chosen for the lectures, New York City, Poughkeepsie, Binghamton-Endicott, and Rochester, at each of which points all 16 lectures are being heard. The tables below list the subjects covered by lectures still to be delivered, the sponsoring company in each of the locations, and the date of presentation at each of the four lecture points.

Lecture No.	Subject	Lecture No.	Subject
7	Picture tubes.	12	Sweep generators.
8	Sync and sweep circuits; a.f.c.	13	Alignment.
9	High-voltage circuits.	14	Installation.
10	Oscilloscopes.	15	Servicing.
11	Projection systems.	16	Examination.

A Great All-Triode Amplifier Kit

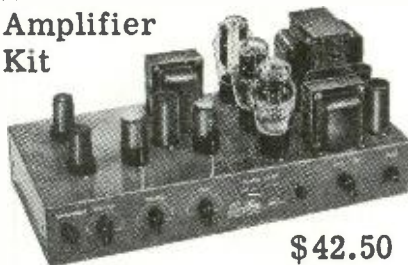

\$42.50

Engineered to Sun Radio's own rigid specifications. From design published by CONSUMERS' RESEARCH, INC., OF WASHINGTON, N. J. (Bulletin #31). Clear, rich, full, brilliant High Fidelity at a low, low price.

Flat frequency response from 20 to 15,000 cycles (±1 db). Distortion less than 2.5%. Gain: radio - 75 db, phono - 97 db. Tubes: 1 - 6SC7, 2 - 6SN7, 1 - 6J5, 2 - 6B4G and 1 - 5U4G rectifier. Complete with punched chassis, hardware, wire, all components, clear instructions, pictorial and schematic diagrams, \$42.50.

Laboratory wired and tested, ready to use, \$69.50.

Order today by mail direct from Sun. Send check or money order for full amount or send 25% with COD orders. Also write us for our new 68 page booklet-catalog on high-fidelity equipment.



LECTURE SCHEDULE

Lecture No.	New York City	Poughkeepsie	Binghamton-Endicott	Rochester
7	December 7 Allen B. DuMont Labs., Inc.	December 14 Allen B. DuMont Labs., Inc.	January 3 Allen B. DuMont Labs., Inc.	January 9 Allen B. DuMont Labs., Inc.
8	January 4 Precision Inst.	January 11 Precision Inst.	January 17 Motorola, Inc.	January 23 Motorola, Inc.
9	January 18 Beta Electronics Company	January 25 Beta Electronics Company	January 31 Precision Apparatus Co., Inc.	February 13 Precision Apparatus Co., Inc.
10	February 1 Hickok Elec. Inst. Co.	February 8 Hickok Elec. Inst. Co.	February 14 Hickok Elec. Inst. Co.	February 27 Hickok Elec. Inst. Co.
11	February 15 Allen B. DuMont Labs., Inc.	February 22 Allen B. DuMont Labs., Inc.	February 28 Allen B. DuMont Labs., Inc.	March 13 Allen B. DuMont Labs., Inc.
12	March 1 Coastwise Electronics Co.	March 8 Coastwise Electronics Co.	March 14 General Electric Co.	March 27 General Electric Co.
13	March 15 Kay Electric Co.	March 22 Kay Electric Co.	April 4 Kay Electric Co.	April 10 Kay Electric Co.
14	April 5 Service Magazine	April 12 Service Magazine	April 18 Service Magazine	April 24 Service Magazine
15	April 19 Allen B. DuMont Labs., Inc.	April 26 Allen B. DuMont Labs., Inc.	May 2 Allen B. DuMont Labs., Inc.	May 8 Allen B. DuMont Labs., Inc.
16	May 3 Examination	May 10 Examination	May 16 Examination	May 22 Examination

it's ALLIED for hallicrafters!



ONLY **\$1795** down

hallicrafters SX-71 Communications Receiver

The new top-performing communications receiver at amazingly moderate cost! Designed especially for the discriminating Amateur and SWL fan. Covers five full bands: 538-1650 kc; 1600-4800 kc; 4.6-13.5 mc; 12.5-35 mc; 46-56 mc. Features double conversion superhet circuit, high image rejection, razor-sharp selectivity, extremely high sensitivity. Includes: full electrical bandspread; tuned RF stage, 3-step crystal filter; built-in NBFM adapter; automatic noise limiter; calibrated "S" meter; BFO pitch; tone control; extra-wide-vision dials; 3-watt communications-peaked audio; temperature compensation; universal antenna input. In satin-black steel cabinet; 18½ x 7¾ x 12". Complete with 11 tubes, rectifier and regulator. For 105-125 volts, 50-60 cycles. Shpg. wt., 33 lbs.

97-506. SX-71, less speaker. *Only* **\$1795.00**

\$17.95 down, \$14.27 monthly for 12 months

97-786. R-44B matching speaker. Shpg. wt., 19 lbs. *Only* \$24.50



hallicrafters S-40A All-Wave Receiver

ONLY **\$8.00** down

Popularly-priced Hallicrafters communications receiver, packed with advanced features. Covers 550 kc to 43 mc in 4 bands. Highlights include: full electrical bandspread; inertia flywheel tuning; calibrated main dial; automatic noise limiter; adjustable pitch BFO; standby switch; code-phone switch; headphone jack; shock-mounted speaker; separate sensitivity and volume controls; 3-position tone control. All tubes included. In handsome all-steel cabinet, 18½" x 9" x 11". For 105-125 volts, 50-60 cycles AC. Shpg. wt., 32 lbs.

97-546. Hallicrafters S-40A Receiver. *Only* **\$7995**

\$8.00 down, \$6.36 monthly for 12 months

(ALL PRICES NET F. O. B. CHICAGO)

FREE

Send for Your Copy of the 196-Page 1950



ALLIED CATALOG!

Get the only complete Radio Buying Guide! It's used daily by thousands of expert servicemen, engineers, amateurs, soundmen, builders and experimenters. Get every buying advantage at ALLIED: widest selection of equipment at money-saving low prices — speedy, expert shipment — personal attention — complete satisfaction on every order. Get your latest ALLIED Catalog today — use handy coupon below!

GET IT NOW!



hallicrafters S-38A the Super-Value All-Wave Receiver

The all-star, all-wave value that amazes even the experts. Covers 4 full wave bands, continuous range from 540 kc to 32 mc. Features: full electrical bandspread; Band Selector; Voice-Code switch; Speaker-headphones switch; Standby-receive switch, latest PM speaker. In handsome furniture-steel cabinet, 12¾ x 7¾ x 7¼". Complete with all tubes. For 105-125 volts DC, or 40-60 cycles AC. Shpg. wt., 15 lbs.

97-508. Model S-38A Receiver. *Only* **\$3995**



S-72 All-Wave Portable

The DeLuxe portable! Covers 4 bands: 540-1600 kc, 1500-4400 kc, 4.3-13 mc, and 12-31 mc. Has built-in loop for standard broadcast and 27" whip for short wave. Automatic Noise Limiter; sensitivity control; AVC; BFO; main and fine tuning controls; tone control; phone jack. Brown leatherette-covered cabinet, 14 x 12¼ x 7¼". For 105-125 volts DC, or 60 cycles AC, or self-contained batteries. Complete with tubes, less batteries. Shpg. wt., 16 lbs.

97-505. S-72 Portable. *Only* **\$7995**

ONLY **\$8.00** down

\$8.00 down, \$6.36 monthly for 12 months

80-585. Battery Pack. *Only* **\$3.85**

ALLIED RADIO

Everything in Radio, TV & Electronics

FREE

ALLIED RADIO CORP., Dept 2-AA-0
833 W. Jackson Blvd., Chicago 7, Illinois

- Send FREE ALLIED Catalog
- Enter order for Hallicrafters Model Enclosed \$..... Full Payment
- Send ALLIED Easy Payment details and order blank Part Payment (Bal. C.O.D.)

Name.....

Address.....

City..... Zone..... State.....

**YOU'LL WANT BOTH
OHMITE**

**RESISTOR
ASSORTMENTS**

1/2-WATT

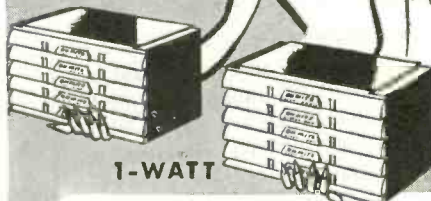

1-WATT

PACKED IN RUGGED

ALL-PLASTIC CABINETS

1/2-Watt Little Devil Assortment, Tolerance ± 10%. Stock No. CAB-1, \$12.50

1-Watt Little Devil Assortment, Tolerance ± 10%. Stock No. CAB-2, \$18.75

NO CHARGE FOR CABINETS

It's easy to find the right resistor . . . fast . . . in these handy, handsome, all-plastic OHMITE cabinets. Compact—only 9" x 5 1/4" x 4 3/4"—each one has 40 compartments factory packed with a carefully selected serviceman's assortment of 125 individually marked "Little Devil" resistors, either 1/2 watt or 1 watt, in the 40 values from 10 ohms to 10 megohms most frequently used. And, you pay only the regular price of the resistors . . . nothing extra for cabinets.



**LITTLE
DEVIL**
Composition
Resistors

See Your Distributor

BROWN DEVIL

Vitreous Enameled Resistors

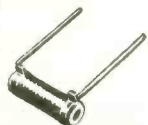

A favorite with servicemen. Easily mounted by its tinned wire leads. In sizes 5, 10, and 20 watts. Tol. ± 10%.

DIVIDOHM

**Adjustable
Resistors**

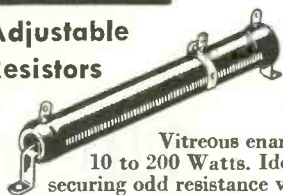

Vitreous enameled. 10 to 200 Watts. Ideal for securing odd resistance values.

OHMITE MANUFACTURING CO.
4894 Flounoy Street • Chicago 44, Ill.

Be Right with
OHMITE

Reg. U. S. Pat. Off.

RHEOSTATS • RESISTORS • TAP SWITCHES

**PLAQUE TO JOHN RIDER
FROM N.Y. TECHNICIANS**

A plaque was presented to John F. Rider by the Empire State Federation of Electronic Service Technicians Associations, at a banquet in Rochester, N. Y., November 12. The banquet was held under the joint auspices of the Rochester Radio Technicians Guild and the ESFETA, and was attended by a large number of technicians from the Rochester area, as well as by ESFETA delegates to the November 13 meeting.

The award was given in recognition of Mr. Rider's work in breaking ground for the Federation's winter lecture course, and for his patience and good humor in the face of finding himself the unintended "trouble-shooter" of all the preliminary roughnesses and organizational difficulties of the lecture series. The presentation was made by Dave Liebowitz, 10-year-old son of ESFETA's president.

TELEVISION SCHOOL

The Radio Servicemen's Association of Luzerne County, Wilkes-Barre, Pa., is running a television school every Friday evening under the direction of Ed Lukas, one of its members. Average attendance at last reports was about 40. There is as yet no television in Wilkes-Barre, but members of RSALC intend to be ready for it when it comes.

OFFICERS ELECTED

The following officers were elected at the annual meeting of the Whaling City Chapter of the Radio Technicians' Guild of New England in Bedford, Mass.: John Tavares, president; Al Gagnon, vice-president; J. L. Shepley, secretary; J. Sumner, treasurer; Louis Senra, sergeant-at-arms; and Frank Cambra, librarian. A board of directors for the next year was also elected at the meeting.

VANCOUVER CONVENTION

Vancouver chapter of the Associated Radio Technicians of British Columbia held a convention on October 12 at the Stanley Park Pavilion. Lecturers were Miles Green of B. C. Laboratories Co., Ltd. (on telephone, FM, and microwave techniques), Don Hinges of Electronic Laboratories of Canada (on TV receiver design and TV conditions in Vancouver), Wilf Munton (on running a service business), and Nick Foster of the Edison Vocational Schools in Seattle (on TV installation and service). Mr. Foster received an honorary membership in the association for his work in its behalf. K. P. Caples, regional director of CBC, spoke to the convention about CBC programs. Jobbers' displays and demonstrations were part of the meeting, as was a party with entertainment.

TELEVISION

● **MFGS.—DISTRIBUTORS
INSTALLERS!!!**
We Manufacture
300 OHM TV TWIN
LEAD TRANSMISSION WIRE

● **AT THE WORLD'S
LOWEST PRICES!!!**

● We supply over 50% of all
Twin Lead used in the
Metropolitan Area

**WRITE FOR QUANTITY
PRICES TODAY!!!**

JERSEY SPECIALTY CO.

Little Falls, N. J.

Phones: L.F. 4-0784-1258

GREYLOCK RADIO TUBE BARGAINS!

GT. Glass and Miniature Types			
1R5	6AQ5	6SA7GT	12AU6
1S5	6AT6	6SJ7GT	12AU7
1T4	6AU6	6SK7GT	12AB6T
1U4	6BA6	6SQ7GT	12J5GT
1U5	6BA7	6U7G	25L6GT
3A4	6BE6	6V6GT	25Z6GT
3Q4	6BH6	6X4	117Z3
6AG5	6J6	6X5GT	

\$32.95
per 100 asstd.

Also available in smaller quantities at 39¢ each.



SPEAKER SPECIALS!
3", 4", or 5" PM, less output. Alnico
5, each 97c
In cartons of 30, each 87c
6" x 9" Oval PM, Alnico 5, 3.16 oz.
magnet, each \$2.59
In cartons of 24, each \$2.39

TERMS: Net C.O.D., F.O.B. NYC.

MINIMUM ORDER \$10.00.

Write for terrific CR tube prices and Bargain Catalog C 12

Greylock Electronics Supply Co.
30 Church Street New York 7, N. Y.

OUTSTANDING VALUES!

**3 TUBE PHONO
AMPLIFIER**

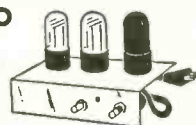

Completely
wired
Volume
& Tone
Controls **\$2.39**

Set of Tubes for above	\$1.25
5" PM Speaker	1.15
6" PM Speaker	1.55
50L6 Output Transformer	.35
Pickup and Hardware	1.79

All prices F.O.B. New York
25% Deposit required on all C.O.D. Orders
Write Dept. RE1 for Descriptive Literature

THE ROSE COMPANY - 98 Park Place
(Corner Greenwich Street) New York 7, N. Y.

EASY TO LEARN CODE

It is easy to learn or increase speed with an Instructograph Code Teacher. Affords the quickest and most practical method yet developed. For beginners or advanced students. Available tapes from beginner's alphabet to typical messages on all subjects. Speed range 5 to 40 WPM. Always ready—no QRM.



ENDORSED BY THOUSANDS!

The Instructograph Code Teacher literally takes the place of an operator-instructor and enables anyone to learn and master code without further assistance. Thousands of successful operators have "acquired the code" with the Instructograph System. Write today for convenient rental and purchase plans.

INSTRUCTOGRAPH COMPANY

4701 Sheridan Rd., Dept. RC, Chicago 40, Ill.

RADIO-ELECTRONICS for



**OVER 2,000,000
IN SERVICE IN
RADIO AND
TELEVISION!**



For dependable service in all Electronic and Radio applications always specify SELETRON Selenium Rectifiers.

Model No.	5M4	5M1	5P1	5R1	5Q1	5S1
Plate Size	1" sq.	1" sq.	1 1/2" sq.	1 1/4" x 1 1/2"	1 1/2" sq.	2" sq.
Max. D.C. Output Current	75 MA.	100 MA.	150 MA.	200 MA.	250 MA.	500 MA.
Max. Input Voltage RMS:	130 V.					
Max. Peak Inv. Voltage:	380 V.					
Approx. Rectifier Drop:	5 V.					

Write Dept. RS-24 for Bulletin!

SELETRON DIVISION
RADIO RECEPTOR COMPANY, INC.
 Since 1922 in Radio and Electronics
 Main Office & Factory: 64 North 9th St., Brooklyn-11, N. Y. • Sales Department: 251 West 19th St., New York 11, N. Y.

AMPHENOL -INLINE- ANTENNA



**SINGLE BAY
INLINE
TV ANTENNA**
 Model No. 114-005
 With Twin-Lead
 Model No. 114-009
 Without Twin-Lead

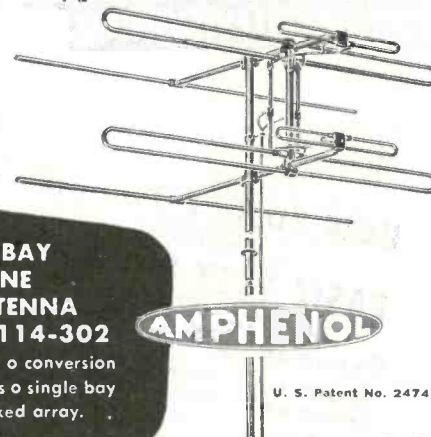

**TWO-BAY
INLINE
TV ANTENNA**
 Model No. 114-302
 No. 114-301 is a conversion kit which builds a single bay into a stacked array.

U. S. Patent No. 2474-480

"Buy Your Eventual Antenna FIRST"

**PROVED SUPERIORITY OF
PERFORMANCE IN LABORATORY
MEASUREMENTS AND FIELD TESTS**

It's cheaper to provide the Best Picture — that's what people want and expect from their TV sets. Giving them the best, first, saves a lot of call back time.

You're in with an Amphenol INLINE Antenna — You're in the good graces of the set owners — you're in at greater profit — you're in for all time. It's too expensive to make installation mistakes — it's unprofitable to have to change antennas as new transmitters are added — or to be called for orienting against ghosts — be right the first time, see that your customers "Buy their Eventual Antenna FIRST".

Leading Distributors Feature the
AMPHENOL -INLINE- ANTENNA

**RADIO - ELECTRONICS
MAGAZINE LIBRARY**

**INGENIOUS, CUSTOM-BUILT
STORAGE FILE... Another
WALTER ASHE
Value Scoop!**

Only
25¢
 each plus 6¢ each to cover packing and postage (anywhere in U. S.)
 Holds 12 complete issues of magazine in its present 82 to 98 page size. Measures 12" x 8 1/2" x 2 3/8"

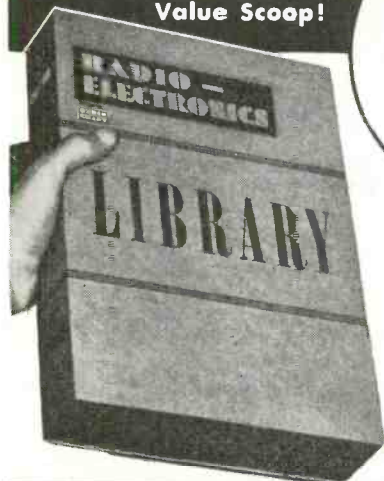

Made of high quality Kraft fibre board, printed and constructed to look like a Euckram-bound book. Affords neat, orderly, flick-of-the-finger convenience. Handy Reference Index, printed on back, records the location of selected articles, wiring diagrams, etc. At the low price you'll want several of these serviceable, attractive Magazine Libraries.

Order now for immediate delivery

**Walter Ashe
RADIO CO.
1125 PINE ST. • ST. LOUIS 1, MO.**

**FREE
NEW
1950
CATALOG**

SAVE WITH SOVEREIGN!

\$84⁵⁰
84

LESS TUBES



THE "ALL PURPOSE"
TELEVISION KIT
10" — 12½" — 16"

MONEY BACK GUARANTEE

FEATURING

- Latest Type of Circuits
- AGC—Automatic Gain Control
- Picture and Sound Automatically Locked
- Sound Cannot Drift
- Non-Microphonic
- Stagger Tuned I.F., for Max. Gain and Ease of Alignment
- 12 Channel Tuner
- Electromagnetic Focus and Deflection
- Automatic Stabilized Synchro-Lock Circuit Holds Picture Steady
- Voltage Regulated Circuit for Stability

Large clarified stage-by-stage pictures and schematics to insure ease of construction. Guaranteed to work. Money-Back Guarantee—Buy it, inspect it, if you don't think it's the best buy on the market—return unused within 5 days and your money will be refunded.

All prices F.O.B. New York. 20% deposit with order. IMMEDIATE DELIVERY

COMPLETE WITH ALL TUBES INCL. C.R. TUBE	
10" KIT	\$129.50
12½" KIT	\$137.50
16" KIT	\$157.50

SOVEREIGN TELEVISION CO. 5508C New Utrecht Ave. Bklyn 19, N. Y.

ELECTRONIC LITERATURE

Any or all of these catalogs, bulletins, and periodicals are available to you if you write to us on your letterhead (do not use postcards) and request them by number. It is necessary to send only the number of item you want. We will forward the request to the manufacturers, who in turn will send the literature directly to you. This offer void after six months.

JV-1—RELAY CATALOG
The Ward Leonard Catalog D-20A describes their line of industrial and general-purpose relays, with some general information. Thermal and motor-driven time-delay relays are included. 12 pages. —*Gratis*

JV-2—NEWARK CATALOG
The Newark Electric Co. of New York and Chicago announce their 1950 catalog. Besides covering their usual complete line of radio and television equipment, a special section features high-fidelity FM and AM radio and phono instruments for custom installation. —*Gratis*

JV-3—CRYSTAL ADJUSTMENT
A new publication of the National Bureau of Standards, *Fundamental Techniques in Frequency Adjustment of Quartz Crystals*, is now available from the Superintendent of Documents, Government Printing Office, Washington 25, D.C. This 9-page booklet points out that there are other methods of changing the frequency of a crystal-controlled device than using a new crystal. The detailed instructions given should enable even a novice to make the necessary adjustments. —*10¢*

Radio Thirty-Five Years Ago
In Gernsback Publications

HUGO GERNSBACK
Founder

Modern Electrics	1908
Electrical Experimenter	1913
Radio News	1919
Science & Invention	1920
Television	1927
Radio-Craft	1929
Short-Wave Craft	1930
Television News	1931
Wireless Association of America	1908

Some of the larger libraries in the country still have copies of **ELECTRICAL EXPERIMENTER** on file for interested readers.

IN THE JANUARY 1916 ISSUE OF ELECTRICAL EXPERIMENTER

The Radio League of America, by H. Gernsback

Photo Transmission, by Samuel Cohen

Wireless on the Firing Line

Two New Wireless Detectors

A Direct Reading Wave Meter for Radio Measurements

Measuring Pressure on Detector Crystals

Ultra-Sensitive Wireless Phones

Cabinet Style Radio Receptor

Regenerating Audion Circuits for Wireless Receiving, by Frank J. Collins

Switch Points and Tickers, by Frederick J. Schlink

An Audion Transformer

Novel Detector Stand, by K. Roberts

A Safety-Pin Detector, by Louis H. Buehl

Hearing Through Your Teeth, by H. Gernsback

HOW TO GET THE MOST
from only
BASIC TEST EQUIPMENT

Servicing by Signal Substitution

The Simple, Modern, Dynamic Speed approach to receiver alignment and adjustment problems, FM-AM-TV.

- Nothing complex to learn
- No extra equipment to purchase
- Universal — non-obsolete
- Employs only Basic Test Equipment



S-S-S tells HOW — in simple, direct language.

New 9th edition now off the press. 100 pages of valuable information.

Available from all leading radio parts and equipment distributors or directly from factory at only 40¢ per copy.

PRECISION APPARATUS COMPANY, Inc. • 92-27 Horace Harding Blvd., Elmhurst 4, N. Y.

WHERE RADIOMEN MEET, EAT and SLEEP

Visit the **FAMOUS FIESTA LOUNGE** Renowned for Fine Food



HOTEL STRAND

Atlantic City's Hotel of Distinction

The Ideal Hotel for Rest and Relaxation • Beautiful Rooms • Salt Water Baths • Glass enclosed Sun Porches • Open Sun Decks atop • Delightful Cuisine • Garage on premises. • Moderate Rate Schedule.

Exclusive Pennsylvania Ave. and Boardwalk

OPEN ALL YEAR

LOW PRICED 2WAY INTER-COM!

SOUND POWERED TWO-WAY INTERPHONE

Here is a complete, ready to use, guaranteed electromagnetically operated inter-communication system.

Set includes two stations, wire, and simple instructions. **NOTHING ELSE TO BUY!**

SAVE TIME AND STEPS. Perfect for use in homes, shops, garage, anywhere between rooms and houses.

Additional station for 3-way conversation, add \$1.35. Don't delay! Order now for fast delivery. C.O.D. send \$1.00 av rest in 1 also epl charges.

\$2.95 POST PAID

The **ROBIN HOOD CO.**, 7 Alling Street, Dept. RE-1, Newark N. J.

—SUB-MINIATURE—

PRINTED ELECTRONIC CIRCUITS

on ceramics, plastic and paper bases from your schematics. Special attention given to small orders. All service and correspondence held strictly confidential.

Write for full details and our latest bulletins on printed circuit components and assemblies available from stock.

PLASTICS & ELECTRONICS COMPANY
272 Northland Ave. Buffalo 8, New York

HARD-TO-GET PARTS POWERFUL ALL-PURPOSE INDUCTION MOTOR

IDEAL FOR EXPERIMENTERS—101 USES
Sturdily constructed to precision standards, this self-starting shaded pole A.C. induction motor is powerful enough for a number of uses. Some of these are: Automatic Timing Devices, Current Interrupters, Electric Fans, Electric Chirres, Window Displays, Photocell Control Devices, Electric Vibrators, Small Grinders, Buffers and Polishers, Miniature Pumps, Mechanical Models, Sirens, and other applications.

Consumes about 15 watts of power and has a speed of 3,600 r.p.m. When geared down, this sturdy unit will constantly operate an 18-inch turntable loaded with 200 lbs. dead weight—THAT'S POWER!

Dimensions 3" high by 2" wide by 1 3/4" deep; has 4 convenient mounting studs; shaft is 3/16" diameter, and runs in self-aligning oil-retaining bearings. Designed for 110-20 volts, 50-60 cycles, A.C. only. Shp. Wt. 2 lbs.

ITEM NO. 147
YOUR PRICE..... \$1.95

ULTRA MAGNET
LIFTS MORE THAN 20 TIMES ITS OWN WEIGHT
LITTLE GIANT MAGNET

Lifts 5 lbs. easily. Weighs 4 oz. Made of ALNICO new high-magneto steel. Complete with keeper. World's most powerful magnet ever made. The experimenter and hobbyist will find hundreds of excellent uses for this high quality permanent magnet. Measures 1 3/4 x 1 1/4". Shp. Wt. 3/4 lbs.

ITEM NO. 159
YOUR PRICE..... \$1.25

GENUINE MICROPHONE TRANSMITTERS

Regular telephone transmitters taken from a large telephone supply company's overstock. Work perfectly on 2 dry cells. Can be used on P.A. systems, cell systems, inter-communications sets, short-line telephone circuits, house-to-house or farm-to-farm 'phone lines, also to talk through your own radio or as concealed dictaphone pick-up. Useful replacements on battery-operated rural telephone lines.

THESE ARE GENUINE TRANSMITTERS, MADE BY KELLOGG, WESTERN ELECTRIC AND STROMBERG-CARLSON, excellent in appearance and operating. A remarkable value and one seldom offered in these times. Shp. Wt. 1 lb.

ITEM NO. 160
YOUR PRICE..... \$1.95

WATTHOUR METER

Completely overhauled and ready for immediate service. Designed for 100-110 volt, 60 cycle 2-wire A.C. circuit. Simple to install; 2 wires from the line and 2 wires to the load. Sturdily constructed in heavy metal case, 3 1/2" x 3 3/4" wide, 5" deep. Westinghouse, G. E. Port Wayne, Sangamo or other available make. Shp. Wt. 14 lbs.

ITEM NO. 33
YOUR PRICE.... \$4.95

AMAZING BLACK LIGHT!!
Powerful 250-Watt Ultra-Violet Source

The best and most practical source of ultra-violet light for general experimental and entertainment use. Makes all fluorescent substances brilliantly luminescent. No transformers of any kind needed. Fits any standard lamp socket. Brings out beautiful opalescent hues in various types of materials. Swell for amateur parties, plays, etc. to obtain unique lighting effects. Bulb only. Shp. Wt. 2 lbs.

ITEM NO. 87
YOUR PRICE..... \$1.95

WESTERN ELECTRIC BREAST MIKE

This is a fine light-weight aircraft carbon microphone. It weighs only 1 lb.

Mike comes with breastplate mounting and has 2-way swiveling adjustment so that it can be adjusted to any desired position. There are 2 woven straps: one goes around neck, the other around chest. Straps can be snapped on and off quickly by an ingenious arrangement.

This excellent mike can be adapted for home broadcasting or private communication systems. By dismounting breastplate, it can be used as desk mike.

Comes complete with 6-foot cord and hard rubber plug. Finished in sherdarized plate. non-rustable. Shipping weight, 2 lbs.

ITEM NO. 152
YOUR PRICE..... \$1.00

HUDSON SPECIALTIES CO.
40 West Broadway, Dept. RE-1-50, New York 7, N. Y.

I have circled below the number of the items I'm ordering. My full remittance of \$..... (include shipping charges) is enclosed (NO C.O.D. ORDERS UNLESS ACCOMPANIED WITH A DEPOSIT) OR my deposit of \$..... is enclosed (20% required). Ship order C.O.D. for balance. NO C.O.D. ORDERS FOR LESS THAN \$5.00. BE SURE TO INCLUDE SHIPPING CHARGES.

Circle item No. wanted:
147 159 160 87 152 33

Name.....
Address..... Please Print Clearly
City..... State.....

Frank B. Powers, formerly assistant vice president in charge of production of the AMERICAN CAR AND FOUNDRY Co. and an executive with more than 20 years of outstanding service in the engineering and manufacturing field, has been appointed director of manufacturing operations of FEDERAL TELEPHONE AND RADIO CORP., Newark, N. J.



The appointment was announced by William H. Harrison, chairman of the board.

Mr. Powers will be responsible for telephone, radio, selenium rectifier, and vacuum tube operations of the company.

Al Friedman has been appointed chief engineer and national field service representative of RADIO MERCHANDISE SALES, INC., New York, according to Sid Pariser, president of the company.



Friedman is well known in the electronics field through his past associations as independent consulting engineer and his connection in similar capacity with Federal Telephone and Radio Co. and, more recently, with the JFD Manufacturing Co. as chief engineer, consultant, and field sales engineer.

Dr. Harry F. Olson, director of the acoustical research laboratory of RCA LABORATORIES, PRINCETON, N. J., received the first John H. Potts Memorial Award from the Audio Engineering Society at the Society's banquet which took place at the Hotel New Yorker.



Dr. Olson, a leading authority on acoustics, was given the award for "outstanding accomplishments in the field of audio engineering." The medal, named for the late editor of *Audio Engineering Magazine*, was given by his widow, Mrs. Dorothy Slavin Potts, to W. Lindsay Black, Chairman of the Awards Committee, who presented it to Dr. Olson.

The RCA scientist pioneered in the research and development of directional microphones, including the velocity type. Directional microphones are now almost universally employed in radio broadcasting, sound motion pictures, and television.

The RCA scientist pioneered in the research and development of directional microphones, including the velocity type. Directional microphones are now almost universally employed in radio broadcasting, sound motion pictures, and television.

Jensen Industries, Inc., 329 S. Wood St., Chicago 12, Ill.



Save 1/2 ON BRAND NEW
SUPREME
MINIMETERS!

Boston's bargain-loving RADIO SHACK slashes dealer-net prices IN HALF with a special purchase of genuine SUPREME Minimizers, new (not surplus) and in original cartons! Save \$\$\$—and—\$\$\$ on voltmeters, milliameters, microammeters and ohmmeters! Servicemen, hams, experimental, school and industrial users like their small size — 2 1/4 x 3 3/8 x 1 1/2" — only slightly larger than ordinary meter movements alone! These precision-built test instruments have solid alnico sintered pole pieces and the same rugged SUPREME movement featured in all SUPREME testing equipment! Shipping wt. 1 lb. Order NOW! No more at THESE prices when our supply is gone!

- Model 402, DC volts: 0-5-50-500 ..\$5.95
- Model 403, DC volts: 0-10-100-1000 6.95
- Model 404, DC volts: 0-2.5-25-250 4.95
- Model 410, DC mils: 0-25-250-2500 4.95
- Model 411, DC mils: 0-50-500-5000 4.95
- Model 420, DC amps: 0-.1, 0-1, 0-10 5.95
- Model 430, DC microamps: 50-0-50, 500-0-500, 5000-0-5000, designed esp. for alignment of FM receivers 7.95
- Model 440, DC ohms: 0-2000-20000-200000, center scale low range 25 ohms, complete with battery 6.95

SAVE \$80.50 NOW on STEPHENS TRU-SONIC HIGH FREQUENCY SPEAKER with electro-dynamic driver!

List Price \$110.00
\$29.50 net



Modernize PM or dynamic speakers into 800 cycle cut-off (flat to 15,000 cps) dual tweeter-woofer systems of incomparable fidelity! True-Sonic horn #24H has 8 cells, each 4 x 4 x 11". True-Sonic 20-watt electro-dynamic driver unit E15 has 16-ohm aluminum voice coil; 3 lb. 150-ohm copper field coil; field dissipation 15 watts. Shipping wt. 26 lbs. Perfect for hi-fi enthusiasts, small theatres, schools, labs, sound studios, WRITE, PHONE or WIRE your order today, because bargain-hunters will immediately recognize this as the most unusual audio "buy since the war! New (not surplus)! Limited quantity!

- 800 Cycle Crossover Network Kit \$9.95
- Driver Unit Field Supply Kit \$5.55

Write for free schematic
FREE 138 pg. CATALOG and SURPLUS BULLETIN

The RADIO SHACK Corp.
CABLE ADDRESS: RADIOSHACK
167 G WASHINGTON ST., BOSTON, MASS., U.S.A.

ATTENTION MANUFACTURERS!

A COMPLETE LINE OF

RADIO AND TELEVISION TUBES

AT LOWEST POSSIBLE PRICES

- Consult us first for your tube requirements.
- All tubes individually tested.
- All tubes carry a money-back guarantee.
- 150,000 of some types available.
- All tubes branded N.J.R.T.

NEW JERSEY RADIO & TELEVISION TUBE CO.

715 ELIZABETH AVE.
ELIZABETH 4, N. J.
Tel. Elizabeth 5-5082-83

If you don't receive our

FREE BARGAIN CATALOGS
you're losing money!

A RADIONIC SPECIAL!
Stacked, All Band Conical TV Array... at Lowest Cost
It's here! Scientifically designed, precision made, all-band conical TV array—giving tremendous gain and absolute minimum interference at a cost no greater than the usual dipole. Permits direct coupling to 72, 150 or 300 ohm line with minimum loss. All dural construction. 10 foot mast included. Amazingly **\$11.95** low price of only.....



In lots of 3, \$11.45 each
Best quality, 300 ohm twin-lead, 100 feet, \$1.25, 1000 feet, \$11.25.
30% discount with order, balance C.O.D.

RADIONIC EQUIPMENT CORPORATION

Tribune Theater Entrance
170-BB Nassau Street New York 7, N. Y.
Worth 2-0421 :: Open daily 9 to 6--Saturday 9-5

FREE! MAIL TODAY!
GET YOUR COPY AT ONCE!
of RADIONIC'S Bargain Catalogs, Radio & Television Sets—Parts—Accessories. Unbeaten Values!

RADIONIC EQUIPMENT CORP., Dept. 101
170-BB Nassau Street, New York 7, N. Y.
Please rush Free Copy of your latest Bargain Catalog of Radio and Television Sets, Parts, Tubes and Accessories.

NAME.....
ADDRESS..... STATE.....
CITY.....

General David Sarnoff, chairman of the board of RCA has received the Peter Cooper Medal for the Advancement of Science from New York's Cooper Union.

Albert E. Keleher, Jr., has been appointed as manager of mobile radio-telephone sales, RAYTHEON MFG. Co.

During the past two and one-half years, Mr. Keleher was engaged in the sale of Raytheon broadcast equipment in New England. His previous experience includes application engineering with Raymond M. Wilmotte, Inc., and manufacturing engineering with Western Electric and Bell Telephone Laboratories.



Percy L. Spencer, manager of the power tube division of RAYTHEON MFG. Co., received the Distinguished Public Service Award in ceremonies recently held at the Waltham, Mass., plant.



Rear Admiral Hewlett Thebaud, Commandant of the First Naval District, acting for the Secretary of the Navy, made the presentation.

The award, highest civilian honor bestowable by the Secretary of the Navy, was given for Mr. Spencer's development of the vacuum tube used in proximity fuses and his simplified method of magnetron tube production.

John K. McDonough, was appointed director of sales, C. K. (Larry) Bagg sales manager, and Bernard O. Holsinger, advertising and sales promotion manager for SYLVANIA's new line of TV receivers.

Mr. McDonough was associated with the Ford Motor Co. and Commercial Investment Trust before joining the company in 1943.

Mr. Bagg comes to Sylvania from Newell-Emmet Co., where he was an account executive. He previously held sales executive positions with 1900 Washer and RCA.

HAVE YOU TAKEN INVENTORY?



A BIGGER BANK BALANCE IS BETTER THAN DEAD STOCK

Send me a list of any excess stock of radios, phonographs, radio or television parts and tubes—I will send you a prompt spot cash offer.

M. BROOKS, 80 Vesey St., N. Y. 7, N. Y.

The Book that takes Drudgery out of Mathematics

Only **\$1.** postpaid

SOLVES EVERYDAY PROBLEMS HELPS YOU GET AHEAD IN LIFE

How many times have you lost money because of a mistake in figuring? Do you know how to figure quickly and correctly? Can you figure discounts, interest rates, taxes and all the other calculations you meet up with in your daily life?

Are you having trouble qualifying for Civil Service Exams or Armed Services Promotions, because you're not up on mathematics?

Here is the book that gives you a good background in mathematics; that takes all the irritation and drudgery out of it. You don't need to be scared of mathematics, because here's the subject explained without frills, without useless computations. Here's the book for men in radio jobs; for business men; technicians and craftsmen, explaining and answering everyday mathematic problems in easy-to-understand words and illustrations.

Yes, it's the key to a simple understanding of mathematics. It's a real home-study course in mathematics for the man who's alert to its importance in the world today.

ELEMENTARY MATHEMATICS

● EASY — SIMPLIFIED — PRACTICAL ●

CONTENTS OF BOOK

- CHAPTER I. Arithmetic—Addition—Subtraction—Multiplication—Division.
- CHAPTER II. Factoring and Cancellation—Fractions—Decimals—Percentage—Ratio—and Proportion.
- CHAPTER III. The Metric System.
- CHAPTER IV. How to Measure Surfaces and Capacity (Geometry).
- CHAPTER V. Powers and Involution—Roots and Evolution.
- CHAPTER VI. Mathematics for the Manual and Technical Craftsman—Thermometer conversions—Graphs or Curve Plotting—Logarithms—Use of the Slide Rule.
- CHAPTER VII. Special Mathematics for the Radio Technician.
- CHAPTER VIII. Commercial Calculations—Interests—Discounts—Short Cut Arithmetic.
- CHAPTER IX. Weights and Measures—Useful Tables.

ONLY **\$1.** POSTPAID

Send Stamps, Cash or Money Order.

Send Today for Your Copy of This Indispensable Book. It Can Be Carried Readily in Your Pocket. (Size 6 x 9 in.)

TECHNIFAX
110 N. Franklin St., Chicago, 6, I.

New!

COLOR on your TELEVISION!

- Pictures will be in glorious color tones instead of dull black and white.
- Simply attach our **TELECOLOR FILTER** to front of your set and find new happiness in favorite programs.
- Enjoy color depth, no haze, no fog, no eye-strain.
- Mail \$3.00 for 10-inch screen; \$4.00 for 12½-inch; \$6.00 for 16-inch.

Trade Discounts.

HARVARD LAB.

659 Fulton St. Brooklyn 1, N. Y.

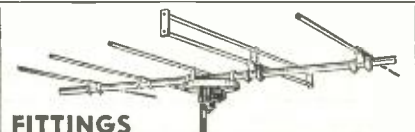

FITTINGS for your BEAM ANTENNA

Speed the building of a neat, fully adjustable, all aluminum job.

Type HASL aluminum bracket attaches half inch tubing to 1¼" center tube, 4 for **\$3.75**

Ask for circular showing fittings for TV. FM 2, 10 and 20 meter beams.

D. H. HARELL COMPANY
315 Fourth Street Logansport, Indiana

SIX TUBE SUPER

Three Gang Condenser

\$33.30
NET
Crowe Panel
Kit Included



Panel kit to fit most all makes (Please specify make of car and year model). New up-to-date latest priced Catalog available to dealers.

Bill Sutton's

Wholesale Electronics

5th at Commerce Fort Worth, Tex.

STEADY PROFITS

YOUR OWN
BUSINESS WITH
COVIDEO

Coin Operated
Television



Place these specially built television sets that play 30 minutes for 25c in the thousands of available public places, hotel rooms, tourist courts, etc. They yield immediate profits and steady income. Install COVIDEO, the finest made.

Limited capital required. Send for further information. Write today.

COVIDEO Coin Operated Television, Dept. B

212 Broadway, Phone: BEekman 3-0038-9
NEW YORK 7, N. Y.

GOVERNMENT SURPLUS!
WORLD'S LOWEST PRICE

PHOTO FLASH
EQUIPMENT



COMES COMPLETE WITH
4 EDGERTON
FLASH TUBES
& REFLECTORS

EASY TO
CONVERT INTO
A 2-WAY PHOTO
FLASH UNIT
OPERATES ON 110V. AC & 12V. BATTERY

Brand new at a fraction of original cost. Contains finest component parts available. All necessary parts and complete instructions included. After conversion, works on 110V AC or 12V battery by a flick of a switch.

\$68.
COMPLETE

Immediate delivery on all mail orders
CINEX, INC., 165 W. 46th St., N. Y. 19, N. Y., Dept. RE-1



ARC WELDER

FOR HOME WORK SHOPS,
MECHANICS, FARMER, ETC.

For light welding. Repairs steel items 16 to 22 gauge, such as fenders, cabinets, troughs, toys, etc. No previous experience necessary. Complete unit only \$5.95 Postpaid or C.O.D. plus postage. Ten day trial offer. Money back guarantee if not satisfied.

MINEX, Dept. 21
CINCINNATI 30, OHIO

MONEY-SAVING PLAN

Dear Editor:

I bought a television set about a year and a half ago and enjoyed it tremendously—for about two weeks. After that the neighbors discovered my antenna, and, not being a very tall fellow I saw few programs over their heads.

I think you will acknowledge that my solution was ingenious. A slight modification in the receiver's sweep circuits converted the image to spiral scan. Anyone can do the same. Simply feed quadrature sine voltage to the horizontal and vertical deflection coils and modulate the sine source with a sawtooth of a frequency low enough to give the correct separation between lines.

You can imagine what this does to the picture! But if you think I cut off my nose to spite my face, think again. While the spiral scan does not present the picture with its elements oriented as in the original, there is nothing random about it—the image is there all right. A famous ophthalmologist (who prefers to remain anonymous) has designed a pair of glasses which restores the picture elements to their proper places. The neighbors are told that the set just won't work—they can see that for themselves. But my wife and I each have a pair of the special double-circular-reverse-anastigmatic lenses, and we enjoy the programs—alone!

SULEIMAN H. CRIPPS

New York, N. Y.

TV TUBE CORRECTIONS

Dear Editor:

Milton Kiver's article on "Replacing Picture Tubes in Television Receivers" in the October issue was very good, but I would like to point out a few errors.

Typical operating conditions are merely selected operating figures, with no significance as maximum and minimum ratings. In the discussion comparing the 10BP4 and 10EP4, for example, there is no difference between the two except for the anode contact.

The 12QP4 is not physically the same as the 12JP4. The 12QP4 has a 12 $\frac{1}{16}$ -inch diameter bulb, while that of the 12JP4 is 12 inches. The 12RP4 is the replacement for the 12JP4 and has the bent-gun type of ion trap using a single-magnet beam bender. This type was created so the tube could be operated at lower anode voltage without formation of ion spots. The 12LP4 is comparable to the 12QP4 except that it is longer and has a female cavity anode contact.

All the 12-inch tubes have the same deflection angle; the 12JP4 was the first

Everybody's
Talking about
the EMC

Economy Line of

*VOLOMETERS

*Reg. Trade Mark for Volt-Ohm-Milliammeter

MODEL 102

(1000 ohms per volt
meter)

• 3" SQUARE METER

• 3 AC CURRENT
RANGES
(0-30/150/600 ma.)

• Same zero adjustment for
both resistance range-
(0-1000 ohms, 0-1 meg-
ohms)

5 DC & 5 AC Voltage
Ranges to 3,000
Volts. Also 4
DC Current **\$13.90**
Ranges.

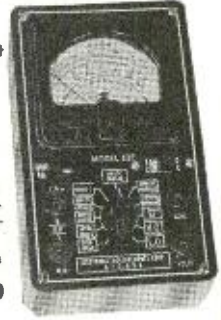

MODEL 103

(1000 ohms per volt
meter)

• 4 $\frac{1}{2}$ " SQUARE METER
• 3 AC CURRENT
RANGES
(0-30/150/600 ma.)

• Same zero adjustment for
both resistance ranges
(0-1000 ohms, 0-1 meg-
ohms)

Same Ranges as Model
102. Also 5 DB **\$17.50**
Ranges.



Model 103-S with plastic
carrying strap \$17.95

MODEL 104

(20,000 ohms per volt
meter)

• 4 $\frac{1}{2}$ " SQUARE METER
(50 micro-amperes—al-
nico magnet)

• Includes carrying strap

5 DC Voltage Ranges to
20,000 ohms/volt to 3,000
V.; 5 AC Voltage Ranges
to 3,000 V.; 3 Resistance
Ranges to 20 megohms. Also
3 AC & DC
Current Ranges **\$24.95**
& 5 DB Ranges.



All of the above have round cornered, bakelite, molded cases.

Export Dept., 303 W. 42nd St., N.Y.C.

Write Dept. B-1 for Free Catalog

Gives More Measurement
Value per Dollar!



ELECTRONIC
MEASUREMENTS CORP.

423 BROOME STREET, NEW YORK 13, N. Y.

tube in this size and subsequent types have maintained the same angle.

A. Y. BENTLEY, Head of
Tube Engineering Dept.,

Allen B. Du Mont Labs, Inc.,
Passaic, N. J.

↓ SOMETHING REALLY NEW—A TV-FM ANT. KIT ↓

WEAVER TV-FM ANTENNA

BROAD BAND, HIGH GAIN ALL CHANNELS

Prefabricated construction makes completion of assembly very fast. All aluminum elements, mast and crossbar. Plastic insulators assure excellent all-weather reception. Instructions supplied.

COMPLETE KIT includes antenna, 75 ft. lead, lightning arrester, mounting bracket, stand off insulators and hardware. Everything needed for an installation.

NET
POST PAID **\$6.95**

NET
POST PAID **\$9.95**



J. M. WEAVER CO. 267 Kings Road
Madison, N. J.

Three decades of radio-television "know-how"

insist on.....insuline

- ... for superb television
- ... for fidelity FM reception
- ... for high quality
- ... for low prices

Challenger
ANTENNAS
KITS and ACCESSORIES

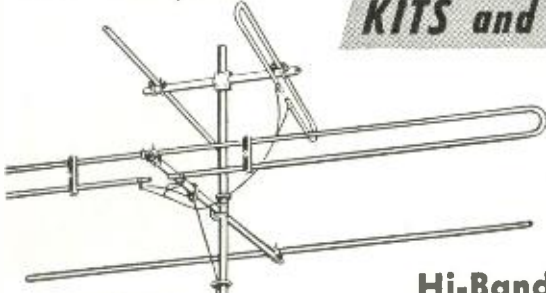

Illustrated is the Model No. 6444

Challenger Antennas are first choice with TV installation men

Hi-Band Lo-Band Folded Dipoles and Reflectors

For outstanding reception over the entire high band and low band television range. Ideal for "fringe" areas. Antenna sections rotate separately. Easy to install.

Write for latest catalog illustrating and describing the complete "Challenger" line of Antennas and Accessories.



The "Challenger Line" features precision engineering ... manufacturing skill ... maximum performance ... competitive prices. There is an Insuline "Challenger" for every requirement ... outdoor, indoor, window.



insuline CORPORATION OF AMERICA

INSULINE BUILDING • 36-02 35th AVENUE • LONG ISLAND CITY, N. Y.
West Coast Branch and Warehouse: 1335 South Flower Street, Los Angeles, Calif.
Exclusive Canadian Sales Agents: CANADIAN MARCONI COMPANY, Montreal

\$1,000 A MONTH



That's what JUST ONE of the many plans in this book brought in—over \$1,000 a month, steadily, from radio service alone. HOW TO MAKE MORE MONEY IN RADIO SERVICE is so full of money-making plans and ideas it will amaze you. Why work for wages? Why not become your own boss and make more money? EVEN BEGINNERS who used some of the earlier plans in this book averaged WAY OVER \$100 A WEEK just working from home. This book is making money for servicemen and beginners, everywhere—U.S.A., Canada

Puerto Rico, Mexico, So. America, Hawaii, Philippines, and other countries. Letters of thanks are continually coming in.

AT LAST!

The real money-making secrets of radio service are given out in this book.

- Book very helpful—following advice in the book earned high as \$100 a week radio repairing, in my apartment. C. C. Seidler, Brooklyn, N. Y.
- In business 10 years—received many valuable pointers—read it 3 times. Would not take twice the price for it. W. J. Phillips, Belington, W. Va.
- In radio 15 years—Book contains far more information than expected—Every radioman should have this book. W. J. Fraser, Elmont, N. Y.
- Best of its kind that have ever been printed. W. Bradford, E. Chicago, Indiana
- Have book only a week—couldn't stop reading it. Already made money and many new customers. A. P. Waters, Jr., Carthage, N. Y.
- In business 17 years. Book contains many things which took me many years to learn the hard way. Book worth many times its small cost. P. V. Fussner, Elmwood, Illinois

25 years experience are packed in this 83 page book, 8 1/2 x 10 1/2, by V. Gale, for servicemen, beginners, students. Among MANY OTHER THINGS it shows you where the money is and how to get it FAST; How to get plenty of customers; How to test sets without taking them out of cabinets and build to full time; How much to charge; How to connect with certain BIG MONEY concerns; How to increase business and expand. Send for this book today and start making more money almost as soon as you get it. The full price is only \$3 (any convenient form) postpaid; or C.O.D. at \$3 plus a few cents postal charge. You have nothing to lose. Examine it for 5 days. If you aren't positively delighted return it and we will refund you \$3 promptly. If you want more information about the book send for literature #2-RE. It's free.

MERIT PRODUCTS, DEPT. RE,
216-32 132 Avenue. Springfield Gardens 13, N. Y.

Approved MODEL A-460 TELEVISION FIELD STRENGTH METER



\$79.50 ONLY

Model A-460 is housed in a heavy gauge steel cabinet. Battleship grey finish with 6 tubes (standard brands) 1N34 Crystal, operating instructions, circuit diagram and guarantee. Weight 25 lbs. D-8" x H-10" x W-12".

Write for 12-page catalogue.

Field Strength Meter: television 12 channel tuner; video IF channel; large 6" directly calibrated meter; hammer tone finished panel; ideal for locating antenna systems; testing transmission lines; testing efficiency of indoor antennas; checking booster efficiency, etc.

APPROVED ELECTRONIC INST., CORP.
142 Liberty St. N.Y.C.

HEADQUARTERS FOR ELECTRONIC TUBES IN ALL QUANTITIES



5000 Magnetrons, 1000 Kylstrons 500,000 other tubes. Write for our Bulletin and Prices.

LIBERTY ELECTRONICS, INC.
135 LIBERTY STREET NEW YORK 6, N. Y.
PHONE WORTH 4-8262

WAS READY FOR TV

Dear Editor:

Some readers of our RADIO-ELECTRONICS should have been in my shoes just a couple of months ago. Most technicians in this little town thought TV was a long way off and did no TV studying. I stayed with your magazine, and with it and the help of Philco's home study course and the school that A. K. Sutton of Charlotte, N. C., put on for Philco members, I was ready for TV. I don't claim to be a hot shot but so far I have serviced a number of TV sets and found it profitable.

But some service technicians did just what Mr. Johnson suggested in an earlier letter: found themselves a hole and crawled into it. They know now that television has arrived—and to stay!

S. P. HALLEY, JR.

Monroe, N. C.

IN MARKET FOR MULE

Dear Editor:

I think there are too many articles on TV. You claim that TV reaches between 50 and 60 percent of the U.S. population. I think a more accurate estimate would be perhaps 20 percent.

In my opinion TV will never replace AM radio. The only ones who think so are the television manufacturers. TV may become popular in five or ten years when transmitters and receivers are perfected to the point where one can receive high-quality, sharp, clear pictures.

After the summer's heat had died away and radio writers could think clearly again, I had hoped to see some good articles like those we've had in the past from James Langham and J. C. Hoadley, but no, the October issue sings of the Geiger counter, a Snooperscope and a neon blinker. (That damned Geiger counter has appeared so much that I'm thinking of buying a mule and heading for uranium territory!)

It is hard for a magazine to please all the readers all the time, but please, can't you please some of us some of the time?

ROBERT O. BARG,

Rochester, N. Y.

(Our statement was that 50 to 60 percent of the U.S. population are in reach of existing television stations—quite a different thing from saying that such a percentage are now enjoying television. As to the other comments—well, what do you readers want? Shall we abandon experimental articles?—Editor)

FIRST-HAND EXPERIENCE

Dear Editor:

I built my own TV receiver (a 630TS) and so far I have serviced it three times. That is the best kind of TV experience for any technician. We hope to have a station here soon.

Continue the good work. I wouldn't miss your articles!

LEW COOK, WFWW,

Lincoln, Nebr.

RADIOMEN'S HEADQUARTERS WORLD WIDE MAIL ORDER SERVICE !!

MICROPHONES



Super Special-Highest quality all chrome bullet shaped CHRYSLER MIKE of 100 flight nationally known brand—\$5.95. Bullet DYNAMIC MIKE—\$7.95. MIKE Jr.—60c. PUSH-TO-TALK MIKE with switch on handle—98c. LAPPEL MIKES —(Specify whether carbon or magnetic) 93c.

CO-AXIAL CONNECTORS

Army No. PL 250 or Amphenol 83-15P Army No. 80-239 or 83-1R Army No. PL 258 or 83-1J Army No. M 359 or 83-14Z 49c each — in lots of 10 assorted 39c each

PORTABLE ELECTRIC DRILL TERRIFIC VALUE

Equipped with 1/2" Jacobs Geared Chuck and Key

\$19.95 (Sold at less than established factory price so we cannot mention brand name)

Not an intermittent duty drill, but a full size rugged tool. Most convenient type switch. Natural grip handle. Balance like a six shooter. Precision cut gears. Turbine type cooling blower. Extra long brushes. No stalling under heaviest pressure because of powerful 110 volt AC or DC motor and multiple ball thrust bearing. Other bearings self-aligning lifetime-lubricated Oilite type. Made for toughest year-in and year-out service in plant or on construction jobs. Amazing perpetual factory guarantee assures you of a lifetime of trouble-free use. Satisfaction guaranteed or money refunded if returned prepaid within 5 days.

HEAT GUN



Streamlined pistol grip heat gun. Vird red hot. 20 cubic feet per minute blast of hot air at 160° Fahrenheit. Ordinary blowers have small fan motors, but this has a lifetime-lubricated AC-DC motor of the rugged vacuum cleaner type, that produces a hurricane of either hot or cold air. Blow out dirt or dust from radio chassis. Dry out fission systems. Heat carburetors. Quick-dry paint. Thaw out radiators or water pipes, etc. Warning!—Keep this away from Your wife. She will use it to dry her hair because it will do it in half the time of her ordinary hair dryer, to say nothing of her using it to dry stockings or clothing, or defrost the refrigerator instantly. Only \$12.95. Satisfaction guaranteed or money refunded if returned prepaid within 5 days.

This analyzer featuring a sensitive resistance type meter housed in a bakelite case; represents the culmination of 15 years achievement in the instrument field by a large company specializing in electronic test equipment. Specifications of the AC—0hm to 100,000 ohms. AC Volts—0-25, 50, 125, 250, DC Volts—0-25, 50, 125, 250, Milliamperes AC—0 to 50, DC Milliamperes—0 to 50, Ohms Full Scale—100,000, Ohms Center Scale—2400, Capacity—.05 to 25 Mfd. Total Price, prepaid anywhere in the USA—\$7.00

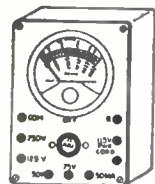

Brand New General Electric BC-375 or BC-197 transmitters, export packed, absolutely complete and including additional complete sets of spare tubes as well as 10 and 20 meter conversion instructions \$100.00. BC-312, BC-348 or BC-224 receivers sold with the above transmitters. (unit for unit) **\$125.00**

SCR610 portable 6, 12, and 24 Volt crystal controlled transmitter receiver with built-in loudspeaker on receiver. Complete \$59.95 SCR-522 Transmitter-receiver in guaranteed condition complete with remote controls, antenna and mike. No conversion necessary to license for taxicab use. A natural for any 2 meter use. **\$100.**

Brand new APNI Altimeters. Both 24 volt and 12 volt models available. Not just chassis, but complete with everything. Original factory packing. Descriptive literature on request. **\$45.00 and \$75.00.**

POWER RHEOSTAT

Exceptionally Rugged, Trouble-free design. Withstands severe overloading to many times the nominal 25 watt rating without burning or smoking. Perfect for motor speed control or line voltage adjustment. 3 sizes available: 50, 60 and 200 ohms. Regular price \$5.20. Special—**\$1.00.**



"SO" RADAR SET

"SO" RADAR SET complete with 9 tubes including picture tube. This Plan—Position—Indicator Oscilloscope has a self-contained pack designed to run from the 110 V. power supply on LST or PT boats. It provides a 3" diameter picture adjustable at will to an 80, 40, or 2 mile circle with the boat at the center, showing location of land, other ships, or any obstruction, so that navigation can be carried out in pitch darkness or densest fog with as much safety as in brightest sunlight. Your cost \$39.95.

CERAMIC INSULATED VARIABLE AIR CONDENSERS

10, 15 or 25 mm—\$35. 10 for \$28.00, 100 for \$23 35 mm—\$40. 10 for \$34.00, 100 for \$28 50 mm—\$45. 10 for \$37.00, 100 for \$30 75 mm—\$50. 10 for \$44.00, 100 for \$38 100 mm—\$55. 10 for \$49.00, 100 for \$39 140 mm—\$80. 10 for \$74.00, 100 for \$64 160 mm—\$100. 10 for \$88.00, 100 for \$75 Buttery condensers, rotor has double ball bearings and 3/4" shaft. 15 mmf. per section \$50, 10 for \$45.00, 100 for \$40 30 mmf per section \$60, 10 for \$55.00, 100 for \$50 50 mmf per section \$70, 10 for \$65.00, 100 for \$60

SUPER SPECIAL! 2 gang midjet superhet tuning condensers with 1/4" shaft and trimmers . . . 9 for \$2.50 2 gang 140 mmf—\$1.60, 10 for \$12.50, 100 for \$100 350 mmdf 5 gang—\$1.95 3 gang—\$1.25 Manufacturers and Distributors: Write for prices on larger quantities. WE HAVE OVER 250,000 VARIABLE CONDENSERS IN STOCK.

AUTO RADIO DEALERS ATTENTION!

Car radio specially made by famous American manufacturer of communications sets for export to South America. (Recently imposed currency restrictions make export impossible.) 6 tubes, 3 gang condenser, and unbelievable sensitivity and selectivity. Fungus proofed and tropicalized. Out of this world, compared to any radio available in the market. A sensational value at \$28.00 net, or \$25.00 in lots of 9.



SCR 274N Command Set (Made by Western Electric) THE GREATEST RADIO EQUIPMENT VALUE IN HISTORY

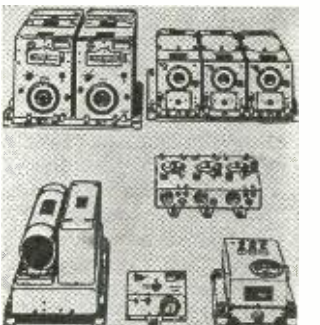

A mountain of valuable equipment that includes 3 separate Communications Receivers, covering up to 9.1 MC, 2 separate 40 watt Transmitters including crystals. 4—28v Dynamos (easily converted to 110v AC operation). Pre-Amplifier and Modulator, 2 Tuning Control Boxes, and 1 Antenna Coupling Box complete with R.F. Ammeter. 29 tubes supplied in all. Receivers and Transmitters instantly detached from mounting racks for use in separate locations. Removed from unused aircraft and in guaranteed electrical condition. A super value at \$59.95 complete.

DELUXE SUPERHET A.C.-D.C. RADIO KIT

Extra high quality standard production line radio in kit form with complete instructions. Features 2 iron core I.F. transformers, a 2 gang condenser, and polyethylene insulated edge-wise wound antenna loop 12A6, 12BE6, 12BE6, 50B5 & 35W4 tubes supplied. Receives broadcast band from 550 to 1700 KC. Kit for \$8.75 or 2 for \$17.00 Assembled, Wired & Tested \$12.95 or 2 for \$25.00

\$7.05 TAKES BARGAIN "C"

(All three items below) ALUMINUM GEAR BOX 18x8x7 that contains two powerful electric motors and two matched gear trains. 62 gears in all varying in size from 1/2 to 4 inches in diameter. This unit is readily converted to rotate in beam antenna or any other similar use. **\$5.00**

SIGNAL CORP INTER-CONNECTOR RELAY BOX 730A

This valuable unit, made by Bell, and more familiarly known by the U. S. Army designation BC616, is encased in a highly polished aluminum case 6 1/2 x 5 1/2 x 2 1/2, and contains 150 mfd. condensers, 250 micro capacity sensitive relays, resistors, and terminal strips. Order several at the giveaway price of only **\$1.95**

REMOTE CONTROL UNIT

Aluminum case 4 x 3 x 2 containing 2 potentiometers, triple pole switch, 4 knobs, phone jack, gear mechanism and revolution counter. Including 8 front JAX connector to fit box **\$1.39**



Meter Rectifiers—Can be used for replacement, or in construction of all types of test equipment—Full Wave—\$1.25. Half Wave—\$1.75.

Phonograph Scratch Eliminator

Consists of 2 condensers and powdered iron core choke connected in a filter network. Same as used in most jukeboxes to improve low note response and eliminate scratch. Connects instantly between pickup and amplifier. A super bargain at **\$2.00**

THE BUFRAD SECTIONAL TOWER

This latest addition to the famous line of BUFRAD antenna products makes up to a hundred foot tower from any desired number of ten foot sections of extremely strong welded construction. The sections are shipped assembled so erection is a matter of minutes rather than hours. Finished in gray "TELECOTE" a new time and climate proof finish that will outlast the materials. Assembly is a one man job and is accomplished by climbing up the completed portion of the tower with the next 25 lb. section to be installed. Hand and footholds are provided to make the work safe and easy. Cap at top of tower provides bearing surface for rotating, and prevents water from entering tubes. Useful for police, or amateur transmitters, and in addition the tower will provide satisfactory TV reception where otherwise it would be impossible. Ideal for supporting permanent or temporary power lines, wind generators, stadium public address speakers, or spot lights for gas stations or parking lots. "B" and "C" sections together cost a total of \$13.75 and total 20 feet. "A" Sections, which make up the entire tower except for the top, are each ten feet long and cost but \$12.75 apiece. Those who wish a mast base will be able to obtain one (not shown) for only \$6.00. The base is especially useful when erecting the tower on a sloping roof.

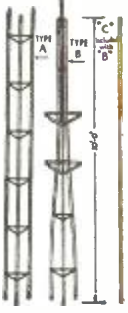

SIGNAL GENERATOR

Genuine Laboratory-type precision signal generator. Manufactured and sold for \$68.00 each in large quantities during the war by Northeastern Engineering Corp., one of the top manufacturers of electronic equipment for the U.S. Govt. Five fundamental bands starting at 150 KC. Strong harmonics up to 120 MC. Five step ladder type attenuator as well as potentiometer output control. Regular 1000 cycle audio oscillator using vacuum tube. Not a cheap neon sawtooth audio oscillator. Audio output separately available externally. Weight without packing material 16 lbs. which should show what a world of difference exists between this signal generator and the ordinary cheap oscillator used by the average serviceman. Complete with fused plug and coaxial output lead. Super Special \$38.75.



Hayonet type radio Pilot Light sockets for model railroad enthusiasts, etc. \$5.00 a hundred. Mazda licensed bulbs, per 10, 50c.

COMPRESSED AIR INSTANTLY ANYWHERE

Portable Air Compressor and Storage Tank. Ruggedly built. Best Materials. Lifetime lubricated ball-bearing pump connecting rod and oil-impregnated main bearing on shaft. Unusual design forever eliminates valve trouble, the most common fault in air compressors.



PATENTED unique air intake system increases efficiency tremendously so that air output is much greater than that from larger compressors powered by heavier motors. Delivers approximately 3500 cu. inches of air per minute at maintained pressure at 90 lbs. or will inflate a 90 lb. truck tire in less than one minute. Complete with 100 lb. gauge. Finger-tip adjustment allows setting of output pressure at any value, which will automatically be maintained. Works from any 1/4 H.P. motor. Useful for spraying paint, lacquer, disinfectant, insecticide, annealing or brazing with natural gas, inflating tires, etc. Price \$14.50 postage prepaid anywhere in the U. S. Efficient, completely adjustable siphon type spray gun complete with 12 ft. of 100 lb. tested hose, only \$7.75 with pint container, also prepaid.

"DRILLMASTER" ELECTRIC DRILL

Low-priced electric drill, ideal for hobbyists. Complete with sander, buffers, grinding wheels, etc. This is bankrupt stock and only a few are available. A sensational bargain at \$9.95. Satisfaction guaranteed or money refunded if returned prepaid within 5 days.



1950 MODEL MUTUAL CONDUCTANCE TUBE TESTER \$56.95

Attractive panel and case . . . Large 4 1/2" meter . . . Calibrated microhmo scale as well as Bad-Good scale . . . Front panel fuse. Individual sockets for all tube base types. Proper filament voltage supplied to test any tube ever made. Unequaled switching flexibility allows all present and future tubes to be tested regardless of location of elements on tube base. Indicates gas content. Detects shorts or opens on any element of any tube. Tests cold cathode, magic eye and voltage regulator tubes as well as all ballast, amplifier and rectifier types. Model "C"—Sloping front counter case **\$56.95** Model "P"—Handsome hand-rubbed portable case **59.95** Built-in roll chart with either of above \$5.00 extra.



Our PE-109 Power Plant Direct Current

A gasoline engine coupled to a 2000 watt 32 volt DC Generator. Can be adjusted to give 12 to 40 V. output. Ideal for use in locations not serviced by commercial power or to run any of the surplus items that require 24-32v DC for operation. The price of this power plant tested and in good condition is only \$79.95. We also supply a converter that will supply 110v AC from the above unit or from any 32v DC source for **\$12.95.**



6.95 TAKES ALL THREE BIG BARGAINS "E"

1. AUDIO AMPLIFIER—Brand new push-pull output triode amplifiers having 2 of the valuable and scarce omer type audio transformers that sell for over \$10.00 apiece. Near aluminum case, fully enclosed (largest dimension 6 inches). Perfect for intercom systems, phone amplifiers, mike amplifier, or signal tracer amplifier for testing radio sets. A sensational bargain at only **\$3.40 each**
2. BANDSWITCHING TUNING TURRET made by Western Electric. Covers 4 bands over 100 MC. All coils wound with #14 silver-plated wire. Complete with tuning condensers and powerful electric driving motor. ONE OF OUR MOST TERRIFIC VALUES—ONLY **\$2.95**
3. CARBON MIKE with Push-To-Talk Switch and Gold Plated Carbon Lapel Mike. Combination offer on both mikes **\$1.75**

SENSATIONAL, FASCINATING, MYSTERIOUS SELSYNS.

Brand new Selsyns. Brand new Selsyns made by G. E. Company. Two or more connected together work perfectly on 110V AC. Any rotation of the shaft of one Selsyn and all others connected to it will rotate exactly as many degrees in the same direction, following unerringly as if the units were connected together by shafting instead of wire. This is true whether you twist the shaft of the master unit a fraction or a revolution or many revolutions. Useful for indicating direction of weather vanes, rotating directional antennas, or controlling innumerable operations from a distance. Complete with diagram and instructions. Per Matched pair **\$4.95.**

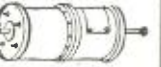

LS-7 "PM SPEAKERS"

Latest type PM Speaker in a fully-enclosed finished metal cabinet. This speaker and case match communications receivers and in addition make perfect intercom remote stations. Our price **\$4.50.** Including output transformer **\$4.95**



BUFFALO RADIO SUPPLY, 219-221 Genesee St., Dept. RT-1 BUFFALO 3, N. Y.

JANUARY, 1950

WHERE TO BUY IT . . .

WHOLESALE RADIO

of Baltimore

TV

RECEIVERS
COMPONENTS
ANTENNAS
ACCESSORIES

One of the Most Complete T.V. Supply Houses in the World

**Unbeatable TV Reception
BEST FOR THE FRINGE AREAS**

Snyder Lazy XX
TV ANTENNA
Complete
With Mast



Extremely hi-gain. Easily stacked double conical Lazy XX type. Just unfold, tighten and erect. All TV channels and FM. Overall height 11 ft. erected. Complete with 3 mating mast sections, guy wire anchors, stand-off pole insulators and adjustable mounting base. Completely pre-assembled. Can be used with any type lead-in 72 to 300 ohms impedance. Order model TX-2A.

\$16.95

TV ANTENNA ACCESSORIES

- RMS LIGHTNING ARRESTORS. For use with 300 ohm twin lead with no wire stripping. Strap mount type Model LA-1 53c
- STEEL EXTENSION POLES 10 ft. long. 1 1/4" di. Weather treated 31.95
- ANTENNA SWIVEL BASE, Aluminum 39c
- GUYWIRE, 6 stranded # 20. Per 50 ft. 24 reels 50 ft. each interconnected \$6.00
- 72 OHM COAXIAL CABLE RG59U (4c per ft.) per 100 ft. \$3.75
- 300 OHM TWIN LEAD (\$1.45 per 100 ft.) 1000 ft. \$11.75
- CHIMNEY MOUNT BRACKETS. Complete with strap \$1.59
- HI-BAND ADAPTER. Folded dipole and reflector. Clamps on existing pole \$2.00
- 3/2"-300 OHM STAND OFF INSULATORS. Wood screw in type, 3c ea. Per 100 \$2.75
- SAMS TV ANTENNA MANUAL \$1.25
- MATCHING TRANSFORMER. 72 ohms to 300 ohms \$2.40

**Sensational Antenna Buy!
SNYDER HI-LO ARRAY**



Complete With Mast Sections Model TV 21
We don't believe you'll find a finer antenna anywhere near this low price. Two folded dipoles (high and low) with reflectors. Complete with two 3/4" mast sections, guy ring, stand-off insulators. Ready for easy, quick installation. \$5.75 in Lots of 6 or More

\$5.95

Rigid Center! Self Adhering Margin!

VU-ALL TV FILTER

- The newest, finest TV filter. Washable, heat resistant. Can't break, tear or wrinkle. Universal for square or rounded-end pictures. Permanent glare relief. Grey tinted. Instantly applied.
- 7"—1.65
- 10"—2.25
- 12 1/2"—2.85
- 15 & 16"—4.05

**Get Perfect Picture in Fringe Area
NEW RMS TV BOOSTER**



Model SP-4
No lead loss. Maximum efficiency at high frequencies. Input and output iron cores assure maximum resonance at desired frequency. Covers all TV channels. Distinctively crafted cabinet. Order RMS Pre-amplifier SP-4. \$22.50
Look at These Other TV Booster units:
JERROLD TV-FM with built-in Match-A-Tran. \$22.50
ANCHOR ARC 101-50 \$22.50

WRITE FOR FREE MONTHLY "FYI" BULLETIN
ADDRESS ORDERS TO DEPT. QR 100
OR PHONE MULBERRY 2134

**WHOLESALE
RADIO PARTS CO., Inc.**
311 W. Baltimore St.
BALTIMORE 1, MD.

ADVERTISING INDEX

Allied Radio Corporation	83, 133
Alproco, Inc.	113
American Electrical Heater Co.	9
American Radio Corp.	135
Amperite Company	116
Amplifier Corp. of America	114
Amy, Aeeves & King, Inc.	115
Approved Electronics	140
Arrow Electronics	135
Walter Ashe Radio Co.	12
Bell Telephone Labs., Inc.	112
Boland & Boyce, Inc.	8
Boyce-Roche Book Company	128
Brook Electronics	138
Brooks, M.	141
Brooks Radio Dist. Co.	105
Buffalo Radio Supply	105
Jack Cantor	7
Capitol Radio Engineering Inst.	114
Certified Television Labs.	139
Cinex, Inc.	116
Circle-X Antenna Corp.	22
Cleveland Inst. of Radio	120
Communication Devices Co.	115
Communications Equip. Co.	139
Covideo, Inc.	130
Coyne Electrical School	11
DeForest's Training, Inc.	130
Frederick J. Drake & Company	130
Electro Products Labs.	117
Electro-Technical Industries	105
Electronic Instrument Co.	139
Electronic Measurements Corp.	123, 125, 127
Espey Mfg. Company, Inc.	132
Fair Radio Sales	128
Far West Trading Co.	144
Feiler Engineering Co.	114, 105
General Electronic Dist. Co.	87, 88, 89, 90, 91
General Test Equipment Co.	115
Green Radio Distributors	144
Greylock Electronic Supply Co.	134
D. H. Harrell Co.	138
Harvard Lab.	138
Heath Company	13, 14, 15, 16, 17, 18, 19, 20
Herbach & Rademan	124
Hershel Radio	131
Hotel Strand	136
Household	21
Hylron Radio & Electronics Corp.	115
Instructograph Company	134
Insuline Corp. of America	140
International Resistance Co.	119
Jackson Electrical Inst. Co.	121
Jensen Industries, Inc.	137
Jersey Specialty Co.	134
J. F. D. Mfg. Co.	104
The Kelsey Company	127
Lafayette Radio	99
Leetronic Research Laboratories	145
Leotone Radio Corp.	115
Lexipower Company	140
Liberty Electronics	140
McGraw-Hill Book Co., Inc.	145
The Macmillan Co.	145
Merit Products	140
Midwest Radio Corp.	103
Minex	139
Murray Hill Books, Inc.	115
National Company	96
National Radio Institute	3
National Schools	5
New Jersey Radio & TV Tube Co.	138
Niagara Radio Supply	111
Odegaard Manufacturing Co.	121
Ohmit Mfg. Co.	134
Opportunity Adlets	127
Plastics & Electronics Co.	136
Precision Apparatus Co.	136
Progressive Electronics Co.	101

RADIO SCHOOL DIRECTORY

(Pages 142-143)

American Radio Institute	Milwaukee School of Engineering
Baltimore Technical Inst.	Pacific Training School
Bliss Electronic School	BCA Institutes
Candler System Company	Radio Television Institute
Commercial Radio Institute	Tri-State College
Commercial Trades Institute	Valparaiso Technical Institute
Don Martin School of Radio Arts	Western-Radio Television Institute
Hollywood Sound Institute	YMCA Trade & Technical Schools
Lincoln Engineering School	
Massachusetts Radio School	

R & M Radio Co.	129
Radio City Products	100
Radio Corporation of America	97, Back Cover
Radio Dealers Supply Co.	122
Radio Receptor Co., Inc.	135
Radio Shack	137
Radio Supply & Engineering Co.	110
Radionie Equipment Corp.	138
John F. Rider Inc. Pub.	Inside Front Cover
Robin Hood Co.	136
The Rose Company	134
Senco Radio, Inc.	94
McMurdo Silver, Inc.	102
Simpson Electric Co.	95
Smithers Co.	120
Sovereign Television Co.	136
Sprague Products Co.	4
Sprayberry Academy of Radio	Inside Back Cover
Sun Radio & Electronics	132
Supreme Publications	114
Bill Sutton's Wholesale Electronics	139
Sylvania Electric Products	85
Tech-Master Products Co.	116
Technifax	138
Tel-A-Ray	114
Telrex Inc.	98
Tenastubs	115
Transvision	126
Triplet Mfg. Company	93
Turner Co.	109
United Surplus Materials	107
Universal General Corp.	115
University Loudspeakers, Inc.	86
D. Van Nostrand Co., Inc.	108
J. M. Weaver Co.	139
Weller Mfg. Co.	10
Wells Sales	146
Wholesale Radio Parts Co., Inc.	144
Wind Turbine Company	106

**SOUND POWER
PHONE CHEST SET**

RCA M1 2454-B TYPE C
NEW EXPORT PACKED
Shipping weight 6 lbs.

\$7.50 per set

IDEAL FOR TV ANTENNA INSTALLATIONS

FARWEST TRADING CO.

209—1ST SO. Seattle 4, Wash.

**ANOTHER OUTSTANDING JOBBER
GREEN RADIO DISTRIBUTORS**

482 SUTTER AVENUE
Brooklyn 7, N. Y.



HAS THE
SENSATIONAL NEW
400-K
RICO
5" Scope Kit
IN STOCK!

\$39.95



**TELEVISION
SERVICING
for RADIO MEN**

Get This Much Needed Book Now and Keep Up-to-Date—Helps You Earn More

This is the TV book of the hour, and it's for the professional radio man only. Not for TV owners who want to finker with their sets. It starts where the radio-man's knowledge and experience with AM sound receivers stops and provides simplified instruction, easy to follow, on all service operations. If you are in radio work, get this timely book now. Protect your job and your future with TELEVISION SERVICING—the complete TV service manual that will keep you up-to-date.

Covers alignment and other adjustments, replacements, test set-ups and connections, and trouble shooting with test patterns and oscilloscope traces. Includes instructions for using sweep and marker generators, oscilloscopes and electronic voltmeters in such work. Over 400 pages. 302 illustrations. The only book of its kind.

Be an Expert on All These Subjects

- The Television Picture—The Television Signal—The R-F Section or Front End—The Video I-F Amplifier—Instruments for Alignment—Alignment of Video I-F and Traps—Sound Section and its Alignment—Front End Alignment—Intercarrier Sound—Picture Tube Controls—Signal Input to the Picture Tube—The Sync Section—Sweep Oscillators—Automatic Control of Sweep Frequency—Sweep Amplifiers and Controls—Magnetic Deflection Amplifiers—Television Power Supplies—Trouble Shooting with Test Patterns.

Rush Order Today

Get this practical, helpful Television Servicing now. Protect your job and your future. Rush order to F. J. Drake & Co., 117 Green Bay Road, Dept. 181, Wilmette, Ill.



**Mail Coupon
MONEY BACK IF
NOT SATISFIED**

Frederick J. Drake & Co., Dept. 181
117 Green Bay Road, Wilmette, Ill.

Send me Television Servicing for Radiomen. If not satisfied I will return book in 5 days and money will be refunded.

- Check or Money Order for \$4.00 enclosed. Send book postpaid.
- Send C.O.D. plus postage.

Name

Address

City State

RADIO-ELECTRONICS for

BC-1206-C BEACON RANGE RECEIVER
"LAZY Q-FIVER"—BRAND NEW
 complete with tubes—\$5.95

FL-8A FILTER—\$1.37

SURPLUS EQUIPMENT
TROUBLE SHOOTING MANUALS
 (includes schematics)

BC-348	SCR-522	\$1.10 EA.
BC-779	BC-610	postpaid

BRAND NEW SOUND POWER PHONES
 TS-10 HANDSET—\$8.92 ea., \$17.60/pr.
 RCA Navy head & chest set—20 ft. cord—\$14.88
 ea., \$28.00/pr.
 RCA sound power unit. Use as mike or recvr.—
 \$1.11 ea., \$2.22/pr.

Send for free monthly bulletin
ELECTRONIC RESEARCH LABS.
 1021-E Callowhill St. Phila. 23, Pa.



JOIN
THE MARCH OF
DIMES

THE NATIONAL FOUNDATION FOR INFANTILE PARALYSIS



Assembled for your convenience
Facts, standards
practices, data
 for the whole field
 of radio engineering

Radio Engineering Library

RADIO specialists of the McGraw-Hill publications selected the books for this library as those giving the most complete, dependable coverage of facts needed by engineers whose special fields are grounded on radio fundamentals. They cover circuit phenomena, tube theory, networks, measurements, and other subjects... give specialized treatment of all fields of practical design and application.

- ★ Special Low Price
- ★ Bought singly, the five volumes would cost \$30.50. Under this offer you save \$3.00.
- ★ Pay in easy installments

Library includes:

1. Fundamentals of Vacuum Tubes—Eastman
 2. Radio Engineering—Terman
 3. Communication Engineering—Everitt
 4. High-Frequency Measurements—Hund
 5. Radio Engineering Handbook—Henney
- 3559 pages!
 2558 illustrations!

FREE 10 Day Trial

McGraw-Hill Book Co., 330 W. 42nd St., N.Y.C. 18
 Send me Radio Engineering Library, 5 vols., for 10 days' examination on approval. In 10 days I will send \$2.50, plus five cents postage, and \$5.00 monthly till \$27.50 is paid, or return books postpaid.

Name

Address

City Zone State

Company

Position RC-1-50

JANUARY, 1950

THEORY OF HEARING, by Ernest Glen Wever. Published by John Wiley & Sons, Inc., New York. 5½ x 8½ inches. 484 pages. Price \$6.

Too many electronics men concerned with audio tend to forget that the final purpose of all their efforts is to stimulate the human ear. The result is that many unwarranted assumptions based on pure mathematics are made. It satisfies a certain sense of neatness to achieve a flat frequency response in an amplifier or to arrange a sound installation so that tones of all frequencies have the same loudness as measured on a sound-level meter. The ear, however, refuses to accept the dicta of the decibel meters and responds differently to identical frequencies at different intensities.

Dr. Wever has made intensive study of the effect of sound on the ear since 1930. His book, while indicating that much remains to be done, contains a wealth of enlightening information for the serious audio man. The physiological basis for ear behavior is discussed throughout but—what is of greater interest to the electronics man—many theories and experimental results throwing light on the ear's behavior are given. Whys and wherefores of response to simple and complex waveforms, to various loudness levels, to different frequencies, and to shifts in phase are discussed in detail.

TELEVISION SERVICING FOR RADIOMEN, by H. P. Manly. Published by Frederick J. Drake Co. 5½ x 8 inches, 418 pages. Price \$4.00.

A book for the practical radio technician rather than the student of television theory, this work goes right into the front end of the receiver after a single preliminary chapter on the television signal. It continues in following chapters through the i.f.'s, video detector and amplifier, and the sound section.

The question of alignment is considered a major one by the author, and a number of chapters are devoted wholly or partly to it. Instructions are practical, and often given step-by-step.

After covering thoroughly those parts of the receiver which handle the video and audio signal, separate chapters are given to sync, sweep oscillators, sweep amplifiers, magnetic deflection amplifiers, power supplies and trouble shooting with test patterns.

TELEVISION WORKS LIKE THIS, by Jeanne and Robert Bendick. Published by Whittlesey House, New York. 6¾ x 10 inches, 64 pages. Price \$1.75.

In this thoroughly nontechnical explanation, only a very few pages are devoted to technical processes and the rest to program production. Probably 50% of the space is taken up with illustrative drawings—almost cartoons in character—with text on the adult level but designed for quick reading.

BASIC ELECTRONICS, by Royce G. Kloeffler and Maurice W. Horrell. Published by John Wiley & Sons, Inc., New York. 6 x 9½ inches, 435 pages. Price \$5.

A basic text book for those with a knowledge of physics but not of electronics. The treatment is not mathematical but calculations are introduced wherever necessary to avoid superficiality.—R.H.D.

WHAT IS YOUR PROBLEM?

You will find the answer in

Radio & Television Mathematics

A Handbook of 721 problems AND SOLUTIONS

Save time and trouble. Arranged under radio and electronic headings and completely indexed for quick reference, these problems give you step-by-step solutions to every problem commonly arising in work on receivers, power supplies, antennas, amplifiers, tubes, transmitters, etc. If you are ever "stuck" on a calculation; if you need a check on your figuring; or if you want to refresh your memory on the formulas to use for a certain problem—you will find your answer quickly and easily in this book.

Good practice for your FCC exams. This book shows you how to solve every problem requiring mathematics in the FCC STUDY GUIDE for licenses of all classes. You will find no better handbook for practice in solving problems with ease, speed and accuracy. \$6.00



Just Published
Television for Radiomen

The how's AND WHY'S in the practical terms of operation & servicing

This book explains the *theory* as well as the techniques of television construction, operation, and servicing in the clearest, most practical terms. It gives the radioman all the basic information he needs to meet the increasing demand for skilled television technicians. It shows how and *why* all modern equipment operates; includes all the essential mathematics and especially good material on antennas. \$7.00

SEE THEM FREE

The Macmillan Co., 60 Fifth Ave., New York 11

Please send me a copy of the books checked below. I agree to remit in full or return the books within ten days without further obligation.

- Radio & Television Mathematics, \$6.00
- Television for Radiomen, \$7.00

Signed.....

Address.....



TUBES

• TRANSMITTING
• RECEIVING
• INDUSTRIAL
• SPECIAL PURPOSE

Guaranteed by WELLS

Check this list for exceptional values in magnetrons, cathode ray tubes, voltage regulators, transmitting tubes—also neon, pilot and flashlight bulbs. These are brand new, standard make tubes. Order enough for future needs directly from this ad or through your local parts jobber.

TYPE	PRICE EACH
0A4G	\$0.95
01A	.45
1A5GT	.65
1B22	4.35
1B23	7.50
1E42	5.25
1C5GT	.65
1D8GT	.95
1E7GT	1.95
1E7G	1.95
1G6	.65
1L4	.75
1LC6	.75
1N5GT	.75
1N21 (Crystal Diode)	.65
1N21A	.95
1N21B	..
1N22	..
1N23	..
1N23A	..
N27	..
1N29	..
1Q5GT	.85
1R4/1294	.65
1S5	.70
1T4	.75
2A3	1.05
2A7	.85
2B7	.75
2B22/GL559	3.75
2C22/7193	.35
2C26	.35
2C26A	.45
2C34	.55
2J21A	11.45
2J22	9.85
2J26	8.45
2J27	12.95
2J31	9.95
2J32	14.85
2J33	18.95
2J34	17.50
2J37	13.85
2J38	6.95
2J48	12.95
2J61	27.50
2Y3G	1.20
2X2/879	.65
3A4	.35
3B22	2.65
3B24	1.75
3BP1	3.75
3C24/24G	.50
3D6/1299	.65
3E29	4.95
3FP7	2.95
3FP7A	4.95
3GP1	4.50
3HP7	2.95
3Q5	.90
3S4	.75
REL-5	14.95
5AP1	3.95
5BP1	2.75
5BP4	3.95
5CP1	3.75
5D21	24.75
5FP7	3.25
5GP1	4.95
5HP4	4.75
5J23	13.45
5J29	13.45
5R4GY	.95
6-4	.35
6-7	.35
6A3	.95
6A6	.75
6AB7	.95
6AC7	.90
6AK5	.80
6AK6	.80
6B4G	.95
6B7	.80
6B8	.95
6BE6	.65
6C4	.40
6C6	.75
6C21	19.25
6D6	.60
6E5	.70
6F6	.65
6G6G	.80
6H6	.45
6J5	.45
6J5GT	.45
6J6	.90
6J7GT	.70
6J8G	.95

TYPE	PRICE EACH
6K6GT	.55
6L7	.75
6N7	.75
6R7G	.75
6SA7	.65
6SC7GT	.70
6SF5	.65
6SG7	.65
6SH7	.40
6SJ6GT	.60
6SK7GT	.60
6SL7GT	.60
6SN7GT	.80
6SQ7GT	.60
6SR7	.60
6SS7	.65
6U7G	.85
6V6GT	.75
6Y6G	.75
7-7-11 Ballast	.35
7A4	.60
7A7	.60
7B4	.60
7C4/1203A	.40
7E6	.60
7F7	.70
7H7	.70
7K7	.70
7L7	.70
7N7	.70
7Q7	.60
10	.45
10T1 Ballast	.50
10Y	.45
12A6	.25
12A6GT	.25
12AH7GT	1.10
1208	.50
12F5GT	.65
12H6	.40
12J5GT	.70
12J7GT	.40
12K8	.65
12SF7	.70
12SG7	.65
12SH7	.40
12SK7	.60
12SL7GT	.60
12SQ7GT	.60
12SR7	.60
12X825 2 amp. Tungar	2.10
13-4 Ballast	.35
1486	.75
15R	1.20
REL-21	2.75
23D4 Ballast	.45
RK24	1.75
24A	.75
25Z6GT	.55
26	.65
27	.50
28D7	.40
30	.75
30 (VT-67) Walkie	.75
33 (VT-33) Talkie	.75
34	.35
RK-34	.45
35Y4	.65
36	.40
37	.40
38	.40
39/44	.35

TYPE	PRICE EACH
45 Spec.	.50
46	.75
EF50/VT250	.45
56	.65
70L7	1.05
72	1.75
RKR-73	1.25
76	.55
77	.55
VR-78	.65
80	.45
FG-81A	3.95
83V	.90
89Y	.40
VR-90	.65
VR-92	.65
100R	2.75
FG-105	9.75
VR-105	.85
VU-111-S	.55
1148	1.20
117Z3	.55
VT-127 British	.35
VT-127-A (Triode)	2.95
VR-150	.50
VT-158	14.95
FG-172	19.75
205B	1.45
211 (VT4C)	.60
215A	1.75
221A	2.10
231D	1.20
268A	2.95

TYPE	PRICE EACH
304TH	5.75
304TL	1.75
307A	4.25
316A	.75
350B	2.55
354C	14.95
371A	.95
371B	.85
388A	3.95
393A	4.65
395A	4.95
MX408U	.40
417A	14.50
434A	3.40
446A	1.55
450TH	17.95
471A	2.55
527	9.95
530	9.95
531	12.95
532A.1B32	3.55
GL-559	3.75
KU-610	7.45
HY-615	1.05
700B	7.95
700C	7.95
700D	7.95
702A	2.95
703A	3.95
704A	1.75
705A	2.65
707A	17.50
707B	19.50
708A	4.95

TYPE	PRICE EACH
710A	2.45
713A	1.55
714AY	3.90
715B	9.75
717A	.85
721A	3.75
723AB	14.95
724A	4.25
724B	4.25
725A	9.95
726A	17.45
730A	10.95
801	.50
801A	.70
803	5.25
804	9.95
805	5.95
807	1.25
808	1.65
811	2.35
813	7.85
814	3.75
815	2.85
826	.75
829B	4.95
830B	3.95
834	5.75
837	1.65
838	3.25
841	.50
843	.50
851	39.00
860	2.40
861	29.25

TYPE	PRICE EACH
864	.45
865	2.55
866A	1.30
869	19.95
869B	27.25
872A	2.45
874	1.95
878	1.95
930 Photo Tube	1.00
954	.45
955	.55
956	.50
957	.45
959	.55
991 (NE-16)	.30
1005	.35
1148	.35
1201	.75
1203A/7C4	1.05
1616	1.25
1619	.45
1624	1.25
1625	.45
1626	.45
1629	.40
1630	3.95
1638	.90
1641/RK-60	.75
2051	.75
7193	.30
8011	2.25
8012	3.25
8020	3.25
8025	6.75
9001	.65
9002	.45
9003	.60
9004	.40
9006	.40
38111A	.45

NEON BULBS

NE-11	.24
NE-16	.24
NE-20	.06
NE-21	.24
NE-48	.24

PILOT AND FLASHLIGHT BULBS

STOCK NO	MFR. NO.	VOLTS	WATTS	BULB	BASE	PRICE EACH
342-5	1256	6	21CP	S-8	DC Spec.	\$0.05
350-41	943	6-8	100CP	G-16 1/2	Auto Soc.	.10
354-76	1491	2.4	.8A	G-7	DC Bay.	.09
LB-200	56	115	6	S-6	Cand. Screw	.16
350-43	11A/T4C	18	.11A	T-4	Cand. Screw	.14
342-6	1245	6	3CP	G-6	SC Spec.	.08
LB-201	319	3	(Aircraft, metal housing, Amber Lens)	T-1 3/4	Pressure Flange	.40
342-6	1245	6	"	G-6	DC Bay.	.07
LB-202	328	24	6A.	S-6	Cand. Screw	.13
350-40	64	6-8	.2 amp.	G-3 1/2	Min. Screw	.07
350-42	Spec.	12	.06	T-3 1/4	Min. Bay	.06
350-20	1446	12	.5 amp.	B-3 1/2	Min. Flange	.05
350-14	49	2	500 W.	T-20	Med. Pf.	1.45
348-22	PR-10	6	.035 a.	T-2	Tel. Base	.18
350-19	Proj. Bulb	120	7W	C-7	Cand. Scr.	.17
LB-17C	248	24	1CP	Min. Bay	.07	
LB-58A	Nite Lite	110	239W	A-19	Med. Pf.	.38
LB-57A	53	12-16	(Aircraft)	T-1 1/2	953	.22
354-78	Airplane Headlite	24	250W	T-20	Med. Pf.	.40
350-55	323	3	50CP	RP-11	DC Bay	.14
342-3	LM-60	115	100W	T-8	DC Pf.	.33
342-2	1195	12-16	.8A	DC Bay.	.14	
354-76	CC-13	110	(Airplane Type)	DC Bay.	.14	
354-77	1491	2.4	.17A	T-3 1/2	Min. Bay	.11
LB-104	302	28	.09-.11A	T-2	Tel. Base	.18
350-24	313	28	.75-.105A	T-2	Tel. Base	.18
LB-107	12A	12	2 1/2 W	S-14	Med. Screw	.22
350-63	24-A2 WE	24	Telephone Type Neon	T-2	Tel. Base	.17
LB-109	AR-1 Argon	105	17	T-3	Min. Screw	.16
350-18	5122	24				
	1477					

MANUFACTURERS: We carry thousands of electronic parts in stock. Send us your requests for quotation.



Distributors: Our standard jobber arrangement applies. Order directly from this ad.

NEW CATALOGS READY
Complete listings of all Wells Electronic Components now available for Distributors, Manufacturers and Amateurs. Write for your copy today.

320 N. LA SALLE ST., DEPT.-Y, CHICAGO 10, ILL.

YOU Need My PRACTICAL Training to Make Money in

TELEVISION- RADIO and ELECTRONICS!



I'll Send You
8 BIG KITS of
Radio Parts and Equipment ...

Learn at
HOME
IN YOUR
SPARE TIME

NOW IS THE TIME To Get Into This Fast Growing Industry—Prepare For A Fine Paying Job Or Your Own Business!

If you want to get into Radio-Television and Electronics . . . you owe it to yourself to get the facts about my training. I have trained hundreds of men to become outstanding service technicians—and I'm ready to do the same for you. Whether your goal is a fine paying job in one of Radio's many branches—or a successful Radio and Television business of your own—you need the kind of training I offer! My training is practical and down to earth. **YOU NEED NO PREVIOUS EXPERIENCE.** You'll be astonished at your rapid progress. I start you with basic fundamentals and give you plenty of practical shop-bench training with many kits of parts I send you. This is the training that sticks with you and makes money for you on the job!

Get Paid For Spare Time While Learning

Soon after you start training I send you my famous **BUSINESS BUILDERS** that show you how to make money in spare time doing interesting Radio jobs. Look at the useful and valuable equipment you get while training with me (illustrated at left)—I send you these 8 big kits of Radio parts and equipment and help you build step-by-step a powerful 6-tube superhet radio, a 16-range test meter, plus other mighty useful equipment for Radio and Television servicing. You will perform over 175 fascinating experiments while training. You will learn about Television—so that you will be qualified to step into this fast growing, profitable field. I also send you many valuable service manuals, diagrams and my book telling exactly how to set up your own Television and Radio shop. *I want you to learn all about my training*—and that is why I urge you to clip and mail the coupon below for my two big **FREE** Radio books. I employ no salesmen—and nobody will call on you. The important thing is to act now and get the facts.

HAVE A BUSINESS OF YOUR OWN

A profitable Radio and Television Service Shop may be started with little capital. I will show you how to get started and how to build your small business. At left is pictured one of my graduates, Mr. Merrit C. Sperry of Fairmont, Minnesota in his own shop. The way is also open for you to build a good **SERVICE BUSINESS FOR YOURSELF.**

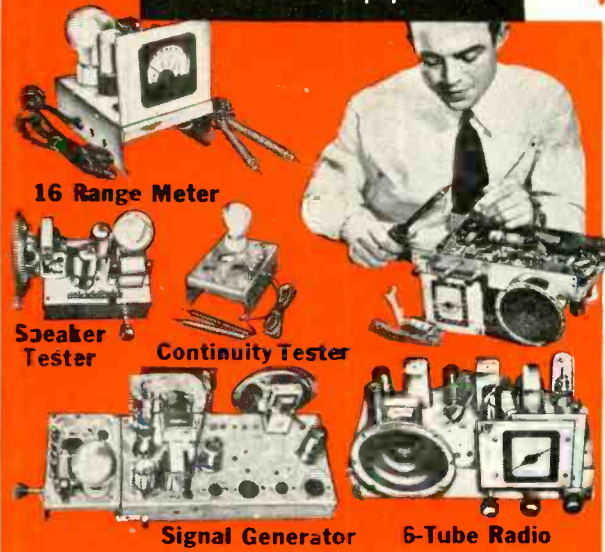

16 Range Meter

Speaker Tester

Continuity Tester

Signal Generator

6-Tube Radio

ALL KITS ARE YOURS TO KEEP

Each of the hundreds of Radio parts and other items I send my students is theirs "for keeps." You may use this equipment in your Radio and Television service work and save many dollars by not having to buy expensive "ready-made" test equipment. Each of my 8 kits will help you advance and learn important steps in Radio and Television servicing.



CALVIN SKINNER of New Orleans, La. tells us he makes \$5 to \$10 in spare time repairing radios. He is now also working with his own Television set.



LOREN D. SAUCIER of Coloma, Mich. reports that my training has made it possible for him to repair large numbers of Radio and Television receivers.

RADIO AND TELEVISION INDUSTRY BOOMING

You couldn't pick a better time to get into Radio-Television and Electronics. New Television stations are going on the air to serve every major city—hundreds of new AM and FM Radio broadcasting stations are also on the air to serve practically every community in America. All this creates new and bigger opportunities for the trained man who knows Radio-Television and Electronics. Good Radio and Television service men are needed **NOW!**

VETERANS

THIS TRAINING AVAILABLE TO YOU UNDER THE G. I. BILL

My Training Includes:

Radio Servicing
Television
FM Frequency Modulation
Public Address and High Frequency Applications



These Two Big **FREE!** Radio Books

Just mail coupon for a **FREE** sample Sprayberry Lesson and my big **FREE** book, "How To Make Money In Radio-Television and Electronics." Learn why my really practical training is best of all for you. Discover what's ahead for you in the fast moving Radio-Television and Electronics industry. No obligation. Don't delay—the future is too important to you. Mail the coupon now—and count on me for fast action.

RUSH COUPON Today!

SPRAYBERRY ACADEMY of RADIO, Dept. 20-E 111 North Canal St., Chicago 6, Ill.

Please rush my **FREE** copies of "How To Make Money In Radio-Television and Electronics" and "How To Read Radio Diagrams and Symbols."

Name.....Age.....

Address.....

City.....State.....

() Check here if you are a Veteran.

SPRAYBERRY ACADEMY OF RADIO
111 N. CANAL, DEPT. 20-E CHICAGO 6, ILL.

Now! Two great volumes...

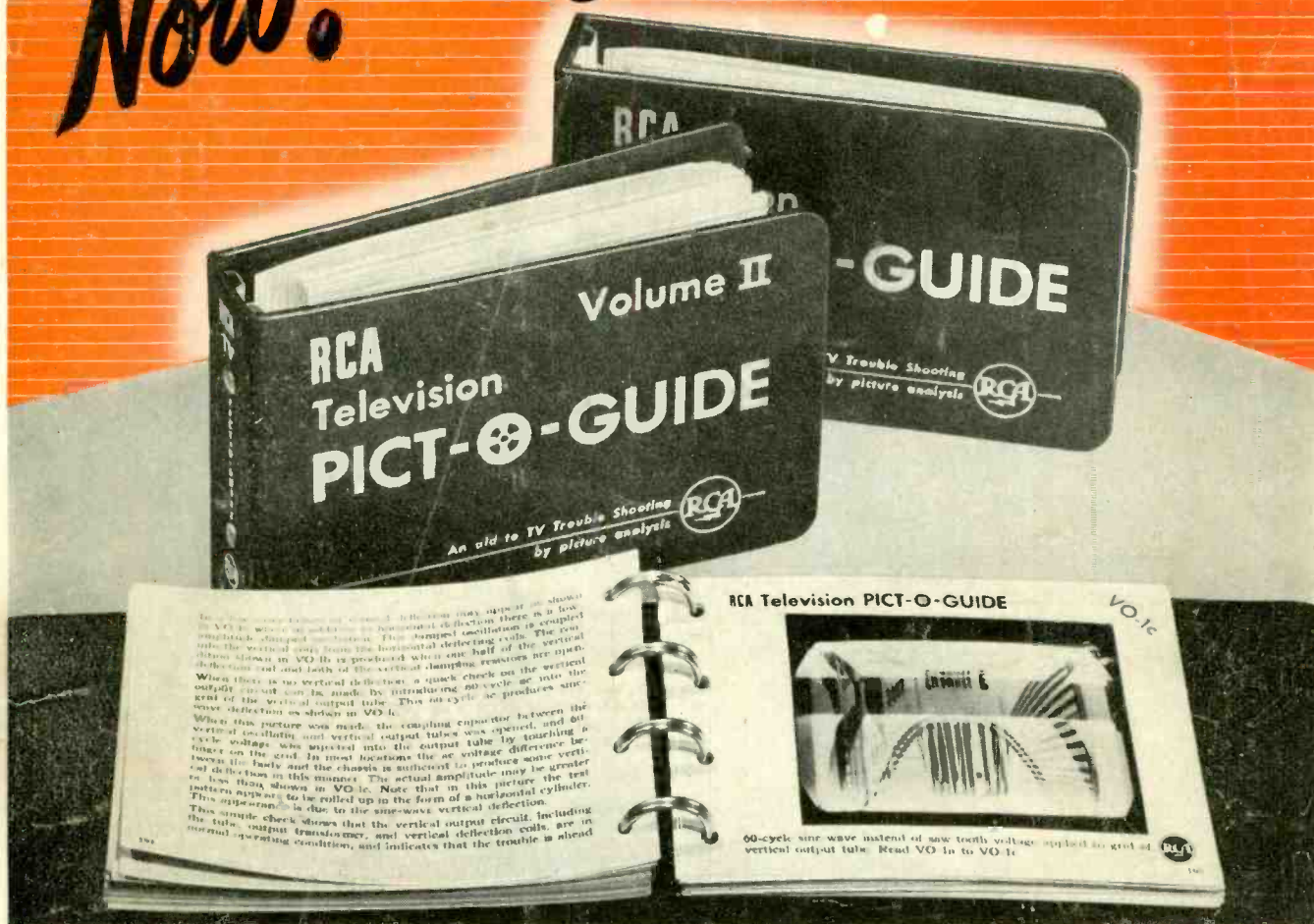

For quick and accurate TV trouble shooting...

Cunningham brings you the indispensable Pict-O-Guide

VOLUME I of the RCA Television Pict-O-Guide has been acclaimed as one of the greatest practical and instructive aids to TV receiver trouble shooting in the field.

Now—in addition—there is a second Volume, with twice as many pages, over 25,000 words of down-to-earth, up-to-the-minute text, covering the simplified time-saving method of TV trouble shooting by picture analysis.

The pictorial data and descriptive material in these Pict-O-Guides provide you with practical information on alignment, interlacing, focusing, blanking, sync, and

interference... basic, eyewitness information applicable to TV receivers, regardless of make!

HOW TO GET YOUR COPIES:

To get one or both Volumes of the RCA Television Pict-O-Guide, ask your Cunningham Distributor today for the folder "One Picture is Worth More Than 10,000 Words." It explains how to obtain either or both volumes at no extra cost to you with your purchase of Cunningham tubes. But don't delay... the supply of Pict-O-Guides is limited!



CUNNINGHAM TUBES - BUILT FOR SERVICE

A QUALITY PRODUCT OF THE RADIO CORPORATION OF AMERICA