

RADIO — ELECTRONICS

K

In this issue:
**TELEVISION
INSTALLATION
ANTENNAS
SERVICING**

HUGO GERNSBACH, Editor

formerly
**RADIO
CRAFT**



**BUSINESS METHODS IN
TELEVISION SERVICING**
SEE TELEVISION NEWS

OCT
1949

30¢

U. S. and
CANADA

LATEST IN RADIO — ELECTRONICS — TELEVISION

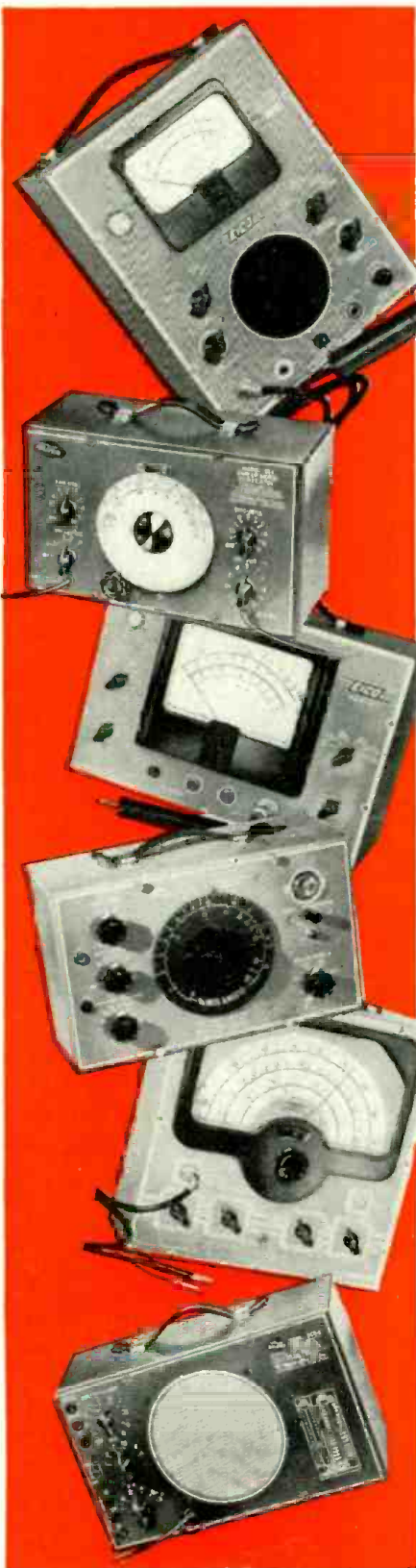

YOU JUST CAN'T SERVICE F.M. and T.V. BY **EAR!**

Or any Quality A.M. radio
— for that matter

2 Minutes . . . Reading Time
Benefits . . . for a Life Time

TODAY, modern time and labor-saving Test Equipment is a **MUST** to do the servicing job that brings satisfied customers *back* to you . . . and eliminates costly "callbacks" . . . in short, to be profitable, jobs must be done *right* the first time.

The days of "Servicing-by-Ear" are gone . . . only the alert, aggressive and properly-equipped technician can thrive and make money. Any Radio Serviceman, anywhere in the U.S.A., can now own new, up-to-date Test Equipment . . . *plus* many luxury items for his home, office, or hobby . . . *At No Cost* . . . through the famous N.U. DEALER EQUIPMENT PLAN . . . the only Plan that gives you this opportunity!

Since 1933, successful servicemen from every state in the Union have built their businesses around the 84,000 pieces of Equipment awarded them through the N.U. Dealer Equipment Plan . . . they earned them without any special effort . . . simply through their usual day-by-day purchases of N.U. Radio Tubes.

**ONLY YOUR N.U. DISTRIBUTOR
CAN OFFER YOU THE N.U. PLAN**

TEST EQUIPMENT: Ask him *today* to tell you how you can equip your shop, store or office.

LUXURY GIFTS: Mail the coupon below for the **FREE** 16-page fully-illustrated catalog.

Select the Test Equipment of your own choice from your N.U. Distributor's large, diversified stock . . . tell him you want to go on the N.U. Dealer Equipment Plan . . . get on-the-spot delivery of the Equipment . . . now you're on your way to a sounder, more profitable career in FM-TV and AM servicing.

Remember too National Union's help to the Service Engineer does not stop with Equipment. Each N.U. Tube, like the thoroughbred it is, best displays its 20 years of fine laboratory breeding, under the most severe operating conditions. No wonder N.U. Tubes are known throughout the industry as the Premium Quality Tube.

CLIP COUPON or
Use Penny Post Card

Free! Fully Illustrated
Luxury Gifts Catalog

NATIONAL UNION RADIO CORP.
350 Scotland Road, Orange, N. J.
Send me the FREE Luxury Gift Catalog and tell
me more about the N.U. Dealer Equipment Plan.

Name _____

Street Address _____

City _____ Zone _____ State _____

My Parts Distributor is: _____

For Prompt Action . . . Mail Today!



NATIONAL UNION RADIO CORPORATION

ORANGE, NEW JERSEY

RECEIVING TUBES • TRANSMITTING TUBES • CATHODE RAY TUBES • TELEVISION TUBES • SPECIAL PURPOSE TUBES
PHOTOTUBES • BALLASTS • BATTERIES • CAPACITORS • PANEL LAMPS • VIBRATORS • VOLUME CONTROLS

NEW



I'LL TRAIN YOU FOR YOUR FCC LICENSE

A Federal Communications Commission Commercial Operator's License puts you in line for a good job in Radio or Television Broadcasting, Police, Marine, Aviation, Two-way, Mobile or Micro-wave Relay Radio. Mail coupon below for book and catalog (both FREE) about my NEW Communications course.



YOU BUILD THIS TRANSMITTER

with parts I send. This low-power broadcasting transmitter shows you how to put a station "on the air." You perform procedures demanded of Broadcast Station Operators, conduct many experiments, make many practical tests.

LEARN COMMUNICATIONS by PRACTICING at Home in Spare Time

with MANY KITS of MODERN EQUIPMENT I SEND



YOU BUILD this Transmitter Power Supply used in the basic experiments in RF and AF amplifiers, frequency multipliers, buffers, etc.

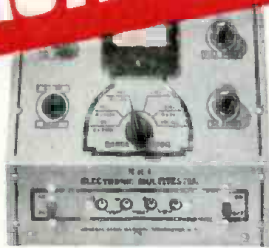

YOU MEASURE current, voltage (AC, DC and RF), resistance and impedance in circuits with Electronic Multitester you build. Shows how basic transmitter circuits behave; needed to maintain station operation.



YOU SET UP code amplitude and frequency modulation circuits (put voice, music, etc., on "electrical signal" you produce). You introduce, correct defects, learn how to get best performance.





YOU BUILD this Wavemeter and use it to determine frequency of operation, make other tests on transmitter currents.

I TRAINED THESE MEN

 "I am now Chief Engineer of Radio Station WORD, in charge of four engineers. Owe all I know about Radio to N. R. I." — C. J. BURDETTE, Spartanburg, S. C.

 "I have been in several kinds of Radio work. I am now specializing in Marine Radio telephone installations and service." — MURRAY DICKSON, Paducah, Ky.

 "Thanks for splendid Home Study Radio Course, a large factor in my getting present position as Senior Radio Operator of Station WRGP." — C. LISTER, Pensacola, Fla.

 "When I enrolled, I had no idea of entering Commercial Radio. Now Operator, Police Radio Station WASP and Highway Station WKSJ." — G. DeRAMUS, Selma, Ala.

 "Hold a Radio telegraph Second Class License. Now with Civil Service as P-4 Electrical Engineer." — OTIS L. WRIGHT, Albuquerque, N. M.

 "Am now Chief Engineer at Radio Station WAGC. Still using my N. R. I. texts as swell references." — CHAS. W. STOKELEY, Chattanooga, Tenn.

VETERANS GET THIS TRAINING WITHOUT COST UNDER G. I. BILL. MAIL COUPON.

Ever think HOW FAST Radio-Television Communications is changing, developing, growing? Have you considered what this amazing progress can mean to you?

In 1945, there were 943 Broadcasting Stations. Today 2,694 are on the air! Result—THOUSANDS OF QUALIFIED MEN STEPPED INTO GOOD JOBS. Only 19 Television Stations were on the air in 1947. Today there are more than 50 and experts say there will be 150 in a few months, 1,000 within three years. That means thousands of well-paid jobs for trained Operators and Technicians. Then add development of FM, Two-way Radio, Police, Marine, Aviation and Micro-wave Relay Radio! Think what all this means! New jobs, more jobs for beginners! Better jobs, better pay for experienced men!

Are you a beginner who wants steady work in this growing field? My NEW course can help you get an FCC License and prepare for the job you want. Are you a man with some training in Radio or Radar, or a Licensed operator? My NEW course modernizes, increases the value of your knowledge and experience!

Servicing Training Also Offered by N. R. I.

If you prefer a good-pay job in Radio-Television Servicing... or your own money-making Radio-Television Sales and Service Shop, I'll train you at home. My famous Servicing Course also includes many Kits of Parts. You conduct experiments and tests with modern Radio and other circuits you build. I also show you how to make \$5, \$10 a week or more EXTRA MONEY fixing neighbors' Radios while training. Full information in my 64-page catalog. Mail coupon.

MY COURSE INCLUDES TELEVISION

Course Is New! Different!

Mail coupon now for facts about my NEW, intensely practical course in Radio-Television Communications. Let me send you FREE books. Read outlines of 78 lesson texts written for you by leading Communications experts, edited by my practical staff. See the nine big Kits of Parts I send that "bring to life" theory you learn. Read about the transmitter you build and operate, about the Electronic Multitester you get. All equipment yours to keep. My BRAND NEW course includes BOTH Theory and Practical Experience, with result-getting kits, in Radio-Television Communications. It's backed by N. R. I.—the world's oldest and largest home study Radio school.

Mail Coupon For Book FREE

Send today! See what my NEW course is like. Find out how I get you ready for a brighter future, better earnings, more security in Radio-Television. Send coupon now in envelope or paste on penny postal. NO OBLIGATION. NO SALESMAN WILL CALL! My books, sent to you FREE, tell the full story. J. E. SMITH, President, Dept. 9KX, National Radio Institute, Washington 9, D. C.

MAIL NOW-BOOK FREE

MR. J. E. SMITH, President, Dept. 9KX National Radio Institute, Washington 9, D. C.

Mail me FREE Catalog and Book about Radio and Television Communications opportunities and training. (No salesman will call. Please write plainly.)

Name..... Age.....
Address.....
City..... Zone..... State.....
 Check if Veteran Approved Under G. I. Bill

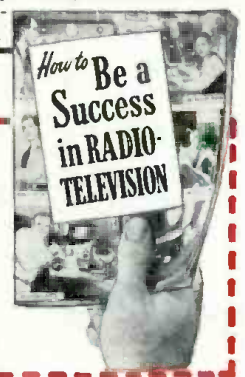

RADIO — ELECTRONICS

formerly RADIO-CRAFT

Incorporating

SHORT WAVE CRAFTS TELEVISION NEWS
RADIO & TELEVISION

*Trademark registered U. S. Patent Office

Sales Managers
John J. Lamson, Lee Robinson
Circulation Manager
G. Aliquo

Hugo Gernsback, Editor-in-Chief
Fred Shunaman, Managing Editor
M. Harvey Gernsback, Consulting Editor
Robert F. Scott, W2PWG, Technical Editor
R. H. Dorf, W2QMI, Associate Editor
I. Queen, W2OUX, Editorial Associate
Angie Pascale, Production Manager
Wm. Lyon McLaughlin,
Tech. Illustration Director

Contents — October, 1949

Editorial	
Electronic Magic	by Hugo Gernsback 19
Television News (Pages 20-36)	
Business Methods in Television Servicing	by Charles Wigutow 20
Replacing Picture Tubes in Television Receivers	by Milton S. Kiver 23
TV Custom Building	by David T. Armstrong 26
Indoor Television Antennas	by Edward M. Noll and Matt Mandl 29
Three New TV Receivers	31
TV Station Studio Controls	by Morton Shore 32
Roof-Top Teviser	by Robert F. Scott 34
TV Antenna Switch	by Lyman E. Greenlee 36
Electronics (Pages 37-39)	
Counters for Prospectors	by Richard H. Dorf 37
New Miniature Printed Circuit	39
Theory and Engineering (Pages 40-41)	
Microwaves, Part VI	by C. W. Palmer 40
Amateur (Pages 42-43)	
How to Become a Ham, Part I	by George W. Shurt, W4AMN 42
Construction (Pages 44-47)	
Home-Built Snooperscope Uses Surplus Tube	by Harold Pallatz 44
Neon Blinker Saves Batteries	by Ralph Hollows 46
Tubeless Oscillator Uses IN34 Crystal	by Rufus P. Turner, K6AI 47
Servicing (Pages 48-65)	
Fundamentals of Radio Servicing, Part VIII—Transformers—How They Work	by John T. Frye 48
Radio Set and Service Review, Motorola VT73	52
Pedro Makes a Record	by Guy Slaughter 56
Selenium Rectifiers Replace Vacuum Tubes	by John B. Ledbetter 63
Foreign News (Pages 68-70)	
European Report	by Major Ralph W. Hollows 68
Test Instruments (Page 72)	
Taking Care of Test Equipment	by Harry Leeper 72
Departments	
The Radio Month	8
Radio Business	10
New Devices	66
New Patents	74
Radio-Electronic Circuits	78
Question Box	80
Try This One	82
Association News	84
Technotes	85
People	86
Miscellany	88
Communications	90
Book Reviews	95

ON THE COVER: One of the benches of the Abington television service, showing the built-in viewing tubes for models to be checked on that bench. Service technician John Mend making the adjustments. Kodachrome by Avery Slack.

RADIO-ELECTRONICS, October, 1949. Volume XXI, No. 1. Published monthly. Publication Office: Erie Ave., P. O. G. Streets, Philadelphia 32, Pa. Entered as second class matter September 27, 1948, at the post office at Philadelphia, Pa., under the Act of March 3, 1879. SUBSCRIPTION RATES: In U. S. and Canada, in U. S. possessions, Mexico, South and Central American countries, \$3.50; \$6.00 for two years; \$8.00 for three years; single copies 30c. All other foreign countries \$4.50 a year, \$8.00 for two years, \$11.00 for three years. Allow one month for change of address. When ordering a change please furnish an address stencil impression from a recent wrapper. RADIO-CRAFT PUBLICATIONS, INC. Hugo Gernsback, Pres.; M. Harvey Gernsback, Vice-Pres.; G. Aliquo, Sec'y. Contents Copyright, 1949, by Radio-Craft Publications, Inc. Text and illustrations must not be reproduced without permission of copyright owners.

EDITORIAL and ADVERTISING OFFICES: 25 West Broadway, New York 7, N. Y. Tel. REctor 4-9699. **BRANCH ADVERTISING OFFICES:** Chicago: 308 W. Washington Street. Telephone Randolph 6-7363. Los Angeles: 1241 W. Harker, 127 Wilshire Blvd., Tel. MA 6-1271. San Francisco: Ralph W. Harker, 582 Market St. Tel. GARfield 1-2481. **FOREIGN AGENTS:** Great Britain: Atlas Publishing and Distributing Co., Ltd., 18 Hyde Lane, Fleet St., London E.C.4. Australia: McGill's Agency, 179 Elizabeth Street, Melbourne. France: Brentano's, 37 Avenue de l'Opera, Paris 20. Holland: Trilectron, Heemstedeche, Dreef 124 Heemstede, Greece: International Book & News Agency, 17 Amerikis Street, Athens. S. Africa: Central News Agency, Ltd., Cor. Itasik & Commissioner Sts., Johannesburg, 112 Long Street, Capetown; 368 Smith Street, Durban. Natal. Universal Book Agency, 70 Harrison Street, Johannesburg. Middle East: Stelmatsky Middle East Agency, Jaffa Road, Jerusalem. India: Susti Gupta (Distributors) Co., Armita Bazar Patrika Lt., 14 Ananda Chatterjee Lane, Calcutta. Broadway News Centre, Post Bag #5557, Dablar, Bombay #14. K. L. Kannappa Mudalir, 30 General Patters Road, Mount Road, Madras 2. Pakistan: Paradise Book Stall, Opp. Regal Cinema, Freedy St., Karachi 3.

NEW TELEKITS

NOW \$59.50

Jobbers: Write for Price Information



NEW TELEKITS
10-B \$82.99
7-B \$59.50

Sparkling new Telekit 10-B has 52-inch screen. Brand new compact lay-out has video tube mounted on chassis. Big illustrated easy-to-follow instruction book guides you step by step through easy assembly. No special knowledge of television is required. All you need is a soldering iron, pliers, and screw driver. 10-B Kit can be used with 12½, 15, 16-inch tubes. Telekit 10-B, \$52.99. Tube kit, including 10BP4 and all other tubes, \$55.80. 10-B Telekit cabinet, \$15.95 to \$24.50. Telekit Guarantee includes free factory service.



Note simple clean lay-out for easy assembly of new Telekit 10-B. Features 2 sound I. F. stages, a new pre-built, pre-aligned tuner that includes a stage of R. F. for distance reception. Easy-to-adjust horizontal lock circuits. Beautiful new model cabinets for 7-B and 10-B are heavily constructed of hand rubbed walnut.



13 CHANNEL TUNER \$19.95

NEW 13 CHANNEL TUNER is a small compact unit with stage of R.F. Tunes all TV and ZFM channels. Made to conform with Telekit or any other TV set having video I.F. of 25.75 Mc. Complete with tubes, pre-wired, pre-aligned; only three connections to make. See your jobber, or write to us for information. Your cost, \$19.95.

Write for catalog of Telekit antennas, boosters, television kits, tuners, television parts and tubes.

TELEKIT
SANDERS ELECTRONICS CO.
AVIATION BLDG., 3240 N.W. 27th AVE.
MIAMI 42, FLORIDA

RADIO-ELECTRONICS for

Editorial and Executive Offices:
25 West Broadway, New York 7, N. Y.

MEMBER
AUDIT BUREAU OF CIRCULATION



Get Into

RADIO, TELEVISION and ELECTRONICS

Master ALL Phases

YOU Build This Superheterodyne

You receive complete standard equipment, including latest type High-Mu Tubes, for building various experimental and test units. You progress step by step until you build a complete Superheterodyne Receiver. It is yours to use and keep.

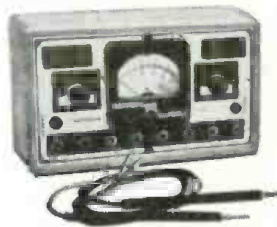

YOU RECEIVE THIS PROFESSIONAL MULTITESTER!

You will use this professional instrument to locate trouble or make delicate adjustments—at home—on service calls. You will be proud to own this valuable equipment. Complete with test leads.

SIGNAL GENERATOR

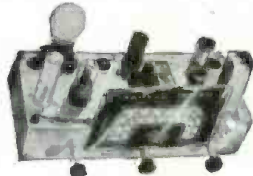

You construct the Transatron Signal Generator shown here, demonstrating Transatron principles in both R.F. and A.F. stages. You study negative type oscillators at firsthand.

AUDIO OSCILLATOR:

An electronic device, which produces audio-frequency signals for modulating R.F. (radio frequency) carrier waves, testing A.F. (audio frequency) amplifiers, speakers, etc.

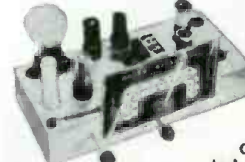

T.R.F. RECEIVER

You build several T.R.F. Receivers, one of which, a 4-tube set, is shown here. You learn construction, alignment, make receiver tests, and do trouble shooting.

Get Complete Training. You Receive and Keep All Equipment, Parts and Lessons. No Extra Charges.

GOOD PAY and Unlimited Opportunities in JOBS LIKE THESE:

- Business of Your Own
- Radio Manufacturing, Sales, Service
- Broadcasting Telecasting
- Television Manufacturing, Sales, Service
- Laboratories: Installation, Maintenance of Electronic Equipment, Electrolysis, Call Systems
- Garages: Auto Radio Sales, Service
- Sound Systems and Telephone Companies; Oil Well and Drilling Companies; Engineering Firms
- Theatre Sound Systems Police Radio
- And scores of other good jobs in many related fields

YOU CONDUCT MANY EXPERIMENTS LIKE THESE!

- Checking action of condensers
- Experiments with cathode-ray principles
- Experiments with resonance
- Producing beat frequencies
- Calibrating oscillators
- Experiments with diode, grid-bias, grid-leak and infinite impedance detectors
- Practical experience in receiver trouble shooting
- Application of visual tester in checking parts and circuits
- Experiments with inverse feed-back
- Advanced trouble-shooting
- ... and many, many others

Complete Training by Practical Resident Trade School, Est. 1905

The same highly trained faculty, instruction materials and methods used here in our large, modern resident school, are adapted to your training in your own home. Shop Method Home Training has been proved by hundreds of successful graduates.

Both Resident and Home Study Courses Offered

YOU LEARN BY DOING

You receive special laboratory experiment lessons to show you how to build with your own hands various experimental units such as those shown at left, and how to conduct many tests.

You will find all lessons easy to understand because they are illustrated throughout with clear diagrams and step-by-step examples that you work out yourself. Every piece of the equipment and complete lesson material we send you is yours to keep and enjoy, including the multitester, experimental equipment, all parts of the Superheterodyne, tube manual, radio dictionary, and complete, modern Television texts. All parts are standard equipment.

Shop Method Home Training . . . Earn While You Learn

With our practical resident Shop Method Home Training, you study in your spare time. You receive Spare Time Work Lessons, which show you how to earn while you learn. Service neighbors' radios and TV receivers, appliances, etc., for extra money and experience. Many National students pay all or part of their training with spare time earnings!

DON'T DELAY! The Radio-Television Industry needs trained men NOW!

APPROVED FOR VETERANS!
Check coupon below!

For quick action, mail coupon today and we'll rush you full information.

Free!

NEW, ILLUSTRATED OPPORTUNITY BOOK AND SAMPLE LESSON SHOW YOU HOW WE TRAIN YOU . . . SEND FOR THEM TODAY! NO COST. NO OBLIGATION.

NATIONAL SCHOOLS
LOS ANGELES 37, CALIF. • EST. 1905

FIND OUT NOW . . . MAIL COUPON TODAY

National Schools, Dept. 10-RE
4000 South Figueroa Street
Los Angeles 37, California

Send me your FREE book "Your Future in Radio" and the sample lesson of your course. I understand no salesman will call on me.

NAME _____ AGE _____

ADDRESS _____

CITY _____ ZONE _____ STATE _____

Check here if Veteran of World War II

Mail in envelope or paste on penny postal.



says EDWARD CROXEN

General Service Manager of Hallicrafters

In addition to providing all necessary signal sources, the new Simpson Genoscope includes a high sensitivity oscilloscope of unique advanced design, complete in every detail. Sensitivity 25 millivolts per inch. Wide band response to 3 megacycles or more. Equipped with a high frequency crystal probe for signal tracing. AM and FM oscillator sections provided with large, easy to read dials with 20:1 vernier control and 1000 division logging scale. *Revolutionary, Ingenious, Exclusive* output termination provides for various receiver impedances, either direct or through an isolating condenser.

Step attenuator for control of output.

Size: 22"x14"x7 1/2". Weight 45 lbs. Shipping Weight 54 lbs.

DEALER'S NET PRICE complete with Test Leads and Operator's Manual \$375.00

the hallicrafters Co.
MANUFACTURERS OF RADIO AND ELECTRONIC EQUIPMENT



510 AND HOSKINS AVENUES
Chicago 24, Ill.

Mr. Ray Simpson, President
Simpson Electric Company
5208 West Kinzie Street
Chicago 44, Illinois

Dear Mr. Simpson:

Congratulations! The Simpson Model 480 FM-TV Genoscope is the perfect instrument for the proper alignment of all FM and TV receivers.

In addition to providing all necessary signal sources, the new Simpson Genoscope includes a

CHECK THESE RANGES AND YOU WILL SEE HOW MUCH THE SIMPSON GENOSCOPE CAN DO FOR YOU

RANGES FREQUENCY MODULATED OSCILLATOR	AMPLITUDE MODULATED OSCILLATOR
Band A—2-120 megacycles	Band A—3.2-16 megacycles
Band B—140-260 megacycles	Band B—15-75 megacycles
Sweep width variable from zero to 15 megacycles	Band C—75-250 megacycles
Sweep rate 60 cycles per second	30% modulation at 400 cycles or unmodulated
Specially designed frequency sweep motor	Continuously variable attenuator
Continuously variable attenuator	Visual method of beat frequency indication
Crystal calibrator—5 megacycles \pm .05%	
Audio Oscillator 400 cycles	

Modern FM and TV development and servicing requires the use of test equipment made to exacting standards. With this in mind Simpson offers you the Genoscope with the assurance that everything possible has been done to make it the most accurate, flexible and convenient instrument available. The Genoscope will render many years of uninterrupted service and always produce accurate results.

HERE'S THE SIMPSON—MODEL 479 TV-FM SIGNAL GENERATOR

Exactly the same circuits, ranges and functions as the Model 480, described above, with the exception of the oscilloscope.

Size 17"x14"x7 1/2". Weight 34 lbs.
Shipping Weight 40 lbs.

DEALER'S NET PRICE with Test Leads and Operator's Manual \$245.00



Simpson
INSTRUMENTS THAT STAY ACCURATE

SIMPSON ELECTRIC COMPANY
5200-5218 WEST KINZIE STREET • CHICAGO 44, ILLINOIS
In Canada: Bach-Simpson, Ltd., London, Ont.

RADIO-ELECTRONICS for



Make More Money in the Expanding Servicing Field

WITH CREI NEW, PRACTICAL "ON THE JOB" TRAINING IN TELEVISION & FM SERVICING

The next twelve months will produce some of the greatest opportunities that have ever been offered to alert men in the Servicing Field.

It is the year for you to make the big decision. Either you are going to catch up with the new developments in the industry, or you are going to be passed by.

This practical course has been written for *today's* serviceman to meet *today's* problems and opportunities.

CREI knows what you need, and every effort has been made to keep this course practical and to the point. If you are now engaged in servicing work, you will be able to understand and apply each lesson. This course has been reviewed and checked by qualified service experts who know what *you must know* to get ahead in this booming field.

VETERANS: CREI TRAINING AVAILABLE UNDER G.I. BILL
For Most Veterans July 25, 1951 Is Deadline—ACT NOW!

If you have had professional or amateur radio experience and want to make more money, let us prove to you we have the training you need. To help us answer intelligently your inquiry—*please state briefly your background of experience, education and present position.*

RADIO SERVICE DIVISION OF

CAPITOL RADIO ENGINEERING INSTITUTE

An Accredited Technical Institute

Dept. 1510A, 16th & Park Road, N. W., Washington 10, D. C.
Branch Offices: N. Y. 7, 170 Broadway; San Francisco 2, 760 Market St.

OCTOBER, 1949

Every lesson can be helpful in your daily work—you will soon have the technical knowledge necessary to handle all types of good paying Television and FM servicing business.

In offering this course at a popular price, CREI is enabling thousands of the "top third" now engaged in service work to enter the ultimate profitable field of television and FM installation and service.

This can be your big year! Write today for complete information. The cost is popular. The terms are easy. The information is free. Write today.

FREE SAMPLE LESSON

Now, see for yourself! Mail the coupon for free sample lesson and see how interesting it is to study at home and improve your income, through ability the CREI way.

TELEVISION AND FM TROUBLE SHOOTING

This lesson is devoted to live, "dollar-and-cents" practical practice based on day-to-day servicing problems. Read this interesting lesson and see for yourself how CREI training can help you. Mail coupon for this sample lesson, free booklet and details.

MAIL COUPON FOR FREE BOOKLET

CAPITOL RADIO ENGINEERING INSTITUTE
16th & Park Road, N. W., Dept. 1510A, Washington 10, D. C.

Gentlemen: Please send your FREE SAMPLE LESSON and complete details of your new home study course in Television and FM Servicing. I am attaching a brief resume of my experience, education and present position.

Check field of greatest interest:

- | | |
|---|--|
| <input type="checkbox"/> PRACTICAL RADIO ENGINEERING | <input type="checkbox"/> PRACTICAL TELEVISION ENGINEERING |
| <input type="checkbox"/> BROADCAST RADIO ENGINEERING (AM, FM, TV) | <input type="checkbox"/> TELEVISION & FM SERVICING |
| <input type="checkbox"/> AERONAUTICAL RADIO ENGINEERING | <input type="checkbox"/> ADVANCED ELECTRONICS COMMUNICATIONS |
| | <input type="checkbox"/> RADIO-ELECTRONICS IN INDUSTRY |

NAME

STREET

CITY ZONE

I AM ENTITLED TO TRAINING UNDER G. I. BILL.

American Beauty

ELECTRIC SOLDERING IRONS

are sturdily built for the hard usage of industrial service. Have plug type tips and are constructed on the unit system with each vital part, such as heating element, easily removable and replaceable. In 5 sizes, from 50 watts to 550 watts.

TEMPERATURE REGULATING STAND

This is a thermostatically controlled device for the regulation of the temperature of an electric soldering iron. When placed on and connected to this stand, iron may be maintained at working temperature or through adjustment on bottom of stand at low or warm temperatures.



For descriptive literature write

**AMERICAN ELECTRICAL
HEATER COMPANY
DETROIT 2, MICH., U. S. A.**

NEW GLASS for television tube faces produces greater contrast, giving sharp black-and-white pictures in well lighted rooms without need for excessive brightness, Pittsburgh Plate Glass Co. engineers announced last month.

In any television tube, as the drawing shows, light from the bright portions scatters, some travelling straight ahead and some at such an angle that it is reflected by the glass surface. Part of this reflected light strikes the dark portions of the phosphor and is reflected again straight ahead, making the dark portions of the picture lighter

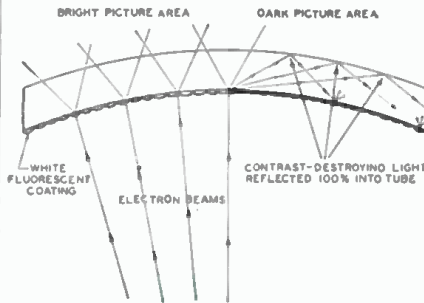

Reflected light can destroy picture contrast.

and weakening the contrast. In ordinary glass, the reflected light is little weaker than the direct beam. The new tube face is made of a special light-absorbing glass, which acts as a filter. The reflected-light paths are more than three times as long as that of the direct beam. Thus undesirable reflected light is attenuated to an extent which makes the increase in contrast impressive to even the most casual looker-on.

Since the tube face is itself a filter, it reduces the effect of room light. The result is a more natural, easy-to-see picture that can be viewed without eyestrain, Pittsburgh Plate Glass engineers believe.

Television receivers with the new glass tube faces have been featured by Zenith and it was expected that they would soon be adopted by other manufacturers.

HAM CONVENTION termed the "biggest show in amateur radio" will be held in New York City October 7, 8, and 9 by the Hudson Division of the ARRL. Features for all classes of amateurs have been planned, with particular emphasis on the younger generation with a "how to get started" theme. The show and convention will be held at the Ninth Regiment Armory.

SYMPOSIUM on electronic instrumentation in nucleonics and medicine will be held at New York's Hotel Commodore on October 31, November 1 and 2. This second annual conference on the subject will be sponsored jointly by the Institute of Radio Engineers and the American Institute of Electrical Engineers. The first day will be devoted to electronics in medicine, the second to nucleonics in medicine, and the third to the physical aspects of nucleonics instrumentation.

TV PROJECTION systems are kindest to the eyes, according to last month's journal of the New York State Optometric Association. The statement followed a study of the Philips Protelgram system. A projection system was said to cause less eyestrain because of the larger image, need less eye accommodation for close viewing, and give the visual advantage of a softer image of photographic quality on an optically correct screen.

TV SERVICE CALLS should be paid for at a nominal rate after the 90-day manufacturer's warranty on the receiver expires, according to Television Manufacturers Association. Michael L. Kaplan, president of TMA and of Sightmaster Corp., announced last month that because of the New York State Attorney General's statement that some service contracts infringe on the insurance domain (see page 9, September issue), TMA is redoubling its efforts to arrive at a standardized per-service-call fee.

TMA is conducting a survey of manufacturers and service organizations to determine a standard agreement satisfactory to all. The fee for service calls would eliminate the insurance aspect of the business, the Association says, and would best serve the public, since most major troubles appear during the 90-day warranty period.

AUDIO FAIR will be held at the Hotel New Yorker in New York City October 27, 28, and 29. Sponsored by the Audio Engineering Society, the Fair will show audio products of leading manufacturers and will include technical sessions on each of the three days. The subjects of recording—tape, disc, and film—and microphones, loudspeakers, and amplifiers will be covered. A banquet is planned for the 27th.

PREVENTIVE MAINTENANCE will be the theme of Pennsylvania's radio service technicians throughout the month of October. Heralded by the Philadelphia radio technician's convention September 18, 19, and 20, Preventive Maintenance Month will be dedicated to the task of showing the radio owner the advantages of having his radio looked after before instead of after it breaks down.

An intensive campaign of advertising by direct mail, newspapers and radio will be carried on by the organized radio technicians, with the cooperation of components and tube manufacturers, the association of manufacturers' representatives, many of the broadcast stations, and the parts distributors of the state.

Experience gained in the Harrisburg area, last year, indicates that a Preventive Maintenance Month can increase the prestige of the radio service technicians, obtain a great deal of additional business, and increase the actual number of operating radio receivers as much as 25%.

RADIO-ELECTRONICS for

TV ANTENNAS may not be placed on the roof without written permission of the landlord, ruled Justice William T. Powers in Kings County Supreme Court (Brooklyn, N. Y.) last month. Verbal permission is not sufficient, as it may be revoked or denied at any time. The ruling was handed down in a test case brought by Scroll Realty Corp., against Ben Mandell, a tenant in an apartment house owned by the corporation. The landlord sought to compel Mr. Mandell to remove an antenna he had erected.

COLOR TV COMMITTEE to survey the present and possible future of the art was organized last month by the National Bureau of Standards at the request of Sen. Edwin Johnson of Colorado. The Committee will study the scientific and technical phases of the problem and report to Sen. Johnson as chairman of the Senate Committee on Interstate and Foreign Commerce.

BUILT-IN TV ANTENNAS are now being supplied by Philco with their new sets. The in-the-receiver system consists of a large broad-band antenna of aluminum foil, designed to receive signals efficiently on both the high and low bands. It is tuned to the desired channel with a variable capacitor, aided by three hairpin loops, which also serve to match the impedance to that of a 300-ohm line.

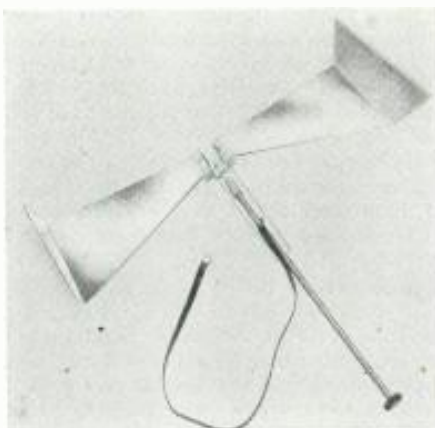

Tuning knob at front of set adjusts antenna.

The tuning control is at the end of a long rod and is usually near the top of the receiver in the front center of the cabinet. The 300-ohm antenna lead is attached near the center of the large hairpin loop.

AUDIO DEGREES will be offered by a new university just chartered by the State of California. Known as the University of Hollywood, it offers a major course in sound leading to the degree of Bachelor of Science in Audio Engineering. Other courses will include film engineering, drama, music, radio, and television.

With the establishment of the new university, the Hollywood Sound Institute, a leading audio school, will cease to exist. It will be merged into the new institution under the name of the College of Audio Engineering of the University of Hollywood.

OCTOBER, 1949

POLONIUM BRUSHES marketed in recent months to remove static charges from plastic phonograph records are dangerous to health, the Atomic Energy Project at UCLA reported last month. The brushes, consisting of ordinary bristles with a strip of polonium-impregnated material fastened to the ferrule, neutralize the attraction of the plastic for dust by emitting alpha rays. They are widely used in industry to drain the static from fast-moving machinery and especially from nonconductive surfaces, such as the speeding paper in a printing press.

The alpha rays do not penetrate the skin, but microscopic flecks of the metal or foil on which the polonium is carried are released into the air. If these are inhaled or carried to the mouth by the hands, a sickness similar to radium poisoning may develop.

Dr. Fred A. Bryan, dean of the UCLA medical school, said in an interview for the *New York Times* that even cautious users of the record brushes and other similar products using polonium would be likely to ingest some of the radioactive flakes.

RADIO MONTH BRIEFS

Color television experiments have been authorized for two more stations, WMAR-TV, Baltimore, and WCBS-TV, New York, by the FCC.

Theatre television channels were requested of the FCC last month by the Motion Picture Association of America. End of sound radio in three or four years was predicted last month by Henry L. Pierce, sales manager for Spartan Radio-Television.

New York television dealers formed an association last month called Television Dealers Association of New York for the primary purpose of stabilizing receiver prices by enforcing the "fair-trade" laws.

The 54-channel allocation plan proposed by FCC for television stations could accommodate approximately 2,245 stations compared with a possible 400 under the present setup.

Ban on rooftop television antennas imposed in Washington, D. C., by the director of the National Capital Housing Authority for public housing projects was decied by Washington receiver dealers as discriminatory. Reply of the Authority was that antennas may injure the house and "certainly are not good looking."

Television Technicians Lecture Bureau held its first lecture on September 11 in Rochester, N. Y. The bureau brings technical information to technicians, by whose paid admissions it is supported. Lecturers are not industry representatives but trained educators without commercial affiliation. The proposed program of lectures is countrywide. The Bureau, which was organized by Paul Wendel and Al Saunders, both well known in the field of radio technical literature, has its headquarters in Chicago, and has a large schedule of lectures already booked for the fall and early winter.

COMPLETE TRAINING

FOR BETTER JOBS
in Radio-Electronics



ONLY
\$14

5 MONTHS TO PAY!

Here are three world-famous books so thoroughly covering radio theory, troubleshooting and servicing methods; so clearly explaining every phase of the work that, with a minimum of time, you'll soon be able to handle repairs on any type of Radio-Electronic Equipment and qualify for better jobs, bigger pay checks! You couldn't get a finer, more complete or easier to understand training course AT ANY PRICE. Remember! These are the same Ghirardi books that were more widely used for wartime radio-electronic training than any other books or courses of their type!

Ghirardi's BIG-3 RADIO SERVICING LIBRARY

These three big books contain a total of 3016 pages and 1214 illustrations covering the complete range of basic radio-electronic and service subjects:

1—RADIO PHYSICS COURSE

Complete basic training for beginners. Makes even the most difficult subjects easy to understand! 972 pages, 508 illus. Price \$5.00.

2—MODERN RADIO SERVICING

The 1300-page book that teaches you to work by truly professional methods. Explains all about test instruments, how to use them, circuit analysis, component replacements and dozens of other subjects. 1300 pages, 706 illus. Price \$5.00.

3—RADIO TROUBLESHOOTER'S HANDBOOK

The great Ghirardi book that cuts service time in half on most jobs. Tells what to do, exactly how to do it in making quick repairs on over 4500 specific radio models. 744 manual-size pages. \$5.00.

Let A. A. Ghirardi train you for Radio-Electronics—AT AN ABSOLUTE MINIMUM COST! Starting with the fundamentals of basic electricity, these 3 books take you step-by-step through the efficient radio testing, adjustment and repair procedures that mean time saving and more profitable work. Hundreds of working data on tubes, color codes, transformers, resistors, capacitors, record changers and other components help you solve job snags in record time.

NEW LOW PRICE . . . Easy Terms

Bought singly, the books in this fact-packed library would cost you \$15. Under this special offer, you save \$1 and also have the privilege of paying in easy monthly installments, while you use the books. No waiting for monthly lessons. You learn fast—and you learn right!

10 DAYS' MONEY BACK EXAMINATION

Dept. RE-109, MURRAY HILL BOOKS, Inc.,
232 Madison Ave., New York 16, N.Y.

Send me GHIRARDI'S BIG-3 Radio-Electronics Library. I enclose \$2 as my first instalment and will send you \$3 a month for four months until the total special price of only \$14 is paid. It is understood I may read the books for 10 days. Then, if not satisfactory, I will return them postage paid and you agree to refund my \$2 and cancel the remaining instalments.

Name

Address

City, Zone, State

Occupation

SEE YOUR JOBBER

on the

SPECIAL OFFER PLAN

to

**RADIO DISTRIBUTION
AND MAINTENANCE**

The complete trade journal devoted to sales and service of Radio, Video, Audio. A monthly magazine that has been a best seller in its field for over four years under the old title RADIO MAINTENANCE. Now—look for the Radio Industry Newsletter . . . giving you up-to-the-minute events in the field—articles on servicing—hints and kinks—test equipment—alignment—TV installation and maintenance—antennas—sound systems—service bench equipment—sales—advertising—store design—merchandising hints—maintenance contracts and scores of other subjects. Completely illustrated with photographs, drawings, schematics.

Single Copies .25

\$3.00 Per Year \$5.00 2 Years

Your Jobber Has The October Issue Now
Get your copy today and ask about the

SPECIAL OFFER PLAN

and save money on your subscription!

VIDEO HAND BOOK

Now in one great book—all the essential knowledge of television for laboratory technician—experimenter—serviceman . . . everyone interested in or working at television! Complete, up-to-the-minute information arranged for quick reference—easy to read . . . no mathematics. Over 900 pages . . . more than 800 photographs, diagrams and drawings. Here are some of the subjects covered: Fundamentals, the TV station, the receiver, antennas, programming, installation, service, test equipment, data, terms, etc., etc.

**\$5.00****RADIO DATA BOOK**

The only radio handbook of its kind! Covers everything in Radio for lab technicians—experimenters—servicemen—everyone and anyone! Over 900 pages, 12 big sections with hundreds of drawings and diagrams. Some of the subjects covered are . . . Testing, Measuring and Alignment . . . All about Antennas . . . Sound Systems . . . Recording . . . Complete Test Equipment Data . . . Complete Tube Manual . . . Charts, Graphs and Curves . . . 50 Tested Circuits . . . Codes.

\$5.00

Symbols and Standards . . . 150 Basic Circuits . . .
Dictionary of Radio Terms . . . etc., etc.

THE RADIO & TELEVISION LIBRARY

A complete library covering everything in Radio and Television in over 1800 pages, completely illustrated! Two handsome bound books (contents described above) in attractive slip case . . . compact, concise, complete!

**Over 1800 Pages \$9.00**

All products of
BOLAND & BOYCE INC., Montclair 3, N.J.
are available at your
local distributor's counters. Order now!

BOLAND & BOYCE INC., PUBLISHERS

The Sprayberry Academy of Radio has moved to Chicago. The move had been planned by FRANK L. SPRAYBERRY, president, for some time because of the increasing importance of Chicago as a television and radio development and manufacturing center. Mr. Sprayberry believes he will be able to serve his students much more effectively because he will be able to include the newest developments into his training.

American Television, Inc., Chicago, put their first television sets on the market late in August. The line, known as "Home Theatre" television receivers, includes all popular direct-view sizes and models.

Radio Corporation of America has issued a consolidated statement of income for the second quarter of 1949 and the first six months of the year, with comparative figures for the corresponding periods of 1948, announced BRIGADIER GENERAL DAVID SARNOFF, chairman of the board.

Total gross income from all sources amounted to \$187,257,987 in the first half of 1949, compared with \$176,079,713 in the same period of 1948, an increase of \$11,178,274.

Net income, after all charges and taxes, was \$10,122,049 for the first six months of 1949, compared with \$10,850,288 in 1948, a decrease of \$728,239.

After payment of preferred dividends, net earnings applicable to the common stock for the first six months of 1949 were 61.6¢ per share, compared with 66.8¢ per share in the first half of 1948.

Howard W. Sams & Co., Inc., Indianapolis, publishers of electronic technical manuals and books, have declared the regular semi-annual dividend of \$2.50 per share on its 5% cumulative preferred stock.

Payable to stockholders of record June 27, this dividend covers the first six-month period of 1949 and represents the fourth consecutive semi-annual dividend on cumulative preferred stock of the three-year-old organization. The company's balance sheet as of June 30, as prepared by company officers, shows total assets of \$267,757.66, with a net earned surplus of \$46,090.90.

Sylvania Electric Products, Inc., consolidated net income for the second quarter of 1949 was \$378,252, equal to 19¢ per share on the 1,456,550 shares of common stock outstanding, after deducting dividends of \$1 per share on the \$4 cumulative preferred stock. This compares with consolidated net income of \$948,565, equal to 84¢ per share, earned on the 1,006,550 shares of common stock in the second quarter of 1948. For the six months ended June 30, 1949, common stock earnings of \$1.01 per share based on the average number of shares (1,343,290) outstanding during the period compare with earnings of \$1.90 per share for the six months ended June 30, 1948.

Second-quarter net sales of \$22,556,653 compare with sales of \$23,662,547 for the second quarter of 1948. For the

six months ended June 30, 1949, sales of \$49,665,548 compare with sales of \$48,210,076 for the six months ended June 30, 1948, an increase of 3%.

Motorola, Inc., Chicago, attaining a new peacetime sales record for the six-month period ended July 2, 1949, provided net earnings of \$1,908,255.95, equal to \$2.39 per share, it was announced by PAUL V. GALVIN, president. This compares with earnings for the corresponding period last year of \$1,650,039.82, which is equal to \$2.06 per share.

Andrea Radio Corp., manufacturers of television receivers, reports a 73% increase in sales for the period of January 1-May 31 of this year, over the corresponding period of 1948. In addition to this sales increase, FRANK A. D. ANDREA, president of the company, reports a corresponding increase in net profits for the January-to-May period of this year.

Admiral Corp., Chicago, in a mid-year earnings statement to stockholders, reported that sales and earnings for the first six months of this year hit an all-time high.

Sales for the second quarter of 1949 were \$29,597,308 as against \$15,382,176 for 1948, an increase of \$14,215,132 or 92%. Net earnings were \$1,619,472 as against \$706,887, an increase of \$912,585 or 129%.

Sales for the six months ending June 30 were shown as \$53,110,405 as against \$27,386,344, an increase of \$25,724,061 or 94%. Net earnings were \$3,155,689 as against \$1,237,297 or an increase of 155%.

Earnings per share (on 1,000,000 shares outstanding) for the first half of 1949 were \$3.16 as compared with \$1.24 for last year's first half or an increase of \$1.92.

Intra-Video, Inc., New York, will manufacture master radio antenna systems for apartment houses, hotels, and department stores. Last December at the convention of the Television Broadcasting Association, their antenna system was used to demonstrate the sets put on display by the television manufacturers.

Westinghouse Electric Corp., Sunbury, Pa., as a price-protection policy, announced that factory list prices on all current television receivers were guaranteed for all dealers and distributors.

The plan, retroactive to July 1, will protect dealers and distributors from loss on any television inventory purchased within a 60-day period prior to price readjustment. The policy has been put into effect because of an increasing trend toward indiscriminate price slashing in the "hotly competitive" television industry, F. M. SLOAN, division manager said.

Motorola, Inc., added 1,000 employees to its payroll for the 1949 fall season. This brings its payroll to more than 4,500, highest employment level in the company's history, according to PAUL GALVIN, president.

RADIO-ELECTRONICS for

SENSATIONAL

New Training Offer!

NOW you build and keep a top quality

TELEVISION

RECEIVER

to help you prepare for a real job in

TELEVISION
RADIO-ELECTRONICS



Choice of 10, 12 or 16 INCH TELEVISION PICTURE TUBE

Now you can get this amazingly practical aid for learning Television at home, to help you get started toward FASCINATING WORK...GOOD MONEY...a THRILLING FUTURE—in a real job, or your own sales and service business. • When you complete our regular home training—described below—you can build and keep a top quality commercial-type Television Receiver. Standardized chassis is adaptable for a 10, 12 or 16 inch direct view tube that gives big, bright, sharp, steady pictures. This is an optional training advantage—designed to provide the utmost in practical “learn-by-doing” home training in Television. Mail coupon for complete details. See why you owe it to your “Television Future” to enroll for DeForest’s Training, Inc.

Mail Coupon NOW for FREE Information!

See how D.T.I.’s amazingly effective methods help start you toward a GOOD JOB or your OWN BUSINESS in one of America’s most promising fields—including Television, F. M. Radio, Aviation, Train, and Taxi Radio, Broadcast Radio, Industrial Electronics. Get modern lessons...plus 16 shipments of Radio-Electronic parts. Work over 300 experiments and projects—including building of (1) commercial-type OSCILLOSCOPE for practical T-V circuit training, (2) double-range R-F SIGNAL GENERATOR, (3) jewel-bearing MULTIMETER, (4) quality 6-tube SUPERHET RADIO. Then build and keep that big new Television Receiver. Here’s EVERYTHING YOU NEED for real laboratory-type training...AT HOME!

YOU ALSO BUILD AND KEEP THIS PROFESSIONAL TYPE EQUIPMENT!

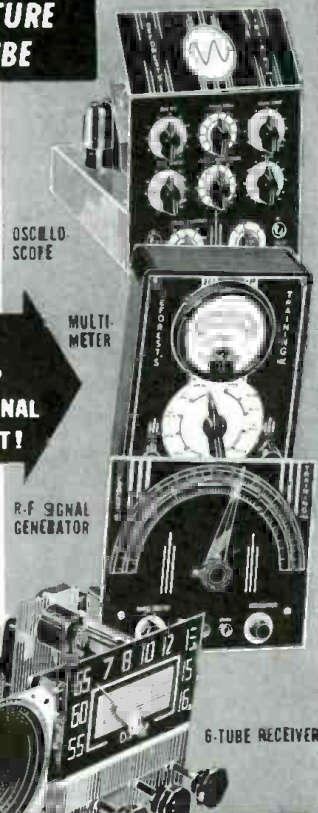

Modern Chicago Laboratories

★ If you prefer, you can get ALL your preparation in our new, Chicago training laboratories...one of the finest of its kind. Ample instructors...modern equipment. Write for details!

Employment Service

★ When you complete your training, our effective Employment Service helps you get started toward a real future in Television—Radio—Electronics.



You also use HOME MOVIES!

a D. T. I. Exclusive!
D. T. I. alone includes the modern, visual training aid...MOVIES...to help you learn faster, easier at home. See electrons on the march and other fascinating “hidden action”—a remarkable home training advantage that speeds your progress.

MAIL THIS COUPON TODAY!

DeFOREST’S TRAINING, INC.
2533 North Ashland Avenue, Dept. RC-F10
Chicago 14, Illinois

Without obligation, give me complete facts showing how I may make my start in Television-Radio-Electronics.

Name _____ Age _____
Street _____ Apt _____
City _____ Zone _____ State _____

De FOREST’S TRAINING, INC.

CHICAGO 14, ILLINOIS
A DE VRY Institution

NEW 1950 Heathkits

have all the Features



\$39.50

New 1950 Heathkit PUSH-PULL EXTENDED RANGE 5" OSCILLOSCOPE KIT

Features

- The first truly television oscilloscope.
- Tremendous sensitivity .06 Volt RMS per inch deflection.
- Push-pull vertical and horizontal amplifiers.
- Useful frequency range to 2½ Megacycles.
- Extended sweep range 15 cycles to 70,000 cycles.
- New television type multivibrator sweep generator.
- New magnetic alloy shield included.
- Still the amazing price of \$39.50.

The new 1950 Push-Pull 5" Oscilloscope has features that seem impossible in a \$39.50 oscilloscope. Think of it—push-pull vertical and horizontal amplifiers with tremendous sensitivity only six one hundredths of a volt required for full inch of deflection. The weak impulses of television can be boosted to full size on the five inch screen. Traces you couldn't see before. Amazing frequency range clear useful response at 2½ Megacycles made possible by improved push-pull amplifiers. Only Heathkit Oscilloscopes have the frequency range required for television. New type multi-vibrator sweep generator with more than twice the frequency range. 15 cycles to 70,000 cycles will actually synchronize with 250,000 cycle signal. Dual positioning controls will move trace over any section of the screen for observation of any part. New magnetic alloy CR tube shield protects the instrument from outside fields. All the same high quality parts, cased electrostatically shielded power transformer, aluminum cabinet, all tubes and parts. New instruction manual now has complete step by step pictorials for easiest assembly. Shipping Weight 30 lbs. Order now for this winter's use.

CONVERSION FOR OTHER MODEL HEATHKIT OSCILLOSCOPES

A conversion for all 03 and 04 scopes is available changing them to the new push-pull amplifiers (does not change the sweep generator). Complete kit includes new chassis, tubes and all parts. For a small investment, add the latest improvements to your present oscilloscope (Except C.R. Tube Shield). Shipping weight 10 lbs. Order 05 Conversion Kit No. 315. **\$12.50**

THE NEW Heathkit HANDITESTER KIT

MORE Features THAN EVER BEFORE

- Beautiful streamline Bakelite case.
- AC and DC ranges to 5,000 Volts.
- 1% Precision ceramic resistors.
- Convenient thumb type adjust control.
- 400 Microampere meter movement.
- Quality Bradley AC rectifier.
- Multiplying type ohms ranges.
- All the convenient ranges 10-30-300-1,000-5,000 Volts.
- Large quality 3" built-in meter.

The instrument for all—the ranges you need—beauty you'll enjoy for years and you can assemble it in a matter of minutes—an instrument for everyone. The handiest quality voltohmmeter of all. Small enough to put in your pocket yet a full 3" meter. Easy pictorial wiring diagrams eliminate all assembly problems. Uses only 1% precision ceramic divider resistors and wire wound shunts. Twelve different ranges. AC and DC ranges of 10-30-300-1,000-5,000 Volts. Ohms ranges of 0-3,000 ohms and 0-300,000 ohms. Milliampere ranges of 10MA and 100MA. Hearing aid type ohms adjust control fits conveniently under thumb for one hand adjustment. Banana type jacks for positive low resistance connections. Quality test leads included. The high quality Bradley instrument rectifier was especially chosen for linear scales on AC. The modern case was styled by Harrah Engineering for this instrument. The 400 microampere meter movement comes already mounted in the case protected from dust during assembly. An ideal classroom assembly instrument useful for a lifetime. Perfect for radio service calls, electricians, garage mechanics, students, amateurs and beginners in radio. The only quality voltohmmeter under \$20.00. An hour of assembly saves you one-half the cost and quality parts give you a better instrument. Order today. Shipping weight 2 lbs.

\$13.50



Note
HANDY
OHMS
ADJUST.

EXPORT DEPT.
13 East 40th St.
NEW YORK CITY (16)
CABLE: ARLAB-N.Y.

The **HEATH COMPANY**

... BENTON HARBOR 20, MICHIGAN

Beauty · Quality · Economy



Only
\$69.50

Nothing
ELSE TO BUY

New Heathkit IMPEDANCE BRIDGE KIT

A LABORATORY INSTRUMENT NOW WITHIN
THE PRICE RANGE OF ALL

Measures Inductance from 10 microhenries to 100 henries capacitance from .00001 MFD to 1000 MFD. Resistance from .01 ohms to 10 megohms. Dissipation factor from .001 to 1. "Q" from 1 to 1000.

Ideal for schools, laboratories, service shops, serious experimentors.

An impedance bridge for everyone — the most useful instrument of all, which heretofore has been out of the price range of serious experimentors and service shops. Now at the lowest price possible. All highest quality parts. General Radio main calibrated control. General Radio 1000 cycle hummer. Mallory ceramic switches with 60 degree indexing — 200 micro-amp zero center galvanometer — 1/2 of 1% ceramic non-inductive decade resistors. Professional type binding posts with standard 3/4" centers. Beautiful birch cabinet. Directly calibrated "Q" and dissipation factor scales. Ready calibrated capacity and inductance standards of Silver Mica, accurate to 1/2 of 1% and with dissipation factors of less than 30 parts in one million. Provisions on panel for external generator and detector. Measure all your unknowns the way laboratories do — with a bridge for accuracy and speed.

Internal 6 volt battery for resistance and hummer operation. Circuit utilizes Wheatstone, Hay and Maxwell circuits for different measurements. Supplied complete with every quality part — all calibrations completed and instruction manual for assembly and use. Deliveries are limited. Shipping weight, approximately 15 lbs.



10,000V. H.V. TEST PROBE KIT

No. 310. Extends range of any 11 megohm VTVM to 3,000 and 10,000 Volt ranges. A necessity for television. Shipping Wt., 1 pound. \$4.50

R.F. CRYSTAL TEST PROBE KIT

No. 309 Kit to assemble. R.F. probe extends VTVM range to 100 Mc. Complete with 1N34 crystal. Ship. Wt., 1 lb. \$6.50



New Heathkit TOOL KIT

Now a complete tool kit to assemble your Heathkit. Consists of Krauter diagonal cutters and pointed nose assembly pliers, Xcelite screwdriver, 60 Watt 110V. soldering iron and supply of solder. Shipping Wt. 2 lbs. Complete kit..... \$5.95

New Heathkit TELEVISION ALIGNMENT GENERATOR KIT



\$39.50

Nothing ELSE TO BUY

Everything you want in a television alignment generator. A wide band sweep generator covering all FM and TV frequencies 0-110 and 165 to 220 Megacycles, a marker indicator covering 19 to 43 Megacycles, AM modulation for RF alignment — variable calibrated sweep width 0-30 Mc. — mechanical driven inductive sweep. Husky 110V. 60 cycle power transformer operated — step type output attenuator with 10,000 to 1 range — high output on all ranges — band switching for each range — vernier driven main calibrated dial with over 45 inches of calibration — vernier driven calibrated indicator marker tuning. Large grey crackle cabinet 16 1/8" x 10 3/8" x 7-3/16". Phase control for single trace adjustment. Uses four high frequency triodes plus 5Y3 rectifier — split stator tuning condensers for greater efficiency and accuracy at high frequencies — this Heathkit is complete and adequate for every alignment need and is supplied with every part — cabinet — calibrated panel — all coils and condensers wound, calibrated and adjusted. Tubes, transformer, rest leads — every part with instruction manual for assembly and use. Actually three instruments in one — TV sweep generator — TV AM generator and TV marker indicator. Also covers FM band.

EXPORT DEPT.
13 East 40th St.
NEW YORK CITY (16)
CABLE: ARLAB-N.Y.

The **HEATH COMPANY**

... BENTON HARBOR 20, MICHIGAN

all in HEATHKITS...

Heathkit TUBE CHECKER KIT

Features

1. Measures each element individually
2. Has gear driven roller chart
3. Has lever switching for speed
4. Complete range of filament voltages
5. Checks every tube element
6. Uses latest type lever switches
7. Uses beautiful shatterproof full view meter
8. Large size 11" x 14" x 4" complete
9. Checks new 9 pin piniaures

Check the features and you will realize that this Heathkit has all the features you want. Speed—simplicity—beauty—protection against absolescence. The most modern type of tester—measures each element—beautiful Bad-Good scale, high quality meter—the best of parts—rugged oversize 110V. 60 cycle power transformer—finest of Mallory switches—Centralab controls—quality wood cabinet—complete set of sockets for all type tubes including blank spare for future types—fast action gear driven roller chart uses brass gears to quickly locate and set up any type tube. Simplified switching cuts necessary time to minimum and saves valuable service time. Short and open element check. No matter what arrangement of tube elements, the Heathkit flexible switching arrangement easily handles it. Order your Heathkit Tube Checker today. See for yourself that Heath again saves you $\frac{2}{3}$ and yet retains all the quality—this tube checker will pay for itself in a few weeks—better build it now.

Complete with detail instructions—all parts—cabinet—roller chart—ready to wire up and operate. Shipping Wt., 15 lbs.



Only
\$29⁵⁰

Nothing
ELSE TO BUY

Heathkit SINE AND SQUARE WAVE AUDIO GENERATOR KIT

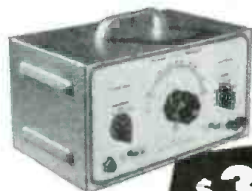

Nothing
ELSE TO
BUY

\$34⁵⁰

Experimenters and servicemen working with a square wave for the first time invariably wonder why it was not introduced before. The characteristics of an amplifier can be determined in seconds compared to several hours of tedious plotting using older methods. Stage by stage, amplifier testing is as easy as signal tracing. The low distortion (less than 1%) and linear output (\pm one db.) make this Heathkit equal or superior to factory built equipment selling for three or four times its price. The circuit is the popular RC tuning circuit using a four gang variable condenser. Three ranges 20-200, 200-2,000, 2,000-20,000 cycles are provided by selector switch. Either sine or square waves instantly available at slide switch. All components are of highest quality, cased 110V. 60 cycle power transformer. Mallory F.P. filter condensers, 5 tubes, calibrated 2 color panel, grey crackle aluminum cabinet. The detailed instructions make assembly an interesting and instructive few hours. Shipping Wt., 13 lbs.

New Heathkit BATTERY ELIMINATOR KIT

Nothing
ELSE
TO BUY

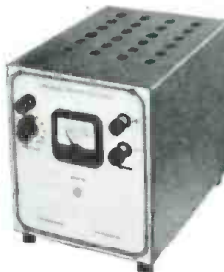

\$22⁵⁰

Now a bench 6 Volt power supply kit for all auto radio testing. Supplies 5 - 7½ Volts at 10 Amperes continuous or 15 Amperes intermittent. A well filtered rugged power supply uses heavy duty selenium rectifier, choke input filter with 4,000 MFD of electrolytic filter. 0 - 15 Volt meter indicates output. Output variable in eight steps. Excellent for demonstrating auto radios. Ideal for servicing—can be lowered to find sticky vibrators or stepped up to equivalent of generator overload—easily constructed in less than two hours. Complete in every respect. Shipping Wt., 18 lbs.

NEW Heathkit SIGNAL TRACER AND UNIVERSAL TEST SPEAKER KIT

Nothing
ELSE
TO BUY



\$19⁵⁰

The popular Heathkit signal tracer has now been combined with a universal test speaker at no increase in price. The same high quality tracer follows signal from antenna to speaker—locates intermittents—defective parts quicker—saves valuable service time—gives greater income per service hour. Works equally well on broadcast—FM or TV receivers. The test speaker has assortment of switching ranges to match push pull or single output impedance. Also test microphones, pickups—PA systems—comes complete—cabinet—110V. 60 cycle power transformer—tubes, test probe, all parts and detailed instructions for assembly and use. Shipping Wt., 8 lbs.

EXPORT DEPT.
13 East 40th St.
NEW YORK CITY (16)
CABLE: ARLAB-N.Y.

The **HEATH COMPANY**

... BENTON HARBOR 20, MICHIGAN

MORE QUALITY in

1950 Heathkits

The NEW 1950 Heathkit VACUUM TUBE VOLTMETER KIT

Features

- New 200 microampere meter.
- Uses 1% precision ceramic divider resistors.
- Burn-out proof meter circuit.
- 24 complete ranges.
- Isolated probe for dynamic testing.
- Most beautiful VTVM in America.
- Accessory probes (extra) extend ranges to 10,000 Volts and 100 Megacycles.
- Modern push-pull electronic voltmeter circuit.
- Electronic AC circuit. No current drawing rectifiers.
- Shatterproof plastic meter face.



\$24.50

A new Model V-2 Heathkit VTVM with new 200 microampere meter, four additional ranges—full scale linear ranges on both AC and DC of 0-3 V., 10 V., 30 V., 100 V., 300 V., and 1,000 V. Accessory probe listed elsewhere in ad extends voltage range to 3,000 and 10,000 volts D.C. New model has greater sensitivity, stability and accuracy—still the highest quality features—shatterproof plastic full view meter face—automatic meter protection, push-pull electronic voltmeter circuit, linear scales—dB scale—ohmmeter measures 1/10 ohm to 1 billion ohms with internal battery—isolated DC test prod for dynamic measurements—1 F megohm input resistance on DC—AC uses electronic rectification with 6H6 tube. All these features and still the amazing price of only \$24.50. Comes complete with cabinet—panel—three tubes—new Mallory switches—test prods and leads, 1% ceramic divider resistors and all other parts. Complete instruction manual for assembly and use. Better start your laboratory with this precision instrument. Shipping weight 8 lbs. Model V-2

New 1950 VERNIER TUNING R.F. Heathkit SIGNAL GENERATOR KIT

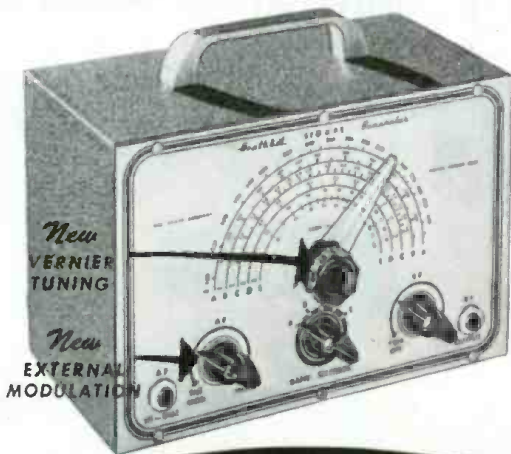

\$19.50

Features

- New 5 to 1 ratio vernier tuning for ease and accuracy.
- New external modulation switch—use it for fidelity testing.
- New precision coils for greater output.
- Cathode follower output for greatest stability.
- 400 cycle audio available for audio testing.
- Most modern type R.F. oscillator.
- Covers 150Kc. to 34Mc. on fundamentals and calibrated strong harmonics to 102 Mc.

The most popular signal generator kit has been vastly improved—the experience of thousands combined to give you the best. Check the features in this fine generator and consider the low price \$19.50. A best buy for any shop, yet inexpensive enough for hobbyists. Everyone can have an accurate controlled source of R.F. signal voltage.

The new features double the value—think of being able to make fidelity checks on receivers by inserting a variable audio signal. Internal 400 cycle saw-tooth audio oscillator modulates R.F. signal and is available externally for audio testing. The new 5 to 1 ratio vernier drive gives hairline tuning for maximum accuracy in scale settings. The coils are already precision wound and calibrated. Uses turret type coil and switch assembly for ease of construction. The generator is 110 V. 60 cycle transformer operated and comes complete in every detail—cabinet—tubes—coils—beautiful two color calibrated panel and all small parts—new step-by-step pictorial diagrams and complete instruction manual make assembly a cinch even for novices. Why try to get along without a signal generator when you can have the best for less than a twenty dollar bill. Better order it now. Shipping weight 7 lbs. \$19.50

CONVERSION KIT FOR G-1 GENERATORS

Conversion kit for G-1 generators for vernier tuning and external modulation includes new high band coil for greater output. Gives all the features of new G-5 listed above. Order G-5 Conversion Kit No. 316. \$4.50

EXPORT DEPT.
13 East 40th St.
NEW YORK CITY (16)
CABLE: ARLAB-N.Y.

The HEATH COMPANY

... BENTON HARBOR 20, MICHIGAN

RADIO-ELECTRONICS for

Want To Double Your Pay?



How To Pass **FCC** **COMMERCIAL** **RADIO OPERATOR** **LICENSE** **EXAMINATIONS**

GET THIS AMAZING NEW BOOKLET FREE!

Add Technical Training to Your Practical Experience and

GET YOUR **FCC** **COMMERCIAL** **RADIO OPERATOR** **LICENSE**

IN A FEW SHORT WEEKS!

It's **EASY** if you use **CIRE Simplified Training & Coaching AT HOME** in **SPARE TIME**

Get your license easily and quickly and be ready for the jobs open to ticket holders which lead to \$3000 to \$7500 (average pay reported by FCC nationwide survey).

CIRE training is the only planned course of coaching and training that leads directly to an FCC license.

CIRE Job-Finding Service
Brings Amazing Offers of Jobs!

"I am working at WRJM as transmitter engineer, and I received this position in response to one of the employment applications sent me upon completion of my course and the receiving of my Diploma. I received my 1st class Radiotelephone License on March 2, 1949. I want to express my sincere appreciation to the staff of CIRE."

Student No. 2608 AT
"Thanks for the Application for Employment you recently prepared for me. I found satisfactory employment. I submitted 57 letters, enclosing the resume you supplied. I received 17 letters indicating my application was filed for future reference; 3 telephone calls, and one letter requesting personal interviews. As a result, I am employed in a development engineering capacity."
Student No. 4235 NB

CLEVELAND INSTITUTE OF RADIO ELECTRONICS
Desk RC-10 • 4900 Euclid Bldg. • Cleveland 3, Ohio
Approved for Veteran Training under the "G. I. Bill of Rights"

1. Tells of Thousands of Brand-New Better Paying Radio Jobs Now Open to FCC License Holders.
2. Tells How We Guarantee to Train and Coach You Until You Get Your FCC License.
3. Tells How Our Amazing **Job-Finding** Service Helps You Get the Better Paying Radio Job Our Training Prepares You to Hold.

YOUR FCC TICKET IS ALWAYS RECOGNIZED IN ALL RADIO FIELDS AS PROOF OF YOUR TECHNICAL ABILITY



Get All 3 FREE Send Coupon Now!

CLEVELAND INSTITUTE OF RADIO ELECTRONICS
Desk RC-10—4900 Euclid Bldg., Cleveland 3, Ohio
(Address to Desk No. to avoid delay)

I want to know how I can get my FCC ticket in a few short weeks by training at home in spare time. Send me your amazing new FREE booklet "Money Making FCC License Information," as well as a FREE sample FCC-type exam and FREE booklet, "How to Pass FCC License Examinations" (does not cover exams for amateur License).

Name.....

Address.....

City..... Zone..... State.....

Veterans check for enrollment information under G.I. Bill
NO OBLIGATION—NO SALESMEN

ELECTRONIC MAGIC

... Electronics—now man's most versatile tool ...

By HUGO GERNSBACK

AS EACH year passes it becomes more apparent that electronics is more versatile than any tool previously known to man. Electronics today reaches into practically every manufacturing process. Every industry can benefit from it.

From A to Z—from Atomics to Zymology (science of fermentation)—electronics plays a vital and leading part today. Yet, we are only at the earliest beginning. How far electronics will penetrate no living man can foresee.

Here are only a few random suggestions as to fields in which electronic research will pay big dividends in the future:

HYDROLOGY*. Underground streams, hidden minerals, and petroleum among other things, have been investigated electronically by engineers. These methods are becoming increasingly popular.

Yet, many of these methods are expensive, not only because of the necessary apparatus, but also in human labor, often requiring from three to ten men. There is no denying that the *dowser* with his forked hazel stick has, in the past, achieved success. These so-called divining rods have had too many striking successes to their credit in the past to be dismissed as black magic or fraud. As far as we know, the dowser has never been investigated electronically. If there is something in the human animal which, by means of a forked stick, can find hidden water, minerals, or oil, electronics should be able to do it much better with some simple machine or apparatus paralleling the Geiger counter now used to discover uranium.

It takes a bit of courage for an engineer to undertake this. Scientists have always looked with great skepticism on the divining rod. Yet it is certain that someone will in the not too distant future discover the actual mechanics of dowsing. It will be a highly profitable discovery.

PATEIOLOGY (the science of food—from the Greek *patasthai* = to eat). I suggest this new term because there is no inclusive scientific word so far to describe the science of food, cooking, etc. A tremendous amount of work remains to be done in the growing of food, and much more in its preparation. There is entirely too much spoilage and far too great a divergence in final results when two different cooks, even good ones, prepare identical foods. Identical steaks or roasts cooked by two chefs with the same ingredients and under parallel conditions will show considerable taste variety. Electronics can do the cooking automatically. Recently such attempts have been made. We all know of the radar range which cooks foods from the inside out and cuts off the elec-

tronic heat automatically when the roast or potatoes are cooked or boiled correctly. But much more work remains to be done here, because the radar range is not suited for many foods, such as stews, pies, etc. Much electronic research is needed in the aging processes of foods and beverages such as champagnes and wines, as well as liquors and cheeses and other similar foods.

Over a century ago in Germany, lightning struck a barrel of wine. It did not destroy the cask, however, and the owner was astonished that the green wine had been aged perfectly. From that time on inventors have occupied themselves with electric aging processes. At first platinum-tipped nails were driven into barrels and attached to a battery which treated the wine or liquor for months at a time. Some success was attained with this method. There are many patents on aging processes today, but the final answer has not been given so far. If more people work on these processes, we may get somewhere and the experimenters may enrich themselves, too.

GERONTOLOGY (the science of aging processes in humans). As people grow older, something happens in their biological processes. Exactly why people age, no one knows. We only see the result in the wrinkled skins, the general sluggishness, and the aging look on faces. Investigators suspect that the aging of the cells plays the important part in these processes. Scientists have already used electronics in an attempt to find the answer. So far it has not been forthcoming.

HORMONOLOGY (science of the human glands) is in a way linked with gerontology. We already know that during aging the body is deprived of certain hormones which it secreted when the body was younger. By feeding these hormones to the aged the body can be rejuvenated to a certain extent. Much remains to be discovered because not all hormones so far can be produced synthetically nor cheaply enough.

To give just one example. Recently sensational advances were made when a new hormone *cortisone*—the synthetic adrenal gland hormone—was discovered. This is now used with spectacular success in the control of arthritis and rheumatic fever. Unfortunately, it still costs \$5,670 an ounce to produce it. Merck and Company, the big chemical firm, announced last month that it is now producing 200 grams a month—a pitifully microscopic amount compared to the needs of millions of sufferers. It seems certain that electronics will play a big role in new processes that must speed up the production, not only of cortisone, but all other hormones badly needed by humanity. Most of the hormones today are out of reach of the average person because of high costs of production. Electronics may be the answer.

*Term specifically used by U.S. Geological Survey with reference to underground water sources.

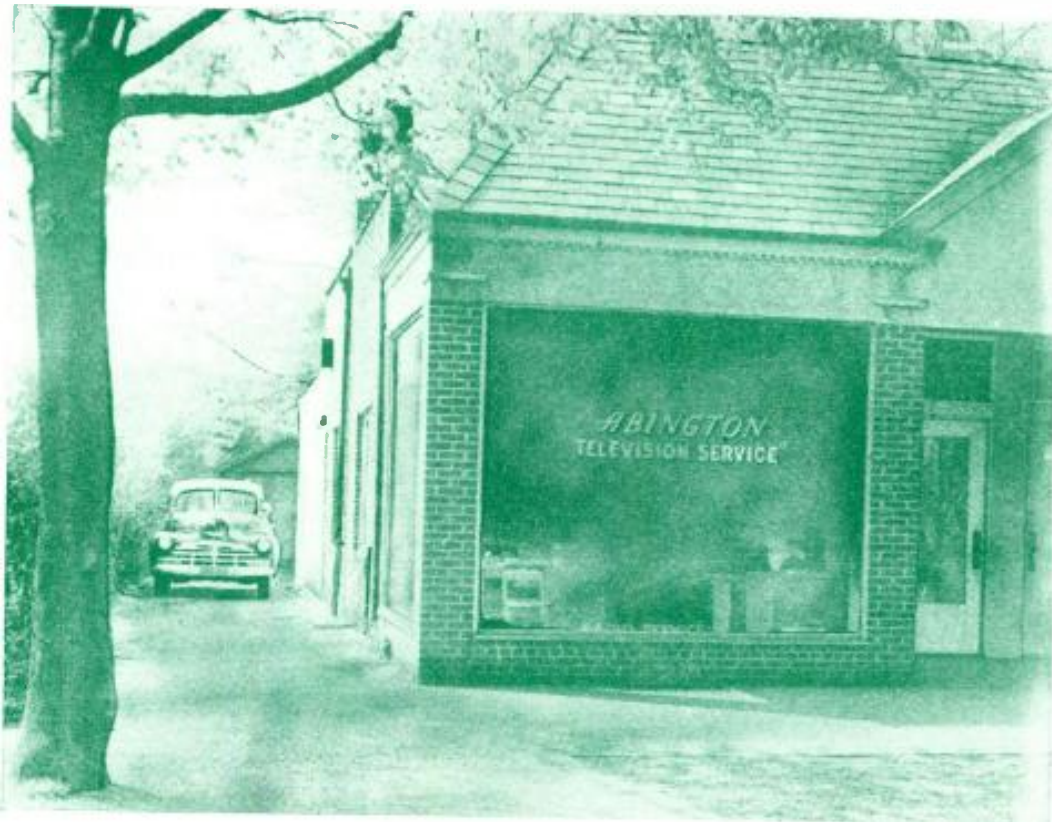

Offices are on street floor. Service shop is in basement. Firm does TV installation and servicing only.

Business Methods in Television Servicing

TELEVISION service on an annual basis is a technical problem, but it is also a business. Make no mistake about that. Insurance averages are involved, as are costs, organization, customer relations, pressure from all sides, and systems of paper work and record keeping. Add the legal problems with which we in New York are now faced, and all the ingredients of an exciting business are present in a going television service organization.

We have tried to organize every detail of our structure and our work. To continue to grow successfully, this kind of organization has been necessary. A \$75 charge for an installation and one year's service may sound like a good deal of money, but a year is a long time. To operate profitably within the framework of this sum, the installation must be both mechanically sound and electrically correct. Future service calls on the antenna system are expensive. The cost of only one such service call will much more than offset

*Abington Television Service, Garden City, N. Y.

By **CHARLES WIGUTOW***

How a successful contractor built a solid business

any money saved by using cheaper materials.

Television is new. However much of a miracle it is that pictures can be pulled out of the air and be presented in almost anyone's home, television's possibilities are still oversold. Service calls for educational purposes, even though no repairs may be required, are costly to the service organization. The responsibility of displaying television to its best advantage rests squarely with the installation men. The reputation of the television set and the company behind it will depend on the

manner in which it is first introduced to the customer in his own home by these men. Enough time must be given to the customer to instruct him in the use of his set.

Service calls on every set are inevitable. Twenty-five or thirty tubes are at work in a television set; many of these tubes operate within critical limits at extremely high frequencies. Defects which might not be discernible to the ear if in the audio system become glaringly noticeable to the eye.

There is also the problem of those service calls which can be classified as psychological. Set ownership becomes a matter of bragging to the Joneses. The pictures one receives are constantly compared to the neighbor's pictures. A tactless technician, regardless of his technical ability, can do a lot of harm to a service organization.

The television set occupies an important position in the family's leisure life. The whole family from junior to mother and dad finds programs which they follow day by day with undivided

RADIO-ELECTRONICS for

attention. Should something go wrong with the set, the speed with which the set can be restored to normal operating condition becomes most important. Our men are instructed to make every effort to repair the set in the customer's home. To that end, each man in the field carries some 150 tubes which include every type used in sets under our care.

Many breakdowns necessitate the use of precision test equipment. Such repairs can be made only in our shop. Just as the hospital is better equipped than a traveling doctor to perform operations, or the automobile repair shop is fitted to do work that no itinerant mechanic can hope to do, our shop is elaborately equipped to make the major repairs.

Engineering needed

The men in our shop have been thoroughly schooled in every phase of television work. Our shop service manager is forever planning new jigs and setups to make the servicing of chassis a more speedy and convenient process. In every case, these men have been with us from our earliest days. They have installed sets, they have been on the road making service calls, and they have been chosen to work in the shop because of their special ability.

Sets that are repaired do not go out of our shop until they have been set up on the "cooking bench" for at least 4 hours. If any further defects are to show, we want them to show up while the set is still on our premises. We try to keep our score perfect in this respect—as perfect as the nature of television design will allow.

We have had to cope with manufacturers' mistakes in design. We have also had to discover factory modifications for ourselves. There has been an almost universal conspiracy of silence among manufacturers about technical data on their sets. Sometimes we think the enemy must have had an easier time stealing our confidential electronic data than we have in getting ordinary service notes. A few manufacturers are exceptions. To them we are grateful, and they have been repaid by our undoubtedly having been able to do better work with their sets.

Manufacturers, by and large, have tried to divorce themselves from the service of their sets as far as is consistent with their sales needs. The potential size of a manufacturer's service organization in number of employees could well rival the size of the manufacturing body. However, some local distributors insist on keeping television installation and service under their strict control because it is an additional source of income. The price difference between what is paid by the customer to the distributor through their strict control because it is an additional source of income. The price difference between what is paid by the customer to the distributor through the dealer and what the service contractor receives may run to as much as \$30. That sum is pocketed by the distributor for various reasons, such as cost of an overpriced antenna, the use of which is made mandatory, and excessive insurance costs on parts.

If you are contemplating doing contract work in the many new television areas which are opening up, our advice is *tie up with only the most reliable manufacturers*. The reliability of the company for whom you work will build your own reputation. The working relationship between the manufacturer and the service contractor is a close one. This relationship is best expressed in technical cooperation, availability of replacement parts, and suitable payment without kickback arrangements to enable the contractor to do a good complete year's service job on each set it installs.

The next step is to realize that you are actually embarked on an insurance venture. You may receive the full year's money at the time of installation. This sum can be temptingly illusory. Top-most in your mind and books must be the idea that *this money must last for one whole year*. A service organization that wishes to remain solid must prorate its funds. We have arranged an escrow account with our bank in which we deposit all contract payments received by us. This money is withdrawn as we earn it, at the rate of once a month.

The most unfortunate thing that has happened to the television industry has been the business failures among those short-sighted enough to have spent during a comparatively short time all the

receipts intended to cover one year's work.

We have tried to eliminate waste in every move we make. Waste in time means that much more bitten off the \$75 received for installation and service. Service technicians on the road spending too much time locating addresses and long hauls between customer's homes are wastes to be eliminated. We keep each of our men within one area. They are then able to locate addresses more quickly. The time between calls is cut down and, more important, they are thoroughly familiar with any specialized reception problems within their own service areas.

Our system of keeping records has been an important factor in keeping down waste. The information called for on our installation form (see figure) immediately tells us the type of antenna used, the size of ladder required, the type of reception of each channel at the time of installation. If we are called for antenna repairs, we have enough information on hand to be sure that the service technician will go out fully equipped for the job.

Our service forms, likewise, are complete with dates and descriptions of failures and work performed. As the work is completed, these forms are filed in their proper alphabetical designations. For alphabetical breakdowns,

INSTALLATION FORM		ABINGTON TELEVISION SERVICE	
224 7th St.		Garden City, N. Y.	
Work Requested			
Mfg.	Model	Serial No.	
Dealer	Address		
Date Installed			
Type of Roof		Type of Mounting	
Type of Lead In		No. of Lead Ins	
Hgt. of Mast		Len. of Ladder Req.	
Hgt. of Antenna from Ground		Supplied By	
Quality of Reception (G-F-S-P)			
(2)	(4)	(5)	(7) (9) (11) (13)
Customer's Signature		Print Last Name	
Time Arrived		Time Completed	
Service Engineers			
Misc. Info.			
		Address	
Date	Name	Phone	

This form, filled out on each TV installation, is an aid if repairs are needed later.



Mobile research truck houses 68-foot collapsible antenna tower, TV set, and test gear.

we use the three-letter card system. If a customer's file shows more than the average number of service calls, immediate attention is drawn to that fact, and the service manager personally goes to work to determine the reasons for the excessive number of calls. Usually, he will team up with our mobile research truck. This unit is equipped with a collapsible 68-foot tower and houses a set of measuring equipment as well as a television set. Thus far, when we have gone gunning for the trouble with our combined forces, we have not failed to come up with the correct answer.

Because television is so new and has become such an important part of the home, customers may seem to be unduly critical of a service company's best efforts. A service technician can

too easily be irritated by seemingly excessive demands. Such an attitude can be a fatal mistake. If the customer complains, he has some sound reason for complaining. It is the job of our field service manager to either locate the trouble or, if the complaint is based on a customer's unfamiliarity with the limitations of television, to educate the customer to the latter's complete satisfaction.

Should the customer call on us personally, his first sight of our premises is not that of a disorderly shop. Quite the contrary; he steps into a nicely furnished office and is greeted by the switchboard operator, who in turn will show him to our service dispatcher or to the person who handles all installation matters. Far from attempting to hide our shop, we go out of our way to

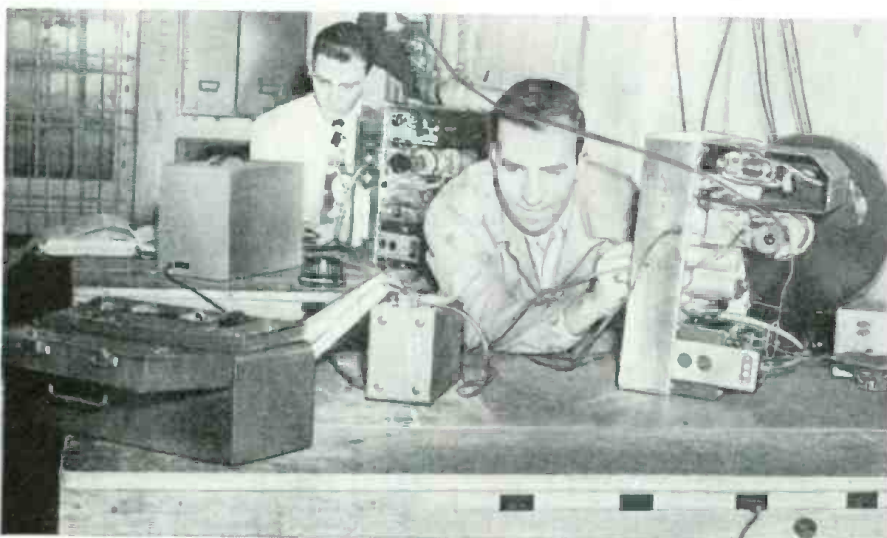

Repairs are made on individual service benches because of number of service technicians.

encourage visitors. We gladly demonstrate the methods used in handling their sets. Enough of the right equipment set up in a workmanlike arrangement is the surest road to customer confidence. He knows that his set is being taken care of by a responsible, well-organized service company. *Responsibility* is the keynote in all our operations.

The number of service calls each day has leveled itself off to a regular pattern. All service calls are funneled into the hands of our dispatcher who is conversant with the geography of our territory, and knows the particular capabilities of each of our men. This dispatcher assembles the calls and routes them the night before. In the morning each man is handed his group of calls and, after a short stop in the shop for parts or chassis, is off on his day's work. To meet any unscheduled emergency, each man is given a specified time to phone the office during the day. Each man handles 6 to 8 service calls a day.

Insurance is another of the little-thought-of phases in this business. We have found it necessary to be thoroughly, even though expensively, insured. For men on the road who operate their own cars, we carry nonownership insurance. This is in addition to the insurance each man is required to keep for himself. For antenna work and repairs in the customer's home, we carry contractor's liability insurance. To make sure that no falling antenna parts can ever result in damage to us financially through lawsuits, we carry products liability insurance. Of course, there is workmen's compensation, burglary, and fire insurance. It does not pay to be without any of these coverages, nor does it pay to underestimate the amount which must be spent to obtain them.

Abington Television Service has grown from a small service shop to an organization of over 40 employees. We feel that this growth is all the more remarkable because our work is specialized and is rigidly limited to television service alone. *We do not sell anything to the consumer.* In this way we avoid the suspicion of competing with the dealers for whom we do service. Dealer good will is a most valuable asset in this business.

What has been most responsible for our expansion? My partner, Sam Barriette, and I agree on one answer. We did everything we could to present a professional, businesslike appearance to the customer. Before the first television installation was given us, we tried to be ready with every tool needed for that installation. Haphazard and wasteful operation is strictly taboo for the business that has ambitious ideas in this competitive world. Our records system has been invaluable in this respect. Adequate financing at the start was another important factor. TV installation and servicing requires much more operating capital than radio servicing.

Replacing Picture Tubes in Television Receivers

Tube characteristics, basing diagrams, and special replacement hints are given in this inclusive article

By MILTON S. KIVER

THE variety of different television sets on the market today exceeds 200—and this in an industry which is still in its infancy. While cathode-ray tube types have fortunately not appeared in equal profusion, there are enough brands to confuse the technician or set owner when replacement becomes necessary, especially when the desired tube is obsolete or unavailable, or some other tube possessing a screen of equal diameter appears to offer a more sharply defined or a brighter image. The problem in a nutshell is this: How interchangeable are cathode-ray tubes in modern television receivers?

To answer this problem, consider the internal construction of cathode-ray tubes. There are basically only two classes of image tubes in use—those which employ electrostatic deflection and those using electromagnetic deflection. It is the general practice to utilize the same electrical method for focusing as is employed for deflection. There are, however, four notable exceptions to this. The 5TP4 projection tube, the 7DP4, the 9AP4, and the 12AP4 all are electromagnetically deflected and electrostatically focused. Of these tubes, only one, the 5TP4, is used extensively today. The 7DP4 has appeared in only one receiver, an early postwar RCA set, which was quickly dropped from production. The 9AP4 and 12AP4 are pre-war tubes, and it is doubtful that more than 1,000 working receivers in the entire country contain either of them.

Some important differences

1. Deflection of a beam electrostatically is accomplished by employing balanced voltages. Essentially, then, we require voltage amplifiers in the output

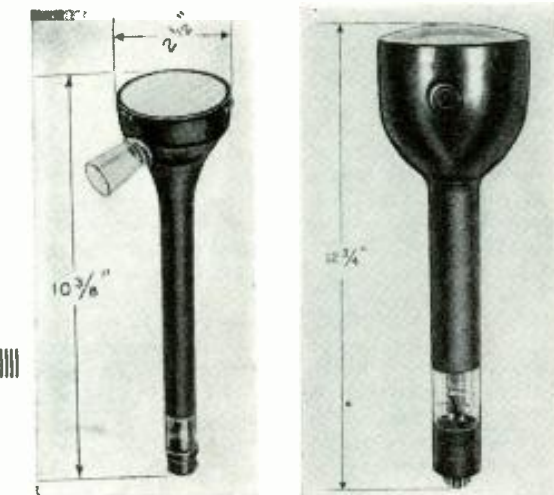

At left is the high-voltage 3NP4 used in Philips projection receivers; center, the Philco TP-400A, another high-voltage projection tube; and above, the RCA 5TP4. In spite of their general similarity, they are not interchangeable.

stage of the horizontal and vertical sweep systems.

2. For electromagnetic deflection, the beam is subjected to the magnetic field established by a deflection coil, and this field, in turn, is developed by the current flowing through the coil windings. Thus, with electromagnetic deflection the vertical and horizontal sweep amplifiers must be capable of providing large amounts of current.

3. Electrostatic deflection tubes require extensive high-voltage bleeder networks to furnish the correct focusing and centering voltages.

4. Electromagnetic deflection tubes utilize relatively simple high-voltage power supplies, the energy, in many instances, being furnished by the horizontal sweep system.

While many additional differences exist between these two types of tubes, the foregoing points permit us to formulate the following rule:

Electromagnetic and electrostatic deflection tubes are not interchangeable without extensive circuit alterations.

In any consideration of interchangeability, whether it concerns ordinary receiving tubes or large television image tubes, we must start with a comparison of the electrical characteristics of the components to be interchanged. With cathode-ray tubes, the added features of physical size and screen diameter must be considered since these have a definite bearing on replacement. The Television Tube Table presents all this information in chart form.

The first tube listed is the 3KP4. It has a 3-inch viewing screen and utilizes electrostatic deflection. The only set on the market containing this tube is the midget Pilot TV-37 receiver. No known replacements exist for this tube, the only other 3-inch tube listed in the table being the 3NP4, which is obviously unsuitable because it employs electromagnetic deflection and requires 24,000 volts for beam acceleration. Thus, the 3KP4 stands alone.

The next three tubes listed (the 3NP4, the TP-400A, and the 5TP4) are all projection tubes developing small, intense images which are enlarged five to 15 times by suitable optical systems. None of these tubes is interchangeable, the chief obstacles being the differences in physical size, the variations in basing, and the second-anode voltages. The 3NP4, shown in the photo, was designed specifically for the North American Philips projection system in this country. It differs so radically in design from either of the other two projection tubes that it requires a special high-voltage power supply and mounting assembly.

A physical comparison of the TP-400A and the 5TP4 tubes reveals some similarity, but when their respective electrical characteristics are examined, decided distinctions appear. First, the 5TP4 uses magnetic deflection and electrostatic focusing and hence its high-voltage power supply contains a bleeder network incorporating the focus control. In the TP-400A, focusing and deflection are accomplished electromagnetically. Secondly, each tube requires a different type of socket, the TP-400A tube using

an octal base and the 5TP4 using a duodecal base. Finally, there is a difference of 7,000 volts in their second-anode potential requirements.

The TP-400A is an exclusive product of the Philco Corp. and is found only in Philco projection receivers. The 5TP4 is employed more extensively, appearing in all projection receivers not utilizing the North American Philips system.

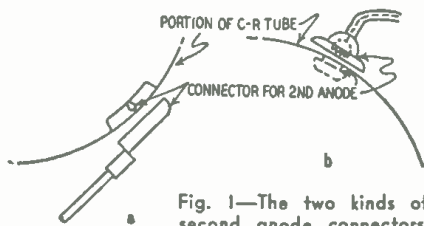

Fig. 1—The two kinds of second anode connectors.

Of the four 7-inch image tubes listed in the table only one, the 7JP4, is used extensively now. The other three 7-inchers represent tubes which appeared since the war but which were subsequently replaced by the 7JP4. The 7DP4, listed first, employs electromagnetic deflection and electrostatic focusing and, as far as is known, appeared exclusively in 7-inch RCA sets during the first year of postwar receiver production.

It is not known how many 7DP4 tubes were sold; if a technician ever has occasion to replace one of these tubes, he may order it direct from RCA if none are available at his jobber. The tube is not interchangeable with any other 7-inch tube listed.

The 7EP4 appeared for a brief period but was soon replaced by the 7GP4 which, in turn, was superseded by the 7JP4, the tube currently being used by all small-set manufacturers. The 7EP4 suffered from lack of brilliance, since only 2,500 volts were employed for acceleration. The 7GP4 was a step forward, producing a brighter image; and the present 7JP4, using 4,000-6,000 volts, gives satisfactory images and possesses higher deflection sensitivity. The 7JP4 and the 7GP4 are directly interchangeable without any circuit changes. This is not true of the 7EP4 and the 7JP4 for two reasons: First, any set designed to accommodate a 7EP4 has a high-voltage output of only 2,500 volts and the 7JP4 cannot be operated with this potential. Secondly, the sockets for the two tubes differ. If a change in tubes is desired by the set owner, determine first how much rewiring in the high-voltage supply will be required to provide 5,000-6,000 volts. If this revision can be readily accomplished, then changing sockets is a relatively simple matter. The table gives the base connections for each tube.

Not many television technicians will recognize the next tube listed, the 9AP4, because it is a prewar tube and does not appear in any postwar receivers. Utilizing magnetic deflection and electrostatic focusing, it is not interchangeable with any of the present tubes. It

is not recommended that the circuit be rewired to accommodate one of the newer 10-inch tubes since the number of changes required would be too extensive. R.f. and flyback power supplies were not used in television receivers in 1939; the supplies built then followed conventional lines. To modify these units to obtain the 9,000 volts required by a 10BP4 would entail an appreciable expense. If a set requires the replacement of a 9AP4, the tube can be obtained by contacting RCA.

We come now to the 10-inch tubes—without doubt the most frequently encountered. Four such tubes are listed in the table, although only two (the 10BP4 and 10FP4) are used to any extent. The 10EP4 is similar to the 10BP4, possessing a slight modification in its gun structure and requiring 8,000 volts for acceleration; the 10BP4 uses 9,000 volts. There are no significant dissimilarities between these tubes to favor one tube over the other, except that 10BP4's are plentiful and used by practically all set manufacturers. Hence, if a set containing a 10EP4 requires an image tube replacement, it will probably be easier and more economical to use a 10BP4—the two being completely interchangeable. If the acceleration voltage is only 8,000 volts and a brighter image is desired, the voltage can be raised, as explained later.

10FP4 tubes are similar to and directly interchangeable with 10BP4's. However, the 10FP4 does not require an ion trap. Thus, when substituting a 10FP4 for either of the other tubes, the ion trap, if electromagnetic coils are employed, is simply laid aside on the chassis; if a fixed or permanent-magnet type of ion trap is used, it is entirely removed from the set. It is not advisable to remove the electromagnetic type of ion trap because its coils are generally part of the low-voltage power supply.

The principal difference between the 10BP4 and 10FP4 is the extremely thin aluminum layer which is coated over the inside of the 10FP4 fluorescent screen. This layer greatly increases brightness, permitting an image to be viewed even when bright sunlight is streaming into the room. To many people this is a distinct advantage, but a word of caution should be given.

There have been numerous reports that the use of aluminized screens has produced eye fatigue after a relatively short period of viewing; to counteract this colored or polaroid filters have been used.

The fourth 10-inch image tube listed is the 10HP4, a 10-inch version of the 7JP4 and completely interchangeable with this tube so far as electrical characteristics are concerned. Since electrostatic deflection is employed in the 10HP4, it is not interchangeable with any of the other 10-inch tubes. Use of this tube was limited to Belmont television receivers and has lately been discontinued. The technician will therefore seldom, if ever, encounter a set having this tube. So far as is known,

Sylvania is the only manufacturer of the tube.

In the 12-inch class, there is one prewar tube (the 12AP4) and four current tubes (the 12JP4, 12KP4, 12LP4, and the 12QP4). The remarks made previously concerning the 9AP4 apply equally to the 12AP4. The 12JP4, a product of Du Mont Laboratories, utilizes neither an ion trap nor a metal-backed screen. Note that nothing can be done to prevent ion spot formation in 12JP4 tubes—if it does occur—because the electron gun structure in the tube is not designed to be used with the external field of an ion-trap coil. It was perhaps because of the appearance of occasional ion spots that Du Mont began recently producing the 12QP4, which has the same shape as the 12JP4, but contains a gun structure that requires an ion trap. The 12LP4 (a big

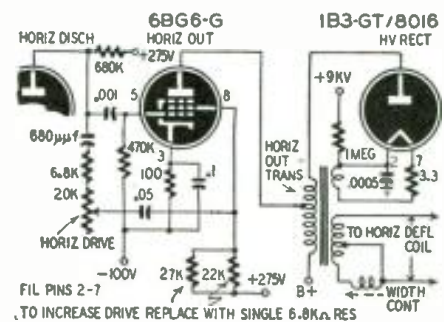

Fig. 2—Replacing resistors increases output.

brother of the 10BP4) also uses an ion trap, while the 12KP4, having a metal-backed screen, does not. All four tubes can be used interchangeably (with the slight modification noted below) because all four possess similar electrical and physical characteristics and all use the same type of socket. If a tube which does not require an ion trap is replaced by one which does, then a permanent-magnet trap can be used.

Both the 12JP4 and the 12QP4 contain a second-anode bulb contact which is a recessed ball cap and therefore requires a female connector. (See Fig. 1-a.) On the other hand, the second-anode bulb contact of the 12LP4 and 12KP4 is a recessed small cavity and a male connector must be used (Fig. 1-b). Thus, when interchanging these two sets of tubes, the second-anode connector must be changed.

It may sometimes happen when replacing a 12JP4 by one of the other 12-inch tubes that proper focusing of the beam cannot be obtained. This is because the focus-coil current for the 12JP4 is 146 ma while for the others it is from 11 to 36 ma less. Actually this means that the 12JP4 requires a stronger focusing field. If the set is originally designed for the 12JP4, there may not be sufficient resistance variation in the focus potentiometer to reduce the current through the focus coil to its proper value. If this is the case, paralleling a fairly high-value resistor across the focus coil will do the trick. The value of this resistor will depend

TELEVISION TUBE TABLE

Type	Screen diam. (in.)	Length (in.)	Base	Socket	Bulb contact	Total defl. angle	Type defl.	Type focus	Heater volts	Heater amps.	Focus coil ma	Ion trap	Typical Operating Cond.				Type
													Cutoff bias	Grid No. 2 volts	Anode No. 1 volts	Anode No. 2 volts	
3KP4	3 $\frac{1}{4}$	11 $\frac{1}{2}$	Magnal	A	None	—	E	E	6.3	0.6	—	No	-64	—	1000	2.5KV	3KP4
3NP4	2 $\frac{1}{2}$	10	Special	B	Cup	42°	M	M	6.3	0.6	—	Metal screen	-65	—	—	24KV	3NP4
TP400A	4	12 $\frac{3}{4}$	Octal	C	Cavity	50°	M	M	6.3	0.6	—	Metal screen	-65	—	—	20KV	TP400A
5TP4	5	11 $\frac{3}{4}$	Duodecal	D	Cavity	50°	M	E	6.3	0.6	—	Metal screen	-70	200	4900	27KV	5TP4
7DP4	7 $\frac{1}{4}$	14 $\frac{1}{4}$	Duodecal	D	Cavity	50°	M	E	6.3	0.6	—	Mag.	-45	250	1430	6KV	7DP4
7EP4	7	14 $\frac{1}{2}$	Magnal	E	None	—	E	E	6.3	0.6	—	No	-60	—	650	2.5KV	7EP4
7GP4	7	14 $\frac{1}{2}$	Diheptal	F	None	—	E	E	6.3	0.6	—	No	-60	—	1000	3KV	7GP4
													-120	—	1620	4KV	
													-180	—	2400	6KV	7JP4
7JP4	7	14 $\frac{1}{2}$	Diheptal	F	None	—	E	E	6.3	0.6	—	No	-45	250	1460	7KV	9AP4
9AP4	9	21	6-pin	G	Metal cap	—	M	E	2.5	2.1	—	No	-45	250	—	9KV	10BP4
10BP4	10 $\frac{1}{2}$	17 $\frac{3}{8}$	Duodecal	H	Cavity	50°	M	M	6.3	0.6	115	Mag.	-45	250	—	8KV	10EP4
10EP4	10 $\frac{1}{2}$	17 $\frac{3}{8}$	Duodecal	H	Cavity	50°	M	M	6.3	0.6	115	Mag.	-45	250	—	8KV	10EP4
10FP4	10 $\frac{1}{2}$	17 $\frac{3}{8}$	Duodecal	H	Cavity	50°	M	M	6.3	0.6	115	Metal screen	-45	250	—	9KV	10FP4
10HP4	10	19 $\frac{1}{4}$	Diheptal	F	None	—	E	E	6.3	0.6	—	No	-100	—	1500	5KV	10HP4
12AP4	12	25	6-pin	G	Metal cap	—	M	E	2.5	2.1	—	No	-45	250	1425	7KV	12AP4
12JP4	12	17 $\frac{1}{2}$	Duodecal	H	Ball cap	50°	M	M	6.3	0.6	146	No	-45	250	—	10KV	12JP4
12KP4	12 $\frac{1}{4}$	17 $\frac{3}{8}$	Duodecal	H	Cavity	54°	M	M	6.3	0.6	135	Metal screen	-45	250	—	11KV	12KP4
12LP4	12 $\frac{1}{4}$	18 $\frac{3}{8}$	Duodecal	H	Cavity	54°	M	M	6.3	0.6	110	Mag.	-45	250	—	11KV	12LP4
12QP4	12	17 $\frac{1}{2}$	Duodecal	H	Ball cap	50°	M	M	6.3	0.6	110	Mag.	-45	250	—	10KV	12QP4
15AP4	15 $\frac{1}{2}$	20 $\frac{1}{2}$	Duodecal	H	Ball cap	52°	M	M	6.3	0.6	160	No	-45	250	—	12KV	15AP4
15DP4	15 $\frac{1}{2}$	20 $\frac{1}{2}$	Duodecal	H	Ball cap	52°	M	M	6.3	0.6	146	Mag.	-45	250	—	12KV	15DP4
16AP4	15 $\frac{3}{8}$	22 $\frac{1}{4}$	Duodecal	H	Metal cone rim	53°	M	M	6.3	0.6	140	Mag.	-60	300	—	12KV	16AP4
16FP4	16 $\frac{1}{8}$	20 $\frac{1}{4}$	Duodecal	H	Ball cap	62°	M	M	6.3	0.6	146	Mag.	-45	250	—	13KV	16FP4
19AP4	18 $\frac{3}{8}$	21 $\frac{1}{2}$	Duodecal	H	Metal cone rim	66°	M	M	6.3	0.6	146	Mag.	-45	250	—	13KV	19AP4
20BP4	20	28 $\frac{1}{2}$	Duodecal	H	Metal cap	50°	M	M	6.3	0.6	140	No	-45	250	—	15KV	20BP4

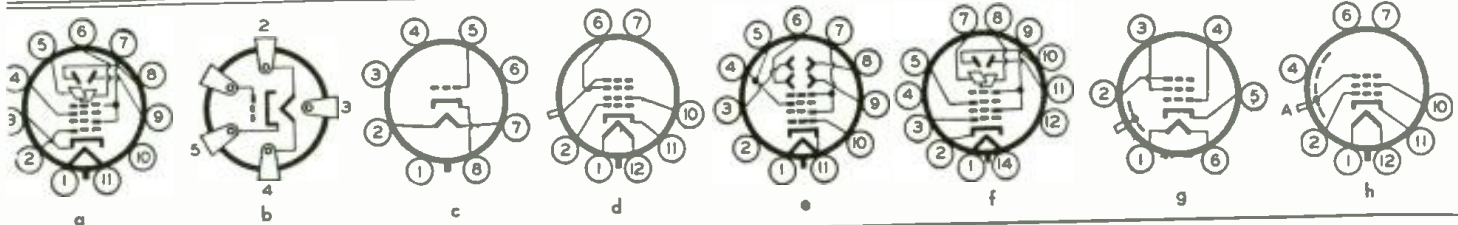

upon the resistance of the focus coil. A good value to start with is 15,000 ohms; the technician can then either increase or decrease it as he sees fit.

The table reveals the deflecting angle in the 12JP4 and 12QP4 is 50 degrees while the angle in the 12LP4 and 12KP4 tubes is 54 degrees. If a 12JP4 or 12QP4 is replaced by either of the other two tubes, the image may not be wide enough to fill the screen. In most sets sufficient reserve power is available so that rotating the width control will widen the image the desired amount. However, in a few sets it may be necessary to increase the B-plus voltage fed to the horizontal sweep system. While each set presents a distinct problem in this respect, a useful procedure is to start with the B-plus voltage of the horizontal output amplifier. Where the output amplifier is a pentode or beam-power tetrode, the voltage on the screen grid rather than the plate should be increased. In such tubes amplifica-

tion is controlled more by the screen-grid potential than it is by the plate voltage.

To illustrate this point more fully, the usual horizontal output circuit employed with 10-inch cathode-ray tubes is shown in Fig. 2. To obtain a greater horizontal sweep and at the same time increase the high-voltage output, the two screen-grid resistors of the 6BG6-G are replaced with a single 6,800-ohm, 2 watt resistor. Fig. 2 can be used by technicians who wish to replace 10-inch tubes with 12-inch ones.

Additional height, if required, can also be obtained by raising the plate and screen voltages of the vertical output amplifier.

The remaining tubes listed in the table (the 15AP4, 16AP4, and 20BP4) possess electrical properties which are very similar and which would permit interchangeability. There are, however, physical considerations to contend with, and in most instances expensive cabinet

alterations would be required. Any set originally designed for a 15-inch image tube will properly drive the 16AP4 or the 20BP4 without any circuit change.

Tubes receive their numbering from the RMA in the order in which they are submitted. Thus, the first 10-inch cathode-ray tube submitted to the RMA received the designation of 10AP4. The second 10-inch tube was labeled 10BP4. The 10AP4 now being obsolete, the 10BP4 is the first 10-inch tube to be encountered. The 12-inch counterpart of the 10BP4 (a tube which is similar in all respects to the 10BP4 except in physical size) is the 12LP4. It is not the 12BP4.

The lesson for the technician in this procedure is obvious: Never assume that cathode-ray tubes which possess identical lettering and differ only in screen diameter possess equivalent electrical properties. Check the physical and electrical characteristics to determine interchangeability.

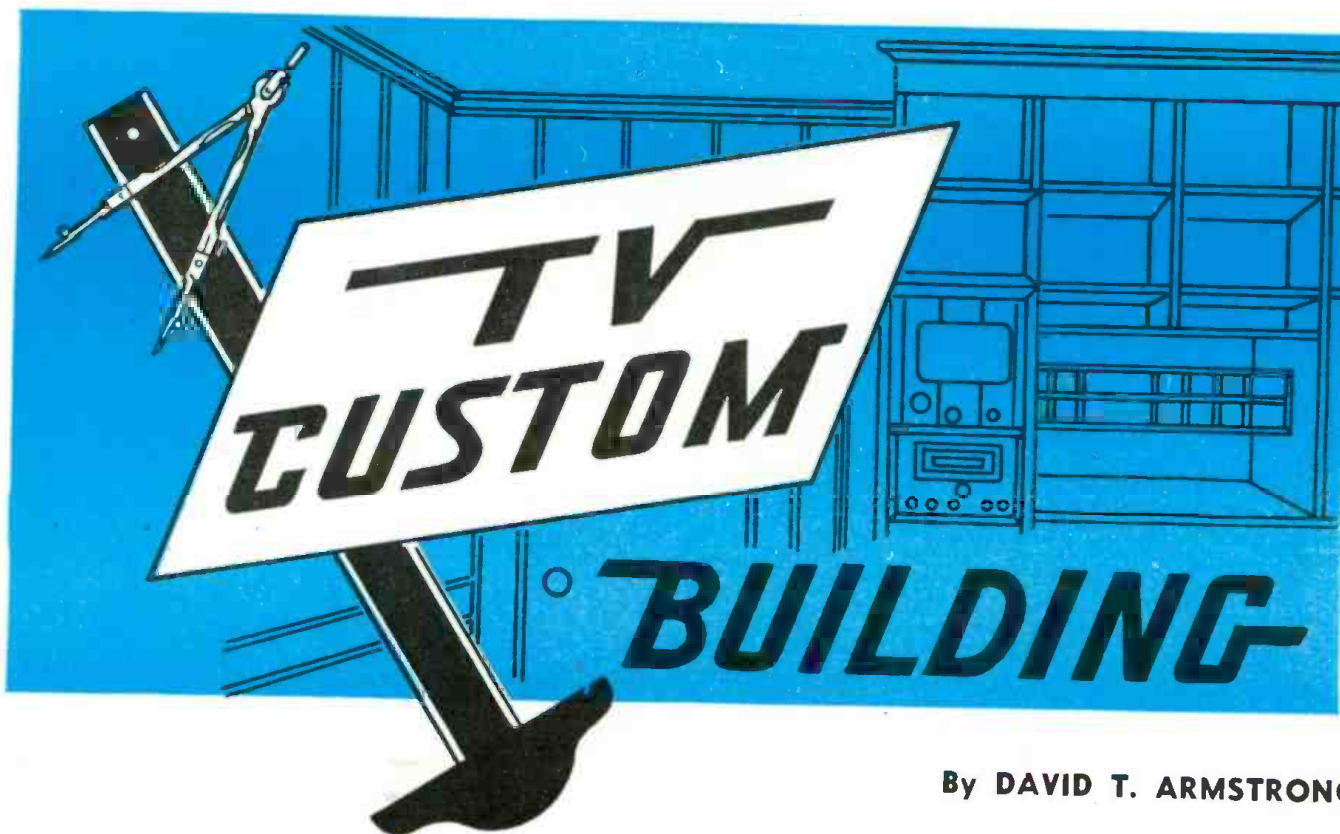

By DAVID T. ARMSTRONG

NEARLY every service technician has had a request at some time in his experience for an unusual custom installation. Not knowing how to proceed, he has been compelled to turn such business away.



Fig. 1—A simple but tasteful installation.

It wasn't so important in the days of AM radios and phonographs, but with the advent of TV custom building is really becoming big business. It is actually possible to do nothing but custom work and make a handsome profit. Many such installations will be made during the next few years. The fellows who get in the elevator now on the ground floor can ride to the penthouse on top in a few years.

Let's suppose a customer comes in and broaches the subject to you. Visit his place and look it over with him. Find out just what he wants. Some

things can be done and some are impossible. If what he wants is impossible, have the courage to say "no" firmly. There are too many heartaches in trying to do the impossible. Then tell him what is possible.

The limitations on an installation are of many kinds, but some fundamental factors cannot be overlooked. There are the actual dimensions of the chassis to be installed; there is the placement of the TV tube or screen; there are the architectural aspects of construction and the problems of cabinetmaking; and there is the placement of the speaker.

Let's consider a single installation and some typical problems.

Selling the customer

Selling the idea is the hardest and most important part of the whole deal. Let the customer feel that *he* is *buying* something, not that he is *being sold* something. The era of high-pressure selling by out-talking and out-thinking your prospect is over. This is a buyer's market, and new techniques must be utilized. Always approach the customer as you would expect a salesman to approach you. You like to buy because you are the master of the situation; and you don't like to be sold.

Capitalize on that. Demonstrate your products and your wares so well that you leave it to the customer to choose what best suits his taste and his pocketbook. A good set of photos similar to the ones used to illustrate this article will do much to simplify the sales approach. I have sold some custom installations to people and despised my-

self later for the poor taste shown in the job. But there are different levels of taste. What I regard as poor someone else regards as good. So try to find out what the customer wants and give him that. Do not try to operate a school for art appreciation. Just sell custom installations. I do better selling a customer what he wants to buy. I sell monstrosities if monstrosities appeal to the buyer. They like me and send me more business.

One very important aspect of the selling campaign is giving the customer *an exact idea* of what the installation



Fig. 2—General Electric projection assembly.

RADIO-ELECTRONICS for



Fig. 3—Woodwork had to match wall panels.

is going to look like. Fig. 1 shows an installation in a simple but tasteful setting. Originally there was nothing there but a bare wall. The bookcase was built in extra because the client always wanted a bookcase; further, it balances the TV installation.

You soon find out in this custom-building business that, when the job is finished, it looks quite different from the picture the customer had built in his own mind. To forestall this I bring with me some pieces of plywood cut out to the dimensions the installation is going to occupy. For most of the installations illustrated here you require 20 inches of depth, 32 inches of width, and 48 inches of height. The height is easy. The 20 inches of depth causes the most trouble. Placing the plywood cut-outs on the floor where the installation is going to be gives the customer an exact idea of what the finished job is going to do to his room, and a notion of how far out it is going to project.

I also have with me a piece of cardboard, cut out in the shape of a TV screen, with a picture in the insert. Several sizes of these will give a client a very clear idea of what size tube or picture he is going to want. This is very much worth while. When the subject first comes up, many people think of a 10-inch tube, or maybe a 12-inch one. But, when they sit down and see in their own living room how tiny one of these is, they often change to a 16-inch tube or to one of the 16 x 20 projection types. Fig. 2 shows the General Electric projection tube and mirror assembly. Generally speaking, projection setups are ideal for custom building because people are not likely to get them in any other way.

The technician should be impartial in his recommendations of the various receivers available. Make a client feel that you are interested in giving him a good custom installation, not that you are trying to sell him a certain set.

Brand names are important. If a customer believes that RCA is the best, let him have an RCA. When another customer wants a Scott, don't try to sell him a Du Mont. I know; I learned the hard way. When something goes wrong with the receiver you urged on him and service is necessary, the customer is sure he was sold a lemon.

If, in your contact with the customer in his own home, you can get the main details of where the unit is to be placed, where the screen is going to be and where the speaker will be located, plus the type of receiver he wants, that is enough. That's basic and absolutely essential for you to work on.

Architectural considerations

Architecture is a very important aspect of any installation. Every job is different and sets its own special qualifications. All you learn from your experience is that you can apply only general considerations. Specific things will depend on the individual job in hand.

In some instances it is desirable to use one part of a wall and build a bookcase on either side of the installation for appearance and balance. In the installation of Fig. 3 it was necessary to build a bookcase and match the paneling of the woodwork in the room. In another instance it was most satisfactory to build a new closet and have some shelving over the unit as in Fig. 4. Let me call your attention to a small item about the cabinet work on this job. In my own opinion and in that of the cabinetmaker whom the client engaged, the closet should have been built flush with the wall. The customer didn't want that. You can see he got what he liked. So long as you install the receiver and he lives with the installation, everybody can be happy.

In another case it might be wisest to take a complete corner and build it up so that it may be closed when the unit is not being used. Fig. 5 shows a very unusual installation. When closed, it is impossible for an outsider to know that a TV set and reproducer are cleverly concealed behind what seems to be a closet in a corner. If you examine Fig. 5 more carefully, you will note the break in the woodwork down the middle. The part on the left with the TV screen is on rollers and slides out for servicing. (Never forget when you make an installation that you may have to service it!)

Sometimes it may be necessary to break into a wall. Some knowledge of wall structure is of inestimable value. Most of the time you can help yourself to 4 inches of depth by cutting into a wall. Here's where this helps. The point selected for one installation had a corner post that projected 15 inches. The installation required 19 inches of depth. Knowing that we could cut into a wall and gain 4 inches, we did just that. But we had to do a little carpentry work and some plastering to make the wall strong and to get it back into shape.

Cutting into a wall is sometimes a tricky business. There may be a concealed plumbing, gas, or telephone conduit right where you want to work. Explain to the customer that you would like to break into the wall and that you will leave things as good or better than you find them. If there are no concealed pipes in the wall, you are to go ahead with the job; but if there are, the customer is to pay you for your trouble and you will find a new location more suitable for the installation.

The more expensive the installation, the more chances there are for a two-aspirin headache. Sometimes the customer prefers to work through an architect, in which case your problems are simplified. You just make your installation and *git*. The architect takes care of the fancy work and smoothing over the rough places with the customer.

Cabinetmaking

Always have a definite understanding with some local cabinetmaker who will agree to work with you and to suit



Fig. 4—Closet assembly was built for TV set.



Fig. 5—Closed doors hide this installation.

the whims of the customers you manage to find. This is not too difficult. Cabinetmakers are used to fussiness. They are fussy themselves, or they would still be carpenters. You must always be ready to supply a cabinetmaker to do the necessary woodworking for any installation. He should be a man with a fine sense of balance and proportion and must be willing to go out of his way to match already established woodwork patterns. One cabinetmaker



Fig. 6—A good commercial dual installation. *Industrial Television photo*

did all the installations shown in Figs. 1, 3, 4, and 5. The layout and arrangements in Figs. 3 and 5 were by architects, while Figs. 1 and 4 were according to the customer's specifications.

Offer the customer the opportunity to choose his own cabinetmaker. It is safe in this business to let the customer choose his own workmen all along the line. *But* don't let him tell you about the radio end of the installation. Here you know your stuff. But when he has some special ideas about cabinetry, let him work them out with the cabinetmaker.

Generally it is better to let the cabinetmaker do his part of the job up to a certain point. Then you make the installation of the chassis and cable leads to various parts of the receiver. It is better for you to drill the holes you need than to have the cabinetmaker responsible for this. Holes that you lay out in theory don't always work out in practice. Sometimes circumstances dictate a different placement of the chassis which would necessitate new hole locations. When your part of the job is done, let the cabinetmaker put the finishing touches to make his part a work of art.

There are infinite possibilities in the design of a cupboard, bookcase, corner installation, etc., to conceal the finished product. The doors can just plain open and be there when the unit is being operated; they can be rolled back; or moved back to fit into a ready-made slide. These are the extras that make the installation a little more expensive,

but in general add nothing to the pocket of the radio technician.

While the technician may not be a cabinetmaker, he must have sufficient understanding of the art and the possibilities of what can be done with little nooks to decide immediately whether what the customer is asking for is possible.

Placing the speaker

The problem of where to put the speaker is important in any custom installation. I am a firm believer in the Klipsch corner speaker because it makes use of the floor and walls as sounding boards, but few installations will ever present the possibility of such a genuinely high-quality installation. The only one I ever made is in my own home.

The speaker usually presents simple cabinetmaking problems because the speaker front can be covered with any one of a large variety of materials, including cloth and woven wood products like raffia. The speaker should be one of the large 12- to 15-inch-diameter units. It is foolish economy to have a good television installation and a little 5- or 6-inch speaker pushing out the accompanying sound. Don't sell the customer anything that is going to make him unhappy with his installation in a short while. The dual commercial installation of Fig. 6 has two 12-inch speakers and two large-screen projection assemblies.

The speaker should be so positioned that it will face the viewers.

In connection with the speaker another little angle is important where there are small children. I always include in a good custom installation a couple of phone jacks and sell the customer a set of headphones for each child. Many times the mother doesn't mind having the children listen to some story, but she wants no part of it. Unless there are headphones and connections, there is no simple solution to the problem. I have several letters of appreciation for these phone-jack installations. Incidentally the writers of these letters are the women who probably sell me to their friends on just such a little widget.

The placement of the controls for the receiver is optional. They may be hidden by the masking frame as shown in Fig. 7, or the receiver may be operated by remote control.

Cost of the installation

Cost depends on the character of the installation and the amount of work necessary. There are several ways of billing the customer for the complete job. You can sell it to him as a package, or you can itemize the unit costs for him. It is generally better to sell the whole deal as a package, which you can break down into component items only on request.

Roughly a TV chassis that includes AM and FM costs about \$75.00 for a 16 x 20-inch picture of the projection

type. The direct-view chassis will cost considerably less. (In today's market, prices are tumbling daily like the walls of Jericho when Joshua "fit" that battle.) This is the fundamental cost and you bill the customer for it at the current list price. To this you add the cost of the cabinet work if you supply the cabinetmaker. If the customer makes his own arrangements with the cabinetmaker, let the customer pay him separately. Don't even inquire into what that work costs. Do your part well and let the other fellow have his.

Securing your prospects

Building up a custom business is not easy, although conducting it is once it is built up. We used a postcard technique. In cooperation with a good printer we drew up an attractive two-color card with some snappy but distinctive copy. We sent it to a specially selected mailing list for which we paid a premium price. I know that many people have used such techniques with mediocre success, but they have used them only once or twice. We sent out *four* mailings before we got any nibbles. You have to keep everlastingly at it or you won't get enough response to keep you alive. We still send out a series of ten monthly mailings per year. This keeps our name before prospective clients and builds good will for us.

There is some serious stuff on the card about us and the services we are prepared to render. But there is some entertaining humor and inspirational stuff there, too. We believe you shouldn't invade a man's home *via* the mailman unless you give him something that will take the edge off your invasion. Giving a little entertainment is really what made those postcards and our business. They were go-givers which became after a short time go-getters.

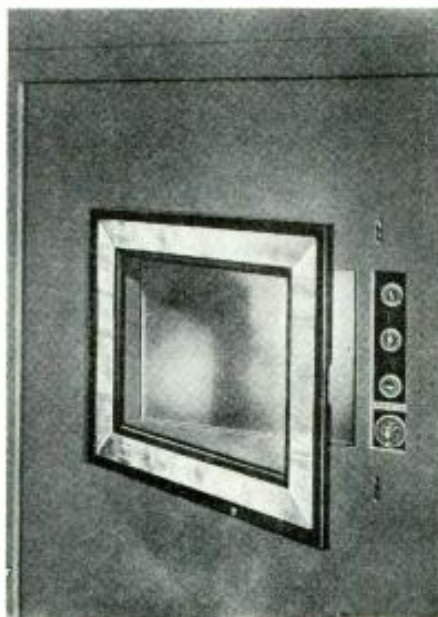

Fig. 7—Controls hidden by the masking frame. *RCA photo*

Indoor Television Antennas

By
EDWARD M. NOLL
 and
MATTHEW MANDL

Outside antennas are not always necessary
 for acceptable television reception

OCCUPANTS of apartments where roof antennas are prohibited must use either an indoor or a window antenna to receive television programs. These antennas are satisfactory in areas where the signal strength is high, and with proper choice of type, dimensions, and positioning, can be made to work fairly well on weaker signals also. Occasionally they perform passably even in

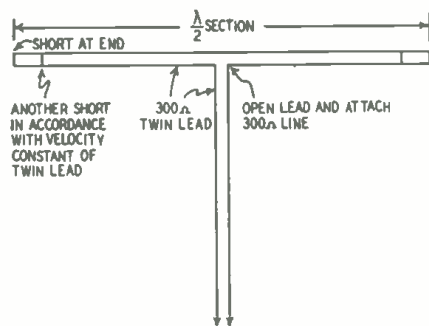

Fig. 1—Correcting the "half-wave" dipole.

fringe areas, especially if the location is high or the receiver is located on an upper floor. Despite the type used, indoor or window antennas will not perform miracles, and at best they rarely come up to a well planned and erected outdoor antenna.

If he finds it necessary to install an indoor or window antenna due to housing restrictions, the television technician and dealer has the additional responsibility of making sure the customer gets a receiver with superior sensitivity. There are wide differences in the comparative sensitivities of commercial television sets. If an indoor antenna is used, best performance is obtained when receiver sensitivity is high and signal-to-noise ratio of the r.f. tuner above average.

The window antenna is preferable to the indoor type because it can be made more elaborate. Because it is usually placed in a less confined area, it can deliver a stronger signal to the receiver. An indoor antenna must be placed where the troublesome multiple reflections within a building do not cancel, but reinforce to give the best signal. There is also appreciable absorption and shunting of signal by the building structure before it reaches the indoor antenna.

Similar troubles, of course, often plague the window antenna—particularly if it must be mounted on the side of the building away from the transmitter. This condition is aggravated if an intervening structure blocks the signal path.

The window antenna is often subject to reflections when it is placed among structures as high as or higher than it is. Distant reflections put ghosts on the screen, while the multiple close reflections to which window and indoor antennas are especially liable disturb the resolution and sensitivity of the antenna. A window antenna on the proper side of the building and with a clear path toward the TV stations will give excellent performance.

Existence of the several variables mentioned above means that an experimental approach must be used. Location and orientation of the antenna is certainly every bit as important as the actual choice of antenna type.

Selection and installation

To obtain full benefit from the weak available signal, the importance of *proper antenna dimensions and impedance matching* cannot be over-emphasized. An adjustable type should be chosen which can be tuned to the various TV channels to be received. The weaker signals can then be "tuned in"

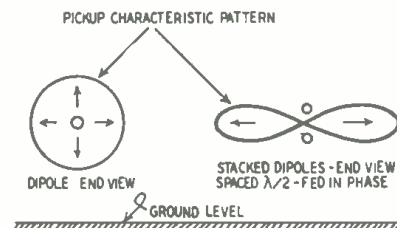

Fig. 2—Fields of single and stacked dipoles.

exactly—which means a substantial increase in picture quality. The antenna transmission line should be ideally matched and of proper over-all length to deliver the signal to the receiver at maximum strength. In the weaker signal areas, a booster improves performance of a window or indoor antenna, particularly if the signal-to-noise ratio and sensitivity of the booster are high.

Orientation and positioning of the antenna are very important for best results. There are definite space patterns

for the various stations in any locality. Position the antenna at various trial points while checking the signal strength by watching picture reception. The many reflections inside and near walls indicate that space loops are closer together and less intense than those encountered outdoors. Because of these multiple indoor reflections, correct orientation of an indoor antenna is not always truly broadside to the direction of the station. Experimental tests must be made before the best placement is found.

Thus, the most can be secured from an antenna which has adjustable dimensions, can be moved about readily and mounted at unusual angles, and can be flexed into various positions after mounting. Trial and error alone can determine the best place within a room and the most satisfactory antenna-arm positioning.

Home-made indoor antennas

The television technician can use his ingenuity in constructing effective indoor antennas for customers who cannot use outdoor installations. Twin-lead, 300-ohm line lends itself well to indoor antenna construction because it can be concealed easily. It can be mounted on the molding or around the window frame, or even placed under the carpet because it lies flat. It can be cut to proper length (depending on the channel frequencies allocated to the area) and connected as a folded dipole. Harmonic relations usually make good reception possible on the higher channels even though the antenna is cut for a low channel. Channel 10, for instance, is the third-harmonic frequency of channel 3 and can be received well with an antenna cut for that channel.

When making a folded dipole from a 300-ohm, twin-lead transmission line, consider the velocity constant of the insulating material. Short each quarter-wave side of the folded dipole (Fig. 1), at a point obtained by multiplying the quarter-wave physical dimension of the antenna by the velocity constant of the dielectric material. Shorting at this point, although it does not change the over-all length of the folded dipole produces additional signal strength because of the effect of the velocity constant on the circulating current in the antenna.

For example, a folded dipole on channel 10 would have an over-all length of approximately 29 inches, this representing a half wavelength. Each side therefore, would be $14\frac{1}{2}$ inches. The

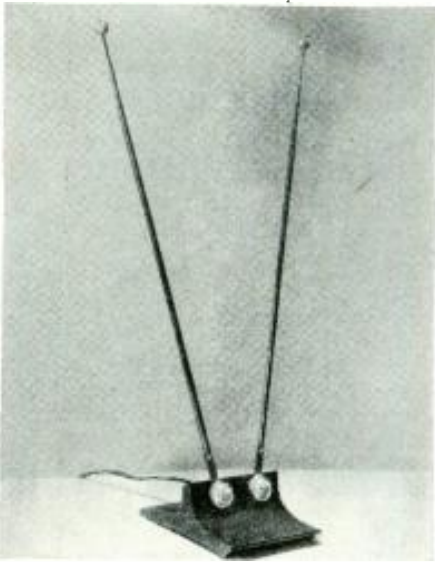

Fig. 3-a—The JFD antenna, a broad "V" type.



Fig. 3-b—The Ward "V" antenna is inverted.

short is placed at a point obtained by multiplying the velocity constant by $14\frac{1}{2}$ inches. If the velocity constant is 82%, a short would be inserted on each side about 11.9 inches from the center of the antenna.

Circular or rectangular antennas for indoor mounting can also be made with No. 14 to 18 wire. Such an antenna can be concealed behind a picture, or the wire can be run around an entire window frame. Again, tests should be made before installing such an antenna permanently, because orientation may be incorrect.

Airplanes and ignition

Fig. 2 shows the relative patterns of a single dipole and a stacked dipole. This is an end view with the observer's eye level with the antenna. The pattern is the same for both the dipole and folded dipole. Note that single antennas have pickup characteristics in the horizontal (the desired) direction and vertical (undesired) direction. The vertical pickup properties make this type of antenna sensitive to ignition noise from below and airplane interference from above. Ignition noise results in streaks across the picture, and airplanes cause

rapid fading of the picture—in and out.

The stacked array is much better, because of its elongated horizontal pattern and low sensitivity to pickup. Indoor or window antennas, however, do not lend themselves to stacking because of limited available space. If interference is severe, a loop antenna is recommended, for it is the only antenna which the authors have found to have the elongated horizontal pattern of a stacked array. This circular loop must be exactly a wavelength in circumference, must be absolutely vertical, fed at exact bottom, and critically orientated. The gain is high and the performance unusual. (See "Antennas for Television, Part VI," RADIO-ELECTRONICS, June, 1949, for further details and channel dimensions.) This type can be made from No. 14 wire and easily concealed behind drapes or furniture.

Commercial indoor antennas

One of the most common indoor antennas is the simple dipole made of telescoping rods. This antenna can be adjusted to proper length and mounted on a stand. The antenna rods can also be swung to various angles for best reception. Typical examples are those manufactured by JFD Co. and Ward, shown in Figs. 3-a and 3-b. Another example of this type is the Jiffy-Junior put out by Delson (Fig. 4). It has a stand with rubber suction cups on the bottom to hold the base firmly to any surface. Occasionally this antenna can be used at the window simply by pressing it against the pane.

Tricraft Products manufactures two special antenna types, (Figs. 5-a and 5-b), one of which is flat and mounts under the carpet or behind drapes. The second indoor type is tunable with a selector switch which is set on the desired channel. This antenna is one-

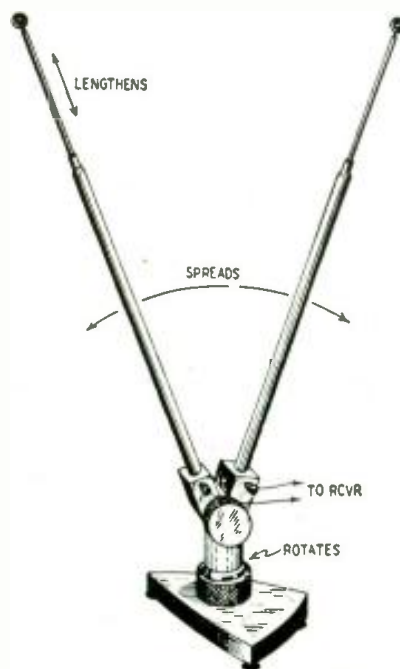

Fig. 4—Jiffy-Junior is another "V" antenna.

fifth the length of an ordinary channel-2 dipole, yet it is tunable to the low- and high-frequency television bands.

Another unusual antenna (Fig. 6) manufactured by Radio Craftsmen consists of a folded dipole which opens up much like a metal-tape rule. The various channel numbers are recorded on the metal tape so the antenna can be opened up into a folded dipole of the proper length for the channel to be received. The arms are fully retractable, just like a metal tape measure, which in a way it is.



Fig. 5-a—This type can be concealed easily.



Fig. 5-b—Cylindrical antenna with tuning.

Jerrold Corporation manufactures a combination indoor antenna and booster. The antenna is a telescoping dipole which mounts directly on the back of the booster amplifier, and is an integral part of the whole unit. This is perhaps an ideal arrangement in the weaker-signal areas when an indoor antenna must be used.

The RCA tube department recently announced a new type of indoor antenna employing end-loading disks which reduce over-all length and still permit reception of low-band stations. Large spheres or flat disks at the end of an antenna increase the effective area at the end and thus increase the capacitive component of the antenna (referred to as "end effect"). Then, the inductive component, represented by the total length of the antenna, can be correspondingly smaller to resonate at a given frequency. This type of antenna functions well on the high-frequency channels because its physical length corresponds to a half-wavelength on these channel frequencies.

A built-in antenna

Philco has just announced that their latest receivers include built-in antennas, and it is likely that other manufacturers will have followed their example before this is printed.

The foregoing commercial indoor types are the result of much research and clever design by manufacturers, and often produce excellent results. But it should be emphasized again that, if the location is in a fringe area and near ground level, not much can be done to secure a completely satisfactory pic-

ture. For really long-range reception, of course, the indoor type of antenna is out of the question. A roof antenna is preferable; if it cannot be used, the window type is the one that must be installed.

Commercial window antennas

Many standard dipoles and folded dipoles commercially available for roof mounting have special mounting brackets



Fig. 6—The "Slide-Rule" is exactly tunable.

which adapt them to window mounting also. There are a few special window-type antennas such as the Jiffy-Tennas manufactured by the Delson Manufacturing Co. (shown in Fig. 7) which can be mounted to the window frame by a screw expansion system which holds it firmly.

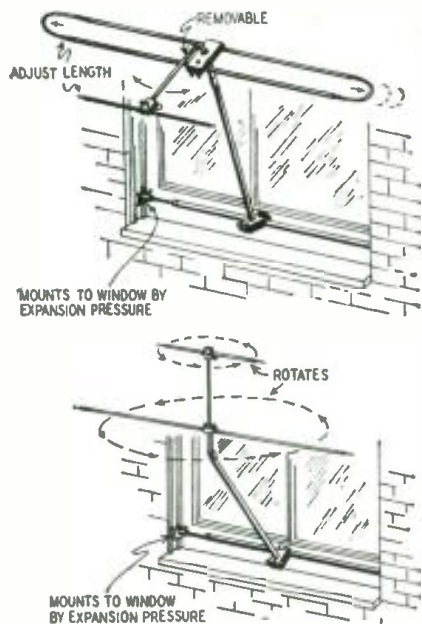

Fig. 7—Two easily-mounted window antennas.

One type consists of a folded dipole director or reflector combination with sliding rods and trombones to permit adjusting the length for optimum reception of a specific channel. The antenna can be readily moved and oriented for proper positioning. The small element can also be used as an independent high-band dipole and the folded element as an independent low-band folded dipole. The smaller dipole is individually adjustable as to positioning and can be set separately from the folded dipole for ideal reception of a high-frequency station. This is necessary in many locations.

A second type of window antenna consists of a high- and low-band dipole, also independently adjustable as to length and orientation. In this form the high-band dipole is stacked above the low-band dipole.

While there is less opportunity to po-

sition a window than a roof or indoor antenna, it can be tried on each side, below, and sometimes above, each of the available windows.

Many private home housing projects prohibit outdoor antennas. In such instances indoor antennas should be placed in the attic—if there is one—rather than in the room where the receiver is located. Height is always a dominant factor in increasing signal strength, and versatile antenna types can be mounted in the attic at the apex or some other convenient point underneath the roof. The antenna should, of course, be checked in various positions and adjusted for correct length and orientation to obtain the best possible performance.

Summary

All indoor and window types suffer by comparison with the high outdoor types, and installation precautions must encompass all possible means to secure the most from these devices. However, when an indoor or window antenna takes full advantage of installation, impedance match, orientation, and the other factors detailed in this article, it sometimes performs as well or better than an outdoor antenna poorly installed in terms of orientation, impedance match to receiver and position.



The circular antenna is behind the picture.



Indoor antennas need not be exposed to view.

THREE NEW TV RECEIVERS

Raytheon Voyager. Portable for a.c. or d.c. Circular 7-inch screen. Indoor antenna furnished with set. Luggage-type



cabinet 16½ x 17¼ x 9½ inches. Shipping weight 42 pounds. (Raytheon Mfg. Corp., Belmont Radio Corp. Div., Chicago, Ill.)

Meck portable. 7-inch picture tube. 5-inch PM speaker. Luggage-type case has front cover and space for portable



antenna included with receiver. All-channel tuner has fine-tuning control, 18 tubes, 4 rectifiers. A.c. operation only. Weight, 28 pounds. (John Meck Industries, Inc., Plymouth, Ind.)

Hallicrafters T-69 custom chassis. 15-inch tube. 130-square-inch picture. Push-button tuning. 300-ohm antenna input. 8-inch PM speaker. Chassis furnished on wood frame for custom in-

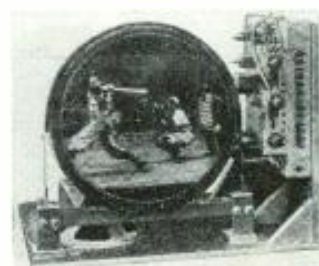

stallations (no cabinet available). Height 19½, width 23, depth (not including knobs) 21¼ inches. 19 tubes, 3 rectifiers. (Hallicrafters Co., Chicago.)

TV Station Studio Controls

The video signals are corrected, mixed, and passed to the master control

By MORTON SHORE



Fig. 1—Control operators "touch up" signals from several studio cameras.

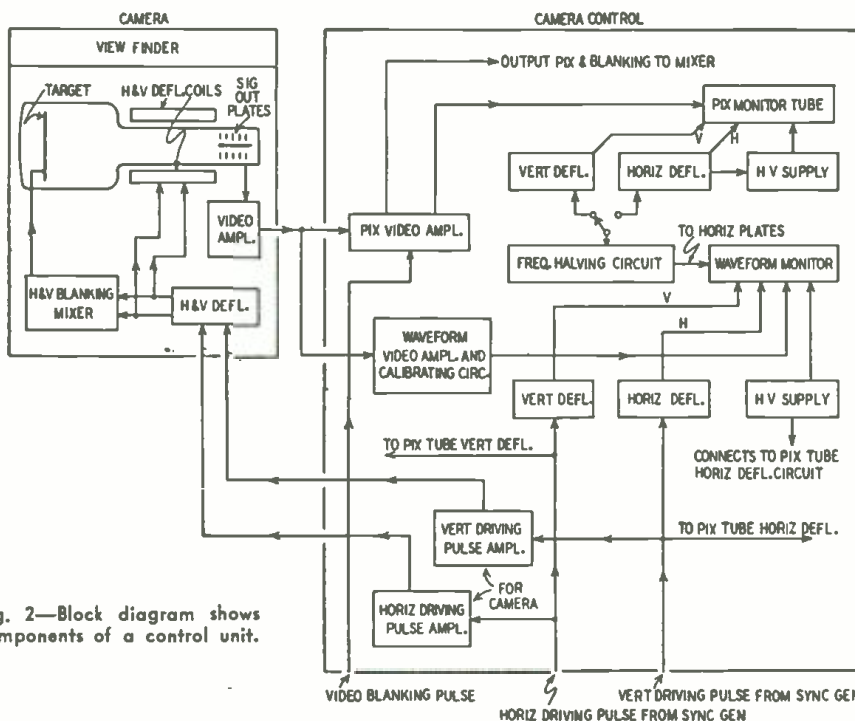

Fig. 2—Block diagram shows components of a control unit.

THE immediate output signal of each camera is usually below the quality standards of the station, or may differ from the exact needs of the particular program. To compensate for these differences a chain of electronic devices is employed. The first of these, the *electronic viewfinder*, is directly attached to the camera by plug and socket connections.

The camera operator looks into the viewfinder and sees a reproduction of the scene picked up by the target of the image orthicon. If it is out of focus or improperly sized he can make corrections immediately. He can also monitor the picture and more easily correlate the program director's instructions with the actual scene.

Each viewfinder consists of a video amplifier which is attached to the camera's video amplifier, vertical and horizontal sweep amplifiers, and a picture tube. The picture tube—unlike any mechanical optical device—can reproduce the televised scene accurately despite quick background changes or low light levels.

Camera control units

Each camera is more completely controlled by the *camera control unit*. There is one for each camera, and they are combined in a console, as in Fig. 1. The main functions of each unit are to amplify and regulate the camera signal, correct its focusing, and insert the blanking pulses for the composite signal.

Other purposes of this unit are to amplify and control the camera driving pulses; provide an accurate calibrated signal for comparison tests, and insert sync pulses into the composite signal when only one camera is used.

Each one of the above functions has an external control. The camera operator uses these in conjunction with two monitor screens to enable him to regulate and correct the picture.

One monitor screen (10 inches for RCA and 12 inches for Du Mont) shows the actual picture, and another (5 inches for RCA and 7 inches for Du Mont) shows it in its original waveform. The operator can adjust the picture for maximum definition and detail by observing the two monitor screens.

The waveform monitor enables him to observe the closeness to the maximum black level (same as blanking pulse height) of the strongest video signal. By setting the black level to approximately 75% of the total composite picture amplitude, and keeping the darkest video signal just below this mark, a picture of ideal brightness and contrast will result.

The picture monitor enables the operator to correct and double check the adjustments made according to the waveform monitor, and adjust the focusing. An accurate combination of all these adjustments results in a picture of maximum definition and detail.

The program director usually sits directly behind and slightly above the camera control console. From this vantage point he or she is able to see all the camera monitors as well as the action in the studio. The director is then in a position to designate which of the cameras shall go on the air and also to direct any special effects such as dissolving or fading that may be desired.

The director uses a small sound system to transmit instructions to the cameramen, control operators and other operating personnel who wear headphones. Thus, full control is maintained over the lighting and placement of cameras and microphones. Actors and sound-effects men may receive instructions off-stage through headphones or speakers.

The actual component parts which supply the signals to the monitors and the other units regulated by the camera control unit are shown in Fig. 2. With few exceptions the circuits are very similar to those in a television receiver. One of the important ones *not* found in a receiver is the frequency-dividing circuit. It consists of a buffer amplifier connected to the output of the picture tube's vertical and horizontal scanning amplifiers, followed by a 2-to-1 frequency divider and a discharge tube.

The output of this circuit is applied directly to the vertical or horizontal plates of the waveform monitor. When it is switched in, two separate waveforms appear, which accurately show the complete blanking pulse and the very beginning and the very end of one complete picture frame.

Mixing equipment

The output of each camera is fed into a *mixer* (Fig. 3), which determines what is to go on the air. Externally it appears very similar to the camera control units, and many of its internal circuits, which include two monitors, are also very similar.

The outstanding circuit of this unit is the *lap* and *fade* dissolve and superimpose signal circuits. With these, one scene can be gradually eliminated, while the other is gradually brought in. Also, the outputs of two or three cameras can be mixed together, with emphasis given to any particular one. These methods make the system highly versatile, and television as a whole, more entertaining.

Master control

There are usually several studios in a large station. Therefore, a *master control system* (Figs. 4, 5) has to be used so that all the programs can be reviewed. Of course, only one program is sent out at one time, but simultane-



Fig. 3—All pix signals go to mixer (second from right). This is a portable control setup. Courtesy Allen S. Du Mont Laboratories, Inc.

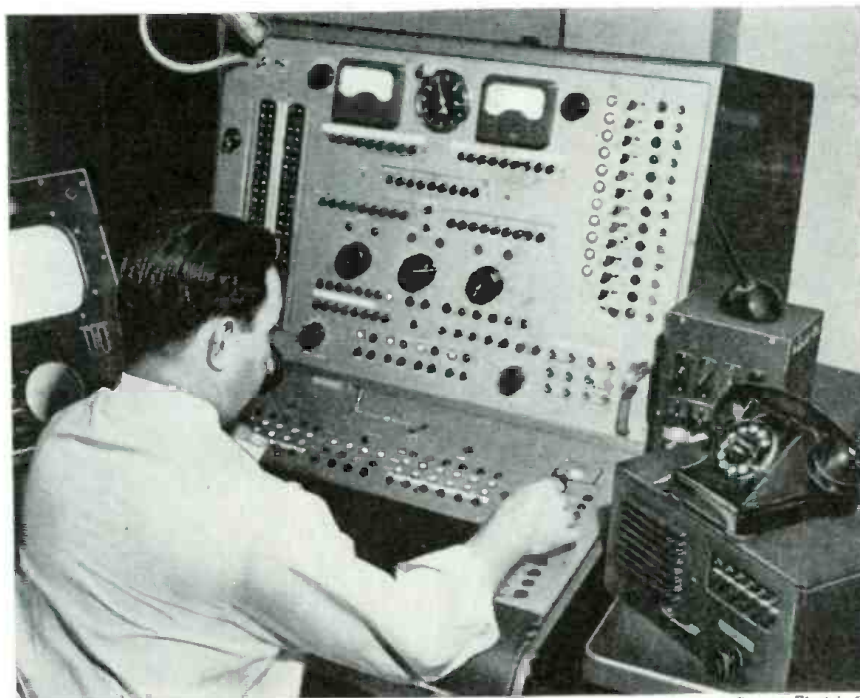

Fig. 4—The master control operator is the distribution chief of the television station. Courtesy General Electric Co.

ously other programs have to be rehearsed, checked, and timed. Also, they have to be distributed to various monitors throughout the studio, especially to the executive offices and sponsor's reviewing rooms.

Other functions of the master control are to pick up and correct remote and network shows, and double-check all programs before and after they leave the transmitter.

Telephone and intercommunicator switchboards enable operators at master control to maintain contact with personnel in the studio, at the transmitter, and on remote locations. Provisions are made for feeding program audio into the head-sets of the cameramen and other personnel to enable them to hear the program when they are not receiving instructions or other

information necessary for the successful television program.

Master control operators are responsible for switching between studios when one program ends and another begins or when it is necessary to inject some types of commercials or weather and time information into a live broadcast.

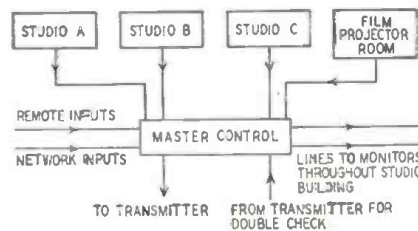

Fig. 5—Block diagram of master control unit.

may be necessary to replace or rewire the picture-tube socket.

If a suitable set is not available, you may find it worth while to build one especially for this application. Its size

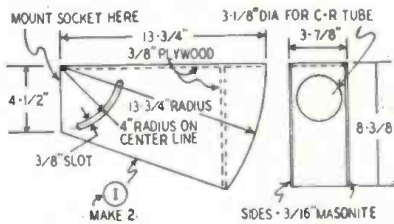

Fig. 3—Working drawing for C-R-tube holder.

can be held down to a minimum by omitting the audio channel.

The chassis of our Pilot TV37 was removed from its cabinet and installed in a lightweight plywood case designed to stand up under hard usage. Construction of the case is shown in the photographs and drawings. A reel holding approximately 100 feet of a.c. line cord is fastened to the back of the case. Additional line cord can be carried on another reel for use when more is required.

The case was constructed from a sheet of 1/4-inch plywood 48 inches wide and 36 inches long. Fig. 1 shows how the plywood sheet can be laid out to avoid excessive waste. Note that only the shaded areas are wasted. A bench saw is recommended for cutting the sheet. If one is not available, use a saw with fine teeth and support the sheet between two chairs or sawhorses to avoid splintering.

Plywood was selected to keep weight at a minimum. Unfortunately, 1/4-inch wood is too thin to hold nails or screws in its edges. Therefore, fillets were made from lengths of 3/4-inch quarter-round molding. These are shown in the exploded view, Fig. 2. The case was constructed in two parts. One consists of the front, right side, and top; the other, the left side, bottom, and back. The pieces of each section are held together with wood glue and brads through the plywood into the quarter-round fillets. The halves are held together with 3/4-inch wood screws.

The chassis of the receiver is turned on its side and screwed to the right side of the case with its controls projecting through 1/2-inch holes drilled in the recessed front panel, as shown in Fig. 2 and in the photographs. The C-R tube is mounted in a hinged lid set into the top of the case. The lid is adjustable so it can be raised to nearly 90 degrees, making it easy to see the picture when working directly above the set as one is likely to do when making installations. In the first case we built, the controls projected through a straight panel and the C-R tube was behind a piece of safety glass located approximately in the spot where the speaker is in this design. We soon found that the projecting knobs are likely to catch on the rungs of a ladder and cause a serious fall or damage the set. Further-

more, it was impossible to see the picture unless we were directly in front of the set. Even then, there was no way of shielding the face of the tube from sunlight. In this design, the tube is adjustable, and the lid protects the tube and serves as a sunshield.

Fig. 1 shows how the sides (I) of the shield are cut from the 1/4-inch plywood sheet while Fig. 3 shows these as being made from 3/16-inch Masonite. We used scraps of Masonite because we wasted some plywood in experimenting with the design of the front panel.

The top and front of the lid were made of 3/8-inch plywood because there was no room inside for fillets. The hole in the front is cut just large enough to pass the face of the C-R tube with approximately 1/16 inch all around. A heavy rubber band may be slipped around the front of the tube to cushion it where it passes through the front of the lid. The duodecal C-R-tube socket was replaced with one with an angle-bracket mounting plate. New leads were installed to permit placing the

tube in the lid. Approximately 10 inches was added to the speaker leads to allow it to be mounted in the front of the cabinet. The present leads are long enough for mounting the speaker in the left side of the case if desired.

The lid can be locked in any position with a carriage bolt and wing nut passing through a hole in the left side and the curved slot in the side of the lid. The head of the bolt rests flat against the inside of piece I, with the shaft extending outside the case. The radius of the slot is shown. If the slot is cut first any misalignment of the lid is likely to cause binding. If you are not handy with tools follow this procedure when cutting the slot: Mount the lid in place with two small butt hinges along the rear edge. Drill a 1/4-inch hole in the left side 6 inches from the rear and 1 inch from the top. Push the point of a pencil through the hole until it rests against the side of the lid. Move the lid up and down several times to trace the radius of the slot. Using this curve (Continued on bottom of Page 36) ▶

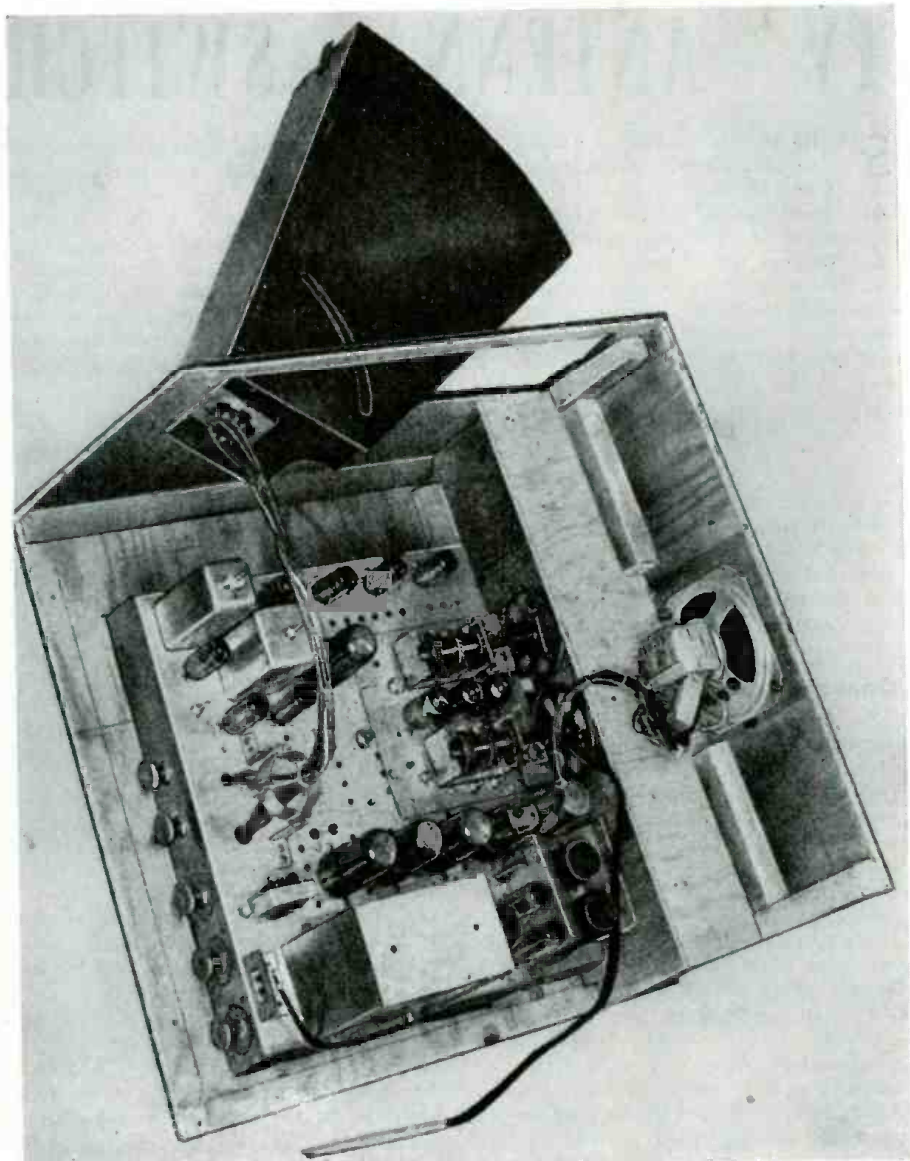

Back, bottom, and left side of case are removable in a single unit for adjusting receiver.

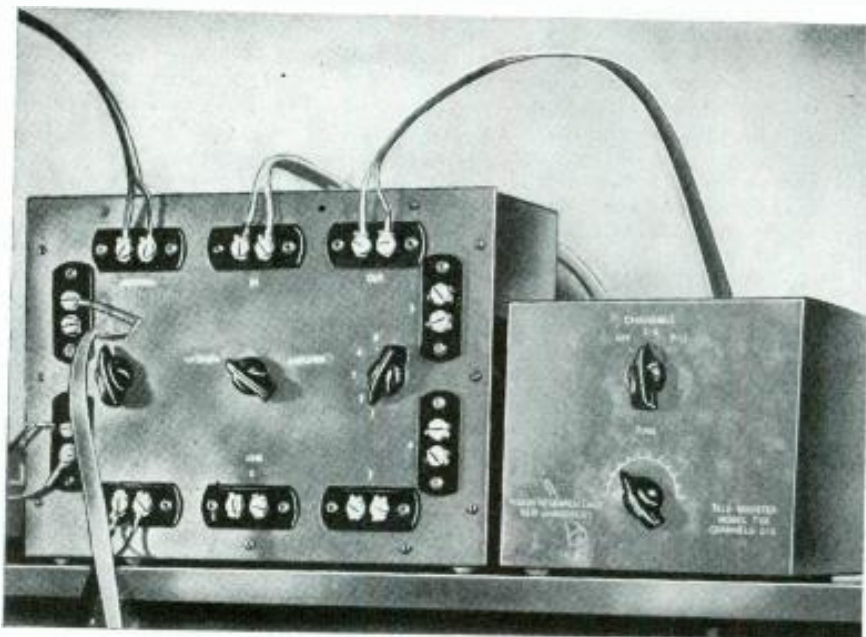

Antenna switch and booster, shown side by side, make good companions for the TV showroom.

TV ANTENNA SWITCH

STORE demonstrations of TV sets require that several receivers be connected to the same antenna. It is also convenient to be able to switch a booster in and out of the circuit at will to show its effect on the picture. To avoid the oscillation troubles and mismatch which invariably occur when several sets are connected together haphazardly with random lengths of 300-ohm line, we

built an antenna change-over switch which enables a salesman to choose any one of several sets for store demonstration and to use the same antenna without having to worry about the possible effects of overloading or oscillation.

There is a small amount of capacitance transfer of signal within the switch, but results in actual use have proved quite satisfactory. Occasionally

By LYMAN E. GREENLEE

it is necessary to move one of the lines going to a particular receiver to stop feedback between sets, but otherwise no trouble has been encountered with the switching arrangement, which saves a lot of time that would be wasted in moving antenna connections from one set to another. The switching arrangement also makes an excellent impression on prospective customers.

Standard Mallory switches were assembled on a Masonite panel as shown in the photographs and drawing. All internal wiring was done with short lengths of 300-ohm line. Connections were made as short as possible, with a definite plan followed so that *both sides of the twin line were kept exactly the same length*. This last point is important. Avoid sharp bends in the internal wiring.

The middle switch was made from two stock switches. The frame from a Mallory No. 151L "Hamswitch" was used with the contact assembly taken from a Mallory No. 1326L switch. The resulting combination has a wide (2¼-inch) spacing between sections to separate the booster input and output lines more. Booster input goes to one section of this switch, and the output to the other section. Thus it is possible to connect and disconnect a booster at will.

Standard antenna terminal strips of bakelite were used as input and output connectors. Ten of these strips are required. The TV antenna goes to the top left strip, and the booster input and output to the middle and right strips.

► ROOF-TOP TELEVISER

(Continued from page 35)

as a guide, cut out the material ¼ inch on each side and sand smooth.

The holes for line cord and antenna terminal strip can be located at any convenient position in the back of the case. A good handle completes the job. The case can be finished as desired.

Operating hints

This set is designed as a time-saver for installation crews and service technicians. Certain precautions must be followed for personal safety. It can replace one man or perhaps two on some jobs but should not be permitted to do so at the expense of personal safety. If the roof cannot be reached without a ladder, make sure the ladder is long enough to project above the roof so you can step from it to the roof without danger of falling. Never burden yourself with more than you can safely carry up and down the ladder. It is much safer to use a rope to pull the antenna and receiver up on the roof. Always carry the set to the roof before unreeling the line cord. A trailing line cord or transmission line can be very

dangerous when moving up or down a ladder.

With this little set, you will be able to make an ideal installation in the shortest possible time. Ghosts caused by multipath reception can be reduced to a minimum consistent with good picture quality. You may find ghosts when the antenna is connected to the set in the home which did not appear in the receiver on the roof. In most cases this will be caused by a mismatch between the line and antenna or line and receiver input. Make sure that the transmission line does not run close to drains, gutters, downspouts, or large metallic bodies. This type of trouble can often be cleared up by using strips of thin metal foil or small metal sliders around the transmission line at the receiver, adjusting them for strongest signal and minimum ghost. Several firms manufacture small metal clips especially for this purpose. Instructions for adjusting these devices will be found in the article "Improve Your Television Picture," in the August, 1949, issue of RADIO-ELECTRONICS.

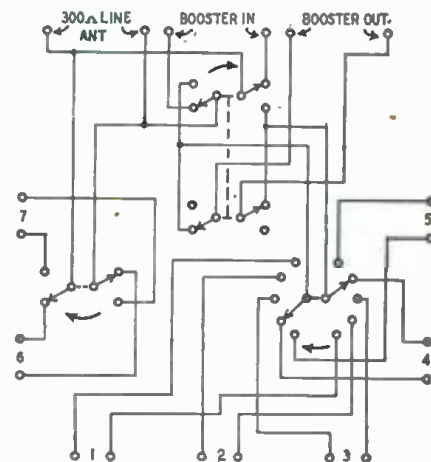

Make all connections with 300-ohm ribbon line.

The other strips numbered 1 to 5 go to TV sets on the floor, while strips 6 and 7 go direct from the antenna to other sets, boosters, etc. Strips 6 and 7 are never connected through the booster circuit. By manipulating switches, the booster may be cut in or out at will from one to five sets selected by the five-position switch, while two other sets or a matching stub may be connected to positions 6 and 7 for direct connection to the TV antenna.

RADIO-ELECTRONICS for

Counters For Prospectors



Nuclear 2610 offers three sensitivity ranges.

BEFORE the war the Geiger counter was a laboratory instrument. Comparatively few people had ever heard of it. Today manufacturers are putting out counters in large quantities to adventure- and fortune-minded prospectors. The new instruments are small, efficient, and thoroughly portable. They're easy to operate, in general, requiring no technical skill on the part of the user.

Geiger counters are available in models from the very simplest—no vacuum tubes at all—to the most complex—several tubes, automatic scalars, calibrated meters, and so on. The most common type consists of the tube, one or more amplifier tubes, a headphone circuit for counting the clicks, and a meter for reading the amount of radiation in more or less accurate terms of milliroentgens per hour.

The term milliroentgens (abbreviated mr), by the way, has been used for years mainly by the medical profession in measuring radium radiation. It is not especially suitable for the ordinary prospector, and at least one counter manufacturer has calibrated his meter in counts per minute. Many of these instruments are used in atomic plants and laboratories, however, to make sure workers do not absorb more radiation than they can stand. The Bureau of Standards gives 12.5 mr per hour as the maximum health tolerance level, and of course the scale markings in mr/hr are vital there.

A typical instrument

The Model 2610 portable survey meter, made by Nuclear Instrument & Chemical Corp., Chicago, is typical. It

Some typical commercial instruments



Nuclear "Sniffer" uses vibrator power supply.

is diagrammed in Fig. 1. Two subminiature pentodes are used, with three 300-volt batteries in series for the high-voltage supply.

Model 2610 contains a self-quenching tube (as do most of the instruments). There is a single pulse of current through R1 each time the tube breaks down.

R2 and R3 are a voltage divider across the 67.5-volt B-battery, and bias

By RICHARD H. DORF

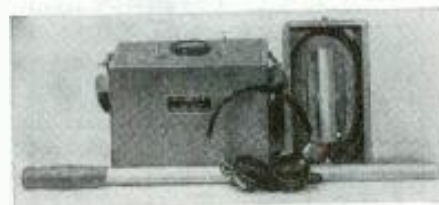

The Fisher C-11 has a neon oscillator supply.

the grid of V1 so that it conducts. The filaments of V1 and V2 are paralleled and connected through R4 to ground. The V1 plate and screen current passing through R4 biases V2 to cutoff.

When a negative pulse from the Geiger tube reaches the grid of V1, V1 plate current decreases, and plate voltage becomes more positive. The rise of plate voltage is coupled through C4,

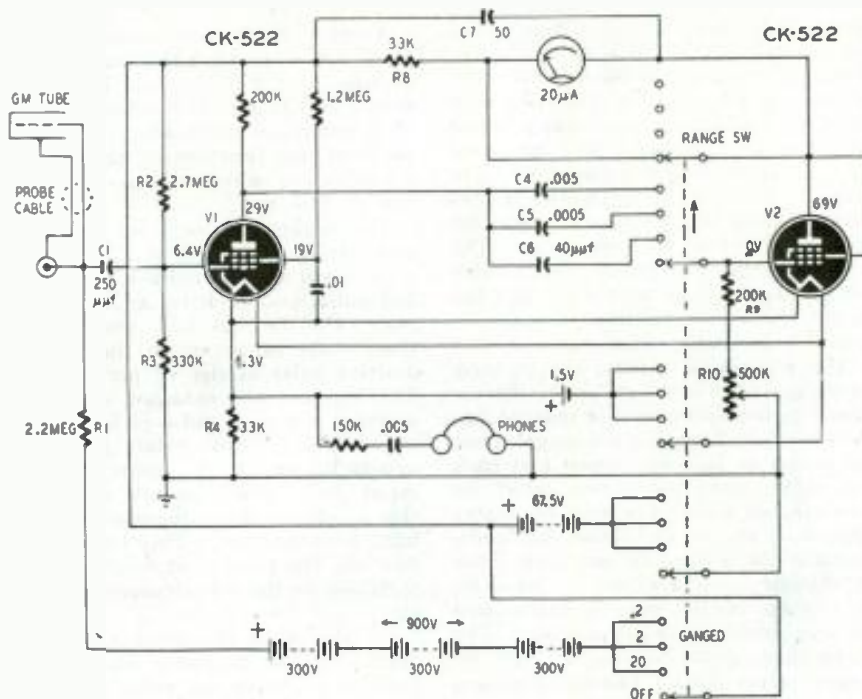

Fig. 1—Pulses furnished the meter deflect it in proportion to the frequency of the pulses.

C5, or C6 to the grid of V2, which, with this positive voltage on its grid, begins to conduct. The V2 plate current passing through R4 makes its top end more positive, pushing V1 further toward cutoff, increasing its positive plate voltage, and making V2 conduct more heavily. The action builds up very quickly until V1 is completely cut off and V2 is conducting heavily.

As soon as V1 has reached cutoff, it no longer furnishes a rising positive voltage to the grid of V2. The V2 grid then falls to its resting value of zero volts, the current through R4 causes a voltage drop sufficient to bias V2 to cutoff, and the charge on C1 from the

changes in radiation intensity would not be registered quickly.

C4, C5, and C6 are the range-selecting capacitors, providing ranges of 0.2, 2, and 20 mr/hr. They are part of a time-constant circuit including R9 and R10. When the pulses are few and far between (on the 0.2-mr/hr scale) a fairly large capacitor (C4, .005 μf) is needed to transmit them. Use the analogy of a low audio frequency.

When the pulses are practically continuous (in a strong field), a very small capacitor (C6, 40 μf) serves to attenuate them and keep the meter from rising above full scale. Here again an analogy—high audio frequencies. R10

therefore, the lamp is effectively an open circuit and no blocking capacitor is needed between the two stages.

When a positive pulse appears at the plate of V1, it is large enough to make the lamp conduct. V2 is normally biased to cutoff by R10 in series with the negative end of the B-supply. When the lamp conducts, the positive plate voltage of V1 is placed across the voltage divider R6-R7-R8-R9. The switch-tapped portion of the voltage is applied to V2, which amplifies it and applies it to a meter integrating circuit similar to that of the instrument described first.

When radiation is in the order of 20 mr/hr, the frequency of the pulses is great enough to keep the meter integrating circuit charged even with fairly low values of voltage. On the lower ranges, however, the pulse rate may be too low to keep the meter still enough to read. For radiation intensities on the 0.2- and 2-mr/hr ranges, therefore, the feedback in V1 raises the V1 output and transfers more voltage through the neon lamp to the voltage divider. Section *e* of the range switch also taps grid voltage for V2 from a higher point on the divider. The neon lamp insures that the voltage at the top of the divider does not greatly exceed 67 (its striking potential) and blocks the d.c. resting plate voltage of V1.

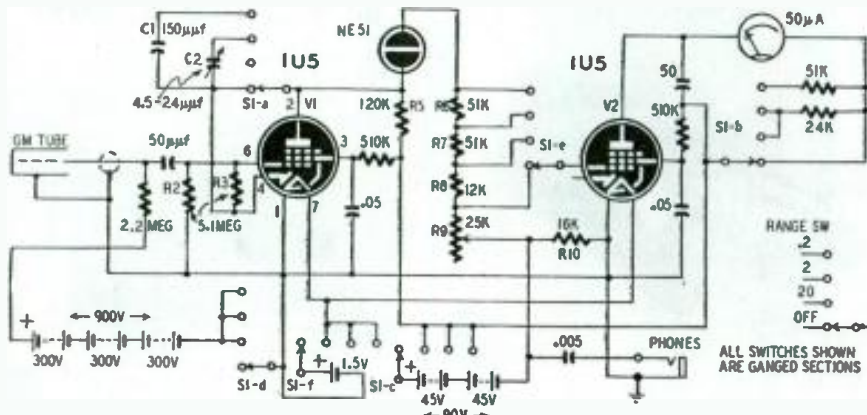

Fig. 2—The neon lamp in the El-Tronics SM-3 limits the amplitude of the pulses reaching V2.

Geiger tube pulse has been dissipated. The circuit then returns to normal. During the return to conduction of V1, the negative-going plate voltage, coupled to the V2 grid through C4, C5, or C6, has hastened the cutoff of V2. The entire cycle takes place very quickly.

The meter is connected in series with the plate of V2 and the 67.5-volt supply. If it were not for C7, the needle would theoretically (not actually, because of mechanical inertia) rise to maximum, then fall to zero for each pulse. The addition of C7, however, together with R8, makes a time-constant circuit known as an integrator. The capacitor C7 is charged by each pulse of V2 plate current. The degree to which it discharges after the pulse is governed by the time interval between pulses. The closer together the pulses, the greater the average voltage across C7 and the higher the meter reading.

Since the meter must respond only to the number of pulses, not to their intensity, the one-shot multivibrator circuit is necessary, rather than a simple amplifier. Since V2 is brought from full cutoff to full conduction and back for each pulse, no matter what its strength, all pulses reaching the meter integrator are of the same amplitude. Because the pulses do not take place at regular intervals, but at random, the meter needle does fluctuate and the eye must strike an average. The fluctuations could be slowed down by larger values for C7 and R8, giving a longer time constant than the present 3-second one. That would make the meter slower to respond, however, and

adjusts the time constant so that the meter can be recalibrated.

It is often more convenient when prospecting to wear headphones and listen for a sudden increase in radiation. Connected across R4, phones are provided for that purpose in this instrument.

Another type of counter

Another instrument which does the same job is model SM-3 made by El-Tronics, Inc., Philadelphia. The circuit, shown in Fig 2, is typical of a number of counters. A neon lamp is used to perform the function of the one-shot multivibrator which appears in the circuit of Fig. 1.

The negative pulse from the Geiger tube strikes the grid of V1, which is zero-biased as an amplifier. The amplified pulse, now positive, appears at the plate. On the 0.2- and 2-mr/hr positions of the range switch, the amplified positive pulse at the V1 plate is rectified by the self-contained diode. The rectified negative pulse is larger than the original input pulse; it appears across R3 and R2 in series. Since the input pulse also appears across R2, this is effectively a regenerative feedback arrangement, giving extra amplification. The amount of feedback is determined by the capacitances of C1 and C2.

On the 20-mr/hr range, there is no feedback. The B-supply and the zero bias on V1, with the value of R5, set the plate voltage of V1 at 50, 17 volts below the breakdown potential of the neon lamp. In the absence of radiation,

High-voltage supplies

The obvious solution to the problem of securing 900 volts for the Geiger tube in a portable instrument is to use three 300-volt, miniature dry batteries. Many manufacturers, including the makers of the two instruments described, have done this. The dry batteries are fairly heavy, however, and are expensive.

The next most obvious solution is the use of a vibrator operating from

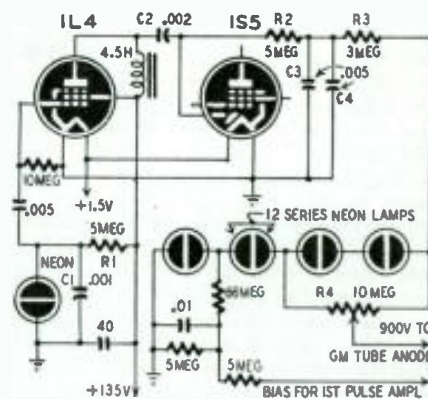

Fig. 3—Relaxation oscillator feeds the IL4.

flashlight cells. A number of counters take this way out, including the homemade job described in the September issue and the Sniffer shown in one of the photographs (Nuclear Instrument and Chemical Corp., Chicago).

An ingenious high-voltage supply using a relaxation oscillator (possibly inspired by television circuits?), en-



The Precision 105 has only a single battery.

ergizes the Geiger tube in some counters. Fig. 3 shows the high-voltage section of the M-Scope, model C-11, made by Fisher Research Laboratory, Inc., Palo Alto, Calif.

C1 and R1, with the neon lamp, form a relaxation oscillator powered by three 45-volt batteries in series (These batteries are also used to power all the vacuum tubes. A pair of flashlight cells lights the filaments.) The output of the oscillator is applied to the 1L4 grid, which is amplifier-biased by a 10-megohm grid leak.

The plate load of the 1L4 is a 4.5-h audio choke. Because the oscillator produces a sawtooth wave instead of a sine and because of the inductive load, the a.c. voltage across the choke is in the neighborhood of 1,000. It is passed through C2 and rectified by the diode section of a 1S5. The 1S5, by the way, has no other function in the instrument, and none of its other electrodes are used.

R2, R3, C3, and C4 form a filter circuit which is adequate because of the very low current drawn by the Geiger tube. Fifteen neon lamps in series across the output of this supply regulate the voltage. The potentiometer across the first two furnishes the voltage for the Geiger tube anode. The control adjusts the voltage to the point at which the tube operates on its plateau. A small positive voltage taken from the top of the lower neon lamp is used to bias the grid of the first amplifier tube in the conventional portion of the counter.

One of the very simplest Geiger counters on the market is model 105 of Precision Radiation Instruments, Inc., Chicago. Containing no vacuum tubes and using a single 300-volt battery, it is claimed to be more sensitive than most instruments.

It is diagrammed in Fig. 4. A single crystal earphone is connected directly across the Geiger tube's anode load resistor; there is no amplification. But the striking feature of the 105 is its power supply.

A single 300-volt dry battery and two polystyrene capacitors with very high leakage resistances give the requisite 900 volts—very nearly a case of getting something for nothing.

In the normal position of the four-pole, double-throw switch (as shown in

Fig. 4) the battery and the two capacitors are in series, with the negative battery pole on the Geiger tube's cathode. The spring-operated switch places the capacitors in parallel with the battery, so that each is charged to 300 volts. When the switch is released, battery and capacitors are again in series. Since the latter are charged to 300 volts each, the total voltage from the negative pole of the battery to the end of the string is 900 volts, and this is applied to the Geiger tube.

The insulation of the capacitors is so good and the current drawn so low that a single flick of the switch suffices to charge the capacitors for as long as 15 minutes of operation. When the operator fails to hear the background count in his headphone, he knows the charge has dissipated and flicks the switch again.

This type of instrument, along with the others which have no meter, is very satisfactory for prospecting but will not give accurate quantitative measures of the amount or quality of a uranium deposit. Accuracy is hardly necessary in most cases, however, since a high click rate is sufficient to indicate that samples of ore should be sent to an assay office.

Although counters suitable for prospecting are entering the market in increasing numbers, no presently available model is yet offered for a few dollars. Prices vary from about \$55 to \$300. For that reason, the prospective buyer should look over the field thoroughly and purchase the instrument best suited to his need. The radio-electronic technician and hobbyist is in an especially good position to pick and choose.

The counters described above represent only a fraction of those on the market. A list—as nearly complete as we can make it—will be sent to any reader who requests one.

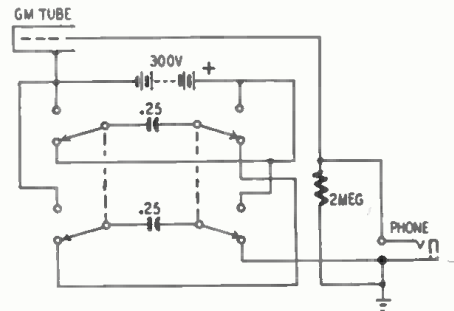

Fig. 4—"Something-for-nothing" power supply.

NEW MINIATURE PRINTED CIRCUIT

A new lightweight printed circuit is being introduced in the Telex model 200 hearing aid. The major portion of the three-stage amplifier circuit is contained on a 0.025-inch-thick polystyrene plate approximately 2 1/4 by 1 3/8 inches. The weight of this plate, complete with resistors, capacitors, and conductors is 1/16 ounce.

Conductors are of a colloidal silver compound which is deposited by a silk-screen process. The material etches into the plastic plate assuring positive adhesion.

Resistors of a colloidal graphite compound are deposited in a thin film; the plate may be bent without damage to the resistors. An acetate film covering hermetically seals the resistors and provides protection against damage.

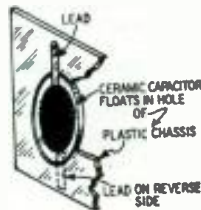

How capacitors are inserted in chassis

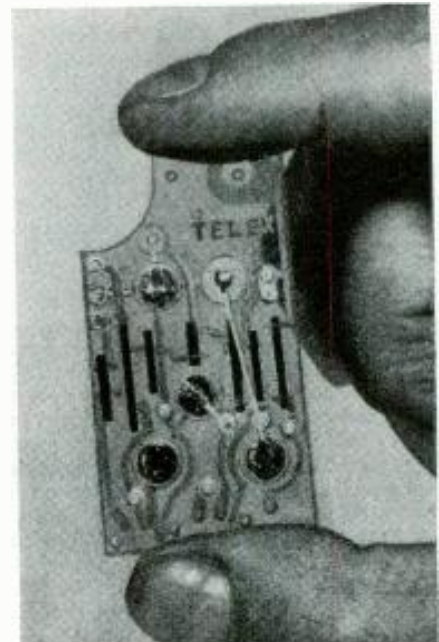

This photograph shows plate's actual size.

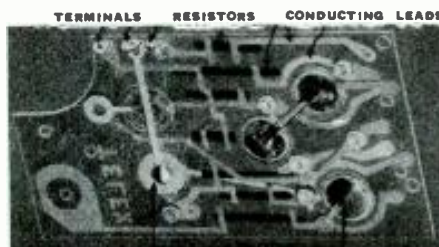

All the components are on polystyrene plate.

Thickness of the printed circuit slate is reduced by inserting the capacitors into punched holes. The capacitor discs are 1/4 inch in diameter and are made of a new high-K barium titanate material. Die-formed capacitor leads are connected to the printed circuit with a riveted connection on the plate. A special tube socket (not shown in photo) provides electrical connections to the printed circuit and makes tube replacement a simple matter.

MICROWAVES

Part VI—Some equipment used for measuring frequency, and crystals for receiver frequency conversion

By C. W. PALMER

CORRECT operation of microwave equipment depends on many factors, one of which is accurate frequency adjustment of transmitters and receivers. A slotted waveguide with a calibrated probe (RADIO-ELECTRONICS, May, 1949, page 56) is probably the most common frequency-measuring device, but there are occasions when it is better to use a direct-reading wavemeter.

Wavemeters for microwave work are of three general types: co-axial, cavity resonator, and transition. The first type consists of a section of co-axial line small enough that only (the Tm_{010}) mode can function. Resonance is then found at odd quarter-wavelength points ($\frac{1}{4}$, $\frac{3}{4}$, etc.). Wavelength is found by measuring between successive resonances with a centimeter scale, an extremely handy method in microwave setups. The instrument needs no calibration, of course.

Loop coupling to the co-axial line is commonly used, with the loop located near a short-circuited end of the co-ax where it is always in a position of maximum magnetic field.

Resonance can also be obtained at even quarter-wavelength points ($\frac{2}{4}$, $\frac{4}{4}$, etc.) if the line is short-circuited at both ends. Several types of co-axial wavemeters are shown in cross section in Fig. 1. A commercial unit is shown in Fig. 2.

The cylindrical or cavity wavemeter has a distinct advantage over the co-axial type in that it has a much higher Q and, therefore, the points of resonance are more distinct and sharply defined. Its disadvantage is that it is not self-calibrating. In fixed-frequency cavities used as frequency standards it is desirable to use the lowest mode to avoid confusion resulting from other modes of operation. In adjustable wavemeter cavities with an adjustable plunger at one end, a higher mode having a zero surface current where the plunger and the sides of the cavity meet is necessary.

When a higher mode is used, lower modes are attenuated or rejected with absorbing materials placed behind the plunger, with grooves filled with absorbing material and parallel to the surface currents on the end plate, by the method of coupling, and by damping wires.

Cavity wavemeters have Q's that approach a theoretical limit of about

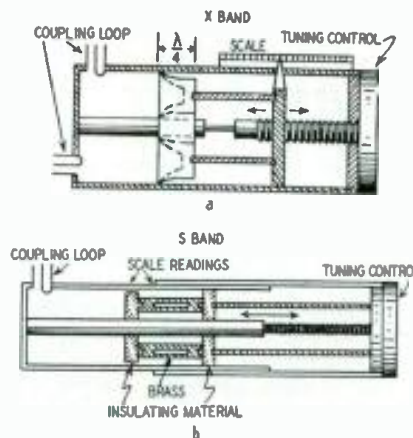

Fig. 1-a—Co-axial wavemeter for transmission or absorption use. Fig. 1-b—Absorption type.

55,000. Actual measurements on existing units have shown Q's of better than 40,000. This means that with a good cavity wavemeter accuracies of ± 28 kilocycles at a frequency of 3,000 megacycles are possible. Fig. 3 shows two types of cavity wavemeters.

The third type or transition wavemeter may be thought of as half co-axial line and half cylindrical cavity—hence its name. It is a cylindrical cavity along whose axis projects a piston which has a diameter considerably smaller than that of the cavity. The diameter of the cavity is large enough to support the $TE_{0,1,1}$ mode. The dimensions of both the plunger and the cavity control the frequency. Thus it is necessary to calibrate this type of wavemeter.

All three types described can be calibrated as direct-reading devices.

Connecting Wavemeters

A wavemeter is called a transmission instrument if it is used in the main line, and a reaction or absorption instrument if it is in a side arm of the waveguide or transmission line.

A transmission wavemeter in use is shown in Fig. 4. It is coupled to a co-axial line with coupling loops projecting into the wavemeter cavity. A crystal detector and d.c. microammeter complete the indicating circuit. Two reaction wavemeter circuits are shown in Fig. 5. At *a* the distance L_1 is such that the side arm presents a high impedance at the junction to the main guide when the wavemeter is off resonance. At resonance the impedance drops so that less power reaches the crystal and meter. At *b* the same action takes place, except that the indicator crystal and meter are placed in the branch circuit at a point of normally high impedance. Length L_2 is independent of L_1 , which is adjusted to present a high impedance at off-resonant frequencies. Fig. 6 shows two examples of commercially available wavemeters. One is the transmission type for a frequency range of 22,950 to 24,950 mc. Second is an absorption-type wavemeter for a frequency range of 8,500 to 9,400 mc.

In all the absorption-type wavemeters the current in the crystal varies as shown in Fig. 7. If the coupling is too tight, this curve becomes distorted and it becomes necessary to reduce the size

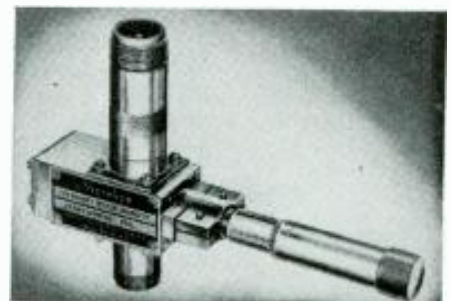

Fig. 2—Photo of the instrument of Fig. 1-b.

RADIO-ELECTRONICS for

of the loop or rotate it so that it cuts fewer lines of force.

The accuracy of a wavemeter depends on the "loaded Q" and the size of the scale. For example if an accuracy of $\pm .001$ cm is desired, the scale must be fine enough to read to

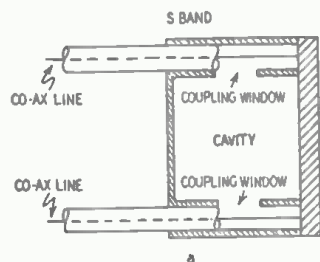

Fig. 3-a—A fixed-frequency cavity wavemeter.

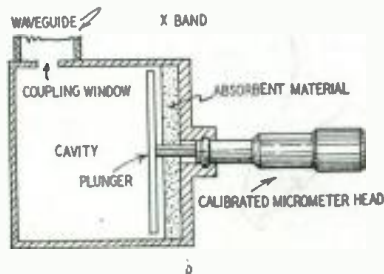

Fig. 3-b—A variable-frequency cavity meter.

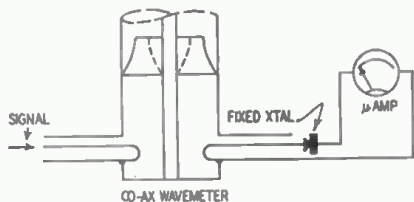

Fig. 4—Co-axial transmission-type wavemeter.

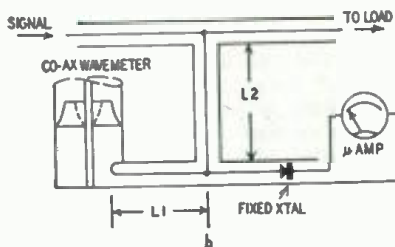
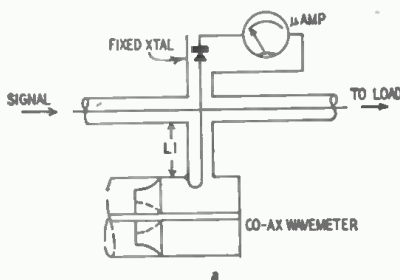

Fig. 5—Two reaction-type wavemeter circuits.

three decimal places and the resolution (sharpness of tuning) great enough to indicate a wavelength deviation of .001 cm. In other words, the frequency-response curve of the wavemeter must drop to its "half-power" points on each side of resonance in a space of not more than .001 cm.

Microwave crystals

It may seem strange to the radio man to find that the ancient crystal detector has found wide application in microwave work as a converter for superheterodyne receivers in conjunction with a vacuum-tube (often a Klystron) oscillator, as an output meter with a d.c. microammeter (as in the wavemeters described above) as a clamping device to hold the d.c. potential of a circuit at definite values, as a rectifier of small alternating currents of both low and high frequency, as a bias rectifier in vacuum-tube circuits, and last but not least as a transistor or crystal oscillator and amplifier (see issue of September, 1948).

Because of the frequency limitations of vacuum tubes due to the finite capacitance between the grid and plate, the transit time of electrons, and other factors which we discussed in Part III, early explorers in microwaves turned to the crystal detector. Intensive development work resulted in silicon and germanium crystals having all the stability of vacuum tubes and much better signal-to-noise ratio and much higher cutoff frequencies.

These crystals are illustrated in Fig. 8, which shows two examples of American manufacture. The units are adjusted in the manufacturing process and sealed so that no fussing with catwhiskers is necessary as in the early radio days.

Naturally, a crystal detector in a superheterodyne type of receiver produces a conversion loss instead of gain. But because the extremely low capacitance in such a unit permits operation on higher frequencies than those at which normal vacuum tubes will work, plus better signal-to-noise ratios than can be realized with vacuum tubes at these ultra-high frequencies, it is preferred over a tube converter. Loss in the converter stage is easily compensated for by additional amplification in the i.f. amplifier, which operates at a lower frequency where amplifier tubes are effective.

These crystals are also used as rectifiers for obtaining small amounts of d.c. for the operation of a.v.c. circuits, biasing circuits, locking circuits in multivibrators, etc.

Crystal Mounts

A crystal connected as shown in Fig. 9 rectifies r.f. energy transferred to it by the probe. Current in the meter circuit is proportional to the square of the r.f. current at the probe (square-law detector).

A somewhat more complicated method is to use a modulated r.f. source and amplify the crystal current, which can then be rectified, the output of the rectifier being connected to a meter. This system is more sensitive than the probe-microammeter arrangement and permits the use of smaller probe projections so that less effect is produced on the current in the main guide. If the



Fig. 6—Transmission and reaction wavemeters. Courtesy DeMornay-Budd

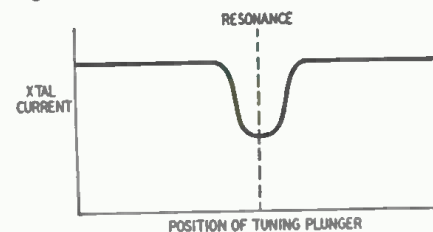

Fig. 7—Crystal current in absorption meter.

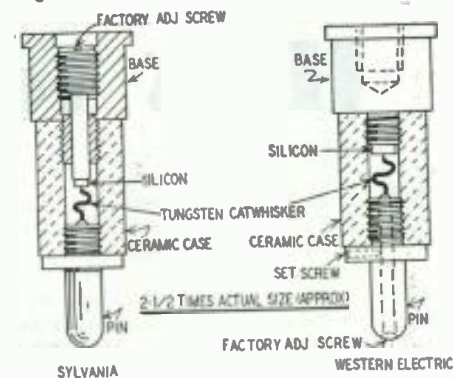

Fig. 8—Two American h.f. crystal rectifiers.

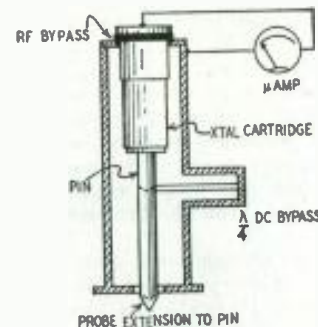
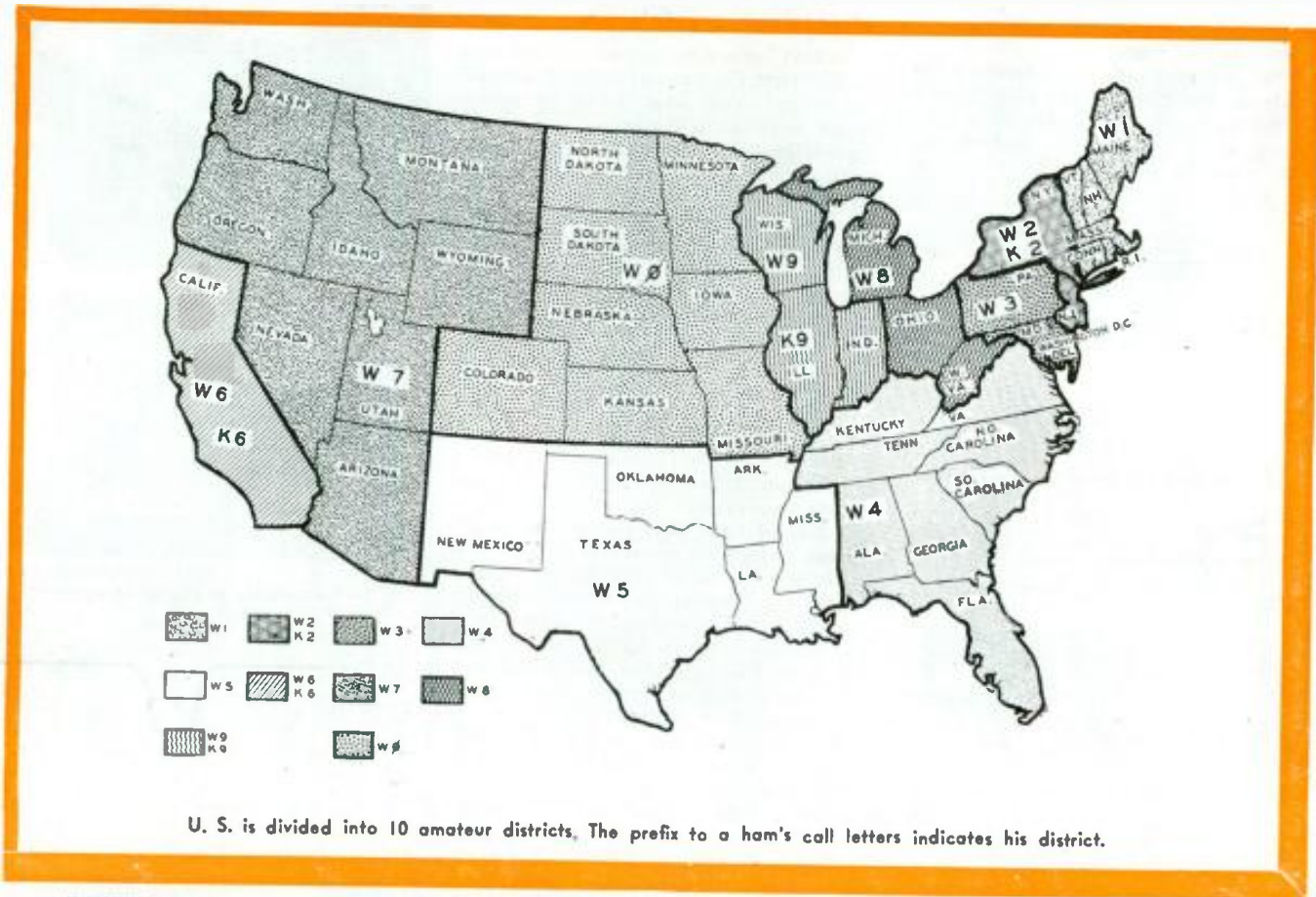

Fig. 9—A high-frequency rectifier circuit.

amplifier and rectifier have a linear characteristic, this setup is also proportional to the square of the current in the probe, because of the square-law characteristic of the crystal.

Such crystal mounts are used in the construction of crystal mixers for superheterodyne reception.



How to Become a Ham

YOU too can be a ham! That sounds like an advertising slogan, but unlike some advertising slogans, it's absolutely true! Being a licensed radio amateur requires neither a great amount of money nor any more time than you want to give it. You needn't be a mental Superman nor a junior Edison. You can even be deaf or blind—yes, many amateurs have earned licenses despite handicaps. All you need is to want to make friends by the dozens in faraway places, to be able to have a party in your parlor at the click of a switch, to be part of a message-handling system relaying radio messages to and all over the world, or to make with your own hands electronic equipment capable of sending calls around the block or 7,000 miles.

Radio transmission and reception is one of history's most fascinating inventions. It enables a single man or woman, alone in a room, to reach out and make contact with others at will, unfettered by wires, routes, or previously charted ways. The contact may carry news or instructions of major importance or a random conversation.

Radio today is big business. Radio broadcasting and communication systems employ many thousands of people and spend millions of dollars. But unlike most big businesses, this is some-

By **GEORGE W. SHUART,**
W4AMN, Ex-W2AMN

Part I—What hamdom offers the hobbyist

thing the lone hobbyist can get in on just as easily as the big financier. The expenditure of a few dollars and some time may allow him to transmit just as far as the "big fellows" by the same methods and at the same time. Except that he cannot broadcast entertainment programs, he may say just about what he wants, and talk to anyone he chooses in any place he is able to reach. The only limit on the enjoyment the ham can get is his own enthusiasm.

Ham radio has so many enjoyable aspects that amateurs divide themselves into several groups. The ham, for instance, whose greatest pleasure is in contacting other hams who are far away calls himself a "dx man." For him the thrill of sitting in his own familiar home and exchanging conversation with someone thousands of miles away is the fulfillment of the spirit of

adventure. Dx men proudly display on their operating room walls QSL cards—postcard-size confirmations of radio contacts—from like-minded men and women in Zanzibar and Cape Town. London, Berlin, Paris, the cities and hamlets of all the world. They compete for awards offered by radio societies for *working* (ham language for contacting) a station in every state of the 48 or one on every continent.

Some amateurs get their greatest pleasure from working traffic, landing together in "traffic nets" for the purpose of relaying messages. No money may be accepted by any amateur for this service; he does it simply for the sense of accomplishment he derives from being a member of a smooth-working system. A man in California, for instance, may want to send a message to a friend in New York. He gives the message to an amateur friend, who transmits it as far east as he can, perhaps only to Chicago. The receiving amateur in Chicago then passes it on to another ham. Finally, A New York amateur receives it and gives or telephones it to the addressee. Sometimes the California station can reach New York directly; at other times, when the message must be relayed from one station to another, it takes a day or so. But every member of a traffic net follows a strict procedure which as-

RADIO-ELECTRONICS for

sure that he will get the message straight and then pass it on. Any amateur with a desire to do so may join a traffic net, and he may handle messages even if he does not.

Because amateur radio requires technical knowledge, many hams are avid experimenters. They may build a new transmitter, use it for a day or two, then tear it apart again to try some newly conceived improvement. When a new tube or component is introduced, the experimenter eagerly tries it out in as many unusual circuits as he can think of. His conversations on the air indicate his branch of the hobby, for he is always discussing new developments or asking for reports on whether some new addition to his *rig* (ham-mese for transmitter) makes a difference in how it sounds. The amateur experimenter is one of the prime reasons for the amateur's being, for the developments he has pioneered, his spirit of "I know it won't work but I'm going to try it anyhow," has contributed toward many of the most important advances in radio. The higher frequencies, for instance, were first explored by amateurs who refused to believe the dictum of the "experts" that only the low frequencies could be useful.

Some hams just like to get on the air and talk about anything and everything—to operators down the block or in the next county. These are the "rag-chewers." Dx, traffic, experimentation, and rag-chewing are the major spheres of interest in hamdom. But each of these is further divided into two sub-groups, code and phone. Though many transmitters provide for both voice and radiotelegraph transmission, almost every amateur has his preference for one or the other. Offhand it might seem obvious that phone is the better. You just speak into the microphone and listen to the loudspeaker or headphones. But c.w. (code) men have strong arguments in their favor. A code transmitter need have nothing in it but parts contributing to better transmission, while a phone rig must have an audio section just to build up the speech power to the point where it can be used to control the transmitter's output. Code can be understood clearly if even a trace of the transmission can be picked up by the receiver, whereas a comparatively good signal is necessary if it is carrying speech. Code can be read through noise and is much more of an international language than any speech. Code and phone men argue through the nights about the merits of their favorites, but you will have an opportunity to try them yourself, which is, after all, the best way to make any decision.

Some people wonder how hams get into contact with each other: you can't ring a bell as you can with a telephone. It's very simple, though. A ham who decides to go on the air first turns on his receiver and tunes around his own frequency, listening for other hams calling "CQ." The CQ call indi-

cates that the caller is ready for a conversation with anyone who may happen to hear him (or if he calls "CQ California," for instance, he wants to speak to anyone in California who can hear him). Our ham then turns on his own transmitter and calls the man who has been sending CQ's. The latter tunes around, hears our friend calling him, and replies. From there, the conversation may carry on for an hour or more and cover as many subjects as the two can think of.

The amateur setup

The Federal Communications Commission, which regulates all interstate communication, is the authority under which amateurs operate. It conducts examinations, awards licenses, assigns call letters, sets minimum technical standards, specifies operating frequency bands, and polices the air for violations of regulations. An FCC operator's license as well as a station license must be procured before anyone operates a transmitter of any type. There is absolutely no loophole for getting around this requirement, despite the efforts of the thousands who have tried to find one.

The amateur examination, given at all offices of the FCC (or under certain circumstances at the applicant's home), requires the applicant to show a certain technical knowledge and ability to send and receive radio code. Amateur acquaintances and books are good sources of technical knowledge. Some especially useful books are listed in the bibliography at the end of this article.

A licensed amateur is assigned call letters for his station. These begin with the letter W or K (in the U. S.) followed by a number. The number indicates the section of the country in which the station is located. There are 10 radio districts, as indicated on the map. (The cancelled zero (Ø) is the standard method of indicating the numeral zero rather than the letter O.

The FCC has assigned certain portions of the radio spectrum exclusively to amateurs. Within these bands, any amateur may operate on any frequency and may change frequency as often as he likes. There are, however, certain frequencies restricted to amateurs who have passed more demanding examinations, so the FCC regulations should be consulted.

What you must do

To become an amateur, there are certain steps to be followed. First, you must acquire some technical radio knowledge. Try to get several books (see bibliography) at the public library if you cannot buy them. After you have absorbed the fundamentals, locate nearby amateurs (you will find them all listed in the *Radio Amateur Callbook Magazine*, on sale at most radio parts stores) and call on them. Say you want to become a ham and ask their advice. If you have acquired enough back-

ground by reading to understand what the general idea is, you will find that most hams are anxious to initiate you into the fraternity.

There is very little point in trying to give you a technical course here. You will find that consulting the *Radio Amateur's Handbook* (see bibliography) will show you what information you need. What you cannot quite grasp from that manual you will find explained differently in other books. Reading this and other magazines is very helpful. You will also do well to join one of the large radio societies and one of the local ham clubs about which any amateur will tell you.

In addition to learning technical facts, you will have to absorb some code and memorize some FCC regulations. When you are ready to take your examination, you will go to the nearest FCC office at an appropriate time and try to prove to the inspectors that you are worthy of a "ticket."

One of the biggest headaches for the prospective ham is learning the International Morse Code. It isn't hard; it just takes a little application of the proboscis to the grindstone. But there are ways and ways of pounding the code into your head. So next month we'll take up the subject in detail, outlining some of the do's and don'ts and trying to clear a few of the stones from your path toward the dots and dashes.

Bibliography

Radio Handbook. Editors & Engineers, Santa Barbara, Calif.

The Radio Amateur's Handbook, by A. Frederick Collins. Thomas Y. Crowell Co., New York.

Radio Physics Course, by Alfred A. Ghirardi. Murray Hill Books, New York.

The following books are published by the American Radio Relay League, West Hartford, Conn.:

The Radio Amateur's Handbook How to Become a Radio Amateur
The Radio Amateur's License Manual Learning the Radiotelegraph Code



Suggested by Frank F. Terry, Clearfield, Utah

Home-Built Snooperscope Uses Surplus Tube



Ingenious infra-red viewing device lets you see in the dark

By HAROLD PALLATZ

DURING wartime, man's inability to see in the dark can often mean the difference between life and death. This is particularly true of scouts, patrols, night drivers, and flyers. Since visible light makes an excellent target for the enemy, military forces began experimenting with infra-red rays as aids to nocturnal vision when visible light is not permitted for reasons of security. Many types of infra-red telescopes were developed as the direct result of this need for invisible illumination.

The sniperscope (an infra-red light source and telescope mounted on a carbine to permit the soldier to locate and shoot the enemy while both are in total darkness) and the snooperscope (an infra-red light source and telescope used for short-range observations) are perhaps the most well known of these developments. Other infra-red instruments include helmet-mounted driving and flying binoculars, and blackout signaling devices.

The infra-red telescope is designed around an infra-red image converter tube which transforms invisible infra-red rays to visible light. Several types of image converters were developed. The American forces used equipment built around the RCA 1P25 infra-red image tube. This tube has a cathode which emits electrons in proportion to the amount of infra-red light falling on it. Additional electrodes within the tube focus the electrons on a fluorescent screen. Thus the image falling on the cathode is focused on the screen without scanning devices. This tube, described in detail in the September, 1946, issue of *RCA Review*, requires

voltages of 15, 100, 600, and 4,000 for proper operation.

The British developed a simplified infra-red image converter tube requiring a single source of 4,000 to 6,000 volts for its operation. This tube, type CRI 143 or CV 147, is currently available on the surplus market and is used in this experimental snooperscope.

The parts for this snooperscope—a CRI 143 or CV 147 infra-red image converter tube, a 4,000-volt, low-current power supply, two infra-red filters, and a light source—are easy to obtain.

The power supply

For indoor operation, a 4,000- to 6,000-volt neon-sign transformer operates the tube satisfactorily. Rectification is not necessary unless the objects under observation are in motion. (Application of the image tube as a stroboscope is the subject of a patent application made by the author.)

A portable 4,000-volt power supply designed for use with this snooperscope is shown in the photograph and in Fig. 1. This efficient supply needs to be turned on only momentarily to charge the 0.1- μ f, 6,000-volt capacitor. The snooperscope works for several minutes on the charge, and thus it can be operated for long periods without noticeable battery drain.

The high voltage is supplied by a model-airplane ignition transformer with a vibrator to interrupt the primary current. The vibrator, not visible in the photograph, was removed from a small buzzer and mounted just above the core at one end of the transformer. A small buzzer can be inserted in series

with the primary of the ignition transformer if desired.

The rectifier tube is a 1B3-GT/8016. When the power supply is turned on, the current drain drops the voltage of each cell to approximately 1 volt; therefore the 1B3 was connected in series with a 1-ohm resistor across two cells. (A 3Q5, with its plate and screen grid tied together and control grid floating, might do the job just as well and would use less filament current. See the battery-operated, high-voltage supply described in the article "Build This Geiger Counter," in the September issue of *Radio-Electronics*.—*Editor*)

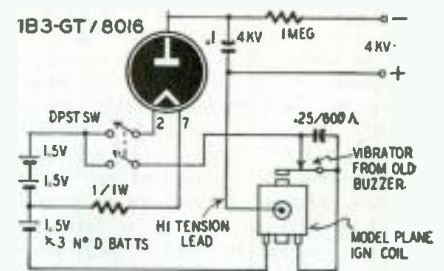

Fig. 1—Miniature high-voltage power supply.

The power supply was constructed in a plastic ice-box dish and fitted with insulated binding posts. Avoid contact with the output of this power supply or a rather uncomfortable shock may result. The capacitor remains charged for some time after the supply is turned off, so be careful. (It might be wise to shunt the output terminals with two or three 47,000-ohm resistors in series when the supply is not being used.—*Editor*)

RADIO-ELECTRONICS for

Assembling the snooper scope

The snooper scope is constructed as shown in Fig. 2. The image converter is mounted in a plastic drinking cup 3½ inches high and 2¼ inches in diameter. The optical system depends on the requirements for the snooper scope. We used a double-lens, fixed-focus jeweler's loupe (engraver's glass). It has a focal length of approximately 3 inches and objects a foot away from the observer's position are focused sharply.

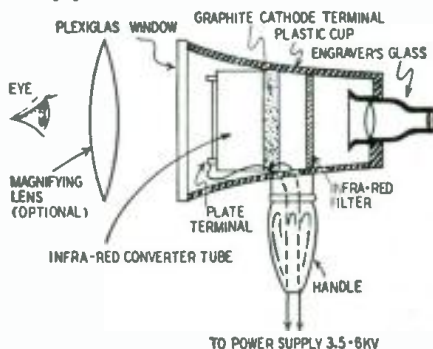

Fig. 2—The construction of the snooper scope.

After selecting the optical system, mount it in a hole cut into the bottom of the cup. A jeweler's saw or coping saw is ideal for cutting the hole. A few drops of household cement will hold the loupe in place. Paint the inside of the cup with a jet black paint such as black airplane dope or telephone black. This will prevent stray reflections.

Place an infra-red filter between the tube and lens to reduce the effects of stray illumination on the tube. No light should be allowed to enter the unit except through the lens. The light source must of course be filtered if it is to be invisible. Near infra-red filters will cut out most of the visible light. Far infra-red filters, while of somewhat lower efficiency, will cancel out visible light completely. They must be used with comparatively powerful light source.

Infra-red filters can be purchased from a number of scientific and photographic supply houses. Experimental infra-red filters can be made by sandwiching several layers of red and blue cellophane between two sheets of clear plastic.

The image-converter tube is inserted with the metal end toward the mouth of the cup. The thin flexible lead connects to the positive side of the power supply. The other end of the tube has a ring of graphite around the outside. This is the cathode terminal. This makes contact with the B-minus lead through a strip of spring brass or a thin coil spring formed to fit snugly around the cathode terminal. A piece of rubber tubing holds the tube in place. It is protected by a window cut from clear plastic and held in place with three brass clips as shown in the photograph.

The handle is a plastic bicycle handlebar grip cemented over a hole drilled in the side of the drinking cup for the high-voltage leads.

The light source

The required intensity of the light source is determined by the distance from the target to the lens. Heat lamps, flashlights, and ordinary bulbs will work well for most indoor applications. Our model is equipped with automobile parking light housings on both sides. These supply a limited amount of illumination. The intensity of the parking lights is insufficient for many applications and a heat lamp is used. Outdoor applications involving greater distances require a bulb with a sharply focused reflector. The sniperscope used a 30-watt, 6-volt bulb operated on a small rechargeable storage battery. Good substitutes are auto headlamps, the sealed-beam type being preferable for this purpose. The heat lamps mentioned are of course those sold for infra-red treatment.

Snooper scope experiments

A number of interesting and entertaining stunts can be devised around the snooper scope's ability to look through any opaque material which passes infra-red rays. Crime-detection laboratories use parallel equipment for reading through certain types of material. Since the infra-red reflection of pigments in paints and inks is different for white light, it is possible to detect forged paintings and checks by the way the colors appear. Demonstrate this by writing a message with India ink and then painting it over with a coat of ordinary fountain-pen ink. The eye will only see the blackened spot but the snooper scope will peer through the top layer of ink and reveal the writing just as clearly as if there were no top coating. This type of inspection can be made photographically if infra-red film is used in a camera. The electronic

method permits instantaneous examination, which is often a great convenience as well as an interesting experiment.

Driving in fog has always been a great hazard. An infra-red beam will display the road with 30% more clarity. This increase may be the difference between a safe situation and a very dangerous one. Snooper scopes for this purpose require very good lenses and powerful headlights. It would probably be difficult for an experimenter to construct one and dangerous to use it.

The image-converter tube can be used as an infra-red phototube. Reduce the voltage to 250 or 300, and insert a 470,000-ohm to 1-megohm resistor in the B-plus lead. Connect a two-tube amplifier and relay across this resistor. The relay operates when infra-red rays strike the converter tube, changing the voltage across the resistors.

A modified snooper scope has been used in biological laboratories to study the behavior of rats and other small nocturnal animals in total darkness. The converter tube has been used with a microscope to study bacteriological and botanical specimens under infra-red rays. They have also been used in measuring temperatures of materials below visible red heat.

For additional reading on this subject, see:

Forsythe, William E., *Fluorescent and Other Gaseous Discharge Lamps*.
Pratt, T. H., *Journal of Scientific Instruments*, Vol. 24, No. 12, December, 1947.

Monahan, A. C., *Science News Letter*, Vol. 50, page 26-28, July 13, 1946.

Pratt, T. H., *Electronic Engineering* (London), Vol. 20, No. 247, page 278, September, 1948; and Vol. 20, No. 248, page 314, October, 1948.

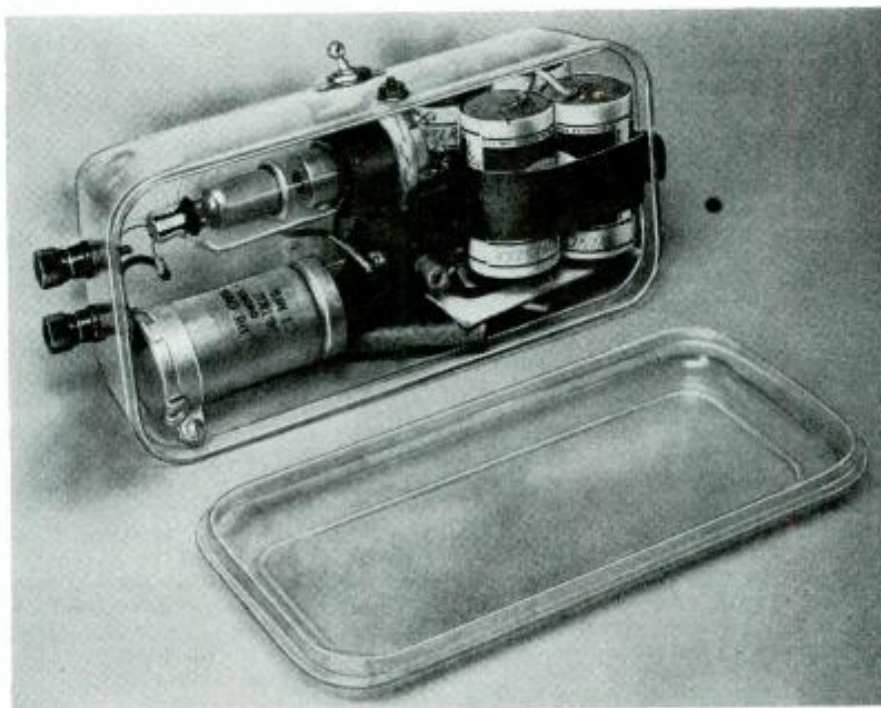

The high-voltage power supply, with its batteries, is built into a plastic food container.

Neon Blinker Saves Batteries

Blinking neon lamp warns user that battery receiver is still turned on

By RALPH W. HALLOWS

WE'VE all done it, and the odds are that we'll do it again. Done what? Why, left a battery-operated radio or some other piece of apparatus using a high-voltage dry battery switched on when we thought that we'd switched it off. The result is that, the next time we urgently need to use the thing, we find a dead battery and curse ourselves for the carelessness which means spending hard-earned money to replace it with a new one. In my experience the discovery that the B-battery has so expired invariably occurs when the shops are shut and there is no way under the sun of replacing it until they open again.

What has long been wanted is some kind of indicator which calls attention to itself so compellingly that its warning just can't be disregarded; something, for example, to make you realize that a radio is silent, not because it's been switched off, but because the transmitter has closed down. Easy enough, if you can afford to use a good deal of current; but that is just what you can't take from the high-voltage dry battery. It is about the most expensive form of power supply used by mankind—a watt from the B-battery

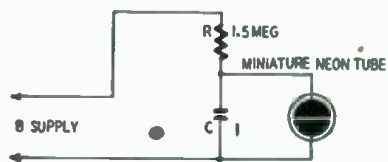

Fig. 1—Neon is used in relaxation circuit.

costs as much as several score from the electric mains. And that is where the difficulty lies. Any effective warning device apparently would need appreciable power to operate it, and power means watts. That brought me up short some years ago, and only lately have I run into something which provides the answer: the miniature neon tube. These tubes have a number of interesting features:

1. If the applied voltage is gradually raised from a low value, they offer infinite resistance until a certain voltage—depending on the type—is reached.
2. When the applied voltage reaches this figure (the striking voltage), the tube instantly lights up.

3. If the applied voltage is now reduced, the tube continues to glow until a value (the extinction voltage) much below the striking voltage is reached at which time the light goes out.
4. Miniature neons give a brilliant light for a very small expenditure of current.

You can, if you like, use a miniature neon connected straight across the B-battery through several thousand ohms of resistance and cut it in or out by the on-off switch. But why keep the tube going continuously when the apparatus is switched on? Why not make it flash briefly, about once per second? If that can be done—and it can very easily—there are two big advantages. First of all, you use far less current, since the tube is out about nine-tenths of the time; secondly, winks at roughly 1-second intervals are far more attention-compelling than a steadily glowing lamp.

The time-constant circuit (Fig. 1) provides the means of doing this. When the switch is first closed, the voltage across the capacitor (and therefore across the neon as well) is zero. As the neon offers infinite impedance, all the current through R flows into the capacitor C, charging it and causing the voltage between its plates to rise. This voltage increases exponentially, the formula being

$$V_c = V(1 - e^{-t/CR})$$

where V_c is the voltage across the plates of C, V is the applied voltage, e is the exponential function, t is the time in seconds, and CR is the capacitance in farads multiplied by the resistance in ohms and is the time constant of the circuit.

Suppose we make $CR = 1$, as we can by using a capacitor of $1 \mu\text{f}$ and a resistor of 1 megohm; let's also make $V = 100$. Then in 1 second V_c equals $100(1 - 0.368) = 63.2\text{v}$. (e^{-1} is equivalent to $1/2.718$, or 0.368 .)

With the same values V_c in 2 seconds = 86.5v ; in 3 seconds, 95.1v ; and in 4 seconds, 98.2v . From this it can be seen that, for any values of V , C , and R , V_c in CR seconds = 63.2% of V ; in $2 CR$ seconds, 86.5% ; in $3 CR$ seconds, 95.1% ; and in $4 CR$ seconds, 98.2% . Using these four "fixes," we can plot voltage and current charging curves for any capacitor in any time-constant circuit as shown in Fig. 2.

Those curves are actually for a time-constant circuit in which $C = 0.1 \mu\text{f}$ and $R = 1.5$ megohms, used in conjunction with a 100-volt battery and a neon whose striking voltage V_s is 72 and extinguishing voltage V_e is 48. The method of incorporating the circuit in a receiver is shown in Fig. 3. Look again at Fig. 2 and see how the device works. When switched on, current flows into the capacitor through R. At no instant can it exceed 67 microamperes since 100 volts are driving it through 1,500,000 ohms. Actually it falls away exponentially as indicated by the vertical scale on the left in the time shown by the horizontal scale at the bottom. Meantime the capacitor voltage V_c rises as shown by the vertical scale on the right. When V_c reaches 72v, the neon strikes. C now discharges through the tube until V_e , the extinction voltage, is reached. The tube then closes down, and C starts to recharge. This time, however, the initial V_c is not zero but 48 volts. So long as the apparatus is switched on, C alternately charges from 48 to 72 volts and discharges from 72 to 48 volts. The discharge is also exponential; it is extremely rapid since, once it has struck, the neon offers very small resistance to current.

As the curves show, the average current I_c taken from the battery is about 28 microamperes, an amount which is a negligible additional load for any battery. This device comes nearer to giv-

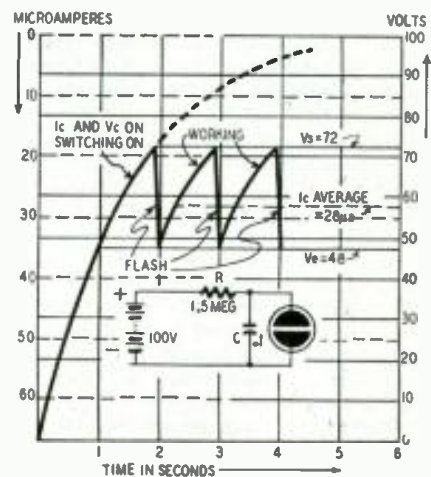

Fig. 2—Curves show action of the oscillator.

RADIO-ELECTRONICS for

ing something for nothing than any other I know. For a current drain so small that its effect on the battery can be ignored, it gives a brilliant and arresting flash about once per second when the plate-supply battery is new and at full voltage.

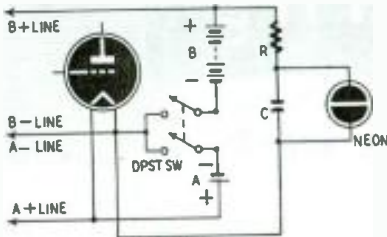

Fig. 3—How blinker is added to the receiver.

As the battery ages and its voltage falls off, V_s becomes a greater and greater percentage of its total voltage. To supply the striking voltage the capacitor must charge for a longer and longer time. Fig. 4 shows what occurs with a neon of the characteristics mentioned when an original battery voltage V_b of 100 falls to 90 and 80. When it has fallen to a trifle over 72 volts, the neon will not flash at all. It packs up as a warning device? Well, not quite! By not striking it goes on warning you that it is time to purchase a fresh battery.

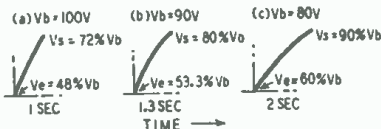

Fig. 4—Frequency falls with aging battery.

V_s and V_e have been taken as 72 and 48 volts, respectively, not because these are the round figures for all miniature neon tubes, but because small neons are scarce in Britain and the only kind I could get hold of had those characteristics. In the U.S.A., I believe, small neons are readily obtainable with rather low striking voltages. The winker, therefore, can be adapted for use in apparatus using voltages well below 100 volts.

My method of installing the winker in a battery portable radio was to find a place for it on the chassis as near as possible to the switch. A $\frac{3}{8}$ -inch hole was then drilled through the panel close to the switch and tidied up with a brass escutcheon. (If the switch is a single-pole type, it must be replaced with a double-pole unit.) The tube was mounted with its end actually in the hole. The result is a warning which just can't be disregarded. I've had the winker in use for over 3 months now, and it has never given me the slightest trouble.

Incidentally, C must be a high-grade capacitor, not of the electrolytic type, for if it has any appreciable leakage it acts simply as a resistor in series with R. The neon in that case may remain glowing continuously, or may not glow at all, depending on the volts dropped across the resistance provided by the leaky capacitor.

Tubeless Oscillator Uses A 1N34 Crystal

By RUFUS P. TURNER, K6AI

AN interesting tubeless oscillator may be obtained by utilizing the negative-resistance characteristic of a 1N34 crystal diode. This characteristic, which is a property of germanium (not silicon) crystals, appears at a relatively high value of negative applied voltage. The negative-resistance point is revealed by a backward loop in the reverse-current curve of the crystal (see Fig. 1) and is located at a different voltage (E_x) for different crystals. Individual 1N34 crystals show the negative-resistance point somewhere between -50 and -175 volts.

When the high negative voltage required to make the crystal oscillate is furnished by a selenium-type power supply, the tubeless oscillator circuit becomes an intriguing combination of dry rectifiers.

Fig. 2 is the complete circuit schematic of the crystal-diode oscillator. Negative voltage is supplied to the 1N34 crystal by a voltage-doubler circuit consisting of the two selenium rectifiers, a filter choke, and three electrolytic capacitors. The 50,000-ohm rheostat serves as a voltage control and permits the d.c. voltage to be adjusted to the negative value at which a particular crystal exhibits negative resistance and oscillates. The 0.1- μ f capacitor and the inductance of the primary winding of the transformer set the frequency of oscillation. If the builder employs the particular transformer used by the writer, a Thordarson T-29A99, oscillation will be an approximately 700-cycle sine wave. A higher capacitance will produce a lower frequency, and vice versa.

Oscillator circuits of this type have been operated at frequencies as high as 1 mc. At radio frequencies, however, the transformer must be replaced with a transformer or coupler having either

an air or powdered-iron core, and the capacitor must be a high-Q air, ceramic, or mica component with a capacitance between 20 and 200 μ f, depending upon the desired frequency of the oscillator.

When wiring the tubeless oscillator, care must be taken to insure correct crystal polarity as indicated in Fig. 2. The positive high-voltage output must be applied to that terminal of the crystal which is labeled with a minus sign or the abbreviation "cath." A reversal of polarity, even though the high voltage is applied only momentarily, is apt to burn out the crystal.

Operation of the circuit is simple. Before inserting the power plug into an a.c. outlet, set the voltage-control rheostat to its maximum-resistance (lowest-voltage) position, and connect a suitable signal indicator (headphones, electron-ray tube, a.c. vacuum-tube voltmeter, oscilloscope, or audio amplifier with loudspeaker) to the oscillator output terminals.

Insert the power plug into an a.c. outlet and close the on-off switch. Advance the rheostat slowly. When the negative-resistance voltage of the crystal is reached, the circuit will break suddenly into oscillation. Some crystals require very careful handling of the rheostat in order to find the exact spot where oscillation starts.

The crystal-diode oscillator is fertile territory for the experimentally inclined electronic technician. Its operating characteristics, as well as its possible applications, open interesting avenues of investigation.

MATERIALS FOR OSCILLATOR

1—10,000-ohm, 10-watt, wire-wound resistor; 1—50,000-ohm, wire-wound rheostat; 3—20- μ f, 450-volt, electrolytic; 1—0.1- μ f, 400-volt, paper capacitor; 1—1N34 crystal rectifier; 2—100-ma selenium rectifiers; 1—10-h, 55-ma filter choke; 1—3:1 interstage audio transformer; miscellaneous hardware.

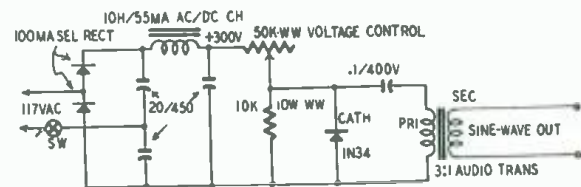
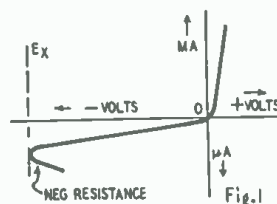

Fig. 1—Crystal voltage-current curve shows negative-resistance point. Fig. 2—Oscillator.

Fundamentals of Radio Servicing

Part VIII—Transformers—How they work

By JOHN T. FRYE

VERY few drivers do not understand why there is a gearshift in a car. You know it provides a choice between speed or power.

Where the highway is smooth and level, high gear hustles the car along at a good gait without the application of much torque to the rear wheels and without racing the motor; but when climbing a hill or plowing through sand, low gear sacrifices speed to provide the driving wheels with increased rotating power.

What the gearshift transmission does for the automobile designer, the *transformer* does for the electrical engineer: it enables him to *transform* a given a.c. voltage to a higher voltage at a lower current, or to a lower voltage at a higher current. Notice that voltage and current act like two kids on a seesaw: when one goes up, the other goes down.

This handy device for stepping voltage up or down is really very simple in construction. It consists of two coils so arranged physically that the magnetic field produced by passing an alternating or pulsating current through one of them (called the *primary*) also surrounds the turns of the other (called the *secondary*). The medium through which the magnetic field passes in *coupling* the two coils together is called the *core* of the transformer.

Fig. 1 is a diagram of a simple air-core transformer. When we apply an a.c. voltage across the 2-turn primary, the variations of current produce an expanding and contracting magnetic field about the coil. The lines of force of this field will be constantly swishing back and forth through the 6 turns of the secondary coil. We know that when moving lines of force are intercepted by a conductor, a current is generated in that conductor. The frequency of the current generated in the secondary is the same as that applied to the primary, but the voltage and amount of current available depend upon other factors.

Note in Fig. 1 that only some of the primary lines of force are intercepted by the secondary. Not much can be done to correct this without introducing other more serious losses in transformers which operate at radio frequencies. But, at audio and power frequencies, winding the two coils upon a common core of iron insures that practically all

the magnetic field produced by the current through the primary acts upon the turns of the secondary.

This is true because a magnetic line of force feels very much "that way" about soft iron, and it never passes through air if a soft-iron path is available. Consequently, as is shown by the dashed-line path of Fig. 2, practically all the magnetic field produced by the primary is confined to the iron core, which it threads through to act upon the secondary. What is more, the intensity of the magnetic field produced by the current flowing through the primary is greatly increased by the use of the iron core, as we learned when studying inductance.

Transformation ratios

When a dog scratches fleas, he scratches himself as well as the fleas. The magnetic field produced by the primary of a transformer does about the same thing. Not only does it act upon

the turns of the secondary, but it acts upon the turns of the primary as well and produces a back-e.m.f. (voltage) that is nearly equal to the applied voltage producing the field. In fact, if there were no losses, it *would* equal the applied voltage, and no current would flow.

Watch closely now, we are going to do a little tricky but true reasoning. If we applied 10 volts across a 2-turn primary, and if the magnetic field produced developed a counter-e.m.f. of nearly 10 volts, would it not be safe to say that every primary turn cut by this magnetic field produced very nearly 5 volts of back-electromotive force? Suppose, then, we have a 6-turn secondary. Since the same magnetic field that produces the counter-e.m.f. in the primary is also working on the secondary, is it not logical to expect to find close to 5 volts per turn, or 30 volts across a 6-turn secondary? Well, that is exactly what we do find; and all of



Some of the many types of transformers used in radios. Rear we have an isolation and a power transformer. Front, an output, an i.f., iron-core r.f. and an antenna transformer.

ALLIED'S NEW **FREE** 1950 RADIO CATALOG

196 VALUE-PACKED PAGES

Send for it now!

ALL THE LATEST RELEASES

BIG MONEY-SAVING VALUES



Get Radio's Leading Buying Guide

Here's the Buying Guide to everything in radio for everyone in radio! Preferred by expert service technicians, engineers, sound men, Amateurs, builders and experimenters—it's packed cover to cover with the world's largest selections of quality equipment at lowest money-saving prices. See the latest in TV and home radio receivers; radio-phonos with new three-speed changers; new Sound Systems, P.A. equipment and high-fidelity sound components; recorders and accessories; full selections of newest Amateur receivers and station gear; test instruments; builders' kits; huge listings of parts, tubes, tools, books, diagrams.

ALLIED gives you every buying advantage; speedy delivery, expert personal help, lowest prices, assured satisfaction—plus the most liberal Time Payment plan in radio. Get the new 1950 ALLIED Catalog. Keep it handy—it will save you time and money. Send today for your FREE copy!

LARGEST STOCKS • QUICK, EXPERT SERVICE

Send for your **FREE** copy of
Radio's Most Complete Catalog
Use the coupon below—**NOW!**

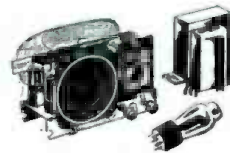

WORLD'S LARGEST STOCKS

Everything in radio for everyone in radio! ALLIED's huge stocks are the world's largest, including complete lines of all leading makes of parts and equipment. Get everything you need from one dependable centralized source—ALLIED RADIO!

TELEVISION & HOME RADIOS

See ALLIED's outstanding selection of new Television sets, new table model radios, FM-AM combinations with new Three-Speed Automatic Changers. Save on these radio models—the choice of experts!

AMATEUR STATION GEAR

You'll find everything you need for your shock in the new ALLIED Catalog. See all the latest releases in receivers, transmitters, parts, station equipment—the biggest and most complete listings in Ham radio!

NEW SOUND EQUIPMENT

Packaged, ready-to-use Sound Systems; amplifiers guaranteed for one full year; high-fidelity sound components; everything in speakers, mikes, P.A. accessories, intercom and recording equipment—ALLIED RADIO is headquarters for Soundmen!

Radio's Leading Buying Guide

THE WORLD'S
LARGEST
RADIO
SUPPLY
HOUSE . . .



ALLIED RADIO CORP.
833 W. Jackson Blvd., Dept. 2-K-9
Chicago 7, Illinois

Send FREE New 1950 ALLIED Catalog.

Name.....

Address.....

City..... Zone..... State.....



this leads up, after a little reflection, to a general statement: *the ratio of primary to secondary voltage of a transformer is practically equal to the ratio of the number of turns of wire in the two windings.*

For example, if we have 100 volts across a 100-turn primary, we will find 10 volts across a 10-turn secondary and 300 volts if the secondary has 300 turns.

Without the resistor in place across the secondary of Fig. 2, we should find

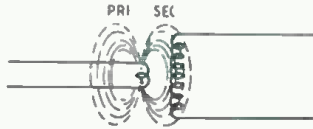

Fig. 1—How an r.f. transformer looks in radio diagrams. Note that while the primary is supposed to have 2 and the secondary 6 turns the schematic does not show the exact number.

our ammeter in series with the primary showing very little current, for the counter-e.m.f. would keep much current from flowing. But if we insert a low resistance across the secondary so that considerable current flows through it, we find our primary current greatly increased. Why is this? With no actual conducting path between the two windings, why does the current in the primary rise in sympathy with the increase in secondary current?

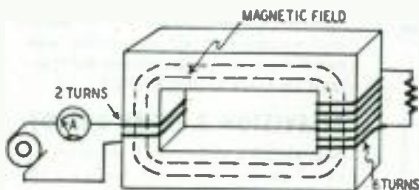

Fig. 2—Step-up transformer with iron core.

The answer lies in what happens to the magnetic flux passing through the core. When no current is being drawn from the secondary, this flux produces a bucking e.m.f. (electromotive force or voltage) that holds the primary current down to a very low level.

Don't hurry past this bucking e.m.f.—it's the important part of the story! The magnetic field which produces an e.m.f. of nearly 5 volts per turn in each turn of the secondary also produces a voltage of almost 5 volts per turn in

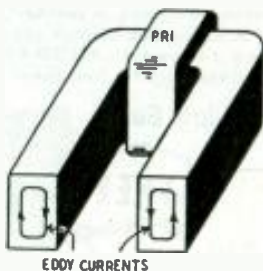

Fig. 3—The path followed by eddy currents.

the primary itself. But a field set up around any winding by a changing voltage across it (current through it) produces in the same winding a voltage which opposes the original voltage which set up the field (Lenz's law). If there were no losses in the transformer, that counter-e.m.f.—or voltage if you

prefer—would be exactly as strong as the line voltage and no current would flow. But all wire has resistance, and there are losses (which we will discuss later) in the best designed core. So we do have a small flow, called the *magnetizing current*.

However, when current flows through the secondary winding, that current produces a magnetic field of its own that *opposes* and partially cancels the magnetic field of the primary. Since the counter-e.m.f. of the primary depends upon the strength of its own field, a reduction in this field means a lowered back-e.m.f. and a consequent increase in primary current.

It is a cardinal principle of physics that "power out equals power in less losses." Power in electricity is measured in watts, the product of volts and amperes. Mull this over a bit and you will see why, for a given power input to

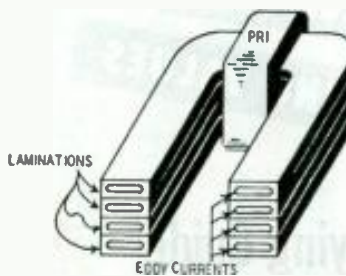

Fig. 4—Lamination reduces the eddy current e.m.f.'s while keeping resistance high, thus reducing the eddy currents to small values.

the primary, the current in the secondary goes down as the voltage goes up. Suppose we input 50 watts to the primary of our transformer and ignore losses. That means that we have 50 watts available in the secondary. We can take our 50 watts in any combination of volts and amperes whose product is equal to 50. For example, we can have 10 volts at 5 amperes, 50 volts at 1 ampere, 100 volts at 0.5 ampere, and so on.

Evidently, any increase in the power taken from the secondary results in an increase in the current flowing through the primary. The actual d.c. resistance of the primary is seldom great enough to hold the current down to the current-carrying capacity of the wire, and the counter-e.m.f. or self-inductance of the primary is depended upon to prevent the current from rising too high. If such a heavy load is placed upon the secondary that this counter-e.m.f. is lowered too much, the wire of the primary will overheat and the transformer be destroyed, in spite of the fact that the secondary winding is heavy enough to carry its current safely.

Transformer losses

We have been ignoring transformer losses about as long as we can, so we may as well take them up here and now. Outside of the small loss due to the resistance of the windings, transformer losses usually take two forms: *hysteresis losses* and *eddy-current losses*.

When an a.c. voltage is impressed across the primary of a transformer,

it produces in the iron core a magnetic field which reverses direction at twice the line frequency. Under the compulsion of this field, the atoms of the core have to keep shifting their position through 180 degrees to have their individual fields lined up with the reversing polarity of the primary field.

Now magnetic substances possess a quality that might be termed *magnetic inertia*, for they tend to retain any magnetism they have once acquired, and it takes energy to get rid of it. The magnetism in such a substance—because of this inertia—always lags behind the magnetic force trying to change it. This resistance to magnetic change is called *hysteresis*, and the energy expended in overcoming it is called *hysteresis loss*. This loss appears in the form of heat developed in the core material.

In some materials the molecules permit themselves to be flipped around with comparatively little resistance, while others are harder to change than bad habits. Hard steel has a high hysteresis loss, while annealed silicon steel has a comparatively low one. This explains why silicon steel is the favorite transformer core material.

Eddy currents

If we used a solid steel core like that of Fig. 2 for our transformer, the closed core would act as a single-turn secondary and have a low voltage induced in it by the varying magnetic field passing through it. This would produce circular currents—which would flow at right angles to the main magnetic field—in the core, as shown in the cross section of Fig. 3. These currents would be very large because of the low resistance of the large cross section of the core material. They would heat the core and

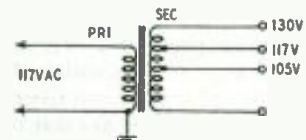

Fig. 5—The isolation transformer frees circuits from the electric light system ground.

waste energy. Such core currents, because of their circular direction, are called *eddy currents*.

To reduce eddy currents, the core is built up of thin sheets of metal insulated from one another, as shown in Fig. 4. Eddy currents still exist in each separate lamination, but because the

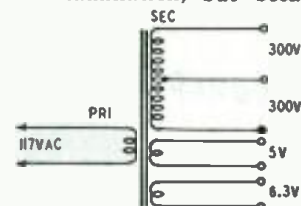

Fig. 6—Several windings may be combined on a core, as in this radio power transformer.

cross section of the lamination is small and the silicon present adds to the resistance to current flow, the eddy currents in the individual laminations re-

main comparatively puny—so puny, in fact, that the sum of all the little eddy currents does not add up to anything like the big papa eddy current we had with the solid core.

As the frequency is increased, eddy-current and hysteresis losses go up; that is why we find air-core transformers being used at radio frequencies. In some cases a special form of powdered-iron core—made up of very minute particles of iron insulated from each other and glued together—is used as the core for radio-frequency transformers. If the core is adjustable, it can be slid in and out to vary the inductance of the coil and tune the circuit.

The radio engineer can do almost as many things with a transformer as a woman can with a bobby pin. He uses it to step voltages up and down, to transfer an a.c. voltage from one circuit to another without disturbing the d.c. components in the two circuits, to provide a low-loss coupling between two different impedances. Isolation transformers are becoming popular for providing the radio technician with a 117-volt line current that does not have one side grounded, as is shown in Fig. 5. This is very useful in working on a.c.-d.c. receivers that employ one side of the line for B₁, since it reduces the chance of shock. (Sometimes, however, you will get oscillation in an a.c.-d.c. receiver thus isolated from the power line.)

A common requirement in a radio receiver is to have two separate low voltages for heating the filaments of the tubes and a high voltage for use in supplying the B-voltage. Instead of using three transformers, we can use a single transformer with three separate secondaries, as diagrammed in Fig. 6.

Transformer troubles

The main troubles encountered in transformers are open windings, shorts between windings, shorts between turns of the same winding, and shorts between a winding and the core. If a single turn is shorted out, very heavy current flows through it and quickly develops a great deal of heat, damaging the insulation of neighboring turns and producing more shorted turns. However, if a well-built transformer is not subjected to overload; if voltage surges, such as are produced by lightning, are not allowed to enter the primary; and if insulation-destroying moisture is kept out, a transformer is a highly efficient, trouble-proof electrical device.

While we have touched on several different phases of transformer action, the subject is by no means exhausted. We will return to it later when studying such special cases as i.f. transformers, in which both the primary and secondary windings are tuned to the a.c. frequency being passed.

In the next chapter, though, we are going to see what happens to this electron we have been hounding through coils, capacitors, and resistors when it enters the vacuum tube. Do not miss this special attraction!

SENCO SPELLS ECONOMY

TUBES for Economy Wise Servicemen

SPECIAL DISCOUNT: Deduct 5c. from each tube when ordering 25 or more assorted tubes.

Guaranteed! Brand new! Immediately Deliverable! Individually cartoned!

19c each	6U6GT	6X5GT	6Q7G
37A5	6V6GT	6Y5	6V5
16A4	6X5GT	6Y6G	6T7G
V99	12AH7GT	7A4XXL	7A7
X99	12AU6	7A5	7C5
	12B6	7B7	7E7
	12J7GT	7E5 1201	7Q7
29c Each	12K7GT	7K7	12BD6
2A7	12M7GT	12A7E	12BD6
2X2	12SA7GT	12BA6	14B6
6C4	12SF5	12BE6	25AC5
6CA8	12SH7GT	12BW7GT	50C6
6SM7GT	12SK7GT	12Z3	50L6
6SN7GT	12SL7GT	12AG0	20S0
6U7G	12SQ7GT	25L6GT	20S1
7Y4	12SQTGT	32L7GT	
12A6	19T8		
12A6GT	20T8	35Z4GT	
12F5GT	25Z6GT	43	
12H6	27	45Z5	
30	32	46	
36	35/51	80Y6G	
	35Z6	53	
	35W4	56	
	35Z5	117Z3	
	35Z6		
39c Each			
1A3	41	50c Each	
1U4	42	1ASGT	
1U5	47	1A6	
1V	47	1A7GT	
2A6	50B5	1C5	
3A4	57	1C6G	
50A4	67	1C7G	
5W4	78	1D7G	
5X4G	80	1D8G	
5Y3G	85	1E6G	
5Y3GT	GB4	1F4	
5Y4		1F5C	
6AF5G		1F6G	
6AH6	1B5/255	1H4G	
6AT6	1L4	1H6G	
6AU6	1R5	1H8G	
6BA6	1S4	1MSGT	
6BE6	1S5	1M6G	
6CSGT	1S6	1M8G	
6C6	1A5GT	1N6G	
6F5G	1A5	1NSGT	
6H6GT	2B6	1R4	
6J7	2B7	1R5	
6K6GT	3Q5GT	3Q4	
6K7G	6AL5	3V4	
6L7GT	6B16	5Z1	
6N4	6D7	5Z4	
6S7GT	6F5GT	6A6	
6SD7GT	6S7GT	6B6G	
6SF5GT	6P5GT	6AQ5	
6S7GT	6R7GT	6B8	
6S7GT	6S7GT	6D8	
6S7GT	6S7GT	6FRG	
6S7GT	6S7GT	6L8G	
6T8	6S7GT	6L9	
	6S7GT	6L9	

HARD TO GET TUBES: Our tube stock is constantly being expanded. If your tube is not listed, write us!

POWER TRANSFORMERS

Fully shielded! Guaranteed! 110 V., 60 cycle.

60 mil—6.3V @ 2 1/2 amps 5V @ 3 amps 600V CT. (Upright)...	\$1.89
Flush Mount	
100 mil—6.3V @ 3 amps 5V @ 2 amps 750V CT.	\$2.79
120 mil—6.3V @ 3 amps 5V @ 2 amps 700V CT.	\$2.95
150 mil—6.3V @ 4 amps 5V @ 3 amps 750V CT.	\$3.19
200 mil—6.3V @ 3.3 amps 5V @ 3 amps 815V CT.	\$4.25

Save 20% on Each by Ordering Any 5!!!

Minimum Order \$2.50; Send 25% deposit for all C.O.D. shipments. Include sufficient postage—excess will be refunded. Orders without postage will be shipped express collect. All prices F.O.B. New York City.

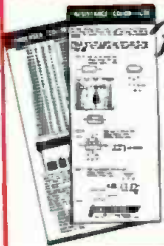

Free! NEW 1950 CONDENSER-RESISTOR COLOR CODE CHART

It's SENCO'S way of thanking their customers and to greet new friends. It's yours... and it's FREE! Just mail this coupon today!

For Real Economy... VOLUME CONTROLS

With switch and 3" Shaft
Only **44c**
10,000 ohms
25,000 ohms
50,000 ohms
100,000 ohms each
250,000 ohms—Tapped
500,000 ohms—Tapped
1 meg. ohms—Tapped
2 meg. ohms—Tapped

Order an assortment of 10 for only \$4.20
SAVE ON THESE TELEVISION PARTS
RCA TYPE HIGH VOLTAGE FLYBACK

Like RCA No. 211-T1 horizontal output transformer. Provides about 9 KV in electro-magnetic deflection for excellent picture brilliance in 10" or 12" tube.
\$3.45 ea.

RCA TYPE FOCUS COIL
At Low Price

For kinescopes that are focused magnetically with deflection angles up to 50° like RCA's 10BP4. Free from corrosion operation—large conductor. Like RCA No. 202D1.
\$3.41 ea.

RCA TYPE HORIZONTAL OUTPUT TRANSFORMERS
Like RCA No. 204T1.
\$6.95 ea.

WEBSTER Record Changers



A Real Buy! Changes 12 10" and 10 1/2" records automatically. Complete with crystal cartridge arm. 110 V., 60 cycle.
Webster, Model 50. Complete
\$11.95

New Stock of Tubular Electrolytics
Nationally Known Brands!

10 Mfd. @ 150V.	30	\$.34
Mfd. @ 25V.		
20 x 20 Mfd. @ 150V.	.39	
40 x 40 Mfd. @ 150V.	.40	
40 x 50 Mfd. @ 150V.	.41	
50 x 30 Mfd. @ 150V.	.40	
80 x 40 Mfd. @ 150V.	.42	
50 x 30 x 20 Mfd. @ 150V.	.46	
8 x 8 Mfd. @ 450V.	.40	
16 x 8 Mfd. @ 450V.	.42	
16 x 16 Mfd. @ 450V.	.42	
20 x 20 Mfd. @ 450V.	.47	
10 Mfd. @ 450V.	.29	
20 Mfd. @ 150V.	.32	
40 Mfd. @ 150V.	.34	
4 Mfd. @ 450V.	.35	
10 Mfd. @ 450V.	.39	
16 Mfd. @ 450V.	.40	
40 Mfd. @ 450V.	.47	
32 x 16 Mfd. @ 450V.	.49	
10 x 10 x 10 Mfd. @ 450V.	.49	
50V. 100 Mfd.		

Order These High Quality SPEAKERS
At These Low Prices

ALL ALNICO V Lots of 5

3" P.M.—.68	1.15	1.05
oz.	\$.99	\$.95
3" P.M.—1.47		
oz.	1.15	1.05
4" P.M.—1.47	.99	.95
4" P.M.—1.47		
oz.	1.15	1.05
4" x 6" P.M.—1.69	1.59	
5" P.M.—1.01	.99	.95
5" P.M.—1.47		
oz.	1.15	1.05
6" P.M.—1.47		
oz.	1.55	1.45
6" x 9" P.M.—2.39	2.25	
8" P.M.—2.15		
oz.	2.75	2.59
8" P.M.—4.64		
oz.	2.95	2.74
8" P.M.—6.8		
oz.	3.69	3.39
10" P.M.—6.8		
oz.	3.75	3.43



Buy 4 and Save More
MAGNAVOX Lots of 4 Ea.
8" 880 ohms field with 6V P.P. output, cord and plug... **\$3.69 \$3.29**
12" P.M.—21 oz. magnet, 6V P.P. output, cord and plug... **5.95 5.50**
12" 1,000 ohms field, 6V P.P. output, cord and plug... **5.95 5.50**
12" 680 ohms field, 6V P.P. output, cord and plug... **5.95 5.50**
RCA SPEAKERS Ea.
2" x 3" P.M. Alnico V... **\$.79**
12" P.M. Alnico V... **3.95**
12" P.M. 6.8 oz. Alnico... **4.75**

Nothing to Buy... It's Yours for the Asking MAIL TODAY

SENCO RADIO, INC.
Dept. N, 73 West Broadway
New York 7, N. Y.
Please RUSH my 1950 Resistance-Condenser Color Code Chart absolutely FREE.

Name..... (Print)
Address.....
R.F.D. No..... P.O. Box.....
City..... Zone..... State.....

Radio Men Who Know SAVE AT SENCO

SENCO RADIO, INC., Dept. N, 73 West Broadway, New York 7, N. Y. Tel: BEetman 3-6498

Radio Set and Service Review



The Motorola VT73, a 7-inch 33-pound television receiver

THE Motorola model VT73 portable televiser may be the answer to the TV receiver problems of apartment house dwellers and others who have neither space for a larger receiver nor facilities for erecting an outdoor antenna. The receiver is designed to receive eight of the 12 TV channels. It is 9½ inches high, 18¾ inches deep, and 17¼ inches wide. Its weight is only 33 pounds complete with its plug-in adjustable dipole antenna. Having only four front-panel controls, it is easy to operate. The controls are: channel selector, vernier tuning, contrast, and volume control and on-off switch. It has a 7-inch picture tube which produces a 4½ x 5¾-inch picture. A transformerless voltage-doubler-type, low-voltage power supply which operates from 117-volt a.c. lines is used.

The circuit in detail

The circuit of the VT73 is shown in Fig. 1. Input connections are provided for 75- and 300-ohm antenna systems. C2, L57, and a length of 75-ohm coaxial cable form a highpass filter designed to reject signals within or close to the i.f. passband.

The permeability-tuned antenna coils connected between S3-a and S3-b match the impedance of the antenna to the input of the r.f. amplifier on channels 1 through 6. Since the input impedance of the amplifier varies inversely as the frequency, the impedance of the circuit is low on the high-band channels and no tuning is required.

The coils connected to S3-c and S3-d are in the plate circuit of the r.f. amplifier V1. Capacitor C85 is inserted in series with L30, L31, L32, and L81 to provide a suitable load for the high-band channels. L60 through L63 are

tuned to the video carriers and L64 through L67 to the audio carriers of the low-band stations. This results in a flat-top r.f. response. L81 is tuned to the center frequency of channel 9 or 10. The output of the r.f. amplifier is capacitance-coupled to the grid of the converter V17-a.

The high-frequency oscillator V17-b, half of a 12AT7, is coupled to the grid of the converter through C7, a 2-μf capacitor. The oscillator coils are connected to S3-e and S3-f.

The intercarrier system is used for sound. The i.f. amplifier has three stages common to video and audio channels. The converter output transformer T1 is over-coupled to provide the same bandwidth as the stagger-tuned i.f. stages. The video i.f. carrier channel is 26.2 mc on channels 2 through 6, and the audio carrier is 21.7 mc. The carrier frequencies are 22.9 and 27.4 mc, respectively, on the high band.

The first and second i.f. stages are biased by a voltage developed by the detector. This voltage is filtered by R145 and C13. These stages are connected in series between B-minus and 250 volts positive (the B++ terminal) to balance the current drain between the 150-volt (B+) and 250-volt buses. Note that the d.c. bias is applied directly to V2. As the grid of this tube goes more negative the cathode of V3 goes more positive, thus effectively biasing its grid more negative.

The third i.f. stage is connected in an unusual manner. Its plate and screen grid are supplied from 250 volts positive, and its cathode is returned to a point 125 volts positive. This connection also helps to stabilize the loads on the low-voltage power supply.

The detector is a 1N34 germanium diode, capacitance-coupled to V5, a 6AU6 video amplifier. The output of the detector consists of the video signal complete with sync pulses and the frequency-modulated 4.5-mc heterodyne produced by the beating between the video and audio carriers. L38, L39, and C24 form a low-pass filter which removes the i.f. harmonics.

An amplified replica of the detector output appears on the plate of the video amplifier. A 4.5-mc audio i.f. limiter amplifier is capacitance-coupled to the

video amplifier plate through C170, L43, and C31, which constitute a band-pass filter. The grid circuit of the limiter V6 is peaked at 4.5 mc by adjusting the slug in L43.

The audio detector is a conventional ratio detector using a 6AL5 duo-diode. Its bandwidth is approximately 180 kc. This stage feeds a two-stage audio amplifier consisting of one triode of a 12SN7 and a 25L6-GT power amplifier working into a 6½-inch PM speaker.

Electrostatic picture tube

The picture tube is a 7JP4, a type using electrostatic deflection and focusing. The output of the video amplifier is positive. Its signal is therefore applied to the cathode of the picture tube for correct polarity of the picture. L79 and R156 form a peaking circuit to provide uniform gain at video frequencies. The video response is 3 db down at approximately 3.7 mc.

Instead of using the d.c. picture component to control the average illumination of the picture, a special stabilized brightness circuit is used. The C-R tube cathode current returns to B-minus through R124 and a part of the brightness control R100. This develops a bias which corrects for variations in line voltage and the high-voltage supply.

Some of the output of the video amplifier is tapped off at a point on the plate load and applied to the first of a pair of cascade-connected clippers. It is these tubes which remove the sync pulses from the composite signal so they can be used to control the sweep oscillators. The first clipper V10-a is biased to cutoff under normal conditions. When a positive sync pulse reaches the grid of V10-a, it drives it positive and into the grid-current region. This charges C44 and builds up a charge that keeps the tube from conducting except on positive sync pulses. The second clipper V10-b operates in much the same way.

A low-pass filter (integrator) consisting of R44, R45, C47, and C48 separates the vertical sync pulses from the horizontal and applies them to the grid of V18-b, one triode of the multivibrator-type vertical sweep oscillator. The multivibrator consists of V18-b and one triode of V8, the vertical output tube.

(Continued on page 54)

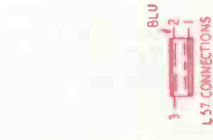
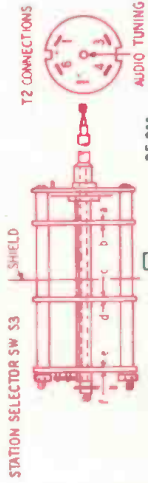
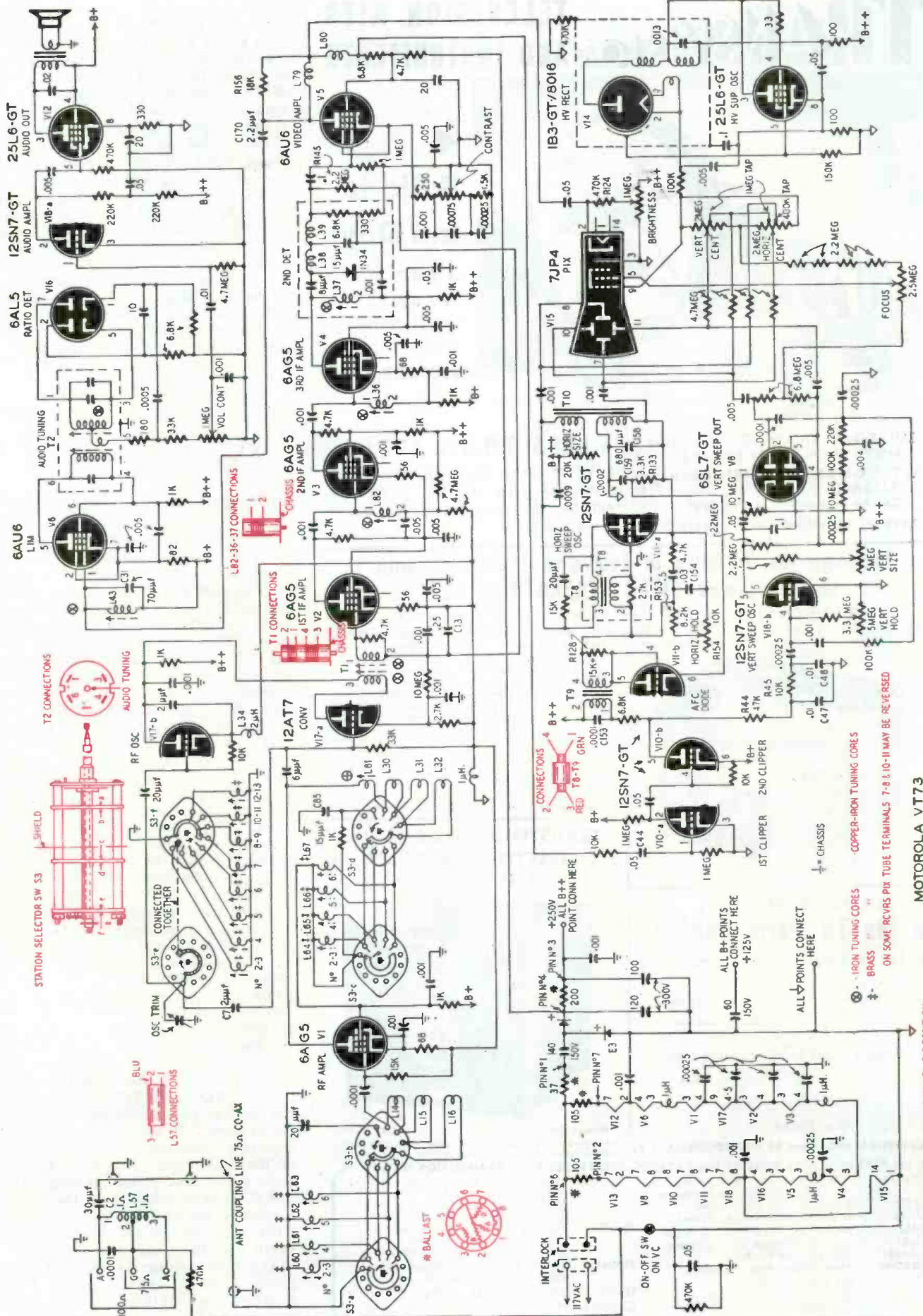

- IRON TUNING CORES
 - COPPER-IRON TUNING CORES
 - CHASSIS
 ON SOME RCVR'S PIX TUBE TERMINALS 7-8 & 10-11 MAY BE REVERSED

MOTOROLA VT73
 CHASSIS T5-4J

STATION SELECTOR SW (S3) SHOWN IN CHANNEL 2-3 POSITION

TRANSVISION TELEVISION KITS AND INSTRUMENTS

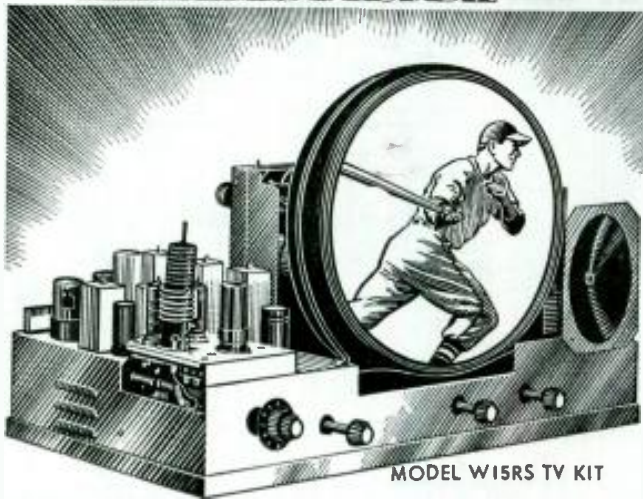

Build it in 1 Day!

GIANT
160 Sq. In.
PICTURE
Has 16"
PICTURE
TUBE

- (All-Glass Picture Tube, giving bright, clear, steady picture.)
- KIT COMES SEMI-WIRED and ALIGNED. Can be completed in one day!
- SAVE by installing the set yourself.

• LESS THAN \$200!

SAVE UP TO 1/2 on the cost of equivalent picture-size sets. For NEW LOW PRICES, see your Transvision Outlet listed below.

Eliminate the Variables in Television Installation with the Transvision FIELD STRENGTH METER

Improves Installations! Saves 1/2 the Work! !

Has numerous features and advantages, including—(1) Measures actual picture signal strength . . . (2) Permits actual picture signal measurements without the use of a complete television set.



- (3) Antenna orientation can be done exactly . . . (4) Measures losses or gain of various antenna and lead-in combinations . . . (5) Useful for checking receiver re-radiation (local oscillator) . . . (6) 12 CHANNEL SELECTOR . . . (7) Amplitudes of interfering signals can be checked . . . (8) Weighs only 5 lbs. . . . (9) Individually calibrated . . . (10) Housed in attractive metal carrying case . . . (11) Initial cost of this unit is covered after only 3 or 4 installations . . . (12) Operates on 110V, 60 Cycles, AC.

NEW LOW PRICE
Model FSM-1, complete with tubes Net \$79.50

TRANSVISION ALL-CHANNEL TELEVISION BOOSTER CONTINUOUS TUNING



Model B-1, complete with tubes . . . List \$32.50

All Transvision Prices are fair traded; subject to change without notice. Prices 5% higher west of the Mississippi.

SERVICE-DEALERS . . .
Be the TV Parts Jobber
and Service Center in your community!
• Beat competition at a profit.
• Stop being undersold—by anybody!

Here's a real opportunity to MAKE MONEY in Television. If you can qualify, you can become the Transvision Television Center in your community—and BUY TV and RADIO PARTS AT JOBBER PRICES. Practically no investment required. This offer is open only to service-dealers in territories where we do not have an authorized distributor.

Contact Transvision Outlets listed below, or write to New Rochelle, for details on Transvision's "TV Center Plan." DO IT TODAY!

TRANSVISION, INC., Dept. RE, NEW ROCHELLE, N.Y.

For FREE 20-page TV BOOKLET and CATALOG SHEETS, SEE YOUR TRANSVISION OUTLET!

- CALIF: 8572 Santa Monica Blvd., Hollywood
3471 California St., San Francisco
4 East 15th St., Wilmington
- DELA: 42 Southeast Eighth St., Miami
- ILL: 1002 So. Michigan Ave., Chicago
- MD: 1912 No. Charles St., Baltimore
- MASS: 1306 Boylston St., Boston
- MICH: 23216 Wilson Ave., Dearborn
- N. J.: 601 Broad St., Newark
- N. Y.: 1425 Boscobel Ave., The Bronx
485 Coney Island Ave., Brooklyn

OHIO:

PENNA:

TEXAS:

CANADA:

- 167-01 Hillside Ave., Jamaica
75 Church St., New York City
606 Central Park Ave., Yonkers
622 No. Salina St., Syracuse
Fourth & Plum Sts., Cincinnati
2001 Euclid Ave., Cleveland
53 W. Norwich Ave., Columbus
- 235 No. Broad St., Philadelphia
620 Grant St., Pittsburgh
- 700 Commerce St., Dallas
Hamilton, Ont.

Note that the plate of V18-b is capacitance-coupled to the grid of one triode of V8. The plate of this triode is coupled back to the grid of V18-b to produce a free-running sawtooth oscillator. A part of the output of the oscillator section of V8 is tapped off and fed to the remaining triode which is a phase inverter producing a sawtooth with polarity opposite that of the oscillator. Both plates of V8 are capacitance-coupled to the 7JP4 vertical deflection plates.

The horizontal sweep voltage is generated by triode V11-a connected as a blocking oscillator. The output transformer T10 has two windings, one of which is in series with the plate and the other in series with the cathode of V11-a. The voltages across the windings being equal and opposite, they can be used to drive the horizontal deflection plates of the C-R tube in push-pull.

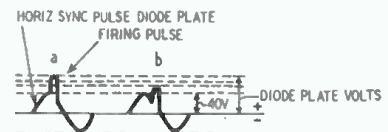

Fig. 2—Horizontal sweep control waveforms.

The horizontal oscillator is controlled by an automatic frequency control (a.f.c.) circuit which reduces the effect of noise and poorly shaped sync pulses. Instead of triggering the oscillator with each received sync pulse as in the vertical oscillator, the a.f.c. circuit controls the phase and frequency of the oscillator by comparing the phase of the incoming sync pulse with the retrace pulse from the horizontal sweep. The sync pulse appears across the primary of T9 where it is distorted into an a.c. wave by C153. This sine wave appears across the secondary of T9 and on the plate and grid of the diode-connected triode V11-b. R128 damps the secondary.

R133 in series with C159 differentiates the horizontal sweep voltage (appearing across C158) into a sharp negative pulse and applies it to the cathode of the a.f.c. diode V11-b. This negative pulse on the cathode is equivalent to a positive pulse on the plate. The effect of the sync and negative retrace pulses on the plate-cathode potential of the diode is shown in Fig. 2. The time at which the sync and retrace pulses coincide is determined by the speed of the horizontal oscillator. If it is fast, the retrace or firing pulse moves up the slope of the sync sine wave as in Fig. 2-a and the diode forces more current through R153 and R154, thus increasing the bias on the oscillator and slowing it down: If the oscillator is slow, the firing pulse moves down on the slope of the sync wave (Fig. 2-b) and the diode passes less current through R153 and R154, thus reducing the bias on the oscillator. With the reduction in bias, C154 does not charge to its normal value and the oscillator speeds up.

The high voltage is supplied by a conventional r.f. power supply using a 25L6-GT as a 140-kc oscillator and a 1B3-GT/8016 high-voltage rectifier.

MONEY BACK GUARANTEE — We believe units offered for sale by mail order should be sold only on a "Money-Back-If-Not-Satisfied" basis. We carefully check the design, calibration and value of all items advertised by us and unhesitatingly offer all merchandise subject to a return for credit or refund. You, the customer, are the sole judge as to value of the item or items you have purchased.

**A COMBINATION
20,000 OHMS PER VOLT MULTI-METER
and TELEVISION KILOVOLT METER**

The New Model TV-20



Added Feature: Includes an Ultra High Frequency Voltmeter Probe with a frequency range up to 1,000 MEGACYCLES. When plugged into the Model TV-20, the V. M. Probe converts the unit into a Negative Peak-Reading H. F. Voltmeter.

The Model TV-20 operates on self-contained batteries. Comes housed in beautiful hand-rubbed oak cabinet complete with portable cover. Built-in High Voltage Probe, H. F. Probe, Test Leads and all operating instructions.

\$39.95
NET

- Specifications:
- 9 D.C. Voltage Ranges: (At 20,000 ohms per Volt)
 - 0-2.5/10/50/100/250/500/1,000/5,000 / 50,000 Volts)
 - 8 A. C. Voltage Ranges: (At 1,000 ohms per Volt)
 - 0-2.5/10/50/100/250/500/1,000/5,000 Volts)
 - 5 D. C. Current Ranges
 - 0-50 Microamperes
 - 0-5/50/500 Milli-amperes
 - 0-5 Amperes
 - 4 Resistance Ranges:
 - 0-2,000 / 20,000 ohms. 0 - 2/20 Megohms
 - 7 D. B. Ranges: (All D. B. ranges based on 0db = 1 Mw. in to a 600 ohm line)
 - 4 to +10 db
 - +8 to +22 db
 - +22 to +36 db
 - +28 to +42 db
 - +36 to +56 db
 - +42 to +56 db
 - +48 to +62 db
 - 7 Output Voltage ranges:
 - 0 to 2.5/10/50/100/250/500/1,000 Volts

The New Model TV-10 TUBE TESTER



The Model TV-10 operates on 105-130 Volt 60 Cycles A.C. Comes housed in a beautiful hand-rubbed oak cabinet complete with portable cover. **\$39.50** NET

★ Tests all tubes including 4, 6, 7, Octal, Lock-in, Peanut, Bantam, Hearing-aid, Thyatron, Miniatures, Sub-Miniatures, Novals, etc. Will also test Pilot Lights.

★ Tests by the well-established emission method for tube quality, directly read on the scale of the meter.

★ Tests for "shorts" and "leakages" up to 5 Meg-ohms.

★ Uses the new self-cleaning Lever Action Switches for individual element testing. Because all elements are numbered according to pin-number in the RMA base numbering system, the user can instantly identify which element is under test. Tubes having tapped filaments and tubes with filaments terminating in more than one pin are truly tested with the Model TV-10 as any of the pins may be placed in the neutral position when necessary.

★ The Model TV-10 does not use any combination type sockets. Instead individual sockets are used for each type of tube. Thus it is impossible to damage a tube by inserting it in the wrong socket.

★ Free-moving built-in roll chart provides complete data for all tubes.

★ Newly designed Line Voltage Control compensates for variation of any line voltage between 105 Volts and 130 Volts.

- Specifications:
- ★ Tests all tubes including 4, 6, 7, Octal, Lock-in, Peanut, Bantam, Hearing-aid, Thyatron, Miniatures, Sub-Miniatures, Novals, etc. Will also test Pilot Lights.
 - ★ Tests by the well-established emission method for tube quality, directly read on the scale of the meter.
 - ★ Tests for "shorts" and "leakages" up to 5 Meg-ohms.
 - ★ Uses the new self-cleaning Lever Action Switches for individual element testing. Because all elements are numbered according to pin-number in the RMA base numbering system, the user can instantly identify which element is under test. Tubes having tapped filaments and tubes with filaments terminating in more than one pin are truly tested with the Model TV-10 as any of the pins may be placed in the neutral position when necessary.
 - ★ The Model TV-10 does not use any combination type sockets. Instead individual sockets are used for each type of tube. Thus it is impossible to damage a tube by inserting it in the wrong socket.
 - ★ Free-moving built-in roll chart provides complete data for all tubes.
 - ★ Newly designed Line Voltage Control compensates for variation of any line voltage between 105 Volts and 130 Volts.

**The Model 88—A Combination
SIGNAL GENERATOR
and SIGNAL TRACER**

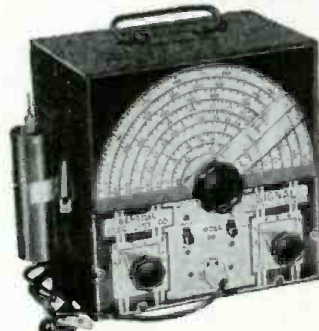

The Model 88 comes complete with all test leads and operating instructions. ONLY.....

Signal Generator Specifications:

- *Frequency Range: 150 Kilocycles to 50 Megacycles.
- *The R.F. Signal Frequency is kept completely constant at all output levels.
- *Modulation is accomplished by Grid-blocking action which is equally effective for alignment of amplitude and frequency modulation as well as for television receivers.
- *R.F. obtainable separately or modulated by the Audio Frequency.

Signal Tracer Specifications:

- *Uses the new Sylvania IN34 Germanium crystal Diode which combined with a resistance-capacity network provides a frequency range of 300 cycles to 50 Megacycles.

\$28.85 NET

The New Model TV-30 TELEVISION SIGNAL GENERATOR



Model TV-30 comes complete with shielded coaxial lead and all operating instructions. **\$29.95** NET

Enables alignment of Television I. F. and front ends without the use of an Oscilloscope

Specifications:

- Frequency Range: 4 Bands
- No switching.
- 18-32 Mc. 35-65 Mc. 54-98 Mc. 150-250 Mc. Audio Modulating Frequency: 400 cycles (Sine Wave). Attenuator 4 position.

ladder type with constant impedance control for fine adjustment. Tubes Used: 6C4 as Cathode follower and modulated buffer. 6C4 as R.F. Oscillator. 6SN7 as Audio Oscillator and power rectifier.

The New Model 670



SUPER METER

A Combination VOLT - OHM - MILLIAMMETER plus CAPACITY REACTANCE, INDUCTANCE and DECIBEL MEASUREMENTS.

- D.C. VOLTS: 0 to 7.5/15/75/150/750/1500/7500 A.C. VOLTS: 0 to 15/30/150/300/1500/3000 Volts
- OUTPUT VOLTS: 0 to 15/30/150/300/1500/3000.
- D.C. CURRENT: 0 to 1.5/15/150 ma.; 0 to 1.5 Amps.
- RESISTANCE: 0 to 500/100,000 ohms. 0 to 10 Megohms.
- CAPACITY: .001 to 2 Mfd., 1 to 4 Mfd. (Quality test for electrolytics).
- REACTANCE: 700 to 27,000 Ohms; 13,000 Ohms to 3 Megohms.
- INDUCTANCE: 1.75 to 70 Henries; 35 to 8,000 Henries.
- DECIBELS: -10 to +18, +10 to +38, +30 to +58.

The model 670 comes housed in a rugged, crackle-finished steel cabinet complete with test leads and operating instructions. Size 5 1/2" x 3 1/2" x 3". **\$28.40** NET

The New Model 770—An Accurate Pocket-Size

VOLT-OHM MILLIAMMETER

(Sensitivity: 1000 ohms per volt) Compact-measures 3 1/4" x 5 1/2" x 2 1/4". Uses latest design 2% accurate 1 Mil. D'Arsonval type meter. Same zero adjustment holds for both resistance ranges. It is not necessary to readjust when switching from one resistance range to another. This is an important time-saving feature never before included in a V.O.M. in this price range. Housed in round-cornered, molded case. Beautiful black etched panel. Depressed letters filled with permanent white, insures long-life even with constant use.

Specifications: 6 A.C. VOLTAGE RANGES: 0-15/30/150/300/1500/3000 volts.

- 6 D.C. VOLTAGE RANGES: 0-7 1/2/15/75/150/750/1500 volts.
- 4 D.C. CURRENT RANGES: 0-1 1/2/15/150 Ma. 0-1 1/2 Amps.
- 2 RESISTANCE RANGES: 0-500 Ohms. 0-1 Megohm.

The Model 770 comes complete with self-contained batteries, test leads and all operating instructions. **\$13.90** NET

20% DEPOSIT REQUIRED ON ALL C.O.D. ORDERS

GENERAL ELECTRONIC DISTRIBUTING CO. Dept. RC-10, 98 PARK PLACE NEW YORK 7, N. Y.

Pedro Makes a Record



... trying to make my eyes focus on the fine print

Jumping to conclusions is bad business, but sometimes it pays

By GUY SLAUGHTER

I'M leaning lazily on the counter wondering whether Pedro is going to show up this morning, when I see him come bounding across the street at a dead run. He shoots through the door, slides to a stop in front of me, and stabs me with a burning glare.

"You're late," I say casually, ignoring the look.

"What a dirty trick!" he gasps, glaring harder.

"Hunh?" I query, surprised. "Dirty trick?"

"You know what I mean," he pants. "That filter capacitor."

"What filter capacitor?"

"The one you gave me last night."

"What about it?" I demand.

"It's no good," he snaps. "As if you didn't know."

"News to me," I say calmly. "What makes you think it's no good?"

"I put it in my girl's set, and it still hums," he accuses.

"Pedro," I say pleasantly, "you jump to too many conclusions. You told me you needed a filter, and I gave you one. To the best of my knowledge it's good."

"How come the set still hums?"

"Apparently it wasn't filter hum in the first place."

"Listen," Pedro says darkly. "I've watched you fix a thousand a.c.-d.c. sets. You turn the volume way down, and if the hum is still there, you change the filters."

"Uh-uh," I reply. "First I check the plate voltage. If it's way below normal, then I change filters. How was the voltage on your girl's set?"

Pedro stares at me a minute, and then

his attitude changes. He drops his hands to his sides, hunches his shoulders up to rub his chin, looks at his feet, and clears his throat embarrassedly.

"I don't know," he says in a small voice. "I didn't check it."

"Fine," I purr pleasantly. "So you jumped to that conclusion, too." I let him suffer a minute, and then I break it gently. "Next time you go see her, take a new output tube along. Know what it uses?"

He nods glumly.

"It's got a 50L6 in it."

I reach one off the shelf, and lay it on the counter in front of him.

"Could be the whole trouble," I point out. "Sometimes they develop a heater-to-cathode short that modulates the plate current at 60 cycles."

"Thanks, Herk," Pedro murmurs meekly. "I'll try it."

"Sounds just like filter hum, too," I say, trying to make him feel better. "Why don't you run over now and see if that cures the trouble?"

"Can I?" he asks eagerly, perking up.

"Go ahead," I say. "Things are dead anyway."

He zooms out and down the street, and I wait for the telephone to ring, and pray for a few customers.

Pretty soon he's back, grinning broadly. I don't have to ask him how he made out, because there's a faint smear of lipstick on his cheek.

"That's it," he announces proudly.

"She thinks I'm a good radioman now."

"The moral of that story," I pontificate, "is don't jump to conclusions until you examine all the possibilities."

"Not me," Pedro declared fervently. "No more conclusions."

I stare at the floor pointedly until he starts for the broom, and then I head for the bench in the back room. There are just three radios in the "to be repaired" rack, and I dive into them, wondering how I'm going to meet my bills with business so bad. Pedro comes back while I'm finishing the last one.

"Herk," he says, and I can tell there's something on his mind.

"Yeah, Pedro?"

"Now that I've got a girl," he begins, rubbing his ear with his shoulder, "I need more money."

"Sure, kid," I agree sympathetically. "I could use more myself."

"I mean I want a raise." He looks me in the face, and stops squirming.

"Oh," I say. "Like that, hunh?" I lay down my iron, and get up off my stool.

"Look, Pedro," I point out gently. "Business is stinko. You know as well as I do I can't afford to pay you any more money. Fact is, I can't afford you at all."

He looks at the floor again, embarrassed.

"As, if, and when business picks up, I'll be glad to discuss a raise," I go on. "But until then, I'm not even sure I can pay the rent."

"Okay, Herk," he agrees, and something in his voice tells me he's got one of his ideas. "Maybe business'll pick up, hunh?"

"Yeah," I grunt, reaching for the iron and diving back into my chassis. "If it doesn't, we'll both be looking for jobs."

I finish the repair, load the sets into

(Continued on page 58)

RADIO-ELECTRONICS for

The Offer Still Stands!

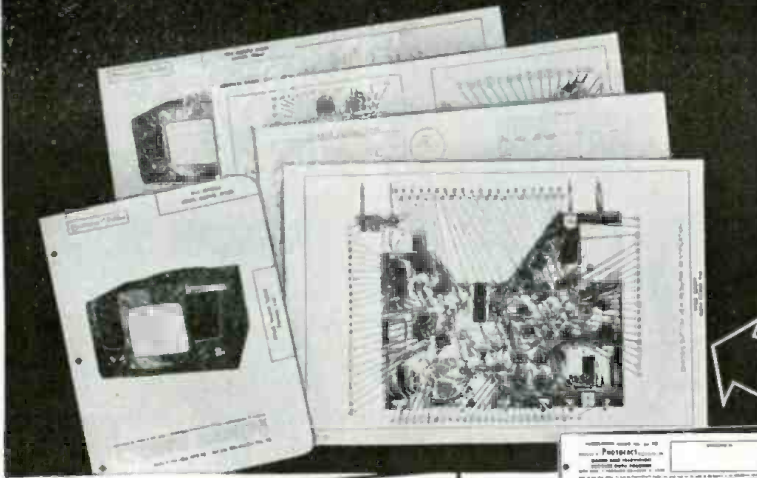

Only \$18.73 Down Puts the Complete Photofact Library in Your Shop Today...

NOW—the new “Pay-as-you-Profit” Plan brings the famous PHOTOFAC T Library within the reach of every Serviceman! Now you can easily own the world’s finest radio service data—seven complete volumes, plus continuous PHOTOFAC T Folder Set service—full coverage of all post-war AM, FM and TV models! Everything you’ll ever need for quicker, more profitable servicing! You pay only \$18.73 down—the remainder in small monthly payments. *Absolutely no carrying charges and no interest!* Make the down payment—and you get the complete Library immediately. Your Jobber has all the details of this amazing new purchase plan. See him today, or write us direct for full information.

Get the Easy-Pay Details Now!

FREE PHOTOFAC T Cumulative Index

Select your FREE PHOTOFAC T Folder (covering any AM, FM or TV model) from the PHOTOFAC T Cumulative Index. Get the FREE Index today. Covers all post-war receivers right up to the present. Helps you find the Folders you want in a jiffy—Folders that make your work quicker, easier, more profitable. Get this FREE Index at your Jobber or write direct for it now.

SERVICEMEN: We’ll Prove You’ll Save Time, and Earn More with PHOTOFAC T!

We’ll Send You Absolutely

FREE

Any PHOTOFAC T Folder Listed in the PHOTOFAC T Cumulative Index!

NOW—learn for yourself—at our expense—how PHOTOFAC T will make your service work quicker, easier, more profitable! Examine an actual PHOTOFAC T Folder. Use it. You’ll learn first-hand why this indispensable service data is used daily by over 25,000 successful service technicians. You’ll discover quickly that no other service gives you PHOTOFAC T’s outstanding advantages: *completeness, accuracy, uniformity and ease-of-use.* PHOTOFAC T alone, is the only radio service data prepared from laboratory analysis of the actual equipment. Nothing in the field equals PHOTOFAC T. Know the facts—get your FREE Folder now. Examine it—use it—compare it—and you will understand why no modern service shop can afford to be without PHOTOFAC T.



CURRENT PHOTOFAC T BEST-SELLERS

The Recording and Reproduction of SOUND, by Oliver Read. The complete, authoritative treatment of the entire subject of Sound, written by the editor of *Radio & Television News* **\$5.00**

Photofact Television Course. The book used by thousands; gives you a clear understanding of TV principles, operation and practice **\$3.00**

Television Antennas. Shows you how to select and install the proper antenna, and how to overcome antenna problems **\$1.25**

1948 Record Changer Manual. Covers 45 models made in 1948, including new LP and dual-speed changers, plus leading wire recorders. Based on actual analysis of the equipment **\$6.75**

Auto Radio Manual. Complete Photofact service data on more than 100 post-war auto radio models—a time-and-money-saver **\$4.95**

HOWARD W. SAMS & CO., INC. INDIANAPOLIS 1, IND.

NOTE: This FREE offer is limited to Service Technicians. Attach coupon below to your letterhead and mention the name of your jobber. If you have no letterhead, send coupon to your jobber. Experimenters and others may obtain the Photofact Folder by remitting 50c.

**HOWARD W. SAMS & CO., INC.
955 N. Rural St., Indianapolis 1, Ind.**

Send FREE Photofact Cumulative Index

Send Full Easy-Pay Details

I am a Service Technician:

Send FREE Photofact Folder for set model

I am an Experimenter:

Send Photofact Folder for set model (50c enclosed)

Name

Address

City Zone State

the truck, and start on my rounds. When I get back, Pedro is sitting at my desk behind the counter. There is a whole stack of 6-inch paper recording discs in front of him.

"Hi, Herk," he greets me, self-consciously.

"Hi, Pedro. Where the devil did those come from?"

"We bought 'em."

"Who did?"

"We did," he asserts. "The salesman just left. Got a good buy."

"That's fine," I reply, trying to keep the old plate current from rising. "How much?"

"Seven cents apiece," Pedro says proudly. "He wanted eight, but I finagled him down to seven."

"How many did WE buy?" I manage, hoping I can keep from choking me a boy.

"Two hundred," he says calmly.

"Two hundred!" I echo. "That's fourteen bucks. The last twenty-five recording discs I had to sell for a nickel apiece to get rid of them. Now you buy two hundred at seven cents."

"The thing is," he avows confidently, "we got a use for 'em."

"We got a use for fourteen bucks, too," I growl. "Who sold you these things? Call him up and tell him we want our money back!"

"Can't," Pedro says laconically. "Traveling man. Wouldn't know where to find him."

I go back to the service bench to cool off, and spend an hour or so trying to make my eyes focus on the print in a magazine. When I finally give up, it's quitting time. I flip off the big switch and go out front to find Pedro asleep at my desk. I shake him awake.

"Okay, Pedro," I say quietly. "Time to go home."

"Good," he agrees. "This is Saturday."

"Yeah. Payday." I dig deep and pay him off, and then I do a very difficult thing. "Pedro," I say gently, "I'm afraid you better look for another job."

His eyes get very big, and he stares at me a full minute. Then he clears his throat before he speaks.

"If it's about the records, Herk, I bought them to . . ."

"No, kid," I interrupt him. "It's just that . . . I can't give you a raise, and things are tough . . . and I've got some obligations to meet, and . . . well . . . I just can't afford any help, that's all."

"I see," he breathes slowly. He extends his hand with his pay still clutched in it. "I . . . I don't really need this, Herk," he offers. "Want to borrow it for a while?"

"Keep it, Pedro," I say gruffly.

He gets up, turns on his heel, and walks out of the door without a backward glance. I blink my eyes a couple of times, and then lock up and go home.

Monday morning I come down to the shop feeling sad. I notice the stack of home-recording discs is gone, and figure idly Pedro must have picked them up on Sunday. I make a mental note to

call him one of these days, and get the shop door key from him. I spend the rest of the day dusting off my merchandise and feeling blue. I get just two service calls and four store customers; three of them have tubes to be tested, and one wants to sell me a used radio.

Tuesday morning is the same old story: no business. I just sit around and listen to soap operas and feel blotto.

Tuesday afternoon a pleasant-looking lady comes in lugging a table model combination. She sets it down on the counter and smiles broadly.

"I'd like this fixed, please," she says. "The phonograph sounds fuzzy."

"Sure, lady," I answer, making out a repair ticket. "Pick it up tomorrow?"

"Fine," she says. "That was a very clever advertising idea." She puts the ticket in her purse and leaves, and while I'm pondering over her remark, the phone rings. It's a fellow who wants his record changer picked up, and he, too, says something about "good advertising." The phone rings constantly after that, and people begin to swarm in and out in a steady stream; about 90% of them want record changers repaired. At closing time I count forty-three service jobs on the books since noon, and I wonder whether Pedro has found another job yet.

I call him up, first thing next morning, and his mother tells me he's not home. I hang up, and just then he walks in the door, looking embarrassed.

"Hi, Herk," he greets me. "I forgot to leave you your key."

"Pedro," I ask, "how'd you like your job back?"

His face lights up like a 117Z6.

"With a raise?"

"Not right away," I demur. "But if business keeps up like it was yesterday, yes."

"It's started already, hunh?" Pedro nods thoughtfully. "Where's my broom?"

The phone starts to ring again, and between it and people streaming in and out, it becomes a very busy day. I find myself whistling at the bench whenever I take time to listen to me, and Pedro keeps shouting back that he's getting writer's cramp from making out repair tags. Things are still going strong when three o'clock comes, and I gather up the phone-in cards and start off on my rounds.

"Hi, Herk," Pedro hails me, smiling pleasantly, when I get back. "Oodles of business."

"Yeah," I drawl thoughtfully. "Pedro, a lot of people have complimented me on my clever advertising stunt. Know anything about that?"

"A little." He flushes, and looks at the floor.

"Come on," I encourage. "Give."

"Well," Pedro begins, solemnly. "I started to tell you why I bought those record discs, and you wouldn't let me."

"Okay," I say testily. "Now I'm letting you. What's the gimmick?"

"Simple," Pedro answers, staring at the floor. "I bought two hundred discs,

and spent all day here Sunday, cutting them on one of the recorders."

"Yes," I murmur blankly. "And?"

"Well, I put band music on one side of them, and a commercial on the other. Yesterday I delivered them door to door."

"Yeah," I say admiringly, as a light begins to flash inside my head. "I get it. People find phonograph discs on the porch, and they get curious. Most everyone has a record player, so they play it and it's music. Then they play the number two side, and it reminds them that in case their set isn't in perfect condition, Valley Radio, Herk Newton, Prop., is ready, willing, and able to make it perfect. For a small fee, of course."

"That's it, Herk," Pedro acknowledges, looking at me hopefully.

"Genius," I mutter. "Pure genius. Two hundred discs, two hundred potential customers. Whenever business slows down, we'll make some more."

"Not two hundred, Herk," Pedro protests, scratching his chin smugly. "Only a hundred and seventy-five like that. The other twenty-five . . ."

He's interrupted by the jangle of the phone. He picks it, then hands it to me.

"For you," he says. "Personally."

"Herk Newton," I say. I listen for a moment and say a few words. Then I hang up. "Johnson's jewelry store," I tell Pedro. "Johnson's coming over. Wonder what he wants to see me about?"

"The other twenty-five," Pedro lets out casually. "He's one of 'em."

"One of 'em?" I echo.

"Yeah," Pedro says. "The other twenty-five discs went to store owners. One side carried music, and on the other I recorded a different kind of commercial; I said if they wanted the latest thing in advertising, they should contact Valley Radio, Herk Newton, Prop., and find out how to get their own messages onto phono discs and distribute them to the public at small cost."

"Yeah," I vocalize thoughtfully. "But Pedro, cutting discs for store owners, probably thousands of discs, is out of our line. We're in the radio business, not the disc-cutting business."

"Trouble with you," Pedro pronounces complacently, trying to hide his smile, "is you jump to conclusions."

"Meaning?" I query.

"Meaning we don't cut discs for 'em. We sell 'em each a recording outfit and let 'em cut their own."

"Yeah," I breathe reverently, mentally multiplying my mark-up per recorder by twenty-five. "Yeah, Pedro. That's wonderful."

"I thought you'd like it, Herk," he says casually.

"And Pedro," I continue softly.

"Yes, Herk?"

"As of now, Pedro, you got a raise." Pedro raises his hand to his mouth to stifle an imaginary yawn.

"Raise?" he says nonchalantly. "Oh, sure. I had already jumped to that conclusion. When do I get the next one?"

Be a "Forty-Niner" in '49 THE "FORTY-NINER" GEIGER COUNTER

- Light weight uranium detector.
- Detects beta and gamma rays.
- Equipped with 36 inch search probe.
- Contains two 67½ volt Minimax batteries in the well-known type of relaxation oscillator supply. Weight 4½ lbs. complete; size 4"x5"x6". Beautifully finished case with handle.

\$89.50

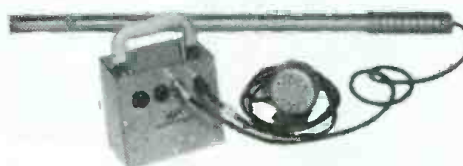

Complete with four tubes, including Geiger tube, batteries, search probe and ear-phon.

ALL-PURPOSE CHASSIS

Contains 3 plugs, 2 vol. controls, 1 25 wt. resistor 2600 ohms, 250,000 ohms 10 wt. resistors, 13,500 ohms, 10 wt. resistors, 3 ½ mfd's, 3 bath-tub condensers 600V, 3 sockets, 4 shock mounts and many other parts in a blank top chassis.



95c



304TL 75¢

Just the tube for that 1KW final — typical operation 2500 volts at 400 MA. An ideal tube for that induction heater or dielectric heater. Efficient operation at 1500V. to 3000V.

TUBES

815	1.95	VR150	.69	9006	.44	RK60	\$.95
3BP1	1.95	955	.65	50B5	.89	1T4	.44
5FP7	.95	9002	.44	35W4	.89	3Q4	.44
7SP7	1.49	12X3	.44	872A	1.95	3B4	.44
9LP7	2.95	9004	.44	1N5	1.69	1N5	.69
				3Q5	.69	VT25	
				6L6GA	.95	(210)	3.44
				5U4G	.44	5W4	.44
				6SA7	.44	2X2	.95

C E PHOTOCCELL . . . 95c
Type used in movie projectors, burglar alarms, etc.



T-17 Carbon Mike
Like New **79c**



30 MC-1F Silver Slugg'd
35c

Exide Aircraft Battery

AN3151-24V 17AH at 5HR. rate. Brand new in original cartons.

Wt. 52 lbs. Filled **\$49.50**

COAXIAL FITTINGS



5c
HOOD



25c
SOCKET SO-239 83-1R



35c
PLUG PL-259 83-1SP



20c
ANGLE ADAPTEF M-359 83-1AD



MICA CAPACITOR
.002 MFD 3000 MVDC **69c**

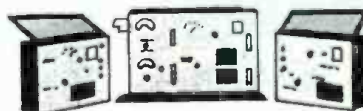

NEW BC 223 AX TRANSMITTER
301 Oscillators and 801 power amplifiers. 2-46 modulators and 1-46 speech amplifier. 4 Xtal frequencies and master oscillator on selector switch. 30 Watts output. Tone voice or C.W. Mod. Ideal for 55 meter band. Comes with 3 coils TU 17A 2000-3000 Kc. TU 25 3500-5250 Kc. Black crackle case. Includes two separate cases to store extra coils. Frequencies chart and tubes included, packed in original cases, less crystals at this low price. **\$39.95**

TEST OSCILLATOR

12 or 24 V DC. Vibrators, switches and many other parts used in 2A Equipment. **95c**

A-5 AUTOMATIC PILOT
Serves—100 pounds max. to use as a steering device, or compass control on ships. **\$9.95**



CD501A

Cord and plug set used with BC854 between PE 103 Dynamotor and Transmitter. **\$1.95**



Butterfly Condensers

Oscillator assembly 76 to 300 MC with acorn tube socket mounted on condenser \$3.95
Type B Frequency range 300-1000 megacycles 2.95
BC4 Antenna condenser 105-330 MC 3.95
Oscillator 105-330 M.C. 3.95

INDUSTRIAL PAPER OIL CAPACITATORS

1. MFD 5000 V. **\$2.95**
1. MFD 6000 V. **\$4.95**
2. MFD 6000 V. **\$8.95**



Complete!

INTER-OFFICE COMMUNICATION SYSTEM

\$29.95

Inter-Phone amplifier BC367 complete with cables 2BC 422 box, BC 369 Box, 3C 370 Box, mounted on board complete with screws, clamps and everything needed for a Inter-Phone communication system.

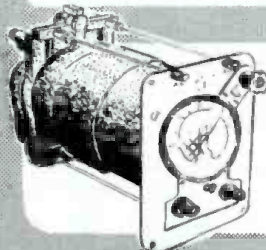
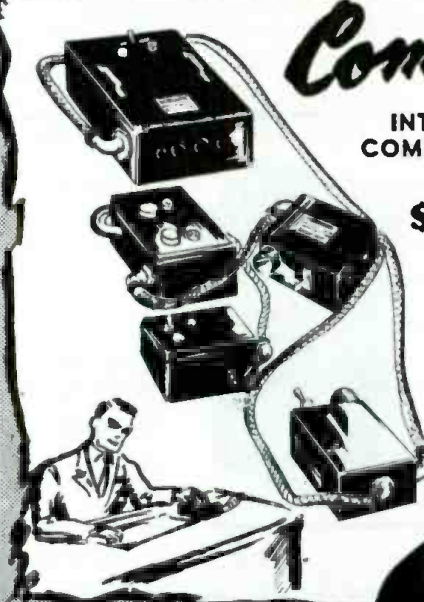

BANK-CLIMB GYRO CONTROL

For Mark 4 automatic pilot **\$9.95**

DIRECTIONAL GYRO M-1

A-5 Automatic pilot Mfd. by A. C. Spark Plug under license of Sperry Gyroscope Co., Inc. **\$9.95**

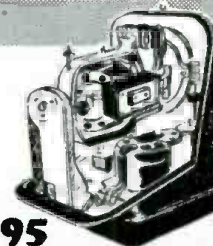

HERSHEL RADIO CO

DEPT. R. E. 10

5249 GRAND RIVER
DETROIT 8, MICHIGAN

Write for Free Catalogue

All orders F.O.D. Detroit—Minimum order \$2.00—Michigan customers add 3% sales tax—20% payment must accompany all orders.



ESSE Specials!

C-1 AUTOPILOT ASSEMBLY made by Norden

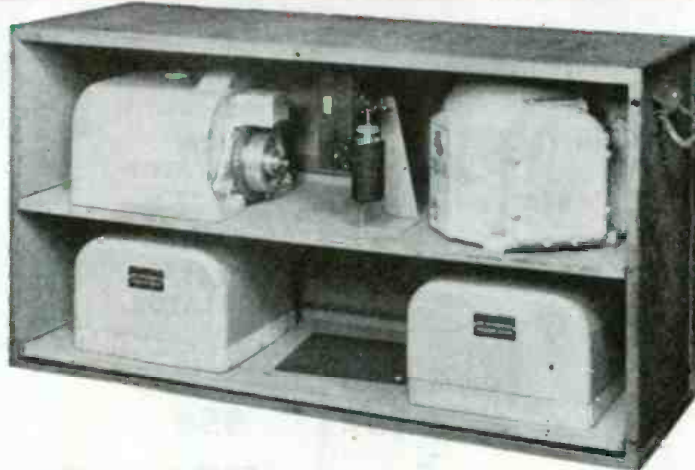

Stabilized bombing approach equipment type M-7. All the following units come high x 12" deep, housed in a steel case, size 36" long x 17". Weighs approximately 160 lbs. net.

SCR-625 MINE DETECTOR

Brand New Metallic Objects Only

Used by the Army to detect buried metallic mines. Its private use suggests the location of underground or underwater pipes, cables and ore bearing rock, the location of metallic fragments in scrap materials, logs, etc., and the screening of personnel in plants for carrying of metallic objects.

The unit consists of a balanced inductance bridge, a two-tube amp. and a 1,000 cycle oscillator. The presence of metal disturbs the bridge balance, resulting in a volume change of the 1,000 cycle tone. The tubes used are low-battery drain types such as 1G6 and 1N5. The circuit may be modified for control of warning signals, stopping of machinery, etc., when metal is detected. Operates from two flashlight batteries and 103 V. "B." However, a power supply operating from 110 V. may be used. Comes complete with spare tubes, spare resonator and instruction manual—in wooden chest 8 1/4" x 28 1/4" x 16". Weight in operation is 15 lbs. Now complete in original overseas packing container. Originally sold by War Assets for \$166.00.

The U. S. Forestry Service has recommended procedure for using the SCR-625 Mine Detector to find concealed metal in tree logs and other timber products.

Price \$59.50
Batteries \$4.00 extra

MINE DETECTOR AN/PRS-1

The detector is designed to detect metals, non-uniformities (rocks, tree-roots) and may be used to detect metal buried in logs, to locate cables, pipes, sewer tile, etc. It is widely used by lumber camps, miners, prospectors, plumbers, treasure hunters and explorers.

A portable device used in the detection of both metallic and non-metallic by aural (ear) and visual (eye) means. These are brand new outfits, complete with instruction book and spare tubes. Shipped in original overseas moisture-proof container.

The set consists of the detector head with antenna and reflector meter, a meter housing and lower section of exploring rod, amplifier assembly, exploring rod extension, bag designed to carry equipment while operating, and wooden case for storing or transporting the complete unit when not in use. This detector is not nearly as sensitive as the SCR-625 Mine detector. However, because of its price and its simplicity, you cannot go wrong on buying one for \$14.95. Shipping weight, 125 lbs. Weight in operation only 22 lbs.

Batteries are not included but we can supply them for \$8.25 per set.

Our Price \$14.95
Shipping Weight 125 lbs
Weight In Operation Only 22 lbs.

Consists of (3) C-1 SERVO UNITS

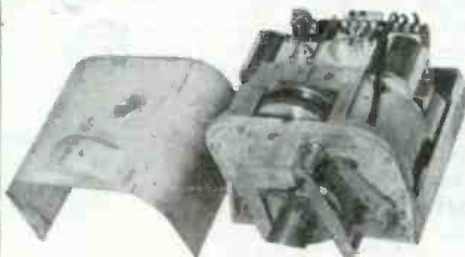

C-1 SERVO UNIT

Use to rotate beam antenna, actuate boat rudder control, etc. Contains 24 V. motor, clutch, relays, etc. Reversible. Size overall approx. 10 1/2" x 8 1/2" x 8 1/2".

and (1) C-1 GYRO



C-1 GYRO

Part of the C-1 Auto Pilot which is sold separate and may be used to conduct many interesting and amusing experiments. Operates from 24 V. DC or may be operated for short periods on 110 V. AC. Gyro will run for approx. 15 minutes after actuating. Size—approx. 8" x 8 1/2" x 8 1/2".

And 1 DIRECTIONAL PANEL with dashpot action (not pictured). All five of these units as described individually and as pictured at top, priced, brand new, at **\$49.50**

PART of AUTO PILOT—BUT NOT INCLUDED IN ASSEMBLY AS SHOWN ABOVE

C-1 AUTO PILOT AMPLIFIER

Used to control operation of servo unit in response to signals received from gyro unit and control unit. The complete amplifier includes one rect. 7Y4, 3-7F7's for amplification and control, 3-7N7's for signal discrimination, 1 power transformer, 6 relays, 4 control pots, chokes, condensers, etc. Convert for use on radio controlled models, doors, etc. Operates from 24 V. DC. Size. 9 1/4" x 6 1/4" x 7 5/8".

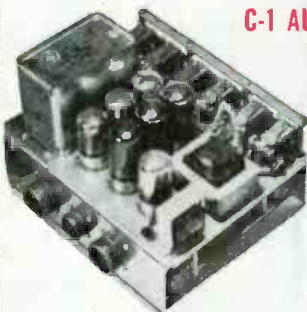

\$6.00

C-1 AUTO PILOT CONTROL BOX

Used for aligning control of C-1 Auto Pilot or use for parts, etc. Contains many useful pots., toggle switches, plugs, etc. Size, 11" x 6" x 8 1/2".



PRICE

\$6.75

BC-348 COMMUNICATIONS RECEIVER

6 bands, 200-500 Kc. and 1.5-18 Mc. 2 stages RF, 3 stages IF, 8FO, crystal filter, manual or AVC. Complete with tubes and 24 V. dynamotor. These receivers have been thoroughly checked in our workshop and found in excellent condition. Converted to 110 V. AC 60 cycle

24 v.d.c. operated suitable for airline use..... \$60.00
\$100.00



ESSE RADIO CO.

Esse's Special Offer

INDIANAPOLIS,
INDIANA



T-26 APT-2 RADAR TRANSMITTER

Contains tunable VHF circuit using 2 JAN CTL 703A's or 868AS tubes. Other tubes are: 2-5R4GY's, 1-2x2, 1-807, 1-6AG7, 2-6AC7's and 1-931A. Other parts such as 24 VDC motor and blower, HV. condensers and transformers, terminal strips and Amphenol connectors, knobs, fuse holders, etc. make this unit invaluable for parts alone. Weight approx. 45 lbs Size 21" L x 10 1/2" W x 7 3/4" H. in metal case. **\$9.75**



TELRAD 18-A FREQUENCY STANDARD

Checks signals in the range of 100 Kc. to 45 Mc. with a high degree of accuracy. Self-contained power supply is 110, 130, 150, 220, and 250 V 25-60 cycle AC. Complete with tubes, dual crystal and instruction book. Brand new. Price.... **\$24.95**

ARMY PHONES LOW IMPEDANCE

Used. With short cord and plug PL-354 and cushions. Price **\$2.50**

AUTOMATIC DIRECTION FINDER RADIO COMPASS SCR-269-G

Brand new in original crates Made by Bendix Complete, a truly magnificent buy for airplane owners or boat owners. **\$125.00**

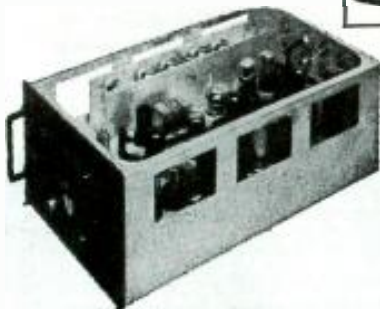

BC-1155A SYNCHRONIZER

Another invaluable unit for the Television and VHF experimenter. Contains 19 Mc. IF strip using 5-WE717A tubes. A total of 24 tubes included, consisting of 6-WE717A's, 2-6SL7GT's, 2-6AC7's, 5-6SN7GT's, 2-6N7GT's, 2-6L6's, 1-6V6GT, 2-6AG7's, 1-6AC7, and 1-6H6GT. Other parts included are 6 pots, 10 Amphenol 831R chassis connectors and numerous condensers, resistors, and transformers. Weight 22 lbs. Size 21" L x 11 1/2" W x 7 3/4" H. Price.... **\$10.00**

RECTIFIER POWER UNIT

ATTENTION: FOR THOSE WHO NEED 6,12,24 VOLT POWER SUPPLY

Navy Type CLG-20341

110/220 Volts, 50/60 cycle, single phase AC operated. Net weight 263 lbs. Gross weight 335 lbs. 28" high, 19 3/4" wide, 23 1/4" deep (4.25 cubic ft.).

Will continuously deliver rated load of 25 amperes at 7 volts. 14 Volts, or 28 Volts DC.

It will furnish an instantaneous dynamotor starting current of 25 amperes at 28 Volts output.

This unit is portable and is sturdily constructed in welded steel frame. It is housed in steel case provided with louvres. 4 handles for carrying are welded to case. Controls, fuses and cables readily accessible. Input and output cables are permanently attached and stored in compartments in front of case. Spare fuses and pilot lamps are easily accessible from the front. On/off switch is mounted in recessed panel on front of case.

4 connector lengths and terminals are provided for proper connections to input and output voltages. Terminal cut-out provides protection. A sturdy blower motor fan is provided for cooling of the 15 amp. Selenium rectifiers running 1550 RPM and has 10" blades.

A sensitive regulating circuit keeps output voltage constant under varying load conditions or input voltage fluctuations. Adequate inductance and capacity are included for good filtering of the output voltages.

A complete operating manual accompanies the unit. This equipment was made by Electronic Laboratories, Inc. of Indianapolis, Indiana and is really a very dependable fine rectifier power unit and can be compared with only the finest. It cost our Government approximately \$500.00.

Our Price, complete, BRAND NEW . . . \$100



RECTIFIER ASSEMBLY

Selenium 15 amps. maximum continuous DC current inductive load for continuous duty. Maximum AC input 46 V. RMS single phase. DC output maximum 34.9 Volts. These rectifiers were used in Navy type CLG-20341 rectifier power unit which delivered 6-12-24 Volts DC current at 15 amps. Maximum dimensions 4 3/4" dia. x 12 3/4" long. Price New **\$12.50**

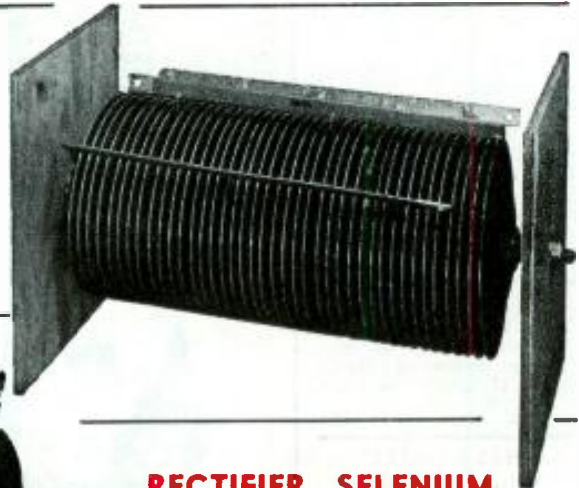

RECTIFIER SELENIUM

Maximum AC 60 cycle sine-wave. Input 13 Volts; output 9 Volts. Continuous current rating 2 amps. with inductive or resistive load. Maximum dimensions 3 1/2" x 1 1/16" x 1 1/16". 12 square plates bridge circuit. (New).

Price **\$4.00 ea.**

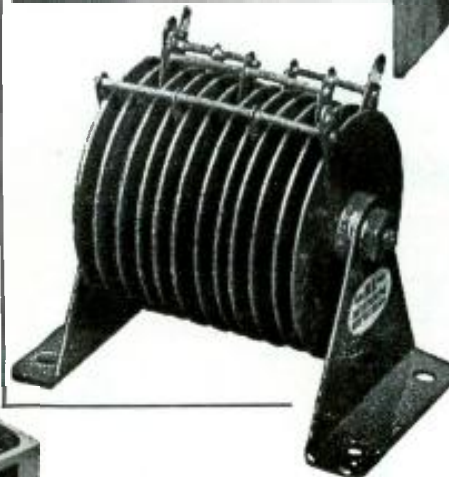

AIRCRAFT BATTERY AN-3152

Brand new, 12 volts, 24 amp hours. Dry packed and charged. Add battery acid Specific Gravity 1.265 (can be bought at any drug store.) Ideal for any amateur on 12 volt operations. Hard rubber case, size, 5 1/4" x 10 1/4" x 10 1/4" with bolt type connectors and with overflow. Weight 35 lbs.

Price **\$12.95**

ESSE RADIO CO.

Esse's Special Offer

INDIANAPOLIS,
INDIANA

A TREMENDOUS BARGAIN

Quartz Crystals without Holders

Get an assortment of these and grind to your own frequencies or use them as they are. .5x.6" B-cut lapped on faces and squared on edges. (Ready to use). We will give you an assortment of these from approximately 13 thousandths of an inch to 24 thousandths of an inch whereby you can grind to frequencies desired. These crystals are now ground to the approximate following frequencies:

3880	4640	6225	7300
3900	4900	6275	7400
4140	5300	6700	7500
4600	5580	6850	7800
4650	5800	6900	7900

Formula for converting thicknesses of B-cut crystals to frequency is as follows: $F = 98.4/T$ where F is frequency in kilocycles and T is thickness in inches. An assortment of 20 different thicknesses.

\$1.50

RF TRANSFORMER

(Not pictured)

For experimental use. Covers four bands. Range unknown. Measures 4" x 4 3/8" x 2 1/4".

Brand new. Price 50¢

HASH FILTER

(Not pictured)

Mounted on strip 3 1/2" x 1". Contains two hash chokes and one dual 135 MFD 400 Volt bath-tub condenser.

Price 50¢

TURBO AMPLIFIER

Used for parts—shipped complete with the following tubes: 2-7C5's, 1-7Y4, 1-7F7.

Price \$1.00 ea.

CRYSTALS IN STANDARD 5 PRONG SOCKET HOLDERS

Choice 50c ea.

5560	7670
7120	7680
7210	7690
7240	7700
7250	7710
7260	7940
7270	7950
7280	7970
7290	7990
7300	8103
7320	8105
7330	8110
7340	8115
7660	8120

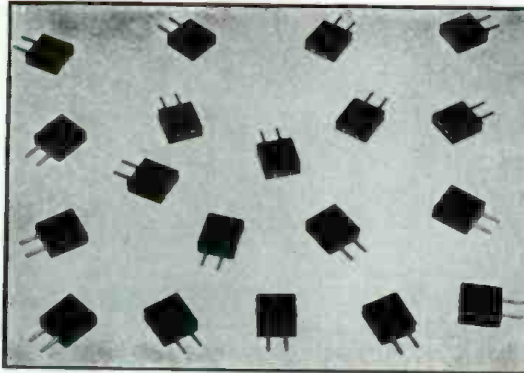

8124	8367
8126	8400
8130	8450
8245	8451
8248	8452
8250	8476
8251	8477
8252	8480
8351	8486
8356	8488
8357	8520
8360	8530
8361	8540
8362	8541
	8547

TUBES 45c ea.

These tubes are brand new, individually boxed and guaranteed.

0Z4	3V4	6BJ6	6S8GT	7C4	12S7GT	36	81
1A5GT	5R4	6BF6	6SA7	7C5	12SK7GT	37	84/6Z4
1A7GT	5T4G	6C4	6SC7	7E5	12SN7GT	38	85
1C5GT	5U4G	6C5GT	6SF5	7F7	12SQ7GT	39/44	89
1C6	5V4G	6C6	6SG7	7H7	12SR7	40	117L7GT
1G4GT	5W4	6C8G	6SH7	7K7	14A7/12B7	41	117N7
1H5GT	5X4G	6D6	6S7GT	7Q7	14Q7	42	117P7
1J6GT	5Y3GT	6D8	6SK7GT	7Y4	14X7GT	43	117Z3
1N5GT	5Z3	6F5GT	6SL7GT	7Z4	19T8	46	182E
1L4	5Z4	6F6GT	6AG7	12A6	24A	47	183
1Q5GT	6A3	6F8G	6SL7GT	12A8GT	25A6GT	50	482B
1R5	6A6	6H6	6SN7GT	12AU6	25A7GT	50B5	483
1S5	6A7	6H6GT	6SQ7GT	12AT6	25AC5GT	35L7GT	717A
1T4	6AB8	6J5	6SR7	12AU7	25L6	50C5	955
1T5	6AC5GT	6J6	6SS7	12BA6	25Z5	50L6GT	956
1U4	6AC7	6J8	6ST7	12AV6	25Z6GT	51	957
1U5	6AG5	6K6GT	6T7	12BE6	10	53	1005
1V	6AK5	6K7	6U6G	12C8	26	56	1629
2A3	6AL5	6K8	6U7	12F5GT	27	57	1625
2A4G	6AT6	6L6G	6V6	12J5GT	30	58	2050
2A5	6AU6	6L7	6W7	12K7GT	31	70L7	1626
3A4	6AV6	6N7	6X4	12K8	32L7	71A	2051
3B7	6B4G	6P5GT	6X5GT	12Q7GT	35	75	9003
3D6	6BG6G	6Q6	6Y6G	12SA7	35B5	76	VR150
3Q4	6B8G	6Q7	6Y7	12SF5GT	35L6GT	77	VR105
3O5GT	6BA6	6R7	6ZY5	12SF7	35W4	78	9001
354	6"E6	6S7	7A7	12SH7	35Z5GT	80	9002

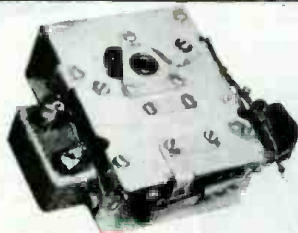

RATCHET MOTOR

Operates from 12 or 24 Volts. Similar to motor used for automatic tuning of SCR-522 transmitter and receiver. This motor measures approximately 3" x 3 3/8" x 1 1/2". Has provision for coupling 1/4" shaft. Idea for remote tuning of mobile and other equipment. Rotates approximately 1 revolution per second. Brand new. Price \$1.25



LOW FREQUENCY RCA I.F. TRANSFORMER

Used for R.F. power supply or double conversion transformer, etc. 3 1/2" x 1 3/8". Brand new. Price 35¢

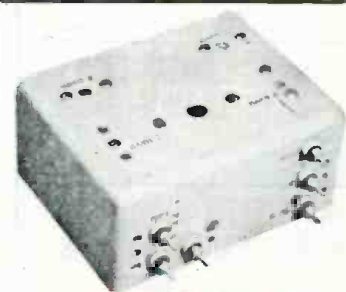

I.F. TRANSFORMER

2 1/2" x 3 3/4" x 1 5/8" marked 142.5 KC IF—243.5 KC IF. Six connectors on bottom grid cap. Connection out of side. Trimmer condensers readily accessible. Brand new aluminum case. Price..... 75¢

ESSE Radio Co

40-42 W. South St.
Indianapolis 4, Ind.

Unless Otherwise Stated, All of This Equipment Is Sold As Used
CASH REQUIRED WITH ALL ORDERS
Orders Shipped F.O.B. Collect

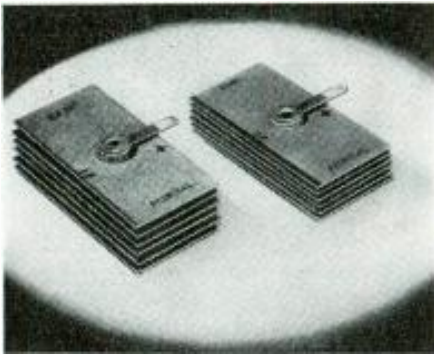

Six Federal selenium rectifiers with ratings from 70 to 500 ma at line voltage.

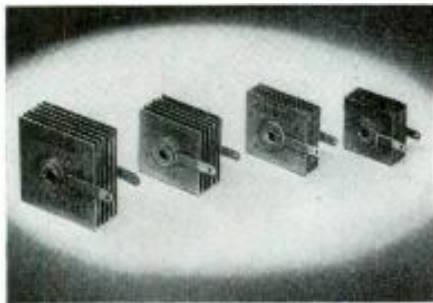

Inserting dry rectifiers in place of tubes is simple and profitable

Selenium Rectifiers Replace Vacuum Tubes

By JOHN B. LEDBETTER

THE miniature selenium rectifier first became popular in the radio service field as a replacement for the 35Z5 in a.c.-d.c. receivers. Its adaptability and ruggedness soon made it a universal replacement item in industrial and electronic fields as well as in radio servicing. This miniature has made possible the design and manufacture of extremely compact, efficient, and transformerless power supplies, built around one selenium cell operating as a half-wave rectifier, or around any number of such rectifiers connected in full-wave, full-wave bridge, doubler, tripler, or quadrupler circuits. For special circuits requiring high voltage and extremely low current (such as television and oscilloscope sweep circuits), the voltage multiplication can be carried even further.

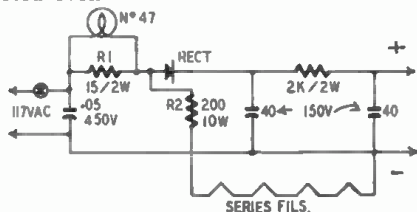

Fig. 1—Replacing 35Z5 in a.c.-d.c. receiver.

In many new applications, the selenium rectifier not only takes the place of the usual high-vacuum rectifier tube, but also eliminates the power transformer. Obviously, these two features alone permit a much smaller power supply with a resultant sizeable reduction in cost, weight, and current drain. New television receivers with selenium rectifiers in both the low and high-voltage supplies have been designed so compactly that the total weight of the receiver is less than that of the power transformer alone in similar receivers using a conventional power supply.

In addition to the features just mentioned, the selenium rectifier has the following six advantages over the vacuum-tube type: instant operation, better voltage regulation, low ripple output, lower heat dissipation, higher efficiency, and increased ruggedness and adaptability to rough handling. When the rectifier is used to replace the power transformer, it adds the advantages of low cost and elimination of a.c. hum fields. The latter reduces power supply filtering and solves the problem of eddy currents in television receivers and other high-quality receivers. Installing a selenium rectifier, particularly in small receivers and amplifiers, increases the life expectancy of such components as tubes, bypass capacitors, and batteries by eliminating the hot rectifier tube and allowing the surrounding parts to operate at a lower temperature.

The ingenious service technician can adapt or rearrange existing power supply circuits to obtain many of the above advantages. The following typical circuits can be altered or improved to meet special or individual requirements.

Half-wave applications

Replacing the 35Z5 in a.c.-d.c. receivers with a 100-ma selenium rectifier requires two additional resistors (see Fig. 1). These replace the 35Z5 pilot-

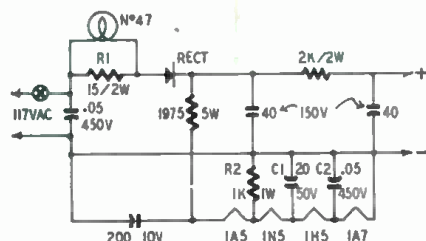

Fig. 2—Using rectifier with d.c. filaments.

lamp section and maintain proper filament voltage on the remaining tubes. R1 is a 15-ohm, 2-watt resistor (preferably wire-wound); R2 is a 200-ohm, 10-watt, wire-wound unit, or (much better) a negative-temperature-coefficient resistor with a cold resistance of about 1,400 and a hot resistance of 200 ohms. Such a resistor eliminates the initial current surge, thus reducing tube and pilot-lamp failures. These resistors may be either permanently wired into the circuit or mounted with the selenium rectifier on a standard octal plug (or tube base) and plugged directly into the rectifier socket.

The same measures may be employed to replace 35Y4, 35Z4, 45Z3, 12Z3, 117Z3, and similar rectifier tubes. This applies also to the 117Z6, 50X6, 50Y6, 25Z5, and other full-wave types when connected as half-wave rectifiers. In the latter case, be sure the current drain of the receiver does not exceed the rated output current of the selenium rectifier. If the current drain is slightly over 100 ma, for example, use a 200-ma replacement. In the majority of these tube replacements, except possibly the 50Y6, the pilotlamp resistor R1 will not be required. R2, in any case, must equal the resistance of the replaced tube's filament.

In some receivers employing a 117Z6 or 117Z3 rectifier, the filament voltage is derived from a dropping resistor across the B-supply. Since the internal resistance of a selenium rectifier is much lower than that of a vacuum-tube rectifier, the output B-voltage, and consequently the filament voltages, will be correspondingly higher. To prolong tube life, a series resistor equal to the tube resistance must be inserted, either in series with the rectifier and line, or in the B+ lead (at the rectifier). The sim-

tancy is not too great. Efficiency of this type of circuit is approximately 50%. The full-wave supply in Fig. 9 is more suitable where high efficiency, long vibrator life, and dependability are important. This circuit is also used when two selenium stacks are used to replace existing full-wave vacuum-tube rectifiers. Efficiencies of up to 70% are normally obtained with this circuit.

For highly specialized circuits in which long vibrator life is absolutely essential and where efficiencies exceeding 70% are desired, the full-wave bridge circuit in Fig. 10 is recommended.

D.c. filament supplies

In many cases, the design of precision or high-quality equipment can be sim-

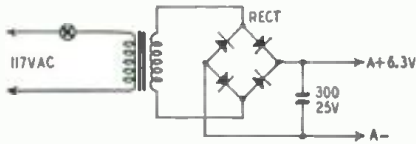

Fig. 11—Dry-rectifier d.c. filament supply.

plified greatly by employing d.c. for the filaments. In the past, design and production costs, not to mention the size and weight of a selenium unit capable of delivering the necessary filament current, were prohibitive. Now selenium rectifiers are available which deliver output currents up to 4 or 5 amperes at d.c. voltages up to and above 24. These

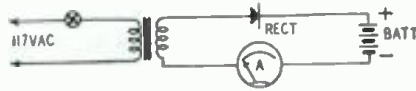

Fig. 12—Selenium unit in a battery charger.

rectifiers not only are suitable for d.c. filament and bias supplies, but also make efficient battery chargers.

The circuit in Fig. 11 is suitable for most filament or bias circuits. (In some instances the addition of an r.f. or filter choke may be desirable.) The output voltage and current of such an arrangement depends on the input voltage, the turns ratio and current-carrying capacity of the transformer windings, and the current rating of the selenium rectifier.

Battery chargers

Selenium rectifiers may be used in battery-charger circuits by connecting in half-wave (Fig. 12) or full-wave (Fig. 13). By selecting a transformer

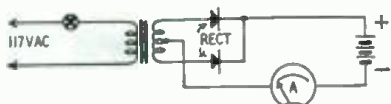

Fig. 13—This is a full-wave battery charger.

having the proper turns ratio and current rating (or winding one yourself), an efficient battery charger can be built to handle either the 2-volt storage batteries used in some battery-portable receivers or regular 6-volt auto receiver batteries.

The author's thanks are due to Federal Telephone and Radio Corp., Clifton, N. J., for assistance with the diagrams and some of the information, as well as the photographs which appear with this article.

2 NEW MHB BOOKS... Just Published
NOW YOU'LL REALLY KNOW
How To Use an Oscilloscope



Don't let the oscilloscope "stump" you! Learn to use it properly—and watch your efficiency and earnings soar! No other instrument is so intensely valuable in AM-FM and TV servicing. Here, at last, is a complete, easy-to-understand book by an expert who gives you the oscilloscope facts and how-to-use-it data you've been wanting.

MODERN OSCILLOSCOPES AND THEIR USES

by JACOB H. RUITER, Jr.
of Allen B. Du Mont Laboratories, Inc.
350 pages, 400 illustrations
Price \$6.00

WHAT IT IS—HOW IT WORKS

- 1. Introduction to Oscilloscopes
- 2. History of the Oscilloscope
- 3. The Development of the Cathode Ray Tube
- 4. Principles of Cathode Ray Tube Operation
- 5. Details of the Modern Cathode Ray Tube
- 6. The General Purpose Oscilloscope
- 7. Power - Supply Circuits
- 8. Amplifiers, Attenuators, and Positioning Circuits
- 9. Time - Base Circuits

HOW TO USE IT ON THE JOB

- 10. Operation of the Oscilloscope
- 11. Interpretation of Basic Patterns
- 12. Auxiliary Equipment
- 13. Typical Applications in the Electronics Industry
- 14. Servicing A-M Radio Receivers
- 15. Servicing F-M Radio Receivers
- 16. Servicing Television Receivers
- 17. Use of the Radio Transmitter
- 18. Using the Oscilloscope in Teaching
- 19. Additional Industrial Uses of the Oscilloscope
- 20. Photographing Cathode-Ray Patterns (a) Glossary

This big book gets right down to earth in explaining the oscilloscope (cathode ray oscillograph) and showing exactly how to use it on specific AM-FM-TV service jobs. No guesswork. No involved mathematics. First the author explains all about the instrument—how it is made—when and where to use it—how it works. Then he tells exactly how to employ it on specific jobs—from locating many types of receiver troubles to aligning and adjusting the most complicated circuits.

EASY TO UNDERSTAND

Each operation is carefully explained including the making of connections, adjustment of circuit components, setting the oscilloscope controls, and analyzing oscilloscope patterns. About 400 illustrations, including literally dozens of pattern photos, make things doubly clear. Besides its radio and TV uses, you learn about many oscilloscope applications in industry and medicine. Send coupon today for your copy of MODERN OSCILLOSCOPES AND THEIR USES. If not more than satisfied, return it after 10 days and we'll gladly refund the purchase price.

FACSIMILE

WHAT IT IS—HOW IT WORKS—
Modern facsimile systems and
how to service them



by Charles R. Jones
Development Engineer

Finch Communications, Inc.
380 pages, 225 illustrations. Price \$6.00

Broadcast a weather map to a plane in flight? Transmit still pictures by wire? Radio a blue print to a far-off construction crew—a sample of a criminal's handwriting to scattered law enforcement agencies—a magazine proof to distant editors. . . .

Of course, you're familiar with the marvels of facsimile in a general way—but how much do you really know about modern facsimile equipment, how it is made, how it works and how to service it? And are you aware of the rapidly growing uses of facsimile in telegraphy, publishing, banking, mining, advertising, manufacturing, police departments, transportation and dozens of other places?

FACSIMILE, a new book by an expert in this fast-growing field, not only covers the entire subject, but includes dozens of tips and detailed notes on servicing facsimile equipment. In clear, easily understood terms, you learn about the latest developments, their present and potential uses, how they operate and exactly what makes them "tick." Throughout, FACSIMILE is an invaluable book for all radio men who realize that it pays to have specialized data on all of the latest, fastest-growing developments at their fingertips. Send coupon now! Read it for 10 full days AT OUR RISK!

10 DAY MONEY-BACK GUARANTEE

Dept. RE-109, MURRAY HILL BOOKS, Inc.
232 Madison Ave., New York 16, N. Y.

Enclosed find \$.....for book(s) checked; or send C.O.D. for this amount plus postage and I will pay postman. (No C.O.D.'s outside U. S. A.) If books are not satisfactory, it is understood I may return them in 10 days and you guarantee to refund my money.

- MODERN OSCILLOSCOPES AND THEIR USES Price \$6.00 (\$6.50 outside U. S. A.)
- FACSIMILE. Price \$6.00 (\$6.50 outside U. S. A.)

Name.....

Address.....

City, Zone & State.....

BY THE PUBLISHERS OF FAMOUS GHIRARDI RADIO-ELECTRONIC BOOKS

SOLDERING TOOL

Instant Tool Corporation
New York, N. Y.

The Super-Instant soldering iron offers a new design in quick-heating irons by employing a quick-heating element to bring the tip to soldering temperature and a "bucking coil" to maintain the temperature and prevent overheating and scaling. Unlike thermostatically controlled equipment, the iron is maintained at constant heat as long as the switch is held on.

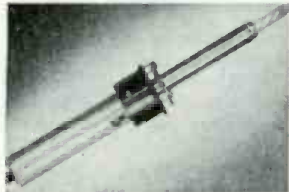

The iron works directly from the 117-volt line, using no transformer either in the tool or independent of it. Weight is under 1/2 pound. In the specimen tested, wire solder was melted in 12 seconds from the time the switch was operated.

CODE-PRACTICE SET

Martin Mfg. Co.,
Brooklyn, N. Y.

The Duplex Practicode is a somewhat more substantial version of the familiar code-practice device long sold to children and beginners. A standard telegraph key is mounted on a small board with a 4-inch PM speaker and

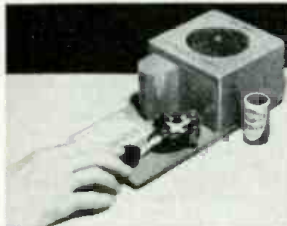

a tone producer. A flashlight cell furnishes power. Terminals are provided to connect similar sets for two-way practice.

R.F. POWER SUPPLY

Spellman Television Co., Inc.,
New York, N. Y.

This completely enclosed r.f. power supply furnishes 30 kv for use in dust precipitation, electrostatic painting, insulation breakdown tests, and projection television. Up to 500 μ a may be drawn. Output may be varied down to 15 kv. The supply includes a focus control and voltage tap variable from 4 to 6 kv for use with 5TP4 projection tubes.

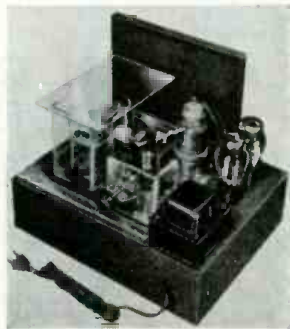
**TV PATTERN GENERATOR**

Hickok Electrical Instrument Co.,
Cleveland, Ohio

A test pattern is provided by the model 620 linearity-pattern generator. The output of the generator is connected to the antenna terminals of the receiver and a switch set for horizontal or vertical lines or crosshatch. The pattern is said to be more accurate in most cases than broadcast patterns. The principal advantage of the generator, however, is that it allows the technician to align the receiver when no pattern

is being broadcast or when a fringe-area location may make broadcast patterns unreliable.

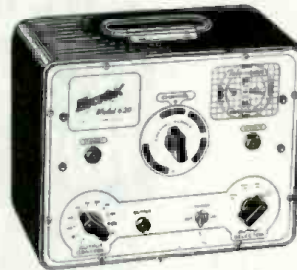
**MICROPHONE STAND**

Electro-Voice, Inc.,
Buchanan, Mich.

New desk-type microphone stands are offered with a momentary press-to-talk, lever-type switch built in. The switch may be locked in the ON position by pressing a locking button. The switch is a self-contained unit which may be removed from the base; it is available separately.

**DISC CAPACITORS**

Sprague Products Co.,
North Adams, Mass.

The new ceramic disc capacitors consist of a dime-sized or smaller ceramic plate with high dielectric constant with silvered electrodes fired on both faces

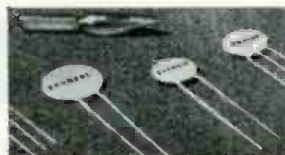

of the disc. Each capacitor is coated with an insulating resin.

TWIST-MOUNT CAPACITORS

P. R. Mallory & Co., Inc.,
Indianapolis, Ind.

New labels placed on the twist-mount FP line of capacitors make identification easier. Rating and part number,



as well as makers' name, appear on each. Recent improvements in the capacitors include stronger anode tabs, ability to withstand higher discharge currents, new high-surge separators, greater heat resistance, extra-heavy rubber seal, heavier cathode tab, and special etched cathode.

D.C. POWER SUPPLIES

Opad-Green Co.,
New York, N. Y.

A new series of power-supply kits for producing 24 to 28 volts d.c. from a 117-volt a.c. line is announced. The supplies are designed primarily for testing and ground operation of aircraft and marine equipment. Supplies are available with capacities of 2, 5, 10, 15, and 20 amperes. A tapped primary on the transformer permits adjustment of voltage.

TV TURNTABLE

Krenco Mfg. Co.,
Chicago, Ill.

The Tele-Turn is a metal turntable on top of which a television receiver may be placed so that it may be faced in any direction. Heavy-gauge steel is used in the construction, and the top plate is felt-covered. The bottom has



rubber suction cups to prevent slipping. The heaviest receivers can be supported on the turntable; but only a light touch is required to revolve it.

KILOVOLT METER

Bradshaw Instruments Co.,
Brooklyn, N. Y.

The Kilovoltmeter is a two-range non-electronic voltmeter. Ranges are 0-25,000 and 0-50,000 volts d.c. The meter has a 20 μ a movement. Input impedance on either range is 1,250 megohms.



The meter is a 4 1/2-inch unit. The multiplier resistor is contained in the polystyrene probe.

PA AMPLIFIER

Allied Radio Corp.,
Chicago, Ill.

The new version of the Knight 20-watt amplifier is flat within 2 db from 20-20,000 cycles and has less than 2% distortion of full output. Hum is 80 db



below rated output. A built-in equalized preamplifier is provided for variable-reluctance pickups. An isolated, equalized output is provided for crystal disc-recording heads. Separate bass and treble controls are included.

TV ANTENNA

Ward Products Corp.,
Cleveland, Ohio

Model TV5-47 is a combination of high- and low-band folded dipoles and reflectors. Installation time is reduced because the antenna is preassembled at the factory. The high-band section can be oriented independently of the low-band array.

Countless Thousands
specify
for
POWER CONVERSION JOBS

Seletron
SELENIUM RECTIFIERS

Today, thousands of nationally known companies are using Seletron Selenium Rectifiers in hundreds of power conversion applications because of their unvarying dependability under the roughest service conditions.

A rectifier with such an enviable background of satisfied users **MUST BE GOOD**. Seletron quality is no accident. The outstanding performance of Seletron Rectifiers is the result of a number of mechanical operations and processes which are held under rigid control.

In addition to the heavy power stacks of a wide variety of voltages and currents, Seletron Selenium Rectifiers are also furnished in small sizes.

See your dealer or jobber. If he can't supply you write us. Address Dept. RS-22.



SELETRON DIVISION
RADIO RECEPTOR COMPANY, INC.

Since 1923 in Radio and Electronics
251 WEST 19TH STREET, NEW YORK 11, N. Y.

NEW SUBSCRIPTION ORDER <<<

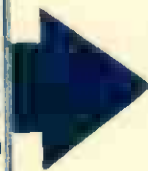

RADIO — ELECTRONICS

formerly RADIO-CRAFT

Please enter my subscription for 3 years \$8.00
 2 years \$6.00
 1 year \$3.50 I'll pay when billed
 Remittance enclosed I'll pay when billed
(Please print clearly)

Name State
Street Zone Company
City
Position

Canada, Mexico, South and Central America, same as U. S. A. All other foreign \$1.00 extra for each year.

RADIO-ELECTRONICS, 25 West B'way, New York 7, N. Y.

BUSINESS REPLY CARD

NO POSTAGE NECESSARY IF MAILED IN U. S. A.

2c Postage will be paid by



formerly RADIO-CRAFT

25 WEST BROADWAY
NEW YORK 7, N. Y.

FIRST CLASS
PERMIT NO. 3062
SEC. 510, P. L. & R.
NEW YORK, N. Y.



NEW SUBSCRIPTION ORDER



RADIO — ELECTRONICS

formerly RADIO-CRAFT

Please enter my subscription for

1 year \$3.50

2 years \$6.00

3 years \$8.00

Remittance enclosed I'll pay when billed

(Please print clearly)

Name

State

Street

Zone

Company

City

Position

Canada, Mexico, South and Central
America, same as U. S. A. All other
foreign \$1.00 extra for each year.

RADIO-ELECTRONICS, 25 West B'way, New York 7, N. Y.

BUSINESS REPLY CARD

NO POSTAGE NECESSARY IF MAILED IN U. S. A.

2c Postage will be paid by



formerly **RADIO-CRAFT**

**25 WEST BROADWAY
NEW YORK 7, N. Y.**

FIRST CLASS
PERMIT NO. 3062
SEC. 510, P. L. & R.
NEW YORK, N. Y.

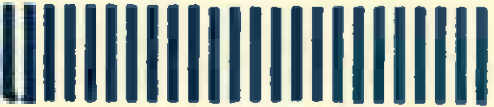

European Report

By Major Ralph W. Hallows

RADIO-ELECTRONICS LONDON CORRESPONDENT

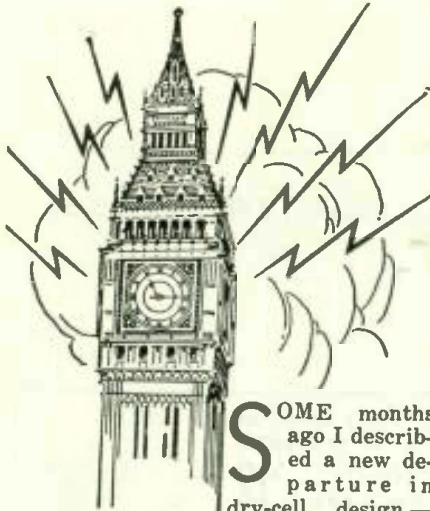

TV Program Exchange

For a long time France's only regular television transmitting station, situated in the Eiffel Tower, has been working on a 455-line system, while in Britain 405 lines is used. Both countries have interlaced scanning with 50 frames (25 complete images) a second, and with positive modulation. The French station suffers from lack of revenue, since its income is derived from TV receiving license receipts; hence its transmissions have hitherto been rather scanty, and it has not been able to pay for some of the very fine talent potentially available. And there you have the perfect vicious circle: small number of listeners = inadequate funds for TV transmissions = few program hours and not very good entertainment = small number of listeners.

listener. Paris, having saved by using our relays, will be able to splash money on a certain number of programs by French star artists. These will be relayed to us and we shall benefit accordingly.

I'm not maintaining that the 405-line system is perfect. All I can say from a good many years' practical experience of it and of systems using fewer lines and more lines is that it does provide a steady, well-defined, and enjoyable picture, so long as the transmitter has a genuine bandwidth of not less than 2.7 mc for the vision channel alone and the response of the televiser is equally good. We shall eventually have a 1,000-1,100-line service and France is going ahead with 819 lines. But such things are very much in the future. Until some means is found of producing low-priced televisers really capable of handling the enormous bandwidths involved in definition of this order, I'm all in favor of using any system of lower definition which gives real entertainment in the home at reasonable cost to the ordinary man and woman. So far there are no signs of our being able to solve the problem of transoceanic TV relays, but it is possible to "pipe" transmissions over the whole of either the American or the European Continent by co-axial or radio links.

Everyone of us wants to see television succeed in gaining the place it deserves as the finest of all sources of home entertainment. To me it seems that the surest way of bringing this about in the quickest possible way is the adoption throughout North and South America of the most highly developed system existing there (525 lines) and all over Europe that of the best developed system existing there (405 lines). Do just that and two things follow: relaying slashes program costs, though increasing entertainment value; prices of televisers come down since manufacturers can plan real mass-production schedules. And those two things are probably the most vital factors tied up today with the progress of television.

Marine Radar For All

The British Decca firm has just placed on the market what it claims to be the world's lowest-priced marine radar equipment. As this sells complete for \$6,000, I think they must be right, for I know of no other set made in any country at anything like the price. Don't imagine that the low price means a set of indifferent performance, or that costs have been cut by omitting some of the more complex—but very useful—fea-

SOME months ago I described a new departure in dry-cell design—the Vidor Kalium type of caustic potash zinc-mercury cell. Apart from its ability to maintain a steady e.m.f. under heavy loads, the outstanding features of this cell are its strong airtight can and its freedom from liability to cause damage by puncturing and letting loose its electrolyte when approaching the end of its service. As any can testify who have had experience with the mess and harm that a punctured dry cell can produce in delicate apparatus, this last is a very strong point. In the Alpha Leclanché (sal ammoniac-zinc-manganese dioxide) cell, due to appear shortly on the British market, the make-up is in many respects similar to the Vidor, as those who remember my drawing of this latter cell will realize by comparing it with the drawing here of the Alpha. The makers of the Alpha cell claim that it is unaffected by wide temperature variations and that during a long shelf life its characteristics remain exactly as they originally were. Whether these claims can be substantiated I cannot yet say, for I have not yet been able to obtain a batch for laboratory tests. The Alpha people are very confident about the performance of this new cell and state that, when it is on the market, they will replace free of charge, not only defective cells and batteries, but also flashlights and similar devices damaged by leakage of electrolyte.

From France I hear well-authenticated rumors of the perfection of an entirely new kind of alkali-cadmium-nickel secondary battery. This also is hermetically sealed in a completely leak-proof metal case. It, therefore, requires no attention whatever, save recharging when run down. I understand that cells of miniaturized type have been produced, which are also of very light weight. It is suggested that batteries built up of such cells may provide A- and B-currents for hearing aids and similar small appliances. If this can be done, it may lead to radical improvements in personal and universal radio receivers, walkie-talkies, vacuum-tube voltmeters, service testing equipment, and a whole host of other electronic apparatus.

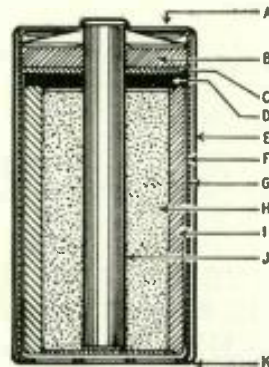

Alpha Leclanché cell. A—double-sealed metal top; B—plastic seal; C—washer; D—expansion chamber; E—metal shell; F—seamless zinc can; G—moisture-proof bitumen board; H—depolarizing core; I—paste electrolyte; J—carbon electrode; K—the metal bottom reinforcement.

We in Britain, on the other hand, are rather differently placed. To use a radio receiver we require a broadcast license costing \$4; for a TV receiver the license costs \$8. The government collects all the license fees (a total of about \$45,000,000), takes its own percentage for collecting them, and hands the rest to the BBC to spend as its council decides. The result is that the TV expenditure is far greater than receipts, but this is counterbalanced by spending a bit less on sound broadcasting than its own license fees bring in. Now that France is to use our 405-line system we can relay some of our programs to Paris at little cost to ourselves and to the considerable gain of the French

He finds trouble by ear

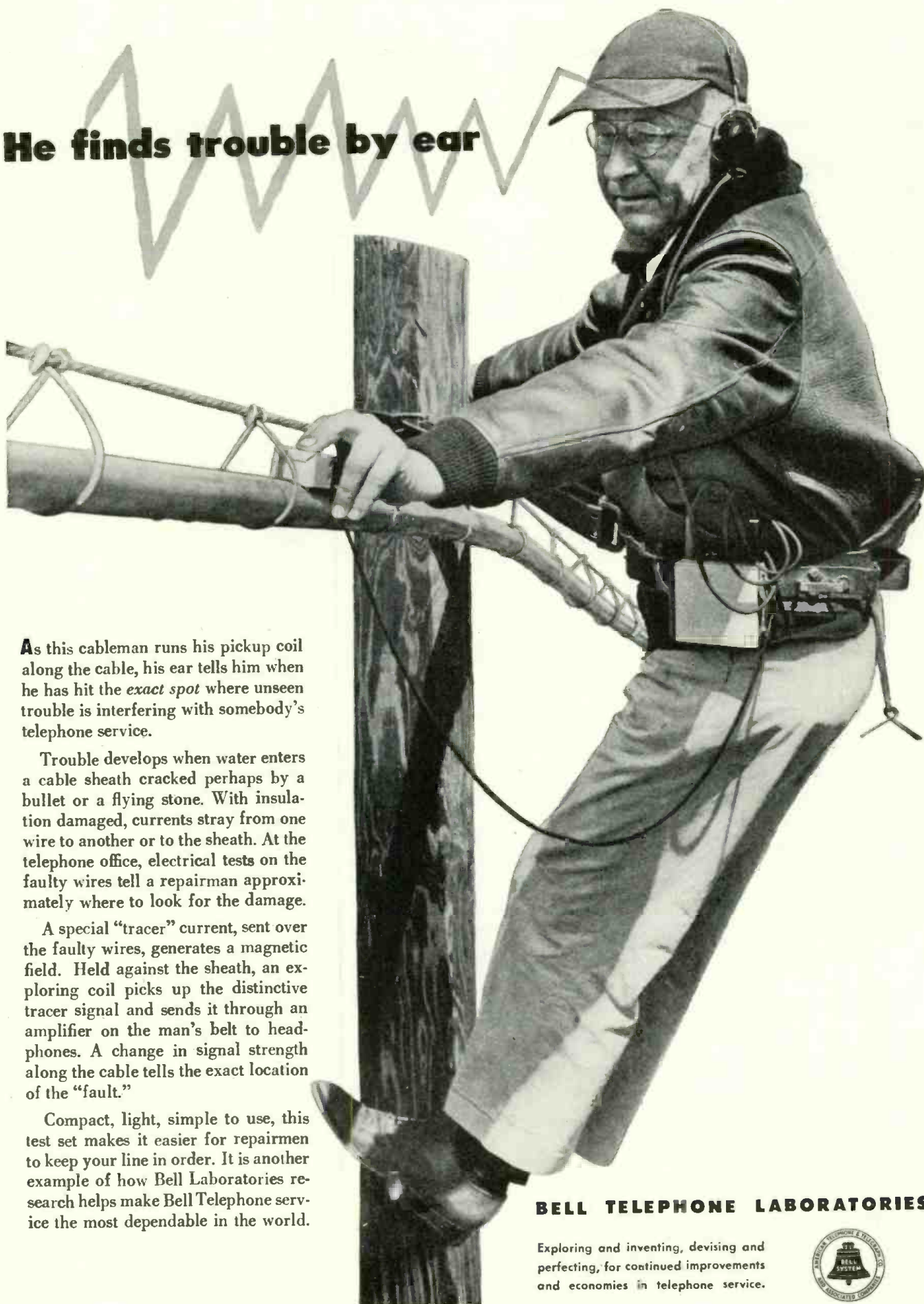

As this cableman runs his pickup coil along the cable, his ear tells him when he has hit the *exact spot* where unseen trouble is interfering with somebody's telephone service.

Trouble develops when water enters a cable sheath cracked perhaps by a bullet or a flying stone. With insulation damaged, currents stray from one wire to another or to the sheath. At the telephone office, electrical tests on the faulty wires tell a repairman approximately where to look for the damage.

A special "tracer" current, sent over the faulty wires, generates a magnetic field. Held against the sheath, an exploring coil picks up the distinctive tracer signal and sends it through an amplifier on the man's belt to headphones. A change in signal strength along the cable tells the exact location of the "fault."

Compact, light, simple to use, this test set makes it easier for repairmen to keep your line in order. It is another example of how Bell Laboratories research helps make Bell Telephone service the most dependable in the world.

BELL TELEPHONE LABORATORIES

Exploring and inventing, devising and perfecting, for continued improvements and economies in telephone service.



PRICES SLASHED!!!



File in the Palm of Your Hand!

A complete Transmitter and Receiver Kit for 75-80 meter C.W., incorporating these features:—3 latest multipurpose tubes—Crystal controlled transmitter—Improved regenerative receiver—Built-in AC-DC 110 V. power supply—Plug-in coil for receiver frequency change—Single control operates transmitter or receiver—Some antenna for transmitting or receiving. The "Mitey Mite" is ideal as a beginner's project or as an auxiliary for the old timer. Tests have shown remarkably gratifying results. Get on the air with the "Mitey Mite," while rebuilding the main rig! Tube line-up: 12 8A6 Det., 50B5 Xial Osc.—Audio Amp. 35W4 Rect. Xmini Pwr. Impl. 4.5 W. Over-all Dimensions: 7" x 5" x 5 1/2". Shipping Weight—3 1/2 lbs.

Immediate Delivery
ORDER NOW!
25% DEP. BAL. C.O.D.

Complete MITEY-MITE Kit \$9.95

(less key and headset)

TG-10 PHOTO ELECTRIC KEYS—Used by Army for code practice. A high gain 25 watt heavy duty amplifier with phono cell input. May be converted to PA or Phono amplifier. Uses 2-6SN7, 2-6BN7, 2-6L6, 1-5U4G and 1-923 tubes. Less tubes, tapes and reels. Shpg. Wt. Approx. 110 Lbs. Express only! Good condition. Size: 21" x 15" x 12". Only—\$14.50.

SCR-522 VHF TRANSMITTER AND RECEIVER—The best all around job for 100 Mc. to 160 Mc. work. Used in cars; by hams and special services. Shpg. Wt. approx. 60 Lbs. Express only! With all tubes. Each—\$32.50.

PE 125 BX MOBILE VIBROPACK POWER SUPPLY—Electronic Industries. Heavy duty. Ideal for Mobile, Marine or portable P.A. use. Input: 12 V. @ 15 A. or 24 V. @ 7.5A. Output: 475 V. @ 200 Ma. Complete with two RIK-60 Rectifier tubes and instruction book. Shpg. Wt. Approx. 75 Lbs. Express only! New—\$5.75.

TS-1/ARR-1 TEST OSCILLATOR—For ARR-1 Receiver. Freq. range 234 to 238 Mc. Gold plated cavity. Housed in attractive black wrinkled aluminum case. Complete with tubes and antenna. A steal at this low price! Shpg. Wt. Approx. 10 Lbs. New—\$3.75.

MN-52H AZIMUTH CONTROL (Bendix)—0-360 degrees. With 3 V. Pilot Lite and Manual Spine fitting. New—75c.

AN/APN-1 ALTIMETER—V.H.F. Transmitter and Receiver operating in 400-500 Mc. region. New, complete with tubes, plugs, indicators, dynamos, antenna and manual. Shpg. Wt. Approx. 80 Lbs. Express only! Only—\$24.50.

274-N SERIES. With tubes. Very good condition.

BC-454 3 to 6 Mc. Recvr. Shpg. Wt. 8 Lbs. \$4.50.

BC-455 7 to 9.1 Mc. Recvr. Shpg. Wt. 8 Lbs. \$6.50.

BC-458A 5.3 to 7 Mc. Trans. Shpg. Wt. 10 Lbs. \$7.50.

Express Only!

DYNAMOTORS

PE-6 Input: 10 V. Output: 300 V. 200 Ma. Good condition. \$1.25.

172-55 Input: 12 V. Output: 500 V. @ 400 Ma. intermittent. With filter box. Good. used condition. \$5.75.

DM-34 Input: 12 V. Output: 220 V. @ 80 Ma. Used—\$1.50.

DM-38 Input: 24 V. Output: 220 V. @ 80 Ma. Used—\$1.10.

DY 16/APG-5 Input: 28 V. Output: 100 V. @ 100 Ma. New—\$1.50.

Z-515-PM. Input: 12 or 24 V. Output: 500 V. @ 50 Ma. New—\$3.00.

Z-516-PM. Input: 12 or 24 V. Output: 275 V. @ 110 Ma. and 12 V. @ 3 A. New—\$2.00.

DM-21-CX. Input: 28 V. Output: 235 V. @ 90 Ma. New—\$2.50.

DM-21-B. Input: 14 V. Output: 235 V. @ 90 Ma. New—\$2.50.

DM-35 SPARE PARTS KIT—Consists of 50 sets LV Brushes, 50 sets HV Brushes, 8-.003/800 V. Condensers, 2 sockets, screws and 1 can of non-fluid oil lubricant. Complete—\$1.50.

CABLES

8 conductors, color coded. Rubber covered No. 20 stranded. Rubber Jacket 1/2" OD. 150 Ft. coil. Express only! \$10.00.

19 conductors. Rubber and fabric insulated. Color coded. No. 14 stranded. Heavy Rubber Jacket 1" O.D. Weatherproof. 25 Ft. Min. order. Lengths to 250 Ft. Express only! New—10c per foot.

CD-283-8 conductor cable and PL-160 plug. Fits PE-125 BX and BC-223 Transmitter. 36" long. New—75c.

MC-124—Manual drive cable for Azimuth control. Compass Recvrs., etc. 228" long. New—\$2.10.

NICHROME WIRE. Enameled. .005" 25 + ohms/Ft. and .004" 43 + ohms/Ft. on spools. New. 1/2 LB.—65c.

HEADSETS. Good condition, used. Each—65c.

ANT. KNIFE SWITCH. S.P.D.T. 6" Blade. Contacts mounted on Ceramic pillars 3" high. Well made. (Square "D") Each—55c.

MAGNIFIER REFLECTOR. 8" Dia. Parabolic. (Lancaster Lens) Metallic coated silver surface. Useful in photographic work. (Glass) Shpg. Wt. Approx. 1 1/2 Lbs. Express only. New—\$1.35.

LIP MIKE CARTRIDGE. New, less mounting straps. 9 for \$1.00.

T-32 DESK MIKE (Carbon). With push-to-talk switch, cord and plug. New—\$1.75.

BUZZER PHONE—EE1-A (W.E.). A complete unit consisting of a tone generator, buzzer, relay, key, headphone, switches, etc. Makes a very practical code practice set. Can be used in remote areas for signaling or communication. Housed in thick wooden case 9 1/2" L X 6 3/4" H X 6 1/2" W. Shpg. Wt. Approx. 16 Lbs. Express only! Like new with diagram. \$4.50.

SPEAKER CONES—6" for Jensen PM 6C. With voice coil assembly. New factory packed. 2 for 95c.

JACK BOXES

J-37. Contains three (3) PL-55 and one (1) PL-68 Jacks in gray finished metal box. Size: 1 1/2" X 2 1/4" X 3". With removable cover. Each 25c. 4 for 95c.

J-33/VRC-1. Outdoor power or telephone junction box with 12 knockouts for conduits or ltr. Heavy terminal strip for 10 pairs with brass numbered terminals. OD. Steel box. Size: 2" X 4 1/4" X 8". Removable cover. New. Each—55c.

RE-1. Antenna switching control box for ARR-1 Receiver. 2 coax inputs. 1-14 or 28 V. rotary relay, resistor, trimmer, etc. An exceptional buy! 3 for \$1.00.

ROTARY SWITCH ASSORTMENT—Various types of ceramic and phenolic wafer units. You Can't Miss! 15 for \$1.00.

COILS! OODLES OF THEM! COILS!

I.F., R.F., B.C., S.W., F.M., T.V., L.W., P.B., ETC., ETC. Grab an assortment of 25 for 85c.

VARIABLE TUNING CONDENSERS. BC-FM or 8V. 2 gang. Cut oscillator section for BC. Trimmers built in. High freq. sections have brass plates. Well made. Ball bearings. 3/16" shaft. New—85c. each.

FREQUENCY METER TYPE. With Drum dial and worm drive. 3 gang double spaced. Heavy cast aluminum construction. Cap. per section: 175 Mmf., 200 Mmf. and 250 Mmf. New—\$1.35.

FILTER CHOKES

32 Hy. @ 40 Ma. D.C. 540 Ohms—65c.

7 Hy. @ 150 Ma. D.C. 200 Ohms—95c.

5 Hy. @ 125 Ma. D.C. 200 Ohms—80c.

SQUELCH RELAY—As used in SCR-522 Transmitter. 5000 Ohm Coil S.P.D.T. Very low operating current of about 1 Ma. Fits SP Socket. New with dust cover. Only—65c.

ELECTRONICS PACKAGE—10 Lbs. of assorted electronic units and parts—\$1.29.

Quantities are limited—Order now. Minimum order—\$2.00. There will be a 25c packing charge for all orders under \$2.00. 25% deposit required. balance C.O.D. All orders shipped P.O.B. Chicago, Illinois. Any orders received without shipping instructions will be shipped Railway Express. Minimum foreign order \$25.00.

tures of modern radar equipment. Neither of those things is possible, for no radar set can receive the certificate of the Ministry of Transport unless it complies in every detail with a very exacting specification as regards both design and performance.

All British marine radar must operate on a frequency between 9,320 and 9,500 mc (the "3-centimeter" type). The range accuracy must be $\pm 5\%$ and the beaming accuracy within 1 degree of angle. The Decca apparatus is fully up to standard in both range and bearing measurement. Perhaps its most remarkable feature is its minimum range. The official specification lays down that a small object, such as a buoy, shall remain visible at a range of 50 yards. Several of our radar equipments have minimum ranges of 35 yards; but Decca has them all beaten with its minimum range of less than 20 yards—a most valuable feature for the navigation of narrow waters amid very dense fog.

This is accomplished by employing separate transmitting and receiving antennas and by cutting the duration of the pulse to 0.1 microsecond. Think that out and see whether you can discover why these things should mean a short minimum range before you read further.

First of all, what is the length from front to rear of the train of waves making up a 0.1-microsecond pulse? Radio waves travel 1,000 yards in 3.05 microseconds. Hence in 0.1 microsecond they travel 1,000/30.5 or nearly 33 yards. That, then, is the length of the train of waves composing the pulse. While the transmitter is sending out a pulse, the receiving antenna must be out of action in order to prevent damage to the receiver. It follows that with a 0.1-microsecond pulse the receiving antenna must be cut out while the pulse is traveling 33 yards. But radar range measurements are made by timing the double journey—out and home—of the pulse. Thus in theory the shortest range that can be dealt with by a 0.1-microsecond pulse is one half of 33, or 16 1/2 yards.

But that's not quite all the story. Most, if not all, other marine radar equipment uses a common antenna for the transmitter and the receiver, the switch-over being made electronically. Such a switch takes a small but definite time to bring about the change-over—and at very short ranges even fractions of microseconds count. With a common antenna the minimum range for a 0.1-microsecond pulse would probably be well over 20 yards. By using separate transmitting and receiving antennas the time needed for cutting the receiver in and out can be reduced and a minimum range of under 20 yards becomes possible.

There is, of course, one other very important factor: the vertical polar diagrams of both antennas must be of the right shape and the antennas must not be mounted so high that the skip distance between them and the surface of the water is too great.

UNITED SURPLUS MATERIALS
314 S. Halsted St. Chicago 6, Ill.



Lafayette

RADIO

ELECTRO NEWS

29 Years of Service—500,000 Satisfied Customers

1950 CATALOG GOING LIKE HOT CAKES!

TV BARGAIN COUNTER ROCK-BOTTOM FOR 10" TV LAFAYETTE CUSTOM TV CHASSIS

New Low Net Prices Creating Sensation

Make more money on every TV installation, cut down on come-back service calls—by picking up top-flight TV equipment at Lafayette's low 1950 prices!

Complete, ready to play, including picture tube

WARD TV-FM ANTENNA
2 Bank Array—13 Channels

LIST PRICE: \$27.00
LAFAYETTE'S PRICE **\$6.25**

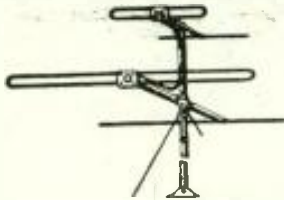

Here's a rare opportunity to pick up this excellent array at 75% off. Receives all 13 TV channels, plus the FM band. Range on the LF array: 44-108 MC.; 174-220 MC. on HF array. Average gain 2.5 db on LF array. 1.5 db on HF array above tuned dipole. Each unit can be rotated individually for maximum signal strength. Complete with 5 ft. mast. Stock up at this low price. No. 99N9612R (Shipping weight: 14 lbs.).....\$6.25



\$149.00

Buy it at less than you would ordinarily pay for a kit alone! You can get it only from Lafayette for your custom installation at just about half price! Comes to you completely wire tested and lined up, all ready for installation into cabinet. Absolute linearity, undistorted viewing. Automatic frequency control for horizontal synchronization. Higher than average sensitivity and picture brilliance. Not a "price" set, but a precision-made receiver 15" high, 21" wide, 19" deep. Shipping weight: 75 lbs.

- No. 1-135R, complete with 10" picture tube (65 sq. inch picture).....\$149.00
- No. 1-136R, complete with 12 1/2" picture tube (97 sq. inch picture).....\$169.00
- No. 1-137R, complete with 16" picture tube (140 sq. inch picture).....\$219.00

"SELF-POWERED" PHONE SYSTEM



You don't even need a phone line when you use this portable communications system for antenna installations. Just hook the phones onto the antenna wire and you're all set for clear 2-way conversations! No batteries needed; it's "sound powered." Also practical as an intercom system for home, shop, farm or office. Can be used as far as 25 miles apart. They're being snapped up at **\$8.75** Lafayette's bargain price! No. 32H14015R (Wt: 1 1/2 lbs.) per phone.....\$219.00

TV POWER XFORMER



\$8 VALUE—ONLY \$3.75

Top quality television power transformer with a rating of 2200 volts at 2 ma. Filament voltages: 6.3V at 1 amp., 2.5V at 2 amps. Take advantage of this special offering. No. 6N1501R (Shipping weight: 2 1/2 lbs.).....\$3.75

RED-HOT BARGAIN IN A BELDEN SOLDERING IRON



Not an unknown make at this price, but a genuine Belden! Need we say anything further? 60 watts. 3/8" screw tip. No. 99N8007R (Shipping weight: 2 lbs.).....\$1.49



IT'S FREE!
YOUR COPY IS WAITING, HAVE YOU SENT FOR IT?



P.A. SCOOP!
\$40.00 OFF ON THIS FAMOUS-MAKE HI-FIDELITY AMPLIFIER 20 WATT DE LUXE

Lafayette made a sensational buy on this 20-watt high-fidelity P.A. Amplifier and passes the \$40 saving on to you. We can't mention the make, but you'll recognize it as one of the most reputable in the business. Frequency response essentially flat from 50 to 15,000 cps. Separate bass and treble tone control. Master Gain Control to regulate all channels without resetting individual control. Output impedances 2, 4, 8, and 500 ohms. Input for 2 microphones and 2 record players. Fader control permit smooth fading from one record to the other. Uses 2 12SJ7, 6SJ7, 6SL7, 26L6G, plus 5Z3 rectifier. Cabinet made of heavy-gauge steel with black crackle finish. Fits standard relay rack, or can be used as individual unit. Size 19 1/4" wide by 17 1/4" deep by 9 1/4" high. For 105-125 60 cycle AC only. Underwriters Lab. approved. No. 2G410R (Shipping weight: 60 lbs.)
Regularly priced at \$87.50.
Now.....\$47.50

Want to know why so many radio men are trying to beg, borrow or swipe a copy of the new 1950 Lafayette Catalog?

Then take a gander at the prices shown on this page. Get that pencil out of your vest pocket, and prove to yourself that Lafayette is *dollars* cheaper—brand for brand, item for item!

You'll find values like these on every page of the great new 164-page Lafayette Catalog. The latest, newest developments straight from America's leading radio electronic laboratories.

EVERY DAY YOU LET GO BY WITHOUT THIS NEW CATALOG IS COSTING YOU HARD CASH

The section on TV sets, parts, tools and accessories alone is worth its weight in gold. (You can save enough on one item to keep you in free smokes for weeks.) Plus complete, rock-bottom listings on Public Address, High Fidelity, Testing Equipment, Ham Gear, Parts, Tools, etc.

So don't borrow somebody else's copy. You can get a new Lafayette Catalog all for yourself by pasting the coupon on a penny postcard. Mail it right now!

SHOP IN PERSON AT ANY ONE OF LAFAYETTE'S 7 OUTLETS —
NEW YORK: 100 Sixth Ave. & 542 E. Fordham Rd.
CHICAGO: 901 W. Jackson Blvd. & 229 W. Madison St.
ATLANTA: 265 Peachtree Street
BOSTON: 110 Federal St.
NEWARK: 24 Central Ave.

TV MAGNE-ROTOR

New Remote Control Rotator Beams Antenna to Signal



Gives you absolute peak performance all around the dial. Keeps the antenna directly "on the beam" to bring in the strongest signal on each channel. Automatic signal light goes off when cycle is completed. Antenna stops instantly on finger-tip release of remote control. Plugs in any 110 standard outlet. Fits any antenna. Compare this price. No. 28N21951R (Shipping weight: 8 lbs.) LIST PRICE, \$29.95

DEALER PRICE: **\$17.97**

CATHODE RAY TUBE



Brand new 5BP1 cathode ray tubes perfect for oscilloscope use Green fluorescence with medium persistence. Large five-inch screen, medium shell magnal 11 pin base. 6.3 volt heater, anode No. 2 voltage 2600 volts. Each tube is individually boxed. Weight: 3 lbs. No. 99N9559R.....\$2.95

RUSH THIS COUPON AT ONCE FOR YOUR FREE 1950 CATALOG

LAFAYETTE RADIO, Dept. JJ9
901 W. Jackson Blvd., Chicago 7
100 Sixth Avenue, New York 13

MAIL THIS FOR FREE CATALOG AND TO ORDER

- Check here for FREE Catalog (Please don't check if already on our mail list.)
- Please fill attached order. I enclose \$.....in postal note, money order or check. Please include shipping charge based on weight and zone.

Name.....
Address.....
City..... Zone..... State.....

Taking Care of Test Equipment

by H. LEEPER



PHOTO 1

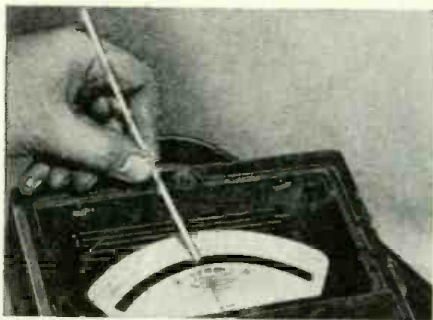

PHOTO 2



PHOTO 3

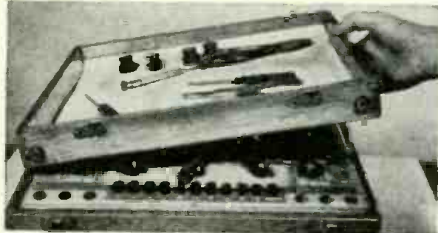

PHOTO 4

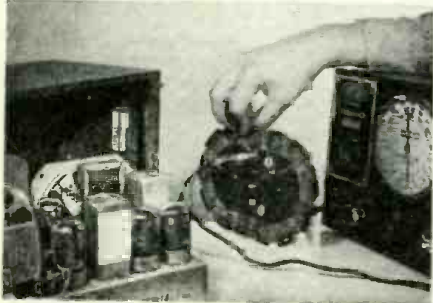

PHOTO 5

Illustrated on this page are some hints on caring for your test equipment. While any single one of them may seem unimportant, the aggregate can make a difference in both the accuracy and life of your instruments. Included also are a couple of kinks which may be helpful in using test equipment.

Photo 1. If meter pointer is stuck due to static charge, blow on glass. If still no results, remove from case and blow lightly on pointer.

Photo 2. When moving pointer by hand, use a very light object such as a peg of wood or a strip of cardboard so you can judge force exerted.

Photo 3. Don't use a soldering iron over a tube tester or other instrument. A drop of solder may get into a tube socket or a jack.

Photo 4. Detachable lids of many common testers may be used to mount small parts which may be needed while using the instrument.

Photo 5. Small loop-type antenna kept with signal generator can be used for coupling signal to sets with loops. Bring two loops near each other till signal transfer is sufficient.

Photo 6. Lead container made from discarded flashlight case and fastened to side of tester keeps test leads out of way when not in use.

Photo 7. Small spring clip carried with tube tester makes easier connection to some grid caps. Tester's clip can be attached to auxiliary.

Photo 8. Metal feet obtained from

dime store and fastened to bench eliminate danger of tripping over dangling leads and pulling tester to floor.

Photo 9. Wooden rack holds meters conveniently. One shown is 35 inches high, 17 inches wide. Discarded radio cabinet with few changes also makes good rack.



PHOTO 7



PHOTO 8

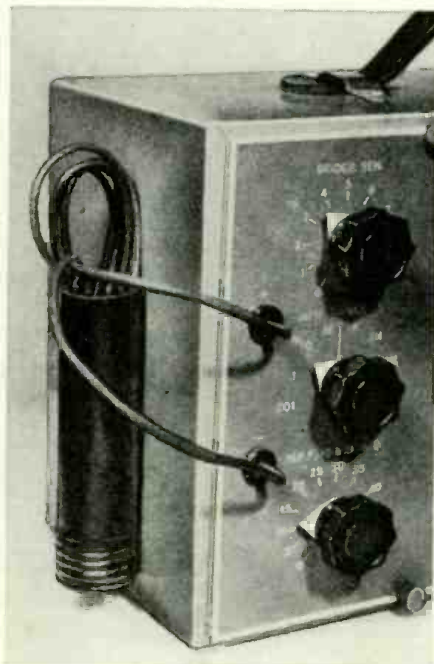

PHOTO 6

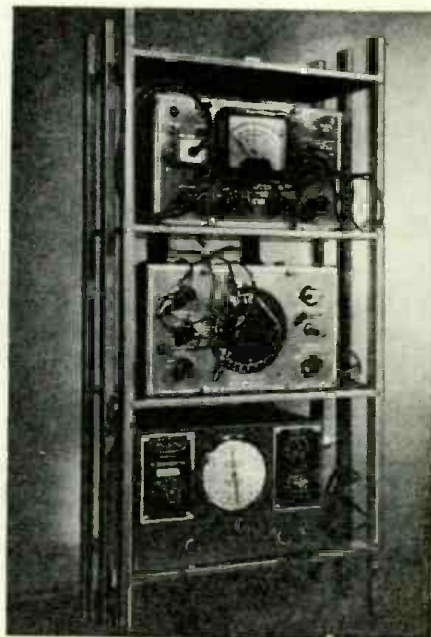

PHOTO 9

RADIO-ELECTRONICS for

EICO TEST EQUIPMENT KITS!

You Build 'Em In One Evening-But They Last A Lifetime!



MODEL 221K HIGH PRECISION VACUUM TUBE VOLTMETER
YOUR COST—23.95

Featuring exceptionally high stability, accuracy and linearity, this quality VTVM is recommended for all laboratory and service applications. 2% accuracy on all ranges. 15 different ranges. Kit form.



MODEL 400K 5" SCOPE
YOUR COST—39.95

For premium performance at amazing low cost, select EICO Model 400. Many 5" Scopes at twice the price do not equal its accuracy, sensitivity and versatility.



MODEL 320K SIGNAL GENERATOR
YOUR COST—49.95

Features a highly stable Hartley oscillator with a calibrated frequency range of 150 KC to 102MC. Fundamentals to 34 MC. Pure 400 cycle audio sine wave available for audio testing and R.F. modulation.



MODEL 145K MULTI-SIGNAL TRACER
YOUR COST—18.95

Engineered for audible tracing of I.F., R.F., F.M., video and audio circuits. Provisions included for VTVM visual signal tracing, enabling actual stage-by-stage gain comparison.

Approved ELECTRONIC INSTRUMENTS

These are NOT KITS



MODEL A-460 FIELD STRENGTH METER 79.50

- Measures actual Television station signal strength
- Orientation of Antennas can be accomplished precisely and quickly.
- May be used to check efficiency of various Antenna combinations.



MODEL A-500 FM TUNER 14.95

Complete with tubes, dial escutcheon, instruction book, aligned and air tested. Shpg. weight 10 lbs. Size: 8" x 5" x 3".



MODEL A-475 TELEV. TUNER 32.50

Two separate Sets of tuning capacitors and coils for the low band and high band respectively, with automatic switch-over by means of the attached detent mechanism.



MODEL A-600 BROADCAST SUPERHET TUNER 12.85

Model A-600 comes complete with 4 tubes (standard brands). Air tested and Aligned, operating instructions, circuit diagram, guarantee. Shpg. weight: 2 1/2 lbs. Size: 4" x 4" x 5".

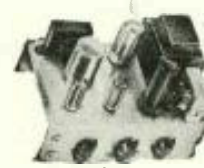

MODEL A-610 4 WATT AC AMPLIFIER 14.25

Model A-610 comes complete with 4 tubes (standard brands) tested, complete operating instructions, circuit diagram, guarantee. Shpg. weight: 5 1/2 lbs. Size: 6" x 5" x 8".

PANEL METERS

3 1/2" G.E. 0-15 A.C. VOLTMETER	\$3.95
2 1/2" WESTINGHOUSE 10-0-6. DECIBEL METER	6.95
2 1/2" BURLINGTON 0-150 A.C. VOLTMETER	4.95
3 1/2" WESTINGHOUSE 0-150 A.C. VOLTMETER	4.95
3 1/2" WESTINGHOUSE 0-500 D.C. VOLTMETER	3.95
2 1/2" GRUEN 0-500 D.C. MILLIAMMETER	2.95
2 1/2" DYMAC 0-50 D.C. MILLIAMMETER	2.95
2 1/2" DYMAC 0-100 D.C. MILLIAMMETER	2.95
2 1/2" DYMAC 0-250 D.C. MILLIAMMETER	2.95

TELEVISION PICTURE TUBES

TP400A	\$49.50
3KP4	13.50
5TP4	59.40
12QP4	46.00
7JP4	16.88
10BP4	27.50
10FP4	26.80
10HP4	48.50
12RP4	44.00
12JP4	41.25
12EP4	36.45
12LP4-12UP4	34.40
12Q14	43.00
12UP4 Luxide	37.15
15AP4	66.75
16AP4-16EP4	56.40
16AP4-16EP4-Luxide	58.15
20BP4	222.75
15DP4	64.75
16FP4	72.50

AMPLIFIERS
25 watt amplifier operates on 6 volt batteries as efficiently as on 117 volt source. Ideal for sound trucks. Self contained record player. Complete with matched kit of tubes. Your cost. \$69.95

35 WATT AMPLIFIER with automatic record player & kit of matched tubes—4 inputs, each separately controlled—this amplifier is highly recommended for fixed systems. 105-125 V.A.C. Your cost. \$69.95

50 WATT AMPLIFIER—A powerful wide range amplifier that delivers better than 50 watts of usable power. Suitable for heavy duty service. And is successfully used for larger auditoriums—theaters—indoor-outdoor rinks—stadiums—auto races—football fields—etc. Complete with matched tubes. Your cost. \$69.95

INTERCOMS

—10 station master for use on intercom systems employing from one to 10 subs. Operates on 110-115 volts A.C. or D.C. low consumption cost. Extra powerful amplification. Beautiful grained walnut cabinet. 9 1/2" x 6". Your cost. \$19.95

MEISSNER KIT BOOKS

Contains many build them yourself diagrams including T.V. \$1.00

CODE PRACTICE SETS

Speed X code practice set—with key & high frequency buzzer. Your cost. \$1.49

Standard signal corp.-telegraph keys. Your cost. 49c

PHILCO AUTO RADIOS

CR9 1942-1949 Fords
1942-1949 Mercury
Has a powerful, new miniature circuit and new electronic tuning system. Custom-built by Philco. \$39.95

CR2 ALL CARS
Custom styled control unit fits perfectly in instrument panel opening provided in almost all cars. Philco—best by far for every car! \$29.95

CONVERSION KITS

To change a 630TS chassis to use 16AP4 picture tube. Model DP voltage doubler includes plastic sleeve, plastic ring and mounting bracket. Complete Kit, less picture tube. Your cost. \$24.95

Kit to convert a 10 inch set to use a 12 inch picture tube (Brackets & wooden block). Your cost. \$4.95

TERMS: 25% deposit with order. Balance C.O.D. 2% off, if full payment is included with order. All items shipped F.O.B. Boston.

LOUIS M. HERMAN CO. 885 BOYLSTON ST. BOSTON 16, MASS.

Established 1928; Rated with Dun & Bradstreet; Member Boston Better Business Bureau
DISTRIBUTORS OF FAMOUS MAKES NATIONAL PRODUCTS



*Radio
Servicemen*

FREE 1949-50
CATALOG

Wards Electronic Equipment Catalog contains nationally known test instruments for the radio serviceman. Has everything from pocket-size meters to large oscilloscopes, including new models for servicing FM, AM and television.

Also features high quality Sound Systems, television sets and accessories, amateur gear, and high fidelity radio components for home installations.

ALL MERCHANDISE AVAILABLE ON
WARDS MONTHLY PAYMENT PLAN
Pay Only 10% Down

Mail coupon for your free Catalog

MONTGOMERY WARD, Dept. RE10, Chicago, Ill.
Please send my free copy of Wards new 1949-50
Electronic Equipment Catalog.

Name _____
(Please PRINT Name and Address plainly)

Street Address _____

Or Route _____ Box _____

Post Office _____ State _____

DIRECTION FINDER

Patent No. 2,468,109

Avery G. Richardson, Boonton, N. J. and
Arbor G. Everhart, Great River, N. Y.

(Assigned to Federal Tel. & Radio Corp.)

Practically all direction finders employ a vertical "sensing" antenna and a loop to obtain a uni-directional reception pattern. This d.f. (direction finder) has an improved visual indicator for accurate results.

The antenna A and the loop L feed energy to the receiver. The output is a varying voltage with alternate maximum and minimum amplitudes as the loop rotates. The fundamental of this output—the frequency of the loop rotation—is passed through a filter. After amplification and clipping, the signal is differentiated to obtain sharp pulses. The positive pulses trigger a gas tube circuit, which in turn excites a circular neon lamp (see small figure). The neon lamp glows once during each rotation of the loop.

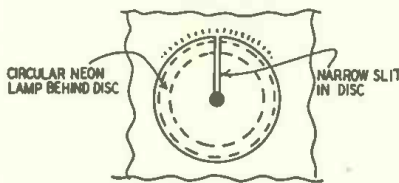
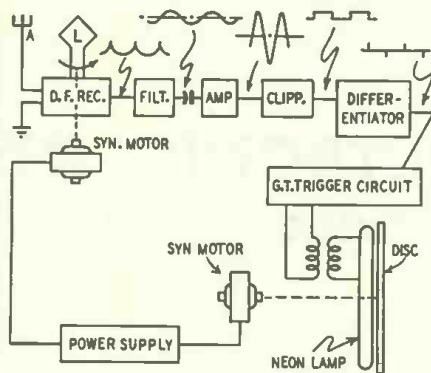

A masking disc rotates in front of the lamp. When the lamp glows, light is observed at one point (through a narrow slit in the disc). The disc and the loop are synchronized, both being operated by synchronous motors.

The disc can be calibrated in degrees corresponding to the instantaneous position of the loop. The position of the loop which gives maximum signal pickup (and therefore the direction of the transmitter) can be read off directly at the point where the glow is observed.

SWEEP GENERATOR

Patent No. 2,469,289

Joseph G. Beard, Haddonfield and
Leo W. Born, Collingswood, N. J.

(Assigned to Radio Corp. of America)

Rapid TV and FM servicing requires the use of a sweep generator in conjunction with an oscilloscope. The generator should be rugged and easy to use, and it should be capable of constant sweep, regardless of the channel in use. The mechanical sweep of this generator is both simple and effective.

The schematic shows a triode oscillator with various capacitors C to cover the different channels. An auxiliary capacitor C1 has one plate fixed and the other connected to the armature of a vibrator V. When the C1 plate vibrates, it frequency-modulates the oscillator to produce the required sweep. The motion of the vibrator can be synchronized with the horizontal sweep of an oscilloscope by generating the sync voltage with auxiliary pickup coils on the vibrator.

The maximum sweep should be about 6 mc, regardless of center frequency; therefore, the ratio of sweep to center frequency must be less at the upper channels. This requirement may be met by progressively reducing the voltage applied to the

TELEVISION SCOPE

**SUPERIORITY
AT A GLANCE!**

The vertical response of this economy TV scope is usable to 5000 kc, not 50 kc. Response is flat to 750 kc, down 3 db at 1000 kc. Amplifier supplies a voltage gain of 20 at 5000 kc.



AR-3

Check this necessary feature before you buy any scope for TV use.

The R.S.E., AR-3 Scope has been built by Ross Armstrong to our rigid specifications. It's a complete unit that embodies standard horizontal amplifier and sweep circuits with normal sensitivity.

The case is 8" high x 5" wide x 14" long, attractively finished in "hammered" opalescent blue enamel. Operates on standard 110 volts—60 cycles—40 watts. Tubes, 3BP1-6AC7-6SJ7-6X5-5Y3-884. Instructions included. Complete specifications upon request. Satisfaction or your money back.

AVAILABLE TO JOBBERS
IN QUANTITY

PRICE
\$4995
F. O. B.
DETROIT

CRYSTALS



UP TO 77% OFF

Your choice of:
ASTATIC L72 Hi Output
SHURE P30 Lever Type
All Less Needle
BUY AN ASSORTMENT

\$149
EACH
NO LIMIT

**A
SPEAKER
STEAL!**



5" 450 ohm
DYNAMICS
Perfect—clean—
Where else but
of RSE?

Limit of 5 to
customer
99¢
EACH

ORDER INSTRUCTIONS



Minimum order—\$2.00. 25% deposit with order required for all C.O.D. shipments. Be sure to include sufficient postage—excess will be refunded. Orders received without postage will be shipped express collect. All prices F.O.B. Detroit.

Quantity and Export
Orders Solicited

**RADIO SUPPLY &
ENGINEERING CO., Inc.**
85 SELDEN AVE. DETROIT 1, MICH.

RADIO-ELECTRONICS for



Chassis

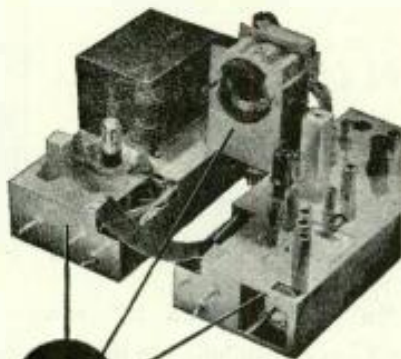

**3 UNIT DESIGN
FITS ANY CABINET**

The most versatile television chassis yet designed! Three basic units — power supply chassis, RF chassis and deflection yoke assembly — may be placed side by side, one above the other, etc., to conform to any cabinet. Simply plug in the cable connectors. Each unit is soundly engineered and built to famous National standards of performance.

1. Choice of 10" (TV-10C) or 12 1/2" (TV-12C) chassis.
2. Tunes all 12 channels.
3. Wired, pre-tuned and tested — not a kit.
4. RF stage employs tuned grid and plate for maximum gain and optimum band width.
5. Unique 36 mc IF minimizes interference.
6. Fine tuning control covers range of 2-3 mc. for maximum tuning accuracy.
7. Improved intercarrier sound.
8. Magnetic deflection and "fly-back" high voltage supply.
9. 72-ohm unbalanced and 300-ohm balanced inputs.
10. Supplied with two six-inch PM speakers.

Specify either TV-10C or TV-12C When ordering **\$149.50** (less picture tube)



vibrator at upper channels. Another method is to use series capacitors (C2 in the figure). These are controlled by S2, which is ganged to S1. Each of the C2 capacitors is adjusted to give equal sweep for any channel switched in.

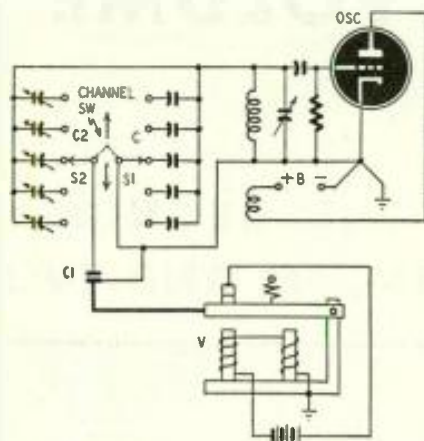

Less series capacitance is used in series with C1 at the upper channels to reduce the relative frequency deviation.

NEON FLASHER

Patent No. 2,467,472

Robert R. Goshorn, Cincinnati, Ohio
(Assigned to Automatic Elec. Devices Co.)

A flashing neon lamp consumes so little current that it may be powered from dry batteries. It has been found, however, that, if the lamp is a long one (for example, 12 inches or more), the first flash generates a static charge along the glass envelope. This may prevent further flashing.

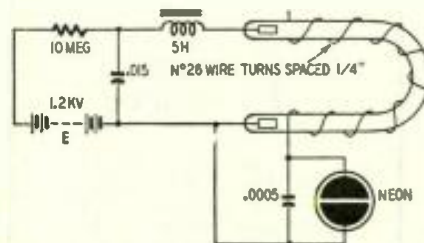

The diagram shows a flasher operated from a high-voltage dry battery. The .015- μ f capacitor is charged through the high resistance; and when a critical potential is reached, the U-shaped neon lamp flashes. Then static accumulates on its glass envelope.

If a coil of wire is wound around the long lamp, the static charge induces a voltage drop along the coil and the 500- μ f capacitor is charged. When the voltage is high enough, the capacitor discharges through the small neon lamp and the static charge is removed.

RADIO MADE EASY!

A JRI Home Trainer

A NEW APPROACH to radio repairing. Here is a SIMPLIFIED METHOD of repairing radios that can be LEARNED QUICKLY—Begin repairing immediately! A COMPLETE KIT OF ALIGNMENT TOOLS INCLUDED! Balance ANY RADIO with these tools. Prepare for a GOOD INCOME NOW! Send for the JRI Home Trainer TODAY and get Alignment Tool Kit—BOTH FOR ONLY \$9.75 postpaid, or plus c.o.d. charge. Pays for itself almost immediately! SATISFACTION GUARANTEED.

THE JRI TRAINERS

P. O. Box 2091, Dept. 15-10, Chicago 9, Ill.

Learn ELECTRIC APPLIANCE REPAIR AND SERVICE
FREE PLAN FOR YOUR SUCCESS
BIG PROFITS — BIG DEMAND for qualified men to sell & Home Freezers, Washing Machines, Dishwashers, Home Wiring, Auto electricity, etc. Learn at home — start your own business. NO PREVIOUS EXPERIENCE NEEDED! Special tools & equipment furnished. Earn while learning. Write for YOUR FREE SUCCESS PLAN — ACT NOW!
PACIFIC TRAINING SCHOOL Dept. C-910
7217 South Broadway • Los Angeles 3, California

Just Published!
NEW FOURTH EDITION
of
The RADIO MANUAL

Complete, practical and authoritative, this great new handbook contains up-to-the-minute information on all types of radio equipment. It gives in step-by-step detail the actual procedures to be followed by operator, technician or student.

The Radio Manual explains the operation of communication equipment of all types—receiving, transmitting, broadcasting; for AM, FM, television, radar, and Ioran; for marine radio, police radio and other specific services. It covers motors, generators, batteries, amplifiers, oscillators, transmitters, and antennae, and all other specific types of apparatus that enter into the complete illustrations.



Prepared by Experts

In this brand-new edition the authors, George E. Sterling, Commissioner, Federal Communications Commission, and Robert B. Monroe, Radio Engineer, Columbia Broadcasting System, give you the specific detailed information you need to qualify for work in government and industry. Basic principles are simple and clearly explained. All necessary computations are illustrated by fully worked examples that require no mathematical knowledge beyond arithmetic. The duties of the operator of any type of installation are set forth explicitly and fully. Hundreds of diagrams, photographs and charts show every detail of construction and wiring. From the first page to the last this brand-new working manual gives the most complete, authoritative information on all up-to-date radio equipment.

Examine This Great Book FREE

MAIL THIS COUPON

D. VAN NOSTRAND COMPANY, Inc. RadioElec 10-49
250 Fourth Avenue
New York 3, N. Y.

Please send me a copy of THE RADIO MANUAL for free examination. Within 10 days I will either return the book or send you \$3.00 as first payment and \$3.00 a month thereafter until the total price of \$12.00, plus a few cents postage is paid.

NAME.....
ADDRESS.....
CITY..... ZONE..... STATE.....

(If you send \$12.00 with this coupon we will pay the postage. Same return privilege guaranteed.)

NOW — IN KIT FORM!

EMC MODEL 300
VACUUM TUBE
Volt-Ohm-Capacity
METER



\$23.95

- Hammered Metal Carrying Case
 - DC VOLTS—6 ranges to 1000 volts!
 - AC VOLTS—5 ranges to 1000 volts!
 - RESISTANCE—6 ranges to 1000 meg-ohms
 - CAPACITY—4 ranges (.00025 mfd to 20 mfd)
 - ZERO CENTER POSITION
 - INCLUDES LEADS
- Completed Unit\$39.50
CAPACITY RANGES and ZERO CENTER POSITION are features not available in competitive VTVM kits.



EMC Model 120
20,000
ohms-per-volt
VOLOMETER

\$22.95

- Portable Model Illustrated 26.95
The ONLY 20,000 ohms-per-volt instrument that gives you
- 6 D.C. Volt ranges at 20,000 ohms/volt to 6000 volts
 - 6 A.C. Volt ranges at 10,000 ohms/volt to 6000 volts
 - 5 current ranges to 6 amps
 - 4 resistance ranges to 300 megs
- Completed Unit (open face).....\$29.95
Completed Unit (portable).....\$34.95

EMC MODEL 500K
R. F. SIGNAL
GENERATOR

\$18.75



- Employs electrostatically shielded transformer for 115V 60 cycle operation.
 - All coils not in use are automatically shorted out.
 - Provision for external modulation.
 - Attractive 3 color panel.
 - Covers range from 150KC to over 30 megacycles on fundamentals—over 100 megacycles on harmonics.
 - 400 cycle internal modulation available.
- Completed Unit\$28.75

EMC Gives More Measurement Value per Dollar!
ELECTRONIC MEASUREMENT CORP.
423 Broome St., Dept. B-10, New York 13, N. Y.
Write For Free Catalog

GOVERNMENT SURPLUS!
WORLD'S LOWEST PRICE

PHOTO FLASH EQUIPMENT



COMES COMPLETE WITH
4 EDGERTON
FLASH TUBES
& REFLECTORS

EASY TO
CONVERT INTO
A 2-WAY PHOTO
FLASH UNIT
OPERATES ON 110V. AC & 12V. BATTERY

Brand new at a fraction of original cost. Contains finest component parts available. All necessary parts and complete instructions included. After conversion, works on 110V AC or 12V battery by a flick of a switch.
Immediate delivery on all mail orders

\$68. COMPLETE
CINEX, INC., 165 W. 46th St., N. Y. 19, N. Y., Dept. RE-10

10-METER CONVERTER FOR BC-312

We have seen, over a period of three years, a number of articles describing conversions and modifications designed to improve the BC-312 and BC-342 receivers for amateur reception. One of the most interesting of these is G3AAK's description in a recent issue of *Short Wave Magazine* (London) of the broadband 10-meter converter he incorporated in his BC-312.

The circuit of the converter is shown in Fig. 2. The unit is constructed on a 1 x 3 3/8-inch chassis which is mounted in the local oscillator compartment of the receiver. The converter coils do not require shielding if the r.f. coil is mounted above the chassis and the mixer coil below. One side of the chassis is fastened to the side of the oscillator tuning capacitor and the other fits snugly against the side of the oscillator compartment. Bolts and small angle brackets are used to fasten the chassis to the capacitor.

The grid of the 6AK5 mixer is coupled through a 20- μ f capacitor to the fixed plates of C24 (the 14-18-mc oscillator trimmer in the BC-312). Because this connection detunes the oscillator, C24 must be reduced until calibration is correct.

The heaters are shown in series. They may be connected in parallel if the set has been rewired for 6.3-volt heater operation. Heater voltage can be taken from the pilot lamps or any convenient source. The 6AK5's drawing a total of 20 ma at 150 volts, the value of resistor R will depend on the available supply voltage.

The variable ANTENNA ALIGN capacitor was replaced by a 200- μ f fixed unit and a d.p.d.t. rotary switch installed in its place. This switch is used to cut the converter in and out of the circuit.

The coils are wound on 3/8-inch forms with adjustable, powdered-iron cores. L1 and L3 have 10 turns of No. 21 enamel wire. L2 is 3 turns of No. 21 wire wound around the grounded end of L3. A thin layer of insulating paper should be used between the windings. The 10,000-ohm resistors load L1 and L3 so they are substantially linear between 28 and 30 mc. The cores should be adjusted to peak the coils at 29 mc.

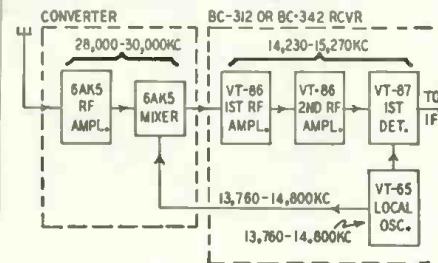

Fig. 1—Converter precedes BC-312 front end.

Fig. 1 is a block diagram of the converter and front end of the BC-312 receiver. The grid circuits of the 6AK5 r.f. amplifier and 6AK5 mixer are broadly resonant between 28,000 and 30,000 kc. The local oscillator—470 kc lower than the signal frequency on the high-frequency bands—is coupled to the 6AK5 mixer. Therefore, if the receiver is tuned to 14,230 kc, its oscillator will be on 13,760 kc. This frequency beats with a 27,990-kc signal to produce a 14,230-kc heterodyne signal which will pass through the r.f. and mixer circuits of the receiver. When the receiver is tuned to 15,270 kc, its oscillator produces a 14,200-kc signal which heterodynes a 30,070-kc signal down to the signal frequency of the receiver. Thus, signals between 27,990 and 30,070 kc can be received by tuning the receiver from 14,320 to 15,270 kc.

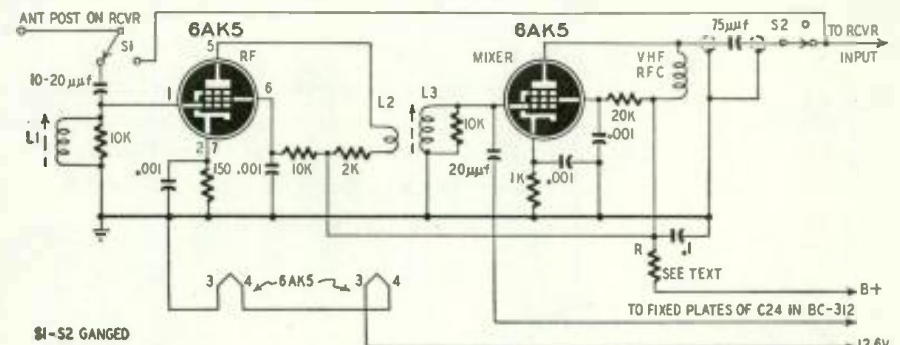

Fig. 2—The 10-meter converter is a broad band r.f. amplifier. Receiver acts as variable i.f.

MOBILE BATTERY-SAVER

A run-down storage battery is a frequent source of trouble and inconvenience to operators of amateur, emergency, and police mobile radio stations. Installing heavy-duty storage batteries and generators does not help the situation if the equipment is used for any length of time with the motor off—as it is likely to be under certain conditions.

A solution to this problem was devised by E. W. Lindfeldt, chief radio technician of the Sacramento, Calif., Police Department, and described in the May issue of *The APCO Bulletin*. In this system, an extra storage battery is suggested for operating the radio and auxiliary equipment. This battery, installed as shown in the diagram, carries the load of the radio equipment, leaving the regular car battery in condition for quick starting. The extra

A solution to this problem was de-

battery is automatically connected to the generator when the motor starts. It is then charged in parallel with the

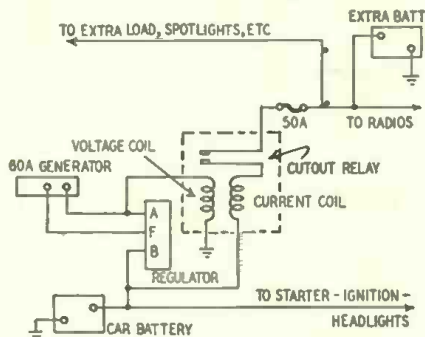

regular battery. A standard 60-ampere generator is adequate for charging both.

60-CYCLE HUM

A customer brought us the other day a little receiver of the standard 6A8, 6K7, 6Q7, 25L6, and 25Z6 type. The radio hummed. We changed the filter capacitors, which had apparently dried out. Everything sounding O.K., the chassis was put back in the cabinet after aligning the circuits. It was hardly in the cabinet before hum started again. Everything in the detector section (Fig. 1) appeared O.K.

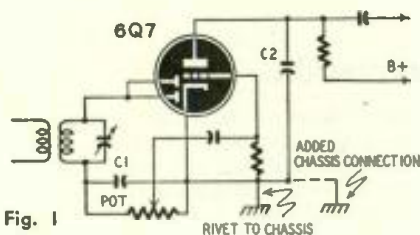

Fig. 1

The next step was to try all the soldered joints and contacts with a screwdriver. On touching the cathode contact of the 6Q7, the hum stopped suddenly. Yet this electrode was connected to chassis with but a scant 1/2 inch of bare wire. We checked the soldered joint to the rivet which held the tube socket to the chassis and which was used as the chassis ground (see Fig. 2).

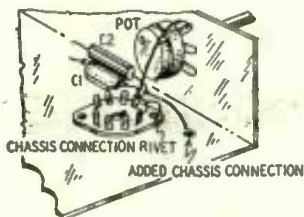

Fig. 2

Everything looked all right and checked zero ohms with the ohmmeter. Yet soldering a piece of wire direct from the lead of C2 to the chassis stopped the hum completely.

We deduced that the contact between the rivet and chassis was defective for the voltages and currents it was called on to carry, though it tested perfect with the ohmmeter. Thus the detector was imperfectly grounded. The set was repaired with an inch of wire. But how much time it took to determine that the piece of wire was needed!—R. B. in *Le Constructeur et Depanneur* (France).

4 KITS AT SENSATIONALLY LOW PRICES!



The New Model KT-40

VACUUM TUBE VOLTMETER

FEATURES: * Uses 4 1/2"-2% accurate D'Arsonval type Meter with high torque movement and Alnico V slug. * Meter guaranteed against burn-out on ALL electronic ranges. Meter will not be damaged even when improperly switched to higher range. * Stabilized degenerative circuit results in linear D.C. scale. * Isolating test-prod for all D.C. Voltage ranges. * Megohm input resistance on all D.C. ranges. * Ohmmeter accurately measures from 1/10th ohm to 1 billion ohms.

SPECIFICATIONS: D.C. VOLTS: (At 11 megohms input resistance) 0 to 3/30/150/750/1,500 Volts. * A.C. VOLTS: (At 1,000 ohms per Volt) 0 to 3/30/150/750/1,500 Volts. * RESISTANCE: 0 to 1,000/10,000/100,000 ohms. 0 to 10 meg-ohms/1,000 megohms. * D.B. Based on 0db equals .008 watts (6 milliwatts) into a 500 ohm line.
-24 db to + 4 db + 10 db to + 38 db
-4 db to + 24 db + 30 db to + 58 db
Model KT 40 Kit comes complete with all parts including test leads, V.T.V.M. prod. circuit, operating instructions etc., Net only

\$19⁹⁰

The New Model 247

TUBE TESTER

Check octals, octals, hantam Jr. peanuts, television miniatures, made e7c, hearing aids, thyatrons, the new type H.F. miniatures, etc.

FEATURES: * Newly designed element selector switch reduces the possibility of obsolescence to an absolute minimum. * When checking Diode, Triode and Pentode sections of multi-purpose tubes, sections can be tested individually. A special isolating circuit allows each section to be tested as if it were in a separate envelope. * The Model 247 Provides a super-sensitive method of checking for shorts and leakages up to 5 Megohms between any and all of the terminals. * One of the most important improvements, we believe, is the fact that the 4-position fast action snap switches are all numbered in exact accordance with the standard R.M.A. numbering system. Thus, if the element terminating in pin No. 7 of a tube is under test, button No. 7 is used for that test.

Model 247 Kit comes with all parts, new speed-read chart, handsome hand-rubbed oak cabinet; slotted for bench use. A slip-on hinged cover is included for outside use.



\$21⁹⁰ NET

NOTHING ELSE TO BUY: ONLY



The Model CA-12

SIGNAL TRACER FOR FM-AM TELEVISION

Increasing Production of F.M. and Television Receivers means MORE COMPLEX Receivers. Now more than ever this time-saving method of quickly and easily LOCALIZING the exact cause of trouble becomes the "must" Method.

The only Signal Tracer in the Low Price Range Including BOTH METER AND SPEAKER!!

FEATURES: * Comparative intensity of the signal is read directly on the meter—quality of the signal is heard in the speaker. * Simple to operate—only one connecting cable—no tuning controls. * Highly sensitive—uses an improved vacuum-tube voltmeter circuit. * Tube and resistor-capacity network are built into the detector probe. * Built-in high gain amplifier—Alnico V speaker. * Completely portable—weighs 8 pounds—measures 5 1/2" x 6 1/2" x 9". MODEL CA-12 Kit includes ALL PARTS, circuit diagram and detailed operating data for the completed instrument.

NOTHING ELSE TO BUY

\$21⁹⁵ NET

The New General

V. H. F. PROBE

Uses a Silicon V.M.F. Diode which together with a resistance-capacity network provides a frequency range up to:

1000 MEGACYCLES

This probe is designed to operate in conjunction with any standard V.O.M. (with a sensitivity of 5,000 ohms per volt or better) any Electronic V.O.M. or V.T.V.M. Probe Kit includes all parts, instructions, etc.

NOTHING ELSE TO BUY: ONLY



\$3⁴⁵ NET

20% DEPOSIT REQUIRED ON ALL C.O.D. ORDERS

GENERAL ELECTRONIC DISTRIBUTING CO., INC.
98 Park Place Dept. RC-10 New York 7, N. Y.

BIG NEWS!
 ABOUT LITTLE CAPACITORS

SPRAGUE

DISC

CERAMIC BYPASS AND COUPLING CAPACITORS

These new ceramic units—no bigger than a dime—find dozens of bypass and coupling uses in both standard and FM as well as television equipment. They have higher self-resonant frequencies than conventional capacitors and fit neatly across miniature tube sockets. They're covered with a tough, protective coating which guards against moisture and heat. Sprague Disc ceramics are available in both single and money-saving dual capacitors.

Use Sprague Disc ceramics whenever circuits call for ultra-compact, bypass or coupling capacitors. Each unit is clearly stamped with capacitance. All capacitors are rated at 1000 v. test, 500 w.v.d.c.

See these remarkable new capacitors at your Sprague distributor today! Write for bulletin M 431.

SPRAGUE
PRODUCTS COMPANY
 Distributors' Division
 of the Sprague Electric Company
 NORTH ADAMS, MASS.

is added in series-aiding with the 6.3-volt winding on the power transformer to provide 12.6 volts for the heaters of the tubes.

The heater string will have to be rewired in both circuits.

The response of the amplifier may be improved by replacing the output transformer in the interphone with a high-quality, 15-watt output transformer having a 10,000-ohm center-tapped primary and a universal secondary. When

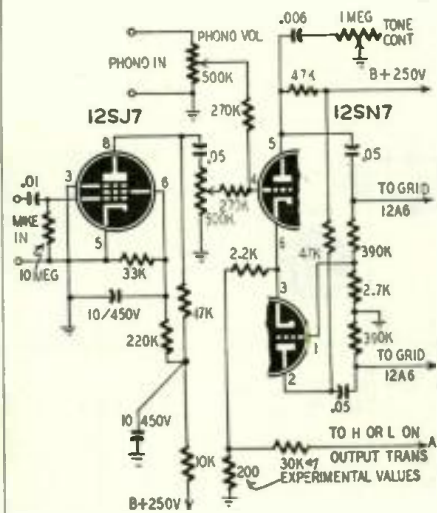

Fig. 2—High-gain amplifier for crystal mike.

this is done, lead A should connect to one of the low-impedance windings on the voice-coil side of the output transformer.

SURPLUS CONVERSION

? I purchased a surplus BC-603 receiver after being informed that it could be converted to receive standard FM broadcasts. The dealer could not supply conversion instructions and I was unable to obtain them elsewhere. Consequently, I ran into no end of trouble. Can you supply a conversion diagram and instructions?—K.A.P., Bronx, N. Y.

A. Before receiving FM broadcasts on the BC-603, you will have a job of rebuilding rather than converting it. This set was designed for narrow-band FM (20-kc average deviation) reception in the 20 to 27.9-mc band. The tuning components are so much larger than those required for the FM broadcast band that they will have to be replaced with units for 88-108-mc operation.

The low intermediate frequency (2.65 mc) means that image rejection will be practically nil on the FM broadcast band. Furthermore, the i.f. transformers not being designed to pass the 150-kc total deviation of the standard FM signal, the over-all fidelity would be poor. It is possible that you can modify the i.f. transformers in a manner similar to that described by Robert C. Paine in his article "FM Receiver From War Surplus BC-624," in the June, 1948, issue of RADIO-CRAFT. A job such as this requires lots of experimenting and patience. Good luck!

Play Safe!
 Use Reliable
TELEVISION
REPLACEMENTS

Television requires the most durable, heat-and-moisture-resistant components you can get. In capacitors, that means Sprague. You'll have no profitless callbacks with extra-dependable Sprague TV capacitors.

SPRAGUE
TELECAP
 MOLDED TUBULARS



Only Telecaps are molded in heat-resistant Bakelite phenolic, oil-impregnated, and then solder-sealed—just like metal-encased oil-paper

capacitors. No other manufacturer can make this claim! Ratings from 600 to 10,000 volts.

SPRAGUE
ATOM and TWIST-LOK
 DRY ELECTROLYTICS



The most complete line of television electrolytics. Engineered especially for tough TV replacement applications, Sprague's new Type TVA Atom and Type TVL Twist-Lok electrolytics stand up under the extremely high temperatures, high ripple currents and high surge voltages encountered in TV receivers.

Write for Sprague Bulletin M-429

SPRAGUE PRODUCTS CO.
 (Distributors' Division of the Sprague Electric Co.)
 NORTH ADAMS, MASS.

★Trademark

AMPERITE

Studio Microphones at P.A. Prices

Ideal for BROADCASTING RECORDING PUBLIC ADDRESS

"The ultimate in microphone quality," says Evan Rushing, sound engineer of the Hotel New Yorker.

- Shout right into the new Amperite Microphone—or stand 2 feet away—reproduction is always perfect.
- Not affected by any climatic conditions.
- Guaranteed to withstand severe "knocking around."



Models
RBLG—200 ohms
RBHG—Hi-imp.
List \$42.00

"Kontak" Mikes
Model SKH, list \$32.00
Model KKH, list \$18.00



Special Offer: Write for Special Introductory Offer, and 4-page illustrated folder.

AMPERITE Company, Inc.
561 BROADWAY • NEW YORK 12, N. Y.
Canada: Atlas Radio Corp., Ltd., 560 King St. W., Toronto

NEW! INSTRUMENT KITS at new low bargain prices!

5" OSCILLOSCOPE & STETHOSCOPE Model TS-7K \$46.50 FOR TELEVISION.

High quality laboratory 5" oscilloscope plus signal tracer; 2 instruments for price of one. Designed for TV and FM alignment and AM servicing. Ring Jack for probe (listed below). Permits signal tracing in any circuit through phones or screen potentiometer. These extra features in addition to conventional scope use. Built-in high gain (0.5 V/inch) amplifiers with response to 350 Kc. Complete with all tubes including 5" CR tube. Less probe and headphones. Steel case 15x9x5 1/2".

TS-7PK, Probe Kit \$4.25
TS-7, factory built \$9.95
TS-7P, factory built 8.25



DELUXE SIGNAL TRACER Model TS-3K \$22.75

Newest, fastest way to find all radio faults in minutes instead of hours. Gives you "know-how" on toughest jobs. Easy to use by expert or beginner. Test parts. Locates causes of fading, distortion, dead sets, etc. Jacks for connecting your present V.O.M. give visual reading on all RF and audio. AC operated. Steel case 8x12x6". With 4 tubes, probe and service guide.

Model TS-3, factory built \$34.95

TS-1K, Beginners' Sig. Tracer Kit \$6.75
Fact. built 9.85

TS-5K, Pocket Sig. Tracer Kit \$20.45
Fact. built 28.95

ORDER from your jobber. If he cannot supply, mail coupon to factory.



FEILER ENGINEERING CO., Dept. 10RC9
945 George Street, Chicago 14, Ill.

Please send me the following instrument: Model _____

FEILER NAME _____ ADDRESS _____

TWIN PHONO TURNTABLES

If your record player has a heavy-duty driving motor, you can use it to drive an extra turntable for quick manual changing and for producing novelty effects.

The extra turntable should be exactly the same diameter as the original and should be as light as possible to reduce drag. It should be mounted on a free-running spindle placed so a small rubber-rimmed idler wheel will touch both turntables. Mount the idler on a slotted center so a tension spring will hold it firmly against both turntables.

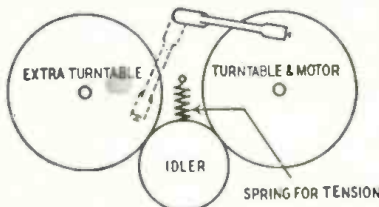

her-rimmed idler wheel will touch both turntables. Mount the idler on a slotted center so a tension spring will hold it firmly against both turntables.

W. GIBSON,
St. Catharines, Ont.

CORRECTION

There is an error in the diagram of the Forty-Niner G-M counter shown on page 20 of the September issue. There should be a vertical line along the right side of the diagram to connect the end of the 135-1200-volt high-voltage lead and the open end of the 35-megohm bleeder resistor to the lead from the bottom end of the 1-megohm resistor going to the anode of the 1B85 G-M tube.

New For 1950

MIDWEST RADIO and TELEVISION

NEW GIANT 16" PICTURE TUBE

Immense 151 square-inch screen on new 16" metal-glass tube... clear, steady, bright pictures... Synchronized sound and picture that a child can tune in perfectly... Long Distance FM Circuit... Big 12" Electro-Dynamic Panasonic Speaker... Available in beautiful consoles or in complete chassis (not a kit). Buy direct at Low Factory Prices, with Low Down Payment and Long Easy Terms... and on 30 Days Trial! Send for 32-page, 4 color catalog today.

EASY TERMS .30 DAYS TRIAL



Also a Complete New 1950 Line of

MIDWEST RADIOS

with new long distance FM Circuit and new 3-Speed Phonograph.



Send this COUPON on 1c Post Card for NEW 1950 FREE 4 Color 32 Page MIDWEST CATALOG

MIDWEST RADIO & TELEVISION CORP.
Dept. X383, 909 Broadway, Cincinnati 2, Ohio

Please send me your new FREE 1950 Catalog.

NAME _____ ADDRESS _____ CITY _____ ZONE _____ STATE _____

MID-AMERICA'S UNBEATABLE LOW PRICES

WARD ALL-CHANNEL TV ANTENNA TVH-9

Regular \$26.50

NOW ONLY **\$5.95 Each** lots of 3 \$6.25 each, singly

MA-3130



TVH-9 covers all channels; high and low bands separately adjustable. Complete with mast, universal mounting base, hardware, instructions, etc. Order while they last! Compare our low price!

- More Ward TV Bargains —
- MA-3131 TV-88, 44 to 88 MC. Complete with 60 feet of 300-ohm lead-in, insulators, mtg. hardware and instructions. Regular \$12.50 list only \$2.95
 - MA-3132 TVA-88. Same as TV-88 but less 300-ohm lead-in and insulators. only \$2.49
 - MA-3133 TVA-94, 44 to 88 MC; provides broad band, high gain. Complete with hardware and instructions. Regular list price \$10.60 \$2.49
 - MA-3134 TV-28, 174 to 216 MC. Easily attached to any dipole using a 1-inch OD mast. Allows independent orientation of either high or low base. With hardware and instructions. List price \$9.50 only \$2.95

(Write for quantity prices on all WARD TV antennas above)

Famous-Make Model 50 ANTENNA CHIMNEY MOUNT

Sturdy all-metal mount fits any average size chimney. No guy wires required. Complete with hardware and instructions. Save over 50% on this item!

MA-3135 \$1.75

— 300-Ohm Twin Lead-in —

Don't miss this great buy! Standard 300-ohm lead-in for TV and FM. Buy in quantity and save!

MA-3136: per 1000 ft. \$13.25
per 100 ft. 1.40
per foot02

Write For **BIG BARGAIN BULLETINS**

29c GENUINE DELCO RADIO TUBES 29c

Every Tube in Original Carton!

1G8GT	116GT	2E5	12SR7
1J6C	1V	787	36

Terrific Savings!

CERAMICON CONDENSERS

Made to close tolerance; rated 500 VDC. Small size with digital leads.

7c each, 10 of one type for 59c, 100 of one type for \$5.00

mmf	mmf	mmf	mmf	mmf	mmf
2	15	40	68	150	232
5	20	47	78	150	237
8	25	50	108	170	250
10	30	56	125	175	350

Famous-Make RECORD CHANGER only \$9.95

Rock-bottom Price! Takes twelve 10-inch or ten 12-inch records. Smooth, gentle change cycle. Removable metal base measures 13 1/2"x13"; overall height 7". Complete with high-quality crystal cartridge and interconnecting wires. A real steal at our low price!



ORDER FROM THIS AD!

All prices f.o.b. Chicago. 25% deposit required on C.O.D. orders, pay balance plus postage on delivery. Send orders to RC-109. Minimum order \$2.50.

MID-AMERICA CO. Inc.

STORE: 2412 S. Michigan Ave. Chicago 16, Ill.
WAREHOUSE: 2307 S. Archer Ave. Chicago 16, Ill.

OUTSTANDING TELEVISION VALUES

A completely factory wired and tested RCA type 630 television chassis, complete with 29 tubes, ready for installation in cabinet. Will operate 16" picture tube or smaller. Price (Less picture tube) **\$157.50**

SPECIAL G. E. 9" TELEVISION TUBE

White screen electromagnetic deflection and focus. Brand new, type MW 22-2. Price **\$13.95**

TELEVISION TRANSFORMER

115V/60 cycles, secondary 2500 volts at 2 MA., 6.3V at .6A, 2.5 volts at 1.75A. Price **\$3.85**

HIGH GAIN X TELEVISION ANTENNAS

Covers channels 2 to 13 without separate section. Constant non-varying center impedance. Better than 12Db front to back ratio. Can be used with 72, 150 or 300 ohm line. Works well in weak areas and gives a sharp conical beam. Price \$6.95 each less mast. Extra for 6 ft. mast **\$13.35**

FRINGE AREA ANTENNA

Stacked X Antennas for extra gain in fringe areas including heavy 10 ft. mast. Price **\$16.95**

PORTABLE RECORD PLAYERS

Dual Speed, AC/DC. U. S. government surplus, used but reconditioned. 33 1/3 & 78 R.P.M. fully adjusted speed control, embodies a 3 tube phono amplifier with electrodynamic speaker, housed in portable, black leatherette case. Price **\$16.95**

PHONO MOTORS AC/DC DUAL SPEED

"Green Flyer G. 1," type reconditioned and guaranteed. Complete with 12" turntable. Price **\$8.95**

AC PHONO MOTOR 33 1/3 RPM

Price **\$2.45**

MODEL NFRD—RADIO NOISE FILTER

made to U.S. government specification will eliminate all line noises when properly connected to radio television, motors, and electric appliances. Will carry up to 12 amps. Price **\$1.95**

SPECIAL

Mammoth assortment of radio & electronic parts of such items as transformers chokes, condensers resistors wire, coils, hardware etc. of not less than 10 pounds. Price **\$1.25**

Satisfaction guaranteed on all merchandise
All prices F. O. B. New York City

WRITE FOR FREE CATALOGUE TO

RADIO DEALERS SUPPLY CO.
154 Greenwich St. New York 6, N. Y.

ESFETA TV COURSE

Empire State Federation of Electronic Technicians (N.Y.) is launching a state-wide television course in the fall and spring of 1949-50. A series of 16 lectures by representatives of manufacturers will be held in New York City, Poughkeepsie, Rochester, and the Binghamton-Endicott area. Lectures are scheduled from September to May, with the concluding session an examination.

WARD RECEIVES AWARD

Harry E. Ward, chairman of the board of the Long Beach, Calif., Radio Technicians Association, Inc., received the Archie J. Mooney award recently from Carleton E. Webb, representing the Bureau of Apprenticeship Standards of the U. S. Department of Labor. The Technicians Apprenticeship Committee voted Mr. Ward "the most outstanding, aggressive, and valued member" in the Long Beach and harbor area for the past year.

AN OPEN LETTER

Television receiver manufacturers were addressed last month in an open letter to the industry by Max Liebowitz, writing as president of the *Associated Radio Service Technicians of New York City*. Pointing out that the manufacturers had been at considerable expense to finance the "Town Meetings" last year, he stated that some of the increase in television sales following this campaign was attributable to it.

No small part of the recent slump, which has hit television so much harder than other industries, may be traced to the manufacturers' turning away from the principles of the Town Meetings, says the ARSNY president. Instead of continuing to encourage the independent technician, they have, in effect, attempted to monopolize the service industry through setting up their own service organizations or dealing exclusively with large service contractors. Their predetermined fixed fees for all installation and service discourage the special and sometimes expensive antenna installations needed in many cases. In addition, sets with overrated components were put on the market, causing breakdowns and unnecessary service calls. The television service contractor lost money on these "sour sets," and the customer lost confidence in television.

The remedy is, according to Liebowitz, for the manufacturer to quit trying to kill the golden goose and to restore the confidence in the independent technician that was expressed at the Town Meetings. The independent technician proved more than 25 years ago that radios could be serviced more efficiently, cheaply, and satisfactorily in the independent shop than in the manufacturer's service department. The same independent technician is prepared to furnish similar efficient service in the television field.

EASY TO LEARN CODE

It is easy to learn or increase speed with an Instructograph Code Teacher. Affords the quickest and most practical method yet developed. For beginners or advanced students. Available tapes from beginner's alphabet to typical messages on all subjects. Speed range 5 to 40 WPM. Always ready—no QRM.



ENDORSED BY THOUSANDS!

The Instructograph Code Teacher literally takes the place of an operator-instructor and enables anyone to learn and master code without further assistance. Thousands of successful operators have "acquired the code" with the Instructograph System. Write today for convenient rental and purchase plans.

INSTRUCTOGRAPH COMPANY

4701 Sheridan Rd., Dept. RC, Chicago 40, ILL.

WANTED

The following old E.I.Co. apparatus:
E.I.Co. Fixed condenser (in wooden box, with 3 binding posts)
E.I.Co. 17-Slide plate, variable condenser (with wooden frame)
E.I.Co. Rotary potentiometer (in black molded case)
E.I.Co. Plastic radio fixed condenser .0185 mf (with 2 binding posts)
E.I.Co. double-slide tuner with black molded ends
All above were made between 1905 & 1910
Please communicate with
H. GERNSBACK
25 West Broadway, New York 7, N. Y.

Get Your License!



with these

BRAND-NEW BOOKS

A separate book for each element of the study-guide questions pertaining to the various classes of commercial U.S.A. radio operator licenses. You need buy only those elements required for the license you want. The F. C. C. is expected henceforth to revise questions element by element. Now, to keep up to date, you need buy only a new element, not a complete new book!

NOW READY:

Element 2: Basic Theory and Practice
Element 3: Radiotelephony
Element 4: Advanced Radiotelephony

Please do not order elements not yet announced. They will be published and announced soon after the F.C.C. completes each revision.

85¢ EACH

BUY FROM YOUR FAVORITE RADIO PARTS DEALER. If he cannot supply you, we will ship postpaid at \$1 for one, or 90¢ for two or more.

Editors and Engineers
1303 KENWOOD ROAD, SANTA BARBARA, CALIFORNIA

RADIO-ELECTRONICS for

OPPORTUNITY AD-LETS

Advertisements in this section cost 25c a word for each insertion. Name, address and initials must be included at the above rate. Cash should accompany all classified advertisements unless placed by an accredited advertising agency. No advertisement for less than ten words accepted. Ten percent discount for six issues, twenty percent for twelve issues. Objective or misleading advertisements not accepted. Advertisements for November, 1949, issue, must reach us not later than September 24, 1949. Radio-Electronics, 25 W. Broadway, New York 7, N. Y.

WANTED TO RENT—SLEEPING ROOM IN HOME OF a ham or someone interested in becoming a ham. Anywhere in Chicago or suburbs. Please write P. O. Box #41, Cicero, Ill.

Radio—Sales—Service. Sell for net inventory. Grossing \$9,000.00 annually. Box 101, Stout Falls, South Dakota.

AMATEUR RADIO LICENSES. COMPLETE THEORY preparation for passing amateur radio examination. Home study and resident courses. American Radio Institute, 101 West 63rd St., New York City. See our ad in Page 95.

MAGAZINES (BACK DATES)—FOREIGN. DOMESTIC. arts, books, booklets, subscriptions, pin-ups, etc. Catalog 10c (refunded). Cicero's, 863 First Ave., New York 17, N. Y.

RECORD CHANGER PARTS for leading makes. We ship everywhere. Friends Wholesale Distributors, 106 North Sixth Street, Philadelphia 6, Pa.

HERMAN LEWIS GORDON, REGISTERED PATENT Attorney. Patent Investigations and Opinions. Warner Building, Washington, D. C.

WE REPAIR ALL TYPES OF ELECTRICAL INSTRUMENTS. tube checkers and analyzers. Hazleton Instrument Co. (Electric Meter Laboratory), 140 Liberty Street, New York, N. Y. Telephone—Barclay 7-4239.

BARGAINS: NEW AND RECONDITIONED HALLI-crafters, National, Collins, Hammarlund, Meissner, RME, other receivers, tuners, television receivers, transmitters, etc. Wholesale prices. Terms: Shipped on trial. Liberal trade-in allowance. Write, Henry Radio, Butler, Missouri and 11240 West Olympic, Los Angeles, California.

BARGAIN HUNTING? RADIO SERVICEMEN WRITE. Sensational catalog. Henshaw Radio Supply, 3619 Troost, Kansas City 3, Missouri.

TELEPHONE DIALS, N-E Type-1 Rebuilt \$2.25. Re-adjusted \$1.25. All dials postpaid in U.S. Kissel Electric Products, 431-C Sherman, Galton, Ohio.

15 TESTED ONE TUBE CIRCUITS 10c. LABORATORIES, 578-B, San Carlos, California.

LANCASTER, ALLWINE & ROMMEL, 436 BOWEN Building, Washington, D. C. Registered Patent Attorneys. Practice before United States Patent Office. Validity and infringement investigations and opinions. Booklet and form "Evidence of Conception" forwarded upon request.

RADIOMEN, SERVICEMEN, BEGINNERS—MAKE more money, easily, quickly, \$250 weekly possible. We show you how. Information free. Merit Products, 216-32L 132nd Avenue, Springfield Gardens 13, New York.

FREE LIST, TUBES, PARTS, METRO RADIO, 605 E. 135 St., N. Y. C.

TECHNICIANS !! ENGINEERS !! Interested in a top-paying electronic position? ?? Send post card for information on HOW, WHY, WHERE, MID CONTINENT RESEARCH BUREAU, P. O. Box 121, Wichita, Kansas.

SURPLUS: BC221 FREQUENCY METERS, clean and in perfect condition, \$49.50 each. Send orders to Monarch Electric Company, 411 Wood Street, Pittsburgh 22, Pa.

BRITAIN'S BEST radio monthly, PRACTICAL WIRELESS AND PRACTICAL TELEVISION, enthusiastically read throughout United States. Latest British-European radio-television developments; exclusive articles by leading experts; newest transmitters and receivers fully analyzed. Annual subscription (12 consecutive issues direct to your address from London) only \$2.00 from George Newnes Ltd., U. S. Subscription Office (PW.45), 342 Madison Avenue, New York 17, N. Y. Two Years \$3.75.

PHONOGRAPH RECORDS 15c. Catalogue. Paramount TG-313 East Market, Wilkes-Barre, Penna.

ALUMINUM TUBING, ETC. BEAMS FOR AMATEURS. TV, FM. Lists free. Willard Radcliff, Fostoria, Ohio.

27 years experience radio repairing. Simplified system. No calculations. No formulas. Total price \$2.00 postpaid or COD. Moneyback guarantee. Ross Radio, 14615 Grandriver, Detroit 27, Mich.

"TAB" GUARANTEED TUBE BARGAINS! 6J6, 6AK5, 6AQ5, each 37c—6C4, 24c—388A, 40c—Tuning meter 5 MA, 98c. Selsyns GE-211G1 used tested, pair \$1.49. 6V Carter dynamotors permanent magnet high efficiency 400V/150 MA \$8.98; 250V/100 MA \$4.98; both units \$12.49. Write for bargain TABOGRAPH "TAB" Dept. 10-RE, 6 Church Street, New York City.

DEALERS—SERVICEMEN—HAMS Save 50% or more. Buy your TV antennas and accessories direct. Chimney Mounts \$1.25 ea. in lots of 12, singles \$1.40. Shipping wt. 4 lbs. ea. Send for complete catalog. TELEVISION SUPPLY CO., Dept. 21-K, P. O. Box 213, Grace Square Station, New York, N. Y.

GEIGER COUNTER KITS, COMPLETE PARTS LIST and schematic free. Write today. Woodward 5217-G Hollywood Boulevard, Hollywood 27, California.

ZENITH 9H881
The dial cord starts to slip after the set heats. If tightening the springs and applying various dial cord dressings does not help, a sure cure is wrapping three turns of the dial cord around the control shaft and tightening the springs.

HOMER L. DAVIDSON,
Fort Dodge, Iowa

SILVERTONE 6405
A number of these sets have come in with C12, the .05- μ f line bypass capacitor, missing from the circuit—probably an oversight on the assembly line. Although omission of this capacitor may cause tunable hum or buzzing on some stations, this is not always the case—it all depends on the condition of the a.c. line in different locations.

Connect a .05- μ f, 600-volt capacitor from the No. 3 pin on the 35Z5 to the negative bus for trouble-free operation.

L. E. VOIGT,
Rockford, Ill.

FORD 6MF780
A common cause of intermittent operation is a bad coupling capacitor between the plate of the 7A7 r.f. amplifier and the grid of the 7B8 converter. Replace this capacitor with a high-quality mica having a capacitance of approximately 100- μ mf (not critical).

ADAMS RADIO SERVICE,
Cleveland, Ohio

DEWALD A-503
If tunable hum is present and cannot be traced to poor filtering or power-line pickup, check the leads to the pilot light. These leads may be long enough to touch the built-in antenna, thus producing hum. Shorten these leads to keep them from touching the antenna and eliminate hum from this source.

PETER HICKEY,
Hoboken, N. J.

SILVERTONE 8052
If the volume drops intermittently and distortion sets in, check the 100- μ mf mica capacitor between the plate and cathode of the 7C6. This capacitor shorts intermittently causing the trouble. Replace it with a high-voltage 100- μ mf mica capacitor value.

CARL R. THORNROSE,
Chicago, Ill.

DAH DI DAH

(INVITATION TO TRANSMIT)
LEARN CODE NOW!!

Beginners, or Old Timers
who want to get up speed.

A Complete Code Practice Oscillator . . .

Operates from 115V-60 cy.—Built on a small compact chassis—Variable tone control. With Key and I1P7 Tube. Will operate with any phones or small speaker. Plug in and **\$3.45**

Use. Complete, Guaranteed.

Available less tube and key \$2.25

GREENWICH SALES CO.
59 Cortlandt St. New York 7, N. Y.

QUALITY TUBULAR CONDENSERS MONEY BACK GUARANTEE

An example of value, the 20/20-150V condenser listed below is made for us by a standard manufacturer, lists at \$1.30, our selling price—only 26c.

	PER HUNDRED		EACH
.001 — 600V . . .	\$ 3.95	.25 — 600V12
.002 — 600V . . .	3.95	.5 — 600V17
.003 — 600V . . .	4.40	10 — 50V12
.005 — 600V . . .	4.40	16 — 150V18
.01 — 600V . . .	4.40	20 — 150V24
.02 — 600V . . .	4.95	20/20 — 150V26
.03 — 600V . . .	4.95	30 — 150V28
.05 — 600V . . .	4.95	40/20/20-150V-25V	.44
.1 — 600V . . .	7.20	40/40/20-150V-25V	.44
		50/30 — 150V44
		8 — 450V27
		16 — 450V36
		16/16 — 450V49
		20 — 450V39
		30 — 450V47
		40 — 450V59
		80 — 450V97
		.005 — 1700V13
		.008 — 1700V15
		.01 — 1700V17
		.02 — 1700V19

NEW LOW PRICES ON TELEVISION CONDENSERS

.05 — 2500V	.52
.1 — 2500V	.57
.25 — 2500V	.72
.05 — 3000V	.54
.003 — 6000V	.49
.005 — 6000V	.52
.01 — 6000V	.58
.0005 — 7500V	.48
.003 — 7500V	.52
.0005 — 10000V	.54

BUY THEM BY THE HUNDREDS
5% Discount on Orders of \$50 or Over

BROOKS RADIO DIST. CORP.
80 VESEY ST., DEPT. A.
New York 7, N. Y.

To be sure your calculations are RIGHT, use



1. Fischer's RADIO & TELEVISION MATHEMATICS

Save time and trouble. In this new book you can quickly find the solution of any mathematical calculation required in radio or television work, as, for instance, the factors in distortion, television focus control, antennas, etc. Whenever you are "struck" on a problem, look in this book. Its complete index shows you immediately where to turn for the answer you want.

Over 400 sample problems, completely worked out. All the calculations commonly required in the design, operation or servicing of radio, television and modern industrial electronics are included, arranged under electronic headings where they can be easily found. All formulas, mathematical tables, and a math review are included. A highly useful handbook for anyone working in radio or television and for all those preparing for FCC license exams. \$6.00

Have you got these useful books?

2. Introduction to Practical Radio

By Tucker. Says one of the thousands of radio men using it: "I have this book and it is money well spent." It explains all radio essentials in the clearest, most practical terms, with hundreds of problems showing specifically how theory is used in the construction and servicing of radio equipment. \$3.00

3. Principles of Radio for Operators

By Atherton. Using wartime training methods this book teaches radio essentials through hundreds of illustrations and graphic demonstrations, with very simple explanatory text. \$4.00

4. Introduction to Electronics

By Hudson. Will help you understand the principles and key equipment of television and other modern electronic developments. \$3.30

5. Public Relations for Retailers

By Mahoney & Hession. The first complete practical guide to modern business techniques that the retailer can profitably use to gain public approval and increase his trade, with examples of successful public relations practices in over 200 stores throughout the country. \$4.50

SEE THEM FREE

The Macmillan Co., 60 Fifth Ave., New York 11
Please send me a copy of each of the books checked by number below. I agree to remit in full or to return the books within ten days without further obligation.

1. 2. 3. 4. 5.

Signed

Address

William Dubilier, Technical Director and founder of the CORNELL-DUBILIER ELECTRIC CORPORATION, was awarded



two of the highest honors of France at a ceremony recently held in the French Embassy in New York City.

The awards were made in considerations of his services to France both recently and during

World War I. They consisted of the Honorary Medal of the Association des Engineers-Docteurs de France and the Diploma of the Officer of the Academy and the Order of Academic Palms.

Mr. Dubilier's most recent service to France has been to provide—through the Cornell-Dubilier Electric Corporation—emergency relief for the serious French power shortage. His service in World War I was the development of a submarine detector for the government of France. He volunteered his service to France without compensation, and carried on his work at Cherbourg. His electrical method of detecting submarines was a factor in turning the tide in the French struggle against the German submarines.

Dr. Allen B. Du Mont and Earl W. Muntz were among the recent recipients of the Horatio Alger Awards presented annually by the American Schools and Colleges Association. The awards are given to leaders in American industry and government selected in a nationwide poll of school and college students on the basis of outstanding characteristics responsible for their success.

Dr. Du Mont, president of ALLEN B. DU MONT LABORATORIES, conducted television experiments in the basement of his home before becoming head of "a television empire." Mr. Muntz, president of MUNTZ TV, INC., was a door-to-door radio and automobile salesman before attaining his present position.



Austin C. Lescarboua, well-known radio journalist, publicist, and advertising man, who heads his own advertising agency at Croton-On-Hudson, New York, completed his year's term as governor of the 174th District, Rotary International.

James H. Carmine, vice-president in charge of distribution for the past two years, has been elected executive vice-president of PHILCO CORP., Philadelphia.

F. B. Atwood, formerly supervisor of industrial engineering and production control, has been appointed manufacturing superintendent for the radio tube plant of SYLVANIA ELECTRIC PRODUCTS, INC., Huntington, W. Va.

A BETTER CONE-BUY.. LEOTONE

THEY'RE GOING FAST!!... PORTABLE DC AMMETER 0-15 AMPS. COMPLETE WITH INSTRUCTIONS FOR EASY CONVERSION TO MULTI-TESTER (AC & DC volts Ohms & Milliamps)!!... 3 1/2" fan-type mirror scale. Perfect as is for testing: Electric appliances; Batteries; Motor, Automotive, Industrial & Medical Eqp't. With 38" test leads & hinged lid black crackle metal case. BRAND NEW!! Shpg. wt. 6 lbs. THOUSANDS SOLD AT TWICE THE PRICE OF

3.95

W-108 ARMY FIELD WIRE. Twisted pair (7 strand), weatherproof. Avail. only in rolls 300-450 ft. ea. Shpg. wt. 4 lbs./100 ft. PERFECT CONDITION. ONLY

1/2 FT.

CABINET HARDWARE SPECIALS!!!... Lill. SUPPORTS (stay hinge)... for safe holding of med. or hvy. cabinet lids at angles up to 70 deg. Antique bronze finish. Shpg. wt. 1 lb. SPECIAL

79¢

CABINET DRAW SLIDES... FOR CONSOLE CHANGERS, RECORDERS, XMITR RACKS, DRAWERS OF EVERY TYPE. Sturdy steel-aluminum. Smooth ball-bearing action. Shpg. wt. 2 lbs. dr. 9" extension (13" overall)... \$1.89 dr. 11" extension (15" overall)... 1.98 dr. 12 1/2" extension (18 1/2" overall)... 2.19 dr. Hvy. duty: all-steel; 12 1/2"/16 1/2"... 2.75 dr.

GRILLE CLOTH... Attractive Gold or Silver weave... 25¢ sq. ft. "OUNGER" INPUT TRANSFORMER (3/4" x 1 1/4")... for Dynamic mikes, Intercoms. low impedance pickups, etc. ea. 75¢ 3 for \$1.98

"OUNGER" OUTPUT TRANSFORMERS... 2000 ohm tapped dble. pri. to voice coil. Use with Beam Power tubes (50L6, 50B5, etc.) ea. .49; 12 for 5.00

HEARING AID AMPLIFIER ASSEMBLY (Rotonone, vacuum tube type)... To make a REAL VEST POCKET RADIO add only speaker or phone & simple tuner sect. Ready-wired miniature components include: Tone & Vol. controls, choke, output, switch, resistors, etc. COMPLETE WITH SCHEMATICS FOR BUILDING A 2 OR 3 TUBE SET. Less tubes. Overall: 2" x 1 1/2" x 5". WEIGHT ONLY 3 1/2 ozs. l. ONLY

2.49

MINIATURE TUBES for above amplifier. Set of 2... 2.49

MINIATURE ALNICO V MAGNETIC PHONE UNIT (HS-30 replacement)... Use as PM spkr. with above amplifier. Makes sensitive MAGNETIC CONTACT MIKE... ea. .39; 6 for 1.98

SOCKET SPECIALS!!! OCTALS, saddle 1 1/2" mtg. ea. .06; 18 for 1.00 4 PRONG WAFER... doz. 25¢; 100 for 1.49 LOCTAL WAFER... 12 for .50

HS-23 HEADSETS... Complete with rubber cushions... 1.25 AC-DC NEON TESTER... Handy POCKET SIZE indicates AC or DC Volts, Continuity... 15¢ 8 for 1.00

PILOT BULBS... #1816, 13V. min. bay 10 for .39 2630 KC IF's (8CR-274). Plug-in... ea. 39¢ 3 for 1.00

50 WATT-200 OHM DUAL REOSTAT... BRAND NEW. 3/4" shaft... 1.49

RADIO HARDWARE TREASURE... A FULL POUND of Nuts, Screws, Washers, Lugs, etc. All in a HANDY SELF-SEALING HINGED LID METAL CAN. Shpg. wt. 2 lbs. 49¢

INTERPHONE CONTROL BOX (BC-606)... Contains: JK-33, JK-34, 50K pot., Toggle, etc. 4" x 4" x 2". Shpg. wt. 3 lbs. 49¢

SO MUCH FOR SO LITTLE!!!... LEOTONE'S "JUMBO RADIO PARTS KIT"... 17 FULL POUNDS of new & dismantled radio & electronic parts for every RADIOMAN... TRANSFORMERS, COILS, WIRE, SOCKETS, RESISTORS, CONDENSERS, SPEAKER ACCESSORIES, HARDWARE, ETC., ETC. All these (shpg. wt. 21 lbs.) AND MUCH MORE FOR ONLY

2.95

ALUMINUM PANELS (.051) 7" x 12"-45¢ 7" x 14"-49¢ 7" x 18"-59¢

BROWN BAKELITE PANELS... 7" x 18" 9" x 15" 1 1/8" (dark) .35 .45 .55 .65 3/16 (light) .65 .85 1.05 1.15 1/4" (light) .75 .90 1.15 1.25

TUBE CARTONS... Miniature (1" sq. x 2 1/2") Per 100... .98 GT 1 1/2" sq. x 3 1/2" printed. 100... .98 Medium (1 1/2" sq. x 4 1/2") Per 100... 1.49 Large (2" sq. x 5") Per 100... 1.79

CHECK FREE SUPPLEMENTS DESIRED... RECORDING PARTS & ACCESSORIES ALNICO MAGNETS HEARING AID & MINIATURE PARTS RADIO & ELECTRONIC SUPPLIES GEARS, SHAFTS & PULLEYS MINIMUM ORDER \$2.00. 20% Deposit on all COD's Please add sufficient postage—express refunded

LEOTONE **RADIO CO.**
MAKERS OF CONES AND FIELD COILS
65-67 DEY STREET, NEW YORK 7, N.Y.
WORTH 2-0284.5
12,000 SQ. FT. OF RADIO PARTS

RADIOMEN'S HEADQUARTERS ✈ WORLD WIDE MAIL ORDER SERVICE !!

**\$9.95 TAKES ALL THREE
BIG BARGAINS "B"**

HOME WORKSHOP AT BARGAIN PRICE. Accurate and precise 2 speed guaranteed hobby lathe, the essential machine for the home workshop. Sturdy enough for light production work or factory standby service. Supplied with 36" of belt for connecting to any available electric motor or power take-off. Also included in this unbelievable offer are such accessories as a 1/2" drill chuck with specially hardened tool steel jaws, a 4" electric furnace high speed grinding wheel, a cotton buffing wheel with a large supply of buffing compound, and a 4" steel wire scratch brush. Your cost \$6.00. Sole export agent. Distributor inquiries invited.

1 SENSATIONAL, FASCINATING, MYSTERIOUS SELSYMS. Brand new Selsyms made by G. E. Company. Two or more connected together work perfectly on 110 V. A.C. Any rotation of the shaft of one Selsym and all others connected to it will rotate exactly as many degrees in the same direction, following unerringly as if the units were connected together by shafting instead of wire. This is true whether you twist the shaft of the master unit a fraction of a revolution or many revolutions. Useful for indicating direction of weather vanes, rotating directional antennas, or controlling innumerable operations from a distance. Complete with diagram and instructions. Price \$4.95. Mailed Pair \$4.95.



STROMBERG CARLSON

Power Switching Relay Box. Nest 3 1/2 x 4 x 5 1/2" Steel case with tight fitting cover finished in Stromberg's usual beautiful chocolate color crackle finish. \$1.00
Battery type BASH. 103.5v. battery used in handwalkies and mine detectors. 1x1x1 1/2". Outdated but test OK. \$1.98
Standard type normally open MICRO SWITCHES. 39c
Leaf actuator SPDT MICRO SWITCHES. 49c
Brand new fully shielded GE single button mike transformer in beautiful silver finish. \$1.99
Television 300 ohm twinline, per 500 ft. steel. \$1.99
Miniature bayonet pilot light socket per hundred. \$2.50
Universal 4 lead broadcast band oscillator coil (can be converted to 3 lead type by addition of jumper). Eight for \$3.00
Brand new motor driven hand switching turret with slug tuned 2-14 silver wire coils on ceramic form and air trimmers. 100 to 160 MC. A steel set. \$2.95

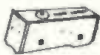

HEAT GUN



Streamlined pistol grip heat gun in vivid red housing, that delivers a powerful 20 Cubic Ft. per minute blast of hot air at 160 Fahrenheit. Ordinary blowers have small fan motors, but this has a lifetime lubricated AC-DC motor of the rugged vacuum cleaner type, that produces a hurricane of either hot or cold air. Perfect for blowing out dirt or dust from radio chassis, drying out ignition systems, warming up carburetors. Quick-drying paint, thawing out radiators of water pipes, etc. Warning: Keep this away from your wife, or she will be using it to dry her hair because it will do it in half the time of her ordinary hair dryer to say nothing of her using it to dry stockings or clothing, or defrost the refrigerator instantly. Only \$12.95. Satisfaction guaranteed or money refunded if returned prepaid within 5 days.

"P.M. SPEAKERS"



Latest type PM Speaker in a fully enclosed finished metal cabinet. This speaker and case match communication receivers, and in addition make perfect intercom remote stations. Our price \$4.50. Including output transformer. \$4.95

RT1655

Only \$14.95



11 tube crystal controlled superheterodyne receiver that covers the FM band. The ultra modern circuit uses the latest types of tubes including 7 miniature 6AJ7's. Beautiful chassis and aluminum cabinet. Tubes and diagram included.

AUDIO AMPLIFIER - Brand new, Push-Pull stage triode amplifiers having 2 of the valuable and scarce ounce type audio transformers that sell for over \$10.00 each. Neat aluminum case, fully enclosed (largest dimension 6 inches). Perfect for intercom system, phono amplifier, mike amplifier or signal tracer amplifier for testing radio sets. A sensational bargain at only \$3.40 each

COMPRESSED AIR

INSTANTLY ANYWHERE



Portable Air Compressor and Storage Tank. Specially built. Best Materials. Lifetime lubricated ball-bearing on connecting rod and oil-impregnated main bearing on shaft. Unusual design forever eliminates valve trouble, the most common fault in air compressors.

PATENTED unique air intake system increases efficiency tremendously so that air output is much greater than that from larger compressors powered by heavier motors. Delivers approximately 3500 cu. inches of air per minute at maintained pressure of 30 lbs., or will inflate a 90 lb. truck tire in less than one minute. Complete with 100 lb. gauge. Fingers-up adjustment allows setting of output pressure at any value, which will automatically be maintained. Works from any 1/2, 3/4, 1 HP motor. Useful for spraying paint, insecticide, disinfectant, insecticide, annealing or brazing with natural gas, inflating tires, etc. Price \$14.50 postpaid. Made anywhere in the U. S. Efficient, completely adjustable siphon type spray gun complete with 12 ft. of 100 lb. tested hose, only \$7.75 with pint container, also prepaid.

SENSATIONAL AC-DC Pocket Tester

This analyzer, featuring a sensitive reputation type meter housed in a bakelite case, represents the culmination of 15 years achievement in the instrument field by a large company specializing in electronic test equipment. Specifications of the AC-DC Model Volt-Ohm-milliammeter: AC Volts - 0-25, 50, 125, 250; DC Volts - 0-25, 50, 125, 250; Milliamperes AC - 0 to 50; DC Milliamperes - 0 to 50 Ohms Full Scale - 100,000; Ohm Center Scale - 2400; Capacity - .05 to 15 Mfd. Total Price, prepaid anywhere in the USA - \$7.00. Similar DC Meter, lacking the AC operated range of above. \$5.50 prepaid.



DELUXE SUPERHET A.C.-D.C. RADIO KIT.

Extra high quality standard production line radio in kit form with complete instructions. Features iron core I.F. transformers, a 2 gang condenser, and polyethylene insulated edge-wise wound antenna loop. Tubes include 12AT6, 12BA6, 12BE6, 50B5 & 35W4. Receives broadcast band from 550 to 1700 KC. Kit form \$8.75 or 2 Assembled, wired & tested \$12.95 or 2 for \$25.00

**SPECIAL ANNOUNCEMENT!!
FCC AUTHORIZES RADIO FOR
PRIVATE SERVICE!!!**

(The FCC announced that effective June 1, any American over 18 years of age may be eligible for a 5 year station permit. In the "Citizens" band, no code test or technical knowledge are necessary for voice transmissions.)

GENERAL ELECTRIC 15 TUBE TRANSMITTER-RECEIVER SET. This brand new 15 tube transmitter-receiver was designed for mobile storage battery powered service. Properly modified, it will operate on voice in the Citizens Band. It's a cinch for the experimenter to connect this unit for 110-volt a.c. operation by following the instructions and diagrams supplied, which cover numerous applications, including FM and amateur television transmitter and reception. For those intending to use on car or boat, a new dynamotor, exactly as originally supplied, costs only \$15.00. Don't fall to write for FREE descriptive bulletin. Order our RT-1248 for only \$29.95, or two for \$53.90.

MICROPHONES - Gold-plated single button midgeet carbon mike - waterproof and rugged - built for Signal Corps. May be used as lapel mike, concealed or secret pickups, for radio. **SUPER SPECIAL** - \$3.95 ea. Bullet Crystal Mikes - \$5.45; Bullet Dynamic Mikes - \$7.45.

RT 1577 with tubes diagram and parts list only \$14.95

A three stage, cascade 6SJ7's and 6F6 output stage, high gain, high fidelity amplifier with d.c. cycle, 110 v. power supply on the same 13 1/2 x 1 1/2 chassis, which is protected by a substantial steel cover over tubes and parts. Made by Western Electric with typical quality components such as a husky power transformer and oil condensers, this unit is obviously intended to give years of trouble-free service with no more need for repairs than a telephone. Disconnecting one wire each, from the special input and output filters, will result in as high a fidelity amplifier as can be obtained.



**IN LOTS OF TEN
ALL RADIO TUBES 60% OFF**

BUFFALO RADIO SUPPLY, 219-221 Genesee St., Dept. 3, BUFFALO 3, N. Y.

Ralph R. Shields and Clarence L. Simpson, engineers for the radio division of SYLVANIA ELECTRIC PRODUCTS, INC., Emporium, Pa., are scheduling a group of nation-wide meetings to be sponsored by Sylvania distributors for



service technicians to discuss and instruct on the subject of television. Meetings are being scheduled between August 15 and December 15 in 36 states and the District of Columbia.

Willis E. Phillips has been named vice-president and general manager of the RAULAND CORP., Chicago, manufacturers of television picture tubes, according to E. N. Rauland, president. Phillips was previously assistant to the president of the Rauland Corp., to which position he came from Motorola where he was division chief engineer.

OCTOBER, 1949

WHERE RADIOMEN MEET, EAT and SLEEP

Visit the FAMOUS FIESTA LOUNGE Renowned for Fine Food

HOTEL STRAND

Atlantic City's Hotel of Distinction

The Ideal Hotel for Rest and Relaxation • Beautiful Rooms • Salt Water Baths • Glass enclosed Sun Porches • Open Sun Decks atop • Delightful Cuisine • Garage on premises. • Moderate Rate Schedule.

OPEN ALL YEAR Exclusive Pennsylvania Ave. and Boardwalk

HOW TO GET THE MOST from only BASIC TEST EQUIPMENT

Servicing by Signal Substitution

The Simple, Modern, Dynamic Speed approach to receiver alignment and adjustment problems, FM-AM-TV.

- Nothing complex to learn
- No extra equipment to purchase
- Universal - non-obsolete
- Employs only Basic Test Equipment

S-S-S tells HOW - in simple, direct language.

New 9th edition now off the press. 100 pages of valuable information.

Available from all leading radio parts and equipment distributors or directly from factory at only 40c per copy.

PRECISION APPARATUS COMPANY, Inc. • 92-27 Horace Harding Blvd., Elmhurst 4, N. Y.

*** SPECIALS ***

ELECTROLYTIC CONDENSERS D.Y. TYPE
TUBULAR, PRONG MOUNT, LUG TERM.
18c ea. 10 For \$1.75

MFD.	VOLT	MFD.	VOLT
30	250	40-40	150
40	250	40-120	150
40	250	40	450
2x20	20	10	300
2x10	150	10	200
30+30	25	8	450
40+40	25	40	250
40	250	40	250
80	200	40/20	150
2x10	150	25/40	25/200
2x20	25	2x40	150
30-15	150		

DY TYPE

MFD.	VOLT	PRICE
2x10	300	\$1.75
2x20	150	.49
20/20	350/25	.49
20/30	250	.49
2x30	150	.49
30+20	150	.49
30/20	350/25	.49
10/50/100	450/100/50	.49
15-15/20	380/25	.49
15-15/40	150/25	.49
25-25/10	25/350	.49
20-20/10	50/400	.49

DS TYPE CARDBOARD W/LONG PIGTAILS

MFD.	VOLT	PRICE
2x10	450	.45
2x40	150	.45
20-20	350	.45
22-20	250	.45
30-30	150	.45
30-30	350	.45
30-30	450	.45
40-40	150	.45
40-40	250	.45
40-40	450	.45
40-40	150	.45
40-40	250	.45
40-40	450	.45
40/25	150/25	.45
40/30	150	.45
10/50/100	350/100/50	.45
10/10-10	25/150-150	.45
15	450	.45
25	350	.45
25	250	.45

MINICAPS PIGTAIL

MFD.	VOLT	PRICE
30	450	\$1.49
30	300	.45
30	350	.45
40	450	.45
40	525	.70
40	525	.45
15	525	.45
15	450	.40
15	300	.24
20	25	.25
20	50	.25
20	80	.40
24	350	.30
8	450	.30
10	150	.15
10	50	.15
4	50	.15
4	150	.14

WRITE FOR LIST OF OTHER VALUES

TOP TRANSFORMER BUY!

Power Transformers—115V/50-60 cps input

Volts Out	AMP.	Filaments	Each
770V	.0025	2.5V/3A	\$1.98
550VCT	.050	6.3V/.5, 2.5VCT/1.75	2.49
2x200V	.350	2x20V/.01	2.49
2x110VCT	.010	6.3V/10, 2.5VCT/7	3.45
2x110V	.010	6.3V/2.5, 2x2.5/7	3.45
550VCT	.100	6.3V/1.8, 6.3V/.6	2.29
580VCT	.040	5V/3	2.95
700VCT	.017	5VCT/3A	2.25
2500V	.004	2.5/2A	6.49
100VCT	.1	18VCT/10, 40V/1	3.49
85V	.100	18VCT/1, 18-6/1, 6.3/1	6.95
1500V	.100	2.5VCT/12, 30V/0.1	6.95
1100VCT	.250	6.3V/1.6	6.95
TAP. 400V	.300	6.3V/2	1.79
78V	.100	5VCT/3A	3.95
825VCT	.150	5V/3A, 2.5/2A	3.95
800VCT	.042	55V/125, 45V/7.5	3.95
2x300V	.088	5V/3, 6.3V/6	3.95
583V	.055	6.3V/1.2, 6.3/1.2	5.95
1080VCT	.155	6.3V/1.5, 5VCT/3	3.95
600VCT	.600	2x5VCT/6-2, 6.3VCT/3	14.95
1120VCT	.300	6.3V/300	2.29
215VCT	.300	5VCT/6	

Plate Transformers—115V/50-60 cps input

Volts Out	Amp.	Each	Volts Out	Amp.	Each
65V	.500	\$1.49	70V	1.	\$1.95
500VCT-	.150-.015	3.00	100V	3.	1.95
650VCT-			1620VCT	.400	11.95
2X150V	2x-.940	4.25	246VCT	.880	3.95
600VCT-	.0165-.077	2.49	111V		
250VCT			126.5V-	1.5A	2.25
600V	.450	4.95	153V		
1470VCT	1.2	24.00			

Filament Transformers—115V/50-60 cps input

Rating	Each	Rating	Each
2.5V/5AHV INS	\$1.79	30VCT/.880	\$1.95
6.3/2A, 78V/300	1.79	34VCT/.880	
36V/1.11A	1.49	6.3/2.5, 2x2.5/7	3.25
5VCT/20A	5.49	2x2.5VCT/6.5A	3.25
4V/16A, 2.5V/1.75	4.75	2x5V/1.75A, 5V/3A	3.85
HV INS		6.5V/1.8A, 6.5V/.6A	
5V/115A	12.95	10VCT/3.25A	6.95
7.2V/7A, 6.4V/10.6, 4/2	8.95	5VCT/13.5A	6.95
2x26.2V/2.5, 18V/1A	2.75	2x5VCT/6.75	
6.3VCT/1, 6.3VCT/7A	2.25	1.3V/.0091 KVA	2.95
6.3V/5A, 6.3V/1A	2.25	6.3VCT/.6A, 5V/2A	1.85
6.3VCT/3.2	2.25	2x6.3VCT/2A	2.45
6.3VCT/1A	2.25	6.3V/1A, 6.3V/1A	1.95
5V/6A	2.25	6.3V/2.5A, 2.5V/7A	3.25
6.3VCT/1A, 5V/2A	1.85	6V/3A	1.10

T.V. Transformer, 7" or 8" scope, 3000v/MA.
720vct/200MA. 6.4/8.7A, 6.4/.6A, 3/3A.
1.25/.3A. Price \$6.95

ROTARY BEAM COUPLER



RF Coupler
360° rotation
turn coupling
link. Plastic
case mount on
side. Price.... **\$2.95**

BIRCHER TUBE CLAMPS



928C
928-16
928-21
928-25
928-25
928B-16
928A-14
928C-10
928A-C1
928-A11
928-C13
928B

15c
EACH
100 FOR 13.90

CERAMICONS

MMF.	1	3	3.1	4	5	6	8.5	11	15
20	60	220	24	52	140	25	67	24	74
27	70	350	27	70	350	30	115	47	125
50	150	1000	50	150	1000	57	180	57	180
58	200		58	200		58	200		

100 FOR \$7.50

XMTR COILS AIR WOUND



80 MTR Bar Prong 100 w
in socket \$1.19
40 MTR. 5 Prong 50w plug
in socket \$1.19
160 MTR 5 Prong 50w plug
in socket \$1.19
40 MTR 3 Prong Bar 100w
in socket \$1.19

BUTTON FEED THRU

180	200	800
40	100	50
175	500	470

100 FOR \$9.50

WHIP ANTENNA

M849 & M950 for Mobile
or Dipole 7" Set 49c

RECTIFIERS

KS 9020, 20 MA. Twenty
12V Discs, 13 1/2 Dia. Two
stacks, one of 5 other 12
discs for T900. Price \$3.49
Rect. in 7.1VAC—Out 2.4V 6
3A Gal. 61289 Dual Sel.
Price \$3.49
Rect. Full Wave in. 180VAC.
Out 120VDC. 4A.
Price \$2.49
Rect. Dual Input 2.3V @
1.5A: Out w/6.5V for SCR
593-BC72B. Price \$3.49

AMPHENOL "AN" CONNECTORS



LARGE VARIETY AVAILABLE
AT GREAT SAVINGS
Send your specs and let us quote

TELEVISION RECEIVER—\$1.00

Complete instructions for building your own television receiver, 16 pages—11"x17" of pictures, pictorial diagrams, clarified schematics, 17"x22" complete schematic diagram & chassis layout. Also booklet of alignment instructions, voltage & resistance tables and troubleshooting hints.—All for \$1.00.

CERTIFIED TELEVISION LABORATORIES
Dept. C, 5507-13th Ave., Brooklyn 19, N. Y.

PROJECTION OSCILLOSCOPE

When lectures and demonstrations on electronic subjects involving oscilloscope patterns are given before large groups, making the oscilloscope traces visible to the whole audience is a problem.

Beta Electric Corp. of New York has produced a portable projection oscilloscope especially designed for large-group use. The instrument, model 701, contains a standard-type scope in a carrying case 13 x 16 x 19 inches, weighing about 60 pounds. For use, the cabinet is opened and the self-contained projection screen set on the front. The trace is bright enough to be seen in a normally lighted classroom. The screen is 16 inches wide and 12 inches high.



All the usual oscilloscope controls are present. Sensitivity is 60 mv per inch vertically and 0.65 volt per inch horizontally. Vertical amplifier response is good to 50 kc and usable to 100 kc. Horizontal sawtooth sweeps are good to 2 kc and usable to 5 kc.

LEARN

Electricity OR Radio-Television

IN THE GREAT SHOPS OF COYNE

TRAIN QUICKLY!
OLDEST, BEST EQUIPPED
SCHOOL OF ITS KIND IN U.S.
2 Opportunity Fields

Come to the Great Shops of COYNE in Chicago during our 50th Anniversary Year! Get quick, practical training in RADIO-TELEVISION at COYNE. I.T.Y. G.I. Approved. Finance plan for non-veterans. Mail Coupon Today for complete details.

NOT "HOME-STUDY" COURSES!
You learn on real, full-size equipment, not by mail. Finest staff of trained instructors to help you get ready quickly for a better job, a fine future.

FREE BOOKS Clip coupon for big illustrated Coyne book on either ELECTRICITY or RADIO-TELEVISION. Both books sent FREE if you wish. No obligation; no salesman will call. Act NOW!

B. W. COYNE, Pres.
COYNE Electrical & Radio School, Dept. 79-81H
500 S. Paulina Street, Chicago 12, Illinois

Send FREE BOOK and full details on:

ELECTRICITY RADIO-TELEVISION

NAME.....
ADDRESS.....
CITY..... STATE.....

FITTINGS for your BEAM ANTENNA



Speed the building of a neat, fully adjustable, all aluminum job.

Type HASL aluminum bracket attaches half inch tubing to 1/4" center tube, 4 for **\$3.75**

Ask for circular showing fittings for TV, FM 2, 10 and 20 meter beams.

D. H. HARRELL COMPANY
315 Fourth Street Logansport, Indiana

SIX TUBE SUPER

Three Gang Condenser

\$33.30 NET
Crown Panel
Kit Extra
\$4.50



Panel kit to fit most all makes (Please specify make of car and year model). New up-to-date latest prices. Catalog available.

Bill Sutton's
Wholesale Electronics
5th at Commerce Fort Worth, Tex.

ALL IN 1

TUBE TESTER
SET TESTER
BATTERY TESTER
CONDENSER TESTER
AUDIO R.F. - F.M.
SIGNAL GENERATOR



RCP Model 8573
at the record smashing price only

\$99.95

Every square inch solid-packed with value! Look what you get in this phenomenally low-priced tester:

(1) A complete tube tester with over 800 listings in its famous RollIndex roll chart, (2) A battery tester indicating actual voltage under rated load, (3) A capacitor tester, (4) A fixed point calibrated AM-FM signal generator, (5) An audio oscillator, and a dozen additional features.

Readable scale divisions on the ohm meter start at 0.05 ohm to 25 megohms.

DC Volts: 0, 2.5, 10, 50, 250, 1000, 5000
AC Volts: 0, 10, 50, 250, 1000, 5000
DC Milliamps: 0, .5, 2.5, 10, 50, 250, 1000
DC Amps: 0, 10
Ohms: 0, 250; 2500; 25000
Megohms: 0, 2.5, 25
Decibels: -8 to +15, 15 to 29, 29 to 49, 32 to 55
Output Voltmeter: 0, 10, 50, 250, 1000, 5000

Complete with tubes, batteries and test leads, output leads, etc., housed in natural finish oak case; hammer-tone gray panel. See this outstanding buy at your jobber today—or write for new catalogue! C.

RCP INSTRUMENTS—BEST FOR EVERY TEST

RADIO CITY PRODUCTS CO., INC.

152 West 25th St. New York 1, N. Y.

Radio Thirty-Five Years Ago In Gernsback Publications

HUGO GERNSBACK
Founder

Modern Electrician.....	1908
Electrical Experimenter.....	1913
Radio News.....	1919
Science & Invention.....	1929
Television.....	1927
Radio-Craft.....	1929
Short-Wave Craft.....	1930
Television News.....	1931
Wireless Association of America.....	1908

Some of the larger libraries in the country still have copies of ELECTRICAL EXPERIMENTER on file for interested readers.

In the October 1915 issue of ELECTRICAL EXPERIMENTER

Marconi Heads Wireless Corps of Italian Army
Tufts College Professor Devises New Wireless Control Scheme
A New Audion Receiving Circuit
A Unique Chemical Radio Amplifier
Telemechanics or Control, by Radio Waves
Efficiency in the Amateur Radio Station by Thomas W. Benson
An Almost Human Wireless Receiving Set
The "Brodie" Detector, by Thomas W. Benson
Window Screen Serves as Antenna, by Donald Palmeter
Dr. Cohen's New Navy Type Radio Set, by Harry Y. Higgs, R.E.
Spiral Indoor Aerials, by Irving Byrnes.
Hiram Maxim's Radio Station

Some Prefer a Portable



Others Prefer a Standard

But ALL Prefer TWIN-TRAX*

"The Tape Recorder
the Engineers are Buying"

When it comes to high fidelity sound equipment, it's the specifications that count with engineers. And that's why they're buying Twin-Trax—the popular-priced tape recorder with professional specifications. Extended frequency response, wide dynamic range, low hum level, easy operation, trouble-free performance! And two tracks means twice the playing time on standard tape reels, with tape costs cut in half—a saving you don't have to be an engineer to appreciate.

Write today for technical literature and professional factory discounts.

AMPLIFIER CORP. OF AMERICA
398-10 Broadway New York 13, N. Y.

GREYLOCK OFFERS YOU

TERRIFIC

TUBE VALUES!

CRYSTAL CARTRIDGE

Webster N-7, replacement for Astatic L-26, L-40, M-22, M-23, etc. Very specially priced at only... **\$1.09**

CRYSTAL PICKUP



Special pickup with high gain Webster N-7 crystal cartridge. A real buy at... **\$1.59**

PHONO MOTOR

Here's a terrific value! Special I.I.N.D.S.T.R.O.M. Motor, with 9" turntable, fully guaranteed, only... **\$1.95**

CONDENSER BUYS!



Upright Can Single Hole Mount Brand New, Fresh Stock			
Mfd.	W.V.DC	Your Cost	
8	475	39c	
8-8	475	54c	
8	600	69c	

TUBULAR ELECTROLYTICS

Top quality, fresh stock. All brand new, fully guaranteed.



Look At These Prices

8 mfd 450 V	29c
16 mfd 150 V	19c
40 mfd 150 V	29c

CHECK THIS LIST AND SAVE! Here is your opportunity to stock up on these popular tube types, NOW, while we're offering them at MONEY-SAVING PRICES! Avoid disappointment, order NOW, our stocks are large but not unlimited! All tubes shown below are individually boxed in handsome Greylock cartons, and carry standard RMA 90-day guarantee.

1L4	6BH6	6X4	12S8GT
1R5	6BJ6	6X5GT	19T8
1S5	6C4	12A6 RCA	25L6GT
1T4	6CS5GT	12A8GT	25Z6GT
1U4	6C6	12AT6	32L7GT
1U5	6J6	12AT7	35B5
3A4	6P5GT	12AU6	35C5
3Q4	6S8GT	12AU7	35W4
3S4	6SA7GT	12AX7	50B5
3V4	6SD7GT	12BA6	53
6AG5	6SJ7GT	12BA7	117Z3
6AK5	6SK7GT	12BE6	9001
6AL5	6SL7GT	12BF6	9002
6AQ5	6SN7GT	12J5GT RCA	9003
6AT6	6SQ7GT	12SA7GT	954
6AU6	6SU7GT	12SJ7GT	955
6BA7	6T8	12SK7GT	956
6BE6	6V6GT	12SN7GT	956
6BF6	6W4GT	12SQ7GT	77

Any Above Type, Each **39c**

100 Assorted

\$33.95

At these sensationally low prices, we cannot accept orders under \$10.00. All merchandise shipped F.O.B. New York City, net C.O.D. Please include 10% deposit with all C.O.D. Orders.

GREYLOCK ELECTRONICS SUPPLY CO.

30 CHURCH STREET NEW YORK 7, N. Y.

"A Trusted Name in Radio!"

TELEVISION

CATHODE RAY TUBES

First quality—fully guaranteed.

Type	Size	Your Cost Each
7JP4	7"	\$15.95
10BP4	10"	19.95
12LP4	12 1/2"	29.95
All-Glass	15" or 16"	44.95

SPEAKER SPECIALS

3", 4", or 5" PM, less output, Alnico No. 5, each... **97c**

In cartons of 30, each **87c**

6"x9" Oval PM, Alnico No. 5, 3.16 oz. magnet, each... **\$2.59**

In cartons of 24, each **\$2.39**

3" Dynamic, 3000-ohm field, each **49c**

7 1/4" PM Replacement Auto Speaker, less output, each... **\$2.25**

INDOOR ANTENNA

for Television Sets

Provides excellent reception on channels 2 to 13. Handsome, solidly constructed. Smashing Low price. Each... **\$1.49**

6 for \$7.95



This offer expires October 31, 1949. This publication must be mentioned on your order for you to buy at these special low prices.

New
Just completed Model PR-30

POLICE FM ALARM

FM RADIO RECEIVER
For **MOBILE Communications**

TUNES 30-44 MEGACYCLES

6 Tube superheterodyne, 115 volts, AC or DC. Now you may enjoy . . .

- POLICE
- MARITIME
- FIRE
- FORESTRY
- HIGHWAY TELEPHONE



\$44⁹⁵

List Price

Improved model PR-7 POLICALARM FM radio receiver tunes 152-162 megacycles; list price

\$39⁹⁵

See your radio supplier FIRST, or write Dept. RE-1

RADIO APPARATUS CORP.
303 FOUNTAIN SQUARE THEATER BLDG.
INDIANAPOLIS 3, INDIANA

NOW!

PUSH-BUTTON CONTROL

for
PEAK PERFORMANCE
on **EVERY TV CHANNEL**
WITH
SELECT-O-VISION
ANTENNA SWITCHING SYSTEM

A Complete line of
SELECTIVE ANTENNAS
are available
for use with the
SELECT-O-VISION SYSTEM

- Selects individually oriented antennas on all channels.
- Capacity for 12 antennas, permitting use of FM and UHF TV antennas.
- Instantaneous antenna selection.
- No exposed moving parts on roof.
- Ideal installation for fringe areas.
- Field and life tested. Assures trouble-free performance.

Write to-day for complete
illustrated, descriptive literature.

COMMUNICATION MEASUREMENTS LABORATORY, INC.
120 GREENWICH ST. • NEW YORK 6, N. Y.

SHOULD CONSIDER READERS

Dear Editor:

I read with interest the letter from Mr. William Krider in the July issue and your reply thereto. I agree with Mr. Krider in all but one instance. In my opinion RADIO-ELECTRONICS was a good magazine. Granted that television is new and radiomen should learn about it, suppose, as in the case of Mr. Krider, they don't want to learn about it. In my opinion, in selling magazines, the situation is definitely a buyers' market, which would indicate that the tastes of the readers must be considered rather than feeding them large doses of what the editors consider good for them.

The people who bought your magazine before this flood of television articles were interested in it for its contents then, and I doubt that their tastes have changed. You can lead a horse to a bar, but that doesn't necessarily mean he is going to be interested in the television there.

My interests in the magazine were in the fields of amateur radio and audio work, and as I considered that RADIO-ELECTRONICS was doing the best job of covering these fields of any of the general-coverage radio magazines, I subscribed to it. However, such is not now the case. I am inclined to believe that your version of the percentages of television articles does not tell the complete story. While there may have been the stated number of articles, in almost every instance each television article was considerably longer than articles devoted to other subjects, giving a much larger percentage of total reading matter devoted to television.

Mr. Krider and I are only two of your readers who have been moved to write you concerning this—to us—distasteful state of affairs. There are undoubtedly many more who feel the same way but have not troubled to write. A friend of mine, Mr. Wayne Brown, a radio maintenance technician with the CAA at Skwentna, Alaska, also a subscriber, has reached the point where he glances through the magazine and throws it away without reading it.

Obviously the editors have one opinion as to the value of television to the magazine and no small segment of the readers have another. A poll of your readers conducted through the pages of your magazine wouldn't cost you a dime and might prove rather interesting.

Unless the magazine undergoes a drastic change and reverts to the former editorial policy, my subscription will not be renewed. I seriously doubt that Mr. Brown will renew his.

CARL L. SHUTE
Gulkana, Alaska

The matter of television articles in RADIO-ELECTRONICS has come up repeatedly in the past and probably will keep recurring until television has reached a density throughout the country similar to that of sound radio broadcasting.

No publication is worth its salt if it does not keep up with trends. At the

RADIO-ELECTRONICS for

present time the television trend is on the up-curve and will continue so until a saturation or near-saturation point has been reached.

It is a fact that television already reaches between 50 and 60% of the population in the U. S. This is a big percentage; if RADIO-ELECTRONICS did not keep this trend in mind, it would not stay in business very long.

It is true that the complaints on television articles—which, frankly, have increased during the past year in RADIO-ELECTRONICS—come exclusively from readers who are not now located in a television zone. But, certainly, these readers should know and appreciate that sooner or later they too will have television and that now is the time to get acquainted with it and not wait until broadcasting starts.

Our present correspondent is located in Alaska where, of course, there is no television at the present time. We can readily understand his displeasure with television articles, which at the moment do not seem to do him much good. But, sooner or later Alaska too will have television and we are certain that our correspondent does not wish to be a back number then. If there were no television articles in RADIO-ELECTRONICS, our correspondent would then have to start from scratch to learn television, which, at that time would certainly prove a handicap to him.

Contrary to the views of our correspondent and others similarly minded, RADIO-ELECTRONICS' editors have no opinions as to the value of television to the magazine—they are only interested in serving the majority of the readers. And, the majority of the readers in the United States today overwhelmingly want television.—Editor

U.S. HAS RADIO AMBULANCES

Dear Editor:

I noticed in the April "European Report" that British ambulances are now being equipped with two-way radio. An editor's note said this would be a good idea for American cities.

I agree with the editor but would like to point out that his proposal is several years late. For the past seven years, the Sheriff's office radio division in Alameda County, Calif., for which I work, has made use of such an arrangement, and all major California cities have radio-controlled ambulances, either municipally owned or operated on contract.

ARTHUR E. ALLEN, JR.,
Hayward, Calif.

CORRECTION

Dear Editor:

I noted an error in the formula given in Step No. 4 in the calibrating instructions in my article "Frequency Bridge for Audio" in the August, 1949, issue. The formula now reads $K_A = \sqrt{R1} \times R2$. It should be $K_A = f\sqrt{R1} \times R2$.

K. A. FORNSBERG,
Cambridge, Mass.

HICKOK
610-A



Features
FOR TODAY AND THE FUTURE

1. Complete frequency coverage.
2. Variable, self-contained markers.
3. Crystal markers, any frequency, modulated or unmodulated.
4. Outstandingly stable.
5. High output.
6. Excellent attenuation.
7. Enables you to align any TV receiver independent of any local station. This generator is complete, and will remain up-to-date for a long time to come.

Thousands of the HICKOK Model 610 have been in use by leading technicians for over a year.

The complete
TELEVISION
Generator
with
SELF-CONTAINED
MARKERS

makes your
TV SERVICING

RAPID
ACCURATE
PROFITABLE

WITH THE HICKOK MODEL 610

you can

- ✓ Align I.F.
- ✓ Align R.F.
- ✓ Align Oscillators
- ✓ Align Traps
- ✓ Insert Markers (3 types)
Oscillator, Absorption,
Crystal
- ✓ Cover all TV channels



For over 39 years builders of the finest electrical and electronic test instruments.

THE HICKOK ELECTRICAL INSTRUMENT CO.
10531 DUPONT AVE. CLEVELAND 8, OHIO

Please send me full details on the complete new HICKOK 600 series Television test equipment, including the brand-new linearity Pattern Generator.

NAME _____
STREET & NO. _____
CITY _____ ZONE _____ STATE _____

ATTENTION!

• MANUFACTURERS •
RADIO & TELEVISION SCHOOLS

A COMPLETE LINE OF RADIO AND TELEVISION TUBES

- Consult us first for your tube requirements
- Complete kits available at lowest prices
- All tubes individually boxed or bulk, whichever preferred
- All tubes branded N. J. R. T.
- All tubes unconditionally guaranteed
- Open accounts available for reputable concerns

• 150,000 of some types available

NEW JERSEY RADIO & TELEVISION TUBE CO.

715 Elizabeth Ave. Elizabeth 4, N. J. Tel. Elizabeth 2-5180

NOW... THE FAMOUS #630 TYPE TELEVISION CHASSIS THAT HAS SET A STANDARD FOR THE TELEVISION INDUSTRY OFFERED TO YOU IN A 16 INCH CHASSIS

Not in kit form, completely wired and ready to operate

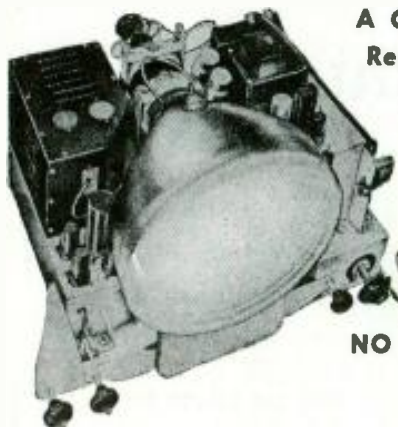

A COMPLETE TELEVISION CHASSIS Ready for Custom Built Installation

Licensed by RCA

- Built-in voltage doubler
- 31 RCA tubes incl. rectifiers
- RCA 13-channel tuner
- 16" brackets included
- Automatic picture stabilizer
- Long-range fringe reception
- New improved daylight viewing
- Dimensions W-21 1/2" H-10" D-16"

NO FINER RECEIVER AT ANY PRICE

Your Net Price Complete as Pictured (Less C-R Tube) **\$179.45**

16" RCA C-R Tube #16AP4 (Metal).....\$ 54.25

16" TEL-O-TUBE C-R Tube #16CP4 (Glass).....\$ 57.50

BEAUTIFUL TV CABINET



Fits any 630 type chassis. In Genuine Mahogany or Walnut. Incl. Safety glass & supports. W—23 3/4", H—24", D—24 1/2".

Special **\$47.50**

G.I. 3 SPEED CHANGER



Plays all 33 1/2, 45 & 78 RPM records. Simple, streamlined. Combine with your radio or TV set.

Complete ready to operate. **\$23.49**



TWIN TRANSMISSION WIRE

(300 Ohms)

100 foot hank.....\$ 1.39
500 foot spool..... 6.45
1000 feet 11.95

HIGH VOLTAGE FLYBACK

Horizontal Output Transformer



Similar to RCA No. 211-T5. Ample stepped up voltage to convert your 10" receiver to a 16 inch set.

Only **\$4.89**

ALL CHANNEL ANTENNA

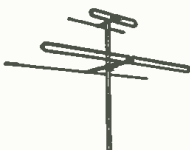

Covers all TV & FM channels. Tuned impedance for line matching. Assembles in a jiffy. 10 ft. upright. List price, \$14.75.

Yours for **\$7.37**

INDOOR TV ANTENNA



Instantaneous adjustment, chrome telescoping dipoles. Excellent performance. 300 ohm lead-in included. Regular price \$6.95.

Special at **\$3.89**



COAXIAL CABLE #RG59U (72 Ohms)

100 foot hanks..\$ 4.65
500 foot spool.. 21.95
1000 feet 39.85

RCA FRONT-END TUNER



Complete ready to install: Pre-aligned and tested. Incl. 3 6J6 tubes.

Net **\$28.95**

GUARANTEED TELEVISION TUBES, RCA, SYLVANIA, ETC.

1B3GT\$1.49	6AC7\$.79	68G6G\$1.59
5U4G59	6AG569	6SH759
5V4G85	6AL579	6SK7GT49
6J549	6AT679	6SN769
6J669	6AU679	10BP4 24.95
6H6GT39	6BA679	12LP4 39.50

IMMEDIATE DELIVERY—SEND 20% DEPOSIT WITH ORDER

BROOKS RADIO DISTRIBUTING CORP.

80 VESEY ST. (Dept. A) NEW YORK 7, N. Y.

We manufacture
Twin-Lead

TELEVISION

TRANSMISSION WIRE

Wholesalers and Distributors Write, Wire or Phone for quantity prices.

Our prices are the lowest
JERSEY SPECIALTY CO.

Little Falls, N. J.

Phone Little Falls 4-0784—1258

Check these Prices!



SELENIUM RECTIFIERS

115 VOLTS

For Radio & Television Application.

fully guaranteed	lots of 10, each	lots of 100, each
75 MA	.55	.50
100 MA	.64	.56
150 MA	.72	.66
200 MA	.89	.78
250 MA	1.16	.88

OPAD-GREEN COMPANY

71 Warren St., N. Y. 7, N. Y. B Eekman 3-7385-6

Now... shortcut your mastery of the best

TELEVISION SERVICING TECHNIQUES



Here is an up-to-the-minute manual covering TV receiver installation and servicing. You get a detailed picture of both AM and FM circuits, operation, and servicing. Everyday TV receiver jobs go faster with the understanding of fundamentals you get in this down-to-earth manual.

Elaborate trouble-shooting charts show symptoms, causes and cures for over 50 common TV receiver problems. Simplified diagrams, schematic drawings, and photographs help show you what to do and how to do it.

Just Published!

BASIC TELEVISION PRINCIPLES AND SERVICING

By **BERNARD GROB**
Instructor, RCA Institutes
592 pages, 6 x 9, over 400 tables, charts, illustrations
\$6.50

This new book combines well-rounded self-instruction in basic TV Principles with Practical, ready-reference receiver trouble-shooting guidance. Each block of receiver circuits is discussed separately to ensure clear understanding of all details. You get more than enough material to qualify for the FCC's added FM and TV requirements for the 1st class license test.

COVERS

- Oscilloscope operation
- Ratio detector system and intercarrier sound receivers
- Automatic synchronizing control and synchroscan system
- Projection systems
- Sequential, simultaneous color TV
- Picture tubes from 3NP4 to 20BP4
- Power supplies
- Brightness control
- Separation of synchronizing signals, etc., etc.

10 DAYS FREE EXAMINATION

McGraw-Hill Book Co., 330 W. 42nd St., NYC 18
Send me Grob's BASIC TELEVISION Principles & Servicing for 10 days' examination on approval. In 10 days I will remit \$6.50. Plus few cents for delivery, or return book postpaid. (We pay for delivery if you remit with this coupon; same return privilege.)

Name
Address
City Zone State
Company
Position RC-10-49

RADIO-ELECTRONICS for

PRO AND CON

Dear Editor:

Your August article, "Improve Your Television Pictures," is the best thing along these lines I have seen in many years. I feel that the man in the street wants to know a little bit about his TV. This kind of thing will reduce service calls, I'm sure.

Maybe I can guess why so many people pick on radio repairmen but not on washing-machine servicemen and so on. Radio is glamorous and newsworthy while washing machines are helpful but humdrum. Everybody talks about radio and TV programs—but who talks about washing machines?

BART BYRNE,
North Pelham, N. Y.

Dear Editor:

As far as I am concerned, any of my customers who attempt to adjust their own sets will be charged for the subsequent service call it will take to put the sets back in working order.

Your article is not an asset to the trade nor to the layman.

W. R. COBB,
Silver Spring, Md.

LIKED TRAINING ARTICLE

Dear Editor:

I want to thank you for the article, "Training for Radio," on page 53 of the August issue. Articles written for those of us just starting in the field of electronics are not only helpful but encouraging. In aiding youth I think you are insuring a better and expanding industry for the future.

ROBERT C. CARDEN III,
Richmond, Va.

THE ARM WITH A HAND

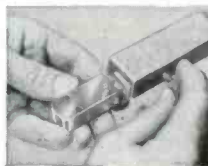

A fine quality tone arm that features the new "SLIDE-IN" cartridge holder. It fits any cartridge—just a quick twist of the thumb screw and the cartridge is securely held in place. No need for soldering. Silver plated spring loaded plungers maintain positive electrical contact. The quick act-



CLARKSTAN RV WIDE RANGE PICKUP WITH EASILY REMOVABLE STYLUS

This wide range variable reluctance pickup meets the requirements of discerning users and FM specifications. Removable and interchangeable still available with various tip radii for all types records, LP micro-groove, etc. See your jobber or write for Bulletin No. 141B.

HAS SLIDE-IN CARTRIDGE HOLDER



ing weight adjustment gives positive and accurate balance plus proper needle force. Meets all requirements for LP records as well as standard speed and groove sizes. Arm made in two sizes, for records up to 12" and also up to 17". See your jobber or write for Bulletin No. 172B.

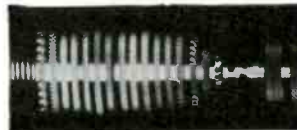

STEADY STATE FREQUENCY RECORDS

Clarkstan now offers three new test records which for the first time conform to exact specifications, permitting the user to work in known quantities. The reproduction of these fine test records involves no polishing and employs the very latest techniques which insures exact duplication of the original recordings in each pressing. Complete specifications of the original recordings are furnished. See your jobber or write for Bulletin No. 181B.

CLARKSTAN

CORPORATION
11927 WEST PICO BOULEVARD
LOS ANGELES 34, CALIFORNIA

UNIVERSAL SAVES U 50%



2 STATION INTERCOM KIT \$9.95

A must item for offices, schools, churches, etc. A wonderful bargain at the price. COMPLETE KIT—ALL PARTS. TUBES & 2 SPEAKERS



25 WATT P.P. 516 HI GAIN AMPLIFIER KIT

A wonderful buy! Make up an amplifier worth \$50 to you. Powerful enough for auditoriums seating 1500 people. Separately controlled Mike & Phono inputs. All parts, incl. drilled chassis, hardware, solder, circuit diagram, etc. Less tubes, 2 1/2 lb., net. 13 lbs.

\$11.95 ea.



PHONO OSCILLATOR 2 TUBE KIT

If you know value, this is it! Orders come from Maine to Miami, Sandy Hook to San Francisco... 111 gain with microphone jack and all parts including tubes. 2 1/2 lb. net. 2 lbs.

\$2.95 ea.

PRICES NET F.O.B. OUR PLANT. Write for FREE data circuits designed by ROBT. G. HERZOG.

Universal/general corp
365 J CANAL ST. N. Y. 13,
Walker 5-9642



MODEL 292X

Hickok New Mobile Radio MICROVOLT GENERATOR

Accuracy to .005%

World Famous

THE HICKOK ELECTRICAL INSTRUMENT CO.
10531 DUPONT AVE. CLEVELAND 8, OHIO

SEE YOUR JOBBER OR WRITE FOR COMPLETE INFORMATION TODAY



in KANSAS CITY, MO. the exact Center of America

DAYS CLOSER TO EVERYWHERE

A FAST . . . RELIABLE . . . ONE STOP SOURCE FOR EVERYTHING IN RADIO—TELEVISION—ELECTRONICS.



Catalog No. 501, 144 big pages now being mailed to Dealers, Servicemen, Broadcast Stations, Schools, Factories, Public Utilities, Laboratories, Engineers, Amateurs, Experimenters.

Its FREE . . . Write us if you haven't received it.

BURSTEIN-APPLEBEE CO.
1012 McGee St., Kansas City 6, Mo.

Send me your FREE catalog;

NAME _____

ADDRESS _____

TOWN _____ STATE _____



JACKSON TEST OSCILLATOR

\$49.50

YOUR COST



New Jackson Model 106 Challenger Test Oscillator tests both AM and FM radios. Serves as Marker Generator for AM, FM, and TV Sweep Generators. Fundamental frequencies from 100 Kc to 32 Mc. Has 400 cycle modulated signal or straight CW. Accuracy: 1/2 of 1% on all ranges. Write for yours today.

Write for FREE Broadcaster newspaper

10% Cash with Orders

Phone LO 3-9255

509 ARCH ST., PHILA., PENN.
SIXTH & ORANGE, WILMINGTON, DEL.
6205 MARKET ST., W. PHILA., PA.

ATTENTION Amateurs-Experimenters-Inventors

Cut your cost on radio supplies and equipment in half. Clip coupon today.

Hundreds of "hard to get" war surplus items along with the best in standard brand equipment—all at great savings to you. Let us know your particular requirements. IMMEDIATE DELIVERY.

PLEASE PUT MY NAME ON YOUR MAILING LIST FOR SPECIAL BULLETINS.

NAME _____ ZONE _____
ADDRESS _____ CITY _____ STATE _____

NIAGARA RADIO SUPPLY CORP.

160 Greenwich St., Dept. C-109, New York City 6, N.Y.

BIG MONEY IN RADIO & TELEVISION

New 7-Volume Set

FREE for 7 days trial

APPLIED PRACTICAL

RADIO

Be The Radio Expert Of Your Locality Who Handles The Toughest Service Jobs.

This new 7 volume set gives you solid working knowledge of Radio and Television. Covers everything from fundamentals to newest in FM Television, Electronics, etc. Clear, practical, Tells you how to construct, install, service. Short-cut trouble shooting methods. Handy "on the job" manual included. More than 2500 pages. 1200 illustrations, charts, diagrams.

FREE TRIAL OFFER Examine these great, pay raising books for 7 days at our expense. Just mail coupon below.

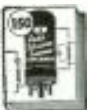

FREE RADIO-TELEVISION DIAGRAM BOOK

Act at once and get with APPLIED RADIO, book of 1150 Radio-Television Diagrams Explained, as a FREE Gift. Keep it even if you send the set back after 7 days Free Trial. If you keep the set, send either \$22 cash, or \$3 in 7 days and \$3 a month until \$23.50 is paid. Either way, Diagrams book is yours! Send coupon TODAY! It's not an order—just a request to see the Set and get the Diagrams book Free. Act now!

GOOD FOR FREE TRIAL and FREE BOOK!

Educational Book Publishing Division
COYNE ELECTRICAL & RADIO SCHOOL
500 S. Paulina St., Dept. 79-T1, Chicago 12, Ill.

Rush 7-Volume APPLIED PRACTICAL RADIO, post-paid, for 7 days Free Examination per your offer. Include FREE Book of 150 Radio-Television Diagrams.

Name _____ Age _____
Address _____
Town _____ Zone _____ State _____

Index to Advertisers

Allied Radio Corporation	49
Aimo Radio Co.	96
American Electrical Heater Co.	8
Amperite Co.	83
Amplifier Corp. of America	89
Arrow Electronics	97
Atlantic Industrial Corp.	82
Bell Telephone Labs., Inc.	69
Boland & Boyce, Inc.	10
Brooks Radio Dist. Co.	85, 92
Buffalo Radio Supply	87
Burstein Applebee	93
Capital Radio Engineering Institute	7
Cargille	96
Certified Television Laboratories	88
Cinex, Inc.	78
Clarkston Corp.	93
Cleveland Institute of Radio Electronics	18
Communications Equipment Company	88
Communication Measurements Lab., Inc.	90
Coyne Electrical School	80, 96
DeForest's Training, Incorporated	11
Editors & Engineers	84
Electronic Measurements Company	78
Esse Radio Company	60, 61, 62
Feiler Engineering Company	83
General Electronic Distributing Co.	55, 79
General Test Equipment Company	82
Greenwich Sales Company	85
Greylock Electronic Supply Co.	89
D. H. Harrell Co.	88
Heath Company	13, 14, 15, 16, 17
Louis M. Herman Co.	73
Hershel Radio Company	59
Hickok Electrical Instrument Co.	91, 93
Hotel Strand	87
Instructograph Company	84
International Resistance Company	76, 77
JFD	95
Jersey Specialty Company	92
The JRI Trainers	75
Lafayette-Concord	71
Lafone Radio Corporation	86
Liberty Electronics	97
The Macmillan Company	86
McGee Radio Company	67
McGraw-Hill Book Company, Inc.	92
Magnecessories	95
Mechanics School	97
Meissner Manufacturing Company	96
Mid-America Company	83
Midwest Radio Corporation	83
Montgomery Ward & Company	74
Murray Hill Books, Incorporated	9, 65
National Co.	75
National Radio Institute	3
National Schools	5
National Union Radio Corporation	5
Inside Front Cover	
New Jersey Radio & Television Tube Co.	91
Niagara Radio Supply	96
Opad-Green Company	92
Opportunity Adlets	85
Pacific Training School	75
Plastics & Electronics Company	97
Precision Apparatus Company	87
Progressive Electronics Company	80
Quam Nichols Company	97

RADIO SCHOOL DIRECTORY

(Pages 94-95)

American Radio Institute	
Baltimore Technical Institute	
Candler System Company	
Commercial Radio Institute	
Commercial Trades Institute	
Don Martin School of Radio Arts	
Hollywood Sound Institute, Inc.	
Milwaukee School of Engineering	
RCA Institutes	
Radio Television Institute	
Tri-State College	
Valparaiso Technical Institute	
Western Radio TV Institute	
YMCA Schools	

Radio Apparatus Company	90
Radio City Products Company, Inc.	89
Radio Dealers Supply Company	84
Radio Receptor Company, Inc.	66
Radio Supply & Engineering Company	74
Radionic Equipment Company	82
The Rosticrations	97
Howard W. Sams & Company, Inc.	57
Senco Radio, Incorporated	51
Simpson Electric Company	6
Sprague Products Company	81
Sprayberry Academy of Radio	Inside Back Cover
Bill Suttan's Wholesale Electronics	88
Sylvania Electric Products	12
Teletik	4
Transvision	54
Triplett Mfg. Company	Back Cover
United Surplus Materials	70
Universal General Corporation	93
D. Van Nostrand Company, Inc.	75
Wells Sales, Incorporated	98
Wholesale Radio Parts Company, Inc.	82



MEISSNER

"HOW TO BUILD" instruction manual

160 Big Pages Costs Only \$1.00

Yes, here's a manual chock full of information, detailed description profusely illustrated with charts, radio formulae, schematic circuit diagrams and pictorial wiring diagrams.

It contains a wealth of information on basic theory, design and construction of:

- AM circuits
- Audio Amplifiers
- FM circuits
- Speakers
- TV circuits
- Disc Recorders
- Phono pickups
- Many Others

There's also useful coil design and circuit application data for the serviceman and experimenter. An ideal manual for beginners, advanced students and instructors. Get a copy from your MEISSNER jobber today!

MEISSNER

Mfg. Div. Maguire Industries, Inc.
Mt. Carmel, Illinois

"ALL-SEE" TRANSPARENT BOXES!

Safe and Loss-Proof Containers for

- Screws • Nuts
- Small Parts

Guard those small parts—so easy to lose and very hard to replace—with a set of these "All-See" Plastic transparent containers and covers. Assure easy and safe storage. Pay for yourself!

Each set contains: one box, 1 1/2" sq.; five boxes, 1 1/4" x 1 1/2"; four boxes, 1 1/8" sq. 10 boxes in all.

Transparent case. Order a set for yourself and a set for that tinkering pal of yours. An inexpensive and unusual gift. No \$1.00 C.O.D.'s, please. Remit \$1 for each order complete set (6 for \$5). Or send for FREE leaflet BC.

GARGILLE, Dept. RC, 116 Liberty St. New York, N. Y.

MODERN WONDERS & HOW THEY WORK, by Capt. Burr W. Leyson. Published by E. P. Dutton & Co., Inc., New York. 5½ x 8¼ inches, 216 pages. Price \$3.50.

Written for the layman with some knowledge of general science, this volume undertakes to explain the atomic bomb, rockets, jet engines, supersonic speeds, guided missiles, automatic pilots, radar, ground-controlled approach (GCA), color television, and space ships.

The explanations are simplified to a great extent, but not to the point of the ordinary "popular" book.—*R.H.D.*

MOST OFTEN NEEDED 1949 TELEVISION SERVICE INFORMATION, compiled by M. N. Beiman. Published by Supreme Publications, Chicago. 8¾ x 10¾ inches. 193 pages. Price \$3.

The service manuals of 16 television receivers, representing 13 manufacturers, are brought together in this compilation. A number of the schematics are printed in blue-print form on folded sheets a little less than twice the page size.

In view of the tremendous popularity of a small number of models, this book—supplemented by its predecessors in the same series—will probably cover a majority of the sets the service technician is likely to be called upon to handle.

ULTRASONICS, by Benson Carlin. Published by McGraw-Hill Book Co., New York. N. Y. 6 x 9 inches, 276 pages. Price \$5.00.

The field of ultrasonics is comparatively new, and is literature so surprisingly scanty that this book is therefore all the more welcome. It gives, on the engineering level, a qualitative treatment of ultrasonic theory and a large quantity of material on practical techniques.

Various types of generators and receivers are described, with special attention given to impedance matching to loads. The action of waves in given materials is discussed at length, resonance, reflection, simultaneous waves of different types, and other considerations all being covered.

Subjects such as pulsed ultrasonic systems, ultrasonic agitation, and material testing are treated in considerable detail, with ultrasonic signaling also receiving some attention.

COMMUNICATION CIRCUITS, by Lawrence A. Ware and Henry R. Reed. Published by John Wiley & Sons, Inc., New York. 6 x 9¼ inches, 403 pages. Price \$5.

This is a textbook on transmission-line theory written by two professors of electrical engineering. Prof. Ware is at the State University of Iowa and Prof. Reed at the University of Maryland.

The book was first published in 1942. In this third edition the authors have added material on high frequencies and have brought the text up to date on the basis of techniques developed during the war. The treatment is wholly mathematical, a knowledge of calculus being required of the reader.—*R.H.D.*

OCTOBER, 1949

MIND POWER

A FREE BOOK

Develop your personal, creative power! Awaken the silent, sleeping forces in your own consciousness. Become Master of your own life. Push aside all obstacles with a new energy you have overlooked. The Rosicrucians know how, and will help you apply the greatest of all powers in man's control. Create health and abundance for yourself. Write for Free book, "The Mastery of Life." It tells how you may receive these teachings for study and use. It means the dawn of a new day for you. . . Address: Scribe L.A.1

The ROSICRUCIANS
SAN JOSE (AMORC) CALIFORNIA

Learn REFRIGERATION AND AIR CONDITIONING

FREE! PLAN FOR YOUR SUCCESS

EXTRA CASH NOW - Spare time at home - Earn while you learn by doing with Easy Home Course. **START YOUR OWN BUSINESS** - No Experience Needed. Special tools & equipment furnished. Send for **FREE BOOK** - TODAY!

MECHANICS TRAINING SCHOOL Dept. C910
7217 South Broadway * Los Angeles 3, California

SUB-MINIATURE PRINTED ELECTRONIC CIRCUITS

Components and assemblies available from stock! Circuits printed on ceramic, plastic and paper bases • Designed for miniature radio and electronic applications.

SAMPLES

- Single Stage Circuits
- Voltage Amplifier
- Power Amplifier

.85 x 1.90 x .285 in.

High temperature resistors, silver leads and capacitors fired on special vitreous base. Complete amplifier less popular brand subminiature tube \$2.99 each. State amplifier desired. C.O.D. orders.

PLASTICS & ELECTRONICS COMPANY
272 Northland Ave. Buffalo 8, New York

HEADQUARTERS FOR ELECTRONIC TUBES IN ALL QUANTITIES

5000 Magnetrons, 1000 Kylstrons
500,000 other tubes. Write for our Bulletin and Prices.

LIBERTY ELECTRONICS, INC.
135 LIBERTY STREET NEW YORK 6, N. Y.
PHONE WORTH 4-8262

WARNING!

The Universal Mounting Bracket furnished with Quam Adjust-a-Cone Speakers was originated, designed and produced by the Quam-Nichols Company.

Its use by other manufacturers has not been authorized.

J. J. Quam

QUAM-NICHOLS COMPANY

522 East 33rd Place, Chicago 16, Illinois

MAKERS OF FINE SPEAKERS SINCE 1923

FREE TELEVISION FREE

OF

ALL T-V COMPONENTS EQUIPMENT • PARTS • KITS CABINETS • ANTENNAS, ETC.

WRITE DEPT. 200

ARROW ELECTRONICS
I N C O R P O R A T E D
82 CORTLANDT STREET • N. Y. C. 7, N. Y.

RADIO-ELECTRONIC Components by the Thousands!

6 OUTSTANDING VALUES FROM WELLS' FAMOUS STOCK



Heavy Duty Blower

Centrifugal type blower for cooling your transmitter or dark room. Adjustable air control. Capacity 200 CFM. 115 VAC. Price only \$12.95.

Junior Centrifugal Blower with 75 CFM capacity—\$6.95.

S Meter

Add an S meter to your receiver at low cost. High grade 5 mil movement. 2 inch barrel. Only \$1.25.



Servo Amplifier

Beautiful 7 tube amplifier complete with 6 relays for servo system operation. Parts alone worth several times our low price. New in original packing—only \$11.95.

Fractional H. P. Motor

Perfectly built, silent running motor originally built for ART/13 tuner. 3900 RPM. 1/20 HP. Instructions for operating on 115 VAC. Makes a fine sewing machine motor. Priced very low at \$7.95.



Circuit Breaker

25 Ampere circuit breaker protects your equipment in case of overload. Ideal for replacing household fuse boxes. Price only \$1.95.



Relay for Electronic Keyer

Sensitive type relay, 3500 ohms, SPDT contact for use in electronic keyer described in QST October 1948. Our stock No. 110. Price only \$1.50 each or \$2.75 per pair.



WELLS

TUBE DEPARTMENT

Brand new, standard make tubes by the thousands are ready for immediate delivery at the lowest prices in our history. Check this list for exceptional values.

Type	Price	Type	Price	Type	Price
O1A	\$0.45	10Y/VT-25	\$0.45	707B	\$23.25
1B22	4.35	12A6	.25	710A	2.15
1N21 Xtal Diode	.65	12K8	.65	713A	1.55
1N21B ..	.80	12SF7	.70	714AY	9.95
1N23 ..	.80	12SH7	.40	RK715B	7.95
1N23A ..	.85	12SK7	.60	717A	.90
1N27 ..	.85	12SL7/GT	.70	721A	3.95
1R4/1294	.65	12SR7	.40	724A	4.65
1R5	.95	12x825 2 amp.	2.25	724B	4.25
1S5	.95	13-4 Ballast	.35	725A	19.95
1S21	1.10	15R	1.40	726A	11.95
1T4	.95	FG-17	2.85	730A	19.95
2C26	.35	REL-21	3.25	801	.60
2C26A	.45	23D4 Ballast	.45	801A	.75
2C34	.55	25Z6/GT	.55	803	6.95
2J21A	11.45	28D7	.40	804	9.95
2J22	9.85	30/VT-67	.75	805	5.45
2J26	8.45	33/VT-33	.75	808	1.75
2J27	14.45	RK-34	.45	809	2.75
2J31	9.95	34	.35	810	7.95
2J32	14.85	39/44	.35	811	2.35
2J33	19.95	45 Spec.	.55	813	7.85
2J37	13.85	46	.80	814	3.75
2J38	12.95	EF50/VT250	.45	815	2.85
2J48	14.95	CEO 72	1.50	826	.49
2X2/879	.65	72/3B24	1.75	829	3.25
3A4	.35	VR-75	.90	830B	3.95
3A5	1.05	76	.55	837	1.75
3AP1 CRT	3.85	VR-78	.65	838	3.25
3B22	2.95	80	.841	841	.55
3B24	1.75	FG-81-A	3.95	843	.55
3BP1 CRT	3.75	83	.85	851	39.50
3CP1-S1	1.95	83V	.95	WL-840	2.55
3C24/24G	.47	89Y	.40	861	32.50
3D6/1299	.65	VR-90	.70	864	.55
3FP7 CRT	2.95	VR-92	.65	865	2.55
3HP7 CRT	2.95	100R	3.25	866A	1.30
3GP1 CRT	3.75	FG-105	9.95	869	26.50
3Q5	.90	VR-105	.85	869B	28.95
REL-5	17.95	VU-111	.65	872A	\$2.45
5AP1 CRT	3.95	117Z3	.55	874	2.15
5BP1 CRT	2.95	VT-127 English	.25	878	2.15
5CP1 CRT	3.85	VT-127A	2.95	930	2.20
5GP1 CRT	6.55	VR-150	.55	954	.50
5J23	14.25	VT-158	9.85	955	.55
5J29	14.25	FG-172	29.50	956	.55
5Y3G	.40	205B	1.95	957	.55
6A6	.90	211 (VT-4-C)	.65	991 (NE-16)	.30
6AB7	.95	215A	1.95	1005	.35
6AC7	.90	231D	1.30	1148	.40
6AK6	.80	282B	4.25	1201	.75
6B7	.95	304TH	5.95	1616	1.25
6BE6	.65	304TL	1.75	1619	.55
6C4	.45	307A	4.25	1624	1.25
6C6	.75	316A	.75	1625	.45
6C21	19.75	350B	2.55	1626	.45
6D6	.60	371B	.85	1629	.45
6E5	.70	388A	4.95	1635	.95
6H6	.50	417A	19.95	2051	.95
6J5/GT	.50	434A	7.45	7193	.35
6J6	.90	446A	1.55	8011	2.55
6N7/GT	.80	450TH	19.95	8012	4.25
6R7G	.80	GL-471A	2.75	8020	3.35
6SF5	.65	527	11.25	8025	7.50
6SG7	.70	WL-530	17.50	9001	.70
6SH7	.40	WL-531	17.50	9002	.45
6SJ7/GT	.65	532A/1B32	3.55	9003	.65
6SK7/GT	.65	GL-559	3.75	9004	.45
6SL7/GT	.65	KU-610	7.45	9006	.45
6SN7/GT	.80	HY-615	1.20		
6SQ7/GT	.60	700B	9.95	NEON BULBS FOR RADIO	
7A4	.65	700C	9.95	NE-2	\$0.06
7A7	.65	700D	9.95	NE-15	.06
7C4/1203	.40	702A	2.95	NE-16	.24
7C7	.65	703A	4.85	NE-20	.06
7E6	.65	705A	2.65	NE-21	.24
7F7	.75	707A	19.50	NE-48	.24
7H7	.75			NE-51	.06
7N7	.75				
7Q7	.65				
10/VT-25A	.40				

Brand new, complete catalogs for Manufacturers, Distributors and Amateurs now ready. Write for your copy today.

Distributors: Our standard distributor arrangement applies on these items.



Order directly from this ad or through your local Parts Jobber.

320 N. LA SALLE ST., DEPT. Y, CHICAGO 10, ILL.

YOU Need My PRACTICAL Training to Make Money in

TELEVISION- RADIO and ELECTRONICS!



I'll Send You
8 BIG KITS of
Radio Parts and Equipment . . .

Learn at
HOME
IN YOUR
SPARE TIME

**NOW IS THE TIME To Get Into This
Fast Growing Industry—Prepare For A
Fine Paying Job Or Your Own Business!**

If you want to get into Radio-Television and Electronics . . . you owe it to yourself to get the facts about my training. I have trained hundreds of men to become outstanding service technicians—and I'm ready to do the same for you. Whether your goal is a fine paying job in one of Radio's many branches—or a successful Radio and Television business of your own—you need the kind of training I offer! My training is practical and down to earth. **YOU NEED NO PREVIOUS EXPERIENCE.** You'll be astonished at your rapid progress. I start you with basic fundamentals and give you plenty of practical shop-bench training with many kits of parts I send you. This is the training that sticks with you and makes money for you on the job!

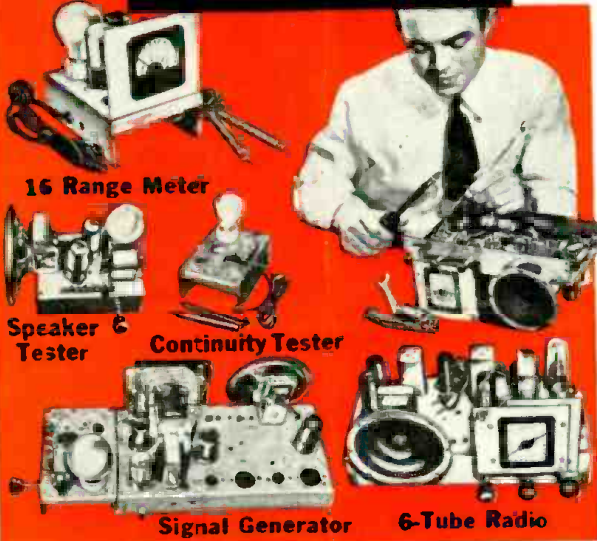

Get Paid For Spare Time While Learning

Soon after you start training I send you my famous **BUSINESS BUILDERS** that show you how to make money in spare time doing interesting Radio jobs. Look at the useful and valuable equipment you get while training with me (illustrated at left)—I send you these 8 big kits of Radio parts and equipment and help you build step-by-step a powerful 6-tube superhet radio, a 16-range test meter, plus other mighty useful equipment for Radio and Television servicing. You will perform over 175 fascinating experiments while training. You will learn about Television—so that you will be qualified to step into this fast growing, profitable field. I also send you many valuable service manuals, diagrams and my book telling exactly how to set up your own Television and Radio shop. I want you to learn all about my training—and that is why I urge you to clip and mail the coupon below for my two big **FREE** Radio books. I employ no salesmen—and nobody will call on you. The important thing is to act now and get the facts.

HAVE A BUSINESS OF YOUR OWN



A profitable Radio and Television Service Shop may be started with little capital. I will show you how to get started and how to build your small business. At left is pictured one of my graduates, Mr. Merrit C. Sperry of Fairmont, Minnesota in his own shop. The way is also open for you to build a good **SERVICE BUSINESS FOR YOURSELF.**

ALL KITS ARE YOURS TO KEEP

Each of the hundreds of Radio parts and other items I send my students is theirs "for keeps." You may use this equipment in your Radio and Television service work and save many dollars by not having to buy expensive "ready-made" test equipment. Each of my 8 kits will help you advance and learn important steps in Radio and Television servicing.



CALVIN SKINNER of New Orleans, La., tells us he makes \$5 to \$10 in spare time repairing radios. He is now also working with his own Television set.



LOREN D. SAUCIER of Coloma, Mich., reports that my training has made it possible for him to repair large numbers of Radio and Television receivers.

RADIO AND TELEVISION INDUSTRY BOOMING

You couldn't pick a better time to get into Radio-Television and Electronics. New Television stations are going on the air to serve every major city—hundreds of new AM and FM Radio broadcasting stations are also on the air to serve practically every community in America. All this creates new and bigger opportunities for the trained man who knows Radio-Television and Electronics. Good Radio and Television service men are needed **NOW!**

VETERANS

**THIS TRAINING
AVAILABLE
TO YOU UNDER
THE G. I. BILL**

My Training Includes:
Radio Servicing
Television
FM Frequency Modulation
Public Address and High Frequency Applications



These Two Big **FREE!**
Radio Books

Just mail coupon for a **FREE** sample Sprayberry Lesson and my big **FREE** book, "How To Make Money in Radio-Television and Electronics." Learn why my really practical training is best of all for you. Discover what's ahead for you in the fast moving Radio-Television and Electronics industry. No obligation. Don't delay—the future is too important to you. Mail the coupon now—and count on me for fast action.

RUSH COUPON Today!

**SPRAYBERRY ACADEMY OF RADIO, Dept. 20-B
111 North Canal St., Chicago 6, Ill.**

Please rush my **FREE** copies of "How To Make Money in Radio-Television and Electronics" and "How To Read Radio Diagrams and Symbols."

Name Age

Address

City State

() Check here if you are a Veteran.

SPRAYBERRY ACADEMY OF RADIO
111 N. CANAL, DEPT. 20-B, CHICAGO 6, ILL.

BUY THE BEST • THE V.O.M.A. THAT DOES MORE

MORE FOR YOUR MONEY



**Triplet
Model
630**

\$37.50
Dealer Net

In the relatively short time since Model 630 was introduced to the trade it has steadily risen to the top in sales. The reason is obvious. Here is a Volt-Ohm-Mil-Ammeter that does more . . . has proven components . . . and will give a lifetime of satisfaction. All the engineering skill and facilities of the industries' largest manufacturer of Volt-Ohm-Mil-Ammeters joined forces to make it outstanding in every way. Look over all the features and you too will buy Model 630.

NOTE THESE SENSATIONAL IMPROVEMENTS:

- ★ Individual Scales with separated spacing are easy to read.
- ★ Large 5½ Inch Meter In Special Molded Case Under Panel.
- ★ Resistance Scale Markings from .2 Ohms to 100 Megohms—Zero Ohms Control Flush With Panel.
- ★ Only One Switch—Has Extra Large Knob 2½" Long—Easy To Turn—Flush With Panel Surface.
- ★ Enclosed New Molded Selector Switch and insulated resistor housing in unit construction.
- ★ All Resistors Are Precision Film or Wire Wound Types For Permanent Accuracy.
- ★ Batteries Easily Replaced—Balanced Double-Contact Grip. Spiral Spring—Battery for Ohms test due to low drain insures shelf-life usage.

TECH DATA

D.C. VOLTS: 0-3-12-60-300-1200-6000 at 20,000 Ohms/Volt
 A.C. VOLTS: 0-3-12-60-300-1200-6000 at 5,000 Ohms/Volt
 D.C. MICROAMPERES 0-60 at 250 Millivolts
 D.C. AMPERES 0-12 at 250 Millivolts
 D.C. MILLIAMPERES 0-1.2-12-120, at 250 Millivolts
 OHMS: 0-1000-10,000; (4.4 Ohms and 44 Ohms center scale)
 MEGOHMS: 0-1-100 (4400-440,000 at center scale)
 DECIBELS: -30 to +4, +16, +30, +44, +56, +70
 OUTPUT: Condenser in series with A.C. Volt ranges
 High voltage Probes available, extra; also plug-in shunts for other current measurements to suit special needs.

Laboratory Standard Model 630-A—All scales on this model are hand drawn and hand stepped, used with mirror for extreme accuracies, beyond the average servicing needs of the model 630.

Triplet Model 630-A Dealer Net \$47.50

VOMA JR.—A NEW VOLT-OHM-MIL-AMMETER

**Handy "POCKET-SIZE LABORATORY"
By Triplet**

VOMA Jr. MODEL 666-R has many of the design features of the popular Model 630:

1. Switch and controls flush with panel.
2. Enclosed molded selector switch.
3. Exclusive Unit construction-resistor housing integral with switch.
4. Resistors Precision wire wound and permanent film type.
5. Resistance Measurements to 3 Megohms.
6. Batteries with spiral spring contacts, easily replaced.

VOMA Jr. MODEL 666-R . . . \$24.50
U.S.A. Dealer Net Price

Note: Model 666-1111 The Original Pocket-Size Lab—still a favorite with many. U.S.A. Dealer Net \$22.00.



TECH DATA

D.C. VOLTS: 0-10-50-250-1000-5000, at 1000 Ohms/Volt
 A.C. VOLTS: 0-10-50-250-1000-5000, at 1000 Ohms/Volt
 D.C. MILLIAMPERES: 0-10-100, at 250 Millivolts
 D.C. AMPERES: 0-1, at 250 Millivolts
 OHMS: 0-3000-300,000 . . . (20-2000 at center scale)
 MEGOHMS: 0-3 (20,000 ohms center scale)

Precision first... to Last

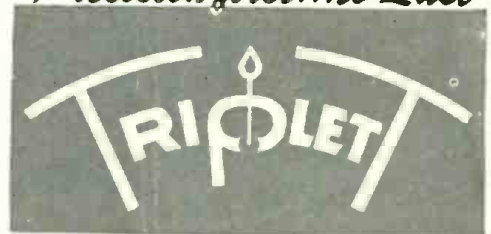

TRIPLET ELECTRICAL INSTRUMENT COMPANY • BLUFFTON, OHIO, U.S.A.

In Canada: Triplet Instruments of Canada, Georgetown, Ontario