

RADIO — ELECTRONICS

Exclusive
**TELEVISION
NEWS**
Section

HUGO GERNSBACK, Editor

formerly

**RADIO
CRAFT**



IMPROVE YOUR TELEVISION PICTURE

SEE TELEVISION NEWS

AUG

1949

30¢

U. S. and
CANADA

LATEST IN RADIO — ELECTRONICS — TELEVISION



THE FUTURE HOLDS GREAT PROMISE

Neither chance nor mere good fortune has brought this nation the finest telephone service in the world. The service Americans enjoy in such abundance is directly the product of their own imagination, enterprise and common sense.

The people of America have put billions of dollars of their savings into building their telephone system. They have learned more and more ways to use the telephone to advantage, and have continuously encouraged invention and initiative to find new paths toward new horizons.

They have made the rendering of telephone service a public trust; at the same time, they have given the telephone companies, under regulation, the freedom and resources they must have to do their job as well as possible.

IN THIS climate of freedom and responsibility, the Bell System has provided service of steadily increasing value to more and more people. Our policy, often stated, is to give the best possible service at the lowest cost consistent with financial safety and fair treatment of employees. We are organized as we are in order to carry that policy out.

BELL Telephone Laboratories lead the world in improving communication devices and techniques.

Western Electric Company provides the Bell operating companies with telephone equipment of the highest quality at reasonable prices, and can always be counted on in emergencies to deliver the goods whenever and wherever needed.

The operating telephone companies and the parent company work together so that improvements in one place may spread quickly to others. Because all units of the System have the same service goals, great benefits flow to the public.

Similarly, the financial good health of the Bell System over a period of many years has been to the advantage of the public no less than the stockholders and employees.

It is equally essential and in the public interest that telephone rates and earnings now and in the future be adequate to continue to pay good wages, protect the billions of dollars of savings invested in the System, and attract the

new capital needed to meet the service opportunities and responsibilities ahead.

There is a tremendous amount of work to be done in the near future and the System's technical and human resources to do it have never been better. Our physical equipment is the best in history, though still heavily loaded, and we have many new and improved facilities to incorporate in the plant. Employees are competent and courteous. The long-standing Bell System policy of making promotions from the ranks assures the continuing vigor of the organization.

WITH these assets, with the traditional spirit of service to get the message through, and with confidence that the American people understand the need for maintaining on a sound financial basis the essential public services performed by the Bell System, we look forward to providing a service better and more valuable in the future than at any time in the past. We pledge our utmost efforts to that end.

LEROY A. WILSON, *President*
American Telephone and Telegraph Company.
(From the 1948 Annual Report.)

BELL TELEPHONE LABORATORIES EXPLORING AND INVENTING, DEVISING
AND PERFECTING, FOR CONTINUED IMPROVEMENTS AND ECONOMIES IN TELEPHONE SERVICE



I WILL SEND YOU BOTH FREE

64 PAGE BOOK

See how I give you practical experience building Radio circuits with **BIG KITS OF PARTS I SEND.** Illustrated book shows how you make **EXTRA MONEY** fixing Radios in spare time while still learning. Read letters from men I trained, telling what they are doing, earning. See the kind of fascinating jobs Radio, Television, Electronics offer. **FREE** with coupon below!

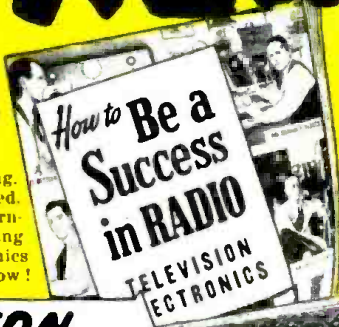

ACTUAL RADIO LESSON

Same coupon entitles you to **FREE** "superhet" circuits work, three reasons why tubes fail, locating defects, repairing loudspeakers. Over 80 pictures, diagrams. **FREE**, send coupon!

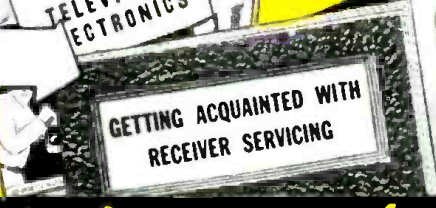

See for yourself how I train you at home to BE A RADIO-TELEVISION TECHNICIAN

Want a good-pay job in the fast-growing **RADIO-TELEVISION** industry? Want a money-making Radio-Television shop of your own? Here's your opportunity. I've trained hundreds of men to be Radio Technicians . . . **MEN WITH NO PREVIOUS EXPERIENCE.** My tested and proved train-at-home method makes learning easy. You learn Radio-Television principles from illustrated lessons. You get practical experience building, testing, experimenting with **MANY KITS OF PARTS** I send. All equipment yours to keep.

You Build This MODERN RADIO with Parts I Send

Complete, powerful Radio receiver brings in local and distant stations. NRI gives you **ALL** the Radio parts . . . speaker, chassis, transformer, sockets, loop antenna, etc.



MAKE EXTRA MONEY IN SPARE TIME

The day you enroll, I start sending **SPECIAL HOOKLETS** that show you how to make **EXTRA MONEY** fixing neighbors' Radios in spare time. From here it's a short step to your own shop, or a good-pay Radio-Television servicing job. Or get into Police, Aviation, Marine Radio, Broadcasting, Radio Manufacturing or Public Address work. And think of getting in on the ground floor of the booming Television industry. Trained men are already in demand . . . new stations are going on the air, manufacturers are building over 100,000 sets a month, more and more homes are getting sets. The man who prepares now will reap rich rewards.

SEE WHAT N.R.I. CAN DO FOR YOU

Act now! Send for my **DOUBLE FREE OFFER.** Coupon entitles you to actual lesson, "GETTING ACQUAINTED WITH RECEIVER SERVICING," absolutely free. Over 80 pictures and diagrams! You also get my 64-page book, "HOW TO BE A SUCCESS IN RADIO and TELEVISION-ELECTRONICS." Tells more about **YOUR** opportunities, details of my Course, how quickly, easily you can get started. Send coupon in envelope or paste on penny postal. **J. E. SMITH, President, Dept. 9HX, National Radio Institute, Pioneer Home Study Radio School, Washington 9, D. C.**

MAIL NOW

I Also Send You Many Other RADIO KITS

I TRAINED THESE MEN

Has Own Radio Business



"Now have two Radio shops, servicing about 200 sets a month. Have largest service establishment in S. E. Missouri."—**ARLEY STU-DYVIN, DeSoto, Mo.**

Extra Cash In Spare Time



"Earned enough spare time cash to pay for my Course by time I graduated. NRI training is tops!"—**ALEXANDER KISH, Carteret, New Jersey.**

Actual Lesson and 64 Page Book FREE

MR. J. E. SMITH, President, Dept. 9HX National Radio Institute, Washington 9, D. C.

Mail me **FREE** Sample Lesson and 64-page book about how to win success in Radio and Television—Electronics. (No salesman will call. Please write plainly.)

Name..... Age.....
Address.....
City..... Zone..... State.....
 Check If Veteran **APPROVED FOR TRAINING UNDER G. I. BILL**

VETERANS GET THIS TRAINING UNDER G. I. BILL

RADIO — ELECTRONICS

formerly **RADIO-CRAFT**

Incorporating

SHORT WAVE CRAFT* TELEVISION NEWS*

RADIO & TELEVISION

*Trademark registered U. S. Patent Office

Circulation Manager **G. Aliquo** Business Manager **Charles K. Brett**

Sales Managers

John J. Lamson, Lee Robinson

Hugo Gernsback, Editor-in-Chief
 Fred Shunaman, Managing Editor
 M. Harvey Gernsback, Consulting Editor
 Robert F. Scott, W2PWG, Technical Editor
 R. H. Dorf, W2QMI, Associate Editor
 I. Queen, W2OUX, Editorial Associate
 Angie Pascale, Production Manager
 Wm. Lyon McLaughlin,
 Tech. Illustration Director

Contents — August, 1949

Editorial (Page 17)
 Squeezing the Service Technicianby the Editors 17

Television News (Pages 18-31)
 Improve Your Television Picture (Cover Feature).....by Allan Lytel 18
 Booster Uses Standard Tunerby Matthew Mandl 22
 New All Channel TV Antenna 24
 Trouble Shooting Television Setsby Irving Dlugotch 25
 The Transpole Variotenna, Part Iby Hugo Gernsback 28
 Television Queries Answeredby Dave Gnessin 30

Electronics (Pages 32-37)
 Spectrometer Measures Mass of Chemical Ionsby Jerry S. Adams 32
 Electronics in Medicine, Part X, Electron Microscope...by Eugene J. Thompson 34
 Experimenting with Ultra-Violet Raysby Ernest J. Schultz 37

Construction (Pages 38-40)
 A High-Fidelity Tuner-Amplifier, Part II.....by M. Harvey Gernsback 38

New Design (Page 41)
 New Devices Exhibited at Chicago Parts Show 41

Audio (Pages 42-45)
 Improved Phono Amplifierby John S. Carroll 42
 Notes on Sound Recordingby Richard H. Dorf 43
 Frequency Bridge for Audioby K. E. Forsberg 44

Theory and Engineering (Pages 46-47)
 Microwaves, Part IVby C. W. Palmer 46

Amateur (Pages 48-49)
 Mobile 10-Meter Rig Puts out 20 Watts on Phone...by A. B. Kaufman, W6YOV 48

Servicing (Pages 50-58)
 Manufacturers versus Service Techniciansby Hugo Gernsback 50
 Why Pick on Radio Technicians?by Lyman E. Greenlee 52
 Training for Radioby Jules L. Hornung 53
 Fundamentals of Radio Servicing, Part VI, Reactance, Impedance and Phase
 by John T. Frye 55

Foreign News (Page 59)
 European Reportby Major Ralph W. Hallows 59

Test Instruments (Page 60)
 Laboratory Square-Wave Generatorby John E. Pitts 60

Departments

The Radio Month	8	Question Box	70
Radio Business	14	Technotes	71
New Devices	63	Miscellany	72
Radio-Electronic Circuits	64	People	74
New Patents	66	Communications	76
Try This One	68	Book Reviews	81

ON THE COVER: Robert Witherspoon tunes the transmission line with a capacitive slider while Joon MacClay adjusts the television receiver. Decorations by John Wanamaker. Miss MacClay's dress by Frances Sider. Kodachrome by Avery Stock.

RADIO-ELECTRONICS, August, 1949, Volume XX, No. 11. Published monthly. Publication Office: Erie Ave., E to G Streets, Philadelphia 32, Pa. Entered as second class matter September 27, 1948, at the post office at Philadelphia, Pa., under the Act of March 3, 1879. **SUBSCRIPTION RATES:** In U. S. and Canada, in U. S. possessions, Mexico, South and Central American countries, \$3.50; \$6.00 for two years; \$8.00 for three years; single copies 30c. All other foreign countries \$4.50 a year; \$8.00 for two years; \$11.00 for three years. Allow one month for change of address. When ordering a change please furnish an address stencil impression from a recent wrapper. **RADCRAFT PUBLICATIONS, INC.** Hugo Gernsback, Pres.; M. Harvey Gernsback, Vice-Pres.; G. Aliquo, Sec'y. Contents Copyright, 1949, by Radercraft Publications, Inc. Text and illustrations must not be reproduced without permission of copyright owners.

EDITORIAL and ADVERTISING OFFICES: 25 West Broadway, New York 7, N. Y. Tel. REtor 2-9880. **BRANCH ADVERTISING OFFICES:** Chicago: 308 W. Washington Street, Telephone RAndolph 6-7363. Los Angeles: Ralph W. Harker, 1127 Wilshire Blvd., Tel. MA 6-1271. San Francisco: Ralph W. Harker, 582 Market St. Tel. GARfield 1-2491. **FOREIGN AGENTS:** Great Britain: Atlas Publishing and Distributing Co., Ltd., 18 Bride Lane, Fleet St., London E.C.4. Australia: McGill's Agency, 179 Elizabeth Street, Melbourne. France: Brentano's, 37 Avenue de l'Opera, Paris 2e. Holland: Trilectron, Heemsteedsche, Dreef 124 Heemstede. Greece: International Book & News Agency, 17 Amerikis Street, Athens. So. Africa: Central News Agency, Ltd., Cor. Risik & Commissioner Sts., Johannesburg; 112 Long Street, Capetown; 359 Smith Street, Durban. Natal. Universal Book Agency, 70 Harrison Street, Johannesburg. Middle East: Snielnalzy Middle East Agency, Jaffa Road, Jerusalem, India: Sani Gupta (Distributors) Co., Armita Bazar Patrika Lt., 14 Ananda Chatterjee Lane, Calcutta. Broadway News Centre, Post Bag #5557, Dadar, Bombay #14, K. L. Kannappa Mudalliar, 30 General Patters Road, Mount Road, Madras 2. Pakistan: Paradise Book Stall, Opp. Regal Cinema, Preezy St., Karachi 3.

You Can't Match these MID-AMERICA Values!

Plate Load RELAY

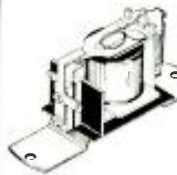

6000-ohm coil. SPST normally open contacts. Extra sensitive and used for many applications. 1 1/2" high, 1 1/4" wide, on 1 1/2" mtg. ctrs. MA-1903 \$1.19

Silver Mica Button Condensers

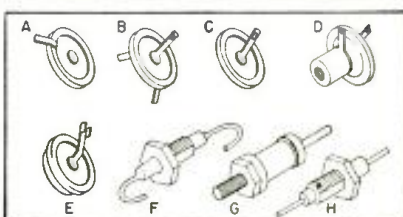

\$7.50 per 100 (all one type)

MA-3536 (G) 20 mmf	MA-3545 (U) 360 mmf
MA-3501 (D) 30 mmf	MA-3509 (A) 500 mmf
MA-3531 (F) 55 mmf	MA-3506 (B) 500 mmf
MA-3503 (B) 75 mmf	MA-3510 (C) 500 mmf
MA-3532 (H) 75 mmf	MA-3502 (I) 500 mmf
MA-3504 (A) 200 mmf	MA-3507 (E) 500 mmf
MA-3519 (F) 250 mmf	MA-3518 (A) 2000 mmf

#18 2-conductor Wire & Drum

Used for running 110 volt AC lines, extension speakers, etc. Full 175 feet of highest quality wire with tough, weather-resistant insulation. Complete with handy drum for spooling wire for storage. Limited quantity. **\$2.39**

BRAND NEW METERS



Delur Model 310 meter for all-around ham and test applications. 10 ma 100 basic movement, 3/4" diameter frame, 2 1/2" body, 1 1/2" deep. Stock up on these while they last. MA-2036 **\$1.95** each

Iron Core FM and AM IF TRANSFORMERS

Highly efficient for new construction and replacement. 110 adjustable iron cores provide high selectivity and gain. Only 1 1/2" x 1 1/2" square; single top mounting.

MA-2296 10.7 Mc IF Transformer	49c ea
MA-2039 455 KC IF Transformer	35c ea

INTERCOM TRANSFORMER SET

One transformer to match voice coil to grid, another for 50L6 and similar output tubes. Both of these fine units PLUS a momentary DIPPY spring return push-button switch for less than value of one transformer alone! These are small, strap-mounting transformers. **ONLY 98c FOR ALL THREE UNITS!**

GRILLE CLOTH

Never before at our low price! Highest quality, golden-tone grille cloth, styled to harmonize with all cabinet designs. Generous 50" width. **\$1.79** per yard

This Month's Specials!

T-17 Microphone and plug; used; good	75c
25 ml iron core RF choke; 100 MA DC	10c
25 mmf butterfly condenser	32c
50 mf butterfly condenser	32c
Mercury switch; flexible 18" leads	20c
Brand new B&K 308 Jack Box	10c
SPDT Slide Switch; black bakelite knob	15c

ORDER FROM THIS AD!

Send 25% deposit with order. Pay balance plus postage on delivery. Get your name on Mid-America's select mailing list and get first crack at latest, greatest values in radio parts, electronic equipment, tubes, etc. Send orders to Desk RC-89. Minimum order \$2.50

MID-AMERICA CO. Inc.

STORE: 2412 S. Michigan Ave., Chicago 16, Ill.
 WAREHOUSE: 2307 S. Archer Ave., Chicago 16, Ill.

Editorial and Executive Offices:
 25 West Broadway, New York 7, N. Y.



MEMBER
 AUDIT BUREAU OF CIRCULATION

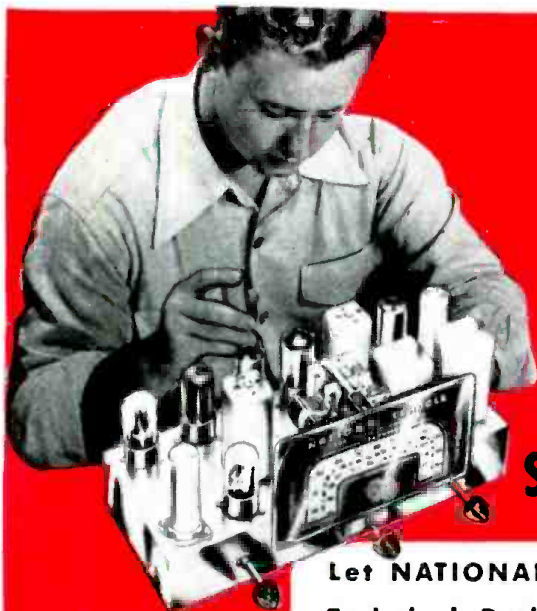

Learn RADIO TELEVISION, ELECTRONICS *by* SHOP METHOD HOME TRAINING

Let NATIONAL SCHOOLS, of Los Angeles, a practical Technical Resident Trade School for almost 50 years, train you for today's unlimited opportunities in Radio

You receive all parts, including tubes, for building this fine, modern Superheterodyne Receiver. This and other valuable standard equipment becomes your property.

these two FREE books will tell you how

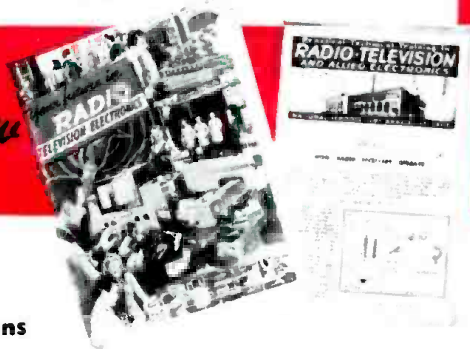

Good Jobs Await the Trained Radio Technician

You are needed in the great, modern Radio, Television and Electronics industry! Trained Radio technicians are in constant and growing demand at excellent pay—in Broadcasting, Communications, Television, Radar, Research Laboratories, Home Radio Service, etc. National Schools Master Shop Method Home Study course, with newly added lessons and equipment, can train you in your spare time, *right in your own home*, for these exciting opportunities. Our method has been proved by the remarkable success of National Schools-trained men all over the world.

You Learn by Building Equipment with Standard Radio Parts We Send You

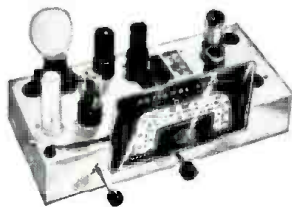

Your National Schools Course includes not only basic theory, but *practical* training as well—you *learn by doing*. We send you complete standard equipment of professional quality for building various experimental and test units. You advance step by step until you are able to build the modern superheterodyne receiver shown above, which is yours to keep and enjoy. You perform more than 100 experiments—build many types of circuits, signal generator, low power radio transmitter, audio oscillator, and other units. The Free Books shown above tell you more about it—send for them today!

Now! NEW PROFESSIONAL MULTITESTER INCLUDED:



This versatile testing instrument is portable and complete with test leads. Simple to operate, accurate and dependable. You will be able to quickly locate trouble and adjust the most delicate circuits. You can use the Multitester at home or on service calls. It is designed to measure AC and DC volts, current, resistance and decibels. You will be proud to own and use this valuable professional instrument.

Lessons and Instruction Material Are Up-to-date, Practical, Interesting

National Schools Master Shop Method Home Training gives you basic and advanced instruction in all phases of Radio, Television and Electronics. Each lesson is made easy to understand by numerous illustrations and diagrams. All instruction material has been developed and tested in our own shops and laboratories, under the supervision of our own engineers and instructors. A free sample lesson is yours upon request—use the coupon below.

You Get This and Other Valuable Information in the Free Sample Lesson:

1. Basic Receiver Circuits and How They are Used.
2. Construction of the Antenna Circuit.
3. How Energy is Picked Up by the Aerial.
4. How Signal Currents are Converted Into Sound.
5. How the Tuning Condenser Operates.
6. How the R-F Transformer Handles the Signal, and other data, with diagrams and illustrations.

Both Home Study and Resident Training Offered

**APPROVED FOR
VETERANS**

Check Coupon Below

NATIONAL SCHOOLS

LOS ANGELES 37, CALIFORNIA EST. 1905



MAIL OPPORTUNITY COUPON FOR QUICK ACTION

NATIONAL SCHOOL, Dept. 8-RE
4000 S. Figueroa, Los Angeles 37, Calif.

Paste on a postcard

Mail me FREE the book "Your Future in Radio" including a sample lesson of your choice. I understand no salesman will call on me.

NAME AGE

ADDRESS

CITY Zone STATE

Check here if Veteran of World War II

GET THE DETAILS—SEND THE COUPON →

AUGUST, 1949

Another radio service dealer thanks Sylvania Campaigns for big rise in business



"THE FIRST DAY'S PROFIT FROM THE MAILING PAID FOR THE ENTIRE THREE MONTHS SERVICE!"

HERE'S YOUR OPPORTUNITY!

BENNY'S
RADIO SHOP
CHIEF KEEPER-UPPER OF YOUR RADIO
411 ARCADIA AVE
ARCADIA, FLORIDA
MODERN EQUIPMENT
EFFICIENT AND RELIABLE
March 9, 1949

R
A
D
I
O

E
X
P
E
R
T

T
R
A
I
N
E
D

B
Y

N
A
T
I
O
N
A
L

R
A
D
I
O

I
N
S
T
I
T
U
T
E

Hammond-Morgan, Inc.
9 South Terry Street
Orlando, Florida

Gentlemen:

Last month your representative showed me his display matter on the Sylvania Direct Mail Advertising campaign for February, March and April.

I placed an order for the series of direct mail cards and received them about two weeks later.

I mailed the first group of cards out on the morning of February 26th about 8 o'clock. Before 2 PM I had a call for service as the result of the mailing!!! Later the same afternoon I had a couple come in to look over new radios. They had received my card regarding repairs and decided that instead of having their set repaired, they would come in and see what I had in new radios. They are at this time about decided on buying a set retailing for \$99.95 plus an FM antenna installation.

I have read the statements of other servicemen over the country about their business increasing 30% and upward as the result of this Sylvania advertising, but I believe the results I have obtained are above anything I have yet heard about. The first day I had made enough profit from the mailing to pay for the entire three months service, and the prospects are that the other two months mailings will bring other business.

I thought perhaps you would be interested in the results I had with this series, and I can tell you now that I hope to increase my mailing list on the next series, and I think I will stick to this form of advertising as long as it is available at such a very low cost.

Yours very truly,

BENNY'S RADIO SHOP

B. McGehee

PUBLIC ADDRESS SYSTEMS BEST REPAIR SERVICE ON ANY MAKE OR MODEL RADIO HOME RECORDING APPARATUS

Increase your Business with Sylvania's Fall Campaign—**READY NOW!**

Sylvania's September, October, November, and December campaigns are available now. Here's what you receive:

- 4 Postal Card Mailings — one for each month.
- 4 Window Displays — one for each month.
- 4 Window Streamers — one for each month.
- 8 Newspaper Ad Mats — two for each month.
- Radio Spot Announcements—several for each month.
- 8- and 12-inch decals for window, door and truck.

Tied up directly with Sylvania's national advertising, these campaigns will boost your business. You pay only the postage on the cards you mail. Sylvania gives you everything else *free*. Write for full details immediately, or see your Sylvania distributor.

SYLVANIA ELECTRIC

RADIO TUBES; CATHODE RAY TUBES; ELECTRONIC DEVICES; FLUORESCENT LAMPS. FIXTURES, WIRING DEVICES. SIGN TUBING; LIGHT BULBS; PHOTOLAMPS

Sylvania Electric Products Inc.
Advertising Department R-1708
Emporium, Pa.

Gentlemen: Please send me full details on your September, October, November, and December Service Dealer Campaigns.

Name.....
Company.....
Address.....
City..... Zone.....
State.....

See how YOU may get started toward an Exciting Future in

TELEVISION RADIO-ELECTRONICS!



OUR GREATEST OFFER IN 17 YEARS!

Here is your big opportunity to get started toward FASCINATING WORK... GOOD MONEY... a THRILLING FUTURE! Mail the coupon today. See how YOU may prepare to tie in your future with a field that includes one of America's fastest-growing new industries—Television. You'll find out, too, about the many other thrilling opportunities in FM Radio... Aviation and Broadcast Radio... 2-Way Taxi, Truck and Police Radio... Industrial Electronics... even the chance to start your own profitable Television-Radio Sales and Service business. And to top it all, you'll see that you don't need to know a thing about this subject at present—that NOW you can get the very training and starting help you need by means of our GREATEST OFFER IN 17 YEARS.

**YOU BUILD and KEEP
THIS EQUIPMENT TO
WORK OVER 300
HOME EXPERIMENTS**

MODERN CHICAGO LABORATORIES

Train quickly, using a wide variety of commercial equipment. D. T. I.'s new laboratories are among the finest of their kind. Ample instructors... every major training advantage. Write for details!

EMPLOYMENT SERVICE

When you complete your training, our effective Employment Service is available to you without extra cost—a grand aid to help you get started.

Send for **FREE** Information

See HOW—in your own home—DeForest's Training, Inc., now brings you one of today's most complete combinations of major home training aids. You (1) Learn-by-Reading from well-illustrated lessons. (2) You Learn-by-Seeing from D.T.I.'s exclusive instructive Home Movies. And (3), you set up your own HOME LABORATORY where you Learn-by-Doing from 16 shipments of Radio-Electronic parts which you use and KEEP to work over 300 instructive... fascinating projects. This includes building the valuable 6 tube "Superhet" RADIO and the commercial-type OSCILLOSCOPE, R-F SIGNAL GENERATOR, and Jewel-Bearing MULTIMETER, pictured at the right.

You may use this test equipment to help you earn real money—both in your spare time and later when working full time in the field. Get complete facts. Mail coupon today!



OSCILLOSCOPE

R-F SIGNAL GENERATOR

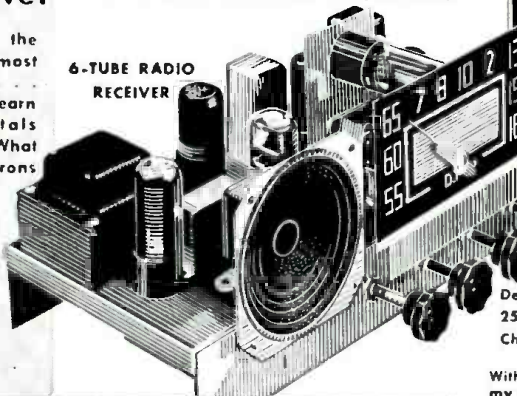

6-TUBE RADIO RECEIVER



MULTI-METER

**YOU ALSO
USE
HOME
MOVIES**
a D.T.I.
Exclusive!



D. T. I., alone, includes the use of one of today's most effective training aids... MOVIES... to help you learn important fundamentals faster, easier, at home. What an advantage to see electrons on the march, and other fascinating "hidden action"—a remarkable home training advantage that speeds your progress.

OPPORTUNITY COUPON!

DeForest's Training, Inc.
2533 N. Ashland Ave., Dept. RC-F8
Chicago 14, Illinois

MAIL TODAY

Without obligation, send me complete facts showing how I may make my start in Television-Radio-Electronics.

Name..... Age.....

Street..... Apt.....

City..... Zone..... State.....

DeFOREST'S TRAINING, INC.

CHICAGO 14, ILLINOIS

Affiliated with the DeVry Corporation,
Builders of Electronic and Movie Equipment.



THE B & B
BOOKWORM
SAYS:

"IT'S HERE!

EVERYTHING IN TELEVISION

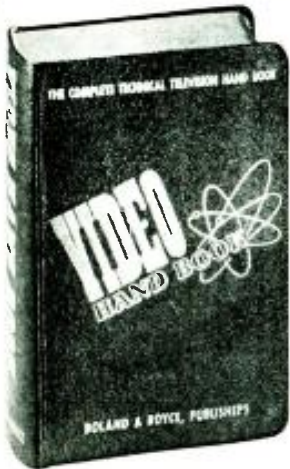

VIDEO HAND BOOK

Over 900
pages... 800
illustrations

by
M. G. Scheraga
and J. J. Roche

bound in
handsome
Dupont
Fabrikoid

CONTENTS—IN 14 BIG SECTIONS:

- Television: Past, Present & Future
- Fundamentals of electronic Television
- The Television Station, The Television Receiver.
- Television Antenna Systems
- Creating a Television Show
- Descriptions of Modern Television Receivers.
- Installing Television Receivers.
- Servicing Television Receivers.
- Television Test Equipment.
- Building a Television Receiver.
- Date Section.
- Television Terms.
- Bibliography.

\$5.00

THE RADIO DATA BOOK

W. F. BOYCE and J. J. ROCHE

THE ONLY RADIO HAND-BOOK OF ITS KIND! OVER 900 PAGES... 12 SECTIONS, EACH A COMPLETE COVERAGE OF ONE RADIO SUBJECT.



CONTENTS:

1. The 150 basic circuits in Radio
2. Complete test equipment data
3. Testing, measuring and alignment
4. All about antennas
5. Sound systems
6. Recording
7. Complete tube manual
8. Charts, graphs and curves
9. Codes, symbols and standards
10. 50 tested circuits designed for optimum performance
11. Dictionary of radio and electronic terms

\$5.00

THE RADIO AND TELEVISION LIBRARY

Comprising THE VIDEO HAND BOOK and THE RADIO DATA BOOK outlined above.

This is the biggest book value on record! A complete library on Radio and Video in a handsome slip case complete only



\$9.00

And don't forget to get this month's copy of

RADIO DISTRIBUTION AND MAINTENANCE

the complete trade journal devoted to sales and service of Radio, Video, Audio.
Single copies 25c, \$3.00 per year, \$5.00 2 years.

All products of
BOLAND & BOYCE, INC., Montclair 3, N. J.
are available at your
LOCAL DISTRIBUTOR'S COUNTERS
get your copies TODAY!

BOLAND & BOYCE INC., PUBLISHERS

The Radio Month

JOHN BALLANTYNE, chairman of the board of Philco Corp., died on June 10th while making a commencement address at Meadowbrook School in Pennsylvania, where his 13-year-old son was a member of the graduating class. Ballantyne was president of Philco from 1943 to 1948, after which



he became chairman of the board of directors, acting only in an advisory capacity. A native of Philadelphia, he was a graduate of the University of Pennsylvania. He became treasurer of Philco in 1940 and vice-president in charge of operations a year later. He was 49 years old at the time of his demise.

DR. WILLIAM W. HANSEN, a professor of physics at Stanford University who helped develop radar, died on May 23 at the age of 39.

As early as 1937 Dr. Hansen was working on the use of radar for military purposes. He was recently elected to the National Academy of Sciences and was awarded the Liebmann Memorial Prize for outstanding work in radio engineering.

LICENSING BILL introduced in the Illinois legislature, requiring all persons servicing radios and TV sets to undergo a training course and examination (see report in this section of July issue) was defeated last month. The Radio Manufacturers Association and the Television Installation Service Association of Chicago were instrumental in having the bill killed in committee.

INTERNATIONAL TV EXHIBIT and convention will be held in September in Milan, Italy, under the auspices of the Italian government. The exhibit, to take place at the Arts Palace in Milan, will show equipment made by European firms; United States companies invited to participate are RCA, Du Mont, Philco, GE, Raytheon, and Westinghouse. The convention will meet at Como, about 45 miles from Milan.

MICROGROOVE reproducing equipment has been installed by 652 AM stations in the U. S., according to a report last month by Robert J. Clarkson, general manager of Columbia Transcriptions, who conducted a survey. Another 185 plan to install the necessary pickups in the next few months. In addition to the standard LP pressings, Columbia offers to program producers a transcription service in which microgroove records take the place of the traditional 16-inch, 33 $\frac{1}{2}$ -r.p.m., 15-minute-per-side transcriptions. Because of the close groove spacing, more than 20 minutes can be recorded on each face of a 12-inch record, resulting in a considerable money saving. In addition, technical characteristics are standardized.

LICENSE PLATES with amateur call letters instead of the usual meaningless numbers and letters are now available to automobile-owning Florida hams, due to a bill which took effect on July 1. In recognition of the valuable work done by amateurs in emergencies, State Senator Lloyd F. Boyle, himself a ham, introduced the bill in the legislature; it was signed by the governor on May 12. Each man wanting a call-letter license plate must apply to the Motor Vehicle Commissioner and pay an extra \$1 fee.

RADAR STATIONS will be built in the Bahamas by the United States, as part of its Florida-based, 3,000-mile guided missile range, the Defense Department announced last month. The agreement was concluded with Great Britain and the Bahamas governments. The department will conduct extensive tests on guided missiles, beginning, it hopes, in July, 1951. The radar stations will be needed to track the paths of the missiles.

TWENTY-FIFTH ANNIVERSARY of the Radio Manufacturers Association is being celebrated this year. The organization's Silver Anniversary Convention was held in Chicago on May 19, concurrently with the Radio Parts Show.

1949 RADIO FALL MEETING formerly known as the Rochester Fall Meeting, will be held October 31st, November 1st and 2nd at Hotel Syracuse, Syracuse, N. Y. according to an announcement by Virgil M. Graham, chairman of the Radio Fall Meeting Committee and director of technical relations for Sylvania Electric Products Inc. The Meeting will be sponsored by the Engineering Department of Radio Manufacturers Association for its members and members of the Institute of Radio Engineers. Officers of Fall Meeting Committee in addition to Mr. Graham, include R. W. Ferrell of The General Electric Co., vice-chairman and treasurer, and R. A. Hackbush of Stromberg Carlson of Canada, Ltd., secretary.

RADIO-ELECTRONICS for

FCC celebrated the 15th anniversary of its creation on June 19th; on that date 15 years ago the Communication Act was signed. On July 1, 1934, the old Federal Radio Commission was abolished and 11 days later the FCC was formally organized. About 125 of the present staff members, including Commissioners Hyde, Walker, and Sterling, were with the Commission when it was organized.

Comparisons of the first annual report and present figures indicate how radio has grown since 1934. At that time there were 51,000 radio stations of all kinds, 600 broadcasters, 45,000 hams, less than 2,000 ship stations, about 700 aeronautical licenses, 250 police transmitters and no fire stations.

In contrast, recent figures show nearly 150,000 total stations (in addition to more than 200,000 associated mobile units), 4,000 broadcast authorizations of all kinds, 80,000 amateur calls, 20,000 shipboard stations, 27,000 air service licenses (and over 100,000 aircraft radio telephone authorizations), more than 4,600 police stations, and 100 municipal fire department systems. Individual licensed operators (holders of commercial tickets) have increased from the 1934 number of 5,500 to almost 375,000.

The grand total of all authorizations outstanding, including both operators and stations, but excluding mobile land stations, has passed the 700,000 mark, testifying to the tremendous importance of radio in present-day America.

TELEVISION PROGRAMS are not worth the phosphor they're projected on, was, in effect, the comment made last month by Lloyd Espenschied, one of the inventors of the co-axial cable which makes large-scale television possible. "I wouldn't give a damn for anything I've seen," commented the 60-year-old inventor, as reported by the *New York Herald Tribune*. "It's the same as sound broadcasting—permeated with commercialism from beginning to end. We in the United States ought to be ashamed. The British have done a far better cultural job in both sound and television broadcasting."

Mr. Espenschied and Herman A. Affel, research engineers in the Bell Telephone Laboratories, devised the co-axial cable in 1929 to satisfy the urgent demand for more telephone circuits.

BRAIN WAVES can be used by an anesthetist during an operation to warn if the patient is approaching death, it was disclosed last month. According to a Mayo Clinic team at the Atlantic City meeting of the AMA, continuous records of the electrical activity of the brain and heart give warning of danger two minutes earlier than the breathing and pulse rates which the anesthetist ordinarily observes. When the regular waves suddenly flatten out almost to a straight line, it is time to stop the anesthetic mixture and turn on the oxygen.

The new life-saving technique was developed by Drs. R. F. Courtin, R. G.

Bickford, and A. Flaconer, Jr., of the Mayo Clinic. It has been tried so far on 60 patients. A machine standing at one side of the anesthetist takes continuous records of the patient's heart and brain waveforms. Preliminary trials indicate that the technique is equally useful with any type of anesthetic.

RADAR aided all-weather operations of the Berlin air-lift, Dr. H. R. Skifter, president of Airborne Instrument Laboratory, Inc., revealed last month. A new type of radar made by the company, the Moving Target Indicator (MTI), shows only objects in motion, simplifying the work of the operator. The principal bad-weather flying problem was traffic control, since ships would be likely to collide with each other. The MTI radar permitted the maximum number of aircraft to operate by keeping track of the position of each and telling pilots how to proceed to avoid collisions.

LICENSING of radio service shops is legal in Los Angeles, according to an opinion furnished by City Attorney Ray L. Chesebro last month to the City Council, reported in the *Los Angeles Times*. Radio repair, says Chesebro, falls into the same category as automobile repair shops and used car lots, which already operate under revocable permits issued by the Police Commission. The Council, in asking for the opinion, was seeking to stop general unethical and fraudulent practices in the radio repair business.

NATIONAL NETWORK of radiotelephone stations for mobile service to the general public was announced last month by the National Mobile Radio System. Operators of local systems which handle messages for private automobiles and trucks have banded together in a nation-wide network operating on the same channels. Subscribers in any area served by an affiliate will be able to send messages from their automobiles or trucks to any point in the country. Present stations, many of which are owned by telephone answering services, are experimental and have served subscribers locally for some time. By August the network will be in operation between Boston and Washington, so that a traveler at almost any point along the route will have continuous contact with one or another of the stations. Messages will be transmitted between cities by the station operators, using the stations themselves for relaying, though regular long-distance telephone calls will be made when necessary.

TRANSISTOR TETRODES are the latest development in germanium crystal amplifiers, Rowland W. Haegele of the Physics Laboratories of Sylvania Electric Products, Inc., announced last month to a Princeton conference. The tetrodes, said Haegele, provide a high degree of isolation in mixer service so that signals on one emitter are not picked up by the other.

NOW! BUILD 15 RADIOS \$14.95
COMPLETE KIT ONLY

Absolutely No Knowledge of Radio Necessary. You Need No Additional Parts. The PROGRESSIVE RADIO KIT is the Only Complete Kit. Operates on 110-120 Volts AC/DC

Contains everything you need, instruction book, metal chassis, tubes, condensers, resistors and all other necessary radio parts. The 36-page Instruction Book written by expert radio instructors and engineers teaches you to build radios in a professional manner. The circuits are designed to provide excellent performance. Altogether, fifteen circuits are constructed, including 11 receivers, 1 audio amplifier and 3 transmitters. SPECIAL OFFER—Electrical and Radio Tester sent absolutely FREE with each Progressive Radio Kit. Plus FREE Membership in the Progressive Radio Club. Entitles you to free expert advice and consultation service with licensed radio technicians. ORDER YOUR KIT NOW!

VACUUM TUBE VOLTMETER KIT
A professional piece of test equipment you need for AM and TV. Attractive steel case. FREE: Book on Advanced Servicing Techniques. **\$23.95**

5" OSCILLOSCOPE KIT AM-FM TELEVISION
an absolute "must" for today's radio-man. Input Impedance: 1 Meg and 50 Minfd. Tubes—2-8F7, 2-6Y3, 1-884, 1-58P1. FREE: Book on Cathode Ray Oscilloscope. **\$39.95**

VOLT-OHM-MILLIAMMETER KIT
simple to construct. Inexpensive but accurate. FREE: Book on Elementary Radio Servicing. **\$14.95**

SIGNAL TRACER KIT
an invaluable aid in trouble-shooting. FREE: Book on Radio Test Instruments. **\$21.95**

7"-10" TELEVISION KITS
Factory-built and aligned 13 channel Tuner—13 Tube Kit—7" Kit. **\$59.50**
Complete set of tubes, including Cathode Ray Tube. **\$41.58**
Factory-built and aligned 13 channel Tuner. 10" Kit, less tubes. **\$82.99**
Complete set of tubes, including Cathode Ray Tube. **\$55.80**
Cabinet for 7" or 10" **\$24.50**
FREE: Television Servicing Notes

PROGRESSIVE AMPLIFIER KIT
High Fidelity Humless Amplifier complete with five tubes and two selenium rectifiers. FREE: Book on Amplifiers. **\$16.00**

TV SWEEP GENERATOR KIT \$28.95
Range—2 Mc.—24 Mc.

SIGNAL GENERATOR KIT \$18.95
150 Kc.—34 Mc. Fundamental, 35 Mc.—190 Mc. Harmonics.

RF SIGNAL TRACER PROBE KIT \$5.50
20 cycles—200 Mc.—1N34 Xtal.

ECONOMY AMPLIFIER KIT.....\$5.95
Simple to build; complete with five tubes. FREE: Book on Amplifiers.

5 TUBE AC-DC SUPERHET KIT.....\$14.25
Complete with tubes and cabinet. FREE: Book on Building Receivers.

6 TUBE AC-DC 2-BAND SUPERHET KIT \$17.45
Complete with tubes and cabinet. FREE: Book on Amateur Radio Building.

7 TUBE AC-DC FM RECEIVER KIT.....\$29.95
Complete with tubes and cabinet. FREE: Television and FM Servicing Notes.

4 TUBE SUPERHET PORTABLE KIT.....\$12.95
Complete with tubes and cabinet; less batteries. FREE: Book on Unusual Radio Circuits.

AUTOMATIC BIKE RADIO
Can be mounted on a bicycle, or carried as a personal portable radio. Supplied with all bicycle mounting hardware and telescopic antenna. Anti-theft feature. Less batteries. **\$17.47**

AUTOMATIC CAR RADIO
6 tube superhet. Three gang condenser, fits all cars—easy installation. mounting brackets included. List price \$39.95. NOW ONLY **\$27.97**
Also 5 Tube Superhet Only **\$25.97**

Deduct 2% if full payment accompanies order. C.O.D. orders accepted in U.S.A. Write for further information concerning the above merchandise. Send for our FREE catalog.

PROGRESSIVE ELECTRONICS CO.
Dept. RE-28 497 Union Avenue
Brooklyn 11, New York

Heathkit TUBE CHECKER KIT

Heathkit TEST



SHIPPING
WT. 15 LBS.

\$29⁵⁰

Features

1. Measures each element individually.
2. Has gear driven roller chart.
3. Has lever switching for speed.
4. Complete range of filament voltages.
5. Checks every tube element.
6. Uses latest type lever switches.
7. Uses beautiful shatterproof full view meter.
8. Large size 11"x14"x4" complete.

Check the features and you will realize that this Heathkit has all the features you want. Speed — simplicity — beauty — protection against obsolescence. The most modern type of tester — measures each element — beautiful Bad-Good scale, high quality meter — the best of parts — rugged oversize 110 V. 60 cycle power transformer — finest of Mallory switches — Centralab controls — quality wood cabinet — complete set of sockets for all type tubes including blank spare for future types — fast action gear driven roller chart uses brass gears to quickly locate and set up any type tube. Simplified switching cuts necessary time to minimum and saves valuable service time. Short and open element check. No matter what arrangement of tube elements, the Heathkit flexible switching arrangement easily handles it. Order your Heathkit Tube Checker today. See for yourself that Heath again saves you $\frac{2}{3}$ and yet retains all the quality — this tube checker will pay for itself in a few weeks — better build it now.

Complete with detail instructions — all parts — cabinet — roller chart — ready to wire up and operate.

New Heathkit TELEVISION ALIGNMENT GENERATOR KIT

Everything you want in a television alignment generator. A wide band sweep generator covering all FM and TV frequencies — a marker indicator — AM modulation for RF alignment — variable calibrated sweep width 0.30 Mc. — mechanical driven inductive sweep. Husky 110 V. 60 cycle power transformer operated — step type output attenuator with 10,000 to 1 range — high output on all ranges — band switching for each range — vernier driven main calibrated dial with over 45 inches of calibrations — vernier driven calibrated indicator marker tuning. Large grey crackle cabinet 16-1/8" x 10-5/8" x 7-3/16". Phase control for single trace adjustment. Uses four high frequency triodes plus 5Y3 rectifier — split stator tuning condensers for greater efficiency and accuracy at high frequencies — this Heathkit is complete and adequate for every alignment need and is supplied with every part — cabinet — calibrated panel — all coils and condensers wound, calibrated and adjusted. Tubes, transformer, test leads — every part with instruction manual for assembly and use. Actually three instruments in one — TV sweep generator — TV AM generator and TV marker indicator. Also covers FM band.

\$39⁵⁰



Heathkit SINE AND SQUARE WAVE AUDIO GENERATOR KIT



\$34⁵⁰
Nothing
ELSE TO BUY

Experimenters and servicemen working with a square wave for the first time invariably wonder why it was not introduced before. The characteristics of an amplifier can be determined in seconds compared to several hours of tedious plotting using older methods. Stage by stage, amplifier testing is as easy as signal tracing. The low distortion (less than 1%) and linear output (\pm one db.) make this Heathkit equal or superior to factory built equipment selling for three or four times its price. The circuit is the popular RC tuning circuit using a four gang variable condenser. Three ranges 20-200, 200-2,000, 2,000-20,000 cycles are provided by selector switch. Either sine or square waves instantly available at slide switch. All components are of highest quality. Cased 110 V. 60 cycle power transformer, Mallory F.P. filter condensers, 5 tubes, calibrated 2 color panel, grey crackle aluminum cabinet. The detailed instructions make assembly an interesting and instructive few hours. Shipping Wt., 13 lbs.

RF Crystal Test Probe Kit

No. 309. Kit to assemble. RF probe extends VTVM range to 100 MC. Complete with IN34 crystal. Shipping weight, 1 lb. **\$6.50**



New Heathkit FM TUNER KIT

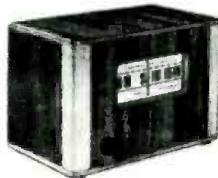

\$14⁷⁵
CABINET
EXTRA

A truly fine FM Tuner with the coils ready wound, all alignment completed — all that is necessary is wiring and it's ready to play — uses super regenerative circuit — 110 V. 60 cycle transformer operated — two gang tuning condenser — slide rule calibrated dial — two tubes — complete instructions including pictorial enable even beginners to build successfully.

The circuit uses twin triode and is extremely powerful — pulls in stations far beyond normal expectations. Shipping Wt., 4 pounds.

Beautiful mahogany cabinet for FM Tuner (shown above) extra **\$3.75**

New Heathkit TOOL KIT



Now a complete tool kit to assemble your Heathkit. Consists of Krauter diagonal cutters and pointed nose assembly pliers, Xcelite screwdriver, 60 Watt 110 V. soldering iron and supply of solder. Shipping Wt., 2 lbs. Complete kit. **\$5.95**

Heathkit CONDENSER CHECKER KIT

\$19⁵⁰
Nothing
ELSE TO BUY



Features

- Bridge type circuit
- Magic eye indicator
- 110 V transformer operated
- All scales on panel
- Power factor scale
- Measures resistance
- Measures leakage
- Checks paper-mica electrolytics

Checks all types of condensers, paper-mica-electrolytic-ceramic over a range of .00001 MFD to 1000 MFD. All on readable scales that are read direct from the panel. NO CHARTS OR MULTIPLIERS NECESSARY. A condenser checker anyone can read without a college education. A leakage test and polarizing voltage for 20 to 500 volts provided. Measures power factor of electrolytics between 0% and 50%. 110 V. 60 cycle transformer operated complete with rectifier and magic eye tubes, cabinet, calibrated panel, test leads and all other parts. Clear detailed instructions for assembly and use. Why guess at the quality and capacity of a condenser when you can know for less than a twenty dollar bill. Shipping Wt., 7 lbs.



10,000 V H.V. Test Probe Kit No. 310. Extends range of any 11 megohm VTVM to 3,000 and 10,000 Volt ranges. A necessity for television. Ship. wt., 1 lb. **\$4.50**



The **HEATH COMPANY**

... BENTON HARBOR 20, MICHIGAN

EQUIPMENT and accessories

New Heathkit BATTERY ELIMINATOR KIT

Now a bench 6 Volt power supply kit for all auto radio testing. Supplies 5 - 7½ Volts at 10 Amperes continuous or 15 Amperes intermittent. A well filtered rugged power supply uses heavy duty selenium rectifier, choke input filter with 4,000 MFD of electrolytic filter. 0-15 Volt meter indicates output. Output variable in eight steps. Excellent for demonstrating auto radios. Ideal for servicing — can be lowered to find sticky vibrators or stepped up to equivalent of generator overload — easily constructed in less than two hours. Complete in every respect.



\$22.50

SHIPPING WT. 18 LBS.
Nothing ELSE TO BUY

Heathkit 5" OSCILLOSCOPE KIT

Features

- Instant switching to plates or amplifier from front panel.
- Sweep generator supplying variable sweep 15 cycles to 30,000 cycles.
- All controls on front panel.
- Cased electrostatically shielded 110 V. 60 cycle power transformer.
- AC test voltage on front panel.
- External synchronization post on front panel.
- Deflection sensitivity .65 V. per inch full gain.
- Frequency response ± 20% from 50 cycles to 50 Kc.
- Input impedance 1 Megohm and 50 MMF.

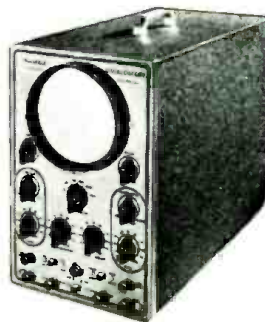

The Heathkit 5" Oscilloscope fulfills every servicing need. The husky cased power transformer supplies 1100 Volts negative and 350 Volts positive. Tubes supplied are two 6SJ7 amplifiers, 884 sweep generator, two 5Y3 rectifiers, and 5BP1 CR tube. Grey crackle aluminum cabinet and beautiful grey and maroon panel. Chassis especially designed for easy assembly.

An oscilloscope provides endless sources of experimentation in radio, electronics, medicine and scientific research.

Detailed instructions make assembly fun and instructive. Shipping Wt., 24 lbs. Express only.

\$39.50

Nothing ELSE TO BUY

1949 MODEL Heathkit VACUUM TUBE VOLTMETER KIT

Features

New 200 ua Meter, 24 Ranges.

New Accessory H.V. Probe makes Heathkit a kilovoltmeter. (Extra)
New Accessory RF Probe extends range to 100 megacycles. (Extra)



A new Model V-2 Heathkit VTVM with new 200 microampere meter, four additional ranges — full scale linear ranges on both AC and DC of 0.3 V., 10 V., 30 V., 100 V., 300 V., and 1,000 V. Accessory probe listed elsewhere in ad extends voltage range to 3,000 and 10,000 volts D.C. New model has greater sensitivity, stability and accuracy — still the highest quality features — shatterproof plastic full view meter face — automatic meter protection, push pull electronic voltmeter circuit, linear scales — db. scale — ohmmeter measures 1/10 ohm to 1 billion ohms with internal battery — isolated DC test prod for dynamic measurements — 11 megohm input resistance on DC — AC uses electronic rectification with 6H6 tube. All these features and still the amazing price of only \$24.50.

Comes complete with cabinet — panel — three tubes — new Mallory switches — test prods and leads, 1% ceramic divider resistors and all other parts. Complete instruction manual for assembly and use. Better start your laboratory with this precision instrument. Ship. Wt., 8 lbs.

\$24.50

New Heathkit SIGNAL TRACER AND UNIVERSAL TEST SPEAKER KIT

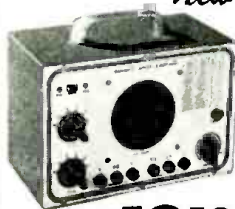

\$19.50

Nothing ELSE TO BUY

The popular Heathkit signal tracer has now been combined with a universal test speaker at no increase in price. The same high quality tracer follows signal from antenna to speaker — locates intermittents — defective parts quicker — saves valuable service time — gives greater income per service hour. Works equally well on broadcast — FM or TV receivers. The test speaker has assortment of switching ranges to match push pull or single output impedance. Also tests microphones, pickups — PA systems — comes complete — cabinet — 110 V. 60 cycle power transformer — tubes, test probe, all parts and detailed instructions for assembly and use. Shipping Wt., 8 lbs.

Heathkit ELECTRONIC SWITCH KIT

DOUBLES THE UTILITY OF ANY SCOPE

An electronic switch used with any oscilloscope provides two separately controllable traces on the screen. Each trace is controlled independently and the position of the traces may be varied. The input and output traces of an amplifier may be observed one beside the other or one directly over the other illustrating perfectly any change occurring in the amplifier. Distortion — phase shift and other defects show up instantly, 110 Volt 60 cycle transformer operated. Uses 5 tubes (1 6X5, 2 6SN7's, 2 6SJ7's). Has individual gain controls, positioning control, and coarse and fine sweeping rate controls. The cabinet and panel match all other Heathkits. Every part supplied including detailed instructions for assembly and use. Shipping Wt., 11 lbs.



\$34.50

Heathkit RF SIGNAL GENERATOR KIT

\$19.50

Nothing ELSE TO BUY



Every shop needs a good signal generator. The Heathkit fulfills every servicing need, fundamentals from 150 Kc. to 30 megacycles with strong harmonics over 100 megacycles covering the new television and FM bands. 110 V. 60 cycle transformer operated power supply.

400 cycle audio available for modulation or audio testing. Uses 6SN7 as RF oscillator and audio amplifier. Complete kit has every part necessary and detailed blueprints and instructions enable the builder to assemble it in a few hours. Large easy to read calibration. Convenient size 9" x 6" x 4 ¼". Shipping Wt., 4 ½ lbs.

Heathkit 3-TUBE ALL WAVE RADIO KIT



\$8.75

An ideal way to learn radio. This kit is complete ready to assemble, with tubes and all other parts. Operates from 110 V. AC. Simple, clear detailed instructions make this a good radio training course. Covers regular broadcasts and short wave bands. Plug-in coils. Regenerative circuit. Operates loud speaker. Shipping Wt., 3 lbs.

HS30 Headphones per set.....\$1.00
2½" Permanent Magnet Loudspeaker..... 1.95
Mahogany Cabinet..... 2.95



The **HEATH COMPANY**

... BENTON HARBOR 20, MICHIGAN

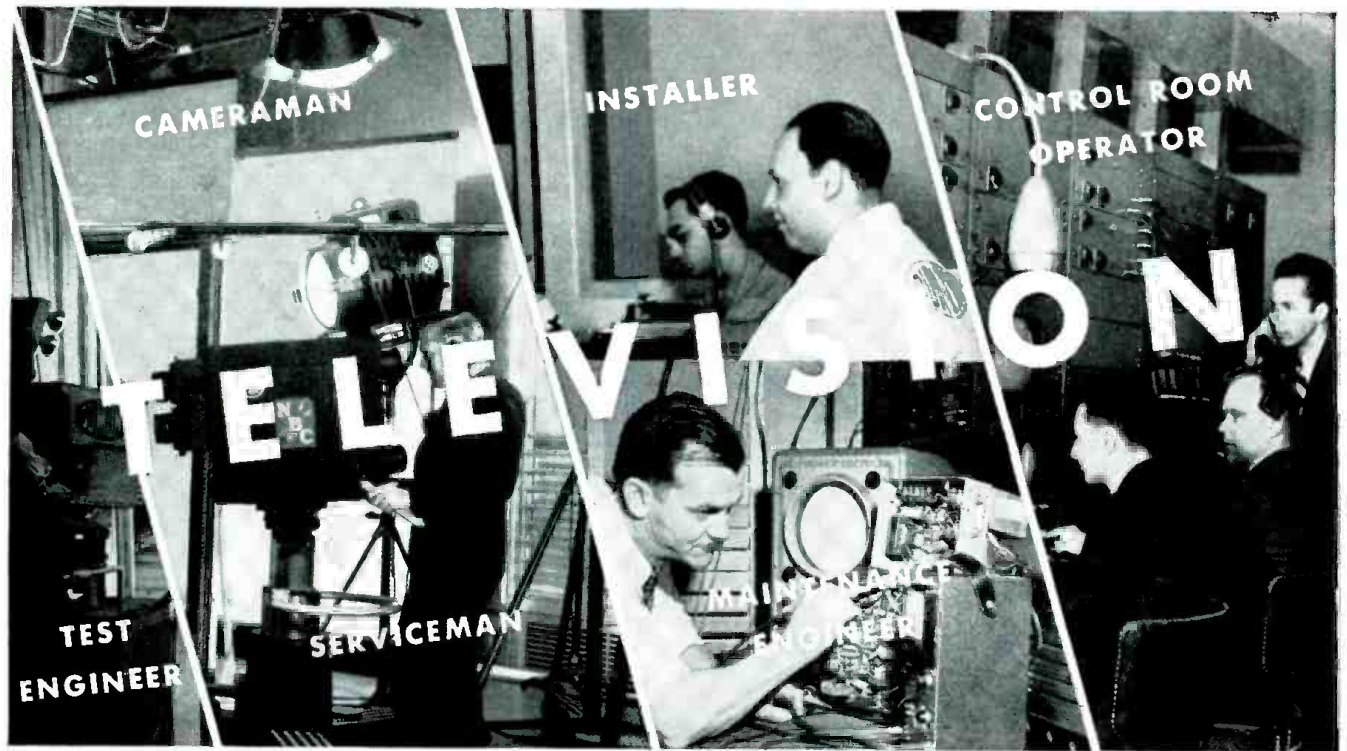

TV Offers YOU Good Pay, Security and Bright Future

CREI On-the-Job Training Can Give You the Technical Ability to Step Ahead of Competition and Get the Better Job You Want

GET IN and *get ahead* in Television! You can make your own opportunity if you start preparing *now*. No need to tell you how fast Television is expanding—or, of the number of jobs being created. One of industry's leaders predicts: *1 Million Persons in TV within 4 Years!* He estimates 12 Million TV sets by 1953—40 Million by 1958.

If your future is in radio, you *must* get in Television. CREI offers the very training you need to go after—and get—a good TV job.

CREI can show you the way with convenient spare-time study at home that gives you the up-to-date technical background you *must* have for Television. CREI courses are designed to give you a thorough grounding in basic principles and take you step-by-step through the more advanced subjects of TV and its related fields. It must be remembered that all new electronic developments have their roots in past techniques. The basic theory of TV finds application in

**VETERANS: CREI TRAINING AVAILABLE UNDER G. I. BILL FOR MOST VETERANS JULY 25, 1951 IS THE DEADLINE—
ACT NOW!**

If you have had professional or amateur radio experience and want to make more money, let us prove to you we have the training you need to qualify for a better radio job. To help us answer intelligently your inquiry—*please state briefly your background of experience, education and present position.*



Capitol Radio Engineering Institute

An Accredited Technical Institute Founded in 1927

Dept. 144-A, 16th and Park Road, N. W., Washington 10, D. C.

Branch Offices: New York (7) 170 Broadway • San Francisco (2) 760 Market St.

every field—aeronautical radio, UHF, wide band operation are based on TV techniques. Your CREI training becomes important no matter in what direction you are heading. You will find CREI training basic and helpful right from the start. You will learn about and understand such subjects as: Optics, Pulse Techniques, Deflection Circuits; RF, IF, AF and Video Amplifiers; FM; Receiving Antennas; Power Supplies; Cathode Ray, Iconoscope, Image Orthicon and Projection Tubes; UHF Techniques, Television Test Equipment, etc.

Don't wait another day. Television won't wait for you. In all our 22 years of association with professional radiomen we know that the man who acts promptly is the man who succeeds.

FREE SAMPLE LESSON

Now, see for yourself! Mail the coupon for free sample lesson and see how interesting it is to study at home and improve your income through ability the CREI way.

"THE ORTHICON AND IMAGE ORTHICON"

This lesson describes the development of the small, 3-inch image orthicon tube; theory and operation of the orthicon; image orthicon; specific features.

MAIL COUPON FOR FREE BOOKLET

CAPITOL RADIO ENGINEERING INSTITUTE
16th & Park Road, N. W., Dept. 144-A, Washington 10, D. C.

Gentlemen: Please mail me **FREE SAMPLE LESSON** and your 32-pg. booklet, "Your Future in the New World of Electronics," plus full details of your home-study training. I am attaching a brief resume of my experience, education and present position.

Check field of greatest interest:

- | | | |
|---|---|---|
| <input type="checkbox"/> PRACTICAL RADIO ENGINEERING | <input type="checkbox"/> PRACTICAL TELEVISION ENGINEERING | <input type="checkbox"/> TELEVISION, FM & ADVANCED AM SERVICING |
| <input type="checkbox"/> AERONAUTICAL RADIO ENGINEERING | <input type="checkbox"/> BROADCAST RADIO ENGINEERING (AM, FM, TV) | <input type="checkbox"/> ADVANCED ELECTRONICS COMMUNICATIONS |
| | | <input type="checkbox"/> RADIO-ELECTRONICS IN INDUSTRY |

NAME _____

STREET _____

CITY _____

ZONE _____ STATE _____

I AM ENTITLED TO TRAINING UNDER G. I. BILL.

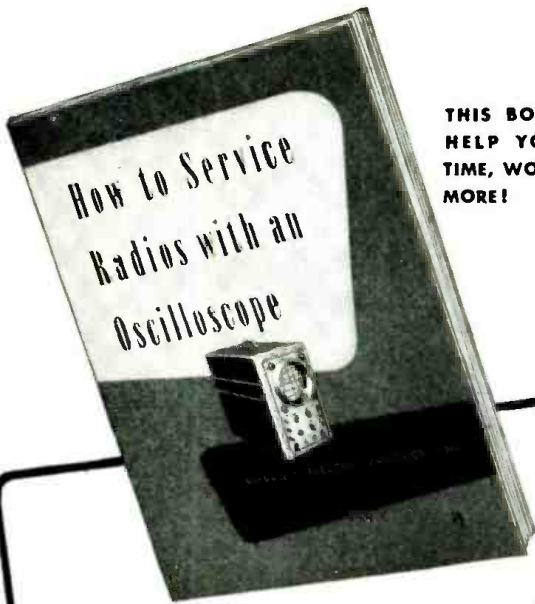

THIS BOOK WILL HELP YOU SAVE TIME, WORK, EARN MORE!

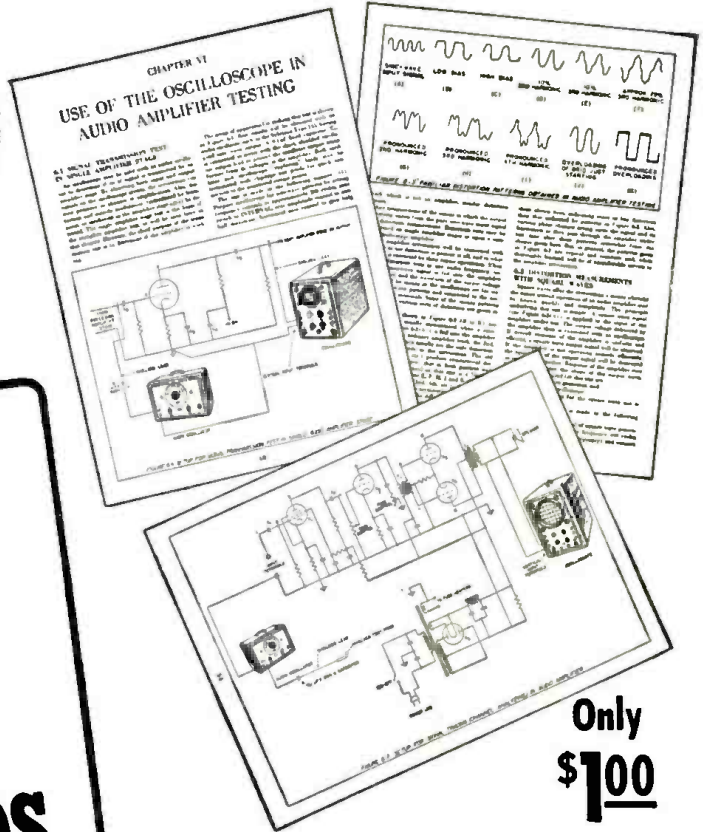

SYLVANIA SHOWS YOU

"HOW TO SERVICE RADIOS WITH AN OSCILLOSCOPE"

Here's a big, complete book that gives you step-by-step instructions for using the oscilloscope in testing and servicing radio receivers, audio amplifiers and transmitters.

The more than 90 illustrations of circuits, 'scope patterns, and set-up arrangements for circuit testing explain over 50 separate oscilloscope applications.

Only **\$1.00**

EXPLAINS THESE AND MANY MORE

1. AM and FM receiver alignment
2. Locating hum
3. Signal tracing and trouble shooting
4. Finding receiver faults from oscilloscope patterns
5. Checking AVC action
6. Voltage gain measurement
7. Auto radio vibrator tests
8. Checking peak current in rectifiers
9. Impedance measurement
10. Checking filter capacitors — and many others!

SYLVANIA ELECTRIC

FLUORESCENT LAMPS; FIXTURES. WIRING DEVICES, SIGN TUBING; LIGHT BULBS; PHOTOLAMPS; RADIO TUBES; CATHODE RAY TUBES; ELECTRONIC DEVICES

- ★ **Get this big 72-page book!**
- ★ **More than 90 pictures and diagrams!**
- ★ **Written in easy-to-follow servicemen's language!**

Sylvania Electric Products Inc.
Advertising Dept. R-2916
Emporium, Pa.

Gentlemen:
Send me "How To Service Radios with an Oscilloscope." Enclosed is \$1.00.

Name

Address

City..... Zone.....

State

WHERE TO BUY IT . . .
WHOLESALE RADIO
 of Baltimore

Unbeatable T. V. Reception
 For the strongest, sharpest, brightest possible picture in any location.

SNYDER LAZY XX T.V. ANTENNA

QUICK TO INSTALL
 Just unfold, tighten and erect.

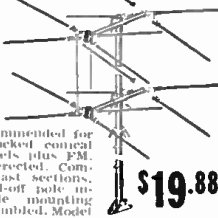

Extremely Hi-Gain. Recommended for fringe areas. Easily stacked against Lazy X type. All channels plus FM. Over-all height 11 ft. erected. Complete with 3 mating mast sections, guy wire anchors, stand-off pole insulators and adjustable mounting base. Completely pre-assembled. Model TX-2.

\$19.88

NEW LOW PRICE! HALLICRAFTERS
MODEL S-38



Model S-38, shown brings outstanding reception at a moderate price. Standard broadcast plus three short wave bands. Built-in P.M. speaker. Continuous AM reception 540 kc. to 32 Mc. Five tubes plus rectifier. . . .

\$39.95

We have complete line of Hallicrafters Receivers.

Application Engineered for T.V.-FM
Wide Range Sweep Signal Generator
Precision Series E-400

Direct frequency reading 2 to 480 Mc. 5 ranges to 240 Mc., 280-480 Mc. Bands harmonically calibrated. Narrow and wide band sweep. 0-1 Mc. and 0-10 Mc. Wide Range phasing control. Multiple Crystal Marker-Calibrator Oscillator built-in. 4 rotary selected crystal sockets. Complete with test cables, 10.7 Mc. and 2 Mc. crystals and technical manual. Size 10 1/2" x 12" x 6"



\$124.70

PRECISION 5" SCOPE
Model ES 500 \$149.50

LOW PRICES ON QUALITY GUDEMAN
ALUMINUM CAN FP TYPE
CONDENSERS



- 30-30 mfd, 150 V 59¢
- 50-50 mfd, 150 V 65¢
- 20-20-20 mfd, 150 V 65¢
- 40-40-40 mfd, 150 V 75¢
- 50-30 mfd, 150 V, 25-25 V 75¢

BUILD YOUR OWN AND SAVE!
NEW! SIGNAL GENERATOR KIT
EICO MODEL 320 K



A top quality signal generator for every servicing need. Can be used for FM-AM alignment and to provide TV marker frequencies. Range—150 kc to 110 mc in 6 bands, with fundamentals to 34 mc. Pure 400 cycle audio by a Roberts type audio oscillator. Easy to follow schematic diagrams included. R x 10"x5". Complete with tubes.

\$19.95

HIGH PRECISION VACUUM TUBE
VOLTMETER KIT. Model 221 K. \$23.95

Top Auto Reception at Low Cost
SNYDER AUTO RADIO AERIALS
 Side-Cowl Mount

MAINLINER C-3D \$1.88

New deluxe model. 3 sections extend to 66". Chrome static ball and chrome capped Bakelite insulators.

BIG BOY C-4D \$2.63

4 heavy duty sections extending to 98". Chrome static ball and chrome capped Bakelite insulators.

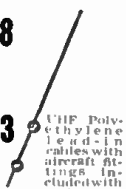

WRITE FOR FREE MONTHLY "FYI" BULLETIN
 Phone MUIberry 2134
ADDRESS ORDERS TO DEPT. QR-83

WHOLESALE
RADIO PARTS CO., Inc.
 311 W. Baltimore St.
BALTIMORE 1, MD.

The Pacent Engineering Corp. of New York, N. Y., specialists and consultants in electronics, have recently been appointed as consulting engineers by the Plessey International Limited of Ilford Essex, England. This company is one of the largest manufacturers of television, electronic, mechanical and other equipment in the British Isles.

International Telephone & Telegraph Corp. has announced the formation of Capchart-Farnsworth Corp. as a wholly-owned subsidiary to acquire the assets of Farnsworth Television & Radio Corp., as approved by Farnsworth stockholders.

At a meeting of directors of Capchart-Farnsworth Corp., ELLERY W. STONE was elected President and DAVID R. HULL, Executive Vice President.

The following officers were also elected: PHILLO T. FARNSWORTH, Vice President; HENRY C. ROEMER, Vice President; WILLIAM CLAUSEN, Vice President; P. H. HARTMANN, Treasurer; W. F. HOEPPNER, Comptroller; and CHESTER H. WIGGIN, Secretary and Assistant Treasurer. EDWIN A. NICHOLAS, former President of Farnsworth Television and Radio Corp., will act as Assistant to the President.

Hytron Radio & Electronics Corp. has been producing TV picture tubes since February of this year in steadily increasing quantities. Shipments are now being made to a broadly representative group of leading manufacturers of TV receivers—as well as to Hytron distributors.

Stewart-Warner Corp. of Chicago had a net profit for the first quarter of 1949 of \$404,292, equal to 31 cents per share of \$5 par value common stock, JAMES S. KNOWLSON, board chairman and president, told the annual meeting of stockholders. The company had a net profit of \$902,094, or 70 cents per share for the period ended March 31, 1948. First quarter sales in 1949 were \$14,706,155 and in 1948 were \$17,338,552.

Phileo Corporation, Philadelphia, reports that the sales in the first quarter of 1949 were \$53,006,000 as compared with \$58,661,000 in the first quarter a year ago.

Net income in the first quarter of this year was \$915,000 and was equivalent, after preferred dividends, to 49 cents per common share on the 1,678,779 shares outstanding on March 31, 1949.

In the first quarter a year ago, net income totaled \$1,959,000 after tax-paid reserves of \$600,000 for inventory and \$185,000 for future research and development work. This was equivalent to \$1.16 per common share on the 1,607,576 shares outstanding at the end of 1948, after preferred dividends.

The West Coast Electronic Manufacturers Association, San Francisco, California, announces the scheduling of the

5th Annual Pacific Electronic Exhibit for August 30, 31, September 1 in San Francisco.

Spokesmen for the West Coast group said the Exhibit will be held in conjunction with the 1949 Western Regional Convention of the I.R.E. Both groups will center their activities in San Francisco's mammoth Civic Auditorium.

The joint meetings of the Electronic Industry and the I.R.E. will follow by four days the Annual National Convention of the American Institute of Electrical Engineers, also scheduled for San Francisco.

Allen B. Du Mont Laboratories, Inc. of Passaic, N. J., announces the publication of a four page "Dealergram," latest dealer aid especially prepared for franchised Du Mont dealers and distributors, according to HENRY R. GEYELIN, advertising manager of the television receiver sales division.

The Dealergram, which consists of four pages of video news items of interest to dealers and distributors, current promotional ideas and sales helps, is profusely illustrated and will be mailed to Du Mont dealers and distributors each month. The first mailing of the Dealergram includes an explanatory letter and an application blank which will enable dealers to have the sales-aid sent to their employees.

Sylvania Electric Products, Inc. announces that a full line of television sets bearing the Sylvania name will be placed on the market this fall, according to DON G. MITCHELL, president of the company.

Sets are expected to be available on October 1. Initially, the line will feature 10-inch and 12 1/2-inch table models, consolettes, and console combinations with three-speed record changer, AM and FM radio, and also a 16-inch consolette.

In making the announcement, Mr. Mitchell stated that Sylvania had delayed entrance into the television set market until an extensive program of field and laboratory engineering research in the direction of simplification, clarity of picture and minimum maintenance, had developed sufficient experience to assure quality performance.

Television Manufacturers Association has started a project aimed at establishing standard service agreements and practises for television sets, according to MICHAEL L. KAPLAN, President of TMA and of Sightmaster Corp. A survey of service organizations and dealers who service sets will be the first action to establish a universal contract for the benefit of the public and the industry.

After this accumulated data has been sifted, TMA expects to be able to formulate a standardized service contract under which service organizations will be expected to meet certain qualifications as to experience, background, technical ability and reputation.

Welin CIRCLE

AMERICA'S FOREMOST TV ANTENNA

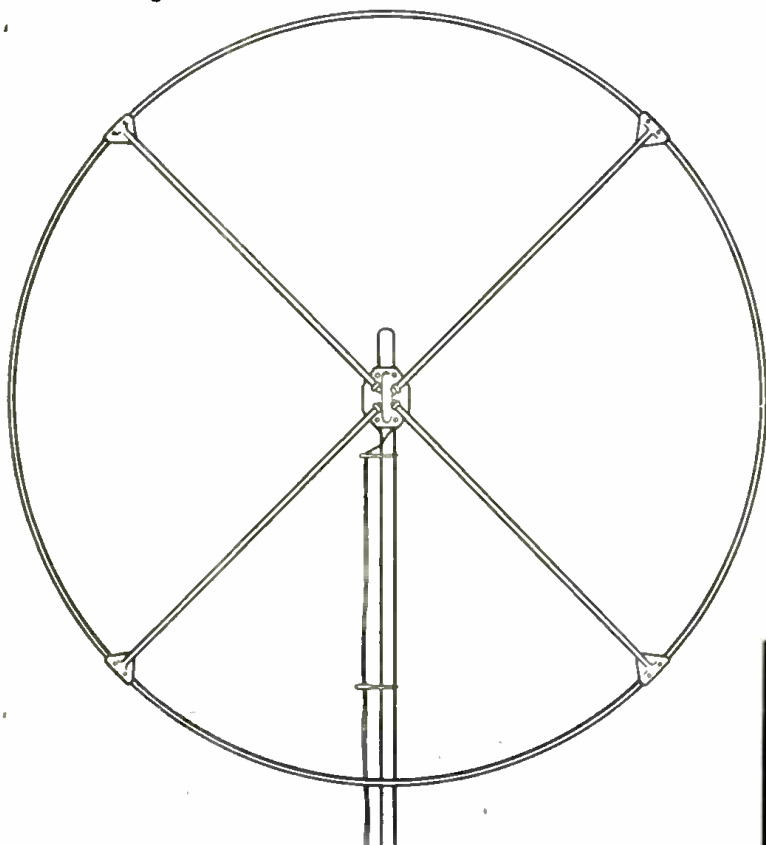
The Welin Circle "X" television antenna has extremely high signal strength and it eliminates the necessity of having rotors, it is quickly assembled, easily installed, structurally sound, has less vibration, no reflectors to align, requires only one lead-in, and is perfectly matched to 72, 150 and 300 ohm receiver input circuits.

Dealers can reduce their service recalls by using the Welin Circle "X". It provides a satisfied customer on first installation.

The Welin Circle "X" has been field tested and has proven far superior to other antennas. In addition to outdoor service the Welin Circle "X" has given outstanding reception when installed in attics 30-40 miles from the transmitting station.

- ALL CHANNEL RECEPTION
- ONE ANTENNA — ONE LEAD IN
- PROVIDES CLEARER, SHARPER PICTURE
- EXTREMELY HIGH SIGNAL STRENGTH
- ELIMINATES GHOSTS
- ELIMINATES REFLECTORS
- QUICKLY ASSEMBLED AND INSTALLED
- LESS VIBRATION
- LIGHT WEIGHT — 1½ LBS.

**AN ANTENNA
OF PROVEN
QUALITY**

\$25⁰⁰
LIST

WRITE FOR CONFIDENTIAL
DISTRIBUTOR AND
DEALER DISCOUNTS



Welin DIVISION

CONTINENTAL COPPER & STEEL INDUSTRIES, INC.

500 MARKET STREET

PERTH AMBOY, N. J.

Which Do You Want?



Better Pay



A Nice Home



A New Car



Greater Security



Happy Vacations and Travel

Get Your FCC Ticket
Jobs leading to
\$3,000 to \$7,500
(Average Pay Reported by FCC
Nationwide Survey)
are opening up
right now for
**FCC Licensed
Radiomen.**



I can train you to pass your FCC License Exams in a few short weeks if you've had any practical radio experience—amateur, Army, Navy, radio servicing, or other. My time-proven plan can help put you, too, on the road to success.

Let me send you FREE the entire story

Just fill out the coupon and mail it. I will send you, free of charge, a copy of "How to Pass FCC License Exams," plus a sample FCC-type Exam, and the amazing new booklet, "Money Making FCC License Information."

Edw. H. Gullford
Vice President

How to Pass FCC COMMERCIAL RADIO OPERATOR

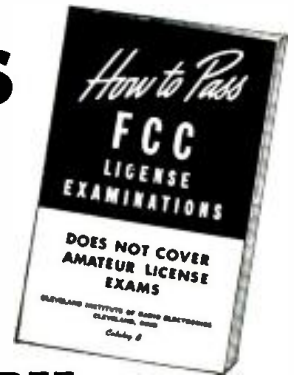

License Exams

FREE

Tells where to apply for and take FCC examinations, location of examining offices, scope of knowledge required, approved way to prepare for FCC examinations, positive method of checking your knowledge before taking the examinations.

Add Technical Training to Your Practical Experience & Get Your **FCC COMMERCIAL RADIO OPERATOR LICENSE** in a Few Short Weeks...

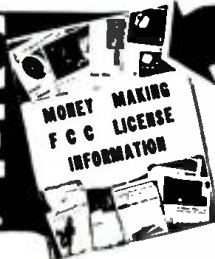

Get This Amazing New Booklet

1. TELLS OF THOUSANDS OF BRAND-NEW, BETTER-PAYING RADIO JOBS NOW OPEN TO FCC LICENSE HOLDERS
2. TELLS HOW YOU WILL BENEFIT BY HOLDING AN FCC COMMERCIAL LICENSE.
3. TELLS HOW YOU CAN GET YOUR FCC COMMERCIAL RADIO OPERATOR LICENSE IN A FEW SHORT WEEKS—EASILY AND QUICKLY, BY USING CIRE SIMPLIFIED TRAINING AND COACHING AT HOME IN YOUR SPARE TIME.
4. TELLS OF HUNDREDS OF OUR SUCCESSFUL STUDENTS WHO NOW HAVE LICENSES AND NEW, BETTER-PAYING JOBS.
5. TELLS HOW WE PREPARE YOU TO PASS THE NEW FCC COMMERCIAL LICENSE EXAMINATIONS, WHICH NOW INCLUDE FM AND TELEVISION.
6. TELLS HOW WE GUARANTEE TO TRAIN AND COACH YOU UNTIL YOU GET YOUR LICENSE.
7. TELLS HOW WE HELP YOU TO GET A BETTER-PAYING, LICENSED JOB, WITH OUR FREE AND EXCLUSIVE SERVICE, WHICH PREPARES YOUR EMPLOYMENT APPLICATION FOR MAILING TO HUNDREDS OF EMPLOYERS, INCLUDING FM, AM AND TELEVISION BROADCAST STATIONS, RADIO MANUFACTURERS, POLICE RADIO STATIONS, AND RADIO-EQUIPPED TAXI, BUS AND PUBLIC UTILITY COMPANIES.

It's EASY if you use CIRE Simplified Training and Coaching AT HOME in SPARE TIME

Get your license easily and quickly and be ready for the jobs open to ticket holders which lead to \$3000 to \$7500 (average pay reported by FCC nationwide survey.) CIRE training is the only planned course of coaching and training that leads directly to an FCC license.

Your FCC ticket is always recognized in all radio fields as proof of your technical ability



CIRE Graduates Find FCC License Pays Off

"I now hold ticket Number P-10-3787, and holding the license has helped me to obtain the type of job I've always dreamed of having. Yes, thanks to CIRE, I am now working for CAA as Radio Maintenance Technician, at a far better salary than I've ever had before. I am deeply grateful."
Student No. 3319N12

"I took the FCC examination on March 4th and received my second class radiotelephone license March 9th. I go to work for the Trans-Texas Airways in the maintenance department. Thanks for all the assistance."
Student No. 2394A1

CLEVELAND INSTITUTE OF RADIO ELECTRONICS
Desk RC-8 4900 Euclid Bldg., Cleveland 3, Ohio

APPROVED FOR VETERAN TRAINING UNDER THE "G.I. BILL OF RIGHTS"

Get All 3 FREE Send Coupon Now!

CLEVELAND INSTITUTE OF RADIO ELECTRONICS
Desk RC-8 4900 Euclid Bldg., Cleveland 3, Ohio
(Address to Desk No. to avoid delay)

I want to know how I can get my FCC ticket in a few short weeks by training at home in spare time. Send me your amazing new FREE booklet "Money Making FCC License Information," as well as a FREE sample FCC-type exam and FREE booklet, "How to Pass FCC License Examinations" (does not cover exams for amateur License)

Name

Address

City..... Zone..... State

Veterans check for enrollment information under G.I. Bill
NO OBLIGATION—NO SALESMEN

Squeezing the Service Technician

. . . *New legislation threatens the television service contractors* . . .

By THE EDITORS

THE radio service technician's bed has never been strewn with roses; and of late the situation has been worsening to such an extent that it threatens to get entirely out of hand.

Latest development comes from New York State, where the Attorney General's office may take action which could strike a mortal blow to the independent television installation and maintenance man. The proposition is to declare that television service contracts come under the existing insurance laws, and that *all organizations handling service should therefore be licensed under the State insurance law*. This means that firms taking television service contracts would have to prove they were financially stable, and would have to put a required sum of money into a trust fund to insure that television set owners would get the service they are entitled to under their contracts.

The real cause, of course, is that television maintenance contracts have been set at a price which has made it impossible for the service contractor to carry them out. His costs have been so much higher than the contract fees that he has been forced into bankruptcy, in many cases watching the savings of a lifetime disappear with the funds he received for his television contracts.

Tragic as this has been for the service technician who has been forced to close up his business, the customer has been hurt as well. He has paid his money for a year's service. Three months after the contract is signed, his receiver may develop a fault. He finds that the company with which he signed the contract is no longer in existence. The dealer who sold him the television set and contracted for its installation through an intermediary service firm is not interested in his plight. Neither is the manufacturer of the set, in spite of the fact that one of his models may have been the cause of the customer's dilemma and the contractor's bankruptcy.

As we go to press no final decision has been taken by New York State on this proposal, and it is hoped that no unfavorable decision will be made. New York State is by far the country's biggest television market, and if such an adverse action were taken in that state, many other states would certainly follow the example.

The New York State Insurance Department contacted many of the larger television manufacturers in an endeavor to have the makers themselves guarantee the service contracts. With the exception of several large television set makers who have their own service setups, the manufacturers declined to have anything to do with the proposition. They insisted that maintenance was the dealers' and distributors' job, and felt that if the manufacturers were made responsible they might become involved in lawsuits and other difficulties.

What then is wrong with the entire setup? How can the trouble be cured? The main difficulty is obviously that the rates paid for television installation and maintenance are so low as to drive the service concerns out of business. The cure is obviously to remove this trouble, not to make the present difficulty an excuse to channel television servicing, installation, and maintenance into the hands of large concerns who—given a near-monopoly on the business—can then raise the contract rate to a figure that will assure them a profit under the most unfavorable circumstances. This will react into higher cost to the customer, and eventually the manufacturer and dealer will pay for it in the form of fewer television set sales.

Why are present service contract rates so low? There are three main reasons. First, it is in the dealer's interest to make the price for installation and service as low as possible, since he does not intend to do this work himself. But because of the novelty of the business, would-be contractors had no means of knowing what their costs would be, and in many cases were sold these "suicide" contracts.

Probably the greatest single cause of loss-producing contracts is the "sour" television model. We have had these models since the beginning of broadcast radio. Every manufacturer makes such a set occasionally, and the complications of television render the chances of putting on the market a model with latent defects that much greater. Such a model may call for twice as many service calls as the average televiser, and the maintenance technician who has contracts for a large number of them is slated for certain economic destruction.

The nature of the contract itself is partly to blame. *Only a term of service, with no restriction on the number of calls, is usually specified*. The customer therefore feels it good business to call up the service technician any time if something out of the ordinary appears on the screen. Many maintenance men report that half their calls are of the "nuisance" variety, in which nothing is actually wrong with the set, and the customer requires only an explanation of what he has seen.

How can we remove these causes?

Obviously **THE UNLIMITED MAINTENANCE CONTRACT MUST GO!** The manufacturer must be responsible for calls due to defects in his receiver. All calls—after the manufacturers' guarantee period—should be paid for by the customer. An ideal installation and maintenance contract would call for a fixed fee for installation and a specified number of calls during the "work-in" period of the receiver. All calls thereafter would be paid for at a stated rate per call. This system would prevent the maintenance technician from going bankrupt.

For—make no mistake about it—the small two- or three-man shop is the most efficient service organization ever devised. We went through this same children's disease in the infancy of broadcast radio in the early '20's. More than one manufacturer wished to assure good repairs by "factory service" and sets were shipped back to the factory when they broke down. But it was soon found that factory repair departments could not break even without charging from three to five times as much as would the local repairman for an equivalent job.

The final answer—for manufacturer, dealer, service technician and set owner—is not a system that will add to the expense of television maintenance by squeezing the smaller service technicians and installation firms out of business, but common sense that will take the "gimmicks" out of the present setup and thereby make it possible for them to stay on the job.

Far-seeing television manufacturers cannot fail to be impressed with this situation. We are faced with a shrinking economy in this country and *the public cannot be placed in a position where it hesitates to buy television receivers, for fear of having to pay twice for television servicing*. Neither can the manufacturer profit from a system that would result in fewer and fewer technicians being left in the field to service the growing number of sets. It is up to them to help the service technicians stay in business if they do not want to lose money in the end.

Improve Your TELEVISION PICTURE



When you adjust the rear-panel controls, have someone hold a mirror so you can see how adjustments are affecting the picture. Large mirror is best.

Without knowing a thing about radio, you can better your reception. A “how-to-do-it” for non-technical TV set owners

By ALLAN LYTEL

IF YOU drive a car, you probably feel fully capable of telling when the gas tank is empty, of filling your tires with air to the right pressure, and of putting antifreeze in the radiator when winter comes along—even though you’re no mechanic. Despite the fact that you may not know a resistor from an inductor, there are certain improvements you can make on your television installation, too.

But wait a minute! Put down that screwdriver and that pair of pliers. It’s definitely *not* a good idea to go barging into the set’s innards—that’s work for your professional television service technician. There are dangerous high voltages inside that back cover. There are also delicate adjustments, disturbing any one of which might put your set out of commission. But there are plenty of improvements you can make *without taking the back cover off the set*.

Your first area of operation might very well be your roof if you have an outdoor antenna. Your regular radio has probably been doing very well with a built-in antenna; but your television

set is much more critical for two good reasons.

First, the very short waves used for television transmission won’t travel around corners—they travel in straight lines, though they will bounce off flat surfaces. That means that for best reception the antenna should be placed where radiation from the transmitter can reach it directly, without obstructions or detours.

Second, a little noise on your radio doesn’t bother the ear much; but on television the noise (interference or static) makes little spots, lines, “rain” and “snow,” dance all over the screen, and—as you may know from experience—eyes won’t stand much of that without complaining.

If you have put up your own antenna, the first thing to do is find out whether it is in the right place. Moving the antenna a few feet in any direction can make all the difference in the world. So try moving it around, with a friend watching the TV screen to tell you when the picture is best. You may have to turn down the CONTRAST control if you get much of an improvement.

If the installation is a professional one or if the antenna might damage someone or something if it falls down, better not move it. Probably your service technician has installed it right.

Whether or not you relocate the antenna, you may be able to improve reception by turning it a bit. Usually you’ll do best by having it broadside to the station, as illustrated in Fig. 1. But that not always being true, try other positions as well.

Eliminating ghosts

There’s nothing mysterious about television ghosts. If you get them, it’s

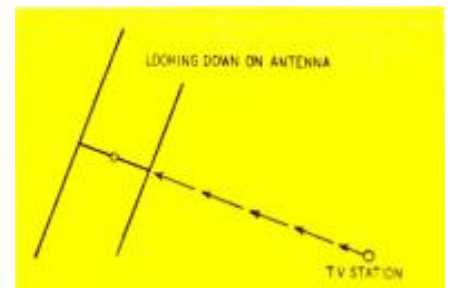

Fig. 1—Antenna is broadside to the station.

because your antenna is picking up *two signals from the same station*. Take a look at Fig. 2. The transmitting antenna squirts out energy in *all directions*. The energy your antenna picks up should be that going along path A—the shortest and most direct route.

But suppose some of the energy going in another direction (path B) hits a building, as the drawing shows. It bounces off the building just as light rays reflect from a mirror. (Angle of incidence is equal to angle of reflection.) The reflected energy also reaches your antenna. But because it has traveled over a longer total distance than the direct ray of path A, *it arrives a little later*. Thus, you have two signals from the same station!

The picture on your screen is “painted” by a spot of light that moves across and up and down the screen very fast. At each point on the screen it varies in brightness to give the right shading to that part of the picture. And the amount of brightness at each instant is dictated by the signal it receives at that instant from the station.

Now, let us say that the signal of

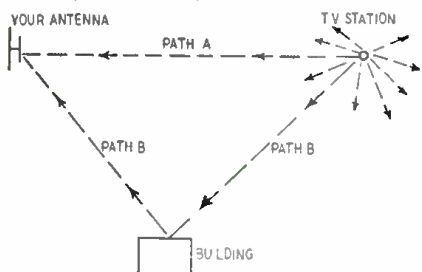

Fig. 2—Dual-path reception can cause ghosts.

path A tells the spot to make your screen black in the center of the picture of a man's vest. Then the signal of path B comes along a fraction of a second later *with the same command*. By that time the spot of light has moved over into the whiteness of a light-colored wall. But the path-B signal tells the spot to go black—and it does. Result: you see two dark areas (two vests) where there should have been only one! The second vest, to the right of the first, is the ghost.

The problem is to eliminate the signal of path B. If your antenna is of a very directional type—that is, it rejects all energy not approaching it directly—you'll probably have little trouble. If you do get ghosts, try revolving the antenna while a friend watches the screen. You'll very likely be able to find one position at which ghosts will be at a minimum for all or most stations. If there is no such position, you'll probably have to get a more directional antenna.

There's no way to predict in advance whether you'll have ghosts; they are *not* caused by the set itself. They are entirely an antenna problem—therefore experiment until you're satisfied.

Better results downstairs

After you've finished with the antenna itself, pay attention to the wire or line connecting it to the set.

The connecting line, usually made of



If your picture is this bad, better get to work! The orrows show the genuine and ghost images.

two parallel wires embedded in a tough, flexible plastic, is known as ribbon line or Twin-Lead or some similar name. It is usually about 3/8 inch wide, and technicians generally call it “300-ohm” line because of its electrical characteristics. If that's what your installation has, it's time to go to work.

Take the tinfoil from a package of cigarettes, tear off about half, and wrap it around the ribbon line a few inches away from your receiver. Keep it in place with a paper clip. The photo will give you the idea.

Slide the foil slowly along the line and *away from the set*, watching the

Strip the plastic away from the first couple of inches of your piece of line, and fasten each wire to one of the antenna posts of the receiver. You'll need a screwdriver because the antenna posts are usually screw terminals, to which the line from the antenna is already attached. When you tighten up the two screws again, you should have *both* the original antenna line and the end of the new piece of the line in place. Fig. 3 illustrates the scheme. Be sure to get one bared wire from each of the two lines securely under the head of each screw.

Now, starting at the free end of the

TO THE SERVICE TECHNICIAN

Written primarily for the nontechnical television set owner, this article is also intended to aid the television service technician. The technician's time is valuable; presenting a copy of the article to each owner he visits will help save him unnecessary trips and stave off time-wasting queries.

For this reason, RADIO-ELECTRONICS has prepared reprints of the entire article (with the exception of this special announcement, which will not be included). The cost of the reprints is low enough to allow the technician to hand one to each of his customers. Postpaid prices are:

Single copies	10¢ each	Lots of 25	5¢ each
Lots of 6	7 1/2¢ each	Lots of 50	4¢ each
Lots of 12	6¢ each		

Orders may be sent to Order Department, RADIO-ELECTRONICS, 25 West Broadway, New York 7, N. Y.

screen. You should have your most difficult-to-receive station tuned in, with the CONTRAST control turned down until you can barely see the picture. You will notice that with the tinfoil at a certain spot, the picture gets worse, and that at another spot it brightens up. Leave the tinfoil at the place at which the picture improved. Check all the other stations to make sure you didn't make them worse. If all is well, you've scored a point!

If reception still isn't good on your worst channel, take the tinfoil off. At your radio store buy 3 or 4 feet of 300-ohm ribbon line. Make sure you have an old razor blade handy.

new section of line, hold the razor blade across the plastic ribbon and dig it in until the metal contacts both wires. Watch the screen. The picture may improve or get worse. Try this razor-blade trick at intervals of an inch or so all the way up to the antenna terminals. You will find at least one point where the contact will improve the picture. *Cut the line at that point*, bare the wires, and twist them together to make the improvement permanent.

While this will probably improve only one station, it isn't very likely to make others worse; therefore you will have gained something again. If two stations are bad, go through the procedure sep-



This photo shows the strip of tinfoil wrapped around the line and held in place with a clip.

arately for each one, and then use a switching arrangement like that shown in Fig. 4. You can buy the double-pole, double-throw knife switch at a hardware or ten-cent store. When you want to watch programs on station A, throw the switch to contact the line adjusted for that station; ditto for station B. When watching stations needing no improvement, leave the switch entirely open. You can screw the base of the switch to the back of the receiver cabinet.

There's one more thing to check in the antenna department. Notice how the ribbon line comes down from the roof. Is it securely anchored all the way so it can't whip about in the wind? If not, move it yourself and see

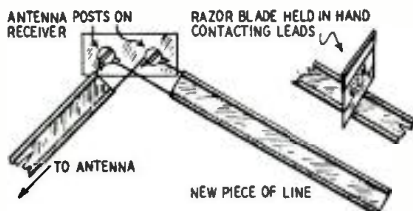

Fig. 3—Add piece of line and test with blade.

whether there's any effect on the picture. If there is, anchor the line firmly at intervals along the way if possible, and at least at top and bottom. Don't use nails or screws; your radio service shop has special insulators.

Adjusting controls

You don't have to be an engineer to adjust a television set's controls correctly, but a few tips will help. You use the front-panel controls more often than those on the rear, and you've probably tamed them so they'll perform as scheduled.

The little, knobless controls on the rear, though, have probably affected you in one of two ways if you're a more or less average set owner. Either you've left them strictly alone or you've become so curious that you twiddled them all and then were unable to do anything but call your repairman. Of the two, the first reaction is the safest, but there's no reason why you can't go around back and adjust at least some of the controls to get a better picture. As your set "breaks in" and the tubes

and parts age, some of the adjustments need changing; you can often do it yourself, without bothering the service technician.

But please read on before you touch anything! One wrong move, and the picture may be standing on its ear. Go slowly!

Item No. 1 is to get a good-sized mirror if you have one. A hand mirror will do if you can't find a bigger one. After moving the set out so you can get behind it, prop the mirror on a chair in front of the screen. If you can't do that, get someone to hold the mirror for you, as the personable young lady is doing in the photograph.

If there isn't much light behind the set, use a flashlight to read the control markings. Usually these are stamped in the metal of the chassis and are hard to read; be sure that the control you are adjusting is the one you want.

First adjust the FOCUS control. (It may be either on the rear or the front of your set.) There are just three ways to do it *right*. Take your choice.

If there is a test pattern on (any channel will do, but choose the one that normally gives you the best picture) tune it in and fix the front-panel controls as usual. Now, watching the image carefully in the mirror, slowly rotate the FOCUS control until the black lines near the apex of the bottom vertical wedge are clearest and most sharply defined. Fig. 5 is a photo of a perfect test pattern and the arrow shows you the area to be watched. Make the adjustment very precise—so that your eye can separate the black lines to a point as near the center as pos-

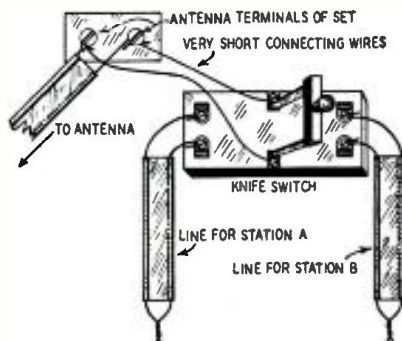

Fig. 4—A switch selects desired tuning line.

sible. This is quite a critical adjustment.

Another good way is to try and find a channel with FM or similar interference. Try the channels *not* used by stations in your location. Turn the CONTRAST control up and watch for a "tweed" (as in men's suits) pattern. If you can find one, adjust the FOCUS control until every detail of the tweed pattern is crystal-clear. The optimum adjustment can be found very quickly.

If there aren't any test patterns and you can't find tweeds, tune in a program. Adjust the FOCUS control until you can see individual horizontal lines of light across the screen. You'll have to look closely on most sets, and you may have trouble seeing the lines at all on 7-inch and smaller tubes. Using a test pattern is by far the best method of the three mentioned.

There are two more controls you can adjust if your set has a 7-inch tube or smaller. These are VERTICAL CENTERING and HORIZONTAL CENTERING. If the picture is too far over to one side of the mask or too high or low, these controls will move it to the right place. Adjustment is very easy—just watch the image and twirl the control shafts.

Once again a warning: The other controls on the rear of the set interact; that is, *adjusting one affects the functions of another*. One twist of a shaft and you're likely to spend the rest of the evening trying to get a good picture.

Light filters and enlargers

There have been rumors that watching television is bad for the eyes. If your receiver works well and you treat it right, the rumors are—just rumors. For instance, don't locate the set where direct light can fall either on it or on your eyes. If it's under a window or there's a lamp beside it, your eyes will have to withstand quite a change of illumination when you look away from the picture to the comparatively bright sunlight or lamp.

If light falls on the screen, the glass will reflect it, along with the light from the picture itself. Effectively that reduces the contrast—"washes out" the picture. So, for best television viewing, keep the room dark except for a little light that doesn't shine on your face or on the screen.

Keeping the room entirely dark is hard on the eyes, too. When you look away from the screen, your eyes have to adjust from reasonably bright light (the picture) to utter darkness, a change that's too sharp, according to medical men, to be healthy.

Picture-tube filters are sold to "increase contrast"—you've probably seen the ads. Some of them are simply tinted, transparent plastic. The light from the picture itself passes through the filter once and is dimmed to some extent. But any external light reflected from the screen passes through the filter twice—once on its way to the screen and once from the screen to your eye. As you can see, the reflected light is cut down twice as much as that from

the picture. As a result, daylight or room lights falling on the screen don't

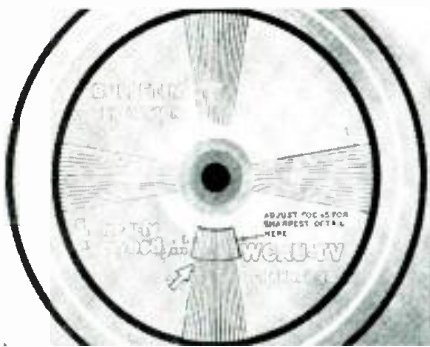

Fig. 5—Watch outlined area when focusing.

tend to wash out the picture so much. Polaroid filters are a little different. They are tinted, too, and act like the others; but in addition, they have the same properties of cutting down reflected glare as do the Polaroid glasses you may have used while driving a car. Apparently reflected light is polarized much more than direct light; the polarized filter removes most of the polarized reflections.

Some viewers like filters and some don't—it's a matter of individual preference. They undoubtedly do prevent eyestrain to some extent by removing the glare from overly bright screens, but you can do the same thing by turning down the BRIGHTNESS control.

If your set has a 20-inch viewing tube like the Du Mont on this month's cover, you probably aren't worrying about getting a bigger picture. But if you have a smaller one, you may want an enlarging lens. Available in many sizes and styles, most of them are either solid or liquid-filled plastic. Unfortunately, you can't get too far off toward the side without getting picture distortion with a lens; but since a bigger picture will allow you to sit farther away from the screen, you can usually get more or less directly in front of the set all the people who want to watch.

There's an important limitation to the size of your picture. Remember that a television picture is not a solid "photograph" but an optical illusion. It's made up of 485 horizontal lines of light from top to bottom of the picture. If the tube is small, the lines must be crammed in; they are so close together you can hardly see them. With even a very large picture—the number of lines remains the same; the lines are now far enough apart to be seen. Whatever the size of your screen, you have to get far enough away from it so that the lines blend together and the eye is fooled into thinking it sees a solid picture. Therefore, with a big screen, be sure your room is large enough to allow you to get back from the set a sufficient distance. The distance will vary according to the condition of your eyes and your preferences. Watch a picture of the size you want at your dealer's store to get the information you need.

You may have heard that American television stations transmit with a definition of 525 lines. What happened to the difference between 525 and the 485 we mentioned above? The answer is that the time that might be occupied by the missing 40 lines is taken up with "sync pulses". These are electronic instructions which tell the receiver what to do to keep the moving light spot in step with that at the transmitter. Without them—no image!

Out in the country

Television stations usually have a maximum useful range of about 40 miles because of the technical characteristics of the wavelengths on which they transmit. Sometimes they'll reach farther, sometimes not the full 40 miles. But if you live more than 25 to 30 miles from a station, you're likely to have a little trouble getting a perfect picture, one without "snow" effect.

The best way to proceed if an ordinary installation doesn't get the results you want is to use a special antenna, one that's very directional. These antennas not only suppress static arriving from directions other than that in which the antenna is pointed, but also provide a gain—they receive energy and send it to your receiver much more efficiently than the simpler antennas.

TELEVISION TUBES LOSE BRILLIANCE

EACH new television set any of our neighbors installed seemed to be better than anything we had seen up to the time. Such bright pictures! But after noting this three or four times, we began to wonder. Television can't be improving that fast! Could it be that new sets give a brighter image, and that the older ones dim down so gradually that one doesn't notice it?

Radio tubes wear out, and the cathode-ray tube should be no exception. But does it lose its brilliancy gradually, drop sharply and then level off, or run at practically full brilliancy through most of its useful life and then drop off sharply?

A letter to H. D. Suesholtz, general manager of Transvision, brought the information:

"The screen efficiency decreases as the tube is used. The curve showing

If you're still not satisfied, try raising the antenna as high as possible. Some owners in outlying districts have even used telephone poles (bought their own, not climbed up existing ones) or tall metal towers. This matter of reception in *fringe areas*, as these locations are called, requires considerable study and is best handled by a professional technician.

If you are located where the signal is weak, but still strong enough to give you some picture, a booster will often help. These are little amplifiers containing one or two vacuum tubes, that any set owner can install himself. Connected between the antenna line and the receiver, they increase the strength of the signal before it reaches the receiver. Even where some stations come in well, there may be others which perform badly; a booster may help with the bad ones and can be switched off when you are watching a strong station.

Improving your television set pays off in better pictures and more satisfying entertainment.

But remember this always: your television receiver is a delicate instrument, and it's immensely complex. *Leave its insides strictly alone*; if something goes wrong that hasn't been wrong before, call your television service technician!

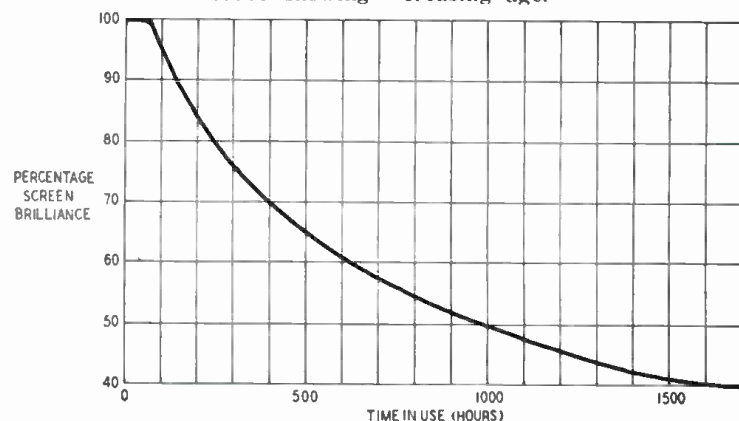

This curve shows how maximum brilliancy of the C-R tube decreases with hours of use.

Booster Uses Standard Tuner

Ready-Made Front End Makes For Efficient Operation

By **MATTHEW MANDL***

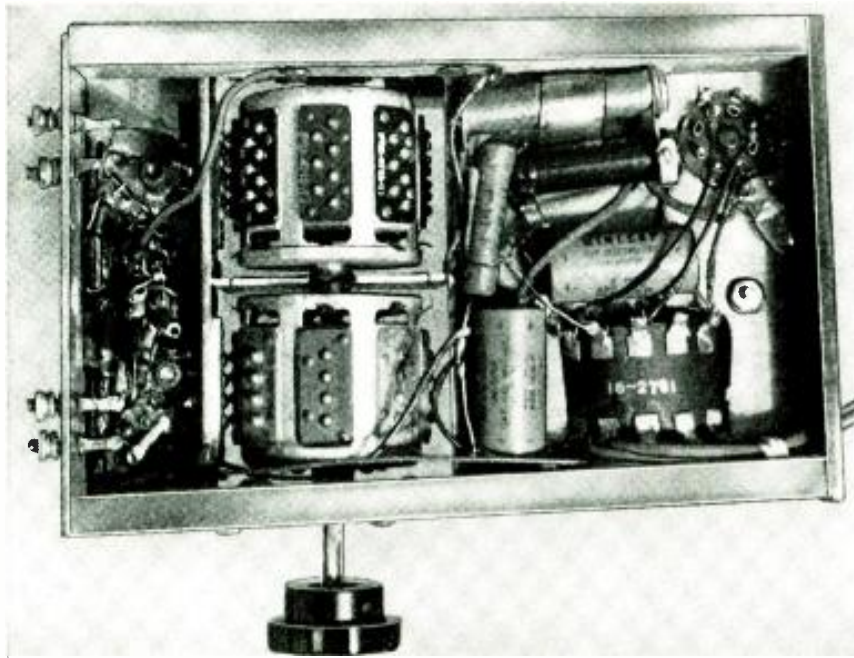

This is the booster made from the Philco front end. Power supply is at right of tuning drum.

A TELEVISION booster consists of one or two stages of r.f. amplification with the output so designed that it will match the input of the TV receiver. While it is not difficult to wire an r.f. stage, the wide band of frequencies which must be covered in television makes the tuning system critical. The channel-selector section is the most troublesome because the high frequencies to which it must tune make necessary a number of precautions for even average performance. Assembly and wiring of such a tuning circuit demands constant attention to stray capacitance, lead inductance, and skin effect, for all contribute to high losses and poor efficiency. When, at the same time, a 6-mc bandpass with a good signal-to-noise ratio is required, the problems become even more complex. For these reasons most homemade boosters fail to give satisfactory results—particularly on the higher-frequency channels.

These difficulties can be greatly reduced by using a commercially built tuner as the foundation unit for the booster. Such tuners have been carefully engineered for the TV frequencies, are fairly high in efficiency, and make bandswitching simpler. Any good tuning section can be used, and many types are available from TV kit manufacturers.

Often a defective tuner which has been replaced by a new one during servicing can be salvaged for use. Tuners frequently develop defects in only one or two channels, and thus can be utilized for booster construction, because a booster is not needed for all channels.

Essentially, a commercial tuner consists of three sections: the r.f. amplifier, the mixer, and the local oscillator. These are combined into one unified assembly, small in size, with the tubes mounted on top. Such a device already has all the components, except for the power supply, necessary for constructing a booster. If we eliminate the local oscillator and convert the mixer to an impedance-matching device, we have an excellent r.f. amplifier, pretuned and designed for easy channel selection.

Three things are necessary. First, disconnect from the oscillator the tuning coil which is coupled to the mixer. The oscillator tuning coil need not be removed, but should be open so that it will not affect the tuning of the unit. Second, convert the mixer tube to an impedance-matching device; cathode and plate circuits must be changed slightly as outlined later. The final step

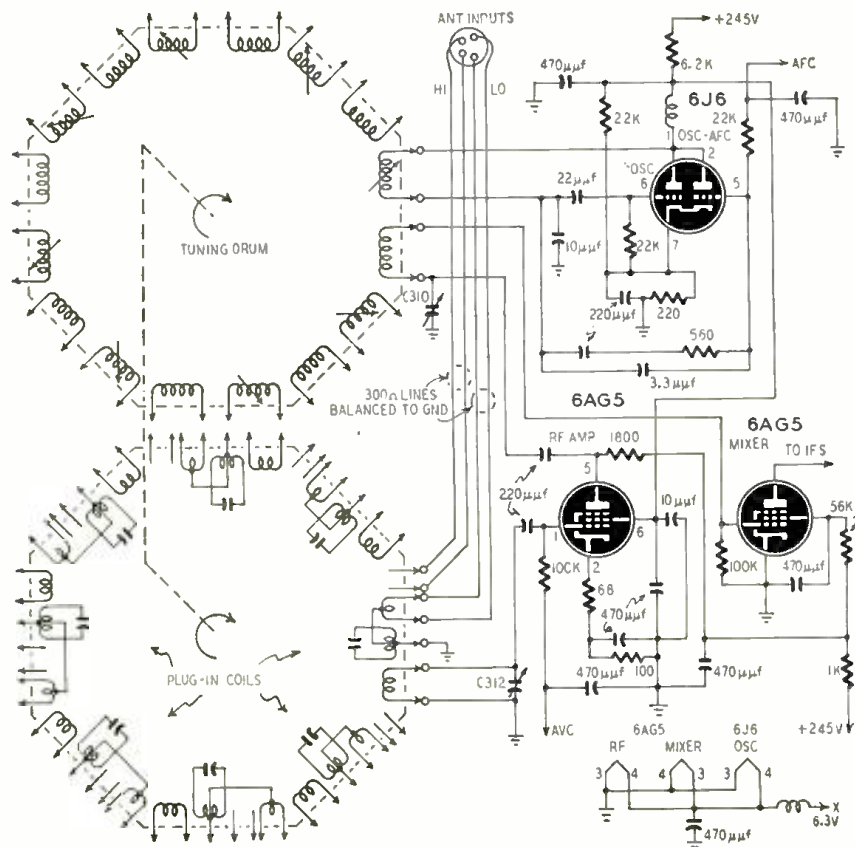

Fig. 1—Original circuit of the Philco television tuner. Coils may be had for any channels.

*Television Instructor—Technical Institute Temple University

is assembly of a small power supply for the device.

A booster of this type was built using a Philco turret tuner. The Philco turret has two rotary drums, each with eight slots into which coils are plugged. One drum receives the antenna-r.f.-input coils, and the other the mixer-oscillator coils. Fig. 1 shows the original tuner circuit. Fig. 2 is a schematic of the booster, showing the changes made in the tuner. The power supply is given in Fig. 3. A comparison of the original and modified circuits shows that only two changes were made: the 6J6 oscillator-a.f.c. tube was eliminated, and the 6AG5 mixer was changed to an impedance-matching device for a 300-ohm receiver input.

With the oscillator eliminated, two tuned circuits are still present—the input to the r.f. amplifiers, and the interstage circuit between the two 6AG5 tubes. Plug-in coils for this tuner are available for any TV channels, and eight different stations can be made available by rotating the drum. As with other tuning units, coils are pretuned at the factory and need little adjustment. If coils should be found too far off frequency, adjustments can be made by changing the spacing of the turns slightly. Tracking capacitors, present in all types of tuners, can also be employed when necessary to get peak performance.

The Philco tuner has provisions for high- and low-band antenna inputs, using 300-ohm transmission lines. Two antennas, with separate transmission lines, can be employed. Each will be switched in automatically as the drum is rotated. If the double antenna system is not desired, a single antenna and lead-in can be used by shorting across the two terminals, as indicated by the dotted lines in Fig. 2.

Constructional details

Since the modified tuner comprises the entire booster, additional chassis space is needed for the power supply. With the Philco tuner, the chassis used is 5 3/4 x 9 x 1 inches. The Philco tuner measures 4 1/2 x 5 3/4 inches, and this much of the chassis top is left open. The tuner is bolted to the chassis, over the open section, as the photos illustrate. The chassis is made of wood; the tuner framework is metal and provides adequate shielding.

A strip of Plexiglas, Lucite, or other low-loss material should be used for the input and output connections. In the tuner illustrated, bolts and nuts were used for terminal connectors, though low-loss jacks or other plug-in devices can also be employed. Connectors with large surface areas should be avoided, however, because the capacitance effect between them becomes quite pronounced for the upper-channel frequencies.

The power supply is a conventional full-wave rectifier type. A 5T4 was used, but any standard rectifier tube will be satisfactory, including the min-

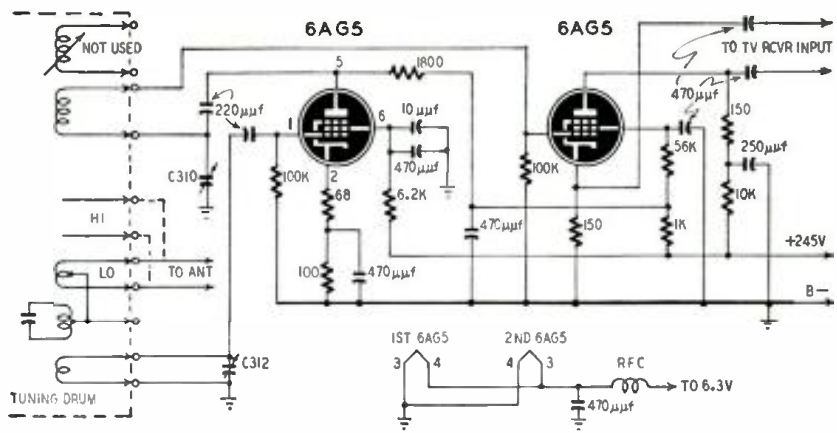

Fig. 2—Circuit of booster. Oscillator-a.f.c. tube was removed and mixer made output stage.

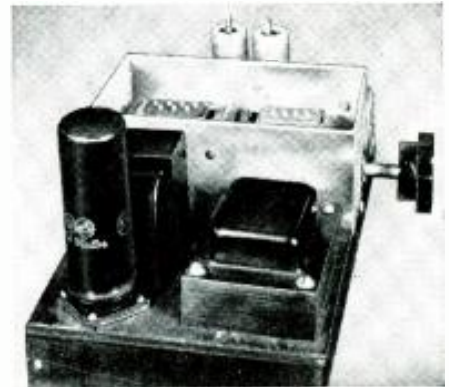
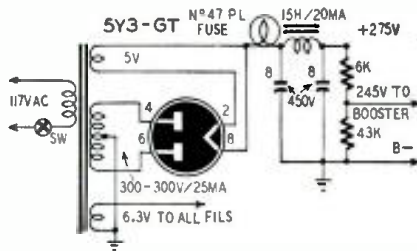

Fig. 3—The booster diagrammed above is powered by the simple supply shown here.

Final construction job appears in the photo.

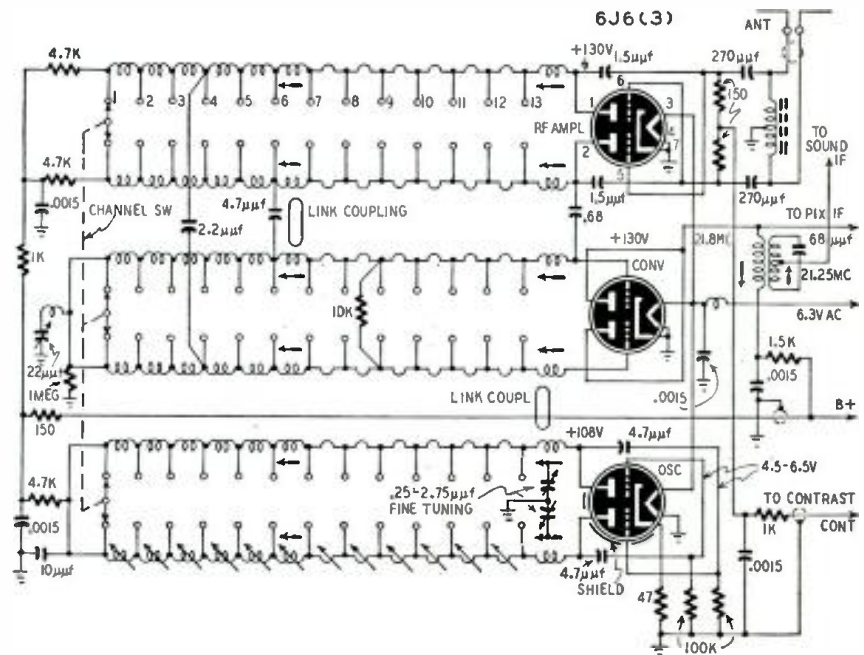

Fig. 4—Circuit of the tuner appearing in RCA, Admiral, Emerson, and other receiver models.

ature type 6X4. Almost any small power transformer will do, because the current drain of any commercial r.f. tuner will not exceed 20 ma. The voltage for the booster circuit, however, should be no higher than 245; and if the output of the supply is greater than this under load, a voltage divider system like that shown in Fig. 3 may be used.

The resistance of the bleeder will depend on the particular power trans-

former used. The type 47 pilot bulb acts as a fuse and protects the rectifier tube and transformer.

With some commercial tuners, the removal of the oscillator tube will suffice, and this should be tried first before disconnecting the oscillator coil. If the unused oscillator coil does not seriously affect tuning, no further changes need be made except to the mixer output. With the booster described, all oscillator wiring was removed to make a

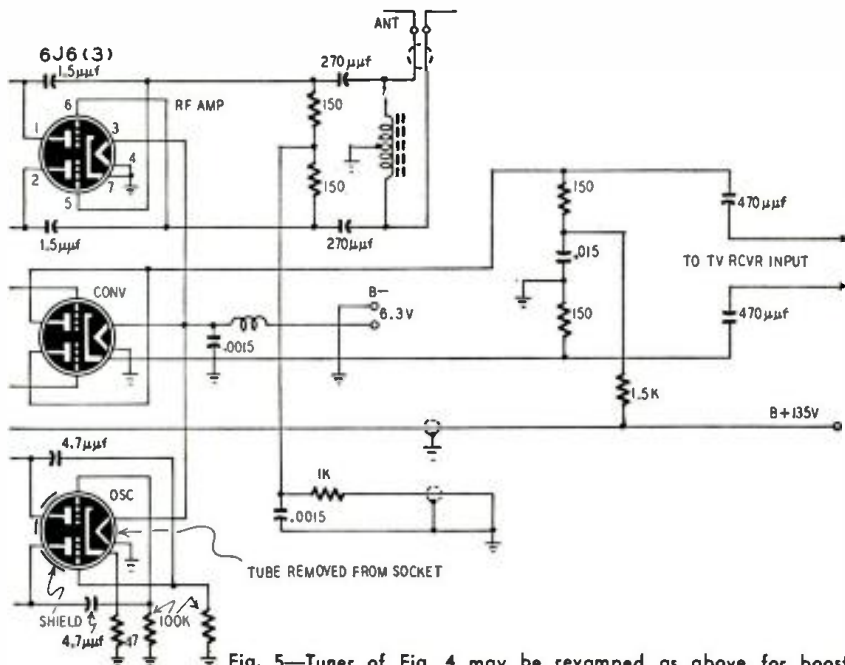

Fig. 5—Tuner of Fig. 4 may be revamped as above for booster.

neater job. Take care not to open circuits unintentionally, because some ground or B-plus returns may be terminated at the oscillator-tube socket.

The mixer tube is used in a circuit whose primary function is to make an impedance match between the booster

output and receiver. Balance is attained by using an unbypassed cathode resistor against the plate-load impedance. Since the circuit is degenerative, gain is less than 1. This double-tube booster is much better than a single-tube booster, even though the gain of the second

stage is below 1. The reason is that single tube boosters have to match the low receiver impedance (300 ohms) in their plate circuits, substantially reducing gain.

Use a common ground for booster and TV receiver to assure balance throughout. When operating the booster, a 300-ohm transmission line is used from its output to the input terminals of the receiver. It should be as short as possible to avoid stray fields. For the high channels, the antenna transmission line may have to be tuned by shorted stubs attached to the input terminals. Tinfoil, wrapped around the line, can also be used for tuning. Slide it up and down the line until the picture is best.

Other tuners lend themselves just as readily to booster construction, with identical changes.

Fig. 4 shows a typical tuner which has been used in several receivers. It was originally the RCA 630TS receiver tuner, and subsequently was used by RCA in 1948 models, 8TS30 series. The Admiral 30A1-B chassis also employed identical tuners, as did Emerson in model 571, and other manufacturers. Removal of the coupling link between the mixer and oscillator and a change in the plate circuit of the mixer, as shown in Fig. 5, converts this tuner into another high-gain booster.

New All-Channel TV Antenna

A TELEVISION receiving antenna of entirely new design was announced recently by Continental Copper & Steel Industries, Inc., New York. Called the Welin Circle X, it consists of a circular tube with four radial rods, the whole forming a shallow cone.

The single antenna is said to be effective over the entire television spec-

trum with a gain of approximately 1.9 over a half-wave dipole. At the lower-band frequencies, the pattern is wide and bidirectional, about the same as that of a dipole. At the higher frequencies, the rear lobe becomes considerably smaller than the front one.

Because a complete investigation of the validity of the design principles has not been completed at this writing, little can be said of the engineering basis for the antenna. It has been found, however, that despite the broad angle of signal acceptance, it is remarkably effective in suppressing ghosts. A slight reorientation to one side or the other diminishes ghost reception, apparently because of certain phase relations between the direct and reflected signals reaching the circular outer ring; cancellation seems to take place. Interestingly, it has been found that a slight reorientation in the vertical sense—tilting the assembly so that it points upward about 7 degrees—also diminishes ghosts to a large degree in some cases.

The photo and diagram show how the antenna is constructed. The outer circle is composed of four segments, each $\frac{1}{4}$ wavelength at 135 mc. The 135-mc frequency was chosen as the median of all the television channels. Each of the radial rods is $\frac{1}{2}$ wavelength. The inner ends of the rods are fastened and connected as the diagram indicates, adjacent pairs going to the two ends of the transmission line. The outer ends

of the rods are mechanically and electrically connected to the junctions of the circle segments so that they are 90 degrees apart on the ring.

The impedance of the feed point is approximately 150 ohms, though it varies somewhat over the range. In ordinary installations, 300-ohm line is used, with a minimum impedance mismatch (and standing-wave ratio) of 2, though neither is much greater than this at any frequency. For critical installations where signal is low or noise level high, matching stubs and transformers of the ordinary type reduce the mismatch.

For optimum results, the antenna should be placed in a space loop and the bottom of the ring should be at least 5 feet above the ground beneath it.



The Circle X resembles shallow skeleton cone.

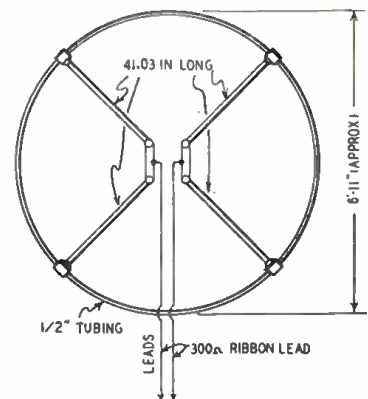

The drawing shows dimensions and connections.



A standard signal generator with 400-cycle modulation and an output meter are necessities.



Sweep generator and scope are optional.

Trouble-Shooting Television Sets

By IRVING DLUGATCH

MANY an old-timer in radio servicing has turned green with envy on seeing the "complete service laboratory" unveiled by his newest competitor. Yet half the servicing the skilled radio technician does is with no other test equipment than his eyes, ears, nose, and fingers. That's possible because he knows his basic theory and has spent years of postgraduate study in the College of Experience.

Television doesn't differ from sound radio in this respect. It is even simpler to service in some respects because the eyes can be used to better advantage. The kinescope tube is a piece of test equipment wired right into the receiver.

Many may have been frightened away from video work by the ballyhoo over special test equipment supposedly needed. Emphatically, special television test equipment *has* a place in every television shop. The purpose of this article is to demonstrate that a large percentage of television servicing can be done with a good volt-ohm-milliammeter and a signal generator.

Servicing any electronic circuit is simplified if we know:

1. What it is designed to do;

2. Whether it is self-excited or receives an external signal;

3. The frequency;

4. How it is supplied with its operating power.

Let's see how the four facts are used in practice. Suppose a device is described as a three-stage amplifier supplying a 15,750-cycle sawtooth wave to its output terminals. It is receiving d.c. potentials from a conventional full-wave rectifier power supply. There is, however, no sawtooth voltage at the output. Now let us proceed to put it into condition.

We know the frequency is 15,750 cycles per second; therefore, we know we need an a.f. voltmeter to trace the signal. Since we are dealing with an amplifier the signal must be coming from some external source. The meter will determine if the signal is arriving at the input terminals. If no signal is present, the amplifier is not at fault. If the signal is coming in, we would next check the power supply. If it is O.K., we need only trace the signal from stage to stage. The trouble can be localized in short order and the defective component found with the ohmmeter or voltmeter.

Required equipment

The foregoing is the general method of solving any servicing problem. Television, even with its multiplicity of circuits, does not introduce any further difficulties. Signal tracing is used in all its possible variations. To do a good job of signal tracing, you need:

1. **Output indicator:** Any a.c. meter with a capacitor in series with the hot lead. Since a high-resistance voltmeter and a wide-range ohmmeter are needed for checking parts, a combination instrument, such as the Superior TV-20, Precision 85, Electronic Measurements 120, or Radio City Products 450C, is recommended.

2. **Signal source:** Should provide modulated r.f. up to at least 30 mc on fundamentals and a 400-cycle audio signal. An attenuator for the 400-cycle note is very desirable. If it can go as high as 200 or 300 mc, it can be used for work in the r.f. sections. The Simpson 340 or Jackson 640 are typical.

Optional equipment

The following test instruments are highly desirable, if available, but are not absolutely required.

1. **Oscilloscope:** Usefulness greatly increased by provision for feeding video signal to grid of cathode-ray tube. Du Mont's 164E or similar instruments can be converted by adding a tip jack as shown in the drawing.

2. **Sweep generator:** Should have variable sweep width and cover a full range of radio and intermediate frequencies. Inclusion of a phaser is also desirable. RCA WR-59A, Hickock 610A, and Triplett 3434 are examples of such an instrument.

3. A number of selected, plainly marked capacitors and resistors for quick substitution.

The true expert soon learns not to trust the calibration of any instrument, regardless of its original cost. The signal generator should be calibrated at regular intervals. This can be done for the sound r.f. and i.f. carriers by using a television receiver that is operating normally. Feed in the signal from the generator while the set is properly tuned. When the 400-cycle note is heard with the television sound, we have the correct frequency to be used for alignment purposes. The picture carriers do not need precise calibration (for reasons to be noted later).

Next, our meters' accuracies are to be questioned. Fortunately, precise resistance and voltage readings are in most cases unnecessary and in many cases foolish. This is obvious when we remember that most parts tolerances are 20%. In addition, we will often be tracing signals that are not sine waves. The results obtained then with most instruments are so mystifying that special interpretation is required. Most a.c. meters used in television servicing are calibrated for r.m.s. measurements of sine waves (the rectifier-type actually reads *average* values but is corrected to read r.m.s.). When, for example, a sawtooth wave—of much lower effective value than a sine wave with the same peak voltage—is measured, the reading is bound to be low. Where a.c. and d.c. are combined, the d.c. component may be measured with a d.c. meter and the combined voltage with an a.c. meter. Subtracting the d.c. from the reading of the a.c. meter will show the amount of a.c. in the circuit.

Despite the claims of manufacturers, very few a.c. voltmeters are reasonably accurate above a few thousand cycles. Such things as rectifier characteristics and meter coil inductance limit the frequency range. Only with special probes can these effects be overcome. The probes still can't offset error which follows any attempt to measure anything but a sine wave.

Oscilloscopes are not immune to these faults. At high frequencies, their amplifiers may distort the wave being examined or so attenuate it that the instrument is worthless. Again a special probe will permit the use of an oscilloscope at these frequencies. The oscilloscope makes it possible to measure peak-to-peak values; and, for this reason, it can be used to compare accurately voltages of different wave shapes. This is all we need for signal tracing.

Checking and signal tracing

Our test equipment is assembled. We understand our instruments. Now what? Certainly not an immediate probing into the "innards" of the television receiver. That must wait until we have used our senses to determine the section of the receiver at fault.

So much has been written in the past on the "test-pattern-examination" type of trouble shooting that I shall not take the space to repeat such information. What follows is an outline of the methods to be followed *after* this step in the localizing of troubles within a suspected section of the receiver. (See "Servicing Televisers," page 50, and "Television Trouble Chart," page 54, of the January, 1948, issue; also "Using TV Test Pattern" in the November, 1948, issue.)

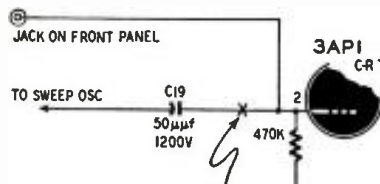

BREAK EXISTING CONNECTION AT X AND INSERT SWITCH
A Z-modulation jack added to scope is useful.

Since misalignment of circuits is a very common complaint in television work, let us begin with

Alignment procedure: The serviceman does not need to go through the complete alignment of all circuits in a television receiver. Normally, a receiver brought in for repairs requires only a "touching up" such as might be done with an AM broadcast set. *Because of the broadness of the picture i.f., it rarely requires any realignment.* A satisfactory picture can be received even if the alignment of the individual circuits varies a bit from the normal. The oscillator and sound i.f. may require realignment from time to time to keep the sound with the picture.

Suppose that, using the standard test-pattern-examination and localization methods, we have localized or partially localized a number of troubles. We would then perform the following signal tracing tests:

R.f. amplifier and converter: Signal injection tracing method using modulated sound r.f. carrier frequency with receiver's speaker as an indicator. If the signal generator cannot tune high enough, use a signal tracer with a good v.h.f. probe and high gain to follow received signal from a television station. Don't forget to check oscillator grid voltage and contacts on channel selector.

Sound i.f. amplifiers: Signal tracing with signal generator and output meter. D.c. output meter is connected across detector load. An a.c. meter at the plates of the audio amplifiers or the speaker can be used, also. The signal generator should be tuned to the sound i.f.

In receivers using intercarrier sound (Motorola, Hallicrafters, Videola, new

G.E., etc.), the i.f. is always 4.5 mc. Also, tracing should be carried to the video amplifiers where the sound is obtained. A very common complaint with these receivers—a buzzing sound heard with the audio—is due to video getting into the audio system. Provided the fault is not with the transmitter, the trouble can be eliminated by carefully aligning the picture i.f., sound i.f., and sound discriminator. If the discriminator and limiters (if used) are working properly, they will reject the amplitude-modulated video signal. In the picture section, the response curve should be such that the sound carrier is down to about 10% of the level of the picture carrier.

Misalignment of the r.f. circuits or mismatch in the antenna system may cause the buzz by changing the ratio between the level of the sound and picture carriers.

Audio amplifiers and detectors: Inject 400-cycle note using speaker as output indicator. For tracing distortion, use an actual signal and listen with signal tracer or headphones.

Picture i.f. amplifiers: Connect output meter at plate of video output amplifier. Inject modulated picture i.f. signal at the grids of the i.f. tubes, beginning with the last i.f. stage first and moving toward the antenna. The last position for injecting the picture i.f. will be the converter grid. The converter usually being part of a compact tuner, it may be more convenient to feed the i.f. signal directly to the receiver's antenna terminals. Make sure there is no trap at this point to prevent the i.f. from getting through. Incidentally, always remember that the carrier frequency is not passed at maximum gain in the i.f. amplifiers. A lower frequency will give greater output.

If the trouble is due to i.f. oscillation, it will be indicated by decrease in d.c. output at detector load when signal generator is removed and suspected i.f. grid grounded.

Video amplifiers and detectors: Signal tracing by injecting 400-cycle signal. This will give about six dark, horizontal bars on the raster. (See "AM Generator Useful for Television" on page 47 of the July, 1949, issue of RADIO-ELECTRONICS.) The darkness of the bars will depend on the signal amplitude and the gain of the stages being tested. An output meter will also be satisfactory. For distortion, investigate peaking coils and capacitors. Defective coupling capacitors and plate load resistors are also common causes of this complaint.

Sync circuits: Signal tracing by injecting audio-frequency signals. Measure output at grid-leak-biased clipper tubes with d.c. high-resistance voltmeter or note whether raster locks in with injected signal. A high-gain signal tracer may be used. Oscilloscope may be used to compare waveforms with manufacturers' data. (Sync clipper tubes usually have the plates and screens, or both, operating at very low voltages with zero bias.)

Horizontal deflection circuit: Here the signal is being supplied by the horizontal oscillator. The signal can be traced with a tracer, output meter, or oscilloscope. The oscilloscope is best but not absolutely essential. It requires accurate waveform photographs for comparison. With the signal tracer, the 15,750-cycle signal may not be audible to some persons. A good compromise is the output meter giving a relative reading.

A correctly operating discharge tube and multivibrator tubes have a plate potential of approximately 10% of the low-voltage supply. Considerable variation will be found, but if the plate voltage exceeds 30% the waveshape may be incorrect. If it approaches the supply voltage in value, the pulse is not present. Magnetic deflection output tubes are usually operated at cutoff. **Do not attempt to measure the plate voltage of horizontal output tubes and damping tubes in magnetic deflection receivers. A high-voltage pulse is present, making voltage measurement dangerous.**

Miscellaneous: All oscillators, regardless of type, develop a high negative voltage on their grids in normal operation. Sync discriminators can be serviced exactly like any FM detector. Always check the balance of push-pull output tubes, if used. Damping tubes are common causes of distorted pictures.

Vertical deflection circuit: Generally the same as for horizontal deflection circuits.

High voltage supply: For flyback systems, listen for 15,750-cycle whistle audible when horizontal oscillator is operating. Check horizontal sweep circuit as described previously. For r.f. oscillator system, test oscillator tube, measure oscillator grid bias with d.c. high-resistance voltmeter and see if rectifier is lit. Test by measuring resistance of bleeder resistors. Voltage may be measured directly with a d.c. voltmeter having sufficient range or using a special multiplier.

Make sure positioning of ion trap magnet is not the cause of a dark screen. A defective kinescope is also to be suspected. A 10BP4 needs not less than 7,000 volts for adequate brightness. With excessive ripple, make sure deflection yoke is properly grounding outside coating of kinescope. Check filter capacitors by substitution.

Low-voltage supply: Most supplies deliver 300 to 400 volts. The usual voltage and resistance checks will uncover most faults. Capacitors are best tested by substitution. Selenium rectifiers can be tested with an ohmmeter. They should have a minimum back-to-forward resistance ratio of 1,000 to 1.

Now that we have gone completely through the receiver, a review will show that no special test equipment was required in most cases. Obviously, sweep generators, signal calibrators, and other elaborate instruments can do

much to speed servicing, and are indispensable in certain jobs.

In conclusion, note that this article is not intended to be a complete servicing manual. It is an outline of the signal-tracing techniques to be used in

television trouble shooting, as far as these techniques are applicable. Television theory must be digested so thoroughly that the individual will be able to develop these simple facts into his own streamlined methods.

New French TV Test Pattern

THE NEW French television test pattern illustrated here is more complex than the usual American one. It is designed to produce usable and accurate performance information, regardless of the technical standards of the TV system.

The chessboard edges are suitable for very exact framing. The aspect ratio is almost the same as the American 4 to 3, 4 to 2.91.

Vertical definition wedges are provided, as on American patterns, but they are calibrated differently. Instead of being marked in terms of the bandwidth necessary for resolution at each point, the figures indicate the number of bars (counting both black and white) which would appear across an entire line. Thus, the bottom of the left vertical wedge is labeled 175, meaning that if the alternate black and white "fence pickets" were extended to fill the entire width of the picture with the same spacing as at the "175" point, 175 of them would appear. This system allows the pattern to be used with TV systems of any standards—specifically (for the purposes of Radiodiffusion Française) with both 440- and 819-line transmissions. Two vertical wedges are provided for a wider range of values, and two horizontal wedges (calibrated in the same manner) are provided, the right one having finer lines for use with the 819-line transmissions.

As with most test patterns, the finer ends of the wedges are at the center of the screen because the cathode-ray-beam spot is always best concentrated (smallest) at the center. The circle encloses the area of best definition, approximately 2/5 of the image height. To observe definition outside this favored area, 16 groups of vertical bars are provided. These are similar in function to the bars of the wedges and are calibrated in the same way.

Modulation percentage may be measured with an oscilloscope. The heavy black bars with white notches provide a signal easily evaluated on the scope. The horizontal extensions on the black bars make lag clearly apparent.

Contrast range may be estimated with the fan-shaped half-tone wedges. The half-tone dots actually are part of the pattern, not added for reproduction purposes in this magazine. The five steps ranging from black to white should be clearly distinguishable on the receiver's screen. Two large half-tone areas were provided in separate places to eliminate errors due to spots on the tube.

Ordinarily the linearity test is the perfection of the large circle. Note that all the wedges are drawn as radii of the circle to eliminate optical illusions which otherwise would make the circle appear imperfect at all times and hinder accurate judgment.

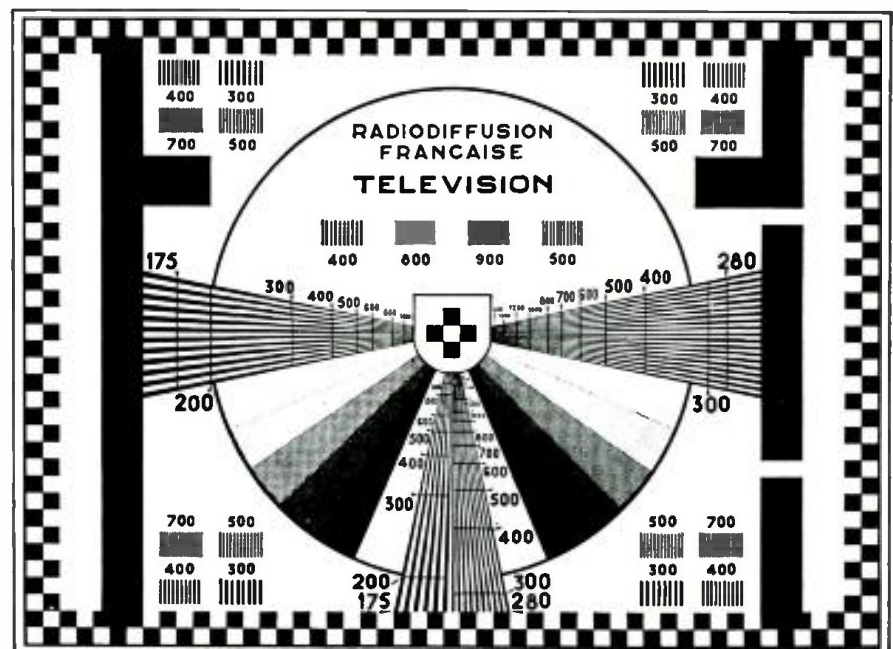

French test pattern is suitable for use with any system. Variety of markings aids testing.

THE TRANSPOLE VARIOTENNA

... An unusual indoor antenna with new features has recently been evolved ...

By HUGO GERNSBACH

Part 1

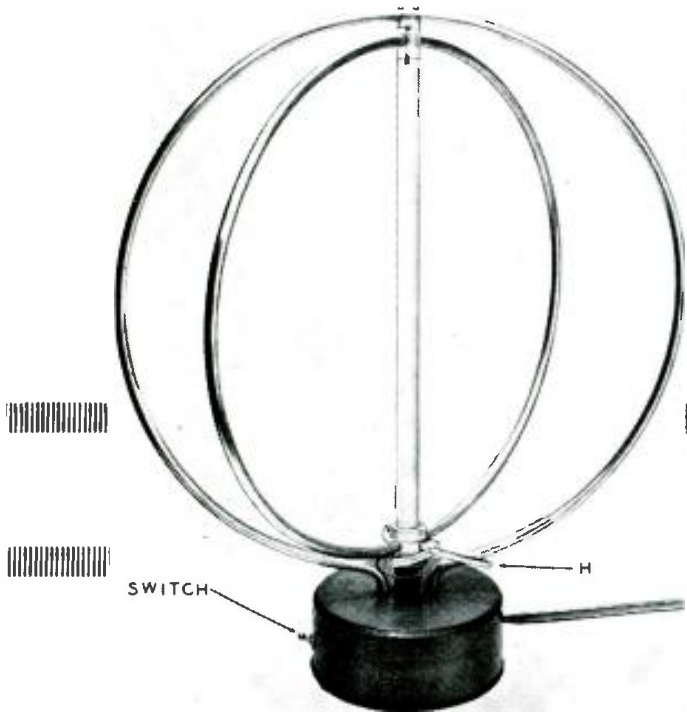

Final model of the transpole variotenna for TV reception.

TELEVISION has brought in its wake a number of problems which have to do not so much with engineering as with living conditions.

It is admitted that the outdoor antenna is at the present time the most efficient. Unfortunately, it cannot always be used—particularly in our larger cities.

Many landlords of apartment houses do not allow antennas on the roof and frequently even the house owner does not wish to disfigure his roof with an unsightly antenna. That is the reason for window and indoor antennas.

I have had the problem under consideration for a long time during which many indoor antennas were tested. It soon became apparent that on account of the peculiar problems arising from wave reflections indoors, a better device was needed than had been proposed so far. The idea of an inductive coupled antenna soon occurred to me and a number of models were built. The two types shown here are the evolution of this idea. The smaller one which only measures 11 inches across proved quite satisfactory on fairly strong signals. It is composed of four $\frac{3}{4}$ -inch brass or nickel ribbons wound concentrically, with lucite spacers on top and bottom to keep the loops about $\frac{1}{4}$ inch apart. A strong inductive effect is built up between the convolutions.

Fig. 1 shows the connections of the antenna itself. For better understanding of the connection, a simplified diagram is shown in Fig. 2. Note that connection is made, not in the orthodox manner as in the dipole, but from opposite ends. For some reason, not perfectly understood, this arrangement works best in such an inductive loop. I termed this connection "transpole," a contraction of the terms *transposed* and *pole*.

By providing a switch which is used to short the open ends, as shown in Fig. 2, snow and ghosts usually can be eliminated effectively. When in use, the antenna is oriented by revolving it on its base. Each station has its own best position.

A far more efficient antenna is the double-loop inductive antenna with a revolving inside rotor shown above. This antenna is larger, the inside loop measuring $15\frac{1}{2}$ inches diameter; the outside 17 inches diameter. The two loops come to about $\frac{1}{2}$ inch from each other. I call it a *Variotenna*.

The connection diagram of this loop is shown in Fig. 3. It will be noted that it, too, is connected as a transpole.

In this loop, aluminum rod $\frac{3}{8}$ -inch diameter was used with a center lucite supporting rod and lucite insulation for the bottom of the loops. A simple horizontal splitting of the lucite rod,

near the top, makes that section rotatable through a 180-degree arc. The inside rotor loop is controlled by a lucite handle "H". The loop assembly is mounted on a cylindrical wooden base. A shorting switch (see Fig. 3) is mounted on the base, also.

It was found that in actual operation all types of ghosts and snow can easily be eliminated in New York City under



An early model of the antenna had fixed loops.

the most unfavorable conditions in steel apartment houses. All six local channels were well received without any trouble. In some cases it is necessary to revolve the base for best reception, then rotate the inside loop for clearest picture. On some of the channels it may be necessary to use the switch, but this is required only in locations where the reception is particularly poor.

It was found advisable to use one or

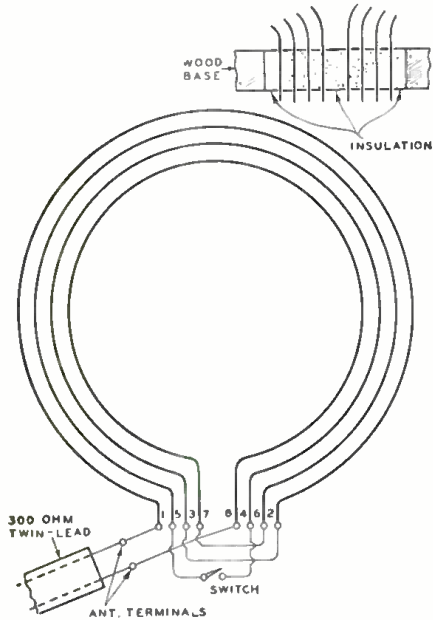

Fig. 1—Connections of the fixed-loop transpole television antenna. Construction inset.

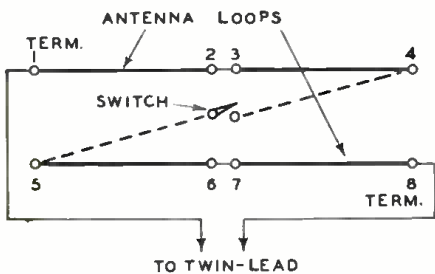

Fig. 2—Simpler diagram explains unit above.

two lead-in metal sliders to balance the transmission line effectively to the receiver. Once this is done the sliders are no longer touched and are clamped into position.

Surprisingly enough, on some stations even the displacement of only $\frac{1}{8}$ of an inch of the rotor loop may make the difference between a good and a poor picture. This is not true of all channels, but some stations may prove quite critical, depending upon location.

This antenna is not at the present time made commercially and is presented here merely as a contribution to the art. It is believed that as television receivers evolve, some such antenna, that is, one of the variotenna variety, will probably be incorporated in future television sets.

Early last Spring I dispatched a sample of the two-loop type variotenna to Messrs. Matthew Mandl and Edward

M. Noll, television instructors at Temple University, for test.

Here are their findings as reported by Matthew Mandl:

"I tried the antenna out on my Admiral TV receiver in Trenton. Channel 3 from Philadelphia came in fairly well—though with some snow. (My set is, of course, on the ground floor and I had the antenna standing on the receiver.) I found the antenna worked best with the 300 ohm line connected to terminals 1 and 2, with 4 and 3 open, and the two sections at right angles to each other.

"Channel 6 (from Philadelphia) came in with same picture quality as 3, although I found the two loops worked best at about a 45-degree angle, with terminals 3 and 4 open.

"Channel 10 (Philadelphia) came in with same picture quality as channels 3 and 6, with both loops in the same plane. Connecting 3 and 4 seemed to make a slight improvement—though not too pronounced.

"Tentatively, my theory on its operation would be as follows: On the low-frequency channels, inductive (magnetic) linkage evidently occurs between the two loops, effectively giving them the required length for resonance. The fact that each loop can be swung at an angle independent of the other, means that full advantage can be taken of the many reflections existing within a room. Noll and I have found that correct orientation of an indoor antenna rarely corresponds with true orientation such as would be found outdoors.

"On the high frequency channels, the capacitive reactance between the two loops becomes low and affords coupling. This, then, unifies the two loops and they act as a short antenna for the high channels.

"Gain for this antenna seemed to be considerably higher than an ordinary folded dipole—though we would like to check this some more.

"Because of the many reflections indoors, however, we are at a loss when we endeavor to theorize on your particular antenna. Positioning the antenna in different parts of a room, for instance, requires a change in the angle of the two circular elements. As soon as we think we have some answers in one particular location in the room, we must revise theory when we move the antenna—for better reception is usually secured by a complete change of angle between the two loops. As mentioned in my previous letter, the capacity between the two antennas with both in the same plane, and the interacting magnetic fields, probably combine to make the L and C resonant at the low TV channels. Because the C-L ratio is large, the Q of the antenna would be low, resulting in a broad bandwidth and greater coverage.

"I have found that better results on the high channels are procured when the two loops are angled, and it is our belief that in this position the two act more or less independently of each

other as two high-band antennas. While it may appear to you that all this is highly conjectural, I believe that it would be difficult for anyone to give a true analysis of the actual performance characteristics because the antenna performance for certain angles of the loops is never the same in any two positions in the room.

"Within a room the reflections would have too short a path to be visible in the form of ghosts on the screen. By rotating the two loops, therefore, a condition can be encountered where each loop picks up (independently) a separate signal from a different reflected angle. If the loops and the antenna position are so regulated that the two reflections are in phase, the antenna would be capable of feeding a signal to the receiver far in excess of a single antenna capable of only one orientation. This factor, combined with the circular configuration of the two elements, means that advantage is also taken of any vertical components present in the room.

"Since, however, so many reflections and polarization changes are encountered indoors, the very versatile arrangement of your antenna is bound to give better performance because it can be adjusted to take advantage of multiple reflections."

Another new type of antenna will be described by the author in an early issue.

Directions for building a simplified Transpole Variotenna will also be given.

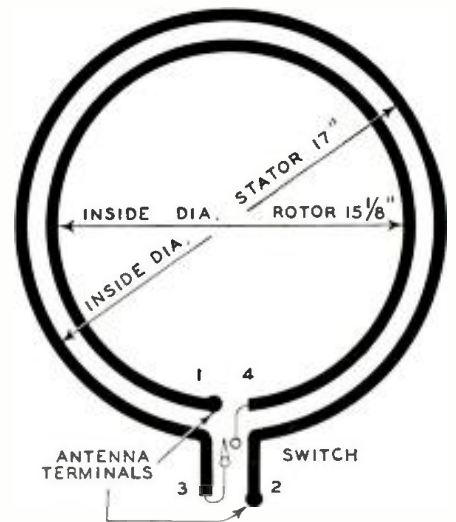

Fig. 3—The antenna with the rotating inside loop is connected as this diagram indicates.

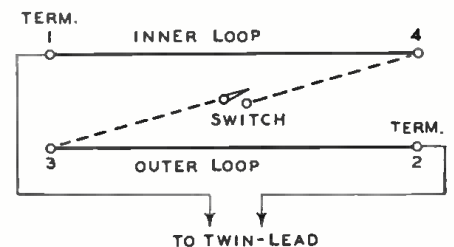

Fig. 4—Diagram of above with loops extended.

Television Queries Answered

IN MY work as a Question Box engineer for RADIO-ELECTRONICS, I have been struck by the broad thinking evidenced in many of the questions about the new subject of television. Unlike queries on other subjects, which are invariably highly practical, many television queries have no immediate practical purpose behind them, but are made in the search for greater knowledge.

As the answers to these questions may help other readers to understand some of the points which occur to many,

I am reproducing below a number of them. Though the selections may not be of the greatest general interest yet they seemed most interesting to me.

If RADIO-ELECTRONICS readers have any other points they would like cleared up, let me hear about them. If they are important enough and numerous enough, we will have another article like this one. If not, they will simply be discarded (not returned to the writer). Thus the worst that can happen to your query is that it may remain unanswered.

By **DAVE GNESSIN**

Ion Traps

? *Two television sets in my town look almost exactly alike; but one has the usual ion trap consisting of two coils on the neck of the cathode-ray tube near the base, while the other doesn't. Yet they both work fine. They are 7-inch tubes. How does the second one work without the ion trap?—L. M., Marion, Ohio.*

A. Up to a diameter of 7 inches, electrostatically deflected tubes work satisfactorily for television. They need no ion traps since ions respond readily to electrostatic deflection and do not burn a brown spot in the center of the screen. Some 7-inch tubes, however, use electromagnetic deflection, as do all the larger sizes. These electromagnetically deflected tubes require ion traps or beam benders to prevent the brown spot from forming.

It may also be that the second set you describe uses an ion trap of the newer PM type. Such a trap consists of two small permanent magnets in an assembly which clamps or slides over the base neck of the C-R tube. Fig. 2 shows three common ion traps.

Interlaced Scanning

? *What's the reason for scanning sideways? Couldn't up-and-down scanning have been used as well—or for that matter—inside-out or outside-in or some other scheme?—P.C., New Rochelle, New York.*

A. You're quite correct. We use interlaced scanning of 525 lines. In Europe they use a different number of lines. Nor do they all interlace. But remember that every separate system of scanning needs a receiver constructed for that particular system. We could scan right to left, up-and-down, or even spirally.

The manufacturers have agreed on a uniform system of scanning for all TV transmitters and receivers in use in the United States. This system is

embodied in FCC regulations. Thus you may take your receiver with you from coast to coast, sure that everywhere (almost everywhere, anyway!) you can plug into 117-volt a.c. and have your TV receiver working normally.

If you are interested in the possible combinations for scanning other than those now used, note Fig. 1. Then figure out how many different ways the scanning function might have operated.

No Raster

? *Maybe it sounds silly, but I was so careful doing it I was sure I couldn't harm anything. I opened up the C-R tube assembly of my new television set to examine it. Then I carefully reassembled it in what I thought was exactly the same manner as it was originally. The tubes light up—I have sound, but the screen is as dead as the proverbial duck. What did I spoil? The set uses a 10BP4.—D.R., Columbus, Ohio.*

A. Don't be alarmed. The symptoms you describe indicate a misadjusted

beam-bender element of the ion trap. Loosen the clamp bolts if any, and adjust the beam bender first for raster and then for brightest picture. The element will probably resemble one of the three types shown in the drawings of Fig. 2.

Vertical Black Line

? *I have a Philco TV model 48-1000, diagram of which I enclose. On the face of my picture I get a vertical black line. My adjustments are correct. I've gone over all the component parts of the set without finding a failure. What do I do now to get rid of the black line?—L.M., Baltimore, Maryland.*

A. Checking with the company, I find they've discontinued the 0.1- μ f screen-grid bypass capacitor C on the 6BG6-G horizontal output tube, because of complaints such as yours. Simply remove that capacitor and leave it off to clear up your trouble. See Fig. 3 for its exact position in the circuit of the receiver.

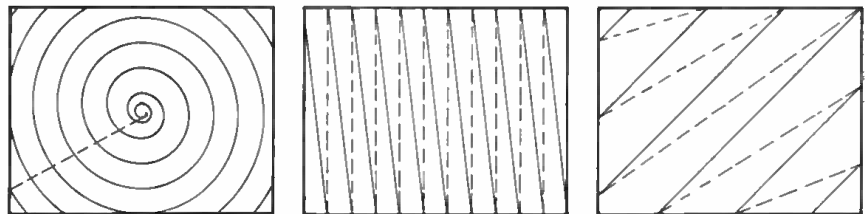

Fig. 1—These examples show three of the many scanning schemes which might have been used.

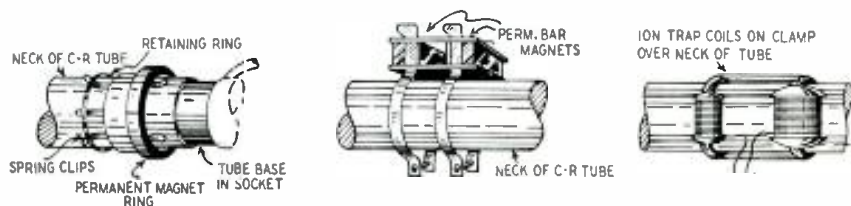

Fig. 2—Three types of beam benders or ion traps. The first two utilize permanent magnets.

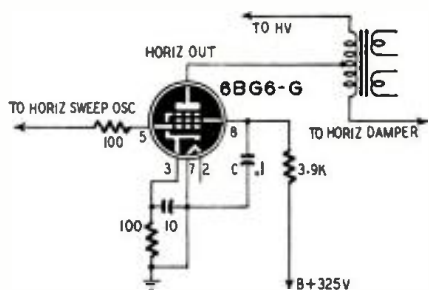

Fig. 3—Remove 0.1-µf screen-grid capacitor.

Replacing Picture Tube

? Is there some standard, safe, recommended way to remove and replace picture tubes in TV sets? It's the most fragile part of the set and probably requires special care.—A.F., Centralia, Ill.

A. Reasonable care, avoiding scratching the screen face or abusing the thin glass neck would suffice. However, here is a step-by-step recommended procedure:

CAUTION: First ground H.V. Anode cap to frame of bracket of tube, and B-plus to the chassis ground for double safety.

1. Disconnect the deflection-cable socket, picture-tube socket, and high-voltage connection.
2. Remove beam bender (ion trap) and any other miscellany attached to tube.
3. Prepare in advance crepe or clean newspaper on top of a table to receive the tube.
4. Loosen tube mounting nuts and support brackets, meanwhile supporting tube.

CAUTION: Avoid touching the coating on the outside of tube.

5. Without forcing or applying undue pressure, carefully remove tube, support brackets, and mounting as single unit from cabinet, laying on prepared paper or crepe, tube face down. (Before completing this step first make sure all wiring is disengaged and clear.) Since the face of the tube has the greatest thickness and weight, it is advisable to place the tube face on the palm of the hand while carrying it, for safety. Don't carry by the neck.

6. Loosen picture-tube clamp screw which fits around the rim of the tube face.

7. Finally, lift the entire assembly off the tube, leaving the tube face down on the paper.

To replace the tube just reverse the steps described above.

The men who best understand television tubes—the professionals in television stations and assembly men in factories—handle them with goggles and gloves. They know exactly what they are doing. In following their example, you will not only be insuring yourself against that day when a tube may implode in your hands; you will be advertising to the set owner that you know what you are doing—and issuing

an implied warning against fooling around with viewing tubes!

Dual Power Supply

? My Philco 49-1278 has a very odd power supply. It uses two low-voltage rectifier tubes, a 5U4-G and a 7Z4. Their outputs are not in parallel, nor do their voltages add. Why this odd combination of rectifiers?—R.F., Zanesville, Ohio.

A. In the first place, the large current demand of this television set requires more output than one rectifier tube (such as a 5U4) can supply. The reason for making the second rectifier a small cathode-type 7Z4 is a sound one. Examination of the circuit diagram reveals an extensive bypassing system, centered mostly about the screen-grid circuits. In the r.f. and video i.f. sections these capacitors are very critical. A synthetic dielectric was used for the close tolerances required. This performed excellently for the specific application, but had a comparatively low-voltage rating (about 50 volts above working voltage).

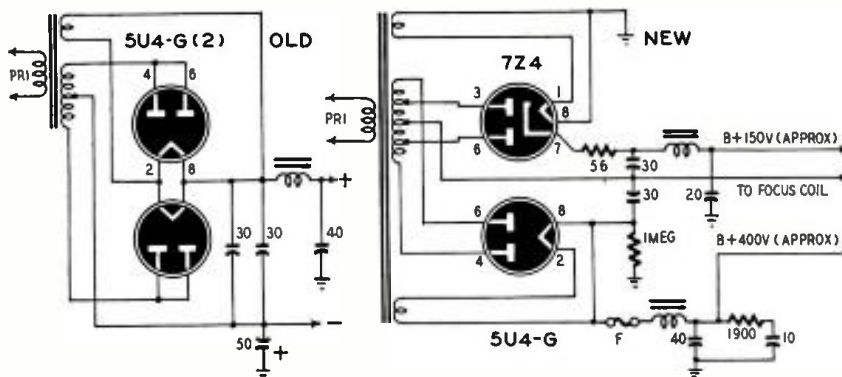

Fig. 4—Old Philco design used two similar rectifier tubes. New circuit appears at right.

In early designs two 5U4's were used as rectifiers. Since they are filament-type tubes, they heat instantly, providing full output voltage throughout the set. The other tubes, being cathode types, were still cold, hence drawing no current yet. This forced the full rectifier voltage to all elements, regardless of resistance step-down. Those valuable TV capacitors, carefully built for this application, popped like so much corn at the overload.

This new technique uses the 7Z4 cathode-type rectifier for the screen circuits. Thus, by the time the 7Z4 produces voltage, the other tubes are heated and ready to receive it. The 5U4 uses its heavy current for the audio and output stages. The division of rectifier output avoids damage to components, and makes for satisfactory steadiness of operation.

See Fig. 4 for comparison between old and new rectifier setups described above.

Folding Over

? My television set has a very large screen. The picture is fine except that

at the left side of the screen the picture is folded; a man walking to the left appears to be walking into himself. I hate to change anything since the rest of the picture is O.K.—L.R., Chicago, Ill.

A. With a large screen you probably use magnetic deflection. Check your horizontal scanning circuit. If your set uses a horizontal damper tube (probably a diode), your fault is probably there.

Stub Technique

? I used the stub technique recommended by RADIO-ELECTRONICS to eliminate interference from the TV antenna (or lead-in). The open-ended stub required is several feet long and consequently unsightly. Coiling it to get it out of the way disturbs its trap action. What do you recommend that I do to solve the problem?—A.B., New York City.

A. There is a general rule covering cases of this sort. The open-ended ribbon-line trap stub is cut to half the

wavelength of the signal concerned. The identical trap action takes place when the stub is shorted at the end of a quarter-wave section. Thus, all you need do is cut your trap stub exactly in half. Then, instead of leaving the end of the stub open, short it. You now have the same effect, plus an extra stub of ribbon-line for your trouble. Whatever the unsightly effect of the original stub, you've reduced it by half. This is a 100% improvement in the appearance. If the result is still unsightly, perhaps you'd better formulate another question. See Fig. 5 for a comparison between the two stubs—the open half-wave and the shorted quarter-wave.

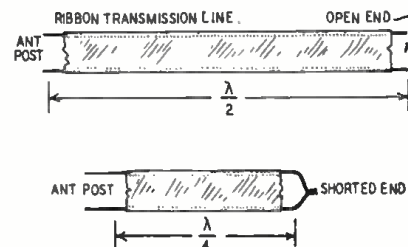
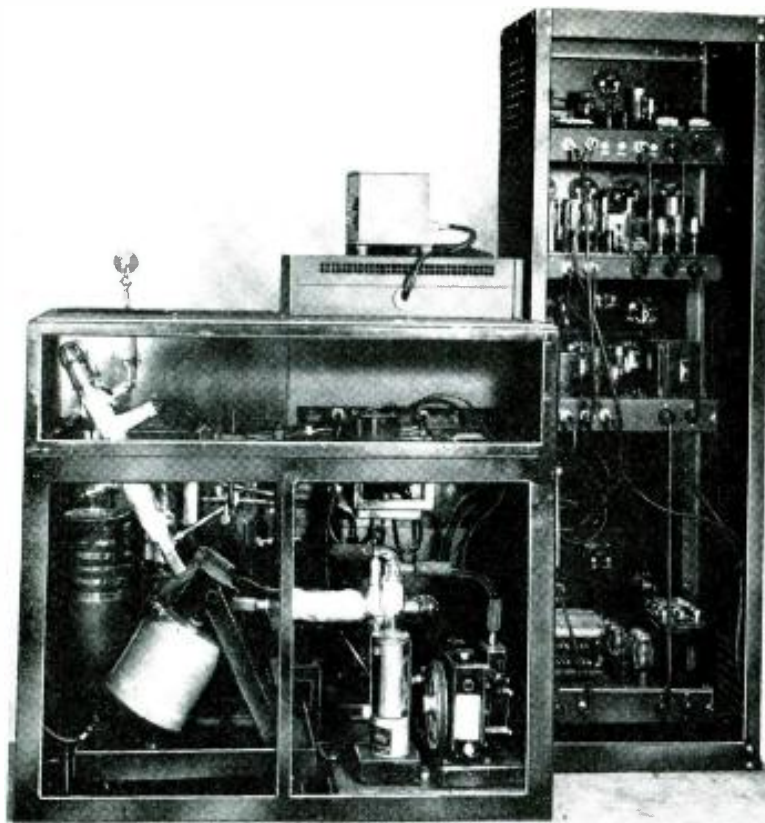

Fig. 5—These two stubs have the same effect.



Rear of commercial mass spectrometer. Note curved tube and vacuum pump.

Spectrometer Measures Mass of Chemical Ions

By JERRY S. ADAMS

THE mass spectrometer is today one of the most useful electronic tools in the experimental laboratory and in large-scale industrial processing plants. Used to analyze and control the quality of chemical compounds simultaneously, it is especially valuable for detecting very small quantities of impurities and for analyzing very small samples.

The principle of the mass spectrometer is as simple as that of the ordinary vacuum tube. Fig. 1 is a rough and simplified drawing illustrating the process rather than the equipment. The material to be analyzed must be in the form of gas or vapor, and is introduced

into the sample bottle at low pressure. The particles of gas are ionized by bombardment from a more or less standard electron gun, and the ions are accelerated in a beam by the field-forming plates.

A magnetic field at right angles to the beam tends to curve the ion path into a semicircle. Ions of less mass are, of course, more easily swayed from their path than those of greater mass. Therefore, after having traveled a short distance, these ions will have separated from the heavier ones. Collected on a photographic plate, as in Fig. 1, a spectrum of ionic weights—similar to that produced by a beam of light in a light

Liquids and gases with many components may be analyzed accurately by mass spectrometry

spectrometer—is produced. This is the reason for the name mass spectrometer.

A practical model

In actual practice, it is more convenient to collect only one of the deviated beams at a time. A collector with a slotted shield ahead of it is used, rather than the broad plate of Fig. 1. Since the acceleration of the ions can be controlled by varying the electric field (the force causing them to move in a straight line) and their curvature by varying the magnetic field, an adjustment of voltage or magnetic field strength can be made which will permit a particle of any given mass to pass through the slit and to the collector plate.

The practical instrument is shown very well in Fig. 2, a cross section of a spectrometer tube. Gas from the sample bottle circulates in the chamber, where it is ionized by bombardment from the electron gun, electrons from which enter through a hole in one of the field-forming plates. These are maintained by the bleeder at such voltages as to accelerate the particles and start them down the analyzer tube. The magnet, which applies the field to curve the beam, is not shown.

The particles which are of the correct mass to pass through the slit are caught on the collector plate and give up their charges, which are registered on the grid of the electrometer tube and made to give an indication on the recording galvanometer as shown. Field voltage or magnetic intensity, or both, being varied in synchronism with the progress of the record, a continuous spectrum may be obtained. Both the presence of ions of different masses and the relative number of ions in each of such beams may thus be recorded automatically.

Uses of mass spectrometry

Applications of the mass spectrometer fall into the following general fields:

1. Rapid and accurate analysis of liquids and gases which may contain a dozen or more components;
2. Determination of the kinetic forces in and mechanism of chemical reactions;
3. Identification of chemical processes which occur in metabolism.

In the first of these applications, samples of as little as .001 cubic centimeter in volume can be used as test specimens.

The energy of the bombarding electrons is made sufficiently high to ionize and fragmentate the molecules, so that ions of several different masses can be formed and the compound identified in a manner analogous to the fingerprint method of identifying a criminal.

One of the major problems in the chemical industry has been the analysis of small impurities in intermediate products. With the mass spectrometer this work is fairly simple. For example, as little as .003% diethylbenzene has been detected in ethylbenzene during tests that have proved to be of considerable importance to the rubber industry. These tests could not have been made without the mass spectrometer.

In the analyses of hydrocarbons (compounds comprising hydrogen, carbon monoxide, nitrogen, etc., with one to five carbon atoms), the mass spectrometer has been used with particular efficiency because it obviates the need for preliminary fractionation, permitting analyses to be completed in 30 minutes, whereas about 8 hours would otherwise be required. This should facilitate the improvement of numerous petroleum products.

In compounds with as many as six isomeric octanes, the mass spectrometer has analyzed fractionated cuts of alkylates and paved the road leading to improvements in aviation gasoline. In the analysis of gases in thermionic vacuum tubes, samples amounting to only .001 cubic centimeter have been detected.

In pure scientific research, the mass spectrometer has proved of particular value in studies of the kinetics and mechanism of reactions. Its application to this field has followed two different lines: In the first, small samples are withdrawn from the reaction chamber during the reaction and analyzed. In the second, heavy isotope tracer techniques are employed.

The fact that the mass spectrometer is capable of analyzing comparatively small particles permits withdrawal and analysis of samples throughout the course of a chemical reaction at intervals ranging from 2 to 10 minutes, depending on the types of analysis that

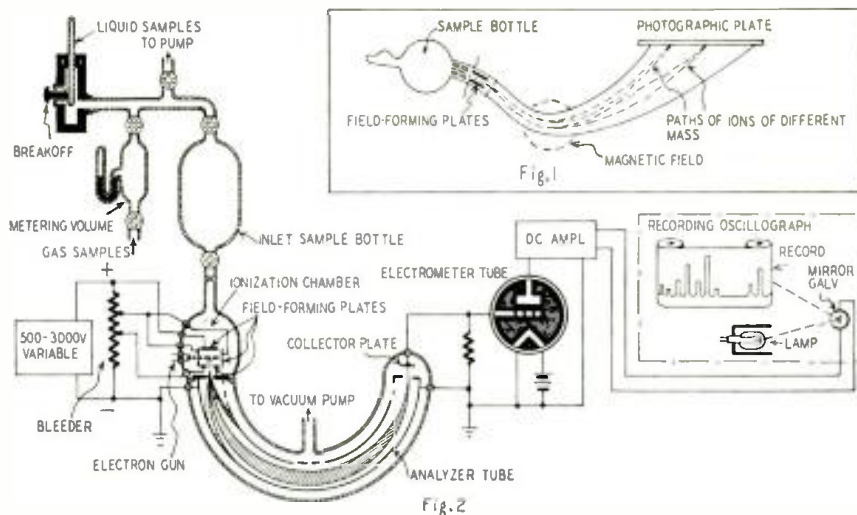
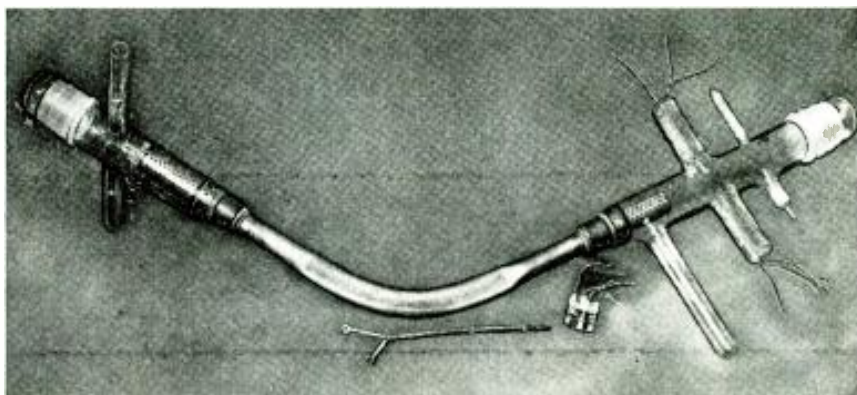

Fig. 1—Diagram shows method by which ions of differing mass are separated in spectrometer. Fig. 2—The complete apparatus consists of the tube plus pumping and recording equipment.



The analysis tube itself. The sample is injected into the transverse tube at the far right.

must be made. In one series of experiments, dimethylether and acetaldehyde were decomposed with heat and continuous analysis was made of the consequent gases—enabling scientists to ascertain the nature of this reaction for the first time.

Tracer methods

Heavy-isotope tracer techniques have also made the mass spectrometer useful in metabolism studies—particularly with regard to intermediary metabolism (that is, the mechanism of the breakdown and synthesis of proteins, fats, and carbohydrates and their interconversion, as well as the effects of vitamins and hormones thereon).

The usual procedure in isotope-tracer work is to submit a labeled substance

(one containing easily identified heavy isotopes) to a biological reaction either in an intact animal or in an isolated tissue or extract, then to isolate the products and determine their heavy-isotope content. In one sequence of experiments, rats were fed a labeled amino acid for a period of several days. The acid was labeled by synthesis with an excess of heavy isotope of nitrogen, so that the body components of the rats could be dissected and analyzed for labeled atoms with a mass spectrometer at the end of the test interval. As a result of this unprecedented work, it was learned that the absorption of food products in a living body is a very extensive succession of chemical reactions—not a simple mixing process, as was previously supposed.



Operating position of the mass spectrometer. AUGUST, 1949

NEW LONG-LIFE RECTIFIERS

Rectifier tubes for X-ray service with life expectancy 50 times as long as previously used types was announced by Z. J. Atlee of the Dunlee Corporation, Chicago. The new tubes have filaments made of a thorium-tungsten alloy. They have a possible use in television.

Thorium-tungsten filaments have long life and are commonly used in low-volt-

age tubes. It was thought, however, up to less than a decade ago, that 5,000 volts was the maximum. During the war 35,000 volts was used and the new tubes raise the ceiling to over 100,000. Because of the much lower work function of thorium on tungsten (2.63 volts) than of pure tungsten (4.52 volts) much more efficient emission is obtained and at a lower temperature.

Electronics in Medicine

Part X—Electron microscopes give a magnification of 100,000 times

By EUGENE J. THOMPSON

THE story is told that the great German physician and bacteriologist, Robert Koch, discouraged and virtually penniless, spent his last remaining funds to buy a microscope. It was indeed a fortunate purchase, both for him and the whole of humanity, because with it he made the discoveries which brought him fame and the everlasting gratitude of his fellow men—discovery of the bacteria that cause tuberculosis, cholera, and other diseases. However, despite the magnificent medical achievements this instrument has made possible, it has many limitations.

For example, a large group of diseases—infantile paralysis, smallpox, influenza, and many others—are caused by viruses, deadly killers so small that they cannot be seen with the finest optical microscope. Hence, there was

clearly a need for an instrument which would extend the limits of human vision.

The first steps in this direction were made about 20 years ago when it was discovered that a stream of electrons passing through an axially symmetric electric or magnetic field could be focused much as a glass lens focuses light (Fig. 1).

It was also found that any particulate body (specific minute particle), such as an electron, in motion, had a characteristic wavelength. Thus, if the velocity V of an electron is expressed in electron volts, its wavelength in cm is $\lambda = 10^{-8} \sqrt{150/V}$.

Practically speaking, a stream of electrons traveling under a potential difference of 60 kv has a characteristic

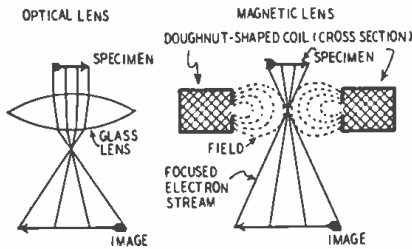

Fig. 1—Magnetic field focuses electron beam.

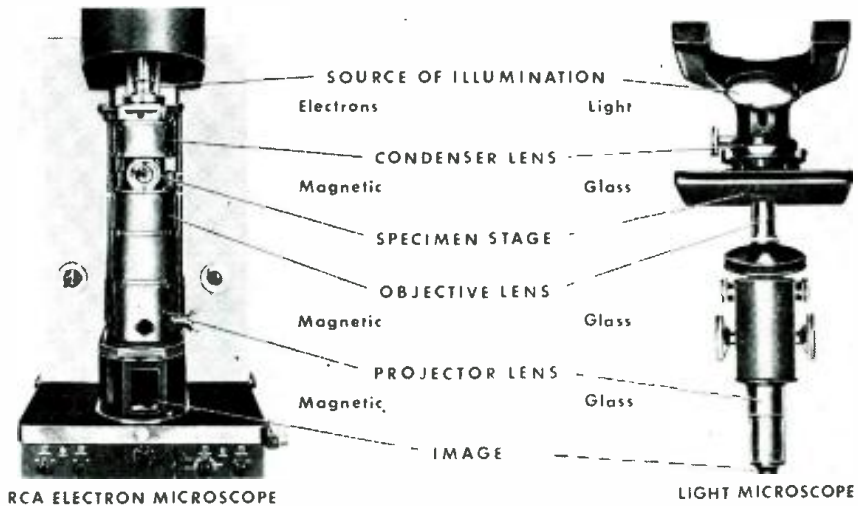

Fig. 2—The electron microscope accomplishes electronically the job of the light microscope.

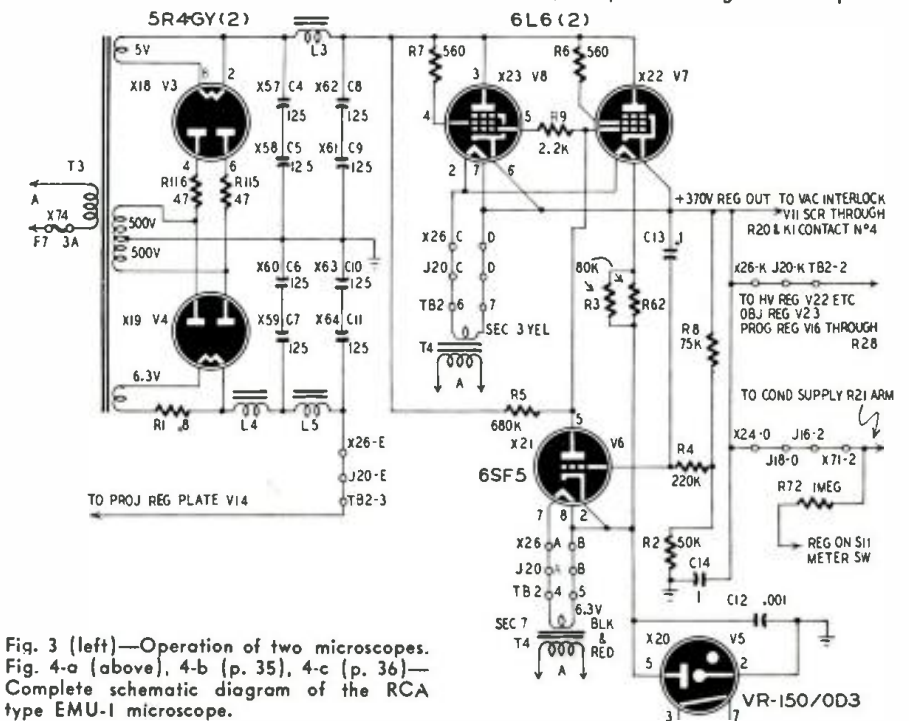
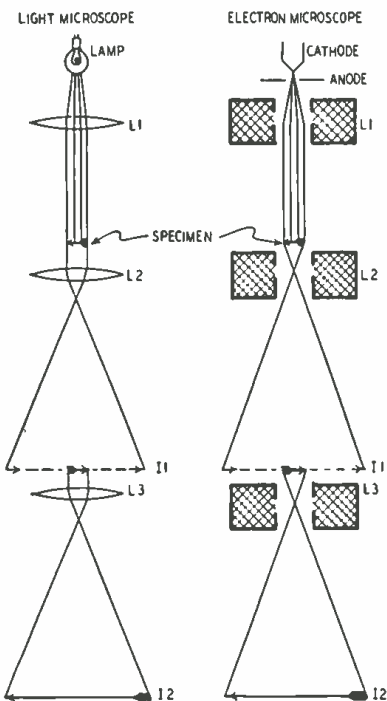
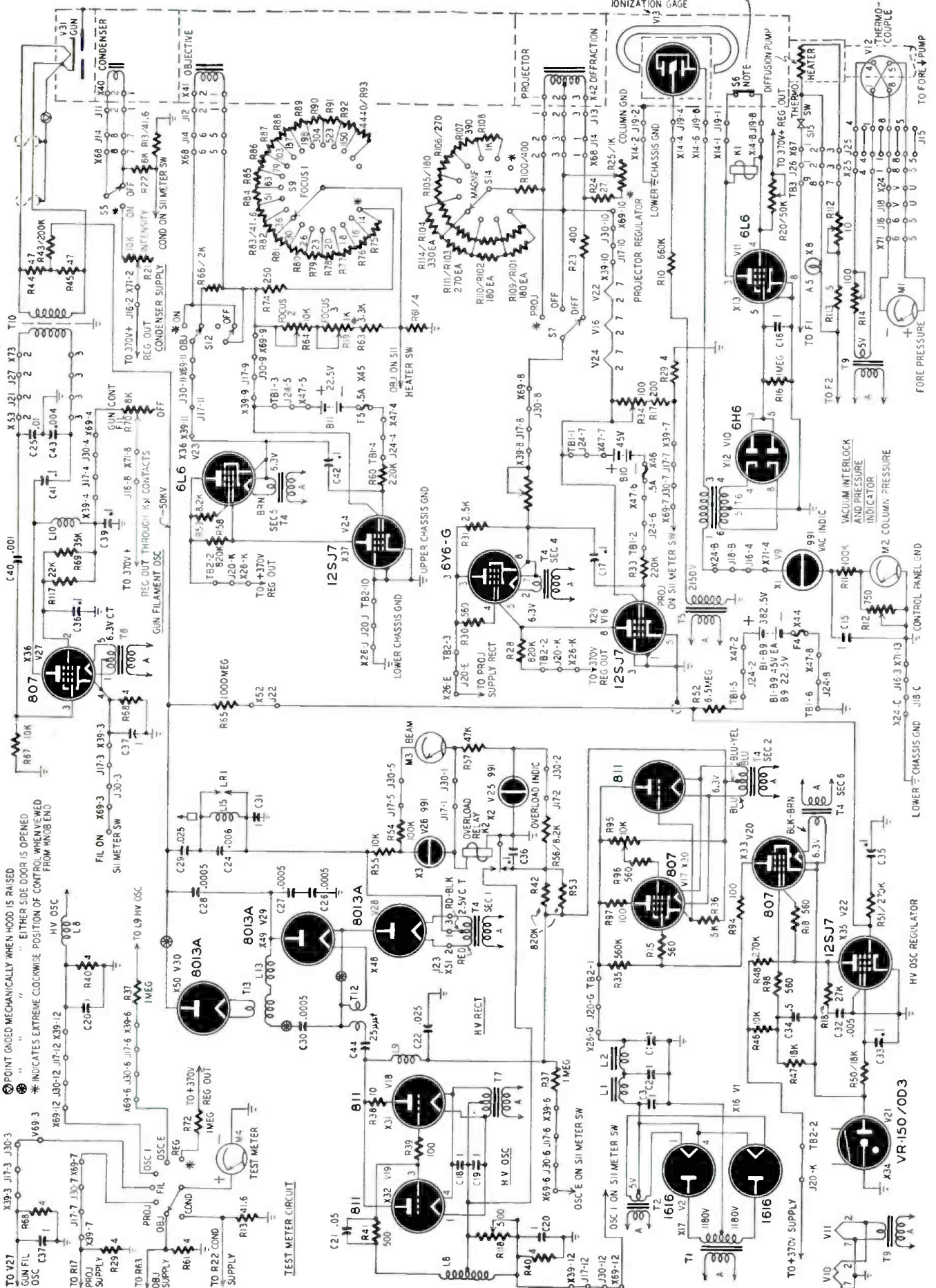

Fig. 3 (left)—Operation of two microscopes. Fig. 4-a (above), 4-b (p. 35), 4-c (p. 36)—Complete schematic diagram of the RCA type EMU-1 microscope.

VALVE INTERLOCK OPEN ONLY WHEN VALVES ARE IN "OPERATE" POSITION



wavelength of 5×10^{-10} cm, which is about .00001 times that of light.

It is not possible to detect objects or details whose dimensions are much smaller than the wavelength of the illumination used, so the magnification obtainable with optical microscopes is relatively slight (about 2,000 times). Because the wavelength of high-speed electrons is only a hundred-thousandth that of light waves, it should be possible, theoretically, to get electronic magnification up to 200,000,000 times. In practice, the maximum enlargement is 100,000 times, which is still 50 times that of any light microscope.

The electron microscope operates much like a transmission-type light microscope. As shown in Figs. 2 and 3, in the light microscope the source of illumination is a lamp (and mirror), the light rays from which are formed

into a parallel beam and directed on the specimen to be magnified by the condenser lens, L1. The image of the specimen then falls on the objective lens L2, which focuses and magnifies it, producing an enlarged image, I1. Part of this enlarged image is further magnified by the projector lens, L3.

In the electron microscope the source of illumination is a hot cathode which emits electrons. An anode with a small hole in the center gives these electrons a high velocity, and a doughnut-shaped coil L1 produces a field which bends the paths of the electrons into a parallel beam directed on the specimen. The electron rays pass through the specimen and are affected in varying degree depending on the composition of the specimen. Those which pass through are brought to a focus by the field of the coil L2 and form an enlarged image I1. The electron rays which form a section of this image are in turn magnified by the field of coil L3, and caused to form a further enlarged image I2. It will be noted that the coils L1, L2, and L3 act like the lenses in the optical microscope, and are referred to as *magnetic lenses*.

The image I2 in the electron microscope is formed by an electron beam which itself is not, of course, visible. A fluorescent screen, therefore, is placed so that the beam falling on it produces a visible image. Photographs are made by allowing the electron beam to fall directly on a photographic plate.

Four basic systems comprise the electron microscope. The schematic diagram is shown at Fig. 4. The optical system has already been described, and the control system is essentially a switching and metering network. The vacuum system consists of an oil diffusion pump, a forepump, and an electronic valving arrangement. Its purpose is to pump the air out of the area through which the electron stream must pass, so that an electron leaving the filament will travel the length of the instrument with a minimum likelihood of striking a molecule of air. This requires a vacuum of about .00001 mm of mercury.

The chief electronic features of interest are contained in the power system. Two power supplies are used. A high-voltage, 60-kv unit is used to accelerate the electron stream. Its high side is attached to the anode and run at ground potential, while the negative leg is connected to the cathode, at -60 kv with respect to ground. A low-voltage supply is used to power the tubes and the magnetic-lens coils. Because the speed of the electron stream and the current flowing through the lens coils are the critical factors in focusing the instrument, both supplies must be *very stable*. For satisfactory operation, regulation must be:

- Over-all microscope voltage .015%
- Objective lens coil current .005%
- Projection lens coil current .063%
- Condenser lens coil current 0.1%

The problem of getting a highly regulated 60-kv power supply in a small space was solved by using an r.f. rath-

er than a 60-cycle design. This feature makes it possible to use a relatively small, low-loss resonance coil which requires very little power to excite it. Also, for a given permissible ripple value, smaller capacitors can be employed. The speed of regulation at r.f. frequencies is not the problem it is with a regulator operating on the low-voltage side of a slow 60-cycle rectifier. In addition to this, it is a simple matter to shield stray r.f. fields.

The actual circuit is shown in Fig. 4, and a block diagram in Fig. 5. Refer-

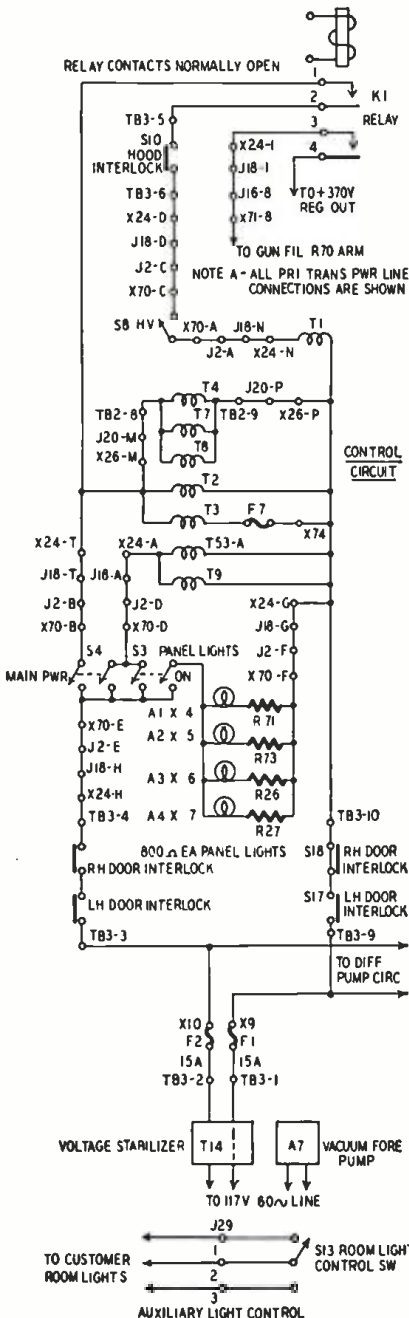

Fig. 4—The microscope control circuits.

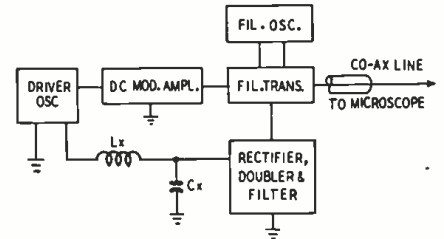

Fig. 5—Block diagram of 60-kv power supply.

ring to the latter, the high-voltage rectifier is essentially a high-Q resonant network consisting of Lx and Cx which is in series resonance with respect to the driving oscillator, but parallel-resonant when viewed from the high-voltage rectifiers. Cx represents the sum of the rectifier and stray capacitances. The resonant impedance of the high-voltage coil and the Q of the circuit determine the amount of exciting power required from the oscillator because of the small load.

The requirements of high Q and maximum impedance demand careful coil design and frequency selection. The Q of the circuit is about 200 and the operating frequency 32 kc. Under these conditions the required exciting power is around 150 watts; the maximum load is approximately 30 watts.

The high-frequency oscillator is controlled by the resonant circuit to maintain the proper driving frequency, and the amplitude of the current from the oscillator controls the power-supply output voltage. The oscillator current is dependent on the screen voltage applied to the oscillator output tubes. Thus, controlling the screen voltage governs both the amplitude and constancy of the output voltage.

The rectifier employed is a voltage doubler which does not require a tuned transformer, because the circuit is such that one side of the high-voltage coil can be grounded. For this reason a simple resonant circuit is permissible.

A tuned filter is used to eliminate high-frequency ripple from the high-voltage output. The low-frequency disturbances are corrected by comparing a portion of the input voltage with a standard voltage and regulating the oscillator screen with a d.c. amplifier. The voltage regulation is better than .002%.

The lens-coil current is also regulated. The current variation is less than .002% for the objective lens coil, .004% for the projector-lens coil, and .02% for the condenser lens coil.

Experimenting with Ultra-Violet Rays

By ERNEST J. SCHULTZ

MANY interesting experiments can be performed with the powerful ultra-violet rays obtainable with the simple apparatus described here. One use of the device is a "heatless" suntan which can be realized with short exposures of only 2 or 3 minutes daily for several days. Study of the weird characteristic colors of fluorescent materials and examination of stamps and documents under "black" light are other very interesting applications of the ultra-violet ray.

There are many other intriguing uses. For instance the germ-killing effect of the rays can be employed in sterilizing materials or areas. Goods that would normally perish rapidly maintain their freshness under the protective glare of the ultra-violet generator.

The circuit employed is an adaptation of the "Furedy" circuit and utilizes r.f. energy to power the ultra-violet-ray tube. In operation it parallels a commercially available lamp, but is more powerful. The tube used is a 15-watt G-E fluorescent *Germicidal* bulb. The tube life (barring breakage) is almost endless as the filaments are not used, and there is no chance of burnout with the r.f. supply. The r.f. oscillator is a 6B4-G, and the rectifier an 80. Other tubes, such as a triode-connected 6L6, can of course be substituted with equally good results.

The oscillator is an ultrasonic operating in the 11-meter diathermy band with a coil L1 of 11 turns of No. 20 bare tinned wire, wound on a 1-inch polystyrene form, the turns being spread to cover 1½ inches. The tube is capacitively coupled to the ends of this coil, with the two leads shown in the schematic. One is wound tightly round the glass at one end (L2). About three turns will be sufficient. The other lead is simply attached to a filament prong at the other end of the tube. Blocking capacitors of 250-µmf capacitance are installed to keep d.c. off the leads for safety's sake.

The two r.f. chokes are standard 2.5-mh chokes. Shortwave types could be used but apparently are not necessary. The tube UV is a G-E 15-watt Germicidal lamp, as stated before.

The ultra-violet tube is mounted with two conventional fluorescent sockets screwed to a metal mount made slightly longer than the tube. The reflector is

made from part of a discarded photographic ferrotype plate. For best results a reflector is essential to avoid wasting the rays. A highly polished chrome reflector is the most effective. The reflector is mounted, with adjustable brackets, on the 11 x 7 x 2-inch chassis. If desired, the actual lamp assembly may be made independent of the power and oscillator chassis, provided the leads are kept to a reasonable length. No particular precautions need be observed in the wiring, and the layout is not critical. A variety of construction methods could be employed for the job.

The germicidal lamp gives rich output throughout the violet end of the spectrum and up. Peaks of output occur between 2,500 and 3,000 Angstrom units. The lower peaks have the germ-killing powers, whereas the rays of frequencies about 2,900Å tan and burn the skin.

Be very careful when using ultra-violet rays. Overexposure causes painful burns of eyes and skin.

No heat accompanies the ultra-violet rays; therefore, you cannot depend on your sense of feeling to warn you when you are getting an overdose.

Determine your sensitivity by making trial exposures starting at not more than 1 or two minutes daily and increasing the exposure gradually till you get the desired tan.

The exposure, of course, varies inversely as the square of the distance from the source.

Goggles are indispensable when experimenting with ultra-violet rays.

Almost any glass (colored or clear) will serve to protect the eyes. The rays will not penetrate ordinary glass without great loss in intensity. The rays will not penetrate clothing, so the experimenter need protect only uncovered parts of his body, such as his eyes, face, and hands, if working under the lights for long periods.

The ultra-violet generator produces profuse amounts of ozone, and the lamp can be used where deodorizing as well as germ killing is required. For the experimentally inclined constructor, making one of these generators will open up new fields of adventure in invisible radiation with moderate expenditure and not a great deal of work.

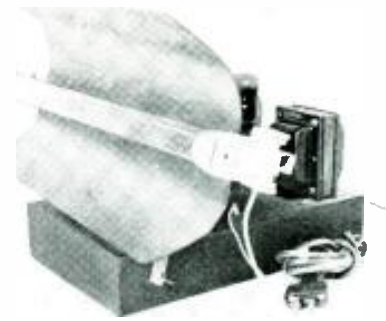

These pictures show how the ultra-violet-ray



tube and its reflector are fitted to the met-

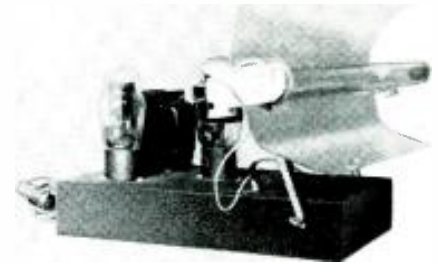

al chassis. Though parts are few (see under

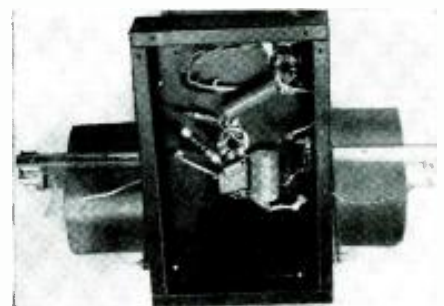

chassis) large base has mechanical solidity.

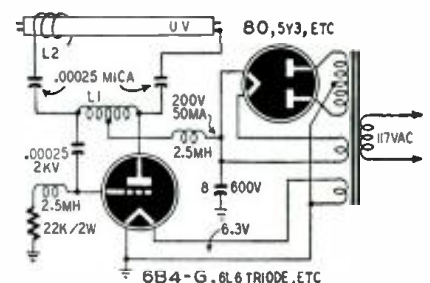

Be sure to adjust oscillator to 11-meter band.

A High-Fidelity Tuner-Amplifier

Part II—Amplifier has two types of equalization, three feedback loops.

By M. HARVEY GERNSBACK

THOSE of you who last month read Part I of this story probably commented to yourselves, after looking at the photos and schematic, "He's using two tubes and two germanium diodes for the r.f. end, but the photos show an awful lot of other tubes and parts. What is he using them for?" A glance at Fig. 1 should answer that question. It shows the wide-range audio amplifier.

Let's leave the two-stage phono pre-amplifier (the 6SL7-GT) until later and discuss the main amplifier first. As Fig. 1 shows, it consists of six triode stages, resistance-coupled. The first three stages (the two 7A4's, and half of the first 6SN7-GT) are single-ended. The two sections of the first 6SN7-GT are direct-coupled. The second section is a kangaroo phase splitter feeding the push-pull second 6SN7-GT. This in turn drives the 10.5-watt output push-pull stage of triode-connected, class-A 807's.

Negative Feedback Loops

The colored lines in Fig. 1 indicate two separate negative feedback loops in the main amplifier (there's a third one in the phono preamplifier). Loop 1, around the two 7A4's, is for bass boosting. The .02- μ f capacitor and the

68,000-ohm resistor in this loop determine the maximum amount of boost and the frequency at which it starts. Potentiometer R1 in shunt with the .02- μ f capacitor controls the amount of bass boost. Although this bass-boost circuit alone will give considerable boost, it is augmented by a second bass-boost circuit at the grid of the first 7A4. This is made up of the 22,000-ohm resistor, the .04- μ f capacitor, and R2 between the 200,000-ohm tap on the volume control and ground. The fixed resistor-capacitor combination determines the frequency at which boost starts. R2 determines the amount of boost and it is ganged with R1. The use of a potentiometer gives a smooth, stepless adjustment of bass boost.

For bass cutting (useful when listening to speech on stations having a tendency to boominess) S1, an ordinary power switch on the back of the dual control R1-R2, opens when the bass-boost control is turned off. With S1 open, a .01- μ f capacitor is placed in series with the 0.1- μ f unit, coupling the plate of the second 7A4 to the following 6SN7-GT grid circuit. This provides effective bass cutting.

Reduce the size of the .01- μ f capacitor for greater bass cut. Likewise, decrease the values of the .02- and .04- μ f bass-

boost capacitors to start the boost at a higher frequency, giving greater boost at the low frequencies. The values we use are the result of listening tests with a wide-range loudspeaker (a Stephens P52-HF). We found that raising the frequency at which the boost starts caused tubby reproduction like that of a juke box. If you like that, fine; but then there's no sense building yourself a wide-range system like this.

Fig. 2 shows the maximum value of bass boost obtainable and the bass cut obtained with S1 open. Adjustment of R1-R2 will give intermediate amounts of bass boost. As the curve shows, boost starts at about 800 cycles but doesn't really begin to climb until about 250 cycles. Below this frequency the rise is at the rate of about 6.5 per octave. Maximum boost occurs at 20 cycles where it is 21.4 db. Bass cut starts at about 350 cycles and reaches a maximum of 14 db at 20 cycles.

Treble boosting is handled by shunting small capacitors of .025 and .015 μ f across the 2,200-ohm cathode resistor of the first 7A4, thus bypassing the negative feedback in loop 1 at high frequencies. The treble switch S2-b does this in positions 1 and 2. Treble cutting is accomplished in positions 4, 5, and 6 of S2. A two-section, resistance-capacitance network from the plate circuit of the second 7A4 to ground causes the high-frequency rolloff to have a steeper slope than with a single section. The two sections can be traced from the two 4,700-ohm resistors in series in the output of the 7A4. The bypassing capacitors are connected to contacts 5 and 6 of the two-gang switch S2.

Fig. 2 shows the amount of treble boost and cut which this arrangement gives. The boost position is used only on broadcasts where the program material lacks highs. It is very effective. The tone-control stages are based on the design used by Lincoln Walsh in the Brook amplifier.

Following the tone-control stages there is a 100,000-ohm screwdriver-adjusted potentiometer to set the overall maximum gain. The following four stages are included in negative feedback loop 2.

You have probably noted the absence of cathode-bypass capacitors within loop 2. This is deliberate. Because of the large amount of negative feedback used (20 db), phase shift at very low and very high frequencies (which could cause negative feedback to turn

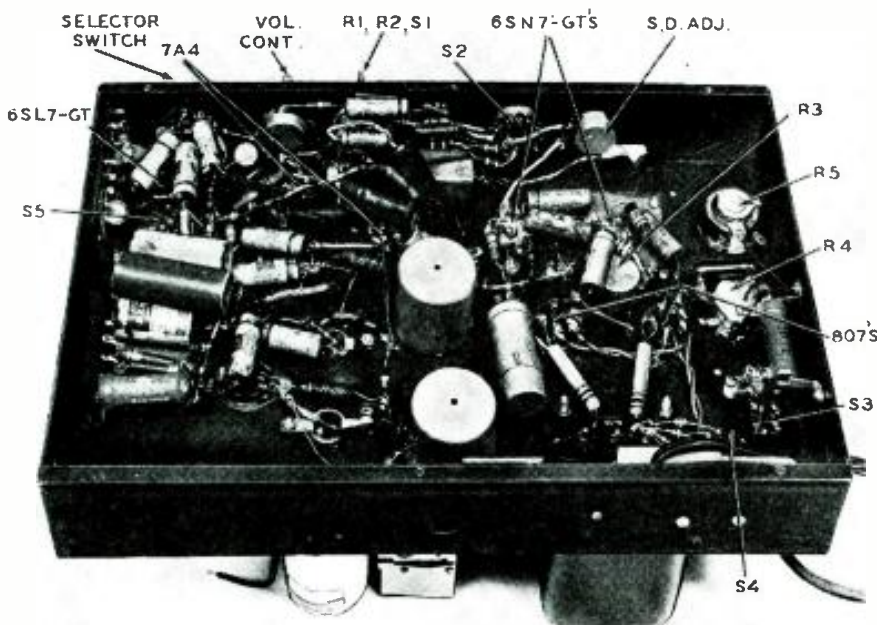

Same photo as last month—but minus veil—shows placement of parts in the amplifier section.

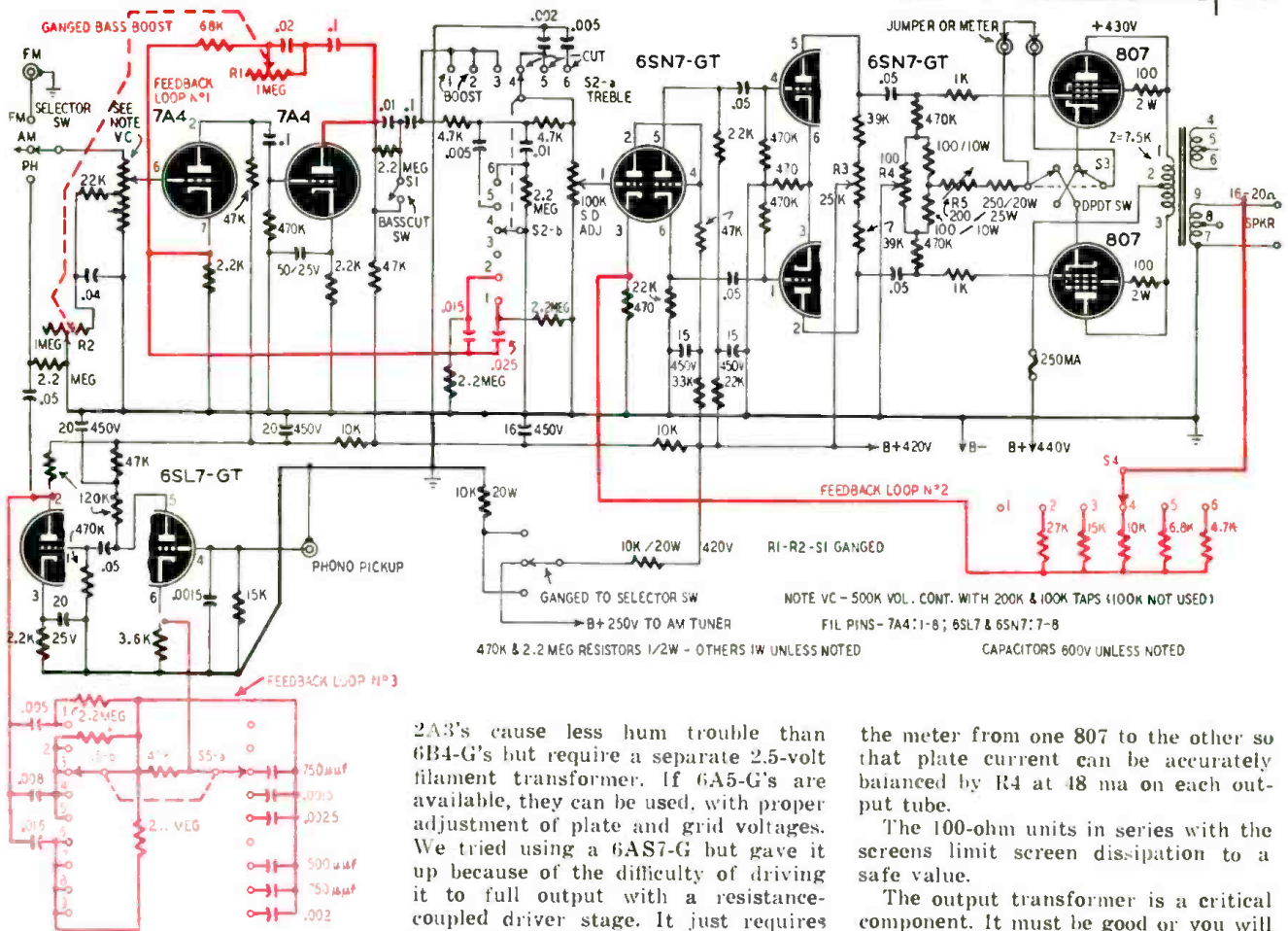

Fig. 1—Complete schematic of the amplifier. The three feedback loops are shown in color.

into positive feedback) must be kept as small as possible. Cathode capacitors could cause too much phase shift at low frequencies. The loss of gain is of no importance.

The first stage in the loop is merely a voltage amplifier (one half of a 6SN7-GT) feeding the phase splitter (the other half 6SN7-GT). Direct coupling is used to eliminate one more source of phase shift. With direct coupling and low-value load resistors in the phase-splitting circuit, balance is good within less than 1 db over the whole audible range.

The second 6SN7-GT is a conventional push-pull stage feeding the push-pull 807's. R3 in the plate circuit of this 6SN7-GT is a balance control to equalize the signal voltages on the 807's. To adjust, disconnect the negative feedback, feed an audio tone of about 1,000 cycles to the amplifier, and adjust for equal signal level at the grids of the two 807's. Use a scope or v.t.v.m.

The output stage is unusual in the use of 807's as triodes. With the plate voltage specified, output at the secondary of the output transformer is about 10.5 watts at the grid-current point. We used 807's because they are available at low cost in the surplus market and, more important, being cathode-type tubes they generate little hum. We gave up 6B4-G's because of this;

2A3's cause less hum trouble than 6B4-G's but require a separate 2.5-volt filament transformer. If 6A5-G's are available, they can be used, with proper adjustment of plate and grid voltages. We tried using a 6AS7-G but gave it up because of the difficulty of driving it to full output with a resistance-coupled driver stage. It just requires too much input.

The two 100-ohm resistors and R4 in the grid circuit of the 807's are for bias balance. R5 adjusts the total plate current on the 807's (about 96 ma with no signal). A 100-ma meter is connected in place of the meter jumper in the cathode circuit to measure individual 807 plate current. S3 switches

the meter from one 807 to the other so that plate current can be accurately balanced by R4 at 48 ma on each output tube.

The 100-ohm units in series with the screens limit screen dissipation to a safe value.

The output transformer is a critical component. It must be good or you will get into oscillation trouble with the large amount of negative feedback employed. It must be a true high-fidelity unit with less than 1-db variation from 20-20,000 cycles. Primary inductance must be high and leakage reactance low. There are a number of transformers on the market which will meet these specifications. Cheaper trans-

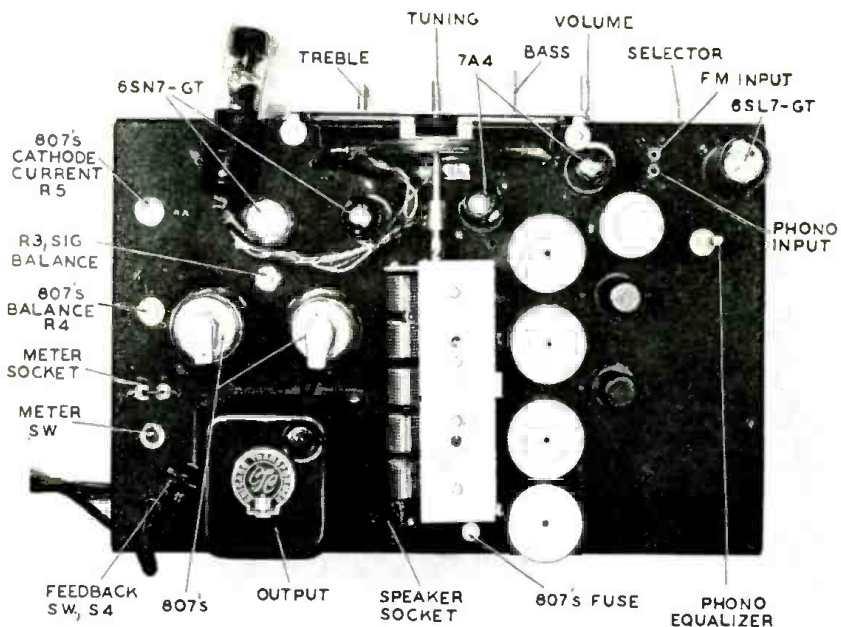

The 11 x 17 x 3-inch chassis holds the push-pull 807 amplifier in addition to t.r.f. tuner.

formers may be used only if the amount of feedback is appreciably reduced. Quality will of course suffer in that case. The transformer we used (Chicago Transformer Co. BO-6) has a tertiary winding (terminals 4-5-6) for use if feedback is applied directly to the cathodes of the power tubes. Don't use this winding.

The output winding is 16-20 ohms, with an 8-ohm tap. Feedback is taken off the 16-20-ohm terminal and goes back to one cathode of the first 6SN7-GT, through S4 and one of five resistors selected by S4. This switch varies the amount of feedback from none (position 1) to 20 db (position 6) in six steps. The amounts of feedback in positions 2 through 5 are 2, 8.6 db; 3, 12.4 db; 4, 14.9 db; 5, 17.7 db. These measurements were made at 1000 cycles with the P52-HF speaker as load. The whole circuit within feedback loop 2 is based on a design by D. T. N. Williamson in *Wireless World* (London).

You may be surprised at the use of feedback with triode class-A output tubes. The difference between triodes with and without the feedback has to be heard to be appreciated. We have checked input-output linearity at various output levels with no feedback and with varying amounts of feedback up to 20 db, using an oscilloscope and a.f. oscillator. The linearity curve is practically a straight line with full feedback and bends rapidly as feedback is reduced.

Another advantage of the large amount of feedback (even with triodes) is greatly increased loudspeaker damping. Electrical output measured at the speaker terminals is flat within 0.5 db from 20-20,000 cycles. This is with a speaker load.

With feedback there is no difference in frequency response when measured with resistive or speaker load. Take away the feedback and response with the resistive load is still good; but with a speaker load, it varies as much as 5 db over the range. The peaks coincide with speaker resonance points. The measured internal impedance of the amplifier at the 16-ohm output (with 20-db feedback) is 0.66 ohm. The net result of all this is very fine response to transients, which shows up particularly well with music.

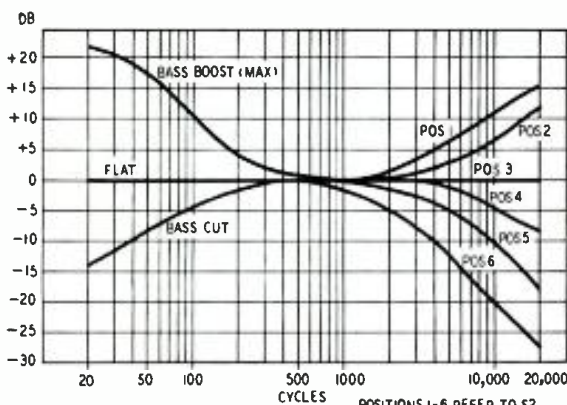

Fig. 2—Responses obtained with the main equalizer controls.

The phonograph preamplifier need not be included if the builder has no use for it. Just omit everything on the lower level of Fig. 1 and use a two-position (FM-AM) selector switch. The 6SL7-GT preamplifier circuit will equalize a low-level, wide-range magnetic pickup for varied recording characteristics.

Fig. 3 shows the response for different positions of S5 when using a Pickering 120M cartridge. The nine positions provide proper equalization for practically all U.S. and foreign records manufactured since electrical recording was adopted. The bass and treble tone controls in the main amplifier augment these nine positions.

Feedback loop 3 provides the preamplifier equalization. The three capacitors selected by S5-b are in series with the feedback line and, with the 47,000-ohm series resistor, set the crossover frequency at which bass boost starts.

The six capacitors which are bridged across the 47,000-ohm resistor by S5-a increase the amount of negative feedback at the higher frequencies, effectively causing high-frequency rolloff. S5-a selects the proper capacitor for the desired rolloff. In positions 1, 2, and 6 there is no rolloff. The 2.2-megohm resistors connected to various switch points in the amplifier are switch-click suppressors. S5 is mounted on the chassis deck. A flexible shaft connects it to the front panel.

Construction

The layout of stages is shown in the two photos. The unsymmetrical arrangement was dictated by the tuning capacitor and coils for the AM tuner and by a desire to keep leads to the front-panel controls as short as possible.

All ground returns are brought to a common bus rather than to chassis. The bus is grounded to chassis at a point near the first audio stage. The outside foil of paper capacitors (curved plates on schematic) should be connected as the schematic shows to keep stray-capacitance effects low. The cable connecting the chassis to the separate power supply chassis (see Part I in the July issue) should have heavy filament wire—No. 12 at least. We used parallel pairs of No. 16.

After the amplifier is completed, it may be necessary to reverse the plate leads to the output transformer if you are getting positive, instead of negative, feedback in loop 2. If it is easier, it is also effective to reverse the secondary leads at the transformer terminals. Use shorting-type switch sections for S2, S4, and S5.

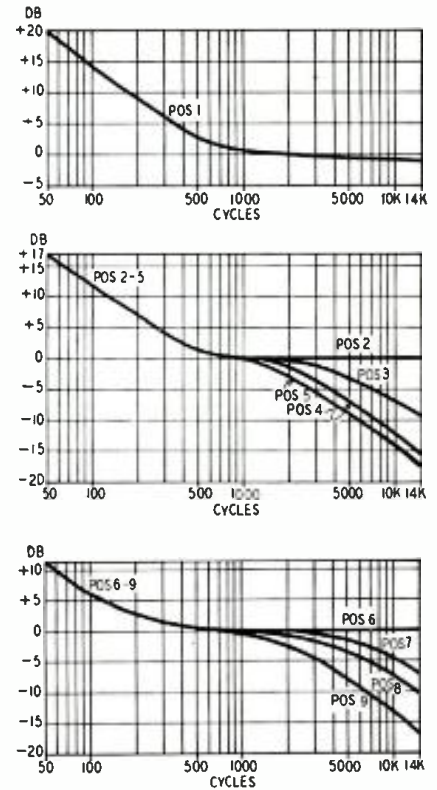

Fig. 3—Phono curves suit almost any record.

Adjustments

An amplifier employing a large amount of feedback (such as in loop 2) is a tricky thing to get working properly. If you plan to use the full 20-db feedback, a scope (or v.t.v.m.) and a.f. oscillator covering the full audio range is almost a necessity. Without these aids you may have unsuspected positive feedback at a supersonic frequency, which will cause baffling distortion and even birdies in nearby broadcast receivers.

In our amplifier, for example, with a resistor load on the output the amplifier is perfectly stable at all settings of the screwdriver-adjusted potentiometer. But with the Stephens speaker connected, and the speaker's tweeter volume control full on, oscillation results unless the screwdriver-adjusted potentiometer is set at least 15,000 ohms away from full on or off. Different output transformers and speakers will have distinct effects. If you don't have the necessary test equipment available, plan to use less feedback.

Adjustment of R3, R4, and R5 has been covered. The screwdriver-adjusted potentiometer is set at about 50% of full rotation (note the caution about this control mentioned above). The feedback-control switch S4 is set for the level of feedback desired and left alone. In fact it may be omitted entirely by wiring in permanently one of the feedback resistors. Note that the values of these resistors must be changed experimentally when a different output transformer is used or feedback is taken off a winding having an impedance other than 16-20 ohms.

EVERY year the radio parts distributors of the nation, manufacturers' representatives, and others intimately interested in radio components gather at the Stevens Hotel in Chicago for the National Radio Parts Show, at which practically all the important manufacturers of radio components exhibit their latest and newest items to prospective customers.

Unlike some of the displays occasionally seen at the IRE show, almost everything exhibited is practical, down-to-earth stuff ready for sale and delivery to the distributor of repair parts or to the manufacturer of radio and television receivers and other electronic devices. Yet products of great technical interest often do appear. Some of these are new items, kept carefully under wraps to get the jump on a competitor. Others may be components which have been in use for some months, but whose



Sprague bypass capacitor resonates at 456 kc.

technical importance has escaped both the manufacturer's own publicity department and the reporters of the radio press.

The Chicago show this year was no exception. There were several outstanding items, including a rotating television antenna that doesn't rotate and a bypass capacitor with an inductance deliberately inserted in series with it.

The paradoxical antenna is known as the Square Root Quad-loop. Once seen, its principle is recognized as that used long ago in the Bellini-Tosi direction finder. One wonders (without detracting from the genius of the designer) why somebody didn't think of it sooner!

Two special dipoles are mounted crosswise to each other (one, for example, is directional north-south; the other, east-west). Leads from each of these antennas are brought into a phasing box, from which a single 300-ohm line goes to the set. A knob on the box is turned to bring in the best picture from any given direction.

While the manufacturer is reticent about the contents of his box, he admits freely that it contains a pair of crossed coils with a revolving pickup loop between them. One admires the ingenuity that adapted the Bellini-Tosi idea to frequencies in the 200-mc range and sympathizes with the designer's decision not to tell anybody how he did it—until, at least, a few of his competitors have paid for the privilege of taking the little box apart.

The Square-Root was by no means the only antenna at the show. It was the Show of the Antenna, with even a rumor that one manufacturer had been

New Devices Exhibited at Chicago Parts Show

refused admission because he had no antennas in his intended display.

The other startling innovation was exhibited by Sprague. Since the dawn of the art, capacitor makers have battled the inductive effects involuntarily introduced into their products, especially where rolled foil is used.

Yet there is a sound reason for the capacitor-with-added-inductance. For any given frequency, there is a series combination of inductance and capacitance which has a much lower impedance than the capacitance alone. Modern radio receivers require a great deal of bypassing of the 455-kc i.f. signal. A capacitor-inductor combination tuned to 455 kc is much more effective than an untuned capacitor of the same value. The Sprague 0.2- μ f resonant capacitor has only $\frac{1}{10}$ the impedance of an ordinary 0.2- μ f capacitor at 455 kc. Therefore this 0.2- μ f resonant unit is as effective as a standard 2.0- μ f capacitor at its correct working frequency.

In the sound field, Electro-Voice has produced an interesting compliance me-

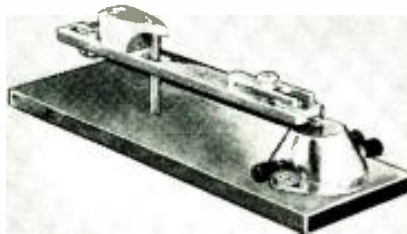

Electro-Voice compliance meter rates pickups.

ter for measuring the stiffness of phonograph styli. Higher fidelity and less record wear result from the use of high-compliance styli, and this instrument measures them for that quality.

A vertical reed (see drawing) is subjected to an alternating magnetic field from a coil surrounding it; the field makes the reed vibrate. A piezoelectric ceramic element is mounted at the free end of the reed. Its inertia causes it to

be distorted (and thus to produce a voltage) in direct proportion to the amplitude of the reed's swing. Placing a pickup on the little platform at the top of the assembly naturally cramps its style, and the voltage drops according to the stiffness of the stylus. Thus the output as read on the meter indicates the compliance or bendability of the stylus assembly being tested. A chart (individually calibrated for each instrument) interprets the meter readings in microcentimeters per dyne of applied pressure.

The compliance meter was a working model for practical use and was not one of the items exhibited for sale at the Electro-Voice booth. It is nonetheless a valuable contribution to the art of recording and reproducing sound.

An important development in the printed-circuit field was signaled by Centralab engineers, who told of the increasing tendency to combine printed and ordinary wired components in standard radios or televisions. The Centralab Couplate and similar units are well known, and a new unit, an integrating device for television receivers which replaces six standard components, was exhibited. People have an unfortunate habit of thinking in terms of pure printed or pure wired circuits, it appears. The future may show that in many cases it will be more efficient and economical to use both printed and wired components in the same piece of equipment.

Users of the glorious but extinct Baldwin phones will be interested in the new dynamic headphones exhibited by Permoflux. The phone is built with a voice coil and pot magnet like a small loudspeaker. Developed for applications where flat frequency response is essential, the new phones are still a bit expensive for general use, but might be interesting to a high-fidelity enthusiast. The acoustic frequency-response curve shown was made in a 6-cubic-centimeter coupler with 1 mw of power available.

RESPONSE IN DB (ZERO DB=.000204 DYNES PER CM²)

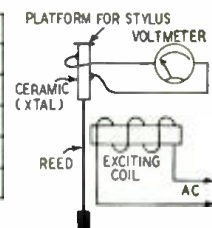
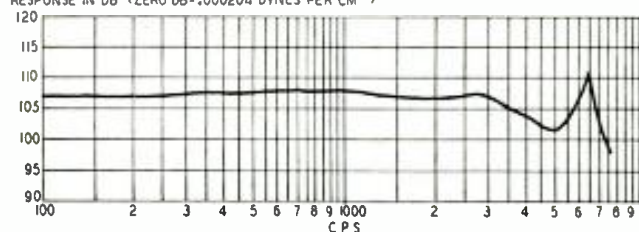

Frequency response curve of the Permoflux phones, left, and diagram of compliance meter.

Improved Phono Amplifier

A design for a cheap, yet good amplifier for a table-model phonograph

By JOHN S. CARROLL

THE amplifier described here is the final one of a series designed to determine how much table-model record players can be improved without excessive increase in cost.

The simplest amplifier used in such phonographs consists of a rectifier and a small beam-power tube, occasionally combined as in a 70L7 or 117N7, sometimes as individual tubes such as the 35Z5 or 35W4 and 50B5 or 50L6. These "one-lungers" are capable of power outputs between 1 and 2 watts, but require high output from the phono pickup.

These small beam tubes actually require a peak signal of 7.5 volts to develop full output. The average high-output crystal pickup generates an average signal of 3 to 4 volts, and reaches a peak value of 7.5 volts only on very high-level passages in the usual record. In general, then, such record players suffer from inadequate power output and excessive distortion, the latter running as high as 11% of the total harmonics.

The logical solution is inverse feedback: this would reduce distortion without loss of output power. But the cost of feedback is higher signal voltage, which is not available in these single-tube record-player amplifiers. A driver stage is a necessity if feedback is to be applied.

The better-quality crystal pickups put out about 1 volt of signal; since 7.5 volts will drive the output tube under normal conditions, a low-mu tri-

ode would seem to be adequate for the input tube. However, large amounts of feedback may increase this requirement by as much as 5 to 10 times, making a high-mu tube necessary.

In the past, such feedback amplifiers have used a resistor between the plates of the input and output tubes as feedback path. This places the feedback voltage on the grid of the output tube by way of the coupling capacitor. While that system reduces distortion in the

back in the output stage, it will be necessary to start with signals as high as 1 volt to secure sufficient driving voltage on the grid of the output tube. Then the distortion developed in the driver stage will be intolerable. This is the reason why so many small a.c.-d.c. amplifiers have such poor tonal quality, even with feedback.

The solution shown in the schematic is to run the feedback loop to the input of the first stage. It then reduces dis-

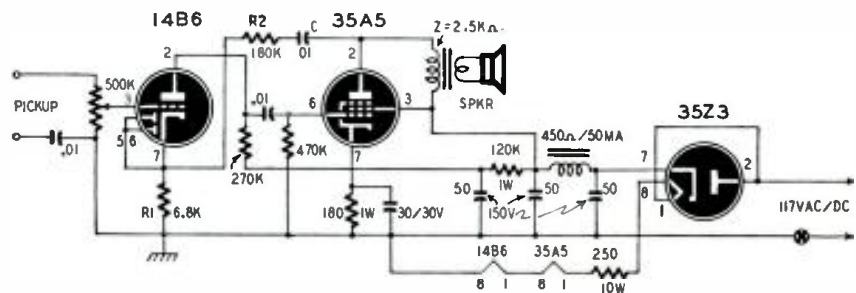

Feedback is applied from plate of the second stage to cathode of first through C and R2.

output stage greatly, it fails to take into account conditions in the input stage.

Given a plate supply of 100 volts, a typical high-mu triode will put out 7.25 volts of signal with an input of 0.13 volt. This, however, is the *maximum-signal* condition for the tube, and is accompanied by 4.6% harmonic distortion. If there is a great deal of feed-

back and flattens the frequency response in the input stage as well as the power tube. Polarity of the feedback is such that the connection is made to the cathode of the input tube; obviously, to develop any a.f. feedback voltage at this point, the bias resistor must *not* be bypassed. Thus, some additional degeneration is introduced in the input stage, further improving its characteristics.

In addition, the polarity of the feedback voltage is such that it adds to the bias of the tube on positive signal peaks, and subtracts from the bias on negative peaks. Thus, it acts as an automatic bias control, avoiding grid current on positive peaks, and cutoff on negative peaks.

The effect of the feedback on the characteristics of the power stage is unchanged; it lowers the effective plate resistance of the output tube, avoiding high-frequency peaks and improving the speaker damping.

Constructional details

The photographs show the prototype amplifier as constructed for test purposes. Lock-in tubes were used in this model, but either octal or miniature types will serve as well. No high-mu single triode was available in the 0.150-amp series with lock-in base. The 14B6

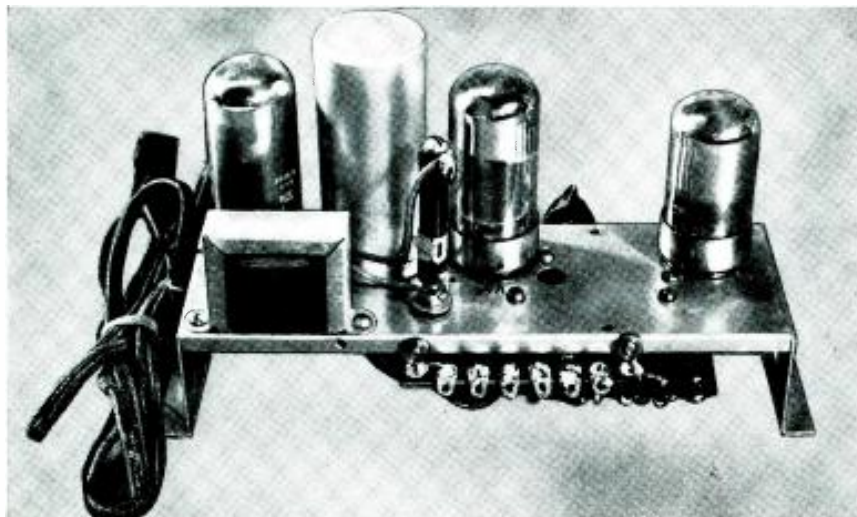

The chassis looks typical of those in inexpensive instruments but performance is excellent.

—a duo-diode, high-mu triode—was chosen instead, and the diode plates connected to cathode at the socket.

The feedback loop consists of R1, R2, and C. The latter is simply a blocking capacitor, intended to keep the d.c. plate voltage of the 35A5 off the cathode of the 14B6. Having no other function, its size is not critical, except that it should not be reduced below the value given. If it is too small, feedback will be reduced at the lower frequencies, causing an over-all bass boost which may overload the speaker.

R1 and R2 act as a voltage divider and put a specified percentage of the output signal voltage on the cathode of the 14B6 (essentially the same as putting it on the grid with reversed polarity). The value of R1 is set by the bias requirements of the 14B6, leaving R2 the only variable to be determined. The calculated value (180,000 ohms) proved satisfactory. However, the over-all gain of the amplifier can be adjusted at this point. Increasing the value of R2 increases the gain, and vice versa. It is easy to determine a value for this resistor by trial and error.

Since the over-all feedback results in a considerably flatter and wider frequency response, plate-supply filtering is made considerably better than usual. This is more for the sake of improved transient response than for hum reduction (feedback reduces the hum to a large extent). Remarkably low hum

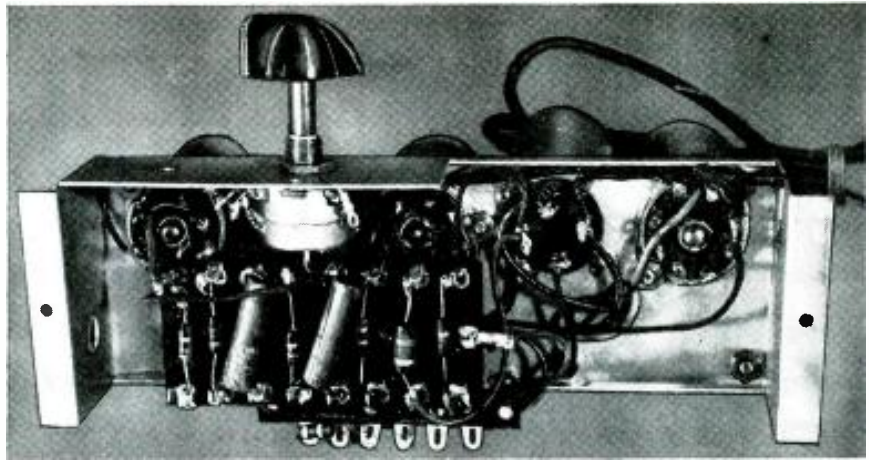

The few components, if wired point to point as in commercial models, make unit inexpensive.

level is attained without such usual gimmicks as hum-bucking speaker fields or hum-cancelling networks.

The amplifier was constructed on an odd chassis which happened to be available. Circuits were simplified considerably with an FP type of tubular capacitor containing all filter condensers and the cathode bypass in one can. All other resistors and capacitors are mounted on a terminal board. Commercially, this probably would not be done; the point-to-point method, using the pigtailed of the components as wiring, is probably cheaper and just as good if not better.

Since this unit was entirely experimental, the chassis was used as ground, and a capacitor was inserted in the chassis side of the input circuit to keep the pickup arm isolated from the a.c. line. In commercial construction, all ground points would be brought to a central tie lug, and grounded to chassis through a .01- μ f capacitor. The grounded side of the pickup could then be connected directly to chassis, and the capacitor eliminated. It would be necessary to mount the can-type electrolytic condensers on an insulating wafer, to avoid grounding to the chassis through the can.

Notes on Sound Recording

By RICHARD H. DORF

THE other night I went to a meeting of the New York Section of the IRE to hear two lectures on tape recording. One of the speakers was Dr. D. G. C. Hare, a physicist who has spent some time developing a new broadcast-quality tape recorder.

Dr. Hare's talk on the subject of noise contained some highly interesting information for those interested in magnetic recording from any standpoint.

One of the problems is keeping noise a reasonable number of db below program level. Apparently no one is quite sure of all the causes of noise; but through the cut-and-try procedure, which every radioman has developed since his radio infancy, certain information has been obtained.

Probably the prime difficulty arises from magnetization of the recording, playback, or erase head. How many owners of tape machines can honestly say they have never had a slightly magnetized screwdriver somewhere near one of the heads? Most screwdrivers become magnetized at some time during their careers; working on a tape recorder with one may raise the noise level by as much as 15 db!

The bias-erase oscillator is another prime factor. If it hasn't a perfect sine-wave output, the distortion will result in a d.c. component which will

magnetize the heads. The frequency of the oscillator and its amplitude—within limits—don't seem to be too important. In fact, if they are critical, you can be pretty sure the waveform is bad. So take a look at yours on a good oscilloscope.

There isn't much you can do about it, but turning off the audio at the peak of a wave will also leave the recording head "permed"—permanently magnetized. Funny thing, though, that speech waves, which are mostly either positive or negative, not equally both, have no effect. Why? Dunno.

One more tip. Dr. Hare said he has taken a brand-new tape and carefully kept it clear of everything before making the first recording. Then he found that running it once through the erase head before making a recording lessened noise.

Demagnetizing a head is quite a chore, it appears. Air-wound coils with 60-cycle a.c. running through them are used in about the same method as for demagnetizing a watch. Details weren't given, but you place the coil around the head, then lift it off. The number of times you have to do it will vary with the quantity of perm the head has; but if there's much magnetism, it may take all day! Shoot as much 60-cycle cur-

rent through the coil as you can without burning it up. According to Dr. Hare, it's about right when you spit on it and it sizzles. If you take this literally, be sure you have a couple of extra fuses and a tube of Unguentine handy . . . but anything for better sound quality!

New discs arrive

Having become an enthusiastic microgroove fan since the long-playing records bowed in, I jumped at the chance to try some of the new RCA 7-inch, 45-r.p.m. discs when samples arrived. I have a Garrard 201V motor which is governor-controlled from 78 right down to 33, so setting it at 45 was simple. If you want to try it, just count revolutions until you get a little over 11 in 15 seconds, then trim up the adjustment while matching the music to a piano.

The center-hole problem was solved for about \$2.00. A machinist made up an aluminum washer approximately $\frac{3}{16}$ inch thick. The outer diameter equals the inner diameter of the disc hole (about $1\frac{1}{2}$ inches), and there is a center hole in the washer to fit the standard turntable center pin (about $\frac{1}{4}$ inch). Furnishing the machinist with a sample disc and a turntable is a good way to get the dimensions accurate.

Frequency Bridge For Audio

By K. E. FORSBERG

Theory, construction, and calibration data for a Wien frequency-measuring bridge

BUILDING an audio oscillator is not a difficult feat—many excellent designs have been published in RADIO-ELECTRONICS and other magazines. But calibration, once the unit is built, is quite another matter, especially if no one in the vicinity has a well-calibrated generator and an oscilloscope.

The solution may well be an audio-frequency meter. Such a frequency meter is valuable for other purposes as well—for instance, as an interpolation device for heterodyne radio-frequency meters or for harmonic-distortion measurements on audio amplifiers.

For an a.f. meter to be really valuable, it must be accurate; to be economical it should be made from standard parts. The one described here contains only 10 parts—no vacuum tubes. The principal investment required is a bit of headwork. No standard component is 100% accurate; therefore, to make the frequency meter tell the real truth, values and calibration must be obtained by experiments and calculations.

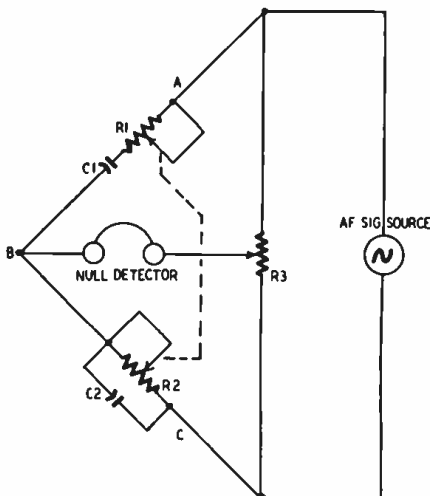

Fig. 1—Basic Wien frequency bridge circuit.

The instrument is a Wien bridge, of which Fig. 1 is the basic circuit. A variable-frequency signal source is connected to a bridge, two arms of which (the two sections of R3) are

purely resistive, and two resistive and capacitive.

The phase shift in an R-C circuit varies with the proportion of R to X_C . Since X_C varies with frequency for any value of capacitance, phase shift varies with frequency for any given combination of R and C. And in the Wien bridge of Fig. 1, R in the reactive arms is variable. As a result, R1-C1 and R2-C2 can be made to give any desired degree of phase shift at any frequency.

R1 and R2, two potentiometers of the same resistance mounted on a single shaft, vary approximately in unison. But because R1-C1 is a series network and R2-C2 a parallel, the phase shifts of the two vary oppositely when the potentiometer shaft is turned. With both R1 and R2 fully shorted, for example, arm AB is wholly capacitive, giving maximum phase shift, while arm BC is shorted out, causing no phase shift. On the other hand, with all resistance in the circuit, phase shift in the AB arm is minimum (because there is a maximum of resistance), while that in arm BC is maximum (because most of the impedance between B and C is capacitive reactance).

The voltage of the signal source is impressed across the series combination of R1-C1 and R2-C2. Because the net impedance from A to C is always at least somewhat capacitive, the current I_{AC} leads the applied voltage E_{AC} by some angle between zero and 90 degrees.

Fig. 2-a is a vector diagram showing this. E_{AC} is represented by the line at zero degrees. Since vectors revolve counterclockwise, the I_{AC} line represents the current, leading E_{AC} by an amount θ_1 .

The current passing through R2-C2 is I_{AC} , leading the generator voltage by θ_1 . This current causes a voltage drop E_{BC} across R2-C2. Since arm BC is capacitive, the voltage drop E_{BC} lags the current I_{AC} which caused it by a certain number of degrees, depending on the values of R2, C2, and the frequency (assumed to be constant throughout this explanation). The lag of the voltage drop E_{BC} behind the current I_{AC} which caused it is shown in

Fig. 2-a as θ_2 . Because of the component values and the frequency, it is, in this case, equal to θ_1 .

Observe the result. E_{BC} is now in phase with E_{AC} , the generator voltage. Since the voltage across any section of

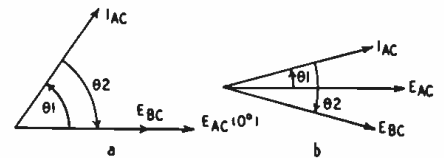

Fig. 2—Vectors show how the null is reached.

R3 is always in phase with the signal source, headphones connected between point B and the arm of R3 will have in-phase voltages at its terminals. All that is necessary to obtain a perfect null is to adjust the arm of R3 so that the amount of voltage appearing between it and point C is the same as that between B and C.

Suppose now that the frequency is raised, but R1 and R2 are left at their present settings. The net reactance between A and C is changed, and so is the reactance between B and C. As a result, the phase shifts in AC and BC are reduced, as Fig. 2-b indicates. I_{AC} still leads E_{AC} (though not as much), but the shift in BC is too great. E_{BC} now falls behind E_{AC} (lags it) because of the new values of θ_1 and θ_2 . The voltage across the headphones now has an in-phase and an out-of-phase component; while the in-phase voltage can be balanced out by adjustment of R3, there is no way of nulling the out-of-phase voltage and a signal will be heard.

The basic formulas for the phase shifts will be found in many textbooks, although this explanation is very hard to find. The null frequency is

$$f_n = \frac{1}{6.28\sqrt{R1 \times R2 \times C1 \times C2}}$$

Construction

Fig. 3 is a schematic of a practical Wien bridge having three frequency ranges: 20-200; 200-2,000; and 2,000-20,000 cycles. R1 and R2 are the sec-

tions of a dual potentiometer with logarithmic taper. Wire the potentiometers so that the resistance-rotation curve will be like that of Fig. 4-a, which will give a frequency curve as

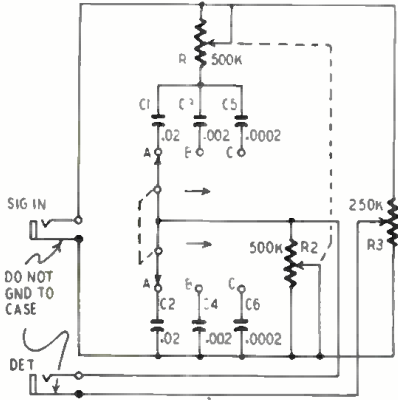

Fig. 3—Schematic of a practical Wien bridge.

shown. If wired backward, as in Fig. 4-b, the frequency calibrations will be very crowded at one end of the scale.

The capacitors should be mica or high-quality paper units. A metal case is useful for preventing stray capacitance, but don't ground the jack frames to it. The dial scale should provide for 270 degrees of rotation; a piece of polar graph paper will provide equally spaced divisions.

Calibration

The easiest way to calibrate the bridge is to feed a signal into it from

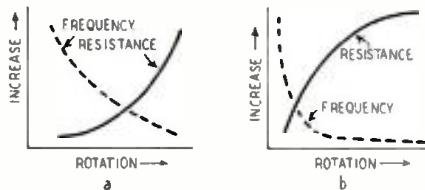

Fig. 4—Correct curve for R1, R2 is as above.

a calibrated generator. But, if the bridge is to be used to calibrate a generator, that is impossible. Some calculations and measurements will then do the trick.

With the capacitors given in Fig. 3 for each range, null frequency depends only on the resistances of R1 and R2. If these two resistances and the capacitances of each pair of capacitors (C1-C2, C3-C4, C5-C6) were equal and as stated, a simple table of resistance vs. frequency could be given. In the actual unit, they will not be equal nor will they be known exactly.

The procedure is as follows:

1. With a good capacitance bridge, measure the capacitance (including strays) actually in the circuit between the switch arm and the other end of each capacitor; note the results. Then solve the following formula for K (the range multiplying factor) for range A (20-200 cycles):

$$K_A = 1/6.28 \sqrt{C1 \times C2}$$

If, for example, the measured capacitances of C1 and C2 are exactly .02 μf each (an unlikely case), then

$$K_A = 1/6.28 \sqrt{.02 \times 10^{-6} \times .02 \times 10^{-6}} = 7,950,000$$

Solve also for K_B and K_C, using the values of capacitance in the circuit when the switch is on bands B and C.

2. Decide on the first frequency for which the bridge is to be calibrated, then substitute it for f in the formula

$$\sqrt{R1 \times R2} = \frac{K}{f}$$

The K to be used is that for the band being calibrated.

If the frequency is 20 cycles, for example, and K_A is 7,950,000,

$$\sqrt{R1 \times R2} = 7,950,000/20 = 397,500$$

3. Find a setting for R1-R2 at which $\sqrt{R1 \times R2} = 397,500$.

If both sections of the potentiometer varied exactly equally and the resistances at any setting were the same, the value of either would be sufficient. Since commercial dual units do vary somewhat, this geometric mean (square root of the product) is necessary, as it was with the capacitors. Using a good ohmmeter, find a setting at which one resistance is slightly above and the other a little below the desired value of 397,500 ohms; then make trial calculations and vary the settings slightly until the last equation above is satisfied. Mark the dial scale with the frequency at the setting found.

4. Go through steps 2 and 3 for each frequency to be used on each band.

It is possible to find the values for K without having a capacitance bridge. Apply 60-cycle line voltage to the input terminals of the bridge through a step-down isolation transformer. Adjust R1-R2 and R3 for sharpest null, and mark the scale. Measure the resistance of R1 and R2. Then

$$K_A = \sqrt{R1 \times R2}$$

Calibrate range A as in steps 2 and 3, extending the calibration to as high a frequency (above 200 cycles) as possible.

Connect an audio oscillator (it need not be calibrated) to the bridge and adjust it so that a null is secured above 200 cycles. Note the frequency from the calibration just made, then switch to band B. Readjust the bridge for null on this frequency, mark the dial, and measure R1 and R2. Then

$$K_B = f \sqrt{R1 \times R2}$$

where f is the frequency to which the oscillator is set. Calibrate range B as before, to a point above 2,000 cycles. Then follow the same procedure to find K_C.

To use the bridge, feed in a signal and adjust first R1-R2 and then R3 for sharpest null. Readjust both controls as often as necessary to get a complete null. Then read the frequency directly from the dial.

While headphones are usually satisfactory, a sensitive a.c. v.t.v.m. gives more exact null indications. Depending on the voltage fed to the bridge, an ordinary a.c. voltmeter might also be used.

If well calibrated and carefully handled, this Wien bridge is an extremely accurate frequency-measuring device.

One useful application not concerned with measurements is in receiving c.w. signals on crowded amateur bands. It is very difficult to copy when a strong interfering note is very close to the desired one in frequency. The bridge may be connected to the output of the receiver and the headphones used as the "detector." Adjusting the two controls will then balance out the interfering note while allowing the desired one to come through. A single-frequency a.f. amplifier may be constructed by inserting the bridge in a feedback loop so that all frequencies but one are fed back 100%. Many other uses will occur to the experimenter.

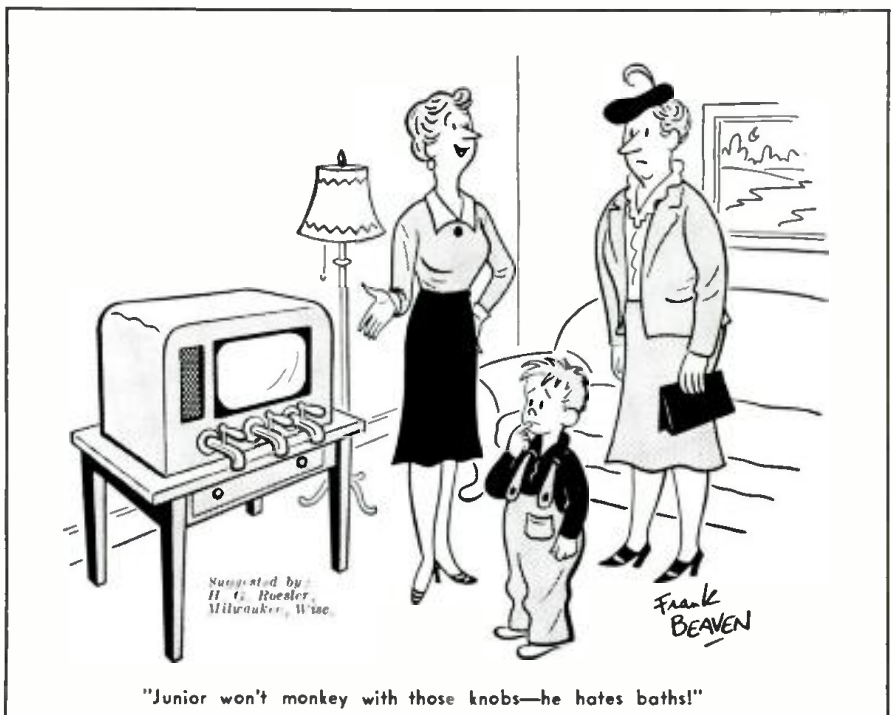

"Junior won't monkey with those knobs—he hates baths!"

MICROWAVES

Part IV—How waveguides are joined and tuned for lowest possible loss

By C. W. PALMER



Fig. 1—In bending waveguides, use is made of either the E or the H bend. Both appear here. DeMornay Budd Photo

SO far we have learned how waveguides are used to transfer microwave radio power from an oscillator or transmitter to an antenna, and from the antenna to the receiver's amplifying and detecting circuits.

We have learned that the familiar radio quantities—inductance, capacitance, impedance, reactance, and resistance—are found in r.f. plumbing, but that their appearance is entirely new. And since we are dealing with *wave propagation* instead of *conduction of r.f. currents* as in low-frequency radio, we must learn a new set of rules.

In this part of the microwave series we will attempt to express those rules in a form that will help the radio man to understand better the do's and don'ts of r.f. plumbing.

One of the most important things to learn in using waveguides is to avoid discontinuities or changes in the internal mechanical shape of the guide from one section or piece of apparatus to another when joining them together in a "circuit."

Look at Fig. 1 as an example. It shows two types of L bends used extensively in r.f. plumbing. The first is known as an E bend, and the second is called an H bend. It is easy to remember which is the E and which the H bend if you think of the E as the "easy" and the H as the "hard" bend (if it were possible just to bend a piece of straight guide to make a right-angle turn, which it isn't).

In manufacturing these bends, deviation from the inside dimensions of the straight section by even a few thousandths of an inch in the bent portion will increase the loss from a nominal

.02 decibel for such a section to several decibels, with a corresponding increase in the standing-wave ratio.

Fortunately such discontinuities can be taken care of by introducing into the guide obstacles that produce reflections which cancel the unwanted ones.

The matching devices most commonly used are *diaphragms* and *tuning screws*. The diaphragm, or *window* as it is sometimes called, is an aperture of thin metal placed across the waveguide. Such a window introduces either inductive or capacitive reactance depending on the direction of the slit.

Fig. 2 shows inductive and capacitive windows. For an inductive window the edges of the slit are parallel to, and for the capacitive window perpendicular to, the electric field. Usually these windows are soldered in place and are not variable. Where large amounts of pow-

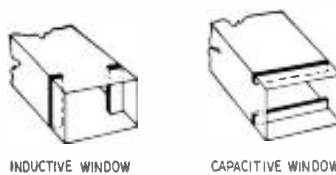

Fig. 2—The inductive and capacitive windows.

er are to be carried in the waveguides, inductive windows are preferred because the capacitance type breaks down, causing arcing and loss of power.

Several examples of the use of fixed windows in waveguide circuits are shown in Fig. 3, which shows E and H tees used for branching or splitting the waves into two paths. The windows in these tees balance out reflections that would otherwise be introduced by the

branch line and would introduce losses in the main waveguide path.

Sometimes it is desirable to have a variable reactance in a waveguide set-up to permit balancing out undesired reflections. In such cases tuning screws—small cylindrical posts projecting into the broad face of the guide as shown in Fig. 4—are used. These screws provide capacitive reactance which varies with the penetration of the post into the guide. A single screw may be sufficient, but usually three screws are provided at quarter-wavelength intervals along the guide.

Sometimes it is desired to insert in a waveguide a device that will either *pass* a desired mode (modes of propagation were discussed in Part I) and no other, or *reflect* completely the power in a certain mode. Resonant diaphragms or windows are used for this purpose. A thin rectangular ring of the proper dimensions placed across the inside of the rectangular waveguide and separated from it by insulation will *reflect*, for example, all the $T E_{0,1}$ mode transmitted through the guide.

If a thin metal diaphragm across the guide is provided with an opening of the proper size, all the power in the $T E_{0,1}$ mode will be *transmitted*.

Resonant slits in the waveguide diaphragms are also useful for passing waves of low power and rejecting those of higher power. The slit is so narrow that breakdowns occur, and the resonant condition is temporarily removed. A device of this sort is useful for preventing the direct power of a transmitter from reaching and damaging a receiver connected to the same antenna system, during transmit periods, while allowing incoming radio waves to be received normally. In a radar system a special form of such a device is called a TR or ATR box, and will be discussed in detail later.

A microwave primer

It is frequently necessary to use long stretches of waveguides, and it is very unusual for them to proceed in a straight line. Bent and twisted sections with the bends in both E and H planes. tees for branch lines, etc., must be used to fit the needs of the individual installation.

In using these lengths with tee's, L's, etc., certain rules must be observed to obtain the desired results. These are

summarized here in the following eight items.

1. A shorted end of waveguide (as the side arm of a tee or a stub) an odd number of *quarter wavelengths* long reflects an "opening" where it joins another waveguide. Waves in the main arm would travel into such a side arm as well as traveling through the main arm.

2. A shorted end of waveguide any number of *half wavelengths* long reflects a "solid wall" where it joins another waveguide. Waves in the main arm of a tee would travel through without entering such a side arm for this reason.

3. A quarter-wave section of waveguide has opposite impedances at its ends (if impedance is high at one end, it is low at the other) just as in ordinary types of co-axial and parallel transmission line. (This summarizes rules 1 and 2.)

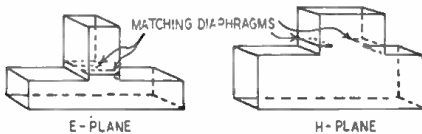

Fig. 3—Windows used in waveguide branch.

4. The Q of a waveguide is a function of frequency and also depends on the ratio of volume to inside area of the guide. Q 's of 25,000 are not uncommon in waveguides and resonant cavities.

5. The characteristic impedance differs with different modes of operation. In a rectangular waveguide the impedance is proportional to the narrow or b dimension of the guide. It varies from about 475 ohms to zero as the b dimension is reduced.

6. The wavelength in a hollow waveguide (as measured in a slotted waveguide section) is always greater than the wavelength of the same wave in air, due to the multiple reflections from the walls of the guide.

7. Sections of open and closed waveguides may be used as switching circuits by applying the principles of Rules 1 and 2 above.

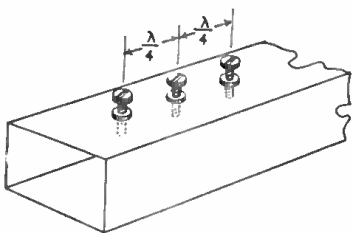

Fig. 4—Tuning screws for varying reactance.

8. Standing waves in waveguides are checked in a manner similar to that used for co-axial lines. A section of waveguide with a narrow slot parallel to the axis of the guide is used. A probe with a crystal detector or a small fuse ($\frac{1}{2}$ ampere) heated to almost the blowing point by direct current is used to detect the presence of standing waves as with a slotted co-axial line at lower frequencies.

Joints in waveguides

Sections of waveguide may be soldered together end to end. If the sections line up and touch, losses and reflections introduced by the joints are negligible.

However, for maintenance purposes and to make waveguide apparatus useable in more than one installation, it has become common usage to terminate waveguides with flanges on the ends which are soldered to the guide and machined flat on the ends. These flanges are bolted together. Experience has shown that this type of joint can be made better than even the average soldered guide-to-guide joint if care is taken to make uniform contact.

To reduce further the possibility of losses due to waveguide joints, it is considered good practice to use the "choke flange" joint, butting a choke flange *always* against a flat one.

The principle on which this choke flange works can be readily understood from waveguide Rule No. 2 above. See Fig. 5. This shows a cross-section view of a choke-to-flat joint. The slot left by the junction of the two waveguide sections is a half wavelength long at the optimum frequency of operation of the waveguide, which means that the side cavity A reflects a "solid wall" to the

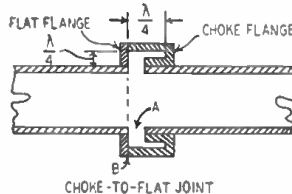

Fig. 5—The choke flange, perfect connector.

main guide so that there can be neither leakage of r.f. nor discontinuity to cause reflections in the main guide path.

In addition to the above, the point B where contact is actually made between the two waveguide sections is at a point of zero current, and perfect electrical contact need not be made between the two sections as is necessary in joining two flat flanges.

Such choke couplings are frequently used as "wobbly" or nonrigid connections between waveguide sections. They are used, for example, at the junction of an antenna where it is desired to shift or rotate the final section of guide to orient the antenna for peak response.

As a rigid connection the loss in a choke-flange joint is in the order of .02 db, compared to about .05 db for a well-made contact joint. The nonrigid connection mentioned, with a gap of about $\frac{1}{16}$ wavelength between the choke and flat flange, has a leakage of about .3 db.

Plungers for shorting bars

In terminating side arms as described in the rules above, it is sometimes desirable to make movable *shorting plates* or *plungers* so that the lines can be tuned exactly to a desired quarter- or half-wavelength point.

Plungers can be either solid blocks, cup terminations, or choke terminations. The solid blocks must make good

electrical contact at all points around the edge with the inside of the guide, or behavior will be erratic as the plunger is moved and power may leak past the termination.

Better results are obtained with a *cup contact* as shown in Fig. 6. Contact is

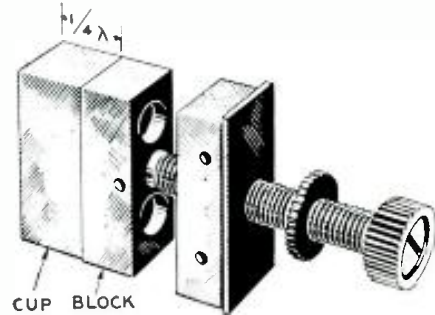

Fig. 6—The cup-type plunger reduces losses.

made with the inside walls of the guide a quarter wavelength from the plunger, where the flow of current in the walls of the guide is zero. Losses in this type of termination can be held to as little .08 db.

An improved termination is the *choke plunger* which uses the same principle as the choke coupling. As shown in Fig. 7, no mechanical contact with the inside walls of the waveguide is made at the front surface of the plunger. Contact is made at B where the current is zero. Choke plungers have losses in the neighborhood of .02 db.

Dielectric in waveguides

The fact that the introduction of a dielectric inside waveguide will decrease the "cutoff" wavelength has been used practically in a so-called "line stretcher." This device introduces controlled amounts of dielectric into the guide to tune it.

The effect of an ideal dielectric in a waveguide is to increase its apparent

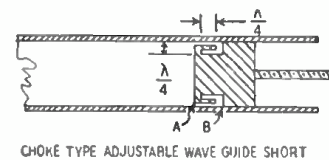

Fig. 7—Improved plunger uses choke circuit.

size. It also lowers the impedance in all but one TM (transverse magnetic) mode. The losses of a guide filled with solid or liquid dielectric are higher than for an air-filled or gas-filled guide. However, the effect is slight.

An exception to the above and a point of caution to the experimenter in microwaves is the effect of water. Small amounts of water condensed on the inside of a waveguide may introduce losses up to $\frac{1}{2}$ decibel per foot of waveguide. This is caused, not only by the large dielectric loss characteristic of water at high frequencies, but also by the high dielectric constant of water. This is why some waveguide installations are pressurized or charged with an inert gas.

◀ Receptacle at left is for PE-103 dynamotor.



Mobile 10-Meter Rig Puts Out 20 Watts on Phone

By ALVIN B. KAUFMAN, W6YOV

WHEN vacation time comes along, why leave ham radio at home? Plenty of fun may be had and some excellent contacts made while mobiling in the high Sierras or other vacation spots.

The low-power, 10-meter, mobile transmitter described was designed and built with this in mind. With all bands open for mobile operation, 10 meters was still selected over all other available bands, with 75 meters the only other one considered. Both bands are good for dx, but 75 is much more crowded than 10. Seventy-five-meter mobile, if really mobile, would require a loading coil to resonate the short whip antennas available, causing low radiation efficiency. But where short skip or ground-wave range is a necessity, 75 meters wins. The other bands, such as 6 meters, were not considered, as their range with low-power equipment is insufficient for the tourist ham.

The first major decision in design was whether to go FM or AM. The choice of FM meant far less drain on the power supply. At the same time, more tubes might be required for modulation. Then, too, where AM receivers were being used on the receiving end, QRM would knock the lower-power signal out easily. Therefore, AM was selected.

Frequency control was the next major issue. Crystal control was preferable from several viewpoints. A major disadvantage was inability to shift frequency to avoid QRM. A v.f.o. would have allowed this, but was impractical because of the cost and the problems of insuring drift-free operation under mobile conditions. The solution was the use of a variable-frequency or "rubber" crystal. It gives some of the best fea-

tures of both methods of frequency control.

The transmitter requires four tubes, and only two tuning controls. The crystal-buffer-stage tuning control may be set to the mid-frequency of the "rubber" crystal and left there. It is necessary only to touch up the tuning on the final tank when shifting frequency.

The r.f. section of the transmitter is unusually simple in design, as the schematic shows. The crystal and buffer stages are combined in one tube. A 40-meter crystal is connected as a Pierce oscillator, using the screen grid of the 6AG7. The plate circuit of the 6AG7 is tuned to 20 meters. The r.f. is coupled to the final grid capacitively.

An unusual feature here is the use of variable-inductance tuning. Taking advantage of the already high distributed wire and output capacitance, no capacitor, fixed or variable, is required across the buffer tank coil L1. Instead, using a National XR-50 coil form, a coil was wound which resonates in the correct range and whose resonance can be varied by moving the iron core in or out. This occurred with a winding of No. 29 enamel close-wound to a length of 1/4 inch. This gives an excellent L-C ratio and very good doubling efficiency. Mechanically and electrically it simplifies the transmitter. Despite the high L-C ratio, at these frequencies the tuning of the stage is not sharp.

The final stage consists of a conventional r.f. amplifier which doubles to 10 meters. It receives all its bias from a grid-leak. As a doubling operation takes place in this stage, it is desirable to have as high a bias as possible to facilitate harmonic generation. The grid leak selected was 68,000 ohms, but a value of 50,000 to 100,000 ohms is

acceptable. No protective bias was included as this was thought unnecessary for the low-power tubes involved.

Depending upon the power supply used with the transmitter, it is possible to overload heavily and burn out the final tube if its plate circuit is not in resonance. The use of protective cathode bias, however, would lower the over-all efficiency, which on this low-power job is not desirable. Momentary overloads will not cause tube failure, and 6L6's are comparatively cheap.

The antenna may be link-coupled to the 25-watt commercial tank coil, or it may be directly tapped on the coil (as in the diagram) where a quarter-wavelength whip is used. As 25-watt tank coils do not usually come with

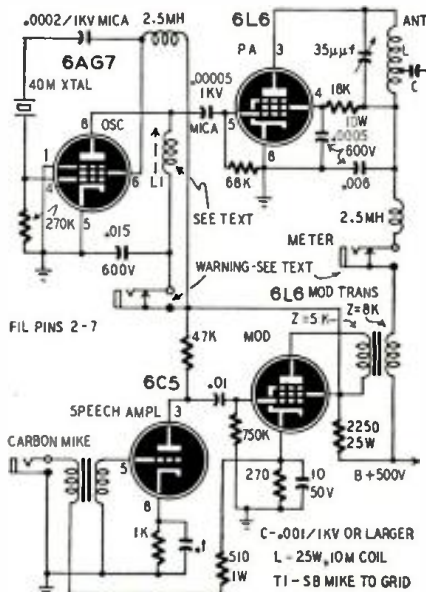

Doubler coil L1 is wound on slug-tuned form.

variable links, and because there are constructional difficulties in making a link hold still under mobile conditions, directly feeding the antenna may be advisable. When this is done, *always* place a mica coupling capacitor in series with the antenna lead. Failure to do this places the power-supply high d.c. voltage on the antenna, and a dangerous shock may occur to an innocent bystander. FCC regulations forbid direct coupling.

Both methods of coupling have disadvantages. A varying link will amplitude-modulate the carrier. With the tapped antenna connection, harmonics may be radiated, and a swaying whip, due to its change of capacitance, may cause detuning of the transmitter and consequent amplitude modulation. The choice is yours!

There is one important mechanical detail in the final stage. The tuning capacitor must have both rotor and stator above ground.

To keep the transmitter compact, jack-and-plug metering with an external meter is used. The plates of the buffer and final must be monitored when the transmitter is tuned. The meter jacks have been put in the plate leads. This places high voltage on the jack frames, which must be isolated from the chassis with fiber washers. Here the meter will indicate true plate current. For safety it may be advisable to place the jacks in the cathode circuits as per conventional design. Of course, grid and screen current must be subtracted for a true plate-current indication in this case.

(Mr. Kaufman's last communication to us was fairly recent, which indicates that he is still alive, even with two jack frames and a capacitor shaft, both 500 volts above ground, on his front panel. Despite the author's apparent good luck in never having accidentally brushed his hand across any of these gadgets while his feet were firmly planted on the ground, we cannot recommend that readers depend on the same good fortune. Mount the final tuning capacitor on the chassis with standoff insulators and use an insulated shaft. Place the metering jacks between the cathode of each tube and ground, with the frame of each jack grounded. You will have a better chance of remaining healthy enough to read the meters.—*Editor*)

Plate power should never be applied until the tube filaments have come up to operating temperature, primarily to protect the capacitors. Where a dynamotor power supply is used, regulation is poor and excessive voltage may be applied to the capacitors until the transmitter loads up the supply and lowers its output voltage.

The modulator

The speech amplifier and modulator are of standard design, a 6L6 driven by a 6C5. Rather than use the 6-volt car-battery circuit (too much hash) or a dry-cell supply for the carbon microphone, a special circuit was employed.

The bias resistor of the 6L6 was increased to a high value which, in parallel with the microphone button and transformer, supplies the correct bias to the tube and current to the microphone. This has several desirable features besides simplicity. It makes possible a.c. operation of the transmitter for portable or home operation. The modulator 6L6 is automatically biased to very low plate current when the microphone is off, conserving the power supply. Of course, where a push-to-

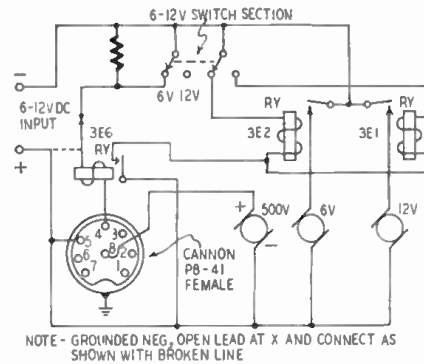

Simplified schematic of the PE-103 dynamotor.

talk microphone also controls the power input to all stages, this is of little advantage.

The power supply

An excellent power supply is an Army surplus PE-103 dynamotor, obtainable for less than \$10, which has built-in circuit-breaker protection and will operate from either a 6- or 12-volt battery. The output is rated at 500 volts at 160 ma. The unloaded voltage may reach 650, so it should not be operated until the transmitter filaments are warm. This will save the 600-volt bypass capacitors.

It is also possible to operate the dynamotor while connected for 12 volts input, on a 6-volt supply. In this case the output is 250-300 volts and may be used directly on all of the transmitter tubes with the 2,250-ohm protective dropping resistor for the modulator and crystal stages removed.

Cathode-type tubes are used, so their

heaters must be on as long as the rig is on standby. The transmitter is then put on the air by applying voltage to the dynamotor. A simplified schematic of the PE-103 dynamotor is shown. The control and output leads terminate in a Cannon type P8-41 connector. (A Cannon type P8-24 plug fits this connector.)

The dynamotor starts when the circuit through pin No. 4 is grounded through a push-to-talk switch on the microphone. The PE-103 may be used without modification if the positive side of the vehicular storage battery is grounded. If the negative side of the battery is grounded, the 6-volt control circuit must be altered. Disconnect the hot side of the control relay, 3E6, from the negative side of the low-voltage input circuit and connect it to the positive side as shown by the broken line on the diagram.

In most of these units, the high-voltage lead terminates at pin No. 8 and 6 volts for controlling an antenna change-over relay at pin No. 3 on the connector. However, PE-103's bearing serial numbers between 4711 and 9500 may have connections to pins 3 and 8 reversed. Be sure to check your dynamotor before connecting it.

At 500 volts input and 60 ma final plate current, input power is 30 watts. Assuming 70% efficiency, power output is 21 watts. The input power may be varied from 15 to a maximum of about 40 watts. With the modulator shown, input power should run approximately 15 to 20 watts to allow a high degree of modulation.

Construction details are not too important, and each amateur will have his own ideas, depending upon available chassis and boxes.

MATERIALS FOR TRANSMITTER

Resistors: 1—270, 1—1,000, 1—47,000, 1—68,000, 1—270,000 ohms, 1/2 watt; 1—510 ohms, 1 watt; 1—4,000 ohms, 10 watts; 1—2,250 ohms, 25 watts.

Capacitors: 1—50, 1—200 μ f, mica; 1—.006, 1—.015, 1—.01, 1—.1 μ f, 600 volts, paper; 1—10 μ f, 50 volts, electrolytic; 1—35 μ f, variable.

Transformers: 1—single-button carbon microphone to grid; 1—modulation, 5,000-ohm primary, 8,000-ohm secondary.

Tubes: 1—5AG7, 1—6C5, 2—6L6.

Miscellaneous: 1—40-meter crystal (variable-frequency); 1—National XR-50 coil form; 2—shorting, 1—non-shorting phone jacks; 1—PE-103 Dynamotor; cabinet, chassis, hardware.

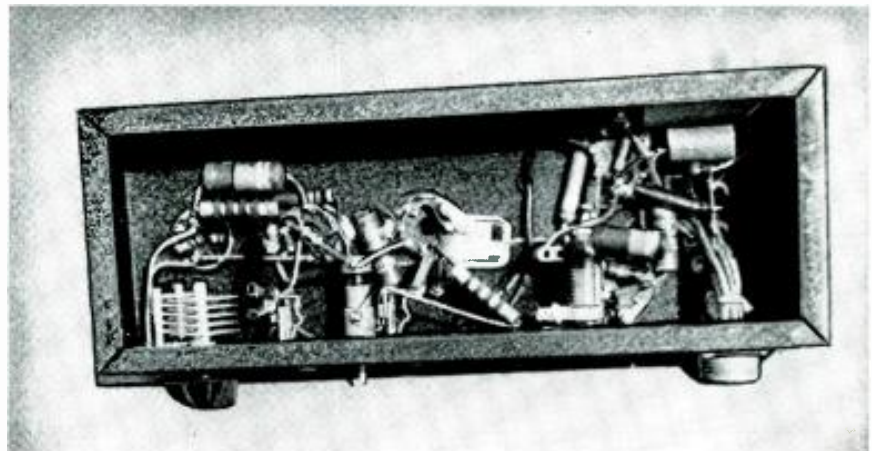

This is the underside of the transmitter chassis. Final tank tuning capacitor is at left.

Manufacturers Versus Service Technicians

It has been a matter of growing concern to us that for over two decades now the radio service technician has not been recognized by the radio set industry. During this period thousands of letters from radio technicians have passed across my desk complaining of the lack of recognition by the manufacturers.

It is true, perhaps, that during the first decade the old so-called "radio servicemen" had only themselves to blame for this treatment because their business methods left much to be desired.

During the last decade, however, this condition changed for the better, yet recognition was not forthcoming. Even at this moment—although a number of forward-looking manufacturers are beginning to work intensely with the radio technicians—more than half of the industry is not only indifferent toward them, but actually hostile.

Recognizing this condition—as this magazine has done for over 20 years—I recently took it upon myself to do something about this state of affairs.

Several months ago I began to address a series of ten weekly letters to the heads of the entire radio-television set manufacturing industry. In these letters I set forth, in no uncertain terms, the service technician's case. This correspondence resulted in a great deal of attention in the trade; I received many letters from the manufacturers—large and small.

The ten letters are much too lengthy to reproduce in full here, so I will limit myself and give certain highlights as follows:

From Letter #1... We think it would be a big surprise to many manufacturers, if it were generally known, how many buyers are actually influenced by the advice of a radio technician, the serviceman. After all, he is supposed to "know," and the family which is in the market to buy a TV set will listen to him. . .

From Letter #2... The great trouble today with set manufacturers, both television and radio, is that there is practically no cooperation with the technician. Letters by the independent technician addressed to manufacturers for servicing information, for information on various parts, etc., meet with little cooperation. He is frequently not even answered.

From Letter #3—Parts of a reader's letter to RADIO-ELECTRONICS.

"... The other day when I visited one of my customers he showed me a full-page advertisement

By HUGO GERNSBACK

from a local newspaper, advertising a new television model by the . . . Radio Company. The customer asked me what I knew about the set. I had, of course, seen the ad in the paper that same day, but I was forced to admit I knew nothing about the new receiver and could give no information . . ."

... The radio service technician is still at odds with the radio set industry . . .

... Instead of taking the trade, and particularly the technicians in the field, into their confidence, the manufacturers are doing everything to antagonize these men, thus losing not only good will but actual sales. . .

From Letter #4... FROM NOW ON EVERY YEAR WILL REQUIRE MORE AND MORE SERVICING OF TELEVISERS. Television sets—being far more complex than sound radio sets—are bound to get out of order quicker than the average radio. During the next few years—unless the number of new service technicians coming into the industry increases greatly—it is easy to foresee that *there will be chaos due to the inability of maintenance technicians to make repairs and do servicing in a reasonable time.* If present conditions prevail in 1952, conceivably it may take *months* before a customer's television set can be repaired. The set manufacturers fully realize the situation, but so far they have made no effective attempt to remedy it. . .

From Letter #6—Taken from a television set manufacturer's letter to us.

"... I think that you could take another look at the extent to which the servicemen are being penalized due to the fact that they are not receiving technical information on new models in advance. This particular point could be the subject of long discussion; but, generally speaking, the average, first-class serviceman in this industry can readily absorb the features of any new model within a short time, provided he has the technical data which is released along with any new model . . ."

... Today's common habit of many set manufacturers is to publicize the new receiver to the home set buyer while instruction and alignment manuals for the service technician are still on the press. Put yourself in the position of the radio technician when this happens—and it happens nearly all the time. *It causes bitter resentment.* . .

From Letter #8... Remember, it is

one thing to manufacture a set, but a totally different thing to service it. Why not tell radio service technicians that they will be paid for every worthwhile suggestion submitted? . . .

But no radio technician will put himself out to send in suggestions to a manufacturer, knowing that he will not be paid for his necessary labor—indeed he does not know whether his suggestions will be welcome or not. However, his experience is invaluable, and should not be lost to the manufacturer.

My final letter to the manufacturers (Letter #10) was sent to the radio-television manufacturers early in June. I thought it worthwhile to reprint, here, the entire substance of that letter:

... For a period of over ten weeks we have addressed to you a series of letters stating the service technician's viewpoint in his relations with the radio set manufacturer. *This is our final letter.*



We believe we are well qualified to represent the service technician, since, for over 20 years, a major portion of our magazine has been devoted to the radio servicing field. Here is a short resumé of the highlights contained in the previous nine letters.

1. Over 75,000 service technicians—who routinely go into the homes of your set users—can create either good will or ill will for you and your product.
2. For nearly 20 years the radio receiver industry—and now the television industry—has done practically nothing to obtain the good will and full cooperation of the service technician.
3. You have not taken the service technician into your confidence.
4. You have continuously made the serious mistake of placing the service technician in the same position as the buying public. *No TECHNICAL information on your new sets reaches these technicians until long after it has been announced to the public.* This has caused justifiable resentment and increasing ill will.
5. You have never thought it worthwhile to sell the service technician on your new product—*before* advertising it to the public—so that when a prospect asks him about it he can discuss it intelligently. (Continued on page 52)

TO THE SERVICE TECHNICIAN

MEMO:

Dear Service Technician:

We have just placed the Model OXOOY on the market. This receiver, we believe, has several new technical features that warrant your consideration. For your benefit, and the benefit of those customers of yours who may ask you for information on this new model, we will supply technical data on these features.

For more detailed data and complete service manuals, please fill out and mail the coupon in the lower right hand corner.

Yours very truly,
Videon Corporation

GENERAL CHARACTERISTICS
 Number tubes: 28
 C.R. Tube: 10-inch
 Loudspeaker: 12-inch
 Video bandwidth: 4.5 mc
 Overall gain: See Service Manual
 Frequency range: All television channels; standard FM band

BUILT-IN MAGNIFIER

The 10-inch tube of the Model OXOOY is equipped with a lens actually sealed on at the factory. Experience has shown that a large number of television users use and approve the imperfect magnifiers that are mounted ahead of the lens, and which cannot give optimum results, due to light losses from the rear surface, astigmatism, etc.

The OXOOY magnifier lens brings the picture up larger than that obtainable from a standard 15-inch tube, yet gives full picture visibility over more than 135 degrees without distortion. Light loss is small. That is because the lens is factory sealed to the front of the tube, which actually forms its rear face. Thus there is no intersurface to reflect the light. The close mounting, plus design factors engineered by the VIDEON research department, is responsible for the wide angle view. This feature alone is a tremendously important selling point. Reception on the normally 10-inch OXOOY is practically indistinguishable from that on a standard 15-inch television. Yet the OXOOY is definitely priced in the 10-inch class.

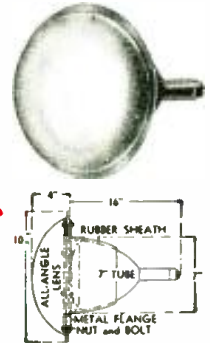

BRIDGED-T I. F. AMPLIFIER

Most revolutionary feature of the Model OXOOY is the Bridged-T video i. f. section. This section employs 6J6 triodes in the well-known grounded-grid amplifier (the cathode varies in voltage at the signal frequency, and the second grid is grounded). Thus we have the low noise characteristic of the triode, and—due to the grounded grid—the excellent isolation between input and output circuits that characterize the pentode. Stability is even better than that of a pentode stage. Instead of the more common two-coil i. f. transformer between stages, the Bridged-T circuit shown below is used. This provides a wide bandpass of 4.25 mc, and eliminates a number of technical difficulties hitherto experienced with two-coil coupled circuits. Briefly, a straighter-sided curve with less loss of gain is possible with this circuit. A total gain of 55 is realized over the whole video i. f. amplifier.

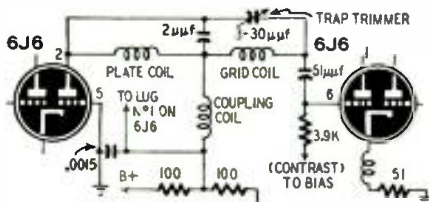

TUNING SYSTEM

Technicians have reported some instability in the push-button circuits of the OXOOU and OXOOV which tended to drift after some months of use. New-type ceramic capacitors reduce this possibility to a minimum in the OXOOY, and any traces of it are eliminated entirely by a vernier capacitor which may be adjusted by the user to bring in each station perfectly after it is tuned with the pushbutton. This vernier may be used on all channels, though in practice it is likely to be used only to "sharpen up" the weakest stations.

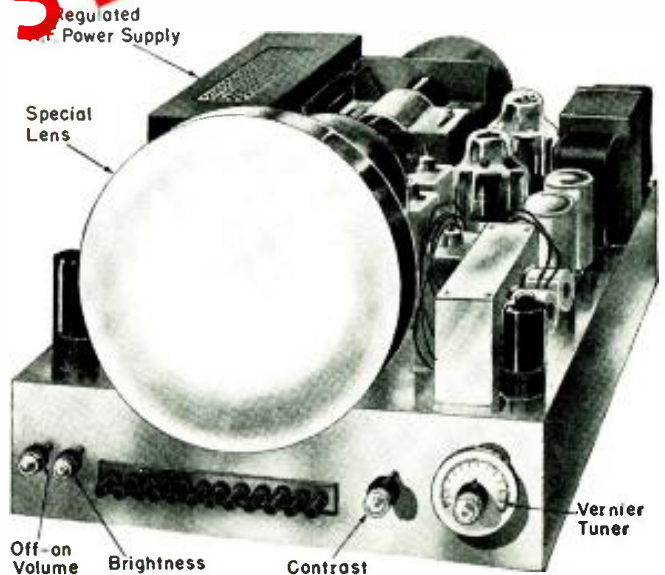

For complete servicing information, mail coupon to:
THE VIDEON CORPORATION
 Radioland, U. S. A.

VIDEON CORPORATION

00000 Tele-Boulevard, Radioland, U. S. A.

- Please send service data on your Model OXOOY.
- Also please send advertising information on Model OXOOY.
- I am interested in receiving further information on your models.....

Name.....
 Company Name.....
 Address.....
 City..... Zone..... State.....

Material for the above ad courtesy Snaider Television, Television Assembly Co., The Hallicrafters Co. and Transvision, Inc.

Why Pick on Radio Technicians?

By LYMAN E. GREENLEE

RECENTLY another wave of "investigations" sponsored by individuals and sundry organizations of various kinds has been supposedly producing statistics to prove conclusively that most radio repairmen are out to "gyp" the public. Two things about these investigations should make all legitimate radio repairmen fighting mad. First, the methods used have been decidedly unfair. Second, why pick on the radioman? What about refrigeration service, auto mechanics, watch repairmen, washing machine servicemen and others who do repairing for the public?

Most of the surveys are based on the planted "fault" in an otherwise normal radio. So the repairman slaves for a couple of hours on some screwy job planted just to test him out. He charges maybe as much as \$5.00 for his time and is classed immediately as a thief and chiseler and gyp artist! Maybe a 14-year-old kid *could* fix it in five minutes—if he was lucky, was a smart kid, and if he knew there was a planted "gimmick." So could the service technician, IF he were lucky. If he finds the fault immediately in one of the doctored sets

and charges 75¢ he is a good guy. Tomorrow he may spend two hours on the same type of set cooked up in a different way. Is he going to charge 75¢ for that two hours of labor?

A fundamental point overlooked or ignored by the unfair survey is: **Is the radioman entitled to pay for his time?** Is he entitled to a fair hourly wage for time spent in checking a set in addition to the actual time spent fixing it? If he is not (and the surveys seem to assume just that) **it's just about time we all quit servicing radios**

We all remember several sets from past experience. One was an a.c.-d.c. midget that could have been fixed in five minutes, if you knew just what to do, but it took four or five hours to find the trouble. Acid solder had been used and was causing enough high-resistance leakage to ground to make the receiver go dead in damp weather. Probably some other repairman *had* used acid solder, but that didn't help the matter.

You can seldom charge full price for your time on these tough jobs; but you certainly can't do them "for free" if you want to keep on eating occasionally.

License regulations will not make an honest man out of a dishonest one, and in many cases will make it easier for the chiseler to operate and harder for the honest newcomer to get a start. Check with any service where licensing is required. Radio repairing has always been a pretty tough racket and some of the boys have been driven to practices which are actually unethical though they were not gyping or overcharging. I refer to "installing" imaginary components instead of itemizing the charge for labor, where it belongs. Strange as it may seem, the public has some radiomen educated into believing their labor *isn't* worth anything!

Organizations of repairmen can help clean up the situation wherever and whenever it is necessary. Maybe they could also help to clean up the situation in other fields!

But the best way is to clean up your own situation—to watch your own reputation and improve it by your manner of dealing with the customers. Every repairman should have a standard schedule of charges and an open and aboveboard method of doing business. This will do more than any other one thing to defeat the charges of racketeering hurled against the industry.

1. Be frank and honest with every customer. Tell him what was wrong, what you had to do, and how long it took, whenever such an explanation is necessary or desirable. If it took two hours to locate an obscure fault, say so and justify your charge.

2. Always make out an itemized bill listing labor and parts separately plus any special charges such as sales tax. Give the customer a copy and keep one for your file. Have established list prices for everything you sell, including your time. Stick to your schedule, but if you make a mistake, admit it and don't charge the customer for it.

3. Give a standard guarantee, and if a job goes wrong within the guarantee period, fix it without quibble or question. Keep accurate records of what was found wrong with each job, but remember that sometimes it pays to fix a set free even if the customer is wrong.

4. Don't advertise "free" service. There is no such thing, never was and never will be!

5. Avoid repair estimates if possible. They cost you time and money. Handle these situations by saying: "Mrs. Jones, if this job runs more than \$5.00, I will call you and give you an estimate." It takes more of your time to fool with repair estimates than it does to repair radios.

MANUFACTURERS VERSUS SERVICE TECHNICIANS

(Continued from page 50)

WHAT'S THE REMEDY?

We have gone to considerable expense through industry research, surveys and personal interviews, to provide manufacturers with the necessary data and information to remedy the above situation. The answer is simple in principle. To us it is amazing that it has not been done before. In our opinion there is only one way to obtain the good will and confidence of the service technician, *namely by talking to him in the language which he understands* through the proper media—the technical trade press.

We are attaching a sample advertisement designed to sell your product in an intelligent manner to service technicians. The advertisement which we have prepared is merely a suggestion of what should and must be done to get the technicians on your side.

An advertisement of the type shown, when placed in the *technical* trade press BEFORE the new receiver or allied product is introduced to the public, will do wonders for you. The cost is small and wholly out of proportion to the good will of the more than 75,000 service technicians that you will earn with this message. Remember please, that the advertisement should always appear *before* the receiver is introduced

to the public through newspaper or magazine advertising.

If you will read the sample advertisement carefully, you will note that it gives all the salient *technical* points of the new product. **YOU ARE NOW TAKING THE SERVICE TECHNICIAN INTO YOUR CONFIDENCE.** Consequently, you will immediately have over 75,000 experienced technical salesmen rooting for you, instead of openly expressing their ignorance—and even their disapproval of your product—when the prospect asks questions about it. There is no reason why this plan should not be adopted by every manufacturer of radio and television receivers. It is bound to earn big dividends for you and the respect of the service technician. . . . (End of letter).

We have here reproduced for our readers the sample advertisement. No advertisement of this type has ever appeared in the technical press in this country.

We would very much like to have the service technician's reaction to this article. As many of your letters probably will be submitted to the manufacturers, I trust that all of you will find the time to comment fully on the above.

Training For Radio

**A training program of real value is possible
only when the student possesses the
necessary qualifications**

By **JULES L. HORNING***

WITH all expectations of a high-paying job, John Doe graduates from the Ready Radio & Television School. He is really amazed at his own knowledge of the field! Just six months ago, he had never seen the inside of a radio or television set. . . .

Armed with his diploma, he begins a tour of service shops and manufacturing plants. In the first two places he is turned down cold. At a third place, the owner tells him frankly that he doesn't know enough; at the fourth place, he is hired, only to be fired two weeks later. It is quite natural for John Doe to register bitterness. There is no greater disappointment for the graduate student in any trade than to find that he is not equipped to take a job in the profession he has chosen, or that he cannot live up to the requirements of the job.

The first reaction of John Doe is usually to blast the training program of the school. On this point, he might be right. Following World War II, a horde of radio and television schools opened to take advantage of the GI Bill of Rights. Many of these schools have not survived simply because the various John Does awoke to the sad truth that

they had acquired little training and a vast number of promises. Their unsatisfactory training programs have in many cases damaged the quality of their work in radio and television servicing.

However, John Doe might consider the fact that his failure to succeed in radio-electronics may have been due, not to the specialized schooling he has

received, but mostly to his own shortcomings. Perhaps he did not study himself and his possibilities prior to entering school. Coupled with the weakness of the Ready School training, the lack of proper self-analysis may be the downfall of John Doe.

In analyzing the progress of a student in a radio-electronics school and later on the job, it has been found that many of the problems encountered are a direct result of failure to consider interests and aptitudes prior to training. If a student is more interested in tinkering with automobiles than radio and electricity, no school in the world can turn him into a successful radio craftsman.

The young man who plans to be a technician and later run his own repair shop should ask himself these questions:

A. Do I have a definite interest or flair for radio-electronics and allied mechanical work?

B. Do I have the background in elementary mathematics and general science to understand properly the elements with which I will be working in electronics?

C. Do I have a reasonable degree of mechanical aptitude or "feel" for handling tools?

D. Do I have the personality to cope with the general public?

E. Am I willing to enter the business from the bottom floor, as a learner, upon graduation from school rather than expecting a top-paying job at once?

If the service-technician-to-be cannot

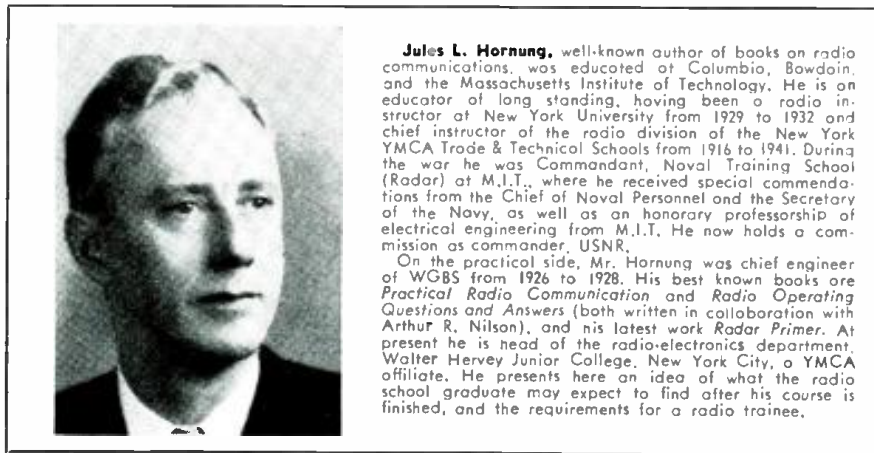

Jules L. Horning, well-known author of books on radio communications, was educated at Columbia, Bowdoin, and the Massachusetts Institute of Technology. He is an educator of long standing, having been a radio instructor at New York University from 1929 to 1932 and chief instructor of the radio division of the New York YMCA Trade & Technical Schools from 1916 to 1941. During the war he was Commandant, Naval Training School (Radar) at M.I.T., where he received special commendations from the Chief of Naval Personnel and the Secretary of the Navy, as well as an honorary professorship of electrical engineering from M.I.T. He now holds a commission as commander, USNR.

On the practical side, Mr. Horning was chief engineer of WGBS from 1926 to 1928. His best known books are *Practical Radio Communication* and *Radio Operating Questions and Answers* (both written in collaboration with Arthur R. Nilson), and his latest work *Radar Primer*. At present he is head of the radio-electronics department, Walter Hervey Junior College, New York City, a YMCA affiliate. He presents here an idea of what the radio school graduate may expect to find after his course is finished, and the requirements for a radio trainee.

*Chairman, Radio-Electronics Division, Walter Hervey Junior College, New York, N. Y.

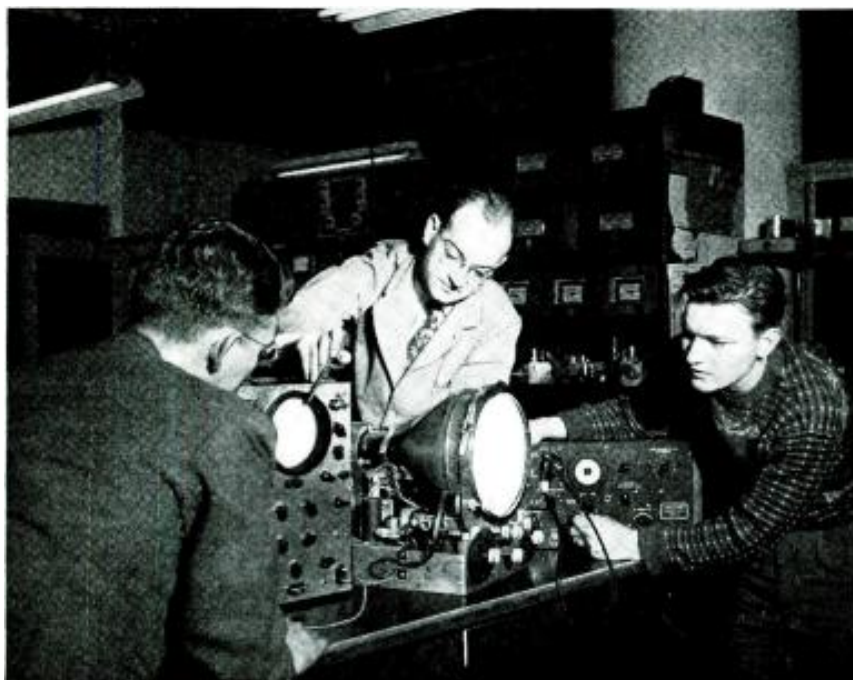

Small groups allow individual instruction in complex procedures such as TV-set alignment.

answer these questions affirmatively, he should immediately cross radio-electronics off his list. No amount of training can fit him for a successful and useful career in the servicing end of the business. There are always exceptions to this rule, but in general the above pattern represents a fairly accurate cross section of the requirements.

It will be easy to arrive at the answers to A and E. However, B, C, and D call for some amount of further explanation.

Requirements of B would include the mathematics and general science necessary to obtain a high school diploma. That means at least one year of general mathematics and one year of general science, or its direct equivalent. Many high schools also require a year of algebra. The prospective technician should not tackle the present field without a high school education, or its equivalent in science, physics, and mathematics, at least.

The requirements of C are comparatively easy to analyze. If the student finds himself at loss in making small mechanical repairs at home (light sockets, wiring, etc.), or if he dislikes working with tools, he had better steer away from radio-electronics. The same reasoning would apply if he had considerable trouble figuring out the circuit of the family electric iron.

The answer to D is harder. Personality poses a great problem in all phases of business and industry. However, the technician will many times deal directly with the consumer of his product. That means facing an occasional irate and altogether unreasonable customer. If the technician cannot damper his temper, keep smiling, and admit that he isn't infallible, he will not only antagonize his trade but may eventually lose his business. He must have the patience to cope with people who know little of his repair problems; he must be willing to offer service even at an occasional personal sacrifice of time. If he has the type of personality that will let him treat each customer as a friend and not a dollar-mark, he has little to worry about.

The prospective engineer

For the young man who plans to become an engineer, the same prerequisites hold true but their scope increases tremendously. An engineering student embarking on a career in radio-electronics must have particular capabilities to face the rigid requirements of the field.

To be successful, the engineering student must possess an inherent liking for and aptitude in mathematics, physics, and English. These subjects are the building blocks for a good engineer. One might question the necessity of English, but it must be remembered that an engineer must be able to put his thoughts and ideas into clear and concise written words and to read written explanations.

Perhaps an even more important re-

quirement than the pure academic prerequisites and accomplishments is generally overlooked. How well is the student suited in terms of personal character? He must view his temperament, personality, integrity, ethics-in-essence, and ability to get along with people. These are of vital importance to the employer. They are also qualities which ensure the young engineer the maximum opportunity for success. These factors are of such major importance that many leaders in industry consider academic ability and mechanical accomplishments only a fraction of the engineer's required characteristics.

After the young man has analyzed himself properly and affirmed his desire to enter the field, the next problem lies in the selection of a school. The student interested in servicing would be wise to carefully consider at least six well-known schools before making a decision. *A school is best judged by its reputation within the industry.* If the industry has received an unusually large number of poorly trained students from a certain school, it will not be any secret. The school will be blackballed by the people who are its greatest asset.

The student may obtain information from various sources—a vocational guidance counselor, a Veteran's Administration counselor, or someone already employed in a responsible position in the industry. He should examine the school's curriculum and test its offerings against what he desires to learn.

On the engineering level, the student must realize that it will be a long haul, financially and scholastically. Choosing a college which will offer the necessary elements to fit him for a career will not be an easy task. Once again, counseling, reputation within industry, and curriculum of study must be considered at length.

In the selection of the radio-electronics educational program, certain basic factors should be observed. The student might well consider the following before making up his mind:

1. Reputation of school,
2. Curriculum,
3. Admission policies,
4. Cost of training against values to be obtained from it,
5. Reputation of faculty,
6. Guidance and counseling program available,
7. Placement bureau,
8. Absence of mass-production tactics; comparative individuality in instruction.

The would-be engineer's high school background should definitely include algebra, chemistry, physics, and if possible, calculus. In other words, he should purposely load his course electives with as much science and math as he can carry. His college work in these subjects will be increasingly easier in direct comparison to the amount of preparation which he took in high school.

Once the student has entered a reputable institution, the onus lies on the

faculty and administration. In the case of the "mismatched" student, it poses a problem which is not easy. When it is clear that the student cannot achieve his goal, it is obligatory for the school to advise that he drop the course. How-



Photos courtesy YMCA Trade & Technical Schools, New York

Instructor points out final set adjustments.

ever, there are degrees of mismatch. Some of these can be cleared up by extra effort on the part of the student and the faculty. If the engineering student cannot meet the necessary mathematical requirements because of lack of previous training, he should be coached or advised to undertake separate courses in his work. For the clearly mismatched student there is no better solution than frank advice and ultimate dropping from the rolls of the school.

The greatest test of any training program in radio-electronics and associated fields begins when the student is employed on his first job. This is where all his study and training meet the acid test. If it has been good, the student can cope adequately with the problems his job presents. If it has been bad, he will find himself in the predicament of John Doe.

In choosing a school or program of study, the young man planning to enter the field of radio-electronics must realize that the entire industry is developing at a breath-taking speed. All phases are becoming more complex in mechanical operation, and the demands of industry are increasing daily. It is no longer enough to be able to tinker with a radio or television set; anyone in the field must be able to know how it works, why it works, and what will make it work better. He must be prepared to keep up with new developments in the field and increase his knowledge continuously from year to year. This new era of electronics is one full of demand and great promise. The right young man, properly trained and well qualified, will go far.

Fundamentals of Radio Servicing

Part VI—Reactance, impedance, and phase

By JOHN T. FRYE

WE ARE now nearly ready to splice inductance and capacitance together into that blissful state known as "the tuned circuit." But before the actual wedding takes place, we ought to make sure that the union can withstand any and all strains that may be placed upon it. It is true that we have observed how both an inductance and a capacitance behave under the influence of a direct current, but do we know what they will do when an a.c. voltage starts pushing and tugging at them? Perhaps it would be well to investigate this angle before we bestow our blessing on the marriage.

You cannot penetrate very far into the a.c. woods without having a clear understanding of *phase*; so we may as well get that straight right now. Phase simply means *comparative time of occurrence* as applied to actions, changes, or events. If two things happen together, we say they are *in phase*. If one happens first, we say that it has a *leading phase*. The thing that happens second is said to have a *lagging phase* with respect to the first.

Consider the case of you and your one-and-only doing a dance step. If the feet of both are in phase, her foot moves back at the same instant your foot moves forward. If your foot has a leading phase, it will move forward before hers is out of the way, and you will probably step on her toes and be told you are a poor dancer. If your foot has a lagging phase, she is doing the leading, and you are going to be a henpecked man!

As applied to electricity, phase usually means a comparison between similar changes in two or more different voltages or between a single voltage and its accompanying current. For example, Fig. 1 shows what happens when an a.c. voltage is applied across a pure resistance. Don't be surprised if you don't see it; Fig. 1 has probably balled up more students than any other diagram in the science of radio! It's supposed to show the life history of a cycle of alternating current. In our figure, having chosen the standard 60-cycle current, our base line is laid off in fractions of a 1/60 second. This makes it a time chart, just like the rolls that record the temperature for a day, with

a thermometer-controlled pen making a continuous track. Any point on the voltage curve on the chart will tell you just what the voltage is at that instant—the curve is simply a combination of all those instantaneous voltages.

No, alternating current really does not wiggle as the chart might lead you to believe. What happens is that current from the alternator starts to flow through the resistor, starting with very low (zero, to be exact) voltage and current. Both current and voltage rise until, at the end of 1/240 second, we have maximums of 170 volts (dashed line) and 2½ amperes (solid line).



Chief actors—inductor, capacitor, resistor.

(The exact quantities are unimportant; in many radio circuits we have alternating currents of some hundreds of volts at only a few milliamperes, and in some welding circuits there may be hundreds of amperes with only a few volts. In most a.c. diagrams, voltage and current curves are arbitrarily drawn the same height—see Figs. 2 and 3. The only reason we didn't do it here is that the two curves would then be on top of each other, and you couldn't tell them apart. Neither is the frequency important; we have used 60 cycles because it's common, but the story would be equally true at radio frequencies.)

But now—because of the way an alternator is built—our voltage and current start to drop, and at the end of 1/120 second there is no voltage across the resistor and no current flowing through it. Then the current starts to flow through the resistor in the *opposite direction*. Our clever mathematicians represent these volts and amps in the reverse direction by just drawing the voltage and amperage curves in the opposite direction to the first ones. Neat, eh?

Following the chart, we find that voltage and current in this direction again rise to a maximum in 1/240 second from the time they started, and in another 1/240 second are also back to zero. Total time 1/60 second, and we are back at the end of the circle (or cycle—it's the Greek word for circle) and ready to start all over again.

This is all to tell you what you probably don't need to be convinced of—that the voltage across the resistor and the current through it are exactly in phase, and that when the voltage is maximum or minimum, so is the current; and both reverse precisely in step. But when the resistor is replaced by either an inductor or capacitor, this harmonious state of affairs no longer prevails. A *phase shift* takes place, and the current reaches a maximum value at a different time from that at which the voltage is highest. Let us see why.

Fig. 2 shows what happens when an inductance is placed across the output of an a.c. generator. The dashed line shows the voltage applied to the coil. You will recall from our discussion of self-induction (read it again if you don't) that the changing current through the coil produces a counter-e.m.f. (voltage) very nearly equal to the applied voltage but directly opposed to it. This induced voltage is shown by the dotted line. Notice that when the applied voltage is positive (or for a.c. it might be better to say "in one direction") this induced voltage is negative ("in the other direction") and *vice versa*.

Remember that this induced e.m.f. is produced by the expanding or contracting lines of force cutting the turns of the inductor. Further recall (or re-read) that these lines of force are in motion *only when the current is changing value*. Still further, the induced voltage is highest when the movement of the lines of force—and consequently the *rate of change* of current—is fastest. Keeping all of this in mind (yes, I know it's a neat trick), where would you say the rate of change of current on Fig. 2 is the greatest? the least?

The solid line represents the current flow. The rate of change is highest when this line is most nearest vertical; least, when it is horizontal. As you suspected all along—but can now see on

the diagram—the rate of current change is least when the current itself is maximum. It is at these maximum-current points that the induced voltage—sustained *only* by a *changing* current—is zero. On the other hand, the *rate of change* is greatest at the point where the current is just starting to reverse its direction or cross the zero line; and this is the point of maximum induced voltage.

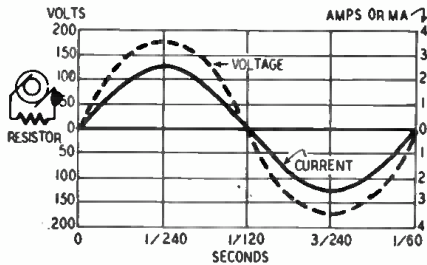

Fig. 1—E and I in a resistance are in phase.

In experimenting with an induction coil, we found that the current reached a steady value a split second *after* the voltage was applied. We can see from our diagram that the current peaks are separated from both the induced and the applied voltage peaks by a quarter of a cycle. Since we know that we must apply the voltage first, we can see that in a pure inductance the current lags the applied voltage by a quarter of a cycle.

The armature of an a.c. generator has to make one complete revolution or turn through 360 degrees to produce one complete cycle of voltage. The angle through which this armature has turned from the starting point is indicated in degrees along the time axis. This is all there is to "degrees," as applied to phase lead or lag or other a.c. terms. It is convenient to divide the cycle (remember, it's a circle) into 360 degrees and refer to fractions of a cycle in degrees instead of saying—as we did, clumsily—1/240 second, etc. Every quarter of a cycle is seen to occupy 90 degrees. Do you see why we say that, *in a pure inductance, changes in current lag changes in applied voltage by 90 electrical degrees?*

Fig. 3 shows what happens when an a.c. generator is connected across a capacitor. The dashed line again represents the value and polarity of the applied e.m.f. with respect to time. As the voltage first starts to rise in the "positive" direction, the electrons are easily pushed onto one of the plates of the capacitor and rush on at their maximum rate, for they encounter little resistance. But as this plate acquires more charge, its voltage rises (note dashed line) and begins to repel the electrons the generator is trying to force upon it. The movement of electrons, which makes up the current in wire circuits, slows down and finally stops when the applied e.m.f. and the electron charge have reached their maximum values (at 90°, or one-quarter of a cycle). Then, as the applied voltage starts to decrease, the packed electrons begin to flow back into the

wire, against the applied voltage, through the generator, and on to the other plate. They keep right on flowing in increasing number while the applied voltage falls to zero and starts to build up in the opposite direction; but the current again begins to droop as the other plate nears its maximum charge. Thus we see that the current through the circuit is maximum when the applied voltage is minimum and is at its minimum when the applied voltage is highest. Since the electrons have to flow onto the plate of the condenser *before* its voltage can rise, it is easy to see why *the current through a pure capacitance leads the applied e.m.f. by 90 electrical degrees.*

You have noticed that a capacitor, which says a firm "No!" to the passage of d.c. after it has once become charged, seems to murmur a coy "Maybe" or even "Yes" to the knocking of a.c.? While the electrons do not actually pass through the dielectric material, their rushing back and forth through the connecting circuit from one plate to another creates an alternating current in that circuit just as if the capacitor were replaced by a resistor.

We say "resistor" instead of "short circuit," for the capacitor does offer some opposition, depending on its ca-

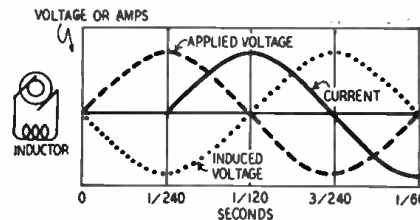

Fig. 2—Phase relations in inductive circuit.

pacitance and the frequency of the applied a.c., to the passage of current. As the capacitance is increased, more electrons must be moved to charge it each time; therefore, the current that is composed of the movement of these electrons is increased just as if the equivalent resistance represented by the capacitor were lowered. If the frequency of the applied voltage is increased, the electrons have to make more trips back and forth between the plates in a given length of time, and more electron trips mean more total current just as if the equivalent resistance were lowered again.

This "equivalent resistance" offered by a capacitor to the passage of a.c. is called *capacitive reactance*, has the symbol X_c , is measured in ohms just like resistance, and for any given capacitor can be found by the formula:

$$X_c = \frac{1}{6.28 f C}$$

in which f is the frequency in cycles, C is the capacitance in *farads*, and 6.28 is 2π (your old friend of grammar-school days, 3.1416). If you want to know the reactance of a 1- μ f capacitor at 60 cycles, you simply substitute in the formula, not forgetting to change microfarads to farads. Or if you want

to work with microfarads, simply multiply the numerator by a million, thus:

$$X_c = \frac{1,000,000}{(6.28) (60) (1)}$$

and you find that the answer is approximately 2,654 ohms.

When you recall that an inductance is stubbornly opposed to any change in the amount of current flowing through it, and also remember that the current in an a.c. circuit is changing almost continuously, it should be easy to see that an inductance, too, is going to offer more than a little opposition to the flow of a.c.

The amount of this opposition increases when either the inductance or the frequency of the applied voltage is increased. Since the induced or opposing voltage increases with the amount of inductance encountered, it is not hard to understand why a greater inductance will offer more opposition to the flow of current. The induced voltage also depends on the speed with which the expanding and contracting lines of force cut the wire; and since an increase in frequency means that the lines have to speed up in order to go through their expanding-contracting routine more often in the same space of time, no great brain is required to grasp why an increase in frequency stirs up more opposition to current flow.

This resistance which an inductance presents to the flow of a.c. is called *inductive reactance*. It has the symbol X_L , is measured in ohms, and is found by the formula:

$$X_L = 6.28 f L$$

in which f is again the frequency in cycles per second, L is the inductance in henries, and the 6.28 is 2π , the same ancient mathematical pastry we had served up in capacitive reactance. If we want to know the reactance of a 10-henry choke to a 60-cycle voltage, simply substitute in the formula: $X_L = (2) \times (3.1416) \times (60) \times (10)$, and we find the answer: just under 3,770 ohms.

To review a little while we catch our breath: *Resistance* is the opposition

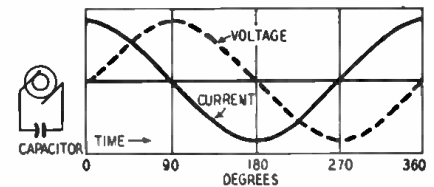

Fig. 3—Current leads in capacitive circuit.

offered to the flow of a steady direct current; *Reactance* is a specialized form of opposition that a.c. runs into. Reactance comes in two flavors: *capacitive* or *inductive*, according to whether the current leads or lags the voltage. While all three impede the flow of current, they are not at all alike. Resistance uses up power and dissipates it in the form of heat. Reactance transforms electric current into a magnetic field in an inductance or an

NOW Save Up to 22% at ALLIED

on these famous Hallicrafters models



Famous All-Wave S-53 World-Wide Coverage

Save \$19.55 on this quality, professional-type communications receiver! Covers 540 kc to 54.5 mc in 5 bands. Advanced features include: full electrical bandspread; large slide-rule dial accurately calibrated for all ranges; automatic noise limiter; adjustable pitch BFO; tone control; code-phone switch; headphone jack; phone jack; separate sensitivity and volume controls; built-in PM speaker. Includes all tubes. In satin-black steel cabinet with chrome trim; 12 $\frac{1}{2}$ x6 $\frac{1}{4}$ x7 $\frac{1}{4}$ ". For 105-125 v., 50-60 cy. AC. Shpg. wt., 20 lbs.

Was \$89.50
ALLIED'S PRICE **\$69.95**

97-573. Hallicrafters S-53, reduced to **\$69.95**
Available on Easy Payment Terms



SX-43 Full Short-Wave AM and FM Coverage

Was \$189.50
ALLIED'S PRICE **\$159.50**

You save \$30 on this great receiver preferred by Amateurs, DX fans and AM-FM listeners! Delivers professional performance over the entire range of 540 kc to 55 mc—plus the 88-108 mc FM range. Features: accurately calibrated main tuning and electrical bandspread dials; accurate carrier-level meter; 4-position control for broad or sharp tuning; variable-pitch BFO; tone control; automatic noise limiter; dual IF system; RF gain control; crystal phasing control; selectivity control; standby-receive switch; 500 and 5,000 ohms output impedances. Complete with tubes. In rich satin-gray steel cabinet; 18 $\frac{1}{2}$ x8 $\frac{1}{2}$ x13". For 105-125 v., 50-60 cy. AC. Shpg. wt., 45 lbs.

97-743. SX-43, less speaker, reduced to **\$159.50**
97-785. Matching R-44 speaker in steel cabinet. Net. \$24.50
Available on Easy Payment Terms

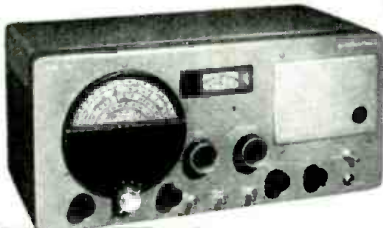

Popular S-40A & S-52 All-Wave Receivers

Here's more value in popular Hallicrafters communications receivers packed with advanced features. Covers 540 kc to 43 mc in 4 bands. Highlights include: full electrical bandspread; inertia flywheel tuning; calibrated main dial; automatic noise limiter; adjustable pitch BFO;

Was \$99.50
ALLIED'S PRICE **\$79.95**

standby switch; code-phone switch; headphone jack; shock-mounted PM speaker; separate sensitivity and volume controls; 3-position tone control. All tubes included. In handsome all-steel cabinet, 18 $\frac{1}{2}$ x9x11". Shpg. wt., 32 lbs.

97-546. S-40A, for 105-125 v. 50-60 cy. AC.
97-588. S-52, for 117 volts AC or DC.
EITHER MODEL, reduced to **\$79.95**
Available on Easy Payment Terms



S-38—the Super-Value All-Wave Receiver

The all-star, all-wave value that amazes even the experts. Covers 4 full wave bands, continuous range from 540 kc to 32 mc. Features: full electrical bandspread; Noise Limiter; Band Selector; BFO pitch; Voice-Code switch; Speaker-head-

Was \$49.95
ALLIED'S PRICE **\$39.95**

phones switch; Standby-receive switch; latest PM speaker. In handsome furniture-steel cabinet; 12x7x8". Complete with all tubes. For 105-125 v. 25-60 cy. AC, or 105-125 v. DC. Shpg. wt., 15 lbs.

97-565. Model S-38, reduced to **\$39.95**

T-64 TV Chassis

complete with
10" Picture Tube
REDUCED TO **\$179.50**

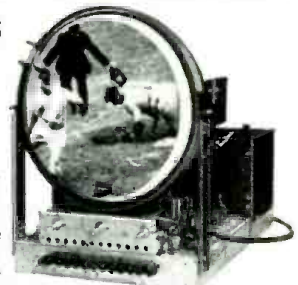

A complete direct-view chassis for 10 or 12-inch tubes. With new Dual-Focus switch—10" tube gives you choice of big 64 sq. in. view for dramatic closeups, or large 56 sq. in. full-range view. Features: 12 channel push-button tuning; RF amp.; 3 IF amps.; 2 video amps.; improved sync circuits; AGC; static-free FM audio system. Complete with power supply, speaker, picture tube and 19 tubes, plus 3 rectifiers. For 105-125 v., 50-60 cy. AC. Shpg. wt., 60 lbs.

Hallicrafters T-64 Television Chassis complete with 10" picture tube. **ONLY... \$179.50**
Hallicrafters T-64, with 12" tube. **ONLY... \$199.50**
Available on Easy Payment Terms

All Prices Net F.O.B. Chicago

You Save at ALLIED RADIO



FREE Radio's Leading Buying Guide

Used by thousands of expert radio men. Get every buying advantage at ALLIED: widest selections—money-saving prices—speedy, expert shipment—personal attention—complete satisfaction on every order. Send today for your latest ALLIED Catalog.

ALLIED RADIO CORP., Dept. 2-H-9
833 W. Jackson Blvd., Chicago 7, Illinois

- Send FREE ALLIED Catalog
 Enter order for Hallicrafters Model. Enclosed \$..... Full Payment
 Part Payment (Bal. C.O.D.)
 Send ALLIED Easy Payment details and order blank.

Name.....

Address.....

City..... Zone..... State.....

FREE CATALOG

YOU'LL HIT THE JACK POT . . . WITH QUAM Adjust-a-Cone SPEAKERS



There's a jack-pot of satisfied customers waiting for the serviceman who uses Quam Adjust-A-Cone Speakers. Here's why!

First, there's the unsurpassed performance and efficiency of Quam Adjust-A-Cone Speakers. They will make any receiver sound as good or better than it did with the original equipment.

Second, you can be sure of trouble-free service. With the construction of the Quam Adjust-A-Cone Speaker, because it permits accurate centering of the voice coil after assembly, a rubbing voice coil is practically unheard of.

Third, By replacing a defective speaker with a Quam Adjust-A-Cone, the serviceman makes a larger margin of profit, ensures a satisfactory job and a satisfied customer.

You can hit the jackpot with Quam Speakers.



MAIL THIS COUPON
FOR FREE CATALOG

QUAM-NICHOLS CO.
521 E. 33rd Place, Chicago 16, Illinois
Please send QUAM Catalog.

Name.....
Address.....
City..... State.....

electrostatic field in a capacitor for a portion of a cycle and then returns this stored energy as an electric current during the remainder of the cycle. With pure reactance in the circuit—never actually found in practice—the energy is just swapped back and forth from one form to another without any loss of power. In a purely reactive circuit, there is a 90-degree phase shift in one direction or the other from the in-phase condition of a purely resistive circuit. The more resistance we have in comparison to the reactance, the fewer are the degrees of phase shift (the closer together are current and voltage maximums or minimums).

Capacitive and inductive reactances have exactly the opposite effect on phase, and can be combined just like positive and negative numbers. In a circuit containing both, the effective reactance is found simply by subtracting the smaller reactance from the larger and giving it the name of the larger. For example, in a circuit containing 15 ohms of capacitive reactance and 10 ohms of inductive reactance, we just take 10 from 15 and say that the circuit has 5 ohms of capacitive reactance.

In addition to reactance, all actual circuits have some resistance; and we have a special word to describe this total opposition to a.c. That word is *impedance*, represented by the symbol Z, and it means "reactance and resistance." The two are somewhat like fractions and decimals in that you cannot add them directly. You have to extract the square root of the sum of their squares, which gives us the formula for finding impedance:

$$Z = \sqrt{R^2 + (X_c - X_l)^2}$$

Suppose, for example, we have a circuit containing 4 ohms of resistance, 10 ohms of capacitive reactance, and 7 ohms of inductive reactance (total reactance 10 - 7, or 3 ohms capacitive). Substituting these values in the formula:

$$Z = \sqrt{4^2 + (10 - 7)^2} = \sqrt{16 + 9} = \sqrt{25} = 5 \text{ ohms.}$$

But here it is the end of the chapter, and the union of capacitance and inductance into a tuned circuit—like the marriage of Little Abner and Daisy Mae—has been repeatedly postponed. These nuptials will take place in the very next chapter!

HOW TO GET THE MOST from only BASIC TEST EQUIPMENT

Servicing by Signal Substitution
The Simple, Modern, Dynamic Speed approach to receiver alignment and adjustment problems, FM-AM-TV.

- Nothing complex to learn
- No extra equipment to purchase
- Universal — non-absorbent
- Employs only Basic Test Equipment

S-S-S tells HOW — in simple, direct language.

New 9th edition now off the press. 100 pages of valuable information.

Available from all leading radio parts and equipment distributors or directly from factory at only 40c per copy.



PRECISION APPARATUS COMPANY, Inc. • 92-27 Horace Harding Blvd., Elmhurst 4, N. Y.

FM-AM CUSTOM CHASSIS

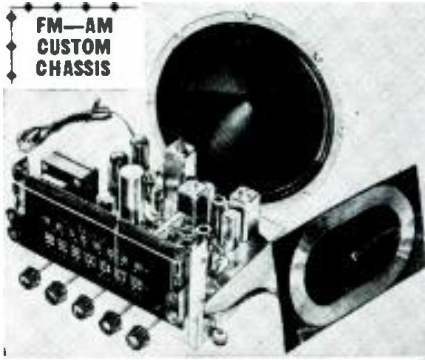

13 TUBE, HI-FIDELITY CHASSIS

12" Wide, 10 1/4" Deep, 7" High
Manufacturers over-run-made for the famous Ansley Consoles—complete with heavy RCA 12" speaker, Dipole, 13 tubes includes 2-6V6 PP for power output, driven by a balanced phase inverter circuit consisting of a pair of 6 AT 6's—Phono input and selector SW, FM band, 8.8 MC-108 MC, AM band 540 KC-1700 KC. Response: 50-10,000 cps ±3 db down; 105-125 volts A.C. Underwriters App. Reg. List \$169.00. Write for full specs. You be the judge of this fine chassis—10 day money back guarantee. 25% deposit, balance C.O.D. Complete \$64.50
SALCO Electronic Distributors Inc.
373 Broadway, Brooklyn 11, N. Y.

32,000 FREE Resistors*

Printed Circuit Kits

*Each Kit contains the equivalent of 32,000 1/4 watt resistors.

ENGINEERS—REPAIRMEN—AMATEURS: Now is the time to learn PRINTED-CIRCUIT METHODS. Most radio and TV makers already are designing printed circuits for their products. Let our S21 Kit be your laboratory.

MANUFACTURERS: A dab or two of conducting or resistance paint on your present products may eliminate components and labor—save you pennies or dimes on every unit. Use one of our S21 Kits to discover where. Write us about your quantity needs, stating characteristics required. The MICROPAINT KITS provide a complete printed-circuit paint laboratory for you, including instructions. The S21 Kit, \$7.27, contains silver and copper conducting paints; low, medium, and high resistance paints; lacquer; and solvent. All are designed for brush application on nearly any insulator. Draw separate components or complete working circuits. The paints air-dry rapidly. The Manual "Design and Repair of Printed Circuits" is included free with each Kit.

MICROCIRCUITS CO.

Dept. 2J New Buffalo, Michigan



European Report

By Major Ralph W. Hallows

RADIO-ELECTRONICS LONDON CORRESPONDENT



IN Roumania they're talking seriously of loudspeaker reception from a plain crystal set.

No tubes, no transistors; in fact no amplification at all. Just a straightforward, common crystal detector of the fixed type, connected on one side to the antenna and on the other to the loudspeaker. When I said talking seriously I meant that no less formidable a publication than the *Bulletin of the Roumanian National Technological Research Institute* has published an article in which Mr. Matei Marinesco gives accounts of both his investigation of the theory of electromagnetic and other reproducing instruments and of the promising results claimed to have been obtained already in his efforts to evolve a practical crystal-detector-loudspeaker receiver.

It all began like this. Feeling that the radio receiver incorporating tubes and needing "juice" either from electric mains or from relatively expensive batteries could never become really popular in its country districts, where there is little money to spare, the Roumanian Radio Company announced a competition, with large money prizes, for genuine "people's receivers". The conditions were, briefly, that sets should contain no tubes, that they should operate loudspeakers and that they should provide a sound intensity of 30 phons in a room with a content of 50 cubic meters for an input of 100 millivolts.

Getting down to the job, Mr. Marinesco decided that the big snag was not the crystal detector, but the loudspeaker. Those which most of us use are, he finds, sadly inefficient devices, since the ratio of power output to power input works out at between 2 and 6%. Devise a loudspeaker with an output-input ratio of 80% or a bit more and the trick should be done. Mr. Marinesco claims to have evolved loudspeakers with efficiencies up to 85% over fairly wide bands of frequencies, in conjunction with which a simple crystal set fulfils most of the conditions laid down for the competition. Well, here's hoping! What with the transistor and the super-efficient loudspeaker, the amplifying tube may have to look to its laurels.

What the televiewer wants

I was very interested in the data produced not long ago by the American firm, Audience Research, Inc., on what Americans want in the way of televisers and in comparing these with the yearnings, the earnings, the likes, and the dislikes of potential televiewers in Britain. There's no doubt at all about what our ordinary man and woman regard as essential in a televiser. First and foremost, they simply won't have any set which gives a picture with an area less than 65 square inches. And that means a 10-inch C-R tube. At one time or another this manufacturer or that has tried to popularize a low-priced set using a 4-inch, 6-inch, or 8-inch C-R tube and the result has invariably been something very like a complete flop. Even if a televiser gives the clearest of images of smaller size than about 65 square inches, the ordinary viewer just won't have it in the house.

Next, our folk won't buy the televiser that does not also reproduce the accompanying sounds. The main reason for this is that few indeed of our domestic radio receivers can tune in the sound channel of the television broadcasts.

Price seems to be a secondary consideration. So long as its cost is not outrageously high, a good televiser sells rather more quickly than its makers can produce it. That is due to some extent to prevailing conditions. We are still on short commons as regards food and our shops (owing to the urgent necessity of exporting all we can in order to pay our way) are still not too well stocked with consumer goods. Hence, there aren't many things on which people can spend what money they have left after paying living expenses and taxes. Televisers can be bought on the installment system and, provided the installments are within their means, people buy them in large quantities.

From the A. R. I. report I see that televiser prices are, on the average, round about the \$400 mark in the U.S. (The A. R. I. report is based on U.S. TV prices in effect last fall.—*Editor*) Now, that does surprise me. On ordinary broadcast radios American prices are far below British. A small 4-tube radio receiver costs at least twice as much here as it does in the States. (I'm leaving purchase tax out of consideration, since it varies from time to time and has, in any event, nothing to do with the efficiency or otherwise of mass-production methods). But

British prices for televisers—remember I'm speaking of sound-and-vision sets with at least 10-inch C-R tubes—seem to be a great deal less than yours. Were I intending to go out to-morrow to buy a TV receiver of the kind mentioned, I'd find two or three types below the \$200 mark and quite a wide selection at under \$300. For \$750 I could buy a good-looking combination all-wave radio-phonograph-televiser with a 12-inch-diameter cathode-ray viewing tube and all the trimmings.

The war on interference

You may recall that I've told you already how we in Britain are tackling the problem of man-made interference with radio and television reception by making it illegal to operate an unsuppressed factory machine, domestic electrical appliance, or automobile. In Switzerland they're dealing with some of the main causes of interference in another way. Switzerland is, in proportion to its size and its population, perhaps the most completely electrified country in the world today. Thanks to its vast resources of waterpower, even small villages and outlying farms have electric mains supplies. No steam locomotive runs on its railways and it has a vast mileage of electric street-car systems. Some of the street cars operate over interurban systems of considerable extent. With cheap electric power available everywhere you can imagine that radio listeners (there are no televiewers yet) complain bitterly of the effects of man-made static. They have to pay for licenses to use radios and they're not a bit pleased when a fine selection of "noises offstage" makes a classical concert sound like a feature program concerning a large boiler factory.

The license fees are collected by the government Posts and Telegraphs Department, which has recently decided to spend a considerable percentage of this income on static suppression at source. To accomplish this will certainly cost a tidy sum, for, to take transport alone, both the railways and the street car systems use overhead conducting wires with spring-loaded sweep contactors on locomotives and cars. At every joint in the overhead wires the travelling contactors are liable to jump, producing sparks and radiation of the kind which shock-excites antennas over a considerable area. The problem is a pretty big one, you'll agree, and the Swiss are to be congratulated on getting down to it in this practical way.

Laboratory Square-Wave Generator

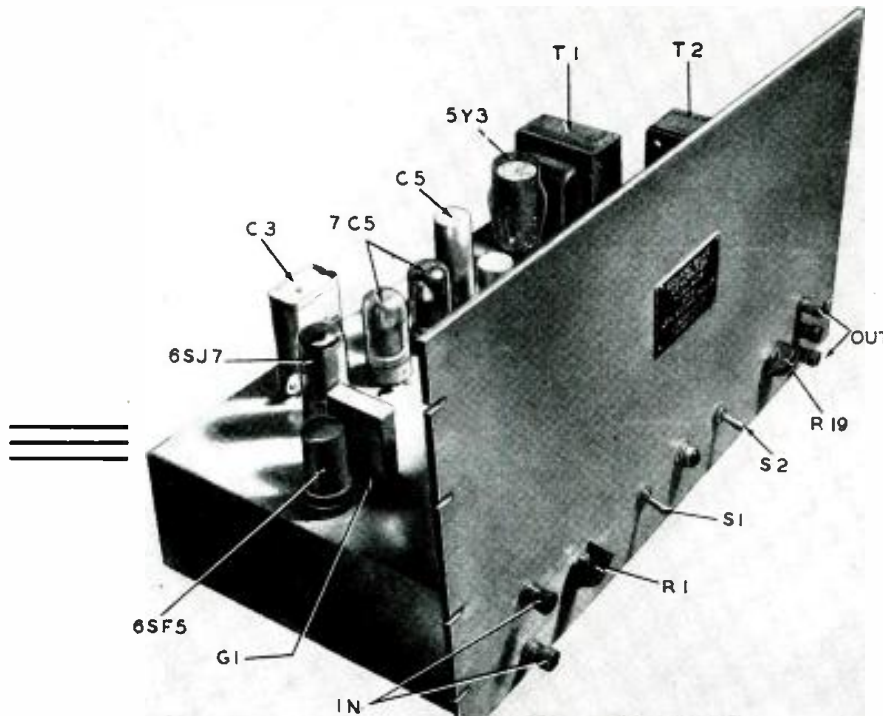

Quarter-view photo shows where the principal parts and controls are placed.

Square waves at frequencies up to 50 kc may be produced with this instrument plus an a.f. generator

By JOHN E. PITTS

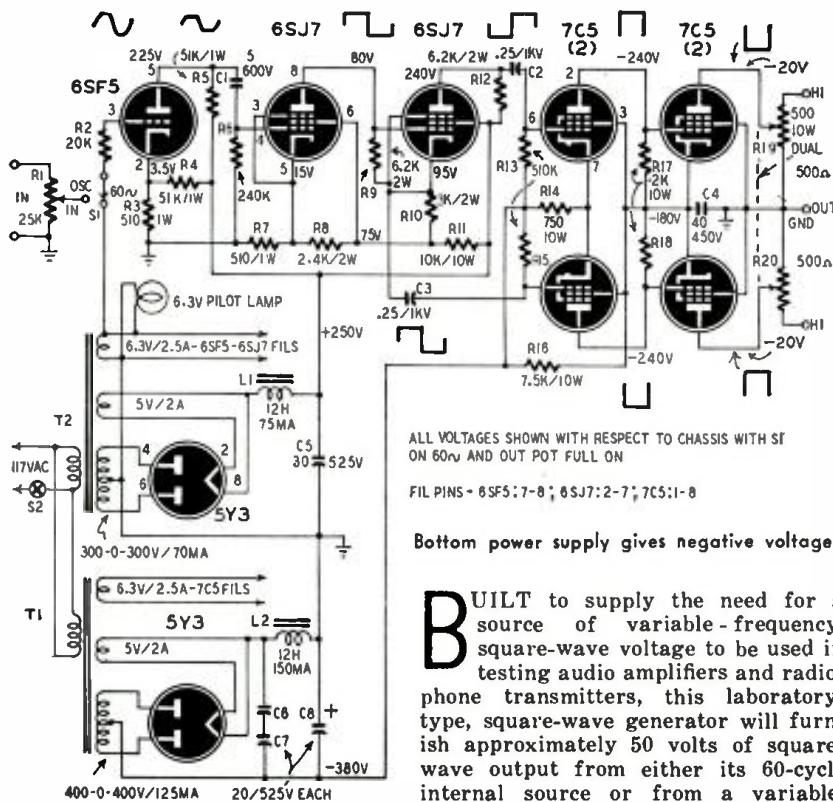

be coupled to the IN terminals to produce square waves as high as 50 kc. The voltage available from the OUT terminals may be varied by the OUT potentiometer when using 60-cycle input or from the IN or OUT potentiometers, or both, when using an external audio oscillator as the signal source.

The instrument was designed for mounting in a relay rack, but it can readily be modified for portable use by building it in one of the amplifier-type covered chassis.

The generator was built on a 10 x 17-inch chassis with a 10½ x 19-inch panel. It begins with one voltage amplifier, a 6SF5, acting as a partial limiter. The 6SF5 is capacitance-coupled to a 6SJ7—in whose plate circuit the square wave appears. This tube is direct-coupled to another 6SJ7 amplifier, which in turn is capacitance-coupled to push-pull 7C5's, which are direct-coupled to the push-pull 7C5 output stage.

The output of a variable audio oscillator may be connected to the IN terminals and the input to the square-wave generator varied by potentiometer R1 when the input selector switch is thrown to osc. With the switch thrown to the 60-CYCLE position, the input is connected internally to one of the 6.3-volt filament windings. The input from

BUILT to supply the need for a source of variable-frequency, square-wave voltage to be used in testing audio amplifiers and radio-phone transmitters, this laboratory-type, square-wave generator will furnish approximately 50 volts of square-wave output from either its 60-cycle internal source or from a variable-frequency audio oscillator which may

**THE NEW
MODEL TV-30**

TELEVISION SIGNAL GENERATOR

**Enables alignment of television I.F. and front ends
without the use of an oscilloscope**



The Model TV-30 represents a radical departure in the design of Television Signal Generators. Unlike the "sweep" type of Generator which requires the use of an Oscilloscope and extensive technical knowledge including pattern interpretation, etc., the TV-30 is a self-contained unit which permits alignment of Television Receivers by the use of exactly the same methods employed in the past to align Broadcast and Short-Wave Receivers.

FEATURES: Built-in modulator may be used to modulate the R.F. Frequency also to localize the cause of trouble in the audio circuits of T.V. Receivers. Double shielding of oscillatory circuit assures stability and reduces radiation to absolute minimum. Provision made for external modulation by A.F. or R.F. source to provide frequency modulation. All I.F. frequencies and 2 to 13 channel frequencies are calibrated direct in Megacycles on the Vernier dial. Markers for the Video and Audio carriers within their respective channels are also calibrated on the dial. Linear calibrations throughout are achieved by the use of a Straight Line Frequency Variable Condenser together with a permeability trimmed coil. Stability assured by cathode follower buffer tube and double shielding of component parts.

SPECIFICATIONS: Frequency Range: 4 Bands—No Switching.

18—32 Mc. 35—65 Mc. 54—98 Mc. 150—250 Mc.
Audio Modulating Frequency: 400 cycles (Sine Wave).
Attenuator: 4 position, ladder type with constant impedance control for fine adjustment.

Tubes Used:
6C4 as Cathode follower and modulated buffer.
6C4 as R.F. Oscillator
6SN7 as Audio Oscillator and power rectifier.

Model TV-30 comes complete with shielded co-axial lead and all operating instructions. Measures 6"x7"x9".

\$29⁹⁵
NET

THE NEW MODEL 670

SUPER METER



SUPER METER. A Combination VOLT - OHM - MILLIAMMETER plus CAPACITY REACTANCE, INDUCTANCE and DECIBEL MEASUREMENTS.

D.C. VOLTS: 0 to 7.5/15/75/150/750/1500/7500. **A.C. VOLTS:** 0 to 15/30/150/300/1500/3000 Volts. **OUTPUT VOLTS:** 0 to 15/30/150/300/1500/3000. **D.C. CURRENT:** 0 to 1.5/15/150 ma.; 0 to 1.5 Amps. **RESISTANCE:** 0 to 200/100,000 ohms, 0 to 10 Megohms. **CAPACITY:** .001 to 2 Mfd., .1 to 1 Mfd. (Quality test for electrolytics.) **REACTANCE:** 700 to 27,000 Ohms; 13,000 Ohms to 3 Megohms.

INDUCTANCE: 1.75 to 70 Henries; 35 to 8,000 Henries.

DECIBELS: -10 to +18, +10 to +38, +30 to +58.

The model 670 comes housed in a rugged, crackle-finished steel cabinet complete with test leads and operating instructions. Size 5½" x 7½" x 3".

\$28⁴⁰
NET

THE NEW MODEL 247

TUBE TESTER

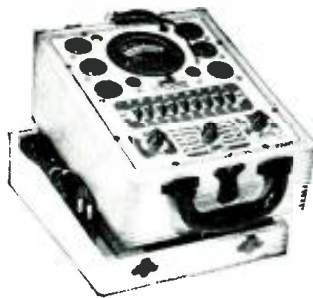

Model 247 comes complete with new speed-read chart. Comes housed in handsome hand-rubbed oak cabinet sloped for bench use. A slip-on portable hinged cover is indicated for outside use. Size: 10¼" x 8¼" x 5¼". **ONLY \$29⁹⁰** NET

Check octals, ortals, bantam jr. pentacs, television miniatures, magic eye, hearing aids, thyratrons, the new type H.F. miniatures, etc.

Features:

- A newly designed element selector switch reduces the possibility of obsolescence to an absolute minimum.
- When checking Diode, Triode and Pentode sections of multi-purpose tubes, sections can be tested individually. A special isolating circuit allows each section to be tested as if it were in a separate envelope.
- The Model 247 provides a super-sensitive method of checking for shorts and leakages up to 5 Megohms between any and all of the terminals.
- One of the most important improvements, we believe, is the fact that the 4-position fast-action snap switches are all numbered in exact accordance with the standard R.M.A. numbering system. Thus, if the element terminating in pin No. 7 of a tube is under test, button No. 7 is used for that test.

20% DEPOSIT REQUIRED ON ALL C.O.D. ORDERS

MONEY BACK GUARANTEE—We believe units offered for sale by mail order should be sold only on a "Money-Back-If-Not-Satisfied" basis. We carefully check the design, calibration and value of all items advertised by us and unhesitatingly offer all merchandise subject to a return for credit or refund. You, the customer, are the sole judge as to value of the item or items you have purchased.

The New Model 770 — An Accurate Pocket-Size

VOLT-OHM MILLIAMMETER

(Sensitivity: 1000 ohms per volt)



Features:

Compact—measures 3½" x 5½" x 2¼". Uses latest design 2% accurate 1 Mil. D'Arsonval type meter. Same zero adjustment holds for both resistance ranges. It is not necessary to readjust when switching from one resistance range to another. This is an important time-saving feature never before included in a V.O.M. in this price range. Housed in round-cornered, molded case. Beautiful black etched panel. Depressed letters filled with permanent white, insures long life even with constant use.

Specifications: 6 A.C. VOLTAGE RANGES: 0-15/30/150/300/1500/3000 volts. 6 D.C. VOLTAGE RANGES: 0-7½/15/75/150/750/1500 volts. 4 D.C. CURRENT RANGES: 0-1½/15/150 Ma 0-1½ Amps. 2 RESISTANCE RANGES: 0-500 Ohms, 0-1 Megohm.

The Model 770 comes complete with self-contained batteries, test leads and all operating instructions.

\$13⁹⁰
NET

The Model 88 — A COMBINATION

SIGNAL GENERATOR AND SIGNAL TRACER



Signal Generator Specifications:

*Frequency Range: 150 Kilocycles to 50 Megacycles. *The R.F. Signal Frequency is kept completely constant at all output levels. *Modulation is accomplished by Grid-blocking action which is equally effective for alignment of amplitude and frequency modulation as well as for television receivers. *R.F. obtainable separately or modulated by the Audio Frequency.

Signal Tracer Specifications:

*Uses the new Sylvania 1N34 Germanium crystal diode which combined with a resistance-capacity network provides a frequency range of 300 cycles to 50 Megacycles.

The Model 88 comes complete with all test leads and operating instructions. **ONLY \$28⁸⁵** NET

GENERAL ELECTRONIC DISTRIBUTING CO. Dept. RG-8, 98 PARK PLACE
NEW YORK 7, N. Y.

**OVER 85 BARGAINS
EVERYTHING BRAND NEW
MONEY BACK GUARANTEE**

ONE POUND ROSIN SOLDER	\$.49
\$ 3.95 SOLDERING IRON, 100 watts	1.97
\$ 37.95 TOM THUMB CAMERA & RADIO	17.97
PERSONAL PORTABLE BATTERY, 67½V	1.44
RCA TELEVISION TUNER, with 3-6J6	29.75
POWER TRANSFORMER, #630 type	11.97
PUNCHED CHASSIS PAN, #630 type	5.45
TELEVISION ANTENNA, hi & lo freq	6.95
TELEVISION INDOOR V-ANTENNA	3.97
TWIN LEAD-IN, 300 ohms, 100 feet	1.79
TWIN LEAD-IN, 300 ohms, 500 feet	6.45
COAXIAL CABLE, RG59U, 100 feet	4.35
COAXIAL CABLE, RG59U, 500 feet	18.95
TELEVISION 10" NO-GLARE FILTER79
6AG5, 6AK5, 6AL5, 6J6	each .79
OUTPUT TRANSFORMER, push-pull37
OUTPUT TRANSFORMER, (6V6)39
FILAMENT TRANSFORMER, 2½V, 10 amp.69
CHASSIS PAN, 8 mounted sockets39
CHASSIS PAN, popular radio type19
A.C.-D.C. CHOKE, 50ma, 10hy17
I.F. TRANSFORMER, 456kc39
OSCILLATOR COIL, 456kc09
VARIABLE CONDENSER, 420/16269
VARIABLE CONDENSER, FM, 88 to 108mc89
RESISTANCE CORD, 150 ohms39
ASTATIC PICK-UP, long playing	2.95
WEBSTER CRYSTAL, fits most arms	1.45
TOGGLE SWITCHES, SPST14
TOGGLE SWITCHES, DPST22
ANTENNA HANK, 15 ft. on handy spool09
100-ASST. CONDENSERS, .001 to .02	3.95
100-ASST. RESISTORS, ½watt	1.50
100-ASST. KNOBS, screw & push on	2.95
100-ASST. SOCKETS, loct, oct, min.	2.95
100-ASST. PILOT LIGHTS, 47, 49, 51	4.95
100-PEANUT TUBE CARTONS75
100-GT TUBE CARTONS95
100-SMALL G CARTONS	1.25
100-LARGE G TUBE CARTONS	1.45
3 INCH PM SPEAKER, Alnico 584
4 INCH PM SPEAKER, Alnico 597
5 INCH PM SPEAKER, Alnico 5	1.07
6 INCH PM SPEAKER, Alnico 5	1.29
8 INCH PM SPEAKER, Alnico 5	2.95
AUTO VIBRATOR, 4 prong, non synchro97
AUTO WHIP ANTENNA, side mount	1.69
TUBULAR CONDENSER, 5 mfd-25V09
TUBULAR CONDENSER, 10 mfd-35V12
TUBULAR CONDENSER, 10 mfd-50V14
TUBULAR CONDENSER, 40/30-150V29

VOLUME CONTROLS

LESS SWITCH, 25M, 100M, 1 meg. .. Each	.14
WITH SWITCH, 50M, 200M, ½ meg. Each.	.29

ROUND CHASSIS PUNCHES

Cut socket holes, etc. in a jiffy.

½" - ⅝" - 11/16" - 7/8" - 1"	
1 1/8" - 1 ¼" - 1 11/16" - 1 3/16"	
Each	1.95

RADIO TUBES

1R4	SYLVANIA	.19
6C4	NATIONAL UNION	.19
26	CUNNINGHAM	.19
1LD5	SYLVANIA	.37
76	PHILCO	.29
125R7	KENRAD	.29
1R5	UNBRANDED	.29
12K8	RCA	.29
35W4	HYTRON	.34
50B5	ARCTURUS	.34
35Z5	KENRAD	.39
80	CUNNINGHAM	.39
5T4	RCA	.49
6K7	RCA	.49
6F5	STANDARD BRAND	.49
125F7	RCA	.49
50L6	KENRAD	.55
1LC6	SYLVANIA	.69
117Z3	TUNGSOL	.69
1LE3	TUNGSOL	.69
25A6	STANDARD BRAND	.69

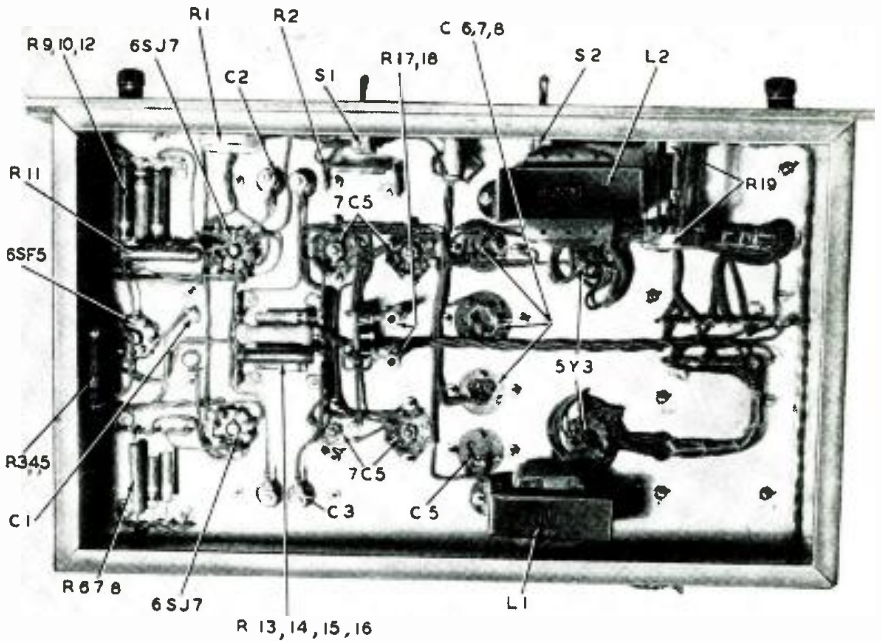

The 10 × 17-inch chassis provides plenty of space for the components, allows neat wiring.

either of these two sources goes to the grid of the 6SF5 through R2, a limiting resistor in the tube's grid circuit. This produces partial clipping at the input. The output produces a wave of the shape shown above the 6SF5 plate lead in the schematic diagram.

The 6SF5 output voltage is capacitance-coupled to the first 6SJ7 which further limits and squares off the wave tops. The mutual coupling resistor R9 in the first 6SJ7 plate and second 6SJ7 grid direct couples the two tubes for minimum frequency discrimination. The second 6SJ7 is used as a phase inverter to provide the proper drive for a push-pull stage. The phase inverter is capacitance-coupled through C2 and C3 to push-pull 7C5's which are direct-coupled to another pair of push-pull 7C5's in the output stage.

To present a relatively constant voltage drop across the first stage of the direct-coupled 7C5's, the stage is shunted by R16 so the voltage applied to the output stage will not depend wholly on the plate resistance of the driving stage. In order that the output stage may have its plate circuit returned directly to ground potential, the last two stages are operated from a power supply whose positive terminal is grounded, thus putting the grid circuit of the first 7C5's approximately 390 volts negative with respect to the chassis.

A 40-µf capacitor C4 is connected between the output cathodes and ground. It must be mounted on an insulated mounting plate. Since one of the power supplies is operated in an inverted manner, the cans of capacitors C4, C6, C7, and C8 are all hot with respect to chassis, and, if exposed, must be adequately protected from accidental contact.

Capacitors C2 and C3 should be at least of the voltage rating (1,000) specified, as they have the combined voltages (about 640) of both power supplies and the peak plate voltage of the 6SJ7 cathode follower stage across their terminals.

It was felt best not to ground one of the 6.3-volt heater windings, since the cathodes of all the 7C5's are at a high d.c. potential above ground. Were one of the tubes to develop a cathode-to-heater leak with the heater circuit at ground potential, one of the rectifier tubes would be destroyed if the primary fuse should not blow.

One of the photos shows a front quarter view of the completed instrument and the other, an underneath view, shows placement of parts. In the latter photo the input circuit is at the right and the output stage in the middle with all electrolytics and the power supplies toward the left.

Though the frequency response of an amplifier may measure up to snuff, the waveform of the input voltage may not be reproduced accurately in the output. This is due to non-uniform phase shift between stages; different frequencies are shifted by different amounts.

A square wave may be fed to the input of the amplifier. Since it is rich in (odd) harmonics, the output waveform as observed on a scope will be square only if the phase shift in the amplifier is uniform and if the frequency response is wide. It tests both at once.

The instrument has proved itself extremely useful in adjusting and testing various types of amplifiers, and also as the timing base for an electronic switch. The time and money spent in its construction have been more than repaid by the usefulness of the equipment.

SOLDERING PLIERS

Durst Mfg. Co.,
North Hollywood, Calif.

A new method of soldering radio parts is introduced by these pliers. The two arms of the tool are insulated from each other and connected to a low-voltage, high-current transformer. The wires or parts to be joined are held by the pliers, and the foot switch is pressed for an instant. The components and the solder are heated enough by the high current to melt the solder and form a solid joint.



The pliers remain cool at all times as does the work, except at the point of contact. Less solder is used and surrounding parts—capacitor wax, plastic spaghetti, and so on—are not damaged. The pliers may also be used as an ordinary tool, saving time ordinarily needed for changing tools for soldering.

CIRCUIT-BREAKER PLUG

Hopax Electric, Inc.,
New York, N. Y.

Providing protection to electrical devices and to power wiring this plug contains an interesting circuit breaker. The power cord from an electric motor or other device is connected to it, and it is then inserted in a line socket as is



an ordinary a.c. plug. When the device shorts or overloads and draws too much current, a small lever, which ordinarily rests between the prongs, springs up and pushes the plug out of the socket. The breaker is reset by lifting the lever, pushing it back between the prongs, and re-inserting the plug in the socket.

Designed primarily for fractional-horsepower motors, this unit should be usable for electronic equipment as well. Ratings up to 10 amperes are available.

VERSATILE BINDING POST

Superior Electric Co.,
Bristol, Conn.

The 5-Way binding post is intended for general radio use. It should be especially suitable for test and measuring equipment. Five different methods of connection to it are possible: spade lugs, wire (size up to No. 12) through



the center hole, wire looped around shaft, clip leads (there is enough shaft for this when head is turned to end position), and standard 3/4-inch banana plugs.

The hexagonal-shaped head being captive, it cannot get lost. The posts are furnished in red and black, with 30-ampere capacity and a 1,000-working-volt rating.

V.H.F. VOLTMETER

Sylvania Electric Products, Inc.,
New York, N. Y.

The Polymer Type 221 is a vacuum-tube voltmeter with essentially flat response from 20 cycles to 300 mc and usable up to 500 mc. A special sub-miniature tube used in the r.f. probe provides high input impedance and very low capacitance. Vacuum-tube rectification is used throughout. Six scales give d.c. ranges of 3 and 1,000 volts, which can be multiplied by 10 with a 10-kv accessory probe. A.c. voltage ranges are the same as those for d.c.; r.f. up to 300 volts may be measured. Resistance and current ranges are included.



ANTI-STATIC COMPOUND

Merix Chemical Co.,
Chicago, Ill.

Plastic phonograph records, such as the vinylite long-playing discs, accumulate a static electric charge which attracts dust and lint, making the playback noisy. Anti-Static Compound No. 79 is a liquid chemical which eliminates the charge. Applied in small quantities with a lintless cloth to either side of a vinylite disc, it dries quickly and (as confirmed in tests by the editors) does not harm the record. After application of the liquid, the discs have no apparent charge; they remain unusually clean and noiseless.

The liquid should be applied with a dampened cloth, using a circular motion following the grooves. About 150 records can be treated (one side each) with a 4-ounce bottle of Anti-Static.

MINIATURE RESISTORS

Wilkor Products, Inc.,
Cleveland, Ohio

Carbofilm resistors are available in sizes from 1/4 to 1 watt and resistances from 20 ohms to 5 megohms. The smallest resistor is 1/16 inch in diameter and only 3/8 inch long. Insulated units may be had.



TUBULAR TWIN-LEAD

American Phenolic Corp.,
Chicago, Ill.

Aphenal's Twin-Lead was one of the first of the ribbon-type dual transmission lines. The flat line undergoes changes in characteristics, however, when moisture or dirt collects on the surface of the insulating material, since all the plastic lies directly between the



conductors. The new tubular 300-ohm Twin-Lead made especially for reception (like the tubular transmitting lines introduced by the company last year) has the conductors separated mainly by the enclosed air space within the tube. Thus dirt collecting on the outside of the tube does not lie between the conductors and has little effect on electrical characteristics. Additional features are lower wind resistance and greater strength.

PORTABLE METERS

Weston Electrical Instrument Corp.,
Newark 5, N. J.

The model 901 series of a.c. and d.c. voltmeters, ohmmeters, milliammeters, and microammeters features instruments with easily seen scales and efficient shielding. Unbreakable windows extend the full width of the meter and curve around each side to reduce shadows. The units have hand-calibrated mirror scales and knife-edge pointers. Basic accuracy is within 0.5%. Instruments using rectifiers for reading a.c. have an accuracy of 1.5% of full scale.



CAPACITANCE COMPARATOR

Clippard Instrument Laboratory,
Inc.,
Cincinnati, Ohio

Model PC-4 capacitance comparator is an accurate production-line test instrument designed to aid in selecting



and grading capacitors. It may be used by non-technical personnel to obtain results within 0.2%. The range of the reading is 10 µf to 1,000 µf. The meter is a 4-inch direct-current D'Arsonval type.

DUAL-POINT PICKUP

Electro-Voice, Inc.,
Buchanan, Mich.

The Twilt is a torque-drive crystal phonograph pickup with two tips on the stylus shank. One has a 1-mil radius for microgroove records and the other 3 mils for standard discs. Either is placed in position by tilting the car-

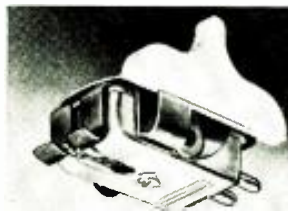

tridge in its special holder, which may be installed in almost any standard arm. The arm should be lightened for a 6-gram stylus force. Output is 1 volt at 1,000 cycles from the RD90 test record.

SWEEP GENERATOR KIT

Radio Kits Co.,
New York, N. Y.

Model SW5 is a kit of parts for building a 2-226-mc test generator for serv-

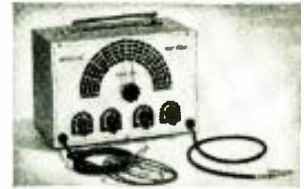

icing AM, FM, or TV sets. Either AM or FM output is available, with a maximum FM sweep width of 10 mc. Sweep and phasing are variable; a sweep-sync output is provided for an oscilloscope.

ABOVE-CHASSIS RESISTOR

Clarostat Mfg. Co., Inc.,
Dover, N. H.

The Standee is a new-type vertical power resistor for above-chassis mounting.

Basically, the Standee comprises a wire winding on a Fiberglas core, bent in hairpin form with a mica separator between the legs, placed in a ceramic tube filled with cold-setting inorganic



cement, and provided with bottom terminals and mounting bracket. The lugs are locked into the tube wall in addition to being sealed in cement. By having this power resistor mounted above the chassis, the problem of heat dissipation is neatly solved.

Standees are available in the standard 19/32-inch diameter, in heights of 1 1/2, 2, 2 1/2, and 3 inches, with power ratings of 10, 15, 20, and 25 watts, respectively. Maximum resistance values are 6,000, 9,000, 12,000, and 15,000 ohms, respectively.

SCOPE LENS

Allen B. Du Mont Laboratories,
Inc.,
Clifton, N. J.

The new Type 2542 oscillographic projection lens, is a two-element, symmetrical, objective lens with a relative aperture of f/3.3 and a focal length of



7.7 inches. It projects an oscilloscope pattern up to 3 inches square from 8 to 30 feet, resulting in a picture as large as 12 feet square. Axial light transmission of the system is about 85%.

An advantage of the lens is the simplicity with which it may be mounted on any oscilloscope equipped with a bezel similar to that supplied with Du Mont instruments. (This bezel may be had separately.) The lens is slipped into the bezel and a clamp knob on the lens is rotated. The lens is designed primarily for use in lectures and demonstrations.

LAFAYETTE SHOWCASE TEST EQUIPMENT AT ROCK BOTTOM PRICES

Limited quantity. Showcase display models of popular type quality test equipment in small quantities. Brand new merchandise . . . current models. ORDER NOW . . . at these SLASHED PRICES!

SUPREME 576 SIGNAL GENERATOR

RF Ranges: 62-205 KC; 650-2050 KC; 2050-6500 KC; 6.5-20.5 MC fundamentals. Audio: 40 cycles—voltage output continuously variable. RF carrier modulated at approx. 50% at 400 cycles, 110-125V., 50/60-cycle. $9\frac{1}{2} \times 8\frac{3}{4} \times 7\frac{3}{8}$ ". Wt: 15 lbs.

K21667 Was \$67.57 Now \$47.77

SUPREME 561 AF-RF OSCILLATOR

5 types of signal output; variable audio 15-15,000 cyc. Unmodulated RF 65 KC-20.5 MC. Variable audio modulated output (0-80%). Frequency modulated RF. $15\frac{1}{2} \times 11\frac{1}{2} \times 8\frac{3}{4}$ ". Wt: 33 lbs.

K21717 Was \$133.87 Now \$91.77

TRIPLETT MODEL 3212 COUNTER TUBE TESTER

Sockets for 4, 5, 6, 7-prong large and small, 8-prong octal and loctal, 5-prong bantam, 7-prong miniature and sub-miniature. Full range filament voltages: 0-.75/1.2/1.4/1.5/2/2.5/3.3/5/6.3/7.5/12.6/25/32/50/70/85/95/100/110. 5 $\frac{1}{2}$ " B&D and GOOD color coded scale. Neon indicator short test. Illuminated roll chart. 110-V., 60-cycle AC. $15 \times 11\frac{3}{4} \times 6$ ". Wt: 15 lbs.

K21518 Was \$62.23 Now \$47.77

TRIPLETT 2432 SIGNAL GENERATOR

6 bands: 75 KC-50 MC. 80% internal modulation at 400 cyc. 400-cycle audio signal at panel jacks. Excellent stability and accuracy. Tubes: 6J5, 6J5, 65GT. VR-150-30. 115-V., 50/60-cycle power supply. $10 \times 10 \times 6\frac{1}{4}$ ". Wt: 16 lbs.

K21507 Was \$66.15 Now \$44.77

TRIPLETT MODEL 2400 VOLT-OHM-MILLIAMMETER

DC sensitivity: 5000 ohms/V. Ranges: DC V, 0-10/50/250/500/1000; DC amps 0-10; DC ma: 0-1/10/50/250; DC micro-amps 0-250; AC V, 0-10/50/250/500/1000 at 1000 ohms/V; AC amps 0-5/1/5/10; Resist: 0-4000/40,000 ohms, 0-4/40 megohms; DB-10 to -15, -29, -43, -49, -55. Portable case $1 \times 10 \times 5\frac{1}{4}$ ". Wt: 14 lbs.

K21506 Was \$48.51 Now \$36.77

JACKSON MODEL 643 VOLT-OHM-MILLIAMMETER

11-key, push button selector. Volts AC and DC: 0/10/50/250/500/1000/5000; -10 to -14, 10 to 34, 30 to 50 db. DC, MA 0/1/10/100/250; 0-10 amps; 0-3000/300,000/3 megohms. DC sensitivity: 2000 ohms/V. Portable steel case $8\frac{1}{2} \times 8\frac{1}{2} \times 6\frac{1}{2}$ ". Wt: 8 lbs. With self-contained battery & test leads.

K21759 Was \$44.75 Now \$32.77

Jackson 642. Same as above except 0-100 microamp meter, and 0/3000/300,000/30 megohms. DC sensitivity: 20,000 ohms/V.

K21653 Was \$58.31 Now \$42.77

SUPREME 565 VTVM

DC Ranges: 0/1/2.5/10/50/250/500; AC 0/1/2.5/10/250; DC input resistance 30-80 megohms; AC 20-10 megohms. Input capacity 9 mmfd. Probe includes hi-frequency diode. Portable case $9\frac{1}{16} \times 4\frac{5}{8} \times 9\frac{1}{16}$ ". Weight: 11 lbs.

K21411 Was \$62.23 Now \$39.77

JACKSON MODEL 637 DYNAMIC OUTPUT SET TESTER

27 ranges, 10 functions; push-button selection. Filament voltages .75 to 115. Neon leakage test. Checks ballast tubes and condensers. AC & DC V, ranges: 0/10/100/250/500/1000/2500; -10 to -54 db. DC MA 0/1/10/100/250, 0-10 amps; Ohms: 0/3000/500,000/30 megohms. Portable oak case $14\frac{1}{4} \times 13\frac{3}{4} \times 6$ ". With self-contained ohmmeter battery and probes. Wt: 18 lbs.

K21440 Was \$95.55 Now \$69.77

Mail Orders Only

LAFAYETTE RADIO

RADIO WIRE TELEVISION, INC.

Dept. JH-9

100 6th Avenue New York, N. Y.

AMPLIFIER CONTROL UNIT

Many lovers of high-fidelity recorded music go to considerable trouble and expense to develop reproducing equipment meeting their needs. All too frequently, the joy of owning and operating such equipment is marred by the fact that the amplifier chassis just doesn't harmonize with most household furnishings and is too bulky to be hidden in a convenient bookcase or radio cabinet. An amplifier is seldom mounted in a closet or an attic because the operator wants it close at hand where he can control the volume and tone at will.

the two BOOST positions, a capacitor is inserted in series with the 15,000-ohm resistor, making the output impedance of the smaller leg of the voltage divider (and therefore the output voltage) increase as the frequency decreases. In either CUT position, a capacitor is inserted in series with R1, increasing the impedance of the larger section of the voltage divider as the frequency decreases. The output voltage available across the smaller section decreases as well.

The TREBLE control is a single-section,

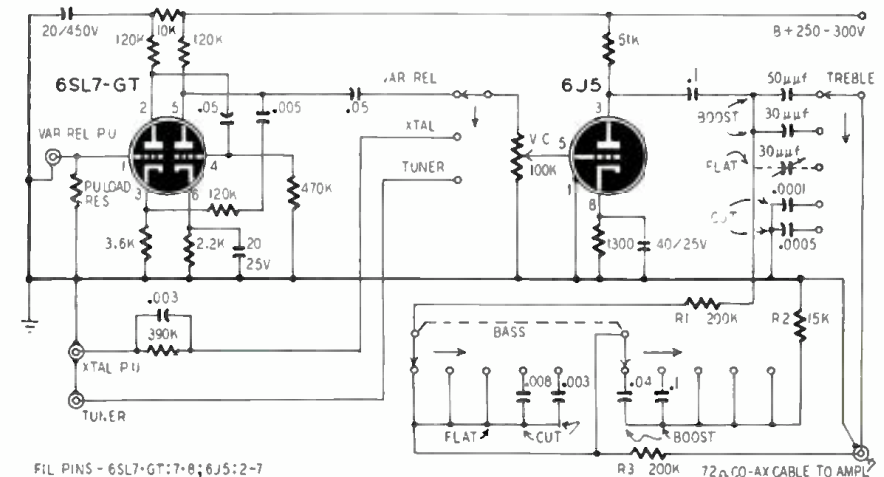

FIL PINS - 6SL7-GT:7-8; 6J5:2-7

This amplifier control unit, with its volume and equalizer controls, is on a $10 \times 4 \times 2\frac{3}{4}$ -inch chassis that can be mounted in the cabinet of a large record player. Suggested by a circuit in *Radio and Hobbies* (Australia), it consists of a 6SL7-GT compensated pre-amplifier for variable-reluctance magnetic pickups and a straight 6J5 amplifier designed with a gain of approximately 14 to compensate for the losses in its plate equalizer circuits.

Separate high-level input channels are provided for crystal pickup (with compensation) and radio tuner.

The BASS control is a two-circuit, five-position switch. When this is in the middle position, the low-frequency response of the equalizer is flat. Low, middle, and high frequencies appear across R1 and R2 in series. Approximately $\frac{1}{14}$ of the available voltage is taken from the junction of the two resistors and applied to the 72-ohm coaxial output cable through a 200,000-ohm resistor. The output and input voltage are approximately equal because the loss in the voltage divider compensates for the gain in the 6J5.

When the BASS control is in either of

five-position wafer switch. When this control is in any BOOST position, a small capacitor shunts the highs directly to the output terminal rather than going through the R1-R2 voltage divider. In the CUT position, highs are attenuated by a 100- or 500-µf capacitor across the output terminal.

The apparent input capacitance of the 6J5 (due to Miller effect) might be sufficiently high to cause high-frequency losses when the treble control is in the center or flat position. This can be compensated by connecting a 30-µf air trimmer to the center position and adjusting it to about half capacitance to give just enough high boost to flatten the response curve. The 200,000-ohm resistor R3 prevents interaction between the equalizer sections.

Operating voltages may be taken from the amplifier, from a tuner, or from a small power supply.

The control unit is connected to the amplifier through the shortest possible length of 72-ohm co-axial cable terminated with a 1-megohm resistor. This 1-megohm resistor is the grid resistor or volume control at the input of the amplifier.

LINEAR S-METER

A number of communications receivers lack S-meters, making it practically impossible for the operator to give accurate comparative signal-strength reports. A simple linear S-meter that can be added to almost any superheterodyne receiver having one or more i.f. stages on the a.v.c. line was described in *Short Wave Magazine*.

Only two resistors and a 1-ma meter are required for the S-meter circuit shown. R1 is the normal cathode resistor in a typical i.f. amplifier controlled by a.v.c. voltage. R2 and R3 are the resistors which must be added to the circuit. Measure the voltage drop across R1 when no signal is being received. Adjust the potentiometer so the

voltage between its arm and ground is equal to that across R1. When this adjustment is made, the meter will read zero. An incoming signal will reduce the cathode current, thereby decreasing the drop across R1. This makes A negative with respect to B, and some current will flow through the meter, mak-

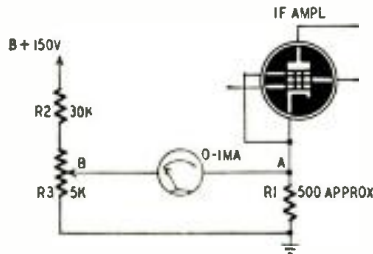

ing it read upward. Sensitivity can be controlled by adjusting the arm of the potentiometer. Values on the diagram are for an i.f. stage using a 6K7, 6SK7, or similar tube. The voltage for the bleeder should be taken from a 150-volt point in the receiver.

UNUSUAL NOISE LIMITER

The plate current and the maximum signal level of a pentode are controlled by the screen-grid voltage. This action is used in a novel noise limiter described in *The Short Wave Listener* (London). The circuit shows a 6B8 as a combination second detector, a.v.c. source, and first a.f. amplifier.

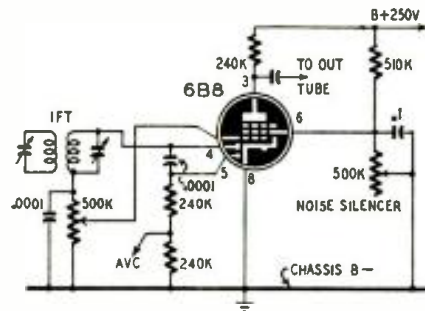

The screen voltage is supplied by a voltage divider consisting of a 240,000-ohm resistor and a 500,000-ohm potentiometer. This control can be adjusted to a point at which noise cannot exceed the signal level.

This circuit can be applied to other tubes similar to the 6B8 and to sets with a pentode first a.f. amplifier.

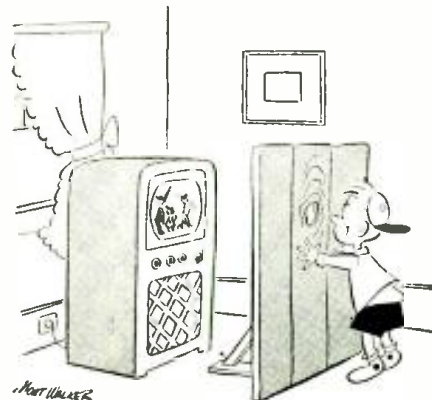

AUGUST, 1949

NEW IMPROVED PR7 MODEL

★ POLICE FM ALARM ★

FOR POLICE CALLS TAXI CABS AND OTHERS

Attached Antenna

Tunes 152-162 Megacycles

F. M. Superheterodyne, 115 Volts, A.C.-D.C. Tubes—12AT7, (2) 6BJ6, 19T8, 35B5, 35W4. 2 stages high gain 10.7 Megacycle I.F.'s. Ratio detector. Plastic cabinet 10 1/2 x 6 3/4 x 6 deep. Schematic and instructions. Shipping weight 7 lbs.

Sensitivity 10 Microvolts or better. Selectivity 250 K.C.'s or better.

Reception expectancy with attached antenna from 50 Watt transmitter 3 miles, much farther from transmitter of more power or outside antenna.

Ready to plug in and use; 28 Watts power consumption.

SEE YOUR DEALER FIRST OR WRITE

\$39.95

Slightly higher West Coast Excise Tax Included F.O.B. Indianapolis \$10.00 with order, rest C.O.D.

DELUXE CA-2 COAXIAL ANTENNA

\$5

RADIO APPARATUS CORP.

303 FOUNTAIN SQ. THEATER BLDG. INDIANAPOLIS 3, INDIANA

FOR BEST RECEPTION—LIST

SUMMER SPECIALS:

- MP-22 MAST BASE Mounting with spring action and mounting bracket installed at top to receive MS-53 Mast section listed below. Mast Base MP-22 only \$2.95
- MAST SECTIONS—For above MP-22 Base, tubular steel, copper coated, painted in 3 foot sections. Bottom section MS-53 can be used to make any length. MS-52-51-50-49 for taper. Screw-in type. Any section—Price 50¢ Ea.
- TELESCOPING STEEL ANTENNA Three sections 94" long. Telescoped 40". Size: 3/8" to 1/4". Price \$1.50

- COMMAND TRANS. AND RECEIVER TRANSFORMERS—110 V.A.C. 60 CYCLE INPUT**
- Output: 600-0-600 V.A.C. at 250 MA. 12 V.A.C. at 3 amps. 12 V.A.C. at 3 amps. & 5 V.A.C. at 3 amps. #REH-108 \$6.90
 - Output: 250-0-250 V.A.C. at 60 MA. 24 V.A.C. at 6 amps. 6.3 V.A.C. at 6 amps. #REH-109 \$3.00

- MOTORS**
- 6 or 12 Volt AC-DC Heavy Duty reversible Motor with 5/16" x 7/16" shaft. Price: New \$2.95
 - 6 Volt AC-DC Motor—Ideal for auto fans, models, etc. Shaft 1/4" x 7/8". Used—Tested \$1.50
 - Model Motor—12 Volt AC-DC 1/2" double end shaft Motor. Size: 2 1/4" L. x 2 1/4" W. x 1 1/4" H. Price \$1.50

- 110 Volt 60 cycle, Ball Bearing Motor, approx. 3500 RPM. 1/25 H.P. Shaft: 3/16" x 7/8". Motor size: 6 1/2" L. x 3" H. Converted type. Price: New \$2.95
- Hand Tool Motor—12 Volt AC-DC—5600 RPM. 3 3/4" L. x 1 1/4" Dia. with splined shaft 1/4" D. x 1/2" L. Price \$2.95

- BLOWER—110 Volt 60 cycle, 4" intake, 2" outlet. Approx. 100 cu. ft. dia. Motor size: 3" x 3"—1750 RPM. Price. New, \$6.95. Price—Motor only \$3.95**

- MISCELLANEOUS:**
- Coaxial Cable—125 OHM Cotton covered—50 Ft. \$1.00
 - Coaxial Cable—72 OHM Rubber covered—8 Ft.50
 - Cable—4 Cond. Rub. covered, shielded—50 Ft. 2.00
 - Wire—2 Cond. Rub. covered #14 stranded—20 Ft. 1.00
 - FL-B FILTER, 12000 CPS. 1.75
 - TL-17 or 25 for BC-223—Price, New 4.50
 - Cable for BC-223 w/PL-50 each end 1.75
 - Cable for BC-275 w/PL-61 each end 1.75
 - Cable for TC8 EQ/65FE, 65F10, or 65F13 2.95
 - LP-21A Loop—Price, Used 3.95
 - PLURS for LP-21 Loop—PL-112 or PL-108 1.00
 - CL-365 Cord for LP-21 Loop 1.50

Address Dept. RE • Prices—F.O.B., Lima, Ohio • 25% Deposit on C.O.D.'s • Minimum Order \$2.00

FAIR RADIO SALES

132 SOUTH MAIN ST. LIMA, OHIO

WHERE RADIOMEN MEET, EAT and SLEEP

Visit the FAMOUS FIESTA LOUNGE Renowned for Fine Food



HOTEL STRAND

Atlantic City's Hotel of Distinction

The Ideal Hotel for Rest and Relaxation • Beautiful Rooms • Salt Water Baths • Glass inclosed Sun Porches • Open Sun Decks atop • Delightful Cuisine • Garage on premises. • Moderate Rate Schedule.

OPEN ALL YEAR

Exclusive Pennsylvania Ave. and Boardwalk



SERVICE Television AND RADIO WITH THIS MODERN SERVICE UNIT

TELEVISION and FM radio present un-limited opportunity for service PROFIT . . . Your profits and service require the best equipment . . . SERV-LUX.

*Custom built instruments available for all types of service . . . or, unit can be supplied with blank panel. Write for bulletin D



SERVELUX
MANUFACTURING CO.
39th and Buchanan Ave.
GRAND RAPIDS, MICH.

SAVE

at **RADIONIC** the House of Radio and Television Buys

BIG 61 sq. in. T.V. Set \$169.50



21 tubes incl. 10" picture tube. RCA lic. Nationally Known Name. TERMS: 20% dep.; Bal. COD; FOB Warehouse.

RADIONIC EQUIPMENT COMPANY

Tribune Theater Entrance
170R Nassau Street New York 7, N. Y.
Worth 2-0421 :: Open daily 9 to 6--Saturday 9-5

FREE! MAIL TODAY!

GET YOUR COPY AT ONCE!
of RADIONIC'S Bargain Catalogs, Radio & Television Sets—Parts—Accessories. Unbeaten Values!

RADIONIC EQUIPMENT CO., Dept 108
170R Nassau Street, New York 7, N. Y.

Please rush Free Copy of your latest Bargain Catalog of Radio and Television Sets, Parts, Tubes and Accessories.

NAME _____ STATE _____
ADDRESS _____
CITY _____

BANDWIDTH CONTROL

Patent No. 2,464,125
Harold G. Fisher and Eugene O. Keizer,
Princeton, N. J.
(assigned to Radio Corp. of America)

Described here in connection with an i.f. amplifier, this electronic control varies bandwidth of an amplifier while maintaining a flat response. The reactance tube is connected as an artificial inductance to couple two i.f. stages.

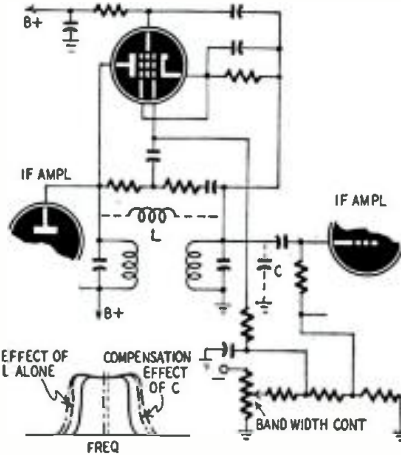

When the bandwidth control (see figure) is set near the grounded end, the gm of the reactance tube is high. This results in a higher I_p for a given E_g and is equivalent to a lower effective L and more loading across this effective inductance. The lower inductance increases the coupling between stages, but the double-hump response does not appear because of the added loading.

The bandwidth variation is also accompanied by a change in mid-frequency. As the value of L is decreased, more of the higher frequencies are passed, making the center frequency higher.

To compensate for this undesired condition, the gm of the following i.f. tube (of which the grid is shown) is also controlled. As the bandwidth potentiometer is set near the grounded end, the gm of the i.f. tube is increased. Due to Miller effect, the input capacitance C of the tube rises thus restoring the mid-band frequency to normal.

As the potentiometer is rotated to the negative terminal, bandwidth is decreased, loading reduced (to maintain the flat response), and the input capacitance to the following tube is less, thus maintaining the center-frequency value.

INTEGRATING CIRCUIT

Patent No. 2,463,553
Raymond C. Olesen, Altadena, Calif.
(assigned to Consolidated Engineering Corp.)

Integrating systems are pulse-shapers used in television receivers and various pulse circuits. In this circuit one is used to convert a voltage proportional to velocity into one that is proportional to amplitude.

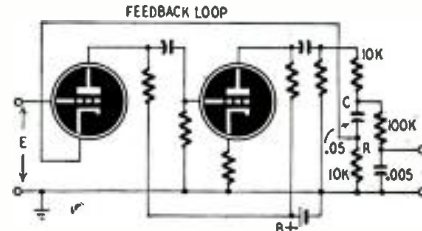

Sound or seismic waves are conveniently detected by a magnetic type of instrument which may consist of a fixed electromagnet with a winding at the poles. The coil support is made so heavy that it cannot follow the motion of the electromagnet. Therefore a sound or seismic wave will cause the electromagnet to vibrate, but the coil remains relatively stationary. This results in an induced voltage in the coil. Its output is proportional to the velocity of the wave.

Often the required response must be proportional to the amplitude instead of velocity. An integrating system can also be used for this purpose.

The circuit shown here gives faithful integration and far more output than is possible with the more simple R-C networks.

Because of a relatively large value for R, the output current through capacitor C is nearly E/R , that is, practically independent of frequency and output impedance. The voltage across C is the integrated response of the input voltage. A resistance-capacitance network is added at the output. This makes possible a grounded output which is convenient as well as extending the range of the integration.

HIGH-EFFICIENCY MULTIVIBRATOR

Patent No. 2,465,249
Cyril E. McClellan, Catonsville, Md.
(assigned to Westinghouse Elec. Corp.)

A conventional multivibrator is a very inefficient device. An input signal causes one tube to conduct and . . . blocks the other. At the end of the short pulse the first tube returns to cutoff, and the second passes current until the next pulse is applied. Usually this interval is much greater than the duration of the signal. The second tube contributes no useful power; yet it conducts almost continuously.

This patented improved multivibrator also uses two tubes, but both conduct only during the existence of the input signal. Then both go back to their normally blocked condition.

Battery B biases both tubes to cutoff. A positive input pulse unblocks the left-hand tube, allowing current to flow through the windings of T to the cathode. As the abrupt flow passes through R, the

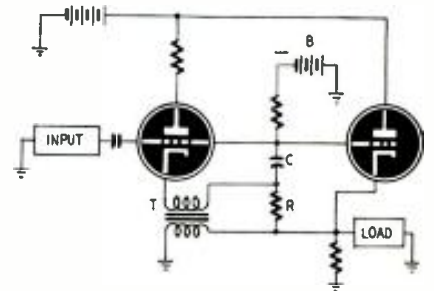

voltage drop is transmitted through C to both control grids. This voltage being positive, both tubes are saturated. When this condition is reached, capacitor C begins to charge; a negative charge collects on the grid and both tubes are quickly blocked, ending the cycle until the next signal arrives.

Transformer T accentuates and sharpens the pulse currents.

WIDE-BAND AMPLIFIER

Patent No. 2,460,907
Alfred C. Schroeder, Feosterville, Pa.
(assigned to Radio Corp. of America)

An excellent i.f. or r.f. amplifier, this 6J6 amplifier is especially effective as a first stage because of its low noise factor.

The first triode is a cathode follower. The second triode is used as a grounded grid stage. This arrangement is slightly different from the "cascode" which has the first stage connected with its cathode grounded (RADIO-ELECTRONICS, October, 1948). The advantage of the cathode follower is that the input capacitance (C_i in dotted lines) is reduced by feedback. This increases the gain bandwidth product of the amplifier. An r.f. choke couples the stages. This choke, with the distributed cathode-to-ground capacitance (C_g), forms a resonant circuit, thereby improving gain and signal-to-noise ratio. The out-

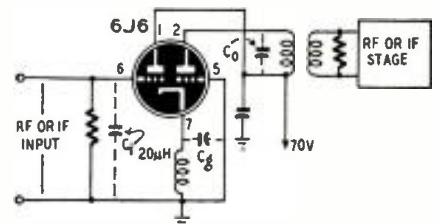

put transformer, tuned by Co to the center of the passband, is shunted by a resistor to lower its Q for wider band response.

The total amplification is nearly equal to that of a high-gain pentode stage. Stability, bandwidth, and noise factor are better.

CRYSTAL OSCILLATOR

Patent No. 2,459,842

George T. Royden, St. Orange, N. J. (assigned to Federal Tel. & Radio Corp.)

In this two-stage oscillator the plate of the second tube feeds back to the tank L along two paths (A and B). A feeds to the first grid. This is positive feedback because the second plate and the first grid are in phase. Path B feeds back voltage which is out of phase. The negative feedback is made greater to keep the circuit from oscillating.

A crystal is connected in the negative-feedback path to form the equivalent of a high-Q series resonant circuit which bypasses the negative-

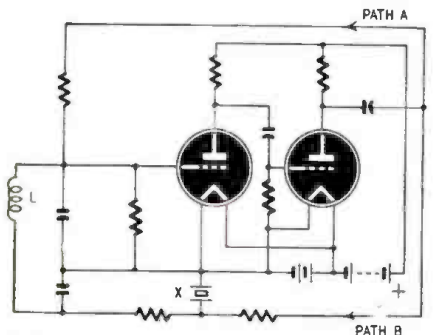

feedback voltage to the cathode. Therefore, at the crystal frequency, there is no negative feedback and the circuit oscillates only at this frequency.

The crystal stabilizes the circuit and compensates for temperature and load variations. Tank L is tuned approximately to the crystal frequency.

REMOTE-CONTROLLED SELSYN

Patent No. 2,462,117

Ward C. Mikkelsen and Jacob Anthes, United States Army (may be used by the U.S. Government without royalty payment)

This is a telemetering system for transmitting data by radio from one Selsyn to another.

The output of any Selsyn is composed of three a.c. voltages, the amplitudes of which vary with the instantaneous position of the stator. In this

to the modulator of a standard radiotelephone transmitter.

At the receiving end, the audio signals are separated by resonant circuits and are rectified and filtered. The respective d.c. signals control sepa-

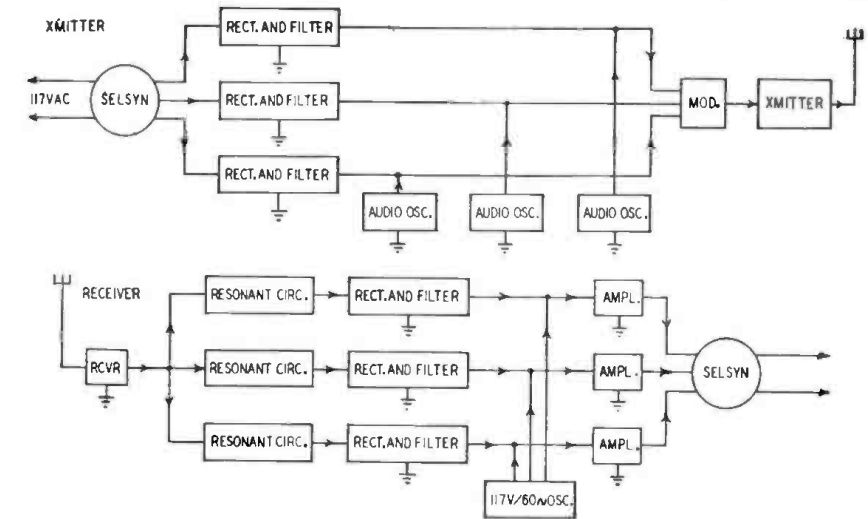

rate outputs from a 60-cycle oscillator. These three a.c. voltages are proportional to those obtained from the Selsyn at the transmitter. After amplification, they are fed to the second Selsyn which will assume the same angular position as the first.

FISHPOLE ANT. For Your Mobile Rig!
MS-10, & MS-30—MOBILE or DIPOLAR. 7' & 10' Whip Antenna. Many Uses. \$6.45 for w/6BET Tubes. New: 3 for \$1.29

49c Threaded Coax Terminal Insul. 1/8" x 1/2" /30cm. AT5/AR1 w/waterpf. gask. range. For MOBILE use—BRAND NEW! Pl.250 for above.....35c

TRANSFORMERS AND CHOKES
115V 60 cy. INPUT Equip. Conservatively Rated.

FILAMENT TRANSFORMERS

5V/6A.	\$2.25	2.5VCT/6.5A.	\$3.25	
8.3VCT/2A.	6.3VCT/2A.		2.45	
FS007-6.3VCT/1A.	6.3VCT/7A.		2.75	
2x8.3V/1A.	\$1.95	8V/1.5A.	1.95	
FS123-6.3VCT/5A.	6.3V/1A.		2.25	
FS127-6.3VCT/3.2A.	6.3VCT/1A.		2.25	
F-2.5V/1.75A.	6.5V/8A.	5V/3A.	6.5V/6A.	2.25
F7411-2x2.5VCT/6.5A.	\$3.25	6V/2.5A.	1.75	
6.3VCT/7A.	6.3VCT/5A.	6.3VCT/6A.	3x6.3V/6.	3.95
F38A-6.3V/2.5A.	2x2.5V/7A.		3.25	
F112-2x2.5VCT/6.5A.	2.5V/6.5A.		4.25	

PLATE TRANSFORMERS

P410-800VCT/40MA.	760VCT/500MA.	\$6.50	
480V/450MA.	\$4.95	70V/1A.	2.25
P413-510VCT/150MA.	650VCT/15MA.	3.00	
P842-800VCT/100MA.	250VCT/0.77A.	2.95	
18R5-1620VCT/400MA.	HV. INS.	11.95	
P894-2x200V/350MA.	2x20V/0.1A.	1.95	
2x150V/940MA.	\$4.50	240VCT/850MA.	3.95

COMBINATION TRANSFORMERS

780V/600MA.	6.3/2.	\$3.95	825VCT/190MA.	5VCT/3.	\$3.95
C811-2x300V/42MA.	55V/125MA.	45V/35MA.	3.95		
C808-800V/150MA.	5V/3A.	6.3V/6A.	\$4.25		
C831-585VCT/80MA.	5V/3A.	6.3V/6A.	\$4.25		
C835-525VCT/75MA.	5V/2A.	6.3/1.8.	10V/2A.	4.45	
T142-1680VCT/155MA.	6.3/1.2.	6.3V/1.2A.	5.95		
800VCT/155MA.	6.3VCT/3A.	5VCT/3A.	5.95		
C800-2x110VCT/0.1A.	63V/1A.	2.5VCT/7A.	4.50		
6.3VCT/10A.	65V/100V/40V.	18VCT/18V/6.3V/1A.	5.25		
5VCT/3A.	580VCT/0.4A.	\$2.95	40V/0.1A.	1.95	
T144-1120VCT/70MA.	580VCT/0.82A.	HV. INS.	12.50		
C578-24V/800MA.	770V/0.025.	2.5V/3A.	HV. INS.	4.25	
T378-2300V/0.04A.	2.5/2A.	HV. INS.	7.95		
C360-840VCT/0.80A.	5VCT/3A.	6.3VCT/3.2A.	3.95		

FILTER CHOKES

23HY/85MA.	\$1.00	6HY/150MA.	\$1.50	
SWR 15-29HY/150MA.	\$3.25	8.5HY/125MA.	1.50	
Dual 7HY/75MA.	11HY/85MA.		1.50	
THY 140MA.	\$1.60	2.5V/3A.	HV. INS.	4.25
Dual 2.5HY/130MA.	\$1.25	11HY/150MA.	7.95	
OHY/2.5A.	\$1.45	15HY/350MA.	7.25	
Dual 5HY/380MA.	\$1.00	5HY/40MA.	55	
Dual 2HY/200MA.	\$0.75	Dual 120HY/17MA.	2.45	
30HY/20MA.	\$0.85	5HY/200MA.	1.65	
2.1HY/200MA.	\$1.00	2x2.2HY/55A.	9.95	
25HY/75MA.	\$1.10	6HY/300MA.	7.95	

Buy with Confidence

BAND PASS FILTER
#70473. Sharp band pass peaked at 700 cps. Band-width: 650 cycles at 20 db. down from peak. High-to-high impedance. Can be plugged into phone output of receiver for good results. Cuts out QRM. \$2.00 New, with circuit diagram

*** SPECIALS ***

ELECTROLYTIC CONDENSERS D.Y. TYPE TUBULAR, PRONG MOUNT, LUG TERM.
18c ea. 10 For \$1.75

MFD.	VOLT	MFD.	VOLT
30	250	40+40	150
40	200	40+20	150
40	300	20	450
2x20	20	10	300
20+10	150	10	200
30+30	25	8	450
40+40	25	40	250
40	400	40	150
50	200	40/20	150
2x10	150	25/40	150
2x20	25	2x40	150
30+15	150		

29c ea. 10 For \$2.75

MFD.	VOLT	MFD.	VOLT
2x10	300	15-15/20	250/25
225	15	10-10/20	350/20
20/20	350/25	3x10	150
20/30	250	3x8	150
2x30	150	12	525
30+20	150	15	450
30/20	350/25	10	450
10/50/100	450/100/50	20	525
15-15/20	350/25	80	150
25-25/10	25/350	40+20+20	150
20-20/10	50/400	40/20	150/25
		40/25	200/25
		40/30	150
		10/50/100	350/100/50
		10/10-10	25/150/150
		16	450
		20	350
		15	250

MFD.	VOLT	PRICE	MFD.	VOLT	PRICE
3x10/10	450/25	\$69	2x90/20	200/50	\$79
3x10/20	400/25	\$69	15-20/6	25/50	\$49
80-40-150	400/50	1.10	120-60-20	150/25	\$49
2x80/60	250	65	3x20	450/25	\$69
40-20-20	400/25	59	40-10-10	450/25	\$69
20-10-50	450/50	49	2x20/20	450/25	\$69
2x20/20	400/25	59	40-20-20	450/25	\$69
40-20-20	400/25	59	40-10-10	450/25	\$69
40-40-25	400/25	59	40-10-10	450/25	\$69
40-10-80	450/150	69	40/20/25	450/50	\$69
40-40-10	450	69	40-10-16	450/350	\$69
3x15-30	300	69	2x30-15/20	400/25	\$89
2x30/20x10	450	1.10	30-15-10/20	450/25	\$89

HiGain Dyn Mike Xfmr
UTC Super-Retic. 3-wdy. 600CT & 4000 ohms tapped 2.5 & 15.0 ohms. Fully shielded. \$59c 2 for \$98c 10 for \$4.50

LINE FILTERS
GE 100 Amp W/2x3 MPD 50V all filled cond. 110 VAC. DC.....\$1.98

FILTER DUAL 1 KW.
Clean up your BC1 & TV1. Easy to Mount. Uses 4-1002 Condensers w/400V. and cond. Complete.....\$4.25

METER 4K.V., 0-10MA MOVE
Roller Smith Typ. w/External Load. Hand. 3 1/2" rd. bake. case. Price.....\$7.95

FLEXIBLE SHAFT
MC215-12 ft., 10 lit. for remote control heavy armoured cable connect.....\$3.95

ROTARY BEAM COUPLER
RP Coupler: 360° Rotation: 1 Turn Coupling Link. Plastic Case Mount on Side. Price.....\$2.95

Kit Lugs—Small Radio Type. 300 For.....\$1.00
Kit Lugs—Large Radio Type. 100 For.....1.00
Kit Trimmer Condensers—Was used as sample kit of famous condenser Co. Some list for \$2.50 ea. Special: 100 Pcs. New, unused.....4.95
Kit Ferrule Resis.—Ideal for Experimenters. 10 For.....1.50
Kit Rotary Switches—Includes 2 and 3 gang. 10 For.....2.95
Kit Volume Controls—50 for 2 meg. 10 For.....1.95
Kit Bathtub Condensers—Single, Duals and Triples. 10 For.....1.00
Kit Hardware—500 Pcs. New, unused......95
Kit Fuse and Ferrule Clips. 20 For.....1.00
Kit Coil and Choke—10 assorted R.F. and Coils.....1.00
Kit Coil Forms—Thrd R.F. 50 For.....1.00
Kit Power Rheostats—25 and 50 watt. 6 For.....3.49
Kit Vitreous WW Res.—20 For.....1.00

KITS POWER SUPPLIES BASIC KITS

Basic 3" and 5" TV Pwr. Supply contains Trans. 1080V/55MA. 6.3V/1.2A. 8.3/1.2A. 2-1MFD 2500V/2 Tube. Socket 1-100000 ohm Resis. Price.....\$7.95
Basic and 7" TV Pwr. Supply contains Trans. 2300/40MA. 2.5/2A. 2-1MFD 750V. Pyr. 2x2 Tube. Socket 1-100000 ohm resis. Price.....9.95
Basic 15 Watt Amplifier Pwr. Supply contains Trans. 600VCT/155MA. 6.3V/3A. 2-1MFD 600V. Dual Choke. 10HY 200MA. 5T4 Tube. Socket. Price.....8.75
Basic 50 Watt Amplifier Pwr. Supply contains Trans. 800VCT/200MA. Dual 10HY 200MA Choke. 2-1MFD 600V. 5T4 Tube. Socket. Price.....10.75

TELEVISION COMPONENTS

Transformer—3000V/5MA. 720VCT/200MA. 6.4V/8.7A. 6.4V/6A. 5V/3A. 1.25/3A. Full Power Packet for 5" and 7" Scope Supply. Special.....6.95
Transformer—10000V/5MA for 10" and 15".....\$10.95
Deflection Yoke for 5" to 12" Scope Tube. Fully Casued. HV 20A.....3.95
Deflection Yoke—Same as above Philco.....3.95
Focus Coil for above WF D-184915.....4.25
Blocking Oscillator Trans.—15000 cy. Horizontal Ratio. 2:1 Free......85
Blocking Oscillator Trans.—9318 T-1:1.....1.50
Blocking Oscillator Trans.—Turns Ratio 2:1.....1.75
Pulse Trans.—Ray UN 8092 2:1:1.....1.75
Sweep Choke—3HY 35MA 250 ohms. 2 for......75

SEND FOR LIST OF MANY OTHERS

COMMUNICATIONS EQUIPMENT COMPANY
NEW YORK 7, N. Y.

WRITE FOR FLYER OF OTHER BUYS

Try This One

INDOOR FM-TV ANTENNA

An adjustable indoor antenna for TV and FM reception can be constructed, as shown in the photographs, from a pair of surplus collapsible antennas and two brass ball-and-socket fittings. Each half of the dipole is made from an antenna adjustable from 10 to 39 inches. The dipole is 81 inches overall when extended; 24 inches when telescoped. It can be adjusted to cover all frequencies between channels 4 and 13. Fully extended, it gives good results on all low-band TV channels.



The antennas used are commonly available on the surplus market. However, if these are not obtainable, collapsible automobile antennas can be used. The ball-and-socket fittings, purchased from a hardware supply house, are similar to those used on some types of casement windows. We used hardwood for the base. Any insulating material will work just as well. The underside of the base should be covered with a layer of felt or fitted with small rubber feet.

EUGENE JACONETTI,
Brooklyn, N. Y.

TV-FM INSTALLATION NOTE

It is not always possible to provide adequate support for ribbon-type transmission line running to FM and TV antennas. Consequently, the line whips in the wind and causes a type of flutter interference that affects TV pictures and weak FM signals. Furthermore, the continued strain on the transmission line is likely to cause it to snap off at the antenna. These troubles are particularly common in installations where the unsupported line crosses wide areas or hangs from the roof of a tall building.

You can minimize trouble from this source by stretching a heavy cord across the area and wrapping the line around it. The cord prevents the line from swaying and takes the strain that would normally be placed on it.

JACK ROTHSTEIN,
Eatontown, N. J.

TELEVISION SETS

PARTS

ACCESSORIES

WRITE FOR FREE CATALOG TO
HERE ARE SOME OF THE SPECIALS

TELEVISION TRANSFORMER

Pri. 115 Volts 60 Cycles Sec. 2500 Volts @ 2 ma.; 6.3 Volts @ .6A.; 2.5 Volts @ 1.75A
Small size—brand new **PRICE \$3.85**

SPECIAL! TELEVISION I.F. TRANSFORMER

Here is a shielded transformer consisting of 2 slug tuned coils, 4 ceramic condensers, 3 mica condensers and two resistors resonating at 21-29 MC. May be converted to Television Video or Audio I.F. Transformers or disassembled for use in the TVRF section. Housed in regular I.F. can.

Rush your orders! Price **\$1.15**

5 TUBE AC/DC SUPERHET KIT

Beautiful Catalin cabinet with complete parts and instructions to quickly and easily make up a sensitive 5 tube AC/DC superheterodyne broadcast radio. Plenty of volume with good tone quality is assured by the beam power output stage and the PM Dynamic speaker.

All material including tubes are furnished for less than half the cost of the built up radio. Nothing else to buy. Tubes used are, 1-12SA7, 1-12SK7, 1-12SQ7, 1-50L6, 1-35Z5. Powerfully sensitive built-in loop included. Price including all tubes and Catalin cabinet. **\$11.95**

3 WAY PORTABLE KIT

5 Tubes plus rectifier provides high sensitivity and excellent tone, even in remote areas. Beautiful 2-tone brown leatherette covered cabinet with plastic front grill-work and slide-rule dial. Light and compact—operates from 110 Volts AC/DC or batteries. Superheterodyne circuit-built in loop. Tubes used: 1-1R5; 2-1T4; 1-1S5; 1-354, plus rect. Complete with all parts and diagrams, less tubes and batteries.

Extra for set of 5 matched tubes, \$3.75
Price **\$13.75**

Model NFRD—Radio Noise Filter

If it doesn't work, send it back!!

We absolutely guarantee that our model NFRD will eliminate all line noises when properly connected to radios, television sets, motors, electric refrigerators, electric shavers, vibrators, oil burners, transmitters and all other sources of interference. This unit will carry up to 12 amperes or 1/4 KW of power and may be used right at the source of interference or at the radio. Small size only 3" x 1 1/2" each **\$1.95** x 7 1/2", very low priced at

SPECIAL! SPECIAL!

Mammoth assortment of radio and electronic parts, not less than TEN POUNDS of such items as transformers, chokes, condensers, resistors, switches, coils, wire, hardware, etc. A superbuy for experimenters, servicemen, and amateurs for only **\$1.25**

Satisfaction guaranteed on all merchandise.
All prices F.O.B. New York City

WRITE FOR FREE CATALOGUE TO

RADIO DEALERS SUPPLY CO.

154 Greenwich St. New York 6, N. Y.

"THE BARGAIN CORNER"

MOULDED BAKELITE CONDENSERS—Top-notch assortment of .0001 to .25 mfd., 200-600WV. Mica-mold; pigtail leads. Shpg. wt. 2 lbs. **\$2.49**
KIT OF 5 ASST'D.
WAFER SOCKETS—4 to 8 prong. Kit of 12 asst'd. .25 **.98**
KNOBS—Selected Bakelite & Wood; including set-screw, push-on & push-button types. Kit of 25 asst'd. **.69**
MICA PADDERS & TRIMMERS—Includes multiple & ceramic base types. Kit of 15 **.69**
VOLUME & TONE CONTROLS—Wire-wound & carbon. Less switches. Kit of 10 asst'd. **1.49**

W-110B ARMY FIELD WIRE—Twisted pair, weather-proof. Avail. only in rolls 300-450 ft. ea. Shpg. wt. 1 lb./100 ft. A STEAL AT **1c Per Ft.**
1/32" 30V THROAT MIKE with rubber cord & plug. BRAND NEW! NOW ONLY **39c**

THROAT MIKE CORD & SWITCH (1-508A) 8 1/2 ft. rubber cord, PL-68 & JK-48 jack, ea. **49c**
RADIO HARDWARE TREASURE—A FULL POUND OF Screws, Nuts, Washers, Links, etc. All in a **HANDY SELF-SEALING HINGED-LID METAL CAN**. Shpg. wt. 2 lbs. **49c**

SPECIAL!!—1 1/2 VOLT BATTERIES—Std. 2 pin socket. Volts & Amps, GUARANTEED! (not currently dated). 3 1/2" x 2 1/2" sq. PKGE. OF 5 (shpg. wt. 8 lbs.) ONLY **59c**
RADIO NOISE FILTER—Precision engineered, hvy. duty, capacitive-inductive type. REMOVES INTERFERENCE FROM MOTORS, SHAVERS, LAMPS, ETC. Shock-proof. Bakelite case, 5" x 2 1/2" x 3 1/2"; shpg. wt. 2 lbs.—Special **\$2.95**

BENDIX AMPLIFIER (Line of Sight)—A "TREASURY OF PARTS." Contains: tower trans., 6 oil condensers, 3 audios, sockets, etc., etc. worth many times the price. Black crackle case 7"x5 1/2"x4". Shpg. wt. 8 lbs. **REDUCED TO \$1.75**
CABINET DRAW SLIDES—for CONSOLE CHANGERS, RECORDERS, TRANSMITTER RACKS, DRAWERS OF EVERY TYPE. Smooth ball-bearing action; steel & aluminum construction. Shpg. wt. 2 lbs. Per pr.
11" extension 11 1/2" overall **\$1.89 pr.**
12 1/2" extension (16 1/2" overall) **1.98 pr.**
14 1/2" ext., all-steel, 12 1/2"/16 1/2" **2.19 pr.**
14 1/2" ext., all-steel, 12 1/2"/16 1/2" **2.75 pr.**

"FACTORY SPEAKER REPAIRS SINCE 1927"
Min. order \$2.00. 20% deposit on all COD's
Please add sufficient postage—excess refunded.

LEOTONE RADIO CO.
67 Dey Street,
New York 7, N. Y.

GOVERNMENT SURPLUS! WORLD'S LOWEST PRICE

PHOTO FLASH EQUIPMENT



COMES COMPLETE WITH
4 EDGESTON FLASH TUBES & REFLECTORS



EASY TO CONVERT INTO
A 2-WAY PHOTO FLASH UNIT

OPERATES ON 110V. AC & 12V. BATTERY
Brand new at a fraction of original cost. Contains finest component parts available. All necessary parts and complete instructions included. After conversion, works on 110V AC or 12V battery by a flick of a switch.

Immediate delivery on all mail orders
\$68. COMPLETE
CINEX, INC., 165 W. 46th St., N. Y. 19, N. Y., Dept. REB

HEADQUARTERS FOR INDUSTRIAL TUBES AND CAPACITORS IN QUANTITIES

5000 Magnetrons, 1000 Klystrons 500,000 other tubes. Write for our Bulletin and Prices.

LIBERTY ELECTRONICS
135 Liberty St., New York 6, N. Y.

TELEVISION RECEIVER—\$1.00

Complete instructions for building your own television receiver. 16 pages—11"x17" of pictures, pictorial diagrams, clarified schematics. 17"x22" complete schematic diagram & chassis layout. Also booklet of alignment instructions, voltage & resistance tables and troubleshooting hints.—All for \$1.00.

CERTIFIED TELEVISION LABORATORIES
Dept. C, 5507-13th Ave., Brooklyn 19, N. Y.

ELECTROLYTIC TESTER

A foolproof method of testing electrolytic capacitors for hum-dissipating qualities is provided by this circuit. The 117Z3 supplies the necessary power to check electrolytics at voltage ratings of 150, 50, and 25. Because the 40-uf input filter capacitor does not supply sufficient filtering action, a hum will be heard in the phones. To check the electrolytic in question, place it from the correct voltage point to the top of the fuse and plug in the phones. Keep the

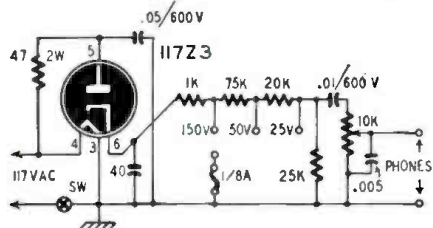

volume control all the way down until the electrolytic connections are made or else an annoying click jars your eardrums. If the hum diminishes the capacitor is good; if not, discard it. All ground returns for the electrolytics under test are made through 1/8 ampere fuse for protection against completely shorted capacitors.

JOSEPH SCIORTINO,
Waterbury, Conn.

SOLDERING RIBBON LINE

The polyethylene insulation on ribbon-type transmission line melts easily making it difficult to solder joints. You won't have this trouble if you wrap several layers of Scotch tape around the insulation where the connection is to be made. The tape prevents the insulation from breaking down or creeping.

WM. GAMBONEY,
Chicago, Ill.

TV ANTENNA MATCHING STUB

A 300-ohm TV transmission line can be matched easily with this method. Cut a 48-inch length of 300-ohm line and short one end. Attach the open end to the receiver antenna terminals across the transmission line from the antenna. Roll up the stub until the picture brightens, then hold the coil in place with tape or a rubber band. Run your hand along the antenna lead-in while watching the picture. If the picture is affected while so doing, add or subtract turns from the coiled stub until the picture remains unchanged.

MILTON M. SCHUMAN,
Baltimore, Md.

PISTOL GRIP

Several of the "instant-heating" soldering irons are equipped with pistol grips. Any ordinary iron can be fitted with one.

Cut the grip from a block of wood to fit the hand. Use a coping saw and a file. Curve the top to fit the iron, then bend a strip of light metal to fit over the original handle.

The metal strip and a few bolts are used to clamp the pistol grip to the iron.

ROBERT L. HYMAN,
Kansas City, Mo.

PRICESTALK at RADIO SUPPLY

R. S. E. 3 inch TELEVISION SCOPE



OZ 4's
(No Limit)

Fresh RK and RCA. Standard commercial grade, not JAN's.

BUY 12 58c
get 1 free EACH

EGG CRATE OF 100 \$49.00

Features:

WIDE BAND VERTICAL RESPONSE
FLAT TO 750kc
DOWN 3db
AT 1mc
VOLTAGE GAIN
OF 20 AT 5mc



AR-3

The R.S.E. AR-3 Scope has been built by Ross Armstrong to our rigid specifications. It's a complete unit that embodies standard horizontal amplifier and sweep circuits with normal sensitivity.

It's different because of the extreme vertical amplifier response. Check the featured specifications against others. Far TV use wide band response if necessary.

The case is 8" high x 5" wide x 14" long, attractively finished in "hammered" opalescent blue enamel. Operates on standard 110 volts—60 cycles —40 watts. Tubes, 3BP1—6AC7 —6SJ7—6X5—5Y3—884. Instructions included. Complete specifications upon request. Satisfaction or your money back.

PRICE
\$49.95
F. O. B. DETROIT

VIBRATORS

MALLORY universal standard 4 prong, non-synchronous. Can size 1 1/2" x 3 1/4".

\$1.29
EACH

BUY 12 get 1 free

EGG CRATE \$10.90
of 100



AERIALS RADIART 363U1 (discontinued model) 3 section

63" top cowl, universal mount, 48" lead. Former list \$6.75.

\$2.41
EACH

BUY 10 get 1 free
\$215.00 per 100



GENERATOR CONDENSERS



By one of the big 3

15c .5 mfd 200 VDC, 6" lead
EACH

BUY 12 get one free **\$12.00 per 100**

ORDER INSTRUCTIONS

Minimum order — \$2.00. 25% deposit with order required for all C.O.D. shipments. Be sure to include sufficient postage—excess will be refunded. Orders received without postage will be shipped express collect. All prices F.O.B. Detroit.



DON'T WAIT—ORDER TODAY

PUSHBACK WIRE



BELOW MILL PRICES!

2,000,000 feet—tinned copper—all 1st class, double cotton serve, waxed finish.

Available solid or stranded
22 gauge (6 colors) per 1000 \$3.98
20 gauge (6 colors) per 1000 \$4.98
18 gauge (brown) per 1000 \$6.49

RADIO SUPPLY & ENGINEERING CO., Inc.
85 SELDEN AVE. DETROIT 1, MICH.

Be a "Forty-Niner" in '49
THE "FORTY-NINER" GEIGER COUNTER

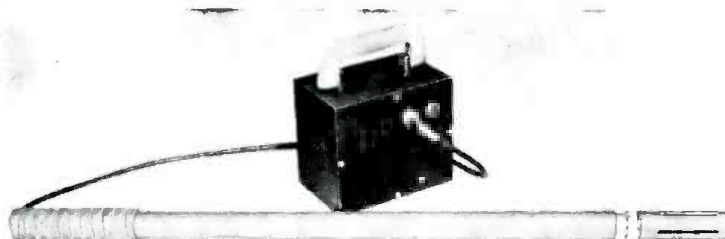

- Lightweight uranium detector.
- Detects beta and gamma rays.
- Equipped with 36 inch search probe.
- Contains two 67 1/2 volt Minimax batteries in the well-known type of relaxation oscillator supply.

Weight 4 1/2 lbs. complete; size 4"x5"x6". Beautifully finished case with handle. Price **\$89.50**
Complete with four tubes, including Geiger tube, batteries, search probe and ear-phone.

THE FORTY-NINER CO., 5245 Grand River, Detroit 8, Mich.

ALL-WAVE RECEIVER

? Do you have a circuit of a small, portable, all-wave superheterodyne receiver suitable for phone and c.w. reception? I do not want one with a loop antenna if it can be avoided.—E.P.J., East Peoria, Ill.

A. A four-tube, all-wave superhet was used in the battery-powered interference locator described on page 46 of the September, 1947, issue of RADIO-CRAFT. Commercial coils are used in this set that tunes from 560 kc to 18 mc. Additional coils can be added to

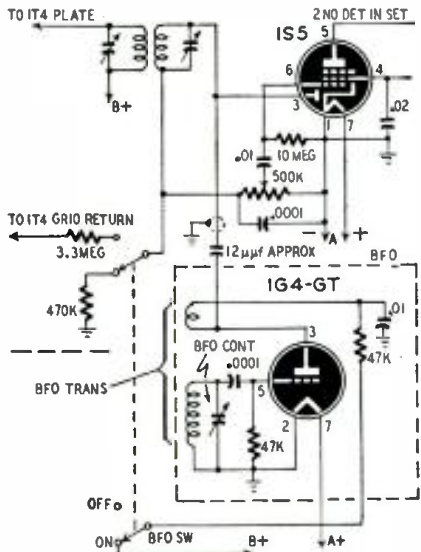

increase the tuning range to 36 mc if you desire 10-meter reception. A two-gang, 35- μ f capacitor can be connected across the main tuning capacitor to provide bandspread tuning.

For reliable c.w. reception, a b.f.o. is needed, a circuit of a suitable one being shown. A standard 455-kc b.f.o. transformer can be used, or one can be made from a standard 455-kc i.f. transformer tuned about 8 kc higher or lower than the i.f. in the set. Note that a switch inserted in the a.v.c. line keeps it open when the b.f.o. is turned on. This prevents the b.f.o. from overloading the detector and reducing the sensitivity of the set.

EXCITER FOR TU-10-B FINAL

? Please print a circuit of an exciter for driving the TU-10-B 10-meter transmitter described in the November, 1948, issue of RADIO-ELECTRONICS. I

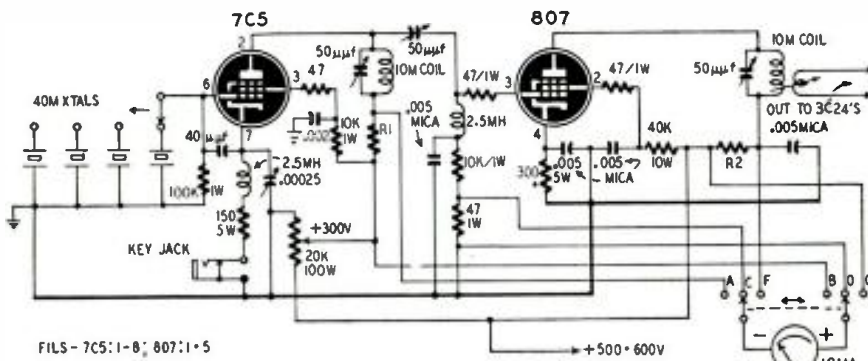

FILES-7C5:1-B; 807:1-B

would like to be able to use several 40-meter crystals that I have.—E.W.F., Berkeley, Calif.

A. More than enough drive for the push-pull 3C24's will be supplied by this exciter. A 10-ma meter is used to meter each stage. R1 and R2 are shunts to increase the range of the meter to 100 and 200 ma, respectively. Connect the meter in series with a 1½-volt battery and a 200-ohm wire-wound rheostat. Adjust the rheostat for full-scale deflection. Connect different lengths of No. 28 or 30 enamel wire across the meter terminals until it reads 1 ma for R1 and 0.5 ma for R2. When the correct lengths of wire have been found, wind them around a pair of 1-watt resistors having a value of 5,000 ohms or more.

Grid current for the 807 should not exceed 4 ma; therefore vary the setting of the 50- μ f variable coupling capacitor so the 807 is not overdriven. Drive for the 3C24's is controlled with the variable link in the exciter output.

The oscillator plate coil has about six turns of No. 18 enamel wire spaced to 1½ inches on a 1½-inch plug-in form. A 50-watt coil with variable link is used in the plate circuit of the 807. If a coil of this type is not available, then use a center-tapped coil with swinging link in the grid circuit of the final amplifier.

SPEAKER CONTROL SYSTEM

? A 25-watt amplifier is to be installed in a hotel. Two speakers are to be used in a dining room, one in the lounge, and another in a garden about 600 feet away. Please show a foolproof method of switching the speakers to use any or all of them at will. Both dining-room speakers are to be used simultaneously. The amplifier has 4-, 8-, 16-, 250-, and 500-ohm output taps.

What size speakers are required, and how shall I connect them?—J.M., Ely, Minn.

A. Maintaining a perfect match between the amplifier and speakers at all times, this speaker control system is designed around a heavy-duty, four-gang, seven-position wafer switch. This switch and the two 1,000-ohm resistors can be mounted in a small box that can be attached to the amplifier. The speaker transformers are the line-to-voice coil type with 500- and 1,000-ohm primary taps and with secondary taps to match the impedance of the voice coils. The speakers in the dining room should each be rated at 15 watts or more, and the others at 25.

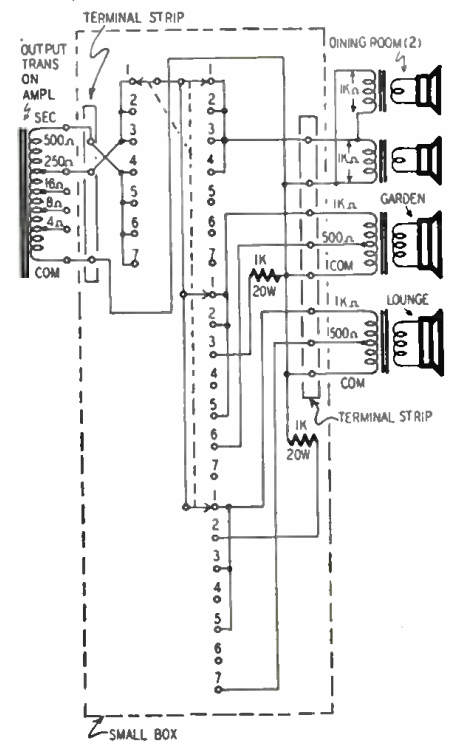

The switch positions are:

- 1—All ON;
- 2—Lounge OFF, garden and dining room ON;
- 3—Garden OFF, lounge and dining room ON;
- 4—Dining room ON, garden and lounge OFF;
- 5—Garden and lounge ON, dining room OFF;
- 6—Garden ON; lounge and dining room OFF;
- 7—Lounge ON; garden and dining room OFF.

... PHONO FOR 3-WAY SETS

The conventional method of connecting a record player consists of providing a switch to transfer the high end of the volume control from the i.f. output to the phono jack, while, at the same time, an extra set of contacts grounds the i.f. output. However, when this method is used with three-way portables, hum and oscillation often result, particularly when the receiver is used on a.e. This effect, caused by lengthening of critical leads, is especially bad when the chassis is isolated from the common negative in the a.c. position.

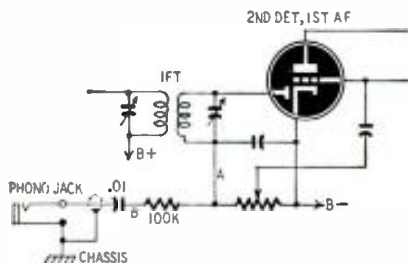

The circuit shown has been used successfully to overcome this difficulty. No switch is used, and the radio is tuned off stations when records are being played. The phono jack is permanently connected to the high end of the volume control through an isolating network, which consists of a 100,000-ohm resistor and a .01- μ f capacitor in series. Leads marked A and B should be as short as possible. The output of a crystal pickup is sufficient to override completely interstation noise in these receivers.

As there is seldom sufficient room to mount the phono jack on the chassis, it may be soldered to the end of a short length of insulated shielded wire such as lapel mike cable. This may be folded inside the case when not in use; all metal parts of the jack should then be covered with an insulating material.

K. R. KNOWLTON,
Toronto, Ont.

... CABINET REPAIR

Plastic radio cabinets are sometimes marred by the chemical action of carbon tetrachloride and other chemicals which fall on them. They can usually be restored to good condition by rubbing the marred surface with fine steel wool soaked in light machine oil.

PETER WALTNER,
Hollywood, Calif.

... BYPASSING BAD TUBE

Every once in a while a customer brings in a set with a bad r.f. tube for which I have no replacement on hand. When the customer is in a hurry for his receiver, I remove the tube and connect a 500- μ f capacitor between the grid and plate connections on the socket, bypassing the tube. As soon as I can get a replacement tube, of course, I install it and remove the capacitor. Most receivers will work nearly as well without the r.f. tube as with it, at least in my location.

P. J. LOMBARD, JR.
Winnebago, Nebr.

Quality **TRANSVISION** Precision
Engineered **TELEVISION INSTRUMENTS** Manufactured

EQUIPMENT AND COMPONENTS

For Better TV Performance and Lower Installation Costs

Eliminate the Variables in Television Installation with
the Transvision **FIELD STRENGTH METER**

Improves Installations! ! Saves 1/2 the Work! !

Has numerous features and advantages, including—(1) Measures actual picture signal strength
... (2) Permits actual picture signal measurements without the use of a complete television set.



TRANSVISION
TELEVISION and FM
SWEEP SIGNAL GENERATOR

Complete frequency coverage from 0-227 MC with no band switching ... Sweep width from 0-12 MC completely variable. ... Accurately calibrated built-in marker generator.

Model SG Net \$79.50

NEW LOW PRICE
Model FSM-1, complete with tubes Net \$79.50

TRANSVISION ALL-CHANNEL
TELEVISION BOOSTER
CONTINUOUS TUNING



Model B-1 List \$32.50

TRANSVISION IS NOW
EXCLUSIVE DISTRIBUTOR OF
DU MONT TV/FM
INPUTUNER

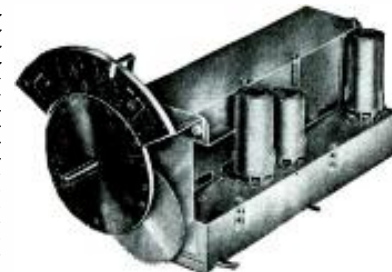

Model IT-1, with tubes List \$59.95

All Transvision Prices are fair traded; subject to change without notice.
Prices 5% higher west of the Mississippi.

TRANSVISION, INC. Dept. RE, NEW ROCHELLE, N.Y.

Please ship the following Transvision Products THROUGH YOUR NEAREST LOCAL OUTLET

RE-8

I am enclosing 10% DEPOSIT in the amount of _____, balance C.O.D.
() I want to get into the Television Business. SEND ME DETAILS OF YOUR DEALER PLAN.

Name (please print) _____ City and Zone _____
Address _____ State _____

RADIO TUBES AT ROCK BOTTOM PRICES!

AM, FM, TV Tubes **34¹/₂¢ each**

1B3	1R5	7B6	
1A7GT	1S5	7E6	
1H5GT	1T4	10	
1N5GT	1U4	12A	
6J6	3A4	12A8GT	40
6AG5	3Q4	12AT6	46
6AK5	5U4G	12BA6	47
6AL5	5Y4	12BE6	50
6AQ5	5Y3GT	12F5	70L7GT
6AV6	6A3	12H6	71A
6BD6	6ABGT	12K7GT	81
6BG6G	6AT6	12SA7GT	112A
6BH6	6BA6	12SH7GT	117Z3
6BJ6	6BE6	12SJ7GT	35W4
658GT	6C4	12SK7GT	50B5
65N7GT	6C5GT	12SN7GT	1A4
6557	6F6GT	12SQ7GT	1A6
6T8	6G6	12SR7	185
6Z7G	6K6GT	14X7	1C6
12AU7	6P5GT	20	1C7G
12AT7	6SA7GT	25L6GT	1D5G
12AX7	6SD7GT	25Z6GT	1D7
12BA7	6SJ7GT	32L7GT	1D8GT
1258	6SL7GT	35	1F4
1978	6SK7GT	35B5	1F5G
2C34	6SQ7GT	35C5	1G6GT
2E24	6U7GT	35W4	1H4G
4A6G	6V6GT	24A	1H6GT
01A	6X4	38	1J6G
1L4	6X5GT	39/44	

KENRADS, RCA, Etc **49¢ each**

Best Brands ONLY

0Z4	6D6	7G7	
O1A	6DB	7H7	
1LA4	6F5	7L7	
1LA6	6F7	7N7	36
1LB4	6F8G	7T7	39/44
1LC5	6H6	10Y	43
1LE3	6J7	12A	56
1LM4	6K7	12A7	57
1LN5	6SD7GT	12J5GT	58
LP5GT	6SF5	12Q7	77
1Q5GT	6SG7	12SF7	78
1T5GT	6SQ7	12SG7	81
1V	6S7G	12SR7	89
2A5	6T7G	12Z3	112
2A7	6U7	14N7	117Z6GT
3LF4	6W7G	2050	182
5X4	7A4	2051	183
6A3	7A7	24A	482
6B8	7B6	30	483
6C6	7E7	35/51	VR150

PM SPEAKERS

	10 or more ea.	Price
5"	87¢	89¢
4"	95¢	\$1.05
3"	95¢	1.05
2"	95¢	1.05
6"	\$1.49	1.59

50L6-35Z5-12SK7-12SQ7-12SA7
ALL AMERICAN FIVE
5 tubes for— **\$1.95**

354-1R5-1S5-1T4
BATTERY TUBE SPECIAL
4 tubes for— **\$1.29**

Minimum order \$5.00. Add 5¢ per tube for orders of less than 100. Tubes may be assorted in mixed price categories. All shipments FOB Chicago. 25% deposit with order, balance C.O.D. ALL MERCHANDISE BRAND NEW and individually boxed. Foreign inquiries invited.

CONCERT MASTER RADIO TUBE COMPANY 1802 Winnemac Avenue Chicago 40, Ill.

BOOKLET FOR SET OWNERS

POSSIBLY the first effective effort by a manufacturer to cooperate with the service technician in building up good will with his customers appears in the form of a booklet entitled *Your Money's Worth in Good Radio and Television Service*, issued by the Sprague Products Company, North Adams, Mass.

The 5 x 7½-inch pamphlet of 16 pages has a beautifully designed cover which impels the recipient to look inside, where the story of modern radio repair is told in language admirably suited to the intelligent, but nontechnical, set owner. Beginning with an illustration of a 1924 radio, it shows on the next two pages an all-band receiver and a televiser, and describes the high degree of technical skill and large amount of precision equipment needed to maintain and repair such complex modern home electronic equipment.

A picture of a large test bench, captioned "The Modern Service Shop Needs This Sort of Equipment," covers the two center pages; the next two detail and itemize the manuals, test apparatus, tools, and other equipment required in a modern repair shop.

The extensive and thorough training necessary to today's service technician is pointed out clearly, and the low comparative cost of his services is driven home at various points throughout the book.

The booklet, published by Sprague for free distribution by the radio service technician to his customers, is available to any bona-fide service shop through all Sprague distributors. Space is provided on the back cover for the technician's own imprint, thereby making it a valuable advertising piece for the individual service shop. The radio-man would be well advised to mail one of these booklets to each of his customers. It is the best piece of publicity he has received since the advent of broadcasting.

FCC AMATEUR PROPOSALS

ON April 21st, the FCC released a document outlining proposed amendments to the rules governing amateur radio service. The amendments are based on proposals submitted by the American Radio Relay League, the National Amateur Radio Council, Inc., and the Society of American Radio Amateurs of Washington, D. C.

Radio constructors and experimenters who are not amateur operators will be interested in the proposals for new novice and technician amateur licenses.

To be eligible for a **Novice Class** license, the applicant must be a citizen of the United States whose actual residence, address and proposed station are more than 125 miles air line from the nearest point where amateur radio op-

erators' examinations are given at intervals of not more than 3 months; or who, according to a physician's certificate, has a disability which prevents him from appearing for examination; or a member of the Army, Navy, Air Force, or Coast Guard whose duties make it impossible to appear for examination at the appointed time and place.

The applicant would be granted a **Novice Class** license upon passing a code test and written examination. The code test will consist of receiving and sending plain language messages in International Morse Code at a speed of not less than 5 words per minute. Each character will be formed at a speed of 7.8 w.p.m. and spacing between then increased so the overall speed is 5 w.p.m. The written examination will include questions on rules and regulations essential to the beginners' operation and elementary radio theory necessary for understanding these rules.

The license would permit the holder to operate c.w. in the 3,700-3,750, 14,100-14,150 28,000-28,500-kc bands and phone and c.w. in the 145-147-mc band. Plate power input to the final amplifier is limited to 75 watts. This license would not be available to holders or former holders of commercial licenses issued on the basis of a technical examination.

The **Technician Class** license would entitle the holder to all amateur privileges in amateur bands above 220 mc. The examination for this license will consist of a code test (same as for **Novice Class**) and examinations on radiotelephone and radiotelegraph theory and amateur rules and regulations.

The present **Class A, B, and C** licenses would be called **Advanced Class, General Class, and Conditional Class** respectively. Under the proposed amendments, **Advanced Class** (Class A) licenses would not be issued after December 31, 1950. Commencing January 1, 1951, valid **Advanced Class** licenses would be renewed only as **General Class** (Class B) licenses. The present **Class A** privileges would be granted only to amateurs qualifying for the new proposed **Amateur Extra Class** license. Qualifications for this new license include a 20-w.p.m. code test and a written examination in advanced radiotelephone theory including techniques for operating in bands assigned for narrow-band emissions.

Many amateurs will no doubt welcome adoption of the proposals for limiting bandwidth of phone signals because they will put an end to the splatter and spill-over all too common on some of the bands. Phone operators will gain 50 kc (3,800 to 3,850) in the 75-meter band; provided that the maximum bandwidth does not exceed 3 kc. A 6-kc bandwidth limitation will be effective on the 3,800 to 4,000 and 14,200 to 14,300-kc bands and in the 29,650 to 29,700 kc sector of the 10-meter band. Ten and 20-kc bandwidths are permitted in the 28,500 to 28 650-kc and 50.1 to 54.0-mc bands respectively.

Metal Ladders Dangerous

By W. OTIS FITCHETT*

IN ADDITION to the best-known hazards of using extension ladders, a new one has been added. It is the danger of possible electrocution while using one of those postwar, all-metal extension ladders. Newspaper dispatches recently described the accidental death in New York of two television mechanics when their metal extension ladder came in contact with a 13,200-volt overhead electric transmission wire. This is direct evidence of the extreme danger of handling metal ladders, flagpoles, or awning brackets in the vicinity of exposed electric wires. Metal gutters and downspouts are also rightly approached with suspicion if adjacent to electrical conductors. In the past, most ladder accidents have been due to loose rungs—with the superstitious souls, of course, maintaining that the greatest ladder hazard of all is to walk carelessly under one.

Three kinds of extension ladders are generally available at the present time, aluminum, magnesium, and kiln-dried wood. Since aluminum is an excellent electrical conductor, its danger when used in close proximity to electric power lines will readily be recognized. However, magnesium is a relatively poor conductor of electricity, and might, therefore, be thought safer. Actually, the resistivities of the two metals are as shown below at 20° C, expressed in ohms per cubic centimeter (copper being the standard, its figure is included for comparison):

- Copper: 1.724×10^{-6}
- Aluminum: 2.828×10^{-6}
- Magnesium: 4.6×10^{-6}

From these figures it will be seen that magnesium definitely has not sufficient current-carrying ability to qualify as a useful electric conductor; but, having less than twice the resistivity of aluminum, it can be equally dangerous

as a "short-circuiting" material. Electricity rushes to ground at every opportunity, and always seeks the best available conductor when doing so.

A wooden ladder made of, say, dried poplar, has a resistivity in ohms per cubic centimeter of 5×10^{11} . This is approximately 1.8 million trillion times the value listed for aluminum, in the direction of safety.

The time of greatest shock danger comes when, while standing on the ground, a human being permits a metal ladder to come into contact with a high-voltage conductor (any voltage above 50 may be considered "high" in this discussion). At such a time the exact specific resistivity of the metal would be of no importance. A thoroughly wet wooden ladder might prove equally hazardous.

Now, here are two rules for ladder safety:

1. If there are live high-voltage wires around do not use any kind of metal ladder.
2. Where wooden ladders are employed, store them indoors so they don't get wet.

Radio Thirty-Five Years Ago In Gernsback Publications

HUGO GERNSBACK
Founder

Modern Electric	1908
Electrical Experimenter	1913
Radio News	1919
Science & Invention	1920
Television	1927
Radio-Craft	1929
Short-Wave Craft	1930
Television News	1931
Wireless Association of America	1936

Some of the larger libraries in the country still have copies of ELECTRICAL EXPERIMENTER on file for interested readers.

AUGUST 1915 ELECTRICAL EXPERIMENTER

- Television, or the Projection of Pictures over a Wire, by H. Winfield Secor
- Submarine "Wireless" Signaling An Interview with Guglielmo Marconi, by Samuel Cohen
- How to Build an Electric Writing Machine or Telautograph, by Homer Vanderbilt
- A New 100-Watt Wireless Telephone New 1½-2 KW. Radiophone Arc Generator
- Up-to-date Wireless Set of the SS. "Olympic"
- A Novel Idea for Wireless Telephones Wireless Relays and Amplifiers
- An Improved Electrolytic Detector, by Isaiah Rosin
- Anti-Hum Stunt for Radio Receivers, by Urban McMiller
- A Cheap but Efficient Carborundum Detector, by H. J. Andrews
- A Simple Galena Detector, by Harold Pruden
- An Alloy for Radio Crystals, by Lloyd Stratton



AUGUST, 1949



TUBES! Some Types at less than manufacturing cost.

ALL BRAND NEW! GUARANTEED! IMMEDIATE DELIVERY! INDIVIDUALLY CARTONED!
Special Discount: DEDUCT 5¢ from each tube when ordering 25 or more assorted tubes.

19¢ Each	6T8 6U8GT 6V6GT 6X5GT 12AH7GT 12AU6 12SH7 12J7GT 12K7GT 12Q7GT 12SA7GT 12SF5 12SK7GT 12SL7GT 12SN7GT 12SQ7GT 14B8 14C7 19T8 24A 25Z6GT 27 30 32 35/51 35L6GT	29¢ Each	6B8 6D5 6F8G 6K8 6L6G 6N6G 6Q7G 6S7 6T7 6W7 7A6 7B6 7C6 7E5/1201 7F7 7H7 7K7 7M7 12AT6 12BA6 12BE6 12SJ7GT 12Z3 14F7 15A6G 15B6G 15L6GT 15Y6 2B7 2L7GT 33 34 35Z4GT 43 44 45 46 50L6GT 50 50B6G 50C6 50D4 50E4 50F4 50G4 50H4 50I4 50J4 50K4 50L4 50M4 50N4 50O4 50P4 50Q4 50R4 50S4 50T4 50U4 50V4 50W4 50X4 50Y4 50Z4	39¢ Each	688 6D5 6F8G 6K8 6L6G 6N6G 6Q7G 6S7 6T7 6W7 7A6 7B6 7C6 7E5/1201 7F7 7H7 7K7 7M7 12AT6 12BA6 12BE6 12SJ7GT 12Z3 14F7 15A6G 15B6G 15L6GT 15Y6 2B7 2L7GT 33 34 35Z4GT 43 44 45 46 50L6GT 50 50B6G 50C6 50D4 50E4 50F4 50G4 50H4 50I4 50J4 50K4 50L4 50M4 50N4 50O4 50P4 50Q4 50R4 50S4 50T4 50U4 50V4 50W4 50X4 50Y4 50Z4	49¢ Each	688 6D5 6F8G 6K8 6L6G 6N6G 6Q7G 6S7 6T7 6W7 7A6 7B6 7C6 7E5/1201 7F7 7H7 7K7 7M7 12AT6 12BA6 12BE6 12SJ7GT 12Z3 14F7 15A6G 15B6G 15L6GT 15Y6 2B7 2L7GT 33 34 35Z4GT 43 44 45 46 50L6GT 50 50B6G 50C6 50D4 50E4 50F4 50G4 50H4 50I4 50J4 50K4 50L4 50M4 50N4 50O4 50P4 50Q4 50R4 50S4 50T4 50U4 50V4 50W4 50X4 50Y4 50Z4	59¢ Each	688 6D5 6F8G 6K8 6L6G 6N6G 6Q7G 6S7 6T7 6W7 7A6 7B6 7C6 7E5/1201 7F7 7H7 7K7 7M7 12AT6 12BA6 12BE6 12SJ7GT 12Z3 14F7 15A6G 15B6G 15L6GT 15Y6 2B7 2L7GT 33 34 35Z4GT 43 44 45 46 50L6GT 50 50B6G 50C6 50D4 50E4 50F4 50G4 50H4 50I4 50J4 50K4 50L4 50M4 50N4 50O4 50P4 50Q4 50R4 50S4 50T4 50U4 50V4 50W4 50X4 50Y4 50Z4
-----------------	---	-----------------	--	-----------------	--	-----------------	--	-----------------	--

Hard to get tubes: Our tube stock is constantly being expanded. If your tube is not listed, write us!

TUBULAR ELECTROLYTICS AT BARGAIN PRICES	OUTPUT TRANSFORMERS
10 Mfd. @ 150V. 30 Mfd. @ 25V \$34 20 x 20 Mfd. @ 150V 35 40 x 40 Mfd. @ 150V 40 20 x 20 Mfd. @ 100V 41 40 x 40 Mfd. @ 100V 42 20 x 20 Mfd. @ 150V 43 40 x 40 Mfd. @ 150V 44 10 x 10 Mfd. @ 450V 42 10 x 10 Mfd. @ 450V 42 20 x 20 Mfd. @ 450V 42 10 Mfd. @ 50V 26 20 Mfd. @ 50V 32 40 Mfd. @ 50V 38 4 Mfd. @ 450V 38 10 Mfd. @ 450V 39 10 Mfd. @ 450V 40 10 Mfd. @ 450V 47 32 x 16 Mfd. @ 450V 49 10 x 10 x 10 Mfd. @ 450V 49 100 Mfd. @ 50V 49	SENCO buyer comes thru with great savings for you! 3Q5 39c Ea 50L6 Push Pull 39c Ea 6V6 Push Pull 49c Ea FRESH STOCK OF CARTRIDGES Webster N7 \$1.49 FN88 Shure Crystal .. 1.69

RADIO MEN WHO KNOW... SAVE AT SENCO!

Minimum Order \$2.50; Send 25¢ deposit for all 60¢ shipments. Include sufficient postage—excess will be refunded. Orders without postage will be shipped express collect. All prices F.O.B. New York City.

WRITE FOR FREE "SENCO SPECIALS OF THE MONTH BULLETIN"

SENCO RADIO INC.
Dept. L, 73 West Broadway
New York 7, N. Y. Tel. BEekman 3-6498

SIGNAL GENERATOR KIT

EICO
MODEL
320K

\$19.95

Complete



Build your own signal generator. Eico kit comes complete with all parts and easy-to-follow instructions. Hartly oscillator range of 150 Kc to 100 Mc; Colpitts audio oscillator gives pure 400 cycle sine wave voltage. Perfect for aligning standard broadcast receivers. In kit form, complete, \$19.95. Factory wired and tested, \$29.95

Write for FREE Broadcaster newspaper

10%
Cash
with
Orders



Phone
LO
3-9255

509 ARCH ST., PHILA., PENN.
SIXTH & ORANGE, WILMINGTON, DEL.
6205 MARKET ST., W. PHILA., PA.

GREYLOCK RADIO TUBE BARGAINS!

GT, Glass and Miniature Types

1H5	354	68A7GT	12817GT	} 34 1/2¢
1S3	3V4	6817GT	128K7	
1T4	6AT6	68K7GT	128Q7	} each in 100 lots
1U4	6BA6	68Q7GT	2526GT	
3Q4	6BE6	12SA7	25L6GT	

SPECIAL OFFER! All above types may be purchased in lots of 100 assorted. Also available in smaller quantities at 39¢ each.

6AK5	} 49¢ ea.	6BG6G69¢
6AG5		183-801689¢
6J6		2E24\$1.89

All tubes in individual cartons
TERMS: Net C.O.D., F.O.B. NYC. MINIMUM ORDER \$5.00.

Write for Bargain Catalog C-6

Greylock Electronics Supply Co.
30 Church Street New York 7, N. Y.

Check these Prices!



SELENIUM RECTIFIERS 115 VOLTS

For Radio & Television
Application

fully guaranteed	lots of 10, each	lots of 100, each
75 MA	.56	.50
100 MA	.64	.56
150 MA	.72	.66
200 MA	.89	.78
250 MA	1.16	.88

OPAD-GREEN COMPANY

71 Warren St., N. Y. 7, N. Y. B Eekman 3-7385-6

ATTENTION Amateurs- Experimenters-Inventors

Cut your cost on radio supplies and equipment in half. Clip coupon today.

Hundreds of "hard to get" war surplus items along with the best in standard brand equipment—all at great savings to you. Let us know your particular requirements. IMMEDIATE DELIVERY.

PLEASE PUT MY NAME ON YOUR MAILING LIST FOR SPECIAL BULLETINS.

NAME
ADDRESS ZONE
CITY STATE

NIAGARA RADIO SUPPLY CORP.
160 Greenwich St., New York City 6, N. Y.

Herbert Bayard Swope has joined the *Radio Corporation of America* as adviser and consultant. His work will not require his full time, and he will continue his independent practice with other organizations. Mr. Swope recently resigned from the Columbia Broadcasting System, Inc., of which he had been a director and member of the executive committee, since 1932.

Drs. C. H. Townes and P. Kusch of Columbia University have been appointed consultants to the Microwave Standards Laboratory of the *National Bureau of Standards*, where they will be available for consultation on microwave absorption spectroscopy and atomic beam equipment for use as frequency and time standards.

Fred R. Lack of New York, vice-president of *Western Electric Company*, has been elected president of the *Armed Forces Communications Association*. Mr. Lack, a member of the Industry Advisory Committee for the Armed Services during and since World War II, succeeds Brigadier General David Sarnoff, chairman of the board of *Radio Corporation of America*, who has served as president of the Association since its formation in 1946.

Dr. Elmer C. Larsen has been appointed chief engineer of the Tungsten and Chemical Division of *Sylvania Electric Products, Inc.*, it was announced by John B. Merrill, division manager. Dr. Larsen will assume direction of the engineering and scientific program for improved production and process control of tungsten and chemical products.



J. Gilman Reid has been appointed chief of the Engineering Electronics Laboratory of the *National Bureau of Standards*, where he will direct research on electronic instrumentation, miniaturization, printed-circuit processes and techniques, electronic circuit components, and electronic standards.

One of the senior scientists in the Bureau's radio proximity fuze program during World War II, Mr. Reid has conducted research on electronic instruments, special controls for isotope separation, auxiliary instruments for mass spectrographs, heat transfer, and thermal conductivity.

Paul W. Erickson has been appointed manufacturing superintendent of the Electronics Division of *Sylvania Electric Products, Inc.*, Boston, Mass., according to an announcement by J. J. Sutherland, general manager. He was formerly supervisor of production engineering and then general foreman in charge of microwave tubes.



In this magazine you will find an exhaustive panorama of French radio in all its phases and a complete report of the radio industry of France. *TOUTE LA RADIO* is the principal French radio magazine.

We will send a sample copy to all radio specialists, industrialists, importers, and radio dealers, if you will make your request on your letterhead. Please address:

TOUTE LA RADIO

9 Rue Jacob

Paris 6, France



WE ARE LOOKING FOR TUBES!

WHAT HAVE YOU GOT?

Interested in small or large quantities of all types of Transmitting, Industrial, and Receiving Tubes.

Send your list to:

MOHAWK ELECTRONICS CO.
160 GREENWICH ST., NEW YORK 6, N. Y.

LEARN

Radio-Television Electricity

OR

IN THE GREAT SHOPS OF COYNE



TRAIN QUICKLY!
OLDEST, BEST EQUIPPED
SCHOOL of ITS KIND in U.S.
2 Opportunity Fields

Come to the Great Shops of COYNE in Chicago during our 50th Anniversary Year! Get quick, practical training in RADIO-TELEVISION or ELECTRICITY. G. I. Approved. Finance plan for non-veterans. Mail Coupon Today for complete details.

NOT "HOME-STUDY" COURSES!
You learn on real, full-size equipment, not by mail. Finest staff of trained instructors to help you get ready quickly for a better job, a fine future.

FREE BOOKS Clip coupon for big illustrated Coyne book on either ELECTRICITY or RADIO-TELEVISION. Both books sent FREE if you wish. No obligation; no salesman will call. Act NOW!

B. W. COOKE, Pres.
COYNE Electrical & Radio School, Dept. C9-81H
500 S. Paulina Street, Chicago 12, Illinois

Send FREE BOOK and full details on:
 RADIO-TELEVISION ELECTRICITY

NAME.....
ADDRESS.....
CITY..... STATE.....

Leonard C. Welling has joined the JEWEL RADIO AND TELEVISION CORP., New York, as General Sales Manager. Mr. Welling is backed by over 20 years of experience in the industry. Formerly associated with Emerson, Mr. Welling was also one of the principal owners of the French Sonora Radio company in Paris.



Emil J. Maginot has been appointed sales manager in charge of Distributor Sales for the NATIONAL UNION RADIO CORP. of Newark, N. J. as announced by Kenneth C. Meinken, President.

Maginot has served National Union successively as Director of Sales Engineering and Manager of Advertising and Sales Promotion.

Louis G. Pacent, President and Technical Director of Pacent Engineering Corp., New York City, has been appointed a member of the AMERICAN STANDARDS ASSOCIATION'S Sectional Committee on Acoustical Measurements and Terminology, Z24, as a representative of the American Institute of Electrical Engineers. He is a Fellow of the American Institute of Electrical Engineers, a member of its Board of Examiners and the Committee on Communications; Fellow of the Institute of Radio Engineers; Fellow and past President of the Radio Club of America; and Member of the Acoustical Society.

Harry F. Dart, Westinghouse engineer who pioneered in radio, has been elected Chairman of the New York section, INSTITUTE OF RADIO ENGINEERS. Dart, office manager of Westinghouse electronics department, Bloomfield, N. J., was secretary-treasurer of the section in 1943.

Raymond C. Cosgrove, executive vice-president of Avco Manufacturing Corporation, Cincinnati, Ohio, has been elected President of the RADIO MANUFACTURERS ASSOCIATION, succeeding Max F. Balcom, vice-president of Sylvania Electric Products, Inc., Emporium, Pa., who declined to be a candidate for re-election following two years as RMA president.

Sidney Jurin has been named sales manager of TELEKING CORP., television Manufacturer. Mr. Jurin was formerly with the Pilot Radio Corporation.

Herb Young's appointment as Sales Manager for the NIELSEN TELEVISION CORP. Norwalk, Connecticut, has been announced by Harold V. Nielsen, President of the firm. He is nationally known throughout the radio appliance and television industry. He was sales manager for the original Majestic Radio, at which time he was Vice-President in charge of sales for the Grigsby-Grunow Company.

AUGUST, 1949

HERE IT IS

THE COMPLETE 2 TUBE RADIO BUILT INTO A HAT!



the Man-from-Mars
RADIO HAT



- Covers entire broadcast band within 20 mile radius
- Set weighs 5 ozs.; hat, 7 ozs.
- Conceals in lining 1/4" thick
- Absolutely mobile, no extra aerial needed
- Volume & tone equal to many portables
- Regulation waterproof sun helmet... adjustable size

\$7.95

COMPLETE WITH plus fed. tax BATTERY PACK

ACCLAIMED FROM COAST TO COAST

Here's the two-tube topper that's got the whole country stirring. You've read about it in Life, Time, Business Week, and many other magazines and newspapers throughout the country. Now here's an opportunity for you to prove to yourself how well this sun-helmet radio can perform. Just fill out, clip and mail this coupon.

Dealers... please write on firm stationery.

AMERICAN MERRILEI 918 Halsey St., Bklyn. 33, N. Y.

Please send me RADIO HATS. (check colors listed)

Lipstick Red Tangerine Flamingo Canary Yellow

Chartreuse Blush Pink Rose Pink Tan

I'm enclosing \$8.65 (check or money order) for each hat. (\$7.95 plus 48¢ Fed. tax, plus 22¢ postage)

or

I'm enclosing 1/2 or \$2.88 for each hat, balance C.O.D.

Please send me more detailed information about this new scientific marvel.

Name _____

Address _____ Zone _____ State _____

City _____ RE 8-49

TELEVISION MARKER

MODEL TV 50

Net Price \$49.95



Designed for use in marking television sweep generators. The large planetary driven dial is calibrated to an accuracy of 1%. Uses 4 frequency bands covering frequency of 5 to 130 mc and 96 mc to 260 mc. A self contained crystal oscillator circuit is available for simultaneous marking or may be used alone with the variable frequency marker turned off. Due to the type of oscillator any crystal from 100 KC up, may be used in the crystal socket. An internal mixing arrangement is provided so that the output of a sweep generator may be connected to the TV 50 and the output lead will carry both the sweep frequency and the marker frequency. Buy it from your jobber.

RADIO CITY PRODUCTS CO., INC.

152 West 25th St. New York 1, N. Y.

MORE PROFITS FOR YOU with these two bargain service manuals

If broken into lessons and sold as a course, you'd regard these famous Ghirardi Books as bargains at \$50 or more—yet you actually buy them for only \$5 each!

MODERN RADIO SERVICING

Complete Professional Training in Test Instruments, Troubleshooting, Repair



Ghirardi's 1300-page MODERN RADIO SERVICING is more widely used than any other book of its type—because it makes every phase of professional Radio-Electronic servicing so easy to learn. Explains service instruments and when, where, and why to use each type. Tells how to troubleshoot radios, analyze circuits, test circuits, make all kinds of repairs, adjustments and installations, as well as how to start a successful service business of your own. 706 illustrations. Only \$5. (\$5.50 foreign.)

TROUBLESHOOTER'S HANDBOOK

Cuts Service Time in Half on 4 Jobs Out of 5

Just refer to Ghirardi's RADIO TROUBLESHOOTER'S HANDBOOK for specific data on the radio you want to repair. Covers common troubles, their symptoms and remedies for over 4,800 receivers by 202 manufacturers. Saves time—eliminates useless testing. Over 300 additional pages contain tube data, charts, etc., to help you repair any radio ever made. Contains 744 manual-size pages. Weighs almost 4 lbs. Only \$5. (\$5.50 foreign.)



SPECIAL OFFER!

5-Day Money back Guarantee!

Order singly at \$5 each—or we'll ship both big books for only \$9.50 for the two (\$10.50 outside U.S.A.). In either event, read books for 5 days AT OUR RISK. If not satisfied, return books and we'll cheerfully refund your money. Send cash with order, or we'll ship C.O.D. (No foreign C.O.D.'s.)

Dept. RE-89, Murray Hill Books, Inc. 232 Madison Ave., New York 16, N. Y., U. S. A.

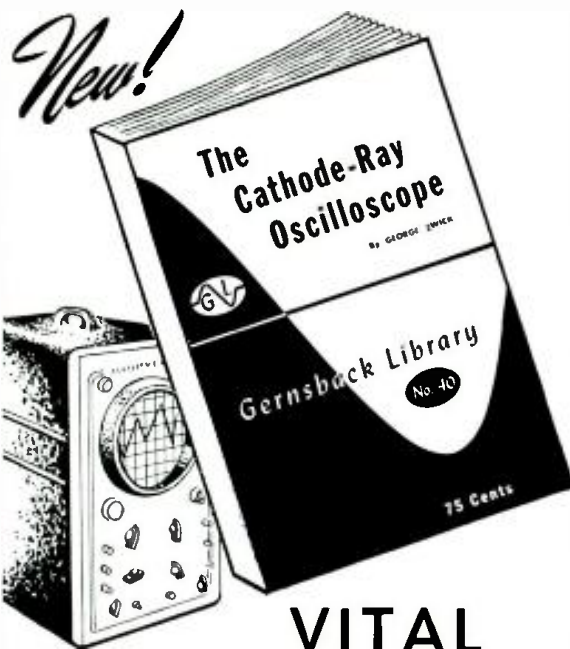

VITAL FOR TV SERVICING

A new and highly important book! Gives a complete understanding of working principles behind oscilloscope operation, and how to use the instrument effectively. Clearly written with a single purpose—to help you use and understand the oscilloscope. No man servicing television receivers can afford to be without this knowledge. Invaluable for anyone who uses the oscilloscope.

ALL ANGLES COVERED

Chapter 1—Direct Current and Alternating Current. Visual observation and measurement of varying voltages and currents on the cathode-ray tube. Chapter 2—How beam from electron "gun" projects image of current and voltage variations onto fluorescent screen, and how beam is deflected by electrostatic and electromagnetic means. Chapter 3—How signal deflects electron beam vertically in c-r tube and sweep voltage deflects beam horizontally. Role of the saw-tooth oscillator—the gas discharge tube—the multi-vibrator—synchronization—locking. Chapter 4—The cathode-ray tube—accelerating and focusing power supplies—the sweep generator—the horizontal and vertical amplifiers—controls on oscilloscope—how to operate a scope. Chapter 5—Aligning TV i.f. channels—TV front-end alignment—Alignment of i.f. amplifiers in AM and FM sets. Use of signal generators—i.f. alignment of a.c.-d.c. receivers—bandpass alignment—aligning the discriminator—the ratio detector—r.f. alignment of AM and FM receivers. Chapter 6—Audio output measurement—voltage gain—power output—audio response curve plotting—peak a.c. measurements. Checking saw-tooth amplifiers—magnetic deflection circuits—synchronizing pulses. Ham transmitter measurements—over and under-modulation. Locating hum—incorrect adjustment of vibrator power supplies. Phase shift in audio amplifiers.

112 PAGES 103 ILLUSTRATIONS

Only 75c

See your jobber today or send for THE CATHODE-RAY OSCILLOSCOPE along with other titles in the GERNSBACK LIBRARY.

MAIL THIS COUPON NOW

10 OTHER BOOKS

- No. 29—Handy Kinks and Short Cuts, 50c
 - No. 30—Unusual Patented Circuits, 50c
 - No. 31—Radio Questions and Answers, 50c
 - No. 32—Advanced Service Technique, 50c
 - No. 33—Amplifier Builder's Guide, 50c
 - No. 34—Radio-Electronic Circuits, 50c
 - No. 35—Amateur Radio Builder's Guide, 50c
 - No. 36—Radio Test Instruments, 50c
 - No. 37—Elementary Radio Servicing, 50c
 - No. 38—How to Build Radio Receivers, 50c
 - No. 39—Practical Disc Recording, 75c
- RADCRAFT PUBLICATIONS Inc.,**
Dept. 89, 25 West Broadway,
New York 7, N. Y.
- Send me the books checked, postpaid.
- NO. 40 CATHODE-RAY OSCILLOSCOPE, 75c
- I enclose \$
- Your Name..... (Print clearly)
- Address
- Jobber's Name.....
- Address

GERNSBACK LIBRARY

Each of these books supplies usable information

- No. 29—HANDY KINKS and SHORT CUTS. A carefully edited compilation of time savers. Kinks on Antennas—Power Supplies—Test Equipment—Servicing—in the Shop—Phonographs and Amplifiers—Coils and Transformers—Miscellaneous Subjects. 50c each.
- No. 30—UNUSUAL PATENTED CIRCUITS, 1944-46. A gold mine in new book-ups! A selection of unusual circuits, many a result of wartime research—of great value to anyone interested in electronics. Control Circuits—Detectors and Amplifiers—Power Supplies—Miscellaneous Circuits—Foreign Circuits. 50c each.
- No. 31—RADIO QUESTIONS AND ANSWERS. Answers to most frequently asked questions. Clear circuit diagrams. Amplifiers—Receivers—Transmitters—Meters and Test Equipment—Interphones—Power Supplies—Phonograph Amplifiers—P. A. Systems. 50c each.
- No. 32—ADVANCED SERVICE TECHNIQUE. An up-to-date collection of information for the advanced serviceman: Visual Alignment—Tracking Problems—Negative Feedback—Tone Control Circuits—Adding Microphones to Sets—Matching Loudspeakers—Remote Juke Boxes—Servicing Record Changers—Hum Elimination—FM Servicing. 50c each.
- No. 33—AMPLIFIER BUILDER'S GUIDE. Invaluable for the designer and builder of audio equipment. Tells how to build a wide variety of amplifiers with power outputs ranging from 8 to 30 watts. Detailed design information on: Push-Pull—Phase Inversion—Bass and Treble Boosters—Volume Expanders—Resistance Coupling—Internal Feedback. 50c each.
- No. 34—RADIO-ELECTRONIC CIRCUITS. An extensive collection of circuit diagrams, with brief, to-the-point descriptions of each, including: Intercommunications Systems—Power Supplies—Balancing Circuits—V. R. Meters—Matchers—Receivers—Phono Amplifiers—Short Wave Adaptors—Electronic Relays. 50c each.
- No. 35—AMATEUR RADIO BUILDER'S GUIDE. For the "ham" who builds his own. Practical, down-to-earth. It tells how to build: A 2 Meter Band Antenna Tube Set—Miniature Communications Receivers—Long Lines Transmitter—Beginner's Transmitter—Preslector—Rotary Beam Aerial—Power Supplies—and other ham gear. 50c each.
- No. 36—RADIO TEST INSTRUMENTS. A MUST for every radio man. This latest book on building test equipment places emphasis on practical construction of: Signal Tracers—Capacity Meters—Portable and Bench Multi-checker—Signal Generators—Tube Checkers—Electronic Voltmeters—and many others. 50c each.
- No. 37—ELEMENTARY RADIO SERVICING. For the radio man who knows little about servicing. How to get started, and even more important how to keep going: Planning the service shop—Equipping the Shop—Systematic Circuit Checks—Signal Tracing Methods—Servicing the Midget—Soldering—Servicing Volume Controls—How to Service Speakers. 50c each.
- No. 38—HOW TO BUILD RADIO RECEIVERS. This book contains a sufficient variety of sets to appeal to every radio fan. Includes: Short-Wave, Broadcast, Portable, A. C. operated, Miniature and Standard Receivers. Complete coil-winding data is furnished. 50c each.
- No. 39—PRACTICAL DISC RECORDING. Whether you're interested in amateur or professional recording, you'll find this book by Richard H. Iorf invaluable. It not only tells you how to make successful records, but in addition each important recording component is given a full chapter, explaining its purpose, and what features to look for when buying. Without waste of words. It gets right down to business on the first page. It tells you what you need to make good records and how to do it by using any type equipment—from the simplest to the most expensive—depending on your purpose and pocketbook. You will find all the practical phases of recording covered as well as the underlying principles. 75c each.

INDIA STARTS RADIO CLUBS

Dear Editor:

We are pleased to announce the formation of the Amateur Radio Club of India and the Short-Wave League of India, with headquarters at Mhow in Central India and a QSL bureau at Bombay—P. O. Box No. 6666.

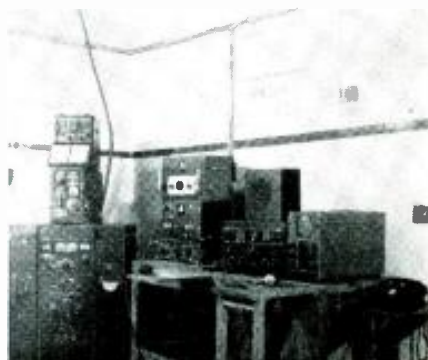

This is the first time in the history of our country that an organization of this kind has been established. The ARCI looks after the interests of all transmitting amateurs, and the SWL takes care of shortwave listeners. A combined journal for members of both organizations, *QRZ*, is published monthly.

The headquarters stations are believed to be the best-equipped amateur stations in Southeast Asia. The calls of the ARCI and SWL stations are VU2ARCI and VU2SWL, respectively. Both are very active on 7, 14, and 28 mc.

We are enclosing a photograph of the main operating position of VU2ARCI. MAJ. B. M. CHAKRAVARTI, PRESIDENT, *Mhow, Central India*

GEIGER COUNTERS

HAMS! BE FIRST AGAIN! BUILD YOUR OWN!

Find radium, trace water mains, prospect, check local contamination, assay ores.

SENSATIONAL BETA COUNTER!
30 MG/CM² WALLS

- Send Beta counter \$7.50
- Send complete parts kit and diagram \$48.50
- Send assembled 5.5 pound portable \$90.00
- Send 110VAC quantitative lab. model \$150.00
- Send detailed information Check COD

AEC Bulletins available

COSMIC COUNTERS

112 Cornell Ave. Swarthmore, Pa.

EASY TO LEARN CODE

It is easy to learn or increase speed with an Instructograph Code Teacher. Among the quickest and most practical method yet developed. For beginners or advanced students. Available tapes from beginner's alphabet to typical messages on all subjects. Speed range 5 to 40 WPM. Always ready—no GRM.



ENDORSED BY THOUSANDS!

The Instructograph Code Teacher literally takes the place of an operator-instructor and enables anyone to learn and master code without further assistance. Thousands of successful operators have "acquired the code" with the Instructograph System. Write today for convenient rental and purchase plans.

INSTRUCTOGRAPH COMPANY

4701 Sheridan Rd., Dept. RC, Chicago 40, Ill.

RADIO-ELECTRONICS for

New for 1950
FACTORY-TO-YOU
MIDWEST TELEVISION

NEW GIANT
16" PICTURE TUBE

Immense 151 square-inch screen on new 16" metal-glass tube... clear, steady, bright pictures... Synchronized sound and picture that a child can tune in perfectly... Long Distance FM Circuit... Big 12" Electro-Dynamic Panasonic Speaker... Available in beautiful consoles or in complete chassis (not a kit). Buy direct at Low Factory Prices, with Low Down Payment and Long Easy Terms... and on 30 Days Trial! Send for 32-page, 4 color catalog today.



30 DAYS TRIAL
EASY TERMS

FACTORY AUTHORIZED SERVICE IN TELEVISION AREAS

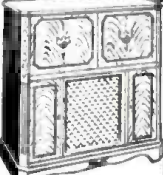

... Also a Complete New 1950 Line of
MIDWEST RADIOS
with new long distance FM Circuit and new 3-Speed Phonograph.

Send This COUPON in 1x Post Card for NEW 1950 FREE 4 Color 32 Page MIDWEST CATALOG

MIDWEST RADIO & TELEVISION CORP.
Dept. X381, 909 Broadway, Cincinnati 2, Ohio
Please send me your new FREE 1950 Catalog.

NAME _____
ADDRESS _____
CITY _____ ZONE _____ STATE _____

NEW! **INSTRUMENT KITS**
at new low bargain prices!

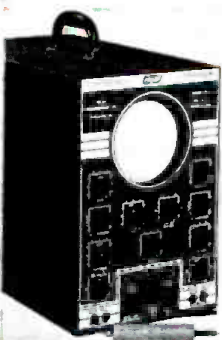

5" OSCILLOSCOPE & STETHOSCOPE
Model TS-7K \$46.50
FOR TELEVISION, FM & AM

High quality Laboratory 5" oscilloscope plus digital tracer; 2 instruments for price of one. Designed for TV and FM alignment and AM servicing. Has hook for probe listed below. Permits signal tracing in any circuit through phones or screen pattern. These extra features in addition to conventional scope use built-in high gain 10.5 V/multi amplifiers with response to 350 Kc. Complete with all tubes including 5" CRT tube, Loss probe and head, change. Steel case 15x 11x8 7/8".

TS-7K, Probe Kit \$4.25
TS-7, factory built \$9.95
TS-7P, factory built \$8.25

DELUXE SIGNAL TRACER
Model TS-3K \$22.75

Newest, fastest way to find all radio faults in minutes instead of hours. Gives you "know-how" on tougher jobs. Easy to use by expert or beginner. Test parts. Locates causes of fading, distortion, dead sets, etc. Jacks for connecting your present V.O.M. give visual reading on all RF and audio. AC regulated. Steel case 8x 12 5/8". With a tubes, probe and service guide.

Model TS-3, factory built \$34.95

TS-1K, Beginners' Sig. Tracer Kit \$6.75

Fact. built 9.85

TS-5K, Pocket Sig. Tracer Kit \$20.45

Fact. built 24.95

ORDER from your dealer. If he cannot supply, mail coupon to factory.



TS-6CK, Crystal (1N31) Probe Kit 4.50

Fact. built 7.50

FEILER ENGINEERING CO., Dept. 8RC9
945 George Street, Chicago 14, Ill.

Please send me the following Instrument: Model _____

FEILER NAME _____
ADDRESS _____

HAM LIKES U.H.F. ARTICLE

Dear Editor:

I have just finished reading Part I of "Microwaves" by C. W. Palmer in the April issue of your magazine. This is a very fine article. By using the elementary and practical approach as Mr. Palmer has done, more interest will be awakened in the u.h.f., especially among hams. Most hams are not graduate engineers; but armed with some knowledge of microwaves and with their natural enthusiasm for radio, they will proceed to make history in the upper bands, just as they have from 200 meters down.

PETER N. SAVESKIE, W2JFE
Staten Island, N. Y.

CENTRAL ORGANIZATION

Dear Editor:

Much had been said and printed pro and con about licensing radio, television and electronics technicians. I think everybody will agree that organization is better than licensing.

The main difficulty is that existing organizations are few and mostly of a local nature. What is needed is a nationwide organization that will be recognized the country over. This will give rural and small-town technicians a chance to benefit from such an organization.

Here is a solution to the problem. What organization has more influence and contact with the service technicians than RADIO-ELECTRONICS? Who has been pioneering on the advantages of organizing more than your publication? You have a golden opportunity to further the industry this way:

Set up an organizing committee and print application blanks in every issue of RADIO-ELECTRONICS, requiring applicants to be engaged in some form of electronic servicing. As soon as there is a sufficient enrollment elect officers and make RADIO-ELECTRONICS official headquarters and communications center. Set the membership dues high enough to cover the cost of expenses, such as wall plaque and membership cards. Print questionnaires regarding fair hourly wages or service charges on the various repair jobs. Have members submit their opinions on the subject and the other problems we are confronted with.

I believe a step like this must be taken to secure a large enough organization to gain recognition from the manufacturers and the public.

James M. Pelley
(No address given)

We would be inclined to agree with you—had we not already tried it! During 1931 we organized the Official Radio Service Men's Association (ORSMA). Despite considerable work and a large amount of money spent on organization, publicity, certificates, booklets, lapel buttons, etc., it did not prove a success.

But we learned one thing. An organi-
(Continued on page 79)

NEW TELEKITS
NOW \$59.50

Jobbers: Write for Price Information

NEW TELEKITS
10-B \$82.99
7-B \$59.50

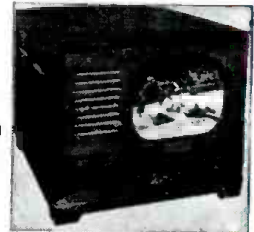

Sparkling new Telekit 10-B has 52-inch screen. Brand new compact lay-out has video tube mounted on chassis. Big illustrated easy-to-follow instruction book guides you step by step through easy assembly. No special knowledge of television is required. All you need is a soldering iron, pliers, and screw driver. 10-B Kit can be used with 12 1/2, 15, 16-inch tubes. Telekit 10-B, \$52.99. Tube kit, including 10BP4 and all other tubes, \$55.80. 10-B Telekit cabinet, \$15.95 to \$24.50. Telekit Guarantee includes free factory service.

Write for catalog listing 10-B and 7-B Telekits. New 7-B Telekit for 7-inch tube, \$59.50. Tube kit, including 7JP4, \$39.58. 7-B cabinet, \$15.95 to \$24.50.

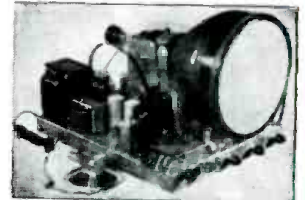

Note simple clean lay-out for easy assembly of new Telekit 10-B. Features 2 sound I. F. stages, a new pre-built, pre-aligned tuner that includes a stage of R. F. for distance reception. Easy-to-adjust horizontal lock circuits. Beautiful new model cabinets for 7-B and 10-B are heavily constructed of hand rubbed walnut.

13 CHANNEL TUNER \$19.95

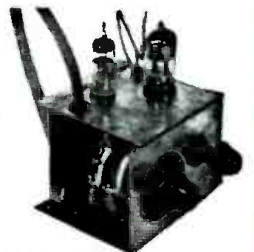

NEW 13 CHANNEL TUNER is a small compact unit with stage of R.F. Tunes all TV and ZFM channels. Made to conform with Telekit or any other TV set having video I.F. of 25.75 Mc. Complete with tubes, pre-wired, pre-aligned; only three connections to make. See your jobber, or write to us for information. Your cost, \$19.95.

Write for catalog of Telekit antennas, boosters, television kits, tuners, television parts and tubes.

TELEKIT

SANDERS ELECTRONICS CO.
AVIATION BLDG., 3240 N.W. 27th AVE.
MIAMI 42, FLORIDA

RADIO SCHOOL DIRECTORY



Become an **ELECTRICAL ENGINEER**



MAJOR IN ELECTRONICS



B. S. DEGREE... IN 36 MONTHS

Make one of the most important decisions of your life—today! Capitalize on your electronic interests—decide to become an **Electrical Engineer**. Choose, also, to save a valuable year by earning your Bachelor of Science Degree here in 36 months of intensive study.

This 46-year-old, non-profit Technical Institute offers a world-famous course in Electrical Engineering with a major in Electronics. You follow an industry-guided program which is constantly attuned to current developments. It presents a solid background in the basic sciences . . . Chemistry, Physics, Mathematics, Economics and Electrical Engineering subjects . . . plus 19 technical specialty courses in Engineering Electronics, including four courses in Electronic Design.

Practical, military or academic training will be evaluated for advanced credit.

ELECTRONIC TECHNICIAN

At the end of the first year of study of the Electrical Engineering course, the student is qualified as an Electronic Technician.

RADIO-TELEVISION TECHNICIAN

To young men interested specifically in radio and television: Prepare here for a career in television—the field which business leaders predict will be among America's top ten industries by 1951. In 18 months you become a Radio-Television Technician, ready for positions in receiver and transmitting testing, servicing, sales, supervision and production.

Because of this school's concentric curriculum, the Bachelor of Science degree in Electrical Engineering (Electronics major) may be earned in 24 additional months.

• • •

A SPECIAL PREPARATORY PROGRAM is offered for men lacking high school diplomas.

TRAIN in modern, well-equipped laboratories, shops and classrooms. Faculty of 85 specialists—over 1500 students and 30,000 graduates.



FALL TERM OPENS OCT. 3

MILWAUKEE SCHOOL OF ENGINEERING

Founded 1903
by Oscar Werwath

Electrical Engineering	36 months
Electronics Major	
Electronic Technician	12 months
Radio-Television Technician	18 months

Send Coupon for free 48-page Pictorial Bulletin "Your Career" and 110-page Catalog.



MILWAUKEE SCHOOL OF ENGINEERING

Dept. RE-849, N. Broadway and E. State, Milwaukee, Wis.

Without obligation send me the Bulletin, "Your Career," and your catalog. I am interested in _____ course.

NAME AGE

ADDRESS

CITY STATE () Veteran of World War II

RADIO-TELEVISION

Save school time and money with WRTI Specialized Trainings. Qualify for high-income technical careers in only ten months under practical engineer-instructors. Practical daily lecture-laboratory training provides the skills necessary to hold down responsible positions. Become an FCC-licensed commercial Radio Operator; or, an FM-Radio-Television Technician. WRTI graduates employed world-wide. Approved for veterans; non-veterans accepted. Send for free illustrated booklet.

WESTERN RADIO-TELEVISION INSTITUTE
341-A West 18th St., Los Angeles 15, California

LEARN RADIO!

PREPARE FOR A GOOD JOB!
COMMERCIAL OPERATOR (CODE)
RADIO SERVICEMAN
TELEVISION SERVICING
BROADCAST ENGINEER

V.A. Furnishes Books and Tools
SEND FOR FREE LITERATURE
BALTIMORE TECHNICAL INSTITUTE
1425 Eutaw Place, Dept. C, Baltimore 17, Md.



JOBS IN TELEVISION

YOUNG MEN 16 TO 60

There is a Job Opening for Every Qualified Trained Television Technician

WE CAN TRAIN YOU

Free Employment Service

Visit Our Modern Laboratories and Class Rooms

APPROVED UNDER G.I. BILL OF RIGHTS

AMERICAN RADIO INSTITUTE

New York Buffalo, N. Y. Syracuse, N. Y.
2010 B'way (68 St.) 640 Main St. 131 Shonnard St.

"Teaching Radio Since 1935"

FILL THAT JOB WITH A C.T.I. TRAINED MAN!

Solve your man-power shortage by employing well-trained, dependable young men who have been trained by Commercial Trades Institute. Our graduates have completed an intensive course in Radio or Television Servicing. Their training has been practical—in well-equipped shops under expert supervision. They've learned to do excellent work. To enable you to evaluate the efficiency of C.T.I. training, we'll be glad to send you an outline of the course. You'll find the subject matter extensive, complete, thorough.

We probably have men who hail from your vicinity, but most of our graduates will travel anywhere for a good opportunity. We cordially invite employers to write us for detailed information on available men. (No employment fees.) Address:

Placement Manager, Dept. P108-8
COMMERCIAL TRADES INSTITUTE
1400 W. Greenleaf Ave., Chicago 26, Ill.

RADIO ENGINEERING!

Complete Radio Engineering Course. Bachelor of Science Degree. Courses also in Civil, Electrical, Mechanical, Chemical, Aeronautical Engineering; Business Administration, Accounting, Secretarial Science. Graduates successful. 66th year. Enter Sept., Jan., March, June. Write for catalog.

DEGREE IN 27 MONTHS

TRI-STATE COLLEGE 2489 College Ave., ANGOLA INDIANA

Make Your Career RADIO and TV

In no other industry does the future hold brighter financial promise and security than in AM and FM Radio, Television. These fields need and want men trained as announcers, script writers, disc jockeys, and radio technicians. It will pay you to investigate the Don Martin School of Radio Arts, established in 1937. Complete day and night classes . . . the latest equipment . . . and a staff of 30 nationally known instructors. Over 97% of the combination men graduates are placed on jobs immediately through the free placement service. Approved for veterans.

FREE—Write for Free Booklet "Your Future In Radio."

Don Martin School of Radio Arts

1655 No. Chroake, Hollywood, Calif. HUDSON 23281

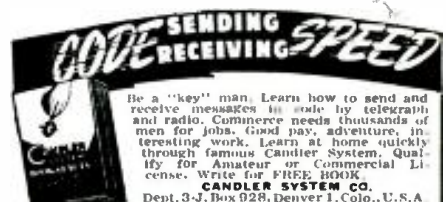

Be a "key" man. Learn how to send and receive messages in code by telegraph and radio. Commerce needs thousands of men for jobs. Good pay. Interesting work. Learn at home quickly through famous Candler System. Quality for Amateur or Commercial License. Write for FREE BOOK
CANDLER SYSTEM CO.
Dept. 3-J, Box 928, Denver 1, Colo., U.S.A.

ELECTRICAL TRAINING

Intensive 32 weeks' residence course in fundamentals of industrial electrical engineering, including radio, electronics. Prepares for technician, engineering aides. Approved for veteran training. 56th year. Enter Sept. 6, Jan. 9, Catalog

BLISS ELECTRICAL SCHOOL
7548 TAKOMA AVENUE
WASHINGTON 12, D. C.



RADIO ENGINEERING
FM—Television—Broadcast

Police Radio, Marine Radio, Radio Services, Aviation Radio and Ultra High mobile applications. Thorough training in all branches of Radio and Electronics. Modern laboratories and equipment. Old established school. Ample housing facilities. 7 acre campus. Small classes, enrollments limited. Our graduates are in demand. Write for catalog.

Approved for Veterans

VALPARAISO TECHNICAL INSTITUTE
Dept. C VALPARAISO, INDIANA

RADIO COURSES

Preparatory Mathematics, Service, Broadcast, Television, Marine Operating, Aeronautical, Frequency Modulation, Radar.

Classes now coming out the fall term Oct. 1st
Entrance exam, Sept. 19th

Veterans, Literature.

COMMERCIAL RADIO INSTITUTE
(founded 1920)
59 West Biddle Street, Baltimore 1, Md.

TELEVISION NEW, INTERESTING TECHNICAL CAREER

As Television gains momentum, rapidly, constantly, it offers to properly-trained technicians careers with a future in Industry, Broadcasting or own Business.

Train at an Institute that pioneered in TELEVISION TRAINING since 1938.

Morning, Afternoon or Evening Sessions in laboratory and theoretical instruction, under guidance of experts, covering all phases of Radio, Frequency Modulation, Television. Licensed by N. Y. State. Free Placement Service. Approved for Veterans.

ENROLL NOW FOR NEW CLASSES
Visit, Write or Phone

RADIO-TELEVISION INSTITUTE

480 Lexington Ave., N. Y. 17 (46th St.)
Plaza 3-4585 2 blocks from Grand Central

AUDIO ENGINEERING SCHOOL

A practical Audio Engineering course in Sound Fundamentals: DISC, FILM and MAGNETIC Recording; Transmission Measurements, Monitoring and Mixing. Laboratories contain Transmission Sets, Oscillators; Harmonic Analyzers, Distortion Sets, Intermodulation Analyzer, and other equipment. Recording Studio simulating Broadcast, Motion Picture and Commercial Sound Recording. H. M. Tremaine, Pres.-Director. Approved for Veterans and Foreign Vinas.

HOLLYWOOD SOUND INSTITUTE, Inc.
1040-E North Kenmore Hollywood 27, Calif.

RCA RADIO and TELEVISION

Thorough Training in All Technical Phases

APPROVED FOR VETERANS
DAYS—EVENINGS WEEKLY RATES

RCA GRADUATES ARE IN DEMAND
For Free Catalog Write Dept. RC-49

RCA INSTITUTES, Inc.
A Service of Radio Corporation of America
350 WEST 4TH STREET NEW YORK 14, N. Y.

zation of this type cannot be run by mail order. Seventy-five percent of the radio technician's problems are local. Take the matter of fair charges for instance. It would be impossible to set these on a national scale, for a technician in one area would starve to death on what would be exorbitant charges for another part of the country.

Besides the difference in problems, a national organization finds it hard to keep in contact with the members and promote local activity. As a result, he finds himself merely a name on a membership roll. Such an organization gets no recognition from the manufacturers nor the public. It just adds another wall plaque to the display of certificates, bonds and diplomas many radiomen already have on their walls, and to which few people pay any attention.

The only organization worth anything is one in which radio technicians join to work together for objectives they could not easily obtain separately. For this the local organization is ideal. If you have a local problem, talk it over with other local men and form a group of five men or more to do something about it. No town is too small. In some Western organizations, members come 30 miles to meetings. Draw a 30-circle around your shop and count the radio technicians inside it!

If your problem is low returns, agree not to cut rates—or each other's throats. If bad publicity, send your chairman and secretary round to the local paper—or broadcast station, if you have one. Do people complain of dishonest repair? Offer the services of your organization to investigate such cases, and to testify where dishonest work is found and the customer is willing to prosecute. Arrange technical meetings with outside talent. Increase business with educational campaigns to the public. Your organization will be a success as long as you work and keep it working.

Some things cannot be well done by a local organization. Top-notch speakers of the radio field are willing to address you if a series of meetings can be arranged. State laws come up—such as the proposed one to permit erection of roof antennas for television—at which the radio technician should be heard. For these purposes the State Federation is perfectly adapted. Both Pennsylvania and New York now have such federations, and other states will follow as radio technicians' organizations increase in number.

A national federation to handle interstate problems will be the next step. Such a national federation—built up the democratic way through local and state associations, and handling only the business they cannot—can be successful.

Remember, no organization can "do something for you," but you can often do more for yourself through an organization than without it. We hope to hear in your next letter that you and your colleagues have formed a local Electronic Technicians Association.—
Editor



25 WATT P.P. 6L6 HI GAIN AMPLIFIER KIT

A wonderful buy! Make up an amplifier worth \$50 to you. Powerful enough for auditoriums, seating 1500 people. Separately controlled Mike & Phono inputs. All parts, incl. drilled chassis, hardware, solder, circuit diagram, etc.



Less tubes, Ship. wt. 12 lbs.
PRICES NET F.O.B. OUR PLANT.

Universal/general corp.
365J Conel St., N. Y. 13; Walker 5-9642

PEN-OSCIL-LITE

Extremely convenient test oscillator for all radio servicing, alignment • Small as a pen • Self powered • Range from 700 cycles audio to over 600 megacycles u.h.f. • Output from zero to 125 v. • Low in cost • Used by Signal Corps • Write for information.

GENERAL TEST EQUIPMENT
38 Argyle Ave. Buffalo 9, N. Y.

OPPORTUNITY AD-LETS

Advertisements in this section cost 25c a word for each insertion. Name, address and initials must be included at the above rate. Cash should accompany all classified advertisements unless placed by an accredited advertising agency. No advertisement for less than ten words accepted. Ten percent discount six issues, twenty percent for twelve issues. Objectionable or misbalancing advertisements not accepted. Advertisements for September, 1949, issue, must reach us not later than July 24, 1949.

Radio-electronics, 23 W. Broadway, New York 7, N. Y.

"RADIOBUILDER", 3 ISSUES 25c. SAMPLE FREE. Laboratories, 578-B, San Carlos, California.

WE REPAIR ALL TYPES OF ELECTRICAL INSTRUMENTS, tube checkers and analyzers. Hazleton Instrument Co. (Electric Meter Laboratory), 140 Liberty Street, New York, N. Y. Telephone—B-Arcley 7-4239.

24 VOLT AIRCRAFT BATTERIES. NEW 11 AMP AT 5 hr rate. Dry charged \$14.50 ea. less 25% in lots of four. No C.O.D.'s please. Security Parachute Co., Oakland Airport, Oakland, Calif.

BARGAINS: NEW AND RECONDITIONED HALLICRAFTERS, National, Collins, Hammarlund, Meissner, RME, other receivers, tuners, television receivers, transmitters, etc. Wholesale prices. Terms. Shipped on trial. Liberal trade in allowance. Write: Henry Radio, Butler, Missouri and 11240 West Olympic, Los Angeles, California.

HERMAN LEWIS GORDON, REGISTERED PATENT ATTORNEY. Patent Investigations and Opinions. Warner Building, Washington, D.C.

MAGAZINES (BACK DATES)—FOREIGN, DOMESTIC, etc. Books, booklets, subscriptions, pin-ups, etc. Catalog, 10c (refund). Cicerone's, 863 First Ave., New York 17, N. Y.

BARGAIN HUNTING! RADIO SERVICEMEN WRITE. Sensational catalog. Henshaw Radio Supply, 3619 Troost, Kansas City 3, Missouri.

AMATEUR RADIO LICENSEES. COMPLETE THEORY preparation for passing amateur radio examination. Home study and resident courses. American Radio Institute, 101 West 63rd St., New York City. See our ad on Page 78.

LANCASTER, ALLWINE & ROMMEL, 436 BOWEN Building, Washington 5, D.C. Registered Patent Attorneys. Practice before United States Patent Office. Validity and infringement Investigations and Opinions. Booklet and form "Evidence of Concealment" forwarded upon request.

27 years experience radio repairing. Simplified system. No calculations. No formulas. Total price \$2.00 postpaid (C.O.D. Moneyback guarantee. Ross Radio, 14615 Grandriver, Detroit 27, Mich.

RADIOMEN, SERVICEMEN, BEGINNERS — MAKE more money, easily, quickly. \$250 weekly possible. We show you how. Information free. Merit Products, 216-32L 132nd Avenue, Springfield Gardens 13, New York.

ALUMINUM TUBING, ETC. BEAMS FOR AMATEURS, TV, FM. Write for lists. Willard Radcliff, Fostoria, Ohio.

101 RADIO REPAIRING TIPS (BOOKLET). SEND 50 cents U.S. Radio, 135 E. 28 St., New York 16, N. Y.

For sale, 300 sets; wireless sets, Canadian, 19 MK and 11, export packed, 193 wireless sets, American, B-19, in crates, 108 wireless sets, Canadian, 19 MK, 11 basic stations, in crates. Export packed sets are complete with antennas and spare tubes; American sets are less antennas and spare tubes; basic Canadian sets are repacked with 1 set of antennas. FOB Canada, \$32. Amco Brass, 428 Broome St., New York.

PHOTOFLASH TUBES PENNSYLVANIA R4330, BRAND New \$10.00. Quantities of Ten \$8.00. Iavaroni, 1218 Leland Ave., Bronx 60, N. Y.

TELEPHONE DIALS, USED, AUTOMATIC ELECTRIC AK-11 \$3.25, N.Y. Type-1 Rebuilt \$2.25. Rebuilt \$1.25. All dials postpaid in U.S. Kissel Electric Products, 431-C Sherman, Gallon, Ohio.

UNITED'S SUMMER VALUES!!!!

BC-454 RECEIVER. 3 to 6 Mc. Like new—\$4.50.
BC-458 TRANSMITTER. 5.3 to 7 Mc. Used, good condition—\$7.95.

274-N TRANSMITTER RACKS. Single (FT-234-A). Double (FT-235-A) New, either type—\$9c.

ARR-1 RECEIVER. A beautifully built T.R.F. job, in the 231 to 258 Mc. band. A "natural" for conversion to 1 1/2 meters!!!! Excellent condition, with tubes and antenna relay box. Approx. shpg. wt. 8 lbs.—\$7.95.

V.H.F. TRANS.-REC. Similar to BC-966 I.F.F. 14 tubes, with dynamotor, gear train, relays and many other useful parts. Operates in the vicinity of 200 Mc. Shpg. wt. approx. 40 lbs. Express only. Like new—\$9.75.

BC-702A RADAR TRANSMITTER. Airborne. Uses 2-R.K.L. #7 tubes in coaxial line I.F. system. 4-2X2 rectifiers in power supply. For 115 V. @ 400 Cye. Exceptional experimenters item or parts buy! Shpg. wt. approx. 60 lbs. Express only. New—\$12.95. Used, good condition—\$9.95.

ASB-5 RADAR TRANSMITTER. Navy. Operates in the 500 Mc. region. Uses 4 type 15-E tubes in P.P. parallel line R.F. 1-150 Rectifier. Completely shielded in black wrinkled case. High quality parts. 115 V. 800 Cye. Shpg. wt. approx. 40 lbs. Express only. Like New—\$12.50.

RELAY SELECTOR UNIT. BC-685A. Consists of two individual band-pass filters, 450 cycles and 700 cycles, each uses 3 25L6GT and 1-1216 tubes. Components include 14 telephone type relays, 200 and 500 ohm coils, one 25 position 4 circuit rotary relay with 12 ohm coil, band-pass transformers, networks, resistors, condensers, etc., etc. Panel controls are missing. Heavy gauge chassis and panel, size: 8 3/4" X 11 3/4" X 10". Metal hood encloses entire unit. Shpg. wt. approx. 55 lbs. Express only. Like new, less tubes, including diagram—\$14.95.

TRANSCIEVER TRANSFORMERS. Input for single button mike and single plate, to single grid. Shielded. Lug terminals. New—79c.

BK-22 ROTARY RELAYS. As used with 269 series compass units. Like new condition—\$1.95.

M-299 MICROPHONE ADAPTER. for SCR-522—79c.

VOLUME CONTROL ASSORTMENT. A selection of various types of carbon and wirewound controls. All new and clean. A SUPER VALUE!!!! DON'T MISS IT!!!! 15 for 98c.

CONDENSER SPECIALS

4.0 Mfd. 800 V.D.C. Square upright can—29c.
40 + 40 Mfd. 250 V.D.C. Round upright can—55c.
1 Mfd. 1000 V.D.C. Small Rect. can. 6 for \$1.00.
2 Mfd. 600 V.D.C. Round can. 6 for \$1.00.
500 Mfd. 200 V.D.C. Sealed round can. with mounting bracket—\$1.05.

OUNCER TRANSFORMER W-226262-4

AF Output. Pri. Impedance: 10,000 Ohms. Sec. Impedance: 4000 Ohms, tapped at 250 Ohms. Metal can: 1 3/4" Lx. X 1" O.D. Overall. 10% at 75 Mw. 400 Cye. 20% at 75 Mw. @ 250 Cye. Response: 250 to 2500 Cye. ± 3 dB Glass sealed. New—95c. ea.

OUNCER TRANSFORMER #7254502

Pri. Impedance: 5000 Ohms. Sec. Impedance: 250 Ohms. Size: 1 3/4" Lx. X 1" Overall. Diagram on case. Hermetically sealed. New—89c. ea.

POWER AMPLIFIER AND POWER SUPPLY

For console radio-phonograph combination. Tubes: 1-68Q7; 1-6J5; P.P. 6V6; 1-5Y3 or 5Z4 Rect. 12 Watts output. Power supply delivers 350 V.D.C. at 150 Ma. Size: 8" X 7" 6-8 Ohms to sock. All outlets built-in for phono motor, pick-up, speaker and input. Beautifully built. Brand new. Less tubes. Shpg. Wt. Approx 17 lbs. Express only. A GREAT BUY!! Only \$7.95.

LAST SHIPMENT, JUST ARRIVED!! V.H.F. TRANS-CEIVER (SCR-522) (AM)

Only a few of these popular sets are left at this attractive price. Our units are clean and in good overall condition. DON'T WAIT!! ORDER NOW!! Shpg. Wt. Approx. 60 lbs. Express only. With tubes. \$39.95.

RADIO PARTS KITS

Registers. Assorted Values.
No. 1 Carbon. Non-Ins. 1/4 W. to 2W. 100 for 65c.
No. 2 Carbon. Ins. 1/4 W. to 2 W. 100 for \$1.69.
No. 3 W.W. Enameled 5 W. to 50 W. 25 for \$1.95.

UNITED SURPLUS MATERIALS

314 S. Halsted St.

Chicago 6, Ill.

Condensers, Assorted Voltages

No. 4 Paper Tube. .0003 Mfd. to .1 Mfd. 100 for \$1.95.

No. 5 Oil paper. .002 Mfd. to 1 Mfd. 50 for \$2.19.

No. 6 Auto. Gen. and Distr. types. 50 for \$1.69.

No. 7 Mica. Ins. 37 Mmf. to .1 Mfd. 100 for \$1.95.

No. 8 Mica Nmtg. .0002 Mfd. to .01 Mfd. 10 for \$1.19.

No. 9 Ceramics. 1.0 to 1000 Mmf. 100 for \$1.95.

No. 10 Trimmers. 1, 2, 3 and 4 sections. 15 for \$1.00.

No. 11 Fillets. Tub., F.P., cartridge, etc. 10 for \$1.95.

No. 12 Air Pad. All types. Ceramic Ins. 10 for \$1.19.

Transformers

No. 13 Power. 40 to 140 Ma. 5 and 6.3 V. Fil. ass't of 5 for \$8.95.

No. 14 Output. P.P. Singles. 3 to 15 W. 10 ass't \$3.95.

No. 15 Chokes. 40 to 180 Ma. Ass't Induct. 10 for \$4.45.

Tube Sockets. All new

No. 16 4 to 8 Pin. Inc. min. 25 ass't 89c.

Terminal Strips

No. 17 Assorted styles and sizes. 50 for 89c.

Hardware Assortments

No. 18 Solder lugs. All sizes and types. 3 lbs. for \$1.29.

No. 19 Screws, Nuts, Washers, etc. 3 lbs. for \$1.29.

No. 20 Alum. Rivets. All sizes and types. 3 lbs. for \$1.29.

Insulators. Ceramic

No. 21 Studs. Spacers. Feed-thrus, etc. 50 for \$1.79.

**1 SET OF ALL
21 KITS LISTED—\$35.00**

METERS, 2" ROUND CASE. ALL NEW

Volts. D.C.

(a) Gruen, 0-150, \$1.49.

(b) Wsthouse, 2 scales 0-3.5, 0-140, \$1.85.

Amps., D.C.

(c) Gruen, 0-1.5, \$1.59.

(d) G.E., F.S.—5 Ma. 0-50 scale. Less Sht., \$1.49.

(e) Trin. F.S.—10 Ma. 0-50 scale, \$1.49.

Amps. R.F.

(f) G.E. 0-6 With Thermocouple, \$1.69.

(g) G.E. 0-8 With Thermocouple, \$1.69.

Milliamps.

(h) Weston, #507. F.S.—1.2 D.C. 0-100 scale, \$1.69.

(i) Readrite, sq. 0-10 Volts DC. Black Fin., \$0.59.

FENWAL THERMOSWITCHES

S-17, 115 V. 10 Amps. Set at 275 degrees. 3/4" D. X 4 1/2" L. Asbestos covered shielded leads. Variable from -100° to +400° F. at 90° per turn. New 95c. S-15. Same as S-17 except for 5 Amps. rating. New. 79c.

G.E. 5 DY83AB31 Dynamotor

12 V.D.C. at 6.9 Amps. Input: 550 V.D.C. at 85 Ma. Output. Shpg. Wt.—9 1/2 lbs. New—\$2.95.

HOOKUP WIRE

Assorted sizes and colors. Fabrics, Plastic. Rubber and Glass Insulation. Solid and Stranded. 500 Ft. assortment—\$2.39.

HOOKUP WIRE

New cut wire. Lengths from 3" to 20" L. in various sizes and types of insulation. Our selection of 3 lbs. Only \$1.00.

NOW!!! BETTER THAN EVER BEFORE!!!! OUR ELECTRONIC PACKAGE!!!!

Check full of new and different parts and assemblies. 10 lbs. of good usable material for only \$1.29. GET YOURS NOW!!!!

Quantities are limited—Order now. Minimum order—\$2.00. There will be a 25c packing charge for all orders under \$2.00. 25% deposit required. balance C.O.D. All orders shipped F.O.B. Chicago, Illinois. Any orders received without shipping instructions will be shipped Railway Express.

Index to Advertisers

Allied Radio Corporation	57
Almo	74
American Merrilei Company	75
Amplifier Corporation of America	81
Bell Telephone Laboratories, Inc. Inside Front Cover	
Boland & Boyce, Inc.	8
Brooks Radio Distributing Company	62
Buffalo Radio Supply	81
Capital Radio Engineering Institute	12
Certified Television Laboratories	68
Cinex, Inc.	68
Cleveland Institute of Radio	16
Communications Equipment Company	67
Concert Master Radio Tube Company	72
Cosmic Counters	76
Cayne Electrical School	74
DeForest's Training, Inc.	7
Fair Radio Sales	65
Feiler Engineering Company	77
The Forty-Niner Company	69
General Electronic Distributing Company	61
General Test Equipment Company	79
Gernsback Library Series	76
Greylock Electronic Supply Company	74
Heath Company	10, 11
Instructograph Company	76
International Resistance Company	Back Cover
Lafayette-Concord	64
Leatone Radio Corporation	68
Liberty Electronics	68
Microcircuits Company	58
Mid-America Company	4
Midwest Radio Co.	77
Mohawk Electronics Company	74
Murray Hill Books, Inc.	75
National Company	Inside Back Cover
National Radio Institute	3
National Schools	5
Niagara Radio Supply	74
Opad-Green Company	74
Opportunity Adlets	79
Precision Apparatus Company	58
Progressive Electronics Company	9
Quam Nichols Company	58

RADIO SCHOOL DIRECTORY

(Pages 78-79)

American Radio Institute	
Baltimore Technical Institute	
Bliss Electrical School	
Candler System Company	
Commercial Radio Institute	
Commercial Trades Institute	
Dan Martin School of Radio Arts	
Hollywood Sound Institute	
Milwaukee School of Engineering	
RCA Institutes	
Radio-Television Institute	
Tri-State College	
Valparaiso Technical Institute	
Western Radio-Television Institute	

Radio Apparatus Corporation	65
Radio City Products Company, Inc.	75
Radio Dealers Supply	68
Radionic Equipment Company	66
Radio Supply & Engineering Company	69
Salco Electrical Distributors	58
Senco Radio, Inc.	73
Servelux Manufacturing Company	66
Hotel Strand	65
Sylvania Electric Products	6, 13
Telekit	77
Toute La Radio	74
Transvision	71
United Surplus Materials	80
Universal General Corporation	79
Welin	15
Wells Sales, Inc.	82
Wholesale Radio Parts Company, Inc.	14

THE A.R.R.L. ANTENNA BOOK (5th Edition—1949), by the Headquarters Staff of the American Radio Relay League. Published by The American Radio Relay League, Inc., West Hartford, Conn. 6 1/4 x 9 1/4 inches, 266 pages plus index and catalog section. Price, \$1.00.

Though written especially for radio amateurs, this edition can be considered a textbook on antennas and be used by students, experimenters, and professional engineers.

Its first five chapters are devoted entirely to antenna theory and design problems, and sufficient data is provided to permit the reader to design an antenna to his own specifications. Chapters six through ten give full details on constructing specific types of antennas for the various amateur bands. By following the directions in these chapters, the reader can erect many different antenna systems without resorting to the design data in the foregoing chapters.

The remaining chapters cover the mechanics of antennas and include details on constructing and raising masts, rotary beam mechanisms, and orienting antennas.—R.F.S.

AUTOMATIC RECORD CHANGER SERVICE MANUAL, VOL. 2, published by Howard W. Sams, Inc., Indianapolis, Ind. 8 1/2 x 11 inches. Price \$6.75.

This manual describes 45 record changers and magnetic recorders, and a certificate accompanying the book entitles the buyer to a supplement on the RCA 45-r.p.m. unit when it is issued. The data on each changer or recorder

includes operating instructions, a detailed explanation of how it works, lubricating procedure, and a list of usual troubles and their solutions. As in all the Photofact publications, photos and drawings are plentiful. In this manual, each mechanism is pictured at least once in operating position; and at least two under-chassis photos, with numbered arrows for every part, are furnished. An exploded-view drawing shows in detail how each unit is constructed. Parts lists are furnished.—R.H.D.

INTRODUCTORY RADIO THEORY AND SERVICING by H. J. Hicks. Published by McGraw-Hill Book Co., Inc., New York. 6 1/4 x 9 1/4 inches, 393 pages. Price \$4.

No electronic knowledge on the part of the reader, nor any mathematical training other than the ability to add, subtract, multiply, divide, and square is assumed by this text.

As an introduction to radio—and that is the expressed purpose, according to the title—it turns in a creditable job. The explanations are certainly easy to follow, as far as they go. There are very many diagrams of practical circuits and a large quantity of do-it projects. Servicing is definitely stressed, the author pointing out possible troubles at every opportunity. Separate chapters on FM and television are provided.

All in all, a good introduction for the novice—easy to read and as informative as befits its purpose—a well calculated encourager for more advanced study.—R.H.D.



But ALL Prefer **TWIN-TRAX***

"The Tape Recorder the Engineers are Buying"

When it comes to high fidelity sound equipment, it's the specifications that count with engineers. And that's why they're buying Twin-Trax—the popular-priced tape recorder with professional specifications. Extended frequency response, wide dynamic range, low hum level, easy operation, trouble-free performance! And two tracks means twice the playing time on standard tape reels, with tape costs cut in half—a saving you don't have to be an engineer to appreciate.

Write today for technical literature and professional factory discounts.

AMPLIFIER CORP. OF AMERICA
398-10 Broadway New York 13, N. Y.

BUFFALO RADIO SUPPLY, ONE OF AMERICA'S LARGEST ELECTRONIC DISTRIBUTORS, IS IN A POSITION TO SUPPLY MOST OF THE REQUIREMENTS OF FOREIGN PURCHASERS, DIRECTLY FROM ITS GIGANTIC STOCKS OR THOSE OF ITS AFFILIATES. EXPORT INQUIRIES ARE SOLICITED BOTH FROM EXPORT HOUSES AND FROM FOREIGN GOVT. PURCHASING COMMISSIONS HERE AND ABROAD. EXPENSE CAN BE REDUCED AND REQUIREMENTS FILLED WITH A MINIMUM OF DELAY BY CONTACTING BUFFALO RADIO SUPPLY INITIALLY.

\$12.95 TAKE ALL BIG THREE BARGAINS

HOME WORKSHOP AT BARGAIN PRICE. Arcuate and Lucite 2 special guaranteed hobby lathe, the essential machine for the home workshop. Sturdy enough for light production work or factory standby service. Supplied with 56" of belting for connecting to any available electric motor or power take-off. Also included in this unbelievable offer are such accessories as a 1/2" drill chuck with specially hardened tool steel jaws, a 4" electric turnare high speed grinding wheel, a cotton luffing wheel with a large supply of luffing compound, and a 4" steel wire scratch brush. Your cost \$6.00. Sole export agent. Distributor inquiries invited.

ALUMINUM GEAR BOX 18x8x7 that contains two powerful electric motors and two matched gear trains, 62 gears in all ranging in size from 1/2 to 4 inches in diameter. This unit is readily converted to rotate a beam antenna or any other similar use. \$5.00

SENSATIONAL FASCINATING. AMAZING SELSYNS. Brand new selsyns made by G. F. Co. Two or more connected together work perfectly on 110 VAC. Any rotation of the shaft of one selsyn and all others connected to it will rotate exactly as many degrees in the same direction following inertially as if the units were connected together by shafting instead of wires. This is true whether you twist the shaft of the master unit a fraction of a revolution or many revolutions. Useful for indicating the direction of weather vanes, rotating directional antennas, or controlling innumerable operations from a distance. Complete with diagram and instructions. Per matched pair \$4.95

AUDIO AMPLIFIER—brand new dual stage triode amplifier having 2 of the valuable and scarce inner type audio transformers that sell for over \$10.00 a piece. Neat aluminum case, fully enclosed (largest dimension 6 inches) Perfect for intercom system, phono amplifier, mike amplifier or signal tracer amplifier for testing radio sets. A sensational bargain at only \$3.40 each

"SO" RADAR SET

Indicator (Ocelloscope) has a self contained pack designed to run from the 110 V. power supply on LST or PT boats. It provides a 5" diameter picture adjustable at will to an 80, 40, 4 or 2 mile circle with the boat at the center, showing location of land, other ships, or any obstruction, so that navigation can be carried out in pitch darkness or dense fog with as much safety as in brightest sunlight. Your cost \$39.95.

"P.M. SPEAKERS"

Latest type PM Speaker in a fully-enclosed finished metal cabinet. This speaker and case match communication receivers, and in addition make perfect intercom remote stations. Our price \$4.50, including output transformer. \$4.95

SPEAKERS—These PM Speakers are the finest that are available. All have heavy over-size Alnico V magnets.

3 1/2"	\$1.15	6 for \$6.60
4"	\$1.15	6 for \$6.60
5"	\$1.10	6 for \$6.60
6"	\$1.50	6 for \$8.70
6 1/2" Oval	\$2.10	6 for \$12.50
7" (Car Radio Size)	\$4.50	6 for \$27.00
8"	\$3.95	6 for \$23.70
8 1/2"	\$4.95	6 for \$29.70
10"	\$5.50	6 for \$33.00
12"	\$7.95	6 for \$47.70

AUTO-TRANSFORMER—Steps up 110v. or steps down 220v. to 110v.—\$1.95.

FIL. TRANS.—6.3v., 3 Amps.—\$1.35; Universal Output Trans. 8A, 250-892—1 1/2 Watt—\$3.29; 30 Watt—\$1.69. **AUDIO TRANS.**—FORMER: S. Plate to S. Grid. 311-79E; S. Plate to P.P. Grids—79C; Heavy Duty Class AB or B. P.P. inputs—\$1.49; Midget output for 7-17 Shure microphones, similar to VTC power type—\$2.00, stancor SB or DB mike to line or grid—\$1.95.

POWER TRANSFORMERS—Half-shell type, 110V, 60 cy. Centertapped HV winding. Filament either 2.5 or 6.3V filament when ordering.

For 4-5 tube sets—650V, 40MA, 5V	\$1.49
2.5 or 6.3V	
For 5-6 tube sets—650V, 45MA, 5V	1.75
2.5 or 6.3V	
For 6-7 tube sets—675V, 50MA, 5V	1.90
2.5 or 6.3V	
For 7-8 tube sets—700V, 70MA, 5V	2.35
2.5 or 6.3V	
For 7-8 tube sets—700V, 70MA, 5V	2.35
2.5 or 6.3V	
For 8-9 tube sets—700V, 90MA, 5V	3.60
2.5 or 6.3V	
For 9-11 tube sets—700V, 5V & 6.3V	2.45
2.5 or 6.3V	
For 9-15 tube sets—600V, 150MA, 5V	2.85
2.5 or 6.3V	

SENSATIONAL VALUE IN AC-DC POCKET TESTER

This analyzer, featuring a sensitive re-duction type meter housed in a bakelite case, represents the culmination of 15 years achievement in the instrument field by a large company specializing in electronic test equipment.

Specifications of the AC-DC Model

Volt-Ohm-milliammeter:	
AC Volts—0-25, 50, 125, 250	
DC Volts—0-25, 50, 125, 250	
Milliamperes AC—0 to 50	
DC Milliamperes—0 to 50	
Ohms Full Scale—100,000	
Ohms Center Scale—300	
Capacity—.05 to 15 Mfd.	

Total Price, prepaid anywhere in the U.S.A.—\$7.00. Similar DC Meter, lacking the AC operated ranges of above, \$5.50 prepaid.

1949 MODEL MUTUAL CONDUCTANCE TUBE TESTER, \$52.95

Attractive panel and case... Large 4 1/2" meter... Calibrated microhm scale as well as Bud-Good scale... Front panel fuse... Individual sockets for all tube base types—voltages from .75 v. to 117 v. and comp. switching flexibility allow all present and future tubes to be tested regardless of location of elements on tube base... Indicates gas content and detects shorts or opens on each individual section of all local, octal and miniature tubes including cold cathode, maxic eye and voltage regulator tubes as well as all ball-lamp. Manufacturer's name withheld because of special price offer.

Model "C" Slipping front counter case \$52.95
Model "B" Handsome hand-rubbed portable case \$79.95
Built-in roll chart with either of above \$5.00 extra

COMPRESSED AIR INSTANTLY, ANYWHERE!!

Portable Air Compressor and storage tank. Ruggedly built of best materials using lifetime lubricated ball-bearing on connecting rod and oil impregnated main bearing on shaft. Unusual design forever eliminates valve trouble, the most common fault in air compressors.

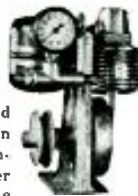

PATENTED unique air intake system increases efficiency tremendously over other compressors so that air output is much greater than that from larger compressors powered by heavier motors. Will deliver appr. 3500 cu. in. air per min. at maintained pressure of 30 lbs., or will inflate a 90 lb. truck tire in less than 1 min. Complete with 100 lb. gauge, fingertip adjustment allows setting of output pressure at any value, which will automatically be maintained. Works from any 1/4 HP. motor. Useful for spraying paints or lacquers, disinfectants, insecticides, annealing or brazing with natural gas, inflating tires, etc. Price \$14.50 postage prepaid anywhere in U.S. Efficient ad justable syphon type spray gun complete with 12 ft. of 100 lb. tested hose for only \$7.75 with pint container, also prepaid.

BUFFALO RADIO SUPPLY, 219-221 Genesee St., Dept. RE-89 BUFFALO 3, N. Y.

• TRANSMITTING
 • RECEIVING
 • INDUSTRIAL
 • SPECIAL PURPOSE

TUBES

Guaranteed
 by
WELLS

**IMMEDIATE DELIVERY
 AT THE LOWEST PRICES
 IN OUR HISTORY!**

Check this list for exceptional values in magnetrons, cathode ray tubes, voltage regulators, transmitting tubes—also neon, pilot and flashlight bulbs. These are brand new, standard make tubes. Order enough for future needs directly from this ad or through your local parts jobber.

Type	Price	Type	Price	Type	Price	Type	Price			
01A	\$0.45	10Y/VT-25	\$0.45	707B	\$23.25	872A	\$2.45			
1B22	4.35	12A6	.25	710A	2.15	874	2.15			
1N21 Xtal Diode	.65	12A6	.65	713A	1.55	878	2.15			
1N21B "	.80	12K8	.70	714AY	9.95	930	2.20			
1N23 "	.80	12SF7	.40	RK715B	7.95	954	.50			
1N23A "	.85	12SH7	.60	717A	.90	955	.55			
1N27 "	.85	12SK7	.70	721A	3.95	956	.55			
1R4, 1294	.65	12SL7 GT	.40	724A	4.65	957	.55			
1R5	.95	12SR7	.40	724B	4.25	991 (NE-16)	.30			
1S5	.95	12x825 2 amp. Tungar	2.25	725A	19.95	1005	.35			
1S21	1.10	13-4 Ballast	.35	726A	19.95	1148	.40			
1T4	.95	15R	1.40	730A	11.95	1201	.75			
2C26	.35	FG-17	2.85	801	.60	1616	1.25			
2C26A	.45	REL-21	3.25	801A	.75	1619	.55			
2C34	.55	23D4 Ballast	.45	803	6.95	1624	1.25			
2J21A	11.45	25Z6 GT	.55	804	9.95	1625	.45			
2J22	9.85	28D7	.40	805	5.45	1626	.45			
2J26	8.45	30/VT-67 (For Walkie	.75	808	1.75	1629	.95			
2J27	14.45	33/VT-33	.75	809	2.75	1635	.95			
2J31	9.95	RK-34	.45	810	7.95	2051	.95			
2J32	14.85	34	.35	811	2.35	7193	.35			
2J33	19.95	39/44	.35	813	7.85	8011	2.55			
2J37	13.85	45 Spec.	.55	814	3.75	8012	4.25			
2J38	12.95	46	.80	815	2.85	8020	3.35			
2J48	14.95	EF50 VT250	.45	826	.49	8025	7.50			
2X2/879	.65	CEQ 72	1.50	829	3.25	9001	.70			
3A4	.35	72 3B24	1.75	830B	3.95	9002	.45			
3A5	1.05	VR-75	.90	837	1.75	9003	.65			
3AP1 CRT	3.85	76	.55	838	3.25	9004	.45			
3B22	2.95	VR-78	.65	841	.55	9006	.45			
3B24	1.75	80	.45	843	.55					
3BP1 CRT	3.75	FG-81-A	3.95	851	39.50	NEON BULBS FOR RADIO USE				
3CP1-S1	1.95	83	.85	WL-860	2.55	NE-2	\$0.06			
3C24/24G	.47	83V	.95	861	32.50	NE-15	.06			
3D6/1299	.65	89Y	.40	864	.55	NE-16	.24			
3FP7 CRT	2.95	VR-90	.70	865	2.55	NE-20	.06			
3HP7 CRT	2.95	VR-92	.65	866A	1.30	NE-21	.24			
3GP1 CRT	3.75	100R	3.25	869	26.50	NE-48	.24			
3Q5	.90	FG-105	9.95	869B	28.95	NE-51	.06			
REL-5	17.95	VR-105	.85							
5AP1 CRT	3.95	VU-111	.65							
5BP1 CRT	2.95	117Z3	.55							
5CP1 CRT	3.85	VT-127 English	.25							
5GP1 CRT	6.55	VT-127A	2.95							
5J23	14.25	VR-150	.55							
5J29	14.25	VT-158	9.85							
5Y3G	.40	FG-172	29.50							
6A6	.90	205B	1.95	Stock No.	Mazda No.	Volts	Watts	Bulb	Base	Price
6AB7	.95	211 (VT-4-C)	.65	350-40	64	6-8	3CP	G-6	DC Bay	\$0.07
6AC7	.90	215A	1.95	350-31	57	12-16	1.5CP	G4 1/2	Min. Bay	.08
6AK6	.80	231D	1.30	350-42	Spec.	12	6	S-6	Cand. Scr.	.13
6B7	.95	282B	4.25	350-20	1446	12	.2 amp.	G-3 1/2	Min. Scr.	.07
6BE6	.65	304TH	5.95	350-14	49	2	.06	T-3 1/4	Min. Bay	.06
6C4	.45	304TL	1.75	350-15	356	120	3	S-6	Can. Bay	.11
6C6	.75	307A	4.25	348-22	PR-10	6	.5 amp.	83 1/2	Min. Flang	.05
6C21	19.75	316A	.75	350-19	Proj. Bulb	120	500W	T-20	Med. Pf	1.45
6D6	.60	350B	2.55	LB-17C	24	.035A	T-2	T-2	Tel. Base	.18
6E5	.70	371B	.85	LB-58A	110	7W	C-7	C-7	Cand. Scr.	.17
6H6	.50	388A	4.95	LB-57A	53	12-16V	1CP		Min. Bay	.07
6J5/GT	.50	417A	19.95	LB-100A	Airplane					
6J6	.90	434A	7.45	LB-101	Headlight	24V	239W	A-19	Med. Pf	.38
6N7/GT	.80	446A	1.55	323	3	(AIRCRAFT)	T-1 1/2	T-1 1/2	953	.22
6R7G	.80	450TH	19.95	LM-60	115V	250W	T-20	T-20	Med. Pf	.40
6SF5	.65	GL-471A	2.75	LB-102	1195	.50CP	RP-11	RP-11	DC Bay	.14
6SG7	.70	527	11.25	LB-102A	CC-13	110V	100W	T-8	DC Pf	.33
6SH7	.40	WL-530	17.50	LB-102B	1491	2.4	.8 amp.		DC Bay	.14
6SL7/GT	.65	WL-531	17.50				(Airplane type)			
6SK7/GT	.65	532A/1B32	3.55	LB-102C	3D2	28	.17 amp.	T-3 1/2	DC Bay	.11
6SL7/GT	.65	GL-559	3.75	LB-104	313	28	.33A		Min. Bay	.12
6SN7/GT	.80	KU-610	7.45	LB-105	1816	13V	.09-.11	T-2	Tel. Base	.18
6SQ7/GT	.60	HY-615	1.20	LB-106	12A	12	.75 .105	T-2	Tel. Base	.18
7A4	.65	700B	9.95	LB-107	24-A2 WE	24	2 1/2 Watt	T-2	Med. Scr.	.22
7A7	.65	700C	9.95	LB-108	S-14 Argon	105	Telephone	Type Neon	T-2	.17
7C4/1203	.40	700D	9.95	LB-109	5	24	17	T-3	Min. Scr.	.16
7C7	.45	702A	2.95	350-18	1477	24				
7E6	.65	703A	4.85							
7F7	.75	705A	2.65							
7H7	.75	707A	19.50							
7N7	.75									
7Q7	.65									
10/VT-25A	.40									

10% DISCOUNT ON ORDERS OF \$100. OR OVER

Manufacturers: We carry thousands of electronic parts in stock. Send us your request for quotations.

Distributors: Our standard jobber arrangement applies. Order directly from this ad.



320 N. LA SALLE ST., DEPT.-Y, CHICAGO 10, ILL.

presenting

the

TV-10W



newest and handsomest of all

- Latest flyback high voltage supply gives clear, bright pictures even in fringe areas
- Automatic frequency control locks picture in place
- Two flanking speakers do justice to FM sound
- Front-of-panel focus control
- Coil switching assures equivalent of separate, high-Q tuned circuits for each channel
- Automatic gain control
- 3-stage 37 mc IF minimizes picture interference caused by other radio services
- Double-tuned RF bandpass circuits improve selectivity and image ratio.
- Automatic Station Selector and fine tuning control.



Features a big 10-inch picture tube — most popular size of all — in a genuine mahogany cabinet handsomely styled in the spirit of tomorrow . . . yet only

\$269⁵⁰

SLIGHTLY HIGHER WEST OF THE ROCKIES



8 NEW IRC RESISTOR AND CONTROL ASSORTMENTS

... all in sturdy metal

Realistically Priced Starting At

\$4.50

DEALER
NET COST

NEW RESIST-O-KIT

Latest addition to IRC's big family of metal kits. Pocket-size case ideal for service calls. 10 compartments, resistors can't mix. Ranges stamped on resistors. 2 assortments: 45 half watt or 30 one watt resistors—popular ranges, widely found in television.



METAL RESIST-O-CABINET

Perfect way to buy and stock resistors. 4 drawers with 28 range identified compartments. 3 fast-moving assortments: 100 half watt, 83 one watt, or Combination Assortment of 91 resistors (includes close tolerance IRC Precistors).



VOLUME CONTROL CABINET

Stocked with 18 new IRC type Q Controls plus switches and special shafts. Handles over 90% of all AM, FM and TV control replacements. Compartments individually marked. 3 drawers are provided for stocking switches, shafts and spare parts.

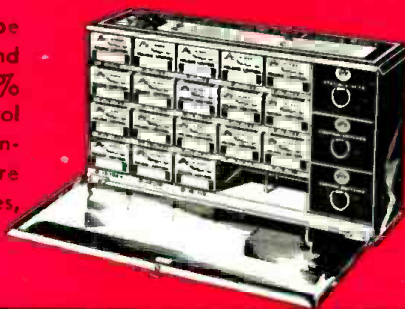

BASIC KIT

Wide variety resistor stock for all daily requirements. Covers 1/2 watts to heavy duty power resistors in selected ranges. Available with Serviceman's Special Assortment—heavy duty resistors omitted leaving space for small tools and parts, 8 new type Q Controls included.



Here's a full family of 8 IRC kits and cabinets tailored to your individual requirements. Each of these new resistor and control assortments comes to you in a beautiful all-metal cabinet at absolutely no extra cost—you pay only the regular price of the merchandise.

You'll want several of these attractive kits. They provide an efficient way to stock parts, add to the appearance of your shop—and save your time in unnecessary buying trips. All ranges have been carefully selected after a detailed analysis of AM, FM and TV requirements.

See these new kits at your IRC Distributor's, or write today for free catalog bulletin. International Resistance Co., 401 N. Broad St., Philadelphia 8, Pa. In Canada: International Resistance Co., Ltd., Toronto, Licensee.



INTERNATIONAL RESISTANCE CO.

Whenever the Circuit Says —W—

