

RADIO — ELECTRONICS

Exclusive
**TELEVISION
NEWS**
Section

formerly

HUGO GERNSBACK, Editor

**RADIO
CRAFT**



THE RADIO HAT
SEE NEW DESIGN

JUNE
1949

30¢

U. S. and
CANADA

ATEST IN RADIO — ELECTRONICS — TELEVISION

TRANSVISION TV INSTRUMENTS



**ELIMINATE the VARIABLES
in Television Installation
with the TRANSVISION
FIELD STRENGTH METER
IMPROVES INSTALLATIONS!!
SAVES 1/2 THE WORK!!**

Has numerous features and advantages, including—(1) Measures actual picture signal strength . . . (2) Permits actual picture signal measurements without the use of a complete television set . . . (3) Antenna orientation can be done exactly . . . (4) Measures losses or gain of various antenna and lead-in combinations . . . (5) Useful for checking receiver re-radiation (local oscillator) . . . (6) **12 CHANNEL SELECTOR** . . . (7) Amplitudes of interfering signals can be checked . . . (8) Weighs only 5 lbs. . . (9) Individually calibrated . . . (10) Housed in attractive metal carrying case . . . (11) Initial cost of this unit is covered after only 3 or 4 installations (12) Operates on 110V, 60 Cycles, A.C. Model FSM-1, with tubes. . . . Net \$99.50



**NEW LOW PRICE
TRANSVISION ALL-CHANNEL
TELEVISION BOOSTER**

CONTINUOUS TUNING

To assure television reception in weak signal areas, or areas which are out of range of certain broadcasting stations, Transvision engineers have designed this new booster. It increases signal strength on all television channels. Tunes all television channels continuously. Can be used with any type of television receiver. Unusually high gain in upper television channels.

Model B-1 List \$32.50

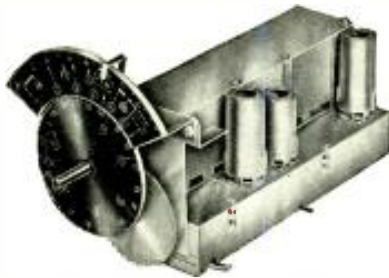

DuMont TV-FM INPUTUNER

The finest TV-FM Tuner on the market today! Distributed exclusively by Transvision.

- Covers all 12 channels, entire FM range.
- Continuously tunes from 44 to 216 mc without a break. Requires no band switching for tuning from channel to channel.
- Complete with tubes and escutcheon.

Model IT-1 List \$59.95

TRANSVISION ALL-ANGLE LENSES for ALL TV SETS

Give picture sizes up to 150 sq. in. Exclusive patented feature makes image visible from wide angle. Lenses come with adapter for installation on ANY 7" or 10" picture tube, and with color kits.

All-Angle Lens for 7" tubes (gives 75 sq. in. picture), \$25.95. All-Angle Lens for 10" tubes (gives 150 sq. in. picture), \$37.50.
For 1 1/2" tubes, \$49.50



**GET INTO the TV BUSINESS
in a BIG WAY with the
TRANSVISION DEALER PLAN
WRITE FOR FOLDER D-1**



TELEVISION and FM SWEEP SIGNAL GENERATOR

Complete frequency coverage from 0-227 MC with no band switching. . . . Sweep width from 0-12 MC completely variable. . . . Accurately calibrated built-in marker generator.

OUTSTANDING FEATURES: (1) Frequency range from 0-227 MC . . . (2) Dial calibrated in frequency . . . (3) Sweep width from 0-12 MC completely variable . . . (4) Self-contained markers readable directly on the dial to 5% or better. (No external generator required to provide the marker signals) . . . (5) Crystal controlled output makes possible any crystal controlled frequency from 5-230 MC . . . (6) Plenty of voltage output—permits stage-by-stage alignment . . . (7) Output impedance 5-125 ohms . . . (8) Directly calibrated markers, 20 30 MC for trap, sound and video IF alignment . . . (9) RF for alignment of traps for IF channels when a DC voltmeter is used as the indicating medium . . . (10) Unmodulated RF signal to provide marker pips simultaneously with the main variable oscillator . . . (11) Markers can be controlled as to output strength in the pip oscillator . . . (12) Power supply completely shielded and filtered to prevent leakage . . . (13) All active tubes are the new modern miniature type . . . (14) Phasing control incorporated in the generator . . . (15) Operates on 110V, 60 Cycles, AC.

Model SG Net \$79.50

REMOTE CONTROL UNIT OPERATES ANY TELEVISION SET from a DISTANCE up to 50 feet.



Model TRCU Remote Control Unit, factory pre-wired and tested, with 25-ft. cable \$69.00
Also available without cabinet 65.00

IF YOU ARE NOT NEAR A TRANSVISION OUTLET . . . USE THIS COUPON

MAIL TO: TRANSVISION, INC., NEW ROCHELLE, N. Y.

114 6

Please ship the following Transvision Products THROUGH YOUR NEAREST LOCAL OUTLET:—

I am enclosing 10% DEPOSIT in the amount of \$ _____, balance C.O.D.

() I want to get into the Television Business. Send me details of your Dealer Plan.

Name _____ City & Zone _____

(please print)

Address _____ State _____

You Practice COMMUNICATIONS

I Send You Parts To Build This Equipment

As part of my new Communications Course I send you parts to build your own Transmitter. Conduct actual procedure demanded of Broadcast Station Operators, practice many interesting experiments and tests, learn how to put a transmitter on the air.



You Practice Radio SERVICING

On This Modern Radio You Build With Parts I Send

As part of my Servicing Course, I send you the speaker, tubes, chassis, transformer, loop antenna, EVERYTHING you need to build this modern Radio Receiver that brings in local and distant stations. You use it to conduct many tests and experiments.



BE A RADIO TECHNICIAN

Learn Servicing or Communications

Learn by Practicing in Spare Time with MANY KITS OF PARTS I Send

YOU BUILD this Tester as part of my Servicing Course. It soon helps you EARN EXTRA MONEY fixing neighbors' radios in spare time.



YOU BUILD this Power Pack as part of my new Communications Course. Use it to conduct fascinating experiments with frequency amplifiers and multipliers, buffer stages, etc.



YOU BUILD this Superheterodyne Receiver Circuit and conduct Frequency Modulation experiments and many other tests as part of my Servicing Course.



YOU BUILD this Signal Generator as part of my Servicing Course for more valuable experience. It provides amplitude-modulated signals for many interesting tests and experiments.



VETERANS
GET THIS
TRAINING
WITHOUT COST
UNDER G. I. BILL
MAIL COUPON

YOU BUILD this Wavemeter as part of my new Communications Course. Use it with Oscillator you also build that furnishes basic power to transmitter and determines transmitter frequency.



J. E. SMITH, President National Radio Institute

Want a good-pay job in the fast-growing Radio and Television industries or to be boss of your own money-making Radio and Television shop? I've trained hundreds of men with no previous experience to be Radio technicians. I can do the same for you! Or now, for the first time, enroll in my new practical course in Radio—Television Communications—learn to be a Broadcasting and Communications technician. You learn Radio and Television principles from clear, illustrated lessons. You get practical Radio experience with MANY KITS OF PARTS I SEND in my train-at-home method. All equipment yours to keep.

MAKE EXTRA MONEY IN SPARE TIME

As part of my Radio Servicing Course, I send EXTRA MONEY booklets, starting the day you enroll. Use your know-how to make \$5, \$10 and more a week EXTRA MONEY fixing Radios in spare time while training. The next step is your own Radio shop or a good-pay Radio servicing job. Or, if you prefer, get into Government, Police, Aviation or Marine Radio, Broadcasting, Radio Manufacturing or Public Address Work.

BRIGHT FUTURE IN TELEVISION

Think of the present and future opportunities in the fast-growing Television field. New stations are going on the air every month. Television manufacturers are producing over 100,000 sets a month. It's a fast-growing field and the man who knows Television will be in demand.

GET ACTUAL LESSON AND BOOK FREE

Send now for my special DOUBLE FREE OFFER. Get actual lesson on Radio Repairing short-cuts absolutely free. Also get 64-page book, "HOW TO BE A SUCCESS IN RADIO—TELEVISION—ELECTRONICS." See how quickly, easily you can start. J. E. SMITH, President, Dept. 9FX National Radio Institute, Pioneer Home Study Radio School, Washington 9, D. C.

I TRAINED THESE MEN AT HOME



Good Job in Radio Station
"Am Chief Engineer of Station WORD, in charge of four men. Owe all I know about Radio to NRI." — CLYDE J. BURDETTE, Spartanburg, South Carolina.



Makes Extra Cash In Spare Time
"Earned enough spare time cash to pay for my course by time I graduated. NRI training is tops!" — ALEXANDER KISH, Carteret, New Jersey.



Operates Own Radio Business
"Now have two Radio shops servicing about 200 sets a month. Have largest service establishment in Southeast Missouri." — ARLEY STUDYVIN, DeSoto, Mo.

Good for Both—FREE

MR. J. E. SMITH, President, Dept. 9FX National Radio Institute, Washington 9, D. C.

Mail me FREE Sample Lesson and 64-page book about how to win success in Radio and Television—Electronics. (No salesman will call. Please write plainly.)

Name..... Age.....

Address.....

City..... Zone..... State.....

Check if Veteran APPROVED FOR TRAINING UNDER G. I. BILL

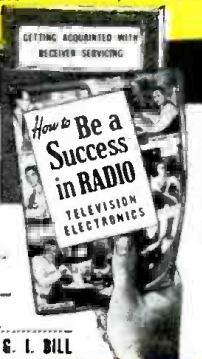

MY COURSE INCLUDES

TELEVISION

RADIO — ELECTRONICS

formerly **RADIO-CRAFT**

Incorporating

SHORT WAVE CRAFT* TELEVISION NEWS*
RADIO & TELEVISION

*Trademark registered U. S. Patent Office

Circulation Manager **G. Aliquo**
Sales Managers **John J. Lamson**
Lee Robinson
Business Manager **Charles K. Brett**
Promotion Manager **Alfred Stern**

Hugo Gernsback, Editor-in-Chief
Fred Shunaman, Western Editor
M. Harvey Gernsback, Consulting Editor
Robert F. Scott, W2PWG, Technical Editor
R. H. Dorf, W2QMI, Associate Editor
I. Queen, W2OUX, Editorial Associate
Angie Pascale, Production Manager
Elmer Fuller, Shortwave Editor
Wm. Lyon McLaughlin,
Tech. Illustration Director

177,000 COPIES
OF THIS ISSUE
DISTRIBUTED

Contents June, 1949

Editorial (Page 19)	Whither Radio	by Hugo Gernsback	19	
Television News (Pages 20-31)	Electronic Magic	by H. W. Secor	20	
	USAF Shows Off its Television	by B. W. Southwell	23	
	Television Helps Astronomy	by William Rhodes	24	
	Antennas for Television, Part VI	by M. Nail and Matt Mandl	26	
	Pedro's Temporary Cure	by Guy Slaughter	28	
	Ignition Interference to FM and Television	by John B. Ledbetter	30	
New Design (Pages 32-33)	The Radio Hat (cover Feature)		32	
Electronics (Pages 34-36)	Electronics in Medicine, Part VIII	by Eugene Thompson	34	
Theory and Engineering (Pages 37-39)	Microwaves, Part III	by C. W. Palmer	37	
Servicing (Pages 40-49)	How to Repair a Hammond Solovox	by Homer L. Davidson	40	
	Servicing Intermittents	by John B. Ledbetter	42	
	Legal Rights of Radio Technicians	by Leo T. Parker	44	
	Heat Reduction in Midget Sets	by John T. Bailey	46	
	Specialize for Increased Profits	by Matt Mandl	48	
Construction (Pages 50-51)	Electronic Metronome has Neon-Lamp Time Indicator	by O. A. Coppens	50	
Amateur (Pages 52-56)	Mobile 10-Meter Rig	by Paul M. Kersten, WØWIT	52	
	A New Low-Cost Transmitter	by Carlton G. Rich, W8ZYG	54	
Test Instruments (Pages 57-61)	Carvalzer Services Auto Radios	by S. H. Covington, Jr.	57	
	Combination Instruments Measures R, C, and L Accurately	by B. J. Cederqvist, OH2NL	60	
Audio (Pages 62-67)	Versatile Amplifier for 6 or 117 Volts	by Paul W. Streeter	62	
	Observation on TV-Sound	by Richard H. Dorf	64	
	Designing Push-Pull Amplifiers	by David Fidelman	65	
Foreign News (Pages 70-71)	European Report	by Major Ralph W. Hallows	70	
Departments	The Radio Month	10	World-Wide Station List	
	Radio Business	16	by Elmer R. Fuller	80
	New Devices	68	Miscellany	83
	Question Box	72	Technotes	89
	Radio-Electronic Circuits	74	People	90
	New Patents	76	Communications	92
	Try This One	78	Book Reviews	97

ON THE COVER: The Radio Hat, posed by Hope Lange. From an Ektachrome original by Avery Slack. See article on page 32.

RADIO-ELECTRONICS, June, 1949, Volume XX, No. 9. Published monthly. Publication Office: Erie Ave., P. O. Box 200, Philadelphia 32, Pa. Entered as second class matter September 27, 1918, at the post office at Philadelphia, Pa., under the Act of March 3, 1879. SUBSCRIPTION RATES: In U. S. and Canada, in U. S. possessions, Mexico, South and Central American countries, \$3.50; \$6.00 for two years; \$8.00 for three years; single copies 30¢. All other foreign countries \$4.50 a year, \$8.00 for two years, \$11.00 for three years. Allow one month for change of address. When ordering a change please furnish an address stamped impression from a recent wrapper. RADCRAFT PUBLICATIONS, INC., Hugo Gernsback, Pres.; M. Harvey Gernsback, Vice-Pres.; G. Aliquo, Sec'y. Contents Copyright, 1949, by Radratt Publications, Inc. Text and illustrations must not be reproduced without permission of copyright owner.

EDITORIAL and ADVERTISING OFFICES, 25 West Broadway, New York 7, N. Y. Tel. REctor 2-6690. BRANCH ADVERTISING OFFICES: Chicago: 308 W. Washington Street, Telephone RAndolph 6-7363. Los Angeles: Ralph W. Harker, 1127 Wilshire Blvd., Tel. MA 6-1271. San Francisco: Ralph W. Harker, 582 Market St. Tel. GARfield 1-2181.

FOREIGN AGENCIES: Great Britain: Atlas Publishing and Distributing Co., Ltd., 18 Bride Lane, Fleet St., London E.C.4. Australia: McGill's Agency, 179 Elizabeth Street, Melbourne. France: Brentano's, 37 Avenue de l'Opera, Paris 2e. Holland: Trilectron, Heemstede, Dreef 121 Heemstede. Greece: International Book & News Agency, 17 Amerikis Street, Athens. So. Africa: Central News Agency, Ltd., Cor. Bissok & Commissioner Sts. Johannesburg. 112 Long Street, Capetown; 369 Smith Street, Durban, Natal. Universal Book Agency, 70 Harrison Street, Johannesburg. Middle East: Sitimatzky Mobile East Agency, Jaffa Road, Jerusalem. India: Susil Gupta (Distributors) Co., Armita Bazar, Patrika Lt., 14 Ananda Chatterjee Lane, Calcutta, Broadway News Centre, Post Bag #5577, Dadar, Bombay #14, K. L. Kannappa Mudalliar, 30 General Patters Road, Mount Road, Madras 2, Pakistan: Paradise Book Stall, Opp. Regal Cinema, Preetly St., Karachi 3.

Editorial and Executive Offices:

25 West Broadway, New York 7, N. Y.



MEMBER
AUDIT BUREAU OF CIRCULATION

SPRAGUE PHENOLIC-MOLDED TELECAP* TUBULARS



THE MOST
TRULY
DEPENDABLE
PAPER
TUBULAR
CAPACITORS
EVER OFFERED
TO THE
SERVICE
PROFESSION

- Extra Dependability at No Extra Cost
- Withstand Heat and Humidity, Shock and Vibration
- High Insulation Resistance
- High Dielectric Strength
- Unequaled for Sizzling AC-DC Midgets, or "Hot" TV and Auto Sets.

See Your Jobber Today!

SPRAGUE PRODUCTS CO.

North Adams, Mass.

*Trademark

RADIO-ELECTRONICS for

The Success Story of Bill Smith... OR YOU!



Mails coupon to National Schools in Los Angeles, and receives Free Lesson and book of Information about Radio, Television and Electronics training.



Enrolls... studies in spare time. Finds personal attention from instructors, interesting material and practical equipment, all increase his interest.



Builds actual units as part of Course. Earns money doing spare time repair and installation work.



Completes Course and receives Diploma... is now a qualified Radio, Television and Electronics Technician.



Applies for—and GETS—a good pay, full time job in industry. Finds that employers know National Schools and like to hire their graduates.



Or he opens own profitable Service Shop, with valuable counsel and aid from National Schools. Now for real happiness and success!



GET INTO RADIO, TELEVISION and ELECTRONICS by NATIONAL SCHOOLS SHOP METHOD HOME TRAINING

THIS PRACTICAL, TECHNICAL RESIDENT TRADE SCHOOL TRAINS YOU AT HOME FOR BIG RADIO OPPORTUNITIES!

Never in history has such rapid progress been made as in the great Radio, Television and Electronics Industry today! This exciting, fast-moving development means new and greater opportunities for the trained, skilled man—for you—in Television and Radio Broadcasting, Installing, Servicing, in Frequency Modulation; in Applied Electronics in many industries; in a business of your own!

National Home Training is Practical
Your National Schools Course fully covers basic, advanced and specialized instruction in all phases, including basic radio principles, receivers, am-

plifier systems, transmitters, television, aviation radio, electronics. You get complete instruction material, including shop manual, tube manual, job sheets, radio dictionary, special laboratory experiment lessons, experimental equipment. You receive complete, modern television lesson texts.

Your Home Study is supervised by our staff of highly trained instructors who daily teach our resident students here. Let the Free Books shown below tell you more about National Home Training. Use coupon today!

APPROVED FOR VETERANS

You Build This Superheterodyne Receiver With Parts We Send
You receive complete standard equipment, including latest type High-Mu Tubes, for building various experimental and test units. You progress step by step until you build a complete Superheterodyne Receiver. It is yours to use and keep.

Professional Multitester Included!

This portable instrument (see right) enables you to perform many practical tests, make delicate adjustments and do service work. Complete with test leads.

You receive a series of special laboratory experiment lessons to guide your practical exercises with your equipment. These lessons have been prepared with a special technique of illustrating radio principles by numerous easy-to-understand examples.

Both Resident and Home Study Courses Offered

Send Coupon Today for These Two Valuable Free Books

NATIONAL SCHOOLS

LOS ANGELES 37, CALIF. • EST. 1905

FIND OUT NOW... MAIL COUPON TODAY

National Schools, Dept. 6-RE (Mail in envelope or paste on postcard)
4000 South Figueroa Street
Los Angeles 37, California

Mail me FREE the book, "Your Future in Radio," and a sample lesson of your course.

NAME.....AGE.....

ADDRESS.....

CITY.....ZONE.....STATE.....

Check here if veteran of World War II

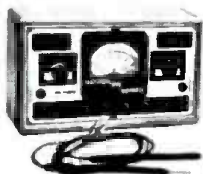

THE FINEST IN "WIDE RANGE SPEAKERS" ARE AVAILABLE AT McGEE



MODEL CR-13X 12" COAXIAL P.M. \$12.95



MODEL 5-15X 15" COAXIAL P.M. \$24.95



MODEL 15-LS 15" 50 WATT P.M. \$16.95



MODEL 15-KR 15" JUKE BOX P.M. \$9.95



MODEL A-50 12" 50 WATT P.M. \$14.95

DELUXE 12" COAXIAL MODEL CR-13X \$12.95

RESPONSE 40 TO 17,000 C.P.S. Fine Construction • REGULAR \$32.50 LIST. NATIONALLY FAMOUS Newly designed by one of America's finest speaker builders...

15" DELUXE 50 WATT P.M. SPEAKER \$16.95 With Wide Range Molded Cone.

Model 15-LS. The finest super heavy duty speaker in America! 15" 1 1/2 oz. Alnico V Magnet P.M. speaker...

15" JUKE BOX P.M. SPEAKER \$9.95

A full 15" 1 1/2 oz. Alnico V Magnet speaker of juke box quality. Has standard 8 ohm voice coil...

50 WATT 12" SUPER HEAVY DUTY P.M. \$14.95

Model A-50. 12" 50 Watt super heavy duty permanent magnet speaker. Has 1 1/2" 8 ohm treated voice coil...

STANDARD 12" COAXIAL P.M. CN-12X \$10.95

Standard Model 12" Coaxial P.M. Model CN-12X. Same as model CR-13X except response 30 to 17,000 C.P.S.

15" KING COAX P.M. SPEAKER \$24.95

The King Coax. A 2 1/2 oz. 1 1/2 inch Alnico V P.M. Speaker with a built-in high frequency tweeter...

CURVELENIER "WIDE RANGE SPEAKER LINE" HIGH FIDELITY CONES. 6-8-12 INCH SIZES.



Designed to meet the ever growing demand for finer reproduction of sound. Wide range 6 and 8 inch models offered for the first time...

COMPLETE AMPLIFIER KITS \$6.95 UP



5 WATT KIT \$6.95

Kit Model TM-4. 5 Watt Amplifier Kit. Ideal for beginner construction. Has features of better priced amplifiers...

8 WATT KIT \$8.95

Kit Model TM-8. 8 Watt Amplifier Kit for utility use, record playing or listening. Matched component parts...

12 WATT KIT \$10.95

Kit Model TM-12. 12 Watt Amplifier Kit. Ideal for a high quality record player, P.A. system or recording amplifier...

20 WATT KIT \$15.95

Kit Model TM-20. A high quality 20 Watt Audio Amplifier with 150 Mill Power Transformer and push pull B.I.V.'s...

THEATRE QUALITY WIDE RANGE AMP KIT \$24.95

Complete 15 watt true-fidelity audio amplifier kit. Features essentially flat from 20 to 17,000 cycles. Inputs for crystal mike and any phono record...

T. V. SCOOP \$2.95

Farnsworth Television Chassis Model GV260 partially built up chassis size 12x17. Has 16 Tube sockets...

OUTPUT TRANSFORMER HIGH FIDELITY 20-20,000 C.P.S. 6600 ohms Plate to Plate \$6.95 EACH



Why pay \$20.00 or \$30.00 for an output? Supreme quality and high fidelity output transformer. Designed to match push-pull plates (2-6B1, 2-6B1, or 4-6B1) class...

GENERAL ELECTRIC VARIABLE RELUCTANCE \$2.95 CARTRIDGE

Another McGee Scoop. Genuine General Electric Variable Reluctance Cartridge RFX-010 with permanent sapphire needle...

CAPE HART \$19.95 2-POST AUTOMATIC RECORD

Capchart Twin Post Automatic Changer. Size 1 1/2 x 1 1/4. Plays 10-12" or 12-10" 78 RPM records automatically...

COMPLETE RADIO KITS \$6.95 UP



KIT MODEL X-45 \$14.95

Complete Personal Portable Radio Kit Model X-45. Made from genuine Gerd factory matched parts. A complete kit to build a broadcast battery operated 4 tube receiver...

KIT MODEL DE-6X \$9.95

Complete Mike Broadcaster Kit Model DE-6X. Broadcasts 800 to 1500 KC from either a phonograph pick up or mike. Makes any radio receiver a P.A. system...

KIT MODEL TF-6C \$9.95

Complete Radio Kit Model TF-6C. A full size broadcast AC-DC, 2 Gang sub-circuit, lighted tube radio dial, 1 1/2" wood cabinet with plastic front, loop antenna...

KIT MODEL TF-4 \$6.95

Complete Radio Kit Model TF-4. A 4 Tube AC-DC Broadcast TFP Receiver. Ideal for the beginner. 2 Gang Condenser, Ready punched chassis...

11-TUBE FM/AM CHASSIS \$59.50

We still have available for delivery the S-51, 11 Tube AM FM custom Receiver Chassis. A retail \$10.00 value complete with tubes, less speaker, \$59.50...

HALLICRAFTERS S-56 \$59.50

ST. GEORGE WIRE RECORDER MECHANISM A \$45.00 VALUE \$22.95 FOR ONLY

Brand new Wire Recorder. Play back mechanism. Same as those used on the Majestic radio wire recorder. This unit has 78 RPM Turntable for recording on wire from a photo record...

MAJESTIC RADIO CHASSIS AND WIRE RECORDER \$49.95

Majestic Broadcast 2-Tube AC-DC Chassis with slide rule dial, 8" Speaker with separate 2-Tube Recorder pre-amplifier and switching arrangement to record from radio station, mike, or play and record 78 RPM photo records...

McGEE RADIO COMPANY • Prices F.O.B. K.C. Send 25% deposit with order. Bal. sent C.O.D. With Parcel Post orders include Postage. • Now at Our New and Larger Headquarters 1424 Grand Ave., Kansas City, Missouri

RADIO-ELECTRONICS for



TV Offers YOU Good Pay, Security and Bright Future

CREI On-the-Job Training Can Give You the Technical Ability to Step Ahead of Competition and Get the Better Job You Want

GET IN and *get ahead* in Television! You can make your own opportunity if you start preparing *now*. No need to tell you how fast Television is expanding—or, of the great number of jobs that are being created. One of industry's leaders predicts: *1 Million Persons in TV within 4 Years!* He estimates 12 Million TV sets by 1953—40 Million by 1958.

If you are now in radio, and wish to get in Television, CREI offers the very training you need to go after—and *get*—a good TV job.

CREI can show you the way with convenient spare-time study at home that gives you the up-to-date technical background and understanding you *must* have for Television. CREI courses are designed to give you a thorough grounding in basic principles and take you step-by-step through the more advanced subjects of TV and its related fields. It must

VETERANS: CREI TRAINING AVAILABLE UNDER G.I. BILL. FOR MOST VETERANS JULY 25, 1951, IS THE DEADLINE — ACT NOW!

If you have had professional or amateur radio experience and want to make more money, let us prove to you we have the training you need to qualify for a better radio job. To help us answer intelligently your inquiry—*please state briefly your background of experience, education and present position.*



Capitol Radio Engineering Institute

An Accredited Technical Institute Founded in 1927

Dept. 148-A, 16th and Park Road, N. W., Washington 10, D. C.

Branch Offices: New York (7) 170 Broadway • San Francisco (2) 760 Market St.

be remembered that all new electronic developments have their roots in past techniques. That's why your own radio experience is so important and worth while when coupled with modern CREI training. You will find CREI basic and helpful right from the start. You will learn about and understand such subjects as: Optics, Pulse Techniques, Deflection Circuits; RF, IF, AF and Video Amplifiers; FM; Receiving Antennas; Power Supplies; Cathode Ray, Iconoscope, Image Orthicon and Projection Tubes; UHF Techniques, Television Test Equipment, etc.

Don't wait another day. Television won't wait for you. In all our 22 years of association with professional radiomen we know that the man who acts promptly is the man who succeeds. The facts about CREI, our courses, and what we can do for you, are described in our 32-page booklet. It is well worth reading. Send for it now.

MAIL COUPON FOR FREE BOOKLET

CAPITOL RADIO ENGINEERING INSTITUTE

16th & Park Road, N. W., Dept. 148-A, Washington 10, D. C.

Gentlemen: Please send your free booklet, "Your Future in the New World of Electronics," together with full details of your home-study training. I am attaching a brief resume of my experience, education and present position.

Check field of greatest interest:

- | | | |
|---|--|---|
| <input type="checkbox"/> PRACTICAL RADIO ENGINEERING | <input type="checkbox"/> PRACTICAL TELEVISION ENGINEERING | <input type="checkbox"/> TELEVISION, FM & ADVANCED AM SERVICING |
| <input type="checkbox"/> AERONAUTICAL RADIO ENGINEERING | <input type="checkbox"/> ADVANCED ELECTRONICS COMMUNICATIONS | <input type="checkbox"/> RADIO-ELECTRONICS IN INDUSTRY |
| <input type="checkbox"/> BROADCAST RADIO ENGINEERING (AM, FM, TV) | | |

NAME.....
 STREET.....
 CITY..... ZONE..... STATE.....

I AM ENTITLED TO TRAINING UNDER G. I. BILL.

HOWARD W. SAMS *presents*
the authoritative new book

by **OLIVER READ** *Editor, RADIO & Television NEWS*

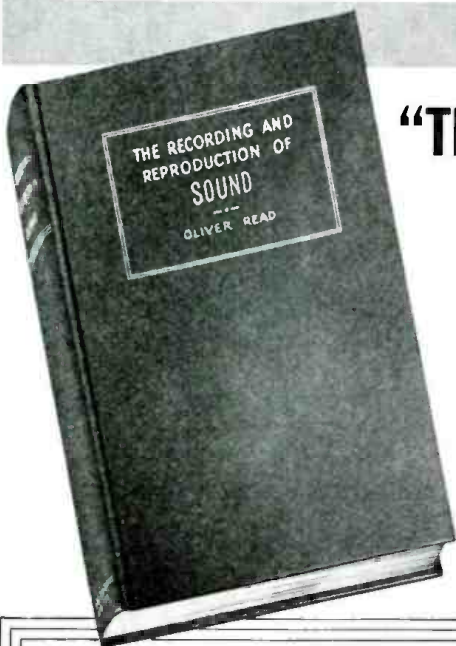

“The Recording and Reproduction of SOUND”
**The first complete reference book that gives
the right answers on all phases of Sound**

Now you can own the book thousands have asked for—the book they got a taste of in the representative chapters which ran in **RADIO & TELEVISION NEWS** during 1948. Now brought up to the minute—*complete*—the one-volume answer to the great demand for a reliable, understandable, full discussion of the theory and methods used in the recording and reproduction of Sound. Absolutely essential to everyone interested in any or all phases of Sound—for a complete, unbiased explanation that gives you a thorough understanding of the entire subject.

Absolutely Invaluable References

A PARTIAL LIST OF CONTENTS:

- Behavior of Sound Waves—History of Sound.
- Basic Recording Methods: Film, Disc, Wire, Tape, etc. Magnetic and Crystal cutters. Magnetic recording methods on wire, tape and coated materials. Magnetic tape recorders.
- Microphones—Types and applications.
- Pickups—Types and applications. Phono pickup tracking error.
- Stylii—Selection and use.
- Microgroove and LP records.
- The Decibel simplified.
- Loudspeakers and enclosures. Dividing networks.
- Amplifiers—complete analysis of types and applications. Dynamic noise suppression. Tone controls, equalizers, and attenuators. Performance and testing of amplifiers.

**PLUS HUNDREDS OF OTHER SUBJECTS—
A “MUST” FOR EVERYONE INTERESTED IN THE
RECORDING AND REPRODUCTION OF SOUND!**

**304 PAGES
180 ILLUSTRATIONS
6 x 9”, CLOTH BINDING** **ONLY \$5⁰⁰**

HOWARD W. SAMS & CO., INC.
INDIANAPOLIS 1, INDIANA

Have the Answers to Questions Like These

Do you know how to select the proper recorder for your purposes? Do you know how to get the most out of your recorder? Can you select the proper amplifier for a given application? Want to know how to test amplifier performance? Which to use—crystal or magnetic pick-up? Do you know how to utilize inverse feedback, expanders and compressors? The answers to these and hundreds of other vital questions are given authoritatively by Oliver Read. His easy-to-understand treatment takes the mystery out of the subject; his facts are based largely on actual laboratory experience. No other single volume brings you this vast wealth of reliable information. This book belongs in your library!

PUBLICATION DATE: MAY 15

ORDER YOUR COPY TODAY!

**Autographed
copies
for the
first 250
purchasers!**

HOWARD W. SAMS & CO., INC.
955 N. Rural St., Indianapolis 1, Ind.

- Send me Oliver Read's "Recording and Reproduction of Sound." \$5 per copy.
- Check Enclosed Ship C.O.D.

E-R

Name.....

Address.....

City.....Zone.....State.....

See how YOU may get started toward an Exciting Future in

TELEVISION RADIO-ELECTRONICS!



OUR GREATEST OFFER IN 17 YEARS!

Here is your big opportunity to get started toward FASCINATING WORK . . . GOOD MONEY . . . a THRILLING FUTURE! Mail the coupon today. See how YOU may prepare to tie in your future with a field that includes one of America's fastest-growing new industries—Television. You'll find out, too, about the many other thrilling opportunities in FM Radio . . . Aviation and Broadcast Radio . . . 2-Way Taxi, Truck and Police Radio . . . Industrial Electronics . . . even the chance to start your own profitable Television-Radio Sales and Service business. And to top it all, you'll see that you don't need to know a thing about this subject at present—that NOW you can get the very training and starting help you need by means of our GREATEST OFFER IN 17 YEARS.

YOU BUILD and KEEP THIS EQUIPMENT TO WORK OVER 300 HOME EXPERIMENTS

MODERN CHICAGO LABORATORIES

Train quickly, using a wide variety of commercial equipment. D. T. I.'s new laboratories are among the finest of their kind. Ample instructors . . . every major training advantage. Write for details!

EMPLOYMENT SERVICE

When you complete your training, our effective Employment Service is available to you without extra cost—a grand aid to help you get started.

Send for FREE Information

See HOW—in your own home—DeForest's Training, Inc., now brings you one of today's most complete combinations of major home training aids. You (1) Learn-by-Reading from well-illustrated lessons. (2) You Learn-by-Seeing from D.T.I.'s exclusive instructive Home Movies. And (3), you set up your own HOME LABORATORY where you Learn-by-Doing from 16 shipments of Radio-Electronic parts which you use and KEEP to work over 300 instructive . . . fascinating projects. This includes building the valuable 6 tube "Superhet" RADIO and the commercial-type OSCILLOSCOPE, R-F SIGNAL GENERATOR, and Jewel-Bearing MULTIMETER, pictured at the right.

You may use this test equipment to help you earn real money—both in your spare time and later when working full time in the field. Get complete facts. Mail coupon today!

YOU ALSO USE HOME MOVIES

a D.T.I. Exclusive!

OSCILLOSCOPE

R-F SIGNAL GENERATOR

6-TUBE RADIO RECEIVER

MULTI-METER

D. T. I., alone, includes the use of one of today's most effective training aids . . . MOVIES . . . to help you learn important fundamentals faster, easier, at home. What an advantage to see electrons on the march, and other fascinating "hidden action" — a remarkable home training advantage that speeds your progress.

OPPORTUNITY COUPON!

MAIL TODAY

DeForest's Training, Inc.
2533 N. Ashland Ave., Dept. RC-F6
Chicago 14, Illinois

Without obligation, send me complete facts showing how I may make my start in Television-Radio-Electronics.

Name Age

Street Apt.

City Zone State

DeFOREST'S TRAINING, INC.
CHICAGO 14, ILLINOIS

Affiliated with the DeVry Corporation,
Builders of Electronic and Movie Equipment.

**NEW
TELEKITS
NOW \$59.50**

Jobbers: Write for Information

**NEW
TELEKITS
10-B \$88.99
7-B \$59.50**



Sparkling new Telekit 10-B has 52-inch screen. Brand new compact lay-out has video tube mounted on chassis. Big illustrated easy-to-follow instruction book guides you step by step through easy assembly. No special knowledge of television is required. All you need is a soldering iron, pliers, and screw driver. Telekit 10-B, \$88.99. Tube kit, including 10BP4 and all other tubes, \$59.50. 10-B Telekit cabinet \$24.50. Telekit Guarantee includes free factory service.

Write for catalog listing 10-B and 7-B Telekits. New 7-B Telekit for 7-inch tube, \$59.50. Tube kit, including 71P4, \$42.08. 7-B cabinet, \$24.50.



Note simple clean lay-out for easy assembly of new Telekit 10-B. Features 2 sound I. F. stages, a new pre-built, pre-aligned tuner that includes a stage of R. F. for distance reception. Easy-to-adjust horizontal lock circuits. Beautiful new model cabinets for 7-B and 10-B are heavily constructed of hand rubbed walnut.

**13
CHANNEL
TUNER
\$19.95**



NEW 13 CHANNEL TUNER is a small compact unit with stage of R.F. Made to conform with Telekit or any other TV set having video I.F. of 25.75 Mc. Complete with tubes, pre-wired, pre-aligned; only three connections to make. See your jobber, or write to us for information. Your cost, \$19.95.

Write for catalog of Telekit antennas, boosters, television kits, tuners, television parts and tubes.

TELEKIT
ELECTRO-TECHNICAL INDUSTRIES
1432 NORTH BROAD STREET PHILADELPHIA 7, PA.

TELEVISION IN BARS may not be as common in the future as it is now, according to New Jersey tavern keepers. Some Jersey bars are removing their sets as a bad investment. The tavern owners report that many drinkers like a quieter atmosphere, that fewer drinks are bought while programs are on, and that some customers leave immediately after their favorite programs. In addition, non-paying "customers" keep drinkers from the bar and patrons argue over which program to watch. As graphic proof of the trend, many tavern ads appearing in local newspapers say "No Television."

MOVIES AND TELEVISION are so closely allied, in the opinion of members of the Society of Motion Picture Engineers, that a proposal was made last month to change the name of the organization to Society of Motion Picture and Television Engineers.

SCIENCE WRITERS were invited last month to try for the \$1,000 AAAS-George Westinghouse Science Writing award offered by the American Association for the Advancement of Science. The award will be presented on September 28th to the writer who has written the best article explaining a scientific subject to the American public. Stories entered must have been published between August, 1948, and September, 1949. Information and entry blanks can be obtained by writing to the Chairman, Managing Committee, AAAS-George Westinghouse Science Writing Awards, 1515 Massachusetts Ave., N.W., Washington 5, D. C.

KINESCOPE RECORDINGS made by NBC total more footage on an annual basis than all the films put out by the Hollywood motion picture producers, Carleton D. Smith, director of NBC television operations, revealed last month. Total output by the major picture producers was 369 features or 550 hours in 1948. NBC, he said, is producing almost 700 hours a year. An average of 223 prints a week are shipped by the network to stations throughout the country.

VHF TV CHANNELS will remain in use to serve audiences in large cities, Dr. Allen B. Du Mont predicted last month. Even after the u.h.f. bands are utilized, the present 12 channels will remain in use, avoiding obsolescence of present sets. The new frequencies will certainly be allotted in areas not now covered by standard-frequency television transmitters. He pointed out that sufficient power cannot now be generated in the 500-900-mc region for large-area coverage.

MOVIES, RADIO, AND VIDEO will be combined in a new home-entertainment instrument soon to go into production, Fred C. Forney, inventor of the unit, announced last month. Called Tel-a-see, the single cabinet will contain radio and television chassis plus a film projector which will hold enough fire-proof film for a two-hour showing.

AUSTRALIAN TELEVISION may be a reality within the next three years. Postmaster-General Senator Donald Cameron announced last month that Australia is planning a national TV service to include the most modern facilities available. The Government regards video as important to defense and training of the armed forces as well as for broadcasting. The first station will be erected in Sydney at an estimated cost of \$1,280,000.

TRANSIT RADIO, which arranges for FM programs to be heard in buses and street cars, is now in operation in 14 cities and one suburb: Covington, Cincinnati, St. Louis, Wilkes-Barre, Houston, Topeka, Allentown, Pa., Huntington, W. Va., Tacoma, Wash., Evansville, Ill., Kansas City, Mo., Des Moines, Washington, Worcester, Mass., and Bradbury Heights, Md.

MAGNETIC RECORDING is able to produce movie sound tracks of excellent quality, John G. Frayne and Halley Wolfe told the Society of Motion Picture Engineers at their recent convention. An experimental recorder was made by revising a standard Western Electric machine intended for optical recording. Sound tracks made at the standard speed (18 inches per second) had excellent frequency response characteristics and were practically free from flutter.

A standard theater-type sound reproducer, modified to operate with either optical or magnetic sound tracks, showed "an excellence of quality unsurpassed in any previously known recording system." The complete absence of background noise is possibly the most striking feature of the system, and "lends an air of reality to the reproduced sound that makes it indistinguishable from direct monitoring of the original pickup."

BOOSTER TRANSMITTERS may be used eventually by television stations to provide coverage of nearby small towns and fringe areas. This was revealed last month by Mark Woods, president of the American Broadcasting Company. Paper work to iron out the problems of such installations has been going on for some time, Mr. Woods said, but a policy decision will be required from the FCC before work is begun.

CITIZENS RADIO SERVICE is removed from experimental status as of June 1 and regular licenses will be issued. Under FCC rules, any U. S. citizen who is 18 years of age or older may obtain a license for the 460-470-mc band without technical knowledge. Only FCC-approved-type equipment may be used, that is, transceivers purchased from manufacturers whose models have been tested and approved by the FCC.

TV IN CARS OR TRAINS will be forbidden under penalty of \$1,000 fine in Connecticut if a bill introduced in the state legislature by Rep. Louis A. Le-maire, Jr., is passed.

RADIO-ELECTRONICS for

BALLOON is used by RCA engineers to determine the best placement for television transmitting antennas, it was reported last month. It carries a high-peak-power pulse transmitter and is raised to the height of the projected tower by means of a windlass. Reception at a number of points in the service area is evaluated with a mobile unit consisting of a receiver, signal generator, scope, and extension mast with dipole.



TV ANTENNAS were officially noted last month by the city of Rochester, N. Y., which adopted an amendment to the municipal code relating to roof structures. The amendment provides that television antenna structures not over 16 feet in height may be erected on the roof of a building without a building permit as long as the antenna is set back from any edge of the building which comes within 16 feet of the lot line by an amount at least equal to the antenna's height. To comply with the regulations, antennas must be solidly built, rigidly mounted, fireproof, and must be correctly grounded.

PULSE CODE MODULATION has been successfully applied to television, W. M. Goodall of Bell Telephone Laboratories reported to the IRE last month. First demonstrated by Bell two years ago as a means for transmitting multiplex telephone signals, a telephone sampling rate of 8,000 times per second had to be raised to 10,000,000 times per second for television. Output of TV pulses is 50,000,000 per second (five channels).

With PCM, poor signals become, in effect, good ones. At repeater stations, the equipment does not pass along the signals it receives but new, entirely noise- and distortion-free ones which are exact representations of the original.

A great deal of additional study is necessary before PCM can become a commercial reality.

FEDERAL TRADE COMMISSION last month reported that nearly all radio manufacturers are now telling the public the truth about the number of tubes in receivers. Under a rule laid down in 1939 it is an unfair trade practice for a manufacturer to pad the tube count by including dummy or fake tubes or those which perform no useful function. In 1947 a Commission interpretation included rectifiers among tubes which should not be included in the count. Closing a two-year investigation of the industry, the FTC said, "Virtually the entire industry . . . has not only pledged compliance with the rule but has furnished proof of compliance."

RADIO RANKS FIRST on the list of leisure activities, according to an announcement in *Fortune* last month of the results of a nationwide poll conducted by Dr. Elmo Roper. Asked to indicate which of a list of leisure-time activities was their favorite, 51% of those polled designated radio listening. Ranking second, but far behind, was spectator sports (26%), followed by visiting and sports participation (23% each), and card playing and movie-going (20% each).

TELEVISION jobs will number 950,000 in 1953, predicted Dr. Allen B. Du Mont last month. TV will have become a \$7 billion industry by then, Dr. Du Mont thinks, and nearly a million people will be employed in technical (manufacturing, servicing, and station-operation) positions and in program production.

CANADIAN TELEVISION should begin in 1950, according to a report last month by the *Toronto Star*. Progress has been made by the Canadian Broadcasting Corporation in discussions with commercial groups, and technical decisions are expected shortly.

NEW GUN developed by the armed forces for anti-aircraft and anti-tank use will not fire on a friendly tank or plane but only on an enemy. Electronic controls identify the target, according to a statement last month by Leighton H. Peebles, electronics production chief for the National Security Resources Board.

Though no details on the new "skysweeper," as the weapon is called, were released its controls are presumably actuated by automatic responses to radar challenges, possibly in much the same way as IFF was used during the last war. The new device thus apparently eliminates the human factor (plane crews sometimes forgot to turn on the IFF equipment).

Peebles said that the new gun could be sighted and the trigger pulled all day—but it would fire only when enemy planes and tanks are targets.

TELEVISION NETWORK cities will increase by 13 in 1949, AT & T's Long Lines Department announced last month. By the end of the year there will be about 8,200 channel miles (number of miles times number of channels in each cable or relay), extending 2,850 actual miles and linking 27 cities.

FOR DEMONSTRATING & TESTING AUTO RADIOS from AC LINES

ATR

"A" BATTERY ELIMINATORS



for DEMONSTRATING AND TESTING AUTO RADIOS

New Models . . . Designed for testing D. C. Electrical Apparatus on Regular A. C. Lines. Equipped with Full-Wave Dry Disc Type Rectifier, Assuring Noiseless, Interference-Free Operation and Extreme Long Life and Reliability.



AUTO RADIO VIBRATORS

A Complete Line of Vibrators . . . Designed for Use in Standard Vibrator-Operated Auto Radio Receivers. Built with Precision Construction, featuring Ceramic Stack Spacers for Longer Lasting Life.

NEW MODELS NEW DESIGNS
NEW LITERATURE

ATR "A" Battery Eliminator, DC-AC Inverters, Auto Radio Vibrators

See your folder or write factory

AMERICAN TELEVISION & RADIO Co.
Quality Products Since 1931
SAINT PAUL 1, MINNESOTA-U. S. A.

Heathkit TUBE CHECKER KIT

Heathkit TEST



SHIPPING
WT. 15 LBS.

\$29⁵⁰

Features

1. Measures each element individually.
2. Has gear driven roller chart.
3. Has lever switching for speed.
4. Complete range of filament voltages.
5. Checks every tube element.
6. Uses latest type lever switches.
7. Uses beautiful shatterproof full view meter.
8. Large size 11"x14"x4" complete.

Check the features and you will realize that this Heathkit has all the features you want. Speed—simplicity—beauty—protection against obsolescence. The most modern type of tester—measures each element—beautiful Bad-Good scale, high quality meter—the best of parts—rugged oversize 110 V. 60 cycle power transformer—finest of Mallory switches—Centralab controls—quality wood cabinet—complete set of sockets for all type tubes including blank spare for future types—fast action gear driven roller chart uses brass gears to quickly locate and set up any type tube. Simplified switching cuts necessary time to minimum and saves valuable service time. Short and open element check. No matter what arrangement of tube elements, the Heathkit flexible switching arrangement easily handles it. Order your Heathkit Tube Checker today. See for yourself that Heath again saves you $\frac{2}{3}$ and yet retains all the quality—this tube checker will pay for itself in a few weeks—better build it now. Complete with detail instructions—all parts—cabinet—roller chart—ready to wire up and operate.

New Heathkit TELEVISION ALIGNMENT GENERATOR KIT

Everything you want in a television alignment generator. A wide band sweep generator covering all FM and TV frequencies—a marker indicator—AM modulation for RF alignment—variable calibrated sweep width 0-30 Mc.—mechanical driven inductive sweep. Husky 110 V. 60 cycle power transformer operated—step type output attenuator with 10,000 to 1 range—high output on all ranges—band switching for each range—vernier driven main calibrated dial with over 45 inches of calibrations—vernier driven calibrated indicator marker tuning. Large grey crackle cabinet 16-1/8" x 10-5/8" x 7-3/16". Phase control for single trace adjustment. Uses four high frequency triodes plus 5Y3 rectifier—split stator tuning condensers for greater efficiency and accuracy at high frequencies—this Heathkit is complete and adequate for every alignment need and is supplied with every part—cabinet—calibrated panel—all coils and condensers wound, calibrated and adjusted. Tubes, transformer, test leads—every part with instruction manual for assembly and use. Actually three instruments in one—TV sweep generator—TV AM generator and TV marker indicator. Also covers FM band.

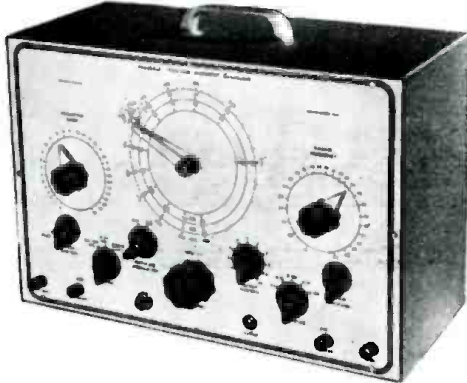

\$39⁵⁰

Heathkit SINE AND SQUARE WAVE AUDIO GENERATOR KIT

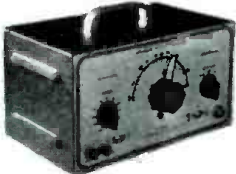

\$34⁵⁰
Nothing ELSE TO BUY

Experimenters and servicemen working with a square wave for the first time invariably wonder why it was not introduced before. The characteristics of an amplifier can be determined in seconds compared to several hours of tedious plotting using older methods. Stage by stage, amplifier testing is as easy as signal tracing. The low distortion (less than 1%) and linear output (\pm one db.) make this Heathkit equal or superior to factory built equipment selling for three or four times its price. The circuit is the popular RC tuning circuit using a four gang variable condenser. Three ranges 20-200, 200-2,000, 2,000-20,000 cycles are provided by selector switch. Either sine or square waves instantly available at slide switch. All components are of highest quality, cased 110 V. 60 cycle power transformer, Mallory F.P. filter condensers, 5 tubes, calibrated 2 color panel, grey crackle aluminum cabinet. The detailed instructions make assembly an interesting and instructive few hours. Shipping Wt., 13 lbs.

New Heathkit FM TUNER KIT

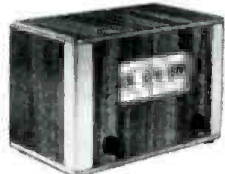

\$14⁷⁵
CABINET EXTRA

A truly fine FM Tuner with the coils ready wound, all alignment completed—all that is necessary is wiring and it's ready to play—uses super regenerative circuit—110 V. 60 cycle transformer operated—two gang tuning condenser—slide range calibrated dial—two tubes—complete instructions including pictorial enable even beginners to build successfully. The circuit uses twin triode and is extremely powerful—pulls in stations far beyond normal expectations. Shipping Wt., 4 pounds. Beautiful mahogany cabinet for FM Tuner (shown above) extra.....**\$3.75**

Heathkit CONDENSER CHECKER KIT

\$19⁵⁰
Nothing ELSE TO BUY

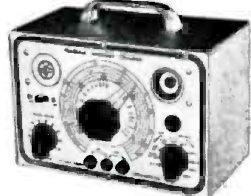

Features

- Bridge type circuit
- Magic eye indicator
- 110 V transformer operated
- All scales on panel
- Power factor scale
- Measures resistance
- Measures leakage
- Checks paper-mica-electrolytics

Checks all types of condensers, paper-mica-electrolytic-ceramic over a range of .00001 MFD to 1000 MFD. All on readable scales that are read direct from the panel. NO CHARTS OR MULTIPLIERS NECESSARY. A condenser checker anyone can read without a college education. A leakage test and polarizing voltage for 20 to 500 volts provided. Measures power factor of electrolytics between 0% and 50%. 110 V. 60 cycle transformer operated complete with rectifier and magic eye tubes, cabinet, calibrated panel, test leads and all other parts. Clear detailed instructions for assembly and use. Why guess at the quality and capacity of a condenser when you can know for less than a twenty dollar bill. Shipping Wt., 7 lbs.

New Heathkit TOOL KIT



Now a complete tool kit to assemble your Heathkit. Consists of Krauter diagonal cutters and pointed nose assembly pliers, Xcelite screwdriver, 60 Watt 110 V. soldering iron and supply of solder. Shipping Wt., 2 lbs. Complete kit.....**\$5.95**

RF Crystal Test Probe Kit
No. 309. Kit to assemble. RF probe extends VTVM range to 100 MC. Complete with IN34 crystal. Shipping weight, 1 lb.....**\$6.50**



10,000 V H.V. Test Probe Kit
No. 310. Extends range of any 14 megohm VTVM to 3,000 and 10,000 Volt ranges. A necessity for television. Ship. wt., 1 lb.....**\$4.50**



The HEATH COMPANY

... BENTON HARBOR 20, MICHIGAN

EQUIPMENT and accessories

New Heathkit BATTERY ELIMINATOR KIT

Now a bench 6 Volt power supply kit for all auto radio testing. Supplies 5-7½ Volts at 10 Amperes continuous or 15 Amperes intermittent. A well filtered rugged power supply uses heavy duty selenium rectifier, choke input filter with 4,000 MFD of electrolytic filter. 0-15 Volt meter indicates output. Output variable in eight steps. Excellent for demonstrating auto radios. Ideal for servicing — can be lowered to find sticky vibrators or stepped up to equivalent of generator overload — easily constructed in less than two hours. Complete in every respect.



\$22⁵⁰

SHIPPING WT. 18 LBS.
Nothing ELSE TO BUY

Heathkit 5" OSCILLOSCOPE KIT

Features

- Instant switching to plates or amplifier from front panel.
- Sweep generator supplying variable sweep 15 cycles to 30,000 cycles.
- All controls on front panel.
- Cased electrostatically shielded 110 V. 60 cycle power transformer.
- AC test voltage on front panel.
- External synchronization post on front panel.
- Deflection sensitivity .65 V. per inch full gain.
- Frequency response ± 20% from 50 cycles to 50 Kc.
- Input impedance 1 Megohm and 50 MMF.

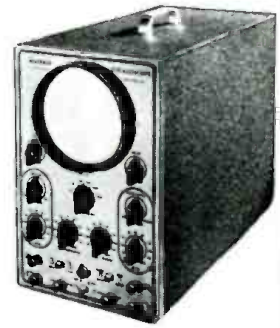

\$39⁵⁰

Nothing ELSE TO BUY

The Heathkit 5" Oscilloscope fulfills every servicing need. The husky cased power transformer supplies 1100 Volts negative and 350 Volts positive. Tubes supplied are two 6SJ7 amplifiers, 884 sweep generator, two 5Y3 rectifiers, and 5BP1 CR tube. Grey crackle aluminum cabinet and beautiful grey and maroon panel. Chassis especially designed for easy assembly.

An oscilloscope provides endless sources of experimentation in radio, electronics, medicine and scientific research. Detailed instructions make assembly fun and instructive. Shipping Wt., 24 lbs. Express only.

1949 MODEL Heathkit VACUUM TUBE VOLTMETER KIT

Features

New 200 ua Meter. 24 Ranges.

New Accessory H.V. Probe makes Heathkit a kilovoltmeter. (Extra)
New Accessory RF Probe extends range to 100 megacycles. (Extra)



A new Model V-2 Heathkit VTVM with new 200 microampere meter, four additional ranges — full scale linear ranges on both AC and DC of 0-3 V., 10 V., 30 V., 100 V., 300 V. and 1,000 V. Accessory probe listed elsewhere in ad extends voltage range to 3,000 and 10,000 volts D.C. New model has greater sensitivity, stability and accuracy — still the highest quality features — shatterproof plastic full view meter face — automatic meter protection, push pull electronic voltmeter circuit, linear scales — db. scale — ohmmeter measures 1/10 ohm to 1 billion ohms with internal battery — isolated DC test prod for dynamic measurements — 11 megohm input resistance on DC — AC uses electronic rectification with 6HG tube. All these features and still the amazing price of only \$24.50.

Comes complete with cabinet — panel — three tubes — new Mallory switches — test prods and leads, 1% ceramic divider resistors and all other parts. Complete instruction manual for assembly and use. Better start your laboratory with this precision instrument. Ship. Wt., 8 lbs.

\$24⁵⁰

New Heathkit SIGNAL TRACER AND UNIVERSAL TEST SPEAKER KIT

The popular Heathkit signal tracer has now been combined with a universal test speaker at no increase in price. The same high quality tracer follows signal from antenna to speaker — locates intermittents — defective parts quicker — saves valuable service time — gives greater income per service hour. Works equally well on broadcast — FM or TV receivers. The test speaker has assortment of switching ranges to match push pull or single output impedance. Also tests microphones, pickups — PA systems — comes complete — cabinet — 110 V. 60 cycle power transformer — tubes, test probe, all parts and detailed instructions for assembly and use. Shipping Wt., 8 lbs.

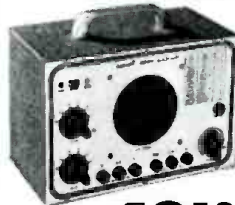

\$19⁵⁰

Nothing ELSE TO BUY

Heathkit ELECTRONIC SWITCH KIT

DOUBLES THE UTILITY OF ANY SCOPE

An electronic switch used with any oscilloscope provides two separately controllable traces on the screen. Each trace is controlled independently and the position of the traces may be varied. The input and output traces of an amplifier may be observed one beside the other or one directly over the other illustrating perfectly any change occurring in the amplifier. Distortion — phase shift and other defects show up instantly, 110 Volt 60 cycle transformer operated. Uses 5 tubes (1 6X5, 2 6SN7's, 2 6SJ7's). Has individual gain controls, positioning control, and coarse and fine sweeping rate controls. The cabinet and panel match all other Heathkits. Every part supplied including detailed instructions for assembly and use. Shipping Wt., 11 lbs.



\$34⁵⁰

Heathkit RF SIGNAL GENERATOR KIT

\$19⁵⁰

Nothing ELSE TO BUY



Every shop needs a good signal generator. The Heathkit fulfills every servicing need, fundamentals from 150 Kc. to 30 megacycles with strong harmonics over 100 megacycles covering the new television and FM bands. 110 V. 60 cycle transformer operated power supply.

400 cycle audio available for modulation or audio testing. Uses 6SN7 as RF oscillator and audio amplifier. Complete kit has every part necessary and detailed blueprints and instructions enable the builder to assemble it in a few hours. Large easy to read calibration. Convenient size 9" x 6" x 4½". Shipping Wt., 4½ lbs.

Heathkit 3-TUBE ALL WAVE RADIO KIT

An ideal way to learn radio. This kit is complete ready to assemble, with tubes and all other parts. Operates from 110 V. AC. Simple, clear detailed instructions make this a good radio training course. Covers regular broadcasts and short wave bands. Plug-in coils. Regenerative circuit. Operates loud speaker. Shipping Wt., 3 lbs.

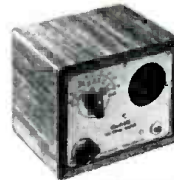

\$8⁷⁵

HS30 Headphones per set.....\$1.00
2½" Permanent Magnet Loudspeaker.....1.95
Mahogany Cabinet.....2.95



The **HEATH COMPANY**

... BENTON HARBOR 20, MICHIGAN

RADIOMEN'S HEADQUARTERS ✦ **WORLD WIDE MAIL ORDER SERVICE!**

Highest quality telescoping folded dipole rooftop type antenna with all the features usually expected in such an antenna, including use as dipole and reflector, and in addition a mounting bracket. Provided so that the antenna can be installed in any window in two minutes or less. Any slight loss in gain because of the reduction from rooftop height is more than compensated by the ability to orient the antenna instantly by opening the window and adjusting for maximum signal strength. Mounting bar can be installed horizontally or vertically in window frame or even between attic rafters, whichever is most convenient. Your cost \$8.65. With high frequency attachment for channel 7 to 13 \$11.00. Either type 10% less in dozen lots.

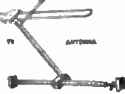

NO ROOFTOP CLIMBING HERE!

The BUFRAD Model 1088 portable indoor antenna adjusts easily to any channel and any station direction. Triple chrome plated brass dipoles. Antique finished base with felt pad to prevent scratching furniture. Can also be readily installed attached to ceiling with base up. 300 ohm line furnished. Your cost \$3.95. Lots of 12 at \$3.50 each.

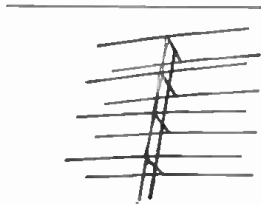

The famous VEE-D-X LONG RANGE ANTENNA. Consistent perfect results way beyond what usually are called fringe areas. The directional characteristics and extreme gain from this 4 bay unit provide the desired answer for those who have given up hope of satisfactory reception. An absolute necessity for reception over distances greater than 70 miles. Your wholesale price—\$75.00.

AFTER SEEING OUR ANTENNAS AND COMPARING, YOU WILL NEVER BUY ANY OTHER MAKE!

BUFRAD RADIO ANTENNAS

All of our car radio antennas are made of triple plated Admiralty Brass Tubing, complete with low loss shielded antenna leads and high quality fittings.

SIDE COWL—Rt-1. 3 sections extend to 66". Your price—single units—\$1.75; in lots of 12—\$1.50 ea.

SKYSCRAPER—Rt-2 has 4 heavy duty sections that extend 98". This super-aerial must be seen to be fully appreciated. Your price—single units—\$2.50; in lots of 12—\$2.25 ea.

TILT ANGLE—Rt-3. may be adjusted to all body contours. 3 sections extend to 66". Single unit price—\$1.75; 12 lot price—\$1.50 ea.

VERSATILE—Rt-4. single hole fender or top cowl mounting may be adjusted to conform with all body contours. 4 sections extend to 66". Single unit price—\$3.00; 12 lot price—\$2.75 ea.

THE MONARCH—Rt-5. single hole, top cowl mounting. 3 sections extend to 56". Single unit price—\$2.00; 12 lot price—\$1.75 ea.

OUR PE-109 POWER PLANT DIRECT CURRENT

This power plant consists of a gasoline engine that is coupled to a 2000 watt 32 volt DC generator. This unit is ideal for use in locations that are not served by commercial power or to run any of the surplus items that require 24-32v DC for operation. The price of this power plant tested and in good condition is only \$79.95 F.O.B. Buffalo, or we can supply in strictly "as is" condition for \$58.95 F.O.B. New York City. These latter are exactly as received, in heavy steel-strapped gun cases, and we are unable to determine if the individual units are new, or what the condition is if used, while the \$79.95 are some of the same that we have brought to Buffalo for testing and repair if necessary. We do not recommend skimming on the "as is" condition, except for quantity purchasers. We can also supply a converter that will supply 110v AC from the above unit or from any 32v DC source for \$12.95.

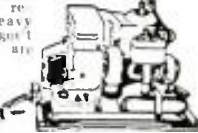

FCC AUTHORIZES RADIO FOR PRIVATE SERVICE!!!!

(The FCC announced that effective June 1, any American over 17 years of age is eligible for a 5 year station permit. In the "Citizens" band, no code test or technical knowledge are necessary.)

GENERAL ELECTRIC 15 TUBE TRANSMITTER-RECEIVER SET

This brand new 15 tube transmitter-receiver was designed for mobile storage battery powered service. It will operate in the "Citizens" band where no amateur license to transmit is necessary. Its a cinch for any experimenter to connect this unit for 110 VAC operation by following the instructions and diagrams supplied, which cover numerous applications, including television. For those intending to use on car or boat, a new dynamo, exactly as originally supplied, costs only \$15.00. Don't fail to write for FREE descriptive bulletin. Order our RT-1248 for only \$29.95, or two for \$53.90.

Sensational Value In AC-DC POCKET TESTER

This analyzer, featuring a sensitive reputation type meter housed in a bakelite case, represents the culmination of 15 years experience in the instrument field by a company specializing in electronic test equipment. Specifications of the AC-DC Model Volt-Ohm-Milliammeter: AC-Volts—0-25, 50, 125, 250; DC Volts—0-25, 50, 125, 250; DC Milliamperes—0 to 50; Ohms Full Scale—100-000; Ohms Center Scale—2400; Capacity—.05 to 15 Mfd. Total Price, prepaid anywhere in the USA—\$7.00. Similar DC Meter, lacking the AC operated ranges of above, \$5.50 prepaid.



"SO" RADAR SET

"SO" RADAR RECEIVER, complete with 9 tubes including picture tube. This Plan—Position-Indicator Oscilloscope has a self-contained pack designed to run from the 110 V. power supply on LNT or PT boats. It provides a 5" diameter picture adjustable at will to an 80, 40, 4 or 2 mile circle with the boat at the center, showing location of land, other ships, or any obstruction, so that navigation can be carried out in pitch darkness or densest fog with as much safety as in brightest sunlight. Your cost \$39.95.



ACRO TELEVISION CHASSIS CRADLE

Pays for itself in a week—Saves and eliminates broken tubes, coils, dial knobs, etc. Cadmium plated steel. Finger-tip control. A necessity for Television Service. Your Cost \$4.69

SAVE HOURS OF HARD WORK

Do the job in minutes with a BUFRAD Socket Hole Punch. Cut clean accurate holes for sockets, links, connectors, etc. Cutting holes in radiator is as simple as cutting punch with a hot knife with a BUFRAD punch. Just insert the punch in a 1/2" hole and turn with an ordinary wrench. In a minute or less you can complete a job which often takes an hour with the old "drilling, reaming, and filing" method. With BUFRAD punch you can make 13 different sizes of openings from 3/8" to 2 1/4" diam. etc.



\$12.95 Takes All Three Big Bargains

1. **SENSATIONAL FASCINATING, MYSTERIOUS SELSYNS.** Brand new Selsyns made by G. E. Company. Two or more connected together work perfectly on 110V AC. Any rotation of the shaft on one Selsyn will rotate all other Selsyns connected to it will rotate exactly as many degrees in the same direction, following unerringly as if the units were connected together by shafting instead of wire. This is true whether you twist the shaft of the master unit a fraction of a revolution or many revolutions. Useful for indicating direction of weather vanes, rotating directional antennas, or controlling innumerable operations from a distance. Complete with diagram and instructions. Per Matched pair \$4.95.

2. **ALUMINUM GEAR BOX 18MMX2** Two powerful electric motors and two matched gear trains. 62 gears in all varying in size from 1/2 to 4 inches in diameter. This unit is readily converted to rotate a beam antenna or any other similar use. \$5.00

3. **HOME WORKSHOP AT BARGAIN PRICE.** Accurate and precise 2 speed guaranteed hobby lathe, the essential machine for the home workshop. Sturdy enough for light production work or factory standby service. Supplied with 56" of belt for connecting to any available electric motor or power take-off. Also included in this unbelievable offer are such accessories as a 1/2" drill chuck with specially hardened tool steel jaws, a 4" electric furnace high speed grinding wheel, a cotton buffing wheel and a large supply of cutting compound, and a 4" steel wire scratch brush. Your cost \$6.00. Sole export agent. Distributor inquiries invited.

COMPRESSED AIR

INSTANTLY ANYWHERE

Portable Air Compressor and storage tank. Ruggedly built of best materials using lifetime lubricated ball-bearing on connecting rod and impregnated main bearing on shaft. Unusual design forever eliminates valve trouble, the most common fault in air compressors. PATENTED unique air intake system increases efficiency tremendously over other compressors so that air output is much greater than that of similar compressors powered by heavier motors. Will deliver approximately 3500 cu. inches of air per minute at maintained pressure of 30 lbs., or will inflate a 90 lb. truck tire in less than one minute. Comes complete with 100 lb. gauge, although finger-tip adjustment allows setting of output pressure at any value, which will automatically be maintained. Works from 1/4 H.P. motor. Useful for spraying points or lacquers, disinfectants, insecticides, annealing or brazing with natural gas, inflating tires, etc. Price \$14.50 postage prepaid anywhere in the U. S. Efficient, completely adjustable siphon type spray gun complete with 12 ft. of 100 lb. tested hose available for only \$7.75 with pint container, also prepaid. 25% required on all C.O.D. orders.



SENSATIONAL CAR RADIO BARGAIN

Nationally advertised brand 1949 car radio that will fit practically any car. We can't advertise the brand name because we are selling them below regular list price, but they are sure fire hits because of their outstanding performance. Plenty of eye appeal plus a host of other features that other car radios do not offer: a 3 gang condenser for razor sharp selectivity, an R.F. stage for extreme sensitivities, superhet circuit A.V.C. to eliminate fading, and a 6 1/2" speaker for good tone quality at any volume. Your cost \$27.95.



THE BUFRAD SECTIONAL TOWER

This latest addition to the famous line of BUFRAD antenna products makes up to a hundred foot tower from any desired number of ten foot sections of extremely strong welded construction. The sections are shipped assembled and painted, so that erection is a matter of minutes rather than hours. Assembly is a one man job, and is accomplished by climbing up the conical portion of the tower with the next 25 lb. section to be installed. Hand and footholds are provided to make the work safe and easy. Cap at top of tower provides bearing surface for rotating, and prevents water from entering tubes. Useful for police, or amateur transmitters, and in addition the tower will provide satisfactory TV reception where otherwise it would be impossible. Ideal for supporting permanent or temporary power lines, wind generators, stadium public address speakers or spotlights for gas stations or parking lots. Sections, together cost a total of \$15.75 and total 20 feet. "A" sections, which make up the entire tower except for the top, are each 10 feet long and cost but \$12.75 apiece. Those who wish a mast base will be able to obtain one (not shown above), for only \$6.00. The base is especially useful when erecting the tower on a sloping roof.



MICROPHONES

Super Special!!! Best quality all chrome bullet shaped DYNASPEAKERS of top-flight nationally known brand \$5.95. Bullet DYNAMIC MIKE \$7.95. MIKE Jr.—60c. PUSH-TALK MIKE with switch on handle—98c. LAPEL MIKES—(Specify whether carbon or magnetic 93c.



SUPER SPECIAL

FAIRCHILD bombproof POWER UNITS. Our quantity of these is too limited to justify the space required by a photo, but each unit is brand new, contains 9 tubes which alone have a total value of \$15.00; 8 electric motors or generators, 6 of which are of the permanent magnet field type; relays; and 20 valuable precision resistors plus a multitude of the ordinary kind, in addition to many condensers and potentiometers. All for only \$14.95. We will ship but one to a customer while our small quantity lasts.

6.95 TAKES ALL THREE BIG BARGAINS

1. **AUDIO AMPLIFIER**—Brand new, push-pull output amplifier having 2 of the valuable and scarce overtype audio transformers that sell for over \$10.00 apiece. Neat aluminum case, fully enclosed (largest dimension 6 inches). Perfect for intercom systems, phono amplifiers, mike amplifier or signal tracer amplifier for testing radio sets. A sensational bargain at only \$3.40 each

2. **BANDSWITCHING TUNING TURRET** made by Western Electric. Covers 4 bands above 100 MC. All coils wound with #14 silver-plated wire. Complete with condenser and powerful electric driving motor. Diagram included. ONE OF OUR MOST TERRIFIC VALUES—ONLY \$2.95.

3. **The dual meter**—One 50 uA and one 200 uA movement in the same case. This meter is ideally suited for use as a combination modulation percentage and carrier shift indicator. If desired the movements may be removed from the case and used separately. All meters are in perfect operating condition, but a few have cracked glass.

This super value costs only \$1.95.

AMAZING PORTABLE RADIO

The year's hottest sensation. Powerful sub-ether in beautiful maroon crackle finish case with built-in gleaming chrome telescopic whip antenna. Exactly like a car radio except works off self-contained standard portable radio batteries, easily obtainable anywhere. Theft-proof mounting bracket attached by anyone to a bike or motorcycle in 3 minutes. Readily installed on any vehicle from a wheelbarrow to a witch's broom. Radio removable from mounting bracket instantly by means of a special key provided, so that it can be carried anywhere for use as a portable if desired. Weight 5 lbs. Your cost with batteries—\$24.95; without batteries—\$22.50.

All sales final and no returns unless otherwise specified in ad of item. Right reserved to change prices and specifications at any time. Cable address BUFRAD

BUFFALO RADIO SUPPLY 219-221 Genesee St., Dept. RE-3, BUFFALO 3, N. Y.

RADIO-ELECTRONICS for

NOW! T.A.C. AGAIN SCOOPS THE INDUSTRY!

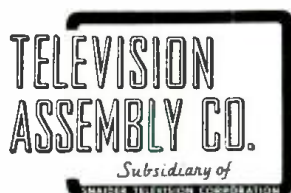

Builders of America's Finest Television Kits Now Offers

DIRECT VIEW AND PROJECTION

COMPLETED SETS!



T.A.C. "CHAMPION"
12 1/2"-TUBE DIRECT VIEW

BIG 81 Square Inch Screen without lenses or gadgets. Exclusive T.A.C. designed handsome, modern-styled Select-Grain Cabinet in Walnut, Mahogany or Blonde. 30 tubes, including BIG 12-inch Picture Tube. Manufactured by the nationally accepted Leader in Custom-Built Television. Licensed by Radio Corporation of America. The ideal home Television and FM Receiver! Remarkable performance and value! A miracle of Television engineering as well as a rich, beautiful furniture piece.

"AUDITORIUM" 520 SQ. IN.
PROJECTON TELEVISION



Optical system by Bausch & Lomb and Eastman Kodak. 37 tubes. 12" High-Fidelity Speaker. 20" by 26" screen for **BIGGER - THAN - LIFE-SIZE**, bright, steady, clear pictures. Can be viewed by an audience as large as 750 people. For home recreation rooms, schools, institutions, clubs, commercial establishments and offices.

COMBINATION TV and ALL FM Sets

DuMont Inputuner for continuous tuning of ALL TELEVISION and ALL FM channels with utmost sensitivity and stability.

Exclusive T.A.C. "VIVideo" Feature

Pat. Pending
Renowned I.F. Picture and Sound Strip with 5 1/2 stages of Cathode-Coupled Grounded-Grid Video I.F. Amplification that brings television reception to a new high standard of quality.

FREE!

Complete Service Data Manual SB-1 on the "VIVideo" feature, contains all information needed to thoroughly understand and service this unique high-gain I.F. Strip. Write for it today or ask your local jabber for it.

Studio Quality Picture

Until you've seen and enjoyed T.A.C.'s "Studio Quality Picture" you haven't really viewed television at its best. Here is a new standard of video quality. It's a NEW KIND of picture and we know you will agree it's the best yet.

Finest Obtainable Components

Combination of RCA, DuMont and highest rated nationally advertised components.

AMERICA'S GREATEST TELEVISION VALUE PER SQUARE INCH OF PICTURE!

GUARANTEE

All T.A.C. receivers and their components are of the highest quality and are guaranteed under the Standard RMA Guarantee.



T.A.C. "SPORTS-VIEW"
15"-TUBE DIRECT VIEW

128 Square Inches. Amazingly bright, steady and clear! 30 tubes, including BIG 15" Picture Tube. Large 12" Heavy Duty PM Speaker for fidelity sound. Licensed by Radio Corporation of America. Manufactured by the nationally accepted Leader in Custom-Built Television. Leatherette covered cabinet in choice of colors. Perfect for commercial installations and all large audience viewing. Special—Controls under Lock and Key!

DISTRIBUTED THROUGH NATIONAL PARTS DISTRIBUTORS

DISTRIBUTORS! DEALERS! WRITE FOR LITERATURE AND CONFIDENTIAL PRICE INFORMATION TODAY!

TELEVISION ASSEMBLY CO.

Subsidiary of
SNAIDER TELEVISION CORPORATION

**540 BUSHWICK AVE.,
BROOKLYN 6, N. Y.**

5% Higher West of the Mississippi
Prices subject to change without notice.

HIGH-VOLTAGE

PAPER

TUBULARS

for TELEVISION,

OSCILLOGRAPHS, etc.



• Interested in higher-voltage, dependable yet inexpensive paper capacitors? Here's the Aerovox answer:

The popular Aerovox Type "84" paper tubulars are now available in extended-voltage ratings — 2500, 3500, 5000, 7500 and 10,000 volts D. C. W. Capacitances of .0001 to .05 mid. Compact dimensions—from 3/4" dia. by 1-1/2" long for smallest, to 1-3/4" dia. to 3" long for largest. Oil-impregnated wax-filled. Sturdy insulating tube. Sealed ends. Bare pigtail leads that won't work loose. Bright yellow-red-black label jacket. And tough!

• See Our Jobber ...

These extended-voltage paper tubulars are now available. Order your needs from our jobber. Ask for latest catalog.



FOR RADIO-ELECTRONIC AND INDUSTRIAL APPLICATIONS

AERVOX CORP., NEW BEDFORD, MASS., U. S. A.
 Export: 13 E. 40th St., New York 16, N. Y. • Cable: 'ARLAB'
 In Canada: AERVOX CANADA LTD., Hamilton, Ont.

Zenith Radio Corp. of Chicago reports estimated net consolidated operating profits amounting to \$2,025,781 for itself and its subsidiaries for the first nine months ended January 31, 1949 of its current fiscal year, after Federal income taxes of \$1,227,450, depreciation, excise taxes, and reserves for contingencies.

Net consolidated operating profits for the three-month period ended January 31, 1949, amounted to \$1,041,246, after taxes, depreciation, and reserves.

Radio Manufacturers Association reports that January sales of radio receiving tubes, in a seasonal decline, were 5.7 million under those in December, 1948, and 2.4 million under January, 1948. Tube sales in January totalled 13,508,906, compared with 19,270,164 in December and 16,004,927 in January a year ago. Of the total sales during the month, RMA member companies sold 10,425,566 receiving tubes for new sets and 2,256,996 for replacements. Tubes sold for export totalled 749,685 and to government agencies 76,659.

Shipments of television receivers by RMA member manufacturers increased 88% during the fourth quarter of 1948 over shipments in the third quarter. At the end of the past year, RMA set manufacturers had shipped 964,206 TV receivers into 42 states and the District of Columbia since January 1, 1947, when the shipment reports were started.

Fourth-quarter shipments by RMA members totalled 354,314, compared with 188,120 during the third quarter of 1948. Shipments during the entire year numbered 802,025.

TV set shipments, RMA explained, always trail behind production reports, which previously had shown RMA member companies producing 866,832 television receivers in 1948. Total industry production was estimated at more than 975,000 TV sets.

Westinghouse Electric Corp. of Pittsburgh announces that the 1948 net sales were \$970,673,847.

The net income for 1948, after all charges, was \$52,656,351, equal, after preferred dividends, to \$3.88 a share on common stock.

Motorola, Inc., Chicago, reports in the company's twentieth annual statement that net sales rose to \$58,080,236 last year, compared with \$46,679,148 in 1947. The 1948 net earnings amounted to \$3,332,739, equal to \$4.17 per share, against \$2,510,410 or \$3.14 a share, in the preceding year.

Stewart-Warner Corp., Chicago, reveals that net sales in 1948 were \$72,534,085, down 5.7% from 1947 sales. Net profit carried to surplus was \$3,154,316, equal to \$2.44 per share of \$5 par value common stock and 29.5% greater than 1947 profits. Sales in 1947 were \$76,930,304, and profit carried to surplus was \$2,436,634 or \$1.88 per share.

Admiral Corp., Chicago, reported net

earnings of \$3,782,825 after all charges, for the fiscal year ended December 31, 1948, as compared with \$2,248,186 for the previous fiscal year, in its annual report released to stockholders. Per share earnings were \$3.78 on the 1,000,000 shares now outstanding as compared with \$2.25 for 1947 on the equivalent number of shares, representing an increase of 68%.

Net sales amounted to \$66,764,266, showing an increase of 39% over sales of \$47,898,938 in 1947, and an increase of 85% over sales of \$36,169,850 for the fiscal year ended December 31, 1946.

Allen B. Du Mont Laboratories, Inc., New York, reported that sales in 1948 amounted to \$26,859,000, compared with \$11,109,172 in 1947. Net profit advanced to \$2,701,000, equivalent to \$1.29 per share, after taxes, on 2,043,652 shares outstanding. This compares with earnings of \$563,677 or 27 cents per share on 2,031,040 shares in 1947.

Cornell-Dubilier Electric Corp. declared a dividend of 20 cents per share on the common stock, payable March 10, 1949, to stockholders of record February 28, 1949.

Directors also declared the twentieth regular quarterly dividend of \$1.31 1/4 per share on the company's \$5.25 cumulative preferred stock, series A, payable April 15, 1949, to stockholders of record March 23, 1949.

Radio Manufacturers Association has started a public relations program to give the public, government, trade, and other interests complete and accurate information regarding television-broadcasting service and receiving sets.

An "objective, orderly, and constructive" presentation of full information on television, including present broadcasting service and receivers, in the present VHF channels and also in the UHF channels in the future was voted by the RMA Board of Directors at its meeting in Chicago on March 17, following recommendations from the Association's Set Division Executive Committee.

RMA President MAX F. BALCOM was authorized to appoint a special committee, widely representative of the manufacturing industry, to determine and direct the Association's television public relations project, for which the Board of Directors voted substantial funds. The committee will be appointed promptly and the information program begun in the immediate future.

Upon recommendation of the Parts Division Executive Committee and Section Chairmen, the Board of Directors also adopted a resolution continuing the Town Meetings of Radio Technicians under RMA sponsorship and authorized President Balcom to appoint a representative committee, including members of the Set Division, to develop a program of future activities and methods of financing them.

Harry A. Ehle, chairman of the Town Meeting Committee, reported that more than 10,000 persons had attended the five Town Meetings held to date.

RADIO-ELECTRONICS for

AS! EXPERIMENTERS! LOOK AT THESE TERRIFIC BUYS!

MY AIRCRAFT RECEIVER— BC-946-B

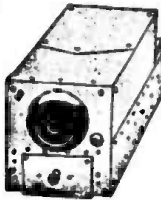

Covers 520 Kc to 1500 Kc Broadcast Band. 6 Tubes: 3—12SK7, 1—12SR7, 1—12A6, 1—12K8. Designed for dynamotor operation; can be easily converted to 110 volt or 32 volt use. Two IF Stages. Three-range tuning con. BRAND NEW, in sealed carton, with tubes and instruction manual, less dynamotor

\$24.50

Dynamotor DM-32A \$2.95

SMASH VALUES IN RADIO RECEIVERS

BC-453—RCVR	Used \$10.95	New \$17.95
BC-454—RCVR	Used 6.95	New 8.95
BC-455—RCVR	Used 7.95	New 8.95
BC-456—MOD	Used 2.95	New 3.95
BC-457—XMTR	Used 6.95	New 9.95
BC-458—XMTR	Used 6.95	New 9.95
BC-459—XMTR	Used	New 19.95

BC-645 XMTR RECEIVER 15 Tubes 435 To 500 MC



The electronic equipment that saved many lives in the war. Set can be modified to use for 2-way communication, voice or code, on following bands: ham band 420-450 mc, citizens radio 460-470 mc, fixed and mobile 450-460 mc, television experimental 470-500 mc. 15 tubes (tubes alone worth more than sale price!): 4—7F7, 4—7H7, 2—7E6, 2—6F6, 2—955 and 1—WE316A. Now covers 460 to 490 mc. Brand new BC-645 with

\$11.95
each

tubes, less power supply in factory carton. Shipping weight 25 lbs.
PE-101C DYNAMOTOR for above BC-645 **\$2.95**
UHF ANTENNA ASSY. for above BC-645 **\$2.45**

SETCHEL-CARLSON Beacon Radio Receiver BC-1206-C



Receives A-N beam signals, operates on 24-28 V DC. 5 Tubes: 3—14H7, 14R7, 28D7. Tunes 195 to 420 Kc. Size 4"x4"x6 1/2" wide, 4 lbs. In original carton.
BRAND NEW

\$7.95



BIAS METER BRAND NEW!

Excellent for measuring DC voltages, bias voltages, or checking polarity of DC voltages. Designed originally for telephone and teletype voltage measurements. With adaptor plug, schematic, metal carrying case. Batteries not needed for operation.
Your cost, only **\$5.95**



SIMPSON DC AMMETER

Brand new! 0-80 amps DC. Round, 2 1/2" meter, with flange. Accurate, rugged. Excellent for battery charging, etc.
\$1.79

FREQUENCY METER CABINET

For BC-221 Series freq. meters. BRAND NEW! 3 compartments. Massively built. 14 1/2"x10 1/2"x10". Value \$20.00. Complete with canvas cover for both ends. Yours for **\$3.95** only

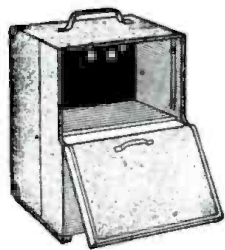

GE THYRATRON FG-105

Brand New
MERCURY RECTIFIER

Individually boxed in factory sealed cartons. List Price \$40 your cost

\$11.95 While They Last!
each

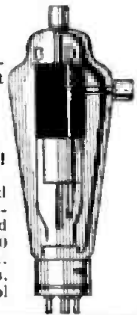

For continuous rectifier and welder control service. Tetra-rode type, indirectly heated cathode; 10000 V peak, 10000 V peak inverse. Av. Max. current 6.4 amps continuous, 2.4 to 4 amps welder control service.

SPECIAL!

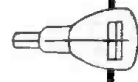

SPERT R-F Vacuum Switch
Famed Collins Xmtr Antenna Switch. 9200 peak volts. 8 amperes. BRAND NEW!
Only **\$1.69**

OTHER TUBE VALUES

162535c	86425c	6K739c
162635c	RK6060c	12SQ739c
		12J5GT31c		

DC AMMETER 0-15 Amps



A terrific buy! 3 1/2" easy reading scale, 75 divisions. Black plastic case 4 1/4"x5 1/4"x2 1/4". Rubber covered test clip leads plus black metal carrying case with hinged cover. Brand New. Wonderful for automotive, battery charging, general test work. Value \$25. All yours for only **\$3.99**

McElroy Automatic KEYER

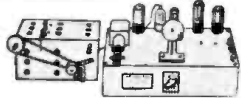

For Xmtr keying or code practice. Has photocell and sensitive relay. Variable speed motor, 110V AC or DC. Complete with 2-117Z6 and 1-11L7 tubes.
\$14.95
your cost

CARBON HANDMIKE



Genuine Sig. Corps Mike. 200 ohm, single button, has press-to-talk switch, 4-ft. rubber cable, amphenol plug. Beautiful satin chrome finish.
BRAND NEW **\$2.25**

SELSYN 2JIG1

Operates from 57 1/2 V 400 cycles. Suggested wiring for 110 V 60 cycle included. Used, tested.
Price per pair **\$3.50**

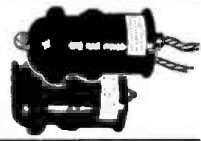

ARMY FIELD TELEPHONES

Type EE8—Talk as far as 17 miles. Dependable 2-way communication at low cost. Ideal for home, farm, field. Up to six phones can be used on one line. Each phone complete with ringer. Originally cost govt. \$39.90 each.
\$9.95
Used, good condition



QUANTITY PRICES

Inquiries welcomed from institutions, wholesalers, dealers, large users. Phone, write, wire for quantity prices.

Please include 25% Deposit with order—Balance C.O.D. MINIMUM ORDER \$3.00. All Shipments F.O.B. Our Warehouse N.Y.C.

G & G GENUINE MAJESTIC
RADIO PARTS SERVICE
53 VESEY STREET · NEW YORK 7, N.Y.

TERRIFIC VALUE 24-VOLT STORAGE BATTERY, BRAND NEW 17 AMP. HRS.

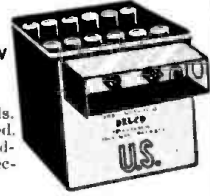

Made by Delco. 12 cells, heavy duty, very rugged. Shipped dry, uses standard sulphuric acid electrolyte.

VERY SPECIAL **\$17.95**



WILLARD 2-VOLT STORAGE BATTERY 20 Ampere-Hours

Exact replacement for GE portables—brand new. Each..... **\$1.95**

GOULD 6-VOLT STORAGE BATTERY

Navy Standard, Black Rubber Case. BRAND NEW. 15 Amp. Hour Rating **\$4.95**

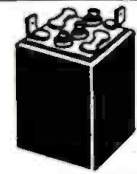

WILLARD 6-VOLT STORAGE BATTERY

Similar to above but in transparent plastic case. Real value at... **\$4.95**

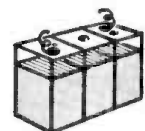

WILLARD MIDGET 6-V STORAGE BATTERY

3 amp hour rating. Transparent plastic case. Brand new. 3 3/8" x 1-13/16" x 2 3/8" high. Uses standard electrolyte. each. **\$3.25**
in lots of 12..... **\$2.99**

WILLARD 6-VOLT STORAGE BATTERY

3 cells @ 2 volts each. 15 amp hour rating. Transparent plastic case. Uses standard electrolyte listed below. Brand new! 7-1 1/16" x 6 3/4" x 4 1/4" high. **\$4.95**

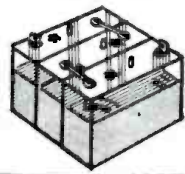

1-QUART BOTTLE BATTERY ELECTROLYTE

Made by Willard, for above storage batteries, 1 qt. sufficient for two 2-volt cells. Hermetically sealed. SPECIAL! **\$1.25**
per qt. bottle

7-PRONG 2-VOLT RADIO VIBRATOR for Portable and Farm Sets Replace-

ment for GE LB 530..... **\$1.65**

LOOK AT THESE PM SPEAKER BUYS!



Alnico V, 4" PM, less trans.	\$1.30
Alnico V, 5" PM, less trans.	1.45
Alnico V, 6" PM, less trans.	1.79
Alnico V, 8" PM, less trans.	2.75
Alnico V, 10" PM, less trans.	4.50
Alnico V, 12" PM, less trans.	4.95
Alnico V, 6" PM, with trans.	2.35
Alnico V, 8" PM, with trans.	3.25
Alnico V, 10" PM, with trans.	4.65
6V6—Midget Output Trans.	42c
50L6—Midget Output Trans.	42c
ACDC—Chokes	32c

Wonderful Condenser Buys!

Oil-Filled Metal Cased Condensers
All Brand New—Perfect—
Standard Makes

.1 mf 400V .14c	4.0 mf 600V .79c
.5 mf 600V .17c	3-3 mf 600V .88c
2.0 mf 600V .34c	25 mf 600V \$1.79
1.0 mf 1000V .49c	8 mf 1000V 2.25
1.0 mf 1500V .69c	

FP TYPE FILTER CONDENSERS Standard Makes—Brand New

30 mfd 50 V.....	12c
100 mfd 50 V.....	17c
40/40/20 mfd 150/150/20 V.....	35c
8 mfd 500 V.....	38c
16 mfd 500 V.....	49c
8x8 mfd 500 V.....	59c
20/20 mfd 450/25 V.....	59c
30 mfd 350 V.....	55c

TUBULAR 50 + 30 Mfd 150V NEW.....lots of 12. 19c ea.

20 Mfd 200 V INVERTED CAN SCREW MT	29c
4/3 Mfd 400/375 V Round Metal Can Com nek	39c
60 Mfd 110 V 60 cy. AC motor start Cond. round metal can.	99c

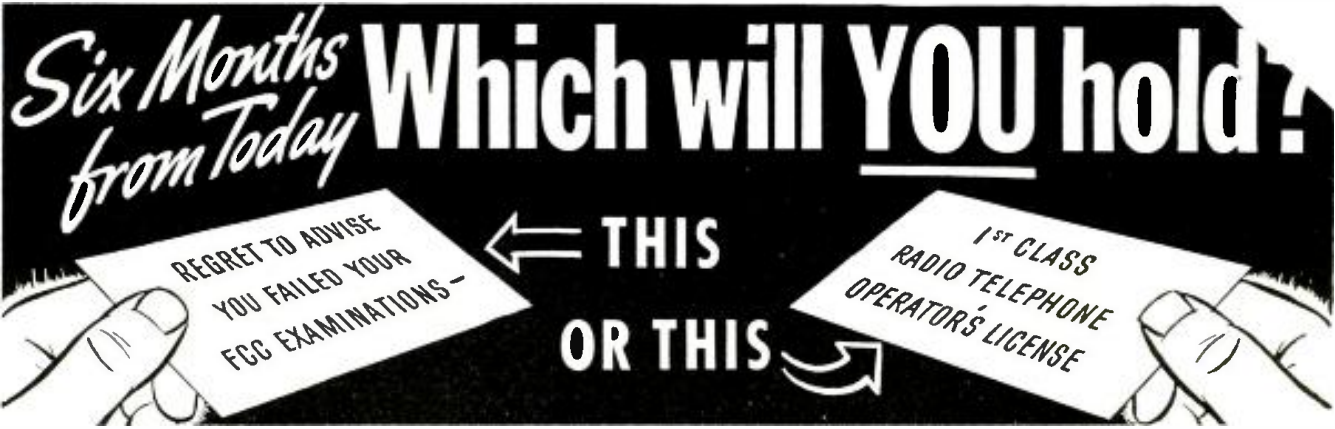

WANT YOUR FCC COMMERCIAL LICENSE IN A HURRY?

Add Technical Training to Your Practical Experience and Get Your "Ticket" in a FEW SHORT WEEKS It's EASY When You Use CIRE Simplified Training and Coaching AT HOME in SPARE TIME

Thousands of new jobs are opening up—FM, Television, Mobile Communication Systems. These are only a few of the radio fields which require licensed radio technicians and operators. Get your license without delay. Let Cleveland Institute prepare you to pass

FCC license examinations, and hold the jobs which a license entitles you to, with CIRE streamlined, post-war methods of coaching and training.

Your FCC Ticket is always Recognized in ALL Radio Fields as Proof of Your Technical Ability

More than ever before an FCC Commercial Operator License is a sure passport to many of the better paying jobs in this New World of Electronics. Employers always give preference to the license

holder, even though a license is not required for the job. Hold an FCC "ticket" and the job is yours!

Hundreds of Satisfied, Successful Students

"Transmitter engineering is great, especially on the job I am on. Thanks again for all you have done, and you can take the credit for the fact that my "ticket" is now posted on the wall of a 1000 Watt broadcast station."
Student No. 3678N12

"I now hold ticket Number P-10-3787, and holding the license has helped me to obtain the type of job I've always dreamed of having. Yes, thanks to CIRE. I am now working for CAA as Radio Maintenance Technician, at a far better salary than I've ever had before. I am deeply grateful."
Student No. 3319N12

"I took the FCC examination on March 4th, and received my second class radiotelephone license March 9th. I go to work for the Trans-Texas Airways in the maintenance department. Thanks for all the assistance."
Student No. 2394AI

"I take great pleasure in informing you that I have taken the examination for radio telephone first class license on June 29th, and passed and have received my license. I am now working at WCNH, a local 250 Watt Station."
Student No. 3171N12

OTHER

Cleveland Institute Home Study Courses Offer Complete Technical Radio Training from Low-Level to College-Level, for the Radioman with Practical Experience!

COURSE A—Master Course in Radio Communication

A complete course covering the technical fundamentals of radio-electronics, for the radioman who wants a general review. Includes preparation for Broadcast station employment.

COURSE B—Advanced Course in Radio Communication Engineering

A genuine college-level radio engineering course, completely mathematical in treatment. For the advanced radioman with considerable practical experience and training.

COURSE C—Specialized Television Engineering

An advanced college-level course for the radioman who has had formal training equivalent to A and B.

COURSE D—Advanced Radio Telephony

An advanced, specialized course covering broadcast station engineering and operation. Covers the engineering knowledge and the technical duties required of the studio control operator, the master control operator, and the transmitter operator.



1. TELLS OF THOUSANDS OF BRAND-NEW, BETTER-PAYING RADIO JOBS NOW OPEN TO FCC LICENSE HOLDERS
2. TELLS HOW YOU WILL BENEFIT BY HOLDING AN FCC COMMERCIAL LICENSE.
3. TELLS HOW YOU CAN GET YOUR FCC COMMERCIAL RADIO OPERATOR LICENSE IN A FEW SHORT WEEKS—EASILY AND QUICKLY, BY USING CIRE SIMPLIFIED TRAINING AND COACHING AT HOME IN YOUR SPARE TIME.
4. TELLS OF HUNDREDS OF OUR SUCCESSFUL STUDENTS WHO NOW HAVE LICENSES AND NEW, BETTER-PAYING JOBS.
5. TELLS HOW WE PREPARE YOU TO PASS THE NEW FCC COMMERCIAL LICENSE EXAMINATIONS, WHICH NOW INCLUDE FM AND TELEVISION.



Mail Coupon At Once GET ALL 3 FREE

Approved for Veteran Training under "G. I. Bill of Rights"

CLEVELAND INSTITUTE OF RADIO ELECTRONICS (Address to Desk No. to avoid delay)
Desk RC-6 4900 Euclid Bldg., Cleveland 3, Ohio

Please send me your Catalog C "Money Making FCC License Information," your Booklet B "How to Pass FCC Commercial License Examinations," (does not cover Amateur License Examinations) and a sample FCC-type exam.

Please send me your Catalog A, describing all of your home study radio-electronics courses. I desire training in course A B C D

NAME _____

ADDRESS _____

CITY _____ ZONE _____ STATE _____

Veterans check for enrollment information under G. I. Bill NO OBLIGATION—NO SALESMEN

6. TELLS HOW WE GUARANTEE TO TRAIN AND COACH YOU UNTIL YOU GET YOUR LICENSE
7. TELLS HOW WE HELP YOU TO GET A BETTER-PAYING, LICENSED JOB, WITH OUR FREE AND EXCLUSIVE SERVICE, WHICH PREPARES YOUR EMPLOYMENT APPLICATION FOR MAILING TO HUNDREDS OF EMPLOYERS, INCLUDING FM, AM AND TELEVISION BROADCAST STATIONS, RADIO MANUFACTURERS, POLICE RADIO STATIONS, AND RADIO-EQUIPPED TAXI, BUS AND PUBLIC UTILITY COMPANIES

RADIO-ELECTRONICS for

Whither Radio?

. . . *Radio broadcasting is by no means obsolete or dying* . . .

—By HUGO GERNSBACH

HERE is an unfortunate tendency among some people in certain quarters, who nowadays are shouting from the roof tops! "radio is dead—long live television" . . .

While the advent of television has made some inroads into radio broadcasting, it is certainly not true that radio in this country is doomed to an early extinction—say within the next few years. While it is also true that at the present time television has and is making tremendous strides, radio is still a vital force that will be with us for a long time to come.

In a recent issue of *Look*, we note an article entitled "Radio is Doomed," by Merlin H. Aylesworth. The author, a former head of the National Broadcasting Corporation—who certainly should know better—glibly predicts that "within three years, the broadcast of sound, or ear radio, over giant networks will be wiped out." Mr. Aylesworth however fails to advance a single sound or logical reason for that prediction.

It is only natural that television should have captured the imagination of our people. Every new and revolutionary scientific advance in the past has done the same. Added to this is the important fact that television goes right into our homes where it touches all of our lives most intimately.

After the novelty has worn off—that is, during the next few years—radio will not only continue on its former road, but conceivably will become more important than ever before.

This has always been true in the technological field. The automobile did not put the railroads out of business. Nor did the faster airplane doom the railroads. You can fly across the Atlantic in less than a day now, while it takes the fastest express steamer four days. That does not mean that steamships are even seriously threatened by the airplane.

When radio first made its triumphant march across the world everybody predicted the end of the phonograph and phonograph records. Today many times more phonographs and records are in use than ever before. The new technological advances made the phonograph and phonograph records more popular than they had ever been at any time.

This is true of many inventions in the past and will presumably hold true in the future.

One thing, however, is certain, there will surely be a quiet revolution in radio during the next decade.

Radio, now seriously threatened with extinc-

tion, will make a strong comeback in the early future.

It is safe to predict that new electronic inventions and advances will be made that will enhance the value of radio far above the pre-television level.

The stimulus to radio's survival is great. Many new and at this moment unimagined inventions and features will in the future push radio on to new heights. Radio today is a particularly popular attraction when a good musical background is eagerly sought by millions of listeners. It is not always possible or feasible to watch the television screen for hours at a time. Listening to symphonic or other cultural music presents no such obstacle, hence the popularity of such stations as—for instance New York's WQXR station which gives almost uninterrupted musical background of the highest order.

One thing seems certain: *radio broadcasting must put its house in order.*

If it is to survive, the present-day crude "plug-uglies" will vanish completely to make way for more subtle and artistic commercials.

Radio will always have a strong following among the people if it gives that service which television cannot give. There is really no necessity for television and radio to compete with each other. Each has its own special sphere of usefulness. It is up to each to exploit that sphere to the limit.

Thus, for good symphonic and operatic music, weather reports, time service, short news reports and similar features radio will probably always remain in the foreground. *These services will be vastly bettered as time goes on.*

Then there is also the facsimile service which has as yet not been exploited by radio and which conceivably will be pushed energetically from now on.

In the next few years miniaturization of radios will certainly be a commonplace. We have spoken of this a great many times. Only recently have technological advances made the vest-pocket radio set possible. This type of receiver is soon coming to the front. It will be important for reception of news, weather reports, etc., which can be heard by everybody wherever he may happen to be. In other words, we will no longer be dependent upon the stationary receiver as we are today.

Rest assured radio will continue to be a great force in this country despite the false prophets of doom, whose croaking voices we hear from all sides today.

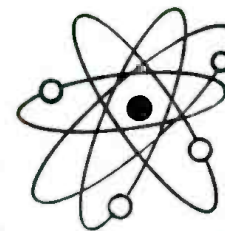

Television News

ELECTRONIC MAGIC

THE many startling and mystifying sights shown on the screens of our television receivers have made many a viewer wonder how such things as "ghosts," for instance, are made to appear and disappear in television plays. A man reaches for a cigar in the breast pocket of his jacket—out jumps a tiny Lilliputian figure of a man. A volcano belches forth smoke and lava which rolls down the

mountainside in most realistic fashion. How are such effects produced in the television studio? Have you seen a ghostlike figure of an actor mysteriously appear on the television screen?

By H. W. SECOR

(Drawings by Frank Paul)

Perhaps the figure seemed to pass miraculously through a closed door? Or an empty chair was suddenly occupied by a figure which materialized before your very eyes? Such stage effects used to be produced with the aid of mirrors, but in this television age ghostly materializations are produced electronically.

A method of fading the image of a person or object in or out of a television scene electronically has been developed by Roy Moffett of the NBC engineering staff. The device is known as an electronic *lap dissolve*.

Suppose we wish to make the figure of a person slowly materialize in an empty chair (Fig. 1). The actor is dressed in light-colored clothes and appears in front of a black background. He is seated on a black chair (to render it invisible to the television audience) of the same shape and size as the empty chair shown on the television screen.

Two television cameras are used to produce the lap dissolve. One of them picks up the image of the actor, while the other is focused on the empty chair. As Fig. 2 shows, the images from the two cameras are fed into separate amplifiers and control devices (tube bias controls) and then pass into a common mixer stage. From this point the blended image of chair and figure are passed on to the video transmitter and broadcast. Either image can be made of any strength desired—that is, faded in or out.

Another adaptation of Moffett's development is the electronic *super-imposition* device, which operates similarly to the ghost-producing scheme. By focusing two television cameras from two different angles on a pianist, for example, a novel effect can be produced whereby we see the figure of the pianist seated at the piano, while across this scene appears another image showing the pianist's fingers moving over the keyboard. The superimposed image may be made of any strength desired, say about 60% of full strength for the fingers and keyboard closeup, and 40% for the long shot of the pianist. Many variations of this arrangement can be made. See the superimposed "montage" video image of Toscanini photographed from the kinescope tube by NBC.

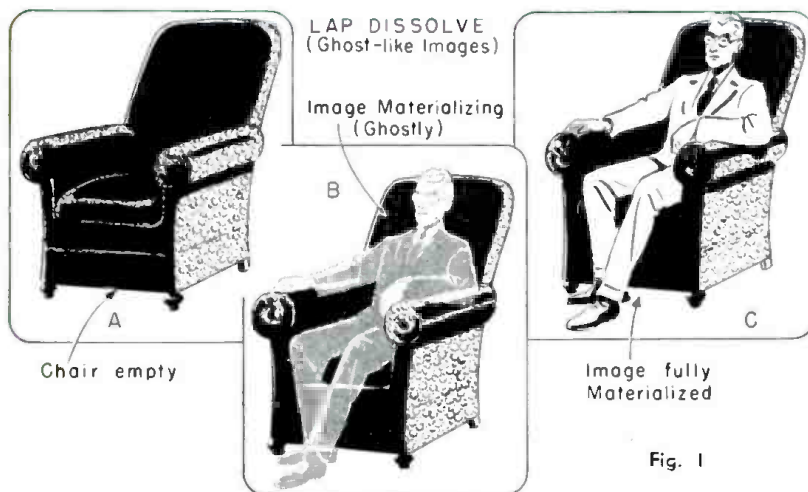

Fig. 1

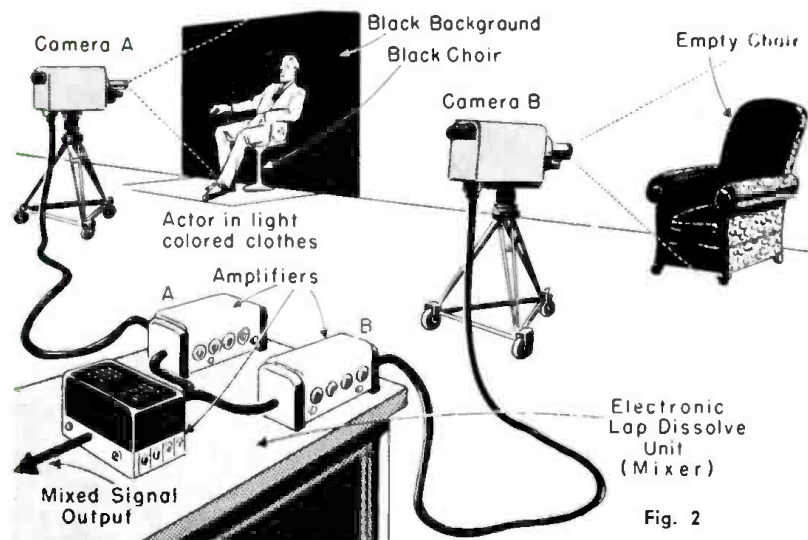
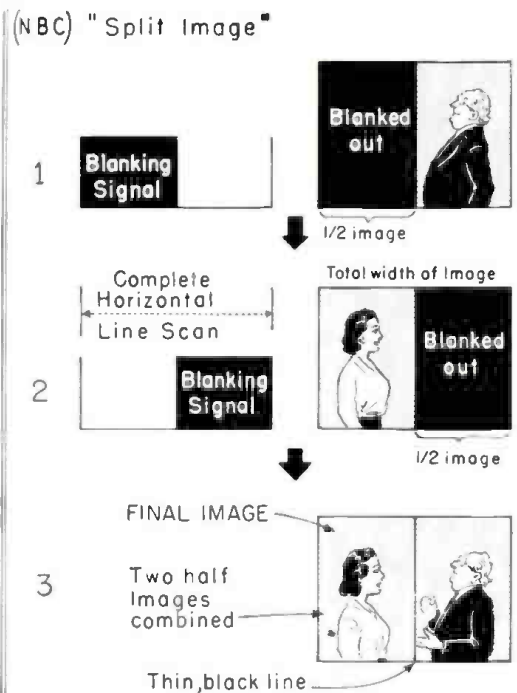
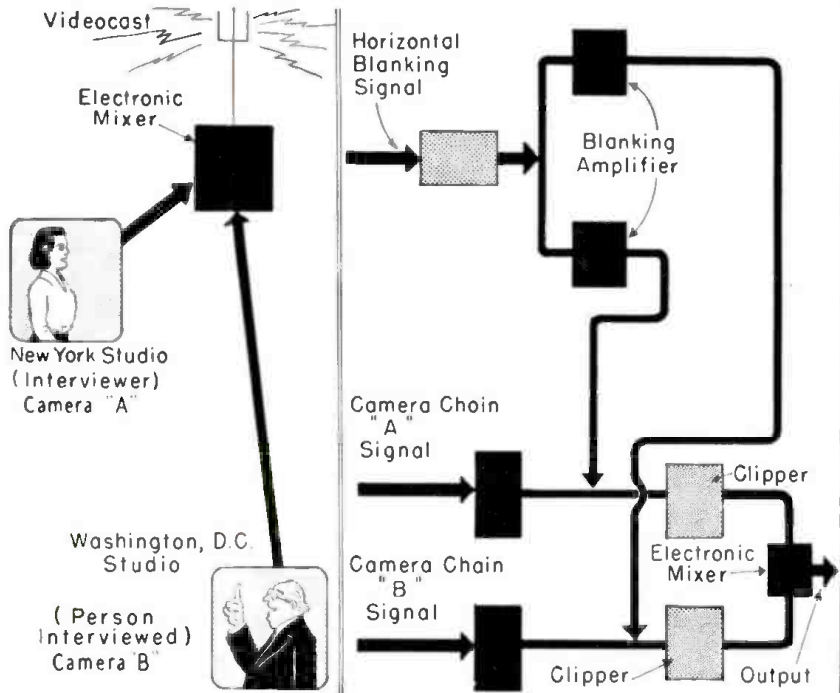

Fig. 2

Fig. 1—What the television audience sees.

Fig. 2—How the "ghost" is materialized.



Figs. 3, 4, and 5—How blocked scanning is used to produce split-image "interviews" between persons who may be far apart geographically.

The split image

One of the most promising novelties in television is the split image, in which two people appear side by side, each image being picked up at a different remote point (possibly in two cities). While in no way weird in effect, the technique very much resembles that used in "magic" stunts, and is even more interesting from the electronic point of view. The diagram (Fig. 3) shows how the separate television camera images are picked up and transmitted to a central point. The unwanted half of each image is blanked out by electronic means. The two half-images are then combined in a mixer and passed on to the video transmitter.

In the split-image arrangement, the sync generators at both originating studios *must be synchronized* (by signals transmitted over the co-axial cable connecting the two stations) so that each scanning trace starts and stops at exactly the same time. Fig. 4 shows a simplified block diagram of the setup for mixing the split images. Blanking generators are used to feed in the blanking pulses to the amplifier circuits carrying the image signals from each camera. Half of each picture is thus blanked out. Clipper stages are added to the mixer unit and the combined signals corresponding to the two half images, one from each originating station, are then mixed through a suitable mixing amplifier and passed on to the television transmitter.

This split-image device is useful, for example, in creating the illusion of an actual, personal interview, when in reality the principals may be in different cities (see Fig. 5). Many other applications of this novel development will find ready application in television. The size of each image has to be watched at its pickup station, so that they will both be approximately the same and



A growing volcano backs up this love scene.

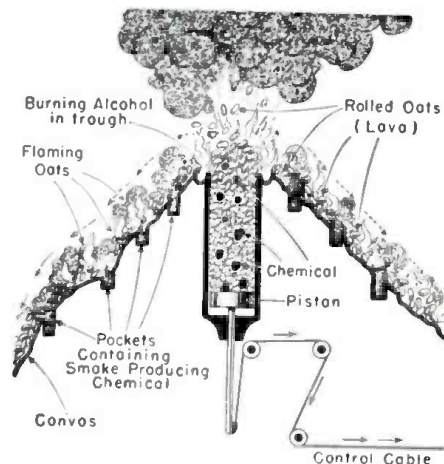

Fig. 6—How to make volcanos erupt on order.

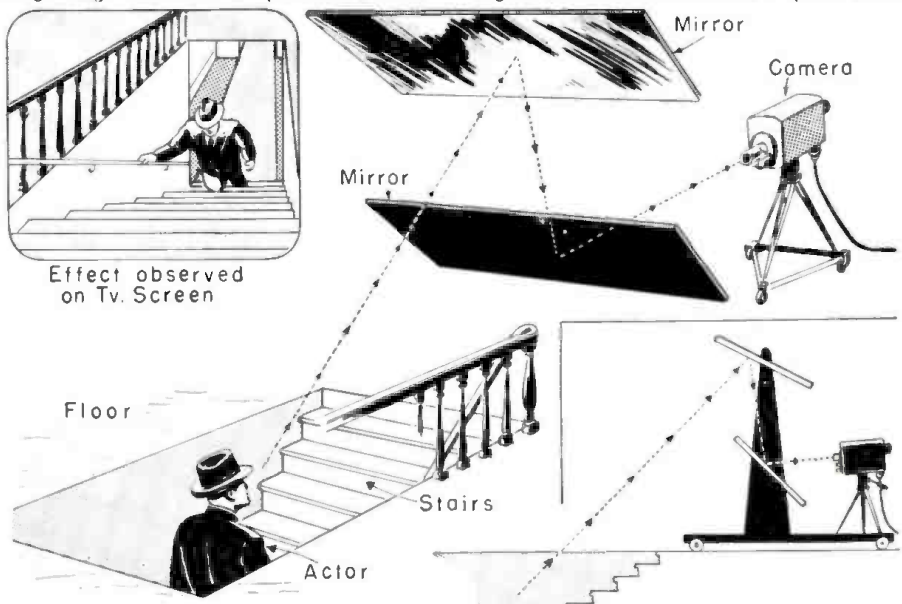

Fig. 7—This overhead shot of a CBS actor ascending a stairway is "all done with mirrors."



Superimposition of Toscanini on his chorus by the techniques described in Figs. 1 and 2.

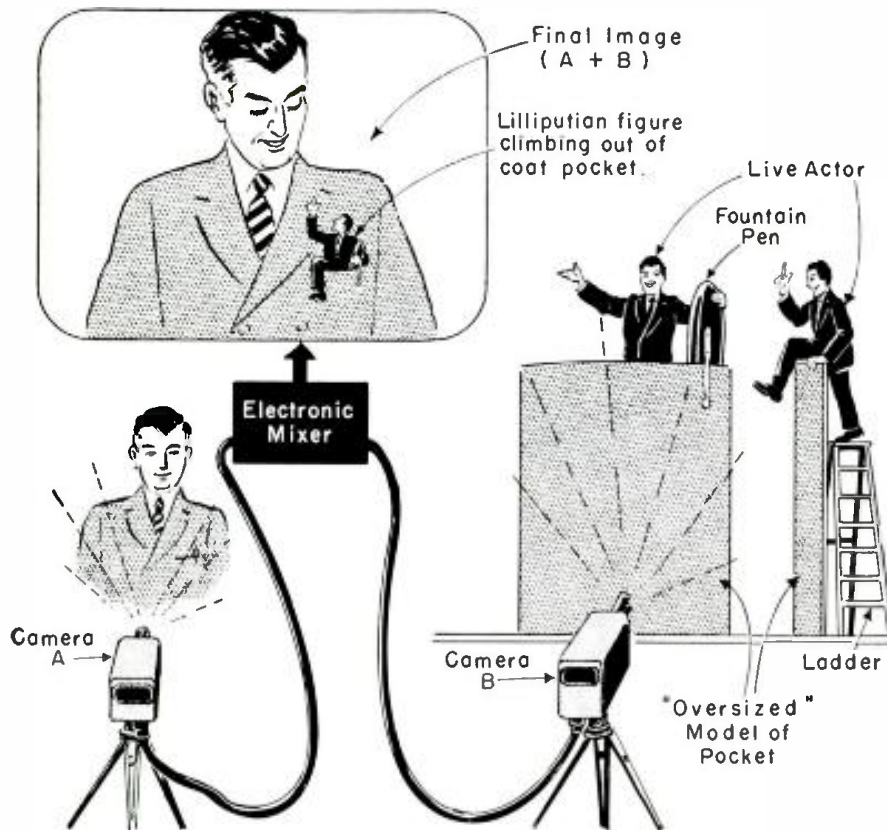

Fig. 8—Two cameras are set up at different distances to produce this mystifying effect.

thus make a harmonious picture when they are combined.

Volcanos made to order

For video entertainment purposes an artificial volcano is often more practical than a real one. At the CBS television studio in New York City, a very realistic erupting volcano was created from a piece of canvas, some rolled oats, and a smoke-producing chemical (titanium

tetrachloride). Fig. 6 shows how the volcano was built of canvas stretched over a framework to resemble a mountain. Pockets were arranged in the surface of the artificial mountain to hold portions of the smoke-producing chemical. Around the mouth of the crater there was a ring-shaped trough to hold alcohol, the flames of which provided the fiery effect of a volcanic eruption. At the start of the display a burst of

magnesium powder added realism to the scene.

In the center of the volcano was a hollow cylinder fitted with a plunger. The cylinder was filled with rolled oats, interspersed with some of the smoke-producing chemical. When the plunger was moved upward with a cord, the rolled oats swelled out through the top of the volcano, some of the oats catching fire and tumbling down the sides of the mountain as lava. The smoke chemical added the necessary steam effect. At the same time the chemical in the pockets on the surface of the volcano was liberated, adding still more smoke and steam to the display.

Overhead shots with mirrors

In motion picture studios it is easy to take overhead shots, looking down on the actors, where such scenes are desirable to lend dramatic emphasis. In the close confines of a television studio it is usually impossible to do this because of lack of head-room. An ingenious device for taking these overhead shots of actors was worked out at the CBS studios, the arrangement making use of two mirrors as shown in Fig. 7. The top mirror is tilted to any desired angle to pick up any portion of the scene. The image picked up by the top mirror is reflected down to the lower mirror, and from there into the lens of the television camera.

By this simple application of ordinary optics, a scene showing a person ascending a flight of stairs or a ship's ladder can be reproduced on the television screen, when it would be practically impossible to do so otherwise. One such scene showed a man coming up out of the hold of a ship, a scene adding greatly to the dramatic appeal of the play presented and which would have been lost without this mirror device.

Lilliputian figures

In one mystifying scene recently staged at the CBS studios and devised by John DeMott, a Lilliputian figure of a man crawled out of the pocket of a normal-sized man's coat. The actor reached toward his pocket for a cigar and the little man bit him, much to the enjoyment of the television audience. The viewers were much mystified—to say the least.

This effect was attained by using two video cameras. One picked up the man reaching for a cigar in his breast pocket; the second camera was trained on a large, oversize replica of the coat pocket, made from plywood. Behind the large model of the pocket a ladder was placed, and the "Lilliputian" actor climbed up the ladder and reached upward as if he were actually in the man's coat pocket and attempting to climb out of it (see Fig. 8).

When the two camera images were combined through an electronic mixer, the novel effect of a tiny but live man climbing out of the coat pocket was produced.

Other effects will be described in a succeeding article.

USAF Shows off its Television

By B. W. SOUTHWELL

VISITORS to the California State Fair last fall were treated to their first glimpse of military television. The exhibit of the United States Air Force unit based at McClellan Field did much to acquaint the public with television as employed by the armed forces for reconnaissance.

Cameras were set up on the Fair Grounds for on-the-spot pickups to be transmitted to the Machinery Building where receivers were feeding external monitors for viewing. The monitors employed cathode-ray tubes having both green (P1) and white (P4) screens.

Perhaps the most interesting feature was an airborne camera, which was mounted in a C-17, for televising an aerial view of Sacramento. The visual transmission was made on a frequency of 336 mc. The commentary while in flight was given by Lt. C. R. Hart of the Public Information Office on a frequency of 138 mc and was received on an SCR-522.

Technical standards for the equipment used in the project differed in most respects from those prescribed by the FCC for commercial broadcasting.

Both sidebands were transmitted, since it was not considered feasible to employ a vestigial-sideband filter because of weight and complexity. Negative transmission was employed, as in broadcasting, as less objectionable ef-

fects with the reproduced picture are experienced; interference drives the maximum carrier amplitude further into the sync-pulse or blacker-than-black region. Positive transmission, on the other hand, would produce serious loss of resolution due to interference.

The aerial camera was locked at infinity focus, as all objects to be televised were at a distance. A cathode-ray-tube view finder was used to advantage. The camera utilized the sensitive image orthicon tube enclosed in a single housing along with all tubes and components except the synchronizing generator. This assembly produced a complete video signal to modulate the transmitter. The view finder was mounted in a similar housing and was fastened to the camera to make a complete unit.

The transmitter line-up consisted of an ultraudion oscillator circuit, buffer stage, and a push-pull-parallel, grid-modulated class-C stage.

The receiver was continuously tunable over a range of 264 to 372 mc and employed a 5-mc bandwidth. The receiver sensitivity was such that an input signal of 35 microvolts with 40% modulation produced an output with unity signal-to-noise ratio. A 72-ohm co-axial line matched a half-wave dipole to the receiver input. A fast-acting automatic volume control, operated from the peak value of the detected synchro-



The camera and commentator in the airplane.

nizing signals, served to smooth out signal fluctuations due to addition to or cancellation of the direct wave from the transmitter in the C-47 by waves received over indirect paths. The receiver furnished a composite video and sync signal for external viewing monitors. Sufficient resolution was obtained to show autos on the city streets and boats on the Sacramento River.

The receiver line-up included one r.f. stage, mixer, oscillator, six stages of i.f. second detector, video stages, horizontal and vertical blocking oscillators, and amplifiers, sync separators, a.v.c. circuit, and picture tube. The high voltage (4,800 volts) for the C-R tube was obtained through a flyback system.

An interesting point is that the positioning controls had 12 volts at 600 ma fed to them. Input to the receiver was 28 volts d.c., and a dynamotor supplied 410 volts positive (225 volts for video and i.f. circuits was stabilized by means of VR tubes) and 30 volts negative for bias. The i.f. stages were stagger-tuned and covered from 47 to 52 mc.



The camera below picks up scenes which are transmitted to receivers and monitors located in the Machinery Building (see photo at left).



Television Helps Astronomy



Inventor holding control box. Viewing screen is within black ring on white cylinder, left.

This telescope “brings the picture inside,” enlarges and projects it on a screen for the benefit of a large class or other gathering

By WILLIAM RHODES*

ASTRONOMY is interesting to a large number of people who are not even amateur astronomers. They are fascinated with the appearance of the heavenly bodies and with their doings, possibly for much the same reason the stay-at-home likes to read in the *National Geographic Magazine*, for instance, about far-off places on his own planet.

To tell people about the solar system, elaborate planetaria have been set up to reconstruct the movements of the bodies mechanically and project them on the inside of a domed roof. While this is instructive, it does not give the same thrill of *personal observation* as does a look at the surfaces of the moon, the stars, and the planets themselves.

Ordinarily only one person at a time can look through a telescope. To allow many people at a time to observe the heavens, we developed an “electron-multiplier” telescope, using the principles of television to transform the small, dim image at the telescope eyepiece into a large image projected on a screen for a roomful of observers. Besides making it possible for many people at one time to see the images, the invention allows us to leave the telescope itself outdoors in its best location (heated air is bad for telescopes) while the observers can stay indoors.

The pickup cell at the prime focus of the telescope mirror was constructed at the Panoramic Research Laboratory and is a miniature of the latest television design. It is inclosed within the shell at the base of the hornlike device near the end of the barrel (see photo).

The pickup cell transmits images to a primary receiving cathode-ray tube. Both are tied to the same sweep oscillators, which are set for 2,000 lines per frame and 120 frames per second.

This high number of frames and lines is necessary because the original image is about the size of a 25-cent piece and is blown up to a disc 64 inches in diameter, with detail that rivals the finest existing television pictures. The screen of the final viewing surface is about 8 inches in diameter and shows only about 280 miles of the moon's surface at a time. If ordinary TV equipment and standards were used, the magnification would be so great that only a few lines would be seen and images would hardly be recognizable. As it is, every detail down to an object only a few thousand feet across on the moon's surface can be seen clearly. Much depends, of course, on the clarity of the atmosphere at the time. The detail, in other words, is limited, not by the electronic equipment, but only by the telescopic and atmospheric conditions.

Scramble scanning

By using a 120-cycle sine wave, we get what we call random or scramble scanning—the lines lace, interlace, and overlap to such an extent that not a single line is visible on the small screen of the cathode-ray tube which first receives the image. This is possible because both transmitting and receiving tubes are tied to the same sweeps so that they lock together, regardless of the vagaries of the scanning system. The detail is so great that the image might as well be coming through as a solid reflection from a mirror.

One trouble we had from the first, however, was that when gain or bril-

liance was turned up, halation or spreading of any given point in the image caused the picture to blur and lose definition. We eliminated the problem (or hypassed it) by turning brilliance down to a point at which the image is just detectable in a dark room. The definition is then at its best. (Incidentally, the tube was constructed with the narrowest possible electron beam.)

As a result, we were left with an image dimmer than the dial of a luminous watch, one, in other words, about equal in every way to that at the main mirror of the telescope itself. What had been done up to this point was to *bring the image indoors* where folks could view it in comfort, while the telescope stayed outside where it could work best.



Outdoor unit—the telescope and its mounting.

* Chief of staff, Panoramic Research Laboratory and Observatory, Phoenix, Arizona

The image was too small and dim to be seen by anyone not gifted with super-vision. By using another, very special cell, we built up the brilliance (not the diameter) of the picture until it is so bright one can hardly look directly at it.

An electron multiplier

The drawing illustrates the special photomultiplier tube. The image on the face of the cathode-ray tube is focused by a lens on the glass bottom of the photomultiplier. On the back of the glass is a light-sensitive coating of cesium, frequently used in phototubes, which emits electrons when struck by light.

Because the face of the C-R tube is curved and the photomultiplier glass is flat, the border of the focused image is somewhat distorted, though the rest is excellent. We get rid of the border by masking it out with a diaphragm.

Atop the cesium coating is a very thin aluminum foil which is a few volts positive with respect to the cesium layer, so that the photo-emitted electrons are accelerated enough to pass through it.

Next the electrons hit a silver-magnesium alloy which is electron-sensitive. This gives off about six to eight electrons for every one which hits it, giving an effect of *electron multiplication*.

Tiny pinholes which transmit some light to the multiplier layer exist in the aluminum foil, but since the layer is not affected noticeably by visible light, this does no harm. When three or four pinholes line up on top of each other, a spot is apparent, but that happened only once with seven cells we have made.

The sheets of aluminum foil are known as Lenard windows. In a device where electrons are accelerated greatly as, for instance, the electron microscope, a straight beam of electrons hitting a window would scatter like shot from a bell-muzzle shotgun. Due, however, to the thinness of the cell and of the foil, the distance the electrons travel is so small there is little spreading.

After going through several layers of foil separated by silver-magnesium multiplying material, the electrons have increased tremendously in number and also in speed. They go through the last foil window and strike the green fluorescent screen. With an image on it, the screen is about as bright as a 100-watt frosted lamp bulb.

The zinc-compound screen could ruin the image by spreading light all over the place, just as in the primary cathode-ray tube, had not the zinc compound been applied by a process which does not allow this. Light cannot spread sideways on the film but can travel only straight through at right angles to the surface. Visualize the effect by thinking of a thin slice of honeycomb filled with fluorescent material. The material in each little cell can fluoresce, but it cannot spread its light to the next cell because the wall will not pass light. These cells are so numerous that it takes a microscope to show them.

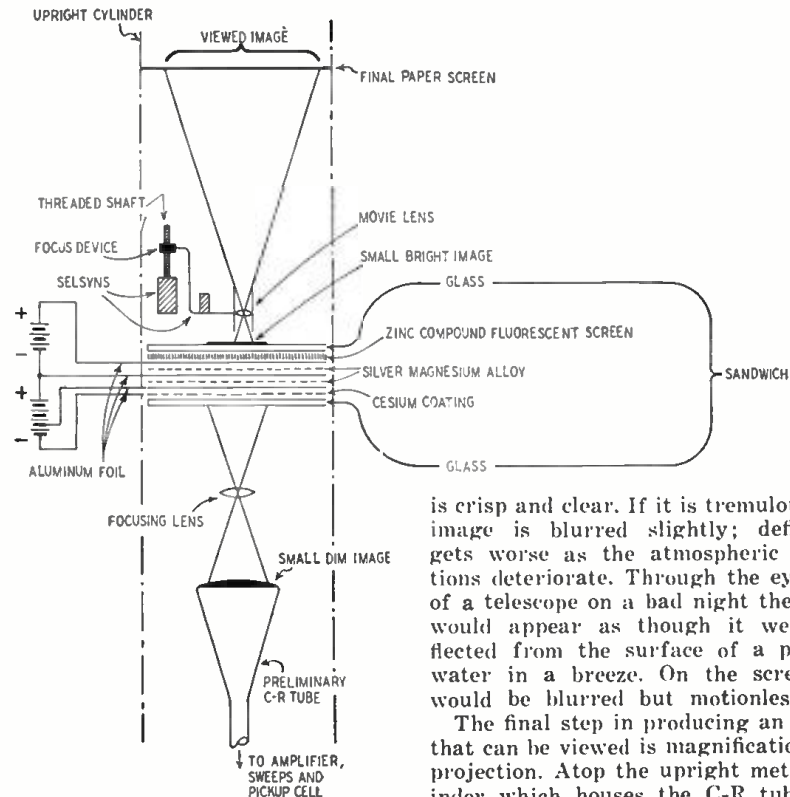

Schematic of the electron multiplier unit.

The image on the face of the multiplier cell is now very bright but has not yet been magnified.

A very-long-persistence fluorescent material was chosen for several reasons. In the first place, it will not show transients like line and tube noises. Second, it will not show the fairly rapid fluctuations in the atmosphere which take place in some degree all the time. The final image has to be on the screen for 2 to 4 seconds so that it can build up; therefore, in effect, the image is an "average" of everything that comes through. The actual image is as still as a photograph.

If the atmosphere is quiet, the image

is crisp and clear. If it is tremulous, the image is blurred slightly; definition gets worse as the atmospheric conditions deteriorate. Through the eyepiece of a telescope on a bad night the moon would appear as though it were reflected from the surface of a pool of water in a breeze. On the screen, it would be blurred but motionless.

The final step in producing an image that can be viewed is magnification and projection. Atop the upright metal cylinder which houses the C-R tube and the multiplier cell is a screen of white tracing paper. Just above the multiplier, within the cylinder, is a lens from an 8-mm movie projector. The lens is mounted on an arm controlled by selsyns. The lens can be moved over any part of the multiplier tube so that it can pick up any desired part of the image. Light goes through it and is projected onto the tracing paper, where the much enlarged image is seen by the observers. The lens may be moved up and down for focusing.

Though the multiplier telescope was not meant to and could not replace existing telescopes used for serious astronomy, it does an excellent job of revealing the mysteries of the heavens to the lay observer.

NEW NAME FOR TV?

"Television" may be fine for engineers, but the public needs a new name, "some catchy, friendly word which may be called out over the garden fence without sounding silly." That's the conclusion of the London *Daily Express*. Even the U.S., according to the *Express*, couldn't think up anything better than video or TV.

Some of the suggestions the *Express* has received sound like a new breakfast food: Oculo, Focal, Imagec, Visray, Telio, Vix. Others are: Lookies, Peeps, Vizema, Rad-E-Eye, and Look-Hear. In all of them the impact of high-pressure advertising or Buck Rogers (or both) seem apparent.

Current leaders are Gazio, Air-Pic, Opalook, I.C., and Kaladio.

Some suggestions for descriptive terms for those who watch television were given at the end of the article on page 69 of the March issue of RADIO-ELECTRONICS.

BETTER TV STANDARDS

More exact scanning standards are required for perfect picture transmission, reported F. J. Bingley of WOR to the recent convention of the Society of Motion Picture Engineers.

Artists may suddenly appear taller and thinner (or the reverse) as studio cameras are changed, he pointed out. Also, if the receiver is lined up to give a nice round pattern on one station, the next one may be an oval. This is due to differences in the ratio of vertical and horizontal scanning velocities. Present standards specify aspect ratio at 4 to 3, but permit tolerances on both horizontal and vertical blanking times. Thus the ratio is not specified exactly. Horizontal and vertical lines (as, for example, the height and waistline of an artist) may be transmitted differently by the same station using different cameras. As cameras are switched rapidly during the shooting of a scene, the result can be disturbing to the onlooker.

Antennas For Television*

Part VI—Construction information and performance reports on several variations of the common half-wave dipole

By
EDWARD M. NOLL
and
MATT MANDL†

A NUMBER of antennas, which can be considered half-wave dipole types, have different characteristics because of their shape. The basic modifications are the short-V, conical, and circular types. These antennas have a higher resistance and generally a broader bandwidth than the dipole. Gain is a bit higher because of somewhat narrower

The improved performance of the expanded types of dipoles is due to the ease with which the transfer is made from propagated wave to antenna current feeding into the transmission line. Perhaps this is best understood if we consider that at the ends of the antenna we have minimum current but maximum voltage. If an end is expanded, it will intercept a greater cross section of the arriving signal wavefront. Energy, if it has a choice, will flow along a conductor. If a substantial part of the wavefront is intercepted, its energy (in the form of antenna current) will flow along the antenna elements, grouping at the apex, the maximum-current point of the antenna. At this point the transmission line is attached.

The conical antenna

The conical antenna (Fig. 2) is a further expansion of the V, each antenna element spanning out in the form of a cone from the apex. The recommended element length for symmetrical bandwidth on each side of a chosen center frequency is 0.365 wavelength from the apex along the conical surface to the rim. Of the modified types the conical has the greatest bandwidth—approximately 30% of center frequency.

For example, a cone cut for a strategic frequency in the low band (depending on local station frequencies) can be made to have peak response to two or three channels and a somewhat reduced sensitivity to other channels, depending on frequency separations. In addition the third-harmonic sensitivity of the cone permits substantial pickup on the high-band channels. A cone cut for 70 mc has a bandwidth of 21 mc and, therefore, would have peak sensitivity to channels 3, 4, and 5. Third-harmonic sensitivity would cover channels 9 through 13.

The cone can be constructed of sheet metal, although (better from the standpoints of wind resistance and economy) it can be formed of 12 equidistant radial wires or of copper screening, with an insignificant change in characteristics. The cone is versatile so far as impedance match is concerned be-

cause its resistance depends on its shape. For example, with an angle of 15 degrees between the sidewall and axis, the antenna resistance is 300 ohms. If two cones are to be stacked, an angle of 10 degrees can be used to obtain a resistance of 600 ohms per unit, again matching a 300-ohm line. Some typical angles and corresponding antenna resistances are:

Angle (degrees)	Resistance (ohms)
5	950
8	750
10	600
13	400
15	300

Reflectors and directors can be used with the various dipole modifications. The parasitic elements, for best performance, should have the same general shape as the driven antenna. Thus a V-shaped reflector is used for a V antenna, while a cone can be used for the conical antenna.

The circular antenna

A circular antenna constructed by the author's was found to have a number of unusual features which make its performance outstanding for television. It has somewhat higher gain than a V or folded dipole, and it is much less sensitive to high-angle radiation. Horizontal directivity is also sharp, and orientation rather critical. This is, of course, advantageous for the suppression of multipath reflections which would produce ghosts.

The manner in which this circular antenna receives signals differs from that of an ordinary radio or a direc-

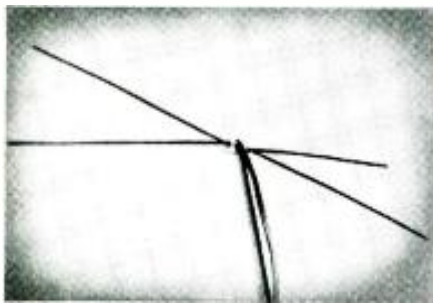

Short-V antenna is usable with 300-ohm line.

directivity, particularly in the vertical plane, and because of greater surface area presented to the arriving wavefront.

The short-V (Fig. 1) consists of two V-shaped sections fed at the apex of each section. Each rod forming the V is an electrical quarter-wave; the separation between the rods of each section forms an angle (which is noncritical) of 30 to 45 degrees. Antenna resistance is 150 to 200 ohms and matches a 300-ohm line with insignificant loss for the usual length of line used for TV installations.

The short-V and other modified types find application in the fringe areas because they lend themselves to stacking and use of parasitic elements without too much reduction of antenna resistance. If antenna resistance is too low, matching problems are more difficult and leakage losses become higher because of the higher current which flows in the antenna system.

* From a forthcoming book: *Reference Guide For Television Antennas*.

† Television Instructors—Technical Institute, Temple University.

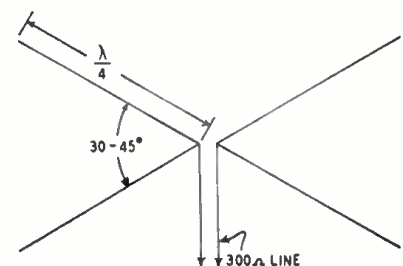
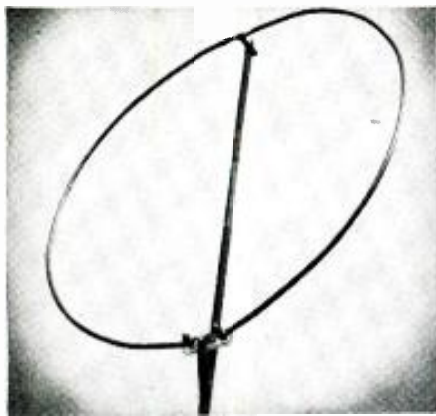

Fig. 1—Short-V uses four quarter-wave rods.



Mast supports the loop of exact center of top.

tion-finding loop antenna with which maximum pick-up is obtained when the edge of the loop points toward the station. In direction finding, a minimum or null is obtained with the loop broadside to the station. Of course, the loop itself is smaller in diameter than the wavelength of the received signals. Inasmuch as the signal phase, therefore, is about the same

antenna must be broadside to the station direction; and the transmission-line feed point must be attached so that it is exactly at bottom or top. The antenna conveniently matches a 300-ohm, ribbon transmission line.

The poor performance of a circular antenna in other than the correct position indicates its ability to reject noise and spurious-signal interference. This improvement is evident when we consider that, for signals arriving from beneath the antenna, the voltages induced in opposite sides of the antenna would be in phase because of the added half-wave of travel necessary to reach the top of the antenna. Noise signal would therefore cancel at the transmission-line feed point. Multipath and other signals which arrive at an angle other than perpendicular to the plane of the antenna encounter the same canceling effects. The directivity pattern of the circular antenna instead of being doughnut-shaped as is that of the more conventional type of dipole, is narrowed and pulled out horizontally toward the station as is the pattern of a stacked system.

channel 10 is shown in the photo. Note that the antenna can be attached to the mast at the top, which is a ground or maximum-current point. Feed point is at the bottom where the antenna is insulated from the mast. The antenna is comparatively small, symmetrical, not top-heavy, and has very little wind resistance.

Summary

1. Antenna placement is of primary importance. It can do more to bring up a stubborn signal than a multi-element array or a booster. Place the antenna in space loops of weak stations.

2. Use directional antennas where needed in fringe areas or multipath localities. To obtain the utmost from a directive system, both impedance matching with stubs at the antenna and proper over-all length of transmission line are important.

3. Choose antenna type and dimensions with an eye to your local allocations. Design antennas for peak sensitivity on frequencies to be received and minimum sensitivity to other frequencies from which interference might come. Broad-band insensitive antennas are not recommended.

4. Use ribbon transmission line to match standard receiver inputs and cut down attenuation on spans of line. Only at the very high TV channels does the loss in twin-lead approach the loss of a very-good-quality co-axial line. Co-axial line is helpful in some noisy localities, but make certain the greater attenuation does not cancel the benefits of shielding.

5. Antennas perform better on frequencies higher rather than lower than those for which they are cut. Choose antenna dimensions to favor the lower frequencies, particularly if one of these stations is weak. Separate high- and low-band antennas are not necessary in most localities. A low-band antenna properly cut will perform just as well on the high band because of harmonic relationship. If stations are not in the same direction, a separate high-band antenna may be helpful in some localities if it can be separately oriented.

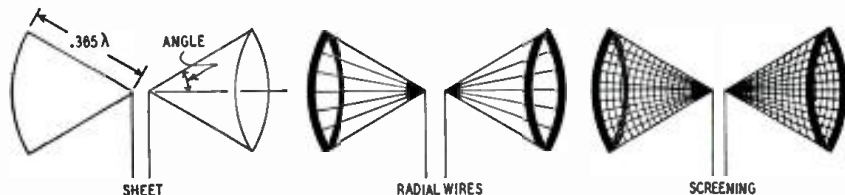

Fig. 2—Conical antennas may be made in a number of ways, as these drawings illustrate.

on both sides of such an antenna, similarly phased voltages are induced in both sides and cancel at the receiver feed point.

The circular antenna illustrated in Fig. 3, however, although in the form of a loop, is just slightly less than a half-wave in diameter; therefore, out-of-phase voltages are present on the sides when the antenna is broadside to the television station. It is this position which feeds maximum signal to the transmission line.

Orientation is critical because the pattern of this antenna is elongated, extending in narrow-beam formation forward and backward. Position of the antenna in its vertical plane is also sharp. A tilt of a few degrees makes a considerable difference in signal pick-up. Because of the electric and magnetic fields of the antenna, rotation about its circumference is also critical, and the transmission line feed point must be either at the exact bottom or top.

The more nearly perfect the circle, the better the reception and noise-reduction characteristics for television. The tubing from which the antenna is constructed can be either 1/4 or 1/2 inch. Too large a surface area may increase signal pickup from ground levels and harm the exceptional noise-reduction characteristics of this circular antenna.

For peak performance, then, the following summarized factors must be closely observed: The antenna must be absolutely circular; it must be mounted vertically; the plane of the

The circular antenna is a full wavelength in circumference, and this dimension must not be corrected for end effect. It was found that peak sensitivity was obtained with the antenna cut to a free-space wavelength. Apparent absence of end effects also indicates less end loss due to capacitive leakage. Dimensions for the various channels (in inches) are as follows:

Channel	Circum.	Channel	Circum.
2	202 inches	8	63 inches
3	183 inches	9	61 inches
4	167 inches	10	59 inches
5	145.5 inches	11	57 inches
6	135.5 inches	12	55.5 inches
7	65 inches	13	54 inches

Perhaps another reason for the increase in sensitivity of the circular antenna is its responsiveness to other than horizontally polarized components of the arriving signal. With the usual turnstile transmitting antenna used by television broadcast stations, there is present a vertically polarized component which is 25 to 30% as strong as the horizontally polarized component. A substantial level of circularly polarized component has also been observed. The circular antenna has some sensitivity to these components also. In fact, the circular antenna can be converted into one with peak sensitivity to a vertically polarized wave simply by positioning the transmission line feed point at the right or left instead of at top or bottom.

A circular antenna constructed for

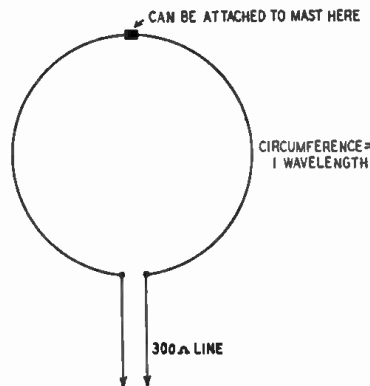

Fig. 3—Loop is a simple 1-wavelength circle.

6. The advantage of stacked antennas, so far as signal strength is concerned, is questionable, the maximum possible increase under the most ideal conditions being 40%. Stacked systems reduce noise pickup from below.

Pedro's Temporary Cure

*This piece of pure fiction
contains more than
a grain of truth*

By GUY SLAUGHTER



*Pedro is perched on my high stool,
elbows on the bench, intently study-
ing an aerial directivity chart.*

"HEY, Pedro," I shout, cradling the telephone. "Dig me up a hatful of spark-plug suppressors, will you?"

He lays down his broom gratefully, and starts for the back room. Then he stops, turns, and gives me the quizzical eye.

"How many?" he queries suspiciously.

"All you can find," I reply shortly. "And make it snappy." I reach for my overcoat, climb into it, and by that time he's back. I can see the curiosity working on him when he hands me the box.

"How come so many?" he asks, trying to be casual but not succeeding very well.

"One per cylinder," I answer, "six cylinders per car, and nine cars."

"Whose cars?"

"Sheriff's office," I snap back, starting for the door. "They're lousing up seven TV sets in the apartment across the street from them." I shut the door behind me, climb into the truck, glance back through the window, and climb out again. I shove my head in the door, and bellow good and loud.

"Stick with that broom!" I shout. I hear a gasp from the back room, and Pedro rockets through the doorway, grabs the broom from the counter, and

begins sweeping furiously. I climb back in the truck, whistling.

When I get to the county jail, I'm not whistling any more. There are six squad cars in the space marked NO PARKING RESERVED FOR SHERIFF'S VEHICLES, their engines running. I glance across the street as I get out of the truck: my antennas are still up, all seven of them.

I climb the steps to the sheriff's office, which is also the reception room of the county jail, and ring the bell. In a minute a surly-faced turnkey opens the door, and regards me stonily.

"Well?" he says, blocking the opening.

"Hello," I falter. "Sheriff in?"

"Naw," he says bitterly. "He ain't never in."

"When will he be back?"

"Couple months, maybe," the turnkey says.

"Where is he?" I ask.

"Florida. Tough life, huh?"

"Yeah," I say. "Look, who's the boss while he's gone?"

"Joe," the hard-faced one says. "Joe Dimitz. Wanna see him?"

"Please," I say.

He steps out of the way, and I walk in. The room is lined on three sides by iron bars, and has a sort of counter

running along the middle. Behind the counter I see two tables of pinochle going strong, complete with four kibitzers.

"Joe," the turnkey says, slamming the iron door shut behind us. "Fer you."

One of the pinochle players looks up, annoyed. He gets to his feet with a resigned air, sticks his cards in his trouser pocket, and walks to the counter. He leans on it and gives me the once over.

"Yeah?" he says.

"Pleased to meet you," I say, figuring a white lie is no crime. "You're in charge here?"

"Chief Deppity," he says, prodding himself in the chest. "What's on your mind?"

"Well," I say, taking a deep breath. "I'm in the radio business."

"Yeah, yeah," he says impatiently. "I'm in the sheriff business. Whaddya want?"

"I've installed seven television sets in the apartment across the street, and your squad cars are fouling them up."

"G'wan," he says suspiciously. "How?"

"Ignition noise," I say. "Every time one of your spark plugs fires, the pictures jump."

"Yeah?" he says, interested.

"That's right." I manage a friendly smile. "It's just unfortunate that the antennas have to be pointed in this direction, but they do. Your plugs must be gapped too wide, too."

"So?" he says.

"So I'd appreciate it if you'd let me

RADIO-ELECTRONICS for

install spark-plug suppressors," I plead, "and regap the plugs. At my own expense of course."

He looks me full in the face, reaches in his pocket for his cards, and fans them out carefully. Then he turns his back on me and walks on over to the table.

"No can do," he says, his attention on his cards. "Can't have citizens messin' with county cars."

"Well, how about killing the engines when you park out in front?" I ask in desperation. "That would help a lot."

"It would, would it?" he says turning his head to look at me.

"Sure," I say, misunderstanding his tone. "They'd still bother going and coming, but the parked ones wouldn't."

"Listen," he growls in an ugly voice. "Them cars is left runnin' to keep 'em warm so we c'n get a fast start if we have to." He pauses and winks at the man across the table from him. "Besides," he says. "How'd you like to leave a warm room'n climb in a cold car?"

"I know," I falter, "but . . ."

"Leave 'em out, Ike," he interrupts me, motioning to the turnkey. I'm still trying to think of something to say when the door swings shut behind me.

Pedro gets curious

When I get back to the shop, I find Pedro perched on my high stool, elbows on the bench, earnestly studying an antenna directivity chart spread out before him. He looks up, nods vaguely, and goes back to the chart.

"Hi," I say, peeling off my coat.

"Hi," murmurs Pedro absently. "Look." He lays a finger on a figure-eight curve. "I don't get it. Herk."

"Nothing to get," I say, hanging up the coat. "That just shows the directivity of a folded dipole antenna."

"What's the dotted lines for?"

"Directivity of the dipole on different frequencies," I explain, leaning on the bench and tracing out the curves with my forefinger. "Different channels, really, since they're bands of frequencies."

"Over here it's different," he says, pointing at another set of curves.

"Sure," I nod. "This is the same dipole with a reflector added. That makes it more nearly unidirectional."

"Hunh?" says Pedro.

"Capable of receiving better from the front than the back." I elucidate.

"Hey," says Pedro. "If you point the front end at the station, the picture'll be stronger, hunh?"

"Right," I agree. "And noise pickup from the rear will be attenuated."

"Gee," he says. "Hey, Herk, you had some phone calls."

"Oh?" I question absently, still looking at the curves.

"Trouble," declares Pedro happily. "You got more trouble."

"Now what?" I groan.

"Four people called," he says, consulting a list he drags from his pocket. "All from the same address. They got funny lines going through their pictures all the time. The pictures keep

jumping, too." He laughs, pleasantly. "Funny, hunh?"

"Not very," I scowl. "What else?"

"Three of them said you better either fix their sets or give their money back," Pedro says lightly. "That's all."

"Yeah," I mutter. "That's all." I go out front, and make a phone call to a friend of mine who has a friend on the county council. Pretty soon he calls back. His friend, my friend reports, will be glad to recommend to the council that the sheriff's squad cars be equipped with suppressor-type spark plugs; but he'll have to wait for the sheriff to get back before he makes his recommendation. It's not good politics, my friend tells me, for his friend to do anything in the sheriff's absence. I thank my friend bitterly for using his influence with his friend, and hang up.

The phone rings before I get two steps away, and it's another of the seven.

"Yes," I say, after the spluttering subsides. "I know your pictures are streaked and jumpy. It's ignition hash from the sheriff's cars across the street. Yes, I am doing something about it. Yes. Of course I guaranteed it. Yes, I'm working on it." I hang up despondently, and wonder idly where I can find a good, tall cliff to fall off.

"What's the matter, Herk?" Pedro asks eyeing me solemnly.

So I very carefully give him my full opinion of political hirelings who leave engines running 24 hours a day within spitting range of a seven-unit TV installation. I elaborate on the details of how crowded the poorhouse is these days with innocent ex-radiomen who have suddenly had to redeem seven TV sets with cold cash. And I shake a verbal fist at a guy named Edison who started the whole sorry situation by noticing that current flowed through a light bulb with an extra wire sealed into it. Finally I run out of breath.

"Can't you change the aerials, Herk?" Pedro asks.

I shake my head sadly.

"I'm already using co-ax," I explain, "and the antennas are mounted as far back from the street as the landlord will allow."

"You can't put suppressors on the squad cars?"

"Not without permission. The chief deputy won't play, and the sheriff's gone for a couple of months."

"We need a temporary cure, hunh?"

"Yeah," I say.

"Want to spend some money?" Pedro asks innocently. His eyes are narrowed, and his thoughts seem far away.

"I'd rather spend a lot of money than take those sets back," I retort. "But no bribery, thank you. I couldn't cuss politicians any more if I were as crooked as they are."

"Yeah," acquiesces Pedro. "Well, time to go home." He eyes me expectantly, and I suddenly realize it's Saturday.

"Payday, hunh?" I comment, digging deep. "Okay, kiddo, here you go."

"Thanks, Herk," he says, pocketing it. "See you Monday after school." He

starts for the door, and stops with his hand on the knob. "Coming in tomorrow?"

"No," I answer, absently.

"G'nite, Herk," Pedro says. He's got a funny light in his eyes, but I'm too busy worrying to pay much attention. I potter around a few minutes, and then I go home too.

Monday morning

Monday morning I seem to feel something is wrong the minute I walk in the shop. But everything looks all right, so I shrug off the feeling, and go back to the bench and start to work.

Along in the middle of the morning, the phone rings. I figure it's one of the seven and shrink from answering it; but it keeps on jangling, so I grab it.

"Mr. Newton?" a rough voice demands.

"Yeah."

"Joe Dimitz," the voice goes on. "Chief Deppity. Harya this mornin'?" He is all sweetness and light and chumminess, and I don't get it.

"Okay, thanks," I say coldly. "What can I do for you?"

"Where c'n I get some of them things your boy was tellin' me about yestiday? Some kinda spark plugs that don't mess up the television?"

When I come to enough to recover my voice, I tell him of a garage in town that carries them.

"Thanks," he says. "We don't leave our cars runnin' no more when we park. In fact we kill the motors a block away and coast in." His voice goes apologetic. "We'd like ta get a block away before we start up again, but we ain't figgered it out yet." He hangs up, and leaves me in a daze. I just sit there for a minute staring into space.

Then my eyes focus: there's an empty spot where there's supposed to be a TV set. A little 7-inch job that I've been trying to peddle for three months is missing, and way back deep in my alleged brain something keeps whispering "Pedro."

I take the phone off the hook, and call the high school, meanwhile trying to keep my plate current from rising too high. First I have to talk to the principal's secretary, and then to the principal himself; but they finally put Pedro on the line.

"Hi, Herk," he says. "Anything wrong?"

"You know what's wrong," I declare. "You bribed the Sheriff's force with a TV set yesterday, didn't you?"

"No," he says innocently. "I didn't."

"Hunh?" I'm brought up short. Pedro does a lot of things, but he's never lied to me. "Pedro, you tell me the truth."

"I loaned it to them," murmurs Pedro softly. "until the sheriff gets back. With option to buy."

"Yeah?" I say weakly, beginning to see the light.

"I stuck up a folded dipole," Pedro continues gaily. "No reflector." He pauses, and his voice drops. "Any complaints from across the street?"

"No, Pedro," I say reverently. "No complaints."

Ignition Interference to FM and Television

Exhaustive measurements show the effects of automobile interference on reception and ways of preventing it

By JOHN B. LEDBETTER*

WHILE the effects of interference from automobile ignition systems on radio and television reception are well known, the exact process through which they are brought about is not as familiar. A sound basic knowledge of the contribution of each part of the ignition system to the generation and radiation of interfering electrical pulses is necessary for a logical approach to the problem.

We usually think of the electrical system of motor vehicles as handling low-voltage direct currents. There are several points, however, in the ignition system where high-frequency, high-voltage oscillations exist. At any point where an arc is generated, a transient oscillating current flows in certain parts of the wiring. Such arcs occur under certain conditions at the generator brushes, starter motor, heater fan motor, and at the breaker points of any of the relay devices, such as the voltage regulator.

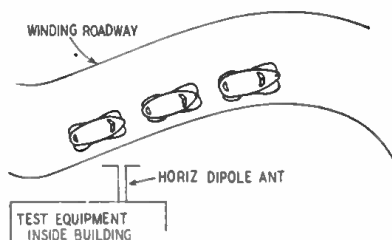

Fig. 1—Cars drove slowly away from antenna.

In the ignition system, high-frequency oscillation takes place in the primary circuit when the breaker points open, even though an arc does not actually form. This is due to the rapid change of current in the primary, which causes a correspondingly rapid change in the magnetic flux linking the primary and secondary of the ignition coil. As the magnetic flux collapses through the secondary winding, it induces a very high voltage in that circuit, which ionizes the electrodes of the spark plug and causes the spark to appear.

* WKRC, WCTS-FM, WKRC-TV, Cincinnati

The spark, or instantaneous secondary discharge, has a *capacitance* component of approximately 1 microsecond duration and a peak current up to 150 amperes. The discharge of the capacitance component, which oscillates at very high frequencies, is followed by an *induction* component of much longer duration and much lower current value. The current, which decreases exponentially during this period, has superimposed on it sine-wave oscillations whose frequency depends on the L-C properties of the primary circuit, that is, the frequency of resonance.

It is the extremely high-frequency, high-current discharge in the *capacitance* component of the spark which results in outward radiation of electromagnetic waves from the high-tension ignition system. Because this radiation does not confine itself to any fixed frequency but occurs at many different frequencies, and at greatly varying amplitudes, interference is caused to almost every type of radio broadcast and communications service, especially those operating in the higher-frequency bands.

Suppression at the source

Although directional receiving antenna systems can be employed to good advantage in discriminating against uncontrolled radiation from a parallel plane or fixed source, they become rather ineffective if interference is received from several different directions. The only logical answer to the problem; therefore, is the suppression of ignition interference at its source, or its reduction to a tolerable limit.¹

The Radio Manufacturers Association has taken steps toward a practical solution of the problem. A meeting was called in February, 1944, between the RMA and the Society of Automotive Engineers, and a joint RMA-SAE Committee on Vehicle Radio Interfer-

¹ "The Automotive Industry's Participation in Reduction of Radio and Television Interference," P. J. Kent, Chief Engineer, Electrical Div., Chrysler Corp. Paper presented at SAE summer meeting, French Lick, Indiana, June 6-11, 1948.

ence was organized. Three subcommittees were formed, and each was given a specific assignment in the interference study.

In 1944, the receiver subcommittee made exhaustive tests to determine the tolerable limits of interference of several makes of FM receivers. The first field test was made at Rye, N. Y., where several different makes of FM and television receivers were set up to receive broadcasts from NBC and CBS in New York City. Conditions were controlled so that the received signal strength at Rye would approximate the fringe-area value of 50 microvolts per meter for FM and 500 microvolts per meter for television.

The measurement setup consisted of a horizontal receiving dipole mounted 7½ feet above the ground and connected to the various receivers, and a Measurements Corporation Model 58 noise meter. With the receivers tuned in, different makes of motor vehicles were driven slowly away from the receiving antenna until a point of tolerable interference (as determined aurally or visually by a committee of three) was reached. (See Fig. 1.) The noise meter was then connected to the antenna and the strength of the interfering radiation was measured.

As a result of these tests, a field strength of 35 microvolts per meter at a distance of 50 feet from the distributor-coil side of the vehicle was fixed as the tolerable limit of interference. This limit is applicable at all frequencies up to 150 mc.

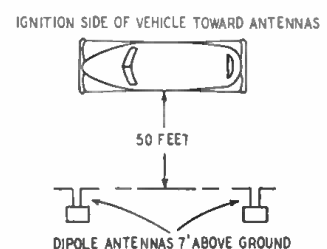

Fig. 2—Noise measurement setup used at Rye.
RADIO-ELECTRONICS for

A second test

In June, 1944, the RMA-SAE interference committees conducted the second field test at Anderson, Indiana. For the test, seven different makes of automobiles were selected as being representative of the engines and electrical systems in common use. The noise-meter antenna was set up for both horizontal and vertical polarization at distances of 5, 15, and 50 feet from the ignition side of the vehicle. Each vehicle was equipped with the suppression supplied or recommended by the manufacturer; in many cases different types or amounts of suppression were employed to determine their effectiveness.

Some general conclusions were reached as a result of this series of experiments:

1. Vehicles employing compactly grouped ignition systems produce less interference than those in which components are more widely separated from each other.

2. Spark-plug and distributor suppressors are more effective below 40 mc than above, although interference is reduced considerably at the higher frequencies.

3. A very effective method of suppression is to completely enclose the ignition system in a grounded metal shield and employ spark-plug and distributor suppressors.

4. Measurements of radiation intensities made by different methods and with various instruments do not necessarily agree.

5. Generator interference, when present, was noticeable at a distance of 5 feet but not at 50 feet.

6. Interference resulting from a group of vehicles is less than the total of the individual vehicles (possibly due to phase cancellations).

7. Radiation from any given vehicle varied widely at a number of different frequencies.

Another series of field tests was made at Anderson in 1945 to determine which type of suppression would work best with each type of vehicle. For this test 13 passenger cars and trucks were used, and the standard Rye measurement setup was used (see Fig. 2). Note the radiation curves (Fig. 3) of a typical six-cylinder engine with two degrees of suppression. The addition of spark-plug suppressors is obviously important.

The conclusions

Several conclusions were reached:

1. The majority of vehicles are capable of meeting the tentative tolerable limit (35 microvolts per meter at 50 feet, measured on a horizontal antenna 7½ feet above ground) by employing 10,000-ohm suppressors at each spark plug and in the distributor center lead, and by locating the ignition coil so that the high-tension lead (from coil to distributor) is not over 8 inches in total length.

2. Addition of a capacitor on the

primary lead at the coil is necessary in some cases.

3. All high-tension leads should be kept as short as possible.

4. All metal tubing, rods, coolant lines, and wiring other than ignition should be kept well away from the ignition system.

5. No excessive interference from electrical equipment other than ignition was noted at the 50-foot distance, although the possibility of such interference does exist.

A third series of field tests was conducted at Anderson in August, 1947, mainly for the purpose of educating automotive personnel who had not seen the previous tests.

Another set of tests

The fourth set of field tests, made expressly to determine the effect of ignition interference on modern television receivers, was conducted at Marlton, N. J., approximately 15 miles from Camden, where a signal strength of 500 microvolts per meter at 7½ feet above the ground could be obtained from WFIL-TV, Philadelphia.

The measurement site was located in an open field, removed from interference except for the vehicles to be measured. The television receivers and the noise meter were placed in darkened area for proper viewing of the C-R-tube screen.

The cars under measurement were driven head-on toward the antenna site until the observers agreed on a tolerable value of interference. For each measurement, the engine was run at the speed which resulted in the greatest amount of interference (usually a repetitive acceleration).

The conclusions were:

1. Interference from ignition systems causes a tolerable black or black-and-white streak in the picture at an interference level varying from 6 to 69 microvolts, depending on the character and duration of the radiated pulse as well as on the receiver. The average limit of tolerable interference for all measurements on the four receivers was approximately 33 microvolts. (This agrees remarkably well with the 35-microvolt level of tolerable interference set up in the Rye tests.)

2. The television receivers did not lose synchronization when subjected to the so-called tolerable limit of interference.

3. The character and duration of the radiated pulse as seen on the television screen determines to some extent the tolerable level of interference. For example, the long, serrated pulse of a Pontiac tested was easily seen and therefore required more suppression than some others.

4. The interference level used for the tests allows satisfactory reception only if it is intermittent but does not if it is continuous interference. For satisfactory reception under continuous interference, a signal-to-noise ratio of approximately 30-40 db (for equal band

width of television receiver and noise meter) would probably be required. This is a considerably better ratio than the "tolerable" ratio decided on during the test.

5. In the receivers tested, the immunity of the sound channel to inter-

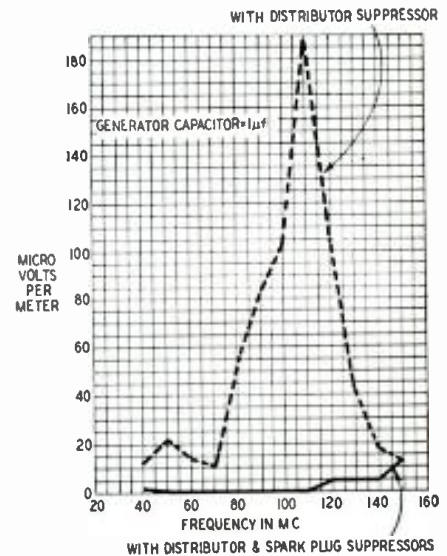

Fig. 3—Curves show suppressors are effective.

ference was better than that of the picture channel, and, for all practical purposes, may be regarded as about complete.

6. The 1948 Chevrolet (the only late-model car tested) incorporated certain ignition changes and was not equipped with suppressors. Its interference radiation was within tolerable limits.

7. Use of the special "resistor spark plugs" (with built-in suppressors) reduced radiation from the ignition system by an appreciable amount. In the two tests conducted with these spark plugs, the tolerable interference distance moved from 200 feet from the antenna to approximately 70 feet, a substantial gain.

Reports from numerous sources indicate that no detrimental effect on engine performance or fuel consumption is brought about by the installation of suppressor resistors. Their addition, in many cases, helps show up spark plugs which are old, coked, or partially fouled.

The ultimate result of all the tests has been to show that by the simple expedient of equipping all motor vehicles—passenger cars, trucks, and buses—with suitable suppressors (and possibly rearranging distributor wiring in stubborn cases) the problem of ignition interference to television and FM and AM radio reception can be effectively solved.

Thanks are due to K. A. Chittick of RCA, P. J. Kent, Chief Engineer of Chrysler's Electrical Division, the Radio Manufacturers' Association, and the Society of Automotive Engineers for permission to use some of the material in this article.

The Radio Hat

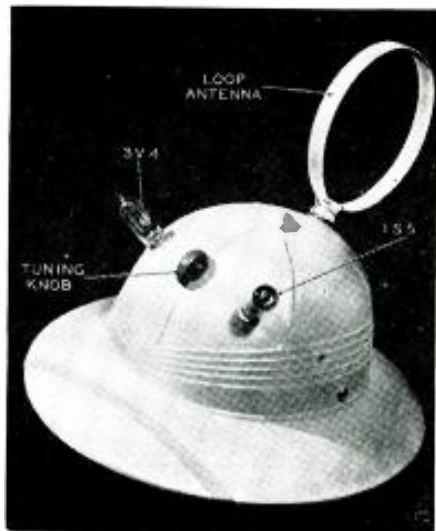

IT IS refreshing to note that not all radio manufacturers in this country believe that radio broadcasting is doomed to early extinction. It seems certain that American ingenuity and inventiveness will do much to keep it in the foreground for generations to come.

This is exemplified by an entirely new radio receiver—the Radio Hat—illustrated on the cover of this magazine. Communication, reception, are a constant necessity to people in this country. So is a light and portable receiver, such as the Radio Hat, illustrated in these pages.

As a new article of manufacture, it will probably cause no little sensation in this country during the next few months. Originally the manufacturer of the Radio Hat believed that the item was geared for the use of youngsters only. It would seem indeed that on account of its low price—below \$8.00—it will find a large market in this particu-

lar sphere. Boy Scouts and youngsters on their vacations, whether in the country or at the beach, will be avid buyers of an article of this type.

Grown-ups, however, will buy it as a stunt and for emergency purposes or sports, such as hiking, canoeing, and boating.

The editors made a number of tests on the Radio Hat and found it to be an exceptionally efficient receiver, particularly for outdoor purposes. In and around New York City, practically all the locals came in with excellent volume. An efficient modified ultraudion circuit is used and the separation of stations is clean and effective. The set is tuned with a control located between the two tubes on top of the hat.

The device was found to be quite directional and for this reason the rotatable loop antenna should be used, unless the wearer of the hat turns on his own axis to get the best reception.

A number of tests were also made indoors. Reception was fair, even in steel buildings; good in non-steel buildings.

The battery, incidentally, is made up of one 22½-volt B-battery and two 10¢ A-batteries. These are contained in a carton which is kept in the pocket and is connected to the hat with a flexible short lead cord.

ONE of the most useful and eye-catching radio novelties in a long time is the Radio Hat, a new type of personal receiver manufactured by the American Merri-Lei Corporation of Brooklyn, N. Y. It is a sensitive little two-tube set built into a tropical-type helmet with the tubes projecting from the front like two small horns.

Its tuning control is a small, streamlined bar knob mounted between the tubes. The antenna (and tuning inductor) is a 5-incl. loop, ½ inch wide, mounted vertically on the rear of the crown. It fits into a socket that permits rotation through 90 degrees for directional effects. A single headphone is built into the inside of the hat just over one ear.

Power is supplied by a tiny 8-ounce battery pack that fits into a pocket and connects to the set through a 36-inch length of thin 3-conductor wire. The

appearance of the set is bizarre but strangely impressive, as seen in the photographs.

At a glance, this "man-from-Mars" personal radio would appear to be a child's toy but after using it for a few hours, we began to see its possibilities.

For example, it is just the thing for baseball fans who want to keep up with the doings of the out-of-town teams while rooting for the home-town favorites in the local ball park. Followers of the sport of Izaak Walton

will be wearing their radios as they head—rod and reel in hand—for a spot on the banks of the old mill stream. For beaches, hiking, bicycling, picnics, or strolling in the park, the Radio Hat will prove its worth to all who wear it.

Substantial and water-resistant, the Radio Hat weighs only 12 ounces and can be fitted to any size head by adjusting the leather sweatband. Twelve ounces may seem heavy for a hat until compared with the five to seven ounces of the average man's hat. The Radio

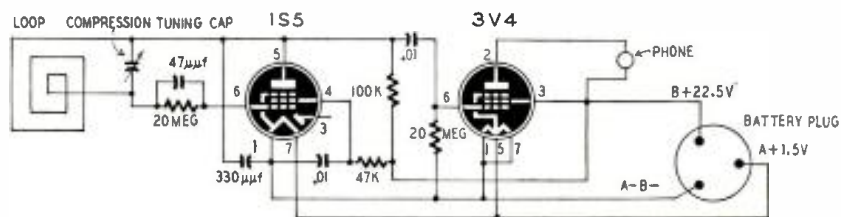

The interesting detector circuit apparently adds considerably to the receiver's sensitivity.

RADIO-ELECTRONICS for

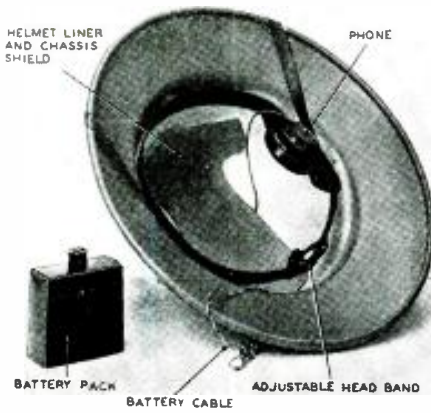

Within the hat. Interior is perfectly smooth.

Hat fits well and can be worn at almost any angle. Probably young ladies will wear it perched on the back of their heads (see this month's cover) and youthful gay blades can wear it tipped jauntily over one eye. The phone is over the left ear but can be moved to the right if the wearer desires.

The Radio Hat is made in such gay colors as canary yellow, lipstick red, turquoise, chartreuse, tangerine, lavender, blue, and cerise for teen-agers, and in tan, gray, green-gray, and blue-gray for adults.

The circuit

The circuit of the Radio Hat is shown in the diagram. The 1S5 is connected as a modified ultraudion detector. Its tuned circuit consists of the loop and a small compression-type capacitor with the control knob on the front between the tubes. The audio amplifier is a 3V4 pentode, resistance-coupled to the detector. Bias for the amplifier is developed across its 20-megohm grid resistor. The single phone is in the plate circuit of the 3V4 where it provides sufficient volume for local stations.

The power supply is a small battery pack that supplies 1½ volts for the filaments and 22½ volts for the plates and screen grids. The A-battery is a standard No. 2 flashlight cell that will last as long as 20 hours with intermittent use. Replacement battery packs will be available at retailers or from the manufacturer. These are 2½ x 2½ x 1¼ inches, housing the A- and B-batteries. The A-battery is held in the pack with spring-brass clips that connect to the battery terminals.

The batteries connect to the set through a 3-prong connector and a thin flexible cable. There is no switch. The set is turned on by plugging the battery cable into the socket on the pack.

The selectivity is surprisingly good. It separates stations much better than some 4-tube t.r.f. sets. Like most regenerative detectors, this one requires careful adjustment of the tuning control and antenna for best reception.

The manufacturer states that when the Radio Hat is put on the market, its tubes will be coated with a tough plastic that will prevent damage from flying glass should a tube be broken.

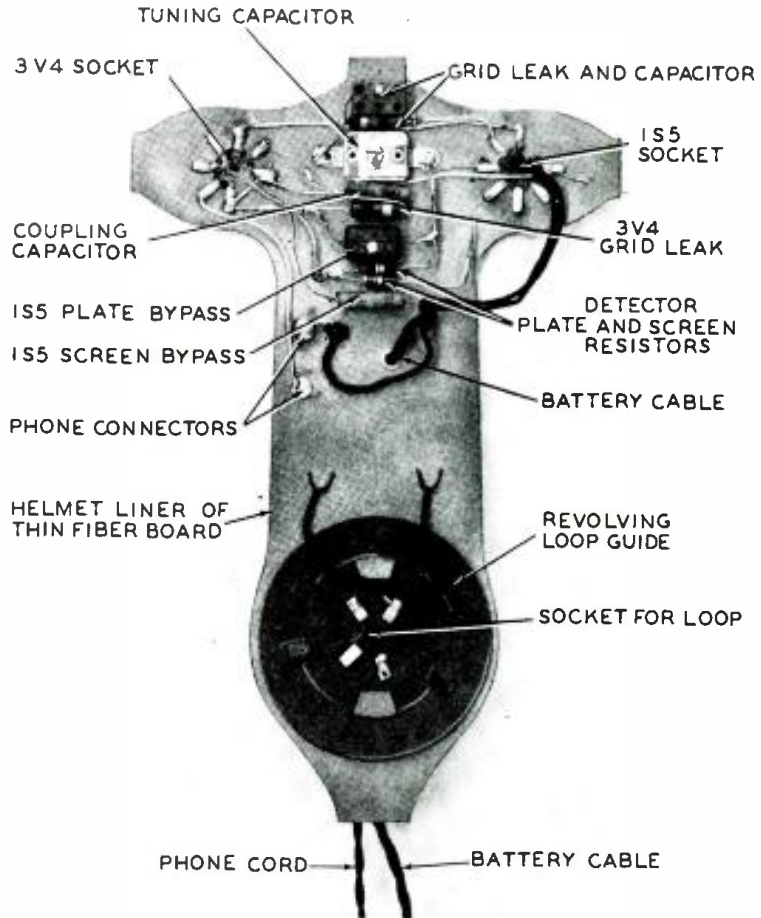

This "chassis" is covered and shielded with foil-coated liner seen in photo at left.

NEW AND IMPROVED TRANSISTOR

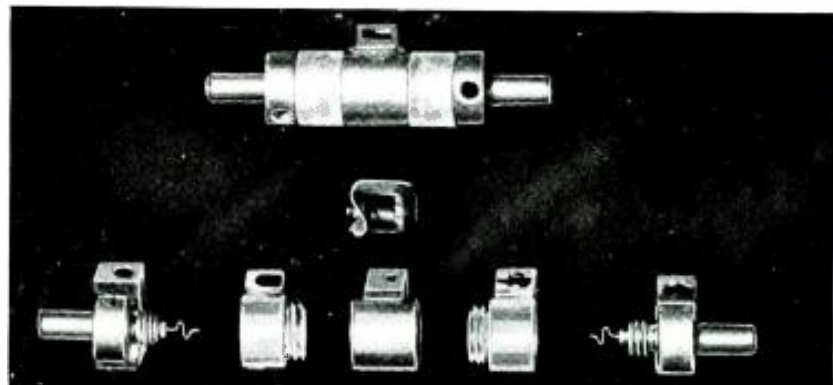
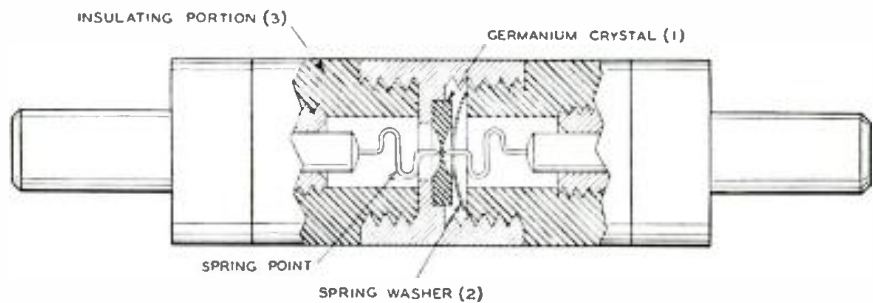

Courtesy Bell Telephone Laboratories
New design in the Transistor has resulted in the model above. A thin crystal occupies the central portion of a cylinder, and the two cat-whiskers press on it from the opposite ends.

Electronics in Medicine

Part VIII—A radio technician can repair and maintain almost any X-ray installation

By EUGENE THOMPSON

X-RAYs are an invisible form of radiant energy of extremely short wavelength (0.125×10^8 to 0.5×10^8 cm). They have the ability to penetrate many opaque materials. They are produced in an evacuated glass envelope by bombarding a positively charged, tungsten-plated, copper anode with a high-velocity stream of electrons emitted from a heated filament and negatively charged cathode (Fig. 1).

As the potential between cathode and anode increases, the X-rays become shorter in wavelength and more penetrating. Commercial X-ray tubes are operated at voltages ranging from 50 kv to several million volts, depending on the design of the tube. The current consumption runs from about 15 to several hundred ma. Higher-current tubes produce better contrast in X-ray pictures.

Most of the energy produced by the electronic bombardment of the anode is liberated in the form of heat. Only a small proportion is emitted as X-rays. This heat may be dissipated by radiation fins attached to the anode, by circulating water, or by immersing the tube in oil.

Tubes may have either stationary or rotating anodes; Fig. 2 illustrates the latter. Its chief advantage is that it permits the X-rays to be concentrated into a much smaller area because of



Control panel for an X-ray-fluoroscope unit.

the more efficient heat dissipation of the rotating anode. A rotary anode is cool under conditions that would generate enough heat to destroy a stationary anode.

Radio technicians are occasionally called upon for emergency servicing of X-ray apparatus belonging to local hospitals or physicians. Although many repairs can be made only by specially trained personnel with the proper replacement parts, the most commonly encountered difficulties are relatively simple to remedy. Therefore, the remainder of this article deals with some of the basic components of all X-ray equipment, with which some familiarity is required for servicing profitably such machines.

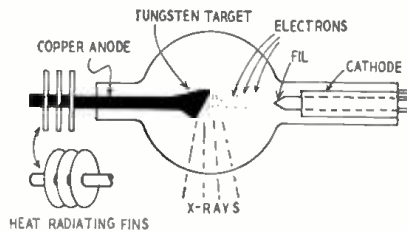

Fig. 1—High-velocity electrons strike anode.

A word of caution at the outset. X-ray equipment is dangerous! Carelessness may lead to serious injury or loss of life. *Never* violate the following rules:

1. *Never handle the free end of any cable without first carefully grounding it to discharge any high voltage.* This is doubly important in machines which employ capacitors in the power supply. Also, the negative leg of the high voltage is common with one of the filament leads.

2. *Never take measurements with the power on. Make certain that the equipment is turned off, and use a continuity meter.*

3. *Never observe an uncovered X-ray tube unless protected by the lead and glass shield provided with the equipment.* Excessive exposure to X-rays may cause severe burns. Carelessness may lead to the loss of a hand or of eyesight.

Although these warnings make X-ray servicing appear exceedingly dangerous, actually it is no more so than television work. The fact that many thousand physicians and X-ray servicemen work with such equipment daily with safety proves that it is harmless

when correct and careful precautions are taken.

Typical generators

Figs. 3, 4, and 5 are schematic diagrams of relatively simple X-ray machines. Although more complicated instruments are sometimes encountered, they all boil down to the basic essentials illustrated here. The servicing of all X-ray apparatus, no matter how complex, may be greatly simplified

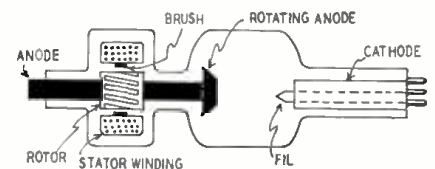

Fig. 2—The anode rotates to dissipate heat.

when it is remembered that they must all contain an X-ray tube, a high-voltage power supply, and a source of filament voltage. The remaining components found in more complicated machines are usually incorporated in the control unit to make the equipment more convenient for non-technicians to operate.

No attempt will be made to enumerate all the possible defects which may be encountered. The reader can obtain this information by inspecting the diagrams. The X-ray trouble-shooting chart enumerates those common difficulties which can be remedied by the average radio repairman. The following discussion is limited to basic principles.

The machine in Fig. 3 is a small, 15-ma portable unit of the type commonly used in many doctors' offices and for bedside work in hospitals. The schematic is more or less self-explanatory. The X-ray tube is self-rectifying because of the comparatively low potential and current at which it is operated. For higher-voltage tubes, external rectification is necessary because the operating potential is so much higher than the peak inverse voltage of the tube. Note that one side of the high voltage is common with one leg of the filament: that is why the filament's cable must be grounded when removed from the tube for inspection before being handled.

Fig. 4 is a schematic of a typical high-voltage X-ray unit. The amplitude of the high voltage is controlled

RADIO-ELECTRONICS for

by the autotransformer voltage-selector setting. A four-tube bridge-type, full-wave rectifier is used. Some units employ only one or two rectifier tubes. X-ray rectifiers are of the heavy-duty type and are commonly immersed in oil to dissipate heat. Note that again the negative side of the high voltage is tied to one side of the X-ray tube filament circuit.

As a safety measure, the filaments of the X-ray tube and rectifier tubes can be lighted independently of the high-voltage circuit. This makes possible safe inspection for servicing purposes. It also permits the X-ray operator to keep the machine warmed up for instant use.

The X-ray tube filaments can be inspected by looking through the window in the tube in some cases. In other tubes, the filament cannot be seen and continuity testing is the answer. When testing for gassy tubes with the high voltage on, always stay behind a protective shield.

An additional feature of X-ray equipment illustrated in Fig. 4 is the dead contacts or buttons between the tap contacts on the autotransformer. This prevents shorting of the high voltages developed across the autotransformer windings when switching from one contact to another. The importance of these dead buttons from the servicing standpoint is that the voltage selector may sometimes be unintentionally left on a dead button; and when the operator attempts to use the equipment, it appears to be out of order.

A two-tube unit

The circuit in Fig. 5 is similar to that in Fig. 4. However, two tubes are used instead of one. One tube is used for taking X-ray photographs, and the other is used for fluoroscopy. In this respect it is similar to the table unit illustrated in the photograph. The fluoroscopic tube is concealed under the table. The radiographic tube is mounted on the moving carriage above the table. On occasion the cables or switches to the tubes of some X-ray machines may get transposed and cause some difficulty.

The four large circles in Fig. 5 represent the X-ray tube connections. The two black circles are anode contacts. The other terminals are the filament and cathode connections. The large and small filaments are used to vary the area covered by the X-rays. The rays from the small filament are used to take pictures or fluoroscope small areas of the body, such as a finger or hand. The large filament is employed for such jobs as chest X-ray work. The cathode terminal is common to one leg of both filaments and the negative side of the high voltage.

The solenoid-actuated contactors are oil-immersed steel contacts for closing the various circuits. One of the commonly encountered difficulties in X-ray equipment servicing is a defective or dirty contact.

Many X-ray installations are pro-
JUNE, 1949

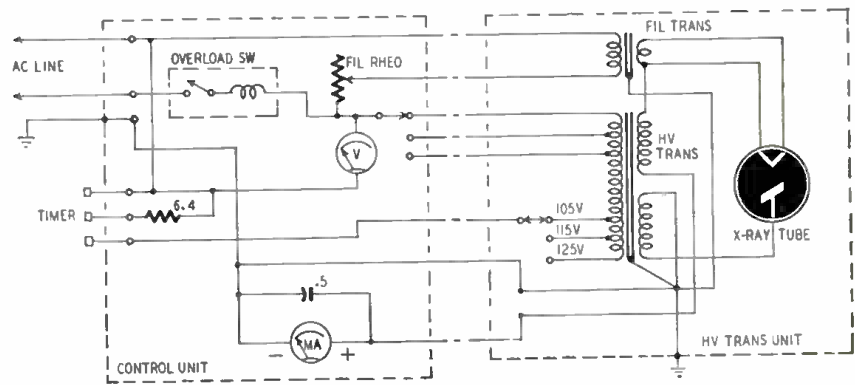

Fig. 3—Portable X-ray units like this are often found in doctors' and dentists' offices.

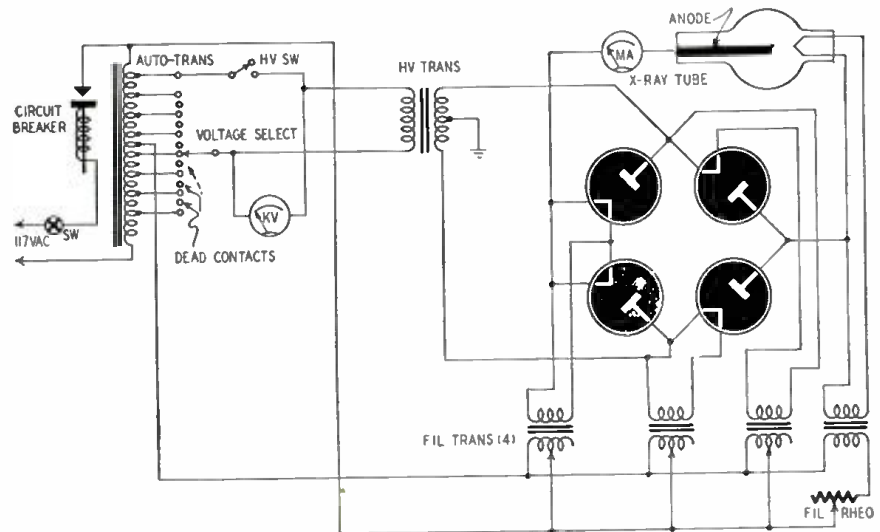

Fig. 4—A hospital X-ray machine is likely to be a high-voltage unit much like this one.

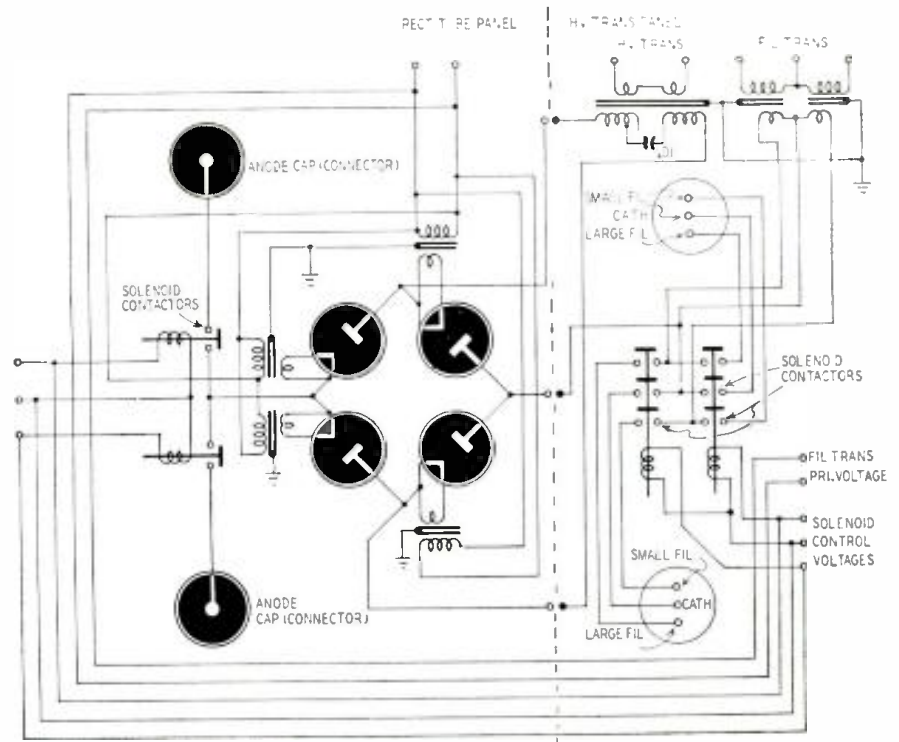

Fig. 5—To provide for both radiography and fluoroscopy, this circuit includes two tubes.

X-RAY EQUIPMENT TROUBLE-SHOOTING CHART

FAULTS	CAUSES																								
	H.v. switch to wrong tube	Burned out X-ray tube fil. or open fil. circuit	Shorted X-ray tube fil. circuit	No a.c. supply	Power switch open	Lamp fuses removed or defective	Open control unit circuit	Intermittent or loose connections in X-ray tube fil. circuit	Faulty meter	Lamp-voltage fluctuations	Burned-out rect. fil.	Open rect. fil. circuit	Timer defective	Inadequate rect. fil. current	Gassy X-ray tube	Partial h.v. insulation break-down	Overloaded X-ray tube	Autotransformer selector on dead contact	Complete h.v. insulation break-down	Main exposure switch open	H.v. capacitor breakdown	Solenoid contactor not closing	Wrong meter scale	Arc-over in h.v. circuit	
X-ray tube fil. not lighted	1	2	3	x	x	x	x	x																	
No reading on X-ray tube fil. meter		1		x	x	x	x	x	x																
Fluctuations in X-ray tube fil. meter								1		2															
Off-scale X-ray tube fil. meter reading			1						2																
Rect. fil. not lighted				x	x	x	x	x			1	2													
No reading on rect. fil. meter				x	x	x	x	x	x		1	2													
No current through autotransformer				2	1	3																			
Erratic radiographic results								1		2	x		3	x	x	x									
Rect. anodes excessively hot											1						2								
No reading on h.v. prim. voltmeter				x	2	3	x	x	x									1							
H.v. prim. meter reads too low									1																
H.v. prim. meter fluctuates										1															
No reading on ma or ma-second meter		2	3	x	x	x	x	x	x		x*	x*						x	x	1	x	x			
Reading of ma or ma-second meter low									1		3†	3†				2								1	
Ma or ma-second meter fluctuates									1		3			x	2	x									
Ma or ma-second meter off scale									x									x	3	1			2		
No high voltage				x	x	x	x											x	3	1		2			
Overload switch opens														1	2	x		x			x			3	

Causes for each fault are listed in order, the most usual being numbered 1. Causes found only occasionally are marked with X.

* Found only in units with one or two rectifiers.
† Found only in bridge rectifiers.



Photo Courtesy Westinghouse Electric Corp. X-ray-fluoroscope table is tilted by a motor.

vided with an operating and servicing manual which aids greatly in servicing the equipment. However, some manufacturers sell their machines installed and provide a course of instruction for the physician or X-ray technician operating it. Under these circumstances,

no diagrams of the machine may be available and servicing is somewhat more difficult. Often the physician or technician may be of great assistance if he explains the operation and purpose of the various controls to the repairman.

The chart shown above should be helpful in servicing X-ray machines. While it will not help in fixing specific faults, it will aid diagnosis by substituting for trial the experience of many technicians in associating a certain symptom with a certain cause or bad effect.

In any event, equipped with a knowledge of the basic principles and circuits of X-ray equipment, a continuity tester, and a little common sense, the average technician can trouble-shoot and repair upward of 70 per cent of the common defects in X-ray machines and add a lucrative source of income to his business.

In a previous article of this series, Part III, dealing with phototubes and pressure measurements in medical work, a photograph captioned as a photoelectric blood-pressure measuring device was actually the resistance-wire strain gauge manufactured by Statham Laboratories.

X-RAYS SEE THROUGH STEEL

New X-ray machine that "looks" through 16 inches of solid steel to find otherwise undetectable flaws was exhibited last month at the Navy's new \$35 million White Oak Ordnance Laboratory in Maryland. Developed by the General Electric Consulting and Engineering Laboratory, the machine cost \$95,000 and is part of the Navy's new X-ray plant. At the demonstration, pictures were taken through a 17,000-lb. cruiser anchor.

HOSPITAL USES TV THERAPY

Television therapy will be tried out in the Loudon-Knickerbocker Hall psychiatric sanatorium, Amityville, N. Y., according to a report last month. The TV setup will be similar to that used in some New York hotels, but individual receivers will have no tuning controls. All tuning will be done at the central control unit, with the psychiatrist choosing the programs he believes to have the best therapeutic value.

Other features of the special sets will be shatter-proof Plexiglas windows over the C-R tubes, steel cabinets, and provision for turning off each picture unit from the central office.

MICROWAVES

Part III—Tubes for the microwave frequencies, giving special notice to the lighthouse triode, velocity-modulated tubes, and the magnetron

By C. W. PALMER

THE early investigators of microwave frequencies above 3,000 mc soon discovered that conventional vacuum tubes with the grids operated at a negative bias were inadequate or entirely inoperative for several reasons.

First, interelectrode capacitance between the elements of the tubes was large enough to bypass the high-frequency currents so that they went around the tube instead of through it.

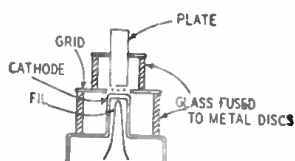

Fig. 1—Cross-section of a lighthouse tube.

Second, the internal leads from the tube elements to the external connections were often first-class inductances at the desired frequencies. This combination of L and C limited the highest frequency at which the tube could operate.

However, even before this theoretical limit was reached, it was found that tubes would not oscillate because of losses in the insulation, electronic emission from the grids, and (perhaps most important) the *transit time* of electrons from cathode to plate.

As an example of this transit-time trouble, let us consider a conventional tube operating at 1,000 kc (in the broadcast band). A typical transit time of .001 microsecond at this frequency is only one one thousandth of a cycle of the r.f. current, and would have little effect on the flow of electrons. At 500 mc, however, the same transit time would become a half cycle, which would make the tube entirely inoperative.

The upper limit of oscillation of tubes of ordinary construction is about 150 to 175 mc or even lower. Special acorn, door-knob, and miniature tubes were developed to reduce the capacitance and inductance of the leads in an effort to increase the maximum operating frequency.

Next, tubes were made with the grid-cathode spacing cut to as little as .005 inch to reduce transit time and still

maintain control of the electron flow. By these methods the maximum operating frequency was raised to about 800 mc.

Another trick—using multiple leads to the tube elements—provides additional gains. The grid and plate leads are run right through the glass envelope on both sides of the tube, forming terminals at each side which are connected to the ends of the tuning inductances, providing resonant circuits with the tube capacitance and inductance included in the over-all values. This serves to divide the shunting capacitance between the two circuits (grid and plate), and, since the inductance of the leads is then part of the resonant line, it becomes a distributed, instead of a lumped, constant. Of course, there is no effect on the transit time.

Lighthouse triodes

Up to this point, microwave tubes were of conventional design with wrinkles added to make them operative at higher frequencies.

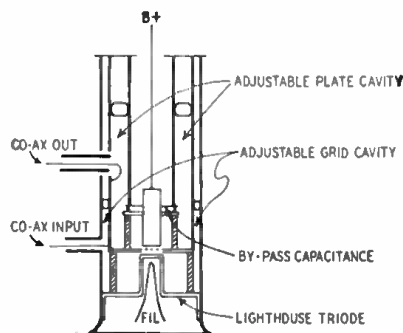

Fig. 2—Lighthouse tube in co-axial circuit.

One tube that is truly a microwave design instead of a modification of conventional forms is the Lighthouse tube or Megatron. In this tube the cathode, grid, and plate are mounted in parallel planes instead of co-axially. This can be seen in Fig. 1. The cross section shows how glass cylinders are fused to metal discs and cylinders to form the housing and the control elements. This coplanar electrode design and disc-seal

construction permits really low inter-electrode capacitances.

In addition, the construction permits the tube to become a part of a resonant cavity for providing high-Q resonant circuits at microwaves. Fig. 2 is a typical cross section of a lighthouse tube mounted in co-axial cavity resonators to form a grounded-grid amplifier of microwave signals.

The lighthouse tube is used in local oscillators for superhet receivers, in detectors and amplifiers, and as a signal source for microwave measurements. Its main limitation is its low power output for transmitting purposes, compared to some other microwave tubes to which we will turn our attention.

Orbital beam tube

Secondary electron emission plays an important part in several of the microwave tube designs. One of these is the orbital beam tube. Fig. 3 shows a cross section (looking down from the top) of such a tube. A small electrode structure of cathode and two grids with a secondary electron emitter raises the transconductance of the tube above the level obtainable in the usual direct-emission construction.

Electrons emitted by the cathode K1 are accelerated through the control grid G1 by a screen grid G2 which has a high positive bias. The electrons enter a strong electrostatic field set up by electrodes J1 and J2 causing them to follow a circular path at high speed until they strike the secondary emitter K2. Here they "bounce off" about 10 secondary electrons for each primary electron in the cathode stream. The

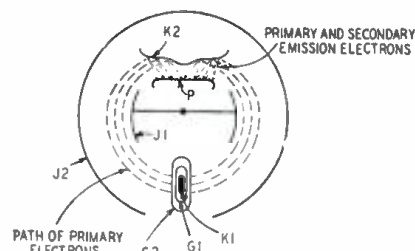

Fig. 3—Operation of the "orbital-beam" tube.

greatly multiplied electron stream proceeds to the plate P, causing a considerably greater plate current to flow than would be possible by direct emission. The result of this beaming effect is a tube having a high transconductance without increasing transit time or internal capacitance effects. Transconductances of 15,000 at higher than 500 mc have been measured.

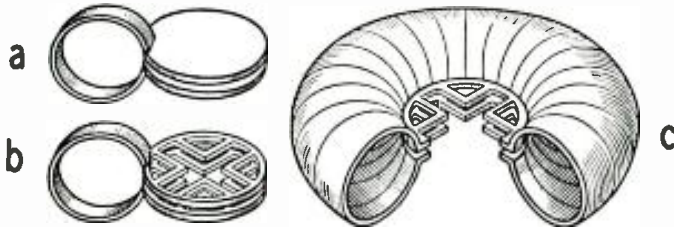

Fig. 4—Evolution of the resonant cavity and grid system of the Klystron.

This tube finds application in amplifiers where high voltage gain is needed with small input loading effects. In both transmitters and receivers it is desirable to have high-gain amplifiers in the low-level parts of the circuit. R.f. and i.f. amplifiers, detectors, and oscillator circuits are typical examples of this, particularly at frequencies under 1,000 mc.

Velocity-modulated tubes

In conventional negative-grid tubes, the control grid restricts the flow of electrons when it becomes negative and increases the flow when it becomes positive. Thus, the electrons, after passing the control grid, tend to separate into groups. Those which pass the grid during the negative half-cycle are collectively slowed down while those passing during the positive half-cycle are speeded up.

However, because of incomplete control of the electron stream, only part of the electrons reach the plate in the alternating slowed-down and speeded-up groups, the remainder reaching the plate at random speeds, thus contributing nothing to the tube action. The efficiency of the tube is thus reduced in proportion to the variation in velocity and reaches zero when the transit time approaches a half-cycle, as we mentioned before.

A velocity-modulated tube has been developed, in which this effect serves a useful function. In this tube, the input signal on the grid is used to control the velocity of the electrons in a constant-current beam instead of varying the intensity of a constant-velocity flow.

A specialized form of velocity-modulated tube, which is extensively used for wide-frequency operation because it can be readily tuned over a wide range, is the Klystron.

The Klystron depends on the resonant cavity discussed in our last installment. There are two of these in the standard Klystron. Each of them has two grids, which may be considered the capacitor plates of a greatly modified coil-capacitor circuit. See Fig. 4, which is developed in a little different way from the resonator of Fig. 4 in last month's installment. At a we see a sin-

gle turn with a capacitor across it. At b the capacitor plates are made of mesh so they can also act as grids. At c a large number of turns are joined together to suggest how the resonant cavity can be built up. In the complete resonant cavity, as seen in the Klystron of Fig. 5, one end of the cavity is made flat, of corrugated flexible metal, so the circuit can be tuned by pressing the

two grids closer together. This is the same as turning the plates of a variable capacitor further "in."

If r.f. is introduced through the input terminal, any part of the wall and

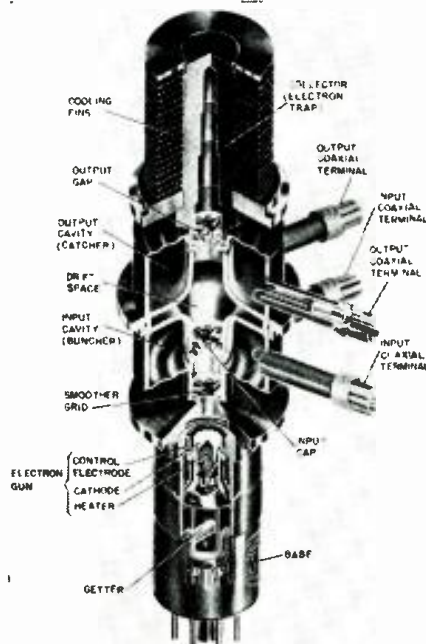

Courtesy Sperry Gyroscope Co.

Fig. 5—Cutaway of a typical Klystron tube.

the two grids act like the single turn of Fig. 4-a, electrons flowing along the wall and voltages building up on the grids at the frequency of operation.

Electrons are attracted by the grids, which are maintained at a higher positive d.c. voltage than the cathode. Those which pass through the two grids at a part of the r.f. cycle when the first grid is at a higher voltage than the second are slowed down somewhat by the relatively more negative second grid. Those electrons which pass through the grids when the second is at a higher voltage are speeded up. Thus there is a tendency for the electrons to bunch.

The bunching effect is increased by letting the electrons travel through a "drift space" where the faster-moving electrons gradually overtake the slower-moving ones. The electrons emerging from the pair of grids are separated

into groups or bunched along the direction of motion. This *velocity-modulated electron* stream is passed into a *catcher* cavity similar to the one that bunched the electrons. As the groups of electrons approach each of the two grids in turn, they induce positive charges in them by capacitor action, causing r.f. currents to flow in the catcher cavity at the frequency set by the input r.f. In other words, the catcher cavity is tuned or made resonant to the frequency of the velocity-modulated electron beam so that oscillations are set up in it by the passage of the electron bunches through the grid aperture. If a feedback loop is provided between the catcher cavity and the bunches, oscillations will occur at a frequency determined by the electrode voltages and the dimensions of the cavities. The Klystron is tuned by varying the supply voltages and altering the size of the cavities by means of their bellows or "rhumbatron" construction.

The bunched-beam current in a Klystron is rich in harmonics, but the output wave is remarkably pure because of the high Q of the cavity resonators which suppresses the unwanted harmonics.

Klystrons may be tuned through several modes of the cavity resonators and thus are "wide-range" devices covering a wide band of frequencies. They are, however, designed for a specific band of frequencies and are applicable only to that band.

Klystrons are perhaps the most widely used vacuum tubes for microwave measurement work, as oscillators. However, they find many applications also as amplifiers, frequency multipliers, and as detectors or mixers in super-heterodyne receivers.

The reflex Klystron differs from the type described above in that only one cavity resonator is used instead of two. The electrons are reflected back from the drift space into that cavity by a reflector electrode. The action is otherwise very similar.

Positive-grid oscillators

If a triode tube is arranged in a circuit in which the grid, rather than the plate, is at a high positive voltage with respect to the cathode, it will oscillate at higher frequencies than the conventional circuits.

Electrons emitted by the cathode are accelerated toward the positive grid, some striking it and some passing between its meshes. Those that pass through are repelled by the negative

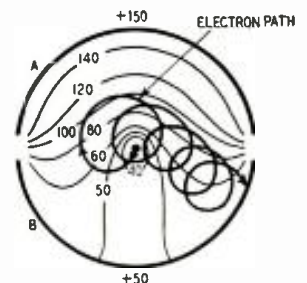

Fig. 6—Electrons in split-plate magnetron.

plate and return, passing once again between the grid meshes. In this process, the electrons induce high-frequency voltages in the grid at a frequency depending directly on the electron transit time.

Some electrons may pass through the grid structure several times while others strike the grid on the first trip. The former lose energy, but the latter gain energy. However, since the former are free for a longer period of time, there is a net transfer of energy that main-

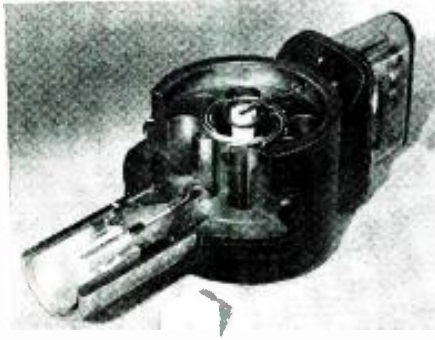

Fig. 7—Cutaway view of W.E. 5J23 magnetron.

tains oscillation.

In this type of oscillator the frequency is controlled by the grid voltage and the tube-element spacing as well as by the external resonant circuit into which the oscillation energy is fed.

Positive-grid oscillators can be operated at frequencies approaching 10,000 mc (3 cm) but are low in efficiency—only 2 or 3%—and are useful mostly for laboratory experimental and research work.

The Magnetron

Perhaps the tube with the most exciting of all careers is the magnetron. Invented many years ago, the early split-plate type was known only as a cranky but efficient laboratory oscillator. The demand for a high-power, high-frequency radar oscillator speeded research to the point where the present cavity magnetrons were born.

The magnetron is fundamentally a diode with one, two, or a number of anodes placed in a cylinder around the cathode. The tube is placed in a strong magnetic field, with the lines of force parallel to the elements (N and S poles at ends of tube). Magnetron oscillators operate in two different ways—with negative-resistance (dynatron), or transit time.

When no magnetic field is applied, the magnetron acts like an ordinary diode. Electrons leaving the filament are drawn directly to the positively charged plate. Upon application of a magnetic field, the electron is acted on by two forces—the electrostatic force attracting it to the plate, and the magnetic force urging it in a direction at right angles to its path from cathode to anode. Therefore, the electron moves in a curved path, the curvature of which increases with the magnetic field strength, until a point is reached at

which the plate is missed altogether, and the electron—carried on by its own momentum—curves back toward the filament.

To make the tube act as a negative-resistance magnetron oscillator, anode voltage and field strength are so adjusted that the tube acts as a negative resistance. The magnetic field force is increased to a point which prevents practically all electrons from reaching the anodes. If, however, one of the split sections is at a higher voltage than the other, the electrostatic field in the vicinity of the slot between sectors will be distorted as shown in Fig. 6. Any electron whose circular path causes it to move parallel with the plate and in the direction of the one with lower voltage is retarded by the opposing field and no longer has momentum enough to carry it clear of the plates and back to the cathode. Consequently, it comes to rest on the lower-voltage anode.

This is a true case of negative resistance. A lowering of voltage results in an increase of current, and vice versa.

The action is more completely described in RADIO-CRAFT, February, 1946, from which the above description is taken.

In the transit-time oscillator, the electrostatic and magnetic fields are so adjusted that all the electrons rotate in circles and never reach the plates, but form a strong space charge between cathode and anodes.

If an alternating current is now applied between the plates, they alternately draw electrons from the space charge, causing momentary plate current to flow. If the frequency of the alternating voltage applied between the plates equals the time it takes for an electron to rotate once round the cathode in the magnetic field, the a.c. component of the plate current changes direction twice for each electron rotation. The result is a sustained oscillation due to transfer of energy from the electrons to the electric field in the tube.

In the early magnetrons, the plates were semicircles surrounding the cylindrical cathode and the output of the plates was fed to a resonant transmission line. Modern magnetrons have

built-in cavity resonators as shown in Figs. 7 and 8. At extremely high frequencies the plate structure is divided into as many as six or eight segments, each with its own resonant cavity coupled to the cathode by slots of critical dimension. Sometimes, further to increase efficiency, the segments are cross-connected with wires. The magnetron is then said to be "strapped." See Fig. 7.

The efficiency of multisegment magnetrons may be as high as 70%. The frequency of high-order modes of oscillation can be as high as 120,000 mc (0.25 cm) at power outputs of 100 watts or more. Thus it can be readily seen why magnetrons are almost exclusively used as high-power oscillators and transmitters in the microwave regions.

The above descriptions cover most of the microwave tubes now in use. We have not covered some of the specialized types such as the Micropup, which is a special triode of English origin in which the plate is part of the external tube envelope and is equipped with radiating fins to dissipate heat and permit it to produce higher power; the Zahl internal-circuit tube, which contains four triodes in one envelope connected directly to resonant quarter-wave lines and can develop up to 200 kw of pulsed microwave power; or the ring triodes in which separate triodes are mounted around the periphery of a circular mounting with their elements con-



Fig. 8—A 20-kw magnetron, the W.E. 728-AJ, connected in parallel. These and other special types are either outmoded or have little general application and are interesting only from a purely academic viewpoint.

INSECTS ARE RADAR "ANGELS"

Many a GI who sat at a radar screen in the South Pacific during the war can attest to the harassing power of flying (and lighting) insects. But he never dreamed that these insects were responsible for the "angels" which confused his observations when they appeared on his radar scope.

"Angels" is the nickname applied to the short, sharp echo "blips" that have been noted on radar equipment for years. These little spots of light defied all the laws of aerodynamics and bewildered all the experts, who were at a loss to explain them.

Recently, however, tests and observations conducted jointly by Bell Telephone Laboratories and the Naval Electronics Laboratory confirmed that high-

flying insects were the source of the "angels." Working at night, researchers threw out a strong searchlight beam and stationed observers at different levels of a 200-foot tower. While the observers counted insects, the radar operators counted "angels." In one 15-minute period, for instance, 20 were counted, 15 of which coincided with the sighting of an insect.

A. B. Crawford of Bell Laboratories, who reported the discovery, points out that insects fit most of the descriptions applied to the mysterious reflections. They are small, move at a speed around that of the wind (sometimes with and sometimes against the wind), are present both day and night, and increase in warm weather.

How To Repair a Hammond Solovox

By HOMER L. DAVIDSON



The author has taken the "works" out of the tone cabinet for service. Keyboard is at right.

WHEN a bulky box and a piano-like keyboard is brought into your radio repair shop, you may wonder what it is and how you will ever be able to service it. But don't let a Solovox stump you. It is not hard to service. Last year I repaired 15 of them, and I am now going on my eighth for this year.

While some parts of the circuit more or less resemble standard amplifiers, most parts are peculiar to the Solovox. Since all the components are ordinary ones, however, with which the technician comes in contact every day, repairing the instrument is not a difficult problem. The troubles I have found in actually working with Solovoxes and the repairs made should help other technicians with their own Solovox repair.

Vibrato

The vibrato effect is caused by a metal reed with a magnetic drive. On one end of the reed is an iron core which moves in and out of an auxiliary coil connected (when the VIBRATO switch

is on) across a portion of the oscillator tuning coil. The moving core varies the inductance of the coil and the frequency of the oscillator.

Sometimes the vibrato does not work because the reed is not vibrating. The magnetic drive is not self-starting; the on-off volume-control lever gives the reed a push to get it started. If the lever is moved to the operating position too gently, the push may not be hard enough. The trouble can usually be remedied by turning the instrument off and then pushing the lever to the right more quickly.

Remember, if the keyboard is placed on the workbench for service, that the reed won't vibrate unless the keyboard is in the playing position, as in the photos, not on its back or up-ended.

Silent octaves

There is only one oscillator in the Solovox. It oscillates at 2,093 to 3,951 cycles, equivalent to the C to B at the top of the piano keyboard. The five lower octaves which can be sounded are generated by five 6SN7-GT frequency

dividers and two 6SN7-GT drivers. Therefore, when the top octaves sound normal but all notes below a given C are silent, one or more of the 6SN7-GT's may be bad. The easiest way to find out is to replace them, one by one, beginning with the fifth tube from the left in the upper row (see photo of rear of tone cabinet).

If no sound is heard or if only the top octave is working, the 6SJ7 (tube at extreme left) or the 6J5 first driver (second tube from left) may be bad. Try substitution.

The mute circuit

One of the factors affecting the tone quality of the instrument is the mute circuit, operated by a switch on the front of the keyboard. The MUTE switch cuts in a diode following each frequency divider. The diode, when in the circuit (MUTE switch *off*), gives the tones both odd and even harmonics. When the switch is *on*, the diodes are out of the circuit and the only overtones heard are the odd harmonics, giving the tones a "muted" or softened effect.

If operating the MUTE switch has no effect on the tone—if it remains muted—a 6H6 may be bad. Three 6H6's are used, one of the six diode sections being in the output circuit of the oscillator and each divider. Usually, therefore, only a certain range of tones will not be muted correctly (assuming that only a single 6H6 goes out at a time). If all tones are affected, the contacts on the MUTE switch may be bent or dirty.

Clicks and thumps

One of the two contacts on each key selects one of 12 tuning capacitors for the oscillator. However, when no keys are pressed, the oscillator generates the note B. The amplifier, therefore, must be shut off when no keys are being pressed.

A pair of 6SK7 control tubes (V14, V15) is used in a gating circuit. Normally they are biased to cutoff by a high positive cathode voltage. When a key is pressed, relay coils, obtaining their voltage from the same voltage divider that supplies the cutoff bias, are energized. The current drawn by the coils reduces the voltage at the 6SK7 cathodes so that the tubes operate. The audio fed to them is amplified and passed on to the 6K6 push-pull output stage.

Unless the 6SK7's are well balanced, you may hear a click or thump each time a key is pressed. The unbalance may be due to age, or balanced tubes may not have been installed during a previous service job. As replacements, use two tubes of the same make. If the noises are still heard, experiment with tubes selected at random until a good balance is indicated by the absence of noise.

Relays

Though the keyboard covers only three octaves, six octaves of tones are

available from the oscillator and frequency dividers. The keyboard is "moved" up and down through this range by the registration controls, which select the three octaves to be played. In addition, the upper, middle, and lower octaves of the keyboard are connected to the correct divider by three relays, one for each octave. If these relays do not operate, no tone will be heard.

To determine whether the relays are working, put your ear close to the relay unit and push one note on each of the three octaves successively. You will be able to hear the relay go on. If the relay is heard but the notes are not, the contacts may be pitted or dirty. Before going into the relays, however, check everything else, as the relays are hard to get at. If necessary, apply the usual remedies to the contacts—clean with carbon tetrachloride and burnish them.

Switch and key contacts

Dirty, pitted, or bent contacts are sometimes found on the switches and keys. The BASS, TENOR, CONTRALTO, and SOPRANO registration controls may be removed for inspection and cleaning. Remove the small screws from the bottom of the Bakelite end piece at the left of the keyboard. After removing the end piece, pull out the long rod on which the register controls pivot. Pull off the control or controls that seem to be causing trouble. Clean the contacts with carbon tetrachloride. Bend them into place if necessary; but unless you are sure your bending is correct, don't do it.

When replacing the controls, be sure the small lip fits inside the copper spring to give correct tension. When the rod is pushed in, the controls will sometimes not line up. Jiggle them a little to put them in place. Check all keys, octaves, and controls. Do not leave a Solovox repair job until you have done so, and you will have few callbacks.

If one or more of the notes chirp or don't appear to go on and off cleanly, the key contacts may be dirty. Dirty contacts may also cause complete fail-

ure of one key or may make a key play the note B instead of its correct note.

Each key has two sets of contacts, one for tuning and one for relay control. These contacts hit bus bars. Each bar may be moved slightly to expose a new, clean contact area by loosening one screw in each end of the keyboard. Move the bars about 1/8 inch.

Volume troubles

Low volume or too much volume may be caused by misadjustment of the maximum and minimum volume controls. These are located under the keyboard at the left of the volume-control lever and may sometimes be shifted accidentally by the player.

Complete loss of volume control may be caused by bad 6SK7 control tubes. The volume control itself is not a continuously variable unit, but a multi-point switch. It rarely causes trouble.

Components

As with all electronic equipment, trouble can always be caused by failure of components—resistors, capacitors, and so on. To find these, the usual signal tracing is effective. A good beginning is to trace through the frequency-divider stages, beginning with the oscillator. A signal should appear at the plate of each 6SN7-GT. Trouble will be located between the oscillator and the first tube at the plate of which no signal can be heard.

If all is well here, check the 6J5 pramplifier. The various tone controls are in the plate circuit of this stage. The signal then goes to the control tubes and the power output stage, which may be checked like any push-pull amplifier.

The voltage chart is useful for furnishing a clue to the source of trouble. The readings shown there were taken with a 1,000-ohm-per-volt meter having 50-, 250-, and 1,000-volt scales. Deviations of as much as 20% in readings may be caused by variations in line voltage. All controls were off during the measurements, the volume control in its softest position, and no key pressed unless noted. All voltages are positive with respect to chassis.

Summary

The most common troubles in the Solovox are as follows (in order):

1. Bad contacts (or keys, register relay controls, or relay contacts.)
2. Gassy and microphonic 6SN7-GT.
3. Bad control tubes.

Here is a list of practical troubles and their remedy:

Sputtering and cracking: Dirty key; remove the end piece and shift the bus bar.

Chirping: Dirty key on relay contacts; as above and clean.

Thumping and checking: Bad 6SK7 control tube; replace both.

Cracking and microphonic sound: Microphonic 6SN7-GT or 6V6-GT; replace.

SOLOVOX VOLTAGE CHART

Tube	Pin	Volts	Tube	Pin	Volts
5Y3-GT	2	320	V16, V17	3	310
V1	8	195	V16, V17	4	280
V3	3	45	V16, V17	8	25
V3, V5, V6, V8, V9			Arm of min. vol. contr. (vol. contr. in softest position) arm of min. vol. contr. in loudest position		0-30
V2	2, 5	140			
V4, V7	3	220			
V13	2, 5	220			
V13	3	85			
V13	3	2.5			
V14, V15	8	320			20-50
V14, V15	6	120			
V14, V15	5	175			
(no keys pressed)			Spkr. field black wire (pos. meter lead grounded)		-60
V14, V15 (only key pressed)	5	55			

Unit fails to light up: Large male receptacle plug has been pulled out of its socket.

One key fails to play: Dirty key or contact; shift bus bar about 1/8 inch.

One single octave fails to play: Generally register control tablet; remove end and wipe or brush contacts with carbon tet.

Low volume: First check min and max volume controls as they can easily be turned during operation; then check power output stages.

No vibrato tone: Dirty contact or vibrator; first switch vibrator on vigorously with switch lever; then check contacts.

Can't control volume: Bad 6SK7 control tubes; replace.

Excessive a.c. hum: Bad filters.

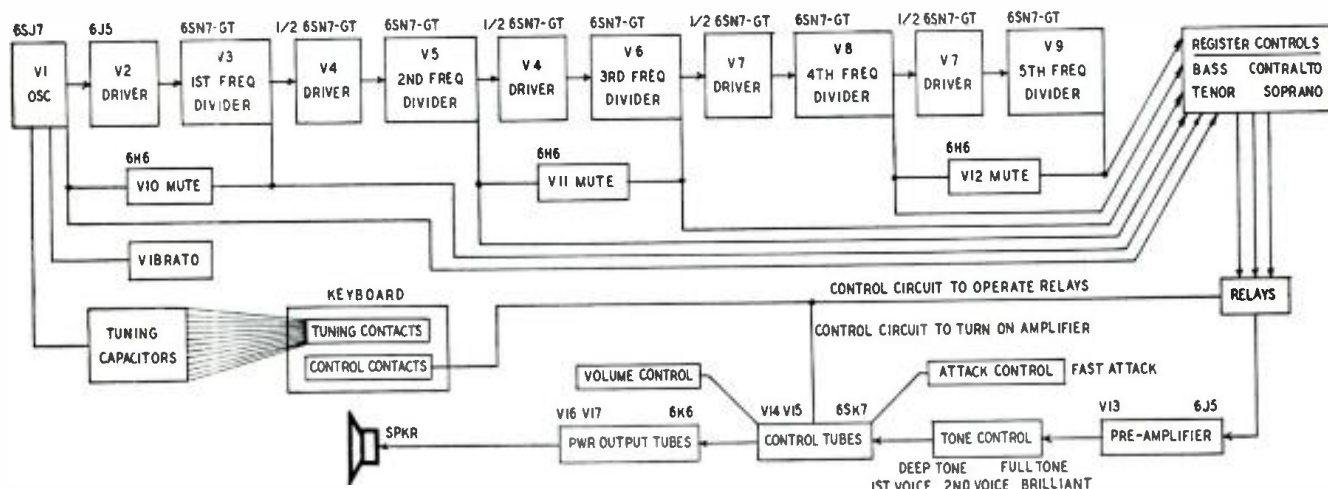

Oscillator and dividers provide tones over 6-octave range. Oscillator is tuned by key contacts. Register controls select octave ranges.

Servicing Intermittents

TO REPAIR INTERMITTENTS

- DO—
1. Obtain all possible information from customer.
 2. Avoid jarring set until trouble appears.
 3. Check tubes for intermittent shorts and noise.
 4. Check capacitors by probing and tapping them gently.
 5. Check resistors by tapping at connections.
 6. Check wiring, terminals, etc., in same way.
 7. Check tube sockets, particularly the rectifier, for arcing.
 8. Play set for several hours if doubtful.

- DON'T—
1. Jar set until trouble is found.
 2. Treat components roughly.
 3. Repair open filter capacitor by bridging with good unit. Remove defective capacitor.
 4. Replace one section of a filter capacitor and leave others in place.
 5. Take anything for granted.

By JOHN B. LEDBETTER

ONE of the most trying and time-consuming problems of radio receiver servicing is the location and correction of intermittent troubles. Intermittents not only waste valuable time; they also cut down profits. It is often difficult for the customer to understand a repair bill for "three hours labor" when the trouble was caused by a 15-cent capacitor.

Intermittents produce a variety of symptoms and are due to as many causes as there are parts in the set. In the majority of cases, however, the probable sources of trouble can be narrowed down and the defective part located by making a few simple aural checks. In addition, it is common knowledge that certain makes and models of receivers have recurrent troubles which often are peculiar only to that model.

Familiarity with these peculiarities, gained through past experience, often will indicate the approximate, if not exact, component at fault. For example, a particular set of several years ago was notorious for its poor bypass capacitors (it was not unusual for the whole capacitor to fall out of the set when one lead was clipped); another was known for open, noisy i.f. primaries. Another set often came up with intermittent broken leads in the voice coil.

The tests described below admittedly

will not show up the trouble in every instance; there are many elusive cases which will clear up at the slightest circuit disturbance or will occur only at rare intervals, sometimes days apart. For ordinary or recurrent intermittents, however, these tests will prove to be worth-while in saving time, patience, money, and customer good will.

In any intermittent complaint, first secure all the information possible from the customer. Here are some of the stock questions which can help a great deal in locating the trouble:

1. Does turning an electric light or appliance on or off cause the set to cut in or out, or does this occur independently?
2. Does jarring the set or operating the volume control or waveband switch affect operation?
3. Does the customer use an external aerial or ground?
4. Does the pilot light flicker or go out when the trouble appears?
5. How long has the set been acting this way?
6. Does the condition appear only after the set has been on for a certain time?
7. Is the trouble more noticeable at certain hours of the day?
8. Does trouble occur at both ends of tuning range on a given band?

On service calls to the customer's home, turn the set on and wait for the trouble to appear before disturbing any connections or jarring the set. In this

way you will obtain first-hand information as to the nature of the complaint; taking the set to the shop *first* often relieves the trouble and makes for undue difficulty in making it reappear. Frequently such simple things as a loose or shorting antenna wire or a loose ground connection are responsible for intermittent, noisy reception. Poor connections at the wall socket or extension plug also contribute their share. Noise in the set can also be caused by a dirty ground, loose lamp socket, etc. Check all light bulbs for tightness in the socket; examine line plugs for loose, dangerous connections. A noticeable change in volume as a light or appliance is turned on is a good indication of a bad coupling or bypass capacitor.

If you have no chance to observe operation of the set in the owner's home, handle it as gently as possible until the trouble has had a chance to show up. Avoid placing the receiver on a metal-top bench where possible contact with the chassis or antenna lead might upset the electrical balance and clear up the intermittent condition. It is always best to obtain an aural indication of the trouble *before* checking the tubes or removing the chassis.

In many cases the fault may be due to a short in the wiring, tube-socket terminals, or component leads; pulling a tube from the socket may relieve the trouble temporarily. Sometimes this effects a permanent cure; more often, it results only in restoring normal operation *until the set is taken home*.

The most common causes of intermittent reception are (in the order in which they commonly occur) capacitors, tubes, coils and transformers, resistors, high-resistance joints, poor connections, and socket breakdown. However, it is more convenient to check the tubes *first*. Many times the symptoms may point to a defective capacitor when actually a tube is at fault. Testing the tubes first often results in locating and correcting the trouble without removing the chassis. (It might be pointed out however, that many technicians remove the chassis anyway to check and clean all components.)

Tubes

Intermittent operation in a tube is usually due to an internal short or to an open due to the heat in the heater circuit. In most instances, intermittent shorts or poor connections in a tube can be located quite readily by tapping the envelope or grid cap. The usual symptom which denotes this kind of tube trouble is a drop in volume, accompanied by a crackling or rustling noise. In oscillator or converter tubes, the noise is often accompanied by loss

or shifting of the station. In high-gain, multi-element tubes, a poor grid connection is frequently responsible for intermittent operation. This trouble is prevalent in such tubes as the 6T7-G, 6B6-G, 75, 6Q7, 6F5, and their 12-volt or single-ended counterparts. Converter tubes such as the 6A7, 6A8, 6K8, and 6SB7Y are similarly affected.

Intermittent heater operation, especially in metal tubes, is a bit harder to locate, particularly when the heater is opening at a steady, slow rate. In the majority of cases, the tube filament will show continuity when checked with an ohmmeter, but will open again as soon as the heater reaches normal operating temperature. The faulty tube may sometimes be located by placing a hand on the metal shell and comparing its warmth with that of similar tubes in the set. Many times it is necessary to use the substitution method. Some servicemen use an electric sun lamp or heater element to raise the temperature of the suspected tube. This method is all right if used for only a short time, but don't overdo it. A sun lamp on the loose can wreck more than a little havoc of its own, particularly on parts adjacent to the tube.

In cases where vibration of *any* tube or *any* part of the set produces the same amount of noise, it is a good idea to try the substitution method first, starting with the converter tube. If the set is out of the cabinet, it is well, of course, to examine the wiring and component leads briefly for indication of poor contact or soldered joints.

Heat-affected heater elements are more prevalent in high-voltage a.c.-d.c. tubes such as the 25L6, 35L6, 50L6, 50A3, and 117L7. The higher operating temperatures in these tubes, along with the increased filament contraction and expansion, make them more susceptible. The 35Z5 and similar types of rectifier tubes are also in this category. In tapped-heater types, such as the 35Z5, which show up with an open pilot-lamp section, be sure to check the pilot lamp for burn-out and to replace it with a bulb having the proper current rating before replacing the tube. If either the pilot lamp or the pilot-lamp section of the tube burns out, the current load on the remaining branch is doubled and it soon burns out.

In some cases a replacement tube in an a.c.-d.c. set will show a tendency to burn brighter than normal. Although this does not necessarily mean trouble, the a.c. voltage across each tube heater should be checked. If any one tube is taking more or less than its share of voltage, the cause should be found and corrected. Often the resistance of the tube is incorrect. (This may be checked by substituting a new tube.)

Capacitors

The most common source of intermittent trouble in capacitors is the loosening of lead contacts which results in a very light pressure on the foil. Usually the trouble can be found by tapping or probing the capacitor

lightly. Avoid pulling or striking roughly, since this is an almost sure way of *making* an intermittent. An intermittently open capacitor generally can be located by bridging it with a good capacitor of the correct value. In some cases, however, substitution may not give an absolute indication unless one end of the suspected unit is cut loose. Bad paper or mica capacitors in the oscillator circuit usually result in a shift in frequency of the station, especially at the lower end of the band.

Electrolytic filter capacitors of the fabricated-plate type often are the cause of intermittent popping, static-like noise, which may be accompanied by hum and oscillation. As with bypass or coupling capacitors, the surge caused by bridging a filter capacitor with a good unit may cause it to heal. The entire filter block should be replaced at the first indication of trouble. Avoid replacing just the bad section; the other is likely to give trouble shortly. If this happens, you will have a dissatisfied customer on your hands.

Coils and transformers

I.f., oscillator, antenna, and r.f. windings are subject to electrolysis and corrosion because of moisture content in the coil forms and absorption from the atmosphere. Trouble usually appears in the primary section first, the windings next to the coil forms showing green, corroded spots on the form and throughout the first few layers of wire.

Noise originating in a transformer can be determined either by measuring the winding resistances with an ohmmeter or by momentarily shorting the plate end of the suspected transformer to ground. Resistance of a corroded winding will vary from the readings of the other windings, reading higher if high-resistance corroded spots are present, and reading lower if the winding is partially shorted.

Coil and transformer noise in a set may be isolated in the following manner:

1. First short the second-detector grid to ground. If the noise persists, the trouble is in the second-detector plate circuit, the audio stage, or the speaker. If it ceases, it is *ahead* of the second detector.

2. Short the grid of the last i.f. stage to ground. If the noise stops, look for a defective tube or plate circuit in the stage *ahead*. If the noise is still present, the trouble is in the last i.f. stage.

3. Continue the test, successively shorting the grid of each stage to ground, working back to the converter or r.f. stage. Noise which ceases when the grid of the r.f. stage is grounded is being picked up from a defective antenna coil or from an external source.

A defective oscillator coil is indicated by improper tracking or by inability to pick up a station even though the converter is operating. Noise in the speaker may be due to a defective field coil or to turns of the voice coil which are rubbing against the speaker frame. The voice coil may open inter-

mittently or short under these conditions. Braided voice-coil leads are found in some sets; vibration may cause the braid to wear and pull loose, producing an intermittent open.

Resistors

Resistors usually giving trouble are wire-wound, metal-covered bleeder units which are riveted to the chassis. Poor connections between the terminal lugs and resistor elements often cause an open condition, which may show up when the set is first turned on but which will disappear after the resistor has warmed up and expanded. To check this possibility, make a resistance measurement of the resistor sections when the set is hot, and again after it has cooled. An open or partially shorting condition will often be shown up here.

Carbon resistors frequently develop internal noise. This trouble is usually continuous when it develops and may easily be found; intermittent noise may be located by twisting or probing the resistor.

Other causes

A set may become intermittent only at certain times of the day. Usually trouble will be found in a poor oscillator or rectifier tube or filter capacitor. Operation becomes erratic only when the line voltage drops below a certain critical point. Intermittent distortion, especially in a.c.-d.c. receivers, may be due to secondary emission in the output tube when the line voltage is *increased* to a certain value.

Arcing or intermittent operation caused by loose tube-socket terminals, poorly soldered connections, etc., can be located by probing and tapping the wiring or by turning off all lights and watching for a small arc at the loose point. High-resistance joints may be located best by applying a hot soldering iron to the terminals. This is particularly effective in oscillator, r.f., and a.v.c. circuits.

As mentioned before, servicing of intermittents can often be expedited by focusing a heat lamp on the set so that its operating temperature increases. Thermal conditions may also be checked by placing the set for a time in an old refrigeration or cold-storage unit. A flasher placed in the a.c. line often causes breakdown of faulty capacitors by generating peak surges. The same result may be accomplished in a.c. sets by removing all the tubes except the rectifier and letting the set "cook." The increased voltage, in most sets at least, will not damage a good capacitor but very often one on the verge of breakdown will be shown up.

Most intermittents can be located by combining patience with simple logic and circuit analysis, based on practical experience and a knowledge of typical receiver peculiarities. There are cases, however, where an intermittent may refuse to show up for hours or even days. This type of set should be connected to some form of signal tracer and left to run while other sets are being repaired.

Legal Rights of Radio Technicians

By LEO T. PARKER

It is important to radio technicians and dealers to know the modern law involving sale contracts in which the seller agrees to render specified service on television sets, equipment, and electrical merchandise. The higher courts consistently hold that contracts of this nature are valid and enforceable by the purchaser, provided, of course, the purchaser does not breach any obligation he assumed under the contract. In other words, a seller who has made a valid contract always is obliged to perform promised service in strict accordance with the terms of the contract if the purchaser fulfills *his* agreement.

It should be remembered that whether or not the buyer of the equipment agreed to pay for service, he is liable for the "reasonable" value of the services rendered—if the seller did not agree to furnish free service. This is so because all higher courts consider that one who orders service will pay its reasonable value. The courts will not permit a purchaser to "impose on the good nature" of a seller.



For illustration, in one case a contract for sale of a television set contained a clause which guaranteed that "the purchaser shall be satisfied." Although the set was apparently worth the purchase price, the purchaser refused to make the agreed payments. The seller demanded final payment and the purchaser refused on the grounds that he was not, as he termed it, "satisfied."

The seller filed suit and proved that the television set was "reasonably" satisfactory, notwithstanding the complaints registered by the purchaser. In view of this testimony, the higher court held the purchaser bound to pay the full amount due on the original sales contract.

Special service

On the other hand, if a contract or agreement clearly and distinctly specifies the kind of service the seller of radio equipment will supply and on what dates inspections, alterations, adjustments, and necessary repairs shall be made, then the seller positively is obligated to fulfill the *exact* terms of this contract. Failure of the seller to do so is a legal breach which entitles the purchaser to rescind the contract and force the seller to take back the appliance or the equipment covered by the contract.

The courts have laid down well-defined laws respecting different kinds of service contracts. The distinctions are important.

For example, modern higher courts consistently hold that if a seller fails to carry out an agreement to keep radio equipment in repair, and if a seller did not guarantee that he *personally* would keep the radio in repair, the buyer is not entitled to rescind the contract and recover the purchase price. In this kind of a contract the *buyer* must make

necessary repairs, and then he must sue the seller for a credit against the contract price, this credit equaling the expense he incurred in keeping the radio in proper repair for the period of the guarantee.

For illustration, in *Welkner v. D. G.*, 27 A. (2d) 351, it was shown that a seller brought suit against a purchaser who refused to pay for a radio. The sale contract stated that the equipment was guaranteed "one year free." There was no guarantee of the quality except that the service was "guaranteed" for one year. In other words, the seller did not guarantee that he *personally* would make repairs.

After the purchaser had the equipment for several weeks, he discovered that it was defective and needed repairs. He phoned the seller several times, but no one came to make repairs. In subsequent suit the purchaser claimed that the radio was so unsatisfactory that he could not use it.

The higher court held that the purchaser must pay the full purchase price for the equipment, but that he could deduct from the contract price the total expenses he incurred in making needed and necessary repairs. This court explained that, since the seller had not guaranteed that he personally would make the repairs, he was not obligated to make the repairs, although he had to pay the purchaser, who had had another technician make them.

For comparison, see *May*, 159 Md. 605. In this case a retail dealer sold and guaranteed electrical equipment to the purchaser. The dealer guaranteed to *keep it in repair* for a year, but he failed to do so.

The court held that, where a seller personally guarantees to keep an appliance in repair for a stated period and fails to do so, the purchaser may rescind the contract and recover from the dealer the full purchase price.

Hence, these two leading higher court decisions clearly distinguished between service guaranteed personally by the seller and "guaranteed service." Both buyers and sellers should examine contracts carefully to determine which of the two is intended.

According to a recent higher court the purchaser of a radio on installment may keep it and refuse to pay the dealer who breaches his agreement to keep the radio in good repair.

For example, in *Sinn*, 30 P. (2d) 761, it was disclosed that a seller and buyer signed a written contract which con-

tained the following clause: "In the event of default in the payment of any installment of this note, the seller may declare the remaining installments not then due hereunder *immediately due and payable.*"

The contract also provided that the seller would inspect the equipment on stipulated dates and make necessary repairs and adjustments.

After the purchaser made several payments, he defaulted in making further payments. In subsequent suit the purchaser proved that, although the seller agreed to keep the equipment in operating order, he had not rendered service when it was reasonably necessary. Therefore, the higher court held that the purchaser was not required to pay the balance due. The court said:

"In the instant case the agreement to make the payments was based upon consideration of the service which plaintiff (seller) was to render in keeping the equipment in operating order. . . ."

It is well-established law that a technician is entitled to a lien on radio equipment to secure service charges. All higher courts agree that a common-law lien is the right of a technician to retain a radio in his possession until certain demands against the customer are satisfied. Similar liens have always been valid in favor of persons such as innkeepers, farriers, common carriers, and warehousemen, who service the public.

Damage to equipment

Considerable discussion has arisen from time to time over the legal question: Is the proprietor of a service shop liable for theft, fire, or other damage to radios or equipment left in his care for repairs? The answer is no if the loss does not result from the technician's negligence. (See *Ablon v. Hawker*, 200 S. W. [2d] 265.)

On the other hand, all courts agree that the owner of a service shop is liable for any loss or injury to radios belonging to customers caused by failure to exercise reasonable care to protect them. Nevertheless, a technician is not liable for any loss or injury to radios which could not have been avoided by exercise of such care as would have been exercised by other reasonably careful and experienced technicians.

One thing is certain: if a technician keeps in his employ a person known to have stolen radios or equipment, that employer is likely to be held liable for theft losses, even though no proof is given that this particular employee stole the equipment in question. (See 269 Pac. 469.)

If a fire destroys a service shop containing customers' radios, the owner of the service shop is not liable unless the testimony proves that the fire started through his negligence.

Rights of seller

Considerable discussion has arisen from time to time over this question: If a buyer of radio or television equipment breaches his contract to make

agreed payments, what rights has the seller? A review of recent leading higher court decisions discloses this established law: Failure of the purchaser to fulfill his agreement to make regular monthly payments affords the seller the right to decide to do one of three things:

1. The seller may sue the purchaser for damages;

2. He may sue the purchaser for return of the radio and the jury will decide the amount due the seller; or

3. The seller may sue and have the court compel the purchaser to fulfill the exact terms specified in the purchase contract.

For illustration, in *Carisch*, 255 N. W. 815, it was disclosed that a purchaser signed a contract in which he made a down payment and agreed to pay the balance in monthly installments, plus an additional stipulated amount for special service and monthly inspections by the seller. An important clause in this contract stated that the seller was to supply repairs and adjustments which *in his opinion were necessary*, and, if the equipment got out of order, the purchaser had to notify the seller immediately.

The equipment got out of order and failed to operate satisfactorily. The purchaser failed to notify the seller and then later refused to make agreed payments. The seller sued the purchaser for the entire balance due on the contract.

The higher court held the purchaser must pay the seller the entire balance due immediately. This court explained that, when a purchaser breaches a contract of this nature and fails to notify the seller immediately when the equipment gets out of order, he cannot complain and he must pay the seller the full balance due.

The seller may sue and repossess the equipment or recover at once all payments due in the future if the purchaser breaches the contract by failing (1) to make agreed monthly or weekly payments on the *exact dates specified in the contract*; (2) to accept delivery of the equipment on the agreed date; or (3) to use the merchandise in the manner prescribed in the contract. The court said that, if the purchaser violates his contract in any of these respects,

1. the seller may refuse to perform his guarantee, and sue the purchaser for damages and profits equal to his financial loss resulting from the breach;

2. the seller may file suit and compel the purchaser to fulfill the exact terms of the contract;

3. the buyer and seller may enter into



negotiations and make a supplementary compromise contract; or

4. the seller may ask the court to compel the purchaser to keep the radio and to pay the entire balance which is due at once.

Rights of purchaser

Obviously a purchaser has certain well-defined rights if a seller or technician breaches his contract. A review of recent higher court cases discloses that the courts have adopted this rule: A purchaser is privileged to cancel a contract of sale and recover damages from a seller who

1. fails to deliver radio equipment on the exact date specified in the contract;

2. refuses to make the delivery in the exact manner specified in the contract; or

3. fails in any other particular to fulfill the obligations assumed in the contract, such as installation, service inspections, or guarantees of quality and efficiency.

At this point it is well to explain that although the seller may not give a written or verbal guarantee, all courts consider that a seller guarantees that the radio is "reasonably fit" for the intended purposes.

For illustration, in *Brand v. Burd*, 192 S. W. (2d) 651, the testimony proved that a purchaser traded in old equipment under a written contract which contained a clause: "The seller warrants the goods . . . for one year, this warranty being limited to the furnishing at our factory of such parts as shall appear to us to have been defective in material and workmanship."

The purchaser soon discovered that the new equipment did not perform satisfactorily, and he refused to pay the amount due. He requested the seller to return his old equipment. The seller refused this offer and the purchaser continued to use the new equipment while corresponding with the seller. The seller sued the purchaser, proving that the latter had failed to return any defective parts as required by the clause.

(Continued on bottom of next page)

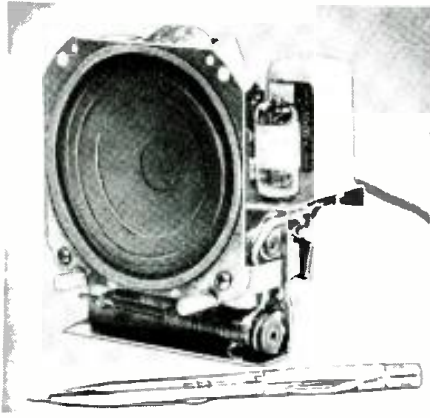

Front view of the compact a.c.-d.c. radio.

Heat Reduction In Midget Sets

The author designs a compact, low-heat set

By JOHN T. BAILEY

A LIMITING factor in the design of compact a.c.-d.c. receivers is the problem of heat dissipation. When using ordinary-

size components, plenty of space must be left between parts to permit circulation of air. If this is not done, coils, resistors, and capacitors change values,

the cabinet gets hot; and premature failures occur. But the public continues to want smaller sets and it is up to designers to plan them. There are a number of ways to reduce heat without cutting down efficiency.

Before describing a compact a.c.-d.c. receiver, it will be well to review the sources of heat. First we must distinguish between heat and temperature. As an illustration of this difference, consider a small, $\frac{1}{2}$ -watt resistor and a larger, 2-watt resistor, both of the same resistance, say 20 ohms. If these two resistors are connected in series and placed across a 6-volt storage battery, the same current (about 150 ma) will flow through each. The voltage drop across each will be the same (about 3 volts), and the wattage dissipated in each will be identical (about $\frac{1}{2}$ watt). But the small, $\frac{1}{2}$ -watt one will be hot to handle, and the larger, 2-watt resistor will be cool.

The wattage is calculated from Ohm's law and is equal to I^2R or EI . In this case it is $(0.15)^2 \times 20$ or 0.45 watt. Since heat is proportional to wattage, each of these resistors is producing the same amount of heat, but the temperature of one is greater than that of the other.

The significance of this in design is that, when a part operates at a high temperature, it must be located further away from nearby temperature-sensitive parts than it would if it were giving off the same amount of heat (I^2R watts) but operating at a lower temperature.

Temperature and heat

It is easy to be confused on the subject of temperature and heat. Parts are damaged by too high temperature. Yet we speak of keeping heat down. The fact is that these interlock in actual practice. A small resistor dissipating two watts may operate at a high temperature, yet would raise the temperature of an enclosed box far less than a 20-watt resistor which would operate cool in open air.

If the two 20-ohm resistors pre-

LEGAL RIGHTS OF RADIO TECHNICIANS

(Continued from page 45)

The higher court held that when a purchaser seeks to rescind a contract because of the seller's breach of a warranty and guarantee, the purchaser does not have a right to keep and use the equipment during the period of the negotiations.

Also, this court held that when a buyer keeps in his possession and uses the equipment, he forfeits all his legal rights to rescind the contract when he violates a contract clause requiring him to submit defective parts to the seller for examination.

What is a breach?

Broadly speaking, either the owner of a radio or a serviceman, breaches the contract if he fails to comply with any detail of the agreement. A review of leading higher court cases discloses that a breach of contract exists under any of these circumstances:

1. If the owner of the equipment notifies the technician that he will not fulfill his obligations unless the technician modifies the contract, this is a breach of the contract by the owner. (92 Conn. 569).

2. If the owner refuses to complete the contract unless the technician will waive a claim for damages, this is a breach. (121 Cal. 153).

3. A refusal by the owner to pay for the service unless the technician consents to reduce the contract price is a breach of the contract. (103 Atl. 843).

4. If a contract provides for credit, refusal of the technician to deliver the radio on credit is a legal breach. (89 Ohio St. 365). If the contract does not specify whether the sale is cash or credit, cash is implied. (146 S. W. [2d] 115).

Very frequently discussion arises be-

tween the owner of a radio or television set and the technician over failure of the technician to complete repair work promptly. It is true, of course, that a technician may be liable for failure to repair a radio within the time promised when the service contract was made. The amount of damages is whatever the owner proves he suffered.

A technician may *without liability* delay completing repair work under the following circumstances: (1) when the owner actually consents verbally or in writing to the delay; (2) when the owner orders a change in the original agreement or specifications which delays the technician in making the repairs; (3) when the technician breaches the contract before the date for completing the repair work arrives; (4) when delayed service results from a public enemy, such as might be caused by service in the Armed Forces during a war; or by an act of God.

Not only is a technician liable in damages for failure to complete repair work within the period promised, but also he may be liable for insults or other injurious acts in a customer's home.

For example, in *Digsby v. Carroll*, 47 S. E. (2d) 203, it was shown that a technician went to a home. The housewife sued the technician and his employer for damages because the employee became unusually boisterous and used vulgar and abusive language to the housewife, and threatened her.

The higher court held the housewife entitled to recover damages and said:

"The courts have settled down to the common-sense doctrine than an employer is liable for the torts (wrong acts) of his employee committed in the course of the employee's employment."

viously mentioned were shut up in small boxes of the same size, the temperature of each box would be the same after a few hours. The temperature of the larger resistor would rise, keeping a few degrees (or a fraction of a degree) above that of the air around it. The small one might rise to a dangerous temperature as the temperature of the surrounding air increased.

A small radio cabinet is often almost an enclosed box. The heat produced by one component acts on another, with a mutual increase of temperature. There are two ways of keeping this temperature down—we can arrange to produce less heat, or we can carry it away rapidly from the components that produce it.

Main heat producers

In an a.c.-d.c. set the tubes generate most of the heat. This heat is the result of the current through the heater plus that from the plate and screen currents.

It is common practice to select combinations of tubes so that their heater voltages total close to the line voltage. A combination of a 12SA7, a 12SK7, a 12SQ7, a 50L6, and a 35Z5 totals 123 volts; and, because they draw 150 ma, the heat generated is $123 \times 0.150 = 18.5$ watts, approximately. Of course, the 12-volt tubes generate less heat than the 50- or 35-volt tubes, the figures being 1.9 watts each for the 12SA7, 12SK7, and 12SQ7, 7.5 watts for the 50L6, and 5.3 watts for the 35Z5.

Let us consider ways of reducing this heater wattage. First, we can substitute a selenium rectifier stack which requires no heater current and eliminates the 35Z5. This saves 5.3 watts. By replacing the 12SQ7 with a miniature 6AQ6 and the 12SK7 with a 6BJ6, 1.9 watts more is saved.

So far the results are a 7.2-watt reduction, with a saving in space because of the miniature tubes—and no reduction in performance. Another big reduction can be made by replacing the 50L6 with a miniature 6AK6. The power output will be less than before but surprisingly adequate for a small set. This change saves 6.6 watts in the heater, making a total heater saving of 13.8 watts or a reduction to 27% of the original value.

In order to make all tubes miniature we should replace the 12SA7 with a 12BE6. Now we have a combination of a 12BE6, a 6BJ6, a 6AQ6, and a 6AK6, whose heaters total 30 volts. The difference between 30 volts and the line voltage is about 90 volts, which can be taken care of by a 600-ohm line cord. Since the heat of the line cord (13.5 watts) is dissipated *outside* the receiver cabinet, it will not affect the components.

Other heat sources

What other sources of heat do we have in a typical a.c.-d.c. set? The next largest offender is plate and screen current. When we changed the output tube from a 50L6 to a 6AK6, we decreased the plate-plus-screen current from about 50 ma to approximately 10 ma.

The wattage produced by these currents is approximately equal to the B-plus-voltage times the sum of the currents, so for this tube change we save $(.05 \times 100) - (.01 \times 100)$ or 4 watts. Nothing can be done about the plate and screen currents in the other tubes.

Assuming the use of a PM speaker rather than a dynamic type, which would dissipate about 2 watts in the field, there are no other large heat-generating components to worry about. The selenium rectifier produces some heat due to the tube currents and the filter-capacitor ripple currents, and the power-supply filter resistor produces a little heat; but with judicious design, these two parts need not interfere with compactness.

Having now reduced the heat to minimum, the designer's talents can be directed toward producing a truly compact set. An example is shown in the photos. In most respects the circuit is conventional, except for the second i.f. transformer and the permeability tuner arrangement. The tuner is mounted on the front face of the chassis in such a way that the coils are sandwiched between the speaker frame and chassis. The i.f. transformer between the i.f. tube and second detector is made from the primary coil and trimmer of a conventional transformer and was chosen to save space.

This set, using a 4-inch speaker, measures only 4 inches wide by 5 inches high by 3 inches deep and has



Rear view of the low-heat midget receiver.

enough excess space to add an untuned r.f. stage if desired. Such a compact design would have been impracticable had not the heat problem first been solved by the methods outlined above.

MATERIALS FOR RECEIVER

- Resistors:** 1—100, 1—470, 1—20,000, 1—100,000, 1—270,000, 3—470,000 ohms, 1—3, 1—5.1 megohms, 1/2 watt; 1—15, 1—1,200 ohms, 1 watt; 1—500,000 ohm potentiometer; 1—600-ohm line cord.
- Capacitors:** 1—50, 1—100, 2—200 μ mf, mica; 1—.001, 2—.01, 1—.02, 1—.05, 1—.0.1 μ f, 400 volts, paper; 1—10 μ f, 10 volts, 1—30, 1—50 μ f, 150 volts, electrolytic.
- Tubes:** 1—6AK6, 1—6AQ6, 1—6BJ6, 1—12BE6.
- Miscellaneous:** 1—broadcast-band permeability tuner; 1—selenium rectifier; 1—output transformer, 10,000 ohms to voice coil; 1—4-inch PM speaker; 4—7-pin miniature tube sockets; chassis and necessary hardware.

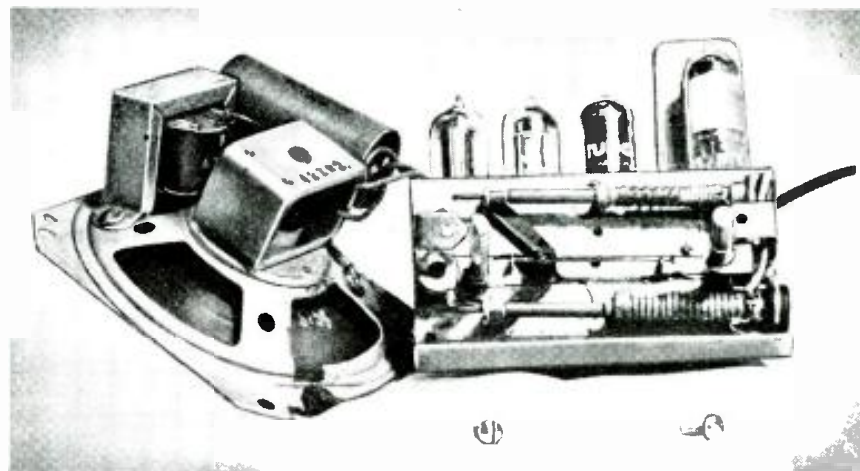

Note the two brackets on the chassis that bolt to the bottom holes of the loudspeaker.

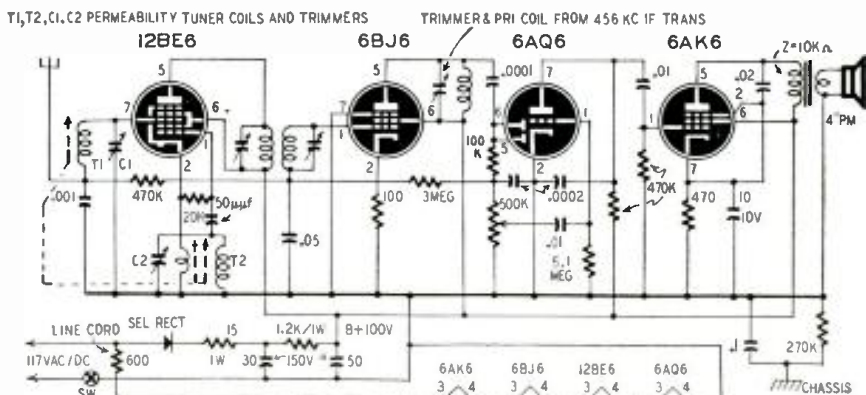

Schematic of the low heat a.c.-d.c. radio is quite conventional from a circuit viewpoint.

Specialize for Increased Profits

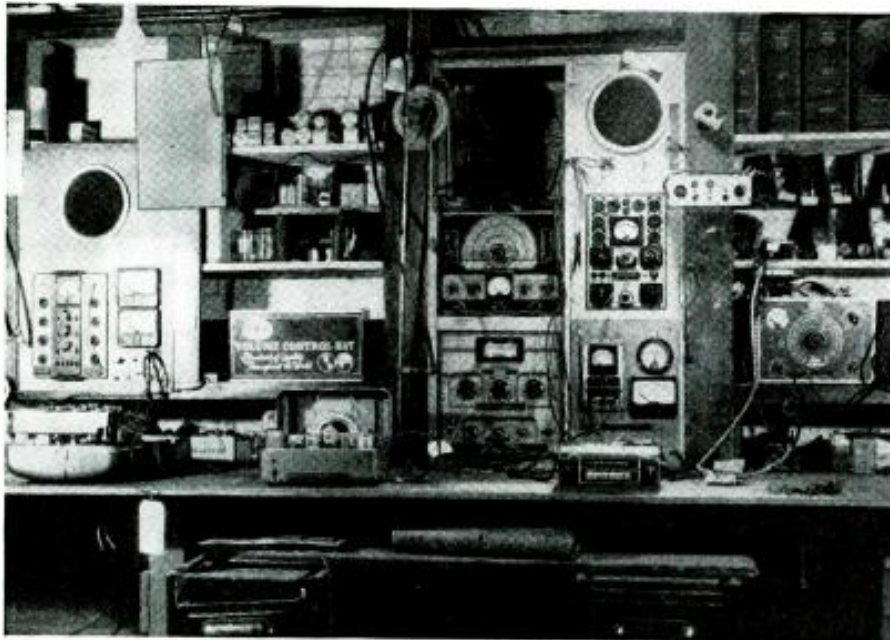

By MATT MANDL*

This bench at Marks Radio Service is especially set up for work on car radios.

LESS than three years ago Isadore Marks, an ex-GI, opened a radio service and sales shop in a neighborhood which already had its full quota of radio stores. From a business standpoint the venture seemed doomed to failure: two of the recently opened sales and service stores in that area were ready to close down because of the serious competition offered by the older, better established firms. Marks, however, had a definite plan and went ahead with his project. Today he has a healthy, growing business with several technicians on the payroll.

The secret of his success? He specialized. Where others were content to sell and service home radios, Marks specialized on car radios. Aiming for this goal he had leased a place with a drive-in for the convenience of his customers. He augmented his Navy training in aircraft radio by thoroughly studying auto-radio trouble shooting and servicing. His familiarity with automobiles aided him in finding short-cut methods and tricks. Backing this up, he acquired a small but complete stock of replacement parts and accessories. The addition of a franchise for the sale of car radios rounded out his specialty.

Later Marks added home radios and television receivers to his line in order to meet the occasional call for these items from his car-radio customers.

Thus, by choosing a particular field and upgrading himself to qualify as a specialist in that field, Isadore Marks had, within a few months time, a thriving business. His Trenton, N. J., store

soon acquired the reputation for being *the* headquarters if you wanted a good job done on that car radio of yours, or if you were in the market for a new one.

This man's experience, however, is not the exception. There are many successful establishments which have reached the top because they were made up of experts in a particular branch of electronics. The same holds true with respect to the individual. The man who is really a specialist in a particular electronic field has an enormous advantage over somebody with just a general knowledge; the high-paying jobs invariably go to the person who has concentrated his abilities and efforts into a single channel and thus has put himself in a class apart by virtue of his superior knowledge and skill.

Granting the advantages of specialization, however, the two questions are: What field shall I choose? What need I learn to qualify?

To answer the first question: The choice of any particular field must lie with the individual himself. You must evaluate your talents and inclinations and choose a field for which you are adapted by reason of your background and ability. For instance, if you can't work with tiny units and small tolerances, don't choose hearing-aid repairing. This field requires manual dexterity of the type encountered in watch repairing.

On the other hand, if industrial controls fascinate you—or if you like installing such devices as intercoms—then by all means choose one of these branches. Likes and dislikes are big

contributing factors toward a success.

Take the case of another acquaintance of the writer. This person has always been interested in photography, film projection, and radio. He combined these interests by securing a job as an assistant projectionist in a motion-picture theater. To qualify, he had to learn all about the particular type of projection system used in motion-picture work. Besides this, he had to work for some time as an apprentice in order to acquire the necessary skill and become familiar with on-the-spot trouble-shooting procedures so often necessary. Today he is ready to step into a high-paying job as a full-fledged projectionist in one of the larger theaters in his city.

The accompanying chart gives some idea of the many fields available for specialization. By analyzing the requirements for each, you will get a better idea of the preparation needed to become a specialist in any particular field.

As a foundation you must have a basic electronic background, which should consist of sufficient knowledge and training upon which to build up to the field you desire. Experience in radio servicing contributes materially to such a foundation by providing the necessary practical work and basic circuit knowledge. The next logical step could be television installation and repair.

Television installation and repair

In preparation for this specialty you must learn some circuits quite foreign to those previously encountered in radio servicing. You should study the ef-

* Technical Institute, Temple University.

fects of the very high television frequencies on the behavior of amplifier circuits, tubes, and other receiver components. This is of vital importance in servicing, because improper dressing of leads and unit replacement can seriously hamper the proper functioning of a television receiver.

You must also learn about wide-band amplifiers, pulse separation, d.c. restorers, vertical and horizontal sweep circuits, and synchronization circuits. In television receivers, you will no longer encounter conventional tuning methods, but will run across pretuned channel switching embodying novel innovations. Three r.f. signals are mixed in the converter stage—the picture signal, the FM sound signal, and the local oscillator. You must be able to differentiate between the sound and picture stages for competent servicing.

Added to this should be a thorough grounding in the use of oscilloscopes, sweep generators, and other testing equipment for servicing TV sets.

By reading periodicals and textbooks or by taking a short course, the man with a fairly good background should be able to understand these circuits without much difficulty.

PA and intercom systems

Public-address systems and intercoms are closely allied because they are primarily audio amplifiers; for this reason, many shops combine both under one specialty.

In the public-address-system field a thorough knowledge of audio voltage and power amplification is necessary. At the same time, there is a growing need for the type of man who can estimate the size and scope of a particular installation in terms of the number of units required, the job layout, and the total cost of material and installation.

A similar situation is encountered with intercommunicating systems. You have to know about call-in circuits, master stations, substations, cable layout, and switching methods.

Hearing aids

Branching off from radio repair on our chart, we also have the field of hearing-aid repair. This again requires a basic knowledge of audio circuits, coupled with the problems encountered with a device worn close to the body. The technician finds a tiny chassis, extremely small components, and usually self-contained batteries. This means audio-amplifier repairs on miniature units, tubes, and chassis. Troubles occur due to the body moisture absorbed by the instrument. Clothing lint, temperature, receiver cord wear, and delicate components contribute to circuit failure; their effects should be known to the repairman.

A hearing-aid technician should have a knowledge of audiometers, their function and repair. Audiometers are used by hearing-aid retailers to test a customer's hearing loss; the use and servicing of these are within the scope of a

well-equipped hearing-aid technician.

The hearing-aid repair field is particularly uncrowded and offers many opportunities. Few realize that with the advent of subminiature vacuum tubes, the hearing-aid business has grown to huge proportions. Many opportunities also exist in sales.

specialized components found in industrial devices must also be studied. In industrial electronics you can specialize in estimating and installation, or you can devote your knowledge and activity to maintenance and repair. As with previous fields discussed, the many books and periodicals devoted to such subjects

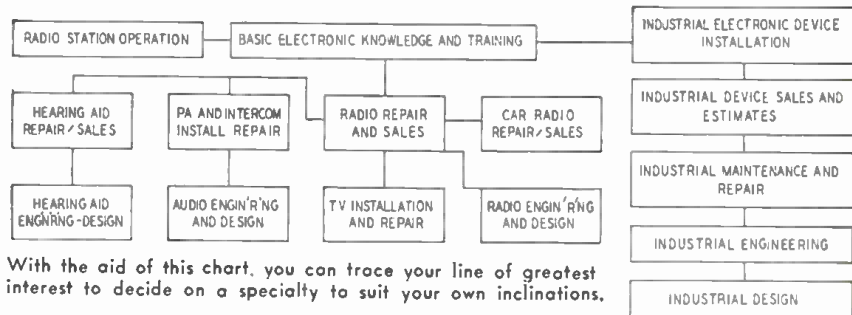

With the aid of this chart, you can trace your line of greatest interest to decide on a specialty to suit your own inclinations.

Station operation

Branching off from our basic electronic knowledge to the left on the chart, we find radio station operation. An entering wedge into this field is a first-class radiotelephone operator's license. You have to study communication laws and basic radio and transmitting theory, as well as power-supply systems. There are several good books on the market containing typical questions and answers, and a study of these will be of great help. When you feel qualified, apply to the nearest FCC district office or examining point (located in most of the larger cities) and take your operator's examination. The first-class license will allow you to take full charge of standard broadcast, FM, or television stations.

Industrial electronics

Your knowledge here has to encompass such items as photoelectric tubes, thyratrons, ignitrons, electron multipliers, counters, and control circuits. Relays, thermostats, switches, and other

contain a wealth of information for the newcomer.

Sales

Not least in terms of increased earnings and profits are the possibilities of being a sales specialist in television, PA systems, intercoms, hearing aids, industrial equipment, or other electronic gear. If you are in business for yourself or are selling for someone else, a thorough knowledge of your specialty will increase sales to a great degree.

In all these electronic branches, the successful salesman is the one whose knowledge goes beyond the superficial appearance or function of the item he sells. He is the one who can point out specific features, performance, and advantage in circuit design and manufacture.

So take a hint from the highly paid specialists in other fields and do likewise in your own—the field of electronics. By adding to your knowledge you will add to your satisfaction—and what is also important, you will add to your income!



Window sign at Marks Radio Service proclaims special interest in repairing car receivers.



Electronic Metronome Has Neon-Lamp Time Indicator

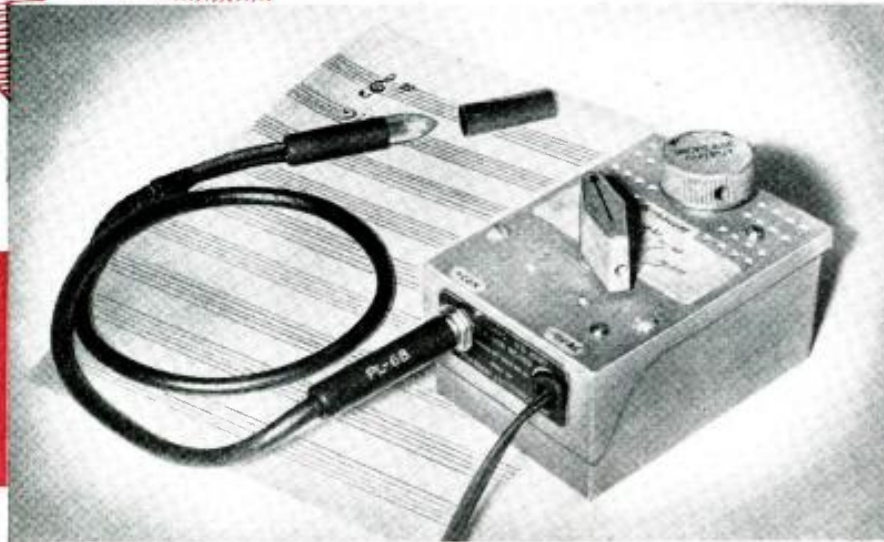

By O. A. COPPENS



The complete metronome is built in an aircraft radio jack box. The original switch is used.

ARTICLES have appeared in magazines in the past few years on the construction of several types of metronomes, the majority ranging from complicated tube assemblies to special relays and unwieldy capacitors. Following the old pattern of mechanical metronomes, the audible beat seems to be almost a requisite for any device described.

An audible beat interferes with the music, so a metronome of this type is generally used for rehearsal or timing practice only. On the other hand, an inconspicuous *visual* metronome provides a check on timing, may be used at any time, and in no way interferes with the music.

A simple, inexpensive, and fairly accurate visual metronome may be constructed from a selenium-rectifier power supply and a neon-bulb relaxation oscillator. Inconspicuous but usable flashes covering a wide frequency range may be obtained from small standard radio components.

A glance at the schematic (Fig. 1) shows the selenium-rectifier power supply to be conventional. R1 is the rectifier protective resistor; R2 and R3 with the filter capacitors form the filter and voltage-divider network. Approximately 140 volts is applied to the oscillator circuit. The power consumption is small, so heating effects are negligible.

Operation of the neon-bulb relaxation oscillator is as follows: When the device is plugged into a 117-volt supply socket and the switch moved from OFF position, current from the d.c. power supply flows through R4 and R5 to charge gradually any capacitor combination switched across the neon bulb. When the capacitor voltage builds up to a certain definite value (90 volts, approximately), the neon bulb ionizes and conducts. This action discharges the capacitance, and the neon bulb stops conducting. The capacitance then slowly recharges through R4 and R5, and the cycle repeats.

The frequency of the neon flashes is

approximately proportional to the supply voltage and inversely proportional to the values of the R-C combinations. Rough frequency control is obtained by switching the various capacitor combinations across the neon bulb. This permits four rough steps of overlapping frequencies with only four small capacitors. The fine control of each step is provided by the high-resistance potentiometer R5 and R4. The high-resistance values of R4 and R5 are also a factor in permitting the use of small capacitors.

A continuous frequency range of approximately 30 to 350 flashes per minute may be obtained. Some alteration in the fixed resistor values may help to obtain

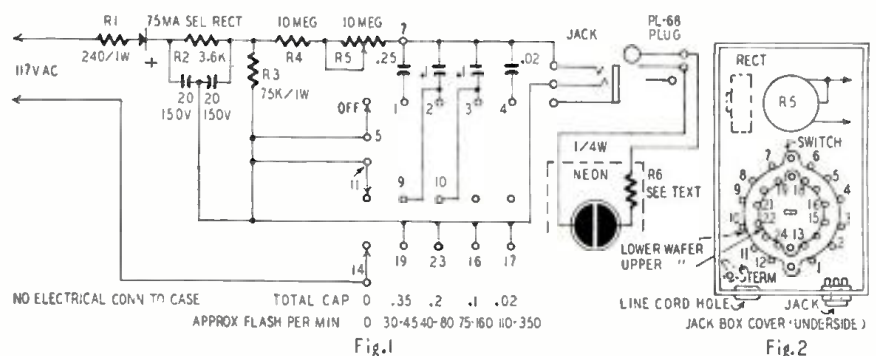

Fig. 1—The circuit diagram. Fig. 2—The switch contact numbers refer to those in the diagram.

correct overlapping of ranges. Due to the high resistances used, well-insulated components and good-quality capacitors are of prime importance for stability and proper operation.

Changes in supply voltage will have some effect on frequency. However, this effect is so small that it is not important in a metronome.

Construction

The metronome was constructed around a war surplus BC-366 jack box, available for a few cents. The box provides an excellent case ($2\frac{1}{4} \times 3\frac{1}{4} \times 4\frac{1}{2}$ inches) together with the required switch, 3-circuit jack, and the control knobs.

Photographs show the original jack box, the complete metronome, and the internal assembly of the metronome. All components except the neon extension are mounted and wired on the box cover for ease of construction and inspection. The box is completely isolated from the electrical circuit to avoid possible shock.

Remove the jack box cover and strip all the wiring. Also remove the banana jack and plug assemblies from the cover and base, as they will not be needed. Replace the original potentiometer with



To get into jack box, remove two top screws, a 10-megohm unit, cutting the shaft to fit the original knob. The single-circuit PHONE jack may next be removed and a rubber grommet inserted in the hole to accommodate the line cord.

Construct a small metal angle bracket for rectifier support, and bolt the rectifier assembly near one corner of the box cover as shown in Fig. 2 and the inside photo. A two-lug terminal strip is also bolted to the cover near the line-cord opening for cord connection and support. A few small holes may be drilled in the cover and base for ventilation.

Remove the rotary switch from the box cover and pry out the spring retention which makes the fifth (CALL) position momentary. This will provide for five switch positions. The switch may then be remounted, using the original knob. The banana-plug insulating strip (not the plug assembly) is remounted in position above the switch, using the original assembly screws, to provide a barrier between switch and capacitors.



After wiring the switch, the fiber banana-plug strip is placed over contacts to insulate them.

A $\frac{1}{4}$ -watt neon bulb is connected to an insulated two-wire extension cord terminating in a three-circuit PL-68 plug. If no plug is available, the neon extension may be connected directly to the metronome circuit by removing the three-circuit MIC jack and inserting a rubber grommet, similar to the line-cord hole. The value of the neon resistor R6 will depend upon the type of neon bulb used. It could be located in the box instead of the extension. A tubular fiber shield with hole, as shown in the photographs, slipped over the neon bulb, will direct and intensify the flashes.

Connect the rectifier power supply, all resistors, and the neon jack according to the schematic. To simplify connections to the switch terminals, an arbitrary numbering system corresponding to numbers shown on the schematic is shown in Fig. 2.

With the power supply on and the neon extension plugged in, temporarily

connect various capacitor combinations until the desired ranges and overlaps are obtained by operation of the switch and R5. After the capacitors have been selected, mount and wire them permanently. Ample space is available for 400-volt capacitors. During construction, one 600-volt unit was used merely because it happened to be of correct value, sufficient mounting space being available near the side.

When the metronome is assembled and tested, a paper dial plate may be glued on the cover indicating the OFF position and each frequency range.

MATERIALS FOR METRONOME

- Resistors: 1—3,600 ohms, $\frac{1}{2}$ watt; 1—240, 1—75,000 ohms, 1—10 megohms, 1 watt; 1—10 megohm potentiometer.
- Capacitors: 2—20 μ f, 150 volts, electrolytic; 1—.02, 2—.01, 1—0.25 μ f, 400 volts, paper.
- Miscellaneous: 1—75-mo selenium rectifier; 1—3-circuit microphone plug (PL-68); 1— $\frac{1}{4}$ -watt neon lamp; 1—BC-366 jack box; necessary hardware.

REGENERATIVE SUPERHETERODYNE RECEIVER

The 6K8 in this receiver converts the incoming broadcast-band signal to the 456-kc i.f. The regenerative triode section of the 6AD7 is the second detector, and the pentode section the audio amplifier.

The tickler coil is added to an ordi-

nary slug-tuned i.f. transformer. Close-wind 15 turns of No. 20 d.c.c. wire $\frac{3}{16}$ inch below the transformer secondary. The antenna and oscillator coils are standard commercial broadcast units available at any parts store—*Manolis Samarakis*.

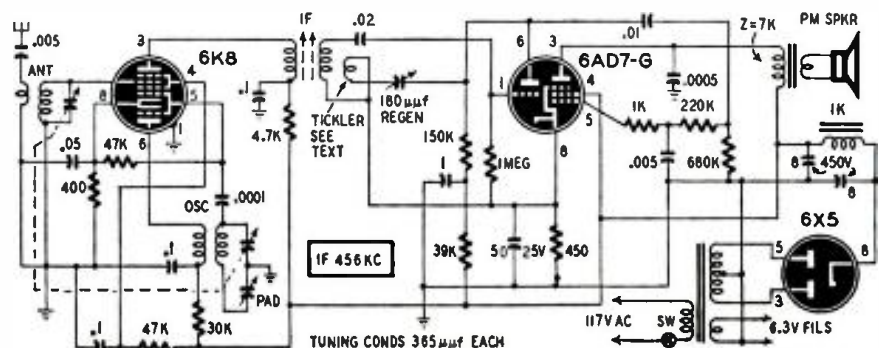

Mobile 10-Meter Rig

By

PAUL M. KERSTEN, WØWIT



T-17 microphone hangs beside the converter. Both are handy to the driver.

PREDICTIONS for the 10-meter band indicate that it is likely to be "hot" for some time. Many amateurs have discovered the dx capabilities of the band even with low power, and some have installed mobile gear in their automobiles. With the useful surplus equipment available and instant-heating tubes, the problems of mobile installation are very slight.

Operating current requirements have been kept at a minimum in the mobile station described here so that the total drain from a 6-volt car battery is not more than 25 amperes. That load is adequately handled by a regular generator which charges at a 35-ampere rate. The generator is kept charging during all testing and operating periods, and there has been no battery failure.

The power unit used is the Army PE-103-A dynamotor, which can be purchased for very little money at almost any surplus outlet. Polarity was a problem; the negative side of the battery in the automobile goes to the frame. In the power unit the B-minus is directly connected to the 6-volt A-plus lead. It is necessary, therefore, to operate the transmitter above car ground and to use a floating link to couple to the antenna. The link is connected to the antenna by 50-ohm co-axial cable and isolated from the transmitter, the outer lead being grounded to the car chassis at the base of the antenna.

Because the A-plus lead is connected to the dynamotor case and to chassis, cabinet, and any other exposed metal parts of the transmitter (via the B-minus line), it is most important not to have any contact between these points and the car frame unless the plus terminal of the battery in the car being used is grounded. Any contact will be a direct short across the battery,

which will not only ruin it immediately, but will very likely fuse the wire or metal that makes the contact. At the very least it will create a very colorful spark which, if gasoline vapor is floating around, may possibly mean one ham less on this planet. That means that tire tools and other miscellaneous metallic articles should not be tossed carelessly into the trunk where they may slide up against the transmitter.

The transmitter r.f. section (Fig. 1) consists of a 2E30 crystal oscillator operating on 28 mc driving a 2E25 class-C r.f. amplifier. This is modulated by an HY31Z dual-triode, zero-bias, class-B stage, which is driven by a 2E30. A T-17 single-button carbon mike is used. This surplus microphone is equipped with a push-button in the handle for push-to-talk operation. The button controls the microphone circuit and a second circuit as well. This is a valuable feature because microphone current flows only when the transmitter is in use and the second circuit is used to control the starting relay in the dynamotor.

The 10-meter oscillator gives more output and is more dependable when it is connected as a triode than as a pentode. A small coil was inserted in the grid-to-ground lead, and one side of the filament was tapped to a point 3 turns from the ground end. A similar coil was inserted in the other filament lead at the tube socket. These coils (L1 and L2), wound on ¼-inch polystyrene rod 1 inch long, consist of 30 turns each of No. 30 enameled wire.

The 2E30 is operated with 250 plate volts and furnishes adequate drive for the 2E25. The oscillator tank coil L3 is six turns of No. 14 wire, self-supporting, soldered directly to the tuning capacitor.

Interstage coupling is capacitive. The 3-30- μ f coupling capacitor reflects capacitance into the oscillator tank and must be carefully adjusted or the oscillator will not perform properly. Once set it will not cause difficulty.

The circuit for the final is straightforward. Parasitic suppressors (100-ohm, 1-watt carbon resistors) were placed at the grid and screen terminals. The 2E25 is operated under load with 425 volts on its plate and 300 volts on the screen. A combination of battery and grid-leak bias is used. There is adequate room under the chassis for this battery as well as the one used to bias the speech amplifier.

The final tank coil L4 is made of 8 turns of No. 14 enameled wire 1 inch in diameter. This coil is center-tapped. In the center of the coil space is provided for the insertion of a 2-turn link L5 made of the same size wire wound to the same diameter, 1 inch. L4 is self-supporting and is soldered directly to the split-stator variable capacitor. An r.f. choke is connected directly to the center tap. The link is also self-supporting and is rigidly mounted to the panel feed-through insulators. A regular coaxial connector fitting was originally used with one side of the link grounded to the chassis. This necessitated connecting the outer conductor of the line to the automobile chassis through a bypass capacitor, which introduced loading problems. This connector was replaced by two insulated feed-through connectors, making the entire link electrically separate from the transmitter and allowing the outer braid of the coaxial line to be directly grounded to the car chassis at the bottom of the antenna. All loading problems were solved in this way.

Meter switching, as shown in the diagram, greatly facilitates tuning and is easier than multiple jacks which would have to be insulated from the panel. A 2½-inch 0-150-ma meter fits



Rear view. Bias batteries are under chassis.

RADIO-ELECTRONICS for

nically in the center of the panel beneath the chassis. The meter switch is located just to the right of the meter, between it and the power-input socket.

The speech end of the transmitter is located along the rear of the chassis. It consists of a single-button carbon microphone driving a 2E30 which is transformer-coupled to the HY31Z. A switch on the gain control breaks the filament circuit of the modulator so that this section can be turned off during tuning. The microphone circuit is given in Fig. 1. A 3-circuit mike jack must be used to match the PL-68 microphone plug. The output of the modulator is capable of fully modulating 30 watts input to the 2E25 final. As in the oscillator plate circuit, a sliding-tap, 10-watt resistor is used to set speech amplifier plate voltage at 250.

Modifying the dynamotor

The PE-103-A will put out 500 volts at 160 ma. It must be removed from its case for modification; circuit diagram pasted inside the case makes the modification easier.

The negative 6-volt terminal is the high side, and the positive end is grounded to the case. As mentioned before, the case must be kept away from the automobile chassis except in certain cars where the positive side of the battery is grounded.

The output socket is an 8-contact Cannon, for which the corresponding male fitting must be obtained. The number of this is P8-24. As the dynamotor is furnished, prong 1 of the output socket is at -6 volts when the unit is turned on (with circuit breakers closed). Disconnect the wire from pin 1, and connect pin 1 to the stationary contact of relay 3E2 in the dynamotor. The tubes in the transmitter are quick-heating; this modification will make them light only when the push-to-talk switch is pressed, starting the dynamotor.

With the dynamotor out of its case, the backs of the three circuit breakers are visible. The center breaker is for high-voltage overload. It was shorted out of the circuit because modulation peaks caused it to cut out. Another reason for shorting it is that the heating time for the 2E30 oscillator filament is 1 second longer than that for the 2E25 final and the static plate current through the 2E25 rises briefly to 90 ma, actuating the circuit breaker. The terminals on the back of the center breaker are numbered. Connect No. 2 to No. 6 and short the remaining two.

Fortunately, the battery input cables which accompany the dynamotor unit are long enough to reach from the trunk compartment to the motor compartment. One lead was connected to the block and the other to the ungrounded side of the starter. Proper polarity must be maintained; otherwise, though the dynamotor will turn over, it will have no output. The equipment was insulated from the car frame by mounting the dynamotor on top of the 9½ x 9½ x 14-inch cabinet which houses the trans-

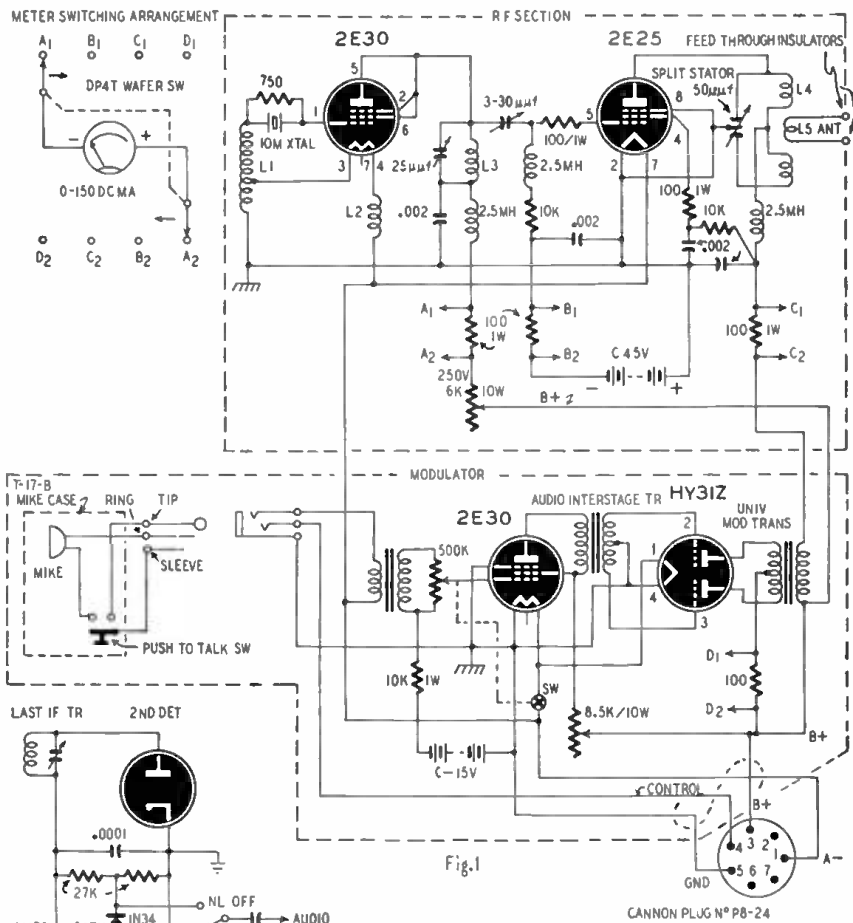

Fig. 1—Circuit of the complete transmitter.
Fig. 2—Noise limiter built in car receiver.

mitter and which, in turn, is shock-mounted to boards bolted to the floor of the trunk compartment. Mounting the dynamotor on top of the cabinet also reduces the space required for the entire unit.

The antenna is a 12-foot variable-length whip. It is mounted on the right rear fender in such a way that the end of the bumper acts as a guard for it. It is fed as a quarter-wave radiator by a 2-foot length of 50-ohm co-axial cable. Field-strength readings are very helpful in determining the proper length for the transmitting antenna.

For receiving, a Gon-Set converter was mounted beneath the automobile radio on the underside of the dashboard. This allows for short leads and convenient operation. Power leads are brought out the rear of the car radio and connect to the converter via a plug. The microphone is conveniently hung just to the right of the converter. Be sure the microphone lead connected to the sleeve of the plug does not contact any car metal.

Conquering ignition noise requires complete shielding of all cables which feed through the fire-wall and some experimentation as to the direction in which the antenna lead travels. To help remove car noise a limiter using a 1N34 crystal was installed in the auto receiver. The circuit for this is given in Fig. 2.

MATERIALS FOR TRANSMITTER—FIG. 1

- Resistors: 1—750, 2—10,000 ohms, ½ watt; 6—100, 1—10,000 ohms, 1 watt; 1—6,000, 1—8,500 ohms, 10 watts, adjustable; 1—500,000-ohm potentiometer with s.p.s.t. switch.
- Capacitors: 4—.002 µf, 600 volts, paper; 1—3.30, 1—25 µuf variable; 1—50 µuf, split-stator, variable.
- Tubes: 2—2E30, 1—2E25, 1—HY31Z.
- Miscellaneous: 3—2.5-mh r.f. chokes; 1—10-meter crystal; 1—single-button-microphone-to-grid; 1—audio interstage; 1—universal modulation transformer; 1—0-150-ma meter; 1—2-circuit, 4-position rotary switch; 2—7-prong, miniature; 1—4-prong, 1—octal tube sockets; 1—PE-103-A dynamotor; 1—T-17 microphone; 1—Cannon P8-24 plug; 1—45-volt, 1—15-volt batteries; 1—3-circuit microphone jack; chassis, panel, and cabinet; necessary hardware and cable.

MATERIALS FOR NOISE LIMITER—FIG. 2

- Resistors: 2—27,000, 1—820,000 ohms, 1—1 megohm, ½ watt.
- Capacitors: 1—.001, 1—.01, 1—0.1 µf, 400 volts, paper.
- Miscellaneous: 1—1N34 crystal rectifier; 1—s.p.d.t. toggle switch.

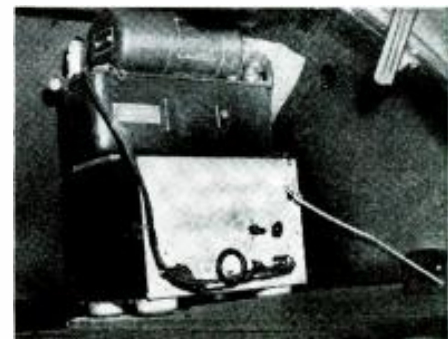

The dynamotor is placed atop the transmitter.

A New Low-Cost Transmitter

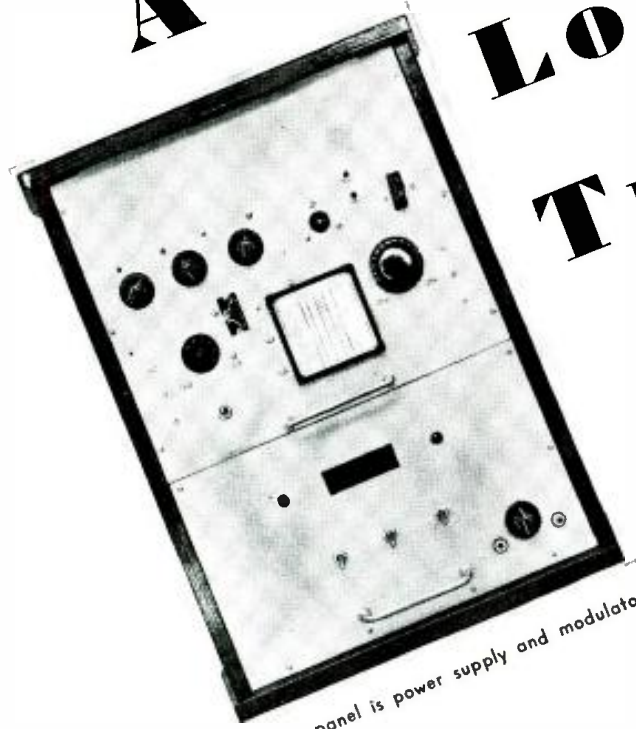

Lower panel is power supply and modulator.

A 75-watt, v.f.o.-controlled rig uses surplus parts to save money and gives excellent performance on 20-80 meters

By **CARLTON G. RICH, W8ZYG**

THE woods are full of 75-watt, all-band transmitters using variable-frequency oscillators, but this one should be of special interest to those who don't have too much green stuff left over after paying for the pork chops. It is practically all war-surplus material of straightforward design, with no freak parts. It will do anything any other rig of like power will do and costs from a quarter to a half the usual price to build. The economy feature stems from the current low prices of the components, especially those which are surplus.

The foundation for the rig is the TU-5-B tuning unit (1500-3000 kc) from a BC-375 transmitter. It is full of the highest-quality parts, all usable. A TU-6-B unit was also bought, its oscillator tuning capacitor being just the right size for the final amplifier tank. The amplifier tuning capacitors in these two units are identical and, with the dials and other parts, make the foundation for a fine antenna tuning unit, using either series or parallel tuning. Another good buy, but not necessary, is the AM26/AIC intercom amplifier. At a low price it provides four needed tubes, sockets, a switch, a mike input transformer, and other small parts. The rest of the components can be purchased individually as needed. Type 1625 tubes are plentiful and very cheap, making a good final amplifier tube if 12 volts for the filament is available. They are the equivalent of

807's, except for their filaments and bases, which have seven prongs instead of the 807's five. They were widely used in military equipment.

Once committed to 12-volt tubes, the logical choice for the exciter stages and the output in the v.f.o. is the 12A6, an audio beam type with the right amount of power for this job. 12A6's are very cheap too. This leaves only the oscillator tube to be chosen, and any r.f. pentode will do—12SJ7, 12SK7, etc. The v.f.o. shown in Fig. 1 uses a 12C8 because the author happened to have one handy.

One way to get 12 volts for the filaments is to use two husky combination power transformers for plate and filament supply and hook the 6-volt windings in series. Depending upon the transformers, the high-voltage windings may be used in series or in parallel to obtain the required 600 to 750 volts at 250 ma. This will take care of the modulator current requirements also. Surplus transformers are usually conservatively rated. If the rig is not to be modulated, about 110 ma will be sufficient.

In the rig shown, a 12-volt filament transformer of the type now being marketed as surplus equipment is used to heat the tubes. A separate receiver-type power supply is used for the v.f.o. and doublers. From 250 to 300 volts is right for the 12A6's. The VR-150 which regulates the 150 volts applied to the v.f.o. is necessary because the current

drain on this power supply varies widely as doublers are switched into or out of the circuit. The maximum current drain is just under 110 ma with all circuits at resonance and loaded to the correct point.

In the front-panel photograph the three pointer knobs in a row at the upper left tune the 12A6 amplifier-doubler stages (Fig. 1). Below these is the dial for the v.f.o. At the upper right are the band-change switch and the closed-circuit meter jacks in the

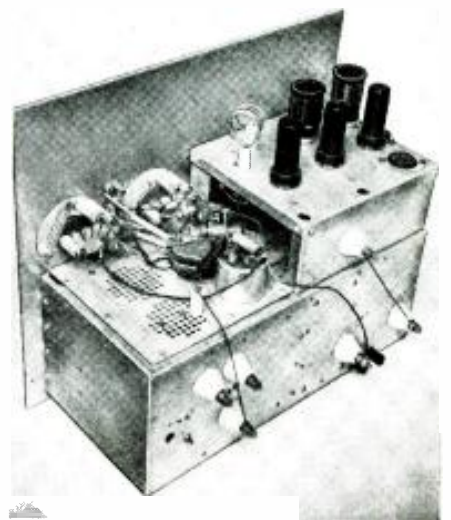

Transmitter is built on converted TU-5 base.

grid and cathode circuits of the final amplifier. Below the jacks is the tuning dial for the final tank circuit. In the bottom panel at the right are the microphone input jacks and speech gain control. The left panel light shows green when the small power supply is turned on, and the right panel light contains a 500-ma dial lamp which is in the high-voltage center-tap lead of the power supply and serves as a fuse for the plate circuit. It glows at about half brilliance with the r.g. turned on and modulated.

Construction

The v.f.o. is constructed entirely within the left-hand compartment of the TU-5-B tuning unit case, using the original dial, capacitor, and coil. This coil (L1 in Fig. 1) has a number of taps fastened to the wire. All connections are unsoldered from these taps and the coil is left in place undisturbed, with new connections made to one end, to the tap located five turns from that end, and to the tap 19 turns from that end. The other end floats, with no connection at all.

A row of fixed mica capacitors with temperature-compensating plates is located under the tuning capacitor. The two nearest the rear, plainly marked .00003 and .0001, are left in place, and all the others are removed. This fixed capacitance, using the 19 turns of the coil, gives just the right amount of coverage on the tuning capacitor, with the 80-meter band taking up about 2,000 of the 2,500 divisions on the vernier dial.

There is plenty of room to mount the tubes and small parts, the main idea being to keep heat away from the coil and other frequency-determining components. The only definite precaution that must be observed is to use dissimilar r.f. chokes RFC1 and 2 in the v.f.o. The tuning units contain two each. One, with resistor attached, is needed for the final grid circuit—RFC3-R1. One, but only one, of the other chokes can be used in the v.f.o. If two are used, the 12A6 amplifier will take off by itself all over the dial. An additional r.f.c. of a different type must be obtained. The common pie-wound, 2.5-mh type is excellent. A liberal slurping with Duco cement after the wiring is completed will hold the leads rigidly in place.

As the rear-view photograph shows, the amplifier-doubler stages are built on an additional chassis mounted atop the tuning unit, on the left side directly above the v.f.o. The ventilated cover plate separates and shields the two sections. The output of the v.f.o. is fed through switch S1 into the first tuned stage, which serves either as a straight amplifier on 80, a doubler to 40, or a crystal oscillator (by opening the switch and plugging a crystal into the socket). This crystal feature was included in the original design and so is shown here, but could very well be eliminated, switch and all; it has never been used by the author except for testing, the v.f.o. being so satisfactory for

use under almost any set of conditions.

The doubler stages are conventional, using plug-in coils, except for the last one, with its 28-mc output, where the coil is fixed. Three plug-in coils are needed, one each for 80, 40, and 20 meters, with a maximum of two in use at any time.

L2 and L3 are wound on 1 1/4-inch forms. The 80-meter coil is 30 turns; the 40-meter, 14 turns; and the 20-meter, 7 turns. L4 is a permanent 10-meter coil made of 4 turns of heavy wire or tubing, self-supported, 1 inch in diameter. The final uses 75-watt plug-in coils with end links, one being necessary for each band, 20, 40, and 80 meters.

Any combination of doubling or quadrupling seems to work equally well,

as the 12A6's provide ample drive. The output tube always works as a straight amplifier. The v.f.o. output will not drive the final directly, so the first exciter tube is always used, with an 80-meter coil for 80-meter output. Series plate feed is used, with the tuning capacitors insulated from the chassis. Hardwood 1/4-inch dowel makes an effective insulated shaft for these capacitors.

The right-hand compartment of the tuning unit contains the output circuit of the final stage. The 1625 hangs upside down in a socket mounted high enough above the tuning unit's ventilated cover so that half the tube projects through the cover into the compartment, with the tuning and bypass capacitors and the 75-watt plug-in coil

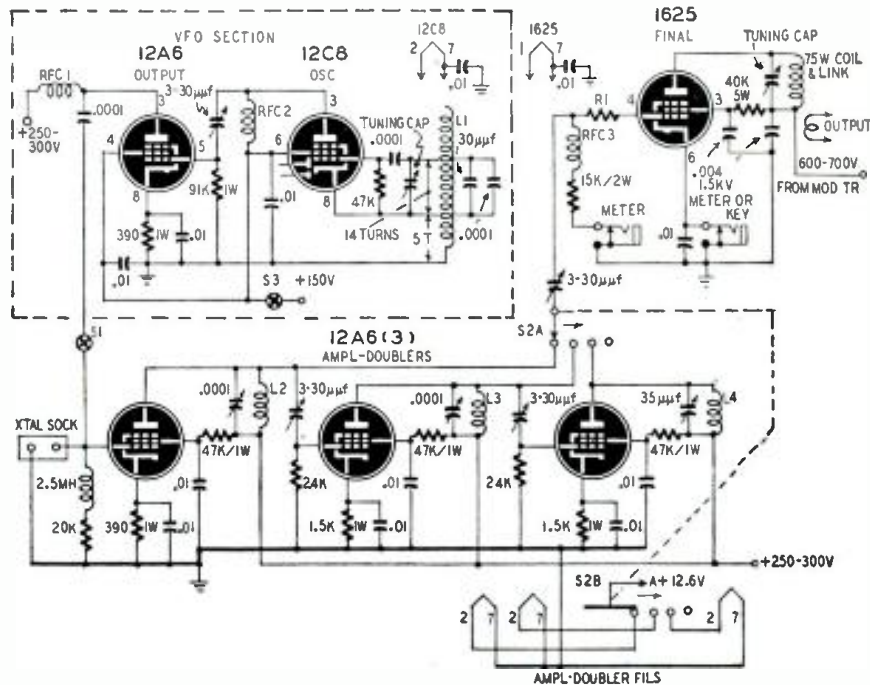
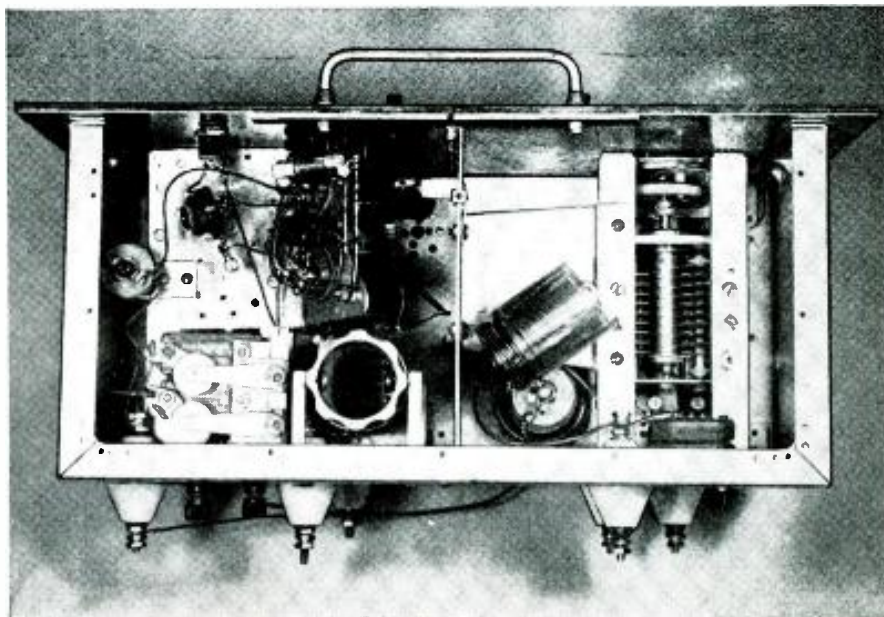

Fig. 1—The r.f. section. S2 is a special switch found in the TU-5-B. It must be modified.



Under-chassis view of completed r.f. section shows 1625 mounted upside down, right center.

inside. This arrangement permits short leads and provides thorough shielding, resulting in a perfectly stable amplifier. The coil plugs in from the bottom of the set (this seems awkward but actually has not proved to be so). For coil changing, the transmitter slides forward like a drawer. It takes no longer to pull downward than upward to remove a coil. A suitable hole is cut in the bottom plate. The link output is at the two close-spaced feedthroughs at the rear. The tuning capacitor was taken from the left compartment of the TU-6-B and fits perfectly in place. The 1625 tube socket shown was sawed out of the BC-456-B modulator unit in the 274-N series. (There is no less painful method of removing it.)

The band-change switch S2 taken from the tuning unit is modified slightly by making a shorter arm, using the original for a pattern, to connect the two sections so they will fit side by side on the right half of the panel. Just enough space is left between them to mount the grid and cathode meter jacks. The switch section nearest the edge (S2-b) is used as is, turning on the filaments as the doublers are connected into the circuit. The other section (S2-a) is altered to a tap switch, instead of the shorting type, by breaking off all but one of the rotor contacts, which selects the output of the proper doubler as required. The contacts snap off readily with a twist of the pliers.

The rig is keyed by plugging the key into the final cathode jack. For tuning, a meter with at least a 0-150-ma range plugs into the same jack. The capacitor bypassing this jack must be able to withstand the full plate voltage when the circuit is open (with the key up). The oscillator runs continuously and is no bother except when working a station directly on one's own frequency. Then it may be turned off while receiving, by the switch S3 mounted below its tuning dial.

The doublers are tuned by watching for maximum grid current on a meter inserted in the final grid jack. Doubler tuning is not critical and ordinarily need not be touched when shifting frequency within a band. It is necessary only to set the oscillator on the desired frequency, guided by the calibration chart on the panel, and then tune the final for cathode-current dip. A minimum of 6 to 8 grid ma is available, which is approximately twice the rated

requirement. High-sensitivity beam tubes like the 1625 can be damaged by too much grid drive. A little detuning of the doubler stages will eliminate this possibility.

The modulator

The entirely conventional modulator circuit (Fig. 2) also uses 12-volt tubes. Most modulators in this power range terminate in 6L6's. It seemed reasonable that a 1625 will do anything a 6L6 will do, and perhaps do it better. Experience has proved this to be true. The 1625 is capable of much greater output than is necessary with this transmitter, and several 1625's cost less than one 6L6.

To avoid wasteful excess power input, the screen voltage is reduced through a dropping resistor to only 275. The original model uses a 12-watt potentiometer (surplus) to accomplish this, but any adjustable resistor of 10 watts or more and 20,000 ohms will do. At this screen voltage the plate input to the two tubes is about 120 ma when idling. A 12SJ7 and 12J5 provide adequate sensitivity for a crystal or dynamic mike.

A small PM dynamic speaker makes a good microphone. The original model also will accommodate a T-17 carbon mike, which is adequate and eliminates the need for the 12SJ7, at a slight decrease in tone quality. Using either mike, the gain control adjusts the output power for the correct modulation. If only the carbon mike is used, the entire 12SJ7 circuit may be eliminated; if the dynamic mike is used, then the microphone input transformer and battery are not needed. The battery is three flashlight cells wired in series. The built-in switch on the T-17 mike shuts off the battery current when not in use. If the modulator is turned off only by the filament switch and plate voltage remains on, then C1, C2, and C3 must be able to withstand the full plate voltage, as there will be no voltage drop in the resistors when the tubes are not drawing current.

There are a number of small surplus modulation transformers that are suitable for use in this transmitter. One of these, used in some ARC-5 transmitters, was designed to match class AB 1625's or 807's to a single-ended r.f. amplifier tube. This transformer has three sec-

ondary windings. One modulates the plate and another the screen grid of the r.f. amplifier. The third is a low-impedance winding used for monitoring the output of the modulator. The screen grid of the 1625 must be fed from a 300-volt supply with this transformer.

The mechanical work is not difficult. The tuning units and most other surplus equipment is made of aluminum. A small Allen wrench is needed for the setscrews. It is useless to try, as the author did, to pull and pry a knob off after loosening one setscrew; there are always two of them. The panel of the r.f. section measures 17 inches wide by 14 inches high, with an additional 9 inches of height in the lower panel, which covers the power supply and modulator. For stability in the v.f.o. the panel must be rigid. A sheet of Presdwood or Masonite $\frac{1}{8}$ inch thick with a very thin galvanized sheet-steel backing meets all requirements and is easily worked. The two sheets can be glued into a sandwich with Miracle adhesive, available in dime stores. This forms a panel which may be pushed, twisted, or thumped upon without any effect whatever upon the oscillator. All the preliminary construction can be done with the original panel in place, and any necessary new holes drilled in it. It is then a simple matter to use it as a template in marking out the new panel, eliminating measurements or mistakes upon the latter.

Operation

When finished, this rig won't drown out the 900 watts in the next block or the next town. But even on the 75-meter phone band there is generally room between a couple of big ones to sneak a signal through. On the higher frequencies, particularly 10 meters, results are very good indeed, with plenty of dx. Even higher-frequency operation might be possible by doubling in the output circuit. The v.f.o. and the various doubler combinations provide maximum flexibility; the rig can be quickly set to any amateur frequency up through the 10-meter band—and when so set, it stays there. After the first initial heating of the tubes, there is no detectable drift. On c.w. the note is always given a 9X tone report and is assumed to be crystal-controlled. Results of phone operation are also excellent, with complimentary reports received. The whole unit makes a very satisfactory transmitter from any angle.

MATERIALS FOR TRANSMITTER

Resistors: 1—20,000, 2—24,000, 1—47,000 ohms, 1—2 megohms, $\frac{1}{2}$ watt; 2—390, 4—1,500, 3—47,000, 1—91,000, 1—470,000 ohms, 1—1 megohm, 1 watt; 1—15,000 ohms, 2 watts; 1—40,000 ohms, 5 watts; 1—250 ohms, 1—20,000 ohms, adjustable, 10 watts; 1—500,000-ohm potentiometer with switch.

Capacitors: 1—100 μ f, mica; 2—10 μ f, 50 volts, electrolytic; 11—01 μ f, 600 volts, paper; 1—01, 1—4 μ f, 1,000 volts, paper; 1—004 μ f, 1,500 volts, mica; 4—3-30 μ f trimmers; 1—35, 2—100 μ f, variable.

Tubes: 4—12A6, 1—12J5, 1—12SJ7, 3—1625, 1—12CB. **Miscellaneous:** 1—TU-5-B; 7—octal, 3—7-prong tube sockets; 2—s.p.s.t. toggle switches; 1—2.5-mh r.f. choke; 1—carbon microphone to grid, 1—3:1 ratio interstage audio, 1—6,000-to 6,000-ohm modulation transformers; power supplies; 1-TU-6-B; necessary insulators, hardware, etc.

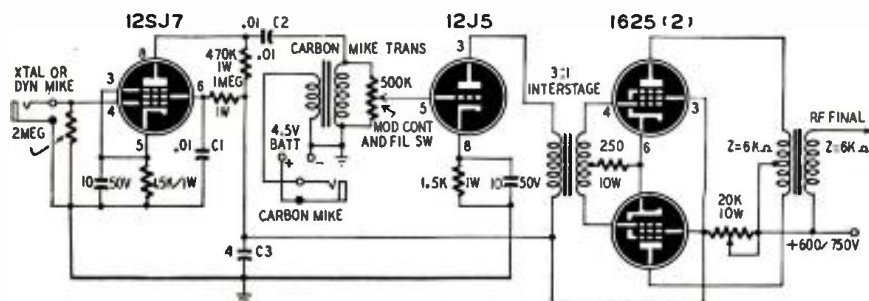
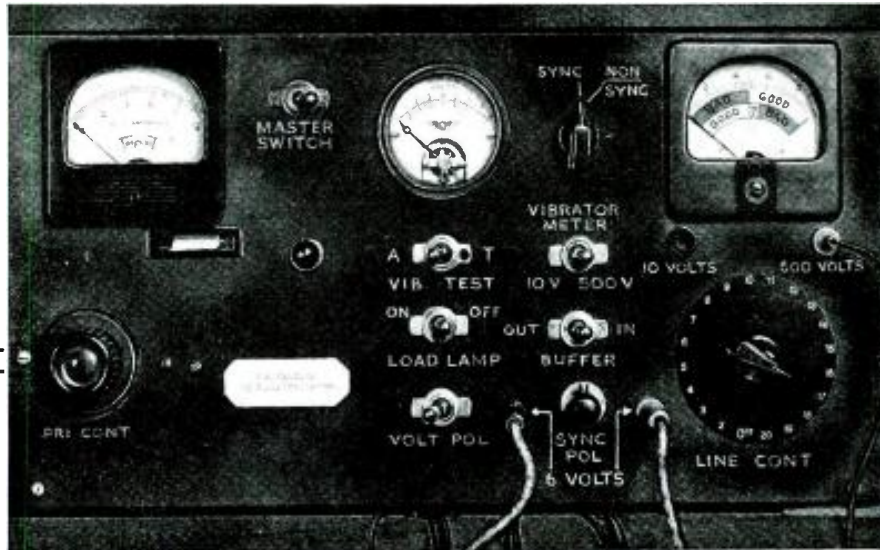

Fig. 2—This modulator is designed for carbon or crystal microphones. Be sure to ground the junction of the 250-ohm cathode resistor and the center tap of the interstage transformer.

Carvalyzer Services Auto Radios



The front panel of the Carvalyzer. The A-eliminator inside the cabinet supplies the power.

Making complete, accurate, and speedy checks on 6-volt receivers requires a versatile combination instrument

By S. H. COVINGTON, JR.

DESIGNED especially for servicing automobile radios and testing vibrators, the Carvalyzer also furnishes A- and B-voltages for servicing many types of battery and three-way radios, particularly those with series filament strings. It supplies 6 volts for auto radios and indicates the current drawn by the entire set or by the vibrator alone. The name Carvalyzer, suggestive of the unit's functions, was coined from "Combined A-Eliminator with Radio and Vibrator Analyzer." Fig. 1 is the circuit.

The first step is to own or get a good husky 6-volt A-eliminator. (One can be constructed from the directions given in the article "A-Battery Eliminator" in the April, 1949, issue of RADIO-ELECTRONICS.) This unit is built around a type 60 ATR eliminator. Other units can be used by following the general outlines of this article.

If you have the type 60 ATR unit or one of similar construction, it may be mounted as follows. Stand the unit on end so the 6-volt terminals are on your right. Discard the bottom cover. Place a 19-inch metal or Masonite panel over the eliminator so that approximately 1 inch of panel extends on the left side. Cut a slot in the panel directly in front of the fuse clip. This will permit the fuse to be withdrawn when a 2-inch

loop of tape is passed around it and allowed to project through the slot (see front-view photo). The fuse clip may be replaced by a fuse extractor post on the panel. Remove the pilot lamp and line switch, and mount them on the panel. Mount a 0-10 or 0-15 d.c. ammeter and primary tap switch on the panel where they will be inside the eliminator case. The panel is fastened to the case with screws or strips of angle iron at the top and bottom.

The PRI CONTROL is a nonshorting switch connected so that turning it to the right increases the voltage at the 6-volt terminals of the eliminator. This switch does not have sufficient control over the output voltage; therefore, a heavy-duty rheostat, marked LINE CONTROL, is inserted in series with the a.c. line. This is a 200-ohm unit with a rating of 200 watts or more. Such units being bulky and expensive, we made one by connecting carbon bars across the contacts of a rotary switch. These carbon bars have various resistances varying from approximately 1.4 to 39 ohms. A general automotive electrician (not a dealer) will probably give you some of these carbon resistors from discarded relays. They have holes in the ends, making it easy to bolt them together. A soldering lug over each bolt connects these points to the switch con-

tacts. The resistors are connected in a square helix as shown in the rear-view photograph. The homemade rheostat is connected in series with one side of the a.c. line so that maximum resistance is in the circuit when the switch is turned counterclockwise as far as it will go.

Additional components

A 115-cycle vibrator transformer must be used in this unit, since most vibrators work at that frequency. If a 115-cycle vibrator is tested on a 180-cycle transformer, it will pass too much current and its contacts will be damaged.

The transformer, hash chokes, 0.5- μ f capacitors, and the filter choke may be salvaged from an old automobile radio. The vibrator replacement guide will tell you whether the set selected has a 115-cycle transformer.

There are three meters. M1, a 0-10 or 0-15 d.c. ammeter, reads current drawn from the eliminator. M2 is a 0-8, or preferably a 0-10, d.c. voltmeter that indicates the d.c. output of the eliminator. M3 is a 0-1 d.c. milliammeter that is converted to a 10- or 500-volt meter by throwing the METER switch.

Two GOOD-BAD scales are drawn on the face of meter M3. The upper scale checks vibrators by measuring the output voltage. The BAD area goes from 0

to 0.47, and the GOOD area covers the rest of the scale. Convert the meter reading to volts by multiplying by 500. The lower scale indicates the starting voltage of the vibrator. A good vibrator will begin to vibrate at as low as 4.7 volts, and a perfect one with no film on its contacts will start at 4 volts. The area between 0 and 0.4 (4 volts) is marked GOOD, the area between 0.4 and 5.6 is marked "?", and the balance of the scale is BAD.

The VIBRATOR switch, a four-circuit, double-throw unit, switches the transformer secondary to the rectifier plates for nonsynchronous vibrators, or to the secondary contacts of a synchronous vibrator.

The SYNC POL switch is a d.p.d.t. leaf type used to reverse the polarity of the secondary winding when testing synchronous vibrators. This switch must withstand several hundred volts; therefore, the usual radio toggle switch cannot be used.

The 50,000-ohm wirewound potentiometer, switch S1, the B-voltage jacks, the push-button switch, and J5 were added after the original Carvalyzer was completed and do not appear in the photographs. The 50,000-ohm control has a s.p.d.t. switch S2 ganged to it and connected so that A- and B-minus are tied together when the control is all the way over in a counterclockwise direction. Advancing the control connects the resistance of the control across the B-supply and isolates the A- and B-supplies. This prevents shunting the bias supply in some sets. A jumper can be run between the vibrator test clip R and the B-minus terminal if the A- and B-supplies must be connected together. The B-supply having very little filtering, faulty filters in a set will show up in the form of hum.

A 32-candle-power lamp loads the 6-volt supply and prevents the voltage from rising when there is no external load.

Leads marked R, A, P1, P2, S1, and S2 are brought out and terminated with insulated alligator clips with the end teeth filed down to fit the pins of the vibrator under test. A small round file will remove the teeth nicely. Mark the leads clearly to avoid mistakes when connecting them to vibrators. Typical vibrator connections are shown in Fig. 2.

J1, J2, and J5 are standard pin jacks, and J3 and J4 are heavy-duty banana jacks. Leads for J3 and J4 are heavy wires, one of which is terminated with a heavy battery clip and the other with a fuse holder of the type most commonly used on auto radios. A pair of smaller leads is made to fit into J3 and J4. These leads terminate in alligator clips filed to fit the A-battery prongs of most battery radios. A similar pair of leads is made with suitable clips for the B-voltage jacks.

Testing vibrators

Determine the make and type number of the vibrator you wish to test and look up its characteristics and base connections in a vibrator manual. Set up the Carvalyzer as follows:

1. MASTER switch OFF.
2. VIB TEST ON T.
3. METER switch on 10 VOLTS.
4. VIBRATOR switch on SYNC or NON-SYNC for synchronous or nonsynchronous vibrators, respectively.
5. BUFFER switch IN.
6. LOAD LAMP switch ON.
7. Set LINE CONTROL for highest resistance.
8. B-VOLTAGE CONTROL counterclockwise until S2 is OFF.
9. PRI CONTROL at lowest-voltage setting.
10. Close S1.
11. Connect VIBRATOR TEST LEADS to vibrator letting unused clips hang clear.
12. MASTER switch ON.

M3 should indicate about 1½ volts.

Hold the vibrator in your left hand and advance the LINE CONTROL until the vibrator starts to vibrate. Note the indication on the lower GOOD-?-BAD scale of M3. If the meter reads BAD or "?", or M1 reads more than 2.4 amperes, reject the vibrator. This test tells the condition of the reed, driving coil, and starting contacts.

If the vibrator is good, test it for

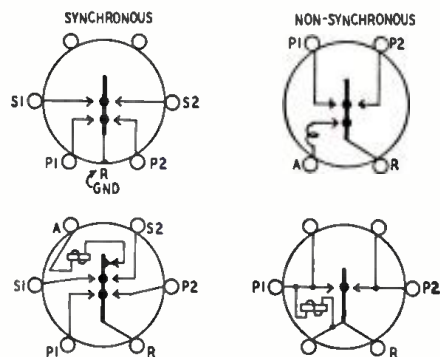

Fig. 2—Typical vibrators, with pin markings.

output. Set the METER switch to 500 volts. If there is no indication when testing synchronous vibrators, throw the SYNC POL switch to the opposite position. M3 should read up-scale. Check the SYNC POL switch as soon as possible because, when it is incorrectly set, a negative voltage is applied to the positive side of the filter capacitors in the Carvalyzer.

When M3 reads up-scale with either type of vibrator, turn the load lamp off and advance the PRI and LINE CONTROL until M2 reads 6 volts. Check M1 to make sure the vibrator is not drawing more than 2.4 amperes. The indication on the upper GOOD-BAD scale of M3 will tell whether the vibrator passes the voltage-output test.

Testing auto radios

Consult the sticker on the chassis or a service manual to determine the drain of the set. Connect the Carvalyzer to the set through the heavy leads from J3 and J4. Set the PRI CONTROL and the LINE CONTROL for the lowest voltage. Close S1.

Make sure all tubes and the vibrator are firmly seated in their sockets. Turn on the Carvalyzer and radio while watching M1 to make sure it does not go off-scale. Advance the LINE CONTROL and note the starting voltage on M2. The vibrator should start at about 4 volts. Adjust the voltage polarity for the lower current on M1. This corrects for positive or negative ground on polarized sets.

If the current drain is greater than specified by the manufacturer, test the tubes, pilot lamp, and vibrator; record any defects. Do not replace these components at this time. Turn on the set and Carvalyzer and adjust the input voltage to 6 volts. Note the current drain. It should be zero if the set has a PM speaker, and less than 1½ amperes if it is more than 1½ amperes, disconnect the hot lead from the coil. The current

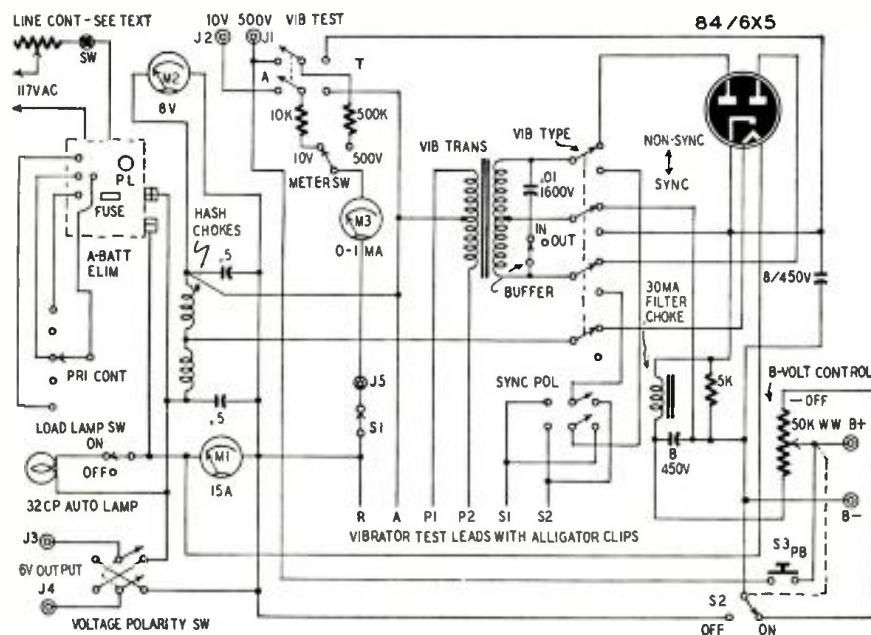

Fig. 1—The vibrator test leads are labeled to conform with the base markings in Fig. 2.

should drop to zero. If current still flows, look for stuck contacts on the push-button solenoid or clutch circuits, leaky capacitors, defective spark plates, and other defects in the 6-volt circuit.

Clear up any trouble in the 6-volt circuit; then check the B-circuits. Some sources of trouble in the high-voltage circuit have been cleared when the vibrator and tubes were checked. To check the vibrator transformer, install a good vibrator in the set. Open the BUFFER switch and disconnect the field coil. Open the center tap of the secondary if the set has a synchronous vibrator. Current greater than 1 ampere indicates shorted turns in the transformer, which must be replaced.

Replace all defective components. Be sure to put in a new buffer capacitor if the vibrator was bad. Turn on the set, adjust the Carvalyzer to 6 volts, and let the set warm up. Note the current drain. Remove the vibrator, readjust the input to 6 volts, and note the current. The difference in current consumption is the current passed by the vibrator. Most vibrators are rated at a 6-ampere maximum.

Measuring B-voltages

To measure B-voltages in any set being supplied by the eliminator, set the VIB TEST switch to A, the METER switch to the desired range, and plug the positive test lead into J1 or J2. Voltages are read on M3. With this connection, the filament lead is the reference point. Plug the negative test prod into J5, and open S1 to make measurements from other reference points, as across individual filaments in a series string.

Continuity tests

For low-resistance circuits, set the VIB TEST switch to A, turn the load lamp off, METER switch to 10 VOLTS, VIBRATOR to SYNC, and B-VOLTAGE CONTROL off. Plug one test lead into the 10-volt terminal J2, and clip the other to vibrator test lead A. Turn on the Carvalyzer, and adjust the primary and line controls for full-scale reading on M2. Touch the prods together, and M3 will read full scale. Use the prods for low-resistance tracing.

For high-resistance testing, connect a good synchronous vibrator as you would when running a test and adjust the output to 250 volts (mid-scale) on M3. Open S1, and M3 returns to zero. Plug one test lead into J5 and the other into the B-minus jack. Touching the leads together will bring M3 to mid-scale. Use known resistances to calibrate M3 on the low- and high-resistance ranges.

Operating 3-volt sets

Connect a good nonsynchronous vibrator to the test leads and adjust the output of the eliminator to 3 volts. Slightly less than 90 volts will appear at the B-terminals. For higher B-voltages, use a synchronous vibrator and adjust the Carvalyzer accordingly.

Plug the small test leads into J3 and J4; place the clips over the A-pins on the battery cable of the set. Plug an-

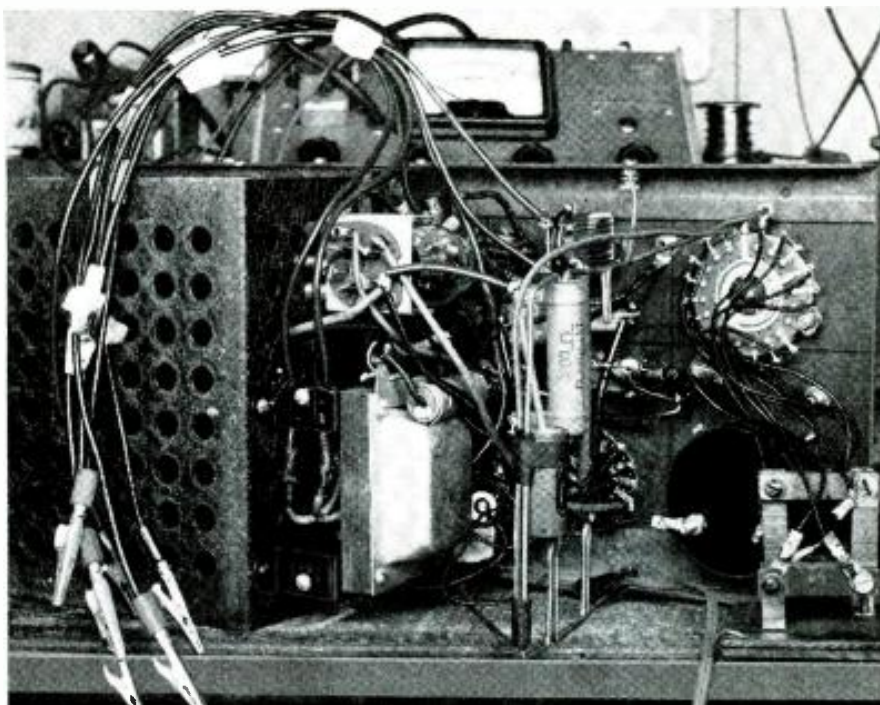

Inside the Carvalyzer. The A-eliminator is at left and the line-control resistor at right.

other pair of leads in the B-voltage terminals and connect the clips to the B-voltage pins on the battery cable. Be sure to observe circuit polarity when making these connections. Consult the diagram of the set to see if there is a resistor in the negative lead; if so, make sure that it is good.

Set the Carvalyzer as for starting-voltage tests on the vibrator attached to the test clips. Turn on the unit and adjust it so the voltage on M2 does not exceed the filament voltage for the set. Turn on the set and correct the fila-

ment voltage if necessary. Insert test leads in J2 and J5, throw the VIB TEST switch to A, and check the polarity of the voltage on J3 and J4. If the polarity is incorrect, reverse it with the VOLTAGE POLARITY switch. Remove the leads from J2 and J3. Close S1. Set the METER switch on 500 VOLTS and advance the B-VOLTAGE CONTROL just enough to throw S2 ON. Check the filament voltage on M2. Hold the push-button switch S3 closed while adjusting the B-VOLTAGE control until the correct B-voltage is indicated on M3.

INEXPENSIVE RESISTANCE BOX

Here is a cheap and easy way to make up a resistance box which will allow the serviceman or experimenter to choose many values. Four octal tube sockets and 31 resistors are needed. The diagram shows the necessary connections.

Though half-watt resistors would be least expensive in making up the box, using 1- or 2-watt units will allow it to be employed where higher voltages and currents are to be dealt with to any extent.

Any combination of series resistors can be selected by plugging test leads into the proper pin holes. For 33,000 ohms, for instance, use terminals 22 and 13. If the desired value cannot be obtained with a series combination, use resistors in parallel by providing a jumper lead with a single phone tip on one end and a phone tip and tip jack on the other. For quick calculation of parallel resistances, one of the commercial cardboard "slide rules" is extremely helpful.

The schematic will be needed each time you use the resistor box, so preserve it well. Draw it with ink on white

cardboard very carefully and shellac it.—G. P. Brunton

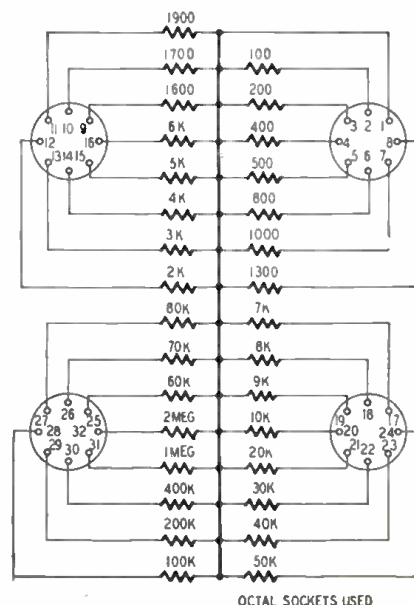

Combination Instrument Measures R, C, and L Accurately

By B. J. CEDERQVIST,
OH2NL*

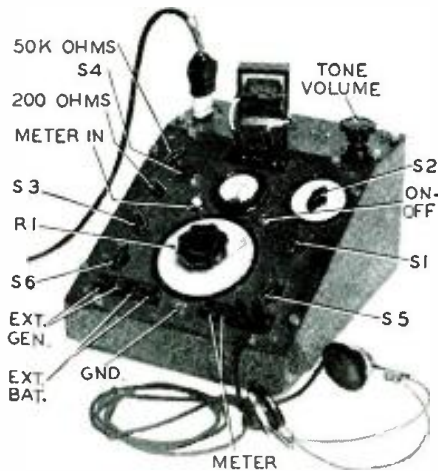

Generator and bridge are in a single cabinet.

IT IS often necessary for an experimenter or engineer to make various kinds of measurements. Everyone is familiar with the common instruments for measuring current and voltage, but not always with the impedance bridge, which can be used for measurements of resistance, inductance or capacitance. The general principle of bridges is shown in Fig. 1.

Fig. 1-a is the Wheatstone bridge. The unknown resistance is R_x while R_v is variable. The resistors R_A and R_B are the *ratio arms*. If R_v is calibrated, and we know the ratio of R_B to R_A , the value of the unknown resistor R_x is equal to

$$\frac{R_B}{R_A} \times R_v,$$

after adjusting R_v so that there is no potential difference between the galvanometer terminals (the *null* adjustment).

Fig. 1-b is a Maxwell bridge. The unknown inductance is L_x ; in the opposite arm we have a standard capacitance C_v . R_v is again a calibrated variable resistor. The Maxwell bridge compares an inductance with a capacitance. After adjusting R_v and R_A for null,

$$L_x = R_v R_B C_A, \text{ and} \\ R_x = \frac{R_v}{R_A} \times R_B.$$

It would be very difficult to obtain a true null point if we had only the standard capacitor in the A-arm, due to the resistive losses in the inductance L_x . These losses can be represented by an

imaginary resistor R_v ; by connecting a variable resistor R_v in parallel with the standard capacitor C_v and adjusting this resistor along with the R_v , we can balance out R_x and obtain a very sharp null in the phones.

Fig. 1-c is the circuit for a usual capacitance bridge (in principle a Wien bridge). C_x is the unknown capacitance and the standard capacitor is C_v . R_v is the calibrated variable resistor. Note that C_x and R_v are in opposite arms. Because the reactance of a capacitor is inversely proportional to the capacitance, the value of C_x is equal to

$$\frac{R_v}{R_v} \times C_v.$$

Capacitors also have losses. To obtain a true null, R_v is connected in series with C_v ; by adjusting it along with R_v , we can again obtain a very sharp null in the phones. The bridge is perfectly balanced when

$$C_x = \frac{R_v}{R_v} \times C_v, \text{ and } R_x = \frac{R_v}{R_v} \times R_v.$$

The impedance bridge

The circuit diagrams of a bridge and generator built by the writer are shown in Figs. 2 and 3. The photos show the complete instrument and bottom views of the bridge chassis and the generator. The following ranges are covered with the bridge:

With the S3 in the Ω position and S2 on 10, values up to 10 ohms can be read from the big dial scale on the potentiometer R1. With S3 in the $k\Omega$ position and S2 on 10,000, values up to 10 megohms can be measured.

The inductance ranges are also divided into two S3 positions, MH and H. With S3 in the MH position and S2 on 0.1, values up to 0.1 mh can be read from the scale. By switching S3 to the

H position and S2 to 100, values up to 100h can be measured.

In the same way, capacitances to 100 μf can be measured with S3 in the μf position, and values up to 100 μf with the switch in the position marked NF. The expression nf (nano-farad) has been employed by the author to make it possible to use the same scale for μf and μf measurements (1,000 nf is equal to 1 μf).

The accuracy of the bridge depends upon the accuracy of the resistors and the potentiometer R1. All resistors must be wirewound and carefully calibrated with a precision resistance bridge. The potentiometer must be of good quality and preferably one with a large diameter. The scale on the potentiometer must also be calibrated with a precision bridge. Good capacitors must be used for the 1,000- μf and 1- μf units. By selecting capacitors with values smaller than 1,000 μf and 1 μf and shunting them with others, the exact values can be obtained.

Switch S5 shunts the galvanometer with a suitable resistor RS so when the bridge, in measuring resistances, is far from balance, the galvanometer deflection is not too big. In the first position an external detector (headphones or an amplifier) can be used when measuring inductances and capacitances. The normally open push-button switch in series with the galvanometer makes it possible to see more easily when the current through the galvanometer is zero by interrupting and closing the galvanometer circuit. The galvanometer is also connected to the terminals marked METER; therefore, it can be used for other purposes.

When measuring resistances, S6 should be in the position marked DC and S7 must be closed. An internal d.c. voltage is then connected to the bridge.

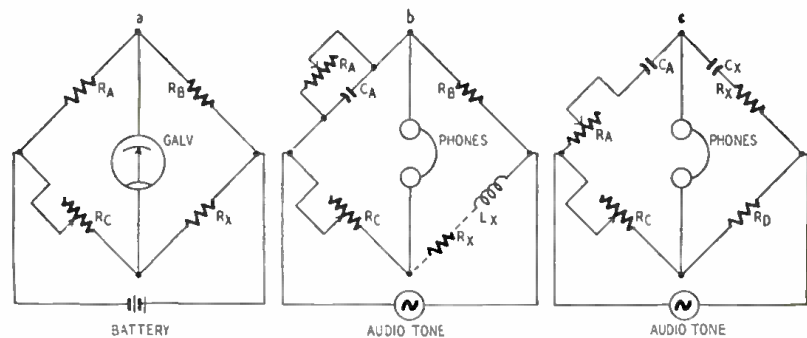

Fig. 1—Wheatstone, Maxwell, and capacitance bridges illustrate general working principles.

*Finnish Cable Co., Helsinki, Finland.

External batteries can be used by opening S7 and connecting the battery to the terminals marked EXT BAT for more accurate measurement of high resistances.

When measuring inductances and capacitances, S5 should be in the EXT position and S6 in the INT position. An 800-cycle audio note is then connected to the bridge. If an audio note of another frequency should be needed, an external generator can be connected to the terminals marked EXT GEN and the switch turned to the position marked EXT.

In the author's bridge, a switch S4 had to be installed to short the 500,000-ohm potentiometer because it was impossible to find a potentiometer which could reach zero ohms. If the 500,000- and 200-ohm potentiometers are furnished with calibrated scales, the power factor can be calculated from the readings.

When making measurements on capacitors of low value, it is desirable to determine the capacitance of the bridge itself. In the bridge shown, this capacitance is very close to 5 μf ; and, when measuring capacitors up to 100 and 1,000 μf , this value should be subtracted.

Fig. 3 shows the generator. It has cathode output. The home-made transformer T has 2,500 turns of No. 38 enameled wire on the primary and two 1,250-turn windings of the same wire on the secondary. Between the primary and the copper screen is an electrostatic shield—a single-layer winding of No. 31 enameled wire. The screen encloses completely the secondary winding. The cross section of the core in the transformer is $\frac{3}{8} \times 1$ inch.

An extra winding on the high-voltage transformer gives 25 volts to a selenium rectifier for the d.c. voltage to the bridge. A 200-ohm current-limiting resistor and a 50- μf electrolytic capacitor are connected between the rectifier and the bridge.

The generator is located in the upper end of the steel box (see photos) and connected to the bridge via a five-prong socket. The dimensions of the steel box are 7 x 11 x 14 inches. All parts of the bridge are mounted on a bakelite panel.

MATERIALS FOR BRIDGE—Fig. 2

Resistors: 2—10, 2—100, 2—1,000, 3—10,000 1—100,000 ohms, precision, $\frac{1}{2}$ to 1 watt; 1—200, 1—10,000 ohms, wire-wound potentiometers; 1—500,000 composition potentiometer.
Capacitors: 1—1.0, 1—.001 μf , precision, paper, 50 volts.
Switches: 1—2-position, 5-circuit, 2—4 position, 2-circuit, 1—3-position, 2-circuit, 1—3-position, 3-circuit, rotary, non-shorting, 2—s.p.s.t. toggle.
Miscellaneous: 1—galvanometer; 1 5-prong male plug; necessary binding posts, terminals, dials and scales, hardware, etc.

MATERIALS FOR SIGNAL SOURCE—Fig. 3

Resistors: 1—20,000, 2—100,000 ohms, $\frac{1}{2}$ watt; 1—200 ohms, 1 watt; 1—250,000-ohm potentiometer.
Capacitors: 1—50 μf , 50 volts, electrolytic; 2—8 μf , 450 volts, electrolytic; 1—0.2, 2—0.25 μf , 600 volts, paper.
Tubes: 2—37, 2—80.
Miscellaneous: 1—4-prong, 2—5-prong tube sockets; 1—1-3 ratio audio interstage transformer; 1—power transformer, 500 volts center-tapped at 75 ma or more, 6.3 volts at 500 ma, 5 volts at 2 amperes, 25 volts at 50 ma; 1—10-h, 75-ma filter choke; 1—5-prong female plug; 4—100-ma selenium rectifiers; necessary hardware.

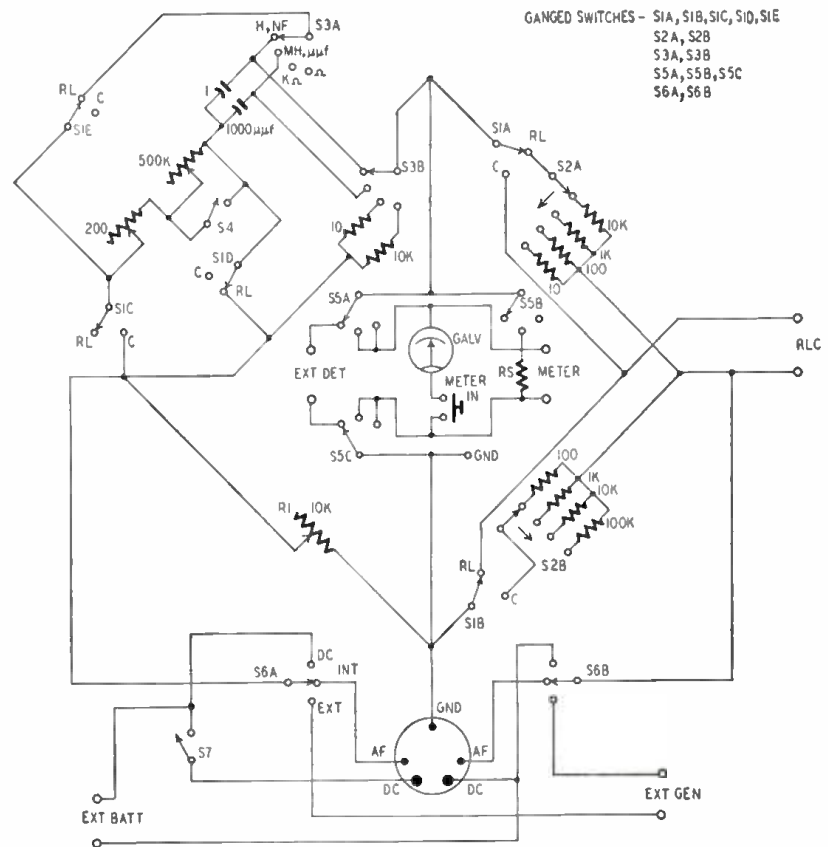

Fig. 2—Switches and controls in the bridge circuit provide for four ranges of R, C, and L.

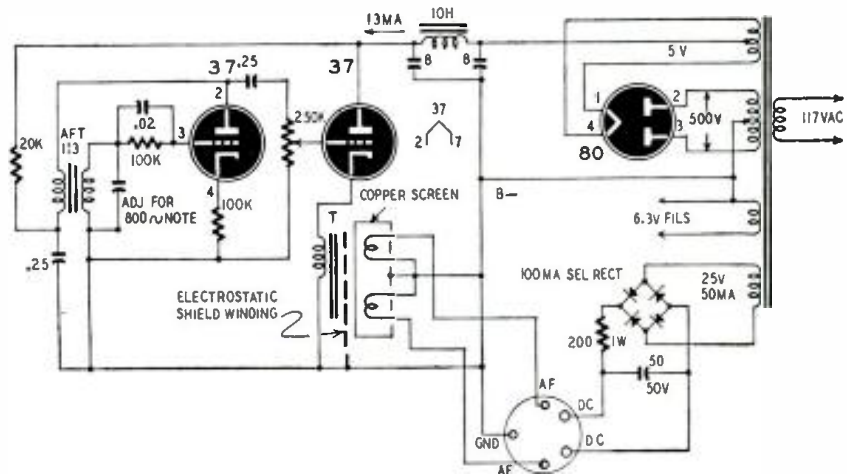
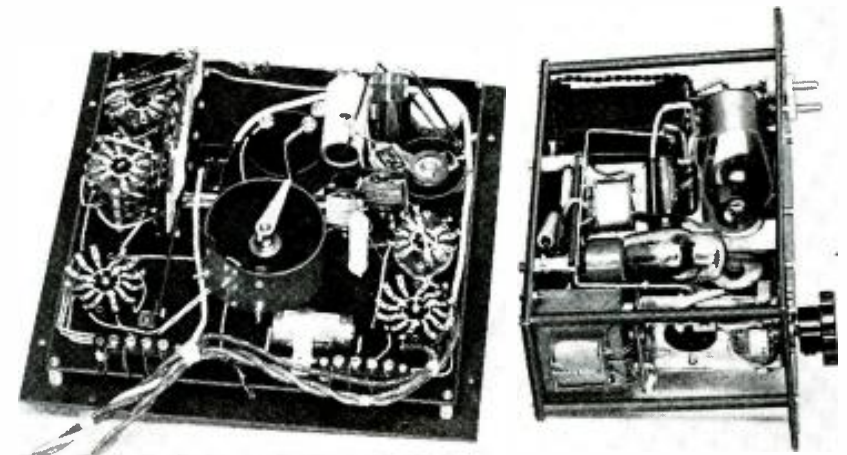

Fig. 3—The tone generator. Note how the output is balanced to avoid upsetting the bridge.



The bridge (left) and generator-power supply (right) are easily disassembled for service.

should be wired first, as far as possible, since four terminals require heavy conductors—at least No. 10 and preferably No. 8 flexible, stranded, rubber-covered wire. It was found that automobile low-tension wire, obtainable at auto-parts supply houses, was adequate.

First terminal 2 on the plug is wired to the chassis, using a short piece of heavy wire. Paint must be well cleaned from the chassis before soldering, to insure good connection. A heavy wire connects terminal 3 on the vibrator socket to this same ground point. Also, capacitors C1, C2, C3, and C4 have their outside foils connected to this ground. Later, after the power transformer is installed, three additional heavy leads from it will have to be fastened to this same chassis point.

A heavy wire is connected to terminal 6 of the power plug, to one side of the on-off switch, and from the other side of that switch to terminal 8 of the power plug. A heavy wire from the standby switch to terminal 9 of the plug and from the other side of that switch to terminal 4 of the vibrator socket completes the heavy wiring.

The No. 1 terminals of all tube sockets are next connected directly to the chassis, using short pieces of bare hookup wire soldered directly to the chassis after paint is scraped off. Be very sure that good solid connections are obtained; poor connections here will cause hum. The amplifier will be subject to considerable vibration and rough handling, so make all connections mechanically secure.

The filament r.f. choke is made of No. 14 solid, insulated, hookup wire and fastened between the rear 6X5-GT socket and the power plug. The choke is made by winding 15 turns of this wire on a piece of 1/2-inch wood dowel, after which the coil is slipped off the dowel and bound with string or heavy thread to retain its shape. It is supported by the leads.

After the amplifier has been completely wired, check all connections to be sure that there are no loose joints. A drop of colored paint should be applied to each connection after testing. It will be an aid later if inspection is necessary, for the paint will flake or peel off if the connection is loose.

If a phonograph motor is to be installed in the top of the amplifier housing, it should be mounted together with the pickup arm and cartridge assembly. The phonograph on-off switch can be installed on the top front left corner of the housing. Wires from the motor and switch should be twisted and firmly clamped in such a manner that they will not be caught in the motor mechanism. They should terminate in a plug to match a socket on the amplifier chassis. The pickup lead should be shielded and terminate in a plug, also. The plugs make it easy to remove the housing for service.

If desired, a separate a.c. outlet can be installed on the chassis to furnish 117 volts for an automatic record changer. Current drain up to about 25 watts can be obtained from this ampli-

fier when used with a 6-volt battery, which is sufficient for most changers. The driver of one of our sound cars runs his electric razor from that power source, shaving while he drives—a practice which we do not recommend!

Automatic changers, if used, should be so constructed that jars or vibration will not cause records to jam or to drop at the wrong time. Pickup cartridges must be rugged and capable of taking considerable abuse. Needle protection (an arm rest) must be provided.

Two power cables are required, one for 6-volt d.c. operation and one to be used when the amplifier is connected to 117 volts a.c. (see Fig. 3). Terminals 6 and 9 of the 6-volt connector are connected with a piece of No. 10 wire, since considerable current to the vibrator is carried through these pins. Bare wire can be used, covering it with a short piece of spaghetti tubing where exposed. Terminals 2 and 3 are connected with a piece of No. 14 wire, as are terminals 4 and 6. Leads are soldered to terminal 8 and to the junction of terminals 2 and 3. These leads should be long enough to reach the hot starter-switch terminal on the car and an accessible ground terminal on the car frame. The leads may be identified

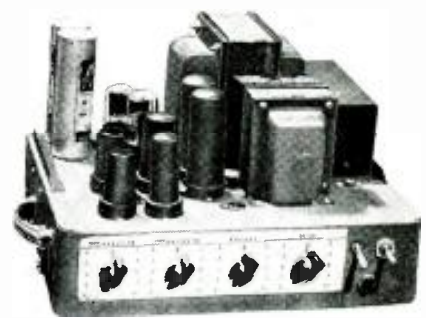

Chassis view; vibrator box at extreme right.

by different-colored insulation, paint, or Scotch-tape tags.

If a permanent installation is intended, solder lugs should be used for power connections. Terminal nuts should be clean and tight. If the amplifier is to be used only occasionally, good husky battery clips can be used. This practice is not recommended, however, as battery-clip connections are a source of annoyance and create a voltage drop due to poor contact or corrosion.

It will probably be most convenient (Continued next page, bottom)

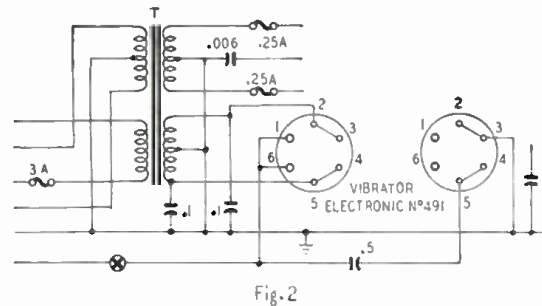

Fig. 2

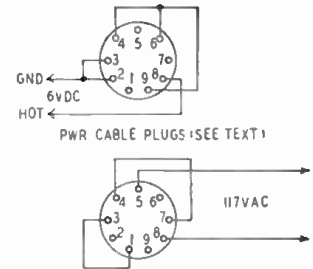
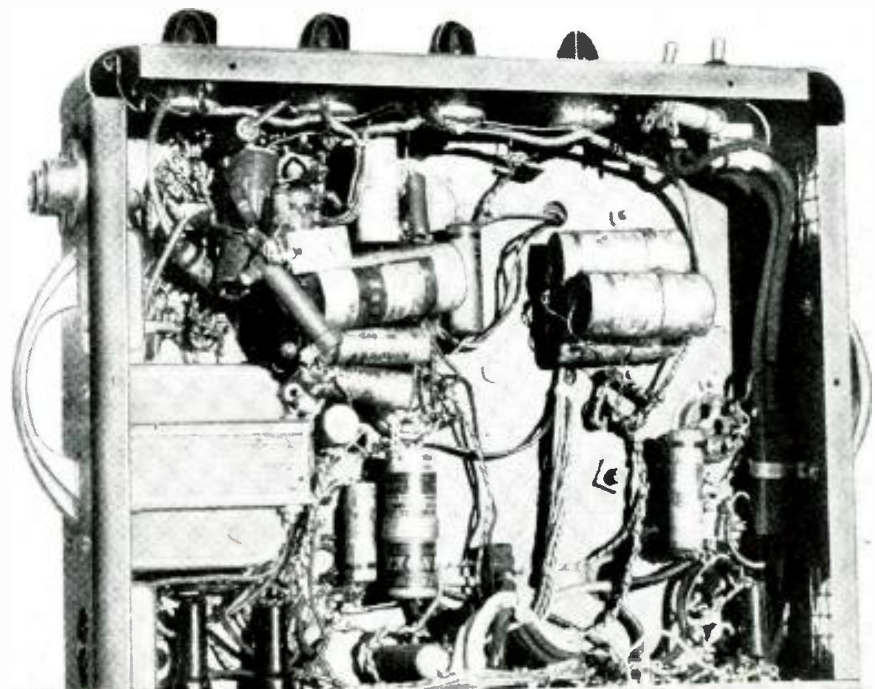

Fig. 3

Fig. 2—Changes for 2-socket vibrator.

Fig. 3—Power cables for 6 and 117 volts.



Underchassis view showing wiring. The large unit at the left is the output transformer.

Observation on TV-Sound

Love is blind, but are tele-viewers deaf?

By RICHARD H. DORF

LET a man get interested in music, then in electronics, then in both together, and you've got a combination of protoplasm that will writhe in agony at a few percent distortion coming from a loudspeaker and will walk out in a huff if three inoffensive decibels stand between him and 15,000 cycles. This, brother, is straight from the loudspeaker's mouth. You're looking at one.

The human-relations experts claim that the large incidence of divorce in this country is due to infidelity, insecurity, and hasty marriage. But, unless I miss my guess, there is also a substantial proportion caused by the wife's inability to remain sane in the face of hours of pure tone coming through the loudspeaker at high levels, generated either by a test oscillator or by a frequency test record. There's a man on the Columbia 100004-M disc who begins by saying "One . . . thousand . . . cycles . . . to set . . . level" and then goes on to announce each frequency in the same flat, pontifical tone. I don't know this man's name, but I take this opportunity of warning him to stay away from my house. My wife, who ordinarily is as peace-loving and law-abiding as most people, has promised

instant and complete decapitation.

I have had a television receiver for over a year. It brings in a nice picture on the 10-inch tube and is a good-looking piece of furniture. But it has a 6-inch speaker. It's a good 6-inch speaker; but, as Paddy observed, standing before Big Ben and comparing his 4-minute-slow watch with it, you can't expect a little wristwatch to run as fast as a big, expensive clock.

But humans are some of the most unpredictable people in the world. You might expect that I'd remove the 6-inch speaker and replace it with a coaxial. Or at least run an audio line from the TV set to my good amplifier and speaker. But no, I'm satisfied. When the studio organist hits a low G with the 64-foot stop pulled out, I never know it. The trap drum is about the lowest-pitched percussion instrument I can hear on TV—but I don't care.

And aside from the speaker, most of the films shown on TV have sound tracks you would swear had been brushed lightly with gray paint and then walked on. Frequently the film seems, moreover, to have been pulled through the projector by hand, judging by the steadiness of musical pitches. Furthermore, because the mike has to

be kept out of the picture, live piano pickups are often made too far off mike; the effect of the multiple echoes will make any old-timer reach into his change pocket for another nickel. But it doesn't bother me.

What's the answer? Does the visual effect so far overshadow the aural (when you have both) that the sound is unimportant? I'm not unique—I've talked to others who feel the same way. Are television listeners still so thankful for the "miracle" of video that they'll tolerate just any kind of sound?

There are a couple of straws that may indicate a cross current blowing in the other direction. A number of kit and set manufacturers are making much of the fact that their newer models are equipped with 10-inch and bigger speakers, for "full-fidelity range." One company is even making for small televisers a table which has a built-in speaker and baffle to improve the audio response. Does this indicate that public taste is changing? Or simply that the manufacturers hope it is?

I'd be interested to hear from anyone with ideas on this. You'll find books on psychology under 150 in your local library. I'll see you there.

VERSATILE AMPLIFIER FOR 6 OR 117 VOLTS

(Continued from previous page)

to test the completed amplifier on 117-volt power first. Connect the power cord to the plug on the rear of the chassis. Connect a microphone (any good crystal or dynamic) to microphone input No. 1. Connect a speaker *large enough to carry the load* to the terminal strip on the rear of the chassis. Turn all controls off before plugging into the outlet.

Turn the on-off switch on and let the tubes warm up for a minute. Turn the microphone gain up slightly, and talk into the microphone. If audio feedback occurs, turn the gain down until it disappears. In use, the microphone should be placed as far as possible from, and behind, the speakers to eliminate feedback. Normal operation should give good volume with the microphone gain turned up one-quarter to one-third of maximum. Next, try the other microphone input. Similar results should be obtained.

The phonograph should now be tested. Normal operation with an average popular-music recording will probably require that the phonograph gain be turned up half-way. Unused gain controls should always be turned off. The

amplifier gain controls can be used to fade or mix any input combination.

When using the amplifier on 6 volts d.c., the on-off switch should be turned on first to allow the tubes to warm up for a minute before the standby switch it turned on to start the vibrator. The standby switch can be turned off to save battery current when the amplifier is used intermittently. If only the filaments are on, the battery drain is 5.35 amperes; the total battery current with the amplifier operating at full output and the phonograph motor on is 21 amperes.

The amplifier should never be turned on with the speaker load disconnected, since a.c. voltages in the output section may rise to dangerous values.

When more than one speaker is used, the speakers must be properly phased or they will have very little volume and poor tone. On most 25-watt driver units obtainable, terminals are marked, and proper phasing can be accomplished by wiring all the No. 1 terminals together. However, if different-make drivers are used or if the terminals are not marked, it is imperative that the speaker phasing be checked. This can

easily be done by placing the speakers so that they face each other and then playing a recording at medium volume. If the low notes are missing or subdued, the speakers are correctly phased. If they are out of phase, reverse the connections to *one* of the speakers. After the speakers have been placed, it is a good plan to make speaker cables with polarized plugs or mark connections to maintain correct phasing.

MATERIALS FOR AMPLIFIER

Resistors: 1—6,200, 4—100,000, 3—270,000, 4—470,000 ohms, 1/2 watt; 3—1,200, 3—47,000 ohms, 1 watt; 2—10,000 ohms, 5 watts; 1—200, 1—5,000 ohms, 10 watts; 1—100,000, 2—500,000 ohms, potentiometers; 1—60,000 ohms, potentiometer, tapped at 12,000 ohms (Mallory TRP617).

Capacitors: 1—20 μ f, 25 volts, electrolytic; 1—50 μ f, 50 volts, electrolytic; 3—8 μ f, 450 volts, electrolytic; 1—0.002, 1—0.02, 1—0.2, 3—0.5, 6—0.1, 1—0.5, 1—1.5 μ f, 600 volts, paper; 2—8 μ f, 600 volts, electrolytic; 1—0.06 μ f, 1,600 volts, vibrator buffer.

Transformers and choke: 1—power transformer (Maldorson 5500 or Thordarson T22R24); 1—output transformer, 6,600 ohms to multitap secondary; 1—8-h, 160-ma filter choke.

Tubes: 2—6L6, 2—6N7, 2—6SF5, 2—6X5-GT.

Miscellaneous: 1—3-ampere, 2—1/4-ampere fuse assemblies; 2—s.p.s.t. toggle switches, at least one with 30-ampere contacts; 8—octal tube sockets; 1—6.3-volt pilot-lamp assembly; 1—9-prong, male, chassis-mounting plug; 2—9-Pin, female, cable-end receptacles; chassis; case; necessary connectors and hardware.

RADIO-ELECTRONICS for

Designing Push-Pull Amplifiers

Calculation methods for better fidelity

By DAVID FIDELMAN

ONE day you will decide to rebuild your audio amplifier system. (If you haven't yet, you will—everybody does, sooner or later.) When you do, the new system should be better than your old one, else there is no point in going to the trouble.

The chances are that most of the circuits obtainable were not designed for your particular requirements. You may already have a good output transformer or some tubes and circuit components which you might like to use to avoid the expense of purchasing new components. The most satisfactory results will almost always be obtained with a good circuit of your own design.

High-quality audio amplifiers should be push-pull rather than single-ended. Push-pull amplifiers have these advantages:

1. There is less distortion, due to the cancellation of all even harmonics.
 2. There is no d.c. saturation of a well-balanced output transformer since the plate currents of the two tubes cancel one another in the transformer core, and low-frequency response is better.
 3. Effects of power-supply hum are greatly reduced.
 4. The push-pull stage does not tend to cause motorboating in the amplifier.
- These advantages are so important that a push-pull arrangement using two small tubes is preferable to a single larger tube capable of developing the same total power output.

The design of the amplifier should

depend mainly upon where it will be listened to, for example, in an average living room or a large auditorium.

For normal listening levels in the home, a system capable of handling 4 or 5 watts peak power will generally sound good enough. The amplifier of the average table-model a.c. radio is capable of putting out about 4 to 5 watts, but at loud levels a considerable amount of distortion is noticeable. In this case, the distortion is often due to the improper use of a small loudspeaker

the reserve power is necessary, because transient peaks in speech and music require considerably more power. For reproduction of these peaks without distortion, 10 watts is about the best compromise design value for home listening.

The output stage

Once the power requirements of the amplifier have been decided, the tubes can be selected. The schematic circuit diagram of the typical push-pull amplifier is shown in Fig. 1. The specific circuit values—plate load impedance, cathode resistance, plate voltage, and so on—are obtained from data and the plate-current-characteristic curves given in the tube manual by a procedure similar to that followed in selecting the values for the ordinary single-ended amplifier stage.

These methods are so well described in the *RCA Receiving Tube Manual* (Technical Series RC15), presumably owned by all radio technicians, that no attempt will be made to duplicate that description here. Reference is made especially to the material appearing on pages 18, 19, and 22 of the tube manual.

However, in using the plate-current characteristics, a *composite set* of curves must be used instead of the ones given in the tube manual. These composite curves are obtained by placing the plate voltage-current curves of the individual tubes back to back with the common operating voltage superimposed, and then averaging the plate current for grid-potential curves corresponding to the same applied signal. (The signal voltages applied to the two grids are opposite; therefore, if the operating grid voltage is -20 , for example, then -15 volts for one tube is averaged with -25 for the other, and so on). The load line is then drawn, using the derived composite curves. The actual plate-to-plate load will be four times the resistance represented by the load line.

The procedure may be best understood by considering a specific example. The curves given in Fig. 2 represent the composite plate voltage-current curves for a push-pull 2A3 amplifier. The complete set of curves consists of two sets of plate-current characteristics, one representing tube 1 and the other tube 2. (Each set of curves can be

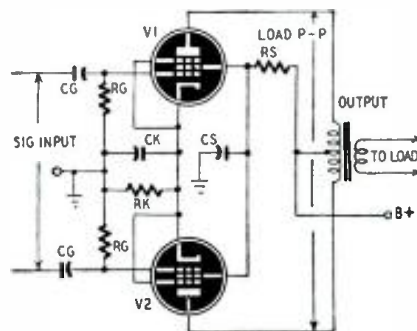
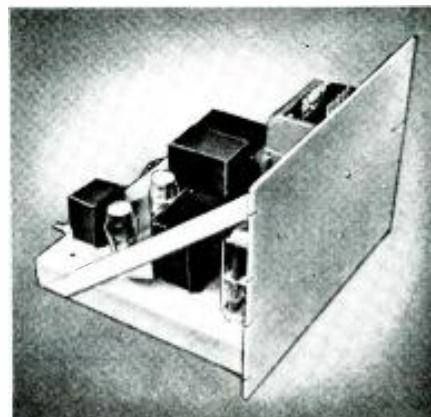
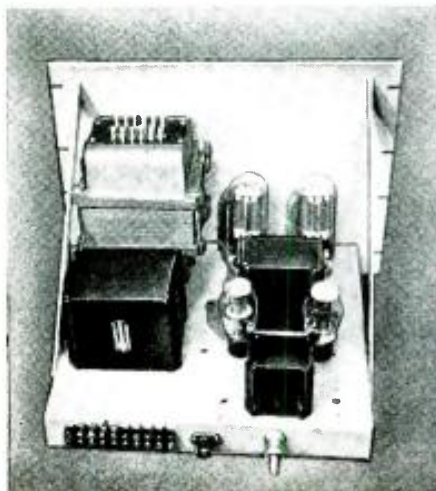

Fig. 1—Circuit of a typical push-pull stage.

which cannot handle the entire output of the amplifier. If the small speaker is disconnected and the amplifier output fed into a good 10- or 12-inch loudspeaker, the quality will be good even at fairly loud living-room levels. Actually, the *average* power into the speaker even during loud levels is considerably less than 1 watt. However,



Two views of a high-power push-pull amplifier built by the author, using the principles and design information contained in this article.

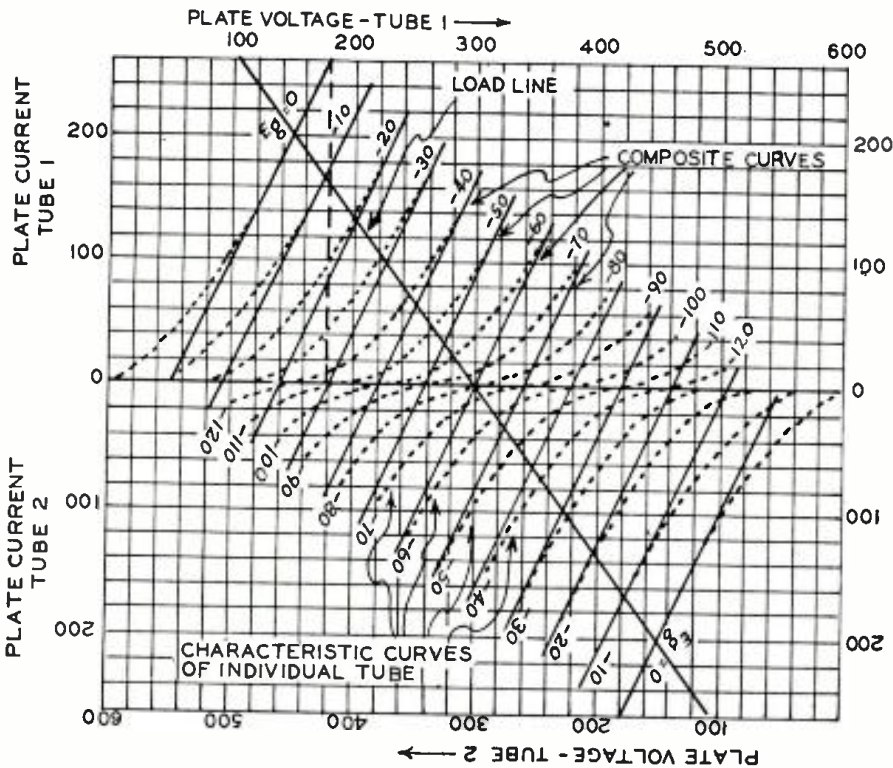

Fig. 2—Composite E_g curves and load line are drawn on superimposed handbook E_p-I_p graphs.

redrawn from the tube manual. For some tubes, these detailed curves will be found only in a professional-grade manual, such as the RCA HB-3 loose-leaf handbooks.) To derive the composite curves, first place the two copied sets back to back, with the 300-volt (recommended plate voltage) points coinciding, as shown.

The load line is then drawn in the same manner as for an ordinary set of tube characteristics, first selecting a convenient value for plate voltage and grid bias, erecting a perpendicular at 0.6 operating voltage, noting the point at which it intersects the zero-bias curve, and then checking for power output. If, as in this case, the plate dissipation is too great, plate voltage may be lowered or load resistance increased and another approximation made. Re-

tion, it would intersect the zero-plate-voltage axis at 400 milliamperes. Therefore its resistance is 750 ohms. This is multiplied by 4 to obtain total plate-to-plate load resistance; thus the load line represents a 3,000-ohm plate-to-plate load.

Therefore, desirable operating conditions for two 2A3 tubes in a push-pull amplifier are:

Plate voltage:	300
Grid bias voltage:	-60
Load resistance (plate-to-plate):	3,000 ohms

(Note that the composite curves which have been derived for this amplifier represent the signal currents through the plate load, and not the actual tube current. Each tube will still draw 40 ma of plate current for zero signal.)

The above is a general method for designing any push-pull amplifier. However, in many cases fairly standard values are available.

For convenience in designing the amplifier, the complete operating conditions and circuit values for a number of the tubes most widely used in push-pull audio output stages are given in the table. These values have been determined as just described.

If the specific requirements in a particular case are satisfied by any of the tubes listed in this table, the best results will be obtained with the values given. Values as close as possible to those recommended should be used in the actual amplifier for maximum power output with lowest distortion. For anyone interested in experimenting with tubes other than those given in the table, or with other operating volt-

ages for the tubes given, the method described of using composite curves will give the best design values.

Once the push-pull output stage has been designed, the problem arises of supplying the grids of the two tubes with voltages which are equal in voltage and 180 degrees out of phase. The simplest method of driving the grid in push-pull from a single-ended amplifier is with a center-tapped transformer. This method is not too widely used because a good transformer is expensive and may not give the fidelity which can be obtained with resistance-capacitance coupling. Two different circuits for driving the grids of a push-pull amplifier with the proper out-of-phase voltages are in general use. These are familiar phase inverters, and their schematics are given in Figs. 3 and 4.

The circuit in Fig. 3 is a cathode-follower phase-splitter. Output signal is taken from the cathode circuit as well as from the plate circuit of the tube. The grid-to-grid driving voltage which can be obtained from the phase-splitter is:

$$E_{\text{grid-to-grid}} = \frac{2\mu R_L}{RL(\mu + 2) + R_p} E_{\text{in}}$$

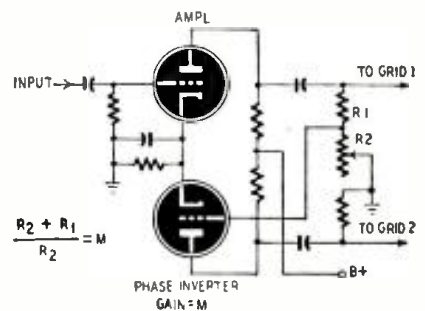

Fig. 4—Common 2-tube phase inverter.

where R_L is the value of the plate and cathode load resistance, μ is the tube amplification factor, and R_p is the plate resistance of the tube. The maximum gain of the phase-splitter stage is 2; therefore, this tube can be used for coupling the single-ended amplifier to the push-pull stage, but cannot be used for voltage amplification.

Another type is shown in Fig. 4. In this circuit, the single-ended amplifier drives one of the push-pull grids directly. An additional tube is used to amplify a small part of this voltage, with a 180-degree phase reversal, and thus to drive the second push-pull grid in the proper phase. The voltage for the phase-inverter grid is obtained by tapping down on the grid resistor of the first push-pull grid, as indicated. For satisfactory balance of the push-pull amplifier, the resistances should be chosen so that

$$\frac{R_2 + R_1}{R_2} = M$$

where M is the gain of the phase inverter stage. In using this type of phase inverter in a circuit, it is best to make resistor R_2 adjustable so that

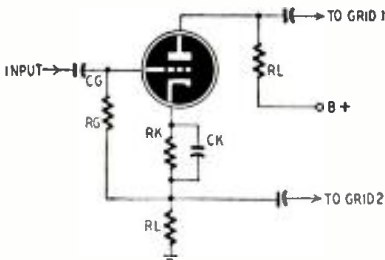

Fig. 3—Cathode and plate outputs are equal.

fer to page 22 of the tube manual for an elaboration of the process, as the constants in the above example have been made to conform with those worked out on that page. The load line which is shown in Fig. 2 crosses the zero-current axis at 300 volts, which is the quiescent (or zero-signal) operating point. If extended in either direc-

balance may be obtained between the two sides. Once the circuit is constructed and placed in operation, a rectifier or vacuum-tube-type a.c. voltmeter should be connected from each push-pull plate to ground, and R2 adjusted until both audio-frequency voltages are the same.

In addition to the preliminary adjustment, it is an excellent idea to check the balance periodically. Aging of

Earlier stages

The stages preceding the phase inverter are conventional single-ended voltage amplifiers, readily designed according to the values given in the resistance-coupled amplifier chart in the receiving-tube manual. The number of stages, the over-all gain, the input impedance, and any equalizing or tone control circuits which may be used will depend upon the individual require-

A MODULATION MONITOR

A simple, low-cost, visual modulation monitor that can be added to many existing phone transmitters was described in *RCA Ham Tips*. It consists of a 2BP1 C-R tube, eight resistors, three capacitors, and a little hardware.

All components can be mounted in a 3 x 4 x 5-inch metal utility cabinet. The socket is mounted inside the cabinet at one end so the tube can project through a hole drilled in the opposite end. A shield originally made for an 807 tube protects the sides of the C-R tube and prevents some of the stray light from striking its face. Operating potentials are taken from a transmitter with voltages up to approximately 1,000 volts. Heater voltages are tapped off a 6.3-volt supply in the speech amplifier, exciter, or elsewhere in the rig. If the filament supply is ungrounded, peak heater-cathode voltage should not exceed 125.

Voltage for the second anode is tapped from a 1,000-volt point on the high-voltage power supply for the final amplifier. A modulation voltage tapped off the hot side of the secondary of the modulation transformer is applied to the horizontal deflection plates. Modulated r.f. voltage, picked up with a special loop, constructed as shown in the drawing, is applied to the vertical plates. Trapezoidal patterns will appear on the screen when the transmitter is modulated. The modulation envelope can be viewed if the lead is removed from the plate end of the modulation transformer secondary and clipped to the plate of one of the transmitter's rectifier tubes.

When the monitor is used on transmitters with voltages higher than 1,000 on the modulated amplifier, bleeder resistors consisting of several 1-megohm, 1-watt resistors in series should be used so the voltage applied to the monitor does not exceed 1,000.

No centering controls are provided. The small metal cabinet may become magnetized while it is being drilled. This residual magnetism will probably deflect the spot from the center of the screen. To compensate for this, take a small horseshoe magnet or an old PM speaker and move it around the outside of the cabinet until the spot is deflected further in the same direction as the original error. When the magnet is removed, the spot will return closer to center. Continue till spot is centered.

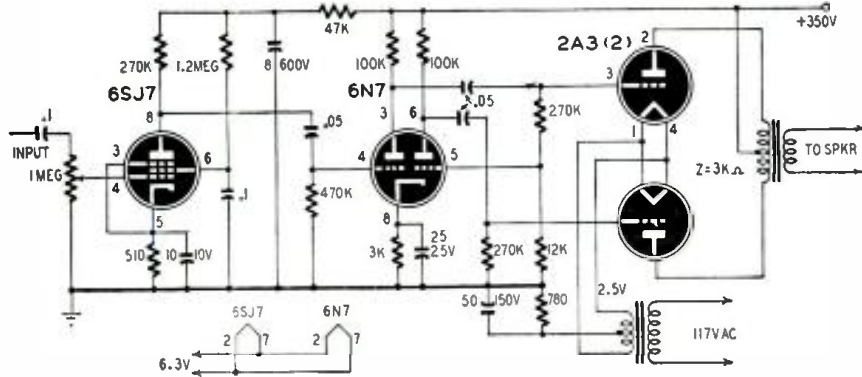

Fig. 5—This simple push-pull amplifier circuit shows how the design information is used.

tubes and components will almost always make readjustment necessary after a time. If the adjustment is not made, distortion may develop.

A number of variations on these phase inverters have been made at one time or another. Several are shown in John W. Straede's article on page 34 of the July, 1948, issue of this magazine. One of the most popular is the floating paraphase, in which the grid of the second inverter tube is connected to the junction of the two final

aments, and should be selected in the usual manner to satisfy the conditions under which it is desired to operate the amplifier.

The circuit of a simple push-pull amplifier which has been constructed according to the information given in this article is shown in the schematic in Fig. 5. It consists of a single voltage amplifier stage, a phase inverter, and the push-pull output stage which drives the loudspeaker. The frequency response and sound quality of this am-

AMPLIFIER DESIGN TABLE

Tube Type	Power Output (Watts)	High Voltages		Grid Bias		Peak Grid-to-Grid Driving Voltage	Load Plate-to-Plate (Ohms)	Typical Commercial Output Transformers
		Plate	Screen	Fixed Bias	Self-Bias (Cathode Resistor)			
2A3 Also: 6A3 6H4-G 6A5-G	10 15	300	—	—	780Ω	156	5000 3000	UTC: LS-57, LS-55, PA-16 Kenyon: T-301 Thord: T-67851 (5000Ω) T-58872 (3000Ω)
6F6	11	315	285	—	320Ω	58	10,000	UTC: LS-63, PA-19 Kenyon: T-303 Thord: T-75875
6V6	14	285	285	—	-19v	38	8000	UTC: LS-52, LS-54 Thord: T-15890; T-17811
6L6 807	18	360	270	-22.5v	—	45	3800	UTC: LS-61A, PA-41.6 (3800Ω) LS-61B; PA-21.6 (6600Ω) Kenyon: T-317; T-319 Thordarson: T-17813 (6600Ω)
	26.5	360	270	-22.5v	—	45	6600	
845	100	1200	—	-185v	—	Drive from trans.-coupled push-pull 2A3's	8800	UTC: LS-845

grid resistors. This point is grounded through a resistor. Any inequality of voltage across the two final grid resistors causes a voltage to appear across the grounded resistor and therefore on the inverter-tube grid.

The phase-inverter stage should be chosen according to the driving voltage required at the grids of the push-pull stage. Normally a general-purpose triode, used either as a cathode-follower or as a phase inverter, will furnish sufficient output voltage to drive any of the various receiving tubes listed in the table above in a push-pull power output stage.

plifier are excellent, and it has sufficient gain to operate a loudspeaker from an r.f. tuner or a crystal phonograph pickup. (No tone controls are included since they are not the subject of this article, but they may be included in the conventional manner if desired.) The circuit is included to illustrate the ease with which the design principles discussed may be applied to the practical construction of a high-fidelity audio amplifier. By proper application of these methods, good, high-fidelity, push-pull amplifiers may be designed with ease to satisfy almost any audio requirements.

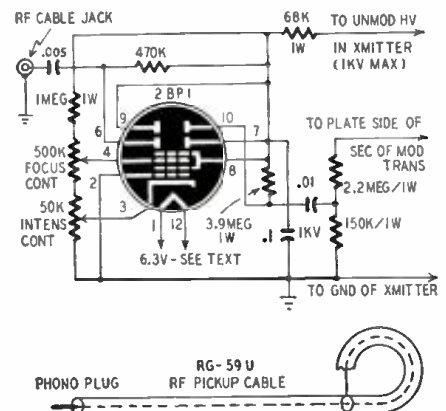

PA AMPLIFIER

Elmhurst Sound Equipment Co.,
Elmhurst, N. Y.

Model A-103 has a maximum normal output of 10 watts, with a 14-watt peak limit. Frequency response is within 2 db from 50 to 15,000 cycles. Inputs are provided for one microphone and one phanograph pickup (low-output pickups may be used), and a single control adjusts tone. Five tubes are used, with push-pull 6V6's in the output stage. Hum level is -65db.



MULTIMETER

Radio City Products Co., Inc.,
New York, N. Y.

Model 447A multimeter is a new version of the Model 447. It is lighter in weight because of a magnesium panel and the inclusion of only one battery. Ranges include d.c. volts to 2,500, a.c. volts to 1,000, d.c. milliamperes to 1,000, d.c. amperes to 10, and resistance to 1 megohm. The case is made of wood.

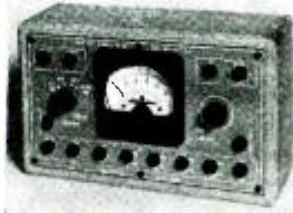

TUBE ANALYZER

General Electric Co.,
Syracuse, N. Y.

The new type YTW-3 is a tube analyzer designed specifically for industrial use. It tests thyratron and phanatron tubes, widely used in industrial welding and control operations. The unit measures the peak arc drop voltage of each tube under either maximum load or under a specified other load. Readings are taken directly from a large dial which controls a slide-back v.t.v.m. Weight of the analyzer is about 55 pounds.

QUICK-DISCONNECT PLUGS

Cannon Electric Development Co.,
Los Angeles, Calif.

The new series RTC connectors meet the need for quick disconnect on radio chassis wall or rack mounting assemblies. One connector is attached to the chassis, its mate to the mounting. Adv-



vantages include low separation force, simple mounting, moisture-drain holes, and provision for lacing wires to plug after soldering. Two kinds of terminals are offered, crimp-on and soldered. Five sizes and several styles are available, including 12- to 36-contact units for No. 18 and No. 20 wire. Spacing between contacts is sufficient for 2,500 volts, and contacts will carry 5 amperes.

REPLACEABLE NEEDLES

Astatic Corp.,
Conneaut, Ohio

The LQD cartridge uses two separate needles, one for microgrooves and one

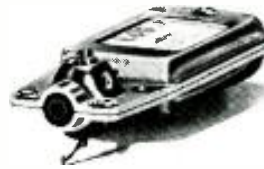

for standard recordings. Each needle may be removed for replacement with the tip of a knife, without removing the cartridge from the pickup arm. The needles are the Q and Q-33 units. The cartridge has a range of 50 to 7,000 cycles, with output voltages of 1.2 and 0.75 for standard and microgroove discs, respectively.

MICROPHONE STAND

Electro-Voice, Inc.,
Buchanan, Mich.

The Century crystal microphone is now available with a desk stand, as Model 916. The stand has a 6-inch riser on a 4 1/2-inch-diameter base. The stand has the standard 3/8-27 thread. Microphone and stand are detachable.



BATTERY TESTER

Triplet Electrical Instrument Co.,
Bluffton, Ohio

The new pocket-size Model 698 battery tester will indicate the condition of any dry battery from 1.5 to 90 volts under load. A LOW-7-GOOD scale is provided; the meter is calibrated in volts as well.



PLASTIC FLASH LAMP

Amglo Corp.,
Chicago, Ill.

The 88P9M is an electronic photoflash lamp with a tough plastic envelope. Containing an auxiliary gas reservoir and an extra-large cathode, the lamp is built for heavy duty. Peak light output is about 45,000,000 lumens of the recommended voltage of 2,000-2,500. Maximum energy is 300 watt-seconds with a high-voltage pulse as the discharge method. The lamp is 1 1/2 inches in diameter and 3 inches long, less pins. A five-pin base is used.



**For The Best in Tape Recorders
Look For The TWIN-TRAX® Label**



TWIN-TRAX
4-HOUR PLAY



TWIN-TRAX STANDARD



TWIN-TRAX
PORTABLE

This label identifies the original and only TWIN-TRAX Recorder, manufactured exclusively by Amplifier Corp. of America. It is your assurance that the recorder bearing this label has the professional specifications that have made TWIN-TRAX the "choice of engineers everywhere."

TWIN-TRAX was the first commercially available two-channel tape recorder. Imitators have announced two-channel recorders with similar names and similar external appearances. But it's the performance that counts, not the appearance. And the performance of TWIN-TRAX recorders cannot be duplicated. Our leadership in the tape recording field has been undisputed since we designed the first magnetic recording amplifier in 1936.

Remember, imitative Twin-Track or Two-Track does not mean TWIN-TRAX, because TWIN-TRAX is the registered trade mark of the best in tape recorders, made exclusively by Amplifier Corp. of America. Send today for literature on the exclusive TWIN-TRAX line, and discover why TWIN-TRAX is the recorder engineers are buying.

*Registered Trade Mark.

AMPLIFIER CORP. OF AMERICA

398-10 Broadway

New York 13, N. Y.

ANTENNA BRACKET

General Cement Mfg. Corp.,
Rockford, Ill.

No. 8000 hinged mast bracket can be tilted to any angle, so that a TV or FM mast may be mounted on a slanting roof or any other sloping surface. It is also useful for vertical installations; the mast can be tightened to the bracket while in a convenient horizontal position, then swung up. The bracket will hold masts up to 1 3/8 inches in diameter.

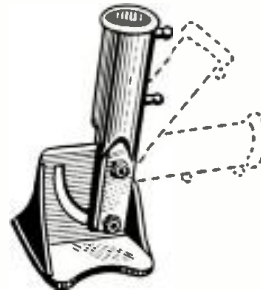

TELEVISION CAPACITORS

Sprague Products Co.,
North Adams, Mass.

A new series of high-voltage paper capacitors, oil-impregnated and encased in molded phenolic housings:



Includes units rated at 6,000 and 10,000 working volts d.c. Known as type TVM Telecaps, they are intended primarily for TV receivers and cathode-ray equipment where temperatures as high as 185° F are encountered.

TELEVISION BOOSTER

Perfect Products Co.,
Queens Village, N. Y.

This is a high-gain, low-noise unit, usable on all 12 TV channels. Bandwidth is 5 to 6 mc over the range.



INSTRUCTIONAL KIT

Eagle Electronics, Inc.,
New York, N. Y.

The Pic-O-Graph Quadrucational Kit Q-5, designed to help radio and electronics instructors, illustrates four devices. In a single constructional project it combines an amplifier, a code-practice oscillator, a receiver, and a miniature transmitter. Complete step-by-step building instructions and pictures are furnished.



ALL THE NEWEST RELEASES

BIG MONEY-SAVING VALUES

They're in your latest ALLIED CATALOG!



FREE

Send for

Radio's Leading Buying Guide

Get the Radio Buying Guide that's used by thousands of expert servicemen, engineers, amateurs, soundmen, builders and experimenters. Get every buying advantage at ALLIED: widest selection of equipment at money-saving low prices—speedy, expert shipment—personal attention—complete satisfaction on every order. Get your latest ALLIED Catalog today—use handy coupon below!

TOP VALUES IN QUALITY TV ANTENNAS



Knight Indoor TV Antenna

High efficiency indoor type—with length and direction easily adjustable for maximum TV reception. Covers all TV channels efficiently. Compact; fits on receiver cabinet or table, or mounts to wall. Ideal for use where roof antennas can't be installed. Shpg. wt. 2 lbs. 97-354. Only **\$325**

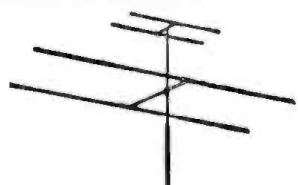

Knight TV All-Band Antenna

An excellent, low cost all-channel TV antenna. Has separate dipole and reflector for the high and low bands. Two-section 6 ft. mast of sturdy aluminum tubing, with dipoles and reflectors of aluminum also. Complete, less only lead-in line. Shpg. wt., 8 lbs. 97-355. Only **\$795**

NEW LOW-COST HIGH-QUALITY RECORDERS

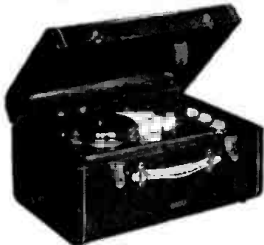

Knight Wire Recorder

Makes and plays high-quality wire recordings; plays any 10" or 12" 78 rpm disc recording; serves also as PA system or as wireless phono oscillator. Easy to operate. Ruggedly constructed. Complete in compact simulated leather case; with crystal hand mike, playback pickup, all tubes, and 2 half-hour spools of wire. For 105-125 v., 60 cy. AC. Shpg. wt., 29 lbs. 96-172. Only **\$9950**



Knight Tape Recorder

A top-grade tape recorder and playback unit at amazing low cost. May also be used as 6 watt PA system. Excellent frequency response. Easy to record; stable constant-speed mechanism. Exceptional playback quality. In sturdy portable case; with crystal hand mike, 600 ft. reel of tape, take-up reel, and all tubes. For 105-125 v., 60 cy. AC. Shpg. wt., 36 lbs. 96-187. Only **\$12750**

NEW! 45 RPM Record Playing Equipment



Knight 45 RPM Automatic Phono

First at ALLIED! Automatically plays ten of the new 7" 45 rpm records at one loading. Just push a button for 50 minutes of fine reproduction. Exceptionally reliable changer mechanism works with amazing speed. High-quality amplifier and built-in speaker deliver plenty of power and excellent fidelity. With tone control. In attractive portable case. With all tubes and precious-point needle. For 105-125 v., 60 cy. AC. Shpg. wt., 16 lbs. 96-284. Only **\$3995**



Knight 45 RPM Player

Plays the sensational new RCA 45 rpm records! Can be connected easily to any amplifier and speaker, or to any radio with phono connection. With special crystal pickup and precious-point .001" needle; dependable 45 rpm phono motor. In attractive, extremely compact cabinet, finished in furniture brown. Includes on-off switch and pickup arm rest. For 110-120 v., 60 cy. AC. Shpg. wt., 5 lbs. A real buy at our low price! 96-257. Only **\$1225**

BIG PRICE REDUCTION ON FAMOUS HALLICRAFTERS S-38



A new low price for this all-star, all-wave value! Covers 4 full bands continuous from 540 kc. to 32 mc. Full electrical handspeed; noise limiter; band selector; BFO pitch; voice-code switch; speaker-headphones switch; standby-receive switch; latest PM speaker. In handsome 12 x 7 x 8" furniture-steel cabinet. Complete with tubes. For 105-125 v. AC or DC. Shpg. wt., 15 lbs. 97-565. Only **\$3995**

Better Than Ever—Knight 20 Watt Hi-Fi Phono Amplifier



New styling—new features! The big high-fidelity value. Response ± 1 db, 20-20,000 cps. Less than 2% harmonic distortion at full 20 watts; hum way down—80 db below 20 watts; dual phono input with 78 db gain; matches anything—output impedances, 4, 8, 16, 250 and 500 ohms. There's nothing finer anywhere near this low price. In handsome new two-tone steel case. Complete with tubes. For 110-125 v., 60 cy. AC. Shpg. wt., 30 lbs. 93-320. Only **\$5995**

ALL PRICES NET F. O. B. CHICAGO

Everything in Radio and Electronics



ALLIED RADIO CORP., Dept. 2-F-9
833 W. Jackson Blvd., Chicago 7, Illinois

Send FREE ALLIED Catalog
 Enter order for.....
Enclosed \$..... Full Pay. Part Pay. (Bal. C.O.D.)

Name.....

Address.....

City..... Zone..... State.....

FREE CATALOG



THIS year's televising of the Oxford and Cambridge boat race by the BBC marked a new high level in TV achievement. The immense technical difficulties were surmounted with complete success. The race, which is one of Britain's biggest sporting events, takes place over a 4½-mile course on the River Thames in London. This part of the river makes some big bends, besides being spanned by several bridges. The banks (lined by scores of thousands of spectators) are high; and along most of the route there are buildings from 40 to 100 feet in height. The BBC is always allowed to have a small motor launch following close behind the contending boats. Bear those facts in mind and then think of what had to be done to give viewers a complete and continuous picture of this world-famous race from start to finish.

First, a means had to be found of housing two television cameras and a microphone, a radio-link transmitter, a power-supply unit, and the cameramen and commentator in one small launch. Next, the problem of cutting down the effects of vibration from the engine of the launch and from the movements of

the hull itself in rough water had to be dealt with. In the third place, there was the headache of suppressing interference from the ignition systems of the launch and the power-supply generator. Next, what was to be done about the inevitable blackouts when the launch passed under bridges? Lastly, how could interruption of the program be prevented if the launch carrying the TV gear were "blinded" for a time by another which inadvertently came between it and the racing boats, cutting off the camera's view?

The most difficult problem was to counter the effects of vibration, for with a telephoto lens in the TV camera this is very greatly magnified in the received picture. The solution was to suspend the cameras in such a way that they were isolated from vibration effects—and that needed a bit of working out! Power was supplied by a small gasoline-driven generator of high efficiency, and the ignition systems of both this and the engine of the launch were fitted with the latest in interference suppressors. To make sure that there should be no cuts in the transmission due to the effects of bridges, of high buildings, or of interruptions in the field of view of the water-borne cameras, a whole range of cameras, each yoked to a radio-link transmitter, was installed along the banks of the river.

Every one of the fixed cameras on

the banks was constantly in operation, so long as the boats were within its field of view. The producer had before him at any moment pictures of the outputs of water-borne and land cameras, and he could fade quickly from one to the other as required. The results were superb. We saw the whole race from start to finish. As was fitting to mark this epoch-making transmission, the race was the closest and the most exciting in living memory. The crews were neck and neck over the whole 4½ miles and were dead level 100 yards from the finishing line. Then the screen showed us Cambridge creeping up by inches with each of their last tremendous 10 strokes and winning by a matter of a few feet. As I'm an old Cambridge man and did a bit of rowing in my time, you'll gather that I blessed TV for such a wonderful show and for such a thrill. Of one thing I'm sure: no one who witnessed the race from the banks had anything like the view or the thrills that TV gave. They saw the boats for just a few moments, while we could follow every stroke during the whole 18 minutes of the race from the start of the event to the exciting end at the finishing line.

An ingenious antenna

An interesting Scophony-Baird televiewer appeared here a short time ago. I should perhaps mention that the Scophony and Baird companies have

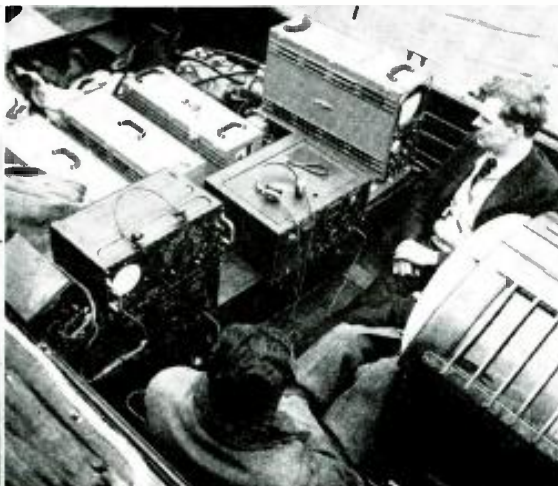

Photographs courtesy British Broadcasting Corporation



The television-transmitting launch *Consuta*. Camera control equipment on the launch. Marconi camera on its vibration-free mount.

RADIO-ELECTRONICS for

now amalgamated, for this set does not use the Scophony principle described by Dr. A. H. Rosenthal in the March issue of RADIO-ELECTRONICS. Actually a lightweight a.c.-d.c. receiver of the familiar C-R-tube type, its outstanding features are its low price and the fact that it incorporates a power-line antenna, which gives excellent results at short range, where the field strength is high. The principle is shown in the drawing. The route from the plug and the line cord to the set is by way of two chokes L1 and L2. Between these two chokes and the actual input to the first tube there is a section of line cord exactly half a wavelength long. The input section consists of the grid coil L3 tuned by the capacitor C1, and a second coil L4 coupled to L3. The chokes L1 and L2 serve to isolate the half-

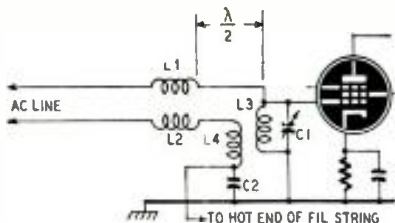

Input of TV receiver connects to power line.

wavelength portion of the lead from the remainder, and it thus forms an antenna for short-range reception. The other connections of L3 and L4 are in accordance with ordinary a.c.-d.c. practice. The lower end of L3 is connected to chassis; the lower end of L4 to the hot end of the heater chain. C2 acts as an r.f. bypass to chassis. For reception at longer distances the set uses an ordinary antenna.

A novel solder

Of the many remarkable things that I saw at the Radio Components Exhibition, few impressed me more than a new type of cored solder designed to be used with some of the more "difficult" metals. Every practical workshop man and technician knows that resin-cored solder is admirable for such jobs as connecting copper wires to tinned tags. But it falls down badly (in fact, it's quite useless) when it comes to dealing with iron, steel, zinc, nickel, and many other metals, which is a pity, because cored solder is so much handier than ordinary solder plus a separate flux of some kind.

The Multicore people have just brought out a new cored solder which tackles almost anything but aluminum. I know it does, because I brought some home and have since tried it on all sorts of things. One test I made was on a piece of blued clockspring, which was not previously cleaned in any way. Another was on a piece of stainless steel. On both an ordinary electric soldering iron made Multicore Arax solder run like butter on hot toast!

The flux incorporated in the core is not claimed to be noncorrosive; but it is perfectly safe so long as any surplus is washed off immediately with just plain water.

New capacitors

I was very much interested at the Components Exhibition in some of the entirely new ways of making fixed capacitors that were shown. Miniaturization is the order of the day in both radio and TV, and it is important to be able to obtain high values of capacitance with small bulk. Take paper capacitors first. Those between .003 and .01 μ f used to be large. With the new manufacturing process devised by the firm of Hunt, they are made from only one strip of metallized paper. The result is a .01- μ f capacitor with a diameter of $\frac{3}{16}$ inch and a length of $\frac{7}{16}$ inch—a good deal smaller than the discarded stub of a cigarette and not very much heavier.

Another new process permits making electrolytic capacitors in much more compact form. This is the fabricated-anode method developed by the British Electrolytic Condenser Co. Here the anode is formed by depositing pure aluminum on a gauze base. Since the surface of the anode is thus greatly increased, capacitors made in this way have up to 12 times the capacitance of electrolytics of the same size made by ordinary methods.

Russian TV

The Russians seem to be going ahead with television in a big way, though how they can ever hope to cover that gigantic and, on the whole, rather sparsely populated country with a TV network is rather hard to see. For all that, they are mass-producing a televiser model known as the Moskvitch. So far as one can discover, two TV transmitters are operating, one at Leningrad and another at Moscow. Two others are being constructed at Sverdlovsk and Kiev. The system in use is 441-line, with 25 frames interlaced. Development of a system of very much higher definition is said to be going forward. The Moskvitch televiser seems to be a neat and compact little set, with a minimum number of tubes and only two tuning controls, a notable simplification. Further details are not available.

LEGISLATORS USE PA



Dr. Armando Codina Subirats, Vice-President of the Cuban Senate, wears lapel microphone connected to a PA amplifier. A special speaker in center of Senate chamber makes voices clearly audible to all the senators.

MARK of QUALITY
for
MAXIMUM PERFORMANCE

Jim Lansing Signature Speakers will provide an almost unbelievable realism. The experience gained through a quarter of a century of leadership in the sound reproduction field has gone into their development and design. For maximum dynamic range and frequency response compare Jim Lansing Signature Speakers before you buy.



MODEL D-130



MODEL D-1002
TWO WAY SYSTEM

Designed especially for music systems and public address use. Has exceptionally high efficiency. Recommended for operation and frequencies from 60 to 6500 C.P.S. with a maximum usable range of 40 to 15000 C.P.S.

Designed especially for FM Monitoring and high quality home sound reproduction. Housed in a beautiful console type cabinet.

Write for Descriptive Catalog containing complete specifications.

SEE YOUR JOBBER OR SEND DIRECT



JAMES B. LANSING
SOUND INC.
7801 HAYVENHURST AVENUE
VAN NUYS, CALIFORNIA

AT LAST! A LOW COST POWER UNIT for Service Work



"A" Eliminator Kit #KC I-10
Including pictorial and schematic diagrams **ONLY \$1950**

These kits fulfill the long-standing need of every serviceman and technician. They are designed to operate from a 115 V.A.C. 50 60 cycle source, and deliver 6 V.D.C. well-filtered from three to eight amperes, with a peak rating of ten amperes. The A.C. ripple percentage is held to remarkably low values.

This unit charges a standard auto battery in one day!!

- Do away with bulky batteries!
- Do away with corroding tubes!
- Simplify your service operation!

Order this fine kit for your bench today!!

No O.D.'s, please. Orders received without sufficient allowance for postage will be shipped via Railway Express collect.

Shipping wt., 12 lbs.

OPAD-GREEN COMPANY

71 Warren St. New York 7, N. Y.

Phone: BEekman 3-7385-6

MAKES AUTO RADIO REPAIR TWICE AS EASY!

Here—prepared by an auto radio expert of 20 years standing—is everything you need to know to install, service and repair all types of auto radios faster—easier—more profitably. Covering every type of auto radio from the mid-1930's, this compact book gives you complete installation, troubleshooting and repair procedures plus tips on how to set up shop and get business.



SERVICING THE MODERN CAR RADIO

by A. L. Hurlbut

2nd Edition, 702 pages, 8 1/2 x 11, 222 illus. and over 500 car radio diagrams.

You'll really know how to repair auto radios profitably after reading this great book! From basic theory through step-by-step servicing methods, every detail of the work is explained in a way you can easily understand. Differences between car and ordinary radios, antennas, antenna input circuits, power supply, circuit features, automotive electrical systems, installations, loudspeakers, interference, vibrator maintenance, alignment, push-button tuning and other related subjects are covered completely.

OVER 500 CIRCUIT DIAGRAMS

Of particular importance, **SERVICING THE MODERN CAR RADIO** contains over 500 circuit diagrams giving circuit details of specific car radio types you are most likely to be called upon to repair. This feature alone can save you many times the cost of the book. Use coupon today for free examination.

10 DAYS' TRIAL

Dept. RE-69, MURRAY HILL BOOKS, INC., 232 Madison Ave., New York 16, N. Y.

Send me Hurlbut's **SERVICING THE MODERN CAR RADIO** for 10 days' examination on approval. In 10 days, I will send \$7.50 (outside U. S., \$8.00), plus a few cents postage or return book postpaid. (Postage paid on cash orders; same return privilege. Book sent on approval in U.S. only.)

Name.....
Address.....
City, Zone, State.....
Occupation.....

Question Box inquiries are answered by mail. Those of general interest are printed on this page. A fee of \$1.00 is charged for questions requiring no research or schematics. Write for estimates on questions requiring research or schematics. Be sure to give full specifications and details. Due to nominal fees charged for this work, it must be handled as a part-time proposition. Therefore rapid service is impossible. Six to eight weeks is required to draw up answers involving large drawings or research.

MARINE-BAND TUNER

Q Please prepare a circuit of a tuner for the marine band (2450 to 2750 kc). I do not want a superheterodyne circuit. Will a regenerative detector with two stages of r.f. amplification prove satisfactory?—E.H., Philadelphia, Pa.

A. A regenerative detector with two r.f. stages should work nicely. The r.f. stages prevent the oscillator from radiating, eliminate dead spots in the antenna, and increase the selectivity.

Standard two-winding plug-in coils can be used in the grid circuits of the r.f. stages and three-winding coils in the detector circuit. The 6SF5 can be coupled to a power amplifier, or a pair of high-impedance phones can be connected between the output terminals and ground.

The 140- μ f bandset capacitors may be small padders mounted in the top of the coil forms. The 35- μ f capacitors are ganged and should be coupled to a good vernier dial mechanism.

The coils are to be wound on 1 1/4-inch

The heaters may be supplied from a 6-volt storage battery or a number of No. 6 dry cells in series-parallel. The B-supply can be reduced to around 135 volts for battery operation. Disconnect the bottom end of L1 from ground if a doublet antenna is used.

LOW-POWERED MODULATOR

Q I have a small transmitter that operates with a power input of slightly less than 1 watt. Please draw a circuit

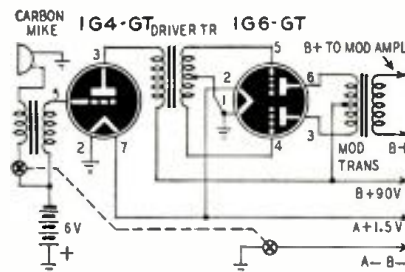

of a suitable modulator using 1 1/2-volt tubes and a 90-volt B-battery.—F.M.S., Mars Hill, Me.

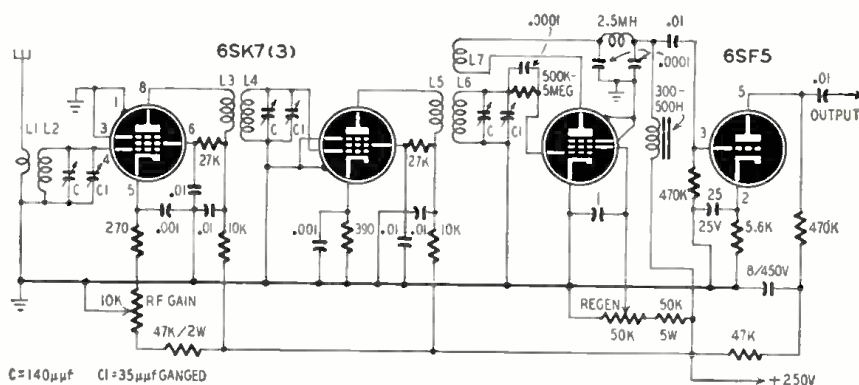

forms. L2, L4, and L6 consist of 37 turns of No. 24 enamel. L1, L3, and L5 consist of 20 turns of No. 32 d.s.c. interwound with L2, L4, and L6, respectively. L7 is a 12-turn winding of No. 32 d.s.c. spaced 1/4 inch from the ground end of L6.

Experiment with the value of the grid leak and the spacing between L6 and L7 to get the smoothest regeneration control over the tuning range. It may be necessary to shield the individual coils and use a shield between the sections of the bandspread capacitors.

This set can be operated from batteries for emergency or portable work.

A. This class-B modulator delivers about 675 milliwatts with a 90-volt plate supply. A zero-bias twin-triode was selected to avoid using fixed bias on the output stage. The speech amplifier uses fixed bias obtained from the microphone battery. A universal modulation transformer should be used so the modulator and power amplifier can be matched under varying load conditions. The driver transformer should match the plate of a 30, 1H4, or 1G4 to push-pull class B grids. The ratio of primary to one-half secondary should be about 2.4 to 1.

MONEY BACK GUARANTEE — We believe units offered for sale by mail order should be sold only on a "Money-Back-If-Not-Satisfied" basis. We carefully check the design, calibration and value of all items advertised by us and unhesitatingly offer all merchandise subject to a return for credit or refund. You, the customer, are the sole judge as to value of the item or items you have purchased.

THE NEW MODEL 247

TUBE TESTER



Check octals, octals, bantam jr. peanuts, television miniatures, magic eye, hearing aids, thyratrons, the new type H.F. miniatures, etc.

- Features:**
- A newly designed element selector switch reduces the possibility of obsolescence to an absolute minimum.
 - When checking Diode, Triode and Pentode sections of multi-purpose tubes, sections can be tested individually. A special isolating circuit allows each section to be tested as if it were in a separate envelope.
 - The Model 247 provides a super-sensitive method of checking for shorts and leakages up to 5 Megohms between any and all of the terminals.
 - One of the most important improvements, we believe, is the fact that the 4-position fast-action snap switches are all numbered in exact accordance with the standard R.M.A. numbering system. If the element terminating in pin No. 7 of a tube is under test, button No. 7 is used for that test.

Model 247 comes complete with new speed-read chart. Comes housed in handsome hand-rubbed oak cabinet sloped for bench use. A slip-on portable hinged cover is indicated for outside use. Size: 10 3/4" x 8 3/4" x 5 3/4". **ONLY \$29.90 NET**

THE NEW MODEL 670

SUPER METER



SUPER METER. A Combination VOLT - OHM - MILLIAMMETER plus CAPACITY REACTANCE, INDUCTANCE and DECIBEL MEASUREMENTS.

D.C. VOLTS: 0 to 7.5/15/75/150/750/1500/7500. **A.C. VOLTS:** 0 to 15/30/150/300/1500/3000 Volts. **OUT PUT VOLTS:** 0 to 15/30/150/300/1500/3000. **D.C. CURRENT:** 0 to 1.5/15/150 ma.; 0 to 1.5 Amps. **RESISTANCE:** 0 to 500/100,000 ohms. 0 to 10 Megohms. **CAPACITY:** .001 to .2 Mfd., .1 to 4 Mfd. (Quality test for electrolytics.) **REACTANCE:** 700 to 27,000 Ohms; 13,000 Ohms to 3 Megohms. **INDUCTANCE:** 1.75 to 70 Henries; 35 to 8,000 Henries. **DECIBELS:** -10 to +18, +10 to +35, +30 to +58.

The model 670 comes housed in a rugged, crackle-finished steel cabinet complete with test leads and operating instructions. Size 5 1/2" x 7 1/2" x 3". **\$28.40 NET**

The Model S-35 — a POWERFUL

REFLEX PROJECTOR

COMPLETE WITH WESTERN ELECTRIC BUILT-IN DRIVER UNIT

CONSERVATIVELY RATED AT 35 WATTS — WILL EASILY HANDLE UP TO 55 WATTS WITHOUT BLASTING

Heavy gauge aluminum in the main trumpet section completely eliminates blasting and blating. New plastic diaphragm overcomes the resonant peaks of the old type; also it is absolutely impervious to atmospheric changes, whereas the old type was subject to atmospheric corrosion. Complete unit unconditionally guaranteed for one year.



Specifications
POWER (CONSERVATIVE) — 35 WATTS; AIR COLUMN—3 1/2 FT.; DISPERSION—80°; POWER (PEAK)—55 WATTS; BELL DIAMETER—15"; IMPEDANCE—8 ohms; FREQUENCY RANGE—130 to 5000 C.P.S. PROJECTION — 1/2 mile; FINISH — Attractive two tone crystalline.
 The Model S-35 Comes Complete with Built-in Driver Unit. **ONLY \$28.50 NET**

SEE and HEAR the Signal with the new CA-12

SIGNAL TRACER

FEATURES:

- Comparative intensity of the signal is read directly on the meter—Quality of the signal is heard in the speaker.
- Simple to operate. Only one connecting cable—No tuning controls.
- Highly sensitive—Uses an improved vacuum-tube voltmeter circuit.



This model also available in Kit Form. All parts assembled ready for wiring. Order Model CA-12 Kit. Only **\$21.95**

- Tube and resistor capacity network are built into the detector probe.
 - Built-in high gain amplifier — Allnico V speaker.
 - Completely portable — Weighs 8 pounds — measures 5 1/2" x 6 1/2" x 9".
- Complete with self contained batteries and instructions **\$29.95**

The New Model 770 — An Accurate Pocket-Size

VOLT-OHM MILLIAMMETER

(Sensitivity: 1000 ohms per volt)

Features:

Compact—measures 3 1/8" x 5 3/4" x 2 1/4". Uses latest design 2% accurate 1 Mil. D'Arsonval type meter. Same zero adjustment holds for both resistance ranges. It is not necessary to readjust when switching from one resistance range to another. This is an important time-saving feature never before included in a V.O.M. in this price range. Housed in round-cornered, molded case. Beautiful black etched panel. Depressed letters filled with permanent white, insures long-life even with constant use.

Specifications: 6 A.C. VOLTAGE RANGES: 0-15/30/150/300/1500/3000 volts.
6 D.C. VOLTAGE RANGES: 0-7 1/2/15/75/150/750/1500 volts.
4 D.C. CURRENT RANGES: 0-1 1/2/15/150 Ma. 0-1 1/2/15/150 mps.
2 RESISTANCE RANGES: 0-500 Ohms. 0-1 Megohm.

The Model 770 comes complete with self-contained batteries, test leads and all operating instructions. **\$13.90 NET**



The Model 88 — A COMBINATION

SIGNAL GENERATOR AND SIGNAL TRACER

Signal Generator Specifications:
 *Frequency Range: 150 Kilocycles to 50 Megacycles. *The R.F. Signal Frequency is kept completely constant at all output levels. *Modulation is accomplished by Grid-blocking action which is equally effective for alignment of amplitude and frequency modulation as well as for television receivers. *R.F. obtainable separately or modulated by the Audio Frequency.

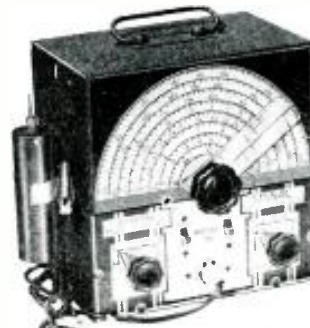

Signal Tracer Specifications:
 Uses the new Sylvania 1N34 Germanium crystal Diode which combined with a resistance-capacity network provides a frequency range of 300 cycles to 50 Megacycles.

The Model 88 comes complete with all test leads and operating instructions. **ONLY \$28.85 NET**

20% DEPOSIT REQUIRED ON ALL C.O.D. ORDERS

GENERAL ELECTRONIC DISTRIBUTING CO. DEPT. RC-6, 98 PARK PLACE, NEW YORK 7, N. Y.

2-METER MOBILE RIG

A prize-winner at a recent Long Beach Associated Radio Amateur meeting, this 2-meter mobile transmitter was designed and constructed by D. E. St. John, W6BRC. It was described in *Radiogram*, a monthly publication of Scott Radio Supply, Long Beach, California.

Its power drain is 100 ma at 300 volts and 1.6 amperes at 6 volts d.c. One section of the 6J6 is a crystal oscillator and tripler, and the other section is a straight tripler. This tube is followed by a 6C4 doubler driving a 6C4 neutralized amplifier on 2 meters. The amplifier is Heising-modulated by a 6AQ5 working from a carbon microphone.

The amplifier is tuned by a butterfly-type capacitor having a capacitance of 1.7-3.3 μf per section. This may be a Johnson type 160-203 or equivalent. The amplifier is neutralized by a small trimmer modified so its maximum capacitance is about 2 μf . A suitable neutralizing capacitor can be made from a 2-inch piece of 300-ohm ribbon. Small pieces are clipped off until the stage is neutralized.

The transmitter is designed to be placed in the trunk compartment and operated by remote control from the front of the car. The meter switch, S1, S2, and the microphone jack are on the chassis for use while tuning the rig. Connections for power and remote-control leads are made to a terminal strip or socket on the chassis.

The radio-frequency chokes are 1-megohm resistors wound solid with No. 32 d.s.c. wire. RFC1 is wound on a 1-watt resistor, and RFC2 and RFC3 are on 1/2-watt resistors. L1 has 22 turns, 1/2 inch in diameter and 1 1/4 inches long, tapped at 5 turns. L2 has 6 turns, 3/16 inch in diameter, 1/2 inch long. L3 has 3 turns, 3/16 inch in diameter and spaced to 5/16 inch. L4 is a 10-turn, center-tapped winding, 3/16 inch in diameter and 3/8 inches long. L5 is a 2-turn winding around the center of L4. No. 18 wire is used for L1, L2, and L4; No. 14 for L3 and No. 22 for L5.

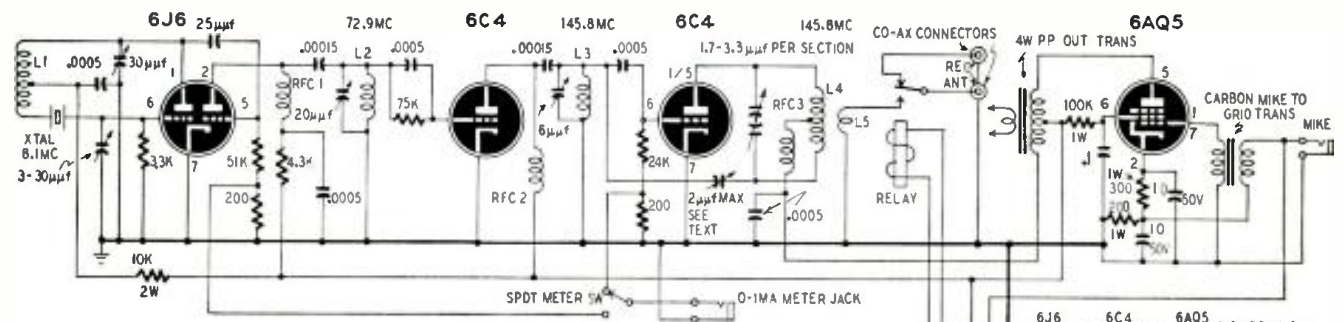

Bill of Materials for 2-Meter Rig

Resistors: 1—1 megohm, 1—75,000, 1—51,000, 1—24,000, 1—3,300, 2—200 ohms 1/2 watt; 1—1 megohm, 1—100,000, 1—300, 1—200 ohms 1 watt; 1—10,000, 1—4,300 ohms 2 watts.
Capacitors: 5—500, 2—150, 1—25-ggf 600-volt mica; 1—1.7-3.3 (Johnson 160-203 or equivalent), 1—6, 1—20, 1—30 μf variable; 1—3-30 μf trimmer; 2—10- μf 50-volt electrolytic; 1—0.1- μf 400-volt paper.

Miscellaneous: 2—s.p.s.t., 1—s.p.d.t. toggle switch; 1—4-watt universal output transformer; 1—carbon microphone-to-grid input transformer; 2—co-axial connectors, male and female; 4—miniature sockets; 1—antenna relay, s.p.d.t. with 6-volt d.c. coil; 2—open-circuit phone jacks; 2—6C4, 1—6J6 tube; 1—6AQ5; 1—carbon microphone, single-button type; necessary hardware.

DUAL VOLTAGE POWER SUPPLY

On numerous occasions, a high-voltage power supply is needed in the shack or on the workbench at a time when no suitable high-voltage power transformer is available. If two replacement power transformers of the same type are on hand, these may be connected, as explained in *G-E Ham News*, to supply approximately twice the voltage of one.

Two 676-volt, center-tapped, 200-ma

In most circuits of this type, the high-voltage output is twice that of the low-voltage supply. In this case, choke input was used on the high-voltage supply to reduce the output to the 500 volts needed by the designer. The output can be raised to approximately 600 volts by using capacitor input to the filter rather than choke input as shown.

A common bleeder resistor is used for

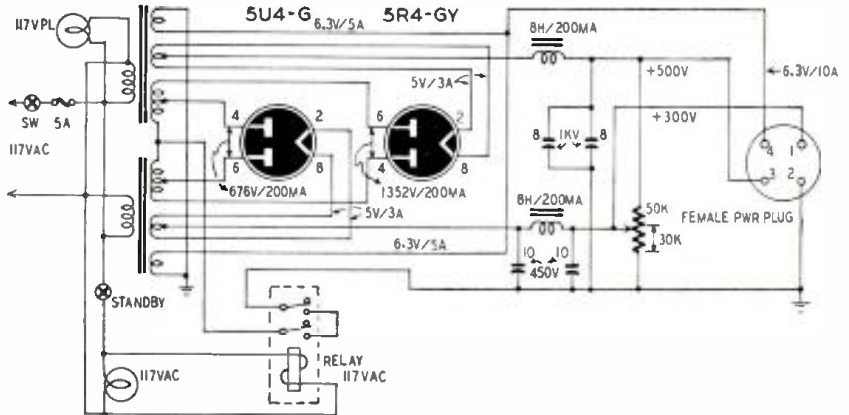

power transformers are connected with their primaries in parallel and the high-voltage secondaries in series-aiding. A 5R4-GY is connected so that the total high voltage is fed to its plates, and a 5U4-G has its plates connected to the center taps on the high-voltage windings. The 5R4-GY filament is supplied by the 5-volt winding on one transformer, and the 5U4-G is heated by the 5-volt winding on the other. The 6.3-volt filament windings are paralleled, and one side terminated at a pin on the output plug.

the high- and low-voltage supplies. The 300-volt tap should be made precisely at 30,000 ohms to prevent overloading the resistor. It may be advantageous to use separate bleeders on each supply because a single resistor may be overloaded under some conditions.

The B-supplies are controlled by a d.p.d.t., 117-volt relay with the normally open contacts in series to increase the distance between contacts in the open position. A maximum of 200 ma can be drawn from either supply when used alone or together.

A NOVEL SWEEP GENERATOR

Sweep generators in most oscilloscopes have comparatively low output which must be fed through the horizontal amplifiers to obtain adequate deflection on the C-R tube. This high-power sweep generator, described in

Broadcast Engineer's Journal, was designed to drive the plates of a C-R tube without going through an amplifier.

The circuit is shown. If the capacitor C is shorted, the current through the plate and cathode circuits of the 6P5

will be approximately 1 ma—limited by the values of R1 and R2. The voltage drop in the cathode circuit will be about 25 volts with 350 volts on the plate. The 884 will not operate because its plate and cathode are at the same potential.

When the short is removed, C begins to charge. Since the grid of the 6P5 is tied to the positive side of C, it will become less positive, increasing the plate current. When the charge on C equals the drop in the cathode circuit, the grid and cathode are both 275 volts positive (zero bias), and the current is stabilized at 11 ma.

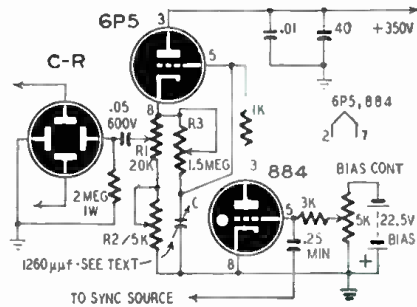

The 884 plate and 6P5 grid are directly connected; therefore, the voltage is the same on both. The bias on the grid of the 884 can be adjusted so the tube fires at a plate voltage determined by the amount of bias. For a linear sweep, the bias should be such that the 884 fires at slightly under 275 plate volts.

Assuming an extinction voltage of 15 volts for the 884 and a 275-volt maximum across R1-R2, C can be charged to any value between 15 and slightly less than 275 volts by adjusting the 884 bias. When R3 is a 1½-megohm variable resistor and C is a three-section, 420-μF variable capacitor with its sections in parallel, the sweep range is variable from about 60 cycles to 100 kc. C and R3 can be ganged on the same shaft for ease of control.

The frequency range and amplitude are affected by the settings of R2 and the bias control; therefore, these may be fitted with locks or screwdriver shafts so they cannot be disturbed after they are adjusted to give the best linearity at the ends of the sweep. R1 is selected to limit the 884 plate current to a safe level. Increasing its value increases the flyback or retrace time. R1 controls the sweep width.

Be sure to use husky, noninductive potentiometers for R1, R2, and R3. Use a clean, high-quality capacitor for C so its power factor will be satisfactorily high.

SOLDERING PASTE HOLDER

Test leads, tools, and components are often smeared with soldering paste from an open container on the work bench. To prevent this from happening, fasten a needle cup with spring cover to the bench and put the soldering paste in it. The lid stays closed and protects both paste and tools.—Harry Ashby

United Cuts Prices!!!

CATHODE RAY TUBES

3CP1—(Altmir. scale)	.98c	5P17—New	\$1.69
5B14—New	\$1.79	5P17—New	\$5.95
5B14—New	\$2.95	9L17—New	\$4.95

RECEIVING AND SPECIAL TYPES

1T4	69c	12SA7	59c
5Y4G	59c	12SF5	39c
6AV7	69c	12SH7	49c
6H6	39c	12SJ7	59c
6S47	39c	12SK7	49c
6SL7	39c	12SN7	59c
6E7	69c	1107	69c
7E7	69c	E1118	49c
7E7	59c	958	69c
12A6	25c	9001	65c
12J5	49c	VR-150	75c
12C8	59c	852	\$2.75

1625 3 for \$1.00

- POWER TRANSFORMERS.** Standard Makes 2 Fil. Windings—5 V. and 6.3 V. All Primaries 115 V. 60 Cye.
 - 700 V.C.T. at 50 Ma. Flush Mounting—\$1.95
 - 700 V.C.T. at 90 Ma. Flush Mounting—\$2.35
 - 750 V.C.T. at 110 Ma. Flush and Upright Mtg.—\$2.95
 - 750 V.C.T. at 150 Ma. Flush and Upright Mtg.—\$3.65
 - 750 V.C.T. at 220 Ma. Flush and Upright Mtg.—\$4.95
 - 750 V.C.T. at 150 Ma. Universal 25 to 60 Cye. 105 to 210 V. Primary \$6.95.
- OUNCERS—Jefferson** #7251502 Prim: 1250 Ohms D.C. Sec: 250 Ohms Z—89c. W.E. #W226262 1 Tapped Sec. Hermetically sealed. Prim: 800 Ohms D.C. Sec: 125 and 125 Ohms D.C.—99c.
- FILTER CHOKES—Open Frame.**
 - 615—3 H. 125 Ma. 200 Ohms D.C. 1500V. Ins.—98c.
 - 675—7 H. 150 Ma. 200 Ohms D.C. 1500V. Ins.—\$1.29.
 - 675—3.8 H. 180 Ma. 125 Ohms D.C. 1500V. Ins.—\$1.29.
 - A.C.—D.C. Choke—12 H. 60 Ma.—45c.

THORDARSON SPECIALS

- ISOLATION** #T-45928. Prim: 110, 115 and 120 V. Sec: 250 V.C.T. and 5 V. 3 A. Shpg. Wt.—8 Lbs.—\$3.49.
- STEP-DOWN** #T-48510. Prim: 115—230 V. Sec: 60, 67 and 75 V. at 5 Ambs. Shpg. Wt.—7½ Lbs.—\$1.49.
- POWER** #T-40650G (C.H.T.). Prim: 220 V. 50 60 Cye. Sec: 215 V. 2 A. Sec: 22 5 V. 3 A. Sec: 23 5 V. or 6.3 V.C.T. 4 Prong offset. 2 for \$1.39. 500 Mfd. 200 V.D.C. Each \$1.19. 25 + 25 Mfd. 300 V.D.C. Oetal Mtg. 2 for \$1.19.
- A REAL BUY!!** 10 assorted Power Transformers, Audios, and Chokes. Any one may be worth the lot! Price! Over 45 Lbs. for only \$3.95! DON'T MISS IT!
- CONDENSERS—**Popular Brands. Fresh Stocks. New!
- PAPER TUBULAR—**#003 Mfd. to 1.0 Mfd. 200 to 600 V.D.C. 50 assorted, only \$1.39.
- OIL FILLED PAPER TUBULAR** .002 Mfd. to 1.0 Mfd. 100 V. to 1000 V.D.C. 50 assorted, only \$2.29. 1 Mfd. 1250 V.D.C. Phenolic Shell. Screw Terminals. 4 for 95c.
- DISTRIBUTOR AND GENERATOR FILTERS—**Various types and sizes. All oil filled. 50 assorted, only \$1.95.
- BATH TUBS—**Oil filled paper. From .01 Mfd. to 2.0 Mfd. 50 V. to 1200 V.D.C. All new. 50 assorted, only \$2.35.
- MICAS** Rectifying types. Ruby and Silver. 150 V. to 1000 V.D.C. 37 Mfd. to 1 Mfd. 50 assorted \$1.45.
- MICAS** Transmitting. .00002 Mfd. to .01 Mfd. 600 V. to 3000 V.D.C.W. 10 assorted \$1.29.
- TRIMMERS—**Mica, Ceramic and Phenolic. Singles, Doubles, Triples and Quads. 10 assorted—95c.
- FILTERS, ROUND CAN TYPES.**
 - 1 Mfd. 2000 V.D.C. 3 for \$1.00.
 - 1 Mfd. 3000 V.D.C. 3 for \$1.45.
 - .25 Mfd. 3000 V.D.C. 3 for \$1.98.
 - 2.0 Mfd. 600 V.D.C. 3 for \$1.00.
 - 3 Mfd. 330 V.A.C. 3 for \$1.45.
 - 300 Mfd. 15 V.D.C. 3 for \$1.00.
 - 800 Mfd. 50 V.D.C. 4 prong offset. 2 for \$1.39.
 - 500 Mfd. 200 V.D.C. Each \$1.19.
 - 25 + 25 Mfd. 300 V.D.C. Oetal Mtg. 2 for \$1.19.
- FLAT CAN TYPES.** 5 Mfd. 1000 V.D.C. 3 for \$1.00. 5 + 5 Mfd. 115 V.A.C. 3 for \$1.29. 1.0 Mfd. 1000 V.D.C. Special 4 for 98c. 2.0 Mfd. 400 V.D.C. Special 1 for 98c. 2.0 Mfd. 600 V.D.C. Special 1 for \$1.25. 4.0 Mfd. 600 V.D.C. 2 for \$1.29. 3.0 Mfd. 2000 V.D.C. Each \$1.79. 3.0 Mfd. 2500 V.D.C. Each \$2.49. 5.0 Mfd. 2000 V.D.C. Each \$3.10. 3.0 + 3.0 Mfd. 2500 V.D.C. Each \$4.95. 1.0 + 1.0 Mfd. 1500 V.D.C. Each \$2.69. 8.0 Mfd. 2500 V.D.C. Each \$6.50. 2.0 Mfd. 5000 V.D.C. Each \$6.95.
- CARTRIDGE AND UPRIGHT TYPES.**
 - 8.0 Mfd. 150 V.D.C. 1 for 95c.
 - 10 + 10 Mfd. 150 V.D.C. 1 for 95c.
 - 10 + 10 Mfd. 150 V.D.C. 3 for \$1.00.
 - 10 + 2.0 Mfd. 150 V.D.C. 2 for 98c.
 - 20 + 20 Mfd. 150 V.D.C. 2 for \$1.29.
 - 40 Mfd. 450 V.D.C. 2 for 95c.
 - 40 Mfd. 25 V.D.C. 7 for \$1.00.
 - 50 Mfd. 150 V.D.C. 3 for \$1.00.
 - 10 + 40 Mfd. 150 V.D.C. 2 for 95c.
 - 60 Mfd. 200 V.D.C. 30 Mfd. 200 V.D.C. + 10 Mfd. 250 V.D.C. Each 85c.
 - 200 Mfd. 40 V.D.C. 2 for \$1.35.
 - 1000 Mfd. 8 V.D.C. 3 for \$1.15.
 - 3000 Mfd. 8 V.D.C. 3 for \$1.59.

- F.P. Tubes. 50 Mfd. 150 V.D.C. 2 for 95c. 10 Mfd. 150 V.D.C. + 20 Mfd. 25 V.D.C. 3 for \$1.55. 40 Mfd. 150 V.D.C. + 200 Mfd. 10 V.D.C. 3 for \$1.69. 10 Mfd. 350 V.D.C. + 10 Mfd. 300 V.D.C. + 20 Mfd. 25 V.D.C. 2 for \$1.19. 20 Mfd. 300 V.D.C. + 20 Mfd. 350 V.D.C. + 20 Mfd. 25 V.D.C. 2 for \$1.39. 40 Mfd. 300 V.D.C. + 15 Mfd. 300 V.D.C. + 20 Mfd. 25 V.D.C. 2 for \$1.39. 1000 Mfd. 15 V.D.C. 1 for \$1.15. 3000 Mfd. 3 V.D.C. 6 for \$1.00.
- CERAMICONS—**1.0 Mfd. to 1000 Mfd. at various voltage and temperature ratings. All new. 50 ass't. \$1.45.
- PRECISION GANG AND OIAL ASSEMBLY**—As used in BC-223 Transmitter. 3 sections. 175 Mfd., 200 Mfd. and 250 Mfd. High ratio trim dial. No backlash. Heavy construction. Ideal for Signal Generators, or Frequency measuring apparatus where high stability is required. New—\$5.95.
- SX28-A TUNING CONDENSER ASSEMBLY—**7 sections. Ceramic insulation. Exact replacement. New. Only a few left! Get yours Now! Each \$4.95.
- RELAYS** ART 13 Ant. Changeover Vacuum Switch. S.P.D.T. G.E. Typ. GL-1821. Hold off voltage 7,500 Vts. Max. continuous current. 20 Ambs. RMS. New—95c.
- POLARIZED RELAY—WE** #230 FM. Coil 500 Ohms. Operating current 3.0 Ma. Release at 1.0 Ma. Soak current .305 AMP. Completely shielded. Contacts adjustable and accessible. S.P.D.T. New \$1.75.
- W.E. TELEGRAPH TYPE** #24 V. Adjustable spring tension and coil starting. 100 Ohms. 104 S.P.D.T. Mounted on heavy slate base with cast frame. A precision instrument. Shpg. Wt. 4½ Lbs. New—\$2.75.
- ALLEN BRADLEY TYPES.** #X960 21 V.D.C. Coil. S.P.S.T. 100 Amp. Silver contacts. Solenoid type. May be used on 6 or 12 V.D.C. by changing tension spring. Shpg. Wt.—2½ Lbs. New \$2.19. #B2A—21 V.D.C. S.P.S.T. Solenoid 30 Amp. Silver contacts. New—79c.
- GUARDIAN TYPES.** #4 37116—21 V.D.C. S.P.S.T. 20 Amp. Silver contacts. New. 2 for \$1.39. #4 37177, 3 P.D.T. 10 Amp. Contacts. 21 V.D.C. New—85c. #4 37161—21 V.D.C. S.P.D.T. 20 Amp. contacts. Time Delay Type B-9. New—\$1.19.
- VIBRATORS** 12 V.D.C. 60 Cye. 4 Prong. Non-Sync. 3 for \$1.00. 21 V.D.C. 9 Prong offset. Non-Sync. New—3 for \$1.00.
- LIP MICROPHONES—**Carbon Cartridges only. New. 6 for \$1.00.
- HOOKUP WIRE—**Assorted sizes and colors. Fabric. Plastic. Rubber and Glass Insulation. Solid and Stranded. 500 Ft. assortment—\$2.39.
- I.F. FILTER CRYSTAL—**109.5 Kc. Mounted in Gap type Phenolic holder. 1" x ½" x ½" with leads. New. 3 for \$1.45.
- WAVE GUIDES—**5 ft. long with flange at both ends. Approx. 3 CM. completely silver plated. Outside finished in Butelshin Gray. Flange ends are sealed. New with Flange Hdwy.—\$3.39.
- HARDWARE ASSORTMENT**—Consists of standard Nuts, Bolts, Washers, etc. 3 Lbs. for \$1.29.
- SOLDER LUGS—**Copper, Brass, Tinned and Natural. Assorted types and sizes. 3 Lbs. for \$1.29.
- ALUMINUM RIVETS—**Assortment of many sizes and types. 3 Lbs. for \$1.29.
- CARBON RESISTORS**—¼ to 2 Watt in assorted values. Strictly insulated. Mfg. to 100 for \$1.95.
- AMMETER SHUNT—**Leeco-Neffile #S-21602. .005 Ohms mounted on Aesicous base with aluminum mounting plate. Perforated metal shield for personnel protection and air cooling. Capable of handling at least 200 Ambs. New—\$1.39.
- JEWEL LITES**—Assortment of types, colors and styles. New. Less Bulbs. 6 for \$1.00.
- SPEAKER CONES—**Exact replacement for Jensen type PM 6" C speaker. With voice coil and metal enforced spider. New. Each—69c.
- COMPASS LOOP AND CABLE** Bendix MN 20E Manual type with 6 ft. cable and connectors. Shpg. Wt. 3 Lbs. New \$8.95.
- DYNAMOTORS** #1-E 5 DYKAB31—12 V.D.C. at 6.9 Ambs. Input; 550 V.D.C. at 85 Ma. Output. Shpg. Wt. 3½ Lbs. New \$2.95.
- PE-94-C** 2x V.D.C. For SCR 722. Used in good condition. Shpg. Wt. Approx.—30 Lbs. \$5.95.
- BC-603 WESTERN ELECTRIC FM RECEIVER—**Complete with 10 tubes, speaker and 12 or 24 V. Dynamotor. Variable frequency range: 20 Mc. to 27.3 Mc. Covers in meter band with minor adjustments. Good condition. (Specify 12 or 24 V.) Shpg. Wt.—to Lbs. \$11.95.
- BC-604 WESTERN ELECTRIC FM TRANSMITTER—**25 Watt. output. 100% wideband phase modulated. Complete with tubes, meter and 12 or 24 V. Dynamotor. (Specify 12 or 24 V.) Good operating condition. Shpg. Wt.—to Lbs. \$17.50.
- CRYSTAL KIT FOR BC-604 WESTERN ELECTRIC FM TRANSMITTER** 40 crystals in metal cabinet. Covers all frequencies from 20 Mc. to 27.3 Mc. in 100 Kc. steps. Shpg. Wt. 7 Lbs. \$12.50.
- ELECTRONICS PACKAGE—**More than 10 Lbs. of assorted electronic units and parts—\$1.29.
- Quantities are limited—order now! Prices subject to change without notice. Minimum order—\$2.00. 25% deposit required. Balance C.O.D. All orders shipped F.O.B. Chicago.

UNITED SURPLUS MATERIALS
314 S. Halsted St. Chicago 6, Ill.

Now...
In Kit Form!

E.M.C. MODEL 30C
VACUUM TUBE
Volt-Ohm-Capacity
METER

\$24.95



- DC VOLTS—6 ranges to 1000 volts!
 - AC VOLTS—5 ranges to 1000 volts!
 - RESISTANCE—6 ranges to 1000 meg-ohms!
 - CAPACITY—4 ranges (.000025 mfd to 20 mfd)
 - ZERO CENTER POSITION
 - INCLUDES LEADS
- Completed Unit.....\$39.50
CAPACITY RANGES and ZERO CENTER POSITION are features not available in competitive VTVM kits.

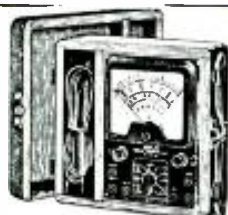

EMC Model 120
20,000
ohms-per-volt
VOLOMETER

\$22.95

- Portable Model Illustrated \$20.95
THE ONLY 20,000 OHMS-PER-VOLT INSTRUMENT THAT GIVES YOU...
- 6 D.C. Volt ranges at 20,000 ohms/volt to 6000 volts
 - 6 A.C. Volt ranges at 10,000 ohms/volt to 6000 volts
 - 5 current ranges to 6 amps
 - 4 resistance ranges to 300 megs
- Completed Unit (open face)...\$29.95
Completed Unit (portable)...\$34.95

E M C

Gives More Measurement Value per Dollar!

ELECTRONIC MEASUREMENT CORP.
423 Broome St., Dept. B-5, New York 13, N. Y.
Write For Free Catalog

EASY TO LEARN CODE

It is easy to learn or increase speed with an Instructograph Code Teacher. Absorbs the quickest and most practical method yet developed. For beginners or advanced students. Available tapes from beginner's alphabet to typical messages on all subjects. Speed range 5 to 40 WPM. Always ready—no GRM.



ENDORSED BY THOUSANDS!

The Instructograph Code Teacher literally takes the place of an operator-instructor and enables anyone to learn and master code without further assistance. Thousands of successful operators have "acquired the code" with the Instructograph System. Write today for convenient rental and purchase plans.

INSTRUCTOGRAPH COMPANY

4701 Sheridan Rd., Dept. RC, Chicago 40, Ill.

H. F. CATHODE-RAY TUBE

Patent No. 2,454,204

Richard C. Raymond, State College, Pa. (assigned to the United States of America)

Very high frequencies cannot pass through most oscilloscope amplifiers, so it is necessary to connect them directly across the deflecting plates. This limits the amount of deflection and makes it difficult to observe low-amplitude waveshapes. This inventor proposes to build an amplifier into

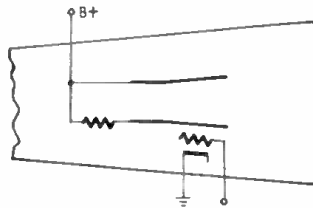

the cathode-ray tube. In this way distributed capacitance is held to a minimum and much higher frequencies can be observed.

As shown in the figure, the deflecting plate can also be the anode of the amplifier tube. The resistor in series with the deflector is the plate load for the amplifier.

TIME INTERVAL MEASURE

Patent No. 2,454,191

Angus A. Macdonald, Catonsville, Md. (Assigned to Westinghouse Elec. Corp.)

This circuit indicates voltage as a function of the time interval between two pulses, E1 and E2. They may be exponential and square, respectively, and both are impressed across the same tube. The first is applied to the plate, the second to the control grid.

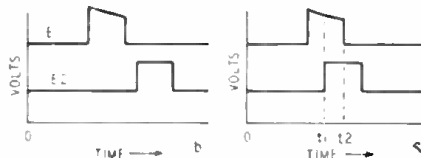
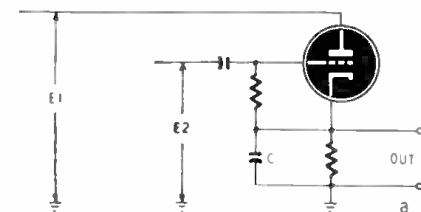

Normally the tube is at cutoff and remains there until E1 rises above its minimum value and is applied simultaneously with E2. For example, the tube cannot conduct in b, but in c conduction begins at time t1. At this instant current flows through the cathode resistor and the capacitor C charges. Its voltage continues to rise until time t2 when pulse E1 returns to minimum and blocks the tube.

If the grid pulse starts earlier or later than t1, the output voltage will be greater or less, as the case may be. A voltage indicator, calibrated in terms of time interval, may be connected across capacitor C.

D.C. AMPLIFIER

Patent No. 2,455,718

Barton L. Weller, Richland, Wash. (Assigned to the United States of America as represented by the U.S. Atomic Energy Comm.)

Random fluctuation in cathode emission is known as cathode drift. It is a serious problem in the design of sensitive amplifiers. The figure shows

a sensitive current amplifier using an FP-54 electrometer tube. A 6SL7 is used to cancel out cathode-drift interference.

The anode of the FP-54 and its space-charge grid S are coupled to triodes A and B, respectively. The total 6SL7 plate current flows through C. Due to negative feedback in this resistor, the gain of triode A is almost zero if the grids of A and B vary in the same phase.

When cathode drift takes place in the electrometer tube, its anode and its space-charge grid are affected in the same way. Therefore the bias on both 6SL7 grids varies in the same direction and there is no output. If a signal appears on the FP-54, only its anode is affected. There can be no change in triode B in this case, and there is no degeneration due to it. Therefore triode A amplifies the output of the FP-54. This circuit can amplify a current as weak as .001 microampere with little interference due to cathode drift.

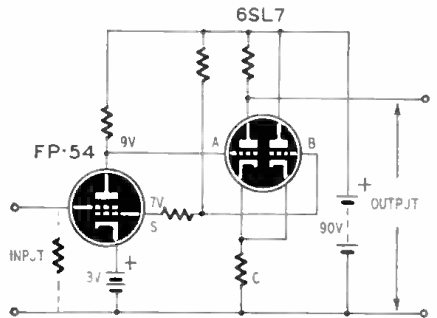

HEATING CIRCUIT

Patent No. 2,455,387

Theodore E Sippel, Valley Stream, N. Y. (Assigned to Bell Tel. Labs. Inc.)

Two thermostats are used in this circuit: one interrupts the total current, but is operated only when power is initially turned on; the other cycles continuously, but makes and breaks a weak current. Therefore both units have long life.

Terminals 2-3 are for filament supply to the thyatron, and 1-2 are for the plate voltage. Both supplies are taken without rectification from the 60-cycle line.

Originally both thermostats are closed. When the power is switched on, a.c. flows through heating element R and thermostat A. Since a.c. causes more rapid heating than equivalent half-wave rectified current, the temperature rises quickly and soon A opens. This puts a.c. on the thyatron plate. B is still closed, so rectified current flows through S, T, and B. The latter opens at a predetermined temperature, interrupting the circuit and cooling the thermostat. At the lower temperature limit, B closes again and the cycle repeats.

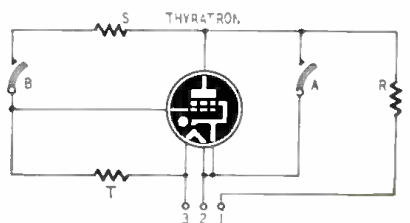

R.F. PRESSING

Patent No. 2, 449,318

Earle C. Pitman, Red Bank, N. J. and Ervin L. Crandell, Wellesley, Mass. (assigned to Compo Shoe Machinery Corp., Boston, Mass.)

When an r.f. heater is used for pressing, danger of scorching or burning is greatly reduced. In addition, no time is wasted heating the iron itself, and the heat is applied to the garment immediately. The garment to be ironed must be slightly damp so that the electrostatic field will generate heat within it. As the cloth dries less heat is produced.

The ironing table has a grounded metal layer just below its surface. The h.f. oscillator is placed within the table behind safety doors. A

cable leads power to the iron. Within the base of the iron are separate parallel metal elements. Alternate elements are connected together and to one of the r.f. leads.

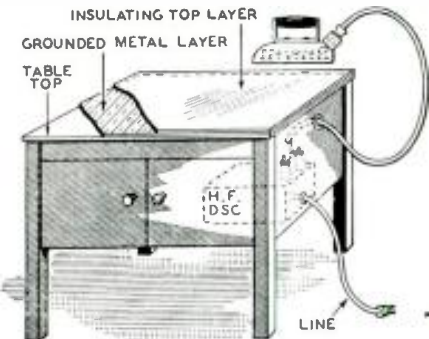

To press a garment, it is placed upon the table and the iron is moved about on it. A h.f. field is set up between each element (within the iron) and the grounded metal plate within the table top. To prevent a short, the r.f. output must be balanced to ground, that is, neither end can be grounded.

PULSE AMPLIFIER

Patent No. 2,459,181

Milton W. Rosen and Conrad H. Hoepfner, Washington, D.C.

Pulses are most conveniently measured by direct comparison with a standard pulse on a cathode-ray tube. It is preferable to see both pulses at the same time as at a, where two pulses appear back to back on opposite sides of the same base line. In this case P1 takes place at the same time as P2 but has less amplitude. Both pulses appear at the same time when they are reproduced alternately and rapidly. For example, they may be passed through separate amplifiers which are alternately blocked by a multivibrator. The amplifiers and the C-R tube must be direct-coupled for sharp pulses.

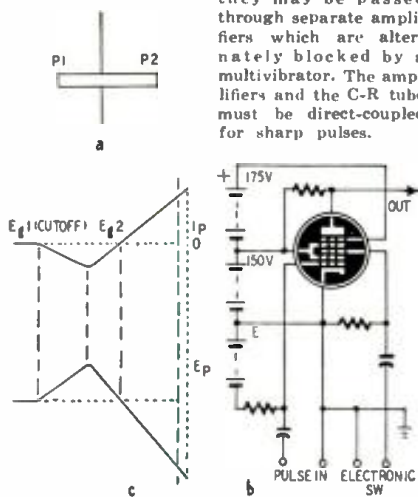

Unfortunately, when an amplifier is blocked and unblocked, its plate voltage rises and falls abruptly. This d.c. change affects the pattern by changing the position of the base lines so that the pulses no longer appear back to back.

To overcome this difficulty, a 6SA7 or similar tube is used in circuit b. Its plate is tapped on the power supply at a point lower than the suppressor grid so that the plate emits secondary electrons. The control-grid bias is set at point E.

The graph c shows the tube characteristic. Due to secondary emission, a negative-conductance period is followed by one which is positive. With the tube unblocked, the control grid bias is set to point E₂, where I_p = 0. Of course, the plate current is also zero when the tube is blocked by the multivibrator.

It is evident (from c) that the plate voltage is the same whether the tube is blocked or unblocked. Therefore, no change in potential is transmitted to the plates of the C-R tube, and the base line remains constant. The pulses appear on either side of this vertical line. Furthermore, the positive-transconductance portion is linear for faithful amplification of the pulse signals.

REVOLUTIONIZES TV WIRE STRIPPING!

FLEXTRON WIRE STRIPPER

Patent Applied for



Strips 300 ohm lead-in safely — quickly — easily. A "must" for every TV Serviceman's Kit!

\$395

individually packaged

DISTRIBUTORS: Write for distributors' prices and circulars. SERVICEMEN: If your distributor does not yet have FLEXTRON Wire Stripper, write to:

MANUFACTURED BY
ELECTRO-STEEL PRODUCTS, INC.
112-14 N. SEVENTH ST. PHILA. 6, PA.

HOW TO GET THE MOST from only BASIC TEST EQUIPMENT

Servicing by Signal Substitution
The Simple, Modern, Dynamic Speed approach to receiver alignment and adjustment problems, FM-AM-TV.

- Nothing complex to learn
- No extra equipment to purchase
- Universal — non-absolutescent
- Employs only Basic Test Equipment



S-S-S tells HOW — in simple, direct language.

New 9th edition now off the press. 100 pages of valuable information.

Available from all leading radio parts and equipment distributors or directly from factory at only 40c per copy.

PRECISION APPARATUS COMPANY, Inc. • 92-27 Horace Harding Blvd., Elmhurst 4, N. Y.

Try This One

WHERE TO BUY IT . . .

WHOLESALE RADIO of Baltimore

Easy To Assemble! Tech-Master's
New 630 TK. 10" TELEVISION KIT

CIRCUIT DESIGN
OF FAMOUS 630T.S.

\$159

Complete
Less picture tube & cab.



Easy to assemble for the most inexperienced amateur. All major components, controls, sockets and terminals mounted. Front end tuner completely wired and aligned. Simplified instructions. Large scale pictorial, schematics and RCA service manual included.

Adds Superb F.M. to Any Reg. A.M. Set
**MEISSNER Model 8C
FM TUNER**



Range 88 to 108 mc. auto frequency flat within 2db from 50 to 15,000 CPS. Can also be used with absolute AM FM for full coverage. **\$38.33**

Harrison PORTABLE WIRE RECORDER



Phono
Combination
\$87.43

Ideal for professional, commercial or personal recording. Records from phonograph, record, or mike. Plays 10 & 12 in. records, 6 tubes. Automatic shut-off Mike. Roll-out control panel. Public address system. 15 min. sound of wire. Weight 23 lbs. Size 8 1/2" x 10" x 14"

GET TOP T.V.—F.M. RECEPTION with
HI-LO ARRAY "Ranger"

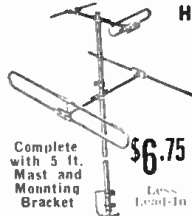

ANTENNA

Two orienting folded dipole with reflector. Range 70-216 mc. All TV channels and F.M. Gain is "plus" 12 for each section over dipole. Each section can be coupled or separated with separate transmission lines. Individually adjustable for maximum signal strength.

Complete with 5 ft. Mast and Mounting Bracket **\$6.75**
Less Lead-In

300 OHM TWIN LEAD \$1.95—100 ft. \$12.75—1000 ft.

**G. E. HIGH FIDELITY
1201 P.M. SPEAKER**

For Custom Installation
Deluxe 12" Alnico V 14.5 oz.
8 Ohm VC Imp. **\$17.70**
25 WATTS
50—13,000 Cycles



CHECK THESE LOW PRICES

Quality Gudeman, Tubular
**HIGH VOLTAGE CONDENSERS
FOR TELEVISION**



.0005 mfd.	6000 V.	\$.19
.001 mfd.	6000 V.	.19
.005 mfd.	6000 V.	.23
.03 mfd.	6000 V.	.35
.05 mfd.	6000 V.	.39
.0205 mfd.	7500 V.	.39
.001 mfd.	10,000 V.	.49

WRITE DEPT. QR 78 TODAY FOR OUR
FREE MONTHLY "FYI" BULLETIN
Phone MULberry 2134

**WHOLESALE
RADIO PARTS CO., Inc.**
311 W. Baltimore St.
BALTIMORE 1, MD.

TIE-DOWNS FOR TONE ARMS

Most service technicians have their pet ways of anchoring a pickup arm to a record changer so it will not bounce around and damage the needle or upset delicate adjustments while the instrument is being carried to or from the service shop.



My pet method is to punch 1/4-inch holes through the opposite sides of a tube carton. The carton is placed over the pickup and lowered over the center post of the changer until the post projects through the carton as shown in the photograph. The carton insert or facial tissue can be used to stuff the carton where necessary.

JOLLY M. WILSON,
Little Rock, Ark.

CABINET REPAIRS

Small scratches on radio cabinets are easily covered with any of the scratch removers on the market, but a deep scratch or dig is a real problem. Commercial scratch removers simply stain the flaw, often leaving a very noticeable scar in the finish.

An undetectable repair can be made with stick shellac in a few minutes and without the need of any great skill. Select a stick of shellac which matches the finish. Hold it an inch or so above the scratch and touch it with the tip of a hot soldering iron. Melt off enough shellac to cover the scratch completely. Hold the iron over the repair just close enough to make the shellac melt and run. Be careful not to let the iron touch either the shellac or the cabinet, nor blister the good finish around the repair.

Allow a few seconds for the shellac to harden. With a sharp knife blade held parallel to the surface chip off the top of the new shellac until it is nearly flush. Dress it down to a smooth finish with very fine sandpaper dipped in oil. Linseed oil or light machine oil will do. It is important to scrape the shellac nearly flush before sanding otherwise a lump will be left. Too much sanding will remove finish adjacent to the repair.

Kits of stick shellac in several colors and shades may be purchased from most radio parts jobbers.

WILLIAM H. CARR,
Saco, Maine

SURPLUS!

DYNAMOTORS & INVERTERS

DM 77	Dynamotor Unit 11v in, 100v, 350 ma out with relay base box and 11 pins. FOB Chicago only	\$5.75
DM 101 C	Dynamotor unit 12 or 24v in, inputs 800v, 20ma, 400v, 135ma. 9v, 3.1A	2.75
DM 54	Dynamotor unit: 12v in, 16 amp, 500v out, 200 ma. FOB Chicago only	3.75
DM 206	Inverter unit, rotary converted, 28v in, 80v at 500VA, 800 cy. out, FOB Chicago only	3.95
DM 32A	Each 95c. Three for	2.00
DM-53	Dynamotor, used with the BC 733, 24v in, 24v, 60ma out, New	2.95

SURPRISE PACKAGE

20 pounds assorted radio parts **\$1.95**
\$2.00 value for only

VERTICAL ANTENNA

1/2 wave vertical dipole antenna, complete with 36 inch whip, 36 inch skirt, 7 ft aluminum pole, mounting brackets and 8 ft. of coaxial cable with PL-250 plug. NEW **\$12.95**

PE-117 UNIVERSAL POWER SUPPLY

6 or 12v input; out, 115v and 90v, less vibrator, voltage regulator and rectifier tube; ideal mobile power supply unit; excellent condition. FOB Chicago only. Each **\$2.95**

VHF TRANSCEIVER

Ideal substitute for SCR 522, freq range 110-111 mc, crystal controlled, 10 watts. The receiver section has two individual RF sections, feeding a common 3-stage 6me 1F amplifier. Both RF sections may be operated simultaneously or either one individually. The receiver has 13 tubes. The transmitter is of straight-forward design. Transmitter unit has 7 tubes, one 2S2 as final modulated by a pair of 6L6 and push-pull. Complete unit in case with tubes, crystals and vacuum less dynamotor **\$14.95**

EXCELLENT CONDITION
New Phantom Antenna for above unit; 3 lamps in parallel with sockets, complete for **95c.**

SMASH VALUES IN COMMAND EQUIPMENT

BC-453-ENC.	\$12.95
BC-454-ENC.	\$3.95-NEW
BC-455-ENC.	4.95
BC-456-NEW	7.95
BC-457-NEW	6.95
BC-458-NEW	7.95
BC-459-ENC.	9.95
BC-606-ENC.	14.95

CONDENSER

2 MFd, 1000V, Pyralol	\$2.95 ea
1 for	\$10.00
2 MFd, 2000V	\$3.95 ea.
1 for	\$20.00
25 MFd, 15000V	\$5.95 ea.

GEARED TUNING DIAL

7 band, vander BRAND NEW Frequency Range: 42.4, 61.8, 12.8, 16, 19.2, 21, 25.6, 32. Ideal for many applications. An exceptional buy **\$1.39**

APS-13 UHF ANTENNA

Suitable for 100 mc citizen band, ideal for UHF experiments. With director and reflector elements mounted BRAND NEW 2 for **\$1.49**

10CM RECEIVER-AMPLIFIER

Contains the following circuits: Blocking oscillator, CRT, gate circuit, AZimuth and Vertical Sweep and 5 stage 20 MC IF strip with AF circuit. Tube complement: 6-6S N74T, 2 6A6GT, 4 6AG7, 2 6L6GT, 8 6AG7, 2 6H6, 1 2050, 1 8SE. **\$14.95**
Good, excellent condition.

BC-620 TRANSMITTER-RECEIVER UNIT

FM transmitter receiver, crystal controlled, two channels, freq. range 20-27.9 mc, 13 tubes, dual meter for testing filament and plate circuits. Used, good **\$9.95**

Mobile Installation Kit for BC-650 or BC-650 consists of TS-13, MF-18, 1 section whip antenna, **\$12.95**
insulators, 2 maintenance manuals; NEW

SPECIAL!

WESTINGHOUSE TRANSMITTER BC-122
Freq. range 325 to 400 KC; in portable field case; 3 meters, plus extra parts (less tubes)
—An Excellent Buy—BRAND NEW—\$7.95 ea.

All shipments FOB Chicago or Los Angeles unless specified. 20% Deposit required on all orders. Minimum order accepted—\$5.00. California and Illinois residents, please add regular sales tax to your remittance.

ARROW SALES, INC., Dept. R

MAIN OFFICE:

1712-14 S. Michigan Ave., Chicago 5, Illinois

NORTH SIDE BRANCH:

1802 N. Humboldt Blvd., Chicago 47, Ill.

WEST COAST BRANCH:

1260 S. Alvarado, Los Angeles, Calif.

RADIO-ELECTRONICS for



MR. SERVICEMAN:
This is for YOU

CREI Presents Just the Course You Need and Want to Safeguard Your Future—Earn More Money

"Television and FM Servicing"

Practical On-the-Job Training Program for the Better Serviceman Who Wants Greater Earnings and Security In This Expanding Field

THIS basic CREI Servicing Course paves the way to greater earnings for you. Since 1927 thousands of professional radiomen have enrolled for our home study courses in Practical Radio Engineering. Now, CREI supplies the answer to the need for a Practical Servicing Course. You do not have to be, or want to be, an engineer to benefit from this course. It is written for *you*—the average *good* serviceman! It's not too elementary for the experienced. It's not "over the head" of those who have limited experience—if they have real ambition and natural ability.

CREI developed this course at the request of several large industrial organizations. The urgent need for capable, trained servicemen is one of the big problems of the industry. Hundreds of thousands of Television Receivers will be marketed in 1949. By 1953—just

4 years—it is estimated that there will be 12 million TV sets in use. With Television comes FM receivers and circuits. This new field demands a tremendous increase in the number of properly trained television and FM technicians to install and service this equipment.

CREI EQUIPS YOU TO INSTALL AND SERVICE ALL TYPES OF TELEVISION AND FM RECEIVERS

Now . . . with the help of this new CREI streamlined Service course you can move ahead to unlimited opportunities in your chosen field. CREI has again taken the lead by offering a course so entirely new that for the first time in our twenty-two year history we can offer a down-to-earth course of training for servicemen. In offering this course at a popular price, CREI is enabling thousands

of the "top third" now engaged in service work to enter the ultimate profitable field of television and FM installation and service.

This can be your big year! Don't waste another day. CREI has the answer to your future security in this new servicing course. Write today for complete information. The cost is *popular*. The terms are *easy*. The information is *free*. Write today.

VETERANS! CREI TRAINING IS G. I. APPROVED

For most Veterans July 25, 1951 is the deadline—Act now!

Radio Service Division of
**CAPITOL RADIO
ENGINEERING INSTITUTE**

An Accredited Technical Institute

Dept. 156-A, 16th & Park Rd., N. W., Wash. 10, D. C.

Branch Offices: New York (7) 170 Broadway • San Francisco (2) 760 Market St.

JUNE, 1949

**MAIL
TODAY**

CAPITOL RADIO ENGINEERING INSTITUTE

16th & Park Road, N. W., Dept. 156-A, Washington 10, D. C.

Gentlemen:

Please send me complete details of your new home study course in Television and FM Servicing. I am attaching a brief resume of my experience, education and present position.

NAME _____

STREET _____

CITY _____ ZONE _____ STATE _____

I AM ENTITLED TO TRAINING UNDER G. I. BILL

Freq.	Station	Location and Schedule
9.680	EQC	TEHERAN, IRAN: 1200 to 1430
9.680	LRAI	BUENOS AIRES, ARGENTINA: 0800 to 2200
9.700		FORT DE FRANCE, MARTINIQUE: 1730 to 1845; and later
9.710		MOSCOW, U.S.S.R.: 2300 to 0730
9.720	PRL7	RIO DE JANEIRO, BRAZIL: 0430 to 0600; 1115 to 1445; 1500 to 2100
9.730	CSW7	LISBON, PORTUGAL: 1400 to 2000
9.740	OTC	LEOPOLDVILLE, BELGIAN CONGO: 1530 to 1845; 1700 to 2300
9.670	TGWA	GUATEMALA CITY, GUATEMALA: 1830 to 2330
9.770	OTC2	LEOPOLDVILLE, BELGIAN CONGO: 2100 to 2300
9.820	GRH	LONDON, ENGLAND: 1830 to 2300
9.830	COBL	HAVANA, CUBA: 0715 to 0045
9.840		LENINGRAD, U.S.S.R.: 1800 to 1900
9.900	ZTJ	JOHANNESBURG, SOUTH AFRICA: 0315 to 0715; 0500 to 1110
9.960	HCB8	QUITO, ECUADOR: 2230 to 2400, except Mon.; Mon., 2300 to 0300; 0800 to 2150
10.000	XGOL	FOOCHOW, CHINA: 0400 to 1000
10.220	PSH	RIO DE JANEIRO, BRAZIL: 1700 to 1800
10.730	VQ7L0	NAIROBI, KENYA: 0500 to 0800; 0830 to 0915; 0915 to 1100
10.780	SOB2	STOCKHOLM, SWEDEN: 1000 to 1055; 1230 to 1330; 2000 to 2100
11.040	CSW6	LISBON, PORTUGAL: 1230 to 1530; 1600 to 1800
11.090		PONTA DEL GADA, AZORES: 1500 to 1600
11.630		MOSCOW, U.S.S.R.: 1930 to 0300; 0600 to 0800; 0830 to 1300
11.650	XTPA	CANTON, CHINA: 0400 to 0830; 2200 to 0030
11.690	XORA	SHANGHAI, CHINA: 0500 to 1000
11.690		TABRIZ, IRAN: 0500 to 0700
11.700	HP5A	PANAMA CITY, PANAMA: 0700 to 2300
11.700	GWV	LONDON, ENGLAND: 2300 to 0030
11.700	SBP	STOCKHOLM, SWEDEN: 0140 to 0220; 0600 to 0650; 2000 to 2100; Sun., 0215 to 1100
11.710	FHE3	DAKAR, FRENCH WEST AFRICA: 1330 to 1700
11.710	VLG3	MELBOURNE, AUSTRALIA: 0245 to 0345
11.710	HE15	BERNE, SWITZERLAND: Mon., Tues., Thurs., Fri., 0215 to 0330
11.720		KIEV, U.S.S.R.: 0700 to 0815
11.720	PRL8	RIO DE JANEIRO, BRAZIL: 0315 to 0700
11.720	CKRX	WINNIPEG, CANADA: 1000 to 2000
11.720	OTC	LEOPOLDVILLE, BELGIAN CONGO: 0530 to 0730
11.730		SINGAPORE, MALAYA: 0325 to 1200
11.740	COCY	HAVANA, CUBA: 0530 to 2330
11.740	CEI174	SANTIAGO, CHILE: 1700 to 2400
11.740	HVJ	VATICAN CITY: 0015 to 0025; 0830 to 0900; 1100 to 1145
11.750	GSD	LONDON, ENGLAND: 2000 to 0300; 1215 to 1345
11.760	VLA8	MELBOURNE, AUSTRALIA: 1500 to 1610
11.780	HP5G	PANAMA CITY, PANAMA: 0630 to 2230
11.780		MOSCOW, U.S.S.R.: 0900 to 1030; 2000 to 2130; 2200 to 0100



Suggested by J. F. Dunnell, Vancouver, B.C., Canada

ARE YOU RECTIFIER-WISE?

WIN A VALUABLE PRIZE

With your Circuit Designs Using Federal's Miniature Selenium Rectifiers





Here is your opportunity to convert your circuit ingenuity into a useful and valuable prize. Federal, the originator of the Miniature Selenium Rectifier, is interested in your ideas on the use of this revolutionary circuit element.

A multitude of circuits have been built around the outstanding characteristics of Federal's complete line of Miniature Selenium Rectifiers—audio amplifiers, home radios, television receivers, 'ham' transmitters, FM adapters, phonograph amplifiers and many other electrical and electronic circuits. They all capitalize on the long life, high current capacity, instantaneous starting and great efficiency of these rectifiers. This compact, lightweight television power supply is typical.

These are but a few applications. The uses of these Miniature Rectifiers are almost unlimited. Get your idea down on paper and send it in today. It may be a prize winner!

CONTEST DETAILS

- All entries must be original circuits.
- All entries become the property of Federal Telephone and Radio Corporation.
- Federal engineers will judge entries on basis of novel and useful applications and select winning circuits.
- Five winners will be selected from the entries received during each month of the contest. A grand prize will be awarded to the outstanding entry of the contest.
- All entries for this month's judging must be received by June 30. Next month's entries must be received by July 31. Contest closes July 31.
- Winners will be announced.

FIVE MONTHLY PRIZES AND A GRAND PRIZE



The five monthly winners will each receive, FREE, a Federal FTR-1342-AS Selenium Rectifier Power Supply-Battery Charger. This compact unit, with its 6-volt, 6-ampere DC output, has many uses in home and shop. It comes equipped with a handy under-dash mounting socket for automobile battery charging.



The grand prize, a Federal FTR-3246-B5 Radio Service Power Supply, is invaluable as a source of heavy duty, filtered DC power. Its 6-volt, 10-ampere DC output will handle auto radio testing and many other test and permanent power requirements. List price \$74.50.

MAIL YOUR ENTRY TO: MINIATURE RECTIFIER CONTEST
Federal Telephone and Radio Corporation
 SELENIUM INTELIN DIV. • 900 PASSAIC AVENUE • EAST NEWARK, NEW JERSEY

TELEMIKE

Picks up telephone conversation on both ends of the line for transmission to any type recorder or for group loud speaker listening. No electrical connection with telephone. Model "R" 1" round x 3/8" thick . . . Price \$15.00. Model "F" 1 1/2" x 4 1/2" x 1/4" thick . . . Price \$20.00

MILES REPRODUCER CO., INC.
812 Broadway New York 3, Dept. RC6

TELEVISION RECEIVER—\$1.00

Complete instructions for building your own television receiver. 16 pages—11"x17" of pictures, pictorial diagrams, clarified schematics. 17"x22" complete schematic diagram & chassis layout. Also booklet of alignment instructions, voltage & resistance tables and trouble-shooting hints.—All for \$1.00.

CERTIFIED TELEVISION LABORATORIES
Dept. C, 5507-13th Ave., Brooklyn 19, N. Y.

YOU CAN PUT ALL YOUR EGGS IN THE QUAM BASKET!



In spite of the old adage, you'll find it pays to specify Quam Adjust-A-Cone Speakers for all your replacement jobs. The Quom Line is complete, there's a speaker for every standard receiver. Quam Speakers are listed in the Radio Industry Red Book for your convenience. Quam Speakers are built by a reliable organization that has

been manufacturing quality speakers for over a quarter century. Customer Good Will is important in your business—you can be sure of building it when you install Quam Speakers. Their fine performance and trouble-free service reflect to your credit! It pays to replace with Quam!



QUAM SPEAKERS

QUAM-NICHOLS CO.
521 E. 33rd Place, Chicago, Illinois

MAIL THIS COUPON FOR FREE CATALOG

Please send QUAM Catalog

Name _____

Address _____

City _____ State _____

For GREATER Earnings... LEARN RADIO-ELECTRONICS

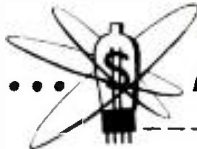

This fast-growing science of RADIO, TELEVISION, RADAR and ELECTRONICS, offers tremendous opportunities, and in no industry is RADIO-ELECTRONICS more important than in aviation. A skilled technician who *knows* the modern application of electronic devices, as used in the aircraft industry, is always in demand . . . not only in aviation, but in many other industries. Many large organizations call on Spartan regularly for graduates. Often, students are hired months before graduation.

Don't confuse the RADIO-ELECTRONICS course offered by SPARTAN with other courses, offered anywhere! As a graduate from this famous school you will know the application to industrial control devices; to the search for petroleum; and the important uses of radar, television and other electronic equipment.

SPARTAN offers two complete and thorough courses. You will work on the most modern and complete equipment. You will build equipment. You may join the SPARTAN "Ham" Club. Either course prepares you for Federal Communication Commission license tests — first class radio telephone, second class radio telegraph, or class "B" radio amateur.



SPARTAN'S 21 years of teaching civilian and army personnel is your assurance of receiving the best possible training in the least possible time. You'll not need MORE than Spartan training — you cannot afford to take LESS.

BIG CATALOG — Free

NAME _____ AGE _____

ADDRESS _____

CITY _____ STATE _____

Dept. RE-69

G. I. APPROVED—Write TODAY for Complete Information

SPARTAN

SCHOOL OF RADIO AND ELECTRONICS

SCHOOL of AERONAUTICS
MAXWELL W. BALFOUR, DIRECTOR

COLLEGE of ENGINEERING
ADDRESS DEPT. RE 69

TULSA, OKLAHOMA

the new Streamlined MODEL 322A TUBE TESTER



Priced at only **\$37.95**

A tube tester downright easy to operate. This is one of the lowest priced tube testers anywhere, yet it permits accurate checking of the widest variety of old or new tubes—equipped with the new sub-miniature tube socket.

CHECK THESE FEATURES

- This tube tester has provisions for checking individual sections of multi-purpose tubes as well as miniature and subminiature receiving tubes.
 - Closer tolerances are easily obtained due to special Alnico A.C. meter and extremely low test circuit voltage drop.
 - Convenient jack is provided for head-phone noise test to check noisy swinging, or high resistance internal tube connections.
 - Neon lamp for rapid short and leakage tests between elements.
 - Compact, sturdy construction.
 - Operates on 100-130 volt, 50/60 cycle A.C. power supply.
- Open-face in new hammer-tone grey finish steel cabinet with sloping panel. Size 5 1/4" x 12 3/16" x 8". Weight: 11 lbs.

Send for Bulletin No. 6C
BUY IT AT YOUR LOCAL DEALER

RADIO CITY PRODUCTS CO., INC.
152 West 25th St. New York 1, N. Y.

Freq.	Station	Location and Schedule	Freq.	Station	Location and Schedule
11.780		VIENNA, AUSTRIA: 2345 to 1805	15.230	VLG6	MELBOURNE, AUSTRALIA: 2330 to 0045; 0100 to 0145; 2200 to 2300; Sat. & Sun., 2100 to 2300
11.780		SAIGON, INDO-CHINA: 0500 to 0545; 0845 to 0900; 1830 to 2000	15.230		MOSCOW, U.S.S.R.: 0745 to 0815; 1820 to 1930; 2000 to 2130; 2200 to 0200
11.820	GSN	LONDON, ENGLAND: 0100 to 0500; 1230 to 1600; 1800 to 2030	15.250	KRHO	HONOLULU, HAWAII: Chinese-Philippine beam, 0400 to 1005
11.830		MOSCOW, U.S.S.R.: 2200 to 0600; 0730 to 0845; 1100 to 1600	15.260	GS1	LONDON, ENGLAND: 0100 to 0500; 1815 to 1845
11.830	CXA19	MONTEVIDEO, URUGUAY: 0600 to 2200	15.270		SINGAPORE, MALAYA: 0330 to 1200
11.830		CONSTANTINE, ALGERIA: 0130 to 0315; 0630 to 0915; 1315 to 1400; 1430 to 1700	15.290	VUD11	DELHI, INDIA: 2215 to 0030; 0125 to 0150; 0200 to 0400; 0500 to 0700
11.840	VLC7	SHEPPARTON, AUSTRALIA: 2330 to 0045; 1500 to 1615	15.300	GWR	LONDON, ENGLAND: 1200 to 1315
11.860	HER5	PARIS, FRANCE: 1330 to 1700	15.300		SINGAPORE, MALAYA: 0330 to 1200
11.870	MUNICH 1	BERNE, SWITZERLAND: 0300 to 0400	15.310	GSP	LONDON, ENGLAND: 1015 to 1315; 2345 to 0030
11.880		MUNICH, GERMANY: European beam, 1100 to 1700	15.310	VLC4	SHEPPARTON, AUSTRALIA: 0215 to 0345; 0355 to 0730; 0800 to 1045
11.880		MOSCOW, U.S.S.R.: 1820 to 1930; 2000 to 2045	15.310	HER6	BERNE, SWITZERLAND: 1545 to 1630; 1645 to 1715; 1830 to 2000; 2030 to 2230
11.880	LRR	ROSARIO, ARGENTINA: 0400 to 2100	15.320		MOSCOW, U.S.S.R.: 2200 to 2300; 0000 to 0500; 0530 to 0800; 0830 to 1100
11.890		MANILA, PHILIPPINES: far East beam, 0400 to 1005	15.230	OQ2RC	LEOPOLDVILLE, BELGIAN CONGO: 1200 to 1300
11.900	XGOY	CHUNGKING, CHINA: 0400 to 0530; 0745 to 0830; 0845 to 1015	15.330		MANILA, PHILIPPINES: Indian-Pakistan beam, 0230 to 0345
11.900	CXA10	MONTEVIDEO, URUGUAY: 1830 to 2115	15.340		MOSCOW, U.S.S.R.: 2200 to 0800; 1000 to 1100
11.960	HEK4	BERNE, SWITZERLAND: 1645 to 1715 except Sat.	15.350		PARIS, FRANCE: 0700 to 0900; 1700 to 1715; 1915 to 2015; 2030 to 2115
11.970	FZ1	BRAZZAVILLE, FRENCH, EQUATORIAL AFRICA: 0000 to 0230; 0415 to 0800; 0930 to 1030; 1100 to 2040	15.350	GRD	LUXEMBOURG: 0600 to 0800
12.000	CE1180	SANTIAGO, CHILE: 0600 to 0800; 1600 to 2300	15.450		LONDON, ENGLAND: 0100 to 0300; 1700 to 2030
12.090	GRF	LONDON, ENGLAND: 2300 to 1615; 1700 to 2030	15.590	FZ1	BRAZZAVILLE, FRENCH EQUATORIAL AFRICA: 0445 to 0800; 0930 to 1030
12.210		VIENNA, AUSTRIA: 2345 to 1800	16.670	CNR3	RABAT, FRENCH MOROCCO: 0715 to 0830
12.260	TFJ	REYKJAVIK, ICELAND: Sun., 0900 to 0930	17.440	HVJ	VATICAN CITY: 0715 to 0845
12.440	HCJB	QUITO, ECUADOR: 1400 to 2230; Mon., 2230 to 2400	17.530	FZ1	BRAZZAVILLE, FRENCH EQUATORIAL AFRICA: 0000 to 0130; 0415 to 0745; 1100 to 1700
15.110	HGJ	LONDON, ENGLAND: 0400 to 1600; 1800 to 1930	17.700	GVP	LONDON, ENGLAND: 0600 to 0900; 1700 to 1800
15.110	HCJB	QUITO, ECUADOR: 0500 to 1200; 1330 to 2230	17.710	GRA	LONDON, ENGLAND: 0045 to 0400; 0600 to 0815; 0915 to 1115
15.120	HVJ	VATICAN CITY: 0830 to 0930; 1100 to 1145	17.730	GVQ	LONDON, ENGLAND: 0830 to 0900; 1700 to 1800; 2345 to 0630
15.120	GSF	ROME, ITALY: 1715 to 2015	17.760		PARIS, FRANCE: 0700 to 0900; 1100 to 1230
15.140		LONDON, ENGLAND: 0600 to 0715; 0915 to 1045; 1030 to 1200; 1300 to 1600; 1615 to 2015; 2300 to 0100	17.770	OTC	LEOPOLDVILLE, BELGIAN CONGO: 0500 to 0930; 1130 to 1045
15.150	SBT	STOCKHOLM, SWEDEN: 0145 to 0645; 1000 to 1100; 1230 to 1330; 2000 to 2100	17.770	SEAC	COLOMBO, CEYLON: 2300 to 0730; 1100 to 1200
15.170	TGWA	GUATEMALA CITY, GUATEMALA: 0730 to 1500	17.790	GSB	LONDON, ENGLAND: 0545 to 0715; 0830 to 1030; 1100 to 1145
15.180	GSO	LONDON, ENGLAND: 2300 to 1600; 1615 to 2015	17.800	KRHO	HONOLULU, HAWAII: Chinese-Philippine beam, 0230 to 0345 (off Mondays)
15.190	CKCX	MONTREAL, CANADA: 0845 to 1100; 1820 to 1935			
15.190	TAQ	ANKARA, TURKEY: 0000 to 0230; 0415 to 0730			

Freq.	Station	Location and Schedule
17.800	DIX5	LAHTI, FINLAND: 0130 to 0200; 0500 to 0515; 0800 to 1700
17.810	GSV	LONDON, ENGLAND: 0030 to 0300; 0100 to 1130
17.820	CKNC	MONTREAL, CANADA: 2015 to 0100; 0515 to 1630; 1830 to 2100
17.820	SEAC	COLOMBO, CEYLON: 1930 to 0115; 0500 to 0700; 0715 to 1115
17.830	VUD10	DELHI, INDIA: 0130 to 0200; 0715 to 0800; 2115 to 0215
18.020	GRQ	LONDON, ENGLAND: 0100 to 0700; 1100 to 1500
18.080	GVO	LONDON, ENGLAND: 1030 to 1400
18.130	PMC	BATAVIA, NETHERLANDS INDIAS: 1100 to 1130
21.470	GSH	LONDON, ENGLAND: 0700 to 1215
21.530	GSJ	LONDON, ENGLAND: 0100 to 1215
21.550	GST	LONDON, ENGLAND: 0100 to 0400; 1230 to 1500
21.640	GRZ	LONDON, ENGLAND: 0100 to 0500; 1030 to 1230; 1300 to 1600
21.750	GVT	LONDON, ENGLAND: 0200 to 0715; 1030 to 1045; 1100 to 1130
26.100	GSK	LONDON, ENGLAND: 0615 to 1200

ELECTRONIC LITERATURE

Any or all of these catalogs, bulletins, and periodicals are available to you if you write to us on your letterhead (do not use postcards) and request them by number. It is necessary to send only the number of item you want. We will forward the request to the manufacturers, who in turn will send the literature directly to you. This offer void after six months.

JN-1—TV-FM ANTENNA FOLDER

An eight-page folder describes FM and TV antennas and antenna accessories made by American Phenolic Corporation. The folder also includes a short technical article on the characteristics of some of the antennas made by the firm. Comparison curves and radiation patterns of the various antennas are included.—*Gratis*

JN-2—RESISTOR DATA BOOKLET

An eight-page catalog and data book gives complete technical specifications and prices on High Stability Carbon Resistors and Pyromatic Resistors made by Welwyn Electronic Components, Inc. Information includes temperature rise, temperature coefficient, Johnson noise factor, and reactive effects.—*Gratis*

JN-3—TECHNIFAX CATALOG

A small folder lists and reviews the contents of 59 technical bulletins published by Technifax Service. The bulletins come under the headings of "Electrical Design and Construction," "Electroplating, Soldering-Brazing-Welding," "Home Improvements," "Metal Casting-Heat Treating," "Plastics-Casting of Novelties—Decorative Arts," and "Specialty Sales Products and Business Opportunities," with several bulletins under each heading.—*Gratis*

JN-4—MAGNET CATALOG

The Chemical Department of General Electric Company issues a 28-page illustrated catalog describing a variety of cast and sintered Alnico magnets as well as special magnetic alloys stocked by the company. Photographs and pull-curves are provided on a large number of the stock items, and completely detailed drawings of all stock patterns are included.—*Gratis to interested parties*

JN-5—HYTRON REFERENCE GUIDE

The new third addition of Hytron Reference Guide for Miniature Elec-

PRICES TALK at RADIO SUPPLY



OZ 4's (No Limit)

Fresh RK and RCA. Standard commercial grade, not JAN's.

BUY 12 58¢
get 1 free EACH

EGG CRATE OF 100 \$49⁰⁰

VIBRATORS

MALLORY universal standard 4 prong, non-synchronous. Can size 1½" x 3¾".

\$129
EACH

BUY 12 get 1 free

EGG CRATE \$109⁰⁰ of 100



AERIALS RADIART 363U1 (discontinued model) 3 section

63" top cowl, universal mount, 48" lead. Former list \$6.75.

\$241
EACH

BUY 10 get 1 free

\$215⁰⁰ per 100



GENERATOR CONDENSERS

By one of the big 3



15¢ .5 mfd 200 VDC, 6" lead
EACH

BUY 12 get one free \$12.00 per 100

ORDER INSTRUCTIONS

Minimum order — \$2.00. 25% deposit with order required for all C.O.D. shipments. Be sure to include sufficient postage—excess will be refunded. Orders received without postage will be shipped express collect. All prices F.O.B. Detroit.



DON'T WAIT—ORDER TODAY

R. S. E. 3 inch TELEVISION SCOPE

Features:

- WIDE BAND VERTICAL RESPONSE
- FLAT TO 750kc
- DOWN 3db AT 1mc
- VOLTAGE GAIN OF 20 AT 5mc



AR-3

The R.S.E., AR-3 Scope has been built by Ross Armstrong to our rigid specifications. It's a complete unit that embodies standard horizontal amplifier and sweep circuits with normal sensitivity.

It's different because of the extreme vertical amplifier response. Check the featured specifications against others. For TV use wide band response if necessary.

The case is 8" high x 5" wide x 14" long, attractively finished in "hammered" opalescent blue enamel. Operates on standard 110 volts—60 cycles —40 watts. Tubes, 3BP1—6AC7 —6SJ7—6X5—5Y3—884. Instructions included. Complete specifications upon request. Satisfaction or your money back.

PRICE \$49⁹⁵

F. O. B. DETROIT

PUSHBACK WIRE



BELOW MILL PRICES!

2,000,000 feet—tinned copper—all 1st class, double cotton serve, waxed finish.

- Available solid or stranded
- 22 gauge (6 colors) per 1000 \$3.98
- 20 gauge (6 colors) per 1000 \$4.98
- 18 gauge (brown) per 1000 \$6.49

RADIO SUPPLY & ENGINEERING CO., Inc.
85 SELDEN AVE. DETROIT 1, MICH.

NEVER AGAIN!

BRAND NEW—GENUINE

WESTERN ELECTRIC DRIVER UNIT with REFLEX PROJECTOR



\$19⁹⁵

WAY BELOW MANUFACTURER'S COST

F.O.B. N.Y.C. A Blast-Proof, Blare-Proof Reflex Speaker with a Projector especially designed for use with the famous WESTERN ELECTRIC DRIVER UNIT.

4 Heavy Gauge metal construction throughout, including the main trumpet section, gives you peak performance without blaring or blasting.

WILL HANDLE UP TO 50 WATTS WITH NO DISTORTION

Excellent for Industrial purposes—Call Systems—Concessions—Ball Parks—Schools—and P. A. Work.

25% DEPOSIT WITH ORDER, BALANCE C.O.D.

MANUEL KLEIN

76 CORTLANDT ST. NEW YORK 7, NEW YORK

**EVERY SERVICEMAN
CAN afford
SUPERIOR
TEST EQUIPMENT**



THE NEW MODEL 770—
**An Accurate Pocket-Size
VOLT-OHM MILLIAMMETER**
(SENSITIVITY: 1000 OHMS PER VOLT)

Features:

- Compact—measures 3 1/4" x 5 1/2" x 2 1/4".
- Uses latest design 2% accurate 1 Mil. D'Arsonval type meter.
- Sensitive zero adjustment holds for both resistance ranges. It is not necessary to readjust when switching from one resistance range to another. This is an important time-saving feature never before included in a V.O.M. in this price range.
- Housed in round-cornered, molded case.
- Beautiful black etched panel. Depressed letters filled with permanent white. Insures long-life even with constant use.

Specifications: 6 A.C. VOLTAGE RANGES: 0-15/30/150/300/1500/3000 volts.
6 D.C. VOLTAGE RANGES: 0-7 1/2/15/75/150/750/1500 volts.
4 D.C. CURRENT RANGES: 0-1 1/2/15/150 Ma. 0-1 1/2 Amps.
2 RESISTANCE RANGES: 0-500 ohms, 0-1 Megohm.

The Model 770 comes complete with self-contained batteries, test leads and all operating instructions.....

**\$13.90
NET**

MFD. BY We manufacture a complete line of radio test equipment.
Write Dept. RC-6 for FREE catalog today!



SUPERIOR INSTRUMENTS CO.

227 Fulton St., New York 7, N. Y.

at your regular jobber

SELSYN TRANSMITTER & INDICATOR SYSTEM

Ideal as radio beam position indicator for Ham, Television, or Commercial use. Complete with five inch 1-82 Indicator, Autosyn Trans., 12 Volt 60 cycle Transformer, and wiring instructions. New..... \$9.95

ANTENNA ROTATOR—Ideal reversible motor for rotating all types of antennas at the top. Weighs only 1 1/2 lbs. Size: 7 1/2" L. less shaft. Gear box and Mtg.: 4 1/2" x 3 1/2". Motor size: 5" L. x 2 1/4" D. Shaft size: 3/8" x 1 1/2" threaded. Operates from 24 V. DC. 2 amps. 4.5 RPM or 36 V. A.C. Torque: 70 lbs. per inch. Price \$8.95
TRANSFORMER for above item..... 2.95

2JIGI SELSYN MOTORS

Can be used as position indicator for antennas; 110 Volt 60 cycle. with instructions. Normally operates from 57.5 Volts 400 cycle. Price per Pair \$3.00



DYNAMOTORS:

INPUT:	OUTPUT:	STOCK No.:	PRICE:
9 V. DC	450 V. 60 MA w/hlower	D 9450	\$3.95
12 V. DC	220 V. 100 MA	D 402	3.95
12 V. DC	440 V. 200 MA	D 401	7.95
28 V. DC	F/SCR 522	PE 94	7.95
12/24 V. DC	F/NO. 10 MARK II	D/S #3	9.50
13/26 V. DC	F/BC-645	1E 101	2.95
12/24 V. DC	500 V. 50 MA	D 0515	2.95
28 V. DC	F/Comm. Receivers	DM 32	1.95
14 V. DC	230 V. 100 MA	DM 20	3.95
12/24 V. DC	440 V. 200 MA— and 220 V. 100 MA	D 104	9.95
28 V. DC	400 Cycle Inverter	MG-149F (Reconditioned)	14.95

DYNAMOTOR—Use your electric shaver in your car! Dynamotor will supply 110 Volt 100 MA from 6 VDC and will operate most types of AC-DC Shavers. Normal operation 12 VDC input; 220 V. 100 MA output. \$1.95

MISCELLANEOUS

- Coaxial cable—125 OHM (cotton covered)—50 Ft. \$1.00
- Coaxial cable—72 OHM Rubber covered—8 Ft. .50
- Cable—4 conductor. Rubber covered, shielded—50 Ft. 2.00
- Wire—Heavy duty 2 cond. Rubber covered #14 stranded—20 Ft. 1.00
- Wire—2 cond. Rubber covered Tlrex #16—Per Ft. .06
- BC-1206 C Rec. 200-400 KC. DET. 6 tube set. 6.95
- PL-17 or 25 for BC-223—Price—New. 4.50
- Cable for BC-223 w/PL-150 each end. 1.75
- Cable for BC-375 w/PL-61 each end. 1.75
- Plug for TCS EQ/85F7, 85F10, or 85F13. 2.95
- Cable for 1-82 Indicator PL-118. 1.00
- Plugs for LP-21 Loop, PL-112 or PL-108. 1.00
- PL-8 Filter 1200 CPS. 1.95
- BC-1023 Marker Beacon Rec. with tubes. 3.79
- BC-301 Marker Beacon Rec. Less tube. 1.95
- BB-54 2 Volt Dry Cell Battery. 4.50
- EC-778 Gibson Girl Receiver—Only. 4.95

Address Dept. RE • All Prices Are F.O.B., Lima, Ohio • 25% Deposit on C.O.D. Orders

WHIP ANTENNA FOR MOBILE AND STATIONARY USE

TELESCOPING ANTENNA with Base Insulator: Four section, steel, extends 6' 2" to 23' 6". Diameter taper from 1-1/16" to 1/4". Each section fitted with adjustable locking clamp. Can be adjusted to length required for freq. Brown glazed base insulator and stand off. Price..... \$12.95

WHIP STEEL—24 ft. two piece. Bottom section 4 ft. long. Taper 3/8" to 1/4". Bottom Sec. threaded 1/4". Price..... \$2.50

TELESCOPING STEEL ANTENNA—3 Sections 9 1/2' long. Telescoped 40". Size: 3/8" to 1/4". Price..... \$1.50

MP-48 MAST BASE Mounting with heavy vertical coil spring, insulated at top to receive Mast Section MS-53. Mast Base only..... \$2.95

MAST SECTIONS: For above MP-48, tubular steel, copper coated, painted—in 3 foot sections. Bottom section MS-53 can be used to make any length. MS-52-51-50-49 for taper. Screw-in type. Any section—Price..... .50 each

TRANSFORMERS—110 VOLT 60 CYCLE PRIMARIES:

Sec. 24 Volt 2 amp.	\$2.25
Sec. 14-14 or 28 Volt 7 1/2 or 15 amp.	4.95
Sec. 12 Volt 1 amp.	1.50
Sec. 24 Volt 1 amp.	1.95
Sec. 24 Volt .5 amp.	1.50
Sec. 36 V. A.C. 2.5 amp.	2.45
550 VCT—60 MA 6.3 V. 5 amp., 5 V. 3 amp.	2.95
700 VCT—90 MA 6.3 V. 4 amp., 5 V. 3 amp.	2.95
800 VCT—200 MA 6.3 V. 6 amp., 5 V. 3 amp.	4.75

COMMAND TRANS. AND RECEIVER TRANSFORMERS—110 V.A.C. 60 CYCLE INPUT

Output: 600-0-600 V.A.C. at 250 MA. 12 V.A.C. at 3 amps.; 12 V.A.C. at 3 amps. & 5 V.A.C. at 3 amps. #REH-108..... \$6.90
Output: 250-0-250 V.A.C. at 60 MA. 24 V.A.C. at 6 amp.; 6.3 V.A.C. at 6 amp. #REH-109..... \$3.00

MOTORS

- 6 or 12 Volt AC-DC Heavy Duty reversible Motor with 5/16" x 7/16" shaft. Price: New..... \$2.95
- 6 Volt AC-DC Motor—Ideal for auto fans, models, etc. Shaft 3/8" x 3/8". Used—Tested..... \$1.50
- Model Motor—12 Volt AC-DC 1/2" H. Price..... \$1.50
- Motor, Size: 2 1/4" L. x 2 1/4" W. x 1 1/2" H. Price..... \$1.50
- 110 Volt 60 cycle, Ball Bearing Motor, approx. 3200 RPM. 1/25 H.P. Shaft: 3/16" x 3/8". Motor size: 6 1/2" L. x 4" H. Converted type. Price..... \$2.95
- Hand Tool Motor—12 Volt AC-DC—5600 RPM. 3 1/2" L. x 1 1/4" Dia. with splined shaft 1/4" D x 1/2" L. Price \$2.95
- PHONO MOTOR only. 110 V. 60 Cycle, for auto. changer..... \$1.75

tron Tubes has six pages giving pertinent characteristics, data, and basing diagrams of 91 types of miniature tubes. Nineteen of these types are recent additions to the Hytron line.—*Gratis*

JN-6—ELECTRO-VOICE BULLETIN

Bulletin No. 144, issued by Electro-Voice, Inc., describes the new high-fidelity broadcast microphone Models 645 and 650. Mechanical and electrical specifications are given on these models.—*Gratis*

JN-7—MOVIE SOUND BOOKLET

The booklet "Sound for Your Home Movies" is issued by Sears, Roebuck and Company. It describes a method of synchronizing a wire recorder with a silent movie projector to produce sound for home movies. A number of applications for synchronized sound are listed and illustrated.—*Gratis*

JN-8—C-R EQUIPMENT CATALOG

The Instrument Division of Allen B. Du Mont Labs., Inc., issues a new 11-page catalog of cathode-ray tubes and related equipment. It lists electrical specifications on 11 cathode-ray tubes and electrical and physical specifications on oscillographs, recording cameras, C-R indicators, voltage calibrators, time-base generators, and electronic switches.—*Gratis*

JN-9—CO-AXIAL CABLE BULLETIN

Bulletin No. 48, issued by Andrew Corporation, is of interest to broadcast engineers. It gives complete technical details on the type 737 7/8-inch semi-flexible co-axial cable made by the firm. The bulletin also lists and illustrates accessories and fittings designed for use with this cable.—*Gratis to interested parties*

JN-10—RELAY CATALOG

The latest Advance Relay catalog is of interest to amateur radio operators, engineers, and experimenters. It lists telephone, time-delay, keying, antenna, latching, overload, underload, and impulse relays as well as several other types. All types are illustrated with photographs and mechanical drawings.—*Gratis*

JN-11—RADIO MAGAZINE INDEX

Radiofile is a subject index of all the information published in RADIO-ELECTRONICS and 11 other radio magazines. A new cumulative index is issued monthly covering all material published during the year. The index is cross-referenced so that most items can be found under several headings. Indexes for 1946 through 1948 are available.—*1-year subscription, \$1.50.*

JN-12—VARIAC CATALOG

A new seven-page catalog issued by General Radio Company lists characteristics and specifications on five different types of Variacs made by the firm. Each type of unit can be had with a number of basic modifications. Drawings and photographs show all types.—*Gratis*

FAIR RADIO SALES 132 SOUTH MAIN ST. LIMA, OHIO

A Lesson in Theological Electronics

By L. S. KOBEL

THE lesson for today is taken from the second chapter of the first book of the prophet FLEMING.

There dwelt nigh unto the gates of the great city of HIGH VOLTAGE BATTERY an official of great importance, known as NEGATIVE TERMINAL. It came to pass that this official, seeing a number of ELECTRONS gather together spake unto them saying:

"Get ye gone, O ye of little mass. Gird up your loins and follow in the footsteps of your brothers and sisters before ye."

And they straightway made haste and departed.

As they traveled in the narrow valley of CIRCUIT DIAGRAM they were guided by a great pillar of fire known as the INDIRECTLY HEATED CATHODE. When they had come nigh unto the INDIRECTLY HEATED CATHODE, a voice cried unto them saying, "Halt! Ye have traveled far and are doubtless footsore and weary. Prepare you camp and rest." And they did so. Whereupon they named this place SPACE CHARGE, as it is known unto this day.

But on the morrow there came a mighty wind, known as the ELECTRIC GRADIENT, of such great force that the ELECTRONS were driven from their camp, swept through the great forest of GRID, up the steep slope of ANODE RESISTANCE, ceasing not until they were deposited on the great plain of PLATE. And there they did rebuild their camp, as they were weary and did hunger and thirst.

But presently there came an inhabitant of PLATE, an aged atom of MOLYBDENUM, renowned for his sagacity and piety throughout all the land. As he drew nigh unto the ELECTRONS he spake thus: "There lieth but a few days' journey distant a great city in a land flowing with ELECTROLYTE and AMPERES and CUR-

RENT." And the ELECTRONS, knowing this to be their birthplace, made haste and journeyed without ceasing.

But lo! in their path stood a great mountain called the ANODE LOAD. Now there were two paths over this mountain, one steep and rocky, passing over the top and the other wide and smooth at its foot. And the two paths were known as INDUCTANCE and CAPACITANCE.

Whereupon the evil ELECTRONS took the smooth path of CAPACITANCE. But presently they came to the great precipice of DIELECTRIC, and they could not pass. Then sprang up a mighty tempest known as the TANK-CIRCUIT OSCILLATORY CURRENT which swept the evil ELECTRONS against the precipice time and time again. But still they could not pass, as it allowed no ADMITTANCE. And there they remain even unto this day.

Now the good ELECTRONS took the rocky path of INDUCTANCE, and it came to pass they were attacked by a great army of warriors known as MAGNETIC LINES OF FLUX. Thereupon the ELECTRONS cried out unto their ruler of POSITIVE POTENTIAL, and he did hear their supplications. And so he blessed them with KINETIC ENERGY, and on that day there collapsed many thousands of MAGNETIC LINES OF FLUX.

And presently they drew nigh unto the great city of HIGH-VOLTAGE BATTERY where they were received with great rejoicing. And the ruler of POSITIVE POTENTIAL spake unto them: "My children have been returned unto me unharmed, let there be a great feast." Whereupon many CURRENTS of AMPERES and atoms of ZINC were slaughtered and many vessels of ELECTROLYTE made ready.

But afterwards, the ELECTRONS having eaten and drunk to SATURATION, they dispersed throughout the city, destroying many vessels of ELECTROLYTE, killing many atoms of ZINC, and POLARIZING the rest with fear. And the ruler of POSITIVE POTENTIAL was exceeding wroth and condemned them to be driven from the city.

And so they wander, even unto this day. Here endeth the lesson.

Robot operator devised by engineers of station WHBF, Rock Island, Ill., virtually eliminates program interruptions on both AM and FM channels. The robot automatically turns on an auxiliary transmitter and switches program to it if the main transmitter breaks down. The switchover, which involves about 20 operations, is made by the robot in 20 seconds. Manual switchover normally requires about two minutes.

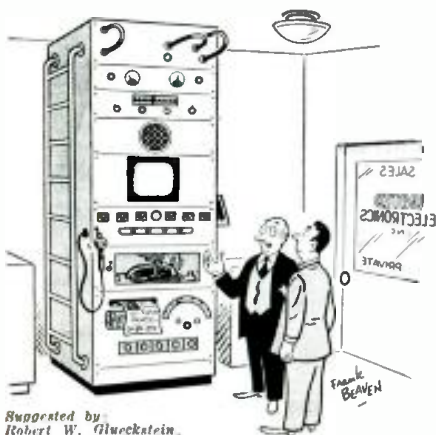

Suggested by Robert W. Gluckstein, Menominee Falls, Wis.

"Our answer to the limited floor space problem for radio-phono-TV combination.

JUNE, 1949

UNIVERSAL SAVES U 50%

UNIVERSAL TROUBLE SHOOTER—Locates every service trouble. Does everything and guaranteed to do everything we say it will. Aligns ladder. Locates dead spots, weak spots, defective parts. Checks gain. All parts including case. Test leads plus 4 1/2"x5" x 2" Ship wt. 2 lbs. **\$3.95**

INDUCTANCE TUNER for TELEVISION & FM front end 2 gang, individually isolated coils. 17 turns silver wire on a ceramic form, per gang. Fully shielded W1 driver. FM and both Television bands with circuit diagram. Ship wt. 2 1/2 lbs. **\$4.25 ea.**

PHONO OSCILLATOR 2 TUBE KIT If you know value, this is it! Orders come from Maine to Miami, Sandy Hook to San Francisco. Hi gain with microphone jack and all parts included. 1 g. tubes. Ship. Wt. 2 lbs. **\$2.95 ea.**

25 WATT P.P. 6L6 Hi Gain AMPLIFIER KIT A wonderful buy! Make up an amplifier worth \$50 to you. Powerful enough for auditoriums seating 1500 people. Separately controlled Mike & Phono inputs. All parts, incl. drilled chassis, hardware, solder, etc. Suit diagram, etc. Test tubes, Ship. wt. 12 lbs. **\$11.95 ea.**

PRICES NET F.O.B. OUR PLANT. Write for FREE data circuits designed by ROBT. G. HERZOG.

Universal general corp

365 J CANAL ST. N. Y. 13,
Walker 5-9642

GREYLOCK RADIO TUBE BARGAINS!

GT, Glass and Miniature Types

1K5	3S4	6SA7GT	12SJ7GT	} 39¢ each
1S5	3V4	6SJ7GT	12SK7	
1T4	6AT6	6SK7GT	12SQ7	
1U4	6BA6	6SQ7GT	25Z6GT	
3Q4	6BE6	12SA7	25L6GT	

6AK5 } 49¢ ea. 6BG6G } 89¢ ea.
6AG5 }
6J6 }

2E24 \$1.89

All tubes in individual cartons
TERMS: Net C.O.D., F.O.B. NYC. MINIMUM ORDER \$5.00. Write for Bargain Catalog C-6

Greylock Electronics Supply Co.

30 Church Street New York 7, N. Y.

GOVERNMENT SURPLUS!
WORLD'S LOWEST PRICE

PHOTO FLASH EQUIPMENT



COMES COMPLETE WITH 4 EDGERTON FLASH TUBES & REFLECTORS

EASY TO CONVERT INTO A 2-WAY PHOTO FLASH UNIT OPERATES ON 110V. AC & 12V. BATTERY

Brand new at a fraction of original cost. Contains finest component parts available. All necessary parts and complete instructions included. After conversion, works on 110V AC or 12V battery by a flick of a switch.

\$68.

Immediate delivery on all mail orders. COMPLETE

CINEX, INC., 165 W. 46th St., N. Y. 19, N. Y., Dept. REG

\$3.00 FOR CARTOON IDEAS

RADIO-CRAFT prints several radio cartoons every month. Readers are invited to contribute humorous radio ideas which can be used in cartoon form. It is not necessary that you draw a sketch, unless you wish.

FEDERATED Terrific SPEAKER VALUES!

JENSEN "CONCERT" SERIES



MODEL A12-PM

Heavy-duty, highly efficient, 12" speaker. Widely recommended for PA and high-quality radio-phonograph use. 8 ohm voice coil, 18 watts power

rating. Made to sell for more than twice this special low price. Comes less transformer, but provides for easy attachment. **\$14.95**

MODEL H12-PM

This fine 12" speaker is very similar to the one described above. Designed so that it may be used in Jensen "Bass Reflex" cabinets. 8 ohm voice coil, 14 watts rating. Comes with output transformer, Push-Pull 6V6's. Sensational buy.



\$11.95

JENSEN Q8P TWEETER

Heavy-duty, PM type. Reproduces 4000 to 15,000 c.p.s. when used with suitable dividing network. 16 ohms impedance. 5 1/2" overall diameter. 3 3/8" deep. Only.....



\$2.95

GE GD650



Famous 6" GE speaker featuring Aluminum Foil voice coil and Alnico 5 Permanent Magnet. Excellent for replacement use. Has "big speaker" quality.

\$1.98

RCA 12" PM SPEAKER



12 watt capacity. For replacement and PA use. 2.15 oz. Alnico 5 magnet. Special.....

\$3.75

Same, but with extra heavy, 4.64 oz. Alnico 5 magnet..

\$4.49

RCA 2" x 3" SPEAKER

Genuine RCA oval midget speaker for portables, intercoms, etc. Excellent sound quality.

79¢



STORAGE BATTERY

Brand new, Willard Storage battery. Delivers 2 volts.

\$1.25

Please include 25% deposit with order. Balance COD. Minimum order \$5. Dept. C-6.

Federated Purchaser
 INCORPORATED
 NEW YORK CITY ALLENTOWN, PA.
 80 PARK PLACE 1115 HAMILTON ST.
 Digby 9-3050 Allentown 3-7441

TUNING TV LINES

For a variety of reasons the impedance of the antenna transmission line rarely matches the input of the television receiver exactly. One of the simplest methods of tuning out the reactive element which results is to shunt the line at a strategic point with capacitance.

This can be done without cutting the ribbon lead or making any connection to it. Wrap a short piece of tinfoil around the lead a few inches from the receiver and place a paper clip over it to keep it in place.

Tune in the station whose signal needs the most improvement. Then slide the tinfoil along the line until the picture improves noticeably. Usually the point of improvement will be fairly sharp and moving the foil away from it in either direction will make the pic-

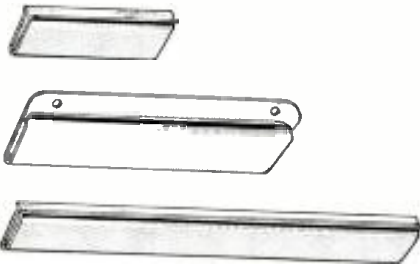

These little units remove the standing-wave "kinks" from the standard 300-ohm lead-in.

ture poor again. Simply leave the foil at the best point on the line.

The Sig-Max, a commercial unit which does the same job as the tinfoil, is shown at center in the drawing. Made by Telecite Television Corp. of East Islip, N. Y., it is a folded piece of metal about 4 inches long which slips over ribbon line. It is slid up and down until a point of best reception is found, then left in place.

The Tenastub, made by Crystal Devices Co., Inc., Freeport, N. Y., functions along the same lines. It is shown in the same illustration. The Tenastub is furnished in three lengths, approximately 6, 3 1/4, and 2 inches. The longer strip is slid along the transmission line first for a point of maximum picture brightness. The improvement takes place over a fairly broad band of frequencies. Next, the 3 1/4-inch unit is adjusted. This gives further improvement in a narrower band. Finally, if necessary, the shortest Tenastub is used for greater improvement in a still narrower band.

Small fasteners are available to slip over the open side of the Tenastub, giving the effect of a closed loop around the transmission line. In many cases, this aids reception still further, sharpening the picture noticeably.

POLISHING CLEAR PLASTIC

Scratches may be removed from plastic meter faces, dials, and other transparent plastics easily. Simply rub Bon-Ami briskly over scratch and finish with a fine buffer. Polish with Glass Wax to obtain original luster.—Lawrence Roeshot.

Low **FACTORY-TO-YOU** Prices

New! MIDWEST TELEVISION

with **BIG 75 Square Inch SCREEN**

- 12 1/2" PICTURE TUBE
- 12 TELEVISION CHANNELS
- PICTURE-HOLD CONTROL

EASY TERMS

Other Models Include: **SYMPHONY GRAND AM-FM RADIO-TELEVISION-PHONOGRAPH with DUAL-SPEED RECORD PLAYER**

Also complete CHASSIS for Custom Installation—and Adapter Chassis and Complete for use with 1947, 1948, 1949 and most Radio Models

FACTORY AUTHORIZED SERVICE in all TELEVISION AREAS

30 DAYS TRIAL

Also **Sensational NEW MIDWEST RADIOS with DUAL-SPEED Phonograph**

Send for TELEVISION Folder, Prices and NEW 1948 MIDWEST RADIO Catalog

MIDWEST RADIO & TELEVISION CORP.
 Dept. T-38A, 909 Broadway, Cincinnati, Ohio

Name _____
 Address _____
 City _____ Zone _____ State _____

RADIO & TELEVISION CATALOG FREE!

BIG SAVINGS

on kits, sets, parts and accessories! 148 pages of values in sound and electronic equipment for professionals and amateurs. **ONE YEAR TO PAY!** Send penny postcard with your name and address to:

NEWARK ELECTRIC CO., Dept. F-1
 242 West 55th Street, New York

N.Y.C. STORES: 115 W. 45th St. & 212 Fulton St.
CHICAGO STORE: 323 West Madison Street

PEN-OSCIL-LITE

Extremely convenient test oscillator for all radio servicing; alignment • Small as a pen • Self powered • Range from 700 cycles audio to over 600 megacycles u.h.f. • Output from zero to 125 v. • Low in cost • Used by Signal Corps • Write for information.

GENERAL TEST EQUIPMENT
 38 Argyle Ave. Buffalo 9, N. Y.

SERVICEMEN'S RADIO PARTS KITS

100 Asst. Insul. Res. \$1.48	20 Asst. Knobs	\$.89
10 Asst. By-Pass	1 Lb. Asst. Radio Hdw.	.25
20 Asst. Trimmers	15 Asst. Sockets	.69
25 Asst. Micac.	10 Asst. Elect. cond.	2.69
10 Asst. Vol. Controls	20 Asst. Term. Strip	.69
1 Lb. Asst. cut wire	20 9" length Soap	.15

Buy All Above Kits for \$9.75. Enclose Postage. **DONGENE FM-AM 13-TUBE TUNER. Complete Ready to Operate** \$39.95

88-108 Mc—\$50-1600 Kc. \$39.95

REMIT IN FULL FOR FAST DELIVERY

RADIO MAIL ORDERS

2 W. Broadway Dept. RE N. Y. 7, N. Y.

THE DANGEROUS MALE

A good number of manuscripts on construction projects which are submitted to RADIO-ELECTRONICS include a detachable 117-volt power cord or cables of one sort or another carrying power. Frequently we find that an experimenter has terminated a cord at one end with a male plug, and connected the other end to a source of voltage.

Consider what may happen. If every plug is in its socket, with no prongs exposed, all is well. But if (a) the power is turned on or the a.c. plug is inserted in a wall socket with the male on the other end of the cable not plugged in, or (b) the plug pulls out of the chassis during operation, someone may touch the exposed power contacts and get a nasty (or fatal) shock. Or a short to ground may destroy valuable equipment.

There is a very simple but extremely important rule to follow in all except the most unusual cases:

If any harmful voltage may appear at a connector when it is not plugged into its mate, that connector must be a female.

Manuscripts which do not follow this rule are changed, wherever it is possible, before publication. However, the fact that so many authors show unsafe connectors indicates that a far greater number of radiomen who are not authors may do the same thing.

It's undoubtedly just habit—chassis-mounting connectors are usually females and cable-end units are usually males. But don't let habit get you into trouble. Be smart and be safe!

MILLIONS WANT TV

The number of prospects to whom television receivers might eventually be sold was put at 16.6 million last month by Frank Mansfield, Director of Sales Research for Sylvania Electric Products, Inc. Of these, three out of four families have purchased, intend to purchase, or are favorable toward television.

These figures are some of the results of a survey on "Attitudes of Non-Owners of Television" made recently by Sylvania. The interest in TV represents an increase of about 70% over that of 1945, when less than half of the families in TV areas were favorably disposed.

The survey revealed that at least 1.58 million sets will be purchased in 1949 but that as many as 2.71 million might be sold if the industry improves its sales techniques. A part of the probable failure to attain the maximum figure is attributed to confusion over pricing, frequencies, and screen size.

While only 16% of the people in television areas had actually seen a telecast in 1945, 89% indicated they had watched the screen in the current survey, confirming the tremendous gains the medium has made. What is more

(Continued on next page)



"TENN-ALIGNER" is amazingly easy to use—no long leads or connections—leaves both hands free for antenna manipulation

One man TV installation now easy, quick, positive



When more than one man is on the installation the extra set of headphones plugs into the "downstairs" cabinet for two-way communications without the necessity of a separate transmission line.

THE NEW McMURDD SILVER "TENN-ALIGNER" works on the audio or video carrier, and makes it possible for one man to quickly and surely match and orientate even the most complicated antenna systems on all TV channels.

Simply place the cabinet pick-up unit near the receiver. Connect the antenna lead-in to the back plate terminals. Run a short piece of the same transmission line from the cabinet to the antenna terminals of the set. Switch the receiver to the desired channel, and tune in the test-tone, video carrier or music/speech being transmitted. No separate line is required between the set and roof positions, as the transmission line itself serves both as antenna lead-in, and dual communication link.

Clip the special headset across the transmission line connection at the antenna to actually hear the re-transmitted signal. This "upstairs" unit has been designed to allow full freedom of the hands at all times. Extra trips between roof and set are now unnecessary. Since the measurement is aural, the ratio of received signal to noise may be easily observed, and no misleading effects can exist.

See this amazing "TENN-ALIGNER" at your favorite jobber today. Model 914 complete for one man operation is only \$23.95 net.

Special lip mike and extra head set for two-way communication \$11.00 net.

Look to McMURDO SILVER for the NEWEST in TV Service Equipment

<p>Send for Catalog See these and other McMurdo Silver LCETI instruments at your favorite jobber.</p>	<p>OVER 37 YEARS OF RADIO ENGINEERING ACHIEVEMENT</p> <p><i>McMurdo Silver Co., Inc.</i></p> <p>EXECUTIVE OFFICES: 1240 MAIN ST., HARTFORD 3, CONN FACTORY OFFICE: 1249 MAIN ST., HARTFORD 3, CONN</p>
---	--

TELEVISION PARTS!!

Our new catalog lists hundreds of new television items; sets, parts and accessories at unbelievably low prices. Write today—it's free!

TELEVISION TRANSFORMER

Pri. 115 Volts 60 Cycles Sec. 2500 Volts @ 2 ma.: 6.3 Volts @ .6A.: 2.5 Volts @ 1.75A
PRICE \$3.85

MODEL NFRD—RADIO NOISE FILTER

if it doesn't work, send it back!!

We absolutely guarantee that our Model NFRD will eliminate all line noises when properly connected to radios, television sets, short wave sets, motors, electric shavers, refrigerators, vibrators, oil burners, transmitters, and all other sources of interference. This unit will carry up to 12 amperes or 1/4 KW of power and may be used right at the source of interference or at the radio.

Small size only 3"x1 1/2"x7 1/2".
Very low price only **EACH \$1.95**

Pre-Aligned TELEVISION KIT

Similar to Famous RCA 630TS and 830TS Circuits. Complete 12 Channel Tuning. 30 RCA Tubes, including rectifiers and Video. New, improved daylight viewing.

Built-in power for picture tubes, up to 16 inches. PM speaker with Choke (Better tone and volume—no hum). Special mounting bracket for 16" tube available. Simplified step-by-step instructions. 6 Full scale lithographed blueprints. All hardware and wire supplied. Exceptional Long Range reception. All components mounted to chassis.

\$168.50
less PICTURE TUBE

- TV cabinet to match \$42.50
- Bracket to mount 12" tube .75
- Bracket to mount 15" or 16" tube 3.00

—TELEVISION COIL ASSEMBLY.

Consists of a set of 5 slug-tuned coils mounted on a bracket 4 1/4" x 1 1/8" and which can be resonated in the frequency range 21-29 mc. This unit can be disassembled readily to make up a Television stagger tuned Video I.F. Amplifier.

Our **PRICE ONLY \$.35**

INTERCOMMUNICATION SYSTEM

A low priced system for executives, professionals or home use. Consists of a master station and one remote. Simple to operate, simple installation. Neat, rugged, beautifully finished wood cabinet, will fit anywhere. Complete with tubes—ready to operate. Ideal for use as Radio Baby Nurse.

Price \$13.95

SPECIAL! SPECIAL!

Mammoth assortment of radio and electronic parts, not less than TEN POUNDS of such items as transformers, chokes, condensers, resistors, switches, coils, wire, hardware, etc. A superbuy for experimenters, servicemen, and amateurs for only **\$1.25**

Satisfaction guaranteed on all merchandise. All prices F.O.B. New York City

WRITE FOR FREE CATALOGUE T6

RADIO DEALERS SUPPLY CO.

154 Greenwich St. New York 6, N. Y.

TUBES - TUBES

TERRIFIC VALUES! Stock up now at up to 80% off list! Perfect condition. **GUARANTEED 90 DAYS!** Unsealed cartons.

39¢	27 35/51 39 44 ea 77	80 85 89 5Y3	6A4 6A7 6H6 6K7	6X5 12SK7 35Z5	
	01A 10 24 41 42 46 50 78 84 1A7 1LA6 1LH4 JQ5	5T4 5U4 5Y4 6Z4 6A3 6AB 6AC7 6B7 6C5 6D6 6E5 6F3 6F6	6G5 6J5 6J7 6K6 6SA7 6S07 6SF5 6SG7 6S17 6SH7 6SK7 7A4 7A7	7A8 7B3 7L6 7B7 7C5 7C6 7C7 7G7 7H7 7V7 7Y4 12SA7 12S17	49¢ ea

TUBE CARTONS

MINIATURE (1 1/2"x1 1/2"x3 1/2")	Per 100	\$0.98
GT SIZE (1 1/2"x1 1/2"x3 1/2")	Per 100	1.25
MEDIUM (1 1/2"x1 1/2"x4 1/2")	Per 100	1.49
LARGE (2"x2"x5")	Per 100	1.79



PORTABLE DC AMMETER O-15 AMPS

COMPLETE WITH INSTRUCTIONS FOR EASY CONVERSION TO A MULTI-TESTER (AC & DC volts, Resistance and milliamperes.)

3 1/2" mirror scale; knife edge pointer. 12.5mm movement. Perfect as is for testing electrical appliances, battery charging, motor work, automotive, industrial and medical apt. INSTRUCTIONS with 30" clip test leads and black crinkle metal lined lid carrying case. BRAND NEW! Slight wt. 8 lbs. THE "SANS" SOLD AT TWICE THIS LOW PRICE or only **\$3.95**

Min. order \$2.00. 20% Deposit Req. on all C.O.D.'s. Please add sufficient postage-excess-refund.

LEOTONE RADIO CO.
67 Dry Street, New York 7, N. Y.

S-T-R-E-T-C-H

YOUR DOLLARS WITH THIS BIG 180 PAGE **FREE CATALOG**

TELEVISION, ELECTRONIC PARTS, HIGH-FIDELITY RADIO, HAM GEAR, PUBLIC ADDRESS EQUIPMENT, PARTS AND WORKSHOP TOOLS

Write today for the 1949 Lafayette-Concord catalog. A penny postcard will do the trick. You'll find pages and pages of the finest equipment at new, low prices. Use the catalog to order everything you need and save both time and money. You'll like shopping from this mammoth bargain guide.

Write for your copy today. It's free!

LAFAYETTE-CONCORD

World's largest radio supply organization

LAFAYETTE-CONCORD, Dept. JF-9, 100 Sixth Avenue, New York 13, 901 West Jackson Blvd., Chicago 7

FREE!

Please rush free catalog No. 89

Name.....

Address.....

City.....Zone.....State.....

important from a sales angle, 91% of the total families contained at least one member who is favorable to television.

The survey results include exhaustive breakdowns of the percentage of people who do and do not want to buy—now or in the future—and why. For instance, 4.6 million families are interested in buying, but only 2.7 million are likely to buy this year. Those who mean to delay say they will do so because they believe prices are too high, that there are not sufficiently varied programs, or that programs are not good enough.

One interesting point is that the largest number of potential prospects—77%—earn less than \$100 a week. This, according to Sylvania, places the future of TV with the great middle-income or mass market. The figures should explode forever the myth that television is or could ever profitably be a luxury item.

Radio Thirty-Five Years Ago

In Gernsback Publications

HUGO GERNSBACK

Founder

Modern Electrics	1908
Electrical Experimenter	1913
Radio News	1919
Science & Invention	1929
Television	1927
Radio-Craft	1929
Short-Wave Craft	1930
Television News	1931
Wireless Association of America	1908

Some of the larger libraries in the country still have copies of ELECTRICAL EXPERIMENTER on file for interested readers.

JUNE 1915

ELECTRICAL EXPERIMENTER

- How to Build a Telegraphone, by Samuel Cohen
- The Gripenberg Selenium Cell, by Samuel Wein
- A Mercury Break Wireless Key, by H. C. Graham
- A New Type Sending Helix, by J. H. Alden
- Intensifying Radio Signals, by H. Secor
- Spectacular Discharges and Large Tesla Coils
- "Electrical Dog" Follows Beam of Light
- The Fessenden Brooklyn Radio Station
- The Kolster Radio Decrometer
- A Commercial Type Helix
- Variation of Strength of Radio Signals
- Improvements on Detectors
- The Perikon-Electra Detector

PRIVATE TV FOR JUNIOR

The major interests of the nation are often mirrored in the children's toys, as witness the large sales of toy guns, tanks, and airplanes during the war. The latest indication of television's widespread importance is Junior's Television, manufactured by Junior's Television Co., Inc., New York. Making use of one of the oldest forms of home entertainment to imitate the newest, the unit consists of a lantern-slide projector and a special translucent screen. The screen is mounted in a frame on which "controls" are pictured and which, in general, looks like the front of a television receiver.

HALLICRAFTERS T-54 and 505
 Insufficient picture height may be caused by low plate voltage on the 12SN7 vertical oscillator. In two cases this was traced to the 1.5-megohm plate load resistor R78 changing its value. Replace this resistor with a good 1.5-megohm unit with a 1-watt rating.
GUY NAYLOR,
 Baltimore, Md.

RCA 630TS, Crosley 307TA
 High voltage failure in these and other sets with similar horizontal circuits may be caused by poor 6SN7's in the horizontal discharge circuits. Such tubes often test good in emission-type testers, but their quality may be checked more definitely by measuring the plate voltage on the tube. The normal voltage is -37 volts. (Yes, minus 37!) If the voltage swings positive, the tube is bad.

PRESCOTT R. DOW,
 Woburn, Mass.

MAJESTIC 7P420
 Frequent tube burn-out in this three-way portable can be caused by a gassy 50B5. When this set is operated on a.c., the filament voltage for the battery-type tubes is supplied by the cathode current of the 50B5. High cathode emission will result in abnormally high voltage across the filament string. Replace the 50B5; then check the voltage across each tube to make sure that it is normal.

E. V. SCHWARTZ,
 Los Angeles, Calif.

The Book that takes Drudgery out of Mathematics

Only **\$1.** postpaid

SOLVES EVERYDAY PROBLEMS HELPS YOU GET AHEAD IN LIFE

How many times have you lost money because of a mistake in figuring? Do you know how to figure quickly and correctly? Can you figure discounts, interest rates, taxes and all the other calculations you meet up with in your daily life?

Are you having trouble qualifying for Civil Service Exams or Armed Services Promotions, because you're not up on mathematics?

Here is the book that gives you a good background in mathematics; that takes all the irritation and drudgery out of it. You don't need to be scared of mathematics, because here's the subject explained without frills, without useless computations. Here's the book for men in radio jobs; for business men; technicians and craftsmen, explaining and answering everyday mathematic problems in easy-to-understand words and illustrations.

Yes, it's the key to a simple understanding of mathematics. It's a real home-study course in mathematics for the man who's alert to its importance in the world today.

ELEMENTARY MATHEMATICS
 ● EASY — SIMPLIFIED — PRACTICAL ●

CONTENTS OF BOOK

CHAPTER I. Arithmetic — Addition — Subtraction — Multiplication — Division.

CHAPTER II. Factoring and Cancellation — Fractions — Decimals — Percentage — Ratio — and Proportion.

CHAPTER III. The Metric System.

CHAPTER IV. How to Measure Surfaces and Capacity (Geometry).

CHAPTER V. Powers and Involutions — Roots and Evolution.

CHAPTER VI. Mathematics for the Manual and Technical Craftsman — Thermometer conversions — Graphs or Curve Plotting — Logarithms — Use of the Slide Rule.

CHAPTER VII. Special Mathematics for the Radio Technician.

CHAPTER VIII. Commercial Calculations — Interest — Discounts — Short Cut Arithmetic.

CHAPTER IX. Weights and Measures — Useful Tables.

ONLY **\$1.** POSTPAID

Send Stamps, Cash or Money Order.

Send Today for Your Copy of This Indispensable Book. It Can Be Arrived Ready in Your Pocket. (Star 6 x 9 in.)

TECHNIFAX
 110 N. Franklin St., Chicago 6, Ill.



SERVICE Television AND RADIO WITH THIS MODERN SERVICE UNIT

TELEVISION and FM radio present un-limited opportunity for service PROFIT . . . Your profits and service require the best equipment . . . SER-V-LUX.

*Custom built instruments available for all types of service . . . or, unit can be supplied with blank panel.

Write for bulletin D



SERVELUX
 MANUFACTURING CO.
 39th and Buchanan Ave.
 GRAND RAPIDS, MICH.

TRANSFORMERS AND CHOKES
 115V 60CY. INPUT EQUIP. Conservatively Rated

2.5V CT 6.5A, 1780 RMS	\$3.25
2.5V 3A, 7V, 7.5 2380 Test	24.00
6.3V ZACT, 6.3V ZACT	2.45
Fil. Trans. — 5V/70A	2.25
Fil. Trans. — 6.3V/100A, 6.3V/2A	1.85
Fil. Trans. — 6.3V/1A CT, 6.3VCT7A	2.75
Fil. Trans. — 5101; 6.3V/1A, 6.3V/1A, 6.3V/1A	2.31
Fil. Trans. — 5123; 6.3VCT/2A, 6.3V/1A	2.25
Fil. Trans. — 5127; 6.3VCT/2A, 6.3VCT/1A	2.25
Fil. Trans. — 7470/74; 8.1V/1A	2.95
Fil. Trans. — 6241/51; 2.5V/1.75A, 6.5V/8A, 5V/3A, 6.5V/3A	3.95
Plate Trans. — 1088; 192VCT/100MA	11.95
Comb. Trans. — 8069; 78V/60MA, 3.5V/Fil.	4.06
Plate Trans. — 15-34; 0: 800V/40MCT	6.95
700VCT 500MA	4.95
Plate Trans. — 5111; 300V/42MA, 300V/42MA	4.51
55V 125MA 45V 35MA	4.51
Telev. Trans. — 5102; 1080VCT 15MA; 6.3V/1.2A; 6.3V/1.2A	5.95
Comb. Trans. — C85608; 880VCT 150MA, 5V/3A	5.25
Comb. Trans. — K88931; 585VCT 80MA, 5V/3A, 6.3V/3A	4.21
Comb. Trans. — 5075; 925VCT 75MA; 5V/2A, 6.3V/1.8A, 10V/2A	4.45
Plate Trans. — 68689; 300VCT, 300VCT, Approx. 150 MA	2.25
Auto Trans. — 34438; 90V, 80V, 70V	2.25
Chokes — 03HY, 2A, \$1.25; 8.5 HV, 125 MA	1.50
Chokes — 23HY, 65MA, \$1.00; 6 HV, 150 MA	1.50
Chokes — Dual 7HY, 75MA; 11H, 60MA	1.65
Chokes — Dual 21HY, 100MA, 75c; Dual 2.5HY, 130MA	1.25
Chokes — 11HY, 150MA, \$4.25; 01HY, 2.5A	1.00
Chokes — 35HY, .35A, \$7.25; Dual 01HY, 350MA	1.00
Chokes — 7HY, 40MA, 55c; 2HY, 200MA	.75
Choke — Dual 120HY	2.45
Chokes — 5HY, 200MA, \$1.45; 2 1HY, 200MA	1.20

SEND FOR LISTS OF TRANS. & CHOKES

HIGH POWER RESISTORS

1000 Ohms	60W	IRC	Lugs	25c, 4 for \$0.95
10 Ohms	50W	W.L.	Ferrule	25c, 4 for 1.00
125 Ohms	20W	Glass	Ferrule	30c, 3 for .85
550 Ohms	20W	Glass	Ferrule	30c, 3 for .85
3300 Ohms	75W	Glass	Ferrule	45c, 3 for 1.30
600 Ohms	35W	Glass	Ferrule	30c, 3 for .85
700 Ohms	90W	Glass	Ferrule	70c, 2 for 1.35
1300 Ohms	18W	Ill.	Lugs	15c, 7 for 1.00
4000 Ohms	90W	W.L.	Lugs	20c, 5 for .95

Send for List of other values.

VIBRATORS

TR 1210, 12 vdc, 5 Pin	\$1.00 ea.
0.4K V-6675, 24-32 vdc, 7 pin	1.00 ea.
Mal. Type G35, 12 vdc, 5 pin	1.00 ea.
Mal. Type G629-C, 12 vdc, 4 pin	1.00 ea.
Radiaart R2, 6 v. DC, 6-Pin special	1.00 ea.

Mfrs. quantities in all types available.

BIRTCHEER TUBE CLAMPS

926-A, 926-A2, 926-B, 926-B2	\$3.00 MINIMUM ORDER
926-B5, 926-B33, 926-C	@ 12c ea.

OTHER TYPES AVAILABLE

★★★ SPECIALS ★★★

INTERPHONE CONTROL BOX
 Permits transfer of H.S. from receiver 4" x 4" wd. x 2" d. Controls JK 33A, JK 34A, Toggle Sw. Lum. Tlp. Pot. 50,000 Ohm Term. Strip.
 A Real Buy. Price **\$1.00**

BAND PASS FILTER
 #70173, Sharp band pass peaked at 700 cps. Bandwidth: 650 cycles at 20 db. Down from peak. High to high impedance. Can be plugged into phone output of receiver for good results. Cuts out QRM. New, with circuit diagram. **\$2.00**

NAVY LINE FILTER
 GE 100 Amp W/2x5 MFD 50V oil filled cond. 110 VAC. DC **\$1.98**

HEINEMANN CIRCUIT BREAKERS
 Can be used for AC and DC operation. Amperes .10, 3, 7, 10, 50, 100, 150. Special 10 for 13.25. Each **\$1.45**. 100 AMP 3 Pole 250V **6.95**

VOLTAGE REGULATORS

Leland 105 to 115 AMP 80V	\$2.95
Leland 22-30V/30A In, 18V 5.7 out 2.95	
Webster .1 to 3 AMP for K14H Gun-sight	2.85
Raytheon Pri. 92-138V/15A, 52-83V, Sec. 115V/7.15A, 82KVA, .96P.F.	99.50

UPRIGHT CAPACITORS

Fig.	Mid.	Voltage	Terminals	Mfrs.	Price
B	1	600VDC	2	Aer	35c. 3 for \$1.00
E	.25	400VDC	2	Solar	39c. 3 for 1.10
E	.5	600VDC	2	Micamold	39c. 3 for 1.16
D	2x.5	600VDC	3	Solar	49c. 3 for 1.45
B	3x.1	600VDC	3	Gudefman	55c. 2 for 1.05
B	.25	400VDC	2	Aerovox	39c. 3 for 1.10
B	.5	600VDC	2	Solar	35c. 3 for 1.00
B	.5	600VDC	2	Aerovox	35c. 3 for 1.00
E	1	400VDC	2	CD	55c. 2 for 1.00
E	.1	400VDC	2	Aero	40c. 2 for .75
B	.4	600VDC	2	Gudefman	39c. 3 for 1.10
D	.1	600VDC	2	Aero	45c. 2 for .85
B	2x.1	600VDC	2	Aero	50c. 2 for .95
E	1.75	400VDC	2	CD	35c. 3 for 1.00
D	3x.1	600VDC	3	Tube	55c. 2 for 1.05
A	2x.5	600VDC	3	Gudefman	49c. 2 for .95
B	.1	600VDC	2	Aer	45c. 2 for .85
B	.1	600VDC	2	Gudefman	45c. 2 for .85
D	1	500VDC	2	G. E. Pyr	45c. 2 for .85
B	1	500VDC	2	G. E. Pyr	45c. 2 for .85
B	.1	600VDC	2	G. E. Pyr	45c. 2 for .85

Send for Lists of other values.

OIL FILLED CONDENSERS

1-1 MFD	7000 VDC	\$3.27, 2 for \$6.50
.1 MFD	6000 VDC	\$2.60, 2 for 5.00
.5 MFD	1000 VDC	57c, 2 for 1.05
.5 MFD	2000 VDC	\$1.15, 2 for 2.25
2x.5 MFD	1000 VDC	95c, 2 for 1.80
1 MFD	1500 VDC	95c, 2 for 1.80
2 MFD	1000 VDC	67c, 2 for 1.30
4 MFD	1000 VDC	87c, 2 for 1.70
6 MFD	600 VDC	65c, 2 for 1.25
7 MFD	800 VDC	95c, 2 for 1.80
10 MFD	1000 VDC	\$1.75, 2 for 2.50
15 MFD	1000 VDC	\$2.25, 2 for 4.50

SEND FOR LISTS OF OTHERS

1619!! 1619!! 1619!!

Type 1619 vacuum tubes, octal based pentode. The most versatile high pervance tube at A New low price. \$2.1 ea. or 5 for **\$1.00**

INSTRUCTION MANUALS

Bc 312, Bc 342	\$1.25
SX 281	\$1.25
Mark II	1.00
SX-32	1.00

FREE! FREE! FREE!
CEC FLYER OF BARGAINS YOU NEED
 WRITE OR PHONE DIGBY 9-4124

COMMUNICATIONS EQUIPMENT CO.
 MANUFACTURERS. QUANTITIES AVAILABLE
 131 LIBERTY ST., N.Y. 7, N.Y., DEPT. C6, PHONE DIGBY 9-4124

932 PHOTO TUBE

This Tube is a Gas Phototube having S-1 Response, particularly sensitive to Red and Near Infrared Radiation. Can be used with incandescent light source. Send for Data. Price **\$1.25**

\$3.00 MINIMUM ORDER

SAVE

at **RADIONIC** the
House of Radio and Television Buys

- ▶ **TV RECEIVER** The famous RCA 630TS design 81 sq. in. picture, 30 tubes. Beautiful cabinet. **\$295**
- ▶ **TV ANTENNA** Hi-Lo freq. 2 dipoles with reflectors. 8 ft. steel mast. Hardware brackets, insulators, complete.....**\$7.25**
- ▶ **TRANSFORMER** RCA model. 400V @ 200 ma., 6.3V @ 4A. 5V @ 3A. Shell type, universal mounting. Shpg Wt: 9 lbs.....**\$3.95**
- ▶ **SPEAKER** Genuine RCA, 10 watt, 12" speaker. Powerful Alnico V magnet. 3.2 ohm voice coil. New. Beautiful design.....**\$3.95**

TUBES Standard brands up to 80% off. Send for list

RADIONIC EQUIPMENT COMPANY

Triune Theater Entrance
170L Nassau Street New York 7, N. Y.
WORTH 3-0421 Open daily 9 to 6--Saturday 9-5

FREE! MAIL TODAY!
GET YOUR COPY AT ONCE!
of RADIONIC'S Bargain Catalog, Radio & Television Sets--Parts--Accessories. Unbeatable Values!

RADIONIC EQUIPMENT CO. Dept 106
170L Nassau Street, New York 7, N. Y.

Please rush Free Copy of your latest Bargain Catalog of Radio and Television Sets, Parts, Tubes and Accessories.

NAME _____
ADDRESS _____ STATE _____
CITY _____

\$139 PHONO AMPLIFIER

2 Tube AC-DC
3 at \$1.25 2 tubes—50L6—35Z5 \$1

PHONO OSC—2 TUBE \$2.75
Uses 35Z5, 128A7, 2 tubes \$1.20

PHONO AMPLIFIER
3 Tube AC-DC **\$1.69**
3 at \$1.49

Volume and Tone Controls.
Uses 128Q7, 35Z5, 50L6.
Set of 3 Tubes.....\$1.35
Output Trans......32
5" Alnico Speaker.....1.10
6" PM Speaker.....1.45
2.50
ALLIANCE PHONO MOTORS
PICKUP \$1.79 HIGH OUTPUT PICKUP 1.99
ALL ABOVE WIRED & TESTED
\$1 Deposit on all orders. Free Catalog RE
RADIO MAIL ORDERS
2 W. Broadway, New York 7, N. Y.

SURPLUS HIGH SPEED DRILLS MICROMETERS

Chrome plated, precision engineered and carefully toolled to give long life. All new.

0-1" capacity . . . each \$2.25
1-2" capacity . . . each 3.50
2-3" capacity . . . each 5.50
3-4" capacity . . . each 6.50

All New Drills! Orig. value \$15.
30 assorted sizes and lengths \$3.50

SEND FOR FREE DESCRIPTIVE CATALOG
Send check, money order, or cash. 25% deposit required on C.O.D. orders. All prices F.O.B. Culver City, Calif.

AIRBORNE SALES CO., INC.

DEPT. RE
CULVER CITY, CALIF.

YOUR HOBBY DESERVES... PRECISION JEWELERS SCREW DRIVERS

Tinkering with your television set, or building your own radio set? For precision work of every type, these eight Jewelers Screw Drivers are perfect! Complete Set of Eight, from the smallest size 9 up to size 2. . . and they'll handle the most delicate job! Finest tempered steel blades . . . lowest price imaginable!

Only **\$2.00** COMPLETE Money-Back Guarantee If Not Satisfied

PINE WATCH CO. C.O.D. \$2 plus postage, or send \$2 and we pay postage.
29 Eldridge St., Rm. 40 Sth New York 2, N. Y.

Paul Ware has been elected head of the Electronics Parts Division, *Allen B. Du Mont Laboratories, Inc.*, of Passaic and Clifton, N. J., announces.

While associated with P. R. Mallory & Co. as consulting engineer (1935-39), Ware developed and patented a new method of inductance tuning which became the Mallory Inductuner, later incorporated in the Du Mont Inputuner under the Mallory-Ware patents. From 1925 to 1935, Ware was consultant for Splitdorf-Bethlehem, Sonora Phonograph, R. E. Thompson, and also for Monmouth Memorial Hospital, developing for the latter a hospital paging system. He has also engaged in the design and manufacture of radio sets for Macy's, Bamberger's, John D. Williams Export, and others.



Dr. F. Stanley Atchison has been appointed chief of the Missile Intelligence Section of the *National Bureau of Standards*, where he will investigate intelligence systems for guided missiles. Dr. Atchison has worked in nuclear physics, in design of radio proximity fuzes for bombs, rockets, and mortars, and in the design of electronic systems for guided-missile control at the National Bureau of Standards. In connection with the proximity fuze work, he was technical advisor to the Air Force in the Pacific theater during their first use of proximity-fuze bombs in the invasion of Iwo Jima.

Robert C. Tait, Pittsburgh banker, formerly of Rochester, is new president of the Stromberg-Carlson Company, Rochester, N. Y. He succeeds Dr. Ray H. Manson, president since 1945.

Roy Boscow has been named general sales manager of the Magnavox Company, Fort Wayne, Ind.

Dr. Paul Wang has joined the staff of the X-Ray Laboratory of the *National Bureau of Standards*, where he will do research in X-rays and nuclear physics, particularly betatron and high-voltage equipment. His present investigations include the design and development of a new type of ionization measurement equipment, X-ray-dosage research, and experimental verification of modern theories of high-energy radiation.

John W. Utecht has been appointed to the staff of the *National Bureau of Standards*, where he will be concerned with development of new electronic ordnance devices and related equipment in the Ordnance Engineering Laboratory. Mr. Utecht has done research on VT proximity fuzes for projectiles, rockets, and bombs. He has also conducted investigations leading to improved design and development of solenoids, shaded-pole motors, gear trains, and turbine wheels and blades.

HARD-TO-GET PARTS

POWERFUL ALL-PURPOSE INDUCTION MOTOR

IDEAL FOR EXPERIMENTERS—101 USES

Sturdily constructed to precision standards, this self-starting shaded pole A.C. induction motor is powerful enough for a number of uses. Some of these are: Automatic Timing Device, Current Interrupters, Electric Fans, Electric Times, Window Displays, Photocell Control Devices, Electric Vibrators, Small Grinders, Buffers and Polishers, Miniature Pumps, Mechanical Models, Sirens, and other applications.

Consumes about 15 watts of power and has a speed of 3,000 r.p.m. When geared down, this sturdy unit will constantly operate an 18-inch battery-loaded

with 200 lbs. dead weight—THAT'S POWER!
Dimensions 3" high by 2" wide by 1 1/2" deep; has 4 convenient mounting studs; shaft is 3/16" diameter, and runs in self-aligning oil-retaining bearings. Designed for 110-20 volts. 50-60 cycles, A.C. only. Shp. Wt. 2 lbs.

ITEM NO. 147
YOUR PRICE..... **\$1.95**

ULTRA MAGNET

LIFTS MORE THAN 20 TIMES ITS OWN WEIGHT

LITTLE GIANT MAGNET
Lifts 5 lbs. easily. Weighs 4 oz. Made of ALNICO new high-magnetic steel. Complete with keeper, most powerful magnet ever made. The experimenter and hobbyist will find hundreds of excellent uses for this high quality permanent magnet. Measures 1 3/4 x 1 1/2". Shp. Wt. 2 1/2 lbs.

ITEM NO. 159
YOUR PRICE..... **\$1.25**

GENUINE MICROPHONE TRANSMITTERS

KELLOGG
Regular telephone transmitters taken from a large telephone supply company's overstock. Work perfectly on dry cells. Can be used on P. A. systems, caravans, intercommunications sets, short-line telephone circuits, house-to-house or farm-to-farm phone lines, also to talk through your own radio or as concealed dictaphone pick-up. Useful replacements on battery-operated rural telephone lines.

THESE ARE GENUINE TRANSMITTERS, MADE BY KELLOGG, WESTERN ELECTRIC AND STROMBERG-CARLSON, excellent in appearance and operation. A remarkable value and one seldom offered in these times. Shp. Wt. 1 lb.

ITEM NO. 160
YOUR PRICE..... **\$1.95**

WATT HOUR METER

Completely overhauled and ready for immediate service. Designed for regular 110-volt, 60 cycle 2-wire A.C. circuit. Simple to install; 2 wires from the line and 2 wires to the load. Sturdily constructed in heavy metal case. 8 1/2" high, 6 1/4" wide, 5" deep. Westinghouse, G. E. Fort Wayne, Bangamo or other available make. Shp. Wt. 1 1/2 lbs.

ITEM NO. 33
YOUR PRICE.... **\$5.95**

AMAZING BLACK LIGHT!!

Powerful 50-Watt Ultra-Violet Source

The best and most practical source of ultra-violet light for general experimental and entertainment use. Makes all fluorescent substances brilliantly luminescent. No transformers of any kind needed. Fits any standard lamp socket. Brings out beautiful opalescent hues in various types of materials. Sweet for amateur parties, plays, etc.; to obtain unique lighting effects. Bulb only. Shp. Wt. 2 lbs.

ITEM NO. 87
YOUR PRICE..... **\$1.95**

WESTERN ELECTRIC BREAST MIKE

This is a fine light-weight aircraft carbon microphone—weighs only 1 lb.

Mike comes with breastplate mounting and has 2-way swiveling adjustment so that it can be adjusted to any desired position. There are 2 woven straps; one goes around neck, the other around chest. Straps can be snapped on and off quickly by an ingenious arrangement.

This excellent mike can be adapted for home broadcasting on private communication systems. By dismounting breastplate, it can be used as desk mike.

Comes complete with 6-foot cord and hard rubber plug. Finished in spherulized plate, non-rustable. Shipping weight, 2 lbs.

ITEM NO. 152
YOUR PRICE..... **\$1.45**

HUDSON SPECIALTIES CO.

40 West Broadway, Dept. RE-6-49, New York 7, N. Y.

I have circled below the numbers of the items I'm ordering. My full remittance of \$..... (include shipping charges)..... is enclosed (10% required). Ship order C.O.D. for balance. NO C.O.D. ORDERS FOR LESS THAN \$5.00. BE SURE TO INCLUDE SHIPPING CHARGES.

Circle the No. wanted:
147 159 160 87 152 33

Name.....
Address.....
Please Print Clearly
City..... State.....

\$1,000 A MONTH



JUST ONE of the many plans in this book brought in over \$1,000 a month steadily from radio service alone. **How To Make More Money in Radio Service** is so full of the real-making plans it will amaze you. EVEN BEGINNERS using the easier plans made WAY OVER \$100 a week working from home. Why work for wages? Become your own boss and make more money. This book is making money for radio men everywhere: U.S.A., Canada, Puerto Rico, Mexico, So. America, Hawaii, Philippines, other countries. Letters of thanks come in continually.

—Book very helpful—following advice in the book earned high as \$100 a week radio repairing, in my apartment.

C. C. Seidler,
Brooklyn, N. Y.

In business 17 years. Book contains many things which took me many years to learn the hard way. Book worth many times its small cost.

P. V. Fugner,
Elmwood, Illinois

25 years' experience packed in 83-page book by Gale. Among MANY other things shows you where the money is and how to get it FAST. How to test sets without taking them out of cabinets and give estimates RAPIDLY. How much to charge. How much work to do on sets. How to start spare and build to full time. How to connect with big-money concerns. How to get plenty of customers QUICKLY.

HOW TO BUILD A MONEY-MAKING RADIO MAIL ORDER BUSINESS—another hit by Gale. 68 pages. Two easy-to-follow plans. Real opportunity to get in HIGH-PAYING business. Start spare or full time. How to start with other dealers' money and stock. How to work with customers' money. How to obtain sales items easily. How to handle your incoming cash, checks, money orders. How to make repeat sales. The secret of the chain and MANY other things. Millions \$\$\$ going in the mails. Get your share. The world is your market; you may reach it from attic, cellar, or apartment. There is MAGIC in your mail box. Learn to use it and start streams of cash, checks, and money-orders toward you from North, East, South, and West.

Price each book ONLY \$3 postpaid. C.O.D.'s in U.S.A. only, at \$1 plus few cents postal fee. Books shipped same day. You have NOTHING to examine. Book 5 days, if not positively delighted return it and we refund purchase price immediately. More information on books FREE.

MERIT PRODUCTS, DEPT. RE.

216-32 132 Avenue Springfield Gardens 13, N. Y.

telrex INC.
CONICAL ANTENNAS
America's Outstanding Television Beam

- ★ The DNE antenna for ALL channels (no high frequency head needed)
 - ★ Maximum efficiency on ALL channels
 - ★ 4 to 1 front to back ratio on all frequencies
- TELREX Conical Antennas provide the highest possible gain to the receiver—since the full strength of the signal (as received at the antenna) is carried to the set with negligible loss—and with a definite reduction in the strength of ghosts or reflections.

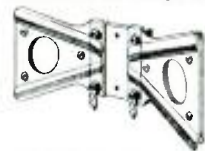

TELREX Conical Antennas are built better. Note this center clamp which provides such a strong grip over better than 3" of each rod surface. It is both a mechanical support and electrical contact second to none. And is only one of the features which result in improved and steadier pictures — from a better antenna — a TELREX.

AVAILABLE IN A VARIETY OF MODELS TO MEET ANY NEED
At your distributor or write

TELREX, INC.
ASBURY PARK 7, NEW JERSEY

George A. Ellinger, chief of the Optical Metallurgy Laboratory of the *National Bureau of Standards*, Dr. Charles Snowden Piggot, consultant to the Research and Development Board of the *National Defense Establishment*, and Dr. Robert Simha, consultant to the Division of Organic and Fibrous Materials of the *National Bureau of Standards* have been elected to honorary membership by the Society of Sigma Xi, national honorary scientific fraternity.

Lloyd Dopkins has become manager of direct accounts for Crosley Corporation with headquarters in Crosley's Radio City offices in New York. His activities are to be nation-wide in scope. Prior to joining Crosley, Dopkins was vice-president in charge of sales of Majestic Radio and Television Corporation. Active in the radio industry since 1923, he was with Crosley as a regional sales manager from 1939 to 1942.



Dr. John R. Pellam has been appointed to the staff of the *National Bureau of Standards*, where he will do research in the Cryogenics Laboratory. Dr. Pellam has conducted studies in ultrasonics and low temperature, including sound diffraction, absorbing materials, ultrasonic velocity and absorption, and liquid helium. In his present assignment, he will continue his investigation of the properties of liquid helium II.

William M. Piper has been appointed to the staff of the *National Bureau of Standards*, where he will do research in the Ordnance Mechanics Laboratory of the Electronics Division. Mr. Piper has designed and built electronic test equipment, including wide-range video amplifiers and high-fidelity public-address systems.

Charles A. Mabey, formerly Director of Research for the Bristol Company, has been appointed to the staff of the *National Bureau of Standards*, where he will supervise electronic miniaturization circuits and processes as assistant chief of the Engineering Electronics Laboratory. Mr. Mabey has done research on ultra-shortwave radio equipment, humidity measurement, industrial instruments, and automatic control apparatus.

C. S. Franklin has been awarded the Faraday medal for 1949 by the (British) Institution of Radio Engineers. The medal was given for his distinguished work in radio engineering, particularly in the development of the beam antenna and other devices which made high-frequency communication possible over long distances.

Mr. Franklin, whose name is best known in America as the originator of the Franklin oscillator, is a real pioneer of radio, having been one of the first group of engineers who joined the Marconi Company 50 years ago.

LEARN Electricity OR Radio-Television IN THE GREAT SHOPS OF COYNE



TRAIN QUICKLY!
OLDEST, BEST EQUIPPED SCHOOL OF ITS KIND IN U.S.
2 Opportunity Fields

Come to the Great Shops of COYNE in Chicago during our 50th Anniversary Year! Get quick, practical training in RADIO-TELEVISION or ELECTRICITY. 4 1/2 Approved Finance Plan for non-veterans. Mail Coupon Today for complete details.

NOT "HOME-STUDY" COURSES!
You learn on real, full-size equipment, not by mail. Finest staff of trained instructors to help you get ready quickly for a better job, a fine future.

FREE BOOKS Clip coupon for big illustrated Coyne book on either ELECTRICITY or RADIO-TELEVISION. Both books sent FREE if you wish. No obligation; no salesman will call. Act NOW!

B. W. COOKE, Pres.
COYNE Electrical & Radio School, Dept. A9-81H
500 S. Paulina Street, Chicago 12, Illinois

Send FREE BOOK and full details on:
 ELECTRICITY RADIO-TELEVISION
NAME.....
ADDRESS.....
CITY..... STATE.....

THE PRICES SPEAK FOR THEMSELVES

RADIO TUBES		Each	CONDENSERS	
				Per Hundred
50L6	Kenrad	55r	.001—	600V. \$3.95
35Z5	Kenrad	39	.002—	600V. 3.95
125A7	Kenrad	55	.003—	600V. 4.40
125K7	Kenrad	54	.005—	600V. 4.40
125Q7	Kenrad	49	.01—	600V. 4.40
35L6	Hytron	55	.02—	600V. 4.95
25L6	Stand. Brand	69	.03—	600V. 4.95
25Z6	Stand. Brand	49	.05—	600V. 4.95
65A7	Stand. Brand	49	.1—	600V. 7.20
65K7	Stand. Brand	49		Each
65Q7	General Elec.	39	.25—	600V. \$0.12
50B5	Sylvania	55	.5—	600V. .17
35W4	Hytron	39	10—	25V. .16
12AT6	Sylvania	49	10—	50V. .22
12BA6	Sylvania	59	16—	150V. .18
12BE6	Sylvania	59	20—	150V. .24
50A5	Sylvania	79	20/20—	150V. .26
35Y4	Sylvania	69	30—	150V. .28
14A4	Sylvania	49	40/20/20	
14A7	Sylvania	49	—	150V-25V .44
14B6	Sylvania	49	40/40/20	
14Q7	Sylvania	49	—	150V-25V .44
14R7	Sylvania	49	50/30—	150V. .44
35A5	Sylvania	79	4—	450V. .24
35Z3	Sylvania	79	8—	450V. .27
1A7	Stand. Brand	69	16—	450V. .36
1H5	Kenrad	59	16/16—	450V. .59
1N5	Stand. Brand	69	20—	450V. .39
1Q5	Philco	69	30—	450V. .47
1LA6	Sylvania	69	40—	450V. .59
1LD5	Sylvania	39	80—	450V. .97
1LC6	Sylvania	69	.005—	1700V. .13
1LE3	Sylvania	79	.008—	1700V. .15
1LM4	Sylvania	69	.01—	1700V. .17
117Z3	Tungsol	69	.02—	1700V. .19
117Z6	Sylvania	88	.05—	2500V. .58
6F5	Stand. Brand	49	.1—	2500V. .64
6F6	Westinghouse	59	.25—	2500V. .86
6A7	Westinghouse	69	.05—	3000V. .69
65C7	Kenrad	59	.003—	6000V. .57
65L7	Philco	59	.005—	6000V. .62
K55B	Hytron	29	.01—	6000V. .74
OZ4	Stand. Brand	69	.05—	6000V. .97
24A	Kenrad	69	.0005—	7500V. .58
47	Philco	79	.003—	7500V. .67
77	Nat. Union	39	.005—	7500V. .72
80	Stand. Brand	39	.0005—	10000V. .64

Send 20¢ deposit with order—Include Postage

BROOKS RADIO DIST. CORP.
80 VESEY ST., DEPT. A, NEW YORK 7, N. Y.

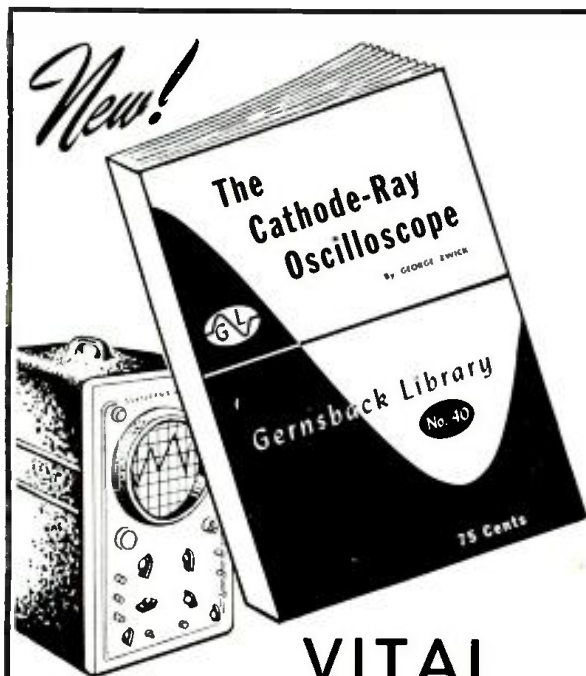

VITAL FOR TV SERVICING

A new and highly important book! Gives a complete understanding of working principles behind oscilloscope operation, and how to use the instrument effectively. Clearly written with a single purpose—to help you use and understand the oscilloscope. No man servicing television receivers can afford to be without this knowledge. Invaluable for anyone who uses the oscilloscope.

ALL ANGLES COVERED

Chapter 1—Direct Current and Alternating Current. Visual observation and measurement of varying voltages and currents on the cathode-ray tube. Chapter 2—How beam from electron "gun" projects image of current and voltage variations onto fluorescent screen, and how beam is deflected by electrostatic and electromagnetic means. Chapter 3—How signal deflects electron beam vertically in c-r tube and sweep voltage deflects beam horizontally. Role of the saw-tooth oscillator—the gas discharge tube—the multi-vibrator—synchronization—locking. Chapter 4—The cathode ray tube—accelerating and focussing power supplies—the sweep generator—the horizontal and vertical amplifiers—controls on oscilloscope—how to operate a scope. Chapter 5—Aligning TV i.f. channels—TV front-end alignment—Alignment of i.f. amplifiers in AM and FM sets. Use of signal generators—i.f. alignment of a.c. d.c. receivers—bandpass alignment—aligning the discriminator—the ratio detector—r.f. alignment of AM and FM receivers. Chapter 6—Audio output measurement—voltage gain—power output—audio response curve plotting—peak a.c. measurements. Checking saw-tooth amplifiers—magnetic deflection circuits—synchronizing pulses. Ham transmitter measurements—over and under modulation. Locating hum—incorrect adjustment of vibrator power supplies. Phase shift in audio amplifiers.

112 PAGES 103 ILLUSTRATIONS

Only 75c

See your jobber today or send for THE CATHODE-RAY OSCILLOSCOPE along with other titles in the GERNSBACK LIBRARY.

MAIL THIS COUPON NOW

RADCRAFT PUBLICATIONS Inc., Dept. 69
25 West Broadway, New York 7, N. Y.

Send me the books checked, postpaid.
 NO. 40 CATHODE-RAY OSCILLOSCOPE

I enclose \$..... 75c

Your Name (Print clearly)

Address

Jobber's Name

Address



Each of these books supplies usable information

No. 29—HANDY KINKS and SHORT CUTS. A carefully edited compilation of time savers. Kinks on antennas. Power Supplies. Test Equipment. Servicing in the Shop. Phonographs and Amplifiers. Cuts and Transmitters. Miscellaneous Subjects. 50c each.

No. 30—UNUSUAL PATENTED CIRCUITS, 1944-46. A gold mine in new hook-ups! A selection of unusual circuits, many a result of wartime research of great value to anyone interested in electronics. Control Circuits. Detectors and amplifiers. Power Supplies. Miscellaneous Circuits. Foreign Circuits. 50c each.

No. 31—RADIO QUESTIONS AND ANSWERS. Answers to most frequently asked questions. Clear circuit diagrams. Amplifiers—Receivers—Transmitters—Meters and Test Equipment—Interphones—Power Supplies—Phonograph Amplifiers—P. A. Systems. 50c each.

No. 32—ADVANCED SERVICE TECHNIQUE. An up-to-date collection of information for the advanced serviceman: Visual Alignment—Tracking—Phonograph Feedback Tone Control Circuits—Adding Microphones to Sets—Marching Loudspeakers—Remoing Juke Boxes—Servicing Record Changers—Hum Elimination—FM Servicing. 50c each.

No. 33—AMPLIFIER BUILDER'S GUIDE. Invaluable for the designer and builder of audio equipment. Tells how to build a wide variety of amplifiers with power outputs ranging from 8 to 30 watts. Regulated design information on: Push-Pull—Phase Inversion Bass and Treble Boosters—Volume Expanders—Resistance Coupling—Internal Feedback. 50c each.

No. 34—RADIO-ELECTRONIC CIRCUITS. An extensive collection of circuit diagrams, with brief, to the point descriptions of each, including: Intercommunications Systems—Power Supplies—Balancing Circuits—V. T. Circuits—Amplifiers—Receivers—Phon. Amplifiers—Short Wave Adaptors—Electronic Relays. 50c each.

No. 35—AMATEUR RADIO BUILDER'S GUIDE. For the "hobby" who builds his own Prae call down to earth it tells how to build a 2 Meter Band Acorn Tube Set. Amateur Communications—Receivers—Long Lines—Transmitter—Beginner's Transmitter—Preselector—Rotary Beam Aerial—Power Supplies and other ham gear. 50c each.

No. 36—RADIO TEST INSTRUMENTS. A MUST for every radio man. This latest book on building, test equipment places emphasis on practical construction of: Signal Tracers—Capacity Meters—Portable and Bench Multi-checker—Signal Generators—Tone Checkers—Electronic Voltmeters—and many others. 50c each.

No. 37—ELEMENTARY RADIO SERVICING. For the radio man who knows little about servicing. How to get started, and even more important how to keep going: Planning the Service Shop—Equipping the Shop—Systematic Circuit Checks—Signal Tracing Methods—Servicing the Midget—Soldering—Servicing Volume Controls—How to Service Speakers. 50c each.

No. 38—HOW TO BUILD RADIC RECEIVERS. This book contains a sufficient variety of sets to appeal to every radio fan. Includes: Short-Wave, Broadcast, Portable, A. C. Operated, Miniature and Standard Receivers. Complete coil-winding data is furnished. 50c each.

10 OTHER BOOKS

- No. 29—Handy Kinks and Short Cuts. 50c
- No. 30—Unusual patented Circuits. 50c
- No. 31—Radio Questions and Answers. 50c
- No. 32—Advanced Service Technique. 50c
- No. 33—Amplifier Builder's Guide. 50c
- No. 34—Radio-Electronic Circuits. 50c
- No. 35—Amateur Radio Builder's Guide. 50c
- No. 36—Radio Test Instruments. 50c
- No. 37—Elementary Radio Servicing. 50c
- No. 38—How to Build Radio Receivers. 50c

IMPROVES ENLARGER

Dear Editor:

I read Pips' article on the magnetic TV enlarger (April issue) with some interest. As you say, it is impossible to draw electrons through glass, as would be necessary for this unit to work. However, there is a solution. When the face of the cathode-ray tube is made of Electro-crystalite (a material whose nature I am not at liberty to reveal, but which will release electrons on the outside in direct proportion to those striking it on the inside), it becomes quite easy to enlarge images in this manner. Furthermore, if we place a large, strong magnet in front of the screen, we can pull the image right out into a three-dimensional picture. There is one difficulty here, however. This makes it necessary to have complete shielding over the whole unit, and of course this seals the picture up inside a box where you can't see it. As soon as I lick this problem, I will let you know.

BILLY R. POGUE,
The Dalles, Oreg.

(A number of clever suggestions have been made on our April Fool story. This, we believe, is the best one.—Editor)

MORE TV DX

Dear Editor:

I noticed a letter from Donald Smith of Northfield, Mass., about television dx reception at 100 miles. I am 150 miles from Louisville, 200 miles from Cincinnati, and 240 miles from Atlanta and I get excellent reception from these cities about 50% of the time. I find that one good booster gives less snow and a clearer picture than two or three.

It's proper matching of the antenna that does the job. Use of a shorting stub matched to a channel is better than adding boosters.

B. WATERS,
Owida, Tenn.

NIX ON COMPULSION

Dear Editor:

I disagree with the men who say that all radio technicians should be licensed. The real reason for such an attitude is to reduce competition.

This is America, the land of opportunity, the better mousetrap, etc. Those who do good work have nothing to fear from less competent rivals. It is too bad that well meaning "gimmick" investigators have spread the idea that technicians are crooks; it makes lawmakers more willing to listen to licensing propositions.

If Johnny Neighbor can fix his friends' radios it is all right with me. I'll get his failures. I learned that way. I built my first radio when I was 13, back in 1926. It got one station and Dad was as proud as a peacock. I've never been threatened with jail because I didn't know all the answers.

I believe voluntary associations requiring certain standards of membership are all right. But nix on the compulsion stuff!

R. N. BEARD,
Hayfork, Calif.

BATTERY ELIMINATOR

Dear Editor:

The improvements recommended for an A-battery eliminator on page 50 of the January issue are already incorporated in my home-made model, but I think I have gone the author one better.

I included a reversing switch in the d.c. output leads. Different car radios have different 6-volt polarities to correspond with the differences in automobile electrical systems. Rather than fool around and reverse leads, I simply flip the polarity switch to the position at which the radio will play.

HENRY C. SZYMANSKI,
Buffalo, N. Y.

HELP FOR FOREIGN RADIOMEN

The following letter was addressed to James R. Langham, author of many RADIO-ELECTRONICS articles on sound:
Dear Mr. Langham:

During the Japanese occupation all my books were destroyed—possession of even an English dictionary might have cost me my life. For that reason my knowledge of radio is like that of a beginner. I would like to make a transformer, following your article ["Rolling Our Own Output Transformer"] in the December issue of RADIO-ELECTRONICS, but I do not have a wire table or enough knowledge to make the calculations. Would you be kind enough to give me some detailed instructions?

Not a cent can be sent out of the country to buy radio parts—not even to get educational books. It took me over two years even to secure a subscription to RADIO-ELECTRONICS, and that I got through the kindness of an American company which does business with my employers.

LAI CHEE CHOY,
Pontianak, West Borneo

Mr. Langham not only answered Mr. Choy's queries but sent the letter to us with a notation that many foreign radiomen are in this same predicament. Could we do anything to help them?

While many countries restrict the export of cash, most will allow merchandise to be sent out. What is more natural, then, than a swap?

Now here is our offer: RADIO-ELECTRONICS will run—without charge—small classified-type advertisements for



Suggested by Anthony Munnich, Budapest, Hungary

"Call a serviceman to repair the set—there are absolutely no ghost images"

foreign radiomen living in exchange-restricted countries who need radio parts or books and who have something they wish to swap for them. American radiomen may then correspond with the advertisers.

RADIO-ELECTRONICS cannot act as intermediary—but it can and will print these free advertisements. They must come from countries from which money may not be exported. All ads must be under 40 words in length. Ads may be re-worded or edited. State your needs exactly and give your full name and mailing address.

Note well that almost all countries (including the U.S.) have export and import duties and regulations. Both correspondents should check up on these before sending anything.

"BRAIN" HAS ANCESTORS

Dear Editor:

Your March RADIO-ELECTRONICS is really sizzling with a great collection of fine articles by experts in their fields and it is a pleasure to send you my congratulations.

Of particular interest to me were the articles on "The Electronic Brain" by W. R. Ashby, M.A., M.D., and the story on the "President's Transmitter."

The "Electronic Brain" is very reminding of the theories of our old and far-seeing friend Nikola Tesla, and of the eminent biologist Jacques Loeb, on the Mechanistic Conception of Life.

(Continued on page 95)



The famous ACA-100 Amplifier — a self-balancing, drift-correcting, direct-coupled amplifier — the most satisfying musical amplifier ever designed. Based on early Loffin-White circuits, perfected by A. C. Shaney in 1936, and now brought to a standard of quality far above that of any corresponding amplifier. Exclusive features include:

- Push-Pull Triode Expander.
- Non frequency-discriminating noise suppressor.
- Push-pull hi and lo freq. variable equalizers.

If you are satisfied with nothing less than the best, write today for free technical literature.

Special models for all magnetic cartridges.



AMPLIFIER CORP. OF AMERICA

398-10 Broadway New York 13, N. Y.

REFRIGERATION SERVICE MANUAL

1935 EDITION

\$2.50 WHILE THEY LAST
Formerly \$5.00

Radio Electronics, 25 W. Broadway, N.Y. 7, N.Y.

T. A. C. DOES IT First AGAIN!

All Major Components Already Mounted on Chassis

including pre-wired "VIVIDeo" I. F. strip (Pat. Pend.) and pre-wired front end. Only 13 tubes remain to be wired! No technical knowledge required!

NEW! SIMPLIFIED INSTRUCTIONS! COMPLETE SERVICE DATA! The most elaborately detailed instructions in television even a layman can follow.

CABINETS AND STANDS IN BLOND AND WALNUT AVAILABLE AT REASONABLE PRICES. WRITE FOR LITERATURE.

FREE!.. Complete comprehensive Service Data on the T.A.C. exclusive "VIVIDeo" 13-tube Picture and Sound I.F. Strip (Pat. Pend.). Contains all information needed to thoroughly understand and service this unique high-gain I.F. Strip which features 5 1/2 stages of Cathode-Coupled Grounded-Grid Video I.F. amplification. For high gain, sensitivity, stability, "VIVIDeo" can't be beat! Write for FREE booklet SB-1 or ask your local jobber for it. Booklet SB-1 also included with each T.A.C. Direct-View Assembly.

NEW LOW PRICES!

- T.A.C. STANDARD MODELS 20 RCA tubes, plus RCA or DuMont C.R. Tube, Pre-wired "VIVIDeo" 13-tube Picture and Sound I.F. Strip with 5 1/2 stages of Picture Amplification, Pre-wired All-Channel Front End with Fine Tuning, RCA 5x7 Oval Heavy Duty FM Speaker, Delivered complete with ALL MAJOR COMPONENTS MOUNTED, PLUS New Comprehensive SUPER-SIMPLIFIED DATA for Wiring and Servicing.
- Model M101S—Complete (less C.R. Tube) **\$169.50** Dealer's Net*
 - Model F101S—Complete with 10" RCA C.R. Tube **\$203.50** Dealer's Net*
 - Model F121S—Complete with 12" DuMont C.R. Tube **\$231.25** Dealer's Net*
 - Model F151S—Complete with 15" DuMont C.R. Tube **\$314.50** Dealer's Net*

T.A.C. CHAMPION MODELS. Identical extra-value features as above except Standard Tuner replaced by DuMont Inductuner for Continuous Tuning of ALL FM RADIO AND TV CHANNELS.

- Model M101C—Complete (less C.R. Tube) **\$209.50** Dealer's Net*
- Model F101C—Complete with 10" RCA C.R. Tube **\$243.75** Dealer's Net*
- Model F121C—Complete with 12" DuMont C.R. Tube **\$271.40** Dealer's Net*
- Model F151C—Complete with 15" DuMont C.R. Tube **\$357.35** Dealer's Net*
- Model F201C—Complete with 20" DuMont C.R. Tube **\$566.75** Dealer's Net*

ALL T. A. C. 15" and 20" Assemblies contain 30 RCA tubes, plus DuMont C.R. tube, RCA 12" Heavy Duty FM speaker, and all features mentioned above PLUS Pre-wired 14KV High Voltage Doubler Power Supply.

★ Write for Catalog on our Complete Line of TV Replacement Components!

Prices subject to change without notice.
**540 BUSHWICK AVE.,
BROOKLYN 6, N. Y.**



*Prices 5% Higher West of the Mississippi

Model P-520 . . . 520 Sq. In. Screen Projection Television Assembly. Wonderful LARGE PICTURE TELEVISION with a 20x26 in. screen. Dealer's Net* **\$769.50**

All components are of the finest quality and fully guaranteed under the Standard RMA Guarantee. All TAC Assemblies are guaranteed to operate when assembled according to instructions.

RADIO SCHOOL DIRECTORY

• SPECIALIZE • • SPECIALIZE •



SPECIALIZE • BUILD YOUR CAREER WITH PRACTICAL TECHNICAL TRAINING

SPECIALIZE • BUILD YOUR CAREER WITH PRACTICAL TECHNICAL TRAINING

You can become a Radio and Television Technician now!

A million new jobs — almost 4,000 a week — will be created in the television industry during the next five years according to estimates of industry leaders. Actually, during 1948, television grew faster than any other industry in the history of America.

Here is a real opportunity for you. Trained television technicians are in demand. By starting now, you can get in on the ground floor — grow as television grows.

To help supply this needed manpower, the Milwaukee School of Engineering has expanded its radio and television courses. Now you can get complete practical, technical training in the MSOE laboratories. *This is not just a serviceman's course.* It prepares you for a career in all of the technical phases of television and radio.

This special course Prepares you for any of the following careers:

Television Serviceman Radio Serviceman Radio and Television Retailer	Supervisor in Radio and Television Assembly Radio and Television Tester Broadcast Radio-Operator	Police, Taxi-Cab and Rail- road Transmitter Operator Police, Taxi-Cab and Rail- road Receiver Serviceman
---	---	---

OTHER COURSES AVAILABLE

<p>SERVICE 6 to 12 Months</p> <ul style="list-style-type: none"> • Electricity • Welding • Refrigeration • Heating 	<p>TECHNICIAN 1 to 2 Years</p> <ul style="list-style-type: none"> • Electrotechnics • Radio and Television • Electronics • Refrigeration, Heating and Air Conditioning 	<p>PROFESSIONAL 3 Years</p> <ul style="list-style-type: none"> • Electrical Engineering • Bachelor of Science Degree • Major in Electronics or Power
---	---	--



A Technical Institute
Founded 1903
by Oscar Werwith

MILWAUKEE SCHOOL OF ENGINEERING,
N. Broadway and E. State

Dept. RE-649
Milwaukee, Wis.

Without obligation send me free booklet "Career Building" and more details on course in Radio and Television or _____ course.

Name _____ Age _____
Address _____
City _____ State _____

LEARN RADIO!

PREPARE FOR A GOOD JOB!
COMMERCIAL OPERATOR (CODE)
RADIO SERVICEMAN
TELEVISION SERVICING
BROADCAST ENGINEER

Veterans get \$130.00 Equipment
SEND FOR FREE LITERATURE
BALTIMORE TECHNICAL INSTITUTE
1425 Eutaw Place, Dept. C, Baltimore 17, Md.



RADIO ENGINEERING

FM—Television—Broadcast

Police Radio, Marine Radio, Radio Servicing, Aviation Radio and Ultra High mobile applications. Thorough training in all branches of Radio and Electronics. Modern laboratories and equipment. Old established school. Ample housing facilities. 7 acre campus. Small classes, enrollments limited. Our graduates are in demand. Write for catalog.

Approved for Veterans
VALPARAISO TECHNICAL INSTITUTE
Dept. C VALPARAISO, INDIANA



JOBS IN TELEVISION

YOUNG MEN 16 TO 60

There is a Job Opening for Every Qualified Trained Television Technician

WE CAN TRAIN YOU

Free Employment Service

Visit Our Modern Laboratories and Class Rooms

APPROVED UNDER G.I. BILL OF RIGHTS

AMERICAN RADIO INSTITUTE
New York Buffalo, N. Y. Syracuse, N. Y.
101 W. 63 St. 640 Main St. 131 Shonnard St.

"Teaching Radio Since 1935"

TELEVISION

NEW, INTERESTING TECHNICAL CAREER

As Television gains momentum, rapidly, constantly, it offers to properly-trained technicians careers with a future in Industry. Broadcasting or own Business.

Train at an Institute that pioneered in TELEVISION TRAINING since 1938.

Morning, Afternoon or Evening Sessions in laboratory and theoretical instruction, under guidance of experts, covering all phases of Radio, Frequency Modulation, Television, Licensed by N. Y. State. Free Placement Service. Approved for Veterans.

ENROLL NOW FOR NEW CLASSES
Visit, Write or Phone

RADIO-TELEVISION INSTITUTE

480 Lexington Ave., N. Y. 17 (46th St.)
Plaza 3-4585 2 blocks from Grand Central

Make Your Career

RADIO and TV

In no other industry does the future hold brighter financial promise and security than in AM and FM Radio, Television. These fields need and want men trained as announcers, script writers, disc jockeys, and radio technicians. It will pay you to investigate the Don Martin School of Radio Arts, established in 1937. Complete day and night classes . . . the latest equipment . . . and a staff of 30 nationally known instructors. Over 97% of the combination men graduates are placed on jobs immediately through the free placement service. Approved for Veterans.

FREE—Write for Free Booklet "Your Future In Radio."

Don Martin School of Radio Arts
1655 No. Cherokee, Hollywood, Calif. HUDSON 23281

CORRESPONDENCE COURSES IN

RADIO and ELECTRICAL ENGINEERING

ELECTRICAL ENGINEERING Get good grasp of wide electrical field. Prepare yourself at Low Cost, for secure future. Modern course. So simplified anyone can understand quickly.

RADIO ENGINEERING Extra fine course in radio work. Trains you to be super-service man, real vacuum-tube technician. Servicemen needed badly. Diploma on completion. Many graduates earning big pay.

Electronic kit given to students enrolling by June 1. WRITE for free school catalog, student magazines, \$25 course details of deferred payment plan, etc.

Lincoln Engineering School, Box 931-RE-8, Lincoln 2, Neb.

AUDIO ENGINEERING SCHOOL

A Practical Audio Engineering course in Sound Fundamentals; DISC, FILM and MAGNETIC Recording; Transmission Measurements; Monitoring and Mixing. Laboratories contain Transmission Sets, Oscillators; Harmonic Analyzer, Distortion Sets, Intermodulation Analyzer, and other equipment. Recording Studio simulating Broadcast, Motion Picture and Commercial Sound Recording. H. M. Tremaine, Pres., Director. Approved for Veterans and Foreign Visas.

HOLLYWOOD SOUND INSTITUTE, Inc.
1040-E North Kenmore Hollywood 27, Calif.

RCA RADIO and TELEVISION
 Thorough Training in All Technical Phases
APPROVED FOR VETERANS
 DAYS—EVENINGS WEEKLY RATES
RCA GRADUATES ARE IN DEMAND
 For Free Catalog Write Dept. RC-49
RCA INSTITUTES, Inc.
 A Service of Radio Corporation of America
 350 WEST 4TH STREET NEW YORK 14, N. Y.

CODE SENDING SPEED
RECEIVING SPEED
 Be a "key" man. Learn how to send and receive messages in code by telegraphical radio. Commercial needs thousands of men for jobs. Good pay, adventure, interesting work. Learn at home quickly through famous Candler System. Qualify for Amateur or Commercial License. Write for FREE BOOK
CANDLER SYSTEM CO.
 Dept. 3-G, Box 928, Denver 1, Colo., U.S.A.

ELECTRICAL TRAINING
 Intensive 32 weeks' residence course in fundamentals of industrial electrical engineering, including radio, electronics. Prepares for technician, engineering aides. Approved for veteran training. 56th year. Enter Sept. 6, Jan. 9. Catalog.
BLISS ELECTRICAL SCHOOL
 7546 TAKOMA AVENUE
 WASHINGTON 12, D. C.

RADIO COURSES
 Preparatory Mathematics, Service, Broadcast, Television, Marine Operating, Aeronautical, Frequency Modulation, Radar.
 Classes now forming for the summer term June 1st
 Entrance exam, May 16
Veterans' Literature.
COMMERCIAL RADIO INSTITUTE
 (Founded 1920)
 38 West Biddle Street, Baltimore 1, Md.

Tesla felt this strongly; Loeb studied life reactions to external stimuli and found definite proof, as disclosed in his 1918 book, "Forced Movements, Trophisms, and Animal Conduct." These theories and tests on lower animals prove conclusively that many of man's actions are merely the result of his reactions to external or internal stimuli.

A moth flies into a flame, guided there automatically and without volition by internal heat- or light-sensitive organs; a bat flies, visionless, by reaction to radar-like, supersonic squeaks it itself emits; homing pigeons and bird migrations have some sort of direction-sensing apparatus, perhaps magnetic, as suggested by some; even plant life, such as the sunflowers, turn with the sun. Man has made proximity fuses which "tell" the flying shell when to explode; gun pointers which "tell" the gun when and where to fire; automatic camera irises, which, like the human eye, regulate the exposure to suit the light intensity on the subject; electronic "computing brains" of great complexity, and many other and similar reactors to stimuli of one sort or another which set up definite actions in the mechanisms they control. Work is progressing on target-seeking guided missiles which will not only take the right course and adjust themselves to course-deviating

forces, but which will seek, identify, and destroy a given target as well as if they had human pilots. Many years ago (1911) I built for John Hays Hammand, Jr., an "electric dog" which would follow a light anywhere it went. This principle has been applied to photographic telescopes for keeping them accurately "on" a given celestial object, irrespective of varying atmospheric refraction. Dr. Ashby goes a long step further in his "homeostat" by endowing it with power to adapt itself and its stimuli reactions to changing environmental conditions.

BENJAMIN F. MIESSNER,
 Morristown, N. J.

(Mr. Miessner is one of the pioneer inventors in the radio field and holds more than 100 patents on aircraft radio, phonography, directional microphones, electronic music instruments and other radio and electronic devices.—Editor)

WOODED BUT NOT WON

Dear Editor:

I have been a reader of your magazines since the "cat-whisker" days of radio and have always enjoyed your editorials. But the latest one, *Manufacturers Woo Servicemen*, has me wondering.

Radio trouble-shooting is my hobby; I do not compete with established concerns and don't have to. I believe I have established a rather enviable reputation as a "radio expert" and any work that I do is on jobs turned out by repair firms but still for some reason or other not satisfactory to the customer. This brings me up to the subject of your editorial:

For many years I have used and recommended Philco products. I know my say-so has resulted in the sale of many of their sets without any financial gain on my part, nor was I looking for any. Last year, 1948, a number of Philcos were purchased by friends on my recommendation and reports to date show three of the jobs very unsatisfactory. For instance, the Philco 5-tube a.c.-d.c. radio-phonograph combination. Examination of this set disclosed the tuning-dial knob broken off. This control and the volume control are bakelite; there is no support whatever, and these knobs just pop off. The least downward pressure on the volume-control knob shorts out the set. Getting into the chassis, I found a blob of solder covering about half of the windings of the oscillator coil. Rotten workmanship, to say the least, and it seems to me inspections must be lax. Try and replace these knobs and you will find the distributor doesn't have any. Simply because I have always had a high regard for Philco, I wrote the factory, told them of these incidents. They didn't even bother acknowledging my letter. If this outfit is so high and mighty and don't give a hoot about my reputation suffering in recommending their products, they can go and jump in the lake.

Apparently Philco Corporation is not "wooing servicemen."

J. E. EPPERSON,
 University City, Mo.

You Can't Match these MID-AMERICA Values!

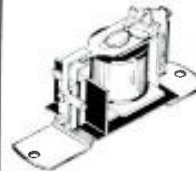
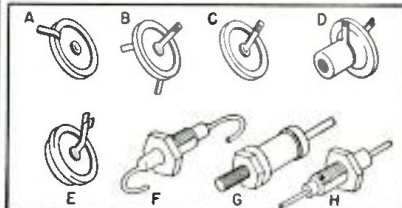

Plate Load RELAY

6000-ohm coil, SPST normally open contacts. Extra sensitive and used for many applications. 1 1/2" high, 1 1/4" wide, on 1 1/2" mtg. ctrs.
 MA-1903 \$1.19

Silver Mica Button Condensers



\$7.50 per 100 (all one type)

MA-3536 (G)	20 mmf	MA-3505 (C)	360 mmf
MA-3501 (D)	30 mmf	MA-3509 (A)	500 mmf
MA-3531 (F)	55 mmf	MA-3506 (B)	500 mmf
MA-3503 (A)	75 mmf	MA-3510 (C)	500 mmf
MA-3534 (H)	75 mmf	MA-3502 (D)	500 mmf
MA-3504 (A)	200 mmf	MA-3507 (E)	500 mmf
MA-3519 (F)	250 mmf	MA-3518 (A)	2000 mmf

#18 2-conductor Wire & Drum

Used for running 110-volt AC lines, extension speakers, etc. Full 175 feet of highest quality wire with tough, weather-resistant insulation. Complete with handy drum for spooling wire for storage. Limited quantity.
 \$2.39

BRAND NEW METERS

Dejur Model 310 meter for all-around ham and test applications. 10 ma DC basic movement. 3 1/4" diameter flange; 2 3/4" body 1 1/4" deep. Stock up on these while they last.
 MA-2036



\$1.95 each

Iron Core FM and AM IF TRANSFORMERS

Highly efficient for new construction and replacement. III-Q adjustable iron cores provide high selectivity and gain. Only 2 1/2" x 1 1/2" square; spade lug mounting.
 MA-2200 10.7 MC IF Transformer 49c ea.
 MA-2039 455 KC IF Transformer 35c ea.

INTERCOM TRANSFORMER SET

One transformer to match voice coil to grid, another for 50L6 and similar output tubes. Both of these line units PLUS a momentary DDT spring return push-button switch for less than value of one transformer alone! These are small, strap mounting transformers.

ONLY 98c FOR ALL THREE UNITS!

GRILLE CLOTH

Never before at our low price! Highest quality, golden-tone grille cloth, styled to harmonize with all cabinet designs. Generous 50" width.
\$1.79 per yard

This Month's Specials!

T-17 Microphone and plug; used; good	79c
25 mh iron core RF choke; 100 MA DC	19c
25 mmf butterfly condenser	32c
50 mf butterfly condenser	32c
Mercury switch; flexible 18" leads	29c
Brand new RC 366 Jack Box	19c
SPST Slide Switch; black bakelite knob	15c

ORDER FROM THIS AD!

Send 25¢ deposit with order. Pay balance plus postage on delivery. Get your name on Mid-America's select mailing list and get first crack at latest, greatest values in radio parts, electronic equipment, tubes, etc. Send orders to Desk RC-69. Minimum order \$2.50.

MID-AMERICA CO. Inc.

STORE WAREHOUSE
 2412 S. Michigan Ave. 2307 S. Archer Ave.
 Chicago 16, Ill. Chicago 16, Ill.

WE ARE



**Looking for
TUBES!**
*What have
you got?*

Yes, we are looking for your excess or obsolete tubes. Dig them up TODAY and convert them into ready CASH NOW...no quantity too large or too small...we need them all.

Send your list to:

MOHAWK ELECTRONICS CO.
160-C GREENWICH ST., NEW YORK 6, N. Y.

WHERE RADIOMEN MEET, EAT and SLEEP

Visit the
**FAMOUS
FIESTA
LOUNGE**
Renowned for
Fine Food

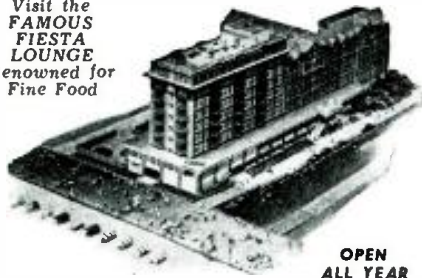

**OPEN
ALL YEAR**

HOTEL STRAND

Atlantic City's Hotel of Distinction
The Ideal Hotel for Rest and Relaxation • Beautiful Rooms • Salt Water Baths • Gloss inclosed Sun Porches • Open Sun Decks atop • Delightful Cuisine • Garage on premises. • Moderate Rate Schedule.
Exclusive Pennsylvania Ave. and Boardwalk

For Quality Pictures—

use **ZETKA** 12½" and 15" Tubes

For rich contrast, freedom from ion stain, long life and dependability there is no better tube. Limited quantity available now. Write or phone immediately as shortages are likely to recur.

ZETKA TELEVISION TUBES, INC.

131 Getty Avenue, Clifton, N. J.

Phone: Passaic 2-9095

SPECIAL \$15⁹⁵
Less Batteries
3 WAY PORTABLE

NOT A KIT but a factory finished **TOP QUALITY PRODUCT.** Operates on 110-220 V.A.C.-D.C. and Battery. 4 miniature tubes plus selenium rectifier 4" Alm'co 5 Speaker. Uses 1-67½ V. and 1-4½ V Battery. Total weight 6½ lbs. Size: 9" x 4¾" x 6½" **MONEY BACK GUARANTEE.**

Rush your order today. 25% with order. Balance C.O.D.
Kit of Batteries for above \$1.95

SALCO ELECT. DIST.
170 Marcy Ave. Brooklyn 11 N. Y.



Index to Advertisers

Aerovox Corporation	16
Airborne Sales Company	90
Allied Radio Corporation	69
American Television & Radio Company	11
Amplifier Corporation of America	68, 93
Arrow Sales, Inc.	78
Bell Telephone Laboratories, Inc.	Back Cover
Brooks Radio Distributing Company	91
Buffalo Radio Supply	14
Capitol Radio Engineering Institute	7, 79
Certified Television Laboratories	81
Cinex, Inc.	85
Cleveland Institute of Radio	18
Communications Equipment Company	89
Coyne Electrical School	91
DeForest's Training, Inc.	9
Electronic Measurements Company	76
Electro-Technical Industries	10
Electro-Steel Products, Inc.	77
Fair Radio Sales	84
Federal Telephone & Telegraph Co.	81
Federated Purchaser	85
G & G Radio Parts Service	17
General Electronic Distributing Company	73
General Test Equipment Company	86
Gernsback Library Series	92
Greylock Electronic Supply Company	85
Heath Company	12, 13
Hudson Specialties	90
Instructograph Company	76
Lafayette-Concord	88
James B. Lansing Sound, Inc.	71
Leotone Radio Corporation	88
McGee Radio Company	6
McMurdo Silver Company	87
Manuel Klein Industries	83
Merit Products	91
Mid-America Company	95
Midwest Radio	85
Miles Reproducer	81
Mohawk Electronics Company	96
Murray Hill Books, Inc.	72
National Radio Institute	3
National Schools	5
Newark Electric Company	85
Opad-Green Company	72
Opportunity Adlets	80
Pine Watch Company	90
Precision Apparatus Company	77
Progressive Electronics Company	97
Quinn Nichols Company	81
Radio City Products Company, Inc.	82
Radio Dealers Supply	88
Radio Mail Orders	80, 86, 90
Rad'onic Equipment Company	90
Radio Supply & Engineering Company	83

RADIO SCHOOL DIRECTORY

(Pages 94-95)

American Radio Institute	
Baltimore Technical Institute	
Bliss Electrical School	
Candler System Company	
Commercial Radio Institute	
Don Martin School of Radio Arts	
Hollywood Sound Institute	
Lincoln Engineering School	
Milwaukee School of Engineering	
RCA Institutes	
Radio Television Institute	
Valparaiso Technical Institute	

Salco Electronic Distributing Co.	96
Howard W. Sams & Company, Inc.	8
Servelux Manufacturing Co.	89
Superior Instruments	84
Sylvania Electric Products	Inside Back Cover
Senco Radio, Inc.	80
Hotel Strand	96
Spartan School of Aeronautics	82
Sprague Products Company	4
Technifax	89
Television Assembly Company	15, 93
Telrex, Inc.	91
Transvision	Inside Front Cover
Universal General Corporation	85
United Surplus Materials	75
Wells Sales, Inc.	98
Wholesale Radio Parts Company, Inc.	78
Zetka Television Tubes	96

RADIO-ELECTRONICS for

COYNE ELECTRICAL TROUBLE SHOOTING MANUAL, prepared and published by the Educational Book Publishing Division—Coyne Electrical and Radio School, Chicago, 9 x 11 inches, 626 pages plus 7-page index. Price \$6.95.

A parallel work to the familiar radio trouble shooters' handbooks, this large volume contains circuit diagrams of more than 600 pieces of electrical equipment of all types, data and specifications where useful, as well as trouble shooting, maintenance, and repair information.

The subjects covered include basic principles of electricity, measurement and tests, transformers, motors, controls, generators and converters, and electronics. Refrigeration is dealt with under controls.

Since considerable general information as well as specific trouble-shooting tips is included in each section, the book may be interesting to the radioman who though not himself a regular electrical worker, may need information on the principles or details of certain electrical equipment from time to time. The general reader will also find the tables, symbol charts, and illustrative diagrams useful. The drawings are especially large and clear, and many of them cover a full page.

SURPLUS CIRCUIT DIAGRAMS, published by Troup Engineering Co., Long Beach, Calif. 11 x 8 1/2 inches, 30 pages. Price \$2.00.

Circuit diagrams of the R-89-A/ARN-5A, AN/ARC-4, BC-733-A, BC-221-Q, Collins MBF, BC-1206-C, AN/APN-1, Navy ARB (CRV 46151), BC-412, R-9/APN-4, ID-6/APN-4, AN/ARC-5 receivers and transmitters (including the v.h.f. transmitter), BC-645, SCR-269-G, T-67/ARC3, R-77/ARC-3, and R-65/APN-9 are given. A simplified schematic of the ARB receiver and conversion data on the BC-412 radar oscilloscope and the BC-645 are also included. (The popular SCR-274-N diagrams are handled in another book by the same publisher.)

Most of the diagrams are reprinted from technical manuals and in some cases they were reduced considerably to fit the pages of the book. Consequently, several of the diagrams are too small to be of great practical value unless they are enlarged. In four circuits, the components are coded and no parts values are supplied. It happens that these diagrams are large and clear and can be used for circuit tracing. —R.F.S.

CYBERNETICS, or Control and Communication in the Animal and the Machine, by Norbert Wiener. Published by John Wiley & Sons, Inc., New York, 6 x 9 inches, 194 pages. Price \$3.00.

Cybernetics is a book which may be the first publication of a new and very important science. Derived from the Greek *Kybernetes* (a steersman, Latin *gubernator*, English *governor*), it refers to the study of feedback mechanisms, such as for example the governor of a steam engine, the negative feedback in a radio circuit, or the complex and little-understood mechanisms by which human body and brain unite to perform any action.

Electronic scientists developing feedback control mechanisms have been increasingly impressed by the analogy between their apparatus and the human brain and nervous system. At the same time advanced students of the brain and nerves discovered essential parallels between the action of the brain and nervous system and the feedback action of certain electronic apparatus—a parallelism so exact that one worker in the field stated that he found it easier to discuss the nervous system with electronic engineers than with doctors. A number of meetings between representatives of the two groups resulted in laying down plans for common and organized study. The book explains the subject, outlines the problems and reports on progress to date.



Frank Bowen

Suggested by:
E. R. Donohue,
Walla Walla, Wash.

"Goodness! They shouldn't permit such language on the radio!"



NOW! BUILD 15 RADIOS \$14.75
COMPLETE KIT ONLY...

Absolutely No Knowledge of Radio Necessary. You Need No Additional Parts. The PROGRESSIVE RADIO KIT is the Only Complete Kit. Operates on 110-120 Volts AC/DC

Contains everything you need, instruction book, metal chassis, tubes, condensers, resistors and all other necessary radio parts. The 36-page instruction book written by expert radio instructors and engineers teaches you to build radios in a professional manner. The circuits are designed to provide excellent performance. Altogether, fifteen circuits are constructed, including 11 receivers, 1 audio amplifier and 3 transmitters. SPECIAL OFFER—Electrical and Radio Tester sent absolutely FREE with each Progressive Radio Kit. Plus FREE Membership in the Progressive Radio Club. Enables you to free expert advice and consultation service with licensed radio technicians. ORDER YOUR KIT NOW!

VACUUM TUBE VOLTMETER KIT
A professional piece of test equipment you need for FM and I.T. Attractive steel case. FREE: Book on Advanced Servicing Techniques. **\$23.95**

5" OSCILLOSCOPE KIT AM-FM TELEVISION
an absolute "must" for today's radioman. Input impedance: 1 MΩ, and 50 MΩ. Tubes—2-8Z5, 2-3Y1, 1-8Y1, 1-6X4. FREE: Book on Cathode Ray Oscilloscopes. **\$39.95**

VOLT-OHM-MILLIAMMETER KIT
simple to construct, inexpensive but accurate. FREE: Book on Elementary Radio Servicing. **\$14.95**

SIGNAL TRACER KIT
an invaluable aid in trouble shooting. FREE: Book on Radio Test Instruments. **\$21.95**

7"-10" TELEVISION KITS
Factory built and aligned 13 channel Tuner—18 Tube Kit—7" Kit. **\$59.50**
Complete set of tubes, including Cathode Ray Tube **\$39.58**
Factory built and aligned 13 channel Tuner, 10" Kit, less tubes. **\$99.50**
complete set of tubes, including Cathode Ray Tube **\$57.30**
FREE: Television Servicing Notes

PROGRESSIVE AMPLIFIER KIT
High Fidelity Humless Amplifier complete with five tubes and two selenium rectifiers. FREE: Book on Amplifiers. **\$16.00**

TV SWEEP GENERATOR KIT **\$28.95**
Range—2 Mc.—26 Mc.

SIGNAL GENERATOR KIT **\$18.95**
150 Kc.—34 Mc. Fundamental, 150 Mc.—1.6 Mc. Harmonics.

RF SIGNAL TRACER PROBE KIT **\$5.50**
20 cycles—200 Mc.—34 Xtal.

ECONOMY AMPLIFIER KIT **\$5.95**
Simple to build; complete with five tubes. FREE: Book on Amplifiers.

5 TUBE AC-DC SUPERHET KIT **\$14.25**
Complete with tubes and cabinet. FREE: Book on Building Receivers.

6 TUBE AC-DC 2-BAND SUPERHET KIT **\$17.45**
Complete with tubes and cabinet. FREE: Book on Amateur Radio Building.

7 TUBE AC-DC FM RECEIVER KIT **\$29.95**
Complete with tubes and cabinet. FREE: Television and FM Servicing Notes.

4 TUBE SUPERHET PORTABLE KIT **\$12.95**
Complete with tubes and cabinet; less batteries. FREE: Book on Unusual Radio Circuits.









ALL MERCHANDISE SHIPPED FOB NEW YORK
Deduct 2% if full payment accompanies order. 25% deposit required on COD orders.
Write for further information concerning the above merchandise. Send for our Free catalog.

PROGRESSIVE ELECTRONICS CO.
Dept. RE-26 497 Union Avenue
Brooklyn 11, New York

FOR EVERY RADIO SERVICEMAN!

The new Sylvania FM-AM Signal Generator Type 216

Supplies all signals necessary for complete stage-by-stage alignment of AM and FM receivers.

Frequency Coverage:

80 kc to 60 mc AM and 80 kc to 120 mc FM, continuously variable in seven bands on fundamental frequencies. Useful AM and FM harmonics to 240 mc.

For FM service:

±350 kc Sweep: up to 120 mc with 60 cps modulation.
±75 kc Sweep: up to 120 mc with 400 cps modulation.

In addition, sawtooth external modulation may be used.

For AM service:

±15 kc Sweep up to 61 mc with 60 cps modulation.
0 to 100% Modulated AM with 400 cps modulation.
In addition, external modulation may be used.

Check these Sylvania features! They're "musts" for complete FM and AM servicing:

AM modulation: 0 to 100%, continuously variable.
Accurate calibration: 1/2 of 1%.

High rf output: 1 volt on all ranges.

True rf meter for constant reference level.

Both step-by-step and smooth attenuator output controls.

Regulated power supply.

Oscilloscope synchronizing voltage output.

Crystal check point circuit.

Multiple shielding and filtered for minimum leakage.

Heterodyne detector for frequency comparison.

Mar-resistant, pearl-gray crackle finish baked on a treated steel case.



To meet your FM and AM service requirements, you'll want Sylvania's new Signal Generator Type 216! With it you can align the rf and if sections of all FM and AM receivers, adjust all types of FM detectors, and make overall receiver checks. Its high level output and accurate calibration make it also a valuable instrument for other service and laboratory uses requiring a high quality rf signal source. Beautiful styling in keeping with modern service shop environment. Dimensions: 11-3/8" x 17-1/16" x 10-5/8". Weight: 24½ lbs. Priced at \$189.50. Mail coupon for complete details!

SYLVANIA ELECTRIC

ELECTRONIC DEVICES; RADIO TUBES; CATHODE RAY TUBES; FLUORESCENT LAMPS, FIXTURES, WIRING DEVICES, SIGN TUBING; LIGHT BULBS; PHOTOLAMPS

Sylvania Electric Products Inc.
Advertising Dept. R-1706
500 Fifth Ave., New York 18, N. Y.

Gentlemen: Kindly forward full details on your new Sylvania FM-AM Signal Generator Type 216.

Name.....

Address.....

City..... State.....

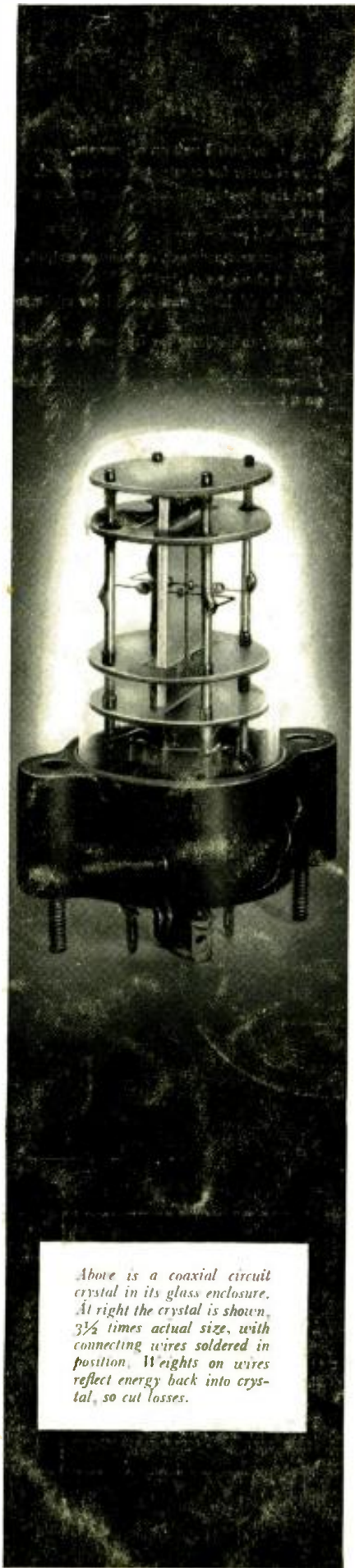

Above is a coaxial circuit crystal in its glass enclosure. At right the crystal is shown, 3½ times actual size, with connecting wires soldered in position. Weights on wires reflect energy back into crystal, so cut losses.

Key to a Crystal Gateway



How would you solder a wire to a crystal? This must be done for most of those wafer-thin plates of quartz used in electrical circuits. They play a big part in the myriad-channel telephone system that utilizes coaxial cables.

This is how Bell Laboratories scientists solved the problem: A spot of paste containing silver is deposited on the crystal and bonded to it by oven heat. The crystal is then vapor-plated with a thin layer of silver. Then a fine wire is soldered to the spot by a concentrated blast of hot air. The result

is a rugged electrical connection to the surface of the crystal which does not interfere with its vibrations.

Sealed in glass tubes, the crystals are precise and reliable performers in the telephone system. Each is a crystal gate to a voiceway, separating *your* conversation from the hundreds of others which may be using a pair of coaxial conductors, at the same time.

This spot of paste, this tiny wire, this puff of air are among the tremendous trifles which concern Bell Telephone Laboratories in finding new ways to improve your telephone service.

BELL TELEPHONE LABORATORIES
 EXPLORING AND INVENTING, DEVISING AND PERFECTING, FOR
 CONTINUED IMPROVEMENTS AND ECONOMIES IN TELEPHONE SERVICE

