

RADIO — ELECTRONICS

K

HUGO GERNSBACK,
Editor

9/27 IN THIS ISSUE
Electronic Flash Gun
Fundamentals of Radio Servicing

formerly

**RADIO
CRAFT**

RADIO ELECTRONICS

February 1949



TELEVISION TECHNIQUE
SPEEDS UP FACSIMILE
SEE TELEVISION SECTION

FEB
1949

30¢

U. S. and
CANADA

LATEST IN RADIO — ELECTRONICS — TELEVISION

**TELEVISION
ASSEMBLY CO.**

for the best in **TELEVISION**
for **CUSTOM-BUILT** installations

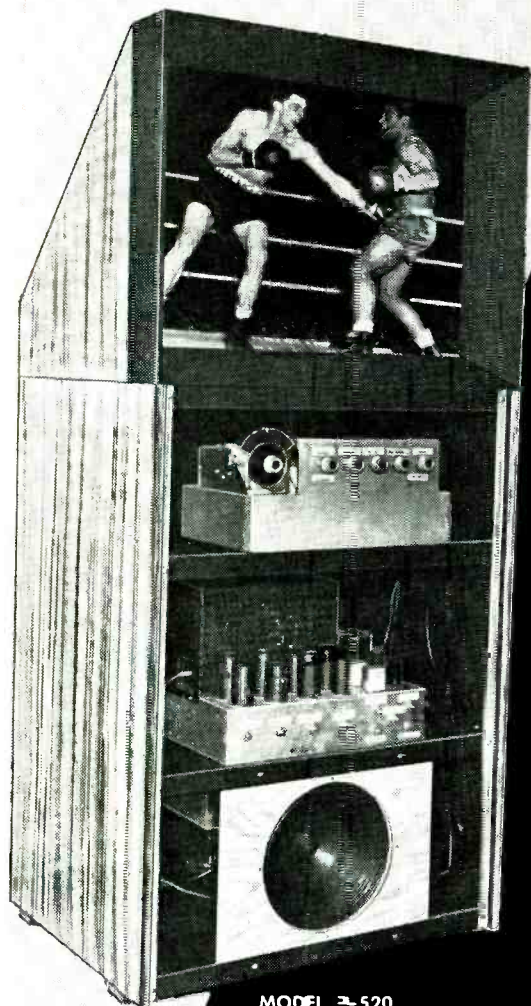

MODEL 520

520 SQUARE INCH **PICTURE** 20 INCHES BY 26 INCHES
PROJECTION TELEVISION

Bausch & Lomb Optical Electronic System provides a contrasty sparkling picture projected onto the Eastman Kodak Glass Projection Screen, completely glare-proof. Every part of the entire set is designed, engineered and manufactured for the express purpose of bringing you the finest in television . . . ready for **CUSTOM-BUILT** installations in homes, schools, lodges, clubs, hospitals, taverns and other public places.

BAUSCH & LOMB F/1.9 PROJECTION LENS

RCA 5TP4 PROJECTION C. R. TUBE
PRE-WIRED 27-30 KV TRIPLER FLYBACK
POWER SUPPLY

ALUMINUM COATED TOP PROJECTION MIRROR
EASTMAN KODAK GLASS PROJECTION SCREEN

PRE-WIRED, PRE-TUNED I. F. PICTURE & SOUND STRIP (PAT. PEND.)

DUMONT INPUTUNER
all channels — All FM Radio

RCA 12" HIGH FIDELITY PM SPEAKER
MANUAL OF INSTRUCTIONS & SCHEMATIC DATA prepared & edited by renowned **JOHN F. RIDER PUBLISHER, INC.**

COMPLETE WITH RACK, HOOD & PICTURE FRAME

10" 12" or 15" TUBE TELEVISION
in easy to install units

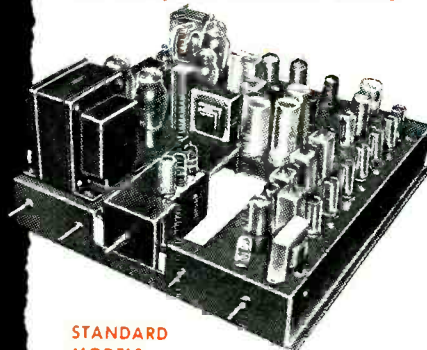

STANDARD MODELS

30-tubes, including the C.R. Tube. Supplied with 13-tube I.F. Picture and Sound Strip (Pat. Pend.) completely wired, tined, tested and aligned. Has standard tuner pre-wired to handle 13 channels, ready to use with above unit.

Here's why Television Experts praise T.A.C. Television

Our products contain every new development, every new creation of television research. Our efforts are bent towards quality and this is particularly evident in the performance of our Assemblies. That's why men who know television are telling others about T.A.C. supremacy.

TELEVISION ASSEMBLY COMPANY GUARANTEE

All components are of the finest quality and are fully guaranteed under the Standard RMA Guarantee. All TAC Assemblies are guaranteed to operate when assembled according to directions.

T. A. C. CHAMPION MODELS WITH DUMONT INPUTUNER

Gives continuous tuning for all 13 channels plus all FM Radio. Available for all tube sizes.

**TELEVISION
ASSEMBLY CO.**

Available only through
National Parts Distributors
Write us for list
Write for literature

540 Bushwick Ave., B'klyn 6, N. Y.

Smart, Modern
Hand-Rubbed
Walnut & Blonde
Cabinets for 10"
12" or 15"
tube chassis

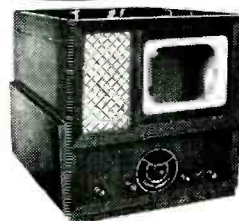

Our own exclusive designs, available for all T.A.C. models. Details on request.

LEARN RADIO

BY PRACTICING IN SPARE TIME

As part of my Course I send you the speaker, tubes, chassis, transformer, loop antenna, etc., to build the modern, powerful Radio Receiver! In addition, I send you parts to build many other real Radio circuits, like the Signal Generator, Radio Tester and Superheterodyne Receiver pictured below. You use this material to get practical Radio experience and to make EXTRA money fixing neighbors' Radios in spare time. Mail coupon below for complete information!

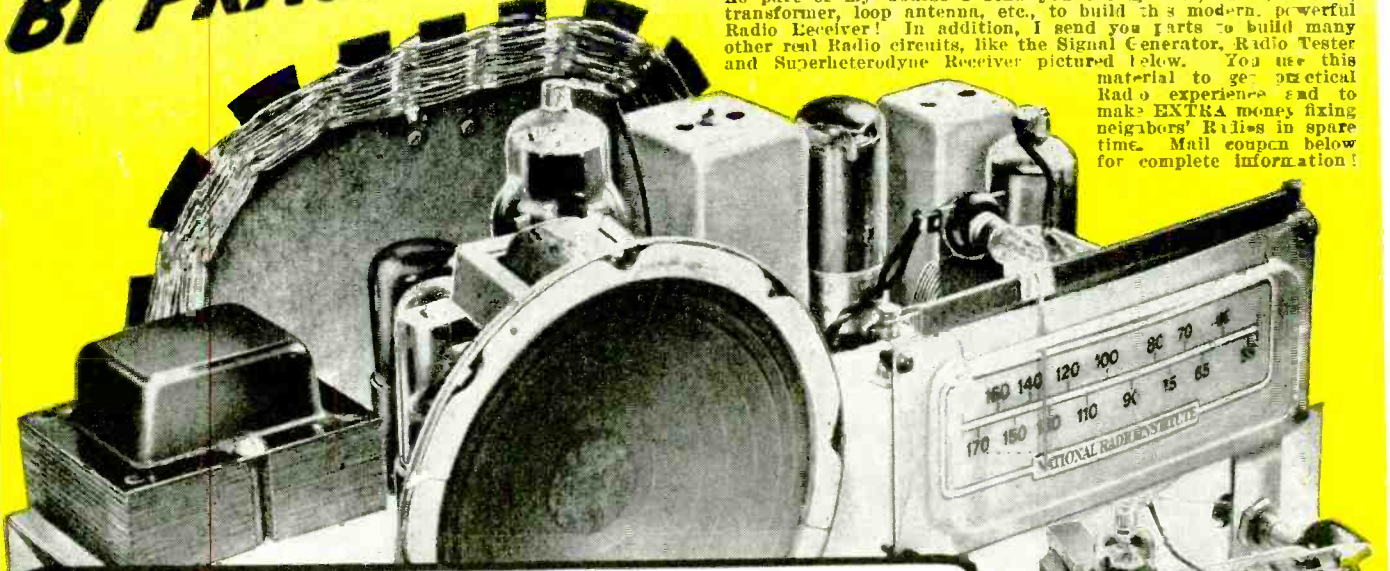

I SEND YOU BIG KITS OF PARTS

You Build and Experiment With this MODERN RADIO AND MANY OTHER CIRCUITS



J. E. SMITH, President of National Radio Institute

I TRAINED THESE MEN

Makes \$60 A Week Plus Bonus



"I am Radio Serviceman for The Adams Appliance Co. Am now getting \$60 a week, plus bonus and overtime." — W. A. ANGEL, Blythesville, Arkansas.

Know Nothing About Radio



"I knew nothing about Radio when I enrolled. I am doing spare time work. I have more than paid for my Course and about \$200 worth of equipment." — RAYMOND HOLT CAMP, Vandalia, Illinois.

Want a good-pay job in the fast-growing RADIO-TELEVISION Industry? Want a money-making Radio-Television shop of your own? Here's your opportunity. I've trained hundreds of men to be Radio Technicians . . . MEN WITH NO PREVIOUS EXPERIENCE. My tested and proved train-at-home method makes learning easy. You learn Radio-Television principles from illustrated lessons. You get practical experience building, testing, experimenting with MANY KITS OF PARTS I send. All equipment yours to keep.

Make EXTRA MONEY in Spare Time

The day you enroll, I start sending SPECIAL BOOKLETS that show you how to make EXTRA MONEY fixing neighbors' Radios in spare time. From here it's a short step to your own shop, or a good-pay Radio-Television servicing job. Or get into Police, Aviation, Marine Radio, Broadcasting, Radio Manufactur-

ing or Public Address work. And think of setting in on the ground floor of the booming Television Industry. Trained men are already in demand . . . new stations are going on the air, manufacturers are building over 100,000 sets a month, more and more homes are getting sets. The man who prepares now will reap rich rewards.

See What N. R. I. Can Do For You

Act now! Send for my DOUBLE FREE OFFER. Coupon entitles you to actual lesson, "GETTING ACQUAINTED WITH RECEIVER SERVICING," absolutely free. Over 80 pictures and diagrams! You also get my 64-page book, "HOW TO BE A SUCCESS IN RADIO AND TELEVISION-ELECTRONICS." Tells more about YOUR opportunities, details of my Course, how

quickly, easily you can get started. Send coupon in envelope or paste on penny postal. J. E. SMITH, President, Dept. 9BX, National Radio Institute, Pioneer Home Study Radio School, Washington 9, D. C.

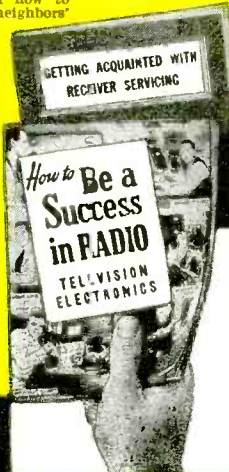

VETERANS

You can get this training under G. I. Bill. Mail coupon.

Good for Both - FREE

MR. J. E. SMITH, President, Dept. 9BX National Radio Institute, Washington 9, D. C.

Mail me FREE Sample Lesson and 64-page book. (No salesman will call. Please write plainly.)

Age

Name

Address

City..... Zone..... State.....

Check if Veteran

My Course Includes Training in TELEVISION • ELECTRONICS FREQUENCY MODULATION

RADIO — ELECTRONICS

formerly RADIO-CRAFT

Incorporating
SHORT WAVE CRAFT • TELEVISION NEWS •
RADIO & TELEVISION

*Trademark registered U. S. Patent Office

Hugo Gernsback, Editor-in-Chief
Fred Shunaman, Managing Editor
M. Harvey Gernsback, Consulting Editor
Robert F. Scott, W2PWG, Technical Editor
R. H. Dorf, W2QMI, Associate Editor
I. Queen, W2OUX, Editorial Associate
Angie Pascale, Production Manager
Elmer Fuller, Shortwave Editor
Wm. Lyon McLaughlin,
Tech. Illustration Director
G. Aliquo, Circulation Manager
John J. Lamson, Advertising Director
Alfred Stern, Promotion Manager

Contents — February, 1949

Editorial (Page 21)	
Manufacturers Woo Servicemen.....	by Hugo Gernsback 21
Amateur (Pages 22-24)	
Grid-Modulated Rig.....	by Alvin B. Kaufman, W6YOY 22
Television (Pages 25-28)	
Television Technique Speeds up Facsimile.....	25
Antennas for Television, Part II.....	by Edward M. Noll and Matt Mandl 26
Television Sweep Circuits, Part II.....	by Allan Lytel 28
Broadcasting and Communications (Pages 29-31)	
High-Frequency FM Relay System.....	by I. Queen 29
Electronics (Pages 32-33)	
Electronics in Medicine, Part V.....	by Eugene J. Thompson 32
Audio (Pages 34-40)	
Audio Console Controls Sound.....	by Richard H. Dorf 34
Adventure in Equalization, or Getting Out the Bumps.....	by James R. Langham 36
A Versatile Audio Oscillator.....	by Harry Hatfield 38
Audio Impedance Matching, Part I.....	by Walter Richter 39
Test Instruments (Pages 41-45)	
All-Round Signal Tracer for Shop or Outside.....	41
Sweep Generators Service FM and TV.....	by Jesse Dilon 42
Two Capacitor Testers.....	by R. L. Parmenter 44
Theory and Design (Pages 46-47)	
Transmission Lines.....	by Robert C. Paine 46
Construction (Pages 48-53)	
A Simple Electronic Flash Gun.....	by Lyman E. Greenlee 48
Electronic Timing Circuits.....	by Norman L. Chalfin 50
Circuitry and Common Sense.....	by Otto Wooley, W0SGG 52
Photoelectric Relay with Variety of Uses.....	by Harold Pallatz 53
Servicing (Pages 54-62)	
Radio Set and Service Review (Philco 49-901).....	54
Radio Cabinets Need Servicing Too.....	by A. G. Sanders 55
Fundamentals of Radio Servicing, Part I—The Electron Theory.....	by John T. Frye 56
Safety or Your Life.....	by R. P. Balin 58
Wire Recorder Service Problems.....	by Willard Moody 60
Foreign News (Pages 63-68)	
European Report.....	by Major Ralph W. Hallows 63
Departments	
The Radio Month.....	12
Radio Business.....	18
World-Wide Station List.....	by Elmer R. Fuller 69
Technotes.....	74
New Devices.....	76
Question Box.....	78
People.....	80
New Patents.....	82
Radio-Electronic Circuits.....	84
Try This One.....	86
Miscellany.....	88
Communications.....	95
Book Reviews.....	97

SPECIAL TELEVISION ISSUE NEXT MONTH!

Television will be the theme of next month's special 144-page issue. Technicians who know and leaders of the industry will describe television progress, television servicing, television accessories and test equipment, and all other phases of this new and important subject. The issue will feature tabulations and charts showing television receiver characteristics, television coverage and other TV information. Non-television articles will not be neglected, and will deal with audio, amateur, theory, and electronics.

RADIO-ELECTRONICS, February, 1949, Volume XX, No. 5. Published monthly. Publication Office: Erie Ave., P. O. G. Streets, Philadelphia 32, Pa. Entered as second class matter September 27, 1948, at the post office at Philadelphia, Pa., under the Act of March 3, 1879. SUBSCRIPTION RATES: In U. S. and Canada, in U. S. possessions, Mexico, South and Central American countries, \$3.50; \$6.00 for two years; \$8.00 for three years; single copies 30c. All other foreign countries \$4.50 a year, \$8.00 for two years, \$11.00 for three years. Allow one month for change of address. When ordering a change please furnish an address stencil impression from a recent wrapper. RADERCRAFT PUBLICATIONS, INC., Hugo Gernsback, Pres.; M. Harvey Gernsback, Vice-Pres.; G. Allano, Sec'y. Contents Copyright, 1949, by Radercraft Publications, Inc. Text and Illustrations must not be reproduced without permission of copyright owners.

EDITORIAL and ADVERTISING OFFICES, 25 West Broadway, New York 7, N. Y. Tel. REctor 5-9690. BRANCH ADVERTISING OFFICES: Chicago: 308 W. Washington Street, Telephone RAndolph 6-7363. Detroit: Frank Holstein, South 1111 St. Tel. Tucker 1793. San Francisco: Ralph W. Harker, 582 Market St. Tel. Garfield 1-2481. FOREIGN AGENTS: Great Britain: Atlas Publishing and Distributing Co., Ltd., 18 Bride Lane, Fleet St., London E.C.4. Australia: McGill's Agency, 179 Elizabeth Street, Melbourne, France: Brentano's, 37 Avenue de l'Opera, Paris 2^e. Holland: Trillectron, Heemsteedsche, Dreet 124 Heemstede. Greece: International Book & News Agency, 17 Amerikis Street, Athens. So. Africa: Central News Agency, Ltd., Cor. Bissik & Commissioner Sts., Johannesburg. 17 112 Long Street, Capetown; 369 Smith Street, Durban, Natal. Universal Book Agency, 70 Harrison Street, Johannesburg. Middle East: Steimatzky Middle East Agency, Jaffa Road, Jerusalem, India: Sushl Gupta (Distributors) Co., Armita Bazar Patrika Ln., 14 Ananda Chatterjee Lane, Calcutta.

Editorial and Executive Offices:
25 West Broadway, New York 7, N. Y.



MEMBER AUDIT BUREAU OF CIRCULATION
ABC PAID CIRCULATION 6 MONTHS TO JUNE 30,
1948—112,592. (Publishers Statement) PRINTED
FOR FEBRUARY ISSUE—176,000

Here's BIG NEWS!

INTERCOM AND RADIO COMBINATION



at a PRICE
That Can't Be Beat

6 tube superhet—3 tube intercom permits communication between radio-master and up to 4 sub-stations.

WHILE THEY LAST \$29.95

With 1 sub-station and 50 feet of cable Extra Sub-stations \$3.95 each

Original cost \$64.50

MIDGET I. F. TRANSFORMERS



Original List \$2.10

NOW 36c EACH

At discounts up to 86%

400-500 Kc range
1 1/4" square, 3" high
hi-gain iron core.

INPUT—A826
OUTPUT—A827

Matched Pair 69c
Specify Type Dozen \$3.95
Egg Crate of 100 \$29.00

1 meg. VOLUME CONTROLS



85% DISCOUNT

Universal with switch

Better Hurry

THESE WON'T LAST AT THIS PRICE 29c Each

ORDER INSTRUCTIONS

Minimum order—\$2.00. 25% deposit with order required for all C.O.D. shipments. Be sure to include sufficient postage—excess will be refunded. Orders received without postage will be shipped express collect. All prices F.O.B. Detroit.

RADIO SUPPLY & ENGINEERING CO., Inc.

85 SELDEN AVE. DETROIT 1, MICH.



Learn RADIO

TELEVISION, ELECTRONICS

by SHOP METHOD HOME TRAINING

Let NATIONAL SCHOOLS, of Los Angeles, a practical Technical Resident Trade School for almost 50 years, train you for today's unlimited opportunities in Radio

You receive all parts, including tubes, for building this fine, modern Superheterodyne Receiver. This and other valuable standard equipment becomes your property.

these two FREE books will tell you how



Good Jobs Await the Trained Radio Technician

You are needed in the great, modern Radio, Television and Electronics industry! Trained Radio technicians are in constant and growing demand at excellent pay—in Broadcasting, Communications, Television, Radar, Research Laboratories, Home Radio Service, etc. National Schools Master Shop Method Home Study course, with newly added lessons and equipment, can train you in your spare time, *right in your own home*, for these exciting opportunities. Our method has been proved by the remarkable success of National Schools-trained men all over the world.

You Learn by Building Equipment with Standard Radio Parts We Send You

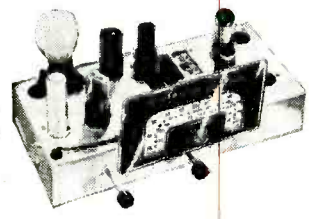

Your National Schools Course includes not only basic theory, but *practical* training as well—you *learn by doing*. We send you complete standard equipment of professional quality for building various experimental and test units. You advance step by step until you are able to build the modern superheterodyne receiver shown above, which is yours to keep and enjoy. You perform more than 100 experiments—build many types of circuits, signal generator, low power radio transmitter, audio oscillator, and other units. The Free Books shown above tell you more about it—send for them today!

Now! NEW PROFESSIONAL MULTITESTER INCLUDED:



This versatile testing instrument is portable and complete with test leads and batteries. Simple to operate, accurate and dependable. You will be able to quickly locate trouble and adjust the most delicate circuits. You can use the Multitester at home or on service calls. It is designed to measure AC and DC volts, current, resistance and decibels. You will be proud to own and use this valuable professional instrument.

Lessons and

Instruction

Material Are Up-to-date, Practical, Interesting

National Schools Master Shop Method Home Training gives you basic and advanced instruction in all phases of Radio, Television and Electronics. Each lesson is made easy to understand by numerous illustrations and diagrams. All instruction material has been developed and tested in our own shops and laboratories, under the supervision of our own engineers and instructors. A free sample lesson is yours upon request—use the coupon below.

You Get This and Other Valuable Information in the Free Sample Lesson:

1. Basic Receiver Circuits and How They are Used.
2. Construction of the Antenna Circuit.
3. How Energy is Picked Up by the Aerial.
4. How Signal Currents are Converted into Sound.
5. How the Tuning Condenser Operates.
6. How the R-F Transformer Handles the Signal, and other data, with diagrams and illustrations.

Both Home Study and Resident Training Offered

APPROVED FOR VETERANS
Check Coupon Below

NATIONAL SCHOOLS

LOS ANGELES 37, CALIFORNIA EST. 1905



MAIL OPPORTUNITY COUPON FOR QUICK ACTION

NATIONAL SCHOOLS, Dept. RC-2
4000 S. Figueroa, Los Angeles 37, Calif. Paste on a postcard

Mail me FREE the book "Your Future in Radio" including a sample lesson of your choice. I understand no salesman will call on me.

NAME AGE.....

ADDRESS

CITYZone.....STATE.....

Check here if Veteran of World War II

GET THE DETAILS—SEND THE COUPON →

SAVE

WILLARD 2 VOLT BATTERIES \$1.25



Brand new, compact, spillproof built-in hydrometer, group several together to get higher voltages. Fully quarantined. Shipped dry, add 35c to cover postage and handling.

New 4 conductor 16 gauge rubber covered cable. Color coded. Used by United States Government as Field Telephone Cable. 1300 feet on steel reel. F.O.B. Our warehouse. Shipped motor freight or express shipping charges collect.

1300 FT. Heavy Duty Cable \$18.00

69¢ Post Paid

Western Electric Extension Control Box, Type CW 23098. Complete with mounting plate. All new in original cartons. Contains one 50000 ohm resistor, 1 toggle switch, one phone jack, one microphone jock, one test key, and one neon indicator lamp.



By Bendix \$1.29 Postpaid

Model 3616, makes an excellent set up for an intercom. set. Contains 3 multiple type water switches, one panel type fuse, one volume control, one master 2 pole double throw switch, one lock type sending and receiving telephone key, one local remote transmitter control, one single pole switch, one 24-volt Cochr Relay with 2 contacts.



Loops \$3.95



Used primarily on aircraft & Marine ADF Systems, Loop LP-21-A contains an electric motor and relay. These loops have been removed from salvage aircraft, but are guaranteed to be in excellent working condition.

Shipped Express Collect

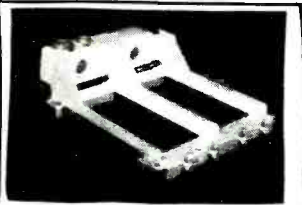

COMMAND SET RACKS

Double Transmitter rack. Brand new in original carton. No. FT-226 only 99c postpaid.

Triple receiver rack. No. FT-220-A. Brand new in original cartons, only \$1.59 postpaid.

ANTENNA REEL

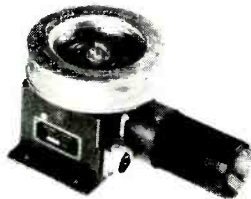

RL 42 B

Antenna Reel RL42B, operates on 24 volts DC, complete with bobbin, each \$2.50 Shipped express charges collect. less wire

Extra bobbin with wire and weight in canvas bag, each \$2.00 Shipped express charges collect.

Fairlead F10 for use with Antenna Reel RL42B, 37" overall length, each \$1.00 Add 25c for postage and handling.

Reel Control Box BC-461 for use with Antenna Reel RL42B, controls winding and indicates the number of feet of wire out, each .75 Add 25c for postage and handling.

50" Flexible Shaft for connecting Antenna Reel RL42B and Control Box BC-461, each \$1.00 Add 30c for postage and handling.

82" Flexible shaft, same as above, each \$1.50 Add 35c postage and handling.



BC-616 RELAY BOX

Originally used with the command set between Modulator BC456A and Control Box BC451A. Contains 3, 24 volt relays and other parts on excellent buy at only \$1.39 postpaid.

PHANTOM ANTENNA

for CITIZEN BAND Still 85¢

B.R. Tubes

- 3 CP 1 (Ind. Screen) .95
- 3 FP 7-A 1.35
- 3 HP 7 1.45
- add 25c each to cover postage and handling
- 5 FP 7 1.75
- 5 CP 1 1.95
- 5 BP 1 2.45
- 5 HP 1 2.45
- add 35c each to cover postage and handling
- 7 BP 7 2.65
- 7 CP 1 3.25
- add 40c each to cover postage and handling
- 9 GP 7 3.50
- Shipped express, charges collect

\$

Lip Mikes, brand new, complete with cord and switch 95c each postpaid.

Throat Mikes, brand new, complete with cord and switch 95c each postpaid.

BC-1366 or 366 Jack Box. Contains Mic. Jack, volume control, 5 position 2 gang rotary switch, 11 contact bayonet plug and receptacle. All nicely assembled in a neatly finished metal box 3 3/16" W x 4 3/8" H x 2 3/16" D. Lots of uses in the Ham shack, lab., or on mobile installations. A sensational buy at only 79c each, postpaid, or 10 for \$6.95 postpaid.

C-2/ARR-2 CONTROL BOX

Contains: 1, 10,000 ohm potentiometer, 1, 5,000 ohm potentiometer, 1 phone jack, 1 10 ohm 1/2W resistor, 1 3 position switch, 1 closed circuit phone jack, and 1 crank operated tuning mechanism. A truly sensational buy at only 95c each postpaid.

Surplus Tubes All New, All Postpaid

- 8012 \$1.69
- 1626 \$.35
- 705-A \$1.19
- 211 \$.69



Brand New Flameproof Telegraph Key 95c Postpaid



TIME DELAY RELAY

24 volt, 200 ohms Resistance, approximately 1/50 of 1 second delay. Brand new type B-9 manufactured by Gaurdion Electric. Part No. 34464. Price, only 99c post paid.

IMPORTANT!

All merchandise subject to prior sale, minimum order \$2.00. No C.O.D. orders accepted. Michigan residents must add 3% State sales tax.

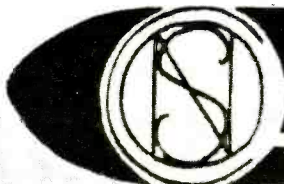

N. SILVERSTINE CO.

6532 EAST McNICHOLS ROAD DETROIT 12, MICHIGAN

Seven Acres of Surplus

HERE'S THE Complete Sprayberry Course!

LEARN RADIO ELECTRONICS-TELEVISION!



I SEND YOU 8 BIG KITS OF RADIO PARTS!

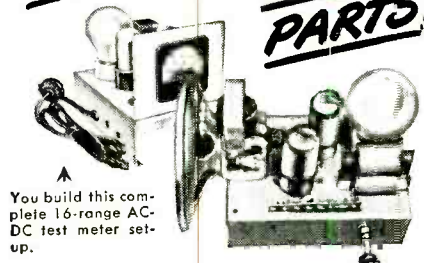

You build this complete 16-range AC-DC test meter set-up.



I show you how to build this speaker tester and many other instruments.

You build, test and trouble-shoot this powerful 6-tube superher Radio.

I'LL TRAIN YOU AT HOME—BETTER—FASTER by Putting You to Work with Your Hands

In this picture I show you exactly what you'll get from me during your Sprayberry Radio Training. This actual photograph speaks for itself! Sprayberry Radio Training is really COMPLETE—I start you with interesting, easily understood basic knowledge...

EARN WHILE LEARNING

Shortly after you enroll I send you my famous BUSINESS BUILDERS that help you get and do profitable neighborhood Radio Service jobs while learning.

All branches of Radio, Television and Electronics are booming! Trained men are needed NOW! I'll prepare you for your own profitable Radio Service Business or a big pay radio job in double quick time.

My course is so perfectly planned—so easy to grasp and understand—you need no previous knowledge or experience of Radio or Electricity. Get the facts now—find out what Sprayberry Radio Training can do for you.

Make Money In Radio, Electronics and Television" that tells all about Sprayberry Training. I'll also send you a Sample Lesson, "How To Read Radio Diagrams and Symbols"—all FREE.

LOW COST COMPLETE TRAINING

Sprayberry Training is surprisingly Low In Cost—and if you desire, convenient monthly payments can be arranged. This is COMPLETE, Up-to-Date training—covering Radio Repairing, Television and F.M., Industrial Electronics and many other new developments.

FREE SAMPLE LESSON AND BIG CATALOG

See how quickly and easily you can get your start in Radio, Electronics, Television with Sprayberry Training. Just fill out, clip and mail the coupon NOW for my big FREE book and FREE Sample Lesson.

SPRAYBERRY ACADEMY OF RADIO, DEPT. 20-0 SPRAYBERRY BUILDING 20 NORTH WACKER DRIVE PUEBLO, COLORADO or CHICAGO 6, ILLINOIS

NOW! TWO LOCATIONS To Serve You Better! Mail Coupon To Location Nearest Your Home

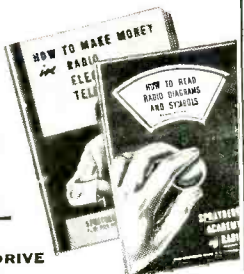

Mail COUPON Today!

SPRAYBERRY ACADEMY of RADIO, Dept. 20-0 Sprayberry Building Pueblo, Colorado, or 20 North Wacker Drive, Chicago 6, Illinois

NAME _____ ADDRESS _____ CITY _____ ZONE _____ STATE _____ [] Check here if a Veteran

MINE DETECTOR SCR-625 *Brand New*

**ATTENTION; LUMBERMEN, PROSPECTORS, MINERS, PLUMBERS,
OIL COMPANIES, etc.**

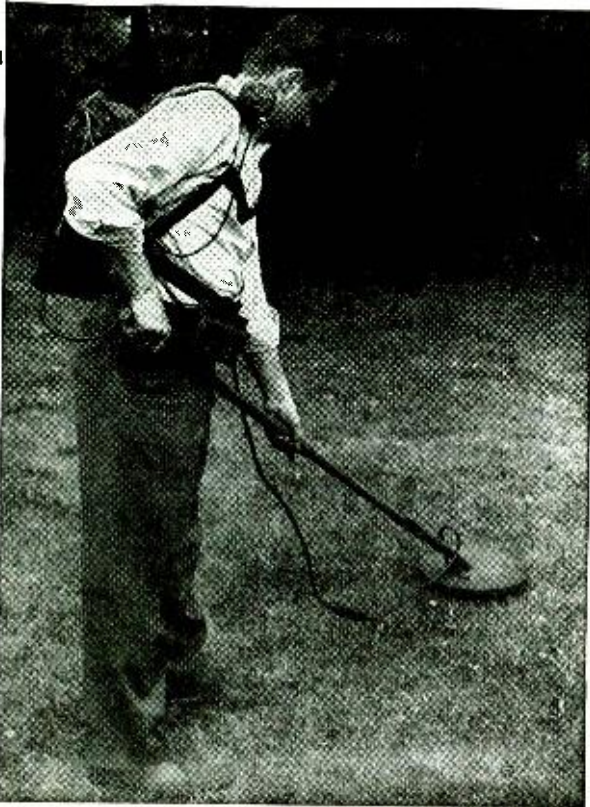

- ★ Below is a description of one of the finest metal detecting Mine Detectors ever built.
- ★ Operates in the manner of aural and visual method.
- ★ If you are looking for metal buried in logs, pipes in the ground, ore bearing rocks, underground cables, metallic fragments in scrap materials, metallic money buried or hidden in undetermined places this Mine Detector will probably surpass anything that was ever built. The United States Forestry Service has recommended procedure for using this detector to find concealed metal in tree logs and other timber products. Our government is reported to have paid several times the amount of our prices. They originally were sold by War Assets to jobbers for \$166.00

- ★ Unit consists of a balance-inductance bridge, a two tube amplifier and a 1000 cycle oscillator. The presence of metal disturbs the bridge balance resulting in a volume change of the 1000 cycle tone. Tubes used are low battery drain types such as 1G6 and 1M5. The circuit may be modified for control of warning signals, stopping of machinery, etc., when metal is detected.
- ★ Operates from two flashlight batteries and 103 v (B). However, a power supply operating from 115 v A.C. may be used.
- ★ This unit is brand new and comes complete with spare tubes, spare resonator and instruction manual—in wooden chest 8 $\frac{1}{4}$ inches x 28 $\frac{1}{4}$ inches x 16 inches. Weight in operation is 15 pounds. Packed in original overseas container.
- ★ We do not know exactly what the deepest possible penetration would amount to when this detector is used but we have had customers who have bought the detectors with the expectation that the detector would locate metallic objects buried several feet under the ground or under water and we have absolutely no complaints whatsoever regarding the detector not living up to the customers' expectations.
- ★ We can not overemphasize our belief that if an Army surplus mine detector could solve your problems in detecting metal that this detector should fill the bill.

NOTE: Batteries are not furnished, we can supply for \$4.50 extra.

our price
is **\$7950**

Shipping Weight 125 pounds

ESSE Radio Co
130 W. New York St.
Indianapolis 4, Ind.

Unless Otherwise Stated, All of
This Equipment Is Sold As Used
**CASH REQUIRED
WITH ALL ORDERS**
Orders Shipped F.O.B. Collect

NOW!

Amazing new equipment helps you learn

OUR GREATEST OFFER IN 17 YEARS

RADIO-ELECTRONICS

AND THIS EQUIPMENT
6-TUBE RADIO RECEIVER OSCILLOSCOPE
SIGNAL GENERATOR MULTI-METER

Here's good news . . . big news . . . our **BIGGEST NEWS** in 17 years. The equipment at right gives a partial idea of D.T.I.'s remarkable, new combination of shop-method training aids . . . to prepare you **AT HOME** for your start in Television-Radio-Electronics.

GET FREE BOOKLET

Mail coupon today for D.T.I.'s big, new 48-page **OPPORTUNITY GUIDE BOOK**. See how this amazing newer method helps you get started toward a **GOOD JOB** or your **OWN BUSINESS** in one of America's most promising fields . . . Television . . . F.M., Train, 2-Way Taxi, Aviation, and Broadcast Radio . . . Industrial Electronics . . . and other fascinating branches.

In addition to well-illustrated lessons, you work over 300 instructive projects from 16 shipments of Radio-Electronic parts — including (1) a commercial-type **CATHODE RAY OSCILLOSCOPE** that helps you get practical Television circuit training, (2) a double range **RF SIGNAL GENERATOR**, (3) a jewel-bearing **MULTI-METER**, and (4) a quality 6-tube **SUPERHET RADIO**. You keep all of this equipment.



WORK OVER 300 HOME EXPERIMENTS

MODERN CHICAGO LABORATORIES

If you prefer, make **ALL** your preparation in our new, Chicago training laboratory . . . one of the finest of its kind. Ample instructors . . . modern equipment. Write for details!

EFFECTIVE EMPLOYMENT SERVICE

When you complete your training, our effective Employment Service is available to you without extra cost to help you get started.

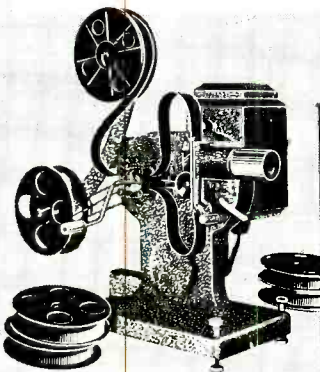

D.T.I. alone, includes the use of modern, visual training aids — **MOVIES** — to help you learn faster at home. You see electrons on the march and other fascinating "hidden action" . . . a remarkable home-training advantage that speeds your progress.

MAIL COUPON TODAY!

DeForest's Training, Inc.
2533 N. Ashland Ave., Dept. RC-F2
Chicago 14, Illinois

Send me **FREE** your 48-page **OPPORTUNITY GUIDE BOOK** showing how I may make my start in Television-Radio-Electronics.

Name _____ Age _____
Street _____ Apt. _____
City _____ Zone _____ State _____

DeForest's Training, Inc.

CHICAGO, ILLINOIS
Affiliated with the DeVry Corporation,
Builders of Electronic and Movie Equipment

TRANSVISION

New TV KITS and CABINETS

STANDARD and CUSTOM-TYPE MODELS at LOW COST
NEWEST in TELEVISION DESIGN • BIGGEST IN VALUE

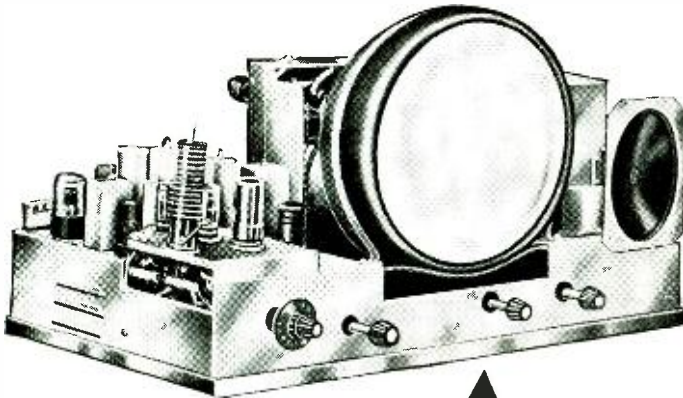

Model 10A TV Kit



New streamlined cabinets for Models 10A or 12A TV Kits, designed by Hal Bergstrom.

Featuring

- PICTURES UP TO 150 SQ. INCHES
- CONTINUOUS TUNING ON ALL 12 CHANNELS
- LONG-RANGE RECEPTION



New 150 Sq. In. TV Kit

Model 10CL, with Roto-Table

This new Model 10CL is a 10" electromagnetic TV Kit, equipped with an all-angle lens (with color kit) giving a picture of 150 sq. in. The image is clearly visible from a very wide angle of vision, because of this specially designed lens. Also has the new CONTINUOUS TUNING UNIT shown on the right. This kit comes COMPLETE with CABINET, LENS, and ROTO-TABLE; also double-folded dipole antenna (all channel) and 60 ft. of lead-in wire.
MODEL 10CL TV Kit.....Net \$299.00

New 10" TV KIT

at amazingly low price!

The new Transvision Model 10A electromagnetic TV Kit gives a bright, stable 52 sq. in. picture. Has 10" picture tube, and **CONTINUOUS TUNING UNIT** (shown on the right hand page) on all 12 channels. Its high sensitivity makes for improved long-distance reception; especially good on high channels. Complete with all-channel double-folded dipole antenna and 60 ft. of lead-in wire.

MODEL 10A TV KIT, less cabinet...Net \$199.00

MODEL 12A TV KIT, same as above, but

has a 12" picture tube.....Net 263.00

◀ NEW STREAMLINED CABINETS for Transvision Model 10A or 12A TV Kit. Made of select grain walnut with beautiful rubbed finish. Fully drilled, ready for installation of assembled receiver.

Walnut Cabinet for 10A or 12A (Specify).....Net \$44.95
Mahogany and Blonde slightly higher.

EASY TO ASSEMBLE . . . NO TECHNICAL KNOWLEDGE REQUIRED

Transvision's simple step-by-step Instruction Sheet makes assembling a TV Kit a pleasure. Each kit comes complete with all-channel double-folded dipole antenna and 60 ft. of lead-in wire. **Nothing else to buy!**

Assemble Your Own Cabinets

Transvision's "MODULAR" Cabinets come in knock-down, unpainted units, offering an unlimited range of combinations, including even a bar. Finish them off to suit your taste and need.

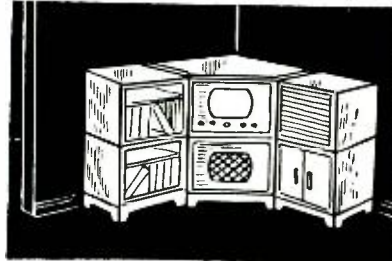

Corner piece, shown above, has room for TV, Phono, Record Storage, and open Book Case. COMPLETE.....Net \$84.00
For other units and prices, write for "Modular" Catalog.

"CUSTOM-ART" CABINETS Made to Order. Radiomen, Dealers—Here is a beautiful line of exclusive, custom-built cabinets, designed and completely built in our factory, and finished to your customer's specifications . . . at very reasonable prices. Shown above is Transvision's "Modern Comprehensive" which has provision for TV/FM/AM, Record Changer, Album Shelf, Bar, and Concealed Wine Cellar. For further details on the complete line, write for FOLDER No. D-1.

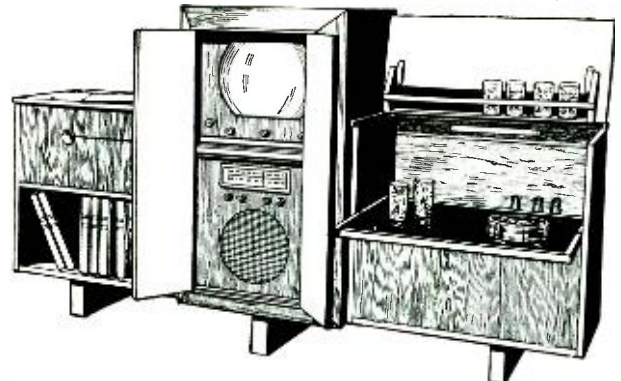

Shown above is Transvision's "Modern Comprehensive" which has provision for TV/FM/AM, Record Changer, Album Shelf, Bar, and Concealed Wine Cellar. For further details on the complete line, write for FOLDER No. D-1.

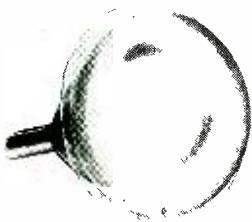

TRANSVISION ALL-ANGLE LENSES for ALL TV SETS. Give picture sizes up to 150 sq. in. Exclusive patented feature makes image visible from wide angle. Lenses come with adapter for installation on ANY 7" or 10" picture tube, and with color kits. All-Angle Lens for 7" tubes (gives 75 sq. in. picture), Net \$21.95. All-Angle Lens for 10" tubes (gives 150 sq. in. picture), Net \$32.50.

GET into the TELEVISION BUSINESS in a BIG WAY

Radiomen, Servicemen, Dealers . . . Transvision offers you, through your jobber, a 3-part Dealer Plan for making big money in television: (1) Sell TV sets constructed by you from Transvision Kits. (2) Sell exclusive Custom-Built Jobs with beautiful "Custom-Art" Cabinets. (3) Sell "packaged" Transvision TV Products, including Kits, Components, and Accessories. For FULL DETAILS about this amazing plan, WRITE FOR FOLDER No. D-1, or ask your jobber.

FREE 162 p. TELEVISION COURSE with purchase of any Transvision TV Kit . . . You don't need this course to assemble a Transvision Kit, because the job is easy enough and our instruction sheet is simple and clear. BUT if you want a good introduction to television fundamentals as a basis for further study, the Transvision Television Home-Study Course is ideal. Remember, you pay nothing extra for this course. Ask your jobber.

For FREE 70 p. TV BOOKLET and 8 p. CATALOG, SEE YOUR TRANSVISION JOBBER. . . .

TRANSVISION

New TV INSTRUMENTS

TUNERS, BOOSTER, and ACCESSORIES

For Every Television Installation Requirement

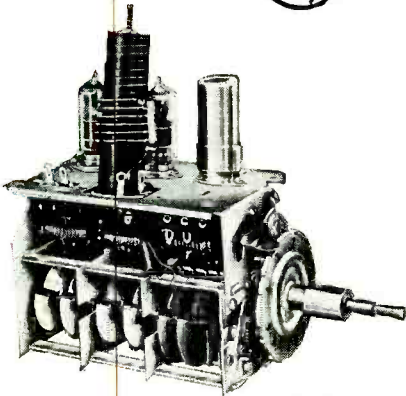

NEW 12-Channel TV Tuner CONTINUOUS TUNING

Model CT-1 (part #653), for TV channels 2 to 13, is notable for its high gain, sensitivity, excellent image rejection ratio, and **CONTINUOUS TUNING** feature. May be used with any 7", 10", 12" or 15" kit.

Model CT-1 TV TunerNet \$32.50

Model TT-2 (part #301-1 or #301-2) covers all TV channels, also FM band (88-108 mc.). Available for 7", 10", 12" or 15" kits. Specify tube size.

Model TT-2 TV/FM Tuner . . .Net \$44.95

TRANSVISION ALL-CHANNEL TELEVISION BOOSTER CONTINUOUS TUNING

To assure television reception in weak signal areas, or areas which are out of range of certain broadcasting stations, Transvision engineers have designed this new booster. It **increases signal strength on all television channels**. Tunes all television channels **continuously**. Can be used with any type of television receiver. Unusually high gain in upper television channels.

Model B-1List \$44.95

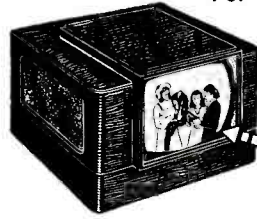
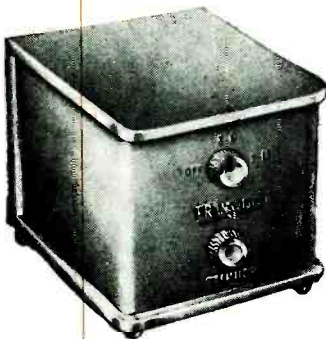

TRANSVISION'S NEW REMOTE CONTROL UNIT KIT—for use with ANY TELEVISION SET

THE REMOTE CONTROL



OPERATES ANY TELEVISION SET from a DISTANCE up to 50 feet.

Now you can sit back in your easy chair, a comfortable distance away and operate your TV set. This new **Transvision REMOTE CONTROL UNIT** turns **ANY SET on, tunes in stations, controls contrast and brightness, turns set off.** Especially ideal for commercial installations where the TV set is inaccessible. **TUNER UNIT** is a high gain, all-channel, **CONTINUOUS TUNING UNIT** (about 50 microvolt sensitivity). **Supplied in KIT form . . . easy to assemble in about an hour.**
Model TRCU Remote Control Unit Kit with 25-ft. cableNet \$69.00
Also available without cabinetNet 65.00

TRANSVISION FIELD STRENGTH METER

Saves 1/2 the cost of TV installations
Improves installations! Saves 1/2 the Work! Has numerous features and advantages, including—(1) Measures actual picture signal strength . . . (2) Permits actual picture signal measurements without the use of a complete television set . . . (3) Antenna orientation can be done exactly . . . (4) Measures losses or gain of various antenna and lead-in combinations . . . (5) Useful for checking receiver re-radiation (local oscillator) . . . (6) **12 CHANNEL SELECTOR** . . . (7) Amplitudes of interfering signals can be checked . . . (8) Weighs only 5 lbs. . . (9) **Individually calibrated** . . . (10) Housed in attractive metal carrying case . . . (11) initial cost

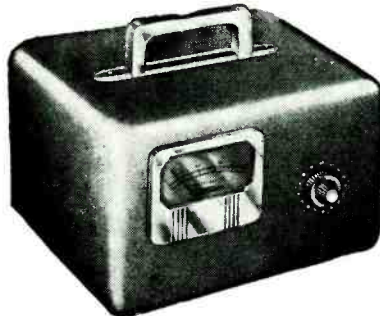

of this unit is covered after only 3 or 4 installations . . . (12) Operates on 110V, 60 Cycles, AC.

**Model FSM-1, complete with tubes
Net \$99.50**

TRANSVISION TELEVISION and FM SWEEP SIGNAL GENERATOR

Complete frequency coverage from 0-227 MC with no band switching. . . Sweep width from 0-12 MC completely variable. . . Accurately calibrated built-in marker generator.

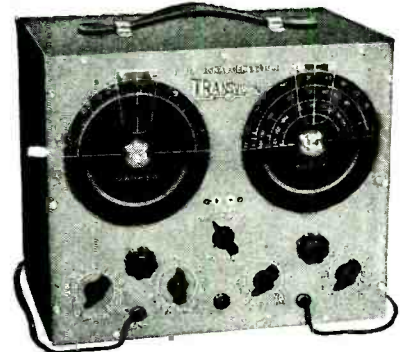

OUTSTANDING FEATURES: (1) Frequency range from: 0-227 MC . . . (2) Dial calibrated in frequency . . . (3) Sweep width from 0-12 MC completely variable . . . (4) Self-contained markers readable directly on the dial to .5% or better. (No external generator required to provide the marker signals) . . . (5) Crystal controlled output makes possible any crystal controlled frequency from 5-230 MC . . . (6) Plenty of voltage output—permits stage-by-stage alignment . . . (7) Output impedance 5-125 ohms . . . (8) Directly calibrated markers, 20-30 MC for trap, sound and video IF alignment . . . (9) RF for alignment of traps for IF channels when a DC voltmeter is used as the indicating medium . . . (10) Unmodulated RF signal to provide marker pips simultaneously with the main variable oscillator . . . (11) Markers can be controlled as to output strength in the pip oscillator . . . (12) Power supply completely shielded and filtered to prevent leakage . . . (13) All active tubes are the new modern miniature type . . . (14) Phasing control incorporated in the generator . . . (15) Operates on 110V, 60 Cycles, AC.

Model SGNet \$99.50

All Transvision Prices are fair traded; subject to change without notice. Prices 5% higher west of the Mississippi.

TRANSVISION, INC., Dept. RE, NEW ROCHELLE, N. Y.

For **FREE 20-page TV BOOKLET and 8-page CATALOG, SEE YOUR TRANSVISION JOBBER!**

NEW YORK, N. Y.
 FEDERATED PURCHASER, INC.
 80 Park Place
 PALLADIUM TELEVISION CORP.
 785 Third Ave.
BRONX, N. Y.
 NATIONAL RADIO DIST.
 899 Southern Blvd.
BROOKLYN, N. Y.
 BENRAY DISTRIBUTING CO.
 504 Coney Island Ave.
STATEN ISLAND, N. Y.
 B. & D. DISTRIBUTING CO.
 Staten Island 5

LONG ISLAND, N. Y.
 ELECTRONIC SUPPLY CO.
 40-14 Greenpoint Ave.,
 Long Island City, N. Y.
ISLAND RADIO DIST. CO.
 412 Fulton Ave.,
 Hempstead, L. I., N. Y.
WESTCHESTER, N. Y.
 RADIOMART
 149 Riverdale Ave.,
 Yonkers, N. Y.

NEW JERSEY
 NIDISCO JERSEY CITY, INC.
 713 Newark Ave.,
 Jersey City, N. J.; also—
 Cliffside, Passaic, Trenton
VARIETY ELECTRIC CO.
 601 Broad St.,
 Newark, N. J.

BOSTON, MASS.
 BEACON TELEVISION, INC.
 1306 Boylston St.

PHILADELPHIA, PA.
 TRANSVISION OF PHILA.
 235 N. Broad St.

WASHINGTON, D. C.
 STAR RADIO
 409 11th St., N.W.

CHICAGO, ILL.
 TRANSVISION OF CHICAGO
 1002 S. Michigan Ave.

HOLLYWOOD, CALIF.
 TRANSVISION OF CALIF.
 8572 Santa Monica Blvd.

QUESTION

Why do so many television sets use Sprague KOOLOHM Resistors for all 5- and 10-watt wire wound power resistor requirements?

ANSWER

Because Koolohms far surpass other wire wound resistor types in the essential characteristic of resistance stability. Also because, being doubly insulated, Koolohms can be mounted anywhere—even directly against a metal chassis. Koolohms are highly heat- and moisture-resistant. One type—the standard type handles any job. No need to worry about choosing special coatings. Moreover, Koolohms cost no more than ordinary resistors, and are actually cheaper in many cases.

SERVICE HINT

Play safe by using Sprague Koolohms in all your work—not only in television, but wherever you want a really first class job. And remember: Koolohms can be used safely at their full wattage ratings, even in enclosed places. No need to buy a 10-watt resistor when the circuit only needs 5-watts. A 5-watt Koolohm dissipates a full 5 watts!

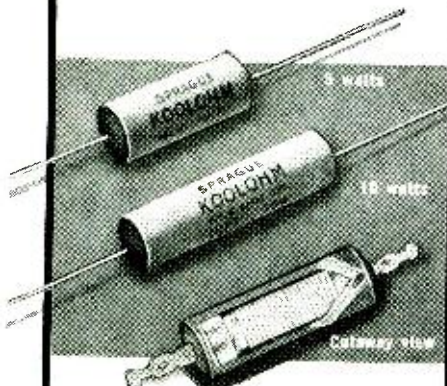

Wound with ceramic-insulated wire. More resistance in less space. Doubly protected, insulated and sealed by outer ceramic jacket. Highly resistant to moisture and heat.

SPRAGUE
KOOLOHM
Reg. U. S. Pat. Off.
WIRE WOUND RESISTORS

SPRAGUE PRODUCTS CO., North Adams, Mass.
(Jobbing distributing organization for products of Sprague Electric Co.)

GEIGER-MULLER COUNTERS can be installed in ordinary home radio sets, reported atomic scientist William D. Schafer last month. Any citizen could, by making a simple change in his receiver, have a Geiger-Muller radiation counter for use in the event of atomic-bomb attack. A low-voltage G-M tube easily added to the set could be removed for ordinary radio listening or inserted for detecting radiation. The tube would indicate the presence of radioactive particles by clicks or roars in the loudspeaker. The low-voltage tubes necessary have not yet been made but could, said Mr. Schafer, be mass-produced. Installation would be simply a matter of removing a radio tube and inserting a G-M tube and socket adapter. Operation could be checked with a radium-dial watch. Even the tiny amount of radiation from the watch numerals would cause a few clicks per minute in the speaker, enough to provide an indication of working condition.

ALL-WEATHER FLYING for commercial airlines will be possible only after an elaborate electronic computer has been developed for handling traffic, Hector R. Skifter, president of the Airborne Instrument Laboratory said last month.

A suitable device does not exist today but it can and will be developed, predicted Mr. Skifter. While many electronic navigation and landing aids are now common on large aircraft, the remaining and most important problem is the routing of air traffic to prevent collisions between aircraft when visibility is low.

Any computer for controlling traffic would have to be fully automatic. It would have to show airborne pilots and ground control personnel the exact position of all planes in the area. Parts of the equipment would have to be set up in all sections of the country, with information fed into the device going to a central clearing point.

The British are cooperating in the development of an all-weather control system, which indicates that it may be a world-wide network rather than several national or local systems.

TELEVISION LABORATORY was set up last month by the Associated Radio Servicemen of Central Pennsylvania atop Mostoller Hill in Williamsport. Facilities available include a 40-foot tower with platform, two types of antennas, meters, signal generators, and other equipment.

Preliminary tests with several television receivers were reported satisfactory, signals being received from New York, Philadelphia, Washington and Baltimore.

Any member of the local association who wishes can drive out to the lab and make his tests. All work on the laboratory was done by members in their spare time.

This is possibly the first instance of a co-operative experimental television laboratory set up and maintained by radio service technicians.

INTEROFFICE TELEVISION is now a reality, according to an announcement last month by Remington Rand. The company has started production of a wired TV system, known as Vericon. The system has three units, a camera weighing only 31½ pounds, a power generator and a master viewer. As many as ten other viewers can be connected to the camera at once.

The company expects to find many uses for Vericon. Used with office intercoms, the two parties will be able to see each other and show each other papers and objects. In banks, each teller will be able to flash a picture of a check to a central record room for verification of the signature. And in store windows, a viewer can show views of merchandise in the store.

The image is said to be bright enough for daylight viewing and clear enough to be photographed.

U. S. RADIOS now total 79 million, according to a report last month by the Broadcast Measurement Bureau (BMB). Of these, 74 million are in use and 5 million are inoperative. The report stated that 40.9% of all radio families have more than one receiver and that median daily listening time is 5 hours 53 minutes.

YOUNGEST RADIO AMATEUR in the world is Jane Bieberman who operates W3OVV from her home in Bala-cynwyd, Pennsylvania. She is ten years old. Jane, the daughter of W3KT, was copying code at 5 words per minute at the tender age of five years. No attempt was made to prepare her for FCC examinations until early last spring when her father began giving her instructions in code and radio fundamentals. On August 20th, 1948, she passed examinations with flying colors in the office of the Radio Inspector in Philadelphia.

AMATEURS and the Army will cooperate in a new Military Amateur Radio System (MARS) somewhat similar to the AARS of prewar days.

The full purpose of MARS, according to the official announcement made in Army and Air Force Regulations, is "to create interest and further training in military radio communication; to promote study and experimentation in military radio communication; to coordinate practices and procedures of amateur radio operations with those of military radio communication; and to provide an additional source of trained radio communication personnel in the event of a local or national emergency."

Membership will be open to any individual in the Military Service, Organized Reserve Corps, National Guard, or the Reserve Officers Training Corps who possesses a valid amateur radio operator's license issued by the Federal Communications Commission or issued under regulations of an oversea commander. Applicants must agree to operate under regulations prescribed by the Secretary of the Army and the Secretary of the Air Force.

CITIZENS RADIOS are now in actual pilot plant production according to Al Gross of the Citizens Radio Corporation which has received the first FCC type approval for equipment to be used on the 465-mc band allocated for civilian use.



Citizens' radio transceiver is pocket-size.

The equipment, Gross reports, is one-fourth the size of the famous wartime Handie-Talkie, and is the result of more than two years of research and engineering in which many new techniques, including subminiature tubes and the use of silver-on-ceramic (printed) circuits, have been perfected for practical push-button, person-to-person radio communication for public use.

The transceiver, two of which are required for person-to-person air contact, is housed in a tiny case measuring only 6 x 2 7/8 x 1 1/2 inches, topped by a small folding antenna. This pocket-sized radio station includes all necessary equipment except a tiny headphone and batteries carried in a separate case about the size of a miniature camera.

The model 100-B citizen's radio is described as a transceiver for Class-B stations only; operating at 465 mc, tolerance 0.4; input 3 watts; emission A-3 with 30% maximum modulation. The transmitting section uses a Sylvania 6K4 subminiature oscillator; the super-regenerative receiver three Sylvania 1V5 subminiature tubes. The transceiver weighs only 11 ounces including antenna and total station equipment including batteries is only two-and-one-half pounds.

RMA-IRE fourth annual Spring meeting for transmitter and transmitting-tube engineers will be held on April 25, 26, and 27 at the Benjamin Franklin Hotel in Philadelphia, Virgil M. Graham, chairman of the Spring Meeting Committee and director of technical relations for Sylvania, announced last month. The program will probably include technical papers and visits to the Philadelphia Navy Yard, television station WPTZ, and the RCA plant at Camden.

IRE 1949 National Convention will be held from March 7 to 10 at the Hotel Commodore and Grand Central Palace in New York City. The theme of the program, which will combine technical sessions, social events, and manufacturers' exhibits, will be "Radio-Electronics—Servant of Mankind."

TELEVISION CLINIC held last month by the Television Broadcasters Association at the Waldorf-Astoria Hotel in New York was attended by nearly 500 television broadcast executives, agency members, manufacturers, federal officials, and others. The principal speaker was FCC chairman Wayne Coy.

HENDRIK J. van der BIJL, one of the pioneer vacuum-tube physicists, died December 2, 1948, at Johannesburg, South Africa. His age was 61.

Born in South Africa, he came to the United States at an early age and engaged in electrical engineering. He was a research physicist for American Telephone and Telegraph Co. and Western Electric Co. from 1913 to 1920. During this time he wrote "The Thermionic Vacuum Tube and Its Applications," which for years was the authoritative work on vacuum tubes. He also invented many devices and improvements in telegraphy, telephony and associated arts.

Dr. van der Bijl returned to South Africa in 1920, at the invitation of Premier Smuts. Three years later he organized the South Africa Electric Supply Commission, becoming its chairman, a post he held till his death. He also turned his attention to steel production, and was at his death chairman of South Africa Iron and Steel Industrial Corporation, a semi-government institution. During World War II he was appointed Director-General of War Supplies for South Africa, in which position he was practically a one-man War Production Board. He is chiefly famous today in South Africa for his success in channeling practically the total production of that country into war materials.

CANADIAN TV station applications are indefinitely deferred, according to an announcement made last month by A. Davidson Dunton, chairman of the Board of Governors of the Canadian Broadcasting Corporation. The freeze was voted at a board meeting pending examination of a proposed cooperative effort between CBC and commercial interests in getting TV started in Canada.

Dunton's statement said that there is need for a thorough study of television's many problems, with special attention to the differences between conditions in Canada and those in other countries. He said that it would be at least two years before the people of Montreal and Toronto would be viewing programs.

A proposed plan put forward at the board meeting calls for CBC to provide technical facilities for programs to be developed by commercial interests.

ONLY \$99.50 IS THE COST!



for the **SENSATIONAL-NEW-IMPROVED**
10 INCH

TELEVISION KIT

Complete with new built-in pretuned and aligned 13 Channel tuner, all parts and easy step-by-step instructions and schematics.

\$99.50 less tubes

Kit, complete with all tubes.....\$149.50
Specially designed cabinet for kit..... 25.00

An amazing value! Even a beginner can assemble one of these fine, new improved television kits. Uses the new 13 channel tuner, prewired and factory aligned for the entire television spectrum. High quality parts and excellent circuit assure perfect performance. Circuit designed by outstanding T.V. engineers. Contains RF stage, oscillator and mixer. Uses new I.F. coils providing maximum gain and picture definition. Sound reception is high quality FM for years of listening pleasure.

Same quality and features for 7" KIT complete, less tubes.....\$59.50
Complete, with tubes..... 99.50
Specially designed cabinet for 7" kit..... 21.00

This kit can be used with Sylvania 10 HP4 10" picture tube without modifications.

7" and 10" KITS AVAILABLE FOR IMMEDIATE DELIVERY FROM STOCK!

The New Model
TC-75 TEST CRAFT
A COMBINATION
TEST SPEAKER
AND
SIGNAL TRACER

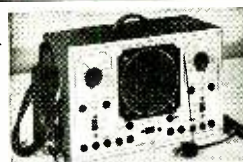

- plus speaker substitution
- plus resistor tester
- plus condenser tester
- plus resistor substitutor
- plus condenser substitutor
- plus output indicator
- plus substitute 100 V. D.C. power supply
- plus field substitutor
- plus voice coil substitutor
- plus signal tracer
- plus an experimental one stage audio amplifier
- plus universal output transformer

Complete including signal tracer probe and full instructions.

A must for every radio serviceman and engineer.

NET \$29.50
IMMEDIATE DELIVERY FROM STOCK

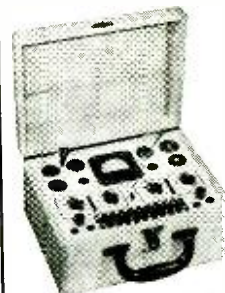

The New Model **TC-50**
TEST CRAFT
TUBE
AND SET
TESTER

A complete laboratory, all purpose test-instrument, this versatile combination tube and set tester will accurately test all up-to-date designed tubes. The multi-meter section affords many necessary measurements for everyday's service work.

The New Model TC-50 Tube and Set Tester combines seven instruments, D.C.V., A.C.V., D.C.M.A., Ohms, Output Meter, Decibel Meter and Tube Tester. Full scale accuracy to 2% English Reading (GOOD) and BAD scale for testing tubes. Obsolescence reduced to absolute minimum. Simple and quick reading charts for tube testing. Multimeter section affords most popular everyday's measurements. Complete with test leads, tube charts and all detailed, operating instructions.

Size 8" x 10 1/2" x 5".....**NET \$39.50**
IMMEDIATE DELIVERY FROM STOCK

All orders filled same day received

Metropolitan ELECTRONIC & INSTRUMENT CO.
Dept. RC-2 42 WARREN ST. N. Y. 7, N. Y.

Features THAT MAKE HEATHKITS

HEATHKIT FM and TELEVISION SWEEP GENERATOR KIT

A necessity for television and FM. This Heathkit completely covers the entire FM and TV bands 2 megacycles to 230 megacycles. The unit is 110V 60 cy power transformer operated. Uses two 6J6 tubes, two 6C4 tubes and a 6X5 rectifier. An electronic sweep circuit is incorporated allowing a range of 0 to 10 MC. A sawtooth horizontal sweeping voltage and phase control are provided for the oscilloscope.

The coils are ready assembled and precision adjusted to exact frequency. As in all Heathkits, the best of parts are supplied, Mallory filter condenser, zero coef. ceramic condensers, all punched and formed parts, grey crackle cabinet, 5 tubes, test leads, etc. Better get it built now and be ready for the FM and TV business. Shipping wt. 6 lbs.

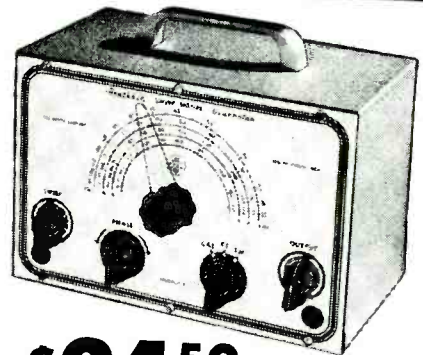

\$24.50

Nothing ELSE TO BUY...

KITS THAT FIT

Heathkit chassis are precision punched to fit the quality parts supplied. The grey crackle aluminum cabinet and the two color panels are die punched to assure proper fitting. Many builders have written marveling at the ease with which assembly can be accomplished. The chassis are specially engineered for easy assembly and wiring—there are no small tight corners which cannot be reached—the installation of the chassis are left open in order that installation of parts and soldering can be done with both hands.

COMPLETE INSTRUCTION MANUALS

Everyone is pleased at the thorough instructions covering the assembly of each Heathkit instrument. Every detail of the assembly is covered, together with sections on the use of the instrument and trouble shooting instructions in case of difficulty. Actual photos of the assembled instrument enable fast and accurate assembly. Clear schematics and pictorial diagrams of the confusing parts such as rotary switches enable the wiring to be completed quickly.

Heathkit SIGNAL GENERATOR KIT...

\$19.50

Nothing ELSE TO BUY

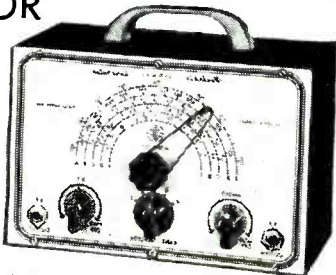

Every shop needs a good signal generator. The Heathkit fulfills every servicing need, fundamentals from 150 Kc to 30 megacycles with strong harmonics over 100 megacycles covering the new television and FM bands. 110V 60 cycle transformer operated power supply.

400 cycle audio available for modulation or audio testing. Uses 6SN7 as RF oscillator and audio amplifier. Complete kit has every part necessary and detailed blueprints and instructions enable the builder to assemble it in a few hours. Large easy to read calibration. Convenient size 9" x 6" x 4 3/4". Shipping weight 4 1/2 lbs.

Heathkit SINE AND SQUARE WAVE AUDIO GENERATOR KIT

\$34.50

The ideal instrument for checking audio amplifiers, television response, distortion, etc. Supplies excellent sine wave 20 cycles to 20,000 cycles and in addition supplies square wave over same range. Extremely low distortion, less than 1%, large calibrated dial, beautiful 2 color panel, 1% precision calibrating resistors. 110V 60 cycle power transformer, 5 tubes, detailed blueprints and instructions. R.C. type circuit with excellent stability. Shipping Wt. 15 lbs.

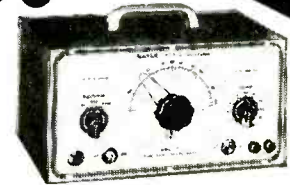

Nothing ELSE TO BUY

HEATHKIT HIGH FIDELITY AMPLIFIER KIT

\$14.95

Build this high fidelity amplifier and save two-thirds of the cost. 110V 60 cy transformer operated. Push pull output using 1619 tubes (military type 6L6's), two amplifier stages using a dual triode (6SL7), as a phase inverter give this amplifier a linear reproduction equal to amplifiers selling for ten times this price. Every part supplied; punched and formed chassis; transformers (including quality output to 3-8 ohm voice coil), tubes, controls, and complete instructions. Add postage for 20 lbs.



12" PM Speakers for above..... 6.95
Mahogany Speaker Cabinet 14 1/2" x 14 1/2" x 8" 8.75

110V A.C. MILITARY RECEIVER POWER SUPPLY KIT

\$5.95

Ideal way to convert military sets. 110V 60 cy. transformer operated. Supplies 24 Volts for filament—no wiring changes inside radio. Also supplies 250V D.C. plate voltage at 50-60 MA. Connections direct to dynamotor input. Complete with all parts and detailed instructions. Shipping wt. 6 lbs.

110 V. A.C. TRANSMITTER POWER SUPPLY KIT

For BC-645, 223, 522, 274N's, etc. Ideal for powering military transmitters. Supplies 500 to 600 Volts at 150 to 200 MA plate, 6.3 C.T. at 4 Amps, 6.3 at 4 Amps, and 12V at 4 Amps. Can be combined to supply 3-6-9-12 or 24 Volts at 4 Amperes. Kit supplied complete with husky 110V 60 cycle power transformer, 5U4 rectifier, oil filled condensers, cased choke, punched chassis, and all other parts, including detailed instructions. Complete—nothing else to buy. Shipping Wt. 22 lbs.



\$14.50

HEATHKIT CONDENSER CHECKER KIT

\$19.50

Nothing ELSE TO BUY

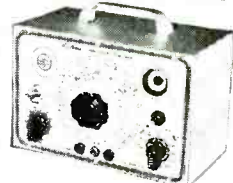

Checks all types of condensers, paper mica—electrolytic—ceramic over a range of .00001 MFD to 1000 MFD. All on readable scales that are read direct from the panel. NO CHARTS OR MULTIPLIERS NECESSARY. A condenser checker anyone can read without a college education. A leakage test and polarizing voltage of 20 to 500 volts provided. Measures power factor of electrolytics between 0% and 50%. 110V 60 cycle transformer operated complete with rectifier and magic eye tubes, cabinet, calibrated panel, test leads and all other parts. Clear detailed instructions for assembly and use. Why guess at the quality and capacity of a condenser when you can know for less than a twenty dollar bill. Shipping wt. 7 lbs.



The **HEATH COMPANY**

... BENTON HARBOR 20, MICHIGAN

IDEAL TEST INSTRUMENTS

HEATHKIT VACUUM TUBE VOLTMETER KIT

Everything you want in a VTVM. Shatterproof solid plastic meter face, automatic meter protection in burn-out proof circuit, push pull electronic voltmeter circuit assuring maximum stability. Linear DC and AC scales. Complete selection of voltage ranges starting with 3 Volts full scale up to 1,000 Volts. Isolated DC test prod for signal tracing and measurements of voltage while instrument is in operation. An ohmmeter section accurately measuring resistance of 1/10 ohm to one billion ohms with internal battery. Extremely high input resistance 11 megohms on all ranges DC and 6.5 megohms on AC. All these features and many more are the reasons hundreds of radio and television schools are using Heathkit VTVM's and recommending them to all students. Like all Heathkits, the VTVM kit is complete, 110V 60 cy power transformer, 500 microamp meter, tubes, grey crackle cabinet, panel, test leads, 1% ceramic precision divider resistors and all other parts. Complete instruction manual. Better start your laboratory now, and enjoy it all winter. Shipping Wt. 8 lbs.

Nothing ELSE TO BUY!
\$24⁵⁰

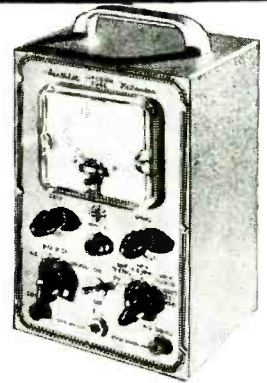

HEATHKIT SIGNAL TRACER KIT

Reduces service time and greatly increases profits of any service shop. Uses crystal diode to follow signal from antenna to speaker. Locates faults immediately. Internal amplifier available for speaker testing and internal speaker available for amplifier testing. Connection for VTVM on panel allows visual tracing and gain measurements. Also tests phonograph pickups, microphones, PA systems, etc. Frequency range to 200 MC. Complete ready to assemble. 110V 60 cycle transformer operated. Supplied with 3 tubes, diode probe, 2 color panel, all other parts. Easy to assemble, detailed blueprints and instructions. Small portable 9" x 6" x 4 3/4". Wt. 6 pounds. Ideal for taking on service calls. Complete your service shop with this instrument.

\$19⁵⁰

Nothing ELSE TO BUY

HEATHKIT 3-TUBE ALL-WAVE RADIO



\$8.75

110-Volt AC Operation and all other parts. Operates from AC. Simple, clear detailed instructions make this a good radio training course. Covers regular broadcasts and short wave bands. Plug-in coils. Regenerative circuit. Operates loud speaker. Add postage for 3 lbs. \$8.75 HS 30 Headphones per set. . . . \$1.00 2 1/2" Permanent Magnet Loudspeaker 1.95

INTERPHONE 2-WAY CALL SYSTEM KIT



\$14.50

Ideal call and communication system for homes, offices, factories, stores, etc. Makes excellent electronic baby watcher easy to assemble with every part supplied including simple instructions. Distance up to 1 1/2 mile. Operates from 110V A.C. 3 tubes, one master and one remote speaker. Shipping Wt. 5 lbs.

Heathkit ELECTRONIC SWITCH KIT DOUBLES THE UTILITY OF ANY SCOPE

An electronic switch used with any oscilloscope provides two separately controllable traces on the screen. Each trace is controlled independently and the position of the traces may be varied. The input and output traces of an amplifier may be observed one beside the other or one directly over the other illustrating perfectly any change occurring in the amplifier. Distortion—phase shift and other defects show up instantly. 110 Volt 60 cycle transformer operated. Uses 6 tubes (1-6X5, 2-6SN7's, 2-6SJ7's). Has individual gain controls, positioning control, and coarse and fine sweeping rate controls. The cabinet and panel match all other Heathkits. Every part supplied including detailed instructions for assembly and use. Shipping weight 11 lbs.

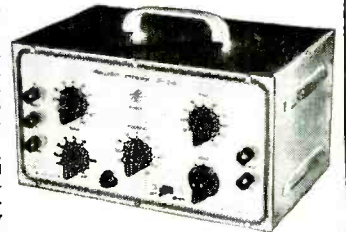

\$34⁵⁰

Nothing ELSE TO BUY

COMPLETE KITS
When you receive your Heathkit, you are assured of every necessary part for the proper operation of the instrument. Beautiful cabinets, handles, 2 color panels, all tubes, test leads where they are a necessary part of the instrument, quality rubber line cards and plugs, rubber feet for each instrument, all scales and dials ready printed and calibrated. Every Heathkit is 110V 60 cy. power transformer operated by a husky transformer especially designed for the job.

New 1948 HEATHKIT 5" OSCILLOSCOPE KIT

A necessity for the newer servicing technique in FM and television at a price you can afford. The Heathkit is complete, beautiful two color panel, all metal parts punched, formed and plated and every part supplied. A pleasant evening's work and you have the most interesting piece of laboratory equipment available.

Check the features—large 5" 5BP1 tube, compensated vertical and horizontal amplifiers using 6SJ7's, 15 cycle to 30 M cycle sweep generator using 884 gas triode, 110V 60 cycle power transformer gives 1100 volts negative and 350 volts positive.

Convenient size 8 1/2" x 13" high, 17" deep, weight only 26 pounds.

All controls on front panel with test voltage and ext. syn. post. Complete with all tubes and detailed instructions. Shipping weight 35 pounds. Order today while surplus tubes make the price possible.

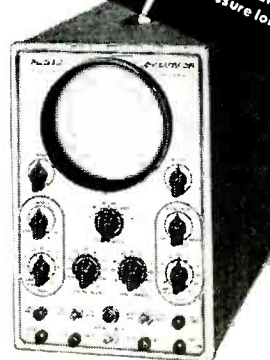

Nothing ELSE TO BUY
\$39⁵⁰

ORDER DIRECT FROM THIS AD.
WE WILL SHIP C.O.D.
Add Postage for Weight Shown



The HEATH COMPANY

... BENTON HARBOR 20, MICHIGAN



3 Great
Mail Centers
To Speed Orders

LAFAYETTE-CONCORD

ELECTRO NEWS

29 Years of Service—500,000 Satisfied Customers

GET IN ON THIS SOCKO MAG DEAL!

BARGAIN HQ. IN CHICAGO

What happens when the out-of-town radio man hits Chicago? Usually, the Mrs. heads for Marshall Field's . . . and the Mr. goes straight to Lafayette-Concord, either the one on Jackson Boulevard or the West Madison St. place. (Matter of fact, L-C even gets priority over the burlesque on lower State St.!) The West Madison Street outlet is one of the newest and neatest layouts in all Chicago. But it's still as homey and comfortable as an old felt hat. No matter how busy the place is with local radio men rushing in to pick up parts, there's always time to bat the breeze with visitors from Iowa or Kansas.

MAIL ORDERS SPEEDED

Mail orders are handled at the Jackson Blvd. place. The orders pour in by the bushel basket every day, and they're processed right through the world's biggest radio supply organization, marked special all the way.



The Parts Counter at
229 West Madison St., Chicago

Usually by the same night, your order has been filled, checked and double checked, packed and sent winging on its way. Quite an operation! Lafayette can do it, because we're geared that way. We keep a tremendous stockpile in Chicago so that you won't be held up a minute. Thousands and thousands of different items are held in instant readiness including the hard-to-get things a man could spend days looking for.

FRIENDLY, HELPFUL ADVICE

Lots of orders come in with pretty tough problems attached, including some lulu's on TV and hi-fi! But it's all in a day's work at Lafayette-Concord . . . and we have a staff of smart engineers who sit in their own private ivory tower and do nothing else but help solve your technical problems.

REAL MONEY-SAVING VALUES

But most of all L-C customers go for the rock-bottom prices, whether they order from the mail order centers in Chicago, New York and Atlanta . . . or shop in person at any of the L-C outlets. With the cost of living what it is, that's a mighty important consideration these days.

**See Page 71 for L-C
Bargain Supplement!**

ORDER BY MAIL OR SHOP IN PERSON
AT ONE OF THESE OUTLETS

NEW YORK
100 Sixth Ave.
542 E. Fordham Rd., Bronx

CHICAGO
901 W. Jackson Blvd.
229 West Madison St.

ATLANTA
265 Peachtree St.

BOSTON
110 Federal St.

NEWARK
24 Central Ave.

4 WAYS TO LOOK AT TELEVISION!

How do you get around the problem of congestion that comes up when groups gather around video? E. Burton Benjamin of New York has come up with an interesting answer. It's a 4-screened, 300 degree, all-angle-vision TV set, for which patent is now pending. This receiver can be encircled with chairs so that up to 100 people can see the action. Mr. Benjamin states that the 4-way screening is achieved without quadrupling the cost; using a single projected cathode-ray tube with a series of semi-silvered mirrors that reflect and transmit the image from one projecting lens-cope. Sounds like a sensible idea for circular bars, theaters, hotel lobbies and other public places.



BE SURE TO SEND FOR THIS NEW BARGAIN BULLETIN

Maybe you think *your* eyes won't pop too, when you see the new Lafayette bargain bulletin, just off the press! Hundreds of super-specials for service men at prices you haven't seen since long before the war . . . close-outs . . . odds and ends . . . limited quantities . . . all sorts of parts and tools that you can pick up at a fraction of the original price!

Send for your copy NOW, so that you can get first crack at the selection. Don't lose a minute . . . this stuff is going to go fast! Rush the coupon to us on a penny postcard. We'll see to it that you get your copy of this "lower-the-cost-of-living" Bargain Bulletin by return mail. Act now!

● TO OUR REGULAR CUSTOMERS ●

Don't write for the flyer if you are on our mailing list, the January Flyer is being rushed to you now!

SOLDER IRON BUY

100 WATT
HEAVY DUTY
U. L. LISTED



LISTS FOR
\$6.75!

\$2.69

while they last

Here's your chance to pick up a fine 100-watt Belden iron, at nearly two-thirds off! Mid. by Drake and Underwriters Listed. Ideal for radios, switchboards and other "close quarter" work. Comes complete with 6-foot cord, stand, 3/8" tip. Don't miss out on a terrific Lafayette bargain!

No. 99N8000, Shpg. wt. \$2.69

"RADIO MAINTENANCE" OFFERS SPECIAL \$2.00 BINDER FREE WITH SUBSCRIPTION TO ALL LAFAYETTE-CONCORD CUSTOMERS



HERE'S THE BEAUTIFUL BINDER YOU GET FREE. WORTH OVER \$2!

"RADIO MAINTENANCE" is the technical "eye and ear" for thousands of veteran radio servicemen and technicians. No matter how busy they are, they always manage to find time to go through every issue . . . even if it's during lunch time. Because RADIO MAINTENANCE is crammed with practical info that service men are thirsting for.

Just to give you an idea, here's the type of article you'll find in RADIO MAINTENANCE:

TELEVISION SERIES: Complete instruction on television from theory to troubleshooting, installation and alignment.

AM SERIES: The biggest chunk of a serviceman's business is still servicing AM sets. Complete coverage on hints and kinks of shop and field work.

FM SERIES: Keep up with the ever-increasing importance of FM—new developments, new working angles, new equipment.

SOUND EQUIPMENT SERIES: Get your share of the thousands of dollars made each year on PA installation and maintenance.

TEST EQUIPMENT SERIES: How to select, how to operate and when to use different test units.

You can see what information like this is worth to the busy service man. Why, the time it can save you on a single job will pay for the entire subscription! That's why Lafayette-Concord is glad to call your attention to this unusual offer of Radio Maintenance Magazine.

The top-flight service man knows he has to keep up with latest developments in radio maintenance. He can't afford to be content with what he knew last month. Things are moving along too fast on TV and hi-fi. New ideas and improved techniques are percolating all over the place.

These new developments are worth money to you. They can help you do a better job with fewer headaches. They can help you earn more per week without putting in any additional hours!

Lafayette recognizes this. We know that it's as important for you to get the latest in service pointers as it is to get a good buy on the parts you use. That's why we're bringing this offer of Radio Maintenance Magazine to your attention.

On the coupon below send in your two-year subscription to RADIO MAINTENANCE Magazine. You will receive free of charge, a beautiful gold-inscribed reference binder—easily worth two dollars! This binder is of heavy quality, with boarded covers, built to take a lot of punishment around the shop without showing it. It holds up to 18 issues of RADIO MAINTENANCE Magazine . . . enables you to keep all this money-making, time-saving information at your fingertips, available for instant reference!

AVAILABLE TO PRESENT SUBSCRIBERS

If you're already a subscriber to RADIO MAINTENANCE, you can still get in on the deal. Send your reorder for two more years to Lafayette-Concord now, to get under the wire for this unusual free offer. This will enable you to receive the binder with your next issue of RADIO MAINTENANCE Magazine.

Send check or money order for \$5.00 covering 2-year subscription to Lafayette-Concord with coupon. Get it into the mail NOW. It's the best investment a service man can make!

RUSH COUPON NOW!

LAFAYETTE-CONCORD, 100 Sixth Avenue, N. Y. 13
901 W. Jackson Blvd., Chicago 7 or 265 Peachtree St., Atlanta 3
Dept. J8-9B

I want to get in on the special dividend offer! Place with Radio Maintenance Magazine my 2 year subscription, for which I enclose \$5.00 in check or money order. I am to receive the \$2 binder FREE OF CHARGE.

Rush FREE Bargain Bulletin.

Check here if subscription is renewal.

Rush FREE 180-page 1949 Lafayette-Concord Catalog.

MAIL TODAY

Name

Address

City Zone State

LAFAYETTE-CONCORD

THE WORLD'S LARGEST RADIO SUPPLY COMPANY



Make More Money in the Expanding Servicing Field

WITH CREI NEW, PRACTICAL "ON THE JOB" TRAINING IN TELEVISION & FM SERVICING

The next twelve months will produce some of the greatest opportunities that have ever been offered to alert men in the Servicing Field.

It is the year for you to make the big decision. Either you are going to catch up with the new developments in the industry, or you are going to be passed by.

We think your opportunities are so great, that over a two year period we have been developing this brand new, practical course. It is written for today's serviceman to meet today's problems and opportunities.

CREI knows what you need, and every effort has been made to keep this course practical and to the point. If you are now engaged in servicing work, you will be able to understand and apply each lesson. This course has been reviewed and checked by qualified service experts who know what you must know to get ahead in this booming field.

RADIO SERVICE DIVISION OF
CAPITOL RADIO
ENGINEERING INSTITUTE

An Accredited Technical Institute

Dept. 152A, 16th & Park Road, N. W., Washington 10, D. C.
 Branch Offices: N. Y. 7, 170 Broadway; San Francisco 2, 760 Market St.

FEBRUARY, 1949

Every lesson can be helpful in your daily work—you will soon have the technical knowledge necessary to handle all types of good paying Television and FM servicing business.

In offering this course at a popular price, CREI is enabling thousands of the "top third" now engaged in service work to enter the ultimate profitable field of television and FM installation and service.

This can be your big year! Write today for complete information. The cost is popular. The terms are easy. The information is free. Write today.

VETERANS! This course is G.I. Approved.

MAIL TODAY!

CAPITOL RADIO ENGINEERING INSTITUTE

16th & Park Road, N. W., Dept. 152A, Washington 10, D. C.

Gentlemen:

Please send me complete details of your new home study course in Television and FM Servicing. I am attaching a brief resume of my experience, education and present position.

NAME _____

STREET _____

CITY _____ ZONE _____ STATE _____

I AM ENTITLED TO TRAINING UNDER G. I. BILL.

COMPRESSED AIR INSTANTLY, Anywhere!!



Portable Air Compressor and storage tank. Ruggedly built of best materials using lifetime lubricated ball-bearing on connecting rod and oil impregnated main bearing on shaft. Unusual design forever eliminates valve trouble, the most common fault in air compressors. **PATENTED** unie air intake system increases efficiency tremendously over other compressors so that air output is much greater than that from larger compressors powered by heavier motors. Will deliver approx. 3500 cu. in. air per min. at maintained pressure of 30 lbs., or will inflate a 30 lb. truck tire in less than 1 min. Complete with 100 lb. gauge, fingertip adjustment allows setting of output pressure at any value, which will automatically be maintained. Works from any 1/4 H.P. motor. Useful for spraying paints or lacquers, disinfectants, insecticides, annealing or brazing with natural gas, inflating tires, etc. Price \$14.50 postage prepaid anywhere in U.S. Efficient, adjustable siphon type spray gun complete with 12 ft. of 100 lb. tested hose for only \$7.75 with pint container, also prepaid. 25% required on C.O.D. orders. Send for FREE catalogs of radio parts and surplus items.

RT-1579 consists of a three stage, cascade 6SJ7's and 6F6 output stage high gain, high fidelity amplifier with 60 cycle, 110V power supply on the same 131x14 1/2 chassis, which is protected by a substantial steel cover over tubes and parts. Made by Western Electric with typical quality components such as a husky power transformer and oil condenser, this unit is doubtless intended to give years of trouble-free service with no more need for repairs than a telephone. Disconnecting one wire each, from the special input and output filters, will result in as high a fidelity amplifier as can be obtained. Your cost with tubes, diagrams and parts list included. \$14.95

AMPHENOL coax plug 83-1SP or PL259. \$.49
 AMPHENOL coax junction 831J or PL258.49
 AMPHENOL coax chassis Connector 83-1H or S0239. . .49
 AMPHENOL coax angle connector 83-1AP or M359.50
 100 ft. RC59U 72 ohm coax cable, new not surplus. 6.90
 Battery type BA38, 102.5V battery used in handys-talkies and mine detectors. 1'x1 1/2". Outdated but tests OK. 1.98
 Standard type normally open MICROSWITCHES.39
 Leaf actuator SPDT MICROSWITCHES.49
 Brand new fully shielded G single button mike trans- former in beautiful silver finish case.99
 Television 300 ohm twinning, per 500 ft. spool. 9.95
 Miniature bayonet pilot light socket—14 pin. 2.50
 Universal 4 lead broadcast band oscillator coil (can be converted to 3 lead type by addition to jumper), six for 1.00
 Brand new motor driven bandswitching turret with slug-tuned ±14 silver wire coils on ceramic forms and air trimmers. 100 to 160 MC. A steal at 2.95

1 1/4 H.P. AC or DC electric motor (ammy surplus dynamotor converted) complete with cord & plug, ready to run. A super special at. \$2.95

SCR-610 Transmitter-Receiver

Ready to operate on 10 meter phone by connecting it to 6, 12 or 24 VAC. \$49.95

SOS EMERGENCY TRANSMITTER SOS

This is the famous Gibson Girl Transmitter that saved so many lives during the war. It is used as a distress call transmitter on boats and airplanes. The Gibson Girl is the easiest transmitter in the world to operate. No instruction or experience necessary. No external power supply required for operation. It is merely necessary to turn the crank on the top of the transmitter and power is generated and the distress signal is automatically sent out on the international distress frequency. Brand New Gibson Girl transmitter complete with tubes. \$9.95
 Antenna kit for Gibson Girl transmitter. This kit was designed to improve the effectiveness of the Gibson Girl Transmitter by increasing the range several times. The kit includes 300 feet of special antenna wire, two balloons for raising the antenna in calm weather, two hydrogen generators to inflate the balloons, a special box kite for antenna erection in windy weather, and a searchlight, powered by the crank operated generator in the transmitter. Complete kit. \$9.95

Book on DRY DISC RECTIFIERS by H. B. Conant, nationally recognized authority on the subject. Theory and practical applications. \$ 25

SENSATIONAL, FASCINATING, MYSTERIOUS SELSYNS

Brand new Selsyns made by G. E. Company. Two or more connected together work perfectly on 110V AC. Any rotation of the shaft of one Selsyn and all others connected to it will rotate exactly as many degrees in the same direction, following unerringly as if the units were connected together by shafting instead of wire. This is true whether you twist the shaft of the master unit a fraction of a revolution or many revolutions. Useful for indicating direction of weather vanes, rotating directional antennas, or controlling innumerable operations from a distance. Complete with diagram and instructions. Per matched pair \$4.95.

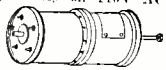

SUPER SPECIAL

POWER UNITS for Fairchild bombsights. A limited quantity of these arrived too late for a photo. Each unit is brand new, includes 8 electric motors or generators, 6 of which are of the permanent magnet field type; relays; 20 precision resistors plus numerous others of the ordinary kind; and 9 tubes which one have a total value of \$15.00; all for only \$14.95.

99c

"DON'T GET YOUR FINGERS BURN'T"
 USE THE NEW AMO MINIATURE
 TUBE PULLER

Save time and money by speedily inserting or extracting tubes in the hard-to-reach places.

All sales final and no returns unless otherwise specified in ad of item. Right reserved to change prices and specifications at any time.

BUFFALO RADIO SUPPLY
 219-221 Genesee St., Dept. RE, BUFFALO 3, N. Y.

Motorola, Inc. Chicago, reports that sales for the fiscal year ending November 30 totaled nearly \$60,000,000 of which \$15,000,000 represented television set business. This compares with less than \$47,000,000 in 1947. Motorola's earnings this year may top \$3.75 per share on the 800,000 capital shares, compared with \$3.14 in 1947.

PAUL V. GALVIN, president of Motorola, said, "Television is the most exciting event in the radio industry's history." Backing up the company's faith in this department, the company has expended a good part of its 1949 advertising budget of \$2,500,000 in television promotion and produced 100,000 units last year. It plans to manufacture 250,000 in 1949. Motorola recently produced its 50,000th small-screen table model, but indications are that this year's production will call for fewer small sets and more of the 10-, 12- and 16-inch receivers. The company recently announced that DR. KURT SCHLESINGER, Motorola engineer, has invented an anastigmatic yoke which the company says will revolutionize the reception quality of large-screen, direct-view television receivers.

Bendix Home Appliances, Inc., South Bend, Indiana, announces a profit of \$3,756,594, for the nine months ending September 30, 1948, after all deductions.

The Muter Co., manufacturers of components for radio sets and the Jensen Manufacturing Co., manufacturers of acoustic equipment, both of Chicago, have announced that Muter has acquired all the common stock of the Jensen company.

National Union Radio Corp. of Orange, N. J., will manufacture cathode-ray tubes for television in a new plant just purchased at Hatboro, Pa., according to an announcement by KENNETH C. MEINKEN, president.

Motorola vice-president WALTER STELLNER declares that present-day television sets will be good for five or six years. He said that color television is not in prospect and will not be for five years. On the other hand, Columbia Broadcasting System staged a private color telecast in New York for the Federal Communication Commission. The telecast was received on a standard table-model receiver equipped with an adapter which would sell for around \$25 and would enable any television set owner to tune in color video. In addition, the pioneer inventor, DR. LEE DE FOREST, has just been granted a patent on a new color TV system.

Andrea Radio Corp. of New York announces the 1949 edition of their Service Manual, which will be distributed to authorized Andrea dealers.

Zenith Radio Corp. of Chicago announces the formation of an International Division to handle the company's export business. H. C. BONFIG, vice-

president of Zenith, said that this new division, under the direction of E. E. Loucks, will handle the export business formerly handled by the American Steel Export Co., Inc.

Radio Corporation of America announced on October 15, according to the NEDA Journal, that mandatory installation and service contracts will no longer be obligatory to purchasers of RCA television receivers. Heretofore, the buyer was obliged to pay for the service and allow only RCA technicians to install and service his set. Under the new policy, installation and repairs may be performed by RCA under contract, or by an independent serviceman, or the owner himself if he has sufficient knowledge to do so.

Cornell-Dubilier Electric Corp. of South Plainfield, N. J. has announced the purchase of the Faradon Capacitor division of the Radio Corporation of America.

Radio Manufacturers Association president MAX F. BALCOM predicted in an address in Boston that about 800,000 television receivers would be produced in 1948 and that the 1949 output of the industry may well exceed 2,000,000. The Association had previously reported that in October the member-companies had established a new monthly record by producing 95,216 sets.

Cornell-Dubilier Electric Corporation of South Plainfield, N. J., declared a dividend of 20 cents per share on the common stock, payable December 10, 1948, to stockholders of record November 26.

The directors also declared the nineteenth regular quarterly dividend of \$1.31 1/4 per share on the company's \$5.25 cumulative preferred stock, series A, payable January 15, 1949, to stockholders who were of record December 20, 1948.

United States Television Mfg. Co. of New York announces two improved commercial television models. These receivers, yielding television pictures of 475 and 675 square inches, are made especially for public places where large crowds gather, such as bars, restaurants, and community halls.

Machlett Laboratories, Inc., Springdale, Conn., is starting to manufacture Western Electric Company's line of high-power tubes intended for broadcast transmitters.

Zenith Radio Corporation, Chicago, reports estimated net consolidated operating profits for itself and its subsidiaries for the first six months of its fiscal year ended October 31, 1948 of \$984,535, after federal income tax of \$599,144, depreciation, excise taxes, and reserves for contingencies.

Net consolidated operating profits for the three-month period ended October 31, 1948 were \$879,566 after federal income tax of \$536,835, depreciation, excise taxes, and reserves for contingencies.

RADIOMEN'S HEADQUARTERS + WORLD WIDE MAIL ORDER SERVICE !!

BUFFALO RADIO SUPPLY, ONE OF AMERICA'S LARGEST ELECTRONIC DISTRIBUTORS, IS IN A POSITION TO SUPPLY MOST OF THE REQUIREMENTS OF FOREIGN PURCHASERS, DIRECTLY FROM ITS GIGANTIC STOCKS OR THOSE OF ITS AFFILIATES. EXPORT INQUIRIES ARE SOLICITED BOTH FROM EXPORT HOUSES AND FROM FOREIGN GOVT. PURCHASING COMMISSIONS HERE AND ABROAD. EXPENSE CAN BE REDUCED AND REQUIREMENTS FILLED WITH A MINIMUM OF DELAY BY CONTACTING BUFFALO RADIO SUPPLY INITIALLY. WE HAVE THE WORLD'S LARGEST STOCK IN MANY ITEMS.

**SUPREME TEST EQUIPMENT AVAILABLE
Send for FREE Supreme Catalog**

504-B	Tube & Set Tester	\$102.50
543-B	(Metal Case) Multi-meter	25.20
543-C	(Bakelite Case) Multi-meter	22.45
543-M	(Metal Case) Multi-meter	25.75
574	Electronic Set Tester	54.85
589-A	Portable Testor (3-inch meter)	49.95
592	Set Tester, 25,000 ohms per volt, steel case	58.95
600	Oak case	117.50
616	Combination Tube Set Tester (7-inch meter)	67.45
620	Tube Tester (7-inch meter)	110.20
623	Multi-meter (7-inch meter)	46.50
640	Multi-meter (4-inch meter)	39.45
644	Multi-meter (7-inch meter)	79.95
650	Oscilloscope (3-inch tube)	99.95
655	Oscilloscope (5-inch tube)	126.50
661	Deluxe Oscilloscope (5-inch tube)	276.80
665	Oscillator (RF Signal Generator)	72.50
670	Oscillator (FM Signal Generator)	141.60
680	Oscillator (AF Signal Generator)	71.45
688	Audio-visor (Signal Tracer) steel case	82.95
	Oak case	145.50
		127.00

**Sensational Value in
AC-DC POCKET TESTER**



This analyzer, featuring a sensitive repulsion type meter housed in a Bakelite case, represents the culmination of 15 years achievement in the instrument field by a large company specializing in electronic test equipment.

Specifications of the AC-DC Model Volt-Ohmmilliammeter:

- AC Volts—0-25, 50, 125, 250
- DC Volts—0-25, 50, 125, 250
- Milliamperes AC—0 to 50
- DC Milliamperes—0 to 50
- Ohms Full Scale—100,000
- Ohms Center Scale—2400
- Capacity—.05 to 15 Mfd.

Total Price, prepaid anywhere in the USA—\$7.00
Similar DC Meter, lacking the AC operated ranges of above, \$5.50 prepaid.

DUAL METER—one 50 uA and one 200 uA movement in the same case. This meter is ideally suited for use as a combination modulation percentage and carrier shift indicator. If desired the movements may be removed from the case and used separately for voltmeters, ohmmeters, ammmeters, etc. All meters are in perfect operating condition, but a few have cracked glasses. This super value costs only \$1.75.

**STUPENDOUS VALUE in 3 Section
PERMEABILITY TUNER**

The entire variable tuning section of a deluxe current model General Motors radio. Amazingly tiny (4x3x2 1/2), though truly half of a radio. Shielded R.F. sections 1/2 inch wide wound. All 3 band circuits adjustable at both low and high ends of dial. Compact enough to be used to pep up any 2 or 3 gang superhet or 2 gang TRF. Will substitute for entire original tuning system including variable condenser and selectivity coil. Can be used as a multiple section wavetrapp that will cut out undesirable interference as with a knife. If only a little bit better than average results with a slug-tuned wavetrapp and selectivity coil, you can be up in a couple of minutes into 3 coils necessary, the unit can be split up in a couple of minutes into 3 coils that can be used on different jobs. These coils, super-compact and really hot, can also individually replace any broadcast band RF oscillator, or 1st detector coil with improvement in results in any set. After seeing one of these units, you'll order a dozen just for general repair or replacement work. Cost the manufacturer several dollars. Your cost—\$1.49.

1949 MODEL MUTUAL CONDUCTANCE TUBE TESTER with new 9 pin socket to handle all future tube developments \$54.95

No possibility of good tubes reading "Bad" or bad tubes reading "Good" as on dynamic conductance testers or other ordinary emission testers. Attractive panel and case equal to any on the market in appearance. Large 4 1/2" meter. Calibrated micromho scale as well as a Bad-Good scale. Front panel fuse. Individual sockets for all tube base types—voltages from .75 volts to 117 volts and complete switching flexibility allow all present and future tubes to be tested regardless of location of elements on tube base. Indicates gas content and detects shorts or opens on each individual section of all local, octal and miniature tubes including cold cathode, magic eye and voltage regulator tubes as well as all ballast resistors. Name of the nationally known manufacturer withheld because of special price offer. \$54.95

Model "C"—Sloping front counter case. \$59.95
Model "P"—Handsome hand-rubbed portable case. \$59.95
Built-in roll chart with either of above \$5.00 extra.

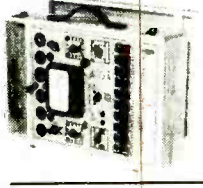

RT-1655—11 tube crystal controlled superheterodyne receiver that covers the FM band. The ultra modern circuit uses the latest types of tubes including miniature beam tube rectifier chassis and aluminum cabinet. Tubes and schematic supplied—\$14.95

TERRIFIC VALUE

ONLY
\$20.95

Equipped with 1 1/2" Jacobs
Geared Chuck and Key

PORTABLE ELECTRIC DRILL

Not an intermittent duty drill, but a full size rugged tool. Most convenient type switch, natural grip handle and balance like a six-shoot-or. Precision cut gears, turbine type cooling blower—extra long brushes. No stalling under heaviest pressure because of powerful 110 Volt self-energizing lithium-lubricated Oilite type. Made for toughest, year-in and year-out service in plant or on construction jobs. Amazingly perfect factory guarantee assures you of a lifetime of trouble-free use. Full refund (you pay transportation) if not pleased with drill after trial.

TUBES—All types in stock—Maximum discounts when ordered in lots of ten or more.
World renowned 700 page tenth edition of the Radio Handbook in cloth binding and hard cover at the sensational reduced price, for a limited time only \$1.49
ICI 17-11 Brand New 12 Tube, 110 Volt Receiver-Oscillator-Oscilloscope complete with all tubes and power supply. Has telescoping hood over scope tube, which is equipped with a detachable calibrated screen. Has centering and amplitude controls and two video inputs. A natural for television. \$39.95

Latest type PM Speaker in a fully-enclosed black crackle finished metal cabinet. This speaker and case match communication receivers, and in addition make perfect intercom remote stations. Our price, \$4.50. Including output transformer. \$4.95

All sales final and no returns unless otherwise specified in ad of item. Right reserved to change prices and specifications at any time.



HEAT GUN

Streamlined pistol grip heat gun in vivid red housing, that delivers a powerful 20 Cubic Ft. per minute blast of hot air at 160 Fahrenheit. Ordinary blowers have small fan motors, but this has a lifetime-lubricated AC-DC motor of the rugged vacuum cleaner type, that produces a hurricane of either hot or cold air. Perfect for blowing out dirt or dust from radio chassis, drying out ignition systems, warming up carburetors, quick-drying paint, thawing out radiators or water pipes, etc. Warning—Keep this away from your wife, or she will be using it to dry her hair because it will do it in half the time of the ordinary hair dryer. To say nothing of her using it to dry stockings or clothing, or defrost the refrigerator instantly. Only \$12.95. Satisfaction guaranteed or money refunded if returned prepaid within 5 days.

Our PE-109 32-Volt Direct Current Power Plant

This power plant consists of a gasoline engine that is direct coupled to a 2000-watt 32 volt DC generator. This unit is ideal for use in locations that are not serviced by commercial power or to run many of the surplus items that require 24-32 Volt DC for operation. The price of this power plant tested and in good condition is \$79.95 F.O.B. Buffalo, or we can supply in strictly "as is" condition for \$58.95 F.O.B. New York City. These latter are exactly as received, in heavy steel-strapped gov't cases, and we are unable to determine if the individual units are new or used or what the condition is if used, while the \$79.95 units are some of the same that have been brought to Buffalo for testing and repair if necessary. We do not recommend gambling on the "as is" condition except for quantity purchasers. We can also supply a converter that will supply 110V AC from the above unit or from any 32V DC source for \$12.95.

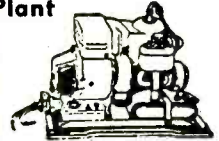

VACUUM TUBE VOLT-OHM-CAPACITY METER

There are more features engineered into this all purpose instrument than in any other instrument on the market regardless of price. It was designed not only to meet present conditions, but to be readily adaptable to future needs. At the sensationally low price of this precision instrument no school, plant, lab or service shop need deprive itself of the "new look" in measuring equipment. Here are a few of the many features of this outstanding meter:

- 5 inch easy to read meter
- 6 DC voltage ranges from 0 to 1000v (Input resistance as high as 1 megohm per volt)
- 5 AC voltage ranges from 0 to 1000v (no dry disc rectifier to age and destroy the accuracy of this Vacuum Tube Voltmeter)
- 6 Resistance ranges from 2/10 ohm to 1000 megohms.
- 4 Capacity ranges from .000025 to 20 MFD.
- A zero center range for balancing FM discriminators.
- Isolating resistor built into probe.
- Sturdy natural finish hardwood case.

This outstanding development of one of the leading manufacturers of test equipment costs only \$38.50 complete with all leads, as illustrated.



20,000 ohm per volt SUPERTESTER. Similar in appearance and made by same manufacturer as Vacuum Tube V.O. Ohm Meter pictured in this ad. Specifications as follows:

- DC volts at 20,000 ohms per volt: 0-3v, 15v, 60v, 300v, 1500v, 6000v
- AC volts at 10,000 ohms per volt: 0-6v, 30v, 120v, 600v, 3000v, 6000v
- Current: 0-60 Microamps, 60MA, 60MA, 600MA, 6A Amperes
- Resistance: 0-3000, 300,000, 3 Mega, 300 Mega
- Decibels: Minus 4 to plus 77 dB divided into 6 ranges.

All special 1% accurate multipliers used. No external source of power required for AC measurements although there is no frequency error in the range from 30 cycles to 1 megacycle. Such as WIDEST resistance range coverage, HIGHEST AC voltage sensitivity, WIDEST power level coverage, and the lowest price—only \$29.95. We urge comparison with this instrument before buying any other tester.

Signal Generator supplying 150 KC to 50 MC as indicated on the 8 calibrated dial scales on the instrument. Crystal frequency stability obtained by use of grounded plate oscillator and resistance loaded grid circuit. Either modulated or unmodulated RF. Type of modulation used has been chosen for its effectiveness in alignment of television and FM equipment as well as ordinary AM work. With this signal generator, packed with FM features you would expect only in the most elaborate laboratory instruments, we in addition include Absolutely Free a signal tracing probe using a Sylvania 1N34 diode, resistance-capacity network and provision for plugging in headphones or oscilloscope, that will cover the entire frequency range of the generator itself. Complete with all leads and operating instructions. A real bargain at \$28.85.



MICROPHONES—Super Special—Highest quality all chrome bullet-shaped CRYSTAL MIKE of topflight nationally known brand—\$5.95. Bullet DYNAMIC MIKE—\$7.95. MIKE Jr.—60c. HANDY MIKE with switch on handle—90c. LAPEL MIKES—(Specify whether carbon or magnetic)—93c.

RADIO SET SCOOP. Product of a famous aircraft radio manufacturer who has abandoned the ordinary. All in 5 ply genuine mahogany cabinets, both regular and die-cast. Original list price given first—then your cost. Sensational discounts. Model 565 is 5 tube, all others are 6 tube.

Model 565	Mah. or blonde	\$ 34.95- 16.97
Model 661	Mah. or blonde	\$ 44.95- 20.97
Model 663	Mah. or blonde	\$ 46.95- 21.97
Model 612	Walnut	\$ 36.70- 17.95
Model 613	Mahogany	\$ 42.05- 19.95
Model 6612	Blonde Mahogany Console	\$215.00-\$105.00

AUTO RADIO DEALERS ATTENTION

Nationally advertised brand 1949 car radio that will fit practically any car. These car radios will be sure fire hits with your customers. They have plenty of eye appeal plus a host of other features that no other radio regardless of cost can offer. Here are but a few of them: Built-in battery charger that will keep a car battery fully charged even if radio is played all day long. An outlet so an electric shaver or similar electrical appliance can be used while driving along highway. The radio is a powerful 6 tube superheterodyne that has a three gang condenser and a state of radio frequency amplification for increased sensitivity. The radio, complete with built-in battery charger and power outlet, is a single compact unit that is easily installed. Sample—\$36.97. Dealer price—\$24.97 each in lots of two or more. Write for special large quantity discounts on all of above sets.

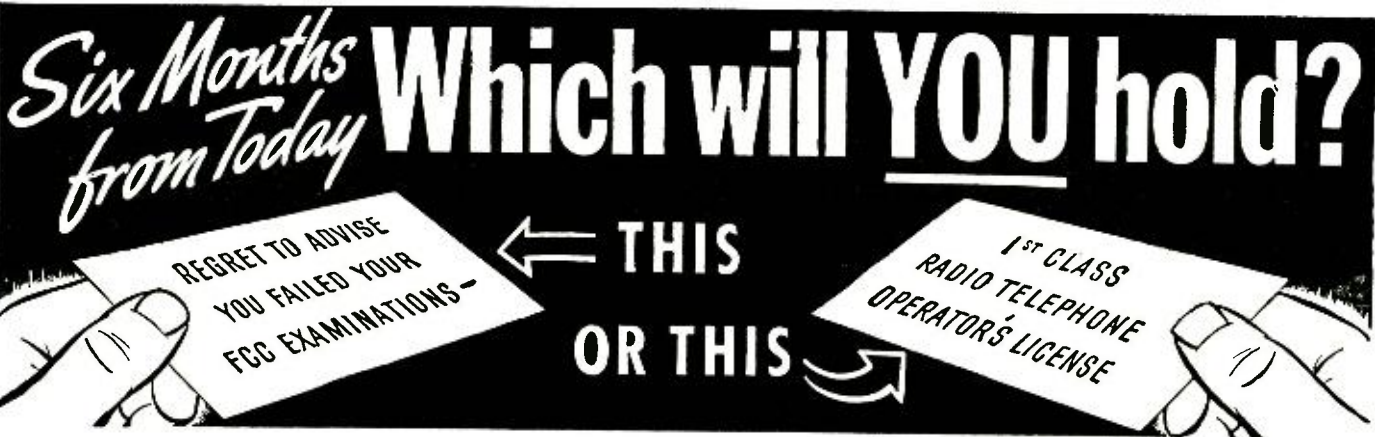

WANT YOUR FCC COMMERCIAL LICENSE IN A HURRY?

Get Your "Ticket" in a FEW SHORT WEEKS! It's EASY when you use CIRE Simplified Training and Coaching AT HOME IN SPARE TIME

Thousands of new jobs are opening up—FM, Television, Mobile Communication Systems. These are only a few of the radio fields which require licensed radio technicians and operators. Get your license without delay. Let Cleveland Institute prepare you to pass

FCC license examinations, and hold the jobs which a license entitles you to, with CIRE streamlined, post-war methods of coaching and training.

Your FCC Ticket is always Recognized in ALL Radio Fields as Proof of Your Technical Ability

More than ever before an FCC Commercial Operator License is a sure passport to many of the better paying jobs in this New World of Electronics. Employers always give preference to the license

holder, even though a license is not required for the job. Hold an FCC "ticket" and the job is yours!

Hundreds of Satisfied, Successful Students

"Transmitter engineering is great, especially on the job I am on. Thanks again for all you have done, and you can take the credit for the fact that my "ticket" is now posted on the wall of a 1000 Watt broadcast station."
Student No. 3678N12

"I now hold ticket Number P-10-3787, and holding the license has helped me to obtain the type of job I've always dreamed of having. Yes, thanks to CIRE, I am now working for CAA as Radio Maintenance Technician, at a far better salary than I've ever had before. I am deeply grateful."
Student No. 3319N12

"I was issued license Number P-2-11188 on November 4. The next day I was signed on board a tanker as Radio Operator/Purser. Besides radio operating I handle the payrolls, etc., which is all over-time and brings my monthly pay up to between \$500 and \$650."
Student No. 2355N2

"I take great pleasure in informing you that I have taken the examination for radio telephone first class license on June 29th, and passed and have received my license. I am now working at WCNH, a local 250 Watt Station."
Student No. 3171N12

OTHER Cleveland Institute Home Study Courses Offer Complete Technical Radio Training from Low-Level to College-Level, for the Radioman with Practical Experience!

COURSE A—Master Course in Radio Communication

A complete course covering the technical fundamentals of radio-electronics, for the radioman who wants a general review. Includes preparation for Broadcast station employment.

COURSE B—Advanced Course in Radio Communication Engineering

A genuine college-level radio engineering course, completely mathematical in treatment. For the advanced radioman with considerable practical experience and training.

COURSE C—Specialized Television Engineering

An advanced college-level course for the radioman who has had formal training equivalent to A and B.

COURSE D—Advanced Radio Telephony

An advanced, specialized course covering broadcast station engineering and operation. Covers the engineering knowledge and the technical duties required of the studio control operator, the master control operator, and the transmitter operator.

Send for this AMAZING NEW BOOKLET

1. TELLS OF THOUSANDS OF BRAND-NEW, BETTER-PAYING RADIO JOBS NOW OPEN TO FCC LICENSE HOLDERS
2. TELLS HOW YOU WILL BENEFIT BY HOLDING AN FCC COMMERCIAL LICENSE.
3. TELLS HOW YOU CAN GET YOUR FCC COMMERCIAL RADIO OPERATOR LICENSE IN A FEW SHORT WEEKS — EASILY AND QUICKLY, BY USING CIRE SIMPLIFIED TRAINING AND COACHING AT HOME IN YOUR SPARE TIME.
4. TELLS OF HUNDREDS OF OUR SUCCESSFUL STUDENTS WHO NOW HAVE LICENSES AND NEW, BETTER-PAYING JOBS.
5. TELLS HOW WE PREPARE YOU TO PASS THE NEW FCC COMMERCIAL LICENSE EXAMINATIONS, WHICH NOW INCLUDE FM AND TELEVISION.
6. TELLS HOW WE GUARANTEE TO TRAIN AND COACH YOU UNTIL YOU GET YOUR LICENSE.
7. TELLS HOW WE HELP YOU TO GET A BETTER-PAYING, LICENSED JOB, WITH OUR FREE AND EXCLUSIVE SERVICE, WHICH PREPARES AND MAELS YOUR EMPLOYMENT APPLICATION TO HUNDREDS OF EMPLOYERS, INCLUDING FM, AM AND TELEVISION BROADCAST STATIONS, RADIO MANUFACTURERS, POLICE RADIO STATIONS, AND RADIO-EQUIPPED TAXI, BUS AND PUBLIC UTILITY COMPANIES.



Mail Coupon At Once GET ALL 3 FREE

CLEVELAND INSTITUTE OF RADIO ELECTRONICS

DESK RC-2 4900 Euclid Building, (Address to Desk No. to avoid delay) Approved for Veteran training under "G.I. Bill of Rights".

Please send me your Catalog C "Money Making FCC License Information," your Booklet B "How to Pass FCC Commercial License Examinations," (does not cover Amateur License Examinations) and a sample FCC-type exam.

Please send me your Catalog A, describing all of your home study radio-electronics courses. I desire training in course A B C D

NAME _____

ADDRESS _____

CITY _____

ZONE _____

STATE _____

Veterans check for enrollment information under G. I. Bill NO OBLIGATION—NO SALESMEN

MANUFACTURERS WHO SERVICEMEN

The radio serviceman is officially recognized after 28 years . . .

By HUGO GERNSBACK

WHEN radio servicing started nearly 30 years ago, it was a free-for-all contest. Any bright lad who knew anything about the then intricacies of radio was soon called upon by his friends to do a repair job when their radios failed. The radio set manufacturers did not look kindly at this and preferred to have their own "trained" technicians do whatever servicing was necessary.

For over 20 years the producers looked more or less askance at the independent serviceman and often considered him a nuisance. For a long period of time practically every radio manufacturer in the land preferred to have his own appointed men make all repairs, and, in many cases encouraged the return of defective receivers to the factory.

The latter, of course, obviously was impractical in most cases. As radio receivers grew in size, weight, transportation problems, etc., made such factory repair work prohibitively costly and inconvenient.

From the radio makers' viewpoint the independent serviceman was a thorn in the side. Most manufacturers for a long time firmly believed that radio technicians outside their own staff were not properly qualified to do the work, and that they often overcharged.

This magazine for more than two decades made it a point to carry the flag for the serviceman in business for himself, and did yeoman service in helping to educate them so they would become a powerful institution in this country. But until very recently the radio production industry remained unconvinced.

It is, therefore, more than refreshing to discover that the manufacturers now have come to the conclusion that the free-lance servicing profession has progressed to such a point that the manufacturers now, for the first time, officially admit that their need for the independent radio serviceman is as real as the latter's need for the manufacturer.

At the Town Meeting for Radio Technicians held recently in Boston, Max F. Balcom, President of the Radio Manufacturers Association, went to great lengths to acknowledge the debt of the Association's members to the radio serviceman.

On November 15, during National Radio Week—the twenty-eighth anniversary of the radio industry—Mr. Balcom addressed the Town Meeting in a long talk of which we quote here the highlights. They make outstanding reading for all radio technicians and servicemen. (Note that Mr.

Balcom uses the term "radio technician" interchangeably with "servicemen.")

"I know that we manufacturers often have failed to recognize the importance of the radio technician who services the sets we make. And I suspect that many of you have not always understood the problems we manufacturers have been up against when you struggled to repair a receiver of an unusual or intricate design. . . .

"All of us in the radio industry are having to, in effect, go back to school to keep abreast of the rapid developments in television. . . . It requires new marketing and selling methods. And TV sets require new servicing knowledge and practices. . . .

"The servicing of home receivers, particularly the new TV sets, is rapidly becoming a big business, and it will require well-trained technicians who are familiar with the instrument they are servicing and the most modern techniques for detecting and correcting any trouble that may develop. . . .

"No competent radio technician today need have any fear that television or any other new broadcasting service will put him out of business. On the contrary, his chances for increasing his profits and making his economic position more secure were never so good as they are today. But he will have to do what every other professional man has to do—learn everything he can about new equipment and techniques as they appear in his field.

"The radio technician today is one of the most important factors in the industry in this rapidly expanding television field. Unless a television set owner can get proper servicing, he may soon lose his initial enthusiasm for this new medium . . . or even turn sour against it. A shortage of qualified television servicemen may prove a deterrent to television set buying. . . .

"Moreover, the radio technician who calls at a home to install or service a TV or radio set is the liaison man between the set manufacturer and the buyer. He is in a position to do an excellent public relations job for the industry because of his personal contact with the set owner—a contact the manufacturer seldom, if ever, makes."

RADIO-ELECTRONICS strongly applauds these words of Mr. Balcom, and sincerely believes that the wide-awake and progressive radio manufacturer who follows this advice will find it one of the best single investments in his business ever made.

Lucite and coil cement in the same way as the original turns.

The natural resonant frequency of this link must not fall in the band to which the final tank is tuned. If it does, there is a good chance of parasitic oscillation. This happened when the final stage was being used as a doubler for the 10-meter phone band; it was necessary to detune the link by inserting a 2-meter choke in series with it.

The final amplifier

The 813's are connected in parallel. It might appear better to use push-pull, but this would involve an additional tuning circuit on the grid side. Then, too, it would be impossible to use the final stage as a doubler for the 10-meter band. Even with the tubes connected in parallel, there is no sign of parasitic oscillation unless parasitic chokes or resistors are placed in the grid, screen, or plate leads, so don't use any of these.

The high output capacitance of the two 813's in parallel is no problem at all when the Jones system of series plate tuning is used. The two plates are connected to one end of the tank coil and the tuning capacitor goes from the other end of the coil to ground. The high voltage is connected to the center tap of the 150 watt tank coil. Effectively, the plate circuit resembles a center-tapped tank coil with a split-stator tuning capacitor across it. The two sections of the capacitor are formed by the plate capacitance and the tuning condenser. As these capacitances are in series, the net capacitance across the tank coil (if both capacitances are equal) is one half of either. Thus, it is possible to maintain a high L-C ratio in the tank circuit.

The antenna is coupled to the transmitter through a swinging link which may be in the center or at the cold end of the coil.

Shields which extend about $\frac{1}{2}$ inch above the lower edge of the plates should be used with the 813's to reduce

grid-to-plate coupling. Be very careful in placing the final tank coil and the doubler coil to prevent feedback due to magnetic coupling between them. A 2-meter r.f. choke placed in series with the hot end of the 813 grid-metering resistor prevents interaction between the metering leads.

The modulator

The modulator (Fig. 2) consists of a 6SJ7 speech amplifier, a 6C5 amplifier, and a 6L6 output tube. The gain is small at the low frequencies to minimize hum and motorboating. The high-frequency response need not extend to more than about 5,000 cycles. The 6L6 modulator tube may be glass or metal. It is advisable to shield the 6L6 plate lead up to the transformer.

The hum level in the modulator stage

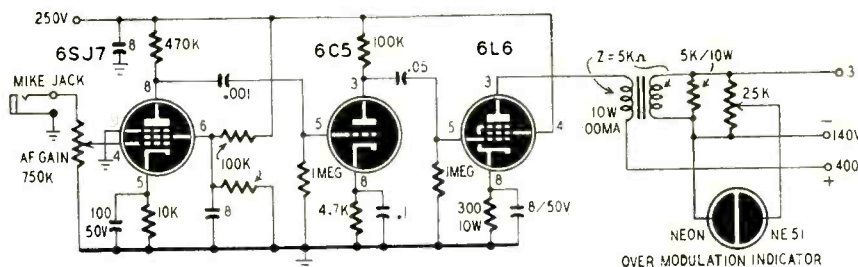

Fig. 2—The grid modulator is shown here. Note its simplicity compared to a plate modulator.

is best checked by an over-the-air contact where the report is R9. The doubler plate supply must be well filtered or it will create considerable hum. To check, remove the 6L6 modulator tube; if the hum persists, it is caused by poor filtering in the doubler plate supply.

The over-modulation indicator consists of a 25,000-ohm potentiometer across the modulation transformer, and a small neon lamp. Modulate the transmitter 100% with a sine wave and set the potentiometer so that the neon lamp just lights. One hundred percent modulation may be checked with an oscilloscope, or multiplying the r.m.s. mod-

ulating voltage by 2.82 will give the peak-to-peak modulating voltage. This may be checked against the tube performance chart in the handbook. With 1,500 to 1,650 volts on the 813's and -140 volts bias, about 60 volts peak is required across the modulation transformer secondary for 100% modulation.

R.f. pickup in the modulator circuits may occur unless the transmitter is loaded. If there is objectionable r.f. feedback at any gain setting, first determine whether it is in the microphone. If unplugging the mike stops all trouble, bypass the microphone or place an r.f. choke in series with it at the end of the cable. It may be necessary to use a high-impedance dynamic microphone instead of a crystal. If there is r.f. feedback in the modulator, bypass the B-plus feed lines or put r.f.

chokes in series with them. R.f. chokes must be used carefully or they may cause more trouble than they eliminate.

Power supply details

The power supplies used with the transmitter (Fig. 3) furnish -140 volts bias, 1,500 to 2,000 volts for the 813's, and 400 volts for the other stages.

All filaments are turned on when the master on-off switch is thrown. A time-delay relay is set into action; after 30 seconds it allows plate power to be applied to the final when the standby switch is thrown to CW or PHONE from its neutral center point.

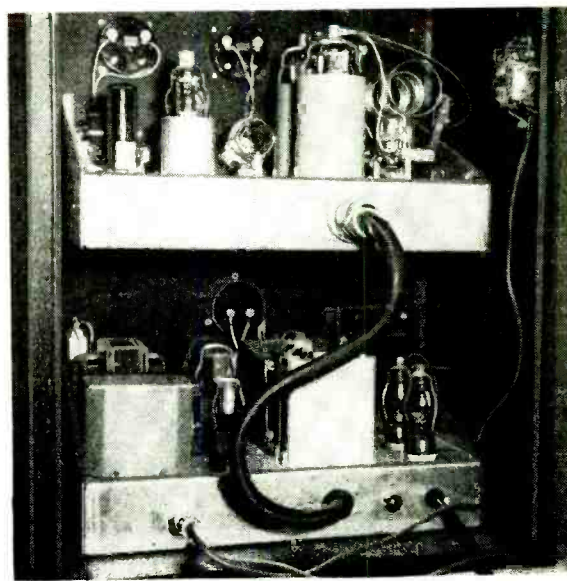

The two 813's and the plate coil are shown in the photo at the left. On the right the r.f. chassis is on the top, with the power supply-modulator below.

Television Technique Speeds Facsimile

Ultrafax transmits facsimile at
one million words a minute

THE recent invention and development of Ultrafax has made possible the transmission of written, printed, drawn, or photographed material at a relative speed of a million words per minute. Like so many other inventions we now regard as commonplace, it represents the culmination of many years of effort along various lines by many investigators.

A high-speed system of direct message transmission—identical reproduction of the transmitted material at the receiving station—has long been sought. The advantages are not too obvious in transmitting straight language, though it would cut down the possibility of mistakes. But there are many forms of intelligence that do not lend themselves to expression in telegraph signals. A weather map is a good example. Another is Chinese language. Coding systems have been developed to send both of these, but they are cumbersome and liable to error. Another class of material, represented by bank checks, depends on being transmitted in facsimile and could not be coded.

Elisha Gray was one of the first to develop a device which would reproduce a handwritten message in its original form. His *telautograph* is still used in many railroad stations to announce train arrivals. Later, Belin and others developed facsimile equipment which scanned both written and pictorial material, breaking the message up into lines and recreating it in the same manner at the receiver.

All these attempts at direct message transmission had the same fault; they were too slow. Only about 30 to 50 words could be sent in a minute. Recent improvements in facsimile have increased this speed at least five-fold, and have made our present facsimile newspapers possible (RADIO-CRAFT, July, 1946). But even 250 words per minute is not fast enough to supplant modern high-speed radio and multiplex wire telegraph. Communications engineers naturally cast interested eyes at television, which flashes its 30 frames per second on the screen.

But it is not possible simply to set up a television camera before the printed (or pictorial) page, transmit the intelligence on a television carrier, set up a camera before the receiver's screen and photograph the received

message. Definition of the image on the television screen is satisfactory for the observer, but does not look so good to the camera's more critical eye. Results of actual experiments were described as "rather crude."

The *flying-spot scanning tube* (described in the August, 1948, issue) gave much better results, and a refined flying-spot tube which illuminates with great intensity a very small part of the material to be transmitted provided the final solution. Definition is improved by a new phosphor of very short persistence. Thus the rapidly moving spot has no trailing edge.

The tube is mounted so the spot is projected through a film and onto a phototube which turns the variations of light into electric variations. (This is shown very well on the cover.) These variations are transmitted in standard television style.

The receiver posed its own problems. Previous experiments in recording television programs had already indicated that a new approach would have to be made for high-speed message photography.

Ultrafax uses this new approach. The receiving camera *sees only one scanned line at a time*. This makes it possible to move the film continuously past the receiving kinescope, instead of jerking it along in frames as in a moving-picture camera. Thus, synchronization problems are solved by eliminating the necessity for synchronization.



The Ultrafax receiving equipment in action.

And so the techniques necessary for transmitting a million words per minute were perfected. But the over-all problem was only half solved at that point. Previous methods of developing the film introduced such a great time lag that most of the benefits of ultra-high-speed transmission disappeared. By a new process in which photographic chemicals are used while hot, developing time was cut from about 45 minutes to 45 seconds. The processed film can be projected for viewing within a minute after it is received.

The role of the Ultrafax is still not quite clear. Whether or how soon it will replace ordinary wire and radio telegraphy is still an open question. Certainly there are fields in which it will be supreme—as in the transmission of maps, plans, bank checks and other material which must be received as a facsimile copy. Other and entirely new fields—for instance the printing of a daily paper simultaneously in New York and Los Angeles—suggest themselves for Ultrafax, and (as was the case in earlier radio developments) its most important fields may not even be suspected at this moment of its invention.

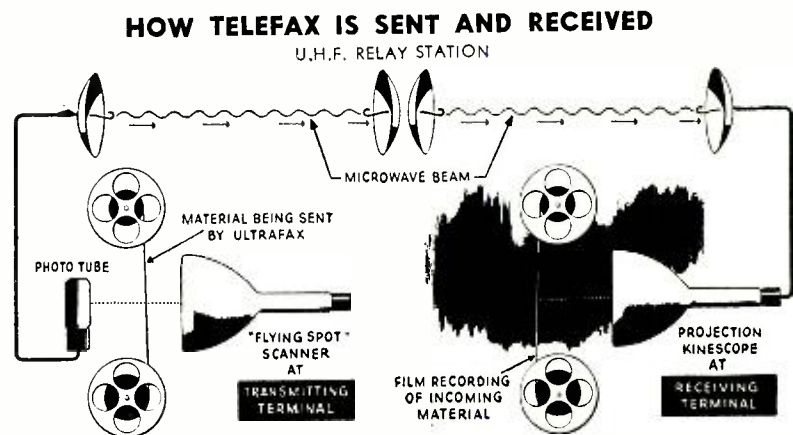

This highly simplified diagram shows the main steps of Ultrafax transmission and reception.

Antennas for Television*

THE two most popular types of transmission line for television reception are twin-lead and co-axial cable. Twin-lead is the most widely used, and almost all receivers today have a 300-ohm input system to match its characteristic impedance.

For best results in any particular locality, however, the relative merits of each line should be carefully weighed. An impedance mismatch at the receiver or at the antenna reduces the energy transfer. A twin-lead may be preferable because there is less line loss, yet a co-axial cable may be necessary because of high noise level. These and other factors must be considered carefully.

Twin-lead has a number of advantages over other types of transmission line. Its line loss is less than 0.8 db per hundred feet at 50 mc. The polyethylene insulating material is a strong, flexible plastic which is not affected by constant exposure to sun, rain, or freezing weather.

A characteristic impedance of 300 ohms rather than a lower value provides a better match over a number of channels. A high impedance is preferable, because line loss is inversely proportional to characteristic impedance; but values higher than 300 ohms find disfavor with manufacturers because of extra cost and because the wider separation of conductors, which approaches an appreciable percentage of a wave length at the higher channels, would introduce greater loss.

The co-axial line in use today consists of an inner conductor, a plastic dielectric, and a braid outer conductor covered with a pliable waterproof jacket. The characteristic impedance of the usual co-axial line is approximately 75 ohms.

Losses for even the better-grade co-axial lines run from 2 to 5 db per hundred feet at 50 mc. Obviously there is an advantage in using twin-lead wherever possible to get greater signal strength. There are occasions, however, where co-axial cable is advisable—though too often it is costly and ineffective.

In choosing twin-lead or co-axial cable, we must consider the types of noise which mar picture reception. External interference consists of static pulses, automobile ignition noise, and high-frequency bursts generated by dirty motor brushes, electrical switches, and the like. These disturb the horizontal sweep circuits, causing streaks across the picture and, in severe cases, tearing and loss of vertical hold, depending on the stability of the receiver.

*From a forthcoming book: "Reference Guide for Television Antennas."

PART II

Co-axial cable is not always superior to twin-lead. The authors explain how the correct line for each set of conditions is chosen.

By **EDWARD M. NOLL**
and
MATT MANDL

Internal noise results from thermal agitation within high-gain tubes. Combined with shot effect, it produces "snow" or "salt and pepper" on the picture. This type of noise is most prevalent when the picture signal is low and the gain of the receiver high (contrast control turned up).

The effect of all these noises differs in various receivers because of special systems employed by manufacturers to minimize interference. A receiver incorporating horizontal synchronization, for instance, suffers less from tearing than one without it. A.f.c. and a.g.c. and the gain of r.f. sections have a pronounced effect on the reception or suppression of noise.

The choice of twin-lead or co-axial cable is influenced, therefore, by the design of the set as well as its location. Each installation represents a different grouping of problems.

Some typical problems

To show how important the choice of lead-in is, a number of typical problems actually encountered by television servicemen will be described. These show clearly the type of reasoning the serviceman must do in order to get the maximum possible signal to the receiver from the antenna.

In a location 10 miles above Trenton, N. J., in a section of the country bordering the Delaware Valley, the customer's complaint was a very bad picture that was full of snow effect. The serviceman found a good receiver having a sync lock system and high gain, but giving very poor reception.

Inspection showed a co-axial cable running some 70 feet to a folded dipole

on the roof. Since this was almost a fringe area, even for Philadelphia stations, the repairman recommended that the co-axial be replaced with twin-lead. This would result in greater signal strength, because the losses in the co-axial and the mismatch of its 75 ohms to the 300-ohm input at the antenna resulted in a low signal-to-noise ratio. The owner, however, pointed out that the co-axial had been installed because ignition interference caused constant loss of horizontal hold.

A quick check indicated a misadjusted sync system, necessitating critical adjustment of horizontal hold. Realigning the horizontal oscillator and installing twin-lead resulted in a stable picture, with the snow effect not visible a few feet from the receiver. Since channel 10 was still below the others in strength, the twin-lead was tuned as detailed in the first article of this series (January issue), resulting in marked over-all improvement.

Another instance occurred in Lambertville, N. J., which is on low terrain within the Delaware Valley. It is a definite fringe area; high masts and stacked antennas are commonly resorted to in order to obtain satisfactory reception.

In one installation, the receiver was at the front of a building on a busy street. The receiver had no horizontal synchronizing system, but did have a tuned r.f. input system, which helped materially in increasing signal-to-noise ratio. A twin-lead ran alongside the building to a 40-foot-high antenna installed on top of the three-story structure. Reception was spoiled by constant tearing of the upper portions of the pic-

ture due to ignition interference from cars going by.

A co-axial cable would have eliminated this trouble but was out of the question because the length needed would have cut down weak signals far too much. The solution was to move the set as far back in the room as possible

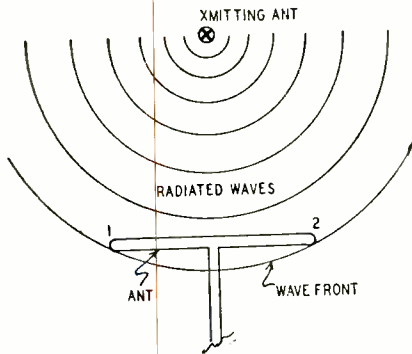

Fig. 1—This antenna is properly positioned.

and run the twin-lead away from the street and up the back of the building. This resulted in a shorter transmission line, too, which always reduces losses. The final step again consisted of tuning the twin-lead with a shorted stub. All these changes eliminated the tearing effect and improved the over-all gain considerably.

In most sections of Philadelphia, excellent reception is possible, since three TV stations are located there. In any such metropolitan area, signals can often be received with the most meager antenna system, provided the antenna is located where tall buildings do not produce reflections.

In this ideal locality, however, a customer living on a street with heavy traffic was having considerable trouble. He had purchased a 7-inch receiver. This particular receiver had inherently poor stability and would tear out completely whenever a car went by. The small apartment prevented moving the set back to any extent, and a co-axial cable had to be installed before good reception was possible. In this instance, the loss caused by the co-axial cable was offset by the high signal strength prevalent in the area.

Whenever the necessity for co-axial cable arises, however, extra precautions should be taken to procure the maximum signal. The cable should have as short a run as possible from the receiver to the antenna. It should preferably be attached to a 75-ohm receiver input. Since a straight dipole has approximately 73 ohms resistance at its center, this type of antenna is preferable to the folded dipole.

Investigation has disclosed that even co-axial cable is not altogether free from standing waves. Reception can be improved by cutting off sections until maximum gain is secured.

These typical cases and the preceding discussion will, it is hoped, explode the popular myth that co-axial cable is su-

perior to open line in every case. Far too little has been written about the differences between the two and many radiomen, if asked which is the better, would automatically reply, "Co-axial cable, of course." It must be emphasized that—for television reception, at least—the important advantage of co-axial cable is its shielding, which prevents it from picking up noise. Where the signal strength is low, twin-lead is preferable because of its lower losses.

Orienting the antenna

Improper orientation will affect the balance between conductors of either co-axial cable or twin-lead. Either type of transmission line becomes unbalanced if the signal wave front does not induce voltages of equal amplitude and opposite polarity at each end of the antenna.

Fig. 1 shows an antenna properly oriented with its end equidistant from the transmitting antenna. In Fig. 2, the antenna is improperly oriented, and

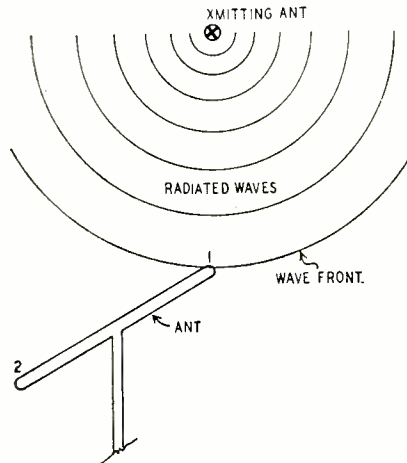

Fig. 2—Dipole is not parallel to wave front.

the arriving signal strikes end 1 almost a quarter-wavelength sooner than it does end 2. This causes a phase displacement at each end of the antenna, and all along the line to the receiver. The antenna will not only furnish a weaker signal because of improper orientation, but will also be inefficient because of the phase displacement.

To check orientation, reverse the transmission-line leads at the antenna or at the receiver. If this dims or

brightens picture, the antenna is not correctly oriented.

Reposition the antenna, checking for a picture difference by reversing the leads at each new orientation. When the antenna is correctly oriented, there will be no difference in the picture gain when the transmission line is reversed.

There are some localities between two metropolitan areas where television stations from both can be received. Usually, however, such a locality is a fringe area for one group of stations, and some provision must be made to increase signal strength.

Many set owners use a booster to bring in the weaker stations, while others use reflectors and directors in conjunction with a rotary beam. Another method consists of separate antenna systems, each oriented for one transmitting center.

If a number of stations are available, the problem of antenna tuning becomes a little more complex, since maximum gain is achieved for one channel only. Adjacent channels are aided, but not to the extent they would be if individually tuned. In such instances several stubs can be used, one for each station. The proper stub length is found as outlined in the first (January) article, then alligator clips are soldered to the end which goes to the receiver. Several lengths can be made up, one for each station. The stubs often eliminate the need for a booster—and are much easier to install and use.

Because of their low frequencies, channels 2 to 4 suffer less from standing waves, and stub tuning does not always give the pronounced results obtained on the higher channels. For the same reason, however, the gain is greater and the signal suffers less attenuation from distributed capacitances, skin effect, and other high-frequency loss factors. Thus, there is no need for stub tuning on channels 2 to 4.

There are other factors which influence signal strength to an even greater degree. One of these is based on the fact that television propagation theory to date has been incomplete: there actually is no free-space radiation at levels commonly used for television antennas. An explanation of this, with detailed procedures for taking advantage of it, will be discussed next.

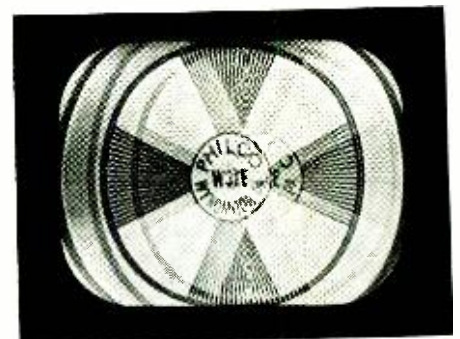

These photos of television screen show typical results of an incorrectly oriented antenna.

Television Sweep Circuits

Part II—Blocking-tube oscillators

By ALLAN LYTEL*

SWEEP voltages in a television receiver are derived from the charging curve of a capacitor. This charging voltage starts out at zero and increases to the applied d.c. voltage. Some discharge device is then used to allow the charge to leak off, and the process is repeated. A linear portion of the charging curve becomes the sweep voltage.

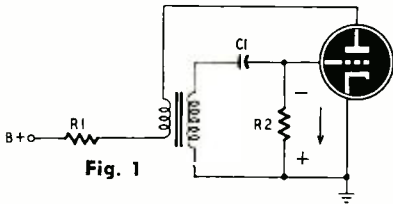

Fig. 1

This "switch" across the charging condenser may be either a multivibrator or a blocking-tube oscillator. Both have the same function; they discharge the capacitor at the proper times as determined by the sync pulses. When the sync fails to keep the sweep in step, the picture moves.

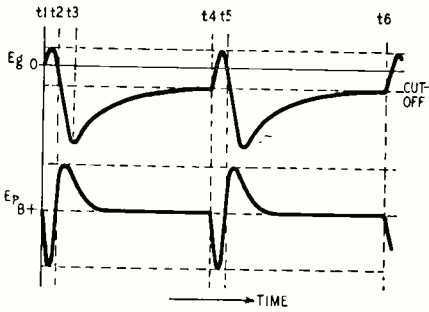

Fig. 2

Feedback from plate to grid is needed with the blocking-tube oscillator, as with any conventional oscillator. An iron-core step-up transformer is used.

Fig. 1 shows a blocking-tube oscillator. B-voltage is applied to the plate through protective resistor R1. A grid-leak C1-R2 develops bias. A transformer provides the usual 180-degree phase reversal.

* Temple University Technical Institute, Philadelphia, Pa.

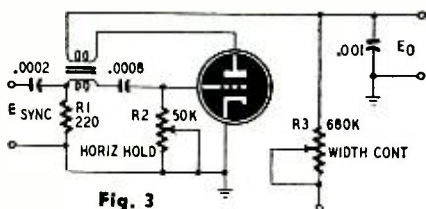

Fig. 3

This circuit has no applied bias; hence when plate voltage is applied, plate current will flow. The transformer terminals are so connected that increasing plate current through the primary causes the grid to become positive due to the transformer action. A more positive grid means a still greater plate current flow, which drives the grid still further positive. This action continues until plate current reaches saturation. The plate current then stops changing, and the transformer's magnetic field starts to collapse. Because the original expanding magnetic field caused the grid to become positive, the contracting field makes it go negative.

When the grid was positive, grid

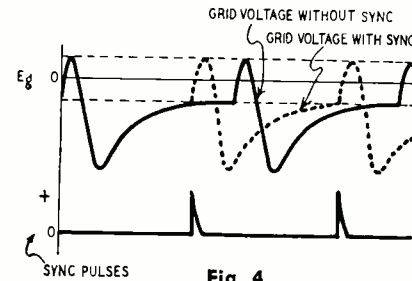

Fig. 4

current (attracted from the cathode) flowed down through R2, making the right-hand plate of C1 negative, drawing electrons to it from the left plate, and charging it. Now that the grid is negative due to the magnetically coupled current, there is no longer any grid current; and C1 discharges through R2, driving the grid further negative.

The time interval between t3 and t4, and therefore the frequency of oscillation, is determined by the period required for the capacitor to discharge as well as by the voltage to which it had time to charge in the first place. These charging and discharging times are functions of the time constants of R2 and C1. The time in seconds, which is the product of R in ohms and C in farads, can be directly translated into frequency: a time of 1/1,000 second, for instance, would allow a maximum of 1,000 operations or cycles per second.

Since the oscillator will not be useful unless the frequency is exactly correct, a method of locking it in with the video signal is necessary. Fig. 3 is a typical horizontal oscillator circuit. A sync voltage is applied through a 200- μ f capacitor across R1. The tube is cut off until the charge of the grid capacitor leaks off across the grid resistor. If positive sync pulses are applied just before the tube would naturally conduct, the oscillator frequency will be in step with the sync pulses.

The output sweep voltage is taken from across the .001- μ f capacitor from plate to ground. While the plate is cut off, this capacitor is charged by the B-voltage through R3. The setting of the slider on R3 controls the time the condenser takes to charge, and consequently the width of the sweep.

One other adjustment is needed: a method of changing the grid time constant and the oscillator frequency. The grid leak is made variable (R2) to control the natural frequency of the oscillator. This hold control is set so that frequency is approximately correct; then the sync pulses assume control. Fig. 4 shows the effect of the sync.

Fig. 5 is the horizontal oscillator of the RCA TRK-90 receiver. The circuit of V1 is similar to other such circuits

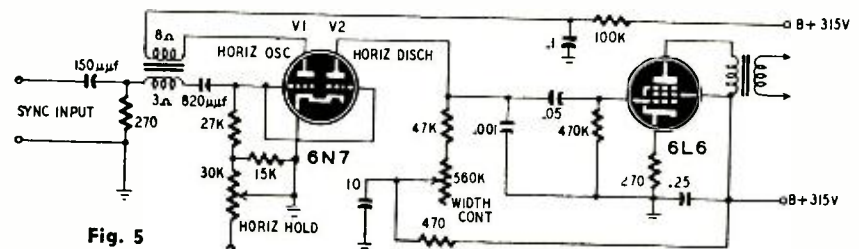

Fig. 5

The combined negative voltages caused by the discharge of C1 and the collapse of the magnetic field are great enough to cut off the tube. There is no current flow through the tube while C1 is discharging. Fig. 2 shows this period of time between t3 and t4. At time t4, the capacitor has discharged and bias has decreased to a point at which the tube again conducts and the cycle repeats itself as before.

we have seen, except for the output. The grids of the 6N7 are tied together. V1 is the oscillator and V2 is the discharge tube.

The discharge triode conducts and is cut off in step with the oscillator. V2 discharges the .001- μ f capacitor when it conducts. Width and hold controls have the same function as with the single tube. V2 feeds the 6L6, which is the horizontal output tube.

(decibels referred to 1 milliwatt in 600 ohms) is required at the modulator. This can be measured on the db meter. The input transformer can match either 150 or 600 ohms. The pre-emphasis network (dotted lines) may be removed by disconnecting the .0001- μ f condenser.

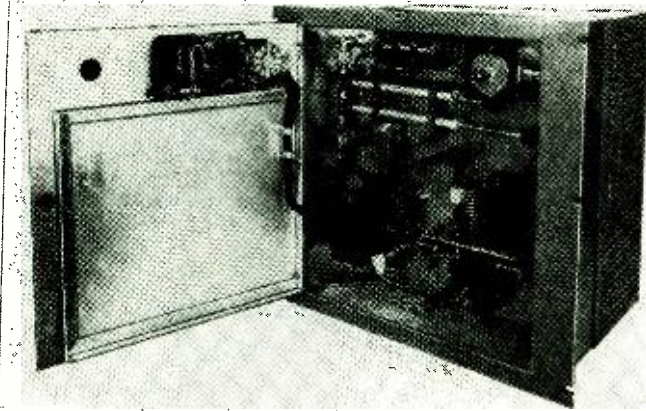

The FM transmitter develops 3 watts output in the 940-952-mc band.

The modulator has three stages of amplification provided by two 6SN7's. The a.f. signal is fed to the first stage through T103, an a.f. transformer flat within ± 1 db from 30-20,000 cycles. This transformer matches a 600-ohm line to 6SN7 grid. Cathode resistors are left unbypassed for degeneration.

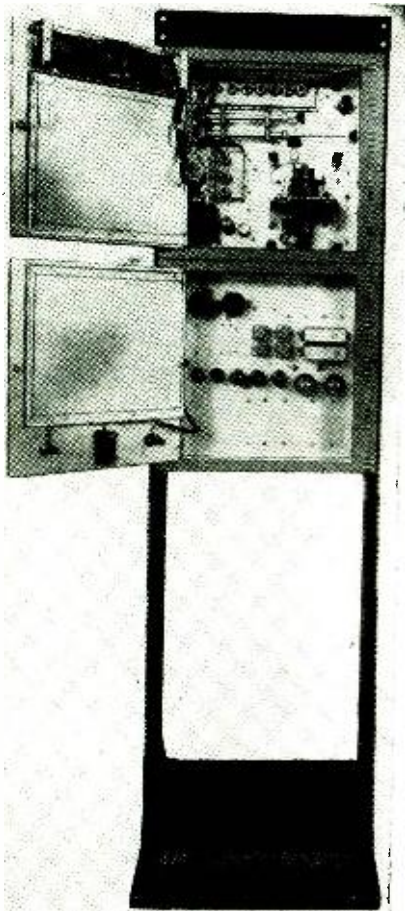

The rack-mounted receiver and power supply.

In addition, the last plate is connected back to the first grid through a 0.82-meg resistor for over-all negative feedback. Hum is greatly reduced by returning the first grid to a source of hum-bucking voltage instead of to ground or cathode (see Fig. 1-a). Total amplification is low, but distortion is

held to 0.5%. The modulator output is about 20 volts.

The oscillator is a reflex Klystron continuously tunable over ± 5 mc by a cavity control. The Klystron frequency is modulated by coupling the modulator output to the reflector (repeller) grid. Variations in reflector voltage cause corresponding frequency changes which produce FM.

The Klystron requires two high-voltage supplies. The beam supply is 1,000 volts at 100 ma. The reflector requires a negative voltage of between 900-1,500 volts at no current. Each voltage is taken from a voltage-doubler using two 5R4-GY's. Provision is available for automatically turning on the reflector voltage before the beam. For safety, these high voltages are shorted to ground through an interlocking arrangement, as shown, when the unit is to be serviced.

The Klystron supplies about 3 watts of r.f. Power is transmitted from its coupling loop through a blocking arrangement to a stub tuner and then to a 50-ohm coupling "tee." There are four outlets. One connects to a cavity (resonated at 950 mc) with a crystal for frequency measurement. Another crystal rectifies part of the output for power measurement. The connector is for r.f. power output. The fourth outlet is connected to a co-axial line terminated by T101 and a crystal.

The center frequency is stabilized by a CFS (center-frequency stabilizing) exciter, a CFS i.f. amplifier, and a discriminator. The exciter utilizes two 6AK5's: the first as crystal oscillator and doubler, the second as a doubler. For a 950-mc carrier, the crystal frequency may be 38.333 mc. The exciter output becomes 153.332 mc. The sixth harmonic of the output is 920 mc, which is combined with the 950-mc output from the Klystron to produce a beat of 30 mc. T101 matches the exciter output impedance to that of the crystal mixer. The beat frequency appears across T102, which is tuned to 30 mc. L105 is tuned above and L106 below 30 mc to produce an amplifier band width of 3 mc.

The radio-frequency choke, L109, is a Sickles No. 12734 (self-resonant to 30 mc). The others are wound with G-E Formex wire on forms with adjustable powdered-iron cores. L103 has

13 turns of No. 28 wire; L104 has 7 turns of No. 24; L105 and L106 have 19 turns of No. 28; and L107 and L108 have 12 turns of No. 28. L103 through L106 are on $\frac{1}{4}$ -inch forms, and L107 and L108 are on $\frac{3}{8}$ -inch forms. T101 and T102 are wound on $\frac{1}{4}$ -inch forms. The primary of T101 has $4\frac{1}{2}$ turns of No. 22 tinned bare wire spaced to 1 inch, and the secondary has $1\frac{3}{4}$ turns of No. 24 Formex close-wound. The primary of T102 has $1\frac{3}{4}$ turns of No. 28 Formex close-wound, and the secondary has 25 turns No. 28 close-wound.

When the Klystron frequency is exactly 950 mc, the i.f. is 30 mc. The balanced crystal discriminator is adjusted to give no output under this condition. If the center frequency drifts higher or lower, a d.c. voltage appears. The polarity depends upon the direction of drift. This d.c. is impressed as grid bias on a 6SH7 (Fig. 1-b). Its plate current controls the reflector voltage and therefore corrects the Klystron frequency. With this arrangement, the mid-frequency is maintained within .01% of the assigned value.

The metering circuit (Fig. 1-c) can be switched to any part of the circuit to check performance. Points indicated by circled numbers on the main diagram connect to numbered terminals on the meter switch. An abnormal reading indicates failure or deterioration of tubes or parts. This is an important indication where interruption to service must be held to a minimum.

The receiver circuit

Fig. 2 is the receiver schematic. The local oscillator uses the same type of reflex Klystron as the transmitter, but lower voltages are applied. An a.f.c. circuit corrects the oscillator frequency for maximum i.f. signal. As in the transmitter, it is done by a 6SH7 control tube which governs the reflector voltage. Various circuits in the receiver are checked by meter switches (301-



Two antennas are used with the equipment.

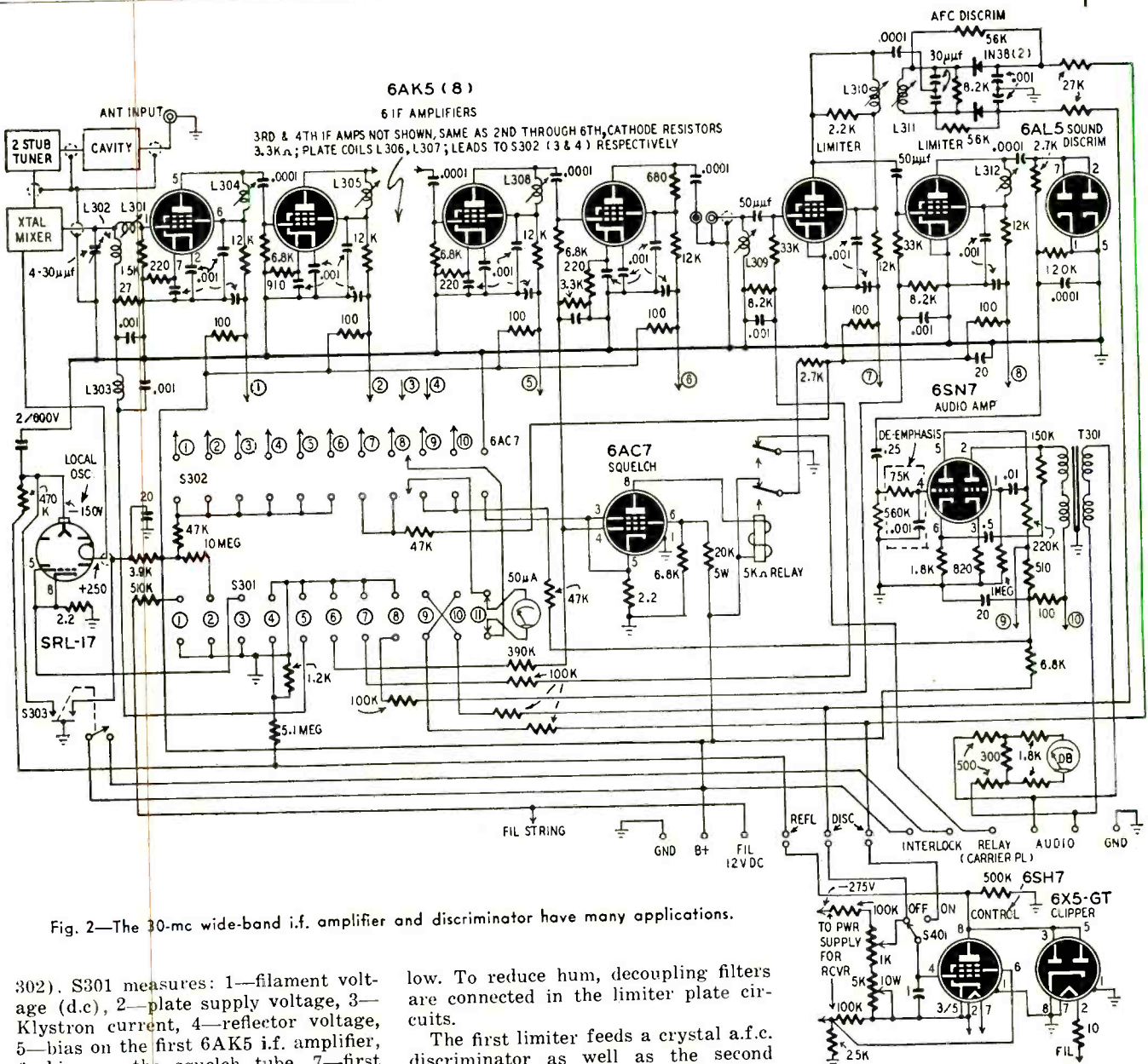

Fig. 2—The 30-mc wide-band i.f. amplifier and discriminator have many applications.

302). S301 measures: 1—filament voltage (d.c.), 2—plate supply voltage, 3—Klystron current, 4—reflector voltage, 5—bias on the first 6AK5 i.f. amplifier, 6—bias on the squelch tube, 7—first limiter grid current, 8—second limiter grid current, 9-10—a.f.c. discriminator output. When S301 is in position 11, the meter is connected to the arms of S302 for measuring currents in the plate circuits of the i.f. and a.f. amplifiers and in the limiters. The circled numbers on this diagram indicate connections to similarly numbered contacts on S302.

Tube filaments are operated from a d.c. supply as in the transmitter to assure low hum and noise levels.

The incoming signal passes through a cavity resonant at 950 mc, which acts as a preselector and reduces image and spurious signals. A signal image gain of 80 db is obtained. A stub tuner matches the cavity to the crystal mixer.

The Klystron is tuned 30 mc from the incoming signal. The i.f. beat is delivered to the amplifier by a π -network which matches the mixer to the grid circuit. It is composed of a small variable condenser, coil L302, and a fixed condenser. The amplifier uses six 6AK5 stagger-tuned stages, giving a band width of 2.5 mc. Two 6AK5 limiters fol-

low. To reduce hum, decoupling filters are connected in the limiter plate circuits.

The first limiter feeds a crystal a.f.c. discriminator as well as the second limiter. Coil L310 feeds the second limiter and is also the primary of the a.f.c. discriminator. The secondary is L311 with a "center-tapped" capacitance and resistance load connected across it. The crystal output is in series with the grid bias of the 6SH7 control tube. The function of this tube is similar to that of the transmitter control tube described previously.

The second limiter tube is coupled to a 6AL5 discriminator designed for low-distortion audio output. The detected a.f. is amplified in a two-stage degenerative 6SN7. The de-emphasis network (dotted lines) may be removed by shorting the resistor and disconnecting the condenser.

A squelch tube (a 6AC7) disables the receiver if the carrier goes off the air or if local trouble interrupts the signal. If r.f. signal is present at the sixth i.f. grid, current flows to bias the squelch tube to cutoff. The relay contacts fall back, completing the plate and screen supplies to the limiters and turning on a pilot light. When the incoming r.f. is absent or below the predetermined

level, the squelch tube conducts.

The output level across T301, +14 dbm when +10 dbm is fed into the transmitter, corresponds to a carrier-frequency deviation of ± 200 kc. T301 is designed to couple a 15,000-ohm plate to a multiple liner. Its response is ± 1 db from 30 to 12,000 cycles.

The coupling inductors L302 and L303 are Sickles No. 12734's. All others are close-wound with the G-E Formex wire on 1/4-inch forms with adjustable powdered-iron cores. L301 has 30 1/2 turns of No. 32; while coils L304 through L308 have 19 turns, L309 and L311 13 1/2 turns, and L310 and L312 17 turns of No. 28 wire.

The antenna

The same type of antenna is used at both ends and it consists of a half-wave radiator and a reflector mounted in an aluminum parabola 6 feet in diameter. Horizontal polarization is used. Gain in the forward direction is 24 db. The antenna is shown in the photograph on the preceding page.



Courtesy Terma Electric Co. Generator can give waves with various shapes.

Electronics in Medicine

By EUGENE J. THOMPSON

Part V—The operation of electronic medical equipment used for treating disease

IN addition to the electronic methods of diagnosing illness described in preceding articles, there are electronic devices and techniques for treating disease. These are grouped under a branch of physical therapy called *electrotherapeutics*.

The basic principle of electrotherapeutics is that the human body converts the energy contained in food into the physical, chemical, and electrical forces necessary for life. In disease, these vital processes become deranged. By subjecting the body to various electrical impulses, the normal balance can often

be restored, allowing the patient to recuperate from the disease with which he is afflicted.

Different types of electric currents have various effects on the body; there-

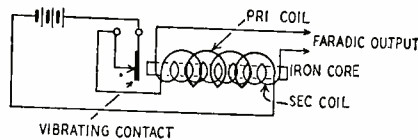

Fig. 2—Faradic generator gives sharp pulses.

fore, in electrotherapeutics, a variety of wave shapes or *modalities* is used. Some of these modalities are shown in Fig. 1.

Galvanic current is simply d.c. up to 75 volts at 1 to 20 ma. It is obtained from batteries, d.c. power lines, or—most commonly—from a.c. lines, using selenium or vacuum-tube rectifiers. *Interrupted* or *pulsating galvanic* impulses are produced by turning galvanic current on and off periodically with a manually operated or electronic switch or various types of electro-mechanical interrupters, such as relays. *Surging galvanic* is d.c. whose amplitude is varied periodically by motor-driven variable resistors, grid-glow tubes, or thyratrons, or by other electrical or mechanical means.

The *faradic* modality is similar to the pulsating galvanic, except for a slight negative dip, a sharp positive peak, and a higher frequency (1,000-2,000 cycles). Its amplitude is about 75 volts, but the current is only slightly over 1 ma. Faradic impulses are produced by

faradic generators or coils, sometimes called *inductoriums* (Fig. 2), and by vacuum-tube oscillators designed to produce the required wave form.

Slow (galvanic) sinusoidal current is a low-frequency modality (5-30 cycles) produced by small, variable-speed, motor-driven generators, or motor-driven variable resistors, or grid-glow or thyatron tubes. The voltage and amperage are the same as the galvanic modality. The low frequency precludes the use of standard oscillators.

In electrotherapeutics, frequencies exceeding 50 cycles are called *rapid alternating* modalities. The voltage and current are the same as in the galvanic modality. However, because such impulses are painful if applied to the body unmodified, they are customarily amplitude-modulated. The resulting modality is known as *surging* or *modulated alternating current*. It can be produced without difficulty in a number of ways.

One method utilizes ordinary 60-cy-

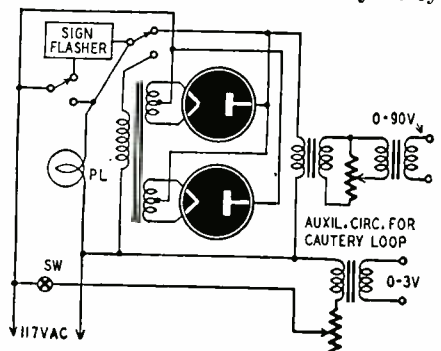

Fig. 3—Sign flasher modulates 60-cycle a.c.

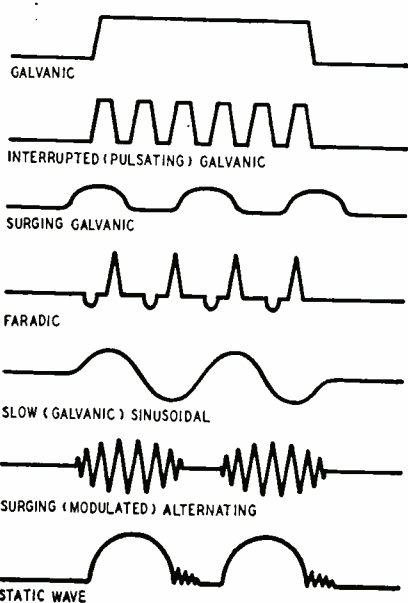

Fig. 1—The common electrotherapeutic waves.

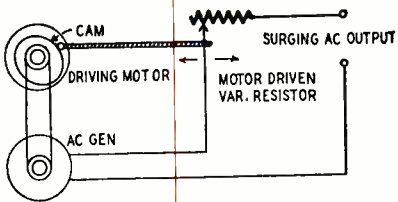

Fig. 4—Motor-driven slow galvanic generator.

cle a.c. which is surged by a thermally actuated interrupter of the type used for sign flashing, in combination with two vacuum tubes. A typical circuit is shown in Fig. 3. Another device consists of a motor-driven generator, the output of which is passed through a cam-actuated variable resistor (Fig. 4). There are also special motor generators which produce surging alternating current. The same results can be achieved electronically with oscillators.

Static waves, generated by rotating friction machines, have an output of many thousand volts and a current of less than 1 ma. Although of proven benefit in certain conditions, they have fallen into disuse because the apparatus is too cumbersome. Newer, more efficient equipment is available today.

Fig. 5 is a schematic diagram of an instrument known as the Scope-Multisine Generator, which produces all the modalities described (except static waves) and several additional modifications of these electronically. There are 14 modalities in all.

The faradic current is generated by the 6B4 oscillator circuit, which eliminates the irregularities often encountered in the output from faradic coils. The frequency is controlled by the resistance-selector switch in the grid circuit.

The various modalities are pulsed and surged by the 117L7 circuit. The active and inactive periods of surge and sine are regulated separately by the two 5-megohm rheostats in the relay circuit.

The output of the instrument is controlled by the 10,000-ohm potentiometer just before the meter rectifier. The instrument has an additional advantage in that it has a small built-in oscilloscope which permits the operator to see the wave form. This is not shown in the schematic.

Electrotherapeutic currents are applied to the body by special electrodes specifically designed for the modality being used, the particular application of that modality, and the area of the body being treated.

One major consideration in electrotherapeutics is the problem of skin resistance. This is most important in the application of the galvanic modality because the body produces a polarization current opposite in phase to the applied galvanic stimulus. The net effect is a high skin resistance to this type of current. Low-frequency currents, on the other hand, cause only slight polarization currents; high-frequency and static waves cause none. The skin resistance to these modalities

ranges from moderate to almost nothing.

In effect, the skin acts like an electrolytic capacitor with a galvanic breakdown level slightly above 50 volts, and (like ordinary capacitors) it passes alternating currents with little opposition. Because of this, when dealing with low-voltage therapeutic currents, every possible attempt is made to keep the skin resistance at a minimum by warm-

in iontophoresis. Certain drugs are attracted to one electrode and repelled from the other. A large dispersing electrode and a painted applying electrode are used. The polarity of each depends on the particular drug. The current strength varies, but averages 5-10 ma. Fig. 6 is a schematic of a simple instrument suitable for electrolysis, epilation, and iontophoresis.

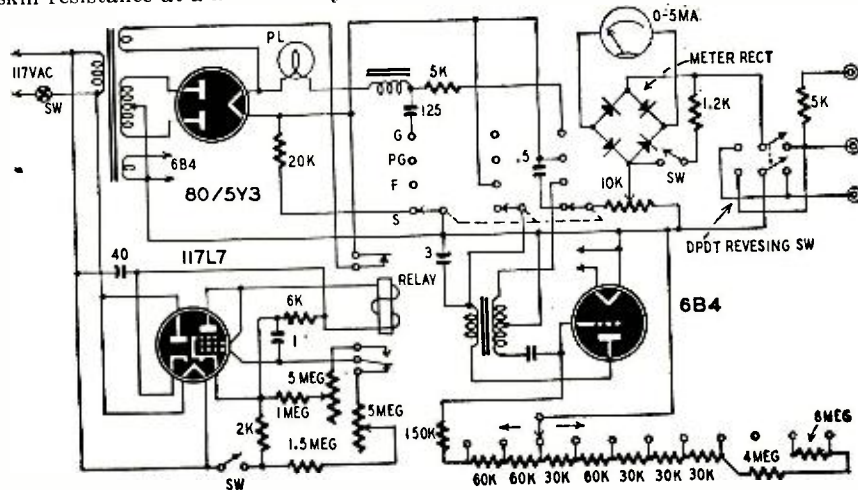

Fig. 5—Scope Multisine Generator produces 14 kinds of modalities. The grid capacitor of the 6B4 faradic oscillator is determined by the operating frequency and transformer inductance.

ing and moistening the skin and by using wet electrodes and salt electrode jellies. For high voltages and higher-frequency currents, plain metal electrodes are adequate.

In view of the diversity of electrotherapeutic currents, it is not surprising that they should have different effects on the body. The galvanic modality has a purely chemical effect; static waves have an electrokinetic effect. The other currents exert varying degrees of chemical and electrokinetic effects.

Galvanic currents are used for treating certain types of painful inflammations, and for electrolysis, epilation, and iontophoresis. In the first case the electrodes are applied to the painful area or the patient sits in a tub of water and rests his body on the electrodes. The current is about 0.5-1 ma per square inch of electrode surface. The benefits obtained are due to increased circulation through the treated part.

Electrolysis means electrical destruction of tissues. It is used for removing warts and other small growths from the skin. Epilation is a form of electrolysis for removing superfluous hair. The patient rests his hand on a large dispersing electrode connected to the positive pole of the d.c. outlet. A small needle attached to the negative pole is inserted into the growth or hair shaft, and a current of 0.5-1 ma is applied briefly.

Certain valuable drugs are best introduced into the body through the skin. The technique for doing this is known as ion transfer or iontophoresis. In a solution of ions (positively and negatively charged particles), positive particles migrate to the negative electrode and negative particles go to the positive electrode. This principle is used

Low-frequency, faradic, and rapid alternating currents are used to stimulate injured muscles and muscles whose nerves are recovering from disease or injury. The currents do not have any curative powers. Their purpose is to prevent muscle wastage from inactivity.

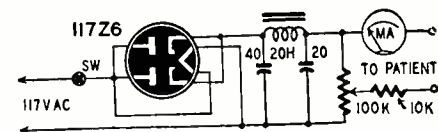

Fig. 6—Simple instrument for iontophoresis.

One of the most important applications of such currents is the stimulation of muscles whose nerves have been afflicted by infantile paralysis. Electrotherapeutics has prevented many polio sufferers from becoming deformed and helpless cripples. A device has been developed recently which electronically stimulates the respiratory muscles, replacing the iron lung in some cases.

Electrotherapists must have a knowledge of the surface anatomy of the body because only over certain skin areas, called motor points, will the application of electronic impulses produce the desired muscle response. Also, the particular type of current to be used is a highly technical medical problem.

Electrotherapeutic currents are used in the treatment of certain mental diseases. The technique is known as electric shock therapy. The general principle is that an alternating current of 80-120 volts is applied to the side of the patient's head for a very brief time (0.2 second). This produces convulsions. After a series of such treatments, the mental symptoms sometimes clear up.

Audio Console Controls Sound



A preamplifier-mixer permits the recordist, PA operator, or remote-broadcasting engineer to control and monitor programs

By RICHARD H. DORF

YOU may not own a broadcasting station, but if you have a collection of audio equipment—AM and FM tuners, phonograph assemblies, and microphones—your needs are very much like those of a typical radio or recording studio. You need some way to control and co-ordinate your equipment, some way to group the pieces together and operate them as a single flexible system. You may want to hear a record or a radio program or use your microphones in quick succession or use two of these items at a time.

The audio control console described in this article acts as a clearinghouse for all your audio components. The turn of a knob or the movement of a switch channels any or all of four sound sources either into the loudspeaker or to a recording amplifier or to both at the same time. In a more expanded form a console such as this is the nerve center in every broadcast studio, the device responsible for the flexibility which allows you to hear the musical backgrounds behind speakers or any of the innumerable common effects.

The console is easy and inexpensive to build, and its appearance is good

enough to satisfy even the feminine members of the household. Its use requires some revamping of most of your sound sources, but the modifications will pay off in convenience. There will be no more plugging and unplugging components every time you want to use them, no more limitations on the length of cables, no more hum pickup or high-frequency losses from long lines.

How to convert

The revamping consists mainly of converting all your devices to 500 ohms output. Most mikes (except crystals, which cannot be used) are available with 500-ohm output at no extra cost. If you already have high-impedance dynamics or ribbons, the manufacturer will install a new transformer for a very small charge. High-impedance, high-level devices like tuners can be converted to 500 ohms without using a transformer, as explained later. Because each input has high gain, resistive losses caused by the impedance change are made up in the console.

Examination of the circuit diagram (Fig. 1) shows that the console is very simple. Four 500-ohm T-pads are used

as mixers. The step-type pads sold for broadcast use are rather expensive, so wire-wound controls were used. Several makes of these are on the market, but the only ones found noiseless enough to work at low level are the IRC J-977's.

The pads are connected so that input and output impedances of the mixer are about 500 ohms. If more or less than four inputs are wanted, the same connections are used, but the value of the 300-ohm build-out resistors is changed. Some impedance value other than 500 ohms can be used, should there be any reason for it. If Z is the impedance of each input and N the number of inputs, then the value of each build-out resistor is $\frac{Z(N-1)}{(N+1)}$.

The output of the mixer goes through a high-fidelity line-to-grid transformer to the 6SF5 grid. A UTC A-10 was used in the console because it is small and relatively inexpensive.

The 100,000-ohm master gain control at the first grid of the 6F8-G (a 6SN7-GT works just as well) controls the over-all level.

The volume control at the 6J5 grid is mounted on the chassis and is screw-driver-adjusted. It fixes the maximum gain of the console for whatever devices are used. The advantage is that only the necessary minimum of hum- and noise-producing gain is present.

The plate-to-line transformer is another miniature high-fidelity unit, a UTC A-26. The A-26 is actually made for push-pull, low-level outputs and was used only because it was on hand. The UTC A-24 (or any other similar high-fidelity unit) made for a single plate can be used, but the value of the primary shunt resistor will have to be changed. These high-quality transformers (input and output) help to give an over-all frequency response flat to within approximately ± 1 db from 30 to 15,000 cycles.

The decibel meter is permanently connected across the transformer secondary, as is the monitor jack. The line jack is connected through the output switch, which substitutes a 500-ohm dummy-load resistor when the line jack

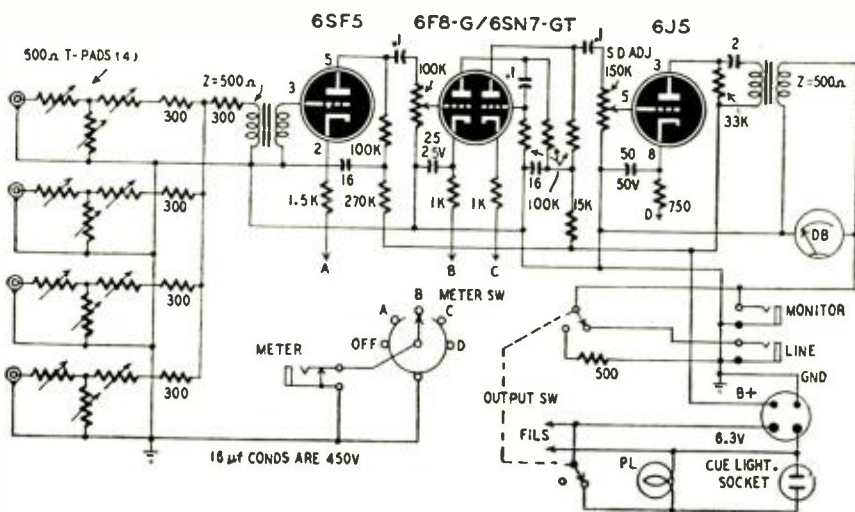

Fig. 1—Formula in text shows how more inputs can be added or a different impedance used.

is switched out. A second set of contacts on the output switch lights a pilot lamp on the front panel to indicate that audio is being fed out. There is also a receptacle for the plug on a cable leading to an external pilot lamp. This is useful in recording; it is actually an "on-the-air" cue. The line jack feeds the recording amplifier and when the output switch is pushed down (a lever-type switch is used), the external light, which has been placed where the player or speaker can see it, lights.

As a help in locating trouble and for preventive maintenance, the meter switch transfers the live contact of the meter jack to any of the four cathodes, keeping the other cathode resistors grounded. A rotary tap switch with a wafer which shorts all unused contacts is used. After the console is built, plug a milliammeter in the jack and make a note of the reading for each tube. In the future, any substantial change in the reading will indicate trouble.

A standard sloping-panel steel cabinet 14 x 8 x 8 inches was used for the housing, into which a 13 x 7 x 2-inch chassis just fits.

Construction

Begin by fastening the chassis to the lower (vertical) portion of the front panel, being careful to fit the two so that the assembly will slide easily into the cabinet. A pair of screws and nuts through chassis and panel will do the fastening job nicely and the attenuator shanks will make it indestructible. Now make holes through the two for the input attenuators. Be sure to center these vertically because the pads are none too small for the space.

On the chassis, the tubes and transformers are mounted in a line, with the 6F8-G in the center, far enough back to clear the meter. In the chassis photo, the components are in logical order from right to left, beginning with the input transformer.

All connectors are mounted on the rear chassis apron. A 2-inch-high slit along the rear wall of the cabinet makes the rear chassis apron readily accessible. From right to left in the photo are the four input connectors, the power connector (a 4-prong male), the socket for the external pilot-lamp connection, line and monitor jacks.

Under the chassis there is no crowding. Mount components where convenient. Shield all leads up to the input transformer primary.

An external power supply furnishing filament voltage (6.3 volts) and about 250 volts B is necessary. The writer uses a single supply for the console and a recording amplifier. The cable from the supply should terminate in a four-pin female plug to avoid shock. *Don't use a tube socket on the console and a male plug on the power cable.*

Connections

Any microphone (or other device) which has a 500-ohm output impedance can, of course, be connected to any input. Tuners having high-impedance

outputs can be connected as shown in Fig. 2-a. The potentiometer should be adjusted for the recommended tuner load impedance. The level across the 500-ohm resistor will usually be about the same as that of a microphone. Exactly the same scheme can be used with the output of the preamplifiers generally used with modern magnetic phonograph pickups. It can also be used with high-output crystal pickups, but usually there will not be enough level unless the variable resistance is made too small to allow good bass response. The scheme shown on page 89 of the October issue of RADIO-ELECTRONICS is a better one.

The console can also be fed from the loudspeaker voice-coil terminals of any receiver or amplifier. Fig. 2-b shows how this is done. The impedance of the speaker line is not important. The speaker can be left connected, or it can be replaced with a dummy load. Adjust the variable resistance until enough level is being fed to the console.

Any monitor amplifier having a high-impedance input can be connected to the monitor jack, the length of the line between it and the console being unimportant. Effectively, this is a low-impedance line bridged by the amplifier grid.

At least one amplifier with a 500-ohm input must be connected to the line jack when audio is switched to it because the output transformer must always be terminated in 500 ohms. The amplifier need not use a transformer, however. Simply connect a 500-ohm resistor across the high-impedance input, in parallel with the line from the console. If additional amplifiers are to be fed by the console, just parallel their

inputs. But all except one should have high-impedance inputs so that only about 500 ohms is across the console.

No equalizers should be placed in the console. One of the console's advantages is that each external amplifier or sound

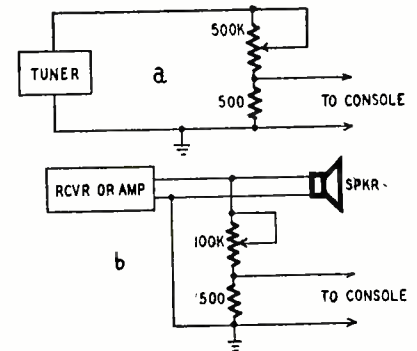

Fig. 2—How to connect a tuner or a receiver.

source can be equalized for its particular job without affecting the others.

MATERIALS FOR CONSOLE

Resistors: 5—300, 1—750, 2—1,000, 1—1,500, 1—15,000, 4—100,000, 1—270,000 ohms, 1/2 watt; 1—500, 1—33,000 ohms, 1 watt; 1—100,000-ohm potentiometer, 1—150,000-ohm, screwdriver-adjusted potentiometer; 4—500-ohm, wire-wound T-attenuators (IRC J-977).

Capacitors: 3—0.1, 1—2 μ f, 600 volts, paper; 1—25 μ f, 25 volts, 1—50 μ f, 50 volts, 2—16 μ f, 450 volts, electrolytic.

High-fidelity transformers: 1—input, 500 ohms to single grid; 1—output, low-level, push-pull plates (or single plate—see text) to 500-ohm line.

Switches: 1—d.p.d.t., lever-type (Centralab 1458) and face plate; 1—5-position, rotary, meter-insertion (Centralab type G wafer).

Connectors: 4—single-circuit, chassis-mounting microphone connectors; 1—4-prong, chassis-mounting male plug; 1—2-contact, chassis-mounting female socket; 2—single-circuit, non-shorting, 1—single-circuit, shorting phone jacks.

Tubes: 1—6SF5, 1—6F8-G or 6SN7-GT, 1—6J5.

Miscellaneous: 1—decibel meter; 1—6.3-volt pilot-lamp assembly; 3—octal tube sockets; 1—sloping-panel metal cabinet, 14 x 8 x 8 inches; 1—chassis, 13 x 7 x 2 inches; knobs, dial plates, and necessary hardware.



Photo shows chassis and panel pulled out of cabinet. Male power connector is used for safety.

Adventure in Equalization or Getting Out the Bumps

Properly designed speaker baffles can overcome low-frequency deficiencies in the audio amplifier.

By JAMES R. LANGHAM

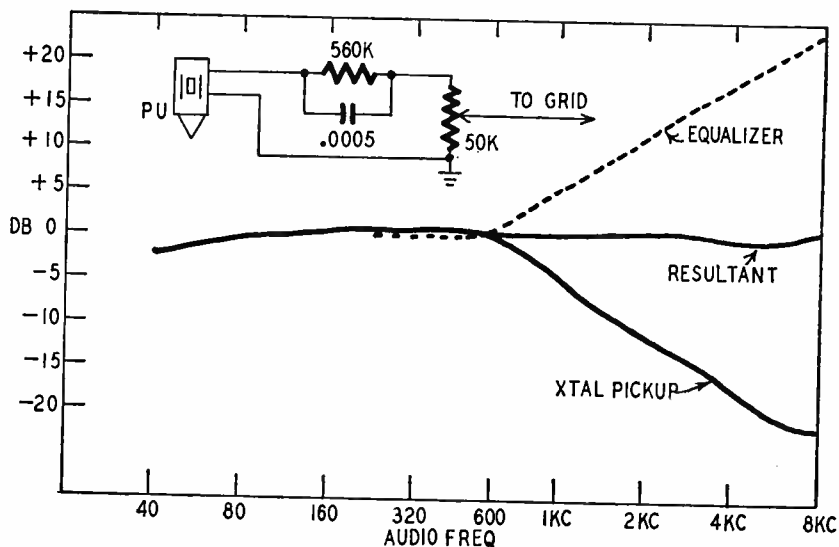

Fig. 1—Typical response curve of a crystal cartridge with and without h.f. equalization.

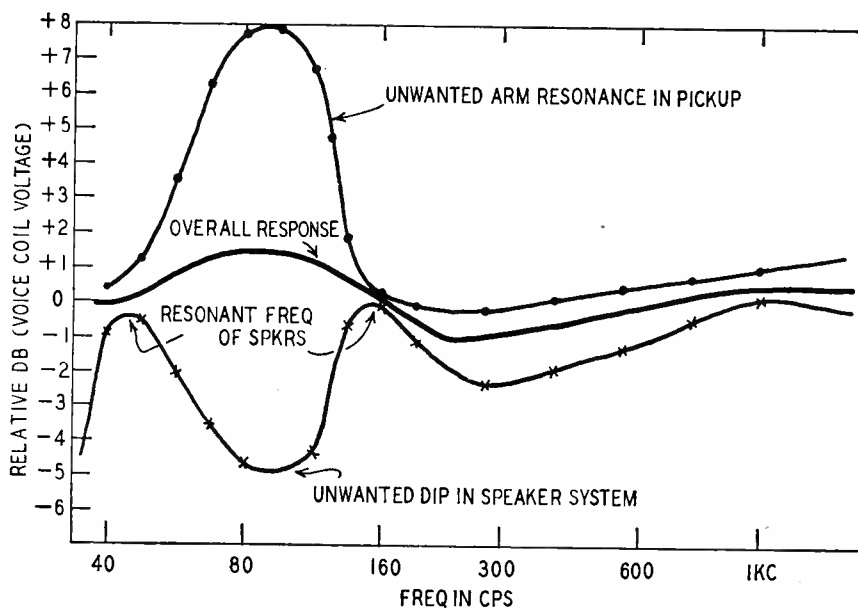

Fig. 2—Curves show how resonant peak in tone arm is equalized by resonance in loudspeakers.

THERE was a time when I had to have everything flat—the tuner, the amplifier—the whole business. I used to spend a good deal of time running response curves to make sure things were as close to flat as I could get them. I worried about things like equalizing the pickups, and used to graph curves like Fig. 1.

The XYL hated the frequency record. She said it sounded like an air-raid alarm. (This was during the war.) I used to sit and listen to the record and watch the meter and then change a resistor or a condenser and start it up again. I wore out two frequency records just playing with pickups.

"You see," I explained masterfully and professionally to the XYL, "a crystal pickup is a pressure device. The more the element is distorted, the higher the output voltage. Our old magnetic put out voltage in proportion to the number of lines of force it cut per unit. . . ."

"Skip the double talk," she urged. "I'm not a physicist; I'm just a household drudge married to a radio dope."

"Well, then, it's like this," I said. "The faster you wiggle the needle in a magnetic pickup, the louder the stuff gets. With a crystal it works the other way. The harder you twist it, the louder comes the Beethoven."

"Who's twisting it?"

"The little grooves in the record wiggle the needle. The needle wiggles one end of the crystal and the other end is tied down. Catch on?"

"Okay. Now what?"

"Just this. Most records are cut with a combination characteristic. That means the wiggles in the grooves are the same width up to a point and then they get narrower and narrower the rest of the way up."

"Why?"

"They cut them with a magnetic cutter. It wants to put out a constant velocity all the way. They don't let it because then the low notes would be so

wide the grooves would run into each other and they'd have to put less music on a disc. So they stop it at some crossover frequency and make it keep to that same width from there on down."

"Smart, aren't they?"

"Yeah. They can accommodate both magnetic and crystal pickups that way. But the magnetics lose 6 db per octave from the crossover on down, and the crystals lose 6 db per octave from the crossover up. The different manufacturers have different crossovers, but 500 cycles is a pretty fair average."

"So all you have to do is boost our highs from 500 cycles up? Then how come all the fuss? You've been driving me nuts with that record."

"Well, there's a little matter of arm resonance, too. There's a bump around 80 cycles that I'm trying to get out."

She looked at me hard. "Last week you were worried about a dip around 80 cycles. Now it's a bump. What's the deal?"

"That was on the speaker. The way our baffle is cut, we lose a bit there and . . ." I had caught the idea. "Say . . ."

Two wrongs make a right

I got busy with the iron then and took out the resonant tank I had been fooling with and clipped the meter onto the voice coil instead of the preamp. I started the record again, and the XYL groaned. Plotted up, it wasn't too bad. The bump didn't go beyond 2 db (Fig. 2). I left it at that.

It taught me a lesson: instead of having everything flat, just worry about the *over-all* response. It's often easier to equalize in one place than in another, and often faults will tend to compensate each other.

That same idea helped again later in a slightly different way. I wanted to get one of those nice expensive speakers, you know, with the high-frequency horn inside the 15-inch cone. Money was the only problem.

The best available as surplus was a bunch of smaller speakers. Pawing through them, I found two of those small accordion-edge jobs. They are awfully nice.

Neither handled a lot of power without distortion, but stacking two of them up in series gave the power I wanted and the impedance was better for my transformer. Plus that, the response was a lot smoother for two than either one by itself. Their resonant frequencies averaged 72 cycles, and there was a noticeable bump there. The speed of sound being approximately 1,050 feet per second, that makes one wave length about 14½ feet at 72 cycles.

A baffle will make a dip in the response where the distance from the front of the cone to the back is a half-wave length, because the air just pushes around there and not much sound will come out. If we make a baffle so that its dip comes just where the speaker-cone resonant point gives a bump, we balance one off against the other.

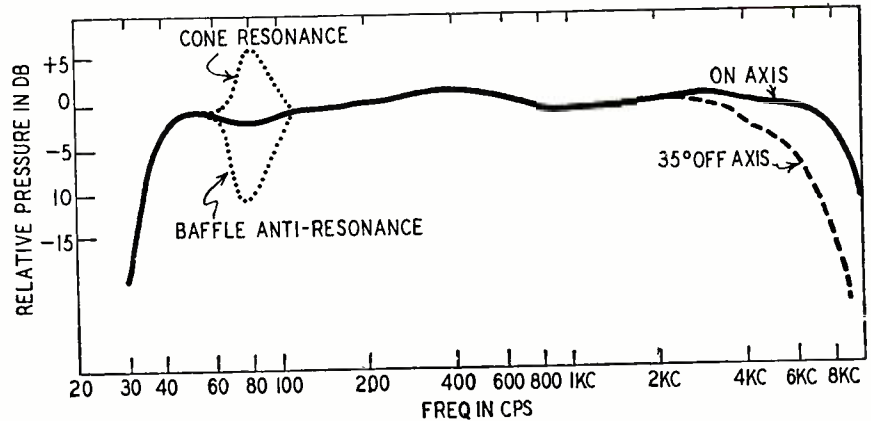

Fig. 3—The highs appear to drop off as the listener moves from in front of the speaker.

I cut a sheet of plywood so that each speaker was 3 feet 7½ inches in from the end and mounted it up against the corner of wall and ceiling so only the ends would affect the response. That way each speaker had a half-wave-length from front to back at about 72 cycles.

The curve I ran (Fig. 3) is not too reliable as it was run with a microphone of doubtful calibration. As far

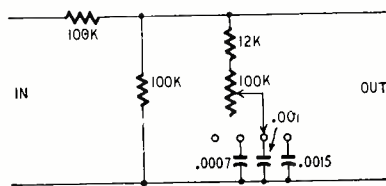

Fig. 4—Advanced high-cut tone control.

as the sound goes, it's just fine. Neither my ear nor the XYL's can hear any deviations from a flat response from 8 kc down to about 40 cycles. That means the curve is close to right, and there isn't more than about 3- or 4-db variation.

The speakers weren't up there longer than a day before the XYL had put little round circles of black paper

against the grill cloth. Later, my brother-in-law, a man of considerable imagination and talent, cut from paper the eyebrows, nose, etc., which he stuck up. The two circles, which appear even smaller because of the big baffle, actually are a pair of loudspeakers, and seem to work just as well as they did before the trimmings were added.

Now the XYL is working on me to figure out some way of making the pupils of the eyes roll up whenever she plays Bach.

¹ The big companies—Victor, Columbia, Decca, as well as some of the smaller ones—record a treble boost into their discs, too. They have done this for some time in their 16-inch transcriptions, but up to now the companies are not following any standard curve. It's nice in a way, because then you can crank down your standard tone control and eliminate a lot of scratch without losing too much of the highs. It has its bad points, though, because—without a standard—no single fixed equalizer can give more than approximate correction. For practical guys who do what they can with what they've got, the answer can be all the way from a standard high-cut tone control to the more elaborate setup shown in Fig. 4. This last gives ideal results for the experimenter who doesn't mind playing with knobs and it can be used almost anywhere in the circuit.

The potentiometer adjusts the amount of roll-off, while the switch selects the point where roll-off begins. Without the switch (which can be left out if your wants aren't so fancy) the circuit is just a standard tone control.

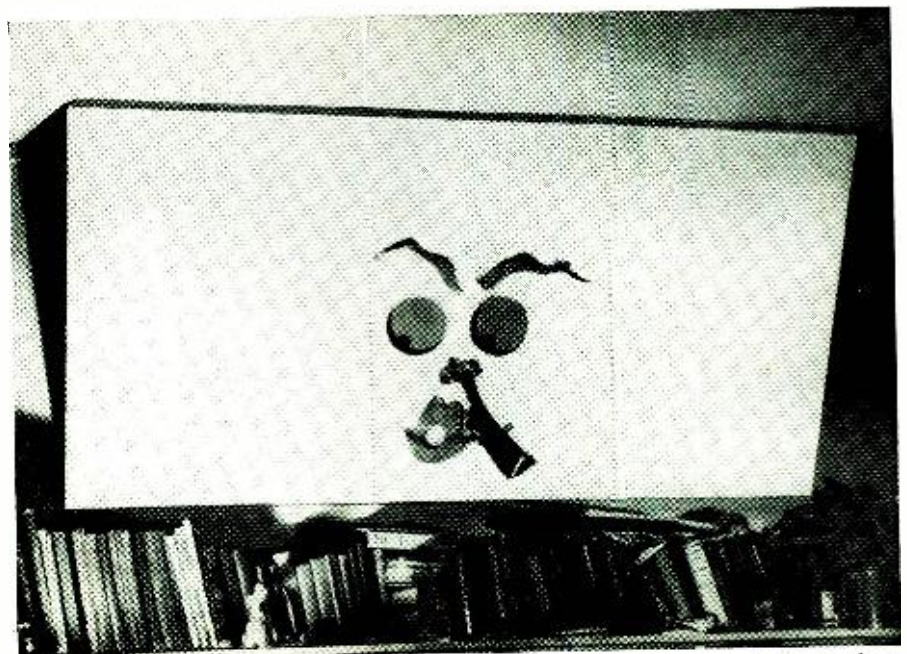

Note the novel decorations on the special baffle used to overcome resonance in the speakers.

Audio Impedance Matching

Part I—Theory governing connection of the speaker and amplifier

By
**WALTHER
RICHTER***

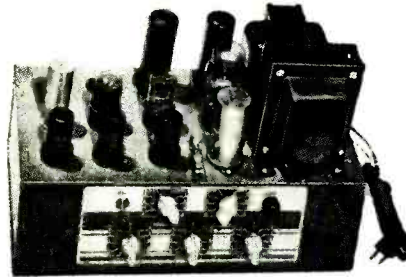

IN spite of the fact that a great deal has been written about impedance matching there is still confusion on the subject. The power engineer never uses the word, often has only a hazy idea about what is meant by it; while the communications man, in whose field the word was coined, may or may not have clearer understanding of its meaning.

An amplifier is a generator of alternating voltage of varying frequency

*Engineering and Development Dep't, Allis-Chalmers Mfg. Co.

and amplitude. The voltage of an ordinary 110-volt, 60-cycle power generator can also be varied by changing its field excitation, and its frequency can be changed by varying its speed. Since the amplifier and generator are fundamentally the same, we can start by comparing the methods of rating their outputs.

An ordinary a.c. generator is usually rated in volt-amperes and voltage; sometimes voltage and current are given, but in any case, with two of these three quantities given, the third can be calculated by Ohm's law. The three values determine a fourth one: the impedance which the load must have to draw the rated output. If the generator is supposed to deliver 550 volt-amperes at 110 volts, for instance, the impedance of the load must be 22 ohms ($Z = E^2/P$); for rated output it cannot

be larger or smaller. If it is 44 ohms instead of 22, the generator voltage of 110 will produce a current of only 2.5 amperes, resulting in 275 watts instead of 550.

Suppose now that the load has a resistance of 5.5 ohms, which is just one-quarter of the optimum value. Since the maximum safe current of the generator is only 5 amperes, we will have to reduce the generator voltage to 27.5 to keep the current to 5 amperes. The 27.5 volts and 5 amperes produce only 137.5 watts, one-quarter of the maximum power the generator can furnish.

If we wanted to have exactly 550 watts in a load of 5.5 ohms, the voltage and the current required are 55 volts and 10 amperes. A power engineer would unhesitatingly use a step-down transformer with a turns ratio of 2 to

(Continued on page 40)

A VERSATILE OSCILLATOR (Continued from page 38)

of the oscillator output. S2 switches this in and out of the circuit. Square waves are available only at the power output. The jack in parallel with the power-output terminals is mounted on the rear of the chassis for convenience under certain conditions.

R1 is a balance adjuster used to make the impedances of the two R-C tuned circuits approximately equal. To set it, watch the oscillator signal on an oscilloscope and adjust R1 for the best-looking sine wave. R1 is located on the chassis, since it seldom has to be adjusted after the initial setting.

R2, the feedback control, should be set initially to the point where the instrument just goes into oscillation at all frequencies. However, if R2 is advanced far enough to insure oscillation at the very highest and lowest frequencies, there will be too much feedback at other frequencies and the wave will be distorted. Therefore, when the highest and lowest frequencies are used,

readjust the feedback with the control on the front panel.

(The feedback control affects not only the point of oscillation and the wave form, as indicated, but also the frequency. If, at any time after initial calibration, the control is touched, the entire calibration will be destroyed. Unless accuracy is unimportant, use of the extreme frequencies had better be abandoned.—Editor)

The oscillator was built on a 17-inch chassis with a standard 19-inch rack panel. The frequency-control potentiometer used an ordinary 1-100 dial, and a calibration chart was made up. Other constructors may prefer to use a direct-reading dial; a National ACN or similar one is appropriate.

Note that several electrolytic capacitors are using for coupling. These are necessary to pass the unusually low frequencies generated. Be sure to observe the polarities shown in the diagram, remembering that the curved

plate of each capacitor symbol represents the negative or outside contact.

Any of the standard calibrating methods is suitable—use of another accurately marked oscillator or use of an oscilloscope and the a.c. line. The entire range can be calibrated by the latter method as outlined on page 52 of the October, 1948, RADIO-ELECTRONICS.

MATERIALS FOR OSCILLATOR

Resistors: 2—8,200, 1—47,000, 2—100,000, 1—470,000, 2—510,000 ohms, 1—2.2 megohms, 1/2 watt; 1—100, 1—500, 1—560, 1—820, 1—10,000, 1—47,000 ohms, 1 watt; 1—1,000, 1—8,500, 3—10,000 ohms, 10 watts; 1—1,000, 1—4,000, 1—5,000, 1—10,000-ohm potentiometers; 1—1-megohm dual potentiometer.
Capacitors: 2—10, 2—30, 2—300 μ f, mica; 2—.003, 2—.03, 4—0.1 μ f, 600 volts, paper; 1—0.5 μ f, paper; 1—16, 8—40 μ f, 450 volts, electrolytic.
Switches: 1—d.p.d.t., 2—s.p.s.t. toggles; 1—2-circuit, 5-position rotary.
Tubes: 3—6SJ7, 1—6SL7, 1—6V6, 1—5Y3-GT.
Miscellaneous: 2—6-watt, 117-volt incandescent lamps and sockets; 1—power transformer, 650 volts, center-tapped, 50 ma, 5 volts, 2 amperes, 6.3 volts, 4.5 amperes; 1—50-ma, 400-600-ohm filter choke; 6—octal tube sockets; 6—pin jacks; 1—single-circuit phone jack; 1—chassis and panel or cabinet; necessary hardware.

1. This will reduce the generator voltage from 110 to 55 volts but step up the current from 5 amperes on the 110-volt side to 10 amperes on the 55-volt side.

The communications engineer would do exactly the same thing, but he would call the device a *matching transformer*.

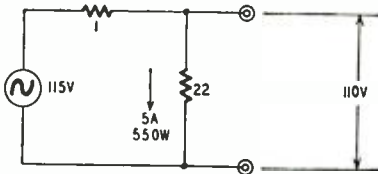

Fig. 1—A basic generator circuit with load.

He would describe the operation as "matching" the 5.5-ohm load to the generator, which must have a 22-ohm load for maximum output. Expressed a little differently, the matching transformer makes the 5.5-ohm load look to the generator like a 22-ohm load. Note that the apparent load impedance is increased 4 times by a transformer with a turns ratio of 2 to 1.

While the voltage change in a transformer is equal to the turns ratio, the impedance change is the *square* of the turns ratio.

For example, if we connect a 2-ohm load to the low-voltage side of a 10-1 step-down transformer and wish to obtain a current of 10 amperes through this load, there must be 20 volts across the load. This means that the primary voltage will have to be 10 times 20, or 200 volts, while the current taken by the primary winding will be 10/10, or 1 ampere. Since the primary side will take 1 ampere with 200 volts applied to it, it acts like a resistance of 200/1, or 200 ohms. The impedance change (100 to 1) is the square of the turns ratio (10 to 1).

Internal resistance

Every generator has an internal resistance or impedance. As a result, the output voltage usually begins to drop as soon as the generator furnishes a load current. Any actual generator can be considered a combination of a perfect generator (one without internal resistance) and, in series with it, a resistance or impedance.

In Figs. 1, 2, and 3 are three generators with different internal resistances, each one supplying 550 watts to a 22-ohm load. Which one of the three generators would you prefer? All three appear to be doing their jobs—furnishing 5 amperes at 110 volts to a load of 22 ohms. But if the load resistance should change, the terminal voltage of the generators will vary; this variation will be least in the generator with the 1-ohm internal resistance (Fig. 1). Disconnecting the load altogether, for instance, would make the open circuit voltages rise to 115 (Fig. 1), 135 (Fig. 2), and 160 volts (Fig. 3).

If the load consists permanently of a single device such as, for instance, a 22-ohm heating element, all three generators would be equally satisfactory. But if the load should consist of eleven

50-watt lamps in parallel (550 watts total), the rise of voltage when some are turned off will become serious in the second and third generators, while it might be tolerable in the first one.

This change of generator voltage with a change of load current or impedance, is usually referred to as *regulation*. For the reason given, the power engineer would like his generators or transformers to have as low a regulation figure as possible.

We said that, if the load consisted of a single piece of equipment (such as a 22-ohm heating element), all three generators would prove equally satisfactory. In most amplifiers the load consists of one or more loudspeakers permanently connected to the amplifier. It would appear that as long as an amplifier can furnish the desired power to the speakers, its internal resistance or regulation would not be important.

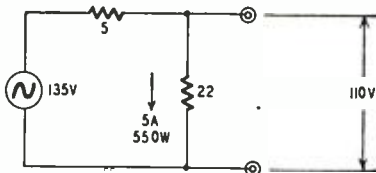

Fig. 2—A 135-volt generator is needed here.

Furthermore, loudspeakers do not have the same characteristics as lamps. A lamp is not much good if operated at half of its rated voltage and will not last very long when operated at twice its rated voltage. An 8-watt loudspeaker, however, usually loafs along on perhaps 2 watts, and will not burn out if the voltage across it should rise to several times normal.

There is, nevertheless, a very good reason why, even with a single loudspeaker as a permanent load, an amplifier with low internal resistance is preferable. This reason is the damping of the loudspeaker. Assume for a moment that the three generators shown in Figs. 1, 2, and 3 produce a single 1-second d.c. impulse. If the load is a loudspeaker connected directly to the generator, the voice coil will leave its neutral position while the voltage is applied and then will return to the neutral position.

When a generator ceases to produce voltage it acts like a short circuit. The movement of the voice coil in returning to the neutral position generates a voltage, since it moves in a magnetic field, and this voltage produces a current whose value is determined by the resistances of the voice coil and generator. This current has a braking effect, similar to the "dynamic braking" found in d.c. motors.

The voice coil will return to its neutral position most smoothly—with the least "hangover" effect—when this braking current is large. Obviously, low internal generator resistance is a step in the right direction. If it can be reduced to zero, the total resistance in the circuit will be only that of the voice coil itself, which cannot be eliminated.

What is the usual internal resistance

of an amplifier? When the amplifier uses a triode or triodes in the output stage and the designer has followed the recommendations of the manufacturer, which are usually to make the load resistance twice the plate resistance of the tube, the load will be looking back into a resistance half its value. The output transformer does not change this. Therefore, if the transformer is designed to operate an 8-ohm secondary load and if the amplifier uses triodes in the output stage, the 8-ohm load will be looking back into a resistance of approximately 4 ohms.

If the output stage has pentodes, on the other hand, the load looks back into an extremely high plate resistance. This is one of the reasons why straight pentode amplifiers do not give as clean-cut results as triodes.

A generator with inherently poor regulation (large internal resistance) can still be used satisfactorily with a varying load if we put a voltage regulator in it. A voltage regulator reduces the apparent internal resistance of the generator; if the terminal voltage of the generator does not change appreciably when the load is varied, it looks to the load as if the generator had an insignificantly small internal resistance.

The communications engineer can also put a voltage regulator on his amplifier, and he does so with a vengeance. He is, in fact, way ahead of his brother in the power field, since he not only keeps the output voltage constant but keeps it in the exact form of the signal applied to the input terminals. In other words, he regulates the output

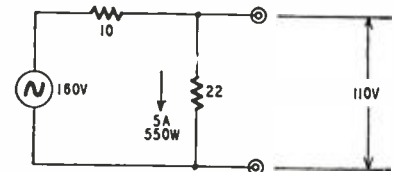

Fig. 3—Internal resistance is much too high.

voltage continually in accordance with the input signal. He calls this trick *negative feedback*. The apparent internal resistance of a pentode amplifier can be brought down to values even lower than those of a triode amplifier without feedback; and when applied to triode amplifiers, apparent internal resistances of only 5% of the load resistance have been achieved. (In the case of one recently constructed amplifier, the 20-ohm load looks back into 0.35 ohms, or 1.75%). Such an amplifier, as far as regulation is concerned, begins to compete with the generators found in our power houses!

Whenever high-fidelity reproduction is desired or a number of speakers are installed, with possible mismatches, this damping question is important.

In the next article of this series we will apply this information to practical examples, showing how to match any combination of speakers to a given amplifier output.

All-Round Sig Tracer For Shop or Outside



SIGNAL tracing has for some years been the accepted method of quick, mass-output trouble shooting in radio receivers. The radio technician prefers to use it to localize defects quickly. Then he may apply other equipment to discover the defective part or incorrect condition.

There have been two trends in signal tracer design. One is toward a highly sensitive, accurately tuned type, usually with multiple inputs. The other is a simple untuned type with wide-band resistance-coupled amplification if more than one tube is used.

Both types have their advantages and disadvantages. The multi-channel tuned type can substitute complete r.f., oscillator, or i.f.-amplifier sections for defective ones in a radio undergoing test. This makes possible a search for secondary defects which would otherwise be masked by a primary fault, itself bad enough to prevent the receiver from working.

Because of its tuned circuits, it may be used for rapid checks on alignment. Its sensitivity makes it useful even in rural service shops far from powerful broadcast stations. It is especially helpful in finding intermittents because of its multichannel feature. The receiver is entered at a number of places with clip-leads and left to play until it cuts off. Visual indicators, usually electron-ray tubes, then show where the intermittent-producing part is located.

The argument for the simple, untuned signal tracer is speed. No elaborate set-up and no tuning is required. Results are indicated unmistakably and immediately on an indicator tube or meter or by headphones. An equally powerful argument in its favor is low cost. The multiple-circuit signal analyzers tend to be large, complex, and expensive.

Since one of the most important uses of the signal tracer is quick troubleshooting, the untuned tracer is by far the more popular type. Its economic availability is of course also an important reason for its wider use.

Many servicemen have used the simplest possible type—a one-tube outfit with a pair of phones or other indicator. A typical one—the Superior CA-11—was described in this magazine in April, 1946. It had the great advantage of combining visual and aural signal checking, instead of depending on either

an electron-ray tube or a pair of phones. The visual indicator was a meter (calibrated in arbitrary units) which made it possible not only to discover the existence of a signal, but to check gain roughly from stage to stage. At the same time the headphones could be used to determine the quality of the signal.

The little CA-11 was a very convenient, low-priced unit, and became very popular. Its success led its manufacturers to put out another model, which could correctly be called an enlargement rather than an improvement of the CA-11. The CA-12 adds a 3S4 to the earlier model and provides a loud-speaker for the serviceman's convenience. The phone jack remains, and the phones cut the speaker out when they are plugged in. This may often be an advantage, either in an exceptionally noisy shop or in the quiet of a customer's home.

The meter, of a rugged type designed for portable use, is connected as in the older tracer. This connection into the circuit is interesting. The 1T4 probe tube is operated as a grid-leak detector; therefore, plate current goes down, not up, when a signal is received. So the meter is connected into the plate circuit *in reverse*, and the pointer brought to zero with the familiar bucking-current technique, in which plate current and bucking current are balanced. When a signal causes plate current to drop, the bucking current produces a proportionate reading on the meter.

Constants of the probe grid circuit are such that the meter remains sensitive from about 10 mc down to low

audio frequencies. It cuts off rather sharply at about 150 cycles so that 60-cycle hum voltages do not mask out other phenomena which may be under observation.

The triode connection of the 1T4 probe tube, in contrast to many v.t.v.m. probes which have a diode-connected tube or even a crystal probe, was one of the secrets of the success of the old CA-11, and is equally useful in the new tracer. The screen and plate are tied together, and the probe tip is led to the grid of the tube. Normal voltage is applied to the plate. Sensitivity is therefore greatly increased over the diode-probe type of tracer. The grid capacitor of 200 μf and leak of 20 megohms were selected to provide a desirable frequency response, as explained in the previous paragraph.

The 3S4 provides a beautiful signal boost for locations where broadcast stations may be weak, and for antenna and loop tests. It is connected as a standard audio amplifier, with a resistance of 50,000 ohms in the probe tube's plate circuit, a coupling capacitor of .025 μf , and the grid attached to the moving arm of a 500,000-ohm potentiometer, which serves as the attenuator or volume control.

The CA-12, like the CA-11, is completely battery-operated, with two 45-volt units and a single large A-cell. This makes it equally effective for bench or outside use. It is in outside work, in fact, that the CA-12 is most likely to show its advantages, its greater sensitivity assuring successful operation even in the worst receiving locations the out-of-the-shop repairman is likely to find.

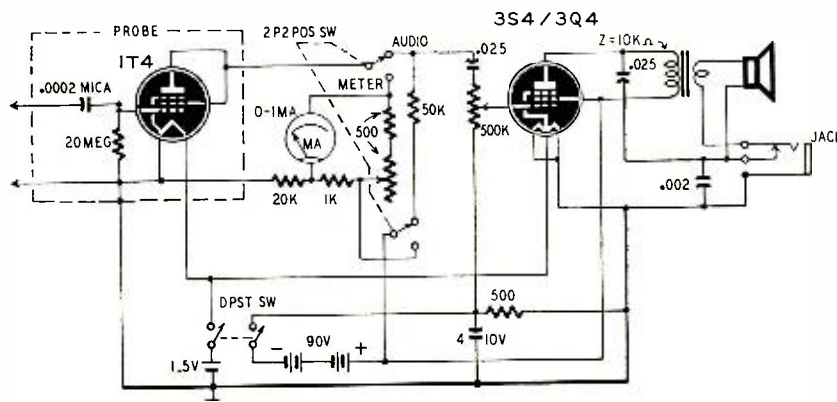

Schematic of the Superior CA-12. This is essentially the CA-11 with an audio stage added.

Sweep Generators Service FM and TV

By JESSE DILSON*

WITH FM and television claiming the attention of the progressive serviceman, the sweep-frequency signal generator assumes the number one spot in any list of necessary test equipment. Used in conjunction with the oscilloscope, it is indispensable for rapid alignment of r.f., i.f., and discriminator stages in FM and TV receivers. To use it intelligently, the radioman must understand how it works.

The sweep generator is an FM transmitter in miniature, just as the ordinary amplitude-modulated signal generator is a replica of an AM transmitter. It puts out a carrier of constant amplitude. When modulation is applied, the frequency of the carrier is automatically varied above and below the center frequency.

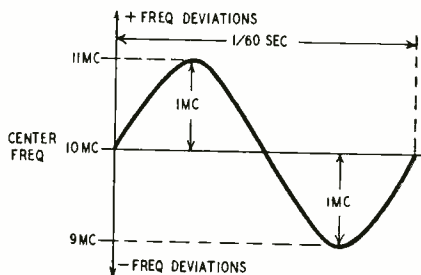

Fig. 1—A 10-mc signal with 2-mc bandwidth.

The carrier is so modulated that its maximum deviation above the center frequency (positive deviation) is exactly equal to its maximum deviation below the center frequency (negative deviation). Consequently, the total deviation or *sweep* is twice the amount of either maximum positive or maximum negative deviation. The rate at which the frequency varies is known as the

sweep frequency, and, in most instruments, is 60 cycles.

A simple example will clarify the meanings of these terms. Suppose an oscillator puts out a 10-mc signal. If the frequency is made to rise to 11 mc, drop back to 10 mc, drop further back to 9 mc, and rise again to 10 mc, it will have swept one complete cycle. If 60 of these complete cycles are made in one second, then the sweep frequency is 60 cycles per second, the center frequency of the generator is 10 mc, its maximum positive and maximum negative frequency deviations are 1 mc each, and its sweep width is 2 mc. Fig. 1 shows this graphically.

The circuit which does this trick of varying the frequency of an oscillator in accordance with a 60-cycle modulating voltage is the reactance modulator. A simple setup could consist of a reactance modulator and an oscillator which would feed into an attenuator and thence to the output, as in Fig. 2-a.

While this arrangement has the merit of simplicity, it has too many drawbacks to be a useful instrument. For one thing, the oscillator frequency must be continuously variable and must be stable over the tremendous range of frequencies demanded by FM and television alignment. Also (and very important) the percentage modulation of the output signal should be reasonably constant over that range.

To obtain these benefits economically, the heterodyne method, as shown in the block diagram of Fig. 2-b, is used. The reactance modulator works on a *fixed-frequency* oscillator. This means that deviation is constant. Because the output frequency of the mixer is equal to the sum and difference of the input frequencies (the fixed and variable oscillators) use of standard, stable circuits to cover wide ranges is possible.

For example, if the fixed oscillator puts out 20 mc, and the variable oscillator is set at 30 mc, frequencies of 10 mc and 50 mc are obtained.

The modulating voltage is 60 cycles, obtained from the instrument's power supply. (Only the more expensive generators use other modulation frequencies, such as 400 cycles. Obviously a separate 400-cycle oscillator is then necessary.)

Fig. 3 shows a commonly used method of modulation. Tube V1 is the reactance modulator. Note that the voltage-divider network R1-R2 is across one half of the high-voltage secondary of the power transformer. R1 is chosen to give about 10 volts to the grid when the slider is at the R2 end of R1. The line voltage is varying at a 60-cycle rate; therefore the voltage fed to the grid of the reactance tube will be of the same frequency.

The resistance of R4 is very small compared with the reactance of C1 at the oscillator frequency. The series combination R4-C1 is therefore predominantly capacitive, and the current (I) through it leads the applied oscillator voltage (E_o) by approximately 90

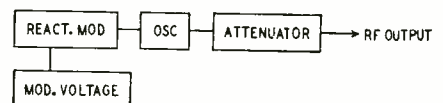

Fig. 2-a—A simple type of sweep generator.

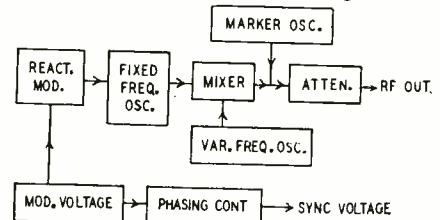

Fig. 2-b—A heterodyne type of FM generator.

*Instructor, Hudson Technical Institute, Union City, N. J.

degrees. This current flowing through R4 produces a grid voltage. Therefore, the grid voltage E_g , in phase with I, produces a plate current 90 degrees ahead of E_g . If the current through a tube is 90 degrees ahead of the voltage across it, the tube is acting as capacitance.

Because the voltage on the grid is varying at a 60-cycle rate, the current through the tube is also varying at a 60-cycle rate. The effective capacitance of the reactance modulator, which depends on the magnitude of the plate current, is likewise varying at a 60-cycle rate. The effective capacitance placed across the tank circuit of the oscillator causes the oscillator frequency, also, to vary at a 60-cycle rate.

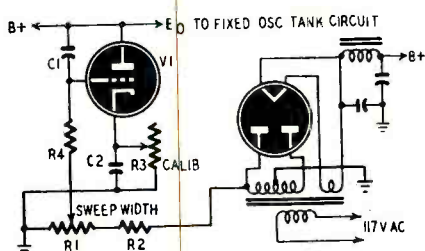

Fig. 3—A capacitive reactance-tube circuit.

The peak-to-peak value of the voltage on the grid of the reactance tube determines the extent of the oscillator's frequency swing above and below the center frequency. R1 is therefore the sweep-width control, and is brought out to the front panel.

R3 and C2 form a conventional cathode-bias arrangement. R3 allows a variable d.c. voltage to be placed on the grid of the reactance modulator to correct the calibration of the fixed oscillator. Changes in voltage on the grid of the modulator are translated into changes in frequency of the oscillator. In some sweep generators, C1 is made variable for this purpose. The control (R3 or C1) is not brought out to the front panel, but is inside the case. It is set by the manufacturer during calibration.

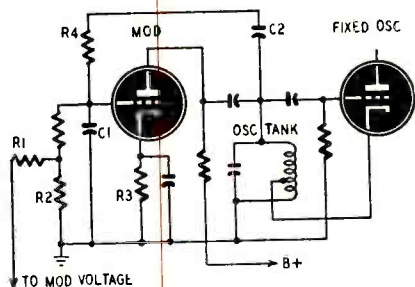

Fig. 4—An inductive reactance-tube circuit.

Another type of reactance modulator used in some instruments is shown in Fig. 4. As before, R1 and R2 form a voltage divider to place only a part of the available modulating voltage on the grid of the modulator. Since the reactance of C2 is low for the oscillator frequency, the top of R4 is at virtually the same r.f. potential as the top of the oscillator tank. With C1 connected from

grid to ground, the modulator of Fig. 4 is the reverse of that of Fig. 3, which has the condenser from plate to grid, and the resistor from grid to ground. R4 is large compared with the reactance of C1; therefore the circuit is largely resistive. The current I through the R4-C1 combination is therefore in phase with the oscillator voltage E_o . Since current through a capacitor leads the voltage across it, the voltage across C1 (which is the tube's grid excitation) lags I and E_o , and causes the plate current to do the same. With the plate current lagging the voltage of the oscillator tank across which it is connected, the tube acts as an inductance.

The fixed-frequency oscillator (Fig. 2-b) is usually a conventional electron-coupled Hartley. It is fixed in the sense that it cannot be varied by a front-panel control; but the variable reactance of the modulator is an effective part of the tank circuit, hence the output of the oscillator is varied in frequency over the sweep-frequency range. A crystal oscillator cannot be used, its output frequency being too tightly held to sweep freely.

The variable oscillator is usually electron-coupled, and its tank condenser is varied by a front-panel knob—the center-frequency control. The outputs of the fixed and the variable oscillators are fed into the mixer stage. The output voltages are developed across cathode resistors, as shown in Fig. 5, to

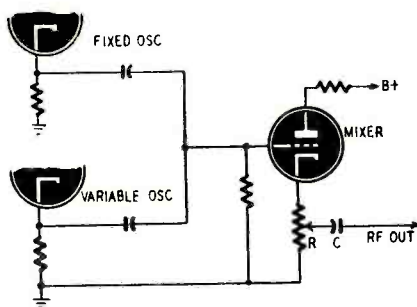

Fig. 5—A typical FM generator mixer circuit.

avoid affecting oscillator stability. The same method is used to obtain the mixer output, with R acting as a simple attenuator and C as a blocking capacitor.

Because of the heterodyning of the two input frequencies, the output of the mixer contains four fundamental frequencies: the fixed-oscillator frequency, the variable-oscillator frequency, the sum of the two, and the difference between the two. The sum, difference, and fixed frequencies are modulated by the reactance tube. The particular frequency to be used is chosen by the tuned circuits of the receiver.

A glance at the block diagram of Fig. 2-b will show that a synchronizing voltage, derived from the 60-cycle source which modulates the reactance tube, is supplied by the instrument. This voltage may be obtained either through a cable or from connectors on the generator panel, depending on the particular model.

In alignment, the synchronizing voltage is placed on the horizontal input terminals of the oscilloscope and the output of the circuit under test is placed on the vertical terminals. For example, in the alignment of i.f. stages of an FM receiver, the voltage across the limiter grid leak is placed on the oscilloscope's vertical terminals while the r.f. output of the generator, set at the i.f. center frequency, is placed on the receiver's mixer grid. The synchronizing voltage is connected to the horizontal terminals. The stationary image appearing on the oscilloscope screen represents the response curve of the i.f. stages.

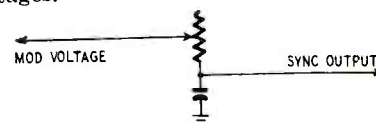

Fig. 6—A phasing control for sync output.

With a great deal of labor, this response curve could be constructed on graph paper by plotting i.f. voltage output against frequency input, using an ordinary signal generator and output meter. The sweep generator-oscilloscope arrangement does it *automatically*. The synchronizing voltage automatically points off the frequencies swept through on the x-axis, while the limiter grid voltage points off the voltage response at these frequencies on the y-axis.

Between the 60-cycle sync voltage and its output cable or terminals is the phasing control (Fig. 6). This is a simple R-C phase-shifting network designed to improve the trace obtained on the oscilloscope screen. Because of slight phase-shifting effects in the circuit under test, a double-traced curve, as in Fig. 7-a, may be observed. Proper adjustment of the phasing control blends the two traces into a single one, as shown in Fig. 7-b.

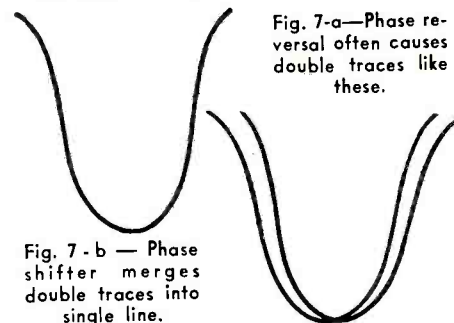

Fig. 7-a—Phase reversal often causes double traces like these.

Fig. 7-b — Phase shifter merges double traces into single line.

The marker generator's oscillators are usually Pierce or tritet crystal oscillators with 1-, 2-, or 5-mc crystals. They place a small pip on the oscilloscope trace to identify certain frequencies. Thus, if the generator uses a 5-mc marker, a slight wiggle appearing on the trace will identify that point as either 5 mc or some harmonic of 5 mc. If two pips appear on a single image, as they might on the picture of a television i.f. response curve, then the horizontal distance between them represents 5 mc.

Two Capacitor Testers

Many elusive receiver faults are due to leaky capacitors. Identifying the culprits is easy with these checkers

By R. L. PARMENTER



This checker tests electrolytics.

THE two test instruments described in this article are valuable to the serviceman because faulty capacitors cause many receiver failures. The first device is a leakage tester for all types of capacitors. The second tests electrolytics only, but the test gives more accurate results, since a meter shows actual leakage current.

The tester diagrammed in Fig. 1 tests mica and paper capacitors by making them part of a relaxation oscillator. The high voltage is provided by a standard power transformer (any unit with a secondary up to 600 volts is appropriate) and a 6V6-GT grid-controlled rectifier. The 270,000-ohm resistor and the 2-megohm potentiometer form a voltage divider, with most of the voltage across the potentiometer. The moving arm selects any desired voltage, varying the bias on the tube, the current through it, and therefore the output supply voltage. This is desirable so that each capacitor tested can be judged under full rated voltage conditions.

When the rotary selector switch is in the MICA-PAPER position, the 0.1- μ f capacitor is in parallel with the neon lamp and the test capacitor is in series with the combination and the power supply. The 33,000-ohm resistor limits maximum current through the lamp in case the test capacitor is shorted. The circuit is that of a standard relaxation oscillator, with the test capacitor taking the place of the usual series resistor.

If the leakage resistance of the test

capacitor is very high, as it should be in a good unit, the neon lamp will flash at very long intervals. With lower values of leakage resistance, the lamp will blink more rapidly. After a little experience and a few tests with some capacitors known to be good or leaky, the owner will be able to judge very quickly the condition of a given capacitor.

When the switch is in the ELECTROLYTIC position, the 27,000-ohm resistor is placed in parallel with the lamp and its protective resistor, and the electrolytic capacitor under test is in series with this combination and the supply. The resistor and the resistance of the capacitor are effectively a voltage divider. If the capacitor leakage is high, enough voltage will be built up across the resistor to ionize the lamp in parallel with it. Electrolytics which have

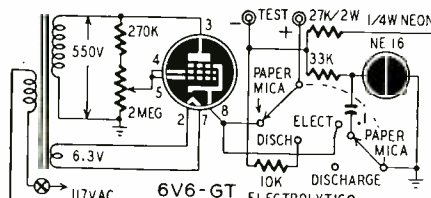

Fig. 1—Dual tester is relaxation oscillator.

been on the shelf for some time may need to be re-formed, so the lamp may light initially and stay on for a short time. So long as it goes out eventually the capacitor can be assumed to be in usable condition.

As the photo shows, the instrument

is built in a homemade wooden box with a Masonite sloping front panel.

The 2-megohm potentiometer scale can be calibrated in volts with a vacuum-tube voltmeter (do not use a low-resistance voltmeter). Connect the voltmeter between the 6V6-GT cathode and ground, and mark the dial scale with the voltages read.

Electrolytic leakage tester

The instrument of Fig. 2 measures the leakage current of electrolytic capacitors. The power-supply filter in-



Inside view of instrument diagrammed at left.
RADIO-ELECTRONICS for

cludes series resistors instead of chokes, which limit maximum current through the milliammeter when a shorted capacitor is connected to the test terminals.

The taps on the 60,000-ohm bleeder provide several test voltages to be applied to various capacitors. They can be set with a high-resistance voltmeter. To approximate usual capacitor tests, the voltages may be set approximately 10% higher than shown, since the normal leakage through most capacitors will lower the voltage somewhat.

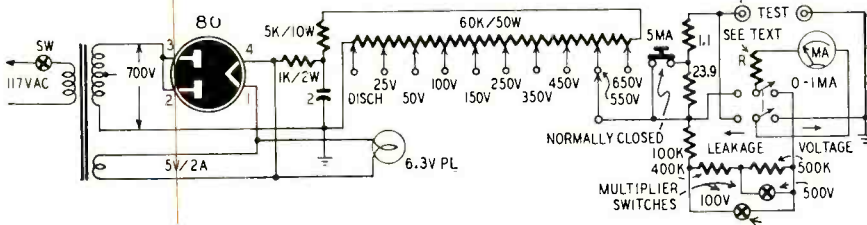
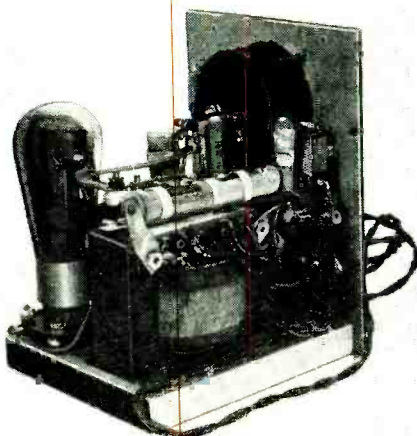

Fig. 2—Electrolytic tester shows capacitor leakage in milliamperes on front-panel meter.

The LEAKAGE-VOLTAGE switch allows the 0-1-ma meter to measure either leakage current through the test capacitor or the voltage across it. With the switch in the VOLTAGE position, current from the selected bleeder tap goes through 100,000-, 400,000-, and 500,000-ohm multipliers. Closing either of the push-button multiplier switches gives the ranges of 100 or 500 volts, as indicated in the diagram. With both switches open, the range is 1,000 volts.

The 1.1- and 23.9-ohm resistors are shunts to give the meter ranges of 100 and 5 ma. With the 5-ma push-button switch closed (in normal position) the range is 100 ma. If leakage current is initially read as less than 5 ma, the button is pushed, the switch opens, and the meter range becomes 5 ma for more accurate reading.



An interior photo of the electrolytic tester.

For ease in calculating shunts, the total resistance of the meter was increased to 100 ohms. If the resistance of the meter itself is not known, it can be measured by the method indicated in Fig. 3. Do not place it across an ohmmeter. Start with the 150-ohm potentiometer out of the circuit and the 2,000-ohm one set for maximum resistance. Adjust the 2,000-ohm poten-

tiometer for exactly full-scale meter reading. Then connect the 150-ohm potentiometer as shown and adjust it for exactly half-scale meter reading. Disconnect it and measure its resistance on an ohmmeter. This will be the resistance of the meter. The value of R in Fig. 2 is the difference between the meter resistance and 100 ohms. The two shunts (as well as R) can be either purchased or wound with resistance wire.

The effects of the shunts and multi-

pliers can be checked against a multi-meter. If no 60,000-ohm resistor is available for the bleeder, use one 50,000- and one 10,000-ohm resistor.

To test a capacitor, set the toggle switch to VOLTAGE and the selector to DISCH. Connect the capacitor to the ter-

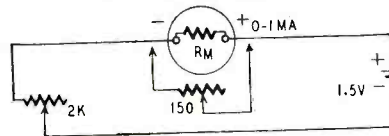

Fig. 3—Circuit for finding meter resistance.

minals and select the desired test voltage. Read the actual voltage across the capacitor, then switch to LEAKAGE and read the current through the capacitor. If this is less than 5 ma, push the 5-MA button for a more accurate reading. If the current drops slowly, allow time for the capacitor to re-form.

Before disconnecting it from the terminals, return the toggle switch to VOLTAGE and the selector to DISCH.

As an indication of the condition of a capacitor, a leakage current of 2 ma



Dual checker has sloping front and a handle.

for each 8 μ f is about the maximum allowable.

CAPACITOR CHECKER PARTS LIST—Fig. 1

- Resistors: 1—10,000, 1—33,000, 1—270,000 ohms, 1 watt; 1—27,000 ohms, 2 watts; 1—2-megohm potentiometer.
- Miscellaneous: 1—0.1- μ f, 400-volt, paper capacitor; 1—power transformer, secondary voltages 550 and 6.3; 1—2-circuit, 3-position rotary, 1—s.p.s.t. toggle switches; 1—6V6-GT and octal socket; 1—NE-16 neon lamp and socket; 2—binding posts, insulated; 1—chassis and cabinet; necessary hardware.

MATERIALS FOR ELECTROLYTIC LEAKAGE TESTER—Fig. 2

- Resistors: 1—100,000, 1—400,000, 1—500,000 ohms, 1 watt; 1—1,000, 1—5,000 ohms, 2 watts; 1—65,000 ohms, 50 watts; 1—23.9-ohm, 1—1.1 ohm meter shunts.
- Switches: 1—s.p.s.t. toggle, 1—single-circuit, 10-position rotary, 1—normally closed s.p.s.t. push button, 2—normally open s.p.s.t. push button, 1—d.p.d.t. toggle.
- Miscellaneous: 1—80 tube and socket; 1—6.3-volt pilot-light assembly; 1—2- μ f, 600-volt, paper capacitor; 1—power transformer, secondary voltages 700 and 5; 2—binding posts; 1—0-1-ma meter; 1—cabinet; necessary hardware.

CALIBRATED LECHER WIRES

A much-needed article for the v.h.f. experimenter and ham is the recently-announced DeciMeter Slipstick. This is a sturdy, accurate Lecher-wire system made by DeciMeter, Inc., of Denver. It can measure frequencies in the range of 90-3,000 mc with an accuracy better than 2%, and the scale is calibrated directly in megacycles.

The slipstick operates like a slide rule. The two silver-plated outer conductors have polystyrene insulation at the ends. The shorting bar and calibrated scale slide in and out, so that the device is

effective over a wide band of frequencies but becomes compact enough to be put away conveniently.

To measure frequency, the square end of the slipstick is coupled to an oscillator, transmitter, or receiver and the scale is drawn in or out. At resonance there will be a fluctuation of grid or plate current, reduction of volume, etc., at the circuit being measured. At very high frequencies there will be more than one indication (every half-wave length). The correct reading is the highest one.

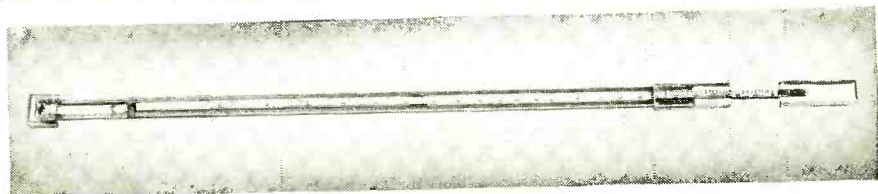

A Simple Electronic Flash Gun



Synchronizing the flash gun is made easy by using a metal lens board.

Your flash bulb worries are ended when you construct this simplified electronic flash gun from components that can be purchased on the surplus market.

By LYMAN E. GREENLEE

A SPEEDLIGHT that compares favorably with the best of the factory-built units can be built from surplus parts for about \$35. Its construction is not difficult, and anyone who can use a soldering iron should have little trouble in getting it to work.

The power unit is built in a standard steel cabinet, 12 x 7 $\frac{3}{4}$ x 7 inches. All the parts are mounted directly to the front panel as shown in the interior photograph. It is easy to locate the required holes by placing the parts themselves in position and tracing their outline with a lead pencil.

The voltage is dangerous to life, and no part of the circuit should be touched when the current is on. Since large capacitors will carry a dangerous charge for several hours if the bleeder should open, it is advisable to let the unit stand overnight before removing it from the case for servicing. Then the capacitors should be carefully shorted with a piece of heavy wire before working on the unit. They should *never* be shorted when fully charged; it may damage the capacitors and result in serious injury to the constructor. Use 3,000-volt ignition wire for all high-voltage connections.

The positive side of the circuit is

grounded to the case. The electrolytic capacitor has the outside foil connection marked, and this connection should also be grounded to the case. Oil-filled condensers have no polarity; therefore either side can be grounded.

A small piece of Lucite was drilled for a mounting to support the resistors. It fastens to the power transformer as shown in the photograph at the bottom of page 49. The rectifier socket is supported on two 6-32 screws to allow about an inch of space below the metal panel. Because one side of the filament is grounded, an ordinary bakelite wafer socket is suitable. Note that two connections go to the power line from the six-prong output socket. A shorting bus in the plug completes the power circuit and prevents the capacitors from being charged if the camera unit is disconnected.

Since a very heavy current is required for discharge of the light, all wiring should be carefully soldered and the wires carrying the discharge voltage should be No. 18 or larger. If no modeling light is wanted, the red wire may be omitted and a five-prong socket used for the output connection.

The camera unit used with the author's power supply is a war surplus vehicular signal unit which contains

the parts shown in the diagram, with the exception of the synchronizer outlet and the 8- μ f condenser.

The reflector was obtained from an old automobile headlight. The center hole was enlarged, and the reflector sol-

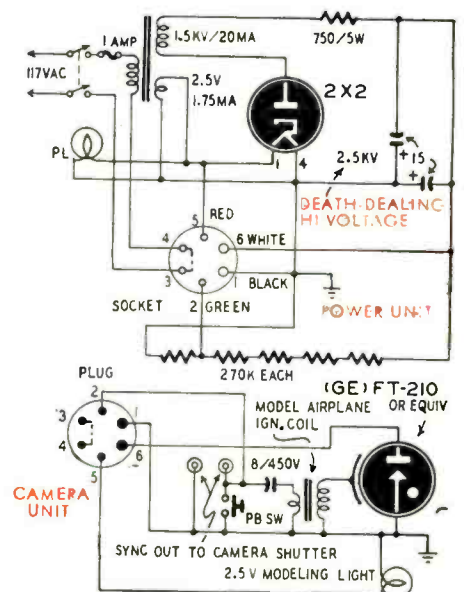

Well-insulated cable connects the two units.

RADIO-ELECTRONICS for

Electronic Timing Circuits

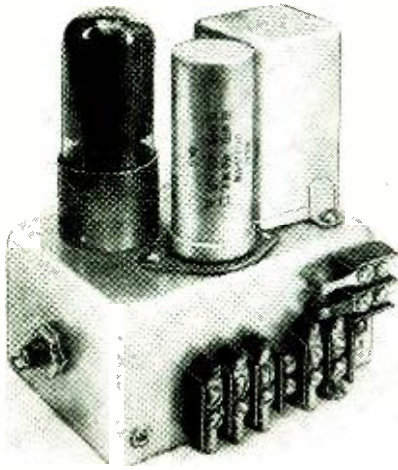

This special timer controls model railroads.

ELECTRONIC timing devices can be made very easily with resistance-capacitance discharge circuits controlling the grid bias of a vacuum tube which has a relay in its plate circuit.

A charged capacitor will dissipate most of its charge in approximately $R \times C$ seconds through a parallel resistance. For example, a charged $4\text{-}\mu\text{f}$ capacitor will discharge through a 10-megohm resistor in $.000004 \times 10,000,000 = 40$ seconds. (A simpler method is to take C in microfarads and R in megohms: $10 \times 4 = 40$.—*Editor*)

Assume that a capacitor connected between the grid and cathode of a vacuum tube is charged with a voltage great enough to cut off the plate cur-

*Crystal Devices Co.

Time delay is based on discharge of a capacitor

By NORMAN L. CHALFIN *

rent of the tube. If a resistor is shunted across it, the capacitor discharges through the resistance until enough of the charge is dissipated so plate current will flow again. If there is a relay in the plate circuit it will open when plate current cuts off (because of the charged capacitor) and close when the capacitor has charged and plate current flows again.

To apply this principle we require a tube, a source of power, and a capacitor-charging voltage. At first thought this may seem a lot of equipment, but it comes down to a simple one-tube device, most of the parts coming from the junk-box. We used the 117P7, a pentode power amplifier and high-voltage rectifier in one envelope. The 117L7 and 117N7 may be used in the same way.



Fig. 2—A switch like this is used for control.

The unit built is shown in the photograph. It was made for use with a special external circuit for controlling model trains and does not have a built-in control button. The relay contacts and the a.c. line connections are brought out to screw terminals, and the time (maximum of 10 seconds) is varied with a 10-megohm potentiometer.

A photo timer

A more practical device for most constructors is shown in Fig. 1. It is an electronic photo timer for use in the darkroom. It has receptacles into which a safelight and a printing lamp may be plugged. Normally the safelight is on, but the printing lamp may be turned on for any predetermined interval up to 110 seconds.

The amplifier section of the tube is operated at approximately half the B-supply voltage. The rectifier section has a voltage divider (R_1 - R_2) across it so that the amplifier may use the positive voltage of R_2 . R_1 provides the negative charging voltage for the $4\text{-}\mu\text{f}$ capacitor. The push button has a spring return to the normal position, in which it is shown. In case a suitable push button is not obtainable, you can make your own with relay contact blades, as shown in Fig. 2. A s.p.d.t. toggle switch could be used, but the operator would always have to remember to bring it back to the upper position.

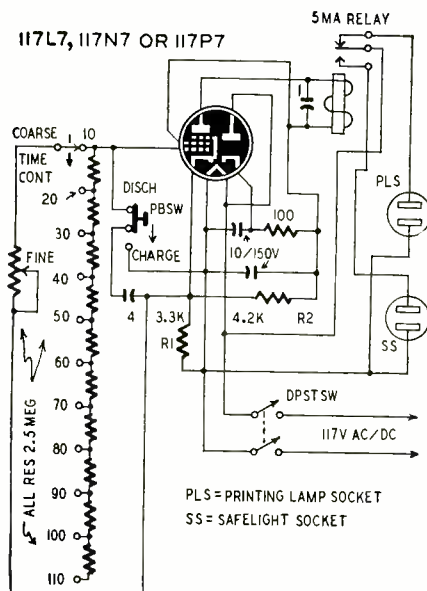

Fig. 1—Circuit of the electronic photo timer.

When the button is pressed, the $4\text{-}\mu\text{f}$ capacitor receives a negative charge from the negative side of the B-supply. When it is released, the capacitor discharges through the switched resistor network, which is in two sections. One 10-position step switch with resistances of the same value in series, controls the time in 10-second steps. The selector arm of the switch is connected to a variable resistance of the same value as the fixed units on the switch. This is a vernier control to provide fine time adjustments. The maximum time is 110 seconds. If you use some other capacitor value than $4\text{-}\mu\text{f}$, you will have to use different resistance values, in accordance with the formula: time = capacitance times resistance. Except that the capacitor must be a paper unit with very little leakage, no special precautions are necessary in construction. The relay should be of the sensitive type, with a pull-in current of about 5 ma.

Operation of the timer is simple. Female power outlets are built into the case, one for the safelight and another for the printing lamp. When the power switch is turned on, the printing lamp will go on momentarily, until the tube warms up. Then the safelight will go on and the printing lamp will go off.

Set the desired exposure time on the selector dials. Set up the paper and negative. Press the button. When it is released, the printing lamp will light and remain on for the desired time interval before the safelight relights.

A reciprocator circuit

Fig. 3 shows the same type of time-delay circuit used as an interrupter or reciprocator.

After the unit is turned on and al-

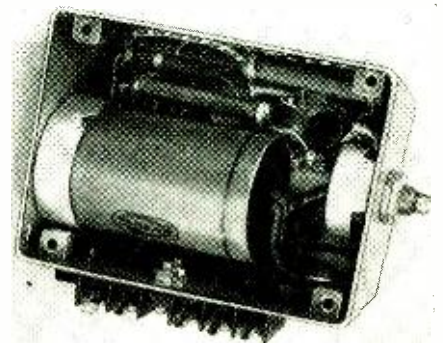

Under-chassis view of the model-train timer.

lowed to warm up, the 4- μ f capacitor is uncharged, and plate current flows, pulling in the relay armature. The top of the capacitor (and the grid of the tube) is then connected through the relay contacts to the negative charging voltage through R_{ch} . This potentiometer controls the time required for the capacitor to charge.

After a certain interval the capacitor will have become sufficiently charged to cut off the tube, and the relay will open. Now the 4- μ f capacitor is shunted by R_{dis} , the familiar shunt discharging resistor. After a time, the capacitor will be discharged and plate current will flow again, pulling in the relay and beginning a new cycle of open-and-close relay operation.

This opening and closing of the relay will continue indefinitely, the time for each action being controlled by the setting of the appropriate potentiometer. The free relay contacts may be used to control blinking lights or any other external circuit. The writer used one of these reciprocators continuously for many months to control a crystal-testing sequence stepper.

(Simple arithmetic may not actually give an accurate indication of the on and off times for the relay in either the

photo timer or the reciprocator. $R \times C$ gives the time required for the capacitor to charge up to about 63% of the applied voltage or for the capacitor charge to decay to about 37% of its original value. These voltages almost certainly will not coincide with the values of grid bias necessary to open and close the relay. In addition to R and C , the operation time of the relay depends on charging voltage, tube transconductance, relay pull-in and release currents, relay resistance, and leakage of the capacitor. In addition, when very high-value resistors are used, especially with a switching system, stray capacitances will bring results farther away from what the calculations indicated.

The solution is very simple: when constructing either of these devices, leave the variable and adjustable resistors to the last, then experiment with different resistor values and a stopwatch.—*Editor*)

MATERIALS FOR PHOTO TIMER—Fig. 1

Resistors: 1—100-ohm, 1—4,200-ohm, 1—3,300-ohm, 10—2.5-megohm, 1/2-watt; 1—2.5 megohm potentiometer. (See editor's note at end of text.)

Capacitors: 1—1- μ f, 150-volt, paper; 1—4- μ f, 50-volt or more, paper; 2—10- μ f, 150-volt, electrolytic.
Miscellaneous: 1—s.p.d.t. plate-circuit relay, pull-in current approx. 5 ma; 1—d.p.s.t. toggle switch;

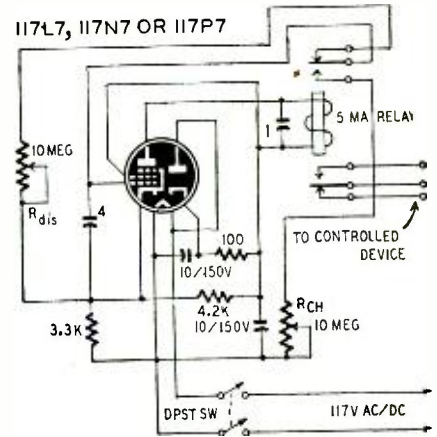

Fig. 3—Reciprocator opens and closes relay.

1—single circuit, 11-position rotary selector switch; 1—s.p.d.t. push-button switch with spring return; 2—panel-mounting female a.c. line receptacles; 1—117L7, 117N7, or 117P7 tube; 1—octal tube socket; 1—chassis; necessary hardware.

MATERIALS FOR RECIPROCATOR—Fig. 3

Resistors: 1—100-ohm, 1—4,200-ohm, 1—3,300-ohm, 1/2-watt; 2—10-megohm potentiometers.
Capacitors: 1—1- μ f, 150-volt, paper; 1—4- μ f, 50-volt or more, paper; 2—10- μ f, 150-volt, electrolytic.
Miscellaneous: 1—d.p.d.t. plate-circuit relay, pull-in current approx. 5 ma; 1—d.p.s.t. toggle switch; 3—terminals; 1—117L7, 117N7, or 117P7 tube; 1—octal tube socket; 1—chassis; necessary hardware.

Personal Receiver For Trailerite

This 1-tuber uses a minimum of parts

by LEON A. WORTMAN

IT seems to me that nothing has ever been written about the radio listening problems of those who live the life of the trailerite. Recently I moved into a house trailer, and I found that listening to a favorite program becomes a serious problem when the other trailer occupants are asleep. So a simple and inexpensive "personal" receiver was devised to solve my problem and restore some peace to the "household."

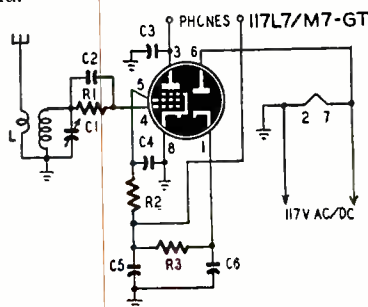

R2—470,000 ohms, 1/2 watt
R1—2.2 megohms, 1/2 watt
R3—1,000 ohms, 1 watt
C1—400- $\mu\mu$ f compression padder
C2—250- $\mu\mu$ f mica
C3—0.002- μ f paper
C4—.05- μ f paper
C5—50- μ f, 200-volt electrolytic
C6—30- μ f, 200-volt electrolytic
L—Broadcast coil (see text*)

The receiver uses a single 117L7/M7-GT in a simple grid-leak detector circuit. The grid-leak is one of the most sensitive of all nonregenerative detector circuits. Its advantages are low cost, efficiency, and gain. It is, in effect, nothing more than a diode detector followed by a single audio stage.

A.c. power is available at all trailer courts, so the power problem is nil. The diode section of the tube acts as the power rectifier with a simple ripple filter consisting of two electrolytic capacitors and a 1,000-ohm resistor.

The tuning circuit can use any broadcast antenna or r.f. coil. The set is tuned with a compression-type condenser with screw-driver adjustment. Using the aluminum body of the trailer itself as an antenna, there is sufficient gain to drive a pair of headphones to an uncomfortable level.

The parts are mounted on a chassis made from a 2 x 2 1/2-inch piece of light aluminum, which provides ample space for the few components. In my trailer the receiver is concealed by being mounted on the wall of a closet close to my bed. I put the plug in the wall socket and the earphones on my head, and in as short a time as it takes for the tube to heat up, I have a personal

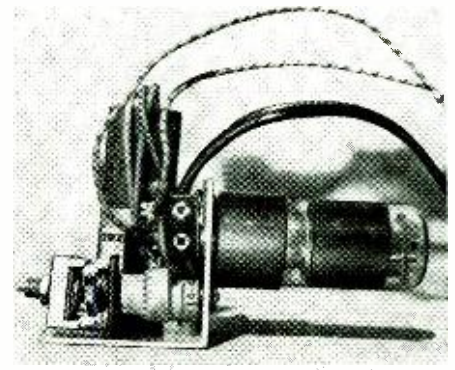

receiver that I can play at any hour without disturbing anyone.

When the trailer is parked close to broadcast stations, this type of receiver provides plenty of signal. A regenerative circuit using one or two extra parts would be better for locations far away from a transmitter. A small tickler would have to be wound and a variable capacitor or resistor installed to control regeneration.

One safety precaution must be observed. Many trailers (including mine) are made principally of metal. One side of the a.c. line is connected to the chassis, which means that the tuning capacitor may be hot. To avoid the possibility of shock, either use an insulated screwdriver to tune the set or—much better—make sure that the chassis is connected to the grounded side of the line.

Circuitry and Common Sense

Values shown in diagrams are not always to be taken too literally—numerous circuits permit wide deviations

By OTTO WOOLEY, WØSGG

THIS article is addressed to the radio constructor—and particularly to you radio constructors who are not radio experts. By reading it you may be able to save yourself some of the worries and headaches that beset a newcomer in the radio game. It may also speed the day when you will become—at least to some extent—an expert yourself.

The beginner too often feels that every component of the device he is constructing is extremely critical and must be of the precise size designated. This attitude complicates what otherwise can be a most entertaining and pleasant avocation.

To get down to cases. The schematic shows a typical receiver. We will show what a wide latitude is permissible in selecting parts.

Our receiver is the familiar regenerative detector, followed by an amplifier tube. The power supply is a full-wave rectifier, which permits the set to be operated without using batteries. Let us begin at the front end of the receiver with the antenna coils L1 and L2.

For coverage of the broadcast band L2 consists of about 95 turns of No. 30 d.s.c. on a 1½-inch form when C2 is a 365- μmf tuning capacitor. It may also be a commercial broadcast coil, or almost any inductance of approximately 250 μh . The variable condenser may be 350 (or even 400) μmf instead of 365, without affecting results to any great extent.

The position of the cathode tap on L2 is not too critical. Generally, a tap about one-fourth of the winding up from the ground end will give good results. However, tubes have been used that worked very nicely with the tap only one-fifteenth to one-tenth of the winding up from the bottom. The best spot is the position that gives reliable

oscillation over the entire tuning range with smooth, stable control of regeneration. At less than about 40 meters it is necessary to use a higher tap point, one-fifth to one-fourth of the winding being a typical value for 19 meters. The instructions given in a magazine article or with a receiver kit are useful only for a first experimental setting. They are not intended to be exact because small changes in the placement and lengths of connecting wires always change the characteristics of a tuned circuit, even if only to a small degree.

The primary coil L1 is not at all critical, and may be approximately one-sixth the number of turns on L2 at broadcast frequencies. For short-wave work the amount may be increased to one-fourth or even one-half.

Consider now the tuning capacitor C2. For broadcast work the 365- μmf value works out best, as 550 to 1600 kc may be covered with one coil. However, a 140- μmf capacitor works just as well if we increase the size of L2. For short-wave use, the 140- μmf size is preferred. The set will operate just as well on short wave with the 365- μmf tuner, but the tuning is very sharp and critical.

Next in line are grid capacitor C1 and grid-leak resistor R1. These parts should be of good quality and should be placed as close as possible to the grid terminal of the tube socket. An inch or two of wire is a great deal at this point, and best results will be obtained with the ends of R1 and C1 soldered right to the terminal with about a ¼-inch lead.

The size of R1 determines the sensitivity and stability of the detector. Most builders use a value between 1 and 5 megohms (a wide variation!), the sensitivity increasing with the higher values. This is one point where

time spent in experimenting will pay big dividends. C1 should be a mica capacitor, and its value may run from 100 to 500 μmf , the smaller size being a bit better for short wave. Anything in this range will work well, and 250 μmf is usually a good choice for all-around use.

C3 provides a short-circuit to ground for alternating current and also silences any noise generated by the movement of the regeneration control R2. Wide latitude is possible here, and any paper capacitor from .02 to 2 μf will suffice. Considering cost and physical size, a 0.25- μf , 200-volt capacitor would be practical. Placement of C3 is important; it should be located very close to the tube socket and soldered with short leads between the screen-grid terminal and the grounding point. (Tube sockets with metal mounting plates and grounding lugs are a great aid to neat, efficient wiring.)

Let us consider now the plate of the detector tube. Connected directly to the plate are C4 and RFC. C4 is used to short-circuit (bypass) radio frequencies to ground. The value may be between .0001 and .001 μf , .0005 μf being widely used. The same applies to C5, although some constructors omit C5 entirely, particularly for broadcast reception. These condensers should be good-quality micas to insure the best possible filtering action.

For RFC, the radio-frequency choke, the 2.5-mh size is chosen almost universally for broadcast and short waves down to around 10 meters. For broadcast waves especially, a 10-mh or even larger choke is O.K. Below 10 meters this choke can be quite critical. Special types are manufactured for these higher frequencies.

R4 is the load resistor for the detector tube. The value is a compromise, being high enough to load the tube properly but not so high as to drop the B-plus voltage too much. Between 150,000 and 250,000 ohms works well. Better performance may be had by substituting an iron-core choke for R4, but this increases the cost and is not necessary.

C6 conveys the audible signal to the amplifier tube. Paper capacitors are used for this purpose, the .01- μf size being generally selected. However, any size from .005 to 0.1 μf will work. The larger sizes favor the bass notes, but bass response is generally of little consequence in a receiver of this type,

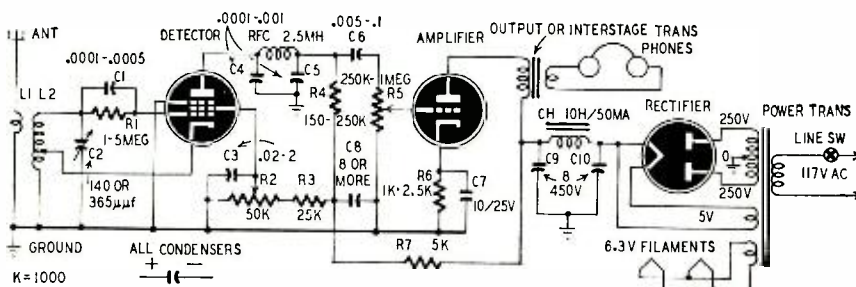

Wide range of values shown for most parts in receiver illustrates the value of experiment.

Photoelectric Relay With Variety of Uses

By HAROLD PALLATZ

A FLEXIBLE unit which can be used for many purposes, this photoelectric relay is simple to build and low in cost. The equipment can be constructed in a single evening. Among the many interesting experiments that can be performed with it are light-actuated bells, talking beams of light, and light-intensity meters. Photoelectric relays are commonly used for many industrial control purposes, but they are useful in the home as well. This unit may be used to switch on a garage-door motor, for instance, to open the garage when headlights are turned on the tube. Many other interesting and useful applications will occur to any builder with a little ingenuity.

A 12SL7 is used as a rectifier and amplifier. The relay should be fairly sensitive (1 ma), but its resistance is not critical. Either a selenium cell or a vacuum phototube may be employed without any change in the schematic diagram.

Although a commercial chassis 4 x 4 x 2 inches was used by the author, bread-board construction will work equally well. A 360-ohm line-cord resistance was used to drop the line voltage to the proper value, and the filament was shunted by an 85-ohm, 2-watt resistor. This resistor should be omitted when a

12SN7 is used in place of the 12SL7 shown in the diagram.

Phototubes require a voltage of particular polarization. If your unit does not operate at first, reverse the phototube connections. On d.c. power lines it may be necessary to reverse the line cord.

For talking-beam experiments headphone output is obtained directly across the relay coil. Greater volume may be obtained by feeding this output into an audio amplifier and speaker. Light-intensity measurements are made with an a.c. voltmeter across the relay coil, using an interrupted light source so that the phototube output will be a.c. and will be able to excite the grid.

For operation in a well-lighted room, a long, blackened cardboard tube is placed over the tube or cell to exclude

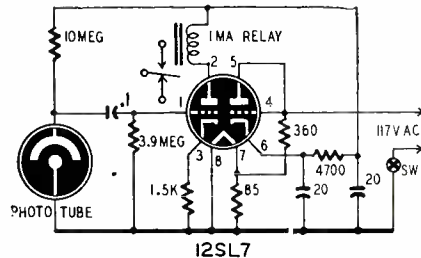

Either a selenium or a vacuum phototube may be used in this photo-relay circuit.

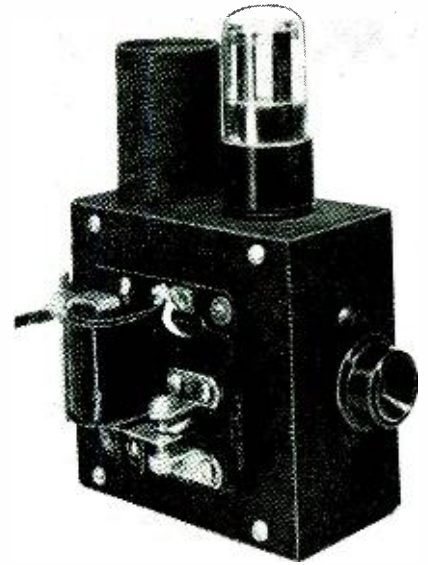

The completed photoelectric relay is compact.

stray light.

The relay contacts are brought out to three binding posts so that the relay may be used to control lights, bells, etc. Sensitive relays do not have much current-carrying capacity so note the manufacturer's ratings and stay well within them.

A very-low-frequency oscillator may be constructed by connecting a flashlight bulb and battery in series with the normally closed relay contacts. After an initial start the output of the bulb will maintain the oscillation until the beam is interrupted. Frequency of the oscillation is determined by the brightness of the bulb, which is held in front of the phototube. The arrangement is what might be called an optical feedback circuit.

CIRCUITRY AND COMMON SENSE

(Continued from page 52)

which is seldom designed for the best fidelity.

R5, the volume control, also serves as the grid resistor for the amplifier tube. It may be from 250,000 ohms to 1 megohm. 500,000 ohms is a frequently used value.

R6 furnishes the bias for the amplifier tube. The value here is 1,500 ohms, although 1,000 to 2,500 are usable. A cathode resistor is usually important because the bias it establishes sets the operating point of the tube. If the reader is not familiar with grid bias, he should go into the subject thoroughly. An extremely useful reference book on vacuum tubes is the *RCA RC-15 Receiving Tube Manual*, which may be purchased for 35 cents. Every builder should have one of these manuals or a similar one. Several other tube manufacturers publish manuals.

C7 bypasses the audio voltages around R6. It can be omitted, but the signal is louder when it is included.

T2 can be an output transformer

(plate-to-line) or an audio interstage transformer (used backward). The phones could be connected directly in place of the transformer, but this would put high d.c. voltage across the phones, a practice that must be avoided with crystal phones and is not best practice with magnetics.

C8 and R7 serve as a decoupling filter, preventing interaction between the detector and amplifier tubes through the common power supply.

C8, an electrolytic or filter condenser, may be any size from 8 μ f up. It may even be omitted, but the receiver will be easier to operate and the hum level will be much lower if it is used.

The power supply is conventional; power supplies are usually much alike. CH is the iron-core filter choke. It could be a replaced by a resistor, but the choke is preferred. If it has plenty of current-carrying capacity, its inductance can vary over a wide range. C9 and C10 are electrolytic filter capacitors. Their capacitance may also

vary widely—say from 4 to 20 μ f without harm.

Many tubes will work in this set. For the detector use a 6J7, 6K7, 6SJ7, 6SK7, 7V7, 7L7, or miniatures 6AU6 or 6AG5.

The amplifier may be a 6C5, 6J5, 7A4, or miniature 6C4. The rectifier may be an 80, 5Y3, 5Z3, 5U4, 5R4, 7Y4, 7Z4, or some other similar tube.

The set can even be built as a battery job, with dry-cell equivalents of the above tubes, without any modifications which would be beyond the ability of an intelligent experimenter.

We hope the reader will feel the urge to experiment—to interchange components and make comparisons. Deviate from the schematics and try your own variations, then check the results. Get away from the stereotyped kind of construction; be a rugged individualist with that soldering iron! Builders of a quarter-century ago where doing it and they learned plenty. What's more—they had a lot of fun!

Radio Set and Service Review

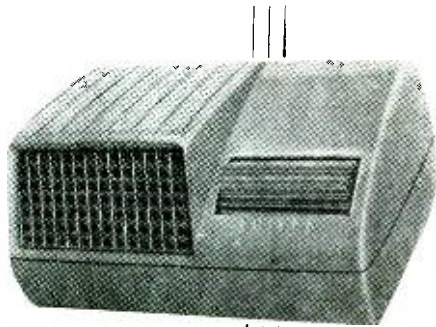

Philco has designed a novel tuner in its 49-901 receiver

PHILCO'S recently produced Model 49-901 a.c.-d.c. table-model broadcast receiver includes a novel tuning arrangement. Housed in a modernistic plastic cabinet, the set has no provision for manual tuning but will automatically select any one of six preset stations.

The only control on the front of the receiver is a 3½-inch-long serrated drum (see photograph). Revolving this operates the volume control and on-off switch. To change stations, the user presses down on the drum. The entire drum-volume control assembly moves down into its slot and actuates a rotary wafer switch which turns, one notch per "press," to select the stations.

A parasol-shaped circular piece of translucent material is fastened to the end of the switch shaft just behind a small glass bezel mounted on the front panel. The circle is divided into segments of six different colors. A pilot lamp shines through the disc and the glass bezel, the color at each station setting indicating the station tuned in. In the sample tested, the red and white

lights were easily distinguished, but it was more difficult to differentiate between the other colors, particularly the darker ones like blue and purple.

The color disc is slipped on the switch shaft. If pushed too far toward the wafers, the drum comes very close to it when depressed. If the user should attempt to rotate the drum when it is pressed down, the color disc may be damaged. To avoid this possibility, the serviceman should pull the color disc out as far as necessary.

The drawing shows how the station-shift assembly works.

The drum assembly is attached to the chassis by two arms which are swung from the rear of the chassis by a transverse shaft.

As the schematic diagram shows, two adjustments are provided for each station position. A trimmer tunes the loop antenna, and a slug tunes the appropriate oscillator coil. The adjustments are located under the chassis and may be reached through holes in the bottom of the cabinet. For the convenience of the set owner who may want to make

changes in the station setup, the oscillator-coil slugs have knurled plastic handles, though screwdriver slots are also provided. The antenna trimmers may be tuned with an aligning tool or screwdriver for each station setup.

As is customary with automatic tuners, each channel may be tuned over

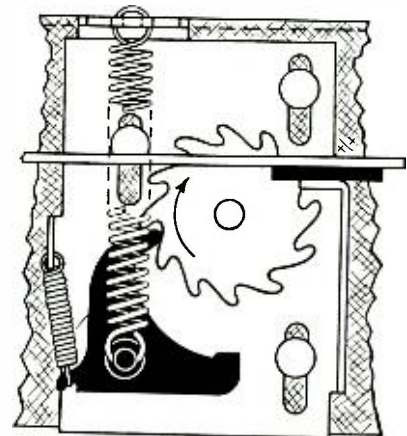

When drum is pressed, white plate moves down, carrying ratchet, which then engages with the next tooth on gear wheel. Upon release, the spring (which is broken in drawing to show the action), draws the plate and ratchet upward, thereby turning wheel one tooth or setting.

only a section of the broadcast band. Two trimmer-coil combinations are available for 900 to 1600 and one each for 850 to 1400, 650 to 1200, 600 to 1100, and 540 to 900. A strip of paper pasted close to the adjusting screws indicates which is which and the color of each slug-trimmer combination.

Electronically, the receiver is an entirely standard five-tube superheterodyne. A loop (or an external antenna) works through a capacitor into a 7A8 converter. Double-slug-tuned i.f. transformers couple the converter to a 14A7 i.f. amplifier and the latter to the detector diodes of a 14B6. The triode section of the 14B6 is the first audio amplifier, feeding a 50A5 output stage. The rectifier is a 35Y4 in the usual half-wave circuit. No chokes are used in the power-supply filter nor does the speaker

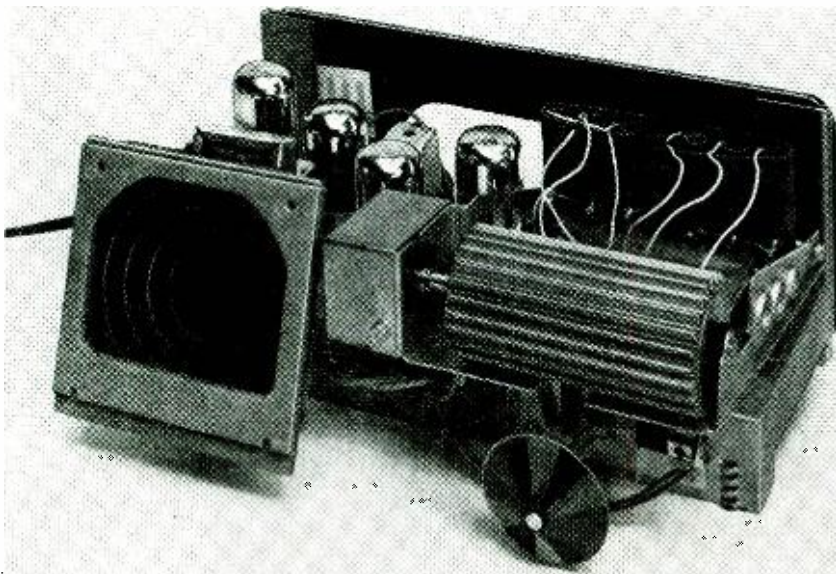

Chassis view of receiver shows bank of tuning coils. Volume control in box at left of drum.

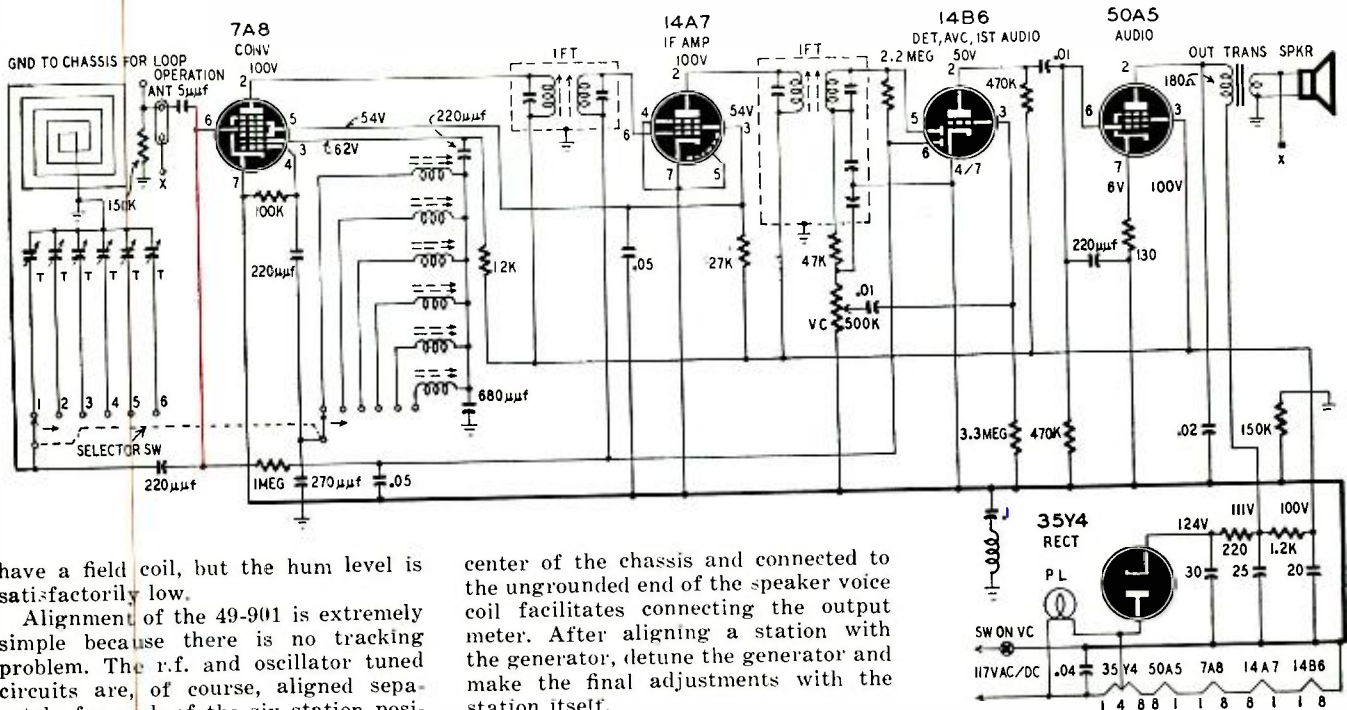

have a field coil, but the hum level is satisfactorily low.

Alignment of the 49-901 is extremely simple because there is no tracking problem. The r.f. and oscillator tuned circuits are, of course, aligned separately for each of the six station positions. Philco recommends loosely coupling a calibrated signal generator to the set for the station setup. A 6- to 8-turn, 6-inch-diameter loop of insulated wire connected to the generator terminals and placed near the receiver's loop is adequate. A terminal near the rear

center of the chassis and connected to the ungrounded end of the speaker voice coil facilitates connecting the output meter. After aligning a station with the generator, detune the generator and make the final adjustments with the station itself.

To align the i.f.'s, set the generator to 455 kc. Connect the hot lead to pin 6 of the 7A8 and the ground lead to B-minus. Align the i.f. transformers for maximum output in the following order: second i.f. secondary and primary; first i.f. secondary and primary. Adjust-

ments are made with a screwdriver through holes in the cans. The primaries are reached from the underside of the chassis and the secondaries from the top.

Radio Cabinets Need Servicing Too

By A. G. SANDERS

From this point on, the cabinet is one service job and the chassis another.

A rag dampened with carbon tetrachloride is used to clean tubes and chassis. Screws are tightened and any loose parts are reanchored. Every part must be tight and clean. The final operation is an accurate realignment of the tuner. The chassis is now ready for replacement in the cabinet.

During this time, the cabinet has also received its share of attention. Escutcheon plates are removed from wood cabinets. If the shape permits, a soft wire buffing wheel is used to clean the plates thoroughly of tarnish and dirt. In other cases, a very fine grade of sandpaper is used to clean the plate by hand. Dial windows, either glass or plastic, are washed with soap and water.

Wood cabinets are inspected for splits and breaks, especially legs that may have been broken off. (There is nothing more irritating to one's nerves than a three-legged radio.) If there is any damage, powdered casein glue is prepared and the cracks filled. The work is then tightly clamped, and the excess

glue, which has been pressed out, is cleaned off. Clamps remain on overnight while the glue dries. The cabinet is next given a coat of scratch-remover polish which dries in a very few minutes. The final coat of wax is applied and brought to a brilliant luster with a chamois polishing cloth.

Plastic cabinets are handled a little differently. Dial windows are removed and thoroughly washed with soap and water. They are easily scratched if ordinary cleansing powder is used. If the cabinet has been painted, extra care is used, because paint is apt to flake off. When the cabinet has not been painted, it is scrubbed with a stiff brush. Bon-Ami or any good cleanser is satisfactory. It is then rinsed in clear water and allowed to dry. The coat of wax is applied and polished with a chamois cloth.

It requires some extra time and effort to return radios with cabinets clean and shining like new, but it pays off big in cash and repeat jobs. Many a woman, seeing the neat appearance of her radio, is so proud that friends are invited in to see it while the serviceman is still there. This invariably leads to other jobs, either then or in the near future. Advertising of this kind is valuable. It cannot be purchased; it must be earned.

Radio servicing means more than just getting a set into working order. There's a big job of selling, too! All too frequently an otherwise capable serviceman will overlook this latter job, letting the cash register lie idle when it should be ringing up profits.

The average person will have new seat covers installed in his automobile or a broken leg of a chair replaced, without questioning the amount of the bill. He is actually able to see the work that has been performed and so forms an idea of its value.

Just the opposite is true in radio. When the radio is returned, repairs are hidden from view and the customer is forced to accept the serviceman's valuation. Many are inclined to doubt the accuracy of a bill of several dollars for repairing a radio that originally cost only \$15. Most customers (especially women) are more impressed with the over-all workmanship if the outward appearance of the radio has also been improved in the shop.

The writer has laid down definite rules in his shop. When a radio is taken in for repairs, and the usual case history has been completed, the chassis is removed from the cabinet. The speaker and loop antenna are also removed if they are not found to be secured to the chassis.

Fundamentals of Radio Servicing

Part I—The Electron Theory

By JOHN T. FRYE

THERE seems to be a growing idea in some quarters that radio servicing is being lifted out of the reach of the ordinary man. There are those who strongly hint that, unless you have a college degree in electrical engineering and have done post-graduate work on the atomic bomb, you have no business taking the back off an a.c.-d.c. receiver to replace a dial lamp.

"Modern receivers are so complicated," they tell us, "what with FM and television and everything, it is almost hopeless for the ordinary fellow to try to learn radio servicing."

To all of this the author says simply but emphatically, "Baloney!"

Anyone who can read and understand what he reads, who can reason from an observed effect back to a logical cause, and who can handle a soldering iron, can learn to repair radio receivers

and do a good job of it. Like everything else, radio servicing looks a lot more complicated and difficult to the uninitiated than it does to someone who works with it every day.

"I don't see how you can make head or tail of all that mess of wires," a customer will often exclaim when he sees his receiver chassis turned upside down on the service bench. What he does not grasp is that there is a great deal of repetition in both parts and circuits. The simplest and the most complicated receivers are each just an assembly of tubes, capacitors, resistors, coils, transformers, wire, and hardware. It is true that each of these basic components can have various forms, but the form has nothing to do with obedience to the laws of electricity. A tuned circuit consisting of a coil and a capacitor looks the same to an electron whether it en-

counters the circuit in a home-made crystal set or the most modern and expensive television receiver. If you understand exactly what takes place in the single tuned circuit of the crystal receiver, you need not be concerned because the TV set has dozens of similar tuned circuits. Tuned circuits are not like girl friends; an increase in the number does not necessarily increase the complications.

The would-be serviceman must understand the nature and behavior of electrical currents. Then he must take up the various pieces of radio apparatus one at a time and consider them both from the point of view of their action in various electrical circuits and from the practical angle of physical construction, common defects, causes of failure, etc.

Then he will be in a position to know exactly *why* a condenser is used in any circuit and the effect its inclusion will have on the circuit action; he will be able to recognize the many different forms that condensers take; he will be prepared to diagnose correctly the symptoms of a defective condenser; and he will be able to do the same thing with any other piece of radio equipment.

Once thoroughly familiar with both the theory and practice of every item that is used in the design of a radio receiver or other electronic device, he will understand readily the functioning of any new circuit he encounters, for the "new" part of the circuit will be simply one of arrangement. To him it will represent simply another grouping of his thoroughly understood circuit elements.

This series of articles is to be a down-to-earth, "horse-sense" radio course, but do not get the idea that radio theory is to be neglected. You cannot become a good radio serviceman without a clear understanding of radio theory, but you can learn your theory in practical, usable form, stripped of all the double talk that makes it seem so much more complicated and difficult than it really is. Let us look at an example:

If we pass an alternating current through a capacitor and vary the fre-

RADIO-ELECTRONICS for

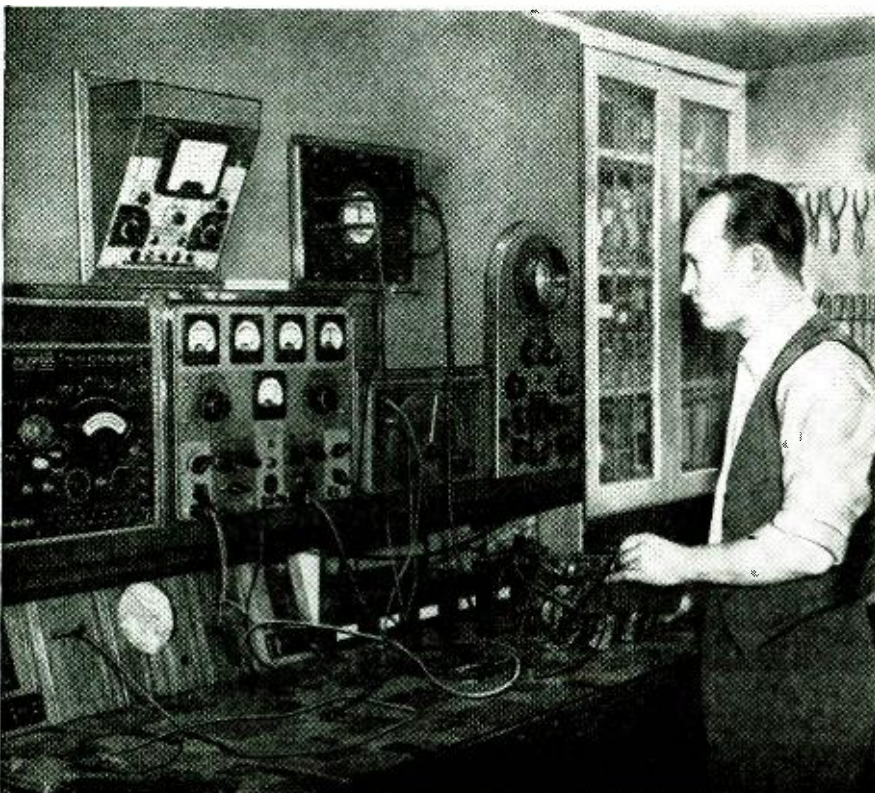

Modern radio servicing requires a thorough knowledge of basic radio and electronic theory.

quency, we find that, as the frequency increases, more current passes through the capacitor. The engineers would have us remember: "The reactance of a capacitor is an inverse function of frequency."

If you want to remember it that way, go right ahead; but if you prefer simply to recall that, as the frequency of an alternating current goes up, the resistance of a capacitor to the passage of that current goes down, and *vice versa*, you will be just as correct. Really to know a thing and to be able to use it, you must know it in your own words.

But enough of telling what we are going to do. Let's start doing it!

The electron theory

Accepting the electron theory is a good bit like ordering hash in a restaurant: you must have faith. It is universally agreed that all matter is made up of atoms; yet no one, not even with the aid of the most powerful microscope, has ever seen an atom. But it is only by dissecting the atom—and it takes millions of them to make up a speck of dust—that we are able to find an electron.

The ordinary garden variety of atom is made up of assorted particles of electricity. In the center is a particle of *positive* electricity called the *nucleus*, and around this circulate one or more particles of *negative* electricity called *electrons*, in about the same manner as the planets in our solar system revolve about the sun.

The thing to keep in mind about these various particles is that there are strong forces of attraction and repulsion connected with them. For example, a positive nucleus has more attraction for a negative electron than Van Johnson has for a bobby-soxer; but two negative electrons or two positive nuclei simply can't stand the sight of each other any more than can two women wearing identical dresses.

Ordinarily, the positive nuclear charges and the negative electronic charge of an atom are in exact balance, but sometimes an atom loses one of its electrons and so becomes slightly positive, in which case it is called a *positive ion*. If, on the other hand, it becomes slightly negative by picking up an extra electron, it is called a *negative ion*. In either case, the atom is said to be *ionized*.

An atom that has lost one of its electrons and so become positive has no morals at all, for it will steal any loose electron it can from a neighboring atom. This state of affairs makes it possible for an electron with an itching foot to swing along from one atom to another; and when we have enough of these electrons all traveling in the same direction for an appreciable length of time, we have an electric current.

Some materials give up electrons easily and allow them to move about when attracted electrically. Called good conductors, such materials include most metals. On the other hand, there are substances which stubbornly hang on to their electrons and refuse to give up

any appreciable amount of them, even under strong electrical pressure. Materials of this kind, such as air, glass, and rubber, are called *insulators*.

The method by which electrons are persuaded to move through a conductor is the application of an *electromotive force* across the ends of the conductor. This electromotive force (e.m.f.) is produced in various ways, each of which produces a crowd of electrons at one end of a conductor. One of the most common is by the chemical action in a battery. The chemical action is such that one terminal of the battery becomes positive and has a very strong attraction for negative electrons, and the other terminal becomes negative and is able to give up electrons very readily because it has a surplus of them.

When this battery is connected across a conductor, say a piece of wire, the electrons start slipping from the atoms near the positive terminal to that

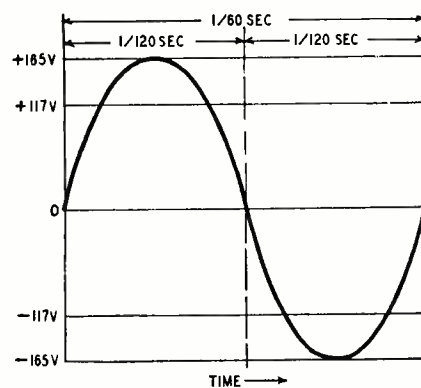

Graph above shows a 60-cycle, 117-volt wave.

terminal. These atoms, in turn, grab some electrons from their neighbors on the other side. The neighbors do the same thing, and the process continues until the atoms at the negative end of the wire replenish their losses from the negative terminal of the battery. This whole bucket-brigade movement of electrical charge takes place at the terrific speed of nearly 186,000 miles a second.

Understand that a single electron does not zip from one end of the conductor to the other at this dizzy pace. The movement is similar to that which takes place when the last one of a whole row of dominoes, standing on end right next to each other, is pushed over—the toppling movement flashes to the end of the row in a split second; yet each domino has moved but a short distance.

Each electron does drift slowly from one end of the conductor to the other, but its speed is much less and its path is much more erratic than that of the electrical charge itself. If we could paint an individual electron a bright red and were able to follow its progress through the conductor, we would find it following as erratic a path as a pin-ball-machine marble and moving along at an average speed of about 1 foot in 11 seconds.¹ This is its linear speed

through the conductor. It whirls around the nucleus at 100 miles per second.

When the electrons move in a single direction through a conductor, we have *direct current* (d.c.). All batteries and some generators produce an e.m.f. resulting in d.c. Other devices, especially certain kinds of generators, produce an e.m.f. that periodically reverses its direction; the current that results from this type of voltage is called *alternating current* (a.c.). Each terminal of such a generator keeps changing from positive to negative and back again, and the other terminal keeps changing its charge so as always to remain opposite to that of the first terminal.

The speed with which this voltage reverses may be from a few times a second to millions of times a second. The portion of its action during which an a.c. voltage starts at zero, builds up to a peak in one direction, falls to zero, builds up to a peak in the opposite direction, and again falls to zero is called a *cycle*. The number of cycles that occur in a second is the *frequency* of the alternating current. Most a.c. voltages furnished to residences are of the 60-cycle variety, and the diagram shows how a complete cycle takes place in $\frac{1}{60}$ of a second.

To use electricity, we must be able to control it; and to secure control, we must have methods of measuring it. The early physicists decided to establish a connection between the newly discovered electricity and the old established standards of weight; so they said that the amount of electricity required to deposit .001118 gram of silver from a standard solution of silver nitrate in water should be known as the *coulomb*. If a coulomb of electricity—about 6.28×10^{18} (6,280,000,000,000,000,000) electrons—flows past a given point in a second, a current of one *ampere* is said to be flowing. A thousandth of an ampere is termed a *milliampere*.

The unit used to measure the *resistance* of a conductor to the flow of current is the *ohm*. It was defined as the resistance offered to an unvarying electrical current by a column of mercury, 14.4521 grams in weight, at the temperature of melting ice, with a constant cross-sectional area, and 106.3 centimeters long. The *megohm*, often used in radio work, is 1,000,000 ohms.

Once the ampere and the ohm have been determined, the *volt*, the unit of e.m.f., is easily defined. It is simply the amount of e.m.f. that will cause a current of 1 ampere to flow through a resistance of 1 ohm.

And so we come to the end of the first chapter, and I still have not told you how to fix a radio; but do not be impatient. If you have understood all the foregoing, you have established for yourself a solid foundation upon which a complete mastery of the theory and practice of radio can be built.

The next installment will tell how to find out what's going on in an electric circuit—Ohm's Law to the radio instructors.

¹Mueller, *Introduction To Electrical Engineering*, McGraw-Hill.

Safety or Your Life!

By R. P. BALIN*

RADIO SERVICEMEN and others familiar with radio sets are well aware of the shock hazards in the average home radio. They know, too, under what conditions an otherwise merely annoying shock can cause electrocution. *But* the average set owner and his family, and even the families of radio servicemen, have no idea of how dangerous a radio can be.

Contact with a small radio (especially midjet a.c.-d.c. sets) while in the bathtub or shower has caused many electrocutions. Fatalities are often the result of a small radio falling from a shelf or chair into the bathtub. (See this magazine, June, 1948, page 19.)

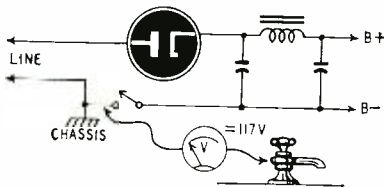

Fig. 1

Contact with the chassis of a radio through its mounting bolts, tuning knob setscrews, or antenna, while touching some nearby grounded object such as a faucet or radiator, is a common cause of painful and unnerving shocks. Wet or damp floors can also ground a person sufficiently well to give him a shock.

The public is not educated to use radio sets safely because no information explaining the matter in laymen's terms reaches them.

Unsafe practices rather than defective equipment cause most accidents.

A program to educate the public should be instituted and supported by the radio industry to help prevent accidents caused by misuse of home radio equipment. Such a program should also make recommendations for eliminating shock hazards built into new equipment.

The construction practice which contributes most to making a radio a safety hazard is that of grounding the chassis by connecting it directly to one side of the line cord. Without a polarized plug and receptacle, chances are 50-50 that the chassis will be connected to the ungrounded or hot lead of the power line. The radio may play equally well no matter which way the plug is inserted in the receptacle.

When the line-cord wire connected to the chassis of the set does not go through the on-off switch, as in Fig. 1, the chassis is energized at all times. It is consequently a shock hazard *even when the set is turned off*. An isolated

B-minus bus connected to the chassis through a parallel resistor and condenser (Fig. 2) is commonly used to limit the current flow if a contact is

These Ten Commandments spell safety for you!

1. Do not handle a radio or any other electrical device while in the bathtub or shower.
2. Do not put a small radio where it may accidentally fall into the bathtub.
3. When placing a radio in the bathroom or kitchen, locate it where **no one** will be able to reach it and touch a water faucet or electric stove at the same time.
4. Do not remove a plug from a receptacle by pulling on the cord alone.
5. Inspect the cord occasionally to see that it is in good condition.
6. Do not force the line cord and antenna wire into the rear of the set when it is not in use.
7. Do not hold onto the bare end of an antenna wire in order to improve reception. Increasing the length of the antenna will give the same results.
8. Do not use low-hanging, make-shift antennas, such as a wire clothesline.
9. Do not attempt to add a ground wire to any radio unless it has a specifically marked ground terminal.
10. Do not use a radio whose cabinet has been broken or discarded.

made between chassis and ground. The open-circuit voltage from the chassis to an external ground such as a water faucet *is still 117 volts*, sufficient to cause a startling electric shock.

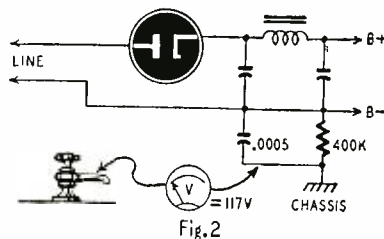

Fig. 2

Fig. 3 shows the danger points on the usual a.c.-d.c. set. A number of mounting bolts will usually be found directly connected to the chassis. These are usually countersunk in the base of the cabinet, but they are seldom covered.

They may easily be touched while moving or lifting the radio.

On the front of the radio the setscrews in the knobs are usually the only contact with the chassis. These should be short and never should be replaced, even temporarily, with bolts long enough to project above the surface of the knob.

The rear of the average radio set calls for the greatest improvement. Here, in the majority of small sets, the metal chassis is exposed, usually with no insulating barrier of wood or cardboard to prevent accidental contact. Rear covers of cardboard are provided on many models, but these loosen and are often discarded after a short time. A wooden cover made, as shown in Fig. 4, with ventilating slots and a pattern suitable for use as a cord holder is best.

Such a cord reel will be very useful if the radio is to be moved often. Many people have the habit of rolling the line cord and antenna together and jamming them into the rear of the set in the space above the tubes, a practice which results in bent condenser plates, shorted grid-cap leads, and damage to the cord.

Antenna terminals, if provided, are seldom adequately marked. Many set owners remember the days when a ground connection was essential to good

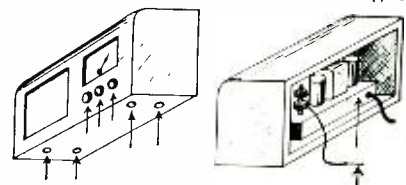

Fig. 3

reception and now attempt to attach ground leads to a.c.-d.c. sets not requiring them. Various mounting bolts at the rear of the set, such as those used for holding a loop antenna, are often mistakenly used as a ground terminal with possible fatal results. Radios on which it is not advisable to attach a ground connection *should be plainly marked with a warning*.

The antenna wire is connected to the chassis through a small series condenser and the antenna coil, as shown in Fig. 5. The open-circuit voltage from the antenna to an external ground, such as a radiator, is 117 volts. The bare end of a hank antenna is therefore a shock hazard. Some simple method of sealing the end of a trailing antenna is advisable.

Phonograph pickup arms grounded for shielding have been a source of annoying shock to many. Reversing the

*Engineer, Florida Power & Light Co.

ALLIED presents **NEW** hallicrafters Television!



NEW 10-Inch Wood Model 508 WITH THE NEW SELECT-VIEW PICTURE

NEW! DIFFERENT! An amazingly finer 10-inch direct-view TV receiver at an unbelievably low price! Incorporates remarkable new Select-View feature. Have your choice at the flip of a switch of a *round* picture for enlarged (64 square-inch) telescopic view for dramatic close-ups, or of a *linear* (56 square-inch) picture for conventional viewing. Either way, you get a sharp picture, with excellent stability and truly photographic contrast. Features include: 12 channel push-button tuning—covers all U. S. TV channels; RF amplifier; 3 IF amplifiers; 2 video amplifiers; improved sync circuits; Automatic Gain Control; static-free FM audio system. Complete with 19 tubes, plus 10" picture tube and 3 rectifiers. Presented in a beautiful mahogany wood table cabinet, 17½" high, 16⅜" wide, 19⅞" deep. For 105-125 volts, 50-60 cycles AC. Shpg. wt., 105 lbs.

Hallicrafters 508, 10" TV wood table model.
NET, f.o.b. Chicago, only..... **\$269.50**
\$53.90 down, \$19.04 monthly for 12 months

NEW

LOW-PRICED 10-INCH AND 7-INCH TABLE MODELS

NEW

EXCLUSIVE! "SELECT-VIEW" PICTURE FEATURE

ROUND
for
Big Picture
Viewing



LINEAR
for
Conventional
Viewing



Have **BOTH** in One TV Receiver

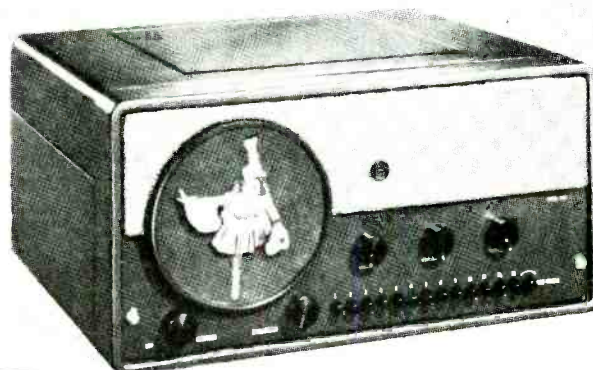

NEW

7-Inch Select-View Model T-65
IN HANDSOME FURNITURE STEEL CABINET

There's nothing like it at this low price! Here's perfected, clear, sharp, bright Television—with a brand-new feature—Select-View. It's remarkable—just flip a switch and view a *round* enlarged (28 square-inch) telescopic view for dramatic close-ups, or have your choice of a *linear* (24 square-inch) picture for conventional viewing—have *both* in *one* receiver! And check these additional features: factory pre-set push-button tuning of all U. S. television channels; simplified contrast control, easy horizontal and vertical framing; fine-tuning control; advanced type static-free FM audio system, using 4" x 6" oval PM dynamic speaker—plenty of audio output and exceptional tonal fidelity. Distinctively styled; in handsome furniture-steel cabinet in rich silver-gray; 20½" long, 11" high, 17" deep. For 105-125 volts, 50-60 cycles AC. Complete with tubes. Shpg. wt., 45 lbs.

Hallicrafters T-65, 7" TV model in furniture-steel cabinet.
NET, f.o.b. Chicago, only..... **\$169.50**
\$33.90 down, \$11.98 monthly for 12 months

507 WOOD MODEL. Identical to model described above, except in deluxe mahogany wood table model cabinet. Includes Select-View picture feature. NET, f.o.b. Chicago, only..... **\$179.50**
\$35.90 down, \$12.69 monthly for 12 months



FREE SEND FOR
THE 180-PAGE
ALLIED
RADIO BUYING GUIDE
VALUE-PACKED—UP-TO-DATE

Get the Radio Buying Guide that's used by thousands of servicemen, engineers, soundmen, Amateurs, builders and experimenters! Radio's biggest catalog brings you the widest selections of newest and finest equipment, at money-saving low prices. Get every buying advantage at ALLIED—speedy, expert shipment, personal attention of seasoned radio experts—complete satisfaction on every order. Get your ALLIED Catalog today!

ALLIED RADIO

ALLIED RADIO CORP., Dept. 2-B-9
833 W. Jackson Blvd., Chicago 7, Illinois

Send FREE 1949 ALLIED Catalog.

Enter order for Hallicrafters Model.....

..... Enclosed \$.....

Full Payment Part Payment (Bal. C.O.D.)

Name.....

Address.....

City.....Zone.....State.....

plug will often remedy this condition, but better shielding of the pickup cartridge leads and isolation of the pickup arm is safer and more practical.

Rubber-covered line cord is the least desirable type for use with some radio equipment. The heat generated in the cabinet is sometimes sufficient to gradually melt the rubber insulation at the



Fig. 4

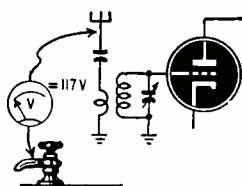

Fig. 5

point at which the wire enters the chassis, and occasional twisting of the cord will eventually cause a short circuit. Cloth-covered cord is more desirable where this can happen. In any case, the electric cord seldom lasts the life of the set to which it is attached, and it should be assumed that it will eventually require replacement.

Because smooth, round plugs are difficult to grasp, many people remove them from wall receptacles by pulling on the cord alone. Plugs made with a short molded handle look good and make removing them a safe and simple task, even when they are stuck tightly in the receptacle.

Every set owner should be familiar with the safety rules listed on page 58. Accidents can easily be avoided. Through the medium of radio itself, listeners could be told to avoid hazards.

Publicity designed to educate the public in the safe use of their radio sets may be distributed in various other ways. Radio manufacturers can provide such information easily in the form of booklets or tags attached to each new set. Warnings against the use of grounds on a.c.-d.c. sets should be stenciled on the chassis. Servicemen can use their window space effectively for the purpose.

The public, once conscious that every electrical shock carries possible death, will be eager to learn how to avoid them.

(As a suggestion for a good-will campaign, as well as a public service, enterprising repair shops might have this list of safety rules printed, together with the name, address, and phone number of the service shop, on gummed labels. Mailing these out to prospective customers or attaching one to the back of each set serviced should contribute to the public's safety and the shop's advertising. And advertising that contributes to the public good is the kind that is the most effective.)

Servicemen interested in their customers' safety can also insulate the heads of all chassis screws by sticking a small piece of cellulose tape over each one. Back covers can be replaced on sets lacking them. These may be available from the maker of the set, or the serviceman might make a special point of installing homemade insulating covers as described above.

The charge, if accompanied by an explanation of the hazard to the owner's family (especially children), will make for added profit and good will.—*Editor*)

Wire Recorder Service Problems

By WILLARD MOODY

SERVICING a wire recorder involves the solution of mechanical as well as electrical problems. Radio set trouble is usually electrical, whereas the recorder may have both kinds of trouble in an average service job. A typical recorder used for office dictation is the Peirce 55B shown in Fig. 1. Initially there is no wire on the right-hand spool. Run the wire from the left spool through the head, down to the right spool, and up clockwise. Secure it to the right spool with a piece of Scotch tape. Set the main selector switch for RECORD and set the timer at zero. Close the mike switch; the recorder will then operate. Allow the spool to wind on wire for about 4 minutes, then reset the timer to zero, and the instrument is set for dictation. Unless this procedure is followed, you may make an overrun on rewind and break the wire, making it necessary to go through the rigmarole of restringing the wire on the drum. Using this method, there will be 4 minutes of winding time to spare; it's unlikely that the average stenographer will daydream for more than a couple of minutes before realizing that the time has come to operate the instrument properly.

Perhaps the most common trouble of wire recorders is a dirty sound head which may cause wire breakage or poor-quality reproduction. The wire passing through the head leaves a deposit of grime which can be cleaned off with a small brush dipped in carbon tetrachloride.

Another common difficulty is wire breakage. This is more a symptom than a defect, and its cause must be traced.

The next most common fault is poor brake adjustment. Each drum on which wire is wound is secured to a driving shaft. Inside the case, at the opposite end of each shaft, is a large drive wheel. Against each wheel is a brake consisting of a piece of spring steel with a soft piece of cotton fiber in contact with the wheel. The spring tension can be adjusted with a screw and locknut. Putting more pressure on the wheel by moving the spring blade nearer to it increases the mechanical load and tends to slow rotation, making the wire tighter. Too little wire tension will make the wire jump in the sound head or unravel from the spool; too much may make it break.

The tension can be checked while the wire is traveling by putting a thumbnail under the wire and lifting up. With experience you can feel the wire tension and tell whether it is right.

The magnetic sound head seems to cause very little trouble. The head should be plugged in when testing the instrument as otherwise there may be excessive hum. Hum may be corrected in some cases by connecting C (in the 6SJ7 plate circuit) to ground instead of the B-plus. Usually office or shop noise level will drown out any normal hum. In one very quiet office the normal hum was reduced by running a grounding wire from the shielding at the 6SJ7 grid to the grounded end of the 6SQ7 cathode resistor.

The instrument is subject to stray electric and magnetic fields. When recording, the mike should be kept away from the power wiring to avoid hum. If erasure is not complete, the cause probably is a defective 6V6 supersonic oscillator tube.

In one recorder low gain was due to a change in the value of the 6SJ7 grid resistor. This should be 1 megohm, but it had gone down to 100,000 ohms.

The main selector switch contacts get dirty occasionally and can be cleaned with carbon tetrachloride applied with a small brush. The relay contacts give far more trouble. To get at them (in the Peirce 55B) it is necessary to remove the drive assembly from the metal cabinet. First unplug the sound head. Next, remove the screw on the right of the head. Pull the head gently straight out. *Never force anything.*

Remove the four screws at the top of the case, holding the drive assembly with one hand as the last two screws are taken out. Now pull straight back. It may be helpful to remove the 6V6 and 5Y3 tubes, although it isn't essential. The drive is connected to the chassis by a cable and multi-element plug (not shown in the diagram). The assembly can be lifted out without removing the plug; but to make ohmmeter tests, or to gain greater freedom in working on the drive, the plug can be removed.

The relay contacts can be cleaned by working a ¼-inch strip of fine crocus cloth back and forth. The relay arma—
(Continued on page 62)

New Supreme TELEVISION Manual

Includes Every Popular Television Receiver

In this giant volume of television factory data, you have everything you need to repair every modern television set. For only \$3, total price, you get complete service and alignment material on all popular T-V sets. You receive easy-to-understand explanations of circuits, 144 pages of alignment procedure, test patterns, T-V antenna data, response curves, oscilloscope waveforms, voltage charts, adjustment hints, many diagrams on mammoth 11x17-inch blueprints, everything to bring you up to date and make you an expert in television repairs.



Compiled by M. N. Beitman, radio engineer, teacher, author & serviceman.

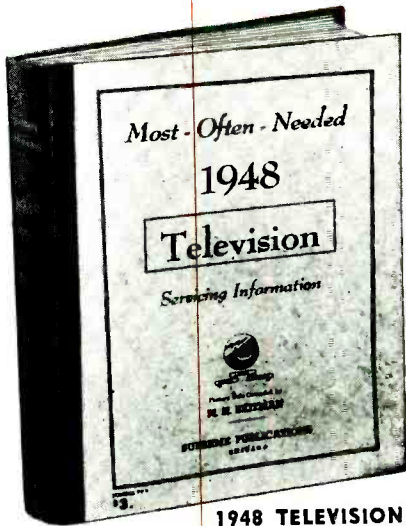

1948 TELEVISION

Contains material on all popular television sets, of Admiral, Belmont Radio, DuMont, Farnsworth, General Electric, Hallicrafters, Motorola, Philco, R.C.A., Sonora, Strouberg-Carlson, and others. Gives description of circuits, many pages of test patterns, response curves, oscilloscope waveforms, alignment tables, service hints, many diagrams in the form of giant double-spread blueprints, test points, voltage charts, etc. Large size: 8½x11 in., manual style binding, flexible covers, priced at only.

\$3.00

FIND-FIX ALL TELEVISION FAULTS

Use this new practical "cyclopedia" of television servicing as your guide to quick fault finding and repair of any modern television set. Eliminates guesswork—tells you just where to look and what to do. Will cut hour-wasting jobs to pleasant moments. Use comparison test-patterns for quick repair, or look up probable cause of trouble in pages of hints after simply observing fault of picture on screen. No equipment needed with these tests. Or use your volt-meter and compare values with many voltage charts included. Observe waveforms similar to hundreds illustrated using test points suggested and in a flash locate what used-to-be a hard-to-find fault. This manual will give you the know-how of a television expert and will repay for itself on the first T-V job.

BIGGEST BARGAIN T-V TRAINING

For over 15 years, radio servicemen expected and received remarkable values in Supreme Publications service manuals. The new 1948 Television Manual is a virtual treatise on practical television repairs. By normal standards, such a large manual packed as it is with charts, practical data, illustrations, diagrams, photographs, and expensive extra-large blueprints, should sell for \$10—but as another Supreme special value, it is priced to servicemen at only \$3, post-paid. Only a publisher who sold over one million of various radio manuals can offer such a bargain, based on tremendous volume-sales. Read about this new T-V manual at left. Find out about other radio manuals listed below. Use and save with Supreme Publications.

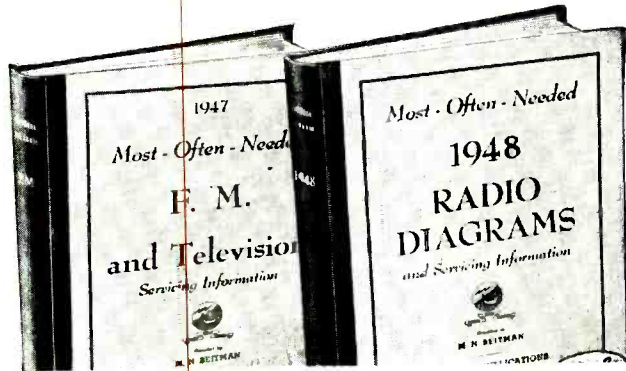

F.M. and Television

Use this large manual of factory instructions for trouble-shooting, repairing, and alignment of all popular 1947 F.M. and Television sets. Covers every popular make, including F.M. tuners, AM-FM combinations, and all types of television receivers. Detail circuit diagrams, theory of operation, test hints, alignment data, including both meter and oscilloscope methods. Use this recent Supreme manual to save time and money on your very next F.M. or T-V job. Data presented on 192 large pages, 8½x11 inches. Sturdy, manual-style binding. Tremendous value. Price postpaid, only.

\$2.

1948 Radio Diagrams

Be prepared to repair quickly all new 1948 radio receivers. In this big, single volume you have clearly-printed, large schematics, needed alignment data, replacement parts lists, voltage values, and information on stage gain, location of trimmers, and dial stringing, for almost all recently released sets. Makes toughest jobs amazingly easy. Find all faults in a jiffy. A worthy companion to the 7 previous volumes used by 120,000 shrewd radio servicemen. Will pay for itself on first job. Manual covers models of 42 different manufacturers. Giant size 8½x11 inches. 192 pages and Index. Manual-style binding. Price only.

\$2.

Radio Diagrams and F.M. Service Manuals

You can speed-up and simplify radio repairs with Supreme Publications Manuals. Service radios faster, better, easier, save time and money, use these most-often-needed diagram manuals to get ahead, earn more per hour. For the remarkable bargain price (only \$2 for most volumes) you are assured of having in your shop and on the job, needed diagrams and other essential repair data on 4 out of 5 sets you will ever service. Every popular radio of all makes from old-timers to new 1948 sets, including F.M. and Television, is covered. Clearly printed circuits, parts lists, alignment data, and helpful service hints are the facts you need to improve your servicing ability. Let these manuals furnish you with diagrams for 80% of all sets. There is no need to spend large sums for bulky, space-wasting manuals, or to buy additional drawings every few weeks; be wise, use SUPREME Manuals to get the most in diagrams and service data for the smallest cost. Select manuals at left and below. Check titles you want and rush coupon.



1947 1946 1942 1941 1940 1939 1926-1938
MOST-OFTEN-NEEDED RADIO DIAGRAMS
 Each manual has between 192 and 208 pages of diagrams, alignment data, voltage values, and service hints, \$2 manual style, large size, 8½x11". Price, each **2**
RADIO DIAGRAMS
 240 Pages
 Price \$2.50

RECORD CHANGERS New Post-War Manual

Service expertly all modern (1945-1948) record changers. Includes every popular make. Just follow simplified factory instructions to make needed adjustments and repairs. Hundreds of photographs and exploded views. Large size: 8½x11 inches. 144 fact-filled pages. Price postpaid, \$1.50 or at your jobber.

\$1.50

Radio Servicing Course-Book

Here is your practical radio course of 22 easy-to-follow lessons at an amazing bargain price. Revive fundamentals, learn new servicing tricks, all about signal tracing, oscilloscopes, recording, P.A., test equipment and T-V. Just like a \$100.00 correspondence course. Everything in radio servicing. With self-testing questions and index. Large size: 8½x11".



New 1949 Edition Great value, only **\$2.50**

NO RISK TRIAL ORDER COUPON

SUPREME PUBLICATIONS, 3727 W. 13th St., Chicago 23, ILL.

Ship the following manuals for a 16-day trial under your guarantee of satisfaction or money-back.

- New 1948 Television Manual... \$3.00
- 1947 F.M. and Television Manual 2.00
- Post-War Record Changers..... 1.50
- Radio Servicing Course-Book... 2.50

Most-Often-Needed Radio Diagram Manuals

1948
 1947
 1946
 1942
 1941
 1940
 1939
 1926-1938 — \$2.50

PRICED AT ONLY \$2 EACH

- I am enclosing \$...., send postpaid.
- Send C.O.D. I am enclosing \$... deposit.

Name:

Address:

Supreme Publications

Available at all Leading Radio Jobbers

FEBRUARY, 1949

European Report

By Major Ralph W. Hallows

RADIO-ELECTRONICS LONDON CORRESPONDENT



TV watchers, hams, radio dx-ers, and FM enthusiasts—and many broadcast listeners as well—are going about with bright smiles on their faces in Britain just now. The reason? The new regulations against causing interference with radio reception. At the moment they're still before Parliament in the form of a bill, but there's no doubt that they will soon become part of the law of the land. Up to now the situation has been absurd and unsatisfactory. The Postmaster General's Department, which is responsible for the control of telecommunications, broadcasting, and television, has had no powers to compel anyone to cease radiating interference. When, as a result of complaints, investigators tracked down the source of interference to a particular factory or private house, all the Post Office officials could do was exercise charm and persuasion on the owner. If his views about where they could put their suppressors were (to say the least) unorthodox and lacking in politeness, they had no more to say.

All this will soon be altered, for it will become an offence to radiate or even to reflect interference on any radio frequency up to 3,000 mc.

The new procedure will work out something like this. You find that unpleasant noises are upsetting your radio reception or that "snow storms" spoil the images on your television screen. A complaint to your local post office brings along engineers equipped with all the necessary instruments. If they track down the trouble to Neighbor A's electric shaver, or Neighbor B's food mixer, or Neighbor C's refrigerator, they can serve notice on A, B, or C to end the nuisance within 28 days by having suppressing appliances fitted. Should the culprit fail to do as he is told, he may then be brought up in court, where he may be fined up to \$250. Owners of all kinds of automobiles and trucks will be

compelled to suppress their ignition systems. Factories will have to see that none of their machinery radiates interference.

Fine news, you'll admit. Many of us, though, would like to see it made illegal to sell any kind of household electrical apparatus which is not guaranteed harmless in the matter of radio interference. It has always struck me as a curious state of affairs that a good many of our radio manufacturers should also be manufacturers of appliances which must interfere with the use of their radios. It would, I feel be fair if the manufacturer who made and sold interfering apparatus were made to pay for the necessary suppressors when a complaint was made. After all, the manufacturer knows (or should know) what his products are likely to do in the way of causing interference; but more often than not, the purchaser, who may not know a commutator from a commutator, has not the faintest suspicion of the trouble that his new domestic gadget may cause.

Sea waves and radio waves

England's telephone network makes considerable use of automatically operated VHF radio links for spanning the estuaries of rivers and the salt water separating small outlying islands from the shore. The height of the antennas and the output power of the transmitters are, as a rule, designed for the required ranges and no more. Some recent tests show that when high winds cause rough seas there is often a completely unexpected increase in the range at which good reception is possible. Investigation of this curious effect isn't yet complete, but the data so far obtained seems to show that when the air above the water is laden with salt spray, a kind of wave guide or duct for v.h.f. transmissions comes into existence. Under these conditions a transmitter with a normal extreme range of about 30 miles often gives strong, clear signals at twice that distance. The effect is most pronounced when the air temperature is several degrees below that of the water. Signal strength at a distant receiver may then be several thousand times greater than it should be in theory.

French high-definition TV

Though TV broadcasts in France have been stabilized at 455 lines until 1956, much experimental work is being done there with systems of higher definition. Equipment already in use or on order is for 729, 819, and 1,029 lines.

(Continued on page 66)

FACTORY SPEAKER REPAIRS SINCE 1927

LEOTONE

SAVE TIME! MONEY!

REPAIR YOUR OWN SPEAKERS with Leotone's SPEAKER ACCESSORIES KITS.

... designed especially to fit the needs of every Radioman. We are told that these kits are the finest of their kind—and the cheapest!

KIT A: SPEAKER CONES... an indispensable assortment for EVERY RADIO SHOP! 12 asstd. 4" to 12" fine quality moulded & free-edge (magnetic incl.) less voice coils. Kit of 12... **2.00**
 (We can supply CONES & VOICE COILS FOR EVERY SPEAKER. WRITE US YOUR NEEDS. PROMPT SERVICE GUARANTEED.)

KIT B: SPEAKER CONE RINGS... 50 asstd. cardboard mtg. rings in popular sizes, 3" to 12". Kit of 50... **.49**

KIT C: SPEAKER SPIDER KIT... handy assortment of popular sizes used in standard speakers. Includes: dustproof, cup, inside & center mtg. etc. Kit of 50 asstd. ... **1.75**

KIT D: RADIO CEMENT & SOLVENT... 3 oz. each of all-purpose fast drying cement and thinner. With brush... **.69**

KIT E: CONE CENTERING SHIMS... set of 16 in 4 thicknesses, all in leatherette case. Kit of 16... **.35**

KIT F: SPEAKER REPAIR KIT... the "BIG KIT" worth many times its price in savings & convenience. Contains 25 asstd. mtg. rings, 10 spiders, 25 voice coil forms, 3 yds. felt strip, 20 chamois leather segments. Kit of 16 ships and tube speaker cement. Instructions included. Now only... **2.49**

DE LUXE SPEAKER BAFFLES... for wall, corner or table mtg. of speakers up to 10". Beautiful polished walnut veneer; sturdy reinforced construction. Sloping front from 3 1/4" depth. Overall: 12" x 14". Shpg. wt. 4 lbs. ... **1.49**

SMALL MOTOR VALUES! DELCO ALNICO FIELD MOTOR: 250 RPM, 27V. DC, 3/4" shaft. 3 1/4" x 1 1/2" Shpg. wt. 1 lb. ... 2.49
110V. AC INDUCTION: 1750 RPM. fract. HP. for phono. fans, displays etc. 2 3/4" O.D., 2" deep. 3/8" shaft. Shpg. wt. 2 lbs. ... 1.39
3 RPM HAYDON TIMING MOTORS: 110V, 60 cycles, 5" OD, 1 1/2" deep. 1/2" shaft. Shpg. wt. 1 lb. ... 2.49

FREE SUPPLEMENTS... CHECK THOSE DESIRED

- RECORDING PARTS & ACCESSORIES
- ALNICO MAGNETS
- HEARING AID & MINIATURE PARTS
- RADIO & ELECTRONIC PARTS
- GEARS, SHAFTS & PULLEYS

TV-FM ANTENNA POLE BRACKETS

Both service man & user rave about how fast and easily these are installed on any wall! Strong diecast aluminum will support any TV antenna using pole up to 1 1/2" diam. Complete with hardware. Shpg. wt. 2 lbs. ... **1.39**

THEY'RE ALL SWITCHING TO LEOTONE'S JUMBO RADIO PARTS ASSORTMENT

Radio Serviceman James E. Riley of West Chester, Pa., says: "... couldn't have gotten a better buy ... nor one which would give so much service for that small price." That's what thousands say about this great assortment of new & dismantled Radio & Electronic parts! 17 FULL POUNDS OF COILS, SOCKETS, WIRE, TRANSFORMERS, HARDWARE, RESISTORS, CONTROLS—the list could go on and on (shpg. wt. 21 lbs.) FOR ONLY... **2.95**

CABINET SLIDES: For console changers, recorders, transmitter racks, drawers of every type. Heavy duty aluminum & steel; smooth ball-bearing action. For side or bottom mtg. Shpg. wt. 2 lbs. pair.

- 9" extension (15" overall) ... **1.89** or
- 11" extension (15" overall) ... **1.98** or
- 12 1/2" extension (16 1/2" overall) ... **2.19** or

MORE TUBES AT NEW LOW PRICES!

STOCK UP NOW at up to 80% OFF LIST. Outstanding buys. Perfect condition; GUARANTEED 90 DAYS! (Unsealed cartons.)

- #27, 35, 35W4, 35Z5, 39, 77, 80, 85, 5Y3, 6A4, 6A7, 6H6, 6K7, 6X5 or 30B5 ... **.39**
- #24, 30, 78, 1A7, 1L4, 1L6A, 1L1H, 5Y4, 6A3, 6B7, 6CS, 6EB, 6F5, 6T, 6T5, 6T7, 12SK7, 12SK7, 12SK7, 7A7, 7B7, 7Y4, 50L6, 12Z6 or 1619 ... **.49**

TUBE CARTONS:

- Miniature (1 1/2" sq. x 2 1/4") per 100 ... **.98**
- GT size (1 1/2" sq. x 3 1/4") per 100 ... **1.25**
- Medium (1 1/2" sq. x 4 1/4") per 100 ... **1.49**
- Large (2" sq. x 5") per 100 ... **1.79**

HIGH FIDELITY CRYSTAL MICROPHONES! Made for world famous hearing aid mfr. Now sensationally low priced! Sensitive diaphragm type. Small size (1 3/4" O.D. 3/4" deep) Ideal for BEGGING, LABEL OR CONTACT MIKE or as BLOWLOW SPEAKER. Rubber shock-mtd. metal frame. This price in effect only until our current supply is exhausted. **FIRST COME—FIRST SERVED.** (Less housing) ... **.98**
 Lightweight ALUMINUM HOUSING for crystal mike .15

Min. order \$2.00—20% d.p. req. on all C.O.D.'s. Please add sufficient postage—excess refunded

LEOTONE RADIO CO.

65-67 DEY STREET, NEW YORK 7, N. Y.

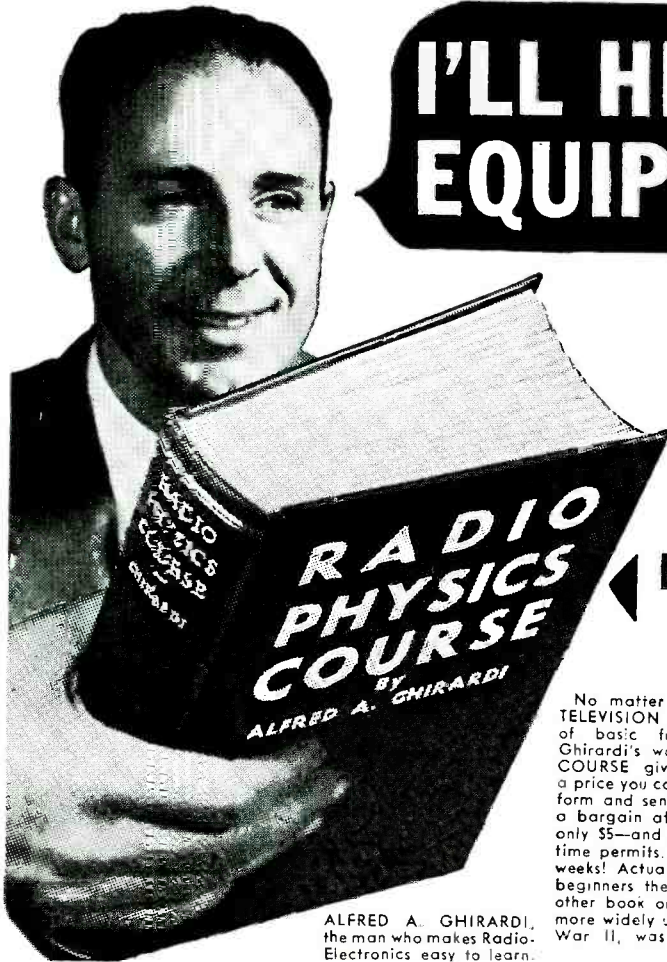

ALFRED A. GHIRARDI, the man who makes Radio-Electronics easy to learn.

I'LL HELP YOU LEARN TO EQUIPMENT EVER MADE



A few nights of **THIS**



Can pave the way to a **THIS** prosperous future of

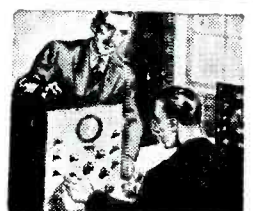

EASY-TO-LEARN BASIC RADIO-ELECTRONICS TRAINING FOR BEGINNERS

36 Big Courses in One...only \$5 complete

No matter what part of ELECTRONICS-RADIO-TELEVISION work you plan to enter, a knowledge of basic fundamentals is absolutely essential. Ghirardi's world-famous 972-page RADIO PHYSICS COURSE gives exactly the training you need—at a price you can afford to pay! If broken into "course" form and sent as monthly lessons, you'd regard it as a bargain at \$50 or more! Instead, you buy it for only \$5—and you progress as fast as spare reading time permits. Many have completed it in only a few weeks! Actually, this big 4 lb. book has given more beginners their start in Radio Electronics than any other book or course! RADIO PHYSICS COURSE is more widely used for home study and, during World War II, was more widely used for Signal Corps

and Navy training than any other book of its kind.

ASK THE MEN WHO KNOW!

Ghirardi's RADIO PHYSICS COURSE starts your training at the very beginning—with Basic Electricity. Then it takes you step by step through the entire field of RADIO-ELECTRONICS. Nothing is omitted or condensed. Everything is explained as simply as A-B-C. You can understand every word of it without previous radio training of any kind. Ask any Radio-Electronics man. He'll know the "boo"—because he probably trained from it himself! Get started now in Radio! Get started right! Our 10-days FREE EXAMINATION offer is your absolute protection. If you don't like RADIO PHYSICS COURSE you don't need to keep it. You cannot lose!

LEARN FAST!—LEARN RIGHT!

Here are a few of the things about which RADIO PHYSICS COURSE teaches you:

- Sound, Speech, Music
- Electron Theory
- Electric Current
- Electric Circuits
- Resistance
- Batteries
- Electromagnetism
- Electromag-Induction
- Condensers, Coils

- Alternating Currents
- Transformers
- Filters
- Measuring Instruments
- Radio Waves
- Vacuum Tubes
- Detector & Amplifier Tube Action
- Radio-Frequency Amplifiers
- Superheterodynes

- Audio Amplifiers
- Power Supplies
- Loud Speakers
- Auto & Aircraft Radio
- Aviation Radio
- Public Address Systems
- Phototubes, Cathode Ray Tubes
- Sound Pictures, etc., etc.

A. A. Ghirardi's RADIO PHYSICS COURSE

972 pages; 508 clear illustrations; 856 self-test review questions that make study doubly easy!



Here's how to train at home to be A PROFESSIONAL SERVICE EXPERT

Don't be a mere "screw driver mechanic!" Learn scientific service methods—at home — for only \$5!

There's a real future for you in servicing—and A. A. Ghirardi's MODERN RADIO SERVICING is just the book to start you on it without delay. And remember: Radio itself only represents the beginning of this big book's usefulness to you. What it teaches you about Radio Servicing, Test Instruments and Modern Scientific Technical Procedure is exactly the training you need to fit you to "grow up" with the fast-expanding Electronics profession in all of its servicing phases. Actually, it gives a COMPLETE MODERN EDUCATION in truly professional service work of the kind that will be your "Open Sesame!" to the real opportunities in RADIO-ELECTRONIC servicing springing up on every side.

ALL ABOUT INSTRUMENTS—TROUBLESHOOTING—REPAIR

Read from the beginning, MODERN RADIO SERVICING is a complete servicing course from A to Z. Used for reference, it is an invaluable refresher course on any type of work that puzzles you. Explains test instruments used in Radio-Electronic service work—also how, when, why and where to use each one; how to make preliminary trouble checks and perform circuit analyses; how to repair or replace parts or make substitutions—and literally hundreds of additional subjects, including How to Start and Operate a Successful Service Business of Your own. Only \$5. 10 days free examination. Use coupon. See MONEY-SAVING OFFER!

A. A. Ghirardi's

MODERN RADIO SERVICING

1300 pages; 706 helpful illustrations; 720 self-test review questions.



REPAIR HOME AND AUTO RADIOS FASTER with Ghirardi Gadgets

Ghirardi's Gadgets troubleshoot radio sets with lightning speed. Just flip a card, and there before you are the "tests" and "remedies" for almost any trouble.

HOME RADIO GADGET—Spots 400 different troubles in Power Units, Receiver Circuits Proper, Tubes, Loudspeaker, Antenna, Ground, Batteries, etc. Covers such symptoms as "Hum," "Weak," "Noisy," "Inoperative," "Intermittent Reception," "Fading," and many more. Tells what tests to make. Suggests the remedy for each trouble. Only 50¢.

AUTO-RADIO GADGET—Spots 444 special auto-radio troubles in all possible trouble-sources for 11 common symptoms including "Hum," "Weak," "Noisy," with and without car and engine at rest, "Noisy" when car is coasting with ignition off, "No Reception," "Intermittent," "Fading," "Distortion," and "Oscillation." Only 50¢.

GHIRARDI TRAINING SAVES YOU TIME AND MONEY

REPAIR ANY RADIO-ELECTRONIC

... and, to **PROVE IT**, I'll send any of these great books for 10 days' examination!

THIS 4¼ lb. HANDBOOK SHOWS EXACTLY HOW TO REPAIR OVER 4,800 RECEIVER MODELS

Cuts Service and Test Time in Half on Literally Thousands of Jobs—Only \$5

Whether you repair radios for a living or work with them only occasionally, Ghirardi's **RADIO TROUBLESHOOTER'S HANDBOOK** will help you do literally thousands of jobs better and **TWICE AS FAST**. Eliminates useless testing! Saves time—helps you make more money!

TELLS YOU WHAT TO DO—EXACTLY HOW TO DO IT!

Actually, this giant, 744-page, manual-size Handbook is a definite, dependable guide for diagnosing, locating and repairing the common troubles in over 4,800 receiver and record-player models of 202 leading manufacturers. When a receiver comes in for repair, simply turn to the 404-page Case History section. Look up the notes on that make and model. Chances are, you'll find **EXACTLY** the information you require. The Handbook tells what the trouble is—how to remedy it. Ideal for training and speeding up the work of new service helpers—handling tough jobs in half the usual time—repairing cheap sets rapidly.

NOT A "STUDY" BOOK

The tabulations on hundreds of additional pages give you invaluable data on Color Codes, Tubes, I-F alignment and transformer troubles, tube substitutions, etc., and the literally dozens of charts, graphs, diagrams, data and helpful hints will save you money every day you use them! "Thanks to Ghirardi's Handbook, I repaired my radio in one hour after it had been returned as 'unrepairable' from a local shop," writes J. L. Fizzell, Kansas City, Mo.

"WORTH 10 TIMES THE PRICE!"

"I would not take ten times the price my Handbook cost me," says C. E. Daniels of Florida.

"Started to work for me the first day I bought it. The Case Histories take you right to the trouble and save headaches and hours of testing," says Julius Siske, Jr., Curtis Bay, Maryland.

Try it for 10 days on our examination offer. See Money-Saving offer in coupon.

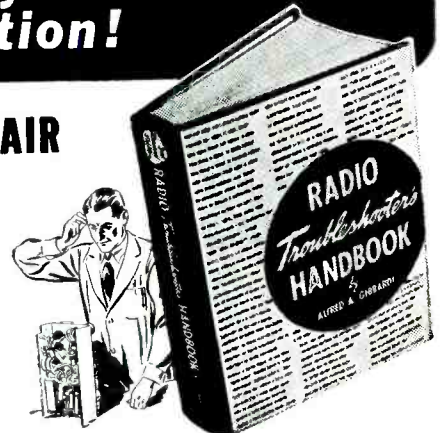

A. A. Ghirardi's

RADIO TROUBLESHOOTER'S HANDBOOK

744 big, manual size pages

BRAND NEW! by the same publisher

Complete, practical data on the theory, types and makes of recorders, their applications and performance measurements

MAGNETIC RECORDING

by S. J. Begun

Vice-president and chief engineer, The Brush Development Company

300 pages, 6 x 9, 130 illustrations. Price \$5

Here, in an authentic, easily understood book, is the "low down" on one of the fastest growing electronic developments in all of its design, engineering, service and experimental phases. From the history and theory of the art, **MAGNETIC RECORDING** brings you accurate data on every detail of modern equipment, as well as its present and potential possibilities in a wide range of applications from home entertainment to motion pictures, broadcasting, professional and amateur radio, and special applications such as secret communications (speech scrambling).

FUNDAMENTALS—COMPONENTS—EQUIPMENT

Acoustic and magnetic factors, including the complexities of ferromagnetic materials are carefully explained. A.C. and D.C. biasing methods, distortion factors, reproducing heads, drive mechanisms, and the various recording media as well as methods of recording, reproduction and erasing are discussed in detail. Of particular value is the book's complete outline of standard and special magnetic recording devices, their features and applications; a helpful study of instruments required to evaluate magnetic recording system performance, and a discussion of important research problems facing this new industry. Even the much debated subject of the magnetic versus other recording methods receives careful consideration. Throughout, the book contains a wealth of material not readily available from any other source. More than 130 diagrams and illustrations aid materially in a clear understanding of the various subjects. Read it for 10 days **AT OUR RISK**. Use coupon.

The first book of its kind about this fast-growing electronic development

- 1—A Short History of Magnetic Recording.
 - 2—Acoustic Factors in Magnetic Recording.
 - 3—Magnetism.
 - 4—Theory of Magnetic Recording.
 - 5—Components of a Magnetic Recording System.
 - 6—Magnetic Recording Equipment.
 - 7—Applications of Magnetic Recording.
 - 8—Instrumentation and Magnetic Recording Measurements.
 - 9—The Magnetic Phonograph.
 - 10—General Glossary.
- Order your copy today!

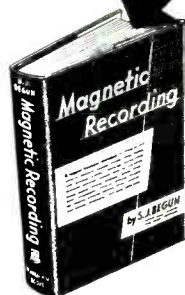

LEARN ELECTRIC MOTOR REPAIR!

Train at home for good pay in an uncrowded field

There's big money in motor repair work! Prices are good. The field is not crowded. The home appliance repair business is a vast one and motor service is a highly important part of it. **ELECTRIC MOTOR REPAIR** by Robert Rosenberg is the book that will train you easily and quickly—for only \$5 complete!

NO OTHER HOME TRAINING BOOK LIKE IT!

ELECTRIC MOTOR REPAIR explains every detail of motor trouble diagnosing, repair and rewinding. Covers a-c and d-c motors, synchronous motors and generators and BOTH mechanical and electrical control systems. Quick reference guides show exactly how to handle specific jobs.

Based on what can be learned from this big book alone, you can train quickly for **PROFITABLE** motor repair service. Ideal for beginners. Unexcelled for actual bench use in busy shops. Every type of work is demonstrated **VISUALLY** by more than 900 easily-understood diagrams. Unique Duo-Spiral Binding arrangement divides book into two sections. **BOTH** text and related pictures can be seen **AT THE SAME TIME**. Lies open flat on the bench while you work. Only \$5 complete.



Robert Rosenberg's **ELECTRIC MOTOR REPAIR**

560 pages; over 900 diagrams and pictures. \$5. **USE COUPON!** Practice from it 10 days at our risk!

10 DAYS' EXAMINATION COUPON

Dept. RE-29, Murray Hill Books, Inc.
232 Madison Ave., New York 16, N. Y.

Okay—let me have a look at them! Send me the books checked below for 10 days' examination on approval. In 10 days I will pay for books, plus 10 cents postage, or return them postpaid. Postage paid on cash orders; same return privilege. (Books sent on approval in U.S.A. only. Outside U.S.A. please send cash or money order.)

- RADIO PHYSICS COURSE \$5 (\$5.50 outside U.S.A.)
- MODERN RADIO SERVICING \$5 (\$5.50 outside U.S.A.)
- GHIRARDI HOME RADIO GADGET (50c)
- GHIRARDI AUTO RADIO GADGET (50c)
- RADIO TROUBLESHOOTER'S HANDBOOK \$5 (\$5.50 outside U.S.A.)
- ELECTRIC MOTOR REPAIR \$5 (\$5.50 outside U.S.A.)
- MAGNETIC RECORDING \$5 (\$5.50 outside U.S.A.)

MONEY-SAVING OFFER: Make your service library complete! Get Ghirardi's MODERN RADIO SERVICING and RADIO TROUBLESHOOTER'S HANDBOOK at special price of only \$9.50 for the two (\$10.50 outside U.S.A.).

Name _____
Address _____ State _____
City & Zone _____



... Helps you learn at home **EASIER, BETTER, FASTER!**

MONEY BACK GUARANTEE—We believe units offered for sale by mail order should be sold only on a "Money-Back-If-Not-Satisfied" basis. We carefully check the design, calibration and value of all items advertised by us and unhesitatingly offer all merchandise subject to a return for credit or refund. You, the customer, are the sole judge as to value of the item or items you have purchased.

20,000 OHMS PER VOLT!!

THE NEW MODEL 777 TUBE & SET TESTER

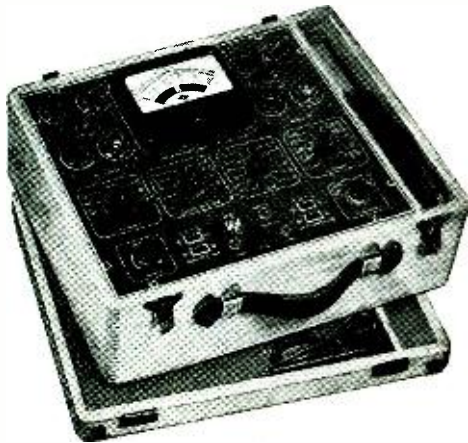

Model 777 operates on 90-120 Volts 60 cycles A.C. Housed in a beautiful hand-rubbed cabinet. Complete with test leads, tubes, charts and detailed operating instructions. Size 13" x 12 1/2" x 6".

\$59⁹⁵ NET PRICE

SPECIFICATIONS:

- Tests all tubes including 4, 5, 6, 7, 7L, Octals, Loctals, Television, Magic Eye, Thyratrons, Single Ended, Floating Filament, Mercury Vapor Rectifiers, New Miniatures, etc. Also Pilot Lights.
- Tests by the well-established emission method for tube quality, directly read on the scale of the meter.
- Tests leakages and shorts of any one element against all elements in all tubes.
- Tests both plates in rectifiers.
- Tests individual sections such as diodes, triodes, pentodes, etc., in multi-purpose tubes.
- New type line voltage adjuster.

V.O.M. SPECIFICATIONS:

- D.C. VOLTS: (at 20,000 Ohms Per Volt) 0 to 7.5/15/75/150/750/1,500 Volts
- A.C. VOLTS: (At 10,000 Ohms Per Volt) 0 to 15/30/150/300/1,500/3,000 Volts
- D.C. CURRENT: 0 to 1.5/15/150 Ma. 0 to 1.5 Amperes
- RESISTANCE: 0 to 5,000/50,000/500,000 Ohms 0 to 50 Megohms
- DECIBELS: (Based on zero decibels equals .006 Watts into a 500-Ohm line.) -10 to +18 db., +10 to +38 db., +30 to +58 db.



THE NEW MODEL 670 SUPER METER

A Combination VOLT-OHM-MILLIAMMETER plus CAPACITY REACTANCE, INDUCTANCE AND DECIBEL MEASUREMENTS

D.C. VOLTS: 0 to 7.5/15/75/150/750/1500/7500, A.C. VOLTS: 0 to 15/30/150/300/1500/3000 Volts, OUTPUT VOLTS: 0 to 15/30/150/300/1500/3000, D.C. CURRENT: 0 to 1.5/15/150 Ma., 0 to 1.5 Amps. RESISTANCE: 0 to 500/100,000 ohms, 0 to 10 Megohms. CAPACITY: .001 to .2 Mfd., 1 to 4 Mfd. (Quality test for electrolytics). REACTANCE: 700 to 27,000 Ohms; 13,000 Ohms to 3 Megohms. INDUCTANCE: 1.75 to 70 Henries; 35 to 8,000 Henries. DECIBELS: -10 to +18, +10 to +38, +30 to +58. The model 670 comes housed in a rugged, crackle-finished steel cabinet complete with test leads and operating instructions. Size 5 1/2" x 7 1/2" x 3".

\$28⁴⁰ NET

THE MODEL 88—A COMBINATION SIGNAL GENERATOR and SIGNAL TRACER

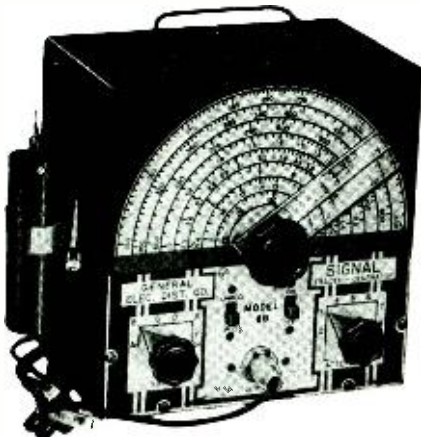

SIGNAL GENERATOR SPECIFICATIONS:

- Frequency Range: 150 Kilocycles to 50 Megacycles. • The R.F. Signal Frequency is kept completely constant at all out-put levels. • Modulation is accomplished by Grid-blocking action which is equally effective for alignment of amplitude and frequency modulation as well as for television receivers. • R.F. obtainable separately or modulated by Audio Frequency.

SIGNAL TRACER SPECIFICATIONS:

- Uses the new Sylvania IN34 Germanium crystal Diode which combined with a resistance-capacity network provides a frequency range of 300 cycles to 50 Megacycles. The Model 88 comes complete with all test leads and operating instructions. ONLY

\$28⁸⁵ NET

20% DEPOSIT REQUIRED ON ALL C.O.D. ORDERS

GENERAL ELECTRONIC DISTRIBUTING CO.

98 PARK PLACE

NEW YORK 7, N. Y.

DEPT. RC-2

(Continued from page 64)

What puzzles me is how anyone hopes, by any methods now known, to make such high-definition systems provide the average home with entertainment.

To me, the position appears to be something like this: to obtain a good image with a large number of scanning lines, a surprisingly wide range of modulation frequencies is needed. So long as plenty of money is available, the required wide-band transmitter can be constructed; but to do justice to these transmissions, the TV receiver must also be of a very-wide-band type. That means that it must be so costly that few can afford to buy it. More lines don't mean a better picture unless a bigger range of modulation frequencies increases horizontal definition to keep step with the vertical. If the vertical definition of the image is better than the horizontal (or vice versa), a viewer with normal sight sees it much as it would appear to a sufferer from severe uncorrected optical astigmatism. It is much better focused in one axis than in the other.

Let's take a few figures for an 819-line transmission. Line and frame sync pulses need about 7% of the available lines—say 58 lines per image. That leaves 761 actual scanning lines. The range of modulation frequencies needed for the faithful transmission and reception of such an image, assuming interlaced scanning, may be taken as:

$1.25L^2AN$, where L is the number of

2 actual scanning lines, A the form factor or aspect ratio of image (usually 3/4), and N the number of complete images per second. In this case we have:

$$2 \times 4$$

N, by the way, is taken as 25 because in most of Europe the frequency of a.c. main supplies is 50 cycles. I make the answer 9 mc in round figures. And that means a carrier-plus-sideband range of 18 mc, which is something to which no low-priced TV receiver could hope to do justice. So where do we go from there?

Auto radar needed

As I write, we are in the second week of the worst spell of foggy weather that I can remember. The fog began with scattered patches of poor visibility in southern England. Day by day these grew larger and larger and more and more dense. Now almost the whole of the country is covered by a cold, damp blanket of mist, with the range of visibility reduced to less than a yard in some places and nowhere much beyond 60 to 100 feet. A day or two ago I had to make a trip of about 25 miles by automobile to visit a hush-hush radio research laboratory. My home stands 500 feet above sea level, and the sun was shining brightly; but the greater part of my road lay at a much lower level, and there the fog was so dense that at the end of an hour I had covered less than six miles. There was nothing to do but to turn back—and the return six

(Continued on page 68)



Who Will Get the Better Job?

The Radioman Who Looks Ahead Will Get Ahead

Don't play blind man's buff with your future! Are you, like many other professional radiomen, so wrapped up in your present routine work that you are losing sight of where you will be tomorrow?

Look at the successful radioman. You'll find that he's the fellow who looked and *planned* ahead. Today, as a member of the great radio-electronic-television industry, you have opportunities that few men ever enjoyed in the past. Your future success can be assured by the plans *you* make *today*.

The radio industry is expanding so fast, that it is doubtful any radioman can truthfully say he has kept pace with all the major developments. Thousands of new men have joined the ranks of the radio industry creating new competition for you. New developments create demands for more advanced technical ability. You can't afford to be

If you have had professional or amateur radio experience and want to make more money, let us prove to you we have the training you need to qualify for a better radio job. To help us answer intelligently your inquiry—*please state briefly your background of experience, education and present position.*



Capitol Radio Engineering Institute

An Accredited Technical Institute

Dept. 142A. 16th and Park Road, N. W., Washington 10, D. C.

Branch Offices: New York (7) 170 Broadway • San Francisco (2) 760 Market St.

FEBRUARY, 1949

a "pre-war model". You must "re-tool" your technical knowledge in order to keep pace.

Look ahead and start now to increase your technical ability with the thorough, practical technical training for which thousands of professional radiomen have enrolled with CREI since 1927. This is a real, honest-to-goodness practical course in radio-electronics and television engineering that leads to better jobs, and security in the knowledge that you are capable of coping with tough problems.

CREI courses are still available at pre-inflation prices and today give you *more thorough instruction service* per dollar than ever before—on convenient terms. It costs you nothing to read the interesting facts. Write today.

VETERANS! CREI TRAINING AVAILABLE UNDER G. I. BILL

MAIL COUPON FOR FREE BOOKLET

CAPITOL RADIO ENGINEERING INSTITUTE

16th & Park Road, N. W., Dept. 142A, Washington 10, D. C.

Gentlemen: Please send your free booklet, "Your Future in the New World of Electronics," together with full details of your home-study training. I am attaching a brief resume of my experience, education and present position.

Check field of greatest interest:

- PRACTICAL RADIO-ELECTRONICS PRACTICAL TELEVISION
 BROADCASTING AERONAUTICAL RADIO ENGINEERING
 RECEIVER SERVICING

NAME

STREET

CITY ZONE STATE

I AM ENTITLED TO TRAINING UNDER G. I. BILL.

A CHALLENGE — Order a model 247. Disregard the unbelievably low price and compare it on the basis of appearance, quality and performance to any other Tube Tester (ANY MAKE, ANY PRICE). If you are not completely satisfied with the model 247 after a 15 day trial, return it to us for full refund—no explanation necessary. The model 247 is not surplus nor is it a hashed over pre-war model. It is newly designed and incorporates new advances in Tube Tester design. Read the description below and order one today!

THE NEW MODEL 247

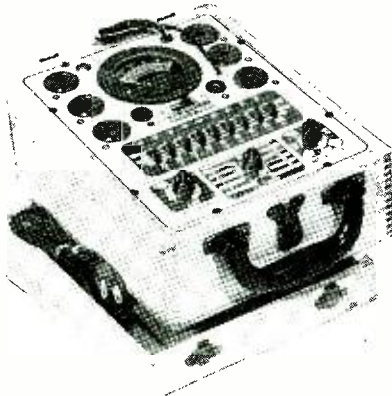

TUBE TESTER

Checks octals, loctals, bantam jr. peanuts, television miniatures, magic eye, hearing aids, thyratrons, the new type H.F. miniatures, etc.

Features:

- * A newly designed element selector switch reduces the possibility of obsolescence to an absolute minimum.
- * When checking Diode, Triode and Pentode sections of multi-purpose tubes, sections can be tested individually. A special isolating circuit allows each section to be tested as if it were in a separate envelope.
- * The Model 247 provides a super sensitive method of checking for shorts and leakages up to 5 Megohms between any and all of the terminals.
- * One of the most important improvements, we believe, is the fact that the 4 position fast-action snap switches are all numbered in exact accordance with the standard R.M.A. numbering system. Thus, if the element terminating in pin No. 7 of a tube is under test, button No. 7 is used for that test.

Model 247 comes complete with new speed-read chart. Comes housed in handsome, hand-rubbed oak cabinet sloped for bench use. A slip-on portable hinged cover is included for outside use. Size: 10 3/4" x 8 3/4" x 5 3/4".

20% Deposit Required on All C.O.D. Orders

ONLY \$29.90 NET

MOSS ELECTRONIC DISTRIBUTING CO. DEPT. RC-2, 229 FULTON ST. NEW YORK 7, N. Y.

(Continued from page 66)
mile journey took a great deal longer.

How I wished that there was such a thing as automobile radar as well as automobile radio! It should not be difficult to design a device which would indicate to the driver his distance from the edge of the road as well as from the vehicle in front. Possibly some form of sonar would be more suitable than radar. It would be a boon here, for though we don't often have such long periods of fog, any really thick mist is apt to immobilize (or to slow down to walking pace) hundreds of thousands of automobiles and commercial trucks; and the cost of such a slowing-down is heavy, to say nothing of the loss of life and the damage due to the crashes which inevitably occur. Here's a field for some of you inventors!

That radar can make travel safe and speedy in even the worst of weather conditions is shown by the record of the shipping entering and leaving Liverpool, with its wonderful port radar system, and by performances of the cross-channel steamers sailing between Dover and Folkestone in England and Calais and Boulogne in France. Thanks to their own radar gear and to that in use on shore, these vessels have been able to maintain a full service; on few occasions have they arrived more than a few minutes late. Yes, we certainly want automobile radar—or its equivalent.

RADIO REPAIR IN CANADA

Radio servicing procedure in Canada differs considerably from that employed in the States. Very few radio repairs are made in the home. Instead, sets are picked up and an operative set left with the customer until repairs are completed. Customers expect that a replacement set will be left with them; considerable ire would be aroused if the serviceman failed to do so.

Repair charges made by the average radio serviceman in Ontario and Quebec approximate \$2.50 for the initial service hour plus \$1.75 for each subsequent hour. In the prairie provinces, however, servicing costs are about \$1.50 per hour. Vancouver service rates are at an all-time low, \$1.25 per hour.

Most radio repairs in Canada are guaranteed for 60 days and the repairman makes follow-up calls without charge unless the difficulty is unmistakably the result of tampering. Eighty per cent of all Canada's radio servicemen own their own shops, the remainder working in department stores, or radio and appliance sales stores. In Toronto, Montreal, Ottawa, Regina, Calgary and Vancouver, most radio service shops offer service only.

The greatest need of Canadian radio servicemen is for portable test equipment. The typical repairman in the prairie provinces spends a sizable segment of his time bouncing over Dominion roadways. For this reason, portable signal generators, tube testers, set analyzers, and small scopes are greatly desired.—Gene Conklin

RADIO-ELECTRONICS for

HOW TO GET THE MOST
from only
BASIC TEST EQUIPMENT

Servicing by Signal Substitution
The Simple, Modern, Dynamic Speed approach to receiver alignment and adjustment problems, FM-AM-TV.

- Nothing complex to learn
- No extra equipment to purchase
- Universal — non-obsolete
- Employs only Basic Test Equipment



S-S-S tells HOW — in simple, direct language.

New 9th edition now off the press. 100 pages of valuable information.

Available from all leading radio parts and equipment distributors or directly from factory at only 40c per copy.

PRECISION APPARATUS COMPANY, Inc. • 92-27 Horace Harding Blvd., Elmhurst 4, N. Y.

NEW IMPROVED PR7 MODEL

POLICE FM ALARM

FOR POLICE CALLS TAXI CABS AND OTHERS



Attached Antenna

Tunes 152-162 Megacycles

F. M. Superheterodyne, 115 Volts, A.C.-D.C. Tubes—12AT7, (2) 6BJ6, 19T8, 35B5, 35W4
2 stages high gain 10.7 Megacycle I.F.'s. Ratio detector. Plastic cabinet 10 1/2 x 6 3/4 x 6 deep. Schematic and instructions. Shipping weight 7 lbs.
Sensitivity 10 Microvolts or better. Selectivity 250 K.C.'s or better.
Reception expectancy with attached antenna from 50 Watt transmitter 3 miles, much farther from transmitter of more power or outside antenna.
Ready to plug in and use; 28 Watts power consumption.

\$3995

Slightly higher West Coast Excise Tax Included F.O.B. Indianapolis \$10.00 with order, rest C.O.D.

SEE YOUR DEALER **FIRST OR WRITE**

READY NOW MODEL PR6-L TUNING 30-44 MEGACYCLES A.M. OR F.M.

\$3995

RADIO APPARATUS CO. 729 NORTH BANCROFT STREET INDIANAPOLIS 11, INDIANA

World-Wide Station List

By **ELMER R. FULLER**

Next month's issue of RADIO-ELECTRONICS will be a special television number with many more pages than usual (144) and many special articles on TV. Appropriately, the World-Wide Station List will be replaced by a complete list of television stations in current operation in the United States, with their channel numbers. The list should be useful to television viewers all over the country, especially those with an experimental turn of mind who like to try for TV dx.

In April you will find a complete listing of commercial FM stations. So expect the short-wave list again in May. We'll be gathering data in the meantime.

Location	Station	Freq.	Schedule
POLAND			
Warsaw		6.100	1100 to 1800
PORTUGAL			
Lisbon	CS2WD	6.150	1330 to 1800
Lisbon	CSX	6.370	1230 to 1800
Lisbon	CSW7	9.730	1900 to 2000
Lisbon	CSW6	11.010	1230 to 1530; 1600 to 1800
PORTUGUESE GUIANA			
Bissau		7.100	1315 to 1730
SALVADOR			
San Salvador	SN	7.310	1300 to 1500; 1900 to 2300
SOUTH AFRICA			
Capetown	ZRK	5.880	0315 to 0130; 1100 to 1800
Capetown	ZRL	9.610	0300 to 0700; 0900 to 1030
Johannesburg	ZRH	6.010	2345 to 0130; 0900 to 1100
Johannesburg	ZRG	9.520	0900 to 1015
Johannesburg	ZTJ	9.900	0315 to 0715; 0900 to 1110
SOUTHERN RHODESIA			
Lusaka	ZQP	3.910	1030 to 1200
SPAIN			
Alicante		7.950	0700 to 1000; 1100 to 1800
Madrid	EAQ	9.370	1330 to 1600; 1830 to 2200
SPANISH MOROCCO			
Tetuan		6.060	0230 to 0300; 1300 to 1500
SURINAM			
Paramaribo	PZH5	5.810	1800 to 2015
SWEDEN			
Stockholm	SBU	9.530	2000 to 2100
Stockholm	SDB2	10.780	1000 to 1055; 1250 to 1330; 2000 to 2100
Stockholm	SBP	11.700	0140 to 0220; 0600 to 0650; 2000 to 2100; Sun., 0215 to 1100
Stockholm	SBT	15.150	0115 to 0615; 1000 to 1100; 1230 to 1330; 2000 to 2100
SWITZERLAND			
Berne	HER3	6.160	0216 to 0715; 1200 to 1700; 2030 to 2230
Berne	HEK3	7.380	1000 to 1045; 1510 to 1530
Berne	HEF4	9.180	
Berne	HE15	11.710	Mon., Tues., Fri., 0215 to 0330
Berne	HEK4	11.960	1615 to 1715 except Saturdays
Berne	HER6	15.310	1545 to 1630; 1615 to 1715; 1830 to 2000; 2050 to 2230
Geneva	HBL	9.340	1300 to 1500
TAHITI			
Papeete	F08AA	6.980	Tuesdays and Fridays, 2200 to 2400
TURKEY			
Ankara	TAP	9.460	1000 to 1615; Sun., Mon., Thurs., 1530 to 1545
Ankara	TAQ	15.100	0000 to 0200; 0115 to 0730
UNITED STATES			
Boston	WRUS	6.040	Mexican beam, 1900 to 2230
Boston	WRUW	9.570	South American beam, 2000 to 2200
Boston	WRUL	11.720	Central American beam, 2000 to 2400
Boston	WRUW	11.730	Central American beam, 1725 to 1900
Boston	WRUA	11.790	European beam, 1450 to 1745
Boston	WRUA	15.200	European beam, 1115 to 1400

No value equal to it...

Model 260 Volt-Ohm-Milliammeter

There's good reason why this is the world's most popular high sensitivity volt-ohm-milliammeter. In every part, from smallest component to overall design, no competing instrument can show superiority. It outsells every similar instrument. And in the Simpson patented Roll Top safety case, shown here, it brings you important and exclusive protection and convenience.

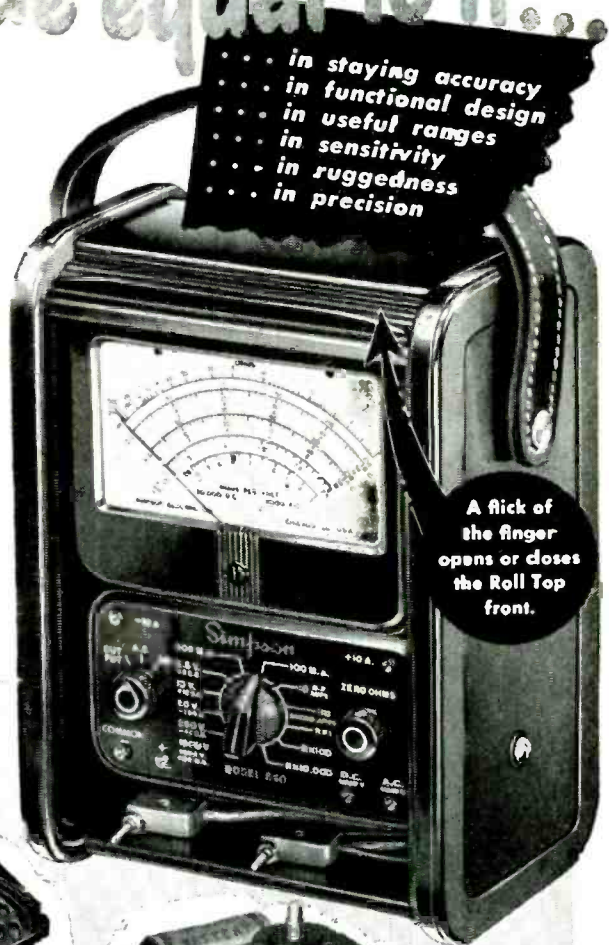

- in staying accuracy
- in functional design
- in useful ranges
- in sensitivity
- in ruggedness
- in precision

Sub-Panel Assembly —Strong, Simple, Accessible



with cover over resistor pockets removed to show design

The ruggedness, the simplicity of design, and the consequent accessibility of components are shown here. Molded of sturdiest bakelite, the sub-panel provides separate pockets for resistors. This separation makes for orderly assembly, highest possible accessibility, and added insulation for preventing shorts. All connections are short and direct. Cable wiring is eliminated. Each battery has its own compartment, again increasing accessibility.

The New Simpson Switch Mechanism. You will find no other switch mechanism on the market like this Simpson switch. It is built of molded bakelite discs. Unusually sturdy contacts, of heavy stamped brass, silver-plated for superior conductivity are molded permanently into each disc. They can never come loose, never get out of position. When the discs are assembled into the complete switch, these contacts are self-enclosed against dust. Danger of shorts is automatically eliminated. As the switch is rotated from range to range, the contact is always positive and unvarying.

A ball-and-spring mechanism positions the switch at the selected range by a 3-point pressure. Switch is thus held securely in place, yet smoothly re-positions to each new range. This mechanism is also self-enclosed against dust in a bakelite housing.

RANGES

- 20,000 Ohms per Volt D.C., 1,000 Ohms per Volt A.C.
- Volts: A.C. and D.C.: 2.5, 10, 30, 250, 1000, 5000
- Output: 2.5, 10, 50, 250, 1000
- Milliamperes, D.C.: 10, 100, 500
- Microamperes, D.C.: 100
- Amperes, D.C.: 10
- Decibels (3 ranges): -10 to +52 D.E.
- Ohms: 0-2000 (12 ohms center), 0-200,000 (1200 ohms center), 0-20 megohms (120,000 ohms center).
- Model 250 - Size: 3 1/4" x 7" x 3 1/8" \$38.95
- Model 260 in Roll Top Safety Case, as shown. Size: 7 1/2" x 7" x 4 3/4" \$45.95
- Both complete with test leads and 32-page Operator's Manual

Ask your dealer or write for complete descriptive literature.



SIMPSON ELECTRIC COMPANY
 5200-5218 W. Kinzie St., Chicago 44, Ill.
 In Canada: Bach-Simpson, Ltd., London, Ont.

AT LAST!! A LOW COST POWER UNIT FOR SERVICE WORK

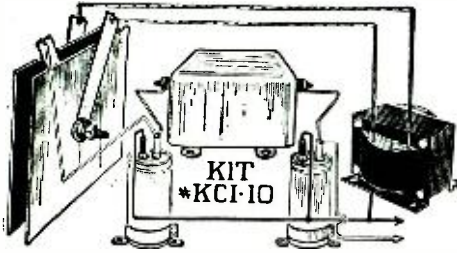

"A" ELIMINATOR KIT # KC 1-10

\$19⁵⁰

Including pictorial and schematic diagrams

For the first time, we are offering a well-engineered six volt direct current power unit for auto-radio and similar service work in kit form!!

This unit was formerly in the high priced range. Now, we have placed all the essential components necessary for construction in kit form, and are offering them to you at this low, low price.

These kits fulfill the long-standing need of every serviceman and technician. They are designed to operate from a 115 V.A.C. 50/60 cycle source, and deliver 6 V.D.C. well-filtered from three to eight amperes, with a peak rating of ten amperes. The A.C. ripple percentage is held to remarkably low values.

This unit charges a standard auto battery in one day!!

- Do away with bulky batteries!
- Do away with corroding fumes!
- Simplify your service operation!

Order this fine kit for your bench today !!

No C.O.D.'s. Full remittance with order. Shipping wt., 12 lbs.

ATTENTION DEALERS! Write for quantity discounts

OPAD-GREEN COMPANY

71 Warren St. Phone: BEekman 3-7385 New York 7, N. Y.

SELSYN TRANSMITTER & INDICATOR

Ideal as Radio Beam position indicator for Ham Television or Commercial use. Complete with five-inch I-82 Indicator. Autosyn Trans. 12 Volt 60 cycle transformer, and wiring instructions. Price: NEW.....\$7.95

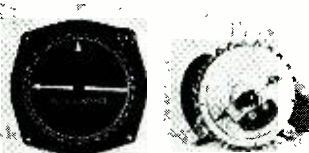

I-82 Indicator only: \$4.95—Transmitter only: \$2.95

TRANSFORMERS

Primary 110 Volt 60 cycle; 21 Volt Sec. 1 amp. \$1.95
 Primary 110 Volt 60 cycle; 21 Volt Sec. .5 amp. \$1.50
 Primary 110 Volt 60 cycle; 14-14 Volt Sec. 7 1/2 or 15 amp. \$4.95
 Primary 110 Volt 60 cycle; 12 Volt Sec. 1 amp. \$1.50

MARKER BEACON RECEIVERS

BC-1023—Receives 75 Mc. Modulated Signal, can be varied from 62 to 80 Mc. Operates self-contained sensitive relay that can be used to operate equipment from remote point. Needs only 12 to 14 Volts DC for filament and plate voltage. Complete with 4 tubes, schematic. Shock mounted. Size: 5 3/4" x 5 3/4" x 3 1/2". NEW, in original boxes. Price.....\$3.79

INTERPHONE AMPLIFIER BC-347

Army Aircraft Type; uses 6F8 Tube. Contains two (2) Midget High Fidelity UTC oscillator transformers (3/4" x 1 1/4"). Input 200 ohm to single or bush pull Grid. Output 200 ohm from single or push-pull plate, plus resistors, condensers, etc. Completely enclosed. Size: 2 1/2" x 4" x 6". Less Tube—only—Each. \$7.95
 Or Three (3) for.....\$2.00

WHIP ANTENNA FOR MOBILE AND STATIONARY USE—MP-48 Mast Base Mounting with heavy vertical Coil Spring, insulated at top to receive Mast Sect. MS-53. Mast Base only.....\$2.95

MAST SECTIONS—For above MP-48. tubular steel, copper coated, painted—in 3 foot sections. Bottom section MS-53 can be used to make any length. MS-52-51-50-49 for taper. Screw-in type. Sections. 50c each

DYNAMOTORS

INPUT	OUTPUT	STOCK NO.	PRICE
9 V. DC	405 V. 95 MA	DM 635 X	\$3.95
12 V. DC	220 V. 100 MA	D 402	3.95
12 V. DC	410 V. 200 MA	D 401	7.95
12 V. DC	F/ SCR 522	PE 98	12.95
28 V. DC	F/ SCR 522	PE 94	7.95
12/24 V. DC	F/ No. 19 MARK II	P/S #3	9.50
12/26 V. DC	F/ BC-645	PE 101	2.95
28 V. DC	400 Cycle Inverter (Reconditioned)	MC-149F	12.95
12/24 V. DC	500 V. 50 MA	USA/ 0151	1.95
28 V. DC	F/ Comm. Receivers	DM 32	1.95
14 V. DC	230 V. 100 MA	DM 20	3.95
12/24 V. DC	410 V. 200 MA & 220 V. 100 MA	D-104	9.95

SELSYNS

110 Volt 60 cycle, 78411 Size V.....\$5.95 Pair
 2J1G1—110 Volt 60 cycle, Instructions...\$3.00 Pair

CHOKES

CHOKE—5-20 H 500 MA (Swinging), 5000 V. Test \$ 7.95
 CHOKE—8 H 500 MA Filter, 5000 V Test. \$ 8.50
 CHOKE—8 H 700 MA Filter, 7500 V. Test \$ 12.90
 CHOKE—5-20 H 700 MA (Swinging), 7500 V. Test \$12.45

MOTORS

6 or 12 Volt AC-DC. Heavy Duty reversible motor with 5/8" x 3/8" shaft. Price: NEW.....\$2.95
 6 Volt AC-DC Motor—ideal for auto fans, models, etc. Shaft 1/2" x 3/8". Used, Tested.....\$1.50
 Model Motor 12 Volt AC-DC 1/2" double end shaft motor. Size: 2 1/2" L x 2 1/2" W x 1 1/2" H. Price.....\$1.50
 110 Volt 60 cycle, Ball Bearing, approx. 3500 RPM 1/25 HP. Shaft 3/8" x 5/8". Motor size: 6 1/2" L x 1 1/2" H. Converted type. Price.....\$2.95
 Hand Tool Motor—12 Volt AC-DC 5600 RPM. 3 3/4" L x 1 3/4" Dia. with spline shaft 3/4" D x 1/2" L. Price.....\$2.95

MOTOR CONTROL RHEOSTAT

Heavy-duty, wire wound control for regulating speed of AC or DC motors, toy trains, etc. 150 Watt. 8.28 ohms, 5 amps. Price.....\$1.75

HIGH VOLTAGE TRANSFORMER—115/230 VAC 50 or 60 cycle; output 2500-0-2500 VAC (2000 Volt DC after choke input filter at 500 MA.). Price: NEW \$39.75

ADDRESS DEPT. RE • ALL PRICES F.O.B. LIMA, OHIO • 25% DEPOSIT on C.O.D. ORDERS

Boston	WBOS	15.210	European beam, 1300 to 1700; South American beam, 2030 to 2230
Boston	WRUL	15.290	European beam, 1200 to 1400; 1430 to 1715; South American beam, 1730 to 1900; Sundays to 1800
Boston	WRUA	15.290	Central American beam, 1900 to 2236
Boston	WRUW	17.750	European beam, 1100 to 1815
Boston	WRUX	17.750	Central American beam, 1725 to 1906
Boston	WRUX	21.460	European beam, 1400 to 1700
Cincinnati	WLWO	9.500	European beam, 1530 to 1700
Cincinnati	WLWS2	9.700	South American beam, 1900 to 2220
Cincinnati	YLWRI	11.710	South American beam, 1800 to 1900; Sundays, 1900 to 2230
Cincinnati	WLWO	11.790	South American beam, 2000 to 2100
Cincinnati	WLWO	15.250	European beam, 1130 to 1630
Cincinnati	WLWRI	15.350	European beam, 1300 to 1600; 1630 to 1700
Cincinnati	WLWR2	15.330	South American beam, 1800 to 1900; Sundays, 1900 to 2230
Cincinnati	WLWK	17.800	South American beam, 1900 to 2230
Cincinnati	WLWS2	17.800	Spanish beam, 1630 to 1700
Cincinnati	WLWSI	21.650	European beam, 1130 to 1600; South American beam, 1900 to 2230
Cincinnati	WLWLI	21.690	European beam, 1100 to 1630
Delano, Calif.	KCBF	9.700	Japanese-Chinese beam, 0400 to 0930
Delano, Calif.	KCBR	15.130	South American beam, 1900 to 2230; Philippine beam, 0400 to 1005
Delano, Calif.	KCBA	15.150	Alaskan beam, 2215 to 0330
Delano, Calif.	KCBF	11.810	Alaskan beam, 2000 to 2200
Delano, Calif.	KCBA	15.330	Philippine beam, 0100 to 0930
Delano, Calif.	KCBF	17.850	Alaskan beam, 2215 to 0330
Dixon, Calif.	KNBA	9.650	Hawaiian-Australian beam, 0230 to 0345; 0400 to 1005 (off Mondays)
Dixon, Calif.	KNBI	9.750	Chinese-Japanese beam, 0400 to 1005
Dixon, Calif.	KNBI	11.770	South American beam, 1900 to 2230
Dixon, Calif.	KNBX	11.790	Chinese-Southeast Asia beam, 0100 to 1005
Dixon, Calif.	KNBI	15.130	Chinese beam, 0230 to 0345 (off Mondays)
Dixon, Calif.	KNBX	15.250	South Pacific beam, 0030 to 0345; South American beam, 1900 to 2230
Dixon, Calif.	KNBA	21.460	South American beam, 1900 to 2230
New York	WCBN	9.650	South American beam, 2000 to 2200
New York	WNRX	9.670	Brazilian beam, 1800 to 1900; 2000 to 2100
New York	WNRA	11.770	European beam, 1700 to 1815
New York	WCDA	11.830	Mexican beam, 1900 to 2230
New York	WOOO	15.130	European beam, 0900 to 1815
New York	WRCA	15.150	European beam, 1400 to 1700; Brazilian beam, 1800 to 1900; 2000 to 2100
New York	WCBN	15.270	European beam, 1200 to 1745
New York	WCRC	15.270	South American beam, 1900 to 2230
New York	WNRE	15.280	European beam, 1015 to 1630
New York	WNBI	17.780	European beam, 0945 to 1745; South American beam, 1900 to 2230
New York	WCBX	17.830	European beam, 1100 to 1630; South American beam, 1645 to 1700; 1800 to 1900 (off Sundays); Brazilian beam, 2000 to 2100
New York	WNRI	18.160	European beam, 0900 to 1815
New York	WOOO	21.500	European beam, 0915 to 1745
New York	WCRC	21.570	European beam, 1015 to 1630; South American beam, 1645 to 1700
New York	WNRA	21.610	European beam, 0900 to 1630
New York	WNRX	21.730	European beam, 1100 to 1700
San Francisco	KWID	9.570	Chinese beam, 0700 to 1000
San Francisco	KWIX	9.570	Alaskan beam, 2215 to 0345
San Francisco	KGEX	11.730	Philippine-East Indies beam, 0400 to 1005
San Francisco	KWIX	11.860	Japanese-Korean beam, 0400 to 0930
San Francisco	KWID	11.900	South Pacific beam, 0030 to 0630
San Francisco	KGEI	15.210	Mid-Pacific beam, 0930 to 0530
San Francisco	KWID	17.760	South American beam, 1900 to 2230
San Francisco	KGEX	17.780	Mid-Pacific beam, 0030 to 0345
San Francisco	KGEX	17.880	South American beam, 1900 to 2230

FAIR RADIO SALES 132 SOUTH MAIN ST. LIMA, OHIO

Schenectady	WGEO	9.530	South American beam, 1960 to 2230
Schenectady	WGEA	11.810	Brazilian beam, 2000 to 2100
Schenectady	WGEO	15.330	European beam, 1115 to 1745
Schenectady	WGEX	17.880	European beam, 1100 to 1745
Schenectady	WGEA	21.590	European beam, 1130 to 1600
Washington	WWV	2.500	U.S. Bureau of Standards; continuous, day and night
Washington	WWV	5.000	U.S. Bureau of Standards; continuous, day and night
Washington	WWV	10.000	U.S. Bureau of Standards; continuous, day and night
Washington	WWV	15.000	U.S. Bureau of Standards; continuous, day and night
Washington	WWV	20.000	U.S. Bureau of Standards; continuous, day and night
Washington	WWV	25.000	U.S. Bureau of Standards; continuous, day and night
Washington	WWV	30.000	U.S. Bureau of Standards; continuous, day and night
I. S. S. R.			
Kiev		11.720	0700 to 0815
Komsomolsk		9.560	2100 to 2100
Moscow		5.810	schedule unknown
Moscow	RV15	5.940	2300 to 1000
Moscow		6.030	schedule unknown
Moscow		9.680	1600 to 1745; 2315 to 2345
Moscow		7.300	1300 to 1800; 1815 to 2100
Moscow		9.480	2200 to 0200
Moscow		9.710	2300 to 0730
Moscow		11.630	1930 to 0300; 0600 to 0800; 0830 to 1300
Moscow		11.780	0900 to 1000; 2000 to 2130; 2200 to 0100
Moscow		11.830	2200 to 0600; 0730 to 0845; 1100 to 1500
Moscow		11.880	1820 to 1930; 2000 to 2045
Moscow		15.320	0100 to 0500; 0530 to 0805; 0830 to 1100; 2200 to 2300
Moscow		15.340	2200 to 0800; 1000 to 1100
Moscow		15.230	0745 to 0815; 1820 to 1930; 2000 to 2130; 2200 to 0200
URUGUAY			
Montevideo	CXA6	9.620	1530 to 2100
Montevideo	CXA19	11.830	0600 to 2200
Montevideo	CXA10	11.900	1830 to 2115
VATICAN CITY			
HVJ		5.970	1000 to 1100
HVJ		11.740	0015 to 0025; 0830 to 0900; 1100 to 1145
HVJ		15.120	0830 to 0930; 1100 to 1145
HVJ		17.440	0715 to 0845
VENEZUELA			
Barquisimeto	YV3RS	3.490	1630 to 2130
Barquisimeto	YV6RC	3.510	1800 to 2130
Barquisimeto	YV3RN	4.990	0630 to 2230
Caracas	YV5RY	3.380	0130 to 2230
Caracas	YV5RW	3.400	0530 to 2230
Caracas	YV5RX	3.500	0930 to 1400; 1530 to 2230
Caracas	YV5RS	3.530	0530 to 2230
Caracas		4.920	0600 to 2230
Caracas		4.770	1600 to 2130
Caracas	YV1RT	3.370	1730 to 2230
Caracas	YV1RU	2.140	1900 to 2130
Caracas	YV1RV	4.750	1730 to 2130
Caracas	YV1RL	4.810	0530 to 2230
Caracas	YV4RK	3.390	1800 to 2230
Merida	YV2RC	3.420	1800 to 2130
Puerto Caballo	YV4RQ	3.480	1700 to 2130
San Cristobal	YV2RN	4.830	1100 to 2130
Trujillo	YV1RO	3.310	1700 to 2130
Valencia	YV4RP	3.460	1730 to 2130
Valencia	YV4RO	4.780	1630 to 2130
Valera	YV1RZ	4.840	1630 to 2145
YUGOSLAVIA			
Belgrade		9.420	0000 to 0230; 0630 to 0845; 1110 to 1125



LAFAYETTE-CONCORD

ELECTRO NEWS

29 Years of Service—500,000 Satisfied Customers

Save \$137 on the finest in TELEVISION
LAFAYETTE'S SENSATIONAL RCA TYPE 630 TS 10" TV KIT
ONLY \$19550

HERE'S A TV KIT WITH ALL CHASSIS COMPONENTS ALREADY FACTORY-ASSEMBLED! All you do is wire and adjust! You can't go wrong! Never before has a TV kit been so simplified! Never before has anyone offered all these features at this low, low price. RCA 630 TS type chassis—complete in every respect. New 1949 front-end completely wired and pre-aligned at the factory. RCA 10 inch 10BP4 picture tube, 30 tubes, every one in its socket. Dual controls for picture and FM sound, and for horizontal and vertical control. Big instruction manual supplied with six, 47" x 22" step-by-step wiring diagrams. All circuits in color—each wiring step clearly outlined. Order now or write for more info.

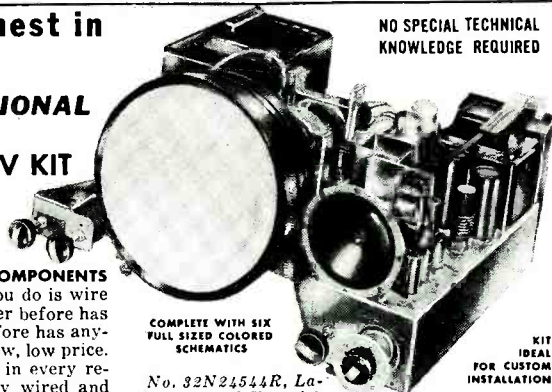

NO SPECIAL TECHNICAL KNOWLEDGE REQUIRED

COMPLETE WITH SIX FULL SIZED COLORED SCHEMATICS

KIT IDEAL FOR CUSTOM INSTALLATION

No. 32N24544R, Lafayette TV Kit with RCA type 630 TS chassis..... \$19550

No. 32N24543R, Walnut or Mahogany Cabinet for the above \$4250

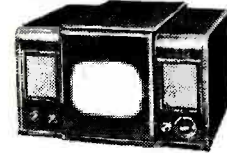

SPECIAL SPEAKER BUYS



5" PM SPEAKER
 with output transformer

Ideal for replacement in radio receivers, call, paging and inter-com systems. Formed one piece seamless cone. Dustproof spider and voice coil construction. 2 watt capacity. Voice coil impedance. 3.2 ohms. Output transformer included matches 50L6 or 50B5 Tubes. Shpg. wt. 3 lbs. No. 99-7016R..... \$1.49



10" SPEAKER

Unbelievably low priced! Buy in lots of 3 or 6 for double savings. They're top quality 10" PM speakers. 4.8 oz. Alnico V magnet. Voice coil impedance 3.2 ohms. Up to booming 8 watt capacity. Ideal for radios, P.A. etc. No. 99-7019R..... \$2.95
 Lots of 3..... \$2.80 each. Lots of 6..... \$2.75
 Shpg. wt. 5 lbs. ea.

ECA FM-TV SWEEP GENERATOR

\$3495

SAVE \$15

Cash in on TV servicing with this generator.

\$15 less than any other on the market. Limited quantity. Complete frequency coverage of 2 to 227MC on 3 bands. Covers entire FM and TV bands. Sweep width 500 KC to approximately 10MC. Maximum output 500,000 microvolts. Built-in power line filter. For operation on 105-125 volts 50-60 cycle AC. Rush your order, and be sure of getting in on this great buy. No. 25-21736R. Shpg. wt. 16 lbs..... \$34.95

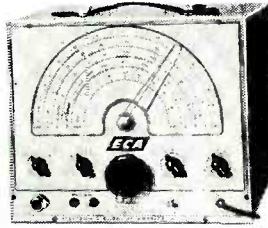

"Hic... Wanna buy one of them geranium crystals they're all talking about."
 Suggested by Arthur Trauffer, Council Bluffs, Iowa.

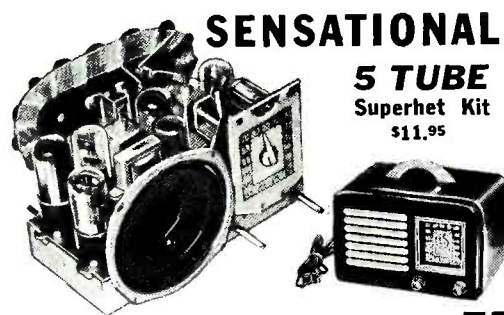

SENSATIONAL VALUE!

5 TUBE Superhet Kit
 \$11.95

Easy to assemble, worth at least \$25. Assemble it for only \$11.95

This extremely popular AC-DC kit comes with a handsome two tone plastic cabinet. Circuit is 5 tube superheterodyne using 12SA7, 12SK7, 50L6, 12SQ7 and 50L6 tubes. Includes automatic volume control, true tone reproduction. Dial is streamlined with wide tuning range covering 550 to 1600 kilocycles. Built in loop antenna. Alnico V speaker. New low price includes cabinet and tubes. No. 32N24548R. Shpg. wt. 9 lbs..... \$11.95

SHOP IN PERSON AT ONE OF THESE OUTLETS
 NEW YORK: 100 Sixth Ave., 542 E. Fordham Rd., Bronx
 CHICAGO: 901 W. Jackson Blvd., 229 West Madison St.
 ATLANTA: 265 Peachtree St.
 BOSTON: 110 Federal St.
 NEWARK: 24 Central Ave.

SEND FOR YOUR FREE CATALOG
 180 bargain crammed pages, fully illustrated, featuring standard radio and television "makes" at rock bottom prices. Write for your free copy.

LAFAYETTE CONCORD

29 Years of Radio Reliability

LAFAYETTE CONCORD Dept. JB-9
 Send your mail order to...
 100 Sixth Avenue, New York 13
 901 West Jackson Blvd., Chicago 7
 265 Peachtree Street, Atlanta 3

MAIL NOW

Please rush free catalog No. 89
 Please send free January Bargain Flyer
 Cabinet for TV Kit @ \$42.50
 RCA TV Kit @ \$195.50

5" Speaker @ \$1.49
 10" Speaker @ \$2.95
 FM-TV Sweep Generator @ \$34.95
 5 Tube Superhet Kit @ \$11.95

I enclose \$..... in postal note, money order or check. Will remit few cents postage when order is received.

Name.....
 Address.....
 City..... Zone..... State.....

for FM-AM-TELEVISION

Increasing production of F.M. and Television Receivers means more complex Receivers. Now more than ever this time-saving method of quickly and easily localizing the exact cause of trouble becomes the "must" method. Since 1939 when we first introduced our CHANNEL ANALYZER we have worked continuously developing and improving the "short-cut" method of Receiver servicing. This new model provides all the services of previous models plus many additional advantages, yet operating time has been reduced to an absolute minimum. Always ready for instant use it takes less than five seconds to begin using this versatile unit.



**THE WELL KNOWN MODEL
CA-12 IS THE ONLY SIGNAL
TRACER IN THE LOW PRICE
RANGE INCLUDING BOTH
METER AND SPEAKER!!!**

MODEL CA-12 Kit includes ALL PARTS assembled and ready for wiring, circuit diagram and detailed operating data for the completed instrument.

\$21⁹⁵

Designed in 1947—thousands in use—a smash value at \$29.95—now available in kit form at only \$21.95. Here is your opportunity to save \$8 and obtain the added advantage of complete familiarity of design and operation made possible when you build your own instrument!

Unprecedented GUARANTEE!!

If after completion, the Model CA-12 does not operate to your fullest satisfaction, you may return the unit to the manufacturer (Superior Instruments Co.) who will ship a new Model CA-12 completely wired and tested for the \$8.00 difference between the factory-built price of the kit and the price of the instrument.

Specifications:

- ★ Comparative Intensity of the signal is read directly on the meter — quality of the signal is heard in the speaker.
- ★ Simple to Operate — only one connecting cable — no tuning controls.
- ★ Highly Sensitive — uses an improved vacuum-tube voltmeter circuit.
- ★ Tube and Resistor Capacity Network are built into the detector probe.
- ★ Built-In High Gain Amplifier — Alnico V Speaker.
- ★ Completely Portable — weighs 8 pounds — measures 5½" x 6½" x 9".

MODEL CA-12 Kit includes ALL PARTS assembled and ready for wiring, circuit diagram and detailed operating data for the completed instrument.

\$21⁹⁵

MODEL CA-12 COMPLETELY WIRED READY TO OPERATE \$29.95

MANUFACTURED BY

SUPERIOR INSTRUMENTS CO.

227 FULTON STREET

NEW YORK 7, N. Y.

for FM-AM-TELEVISION

The Superior Model CA-12 on sale at the following distributors

ARKANSAS

Packard Radio Co.
Grand Ave. at 15th St., Fort Smith, Ark.

CALIFORNIA

E. C. Wenger Company
1450 Harrison St., Oakland 12, Calif.
881 South First St., San Jose, Calif.

Hollywood Radio Supply, Inc.
5606 Hollywood Blvd., Hollywood 28, Calif.

J. B. Radio Television Corp.
2804 So. La Cienega St., Los Angeles, Calif.

Offenbach-Reimus Co.
372 Ellis St., San Francisco 9, Calif.

Pasadena Radio Supply Co.
30 W. Colorado St., Pasadena 1, Calif.

Radio Parts Sales Co.
5220—22 Sp. Vermont Ave., Los Angeles 37, Calif.

Radio Parts Supply Co.
281 9th St., San Francisco Calif.

Valley Radio Supply
449 Blackstone Ave., Fresno, Calif.

V & H Radio & Electronic Supply
2033 West Venice Blvd., Los Angeles 6, Calif.

CONNECTICUT

Congress Radio Co.
207 Congress Ave., New Haven, Conn.

ILLINOIS

Midway Radio Tube Co.
3858 S. South Park, Chicago, Ill.

Quad Electrical Supply
1650 N. Damen Blvd., Chicago, Ill.

Radio Parts Distributors
925 East 59th St., Chicago 15, Ill.

INDIANA

Esse Radio Co.
130 W. New York St., Indianapolis, Ind.

KENTUCKY

R-K Distributing Company
801 West St. Catherine St., Louisville 3, Ky.

MASSACHUSETTS

Legrin Mart Co.
360 Tremont St., Boston, Mass.

MICHIGAN

Electric Products Sales Co.
427 East Michigan Ave., Lansing 29, Mich.

MINNESOTA

Bauman Company
711 West Lake St., Minneapolis 8, Minn.

MISSOURI

Walter Ashe Radio Co.
1125 Pine, St. Louis 1, Mo.

NEW YORK

Arace Brothers
562 Broadway, Kingston, N. Y.

Arrow Electronics
82 Cortlandt St., N.Y.C.

Bronx Wholesale Radio
470 E. Fordham Rd., Box 58, N. Y.

C. A. Winchell Radio Supply Co.
37 Central Ave., Cortland, N. Y.

Fred C. Harrison Co.

108 W. Church St., Elmira, N. Y.

General Electronic Distributing Co.
98 Park Place, N. Y. C.

Progressive Electronics
497 Union Ave., Brooklyn, N. Y.

Radio Mart
149 Riverdale Ave., Yonkers, N. Y.

Senco Rad'o
71 West Broadway, N. Y. C.

Trojan Radio Co.
426 River Street, Troy, N. Y.

OHIO

Holub & Hogg
1400 Sycamore St., Cincinnati 2, Ohio

Lifetime Sound Equipment Co.
911 Jefferson Ave., Toledo, Ohio

Winteradio Inc.
1468 West 25th St., Cleveland, Ohio

OKLAHOMA

Radio Supply Inc.
Oklahoma City 27, Oklahoma

OREGON

Verl G. Walker Company
205 West Jackson, Medford, Oregon

PENNSYLVANIA

Geo. D. Barbey Co.
2nd & Penn Sts., Reading, Pa.

Modern Electronic Supply Company
245 South Main St., Wilkes-Barre, Pa.

Radio Electric Service Co.
1042 Hamilton St., Allentown, Pa.

Radio Service Co.
346 S. Main Street, Wilkes-Barre, Pa.

Warner Radio Co.
631 Market Street, Philadelphia 6, Pa.

TEXAS

Electronic Equipment & Engineering Co.
1310 South Staples St., Corpus Christi, Texas

Mission Radio Inc.
814 S. Presa St., San Antonio 5, Texas

VIRGINIA

General Supply Company
3510 Huntington Ave., Newport News, Va.

Radio Equipment Co.
821 West 21st St., Norfolk 7, Va.

WASHINGTON

Whites
908 1st Ave., Spokane, Wash.

WASHINGTON, D. C.

Northwest Radio Wholesalers
3162 Mt. Pleasant St., N.W., Washington, D. C.

WEST VIRGINIA

Trenton Radio Co.
300 Grant Ave., Morgantown, W. Va.

WISCONSIN

Acme Radio Supply Corp.
510 W. State St., Milwaukee, Wis.

Radio Supply Co.
700 W. State St., Milwaukee, Wis.

Standard Radio Parts Co.
1244 State St., Racine, Wis.

MANUFACTURED BY

SUPERIOR INSTRUMENTS CO.

227 FULTON STREET

NEW YORK 7, N. Y.

**BUILD YOUR OWN SIGNAL TRACER
SAVE \$8.**



**ONLY
SIGNAL TRACER
IN LOW
PRICE RANGE
INCLUDING
BOTH METER
AND SPEAKER!**

MODEL CA-12 Kit includes ALL PARTS assembled and ready for wiring, circuit diagram and detailed operating data for the completed instrument.

\$21.95

CHECK ALL THESE SPECIFICATIONS:

- Comparative Intensity of the signal is read directly on the meter—quality of the signal is heard in the speaker.
- Simple to Operate—only one connecting cable—no tuning controls.
- Highly Sensitive—uses an improved vacuum-tube voltmeter circuit.
- Tube and Resistor Capacity Network are built into the detector probe.
- Built-In High Gain Amplifier—Alnico V Speaker.
- Completely Portable—weighs 8 pounds—measures 5 1/2" x 6 1/2" x 9".

UNPRECEDENTED GUARANTEE!!

If after completion, the Model CA-12 does not operate to your fullest satisfaction, you may return the unit to the manufacturer (Superior Instruments Co.) who will ship a new Model CA-12 completely wired and tested for the same difference between the factory-built price of the kit and the price of the instrument.

Model CA-12 completely wired **\$29.95** ready to operate

Include 25% Deposit, Balance C.O.D., F.O.B. N.Y.

SENCO RADIO, INC.

Dept. A, 73 West Broadway, New York 7, N.Y.
Telephone—BEekman 3-6498

Check Below for R&M BARGAINS!

Write for special listings of communications equipment . . . at DRASTICALLY REDUCED prices.

- Mobile Equipment 10 meter
- RESISTOR KITS
- BC 603 FM Trans
- BC 604 FM Rec
- TUBES
- SCR 274-N
- BC-375-E

**THIS
MONTH'S
SPECIAL
BARGAIN!
\$4.95**

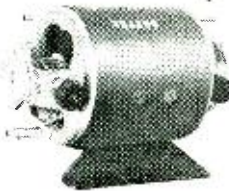

6-Volt

DYNAMOTOR

Here's the ideal dynamotor for mobile operation — at an unequalled price!

(300 v DC 80 mills, 6 v DC input)
(250 v DC 100 mills, 4 to 4 amps)

No C.O.D.'s

R & M RADIO CO.

1426 N. QUINCY ST., ARLINGTON, VA.

**NOW!
BUILD 15 RADIOS \$14.75⁷⁵
COMPLETE KIT ONLY...**



**ABSOLUTELY NO KNOWLEDGE OF RADIO NECESSARY
YOU NEED NO ADDITIONAL PARTS!**

THE PROGRESSIVE RADIO KIT is the ONLY COMPLETE KIT

Operates on 110-120 volts AC DC. Contains everything you need. Instruction Book, Metal Chassis, Tubes, Condensers, Resistors and all other necessary radio parts. The 36-page Instruction Book written by expert radio instructors and engineers teaches you to build radios in a professional manner. The first circuit built is a simple one-tube detector receiver. Each succeeding circuit incorporates new arrangements of detectors, RF and AF amplifiers. This kit is excellent for learning the principles of receiver, transmitter and amplifier design. It is used in many radio schools and colleges. All of the commonly-used detectors are used, including diode, grid leak, plate and infinite impedance. The transmitters are designed with Hartley and Armstrong oscillators, using screen-grid and control-grid modulation. Both vacuum tube and selenium rectification

are employed in these circuits. The circuits are designed to provide excellent performance. Altogether, fifteen circuits are constructed, including 11 receivers, 1 audio amplifier, and 3 transmitters. The sets start with simple circuits of 1 tube plus rectifier, gradually grow more complex, and finish with several examples of radio sets using three tubes plus rectifier.

PROGRESSIVE RADIO KIT . . . ONLY \$14.75

SPECIAL FREE OFFER

Electrical and Radio Tester sent absolutely FREE with each Progressive Radio Kit. PLUS FREE membership in Progressive Radio Club. Entitles you to free expert advice and consultation service with licensed radio technicians. Write for further information or ORDER your KIT NOW!

WE PAY POSTAGE ON PREPAID ORDERS

C.O.D. ORDERS SHIPPED COLLECT

ATTENTION RADIOMEN!! Send for Your FREE DEALERS catalog and Price List Today!

- RADIO KITS • AMPLIFIER KITS • FM COIL & CONDENSER KITS • RESISTOR KITS • CONDENSER KITS • RADIO TOOL KITS • FM-AM CHASSIS • SPEAKERS • RADIO PARTS • PORTABLE RADIOS • CAMERA-RADIOS • TUBES • AUTO RADIOS • HOME RADIOS • TELEVISION SETS • TELEVISION CABINETS • TEST EQUIPMENT • FM TUNERS

PROGRESSIVE ELECTRONICS CO.

DEPT. RE-22 497 UNION AVE. BROOKLYN 11, N. Y.

Watch for the March Special Television Issue

The March issue of RADIO-ELECTRONICS will contain 144 pages—50% more than usual—full of vital, not-to-be-missed information on all phases of Television. Some of the subjects to be covered are: antennas; receivers; kits; service and test equipment; interference; new circuits; foreign developments and practices; test patterns and what they indicate; industrial uses of television; a complete TV station list; and many others. This Special Television Issue is designed to help acquaint you with the facts you need to know in your profession or hobby. Be sure to reserve your March RADIO-ELECTRONICS now to be sure of getting it.

. . . . MOTOROLA TV-71

If you notice partial loss of sync and a good deal of hum in the picture, check the 6AG5's in the r.f. and i.f. stages for internal shorts.

EDWARD TANRATH,
Chicago, Ill.

. . . . PORTABLE RECORDER

Ultratone portable phonograph-recorders have become inoperative because of a short between a crystal transformer lead (color-coded red) and chassis. The lead is one of those taped to the chassis. Untape the leads and dress them away from the chassis to prevent any possibility of future trouble.

L. L. WHEELER,
Vancouver, Wash.

. . . . INTERMITTENTS

To get intermittent receivers to go bad so they can be checked, I put them in a large metal biscuit can approximately 6 inches deep and 10 inches in diameter. A slot is cut in the can for the power lead and the antenna. After operating for a time the set gets hot enough to cause the faulty component to break down. Because placing it in the can heats the receiver deeply and thoroughly, the serviceman has 10 or 15 minutes in which to work on it before it cools entirely.

If the intermittent does not "pop," let the set heat and then try the usual pulling of and tapping on components. The heat will help show up faults.

WALTER J. WOITOWETCH,
Toronto, Ontario.

. . . . HALLICRAFTERS TV SET

When picture and sound fade in the early models of the T-54 receivers, look for an open 3,300-ohm resistor connected to the 6X5 plates. If bad, replace it with two paralleled 7,000-ohm, 10-watt resistors.

JOSEPH E. KULAGA,
Chicago, Ill.

. . . . PHILCO 41-230

Intermittent operation of this set has been traced in several cases to an open .004- μ f capacitor between the grid of the 7B5 and the plate of the 7C6. The capacitor had been installed under strain and one lead had pulled loose. Replace with a new unit, leaving a little slack in the leads.

ROBERT A. HOUSE,
Fort Worth, Tex.

. . . . RCA 45X17

Fading was caused by an intermittent coupling capacitor between the volume control and the grid of the 12SQ7.

C. W. TEWS,
Milwaukee, Wis.

. . . . SILVERTONE 3351

The set was intermittent while in the case but was satisfactory when removed from the case. The trouble was a frayed antenna wire which was shorting to chassis. A short piece of spaghetti over the lead cured the fault.

ROBERT J. ZELLNER,
Menominee, Mich.

... PHILCO 1201

Complaints of low volume can often be traced to a defective i.f. transformer. The one nearest the rectifier tube is heated by the tube until the wax melts, detuning the transformer. To guard against future failures from this cause, soak a piece of asbestos in water to make it pliable, then bend it around the transformer and keep it in place with a piece of wire.

WILLIAM LYNN SMITH,
Carlisle, Pa.

... PHILCO 1201

High d.c. voltage on the chassis may be due to a shorted output transformer (the secondary is grounded to the chassis). In one case, a gentle tug on the primary B-plus lead cured the trouble.

ROGER L. BOYELL,
Miami, Fla.

... PHILCO RADIO-PHONOS

If one of these Philcos is microphonic on either the radio or the phono position, try mounting the speaker on rubber grommets instead of directly to the cabinet.

MILTON MARGOLIS,
Philadelphia, Pa.

(A rubber ring would be better, since it would not destroy completely the baffle effect of the cabinet as grommets might.—Editor)

... PHILCO 47-1230

When you smell smoke in one of these sets, investigate the 33- μ f capacitor between the 6AG5 plate and the FM r.f. tuner. It frequently shorts, causing the nearby 1,000-ohm resistor to burn. Replace both units. The manufacturer's part numbers are C410 and R404.

CITY RADIO SERVICE,
Ambridge, Pa.

... WILCOX-GAY 6B30

Low volume is sometimes a complaint on this set. Sharp edges on the push-button solder lugs penetrate the insulation on audio wiring, which is stretched tight. This makes a high-resistance (or complete) short to ground. Replace the wire and reroute it so that the solder lugs will not touch it.

E. E. BALDWIN,
Grand Island, Nebr.

... RCA 5Q55

Reception was good until the set was tuned to the low end of the broadcast band; then it would cut out. When retuned to the high end, it would operate for a few minutes, then it would cut out again.

Replacing the .006- μ f capacitor in series with the tuning capacitor cured the trouble.

H. G. BLAKE,
Cloverport, Ky.

... KNIGHT G9511

Volume and tone changed intermittently. Signal tracing indicated faulty a.v.c. action, which was finally traced to a 75 which was bad, even though it tested good on a standard tester.

JOHN C. CHEPLA,
Springfield, Ill.

OPPORTUNITY AD-LETS

Advertisements in this section cost 55¢ a word for each insertion. Name, address and initials must be included at the above rate. Cash should accompany all classified advertisements unless placed by an accredited advertising agency. No advertisement for less than ten words accepted. Ten percent discount six issues, twenty percent for twelve issues. Objectionable or misleading advertisements not accepted. Advertisements for March, 1949, issue must reach us not later than January 24, 1949.
Radio-Electronics, 25 W. Broadway, New York 7, N. Y.

WANTED: 2 GEN. RAD. CAP. TEST BRIDGES. Also 10 hi-speed power factor testing units. Goodall Co., Ogallala, Nebr.

LOCATES SCRATCHING, FRYING DUE TO HIGH resistance joints in windings or condensers, etc., without energizing, set 4 in 1 units—signal traces D.C. power supply—phono amp. noise locator. Diagram—Instruction \$1.00. Clyde Cosgrove, 1204 Edison Street, York, Penna.

TELEPHONE DIALS, USED, NATIONALLY KNOWN make. Standard speed, 10 pulses per second. Re-built \$2.25. Re-adjusted \$1.25 postpaid. Kissel Electric Products, 131-C, Sherman, Galion, Ohio.

DX CRYSTAL TUBE EXPERIMENTERS' "RADIO-BUILDERS" 3 issues, 25¢. Catalog, Laboratories, Eye-b, San Carlos, California.

24 VOLT AIRCRAFT BATTERIES, NEW 11 AMP. AT 5 hr. rate. Dry charged. \$14.50 ea. less 25% in lots of four. No C.O.D.'s please. Security Parachute Co., Oakland Airport, Oakland, Calif.

PORTABLE SUITCASE SIZE RADIO SHOP—BUILD IT and be ready for ready cash. Carry in your car and double your income. Write for literature. Grand Federal, Argentine Branch, Box 57, Kansas City 3, Kansas.

LANCASTER, ALLWINE & ROMMEL, 436 BOWEN Building, Washington 5, D.C. Registered Patent Attorneys. Practice before United States Patent Office. Validity and infringement Investigations and Opinions. Booklet and form "Evidence of Conception" forwarded upon request.

12B8 & 25B8 TUBES, ADAPTER UNIT USING 2 miniature tubes (6AT6 & 6BA6 for 12B8, and 12AT6 & 12BA6 for 25B8). Takes less space than original tube—nothing else to buy—just plug in & it works. Money-back guarantee. 12B8 or 25B8 unit complete: \$2.49 each, 10 units for \$22.50. Send 25¢ deposit, balance C.O.D. Write for free parts catalog. COMMERCIAL RADIO, 36 Brattle St., Boston, Mass.

MAGAZINES (BACK DATED)—FOREIGN, DOMESTIC, arts, books, booklets, subscriptions, pin-ups, etc. Catalog, 10¢ (refund). Ciccone's, 863 First Ave., New York 17, N. Y.

YOU CAN ACCURATELY ALIGN SUPERHETERODYNE receivers without signal generator. Complete instructions \$1. Money-back guarantee. Chas. Gates, Pecos 2, Texas.

YOU CAN HAVE 26 YEARS RADIO EXPERIENCE AT your fingertips. I've repaired over 45,000 radios. Have perfected simple, easy system anyone can follow step by step. No calculations, no formulas. Total price, \$46.00 postpaid or C.O.D. Money-back guarantee. Ross Radio, 12615-B Grandriver, Detroit 27, Michigan.

PHONOGRAPH RECORDS CHEAP. CATALOGUE, Paramount, BJ-313 East Market, Wilkes-Barre, Penna.

AMATEUR RADIO LICENSES, COMPLETE THEORY preparation for passing amateur radio examinations. Home study and resident courses. American Radio Institute, 101 West 63rd St., New York City. See our ad on Page 95.

SELECTED GROUP OF MEN, GRADUATES OF WELL-known trade school, desire employment in Radio Field. Will travel anywhere. Qualified in radio servicing, installation, test instruments, circuit operation, etc. Contact Placement Dept., Eastern Technical School, 888 Purchase Street, New Bedford, Mass.

WE REPAIR ALL TYPES OF ELECTRICAL INSTRUMENTS, tube checkers and analyzers. Hazleton Instrument Co. (Electric Meter Laboratory), 140 Liberty Street, New York, N. Y. Telephone—BARELAY 7-4239.

NEWSFLASH from Radio Britain. PRACTICAL WIRELESS, Britain's leading radio monthly, covers entire British-European radio-television field. Latest advances "over there" detailed and explained by experts in every issue. Packed with new ideas and information essential to DX "hams" listening to Europe, servicing experts and all radio enthusiasts. For annual subscription (12 issues mailed direct to your address from London), send only \$2.00 to George Newnes Ltd. (PW/39), 342, Madison Avenue, New York 17.

RHORS MANUAIS 6-17. GERNSBACK MANUAIS 1-7. Melssner Analyst. Other instruments. Tubes, Vibrators, condensers, resistors, controls. Amateur parts. Close out. Bargain prices. Write complete list. Albert Arnold, Box 706 Amarillo Texas.

BARGAINS: NEW AND RECONDITIONED HALL-crafters, National, Collins, Hammarlund, Melssner, HME, etc. Wholesale prices. Terms. Shipped on trial. Liberal trade-in allowance. Write: Henry Radio, Butler, Missouri and 11240 West Olympic, Los Angeles, California.

Special March Television Issue
RADIO-ELECTRONICS!

It will contain 144 pages full of valuable information on television in all its phases. Whether you are a serviceman, technician, amateur—no matter what your radio interest—you won't want to miss the Special Television Issue.

MORE AND MORE
TUBES!
are bought from SENCO

THOUSANDS OF TUBES!

ALL BRAND NEW! R.M.A. GUARANTEED!
Immediate Delivery! Individually Cartoned!

Type	Each	Each	Type	Each	Each
OZ4	69¢	59¢	6U6GT	40¢	29¢
1A3	45	39	6U7G	35	25
1C5GT	69	59	6V5G	59	49
1D7G	69	59	6V6GT/G	45	39
1L4	49	45	6W4GT	69	59
1LC6	69	59	6X5GT/G	49	39
1LD5	69	59	7A4	53	43
1LH4	69	59	7A7	59	49
1LN5	69	59	7B6	49	44
1N5	59	49	7B8	69	59
1P5	59	49	7C5	55	49
1Q5GT	55	49	7F8	61	54
1R4	69	59	7N7	49	44
1R5	55	49	7Q7	69	59
1S5	58	48	7X7 (XXFM)	44	35
1T4	69	55	7Y4	44	35
1T5GT	59	49	12A	79	69
1U4	49	39	12A6	29	25
1U5	36	30	12A8GT	35	28
1V	45	39	12AT6	50	45
2A5	54	43	12AT7	69	59
2A7	32	25	12AU6	65	55
2X2/879	35	29	12AV6	49	39
3A4	49	39	12BA6	50	45
3B7/1291	59	49	12BE6	50	45
3Q5	55	49	12F5GT	35	27
354	55	45	12H6	39	34
3V4	79	69	12J7GT	45	39
5U4G	50	40	12K8Y	35	25
5W4GT	39	34	12Q7GT	45	39
5X4G	39	35	12SA7GT/G	40	32
5Y3G	42	37	12SF5GT	40	32
5Y3GT/G	40	33	12SG7	55	45
5Z4	59	49	12SJ7GT	55	49
6A3	69	59	12SK7GT/G	45	35
6A7	50	45	12SL7	49	43
6AC5	69	59	12SN7	49	43
6AC7/1852	79	69	12SQ7GT/G	40	32
6AH6	49	39	12SR7	35	32
6AL7	69	59	12Z3	55	49
6AN5	65	55	14A7	65	55
6AQ7	65	59	14B6	59	49
6AT6	49	39	14Q7	65	55
6BA6	49	39	19T8	89	79
6BE6	49	38	24A	49	39
6BG6G	99	89	25A6G	69	59
6BH6	79	69	25L6GT	55	45
6BJ6	59	49	25Z5	49	45
6C4	29	25	25Z6GT/G	45	39
6C5GT	40	35	26	32	25
6D4	49	45	27	45	35
6F5GT	55	45	32L7GT	52	48
6F6GT	45	39	35L6GT/G	45	39
6F7/VT70	39	29	35W4	43	40
6F8	69	59	35Y4	43	40
6H6GT/G	43	36	35Z5GT/G	43	39
6J5GT/G	45	39	35Z6G	43	39
6J7GT	42	38	36	35	29
6K6GT/G	45	39	45Z5	59	49
6K7	55	45	46	59	49
6K7G	50	41	47	49	39
6K7GT/G	49	39	50	1.49	99
6K8	69	59	50L6GT	50	45
6L5G	69	59	56	55	45
6N4	49	38	57	45	39
6P5GT	55	49	58	45	39
6R7GT	59	49	75	59	49
6S7G	49	45	76	49	45
6SA7GT/G	44	37	77	35	27
6SH7GT	40	32	78	49	39
6SJ7GT	44	37	80	40	38
6SK7GT/G	49	39	81	1.49	99
6SL7GT	49	47	82	69	59
6SN7GT	49	47	84/6Z4	49	39
6SQ7GT/G	44	37	85	49	45
6SR7	43	36	99V	35	25
6SS7	59	49	99X	35	25
6SV7	55	49	117Z6GT/G	79	69
6T8	89	79	1231	39	29
6U5/6G5	69	59	1644	29	19

WRITE FOR OUR FREE CATALOG!

MINIMUM ORDER \$2.50

WHEN ORDERING—Send 25% deposit for all C.O.D. Shipments. Include sufficient postage—excess will be refunded. Orders without postage will be shipped express collect. All prices F.O.B. New York City.

SENCO RADIO INC.

Dept. E, 73 West Broadway
New York 7, N. Y. Tel. BEekman 3-6498

OSCILLOSCOPE KIT

Electronic Instruments Co., Inc.
Brooklyn, N. Y.

This 5-inch oscilloscope is furnished in kit form. The instrument has a gas-tube sweep circuit, vertical and horizontal amplifiers, and sensitivity of 0.65 volt per inch.

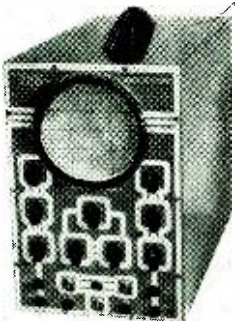
**FM ANTENNA**

Belden Manufacturing Co.,
Chicago, Ill.

The model 8322 Poly-Point antenna is designed for the FM band. It consists of two folded dipoles oriented 90 degrees apart. The pickup pattern is said to be essentially circular. A quarter-wave phasing stub allows the antenna to match the 300-ohm line furnished.

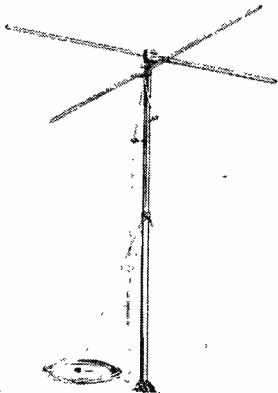
**VU METER MULTIPLIER**

Shallcross Manufacturing Co.,
Collingdale, Pa.

Designed for the audio level indicators used in broadcast and telephone work, this multiplier is only 1 3/4

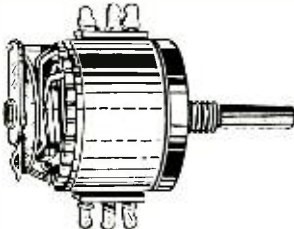

inches in diameter. Using a T-network to present a constant impedance to both line and meter, it is available in two attenuation ranges, 0 to +16 VU and +4 to +20 VU, both in 4-VU steps. Each control has an OFF position in which the meter and multiplier are isolated from the line.

PROFESSIONAL TAPE RECORDER

Fairchild Recording Equipment
Corp., Jamaica, N. Y.

The new magnetic tape recorder is a high-quality unit intended for radio-station use. At a tape speed of 15 inches per second, the recorder is said to deliver performance equal to the usual 30-inch machine. The playback

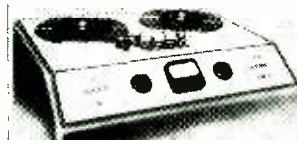

head is slightly behind the recording head, allowing continuous monitoring while recording. Signal-to-noise ratio is 60 db, maximum harmonic distortion 2%, and time accuracy better than one-half second in 30 minutes.

REGULATED SUPPLY

Hastings Instrument Company,
Hampton, Va.

A d.c. power supply with better than 0.1% voltage regulation and less than .01% ripple is intended for industrial and laboratory applications. The supply is adjusted by the manufacturer for any fixed load current and output voltage. Input voltage may be between 75 and 135 volts at 50 to 400 cycles.

**PORTABLE RECORDER**

Harrison Manufacturing Co.,
Chicago, Ill.

The new wire recorder is portable, weighing only 23 pounds. Housed in a leatherette case, it has a cover over the control panel. When the cover is opened, the control panel rolls out, making it more accessible. Recording time of one hour is available, and a player is provided for disc records. The unit may also be used as a PA system or musical instrument amplifier. A microphone is supplied, and a telephone pickup device is available.

**FM-TV ANTENNA**

Andrew Corporation, Chicago, Ill.

The Di-Fan antenna, type 710, is a broad-band unit designed to receive all FM and television broadcasts. The horizontal directivity pattern is a fig-

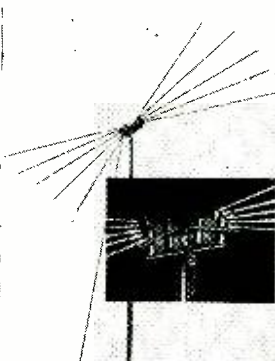

ure eight broadside to the major axis of the antenna. On television channels 7 through 13 the forward gain is decreased somewhat and the angle of acceptance is enlarged. The kit includes a 5-foot steel mounting mast and 60 feet of 300-ohm line. Special kits are available for mounting the Di-Fan to a chimney or a roof.

STL ANTENNAS

Andrew Corporation, Chicago, Ill.

These high-gain parabolic antennas are designed for use with broadcast studio-transmitter links (STL) in the

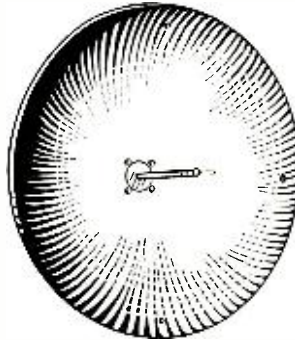

920-960-mc band. They are available in three sizes, 2, 4, and 6 feet in diameter, with gains of 10, 15, and 20 db over a half-wave dipole. The antennas are to be used in pairs—one at the transmitter and one at the receiver—to provide gains of 20, 30, and 40 db over a line-of-sight path. Transmission line should be 52-ohm co-axial cable. The parabolas are made of aluminum.

Each antenna is provided with an easily adjusted mechanism for tilting the beam through ± 10 degrees in azimuth or elevation. Mounting clamps supplied may be attached to iron-pipe supports. The parabolas will withstand wind velocities up to 100 miles per hour.

FOOT-CONTROLLED RECORDER

Webster-Chicago Corporation,
Chicago, Ill.

This version of the Webster wire recorder, known as Model 7, is equipped

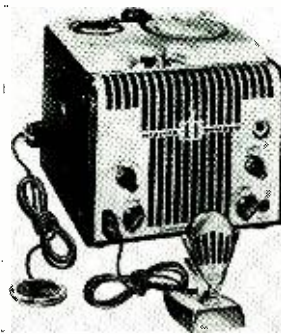

with a foot switch, eliminating most of the hand controlling operations. It is intended for business dictation, interviews, telephone recording, and the like.

SOLDERING IRON TIP

Weller Manufacturing Co.,
Easton, Pa.

Designed for use with Weller Soldering guns, this new Duratip has three to

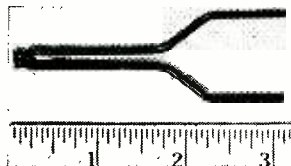

four times longer life than previous models. It is flexible and can be bent around corners to get into odd places. The end is chisel-shaped.

TIME-DELAY RELAY

Agastat Division, American Gas
Accumulator Co., Elizabeth, N. J.

Agastat time-delay relays are used in transmitters to prevent application of plate voltages before the filaments are heated. The initial delay time is one minute. If, during normal operation, a power failure occurs, the relay switches off. If power is restored within 15 seconds, plate voltage is immediately re-applied, but if the off-time exceeds 15 seconds, the relay delays closing the plate circuit for a time proportionate to the duration of the failure.

A combination unit may be made up of several relays to provide delays as long as five minutes.

TUBE TESTER

Hickok Electrical Instrument Co.,
Cleveland, Ohio

Model 533 DM is a display tube tester whose 9-inch meter scale allows

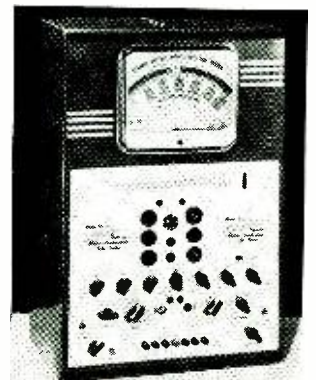

the customer to see the condition of his tube. A mutual-conductance tester, the unit shows transconductance up to 15,000 micromhos. A test is provided for gas and low voltage is available for diodes. The tester measures 26 3/4 x 17 x 11 inches. Flexibility has been provided in the selector switches to take care of unusual tube basing arrangements. Data is given on a roll-type chart.

TV HIGH-BAND ADAPTER

Technical Appliance Corp.,
Sherburne, N. Y.

Designed for use in low-signal-strength areas, this antenna will give high gain on channels 7-13. It is a two-bay folded dipole with reflectors. A coupling clamp is provided to allow mounting above a low-band antenna, and a connecting stub is cut to the correct length for tapping into the lead-in. The standing-wave ratio is unusually low over the entire high-frequency television band.

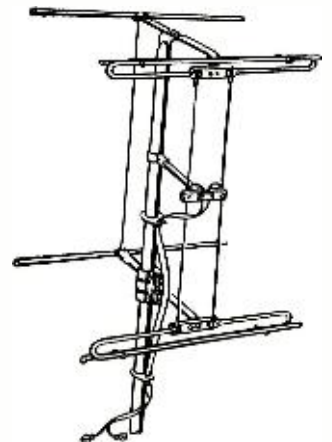

DYNAMOTORS



Type	Volts	Input Amps	Output Amps	Radio Set	Price*
BD 77KM	14	40	1000	BC 191	\$20.00 N
PE 73CM	28	19	1000	BC 375	24.50 N
DM 21	14	3.3	235	BC 312	3.45 N
DM 21CX	28	1.6	235	BC 312	3.45 N
DM 25	12	2.3	250	BC 367	2.49 LN
DM 28R	28	1.25	275	BC 348	8.95 N
DM 33A	28	7	340	BC 456	5.50 N
DM 42	14	46	515	SCR 506	6.50 LN
			1030		
			278		
PE 86	28	1.25	250	RC 36	3.95
PE 101C	137/26	12.6/7	400	SCR 515	5.25 N
			800		
			375		
BD AR 93	28	3.25	285	APN-1	3.50 N
23550	27	1.75	285		3.50 N
35X045B	28	1.2	250		3.50 N
ZA .0515	12/24	4/2	500	Mark II	9.95 N
B-19 pack	12	9.4	275		
			500		
			225		
D-104	12		440		14.95 N
			300		
DA-3A*	28	10	300	SCR 522	3.95
			150		
			14.5		
=5053	28	1.4	250	APN-1	3.95 N
DA-7A	26.5	12.6	1100	TA-23	25.00 N
CW 21AAX	13	6.3	800		37.50 N
			400		
			800		
			9		
PE 94	28	10	300	SCR	15.00 N
			150	522	
			14.5		

N—New. LN—Like New * Less Filter Box & Relays

CERAMICON CONDENSERS \$7.50 per 100

3 mmf. ±5%	67 mmf. ±20%
5 mmf. ±5%	100 mmf. ±5%
4 mmf. ±5%	115 mmf. ±20%
8.5 mmf. ±5%	120 mmf. ±5%
11 mmf. ±5%	240 mmf. ±3%
15 mmf. ±2.5%	250 mmf. ±5%
48 mmf. ±2%	500 mmf. ±15%
50 mmf. ±20%	1000 mmf. ±5%
60 mmf. ±3%	

(Minimum order: 100)

*Silver-Mica Button Capacitors (Erie, Contralab) \$9.50 per 100

185 mmf. ±2.5 mmf	±2.5 mmf
175 mmf. ±2.5 mmf	±2.5 mmf
500 mmf. ±10%	±10%

(Minimum order: 100)

POWER EQUIPMENT

- STEP DOWN TRANSFORMER:** Pri. 440/220/110 volts a.c. 60 cycles. 3 KVA. Sec. 115 v. 2500 volt insulation. Size 12" x 12" x 7" \$40.00
- PLATE TRANSFORMER:** Pri: 117 v. 60 cy. Sec: 17,000 @ 144 ma. with choke. Oil immersed. Size: 24" x 29" x 13" American \$120.00
- FIL. TRANS. UX6899:** Pri: 115 v. 60 cy. Sec: Two 5 v. 5.5 amp w/dgs. 29 KV test \$24.50
- PLATE TRANSFORMER:** Pri: 115/230 v. a.c. 50-60 cy. Sec: 21,000 v. 100 ma. \$145.00
- VOLTAGE REG. Transtat. American type BH** 2 KVA load. input: 90/130 v. 50-60 cy. output 115 v. \$40.00
- FIL. TRANS. KN8767:** Pri: 115 v. 60 cy. Sec: 2 w/dgs: 5 v. @ 5 amps. 15 KV Test. \$15.00

OIL CONDENSERS

1 mfd. 10 KVDC #14F191	\$15.00
66 mfd. 15 KVDC, 25F585-G2	\$ 8.70
1.5 mfd. 6000 vdc	\$12.50
25 mfd. 20,000 vdc	\$17.50
10 mfd. 1000 vdc	\$ 1.79
3x10 mfd. delta connected synchro-capacitor, 90 v. 60 cycles	\$ 4.95
1 mfd. 6000 vdc, 25F509-G2	\$ 6.50
15 mfd. 1000 vdc	\$ 2.25

CROSS POINTER INDICATOR

Dual 0-200 microamp. movement in 3" case. Each movement brought out to 6-term receptacle at rear. Originally used in T.S. equipment. New \$5.50

Typewriter Desk Wells Mounted on Steel Panel for Standard Rack Mtg. 10 1/2" H x 19" W x 1/8" Thick. Well is 22" Wide, 20" Deep, Affording Full Working Space. Grey Crackle Finish. New \$9.90 ea.

TELEPHONE EQUIPMENT F.T. & R. 101-A APPLIQUE

Provides necessary balancing facilities for four wire, or non-loaded or loaded cable. Std. 19" may be voice-frequency telephone lines of open wire, or non-loaded or loaded cable. Std. 19" channel iron rack mtg. Price, new, complete with tech manual. \$54.00

EE-89A REPEATER

Extends range of field telephone apparatus, such as EE-8 up to 25 miles, when inserted in a line. New, with spare tube and instruction manual, less standard type batteries. \$21.50

BC 686 LINE AMPLIFIER

With magnetron ringer, 5 tube 25L6 amplifier. For local point-to-point telephone operation, remote operation of Phone Xmtr. remove reception of receiver output, monitoring facility. Requires only 24 vdc for tube "B" plus supply for full operation. New, less tubes, in wooden chest. \$18.50 Per pair for 2-way pt-to-pt operation. \$35.00

F.T. & R. 102-B REPEATER EE-99

May be used as Terminal or Intermediate Repeater, 20 cycle ringing & DC Telegraph. Applicable on simplex operations. Monitoring facilities, equalizing facilities. Dry or storage battery operation. New \$55.00 Telephone switchboard lamp holders: 10 lamp holders per strip. \$4.25

AUTOMATIC CODE EQUIPMENT
TAPE PULLERS, (McElroy) TP 890, 110-120 v. AC. \$12.50 ea.
TAPE BRIDGES: (McElroy) TG 815, complete. \$3.50
TAPE LOOPS: For TG-8 and TG-9. \$1.00
BLANK CODE TAPE: 47 rolls, 1 1/2" wide. Per roll. \$1.15
MINE DETECTOR
 Model AN/PBS-1 Detector will detect buried Metallic and Non Metallic objects, such as: rocks, pipes, pockets, etc. Ideal for home owners, campers, prospectors. Uses meter and phones for visual and aural indications. Price: New, including detector, amplifier, phones, resonator, and all cables. \$12.75
 With Batteries \$21.65

ARC-3 AUDIO TRANSFORMERS

T-102, #55545	T-104, #55547
T-103, #55546	T-105, #55544
T-206, #55530	

Price, each
 MOD XFMR: PP 807's to PR 807's CL \$1.65
 DRIVER XFMR: 6U6 Driver to PP \$1.11
 Grids \$1.45
 UNIVERSAL OUTPUT: American Silar, PIR: 20,000, 16,000/5000/4000 ohms. Sec: 500/15/7.5/3.85 ohms. 30db. content flat to 17,000 CY. \$2.75

131-C
 Liberty St.
 New York 7, N.Y.

All merchandise guaranteed. Mail orders promptly filled. All prices, F.O.B. New York City. Send Money Order or Check. Only shipping charges sent C.O.D.

COMMUNICATIONS EQUIPMENT CO.

MANUFACTURERS QUANTITIES AVAILABLE

PHONE DIGBY 9-4124

PLASTIC IGLOOS ATOP A NEW YORK SKYSCRAPER PROTECT TV ANTENNAS

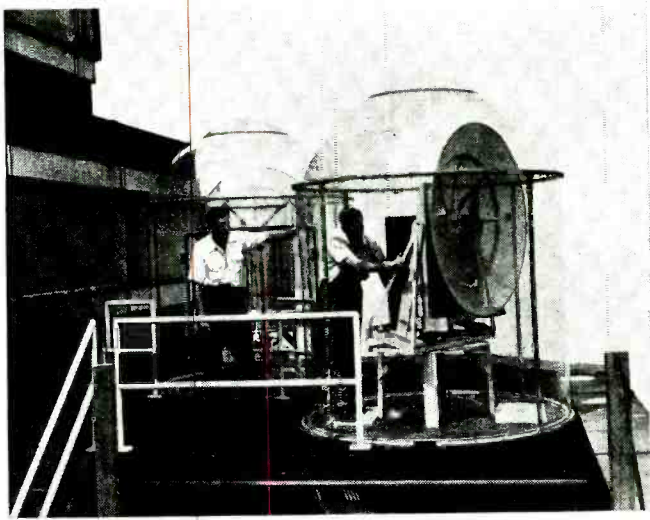

Plastic "igloos" are employed on the 87th floor of the Empire State Building in New York City to house NBC and A. T. & T. television receiving antennas. The antennas, which pick up signals from remote-televasting mobile units, must be protected against wind, moisture, dirt, and cascades of destructive winter ice. Each housing is a gigantic bell jar of half-inch-thick Plexiglas seven feet in diameter and six feet high. The hemispherical domes are 30 inches deep. Reinforcing caps atop the domes will withstand a direct hit by falling ice and anchoring is strong enough to resist hurricane winds. The Plexiglas, a material used extensively during the war in aircraft, as well as for other purposes, is shatterproof and does not affect in any way the reception of radio and television signals.

FEBRUARY, 1949

FOR TELEVISION TESTING AND SERVICING

Advanced practical engineering gives you

TEE VEE SCOPE Model TV-90

NET PRICE \$12750

Combines the two essential instruments needed in television testing—alignment—service. A complete oscilloscope and a complete sweep generator that can be used independently. Tee Vee 90 combines two units for compactness and portability—meticulously engineered in advanced design and construction. Oscilloscope also has its own variable linear sweep. Sinusoidal sweep with phasing control for use with internal R.F. sweep generator when testing band pass characteristics. Synchronization provision for either internal positive, external or line frequency. Z axis terminal permits intensity modulation of electron beam. Input jack provided for marker signal. Independent sweep has range of 4.5 to 40 m.c. in 3 bands giving choice of any I.F. frequency desired. Band width can be varied continuously from 50 K.C. to 50 M.C. Attenuation of R.F. output is continuously variable and is applied through low loss coaxial cable. Traveling deflector probe included for observing signal at any point of R.F. circuit under test. 105-130 volts 50-60 cycles. Weight 25 lbs. Size 14 x 18 x 12 1/2 inches. Finished in attractive hammer-tone grey. Supplied complete with tubes, probe, coaxial output cable and operating instructions ready to operate.

Write for Catalogue 2C

RADIO CITY PRODUCTS CO., INC.

152 WEST 25th ST NEW YORK 1, N. Y.

Question Box queries will be answered by mail and those of general interest will be printed in the magazine. A fee of \$1.00 will be charged for questions requiring no research or schematics. Write for estimate on questions requiring diagrams or considerable research. Be sure to give full specifications and details on the application. Due to the nominal fees charged for this work, it must be handled as a spare-time proposition. Therefore rapid service is impossible. Six to 8 weeks is required to draw up answers involving large schematics or research.

V.H.F. RECEIVER

? Please give me a diagram for a miniature receiver for 157 mc.—E.O., Norwood, Ohio.

A. The receiver shown uses three subminiature tubes and can be built as small as a hearing aid. A square-law detector (the first 2E36) acts as a broad-band r.f. stage without variable tuning. This makes for smaller components.

L is wound on the glass envelope of the detector. While the parts list

specifies five turns for the coil, some experimenting will have to be done to determine exactly the right number of turns; one too few or too many will cause the receiver to miss the desired band entirely. Once the right number is found, cement the coil in place. If the band received is too broad, try removing a turn and adding a small (1- or 2- μ f) ceramic capacitor in parallel with the coil.

A straight wire the length of a pencil will make a good antenna. Satisfactory headphone reception should be had within line of sight of the transmitter.

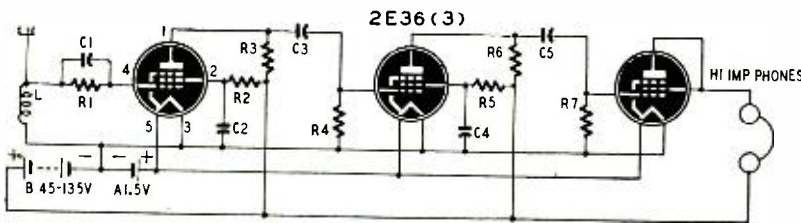

- R1, R4, R5—2.2 megohms, 1/2 watt
- R2—3.9 megohms, 1/2 watt
- R3, R6, R7—1 megohm, 1/2 watt
- C1—300- μ f mica
- C2, C3, C4, C5—.002- μ f, 150-volt paper

- L—5 turns wound around envelope of first 2E36 (see text)
- B1—1.5-volt battery
- B2—45- to 135-volt B-battery

TG-10 AS AMPLIFIER

? Please show how I may use the TG-10-F (surplus code-practice outfit) as an audio amplifier.—G.S., Milton, Oreg.

A. The diagram shows the completed

amplifier after the TG-10-F has been converted. Inputs are provided for microphone and phonograph or tuner, and a bass-treble tone control has been added. Output is about 30 watts maximum, so use a loudspeaker of at least that rating. Be sure to shield the input circuits to avoid hum.

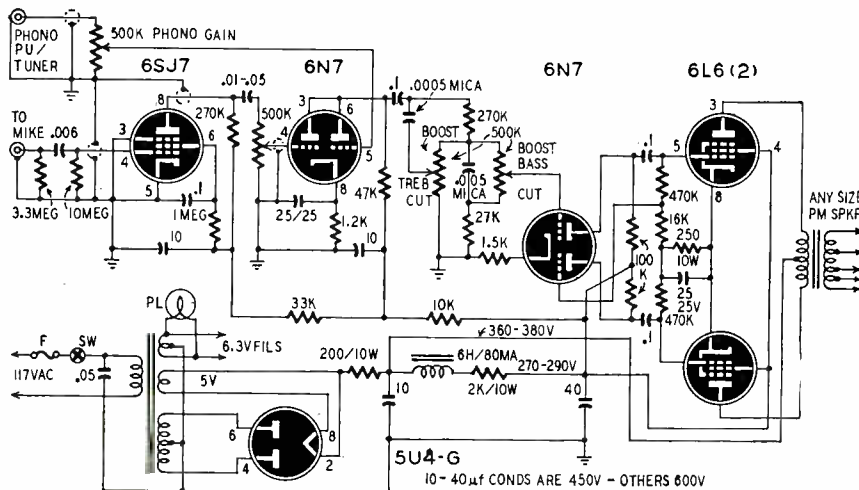

NO MORE COMMERCIAL SCHEMATICS

We are no longer able to supply schematic diagrams of commercial radio receivers, as our stock has been exhausted. If individual schematics are needed, the best source is usually one of the publishers who specialize in servicing information. Most wholesale houses and parts jobbers also have a supply of diagrams.

TWO-STAGE AMPLIFIER

? I have built a two-tube receiver, the audio output of which is very low. Please show a two-stage audio amplifier which I can add to the receiver to get enough output to operate a speaker.—R.Y., Raymondville, Tex.

A. The amplifier diagrammed can be connected to your receiver's detector. The B-supply should furnish about 250 volts at about 45 ma.

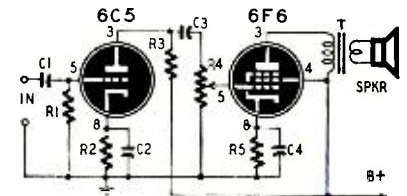

- R1—100,000 ohms, 1/2 watt
- R2—10,000 ohms, 1/2 watt
- R3—270,000 ohms, 1/2 watt
- R4—500,000-ohm potentiometer
- R5—650 ohms, 1 watt
- C1—.05- μ f, 400-volt paper
- C2—10- μ f, 25-volt electrolytic
- C3—.01- μ f, 400-volt paper
- C4—25- μ f, 25-volt electrolytic
- T—output transformer, 7,000 ohms to voice coil
- SPKR—PM speaker

MICROPHONE MIXER

? Please show me how I can connect four high-impedance microphones to a single high-impedance amplifier input. Each mike should have its own volume control.—M.L.S., Reading, Pa.

A. The mixer shown in the diagram will do the trick. Since the 6SC7 plate

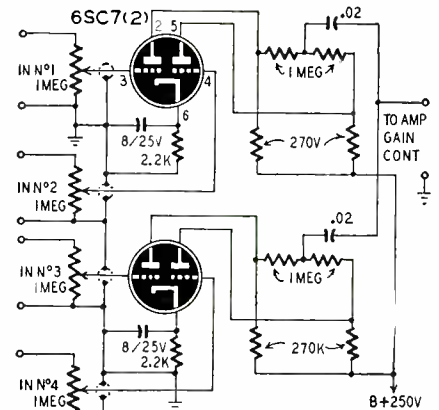

current is low, plate voltage can probably be taken from the B-supply of your amplifier. The four gain controls will not interact, and the main amplifier gain control is a master volume control for all four channels. Everything up to the 6SC7 grids should be shielded, and all other wiring should be kept as short as possible. If there is space on the main amplifier chassis, putting the mixer there will avoid long leads. If there is too much hum, additional shielding may be necessary. Do not add any extra shielding, however, before testing the mixer. If you can do without it, you will not run the risk of cutting down the high-frequency response.

COIL DATA

? Please give coil data for a super-heterodyne receiver operating on the broadcast and 5.8-18.3-mc bands. The set will have an r.f. amplifier. All coils are to be wound on plug-in forms 1 3/8 inches in diameter and 2 1/4 inches long.—G.F.S., Chicago, Ill.

A. Each of the five coils L1 through L5 are identified in the diagram.

For the broadcast band, L1 is 114 turns of No. 26 enameled wire, close-wound. L2 and L3 are 300 turns of No. 36 s.c.e., lateral- or jumble-wound, with L2 spaced about 1/8 inch from L1 inside the coil form. Alternatively, L2 may be about 180 turns of the same wire, 1/8 inch long, spaced 1/8 inch from L1 and wound on the outside of the form. L4 is 325 turns of No. 36 s.c.e., 1/8 inch long, jumble- or layer-wound, and spaced about 1/8 inch from L3. L5 is 78 turns of No. 26 enameled wire, 1 1/4 inches long, with the cathode tap 20 to 26 turns from the ground end.

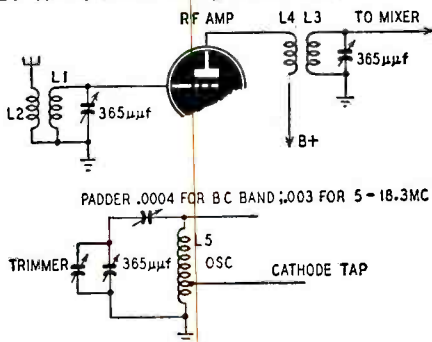

For the 5.8-18.3-mc. band, L1 is 9 turns of No. 18 enameled or s.c.e., 1 inch long. L2 and L3 are 3 to 4 turns of No. 18, close-wound, with L2 spaced about 1/8 inch from L1. L4 is about 4 turns of No. 18 wire, close-wound, about 1/8 inch from L3. L5 is 10 turns of No. 18 enameled or s.c.e., 1 inch long. The tap is about 4 turns from the ground end.

CROSSOVER NETWORK

? Please give me a design for a suitable 4,000-cycle crossover network?—B.T., Los Angeles, Calif.

A. In the crossover network shown in the diagram, the four switched capacitors control the level of the high-frequency output. The values given for

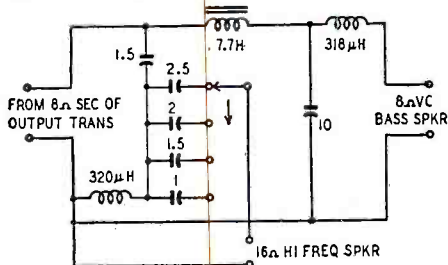

the r.f. and audio chokes are exact calculated values. Since it may be difficult to find or make units with these values, the nearest sizes can be used, with some change in crossover frequency.

Coming Next Month

RADIO-ELECTRONICS BIG ANNUAL TELEVISION NUMBER

Keep Posted on

TELEVISION'S NEWEST TECHNICAL ADVANCES

Watch for the March RADIO-ELECTRONICS—the 144-page SPECIAL TELEVISION ISSUE. Here you will see the amazing progress of television brought up-to-date. It will give you in brilliantly sharp close-up every important technical development—information that any man vitally interested in the subject can profitably apply. The issue will tell you:

- what striking technical advances have been realized during the past year
- where the industry is headed
- how you can tie in your own efforts with the current trend

Business leaders, as well as engineers and other technicians will give you the inside story. The newest models will be revealed and taken apart for you so you can study their circuits and components. You will learn what is new in television test instruments—how and where to install antennas to get best results—and how to service television so you can make a good living out of it. Charts will be liberally supplied along with a complete tabulation of receivers and their characteristics.

Be sure to look for this Special Issue. Ask your newsdealer or radio store to reserve a copy for you—or, better still, send us your subscription at once so we can set aside your copy.

RADIO-ELECTRONICS

25 WEST BROADWAY

NEW YORK 7, N. Y.

\$1,000 A MONTH

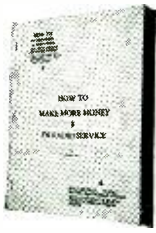

That's what **JUST ONE** of the many plans in this book brought in—over \$1,000 a month, steadily, from radio service alone. **HOW TO MAKE MORE MONEY IN RADIO SERVICE** is so full of money-making plans and ideas it will amaze you. Why work for wages? Why not become your own boss and make more money? **EVEN BEGINNERS** who used some of the easier plans in this book averaged **WAY OVER \$100 A WEEK** just working from home. This book is making money for servicemen and beginners, everywhere—U.S.A., Canada and other countries, Letters of thanks are continually coming in.

Puerto Rico, Mexico, So. America, Hawaii, Philippines, and other countries. Letters of thanks are continually coming in.

AT LAST!

The real money-making secrets of radio service are given out in this book.

- Book very helpful—follow—Best of its kind that have ever been printed.
- In business 10 years—received many valuable pointers—read it 3 times. Would not take twice the price for it. . . .
- In radio 17 years—book contains far more information than expected.—Every radio man should have this book.

25 years experience are packed in this 83 page book, 8 1/2 x 10 1/2, by V. Gale, for servicemen, beginners, students. Among **MANY OTHER THINGS** it shows you where the money is and how to get it. **EASY!** How to get plenty of customers; How to test sets without taking them out of cabinets and give estimates **QUICKLY!** How to operate spare time and build to full time; How much to charge; How to connect with certain **BIG MONEY** concerns; How to increase business and expand. Send for this book today and start making more money almost as soon as you get it. The full price is only \$3 (any convenient form) postpaid; or C.O.D. at \$3 plus a few cents postal charges. You have nothing to lose. Examine it for 5 days. If you aren't positively delighted return it and we will refund your \$3 promptly. If you want more information about the book send for literature #2-RE. It's free.

MERIT PRODUCTS, DEPT. RE,
216-32 132 Avenue. Springfield Gardens 13, N. Y.

telrex INC.

CONICAL ANTENNAS

RUTHERFORD AVENUE ON ROUTE 35
ASBURY PARK, N. J. PHONE: ASBURY PARK 1-0119
BOX 879R, ASBURY PARK, N. J.

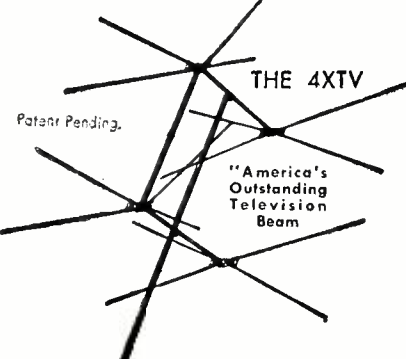

- Hi-Gain Stacked Conical "V" Beam
- Channels 2 to 13 Plus FM
- Low Inception Angle
- Extremely High Signal to Noise Ratio
- 150 Ohm Non-varying Impedance
- Use 72, 150 or 300 Ohm Transmission Lines
- Universal Mounting Clamps

SEE YOUR DISTRIBUTOR

Dr. Vladimir K. Zworykin, vice-president of *RCA Laboratories Division*, Princeton, New Jersey, received last month the Poor Richard Club's 1948 gold medal of achievement in recognition of his invention of the electronic scanner, a major step in the development of television. The award was presented on Benjamin Franklin's birthday anniversary, January 7, 1949, at a public ceremony in Franklin Institute, Philadelphia, Pa. Harry L. Hawkins, president of the Philadelphia Club of Advertising Men said in announcing the award, "Without the invention of the electronic scanner, television would still be a laboratory toy."

Paul V. Galvin, president of *Motorola, Inc.*, Chicago, has announced the appointment of his son, **Robert W. Galvin**, to the post of executive vice-president of the radio and television firm. The new official is 26 years old and has been



a director of the company since 1945. The post he now occupies has been vacant since 1944, following the death of Joseph E. Galvin, who was co-founder of Galvin Manufacturing Company. Motorola's predecessor corporation.

Dorman D. Israel, executive vice-president of *Emerson Radio and Phonograph Corporation* and chairman of the Receiver Section of the RMA Engineering Department, was presented with the annual RMA-IRE award at the Rochester, N. Y., engineering meeting. The annual plaque was for his services in the receiver standardization work of the RMA Engineering Department and was presented by Associate Director Virgil M. Graham at the annual dinner attended by 800 engineers at the Rochester meeting.

Dr. William W. Eaton has been appointed to the Central Research Organization of *Olin Industries, Inc.*, East Alton, Ill., it has been announced by Mr. Fred Olsen, the organization's director of research and development. Dr. Eaton's appointment follows the recent formation of the Central Research Organization, established to assure responsibility for the long-range research activities of Olin Industries, parent organization of the Western Cartridge Company Division and Winchester Repeating Arms Division.

Nelson P. Case has been elected vice-president in charge of engineering and research of *Hallcrafters Co.*, Chicago. Mr. Case, a graduate of Leland Stanford University, is the holder of about thirty radio circuit patents. He has been assistant physicist in the Bureau of Standards, Washington, D. C., and was a research physicist at the University of Michigan. In 1946, he came to Hallcrafters as chief engineer.

AGAIN!! A GREAT VALUE from MORT'S RADIO SHACK . NEW HF 10 TRUSOUND AMPLIFIER



The HF 10 amplifier is a general purpose unit of small size (6" x 9" x 7") designed for high quality reproduction of sound, music and speech from records, radio and microphone. It is engineered and built to meet the high quality standards required of an amplifier when used in conjunction with the new high fidelity pickups, FM-AM

tuners and wide range speaker systems.

NOTE THESE TERRIFIC FEATURES

- 10 watts undistorted power output 18 watts peak.
- Inputs: High Gain for variable reluctance pickups; for high impedance mikes. Low Gain for FM-AM tuners and high output pickups.
- Selector switch for rapid changeover.
- Hum level 70 db below 12 watts.
- Tone compensation. Separate continuously variable bass and treble controls.
- Treble—from plus 10 db to minus 15 db at 10,000 cps.
- Bass—from plus 10 db to minus 15 db at 50 cps.
- Note—that characteristics obtained with controls centered.
- Output impedance 2, 1, 8, 16 and 500 ohms.
- Straight AC for 110-120V 50-60 cycles fused.
- Tubes—6SL7, 6SC7, 2-6V6, 5Y3.
- Chassis and shield silver spray hammerfoid finish.

Compares equally with Amplifiers selling for as much as \$75.00.

Yours for only. **\$29.95**

Complete with Tubes and Cover

WRITE FOR OUR FREE 1949 CATALOG

TERMS: 25% Deposit with order. Balance C.O.D. F.O.B. Chicago

Mort's Radio Shack
Dept. RC-2
630 W. Randolph St. Chicago 6, Illinois

TECHNICAL KO's

Special: 10% discount on orders of \$5.00 or more.

OIL-FILLED CONDENSERS		TRANSMITTING MICAS	
.05 MED	1000V \$0.33	.00005	2500V \$0.13
.05	500V .14	.00005	3000V .35
.1	2500V .73	.00005	5000V .85
.1	7500V 1.65	.00007	2500V .20
2x.1	7000V 4.10	.00007	2500V .20
.12	15000V 7.95	.00025	2500V .25
.25	1000V .35	.00025	3000V .25
.25	4000V 2.13	.0005	2500V .85
.25	6000V 3.75	.00072	2500V .85
10x.25	600V 1.05	.0008	5000V .85
.5	600V .28	.0001	2500V .25
.5	1000V .40	.0011	5000V .85
.5	2000V .75	.002	1000V .20
.75	400V .30	.0025	3000V .65
.85	600V .35	.003	2500V .30
1.0	1000V .43	.003	3000V .65
2.0	200V .20	.004	2500V .35
2.0	600V .40	.005	1000V .15
2.0	1000V .60	.005	3000V .65
2.0	600V .60	.006	2000V .35
4.0	1000V 1.00	.008	1200V .15
5.0	220VAC .35	.01	1200V .15
6.0	1000V 1.45		
8.0	600V .85		
8.0	1000V 1.75		
10.0	600V 1.00		
30.0	90VAC 1.40		
30.0	250VAC 3.75		

25.0 Electrolytic 25V .40
100.0 25V .30

SHIELDED WIRE #22 50 Ft. for .65
RESISTOR KIT Assorted 1/2 & 1W 100 for 1.49
BATHTUB KIT 3x1, 5, .05, ETC. 10 for .58
CONDENSER KIT .01-.00001 . . . 100 for 2.99
MICAS .01, .002, .005, ETC. All Values .08
.01 150V PAPER (MIDGET) 60 for 1.00
.01 600V PAPER 8 for 1.00

\$2.00 min. order F.O.B., N.Y.C. Add postage 50% deposit, balance C.O.D. with all orders. Manufacturers inquiries invited. Send for Flyer. Prices are subject to change without notice.

TECHNICAL RADIO PARTS CO.
MOVED TO LARGER QUARTERS
557 McDonald Ave., Brooklyn 18, N. Y.
DEPT. RE-9

Dr. Ladislaus L. Marton has been appointed chief of the Electron Physics Section of the National Bureau of Standards, Washington, D. C., where he will direct research on the basic theory, methods and applications of electron- and ion-beam devices, including interaction phenomena between charged particles and matter.

R. K. McClintock, assistant to the chief engineer of Sylvania Electric Products, Inc. of Emporium, Pa., delivered a paper to the Rochester, N. Y., fall meeting of the IRE and the RMA on how miniature electronic and radio equipment has been designed to provide for the needs of new applications where compactness and light weight are mandatory.

He recalled that the trend toward miniaturization, which is now vital in many applications, was given impetus by the wartime development of the proximity fuze. The tubes, revealed after V-J day, were considered revolutionary, but since that time, dozens of tiny tubes have been developed for wide radio and electronic application.

Frank M. Folsom was elected president of Radio Corporation of America last month on the recommendation of David Sarnoff, chairman of the board of directors. As executive vice president in charge of the RCA Victor Division, Mr. Folsom administered RCA's production and merchandising activities for the past five years. John G. Wilson succeeds Mr. Folsom in his former post.

V. C. Havens was appointed last month to the post of assistant general sales manager of the Crosley Division, Avco Manufacturing Corporation, Cincinnati, Ohio. Mr. Havens is in charge of advertising, sales promotion, and public relations. His headquarters are at the Crosley main offices in Detroit. Mr. Havens' last post was with Consolidated Vultee Aircraft Corporation; prior to that he spent 18 years with General Motors and was an account executive with the Campbell-Ewald advertising agency in Detroit. He is a graduate of the University of Michigan.



"Hello, Mary, I'm working on an important chassis, so will be home late for supper!"

FEBRUARY, 1949

DRILL PRESS OWNERS! Get This Transformer as a SPOT WELDER \$18.95

Attaches to your drill press to make a professional SPOT WELDER! Highest quality N.W. war surplus. Orig. Gov't. cost over \$160.00. Free copy of picture 1-2-3-4-5 book with each transformer. Containing 105 to 125 V. Sec. 2:1 @ 100 amps. 33Kc ins. Shipping weight approx. 100 lbs.

COMPLETE SUPREME SPOT WELDER KIT— \$39.95 BRAND NEW READY TO INSTALL

Includes 1 transformer* (for welding 16 ga. steel), cable, lugs, connectors, tips, FREE INSTRUCTION BOOK, etc. Your present drill press does double duty with this amazing SUPREME KIT. Install it yourself in a jiffy (no special tools needed) and you've got a combination drill press and spot welder in one! Ideal for all types of welding in industrial plants or home workshops. Will withstand continuous production duty. Operates from house current circuits. 110 V. 50 or 60 cycles @ 30 amps. Easy to install. Complete with step-by-step picture instruction book. *Order the transformer for welding up to 12 ga. steel. COMPLETE PICTURE INSTRUCTION BOOK, alone—50c ea.

VIBRATOR Synchronous (Self-Rectifying)
Hermetically Sealed
Good for 100 million hours. Does not require rectifier tube. Fits standard oval tube socket. Orig. Gov't. price over \$5. Shpg. wt. 2 lbs.
6 Volt Model...\$1.79 12 Volt Model...\$9.9c

NEW! RL-42-B ANTENNA REEL Motor & Gear Box Perfect Beam Rotator

Lightweight (4 lbs.), easy mounted, magnetic clutch, will reverse with s.d.d.t. switch. Also for barbecue spit or dome opener. Many other uses. Shpg. wt. 9 lbs. \$4.25
SEND NO MONEY—WE MAIL C.O.D. or save C.O.D. charges by enclosing check or money order. Shipment made by either last truck freight or express collect, or by parcel post if postage is included with order. No deposit required on C.O.D.'s. No orders less than \$2.50 please.

ELECTRONIC SALES COMPANY
5559 West Adams—Dept. RC-2
Los Angeles 16, Calif.

OUTSTANDING VALUES

3 TUBE PHONO AMPLIFIER
\$1.95

COMPLETELY WIRED, VOLUME and TONE CONTROLS

Set of 3 tubes: 50L6, 35Z5, 12SQ7.....	\$1.25
Output trans. 50L6.....	.35
1/2 Meg. vol. control.....	.15
1/2 Meg. vol. control with sw.....	.35
AB dual control 200M ohm.....	.69
4" pm speaker.....	.95
5" pm speaker.....	1.15
6" pm speaker.....	1.55
6x4" pm speaker.....	1.39
8" pm speaker.....	2.65
Webster pickups.....	1.79
Standard Cartridges 10 MED-400V.....	1.49
Alliance motor & Turntable.....	2.50
Russell Deluxe Motor & T.T.....	2.79
G.E. Reluctance Cartridge.....	4.54
Phono Pre-Amplifier complete with tubes.....	4.95
Phono Oscillator complete with tubes.....	4.52
Oscillator Coil, 12SA7.....	.15
WEBSTER-CHICAGO Dual Speed Automatic Record Changer, Model 246.....	29.25
VM 400 INTERMIX CHANGER	
Automatic Stop—Special Price.....	\$19.95
SEABURG 3 POST INTERMIX CHANGER	
Automatic Stop with Q.T. Cartridge.....	\$27.50
Slow speed motor and T.T.....	3.89
Slow speed pickup with QT cartridge.....	3.89
F.P. cond., 4 section, 10 MED-400V.....	.39
I-F transformers 45KC input or output, ea.....	.39

STANDARD BRAND TUBES THOUSANDS IN STOCK
All prices F.O.B. N.Y.C.—on C.O.D. 25% Deposit. Write for latest circular

THE ROSE COMPANY
98 Park Place, Dept. C, New York 7, N. Y.

32 FACT-PACKED PAGES
Only 25c
AMPLIFIER CORP. of AMERICA
398-10 Broadway New York 13, N. Y.

Radio - Television - Electronic Parts & Equipment Specials

TELEVISION-CATHODE RAY HIGH VOLTAGE

2000 volt D.C. Power Supply
For an unbelievably low price, we can supply a completely filtered television or cathode ray 2000 volt D.C. power supply. Why bother with bulky and dangerous 60 cycle supplies or expensive R.F. power supplies when you can purchase a complete 2000 volt D.C. unit (not a kit), ready to plug into the 110 volt A.C. power line. The ridiculously low price has been made possible by a fortunate purchase of high quality components. These units are brand new, completely tested and guaranteed.

Price \$7.95

4000-6000 VOLT TELEVISION SUPPLY

Similar to the unit above, but has a much higher D.C. output voltage suitable for use with the new 7" and 10" television tubes.

PRICE.....\$12.50

RADIO NOISE FILTERS

Eliminates extremely noisy radio reception due to power line disturbances caused by lights, refrigerators, washing machines, vacuum cleaners, elevators, oil burners, diathermy machines, etc.

Filters out man-made noises in the broadcast, short-wave, and ultra-high frequency bands.

Designed for all radios, appliances, and electrical equipment consuming up to 1300 watts (12 amperes at 120 volts AC or DC).

Housed in a metal case 1 3/4" x 3" x 7 1/2" complete with male and female line connectors.

PRICE..... ONLY \$2.25

EASILY ASSEMBLED RADIO KITS

5 Tube AC-DC superhet kit furnished in a brown plastic cabinet of artistic design, cabinet size (9"x3"x6")

Variable condenser tuned; with 2 double tuned I. F.'s.
Tubes used: 1 - 12SA7, 1 - 12SQ7, 1 - 12SK7 1 - 35Z5 and 1 - 50L6

PRICE \$11.95 Including 5 standard tubes

6 TUBE 3 WAY PORTABLE KIT

- For operation on 110 volt AC or DC and battery
- Superheterodyne circuit
- Full vision dial
- High gain loop
- Cabinet of Blue Aeroplane cloth finish, size 13x9 1/2"x7"
- Tubes used 1A7, 1H5, 3Q5, 117Z6 and 2 - 1N5

PRICE \$13.75 Not including tubes
Extra for Kit Tubes \$3.75

6 TUBE, 2 BAND SUPERHET KIT

Bands covered BC 550-1600 KC and 6-18 MC
Power supply 105-125V AC, DC
Full vision dial
Variable condenser tuned, with two double tuned I. F.'s 455KC

Walnut veneer wood cabinet
PRICE \$15.75

A SCIENTIFICALLY DESIGNED PHONO SCRATCH FILTER

Resonated at approximately 4500 cycles effectively reducing objectionable needle scratch without altering the brilliancy of reproduction.

Contains a HI-Q SERIES resonated circuit. Tested by means of an audio oscillator and an oscilloscope to give 22 db. attenuation with very low signal loss.

Just two wires to clip on. Compact
Price..... \$1.98

THREE TUBE PHONO AMPLIFIER

An assembled unit ready for installation using tone and volume control and six feet of rubber cord
PRICE \$2.95
(Not including Tubes)
With Complete Set of Tubes.....\$3.95

PHONO OSCILLATOR

Wireless phono oscillator transmits recording for crystal pick-ups or voice from carbon mike through radio without wires. Can also be used as an intercom by using P.M. speaker as mike. Price \$2.55 (excluding tubes)

With Complete Set of Tubes.....\$3.95

SPECIAL! SPECIAL!

Mammoth assortment of radio and electronic parts, not less than TEN POUNDS of new transformers, chokes, condensers, resistors, switches, coils, wire, hardware, etc. A super-buy for experimenters, service-men, and amateurs for only \$1.25

Satisfaction guaranteed on all merchandise.
All prices F.O.B. New York City
WRITE FOR FREE CATALOGUE

RADIO DEALERS SUPPLY CO.

154 Greenwich St. New York 6, N. Y.

TWO WAYS

to cut your RECORDING COSTS!

Find out about the MAGNETIC TAPE RECORDER that doubles your playing time, cuts your tape costs in half! Write today for technical literature.

AMPLIFIER CORP. OF AMERICA

398-10 Broadway, New York 13, N. Y.

FREE

TECHNICAL DATA CARD

RADIO ELECTRICAL COLOR CODES, FORMULAS, HELPFUL HINTS. SEND FOR YOURS TODAY.

RADIO MAIL ORDERS

75 Barclay St., Dept. RE, N. Y. 7, N. Y.

METERS LAB. & SERVING TYPES

- Precision 844 6000 VAC & DC Ohms 0-10 Meg. Amps 0-12 Mils 0-1200 34 ranges in Walnut Port. case
- Hi. V. Prods. & inst. book, Reg. \$39.50, new... \$24.75
- Weston 280 DCV 0-150 DCA 0-30, 3 ranges, each... 14.95
- Weston 155 0-30 VAC Lab. meter, new, Reg. \$75... 24.50
- Weston 663 DCV & Ohms in case, Reg. \$69, Used... 22.50
- Test set 1-236 for Res. Cap. AC-DCV W/prods... 2.95
- Amps 0-15 3/4 sq. mirror scale W/loads, new, spec... 3.95
- DB 3" R Triplett Rect. type Q level 6 MV, new... 3.95
- RP 0-1, 0-5, 0-8, 2" R Pop. Make your choice, new... 2.25
- Mil 0-2 Roller Smith, 3" R, New, orig. box... 3.50
- Mil 0-500 Hallifiers, 3" sq. New, orig. box... 3.25
- Ther. type 0-3 A. 25-200 KC West. FT-14, new... 4.95

McCONNELL'S 3834 Germantown Ave. Phila., Penna. RA-5-0633

Prepare for a Good Job Now in

RADIO TELEVISION F.M.—ELECTRONICS

LEARN QUICKLY IN THE GREAT SHOPS OF COYNE

NOT A HOME-STUDY COURSE

Get ready for a better job, bigger pay NOW in Radio-Television. Cash in with "All-around" knowledge of Radio—F.M.—Television Service. Train on actual equipment, not by "Home-study". Learn quickly at Coyne—it's a real shop course!

50th ANNIVERSARY YEAR

G.I. APPROVED... also Finance Plan for NON-VETERANS. Don't let lack of cash hold you back. Many earn while learning. Special plan for men of draft age. Get facts today!

SEND COUPON FOR FREE BOOK Send at once for Big Free Book on Radio, Television, F. M., Electronics and facts about our Finance Plan.

MAIL THIS COUPON TODAY

Coyne Electrical and Radio School 500 S. Paulina St., Dept. 29-8H, Chicago 12, Ill. Please send Big FREE Book and complete details.

NAME.....
STREET.....
CITY.....STATE.....

The Annual Television Issue of RADIO-ELECTRONICS will appear next month. Articles on all phases of television and descriptions of all types of television equipment will appear in this special big 144-page number. Reserve your copy at your dealer today!

R.F. LOSS MEASUREMENT

Patent No. 2,449,621

Walter van B. Roberts, Princeton, N. J. (assigned to Radio Corp. of America)

When a series circuit is tuned to resonance, the voltage across the coil (or the condenser) is proportional to its Q. This gives a method for measuring the losses in a coil or condenser. With the conventional Q-meter it is difficult to measure small differences unless a very sensitive voltmeter is used. Such an instrument is susceptible to damage. This patented circuit can compare or measure coils or condensers where the losses are almost equal, yet the meter is protected against overload.

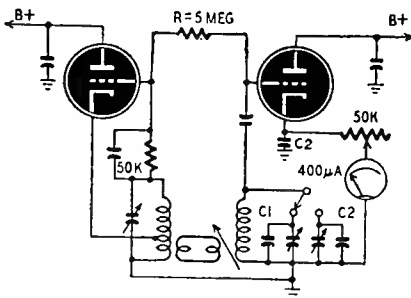

The first tube is an r.f. oscillator which supplies voltage through a link to the second tube which operates as a v.t.v.m. To measure or compare two condensers, for example C1 and C2 as shown, the switch is thrown to C1. The trimmer is adjusted for resonance and the maximum reading is noted on the meter. Now the switch is thrown to connect C2 and its trimmer. As before, the trimmer is resonated and the reading taken. The meter readings are proportional to the circuit Q in each case.

The microammeter is protected in two ways. When current increases through it, the grid bias rises and limits the current. The meter is also protected against unexpected increases in the r.f. signal. If oscillator output increases, oscillator bias rises. The resistor R transfers this voltage to the voltmeter tube to counteract the increase in meter current which would occur otherwise.

SUBHARMONIC GENERATOR

Patent No. 2,451,480

James O. Edson, Great Kills and Donald M. Terry, Brooklyn, N. Y. (assigned to Bell Telephone Labs)

The frequency of 20 c.p.s. needed for telephone ringing supply is conveniently obtained from the line. This invention is simple and efficient for making the needed conversion.

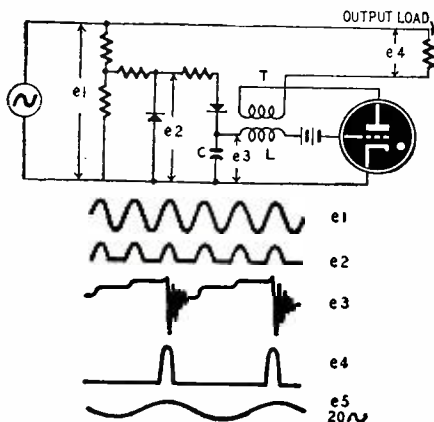

The sine-wave, 60-cycle supply is shown as e1. After the first rectifier it becomes e2, across the second rectifier and condenser C. Current can flow through the second rectifier to charge the condenser. The charge takes place in steps as each half-wave adds its current. At some critical value, the voltage across C is sufficient to overcome the negative bias on the gas-filled tube. It then breaks down and current flows in the

plate circuit. The stepped condenser charge is e3. Note that the discharge is oscillatory because of the presence of both L and C and the positive feedback of transformer T. As a result, the charge is quickly dissipated.

The plate current e4 is filtered by the load. Plate voltage is taken from the line.

The output voltage e5 has a strong 20-cycle component. If desired, the other components may be eliminated by a low-pass filter.

IGNITRON FIRING

Patent No. 2,444,921

John W. Dawson, W. Newton, and Hans Klemperer, Belmont, Mass. (assigned to Raytheon Mfg. Co.)

A vapor-filled tube may be started by passing a current through its igniting electrode. This current must exceed a critical value and must last for a few microseconds. To fire a tube at high frequency (such as 1,000 c.p.s.) the exciting current must be practically a square wave. A gradual rise and fall is not desirable because of the high frequency and because anything less than the critical value merely heats the electrode unnecessarily.

A wave-shaping circuit (A) provides the steep wave for the starting electrode of the ignitron. Timing of the breakdown is controlled by the thyatron (T) which is supplied with d.c. through a diode. Tube T conducts for a definite interval of time determined by its grid voltage.

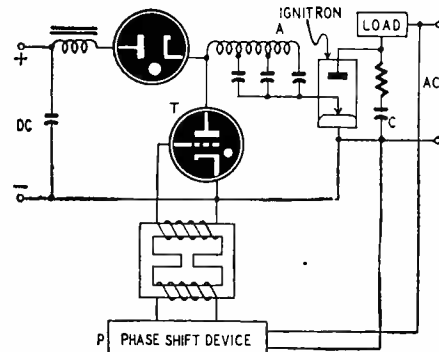

During each alternate half-cycle of a.c., condenser C places a positive potential on both the ignitron anode and the thyatron grid. When the latter exceeds the critical value, the thyatron discharges a momentary square wave of current through the mercury pool of the ignitron. This fires the ignitron through the load.

The diode tube is used to prevent reaction on the d.c. source.

SYNCHRONOUS FREQUENCY DIVIDER

Patent No. 2,444,890

George Hite, Dorchester, and Glenn E. Whitham, Wollaston, Mass. (assigned to the United States as represented by the Sec'y of the Navy)

In this effective means of generating pulses at a subharmonic of another pulse frequency, a

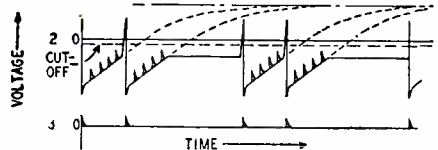
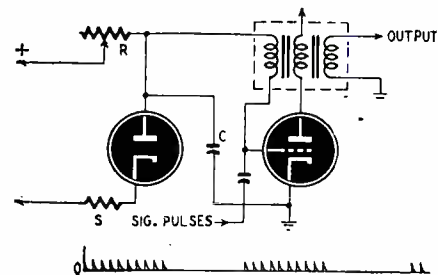

blocking oscillator and a diode tube are used.

The diode and resistors R and S form a voltage divider which keeps the oscillator grid just cutoff as long as the diode conducts. At the first pulse the oscillator grid goes positive momentarily and plate current flows. This generates a strong positive pulse at the grid so that plate current saturation is reached. When the current can increase no further, a strong negative pulse is induced at the grid, bringing the bias beyond cutoff again.

The negative voltage charges C and prevents diode conduction. The condenser discharges slowly through R. The signal pulses are shown at 1, the grid voltage at 2, and the output at 3. Note that each signal pulse is superimposed upon the slowly rising grid potential. Finally one of these pulses exceeds the cutoff value, and the oscillator cycle repeats.

An output pulse occurs whenever the oscillator grid goes positive and current flows in the plate circuit. In the example shown, the output is one-fifth of the signal frequency. A desirable feature is that there can be no output if the signal is interrupted.

DYNAMIC ELECTROMETER

Patent No. 2,449,069
Ross Gunn, Washington, D. C.

This invention is a sensitive instrument to measure an electrostatic field or charge without disturbing it or causing appreciable loss. It may be used by the United States government without royalty payments.

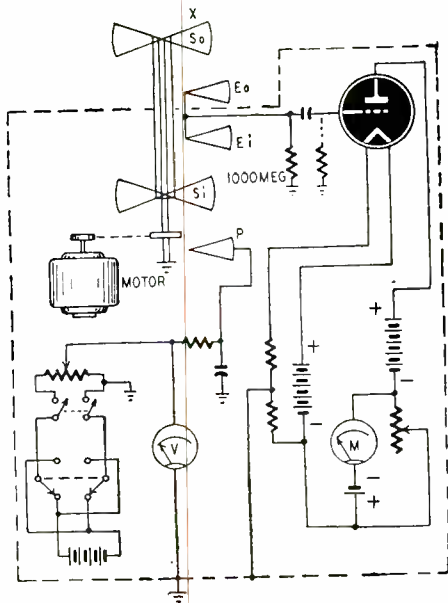

A motor rotates a shaft having two similar shutters or shields So and Si. The first is outside the main electrometer shield (dashed box) and the other is inside. Two stationary electrodes Eo and Ei are connected to the control grid of a triode through a capacitor. Another fixed electrode P is connected to a source of d.c. through a potentiometer. Its potential to ground may be adjusted. The voltmeter V measures this potential.

When the motor is turned on, Eo is alternately shielded from and exposed to the space charge at X. This creates a pulsating voltage at the tube grid. In the same way Ei is alternately shielded from and exposed to the potential at P. When the charges at P and X are equal and opposite, there is no change in plate current.

The meter M is adjusted for mid-scale reading when the shielding elements are between the fixed elements and the two charges. This reading is maintained as long as the charges are equal and opposite.

You won't want to miss the
SPECIAL TELEVISION ISSUE
OF RADIO ELECTRONICS

next month (March). There will be 144 pages of vital information on television circuits, developments, and servicing. Reserve your copy now!

New Headset from TELEX...

NO PRESSURE ON THE EARS

Here's a really new headset: TELEX TWINSET! Sweaty, tiresome "ear-cups" are gone forever! Signal may be piped directly into the ear so that *nothing touches the ear* at all! Marched in-phase magnetic receivers banish listening fatigue—listen for hours in complete comfort with this high-fidelity, 1.6 ounce headset.

An all purpose headset, the unique TELEX TWINSET, is designed for your hearing comfort and exacting headset demands. Obtainable from your favorite parts jobber, or, write Dept. 10, Telex Inc., Telex Park, Minneapolis, Minnesota.

SPECIFICATIONS:

Sensitivity—101 decibels above .000204 dynes per sq. cm. for 10 microwatts input
Impedances—1000 ohms and 64 ohms
Construction—Weight: 1.6 oz. Tenite plastic and bright nickel construction, with headband of Z-Nickel steel wire encased in plastic. Single 5-foot cord plugs into either receiver. Sealed, rustproof diaphragms.

Special Cord with built in miniature Volume Control also available

NEW TELEX TWINSET

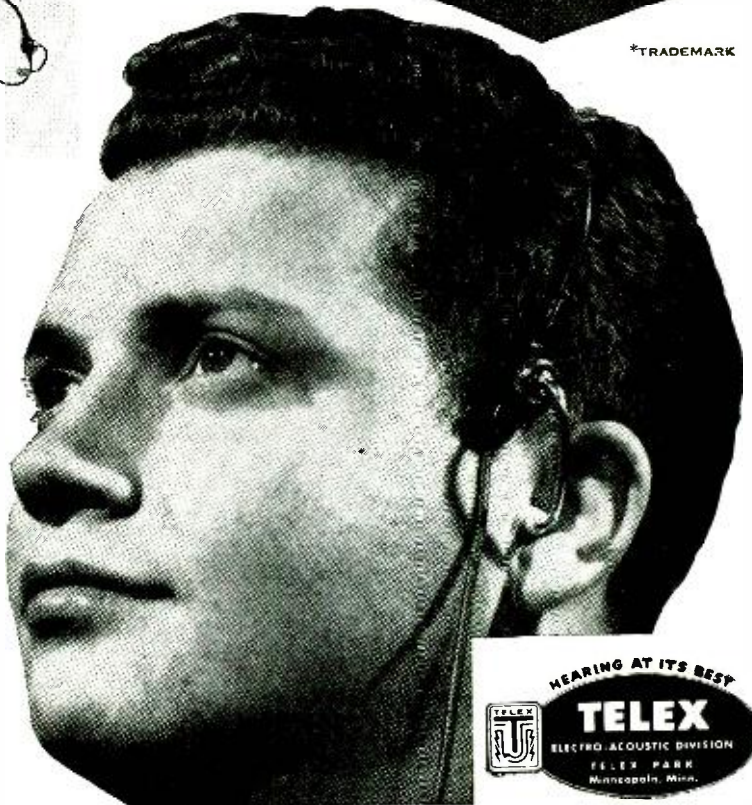

*TRADEMARK



TELEX, Telex Park, Minneapolis, Minnesota

Manufacturers of Telex Monoset* • Telex Pillow Speaker • Telex Precision Hearing Aids

THE PRICES SPEAK FOR THEMSELVES!



CHASSIS PUNCH

ROUND	
1/2 inch\$1.95
5/8 " 1.95
3/4 " 1.95
7/8 " 1.95
1 " 2.15
1 1/16 " 2.30
1 1/8 " 2.30
1 5/32 " 2.30
1 3/16 " 2.30
1 1/4 " 2.30

SQUARE	
5/8 inch\$2.95
3/4 " 3.50



ROSIN CORE SOLDER

Supplied in 1 or 5 lb. spools **59¢/lb**



TWIN LEAD-IN 300 OHMS

100 ft. hank \$1.95
500 ft. spool 7.95
1000 feet 13.75



ANTENNA HANK

for A.C.-D.C. Radios 15 foot spool **14¢**

RADIO TUBES TUBULAR CONDENSERS

6C419	20/20—150V26
12SR729	30—150V28
ILN539	50/30—150V44
ILD539	4—450V24
2739	8—450V27
39/4439	16—450V36
8039	16/16—450V59
5Y339	20—450V39
35Z539	30—450V47
35W439	40—450V59
K55B39	80—450V97
6SQ739	.005—1700V13
6SK744	.008—1700V15
7644	.01—1700V17
6SA749	.02—1700V19
12SQ749	.05—2500V58
12SK754	.1—2500V64
12SA755	.25—2500V86
50B555	.05—3000V69
50L655	.003—6000V57
0Z469	.005—6000V62
6SN769	.01—6000V74
6V669	.05—6000V97
6AC779	.0005—7500V58
6AK585	.003—7500V67
6AL585	.005—7500V72
6AG595	.0005—10000V64

BROOKS RADIO DIST. CORP.

80 VESEY ST., DEPT. A, NEW YORK 7, N. Y.

VEST-POCKET TRANSMITTER

This 5-milliwatt 75-meter phone transmitter is a modification of one of the printed-circuit vest-pocket transmitters developed by Dr. Brunetti. If hearing-aid-type components are selected for use with its subminiature tubes, a compact unit suitable for walkie-talkies or remote control circuits can be made. While its rated range is about 200 feet, there is little doubt that the range may be increased considerably when the unit is coupled to a good antenna and operated under ideal receiving and transmitting conditions.

The circuit consists of a crystal oscillator and a modulated amplifier using CK569AX's, two cascade CK512-AX's as voltage amplifiers, and a CK506AX modulator. The a.f. section of the transmitter supplies sufficient gain to modulate it fully when used with a good crystal microphone. The modulator is coupled to the amplifier through a 1:1 modulation transformer. If a compact modulation transformer

is not available, two small output transformers can be hooked up back-to-back so the plate currents flow through the primary windings.

Power is supplied by a 30-volt hearing-aid battery and 1 1/2-volt flashlight cells. The 2-ohm wire-wound control is adjusted so the filament voltage is 1.25 volts under load. The output can be increased by raising the voltage on the amplifier and modulator. If the plate voltage is raised, replace the 1,500-ohm resistor, R, with one that will develop 4.5 volts across it when the set is in operation.

The amplifier tank coil may consist of 40 turns of No. 26 enamel wire on a 3/4-inch form. A few turns may be wrapped around the lower end of the coil to provide coupling for a doublet antenna.

(This transmitter operates in the 75-meter amateur band. It may not be operated by anyone who does not hold a valid Class A amateur radio operator's license.—Ed.)

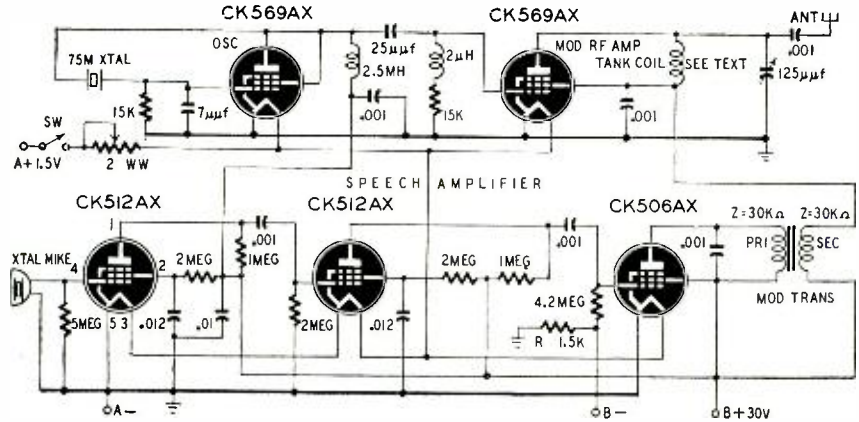

EXPERIMENTAL VACUUM-TUBE WATTMETER

Servicemen frequently find that measuring the power consumed by a receiver gives a clue to what is wrong with the receiver. The device described is a vacuum-tube "wattmeter" of good enough accuracy for service work.

The receiver under test draws line current through the primary of an audio output transformer. The 60-cycle voltage across the secondary depends on the current through the primary. R1, a calibrated potentiometer, taps off enough voltage (rectified by the 6H6) to close the shadow in the 6E5 electron-ray tube. The setting of R1 then shows the wattage being drawn.

To calibrate R1, plug lamps of various wattages in the receiver-input receptacle, and mark the wattages on the dial scale. Set R2 so that the eye will close with normal wattage values.

The lamp-bulb calibration may not be completely accurate with transformer-type receivers because of transformer power factor, but it will do for transformerless sets. Another calibration can be set up using a.c. receivers instead of light bulbs as calibrators.

W. G. ESLICK,
Wichita, Kans.

MATERIALS FOR WATTMETER

Resistors: 1—2,200-ohm, 1—4,700-ohm, 1/2-watt; 1—10,000-ohm, 1—500,000-ohm potentiometers; 2—1-megohm, 1/2-watt.
Capacitors: 1—250- μ f, mica; 1—.05- μ f, 400-volt, paper; 2—8- μ f, 450-volt, electrolytic.
Transformers: 1—9,000 ohms or more to voice coil; 1—power, 5 volts, 6.3 volts, 500 volts or more, center-tapped.
Tubes: 1—6H6, 1—6E5, 1—80.
Miscellaneous: 1—female a.c. receptacle; 1—octal, 1—6-prong, 1—4-prong tube sockets; 1—chassis and cabinet; necessary hardware.

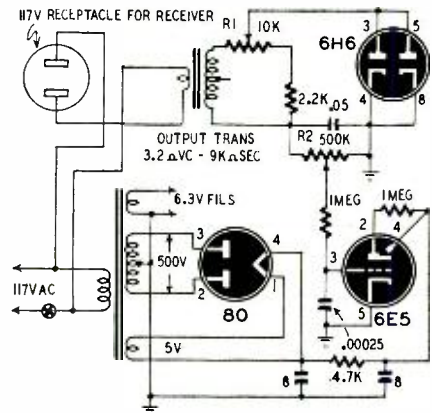

B-BATTERY ELIMINATOR

Useful when servicing battery-operated radios this B-battery eliminator is lighter and smaller than most B-batteries it replaces; and it can be constructed from salvage parts for less than the cost of a new set of heavy-duty batteries. A meter is included to measure the current drawn from the eliminator.

Almost any small transformer and rectifier can be used as long as it supplies about 16 volts to the filter. Most of the small receiver transformers will work well if there is a dropping resistor between the rectifier filament or cathode and the input side of the filter.

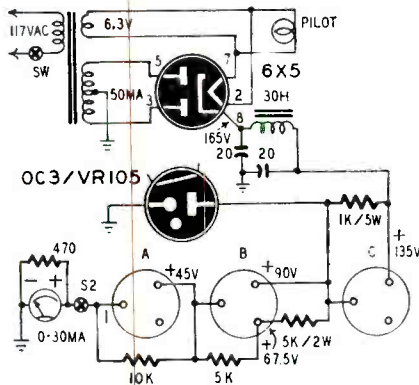

The outlet sockets were salvaged from old B-batteries. Sockets from portable batteries often have holes for different types of battery plugs. When plugging in a set, be sure that the battery plug with the negative lead goes into socket A. If the set uses 135 volts, the plug with the negative lead goes in A, the one with the positive lead in C, and the plug connected to the others with jumpers goes in B.

An OC3/VR105 regulates the voltage on the 90-volt socket. The voltage is actually 105 volts at this point, but this has not made any noticeable difference in a large number of sets we have powered with this unit. The 67½-volt tap is important. If 90 volts is applied to most 2-volt sets, they draw too much current and work poorly. The voltage regulator is recommended because it keeps the voltage constant with different loads.

The average 4-tube set draws from 12 to 18 ma, depending on the type of output tube used. Larger sets use correspondingly more current up to about 30 ma. The advantage of the meter used is its ruggedness. It seems impervious to overloads such as shorts or excessive drain. If the meter swings over hard, it indicates either a short, incorrect bias, or leaky electrolytics. It is a safe assumption that no set should draw more than 25-28 ma, and this can usually be adjusted by correcting the bias. The customer will appreciate the saving.

Sets with class-B audio will have, of course, a varying consumption with signals—the meter needle swings wildly on loud notes.

S2 cuts off the B-plus. This prevents shocks when working on the receiver.

The whole unit may be built in a box approximately 5 x 7 x 3 inches or be designed to fit the test panel.—John A. Dewar.

GREYLOCK
A DEPENDABLE NAME IN
RADIO TUBES

GT, Glass, and Miniature Types

All Tubes in Individual Cartons

IR5	3Q4	12SA7GT	} 39¢ each
IS5	3V4	12SK7GT	
IT4	6AT6	12SQ7GT	
IU4	6BA6	(and many others)	
3S4	6BE6		

SPECIAL OFFER! All 39¢ tubes may be purchased in lots of 100 assorted, at \$35 per 100.

Specials: 2E24 . . . 89¢ 6B6G . . . 89¢

TERMS: Net C.O.D., F.O.B. N.Y.C.

Minimum order \$5.00.

Write for Bargain Catalog C-2.

Greylock Electronics Supply Co.

30 Church Street New York 7, N. Y.

F.M. - A.M. - TUNER

13-TUBES—4x10-SLIDE DIAL

Ready to Operate \$3995

Chassis—7x16x8-4

In Kit Form—\$31.50

EASILY ATTACHES TO YOUR TELE SET

Remit in full for fast delivery.

RADIO MAIL ORDERS

Dept. RE, 75 Barclay St., N. Y. 7, N. Y.

PEN-OSCIL-LITE

Extremely convenient test oscillator for all radio servicing; alignment • Small as a pen • Self-powered • Range from 700 cycles audio to over 600 megacycles i.f.t. • Output from zero to 125 v. • Low in cost • Used by Signal Corps • Write for information.

GENERAL TEST EQUIPMENT

38 Argyle Ave. Buffalo 9, N. Y.

TALK ANYWHERE

Instantly To Anyone with Inter-Talkie! Just push buttons and talk to or from 1 to 7 different places! Not a phone-hand room volume—no electric "plug-ins" or tubes needed! Set or hang in simple and quick to hook up for homes, offices, stores, farms, etc. As Low As \$9.97 EACH. Guaranteed! Write for prospectus today. Also wanted.

MIDWAY CO., Dept. RE-2, Kearney, Nebr.

TELEVISION RECEIVER—\$1.00

Complete instructions for building your own television receiver. 16 pages—11"x17" of pictures, pictorial diagrams, clarified schematics, 17"x22" complete schematic diagram & chassis layout. Also booklet of alignment instructions, voltage & resistance tables and trouble-shooting hints. All for \$1.00.

CERTIFIED TELEVISION LABORATORIES
Dept. C, 5507-13th Ave., Brooklyn 19, N. Y.

Get Started in Radio

10 "HOW-TO-DO-IT" BOOKS



Get a solid foundation in radio by means of these 10 timely text books. Each clearly written, profusely illustrated, contains over 15,000 words. You'll be amazed at the wealth of information packed into these handy books. Excellent for reference—ideal for technical library. Your money back if not satisfied.

5 BOOKS for 50¢
10 BOOKS for \$1.00
Sent to You Postpaid

- | | |
|--|--|
| No. 1—How To Make Four
Oerlic Short Wave Sets | No. 6—How To Have Fun
With Radio |
| No. 2—How To Make The
Most Popular All-Wave 1
and 2 Tube Receivers | No. 7—How To Read Radio
Diagrams |
| No. 3—Alternating Current
for Beginners | No. 8—Radio for Beginners |
| No. 4—All About Aerials
and Antennas | No. 9—Simple Electrical Ex-
periments |
| No. 5—Beginners' Radio Dic- | No. 10—Television |

Remit by check or money order—register letter if you send cash or stamps.

RADIO PUBLICATIONS

25A West B'way. New York (7)

**TELEVISION IS BOOMING—
CASH IN ON IT!**



- ★Wide-Range
- ★Scratch
- ★Suppressor
- ★Volume
- ★Expander

Supreme performance with any variable reluctance pickup.

EXCLUSIVE G.E. PICKUP CIRCUIT

New circuits enable you to attain full benefit from the new G-E Variable Reluctance Magnetic pickup. Employs an exclusive, humless pre-equalized pre-amplifier to produce the most satisfying musical amplifier the world has ever known. If you are a perfectionist, you are the one for whom the ACA-100GE was designed. Send for technical literature.

AMPLIFIER CORP. OF AMERICA

398-10 Broadway, New York 13, N. Y.

HEADSET H-16U SPECIAL



8000 ohm Dual. Headset H-16U—most sensitive phones built—noiseproof—may be used as a sound powered intercom—Also used with Simple Xtal to make a complete radio receiver—light, durable, efficient, molded, soft neoprene earcups, slanted to snugly and comfortably envelope the entire ear. Everyone BRAND NEW. Complete with illustrated manual. Send money order or check today.

Special per pair \$1.89

Plus 25¢ each for postage

ATTENTION Amateurs-Experimenters-Inventors

Cut your cost on radio supplies and equipment in half. Clip coupon today. Hundreds of "hard to get" war surplus items along with the best in standard brand equipment—all at great savings to you. Let us know your particular requirements. IMMEDIATE DELIVERY.

PLEASE PUT MY NAME ON YOUR MAILING LIST FOR SPECIAL BULLETINS.

NAME _____ ZONE _____
ADDRESS _____ STATE _____
CITY _____

NIAGARA RADIO SUPPLY CORP.
160 Greenwich St., New York City 6, N. Y.

E-Z TO ASSEMBLE! Save Money With This WAR SURPLUS Aircraft

PHOTO FLASH KIT!

Offered at fraction of original cost. Simple to assemble. Save many dollars. Comes brand new in its original box complete with: gray metal finished case, all connectors, relay control, 2 condensers each 2000 volts—light output 100 watt seconds, 4 HIGH SPEED FLASH TUBES—plastic sealed, unbreakable. ALSO 4 reflectors, transformer, connectors, connecting cords, spare parts. After conversion unit operates on battery or on 110 volt A.C. by flick of switch. Complete instructions and diagrams.

Immediate Delivery on all mail orders Complete \$68
GINEX, INC., 165 W. 46th St., N. Y. 19, N. Y. Dept. RE-2

Genuine WESTERN ELECTRIC

MICROPHONE plus ASSEMBLY UNIT \$1.00

Limited Stock • Order Now
RICE LABORATORIES

233 MULBERRY ST. • ROCHESTER 7, N. Y.

NOW! CASH IN ON TELEVISION!!

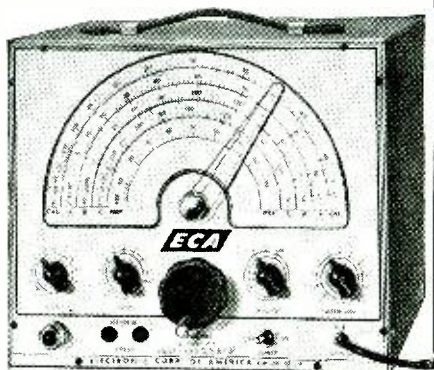

FM and TELEVISION SWEEP SIGNAL GENERATOR \$49.95

A must for progressive service shops—a buy at this sensationally low price! Accurate!—Aligns FM and television receivers. Frequency range 2-227 MC. Output modulated or unmodulated. High frequency insulation throughout, built-in power line filter and special Midline capacity tuning condenser. Easy to operate—use it to adjust to new TV channels. AC only. Exceptional opportunity to purchase instrument of this kind direct from manufacturer at a tremendous saving! Backed by ECA with RMA Guarantee.

- Enclosed find check or money order in full, or
- 20% deposit, balance COD for FM Signal Generator \$49.95
- Send me FREE ECA Bargain Bulletin

Name.....
Address.....
City..... State.....

ELECTRONIC CORP. OF AMERICA
353 W. 48th St., New York 19, N. Y.

Sensational NEW 1949

MIDWEST RADIOS

with DUAL-SPEED RECORD PLAYER

EASY TERMS
Powerful
5 WAVE BAND SERIES
16 AM-FM CHASSIS
SEPARATE CHASSIS OR COMPLETE CONSOLES AVAILABLE
30 DAYS TRIAL

SYMPHONY GRAND AM-FM RADIO-PHONOGRAPH

A magnificent musical instrument that offers the new Dual-Speed Phonograph which plays and changes, automatically, both the new LP (long playing) records as well as Standard records. Uses the powerful Series 16 AM-FM Radio Chassis. Offers Flash-O-Matic Volume and Band Indicator; TELEVISION Audio, Switch-Over; Giant 14 1/2" Panasonic Speaker; Color-Ray Tuning; No-Drift FM. Other beautiful console and table models available with Series 16, 12 or 8 chassis.

BUY DIRECT FROM FACTORY AND SAVE!
SEND THIS COUPON TODAY. Write to Name and Address. (Please Print) on Coupon or to Postcard.

MIDWEST RADIO & TELEVISION CORP.
Dept. 386 909 Broadway, Cincinnati 2, Ohio
Please send me your new FREE 1949 Catalog.

NAME.....
ADDRESS.....
CITY..... ZONE STATE.....

SIGNAL LIGHT

Recordists who have studio and equipment in separate rooms or who may not be in plain sight of the artist will find this "on-the-air" light useful.

Fasten a small pilot-light assembly to a clip bracket (obtainable at hardware stores). Clip the bracket to the microphone stand and run a cable from it to the 6-volt supply of the recording amplifier. Put a switch in series with the supply and mount the switch on the control panel.

When ready to record, operate the switch. The little light will go on, signaling the performer to begin.

A fairly noiseless switch is a good idea; a rotary wafer or a telephone-type key will work well.

Flashing the light once or twice near the end of the record will tell the performer that his time is almost up.

If there is any one control—such as an output switch—which is normally operated at the beginning of each recording, extra contacts can be added for the light.

HENRY FREUND,
New York, N. Y.

THERMOSTAT TESTER

Many radio repairmen also fix toasters, electric irons, and other devices which have thermostat switches in them. Here is an inexpensive device which will check the operation of thermostats.

The parts shown in the schematic diagram are assembled in a small box. The relay is a sealed-unit refrigerator unit which can be purchased from a refrigeration dealer or serviceman. Short out the overload protector as shown.

When the thermostat is closed in the device to be tested, the current drawn through the tester will energize the relay and the 117-volt lamp will light. When the device gets hot and the thermostat opens, the lamp goes out.

If the light goes on and off at fair intervals, the thermostat is good. If it flickers, the points are bad. If it does

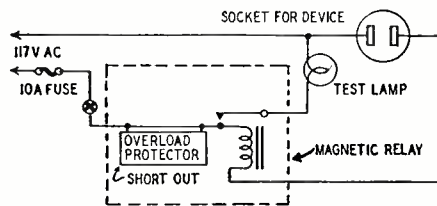

not go on at all, the thermostat switch (or the device itself) is inoperative. Do not test a device that draws more than 1,200 watts.

GEORGE H. HAGUE,
Fall River, Mass.

OPEN FIELD COILS

When you find that a speaker field coil is open and you want to make the repair quickly and cheaply, charge a 4- μ f paper capacitor across a 1,000-volt power supply. Then touch the capacitor to the field-coil terminals. The momen-

tary high current through the coil will often weld the broken ends together.

F. G. SINGER,
Harrisburg, Pa.

CODE-PRACTICE OSCILLATOR

A code oscillator can be made from a regenerative receiver using plug-in coils. Place a key between B-minus and ground. Plug in an audio transformer in place of the r.f. coil. I connected a 4-prong plug to an a.f. audio transformer.

To use as a receiver, screw down the key contacts and re-insert the r.f. coil.

ROBERT W. DIERICH,
Saginaw, Mich.

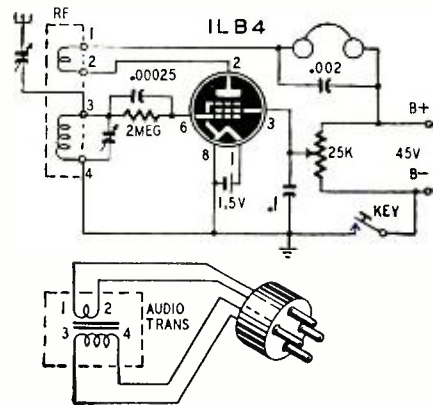

BREADBOARDS

Often it is convenient to use a piece of wood instead of a metal chassis. To eliminate undesirable feedback and hum, run a ground wire to all potentiometer cases, transformer frames, and other parts which would touch the chassis if one were used. For a.c.-d.c. circuits, connect this ground wire to one side of the line through a .05- μ f capacitor.

K. E. FORSBERG,
Sauk Centre, Minn.

BRIDGE NULL INDICATOR

An oscilloscope is an excellent null indicator for bridges using signals in the audio or supersonic range. Connect the signal source to the vertical terminals and the bridge output to the horizontal terminals. The pattern becomes narrower as the null is approached. No sweep generator is used, and the null indication is more sensitive than with other methods.

CHARLES ERWIN COHN,
Chicago, Ill.

A.C.-D.C. SAFETY SWITCH

Most transformerless receivers are dangerous to handle even when they are turned off because the chassis may still be connected to the hot side of the power line, either directly or through a resistor and capacitor.

To remove all danger, substitute a d.p.s.t. switch for the s.p.s.t. usually found. This will disconnect both sides of the line when the set is turned off.

RUFUS P. TURNER,
Los Angeles, Calif.

ANTENNA RELAY

The usual method of switching an antenna between transmitter and receiver uses a d.p.d.t. relay to transfer both feeder leads between the two units. I have found, however, that a s.p.s.t. relay will work as well if the antenna lines are co-axial.

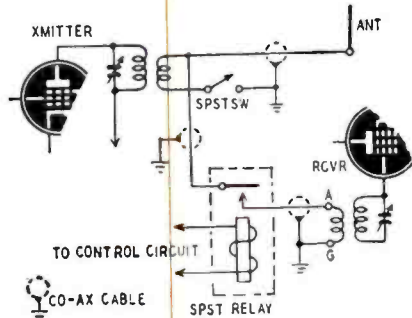

Simply place the relay contacts in series with the lead to the receiver. Wire the control circuits so that operating the transmitter switch opens the relay. (The relay may be normally open or normally closed, depending on the control circuits.) The transmitter is still connected during receiving periods, but the receiver level is not affected.

The diagram shows connections for a mobile set. The s.p.s.t. switch is opened to permit use of the antenna for broadcast reception.

WILLIAM E. JOHNSON,
Detroit, Mich.

SLIPPING DIAL CORDS

The drawing illustrates a sure-fire cure for slipping dial cords. The cord, in most cases, slips on the tuning shaft because the tension on both ends of the cord is not the same. Instead of tying one end of the cord on the drum and using a spring for the other, use springs at both ends. This method produces tension on both sides of the cord as it passes over the shaft of the tuning control. Tying both ends of the cord to the same spring will not give the same result. Manufacturers please note!

H. L. HANIS,
Portland, Ore.

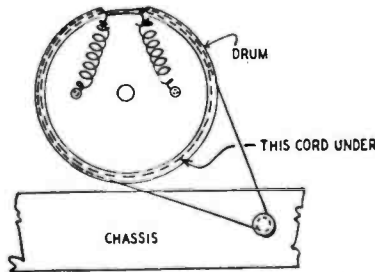

R. F. INTERCOM

Two receivers can be used for one-way communication if one (or both) is a superheterodyne. Remove all connections from the mixer grid of the superhet, and connect a high-level micro-

phone between the mixer grid and ground. (A grid leak across the mike may be needed.—Editor.)

Wrap one end of an insulated wire around the oscillator grid or anode, and connect the other end to the antenna post of the second receiver. The microphone voltage will modulate the r.f. oscillator signal. If the second receiver is tuned to the frequency of the superhet oscillator, the microphone signal will be heard.

CHARLES ERWIN COHN,
Chicago, Ill.

MIKE PLUG ADAPTER

Cables ending in screw-type microphone connectors frequently must be connected to amplifier inputs which have phone jacks. A handy adapter can be made by reaming out the hole in the end of a phone plug cap so that a chassis connector will fit into it. Connect the chassis unit to the phone plug and replace the cap. The plug can be inserted in a jack, and a microphone



connector can be screwed to the connector on the plug's cap. For best shielding, use a phone plug with a metal cap.

L. L. WHEELER,
Vancouver, Wash.

For GREATER Earnings... LEARN RADIO-ELECTRONICS

This fast-growing science of RADIO, TELEVISION, RADAR and ELECTRONICS, offers tremendous opportunities, and in no industry is RADIO-ELECTRONICS more important than in aviation. A skilled technician who *knows* the modern application of electronic devices, as used in the aircraft industry, is always in demand... not only in aviation, but in many other industries. Many large organizations call on Spartan regularly for graduates. Often, students are hired months before graduation.

Don't confuse the RADIO-ELECTRONICS course offered by SPARTAN with other courses, offered anywhere! As a graduate from this famous school you will know the application to industrial control devices; to the search for petroleum; and the important uses of radar, television and other electronic equipment.

SPARTAN offers two complete and thorough courses. You will work on the most modern and complete equipment. You will build equipment. You may join the SPARTAN "Ham" Club. Either course prepares you for Federal Communication Commission license tests — first class radio telephone, second class radio telegraph, or class "B" radio amateur.



SPARTAN'S 21 years of teaching civilian and army personnel is your assurance of receiving the best possible training in the least possible time. You'll not need MORE than Spartan training — you cannot afford to take LESS.

BIG CATALOG — Free

NAME _____ AGE _____

ADDRESS _____

CITY _____ STATE _____

Dept. RE-29

G. I. APPROVED — Write TODAY for Complete Information

SPARTAN

SCHOOL OF RADIO AND ELECTRONICS



SCHOOL of AERONAUTICS
MAXWELL W. BALFOUR, DIRECTOR

COLLEGE of ENGINEERING
ADDRESS DEPT. RE-29

TULSA, OKLAHOMA

You Can't Match these MID-AMERICA Values!

SPECIAL!



for TV Builders

Only \$24.95

Unbeatable value! Gorgeous selected-finish, hand-rubbed cabinet for 10" picture tube. Measures 16" wide, 18" high, 21" deep. Highest quality construction; metal screens at top and bottom for ventilation; top screen covered with tough, decorative plastic mesh. Cabinet delivered with 6" PM Alnico 5 speaker and partially wired TV chassis; you'll save money on sockets, resistors, condensers, etc. Cabinet alone worth several times our low price for entire deal. Order now. Shipping weight—50 lbs.



PM SPEAKERS

- MA-2272 6", 1.47 oz. Alnico 5, 50L6 trans. \$1.59
- MA-2267 8", 21 oz. Alnico 3 slug. 3.29
- MA-2270 10", 6.8 oz. Alnico 5 slug. 5.65
- MA-2268 12", 21 oz. Alnico 3 slug. 6.50

GRILLE CLOTH

Never before at our low price! Highest quality, golden-tone grille cloth, styled to harmonize with all cabinet designs. Generous 50" width. **\$1.79** per yard

6-12 VDC SOLDERING IRON



Carry this handy iron in your car or truck and be ready for any TV installation or quick repair job. Attaches to battery or starter post. Iron has 600 watt capacity and heats in 20 seconds. Holds heat and can be carried to the work. Nothing to burn out or wear out. Brand new! **\$2.95**

CARBON VOLUME CONTROLS

Any of the following, 24c ea. 10 for \$2.19
25K, 50K, 100K, 250K, 1 megohm, 2 megohm
WITH SPST switches, 39c ea. 10 for \$3.09
100K, 500K, 1 megohm, 2.5 megohm



METAL CAN ELECTROLYTICS

- MA-821 500-500 mfd, 25 VDC..... 39c
- MA-869 1000 mfd, 10 VDC..... 39c
- MA-161 20-20 mfd, 150 VDC..... 29c
- MA-50814 10-10-10/20 mfd, 450/25 VDC..... 49c
- MA-50829 40-30 mfd, 150 VDC..... 35c
- MA-112 16 mfd, 500 VDC..... 49c
- MA-50865 30-15/15/40 mfd, 450/350/25 VDC..... 59c
- MA-50866 15/15 mfd, 450/350 VDC..... 59c

AUDIO OUTPUT TRANSFORMERS

- MA-2532 4 watt universal..... 69c
- MA-2522 500 ohm to 6-8 ohm VC..... \$1.19
- MA-1205 12 watt universal..... \$1.19

ORDER FROM THIS AD!

Send 25% deposit with order. Pay balance plus postage on delivery. Get your name on Mid-America's select mailing list and get first crack at latest, greatest values in radio parts, electronic equipment, tubes, etc. Send orders to Desk 10-29.

MID-AMERICA CO. Inc.

STORE: 2412 S. Michigan Ave. Chicago 16, Ill.
WAREHOUSE: 2307 S. Archer Ave. Chicago 16, Ill.

BUILD FROM KITS

YOU CAN MAKE MODERN RADIOS AND TEST SETS YOURSELF! IDEAL FOR SCHOOLS AND HOBBYISTS

KIT S-5 DELUXE PLASTIC TABLE SUPERHET
A STREAMLINED DELIGHT

- Modern circuit
- Built-in "Magic Loop"
- Powerful Alnico speaker

Improved superhet with built-in loop and Alnico magnet speaker! Easy-tune airplane dial. 12SK7, 128SA7 converter, 12SQ7 Detector Audio, 50L6 power output, 3Z5 rectifier. Beautiful bakelite cabinet. Simplified instructions for assembling.

Net Price **\$14.25**

VACUUM TUBE VOLTMETER KIT 012

- 6SN7 bridge type volt-meter circuit.
- 0-500 microamps DC.
- 4 1/2" square meter.
- Frequency range 200 Mc.

For high frequency FM and TV. 11 megohms DC, 0.5 megohms AC input resistance. 1 ohm to 1000 megohms in 2 ranges. Linear AC/DC volts, 0-1000 volts, 3 scales. 610 balanced linear loads AC rectifier. 1% precision resistor. 6X8X3". High frequency probe included. With complete instructions.

NET PRICE **\$29.95**

2-BAND RECEIVER KIT S-6X

- ★ 6-tube
- ★ Equipped for 110 volts AC or DC

This 2-band receiver covers 10-110 low frequency ranges, 550 Kc-100 Mc, 6 in. Complete with tubes and beautiful, sturdy bakelite cabinet ready for assembly.

NET PRICE **\$17.45**

If not available at your local jobber, write directly to us. Write for Catalog K

RADIO KITS COMPANY
120 Cedar Street New York 6, N. Y.

UNBEATEN for VALUES
Thousands of Satisfied Buyers

TUBES 32¢ in bulk lots of 100 per type

Individually white boxed, asst'd 36c each

Made by leading manufacturer—RMA guarantee. Money back, less postage, if not completely satisfied.

1R5	6BE6	6SG7GT	12SA7GT
1S5	6B8G	6SK7GT	12SJ7GT
174	6C8G	6S8GT	12SK7GT
1U5	6K5GT	6V6GT	32L7GT
3Q4	6K6GT	6X5GT	35WA
354	6A7GT	12AT6	50B5
6AT6	6SD7GT	12BA6	117Z3
6BA6	6SF5GT	12BE6	

RCA • GE • SYLVANIA • RAYTHEON
NATIONAL UNION • TUNGSOIL
KEN-RAD • HYTRON

Type Packed in bulk 100 per type Individually white-boxed-assorted

5Y3GT	40¢	49¢
6F6GT	55¢	69¢
6SN7GT	75¢	85¢
12SQ7GT	55¢	65¢
25L6GT	65¢	75¢
25Z5	55¢	65¢
25Z6GT	55¢	65¢
35L6GT	65¢	75¢
35Z5GT	45¢	55¢
50L6GT	65¢	75¢

Above 10 types show manufacturer's brands. Shipment will be made of makes available when order is received. STANDARD RMA GUARANTEED.

Specify Price When Ordering . . .
What other types can you use—bulk backed—100 to a carton. LET US QUOTE!

Minimum order \$3.00. 20% deposit, bal. C.O.D.

Write Dep't C for Current Bargain Flyers on Radio and TV Parts & Equipment.

RADIONIC EQUIPMENT COMPANY

Tribune Theater Entrance
170C Nassau Street :: N. Y. C. 7
Worth 2-0421
Open daily 9-6 :: Saturday 9-5

MECHANICAL COUNTERS

ELECTRONIC circuits are not always better than equivalent mechanical devices. For example, mechanical relays are perfectly satisfactory for counting pulses and are much simpler than equivalent electron-tube circuits, if the pulse frequency is low enough to be followed mechanically and the pulses are strong enough to operate a relay without amplification.

Counting relays have been used for many years in telephone and signal work. The very simple and effective Molina counter is used in telephone communication. It was invented in 1911 by E. C. Molina* of the Bell Telephone Laboratories and has been in use ever since. It is shown in the schematic.

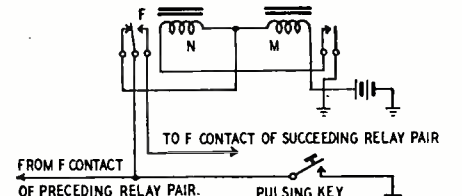

One pair of relays operates with each pulse.

This is how the Molina counter operates: The pulsing key is alternately closed and opened (as in telephone dialing) to provide pulses. When it is closed, the M relay is grounded at one end. Since the battery is already connected to the other end, its contact is closed. The N relay remains as shown because it now is grounded at each end. When the key is released, however, this relay does operate, as it is across the battery in series with M. The net result of a complete on-off pulse is the transfer of the F contact from one relay pair to the next.

Ordinarily there must be as many relay pairs as pulses to be counted. With a slightly more complicated system the same relays may be used more than once, however. In telephone cross-bar circuits, for example, five relay pairs are used to count a maximum of ten pulses. At the sixth pulse, the first relay pair operates just as it did at the first pulse, etc.

* Bell Lab Record, July, 1948.

NAVY TO TEACH VIA TV

Teaching by TV is being investigated by the office of Naval Research at Sands Point, N. Y., it was announced last month. Trial programs used with a class at the Navy television station at Sands Point were supplemented in January with a weekly series of lectures telecast a distance of four miles to part of a third-year class at the Merchant Marine Academy. Results will be compared with those obtained with standard instruction. Equipment has been supplied by General Electric.

The 1,600-room Park Central Hotel in New York City will become the first major hotel in the world to have television in every room. More than 200 miles of special wiring will be needed. Cost of installation is estimated at \$500,000.

BATHROOM SINGS, NOT YOU

Bathtub baritones who find their voices aren't as heroic when they sing elsewhere can blame the tiled bathroom for the flattering illusion. The smooth-walled room is the music-maker, not the vocalist, according to the statement by Dr. Vern O. Knudsen of UCLA to the American Association for the Advancement of Science at its recent Washington meeting. The room has a resonant frequency of its own and the voice just sets up vibrations for the room to respond to.

Dr. Knudsen pointed out that wherever sound is heard—a radio in your living room or a violin in Carnegie Hall—the room is effectively a part of the instrument. It can make average musical tone good or make a beautiful Stradivarius violin sound like a child's toy.

A prime requirement is that the room have the correct shape. Even more important is selection of the right absorptive materials for walls, ceiling, and floor. These must not only absorb a large part of the sound but must also help to give an effect of diffusion. A small broadcast studio, for instance, will not sound good if absorbent material is all over the walls; it should be distributed in patches.

Many absorbent materials absorb only high frequencies. This makes for poor speech intelligibility because most consonant sounds are in the treble region. Measurements in a reverberant auditorium showed that while 93.3% of the vowels were understood correctly, only 76.4% of consonants were clear.

Dr. Knudsen advises that when you are speaking in an auditorium which has reverberation or echo, you should give special emphasis to sounds like "ng" and "th" and the consonants d, v, and f.

In treating a room, use a material that is much more absorbent at low than at high frequencies. And a PA amplifier should, for best speech intelligibility, have a response that rises with increasing frequency.

ABSORPTION WAVE METER

The diagram shows a handy absorption frequency meter which will be useful for finding which harmonic is being amplified in ham transmitters. It can also be used as a field-strength meter and a phone monitor.

The circuit is that of the usual wave meter, except that there is only inductive coupling between the main circuit and the tank. This makes for sharper tuning and more accurate indication because of the elimination of loads (crystal, meter, phones, etc.) on the tuned circuit which would reduce its Q.

The table gives the necessary coil-winding data. All coils are wound on 1½-inch-diameter, plug-in forms. L2 is spaced ¼ inch from L1 and is close-wound with No. 30 wire for all bands.

When the unit is used as a field-strength meter or monitor, a 3-foot piece of wire is attached to the antenna



NEW! CUSTOM BUILT AM-FM Quality CHASSIS

Here is exquisite high fidelity in chassis form that will grace the finest cabinet.

The 513 De Luxe Tuner is easy to install in any console cabinet, old or new and embodies the latest engineering refinements for lasting high quality at a price that defies competition.

The Espey 513 Tuner employs 10 tubes plus tuning indicator in a super heterodyne circuit and features a drift compensated circuit for high frequency stability, tuned RF on AM and FM plus phono input provision, and separate AM and FM antennas.

Model 514 De Luxe Power Supply-Audio Amplifier is designed specifically to work in conjunction with Model 513 Tuner, and is also used wherever a high quality audio amplifier is required.

With an output of 25 watts, Model 514 features a parallel push pull output circuit, self balance phase inverter system, extended range high fidelity response, and inverse feedback circuit.

Write Dept. K for your free catalog.



ESPEY Makers of fine radios since 1928.
MANUFACTURING COMPANY INC.
 528 EAST 72nd STREET, NEW YORK 21, N. Y. • TEL. BUtterfield 8-2300

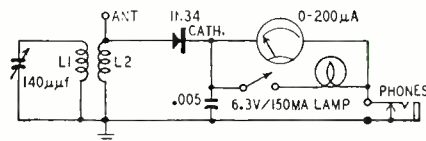

post. The switch places a pilot lamp across the meter so the meter will not burn out with high r.f. input.

PAUL M. KERSTEN,
 Topeka, Kans.

Coil Table

Freq. Range (mc)	Wire size	L1 Turns	Length	L2 (turns)
2.5-8	24	37¾	1¾	11
4.5-14	20	17¾	1½	6
7.5-25	16	8¾	1¼	4
22-70	16	2¾	1	2

HEARING AID KICK-BACKS

"Kick-backs" are now being offered doctors on hearing aids as well as on eyeglasses, the *Journal of the American Medical Association* reported last month.

Acceptance of such "kick-backs" or rebates is strongly censured by the association.

Physicians are being offered money by dealers for recommending particular makes of hearing aids.

"Such a transaction between the doctor and the dispenser of hearing aids constitutes a rebate and is in direct contravention of the stand of the American Medical Association in this matter," the *Journal* states.



The Toast of the Trade!

It is rather remarkable how, year after year, so many of the largest and finest radio and electronic manufacturers depend on Quam for their speaker requirements.

This should be of special significance to the serviceman. For one thing, it means that these receivers are designed with Quam Speakers as a component part and, when replacements are required, another Quam Speaker should be used to maintain the same high quality of performance.

And it also indicates the confidence these manufacturers place in Quam, and their dependence on the consistently high quality of Quam engineering and production.

Take a tip from the people who buy speakers by the thousands, always specify Quam for your replacement job!

*Write for Catalog of Quam
Adjust-a-Cone Speakers*

QUAM-NICHOLS COMPANY

521 East 33rd Place, Chicago 16, Illinois

QUAM SPEAKERS ARE LISTED IN
THE RADIO INDUSTRY RED BOOK

\$3.00 FOR CARTOON IDEAS

RADIO-ELECTRONICS prints several radio cartoons every month. Readers are invited to contribute humorous radio ideas which can be used in cartoon form. It is not necessary that you draw a sketch, unless you wish.

IDEAS NOT WANTED

No electrical or radio definitions wanted. Some of these were published in the past, but the subject is about exhausted. All checks are payable on publication.

Address:

RADIO CARTOONS,
RADIO-ELECTRONICS
25 West Broadway, New York 7, N. Y.

**Television is Booming—
Cash in on it!**



COLUMBUS GETS RADIO TRUCK

The photographs show the inside and outside of the modern communications truck designed for the city of Columbus, Ohio, for use at major fires and disasters.

Four University trumpets are mounted on the roof, each projector equipped with two 25-watt driver units.

The soundproof interior of the truck has dual control desks. The main amplifier is a Bell Medel 1475, 80-watt

unit, operated on a.c. supplied by a 5-kw Koehler generator located in a separate compartment in the rear. For standby or d.c. operation, a smaller Bell amplifier is provided.

Radio transmitting and receiving equipment consists of two 30-watt Motorola transmitters, one a.c.-operated and one d.c.-operated, and two receivers. Instantaneous communication with fire and police headquarters is possible.

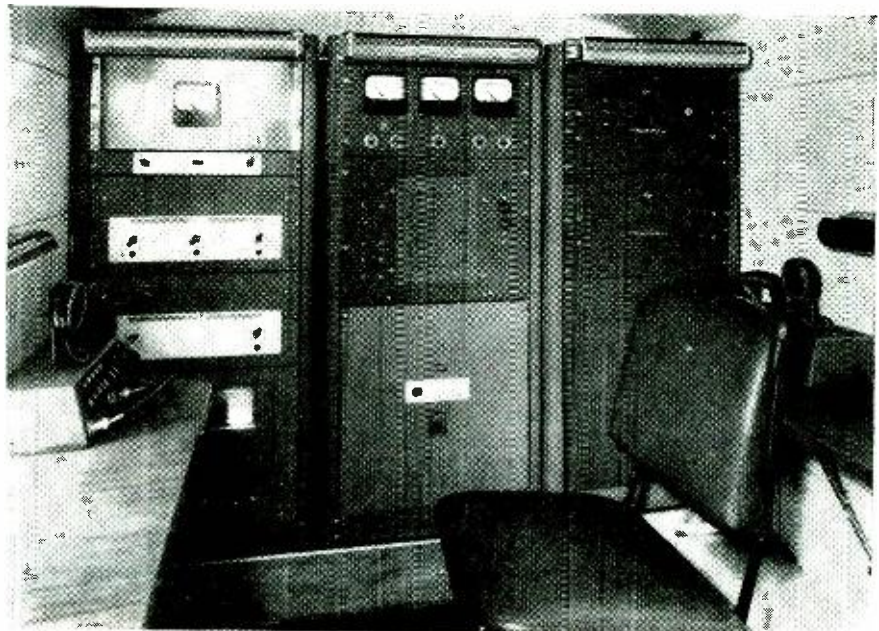

BRITISH SUBMINIATURE TUBES

These subminiature tubes are to be used in a new hearing aid to be supplied, free of charge, to all deaf persons in Britain under the National Health Service scheme. The tubes consume small power and batteries will last long, reducing running costs of the device. Four hundred thousand of the tubes have been ordered by the British government for the hearing aids. Development of the tubes stemmed from the electronic wartime research.



Five New Tubes Introduced

CK5702/CK605CX, GL-5663, 5696, 19J6, and 6W4-GT are new additions to tube lists



Five new tube types have been brought out during the month.

The special tube section of Raytheon Manufacturing Company announces the introduction of its subminiature type CK5702/CK605CX.

The CK5702/CK605CX is electrically identical to the well-known miniature 6AK5 except for a small difference in heater current. Therefore, the subminiature tube may be used in circuits which have been designed for the 6AK5, in most cases.

Sockets are available for the CK-5702/CK605CX, as for all other Raytheon subminiature types, so it is an easy matter, from the tube standpoint, to miniaturize many pieces of equipment up to now designed for the larger type 6AK5.

An inert-gas-filled midget thyratron, Type GL-5663, designed particularly to maintain its low control-grid and shield-grid currents throughout its life, has been announced by the Tube Division of General Electric Company's Electronic Department. Its small size and lightweight construction adapt the tube to control and relay applications where compactness and weight are important factors.

The new tube, 1½ inches high, has a typical heating time of 10 seconds, and a peak inverse and peak forward voltage rating of 500 volts. The anode current ratings are 60 ma instantaneous and 20 ma average.

The Tube Department of RCA has released information on the 5696, 19J6, and 6W4-GT.

The 5696 is a miniature thyratron of the gas-tetrode type designed particularly for relay applications such as counter circuits, where low heater-current drain and short deionization time

are important considerations. It operates with a heater voltage of 6.3 and a current of 0.15 ampere. Anode voltage is given as 500, either forward or inverse, and average current as .025 ampere, with peak current of 0.1 ampere. Some of the other features include low control-grid current, low control-grid-anode capacitance, and a steep control characteristic which is essentially independent of ambient temperature in the range of—55 to 90 degrees Centigrade.

The 19J6 is a medium-mu miniature twin triode intended especially for converter service in a.c.-d.c. FM-AM receivers. It is also useful for oscillator, amplifier, or mixer service in television receivers of the transformerless type. This new tube with its 18.9-volt, 0.15-ampere heater may be operated in series with other miniature tubes having 0.15-ampere heaters. Its transconductance is 5,300 micromhos and its amplification factor 38.

The 6W4-GT is a new half-wave vacuum rectifier tube of the heater-cathode type designed especially for use as the damper diode in television-receiver circuits. It may also be used, however, as a rectifier in conventional power supplies.

In damper service, the 6W4-GT will withstand a peak inverse plate voltage of 2,000, when the duty cycle of the voltage pulse does not exceed 15% of one scanning cycle and its duration is limited to 10 microseconds. The maximum peak plate current rating is 600 ma.

In rectifier service two 6W4-GT's in a full-wave circuit are capable of delivering a d.c. output of about 350 volts at the recommended full-load current of 250 ma.

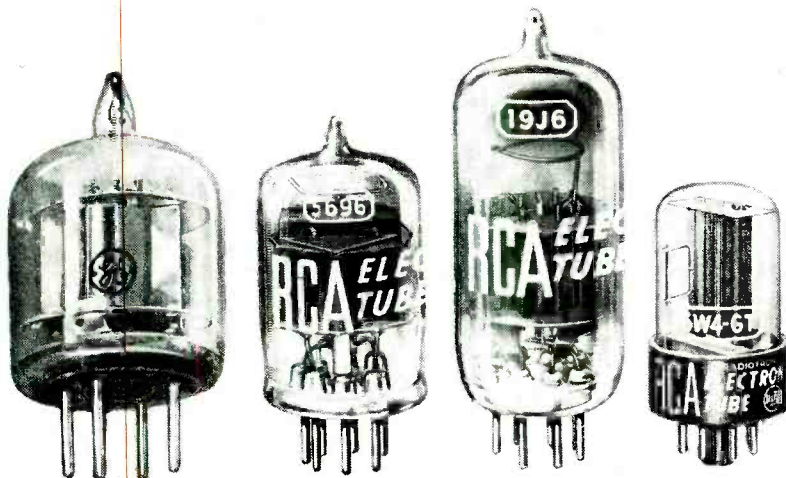

PERSONAL CONTACT!

We fully appreciate business—small and large. And we show our gratitude by personally attending to every whim of our customers. Maybe that is why our list of customers continues to grow. We believe we can satisfactorily fill your needs . . . and our prices are always right. Of course we have our specials, too. Send us your name and address and we'll place you on our mailing list to receive literature from time to time.

ADSON

RADIO & ELECTRONICS CO.
221 Fulton Street New York 7, N. Y.

UNIVERSAL TROUBLE SHOOTER—

SAVES U 50%

Locates every service trouble. Does everything and guaranteed to do everything we say it will . . . Aligns paddler. Locates dead spots, weak spots, defective parts. Checks gain. All parts including case, guaranteed test leads. 2 1/4" x 3 1/2" plug. 2 1/4" x 3 1/2" **\$3.95**

INDUCTANCE TUNER for TELEVISION & FM
Front end 2 gang, individually isolated coils. 17 turns silver wire on a ceramic form, per gang. Fully shielded. Will cover FM and both Television bands. With circuit diagram. **\$4.25 ea**

25 WATT P.P. 6L6 Hi Gain AMPLIFIER KIT
A wonderful buy! Make up an amplifier worth \$50 to you. Powerful enough for auditoriums seating 1500 people. Separately controlled Mike & Phono inputs. All parts including drilled chassis, hardware, solder, circuit diagram, etc. **\$11.95 ea**

PHONO OSCILLATOR 2 TUBE KIT
If you know value, this is it! Orders come from Maine to Miami, Sandy Hook to San Francisco. . . . We gain with microphone jack and all parts including tubes. **\$2.95 ea**

PRICES NET F.O.B. OUR PLANT. Write for FREE data circuits designed by ROBT. G. HERZOG.

Universal general corp.

365 J CANAL ST. N. Y. 13,
Walker 5-9642

Announcing

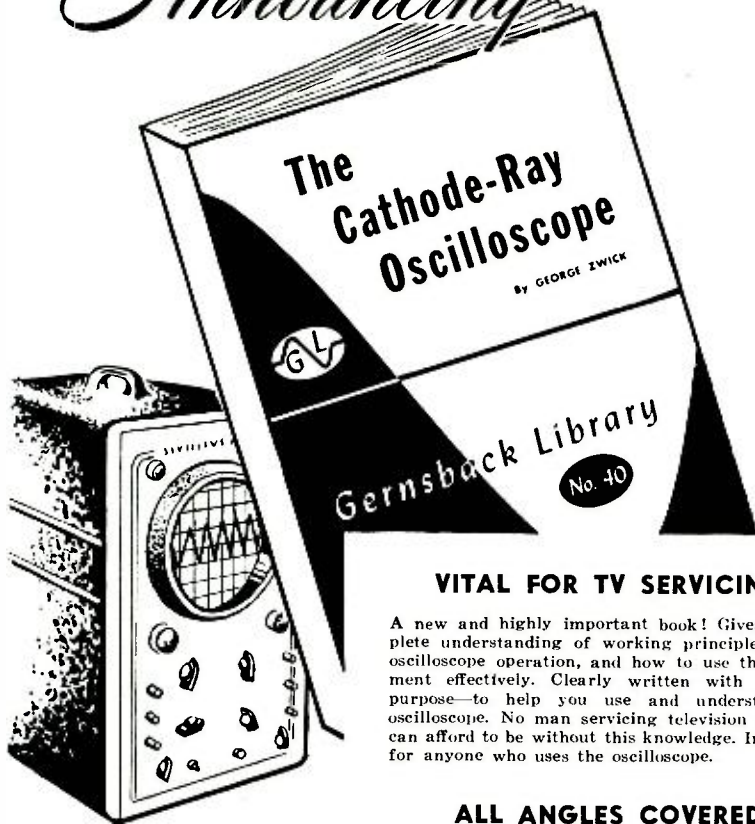

VITAL FOR TV SERVICING

A new and highly important book! Gives a complete understanding of working principles behind oscilloscope operation, and how to use the instrument effectively. Clearly written with a single purpose—to help you use and understand the oscilloscope. No man servicing television receivers can afford to be without this knowledge. Invaluable for anyone who uses the oscilloscope.

ALL ANGLES COVERED

Chapter 1—Direct Current and Alternating Current. Visual observation and measurement of varying voltages and currents on the cathode-ray tube. **Chapter 2**—How beam from electron "gun" projects image of current and voltage variations onto fluorescent screen, and how beam is deflected by electrostatic and electromagnetic means. **Chapter 3**—How signal deflects electron beam vertically in c-r tube and sweep voltage deflects beam horizontally. Role of the saw-tooth oscillator—the gas discharge tube—the multivibrator—synchronization—locking. **Chapter 4**—The cathode-ray tube—accelerating and focussing power supplies—the sweep generator—the horizontal and vertical amplifiers—controls on oscilloscope—how to operate a scope. **Chapter 5**—Aligning TV i.f. channels—TV front-end alignment—Alignment of i.f. amplifiers in AM and FM sets. Use of signal generators—i.f. alignment of a.c.-d.c. receivers—bandpass alignment—aligning the discriminator—the ratio detector—r.f. alignment of AM and FM receivers. **Chapter 6**—Audio output measurement—voltage gain—power output—audio response curve plotting—peak a.c. measurements. Checking saw-tooth amplifiers—magnetic deflection circuits—synchronizing pulses. Ham transmitter measurements—over and under-modulation. Locating hum—incorrect adjustment of vibrator power supplies. Phase shift in audio amplifiers.

112 PAGES 103 ILLUSTRATIONS

Only 75c

See your jobber today or send for THE CATHODE-RAY OSCILLOSCOPE along with other titles in the GERNSBACK LIBRARY.

GERNSBACK LIBRARY

MAIL THIS COUPON NOW

RADCRAFT PUBLICATIONS, Dept. 29
25 West Broadway, New York 7, N. Y.

Send me the books checked, postpaid.
 NO. 40 CATHODE-RAY OSCILLOSCOPE 75c

I enclose \$
Your Name
Address (Print clearly)
Jobber's Name
Address

11 OTHER BOOKS

- No. 29—Handy Kinks and Short Cuts, 50c
- No. 30—Unusual patented Circuits, 50c
- No. 31—Radio Questions and Answers, 50c
- No. 32—Advanced Service Technique, 50c
- No. 33—Amp lifier Builder's Guide, 50c
- No. 34—Radio-Elec-tronic Circuits, 50c
- No. 35—Amateur Radio Builder's Guide, 50c
- No. 36—Radio Test In-struments, 50c
- No. 37—Elementary Ra-dio Servicing, 50c
- No. 38—How to Build Radio Receivers, 50c
- No. 39—Practical Disc Recording, 75c

Radio Thirty-Five Years Ago
In Gernsback Publications

HUGO GERNSBACK
Founder

Modern Electrics	1908
Electrical Experimenter	1913
Radio News	1919
Science & Invention	1920
Radio-Craft	1929
Short-Wave Craft	1930
Wireless Association of America	1908

Some of the larger libraries in the country still have copies of ELECTRICAL EXPERIMENTER on file for interested readers.

IN ELECTRICAL EXPERIMENTER
February 1915

- Lackawanna Railroad Radio Telephony and Telegraphy by Frank C. Perkins
- Condenser as a Shunt to a Telephone by H. Smith, B.Sc.
- A 50-Cent Radio Receptor by Fred Sampson
- A Crystal Testing Set by E. H. Swanson
- Magnetic Detector Adjustment
- Wireless Time Signals in Germany by Frank C. Perkins
- Some Novel Wireless Telephone Schemes by H. Winfield Secor
- The Wave Length of Radio Antennae by H. Winfield Secor
- A Non-Inductive Potentiometer by Thomas F. Carroll
- A Novel Silicon Detector by Franklyn Stratford
- Home-Made Aerial Insulators
- New Wireless Truck of U. S. Signal Corps of 800 Mile Range by Frank C. Perkins
- New de Forest Radio Telephones
- Permanent Detector Adjustment by Randolph Roland
- A Boost for Those with Radio Troubles by Harry L. Dearborn

CORRECTIONS

In Fig. 2, Tube Tester and Analyzer, page 44 of the January issue, the screen grid should connect directly to B-plus.

Step No. 2 in operating the tube tester should be to turn the ANALYZE-TUBE TEST switch to TUBE TEST rather than to ANALYZE as stated in the instructions.

The plate of the 6J5 cathode-follower in the Wobulated Signal Generator (page 34 of the May 1948 issue) should connect directly to B-plus instead of to ground as shown in the diagram. We thank Mr. Reid C. Simpson, Jr., of Troy, N. Y., for this correction.

Condenser C8 was omitted from the diagram. This should be connected between the grid (No. 5 pin) of the 6K8 and the junction of C17 and the lead from L and C18A. Be sure to connect the grid to the end of the coil nearest the tap.

The captions of Figs. 2 and 3 in "Calibrating Audio Oscillators" (October 1948, page 54) were reversed in printing. Fig. 2—30 cycles should be under the pattern on the left and Fig. 3—40 cycles under the one on the right.

We thank Mr. Theodore Bacloswki of Philadelphia, Penna., for this correction.

"DEGAUSSING" TUBES

A new method of curing hum in low-level amplifier tubes has been discovered by three British engineers: Messrs. W. Grey Walter, H. W. Shipton and W. J. Warren, all of the Burden Neurological Institute. A letter reporting their results appeared recently in the English publication, *Electronic Engineering*. The metal elements of many tubes apparently are magnetized when they leave the factory; the magnetization interacts with the magnetic field of the a.c. heater current to produce hum.

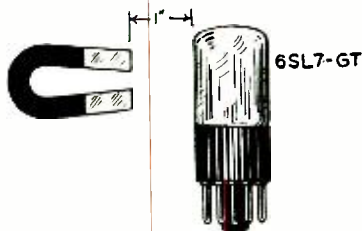

Heater-current hum (an induction effect) can often be cured by placing a small permanent magnet near the tube, but bringing the magnet right up to the tube and then withdrawing it makes the hum become much worse and remain so. After concluding that this was caused by the magnetizing of the tube elements, the three engineers tried demagnetizing tubes in a decreasing a.c. field with a procedure somewhat similar to that used in demagnetizing watches.

They found that demagnetization reduced hum in all the tubes. Whereas previously tubes had to be carefully selected for low hum, any tube can now be made to work by passing it through the demagnetizing coil. This magazine has tried the magnetizing effect with several American tubes, with parallel results. (Hum due to heater-cathode leakage will not, of course, be cured by this method.—*Editor*)

NEW MERCURY LAMP PHOSPHOR

Healthy men working under mercury-vapor lights need no longer look pale and sickly, and women's lips may appear their natural or applied color. A fluorescent material developed by a Westinghouse scientist makes the light from the mercury-vapor tube eight times richer in red than from the tubes of clear glass, and people under it look natural.

The material is a high-temperature phosphor, which is used to powder the inner glass wall of a mercury-vapor lamp. This fluorescent coating transforms the invisible ultraviolet rays into pure red light which, added to the bluish-white light from the mercury vapor, gives illumination under which persons and objects appear more nearly in their true colors.

The discovery of the phosphor which transforms the invisible radiation into visible red light and at the same time withstands the high heat (about 750 degrees F) within the tube, was made by Luke Thorington of the Westinghouse lamp division staff.

LARGEST SURPLUS STOCK in the COUNTRY at the LOWEST PRICES!

BRAND NEW TUBE

304TLeach 90¢
Four for\$3.00

T-26/APT-2

Radar jamming transmitter, 450-710 mc. Heising amp—mod. by noise from 931A Phototube. Output 3 to 7 watts. All controls on front panel. 2- 6AC7 and 1- 6AG7 video circuit supply random noise, with pass band of 20 kc to 4 mc to the 807 mod. 2-368AS tubes in a push-pull 1/2-wave transmission-line osc. circuit supply the RF. Power furnished by 2- 5R4GY and 1- 2X2 tube. Consists of 27 tubes. Power. Input 27 VDC and 75-85 V. or 105-125 V. 400 to 2500 cye. Brand new in original export case with all tubes and handbook. Don't let this get away from you—Order today! FOB Chicago only. At only..... **\$9.95**

APN-1 RADIO ALTIMETER

Complete 420 mc transmitter-receiver unit, complete with all plugs, indicators. BRAND NEW. FOB Chicago only..... **\$34.50**

ALTIMETER TRANSCIEVER RT-7/APN-1.

Frequency 418-462 mc. FM with 13 tubes including 3- 12SK7, 4- 12SH7, 2- 12BH6, 1-VR150, 2- 955, 2- 9004. 2lv Dynamotor, used. in working condition..... **\$7.95**

R-89/ARN-5A

Glide path receiver. Crystal control of local oscillator. 332-335MC, complete with relays, 7- 6AJ5, 1- 12SK7, 2- 12SN7, 1- 280T and 3 xtals; 6497 KC, 6322 KC, 6547 KC, 90 cye. band pass and 150 cye. band pass filters, excellent for making an intermodulation checker. Beautiful cabinet and chassis as foundation for many interesting experimental and construction projects. Broad pass band on 20.7 MC. IP's ideal for television. Schematic furnished. Used, excellent. Only..... **\$6.45**

CROSS POINTER INDICATOR

Dual 0-200 microamp. movement in 3" case. Each movement brought out to 6-term. receptacle at rear. Originally used in ILS equipment. New, only..... **\$1.95**

BC-733-D

Localizer receiver of the blind landing system. Comparison to the glide path receiver. Also contains 90 and 150 cycle band-pass filters. 108.3 to 110.8 mc by relay selection of crystals in the local oscillator. Wide pass-band on 6.9 mc. IP's ideal for FM. Has a wonderful AVC system using rectified output of an RF oscillator as power supply for 100v 10c bias. With relays, crystals and 10 tubes: 2- 717A, 2- 12SK7, 1- 12SO7, 1- 12AG, 1- 12AH7, 2- 12SK7. Schematic furnished! Condition: used, excellent. FOB Chicago, only..... **\$3.95**

New, FOB Chicago only..... **\$9.95**

POWER YOUR RIG FROM AC

RA-1 RECTIFIER. Makes a ground xmitr of BC-191, the 12v version of BC-375-E. Convert BC-375-E to 12v by changing heater link switches and relay connections, power it with RA-34. Input 105-125 or 210-250 V 60 cye. Outputs: for plates, 1000v filtered dc at 350 ma; for relay and mike, 12v filtered dc at 2.4 A; for heaters, 12v ac at 11.25 A. With technical manual. Used, excellent condition. FOB Los Angeles only..... **\$59.75**

With meters and adjustable hi-voltage output..... **\$85.00**

EE-8 ARMY FIELD TELEPHONE

Sturdy, highest quality telephone at less than price of a better-class toy. With ringer. Requires only two flashlight batteries for each phone and two wires between each phone. Excellent condition. Used. Each..... **\$7.95**

BC-659 TRANSMITTER-RECEIVER UNIT

FM transmitter-receiver, crystal controlled, two channels, freq. range 27-38.9 mc. 13 tubes 2 crystals. NEW..... **\$16.95**

BC-604 20-28 FM TRANSMITTER

For 11 and 15 meters: can be operated on 10 meters by use of proper xtals; 10 channel pushbutton xtal controlled, with all tubes, meter, schematic, case and covers; less crystals. Used, excellent, with dynamotor..... **\$14.95**

Used, good, with dynamotor..... **\$18.95**

Used, good, without dynamotor..... **\$8.95**

RE-684 27.0-38.9 FM TRANSMITTER.

Same as above except for freq. range. New.

FOB Chicago only..... **\$24.95**

Used..... **\$19.95**

FREE!

Our new 8-page catalogue featuring many excellent surplus values. Write for your copy today! It's FREE!

All shipments FOB Chicago or Los Angeles unless specified. 20% Deposit required on all orders. Minimum order accepted—\$5.00. California and Illinois residents, please add regular sales tax to your remittance.

ARROW SALES, INC., DEPT. R

Main Office: 1712-14 S. Michigan Ave. Chicago 5, Illinois
North Side Branch: 1802 N. Humboldt Blvd. Chicago, Illinois
West Coast Branch: 1260 S. Alvarado Los Angeles, Calif.

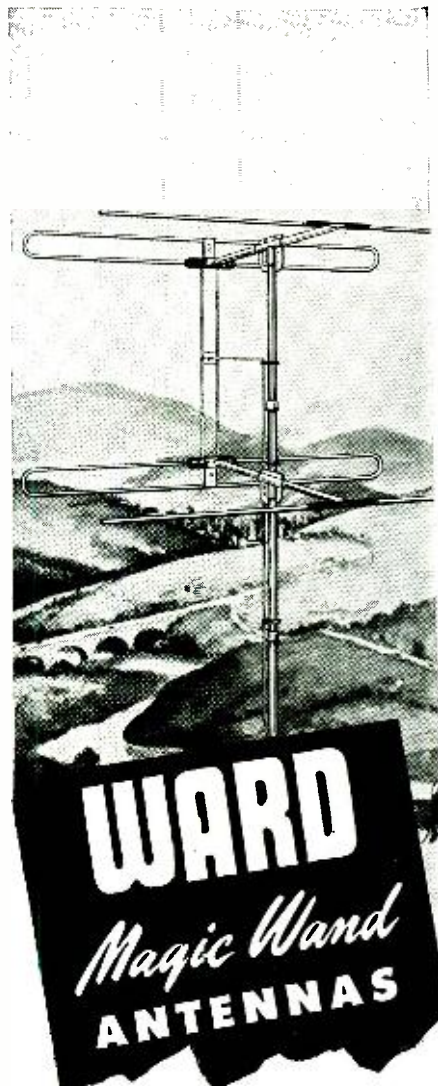

THE ONLY BROAD BANDED, HIGH GAIN, STACKED ARRAY ON THE MARKET

Many times more sensitive for TV reception in fringe areas and poor signal locations, the WARD TVS-6 STACKED ARRAY achieves maximum forward gain by stacking two high gain folded dipoles and reflectors with effective 1/2 wave spacing rather than the ordinary 1/8 or 1/4 wave which materially reduces sensitivity. THE ONLY STACKED ARRAY ON THE MARKET THAT IS BROAD BANDED, it will give excellent results with MANY CHANNELS where others are too selective. The advanced engineering and PRE-ASSEMBLED design of the WARD TVS-6 is only one of the reasons why WARD is the largest exclusive manufacturer of antennas in the world. See any leading parts distributor or write for catalog.

THE WARD PRODUCTS CORPORATION
1520 E. 45TH STREET, CLEVELAND 3, OHIO

RADIO SCHOOL DIRECTORY



SPECIALIZE • SPECIALIZE



You can become a Radio and Television Technician now!

A million new jobs — almost 4,000 a week — will be created in the television industry during the next five years according to estimates of industry leaders. Actually, during 1948, television grew faster than any other industry in the history of America.

Here is a real opportunity for you. Trained television technicians are in demand. By starting now, you can get in on the ground floor — grow as television grows.

To help supply this needed manpower, the Milwaukee School of Engineering has expanded its radio and television courses. Now you can get complete practical, technical training in the MSOE laboratories. *This is not just a serviceman's course.* It prepares you for a career in all of the technical phases of television and radio.

This special course Prepares you for any of the following careers:

- | | | |
|---|---|---|
| Television Serviceman
Radio Serviceman
Radio and Television
Retailer | Supervisor in Radio and
Television Assembly
Radio and Television Tester
Broadcast Radio-Operator | Police, Taxi-Cab and Rail-
road Transmitter Operator
Police, Taxi-Cab and Rail-
road Receiver Serviceman |
|---|---|---|

OTHER COURSES AVAILABLE		
SERVICE 6 to 12 Months • Electricity • Welding • Refrigeration • Heating	TECHNICIAN 1 to 2 Years • Electrotechnics • Radio and Television • Electronics • Refrigeration, Heating and Air Conditioning	PROFESSIONAL 3 Years • Electrical Engineering • Bachelor of Science Degree • Major in Electronics or Power

MILWAUKEE SCHOOL OF ENGINEERING



A Technical Institute
Founded 1903

by Oscar Werwith

MILWAUKEE SCHOOL OF ENGINEERING,
N. Broadway and E. State

Dept. RE-249
Milwaukee, Wis.

Without obligation send me free booklet "Career Building" and more details on course in Radio and Television or _____ course.

Name _____ Age _____
Address _____ State _____
City _____

RADIO COURSES

Preparatory, Service, Broadcast, Television, Marine Operating, Aeronautical, Frequency Modulation, Radar.

Classes now forming for mid-year term Feb. 1st
Entrance exam. Jan. 17

Veterans. Literature.

COMMERCIAL RADIO INSTITUTE
(Founded 1920)
38 West Biddle Street, Baltimore 1, Md.

WANTED:

Men and Women to Fill
TOP RADIO JOBS
in AM—FM—Television

If you are looking for a career with a future, why not join the hundreds of graduates from the Don Martin School of Radio Arts now successfully employed in the radio industry. The demand is great for qualified radio personnel in AM—FM—Television. Train now to be an announcer, script writer, disk jockey, news-caster, or radio technician. Complete day and night classes . . . the latest equipment. Free placement service. Approved for veterans. Write for free booklet.

Don Martin School of Radio Arts
1655 North Cherokee St. Hollywood 28, Calif.

RADIO and TELEVISION

Thorough Training in All Technical Phases

APPROVED FOR VETERANS

DAYS—EVENINGS WEEKLY RATES

RCA GRADUATES ARE IN DEMAND
For Free Catalog Write Dept. RC-49

RCA INSTITUTES, Inc.
A Service of Radio Corporation of America
350 WEST 4TH STREET NEW YORK 14, N. Y.

AUDIO ENGINEERING SCHOOL

A practical Audio Engineering course in Sound Fundamentals: FILM and MAGNETIC Recording; Transmission Measurements; Monitoring and MIXING. Laboratories contain Transmission Sets, Oscillators, Harmonic Analyzer, Distortion Sets, Intermodulation Analyzer, and other equipment. Recording Studio simulating Broadcast, Motion Picture and Commercial Sound Recording.

H. M. Tremaine, Pres.-Director. Approved for Veterans and Foreign Visas.

HOLLYWOOD SOUND INSTITUTE, Inc.
1040-E North Kenmore Hollywood 27, Calif.

CODE SENDING RECEPTION SPEED

Be a "key" man. Learn how to send and receive messages in code by telegraph and radio. Commerce needs thousands of men for jobs. Good pay, adventure, interesting work. Learn at home quickly through famous Candler System. Qualify for Amateur or Commercial License. Write for FREE BOOK.

CANDLER SYSTEM CO.
Dept. 9-B, Box 928, Denver 1, Colo., U.S.A.

LEARN RADIO!

IN ONLY 10 MONTHS
PREPARE FOR A GOOD JOB!
COMMERCIAL OPERATOR (CODE)
BROADCAST ENGINEER
RADIO SERVICEMAN

Television Servicing—15 Months

Veterans get \$130.00 Equipment
SEND FOR FREE LITERATURE
BALTIMORE TECHNICAL INSTITUTE
1425 Eutaw Place, Dept. C, Baltimore 17, Md.

RADIO COURSES

- RADIO OPERATING
- RADIO SERVICING
- CODE
- ELECTRONICS
- F.M. TELEVISION

• REFRIGERATION SERVICING

Write for Catalog and Picture Brochure

Y.M.C.A. TRADE & TECHNICAL COURSES
15 W. 63rd St. (N'r B'way) New York City

RADIO ENGINEERING

FM—Television—Broadcast

Police Radio, Marine Radio, Radio Servicing, Aviation Radio and Ultra High mobile applications. Thorough training in all branches of Radio and Electronics. Modern laboratories and equipment. Old established school. Ample housing facilities. 7 acre campus. Small classes, enrollments limited. Our graduates are in demand. Write for catalog.

Approved for Veterans

VALPARAISO TECHNICAL INSTITUTE
Dept. C VALPARAISO, INDIANA

TELEVISION NEW, INTERESTING TECHNICAL CAREER

As Television gains momentum, rapidly, constantly, it offers to properly-trained technicians careers with a future in Industry, Broadcasting or own Business.

Train at an Institute that pioneered in TELEVISION TRAINING since 1938.

Morning, Afternoon or Evening Sessions in laboratory and theoretical instruction, under guidance of experts, covering all phases of Radio, Frequency Modulation, Television. Licensed by N. Y. State. Free Placement Service. Approved for Veterans.

ENROLL NOW FOR NEW CLASSES
Visit, Write or Phone

RADIO-TELEVISION INSTITUTE
480 Lexington Ave., N. Y. 17 (46th St.)
Plaza 3-4585 2 blocks from Grand Central

LICENSING DOES NOT SOLVE THE PROBLEM

Dear Editor:

Mr. Moody, in his letter in your November issue, says licensing radio technicians would conquer the evils of the profession.

I think he is wrong. Licensing of other trades and professions has not eliminated these evils—there are still worthless and "gyp" doctors, lawyers, and so on. And if servicemen are to be licensed, how about mechanics, carpenters, and painters? Are all these men honest and fully qualified?

I feel that the only antidote for bad repairmen is the public itself. By refusing to patronize shops which do poor

work or which overcharge, the public can do a better clean-up job than will licensing. If servicemen are let alone, wrongs can be righted without government aid.

JOSEPH AMDY,
Mt. Pleasant, Pa.

(The only trouble with this argument is that members of the public don't know enough about radio to recognize a poor or too-expensive job when they get it. *Caveat emptor*—let the buyer beware—may be all right, but not if the buyer has no way of knowing what to be wary of.—Editor)

SYNTHETIC MICA WAS A PREWAR BABY

Dear Editor:

On page 10 of your November issue, it was stated that synthetic mica with the desirable characteristics of natural mica had been produced for the first time.

Synthetic mica was produced long ago; as a matter of fact, without it we would have been in serious trouble during the war. I refer you to U. S. patents

2,266,636, 2,266,637, 2,266,638, 2,317,685, and 2,383,647, as well as to a paper, "Colloid Chemistry of Clays," in the October, 1945, issue of *Chemical Reviews*, and to page 186 of the book, "Q.E.D.," published by John Wiley & Sons, Inc.

ERNST A. HAUSER,
Professor of Colloid Chemistry,
Mass. Institute of Technology

RADIOS OVERWORKED FOR \$3.00 PER DAY

Dear Editor:

The article, "Coin Radios—A Good Business" by James McDaniel, appearing on page 42 of the December, 1948 issue of RADIO-ELECTRONICS, states, "The average income from each of my sets is about \$3 per day."

At this rate, the income of one radio will approximate \$1000.00 per year which we believe is an exorbitant rate of profit to be obtained from an investment of less than \$100.00.

Mr. McDaniel states that he chose the 25c hourly rate. At \$3 per day, this requires the radio to be "coined" twelve

hours every day. A plant of 100 radios would bring in a gross of \$100,000 per year in round numbers.

We believe the article should have read "\$3 per week," which, incidentally, is somewhat higher than our experience. With 100 radios of various makes, for the past year, our gross has averaged 8c per day.

H. L. EMMONS,
Richland, Wash.

(The figure should be \$3 per week, as suggested. Our thanks to Mr. Emmons, and also to Mr. Paul J. Mitman of Detroit, for this correction.—Editor)

RESERVE YOUR MARCH TELEVISION ISSUE NOW!!

Next month's issue of RADIO-ELECTRONICS will be dedicated to the SPIRIT OF TELEVISION. There will be special articles on such phases of television as test instruments, antenna design and installation tips, latest circuits, elimination of ignition interference, test-pattern indications, troubles in receiver kits, latest sets and accessories, and industrial applications. We will not neglect our regular articles on servicing, sound construction, test instruments, amateur radio, etc., so RESERVE YOUR COPY NOW!!

RADIO

TECHNICIAN and RADIO SERVICE COURSES
FM and TELEVISION
AMERICAN RADIO INSTITUTE
101 West 63rd St., New York 23, New York
Approved Under GI Bill of Rights
Licensed by New York State

CORRESPONDENCE COURSES IN RADIO and ELECTRICAL ENGINEERING

ELECTRICAL ENGINEERING Get good grasp of wide electrical field. Prepare yourself at Low Cost, for secure future. Modern course. So simplified anyone can understand quickly.
RADIO ENGINEERING Extra fine course in radio. Private address, photo-electric work. Trains you to be super-service man. real vacuum-tube technician. Servicemen needed badly. Diploma on completion. Many graduates earning big pay.
Send postcard for Free Copies of school catalog. Full details, all about deferred payment plan, experimental kits, etc.
WRITE **\$25** Course
Lincoln Engineering School, Box 931-C-120, Lincoln 2, Neb.

Amplifier BC908 12 Tube Mfg. R.C.A. New orig. box less than cost of tubes w/price. \$13.95
Amplifier for wire recorder MFG. by Brush Co. 9 Tubes constant speed motor heavy duty 115 VAC. 22.50
Amp. R-1292 F. mobile or fixed w/DC & 115 VAC. 100 watt. sup. W. turntable & pickup 20 watt MFG. Bogen. 45.00
Translat VR Amatran 45 A 0-115 V type HL new 69.00
As-built mod. W-115 VAC Sel. cable Ter. Ind. 25 ohm 25 watt Pot F/reading dir. of Ant. 15.95
Wire 218 W.E. cotton cover silk & Eni. 1200 Ft. 3.95
Wire 220 & 22 stranded rubber silk cover per M. 3.95
Trans. H. dieley 490 VCT 6.3 2A. 5V 2A. new. 1.50
Choke Thornderson 130/30 8 Henry 120 ohm. new RFAIF coils with wave trap Philco part 5 for. 1.00
Ohmite dummy antenna 73 ohm 100 watt D-100 Special 50 ohm type 4502. 387 35 ohm voice coil used W. amp. BC1292 Pop. makes, used. 1.75
Excel. 15.00
Rubber tape, we guar. this, reg. 60c ea. 6 rolls 1.50
Xtals. 200 KC standard 2 pin mount holder, ea. 1.00
Transmitter Stancor 110C 100 watt phone CW 59.50
Suppressor Filterette Mfg. Tube Type 1176 250 Vols AC or DC 3 Amp. 4 heavy duty cond. in oil & 2 chokes in one can size 4x3 X1 for 101 noise fil. jobs in line, etc. Reg. \$15.00
Shield Beiden comp. 127 a real buy 50 ft. for AC syn. trans. motors type XV 115 VAC. new. 9.95
McCONNELL'S 3834 Germantown Ave. Phila. Penna. RA5-6033

PHONO AMPLIFIER

\$1.39

3 at \$1.25

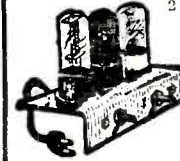

2-TUBE AC-DC WIRED AND TESTED
2 TUBES—50L6—35Z5.....\$1
PHONO OSCILLATOR
2 tube ac dc.....\$2.75
2 tubes 35Z5 & 12SA7.....1.20
PHONO AMPLIFIER
3 tube ac dc.....\$1.69
Wired & tested 3 for 1.49
Uses 12SQ7, 35Z5, 50L6
Set of 3 tubes.....1.25
Output Transformer......32
5" Alnico Speaker..... 1.10
6" Alnico Speaker..... 1.15

Alliance Phono Motors.....\$2.50
High Output Crystal Pickup.....1.89

\$1 deposit on all orders. Free Catalog RE.

RADIO MAIL ORDERS
75 Barclay St., N. Y. 7, N. Y.

3/4 RPM, HI-TORQUE ELECTRIC MOTOR

\$2.95

POSTPAID U.S.A.

GOV'T COST \$40

BRAND NEW SURPLUS!



GUARANTEED!

- Operates on 110V AC, 60-cycles (Requires only 12 MFD condenser.)
- Reversible, Self-Locking Clutch. Quiet.
- With Full Instructions.
- FOR ROTATING HAM, FM, TELEVISION ANTENNAS AND MANY OTHER USES.
- FB for that new QUAD

ALVARADO, DEPT. RC-20

903 S. ALVARADO, LOS ANGELES 6, CALIF.



WE ARE LOOKING FOR TUBES!

WHAT HAVE YOU GOT?

Interested in small or large quantities of all types of Transmitting, Industrial, and Receiving Tubes. Send offerings to:

T. L. BLACK, WHOLESALE TUBE DIV.

NIAGARA RADIO SUPPLY CORP.

160 Greenwich St., New York 6, N. Y.

WALL MODEL



\$15.95 FOR 2 OF EITHER MODEL

Common talking and common ringing. Any number of phones can be connected in same circuit. Simple installation, absolutely no technical knowledge required. 25% deposit required on all orders. F.O.B. Brooklyn.

EASTERN TELEPHONE CO.
320 18th St., Dept. RC-1
Brooklyn, N. Y.

TELEPHONES

Now—Telephones of Deluxe quality at low prices, incorporating latest improvements in dialer and technique. Honest to goodness first class material and finest workmanship. Lowered cost due to increased volume makes it possible for us to sell at the special low price of \$15.95 for Two of either model, complete with wire, power supply and instructions.



DESK MODEL

RADIO-ELECTRONICS needs photos of service shops and service benches. We will pay \$6.00 for each 6x8- or 8x10-inch glossy photo accepted. Do not "dress up" your bench, but take a bona-fide photo, preferably with men working.

TELEVISION IS BOOMING

CASH IN ON IT!

Headphone BARGAINS

Type H523—8000 ohm impedance, highly sensitive, light-weight only 9 oz. Leather covered spring steel adjustable headband. 12' cord with PL54 plug attached at side out of way. Jack and rubber cord supplied to extend length to 5 1/2 feet. Removable rubber ear cushions. Brand New—\$13.50 Value.

Stk. No. 17A37
SPECIAL PER PAIR \$2.45



Type H530—8000 ohm impedance. Small yet highly sensitive. Built on hearing aid principle with ear fitting soft rubber cushions attached to receivers. Shut out outside noise. Comfortable, light metal band easily shapes to contour of head. Supplied complete as illustrated with 6 foot cord and PL55 plug, shirt clip and matching transformer for 8000 ohm impedance. Very popular for conversion to mikes, telephone sets, miniature crystal sets and all around headphone use. Brand New. A Terrific Value!

No. 17A420X.
Per Pair \$1.29

5BP4 CATHODE RAY TUBE \$2.95

Hos 5" white screen. Quality make individually boxed in cushioned carton. Brand New, Perfect, Guaranteed. No. 36T206.

SPECIAL EACH \$2.95

ORDER NOW from this ad—include postage.

FREE—the big NEW B-A Catalog No. 491. 132 pages of Outstanding Values. Write if you have not received it.

BURSTEIN-APPLEBEE
1012-14 MCGEE STREET, Company
KANSAS CITY 6, MISSOURI

The HOUSE OF A MILLION RADIO PARTS

Specials in Condensers

5 Mfd. 35V Tubular	10 for \$1.25
10 Mfd. 150V "	10 for \$1.95
20 Mfd. 150V "	10 for \$2.25
8 Mfd. 400V "	10 for \$2.95
8 Mfd. 450V "	10 for \$4.95
2" Round G.E. 0-1 R.F. Meter	\$1.95

Write for Bulletin No. C-915

Lifetime Sound Equipment Co.
911-913 Jefferson Ave., TOLEDO 2, OHIO

LITZ WIRE

Magnet Wire

★ **LARGE STOCK** ★

MAGNET WIRE, Incorporated
Retail Department
25 WEST BROADWAY
Worth 4-5447-8-9
Cable Address: "Magnetwire, New York"

EASYLEARN CODE

It is easy to learn or increase speed with an Instructograph Code Teacher. Affords the quickest and most practical method yet developed. For beginners or advanced students. Available tapes from beginner's alphabet to typical messages on all subjects. Speed range 5 to 40 W.P.M. Always ready—no QRM.

ENDORSED BY THOUSANDS!

The Instructograph Code Teacher literally takes the place of an operator-instructor and enables anyone to learn and master code without further assistance. Thousands of successful operators have "acquired the code" with the Instructograph System. Write today for convenient rental and purchase plans.



INSTRUCTOGRAPH COMPANY
4701 Sheridan Rd., Dept. RC, Chicago 40, Ill.

HARD-TO-GET PARTS

POWERFUL ALL-PURPOSE INDUCTION MOTOR

IDEAL FOR EXPERIMENTERS—101 USES



Sturdily constructed to Precision standards, this self-starting shaded pole A.C. induction motor is powerful enough for a number of uses. Some of these are: Automatic Timing Devices, current interrupters, Electric Fans, Electric Chimes, Window Displays, Photocell Control Devices, Electric Vibrators, Small Grinders, Buffers and Polishers, Miniature Pumps, Mechanical Models, Sirens, and other applications.

Consumes about 15 watts of power and has a speed of 3,000 r.p.m. When geared down, this sturdy unit will constantly operate an 18-inch turntable loaded with 200 lbs. dead weight—THAT'S POWER!

Dimensions 3" high by 2" wide by 1 1/4" deep; has 4 convenient mounting studs; shaft is 1/8" long by 3/16" diameter, and runs in self-aligning oil-retaining bearings. Designed for 110-220 volts, 50-60 cycles, A.C. only. Shp. Wt. 2 lbs.

ITEM NO. 147
YOUR PRICE \$2.45

ULTRA MAGNET

LIFTS MORE THAN 20 TIMES ITS OWN WEIGHT

LITTLE GIANT MAGNET



Lifts 5 lbs. easily. Weighs 4 oz. Made of ALNICO new high-magnetic steel. Complete with keeper. World's most powerful magnet ever made. The experimenter and hobbyist will find hundreds of excellent uses for this high quality permanent magnet. Measures 1 3/4 x 1 1/4". Shp. Wt. 3/4 lbs.

ITEM NO. 159
YOUR PRICE \$1.25

GENUINE MICROPHONE TRANSMITTERS

Regular telephone transmitters taken from a large telephone supply company's overstock. Work perfectly on 2 dry cells and are based on P.A. systems, call systems, inter-communication systems, short-line telephone circuits, house-to-house or farm-to-farm phone lines. Useful attachments on battery-operated rural telephone lines.

REGULAR GENUINE TRANSMITTERS, MADE BY KELOGG, WESTERN ELECTRIC AND STROMBERG-CARLSON; excellent in appearance and operation. A remarkable value and one seldom offered in these times. Shp. Wt. 1 lb.

ITEM NO. 160
YOUR PRICE \$1.95

WATTHOUR METER

Completely overhauled and ready for immediate service. Designed for regular 110-volt, 60 cycle 2-wire A.C. circuit. Simple to install; 2 wires from the line and 2 wires to the load. Sturdily constructed in heavy metal case. 8 1/2" high, 6 1/4" wide, 5" deep. Westinghouse, G. E. Fort Wayne, Sanfamo or other available make. Shp. Wt. 14 lbs.

ITEM NO. 33
YOUR PRICE \$5.95

AMAZING BLACK LIGHT!!

Powerful 250-Watt Ultra-Violet Source



The best and most practical source of ultra-violet light for general experimental and entertainment use. Makes all fluorescent substances brilliantly luminescent. No transformers of any kind needed. Fits any standard lamp socket. Brings out beautiful opalescent hues in various types of materials. Sweet for amateur parties, plays, etc.; to obtain unique lighting effects. Bulb only. Shp. Wt. 2 lbs.

ITEM NO. 87
YOUR PRICE \$1.95

WESTERN ELECTRIC BREAST MIKE

This is a fine light-weight aircraft carbon microphone. It weighs only 1 lb.

Mike comes with breastplate mounting and has 2-way swiveling adjustment so that it can be adjusted to any desired position. There are 2 woven straps; one goes around neck, the other around chest. Straps can be snapped on and off quickly by an ingenious arrangement.

This excellent mike can be adapted for home broadcasting or private communication systems. By remounting in breastplate, it can be used as desk mike.

Comes complete with 6-foot cord and hard rubber plug. Finished in sherdarized plate, non-rustable. Shipping weight, 2 lbs.

ITEM NO. 152
YOUR PRICE \$1.45



HUDSON SPECIALTIES CO.

40 West Broadway, Dept. RE-2-49, New York 7, N. Y.

I have circled below the numbers of the items I'm ordering. My full remittance of \$_____ (include shipping charges) is enclosed. (NO C.O.D. ORDERS UNLESS ACCOMPANIED WITH A DEPOSIT.)

OR my deposit of \$_____ is enclosed (20% remittance). Ship order for balance. (NO C.O.D. ORDERS FOR LESS THAN \$5.00. BE SURE TO INCLUDE SHIPPING CHARGES.)

Circle item No. wanted:
147 159 160 87 152 33

Name _____
Address _____
City _____ State _____

Please Print Clearly

ADVERTISING INDEX

FEBRUARY, 1949

Adson Radio & Electronics Co.	91
Allied Radio Corporation	59
Alvaradio	95
Amplifier Corporation of America	81, 82, 85
Arrow Sales, Inc.	93
Bell Telephone Labs., Inc.	Back Cover
Brooks Radio Distributing Co.	84
Buffalo Radio Supply	18, 19
Burstein-Applebee Company	96
Capitol Radio Engineering Institute	17, 67
Certified Television Laboratories	85
Cinex, Inc.	85
Cleveland Institute of Radio Electronics	20
Communications Equipment Company	77
Coyne Electrical School	82
DeForest's Training, Inc.	9
Eastern Telephone Company	95
Electronic Corporation of America	86
Electronic Sales Company	81
Espey Manufacturing Co., Inc.	89
Esse Radio Company	8
Fair Radio Sales	70
General Electronic Distributing Co.	66
General Test Equipment	85
Greylock Electronic Supply Co.	85
Heath Company	14, 15
Hudson Specialties	96
Instructograph Company	96
Lafayette-Concord	16, 71
Leotone Radio Corporation	63
Lifetime Sound Equipment Co.	96
McConnell	82, 95, 97
McGraw-Hill Book Co., Inc.	97
Magnet Wire, Inc.	96
Merit Products	80
Metropolitan Electronic Instrument Co.	13
Microcircuits Company	97
Mid-America Company	88
Midway Company	85
Midwest Radio Corporation	86
Mor's Radio Shack	80
Mass Electronic Distributing Company	68
Murray Hill Books, Inc.	64, 65
National Radio Institute	3
National Schools	5
Niagara Radio Supply Company	85, 95
Opad-Green Company	70
Opportunity Adlets	75
Precision Apparatus Company	68
Progressive Electronics Company	74
Quam Nichols Company	90

RADIO SCHOOL DIRECTORY

(Pages 94-95)

American Radio Institute	
Baltimore Technical Institute	
Candler System Company	
Commercial Radio Institute	
Don Martin School of Radio Arts	
Hollywood Sound Institute, Inc.	
Lincoln Engineering School	
Milwaukee School of Engineering	
RCA Institutes	
Radio Television Institute	
Valparaiso Technical Institute	
YMCA Trade & Technical Schools	

R & M Radio Co.	74
Radio Apparatus Company	68
Radio City Products Co., Inc.	77
Radio Dealers Supply Company	81
Radcraft Publications, Inc.	79
Radio-Electronics Library Series	92
Radio Kits Company	88
Radio Mail Orders	82, 85, 95
Radioic Equipment Company	88
Radio Publications	85
Radio Supply & Engineering Company	4
Rice Laboratories	85
The Rose Company	81
Senco Radio, Inc.	74, 75
N. Silverstine Company	6
Simpson Electric Co.	69
Spartan School of Radio and Electronics	87
Sprague Products Company	12
Sprayberry Academy of Radio	7
Superior Instruments	72, 73
Supreme Publications	61
Sylvania Electric Products	Inside Back Cover
Technical Radio Parts	80
Television Assembly Company	Inside Front Cover
Telex, Inc.	83
Telrex, Inc.	80
Transvision, Inc.	10, 11
Universal General Corporation	91
Ward Products Corporation	98
Wells Sales, Inc.	93

THE AMPLIFICATION AND DISTRIBUTION OF SOUND. Second Edition, by A. E. Greenlees. Published by Chapman and Hall, Ltd., London. 5½ x 8¾ inches. 302 pages. Price 16 shillings.

This is a rather general book, apparently intended for the man who rents and installs PA systems, rather than for the designer or hobbyist. Most of the very basic material in audio work is presented, but each subject is touched so fleetingly that the reader comes away with not much more knowledge than that there is such a thing.

A chapter containing material not available already in a number of other standard works is the one on installations. Here several examples are given and the general requirements of various applications are discussed.

Mathematical explanations are conspicuous by their absence from the book, but several useful, standard tables are presented—decibels, phons, parallel resistances, speaker matching, and others.—*R.H.D.*

SERVICING THE MODERN CAR RADIO. by A. L. Hurlbut. Published by Murray Hill Books, Inc., New York. 9 x 12 inches. 692 pages. Price \$7.50.

The first part of this book, consisting of 93 pages, deals with general features of automobile radios, automobile radio servicing, installation, and with the particular problems of specific portions of the car receiver.

The next 478 pages are devoted to service notes, alignment data and schematics of 257 automobile receiver models, representing 15 manufacturers. Breakdowns, partial schematics and complete circuits bring the total number of diagrams to over 500.

The book is well printed and excellently illustrated. It is worthy of note that the pages are so large that each page contains much more material than the average book.

RADIO AT ULTRA-HIGH FREQUENCIES. Vol. II, (1940-1947), edited by Alfred N. Goldsmith, Arthur F. Van Dyck, Robert S. Burnap, Edward T. Dickey, and George M. K. Baker. Published by RCA Review, Princeton, N. J. 485 pages. 6 x 9 inches. Price \$2.50.

This is a collection of approximately 54 papers delivered by RCA engineers

or published in *Proceedings of the IRE, Electronics, Journal of Applied Physics, FM and Television, and Communications.* The papers cover a number of phases of u.h.f. radio including antennas, transmission lines, propagation, reception, radio relays, measurements, and components. The papers are grouped so all those on the same general subject are in the same section of the book. Other papers by RCA engineers, not reprinted in this volume, are summarized.

There are two appendices. One is a bibliography of technical articles on u.h.f. and related subjects written by RCA engineers and published between 1925 and 1947. The other consists of summaries of papers published in Volume I of this book.—*R. F. S.*

RADIO INDUSTRY RED BOOK. compiled and edited by Howard W. Sams & Co., Indianapolis, Indiana. Flexible fiber covers. 8½ x 11 inches. 446 pages. Price \$3.95.

Designed with the object of "providing a single accurate volume that would give radio service technicians instant reliable data on major replacement parts used during the past ten years . . . listing the proper replacement products of most of the leading parts manufacturers . . ." this book is, in effect, an encyclopedia of replacement parts. Model numbers of some thousands of receivers are listed down the left side of each left-hand page and the same model number is listed on the right-hand side of the opposite page. This permits listing the replacement parts numbers on a line 19 inches long. The line is divided into eight sections: capacitors, transformers, batteries, i.f. coils, phono cartridges, speakers, controls, and vibrators. The set manufacturer's part number is given, thus the replacement part numbers of from one to four manufacturers of suitable replacement parts. This makes it possible for the repairman to use those most readily available. This information is likely to make the book the radio technician's bible—a necessary bench-side manual.

An extensive listing of the products of several manufacturers is included.

Design of Vibrating Crystals. by William H. Fry, John M. Taylor, and Bertha W. Hennis. Published by Dover Publications, Inc., New York, N. Y. 6¼ x 10 inches, 182 pages. Price \$3.50.

Calculation of the characteristics of different piezoelectric vibrating systems is tedious work under normal conditions because of the number of setups and computations required.

This book is a report on the work done on crystal development and materials for the Sonar Division of the Bureau of Ships. There are 129 graphs and numerous tables and charts plotted to show characteristics of piezoelectric crystals vibrating in either the thickness or longitudinal modes; in combination with any backing material and in any driving medium.

This report is of particular interest to designers of crystal projectors, but its contents can be applied equally well to the design of wave filters, gauges, accelerometers, and other piezoelectric devices.—*R.F.S.*

Just Published

RADAR PRIMER

By J. L. HORNUNG

Supervisor, Radio Electronics
Walter Hervey Junior College
218 pages \$3.50

HERE is a simple, non-mathematical explanation of the entire field of peacetime radar—showing its basic principles, how it works and how it is used. Designed for easy reading, this up-to-date book explains the uses and workings of radar in such fields as broadcasting, communications, television, etc.

Also Just Out!
New 9th Edition
Nilson and Hornung's
RADIO OPERATING
Questions and Answers

Enlarged to include the 262 new questions, just added to the FCC examinations. This 9th edition answers a total of over 1550 questions on all phases of radio communication—gives you the information you need for passing any class of commercial radio operator examination. . . \$4.50

Includes basic data on Marine and aircraft radar, radar pulses and beams, the electron gun, loran, radio echoes, color television, cathode ray tubes, and a wealth of other topics.

CONTENTS

Fundamentals of Radar—Determining Distance and Direction—Electrons Paint a Picture—The Basic Parts of a Radar Set—Radar at Work—Long-Distance Navigation—Microwaves and Pulses—History of Radar.

SEE THEM 10 DAYS FREE

McGraw-Hill Book Co., Inc.
330 W. 42nd St., N.Y.C. 18

Send me book(s) checked below for 10 days' free examination. In 10 days I will send remittance, plus a few cents postage, or return book(s) postpaid.*

Hornung's RADAR PRIMER, \$3.50
 Nilson and Hornung's RADIO OPERATING—Q. & A., \$4.50

Name
Address
City Zone State
Company
Position RC-2-49

* We pay mailing costs if you send cash with this coupon. Same return privilege.

CONDENSER SPECIALS

- 4 MFD 10000 VDC Cornell oil filled \$20.00
- 5 MFD 5000 VDC CD PFD 502 oil filled paper 12.00
- .0025 MFD 25000 VDC Western Electric oil 7.95
- 2X3500 MFD 25 VDC Solar Metal Can—Special 1.98
- 1000 MFD 150 VDC Sprague VMC mounting98
- 1 MFD 2000 VDC CD TQ Dykanol orig. box 20010 1.45
- 1 MFD 3000 VDC oil filled Aerovox—Special 4.95
- 8 MFD 1000 VDC Sprague or McCard oil filled 1.95
- 8-6-4-1 MFD 600 VDC CD T3 6010 four choice79
- 8X8 MFD 450 VDC CD orig. pack. 40 ea. 3 for 1.00
- 2X2 MFD 250 VDC Sprague oil filled—Special 1.25
- 2 MFD 750 VDC Sprague oil filled—Special90
- 2X 15 M. D. 4000 VDC Sprague Vitamin Q 3.75
- 1045 MFD 16000 VDC Sprague Vitamin Q 1.95
- 1 MFD 3500 VDC (H. B.) ed. Cornell Dubilier 1.75
- 5 MFD 4000 VDC Cornell Dubilier oil filled 1.00
- 25 MFD 25 VDC by pass. Extra special. 10 for a 3.95
- 20 MFD 150 VDC Mighty Midget Iacco. 6 for a 1.00
- 5 MFD 600 VDC Aerovox type 184. box 50 6.50
- 20 MFD 250 VDC 25 MFD. 50 VDC or 30 MFD. 450 VDC cans. CD type UP. choice 3 for 1.00
- 20-20 MFD. 250 VDC or 4X10 MFD. 450 VDC Sprague. 1-.05-.25-.5-.003-.004-.006. etc. paper & mica 600 VDC Aerovox & others 3.00
- 8 MFD 450 VDC Aerovox Hi-Panel 1 pe. 1L Dry Bathubs 25 asso. 3X1-.05-.5-1.2X5-1 & 2 MFD all 600 or 1000 VDC 25 or 50 choice for 1.95

Postage Required with Each Order.
McCONNELL'S Phila., Penna. RA-5-6033

NEW PAINTED LEARN FUN CIRCUITS PROFIT

NO MORE WIRES

Conducting and resistance paints now available.

Professional men need—amateurs enjoy—this real aid in Designing, Testing, and Repairing modern electronic circuits. Paint working circuits over your rough sketches or on any insulating base. Most new radios and hearing aids have partly printed circuits. High instruction value for colleges. Standard Kit, \$3. has Copper Conducting Paint and three Resistance Paints. Silver Kit, \$5. has above plus Silver Conducting Paint, Insulating Lacquer, and Silver & Brush Cleaner. Free Manual with each. Postpaid in U.S.A. Manual separately 25c. Free literature. Just dot down name, address, desired kit or manual; and send with cash, M.O., or C.O.D. + 20% to

MICROCIRCUITS CO.

Dept. 2E New Buffalo, Mich.



"He claims it'll receive underwater!"

RELAYS FOR EVERY PURPOSE Over a Million in Stock!

Whether you require large quantities of relays for production runs or single units for laboratory or amateur work, Wells can make immediate delivery and save you a substantial part of the cost.

Our capable engineering staff is prepared to offer assistance in the selection of correct types to suit your exact requirements.

Each relay is brand new, standard make, inspected, individually boxed and fully guaranteed.

The following list represents only a tiny portion of our relay stock. Write or wire us for information on types not shown.



**CUTLER HAMMER
HEAVY DUTY CONTACTORS**

Stock No.	Operating Voltage	Coil Resistance	Contacts	Manufacturer	Net Each
R-178	24V DC	100	SPST (NO) 100A	6141H34A	\$3.85
R-179	6V DC	6.5	SPST (NO) 50A	6041H83A	3.00
R-180	12V DC	25	SPST (NO) 50A	6041H88	3.25
R-181	24V DC	65	SPST (NO) 100A	6041H88	3.85
H-232	24V	55	SPST (NO) 50A	Metal Cased	3.25
H-233	6V	15	SPST (NO) 50A	Metal Cased	3.15
H-235	24V	70	SPST (NO) 100A	Type B5	3.85

DIRECT CURRENT AIRCRAFT CONTACTORS

Stock No.	Operating Voltage	Coil Resistance	Contacts	Manufacturer	Net Each
R-182	28V	80	SPST (NO) 25 A	Guardian	\$1.85
R-183	24V	60	SPST (NO) 50 A	Allen Bradley Type B6A General Elec.	2.75
R-184	28V	50	SPST (NO) 100A	Leach 7220-3-243 50	2.95
R-185	24V	100	SPST (NO) 50 A	Leach 7220-3-243 50	2.95
R-186	24V	132	SPST (NO) 50 A	Allen Bradley	2.95
R-187	24V	100	SPST (NO) 50 A	Allied Cont.	2.95
R-188	24V	200	SPST (NO) 75 A	Allied Cont.	2.95
H-234	14V	45	SPST (NO) 30 A	—	1.65

ANTENNA CHANGEOVER RELAYS

Stock No.	Operating Voltage	Coil Resistance	Contacts	Manufacturer	Net Each
R-192	6-12V DC	44	2PDT 10 AMP	Allied-NB5	\$1.35
R-231	12VDC	100	DPDT 6 AMP	G. E.	1.95
R-256	24-32V DC	—	SPDT-DPST (NC)	Guardian	1.45
R-501	110 AC	4	DPDT (1KW)	G. E.	2.45
R-503	12-32V DC	100	SPDT-SPST	G. E.-500 W	1.95

**COMBINATION PUSH BUTTON AND
REMOTE RELAY**

Stock No.	Operating Voltage	Coil Resistance	Contacts	Manufacturer	Net Each
H-244	12-24 V DC	Dual-60	SPDT	CR2791-R106C8	\$1.65

ADJUSTABLE TIME DELAY RELAY

Stock No.	Operating Voltage	Coil Resistance	Contacts	Manufacturer	Net Each
R-246	115 AC	—	SPST (NO) or (NC) 10 AMP	R. W. Cramer I-120 Sec	\$8.95

DC MECHANICAL ACTION RELAYS

Stock No.	Operating Voltage	Coil Resistance	Contacts	Manufacturer	Net Each
R-245	12V	25	4' Lever	G. M.	\$0.95
R-527	6-12V	200.	2' Lever	—	.95

TYPE C.M.S. RELAY

Stock No.	Operating Voltage	Coil Resistance	Contacts	Manufacturer	Net Each
R-511	24V DC	200	MICRO-SW SPST (NO)	Clare	\$2.45

DC CURRENT REGULATOR

Stock No.	Operating Voltage	Coil Resistance	Contacts	Manufacturer	Net Each
R-509	6-12V DC	40	SPST (NC)	G E	\$0.85

LATCH AND RESET RELAY

Stock No.	Operating Voltage	Coil Resistance	Contacts	Manufacturer	Net Each
R-500	12V DC	10.	DPDT-10 AMP	St. Dunn- CX-3190B	\$2.85

DC-ROTARY STEP RELAY

Stock No.	Operating Voltage	Coil Resistance	Contacts	Manufacturer	Net Each
R-621	6-12V	30	3 POLE 23 POSITION	W E.	\$10.95

DC-RACHET RELAY

Stock No.	Operating Voltage	Coil Resistance	Contacts	Manufacturer	Net Each
R-230	8-Volt	2	SPDT-OPST (NO)	Guardian	\$2.15

Special Sample Engineering Offer

Any ten relays listed (one of each type) with the exception of Stock Nos. R-621 and R-246—only \$10.00.

ORDER DIRECTLY FROM THIS AD OR THROUGH YOUR LOCAL PARTS JOBBER

Manufacturers: Write For Quantity Prices.
Distributors: Write For The New Wells Jobber Manual.

STANDARD DC TELEPHONE RELAYS

Stock No.	Operating Voltage	Coil Resistance	Contacts	Manufacturer	Net Each
R-101	24V	1500.	DPST (NO)	Auto. Elec.	\$1.35
R-102	24V	400.	SPDT	Auto. Elec.	1.10
R-103	24V	DUAL-1000	3PST (NO)	Auto. Elec.	1.35
R-105	24V	600.	3PST (NO)	Clare	1.20
R-106	24V	1300	3PST (NC)	Clare	1.25
R-152	12V	50	DPDT-SPST (NO)	Guardian	1.10
R-153	12V	200	SPDT-SPST (NO)	Stromberg	1.20
R-154	12V	100.	SPST (NO)	Clare	1.25
R-155	12V	200.	SPST (ANO4NC)	Auto. Elec.	1.15
R-158	6V	50	4PST (NO)	Stromberg	1.10
R-159	6V	50	4PST (NO)	Stromberg	1.10
R-160	6V	12	3PDT-3PST (NO)	Auto. Elec.	1.05
R-161	6V	10	3PST (2NC-1NO)	Auto. Elec.	.90
R-121	150V	5000	2PST (NO) SPDT	Clare	1.65
R-123	150V	6300	SPST (NO)	Clare	1.75
R-602	150V	6500	SPST (NO)	Clare	1.25
R-515	24V	750	SPST (NO)	Clare	1.25
R-517	12V	250	DPST (NO)	Allied Cont.	1.20
R-519	250V	14000.	SPDT	Auto. Elec.	1.95
R-520	250V	14000	DPDT	R. B. M.	2.10
R-521	32V	1000.	DPDT	Kellokk	1.59
R-166	24V	DUAL-200	DPDT-SPST (NO)	Auto. Elec.	1.20
R-168	24V	DUAL-200	4PST (NO)	Auto. Elec.	2.95
H-240	250-350V	40000	DPST (NO)	Auto. Elec.	2.95
H-241	48V	650	SPDT-SPST (NO)	Clare	1.25



**SENSITIVE
DC RELAYS**

Stock No.	Operating Voltage	Coil Resistance	Contacts	Manufacturer	Net Each
R-218	4-6V	1800	SPDT	Allied Cont.	1.20
R-220	75V	5000	SPDT	Allied Cont.	1.15
R-221	18-24V	5000	SPST (NO)	Allied Cont.	1.15
R-174	250V	5000	DPST (NO)	G. M.	1.85
R-175	350V	11000	DPDT-DPST (NO)	G. M.	2.95
R-176	24V	250	DPST (NO)	G. M.	1.50
R-177	24V	300	4PDT	G. M.	1.65
R-600	8-12V	5000	SPDT	S. Dunn-KS	2.10
R-507	24-48V	1000	SPDT-DPST (NC)	Guardian	1.15

TYPE 80 DC RELAYS

TYPE 18 DC TELEPHONE RELAYS

Stock No.	Operating Voltage	Coil Resistance	Contacts	Manufacturer	Net Each
R-109	24-48V	4000.	SPDT	Auto. Elec.	\$1.50
R-110	24-32V	3500	SPDT	Auto. Elec.	1.50
R-112	90-120V	6500	SPST (NC)	Auto. Elec.	1.75
R-114	24V	300	4PST (NO)	Auto. Elec.	1.30
R-603	24V	400	DPST (NO)	Auto. Elec.	1.25
H-238	24V	150	DPDT-SPST (NC)	R. B. M.	1.25
H-239	24V	180	DPST (NO)	Auto. Elec.	1.25



TYPE BJ DC RELAYS

Stock No.	Operating Voltage	Coil Resistance	Contacts	Manufacturer	Net Each
R-169	24V	250	SPST (NO)	Allied Cont.	\$1.95
R-171	24V	230	DPDT	Allied Cont.	2.15
R-172	5-8V	30	DPDT-SPST (NO)	Allied Cont.	1.70
R-173	6-8V	5	SPST (NO)	Allied Cont.	1.25
R-529	24-48V	1000	DPDT	Allied Cont.	2.50

HEAVY DUTY KEYING RELAYS

Stock No.	Operating Voltage	Coil Resistance	Contacts	Manufacturer	Net Each
R-248	28V DC	150	SPST (NO) 10A	Guard. 36471	\$1.05
R-244	75V AC	265	SPST (NO) 20A	Leach 1327	1.75
R-206	24V DC	150	SPOT-3 AMP	P&B-KL	1.20
R-207	24V DC	210	4PDT-3 AMP	P&B-KL	1.10
R-219	50V DC	1500	DPST (NO) 15A	P&B-SP	1.25
R-217	115 AC	600	SPDT-10 AMP	St. Dunn IXAX2.25	1.25
R-525	24V DC	200	DPDT-10 AMP	Guard 34464	1.25
R-508	110 AC	600	SPDT-6 AMP	Guad 37189	1.95
R-506	24 V DC	300	DPST (NO) 6A	—	.95
R-510	24 V DC	200	3PDT-10 AMP	Guard. 516983	1.05
R-604	24 V DC	200	SPST (NO) 30A.	St. Dunn-B2A	1.25
H-608	115 AC	—	SPST (NO) 20A	St. Dunn-LHXX2.25	1.05
R-620	12V DC	35	3PST (NO) 10A	Price Bros.	1.05
R-223	28V DC	150	SPST (NO) 40A	Price Bros.	1.35
H-230	12-24V DC	80	DPST (NO) 10A.	—	1.20
H-231	24V	230.	DPST (NO) 5A.	R. B. M.	1.15

DC-TYPE 76 ROTARY RELAYS

Stock No.	Operating Voltage	Coil Resistance	Contacts	Manufacturer	Net Each
R-197	9-16V	70	DPDT	Price Bros.	\$1.65
R-198	9-16V	125	6PST (3NO) (3NC) SPDT	Price Bros.	1.65
R-199	24-32V	250	SPDT-DPST (NC)	Price Bros.	1.65
R-200	24-32V	275	3PDT-SPST (NC)	Price Bros.	1.65
R-201	24-32V	250	DPST (NO) SPDT (NC) DPDT	Price Bros.	1.65
R-601	9-14V	60.	3PST (NO)	Price Bros.	1.65



**DIRECT CURRENT
KEYING RELAYS**

Stock No.	Operating Voltage	Coil Resistance	Contacts	Manufacturer	Net Each
R-190	12V	65	DPDT 10 AMP	Advance Elec.	1.65
R-191	28V	125	DPDT 10 AMP	Type 2000-A	\$1.15
R-192	12V	44	3PDT 10 AMP	Guardian	1.20
R-193	5-8V	11	DPDT 10 AMP	Type NB5	1.35
R-194	24V	265	SPST (NO)	Type 1027	1.05
R-195	6V	32	DPDT 3 AMP	Type 1054SNW1.25	1.15
R-196	12V	50	DPDT 10 AMP	G.E.Co.	1.25
R-242	24V	170	SPST (NC)	Guardian	1.15
H-236	5-8V	18.5	SPDT 2 AMP	Type 1253DEW	1.25
				Leach-HFM	1.05

SEALED DC TELEPHONE RELAYS

Stock No.	Operating Voltage	Coil Resistance	Contacts	Manufacturer	Net Each
R-125	24V	300.	DPDT	Clare	\$2.75
R-126	90-120V	2000	DPDT	Clare	3.00
R-504	24-70V	2800	SPDT	GE-C103C25	3.00

V TYPE DC TELEPHONE RELAYS

Stock No.	Operating Voltage	Coil Resistance	Contacts	Manufacturer	Net Each
R-164	24-32V	1000	DPDT	W E	\$1.20
R-512	24-48V	3500	DPDT	W E	1.30
R-513	12-24V	3000	DPDT-DPST (NC)	W E	1.20
R-514	4-6V	60	SPDT	W E	1.05
R-526	6V	35	DPDT-SPST (INC-INO)	W E	1.05

AC-STANDARD TELEPHONE RELAYS

Stock No.	Operating Voltage	Coil Resistance	Contacts	Manufacturer	Net Each
R-212	90-135V	—	NONE	Clare	\$0.95
R-213	5-8V	—	DPST (NO)	Clare	1.50
R-605	24V	—	3PST (NO)	Auto. Elec.	.95
R-606	24V	—	DPST (1NO-1NC)	Auto. Elec.	.95
R-607	24V	—	SPST (NO)	Auto. Elec.	.95



**DIRECT CURRENT
MIDGET RELAYS**

Stock No.	Operating Voltage	Coil Resistance	Contacts	Manufacturer	Net Each
R-132	24V	300	DPDT	Clare	\$1.20
R-133	24V	300	NONE	Clare	.60
R-134	24V	250	4PDT	Clare	1.15
R-135	24V</				

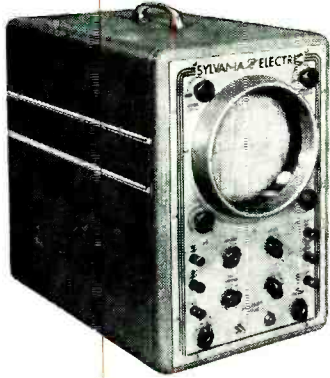

Modern, efficient, Sylvania Oscilloscopes, Type 132 (7-inch screen) above and Type 131 (3-inch screen), are ac operated general purpose cathode ray instruments used to study waveforms, measure voltages and currents in various types of circuits. Excellent for audio circuit analysis, transmitter checking, filter and hum analysis, vibrator waveform checking. Type 132 price: \$144.50; Type 131 price: \$89.50.



The last word in tube testers: Types 139 (Counter Type, shown), and 140 (Portable Type)—smartly styled, scientifically designed. Features: *Shorts Test* at voltage low enough to prevent tube damage, high enough for full brilliancy on indicator; all tube elements tested under dynamic conditions; *Fingertip Controls*; tests all tube types; *Provision for Noise Test*; large 4½-inch meter; 8-foot cord. Each model: \$79.50.

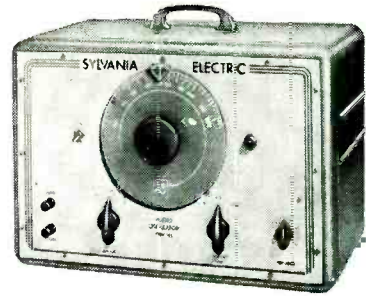

This Audio Oscillator Type 145 is one of the most versatile and convenient test instruments made. Its powerful signal of known frequency provides an accurate tone source for checking radio receivers. It is ideal for response and distortion testing of audio amplifiers, public address systems, juke boxes, wired music installations and individual speaker cones. An exceptionally valuable test instrument. Price: \$129.50.



The Sylvania Poly (MULTI-PURPOSE) Meter Type 134Z provides, in a single compact instrument, the means of making a multitude of electrical measurements and tests. Electrical values measured include audio, ac and rf voltages (up to 300 mc); dc voltages from 0.1 to 1,000; direct currents from .05 milliamperes to 10 amperes; resistances from ½ ohm to 1,000 megohms. Instrument is compactly built, attractively styled, includes all essential accessories. Priced at only \$89.50.

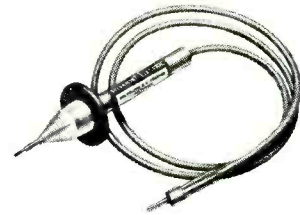

With this new DC Voltage Multiplier, the 1,000 vdc range setting on your Sylvania Polymeter will read 10,000 vdc full scale! The 300 vdc range setting will read 3,000 vdc full scale! Add this accessory to your Polymeter and you have a Kilovoltmeter for testing TV circuits and other high dc voltage applications. Only \$9.95!

GOOD SERVICING STARTS WITH...

Fine test equipment

Now, in addition to selling the best in tubes, you can simplify your testing and trouble-shooting job with the latest and finest in test equipment! For full details about these carefully engineered Sylvania instruments, mail handy coupon today!

**SYLVANIA
ELECTRIC**

ELECTRONIC DEVICES; RADIO TUBES; CATHODE RAY TUBES; FLUORESCENT LAMPS, FIXTURES, WIRING DEVICES; ELECTRIC LIGHT BULBS; PHOTOLAMPS

Sylvania Electric Products Inc.
Radio Tube Division, Dept. R-1702
Emporium, Pa.

Gentlemen:

Kindly forward detailed information about instruments checked below:

- Oscilloscopes Audio Oscillator
 Tube Testers Polymeter
 DC Voltage Multiplier

Name _____

Address _____

City _____

State _____ Zone _____

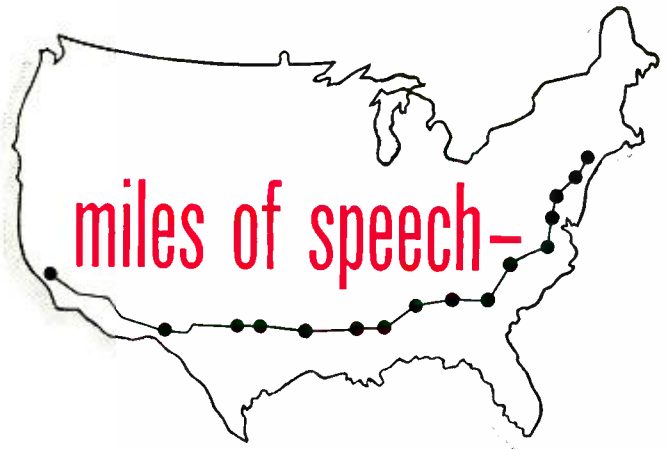
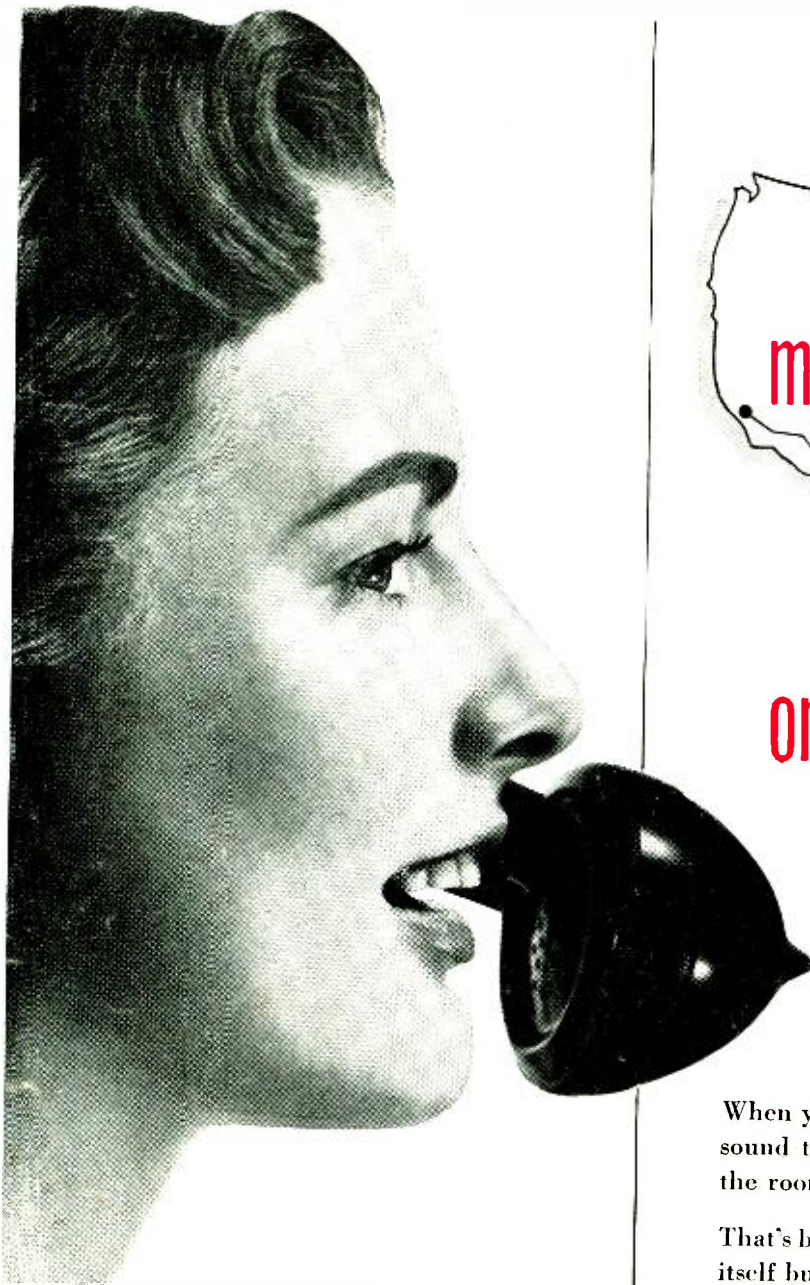

only inches of sound!

When you talk by telephone, far or near, the actual sound travels much less than when you talk across the room!

That's because the telephone system carries not sound itself but an electrical facsimile of sound. When you speak into a telephone transmitter your voice is converted into electrical vibrations which are not changed back into sound until they reach the receiver diaphragm.

Conversion of sound into its electrical equivalent, through the invention of the telephone, opened the way to the measurement of sound by accurate electrical methods. In developing means to make the telephone talk farther and sound clearer, the scientists of Bell Telephone Laboratories had to develop the tools for sound-wave analysis and measurement.

The condenser microphone, the wave filter, the amplifier — each the product of telephone research — have helped to reveal the structure of sound as never before. Each has helped to build the world's finest telephone system.

BELL TELEPHONE LABORATORIES



EXPLORING AND INVENTING, DEVISING AND PERFECTING, FOR CONTINUED IMPROVEMENTS AND ECONOMIES IN TELEPHONE SERVICE.