

HUGO GERMSBACK,  
Editor

**IN THIS ISSUE**  
New Day Dawns for Servicemen  
De Luxe Amateur Transmitter

# RADIO CRAFT

COSMIC RADIO SIGNALS  
FROM SUN AND STARS  
SEE PAGE 34

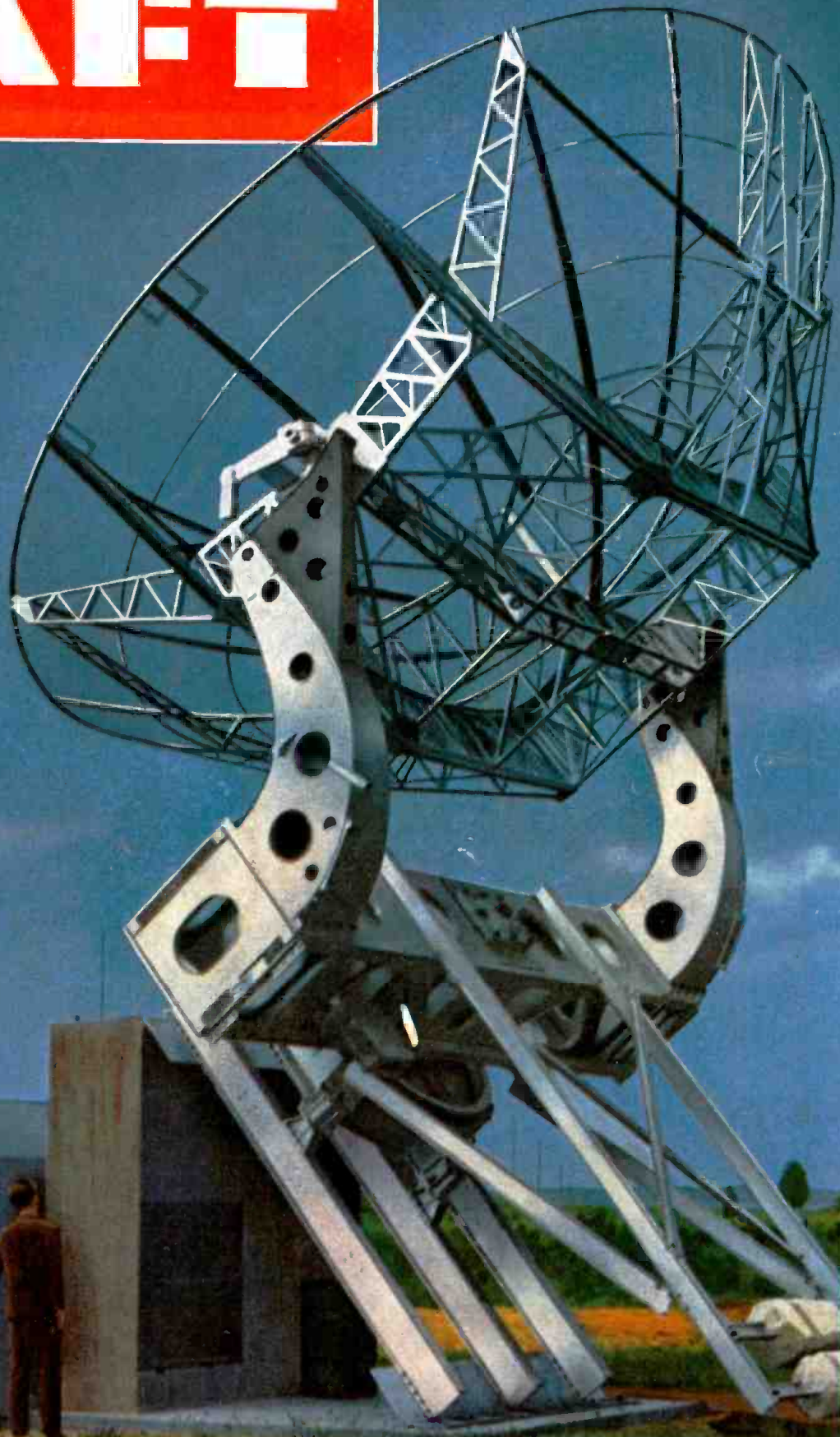

**MAR**  
1948

**30¢**  
CANADA 35¢

**RADIO-ELECTRONICS IN ALL ITS PHASES**

"THE hottest ham performance ever at this price . . ." That's the verdict of amateurs who have had a chance to try Hallicrafters new Model SX-43.

This new member of the Hallicrafters line offers continuous coverage from 540 kilocycles to 55 megacycles and has an additional band from 88 to 108 megacycles. AM reception is provided on all bands, except band 6, CW on the four lower bands and FM on frequencies above 44 megacycles. In the band of 44 to 55 Mc., wide band FM or narrow band AM just right for narrow band FM reception is provided.

One stage of high gain tuned RF and a type 7F8 dual triode converter assure an exceptionally good signal-to-noise ratio. Image ratio on the AM channel on band 5 (44 to 55 Mc.) is excellent as the receiver is used as a double superheterodyne. The new Hallicrafters dual IF transformers provide a 455 kilocycle IF channel for operating frequencies below 44 megacycles and a 10.7 megacycle IF channel for the VHF bands. Two IF stages are used on the four lower bands and a third stage is added above 44 megacycles. Switching of IF frequencies is automatic. The separate electrical bandspread dial is calibrated for the amateur 3.5, 7, 14, and 28 megacycle bands.

Every important feature for excellent communications receiver performance is included.

## Model SX-43



### FEATURES FOUND IN NO OTHER RECEIVER AT THIS PRICE

- ALL ESSENTIAL AMATEUR FREQUENCIES FROM 540 kc to 108 MC
- AM - FM - CW RECEPTION
- IN BAND OF 44 TO 55 MC: WIDE BAND FM OR NARROW BAND AM . . . JUST RIGHT FOR NARROW BAND FM RECEPTION
- CRYSTAL FILTER AND EXPANDING IF CHANNEL PROVIDE 4 VARIATIONS OF SELECTIVITY ON LOWER BANDS
- SERIES TYPE NOISE LIMITER
- TEMPERATURE COMPENSATION FOR FREEDOM FROM DRIFT
- PERMEABILITY ADJUSTED "MICROSET" INDUCTANCES IN THE RF CIRCUITS
- SEPARATE RF AND AF GAIN CONTROLS
- EXCEPTIONALLY GOOD SIGNAL-TO-NOISE RATIO
- SEPARATE ELECTRICAL BANDSPREAD CALIBRATED FOR THE AMATEUR 3.5, 7, 14 AND 28 Mc BANDS

BUILDERS OF

*Skybone*

AVIATION, RADIOTELEPHONE



**hallicrafters RADIO**

THE HALLICRAFTERS CO., MANUFACTURERS OF RADIO AND ELECTRONIC EQUIPMENT, CHICAGO 16, U. S. A.

Sole Hallicrafters Representatives in Canada: Rogers Majestic Limited, Toronto-Montreal

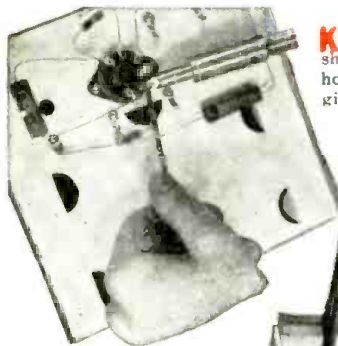

**KIT 1** (left) I send you Soldering Equipment and Radio Parts; show you how to do Radio Soldering, how to mount and connect Radio parts; give you practical experience.

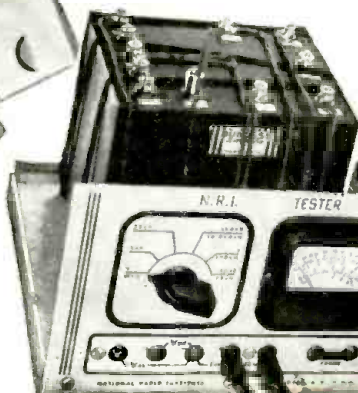

**KIT 2**

You can get this training in your own home under G. I. Bill. Mail coupon for full details.

(left) Early in my course I show you how to build this N. R. I. Tester with parts I send. It soon helps you fix neighborhood Radios and earn EXTRA money in spare time.



# Be a RADIO Technician

## Learn by PRACTICING in Spare Time

with **BIG KITS** of **RADIO PARTS** I send you

**KIT 3** You get parts to build Radio Circuits; then test them; see how they work; learn how to design special circuits, how to locate and repair circuit defects.

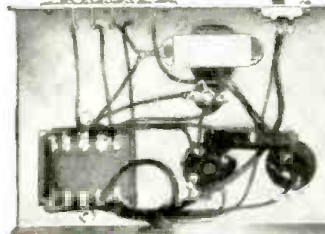
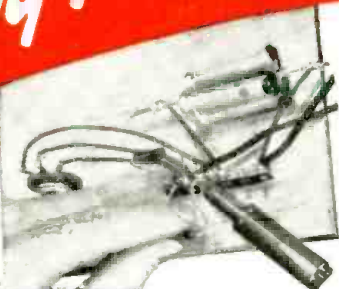

**KIT 4** You get parts to build this Vacuum Tube Power Pack; make changes which give you experience with packs of many kinds; learn to correct power pack troubles.

**KIT 5** Building this A. M. Signal Generator gives you more valuable experience. It provides amplitude-modulated signals for many tests and experiments.

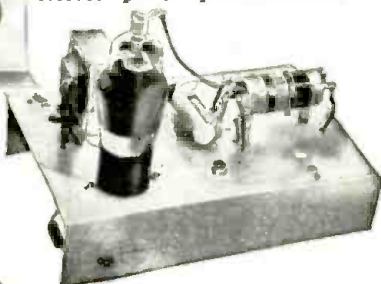

**KIT 6** You build this Superheterodyne Receiver which brings in local and distant stations—and gives you more experience to help you win success in Radio.

My Course Includes Training in **TELEVISION • ELECTRONICS** FREQUENCY MODULATION

Do you want a good-pay job in the fast-growing Radio Industry—or your own Radio Shop? Mail the Coupon for a Sample Lesson and my 64-page book, "How to Be a Success in Radio-Television-Electronics," both FREE. See how I will train you at home—how you get practical Radio experience building, testing Radio circuits with **BIG KITS OF PARTS** I send!

**Many Beginners Soon Make Extra Money in Spare Time While Learning**



J. E. SMITH, President National Radio Institute

The day you enroll I start sending EXTRA MONEY manuals that show how to make EXTRA money fixing neighbors' Radios in spare time while still learning! It's probably easier to get started now than ever before because the Radio Repair Business is booming. Trained Radio Technicians also find profitable opportunities in Police, Aviation, Marine Radio, Broadcasting, Radio Manufacturing, Public Address work. Think of even greater opportunities as public demand for Television, FM, and Electronic devices continues to grow. Send for FREE books now!

**Find Out What NRI Can Do For You**

Mail Coupon for Sample Lesson and my FREE 64-page book. Read the details about my Course, letters from men I trained; see how quickly easily you can get started. No obligation! Just MAIL COUPON NOW in an envelope or paste it on a penny postal. J. E. SMITH, President, Dept. 8CX, National Radio Institute, Pioneer Home Study Radio School, Washington 9, D. C.

Our 34th Year of Training Men for Success in Radio

Sample Lesson **FREE** 64 Page Book

Mr. J. E. SMITH, President, Dept. 8CX National Radio Institute, Washington 9, D. C.

Mail me FREE Sample Lesson and 64-page book about how to win success in Radio and Television-Electronics. (No salesman will call. Please write plainly.)

Name ..... AEO. ....  
 Address .....  
 City ..... State .....  
 (Please include Post Office zone number)

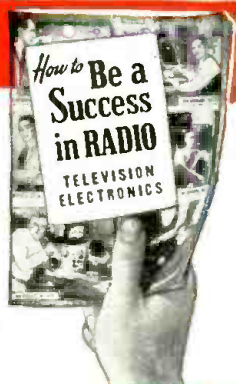

Approved for Training under GI Bill

# I'LL HELP YOU TO EQUIPMENT EVER

ALFRED A. GHIRARDI, the man who has started thousands of students on successful careers by making Radio-Electronics easy to learn.

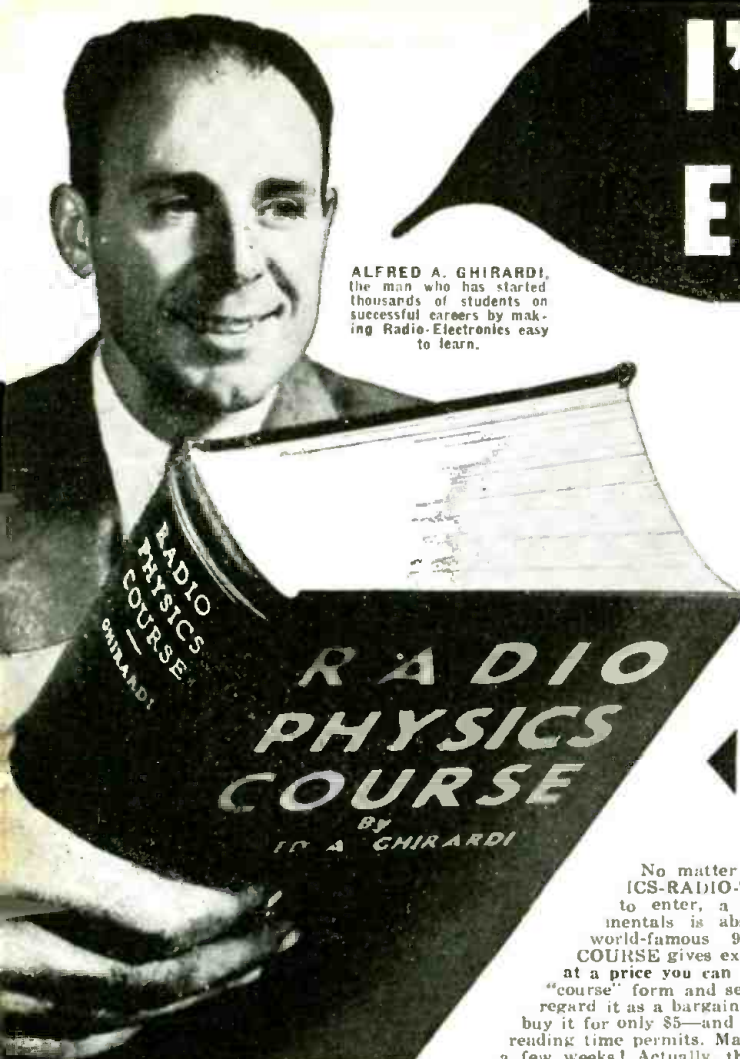

A FEW NIGHTS OF **THIS** CAN PAVE THE WAY TO **THIS** A PROSPEROUS FUTURE OF **THIS**

## Ghirardi's COMPLETE BASIC RADIO-ELECTRONIC TRAINING for Beginners

for only \$5 (\$5.50 foreign)

No matter what part of ELECTRONICS-RADIO-TELEVISION work you plan to enter, a knowledge of basic fundamentals is absolutely essential. Ghirardi's world-famous 972-page RADIO PHYSICS COURSE gives exactly the training you need—at a price you can afford to pay! If broken into "course" form and sent as monthly lessons, you'd regard it as a bargain at \$50 or more! Instead, you buy it for only \$5—and you progress as fast as spare reading time permits. Many have completed it in only a few weeks! Actually, this big, 4 lb. book has given more beginners their start in Radio Electronics than any other book or course!

man. He'll know the book—because he probably trained from it himself! Get started now in Radio! Get started right! Our 5-DAY, MONEY-BACK GUARANTEE is your absolute protection. If you don't like RADIO PHYSICS COURSE you don't need to keep it. You cannot lose!

**NO PREVIOUS TRAINING NEEDED**  
36 Big Courses in One

Here are a few of the things about which RADIO PHYSICS COURSE teaches you:

- |                           |                            |                            |
|---------------------------|----------------------------|----------------------------|
| Sound, Speech, Music      | Filters                    | Power Supplies             |
| Electron Theory           | Measuring Instruments      | Loud Speakers              |
| Electric Current          | Radio Waves                | Auto & Aircraft Radio      |
| Electric Circuits         | Vacuum Tubes               | Aviation Radio             |
| Resistance                | Detector & Amplifier       | Public Address Systems     |
| Batteries                 | Tube Action                | Phototubes, Cathode        |
| Electromagnetism          | Radio-Frequency Amplifiers | Ray Tubes                  |
| Electromagnetic Induction | Superheterodynes           | Sound Pictures, etc., etc. |
| Condensers, Coils         | Audio Amplifiers           |                            |
| Alternating Currents      |                            |                            |
| Transformers              |                            |                            |

The big book that makes it easy to learn Radio at home!

### EASY TO UNDERSTAND

Ghirardi's RADIO PHYSICS COURSE starts you training at the very beginning—with Basic Electricity. Then it takes you step by step through the entire field of RADIO-ELECTRONICS. Nothing is omitted or condensed. Everything is explained as simply as A-B-C. You can understand every word of it without previous radio training of any kind. Ask any Radio-Electronic

RADIO PHYSICS COURSE is more widely used for home study and was more widely used for Signal Corps and Navy wartime training than any other book of its kind.

**SPEED-UP**

Repair Home and Auto Radios Faster With Ghirardi Gadgets

Ghirardi Gadgets troubleshoot radio sets with lightning speed. Just flip a card, and there before you are the "remedies" and "tests" to make for whatever "trouble" symptoms you find!

**HOME RADIO GADGET**—Spots 400 different troubles in Power Unit, Receiver Circuits Proper, Tubes, Loudspeaker, Antenna, Ground, Batteries, etc. Covers such symptoms as "Hum," "Weak," "Noisy," "Inoperative," "Intermittent Reception," "Fading," and many more. Tells what tests to make. Suggests the remedy for each trouble. Only 50c.

**AUTO-RADIO GADGET**—Spots 444 special auto-radio troubles in all possible trouble-sources for 11 common symptoms including "Hum," "Weak," "Noisy" with and without car and engine at rest, "Noisy" when car is coasting with ignition off, "No Reception," "Intermittent," "Fading," "Distortion," and "Oscillation." Only 50c.

**ELECTRIC MOTOR REPAIR**

580 pages. Over 900 diagrams and illustrations.

## Learn ELECTRIC MOTOR REPAIR!

Train for Big Pay in a Field That Isn't Crowded—Just the Thing for Radio Men

There's big money in motor repair work! Prices are good. The field is not crowded. The home appliance repair business is a vast one and motor service is a highly important part of it. **ELECTRIC MOTOR REPAIR** by Robert Rosenberg is the book that will train you easily and quickly—for only \$5 complete!

**NO OTHER HOME TRAINING BOOK LIKE IT!**

**ELECTRIC MOTOR REPAIR** explains every detail of motor trouble diagnosis, repair and rewinding. Covers a.c. and d.c. motors, synchronous motors and generators and BOTH mechanical and electrical control systems. Quick reference guides show exactly how to handle specific jobs.

Based on what can be learned from this big book alone, you can train yourself quickly for PROFITABLE motor repair service. Ideal for beginners. Unexcelled

for actual bench use in busy shops. Every type of work is demonstrated VISUALLY by more than 900 easily-understood diagrams. Unique Quo-spiral Binding Arrangement divides book into two sections. BOTH text and related pictures can be seen AT THE SAME TIME. Lies open flat on the bench while you work. Contains 580 pages. Only \$5 complete.

**TRY IT FOR 5 DAYS ... AT OUR RISK!**

Send coupon now. Practice from **ELECTRIC MOTOR REPAIR** for 5 full days. Then, if not more than satisfied, return book to us and your money will be cheerfully refunded.



NEW • DIFFERENT • EASY TO UNDERSTAND

# GHIRARDI TRAINING TO SAVE YOU LEARN EASIER, BETTER, FASTER...

# REPAIR ANY RADIO-ELECTRONIC MADE . . . AND GUARANTEE TO REFUND EVERY CENT OF YOUR MONEY IN FIVE DAYS IF YOU'RE NOT SATISFIED!

**THIS 4½ lb. HANDBOOK SHOWS EXACTLY HOW TO REPAIR OVER 4,800 RECEIVER MODELS**

**A Definite, Dependable Guide for Diagnosing, Locating and Repairing the Common Troubles in Almost Every Receiver Ever Made**

Whether you repair radios for a living or work with them only occasionally, Ghirardi's **RADIO TROUBLESHOOTER'S HANDBOOK** will help you do the jobs better **AND TWICE AS FAST**. Eliminates useless testing! Saves time—helps you make more money!

**TELLS YOU WHAT TO DO—EXACTLY HOW TO DO IT!**

When a receiver comes in for repairs, simply turn to the 401-page Case History section. Look up the notes on that make and model. Chances are, you'll find **EXACTLY** the information you require. The Handbook tells what the trouble is—how to remedy it. Ideal for training and speeding up the work of new service helpers—handling tough jobs in half the usual time—repairing cheap sets rapidly and profitably.

**NOT A "STUDY" BOOK**

The tabulations on hundreds of additional pages give you invaluable data on Color Codes, Tubes, I-F alignment and transformer troubles, tube substitutions, etc., and the literally dozens of charts, graphs, diagrams, data and helpful hints

will save you money every day you use them! "Thanks to Ghirardi's Handbook, I repaired my radio in one hour after it had been returned as 'unrepairable' from a local shop," writes J. L. Pizzell, Kansas City, Mo.

**"WORTH 10 TIMES THE PRICE!"**

"I would not take ten times the price my Handbook cost me," says C. E. Daniels of Florida.

"Started to work for me the first day I bought it. The Case Histories take you right to the trouble and save headaches and hours of testing," says Julius Sisko, Jr., Curtis Bay, Maryland. Ghirardi's Big Handbook weighs 4½ lbs., contains 734 big manual-size pages. Only \$5 complete—see our 5 Day Money-Back Guarantee offer!

**STOP GUESSING MISTER!**

Don't guess! Don't waste time! Turn to Ghirardi's Big Radio Troubleshooter's Handbook—let it tell you in a jiffy **WHAT** to do and **HOW** to do it.



Only \$5 complete (See Money-Saving Offer in coupon)



Now, as never before, the call is for **PROFESSIONALLY TRAINED** men who really **KNOW** Radio-Electronic repair work.



Only \$5 complete (See Money-Saving Offer in coupon)

## GET A COMPLETE MODERN Professional SERVICE TRAINING . . . . at Home, Without an Instructor

A. A. Ghirardi's **MODERN RADIO SERVICING** is the finest, most complete instruction book on Radio-Electronic service work for either the novice or the professional serviceman—bar none! Actually, it gives a **COMPLETE MODERN EDUCATION** in truly professional service work of the kind that will be your "Open Sesame!" to the real opportunities in Radio-Electronic servicing springing up on every side.

**ALL ABOUT INSTRUMENTS . . . TROUBLESHOOTING . . . REPAIR**

Remember! The call is now for **HIGHLY TRAINED** men having a broad knowledge of modern test equipment and testing techniques

—NOT for "screw-driver" mechanics of limited technical understanding!

Read from the beginning, **MODERN RADIO SERVICING** is a complete servicing course from A to Z. Used for reference, it is an invaluable refresher course on any type of work that puzzles you. Explains test instruments used in Radio-Electronic service work—also how, when, why and where to use each one; how to make preliminary trouble checks and perform circuit analyses; how to repair or replace parts or make substitutions—and literally hundreds of additional subjects, including **How to Start and Operate a Successful Service Business of Your Own**. 1300 pages, 706 clear illustrations, 720 self-test review questions.

### START A SERVICE BUSINESS . . . OR GET A BETTER-PAYING JOB!

There's a real future for you in servicing—and A. A. Ghirardi's **MODERN RADIO SERVICING** is just the book to start you on it without delay. And remember: Radio itself only represents the beginning of this big book's usefulness to you. What it teaches you about Radio Servicing, Test Instruments and Modern Scientific Technical Procedure is exactly the training you need to fit you to "grow up" with the fast-expanding Electronics profession in all of its servicing phases. The amount of Radio and Electronic

equipment that will be manufactured and sold both to industry and the public within the next few years will be tremendous. All of it must be serviced—and there'll be rich rewards for competently trained men who can fill the bill!

**SEND COUPON—NOW!**

**MODERN RADIO SERVICING** gives you real Professional service training—complete in every respect—easy to understand—and priced at only \$5 complete!

## FIVE DAY UNRESTRICTED MONEY BACK GUARANTEE

Dept. RC-38, MURRAY HILL BOOKS, INC.  
232 Madison Ave., New York 16, N. Y.

- Enclosed find \$\_\_\_\_\_ for books checked below; or  send C.O.D. (in U.S.A. only) and I will pay postman this amount plus small postage charge when he delivers books to me. In either event, it is understood I may return books within 5 days if not satisfactory and you will refund my money.
- RADIO PHYSICS COURSE \$5 (\$5.50 foreign)
  - ELECTRIC MOTOR REPAIR \$5 (\$5.50 foreign)
  - GHIRARDI HOME RADIO GADGET 50c
  - RADIO TROUBLESHOOTER'S HANDBOOK \$5 (\$5.50 foreign)
  - MODERN RADIO SERVICING \$5 (\$5.50 foreign)
  - AUTO RADIO GADGET 50c
  - MONEY-SAVING COMBINATION OFFER: Modern Radio Servicing and Radio Troubleshooter's Handbook—BOTH BIG BOOKS—only \$9.50 (\$10.50 foreign)

Name \_\_\_\_\_  
Address \_\_\_\_\_ State \_\_\_\_\_  
City & Zone \_\_\_\_\_

**TIME & MONEY**  
Mail coupon now!



**MONEY-SAVING COMBINATION**

Make your service library complete! Get BOTH Ghirardi's **RADIO TROUBLESHOOTER'S HANDBOOK** and **MODERN RADIO SERVICING** at the special price of only \$9.50 for the two (\$10.50 foreign). Over 2030 pages of the finest service data money can buy! Use coupon today!

# Are the New SPRAGUE TM's REALLY BETTER?

**you be the judge—TRY THEM IN YOUR TOUGHEST JOBS**

We think the new Sprague type TM *molded* paper tubular capacitors are so far ahead of any other capacitors that there just isn't any comparison.

Quite naturally, we should! Not only do we make them . . . we know *how* they are made and *why* they are better.

But don't take our word for it. If you haven't already seen and used these new units, by all means get at least a few today. Try them in your toughest jobs—auto radios that get hot and are subjected to severe mechanical shocks. Use them in

portable sets and in some of those small ac-dc radios that operate at temperatures at which you normally fry eggs. Give them the kind of jobs to do that are tough on paper tubulars. Then check for performance and long life.

All we ask is that you *try* them. If you don't decide the new Sprague Molded TM's are better than any other paper tubular capacitor you have ever used, we don't want to try to convince you! We feel confident of the result because we know that *your reputation* and *your customers deserve the best!*

## **"PROOF POSITIVE!" by Prof. Squeegie**



Professor Oswald Z. Squeegie, the man who first successfully smashed the Atom in Sprague advertising back in 1938, took time out from his secret studies to wire:

HAVE JUST COMPLETED SEVERE LABORATORY TEST OF NEW SPRAGUE TM. SOAKED IT ONE WEEK IN SALINE SOLUTION (FISH BOWL, TO BE SPECIFIC). MIXED CONTENTS INCLUDING FISH AND SPRAGUE TM WITH ONE CAN DOG FOOD. HEATED TO 85° C. FOR THREE HOURS. DOGS ATE EVERYTHING BUT MOLDED CAPACITOR, WHICH WAS TOO HARD FOR CANINE TEETH. HATS OFF TO SPRAGUE! MUST HURRY BACK TO HISTORY-SHAKING EXPERIMENTS.

PROF. SQUEEGEE



CAPACITORS

# SPRAGUE

\*KOOLOHM  
RESISTORS

\* T.M. Reg.  
U.S. Pat. Off.

**SPRAGUE PRODUCTS COMPANY, North Adams, Mass.**

JOBGING DISTRIBUTING ORGANIZATION FOR PRODUCTS OF SPRAGUE ELECTRIC CO.

*Reach for a SPRAGUE  
and Know You're Right!*



HOW TO MAKE MONEY  
in  
RADIO  
ELEC  
TELE

HOW TO READ  
RADIO DIAGRAMS  
AND SYMBOLS

SPRAYBERRY  
ACADEMY  
OF RADIO

GET THESE 2 BIG BOOKS

**FREE..**

IF YOU  
WANT TO LEARN

**RADIO!**

I TRAIN YOU RIGHT BY SENDING YOU 8 BIG KITS OF  
RADIO EQUIPMENT INCLUDING A POWERFUL 6 TUBE  
SUPERHET RECEIVER AND 16 RANGE TEST METER!

**FRANK L. SPRAYBERRY**  
famous Radio teacher of hundreds  
of successful Radio men.

Find out NOW how Spray-  
berry Training prepares you  
for a Radio Service Business  
of your own — or a good pay

Soon after you start I send you my famous BUSINESS  
BUILDERS that help you earn EXTRA CASH  
getting and doing neighborhood Radio Service jobs  
while learning. You couldn't pick a better time to get  
into Radio. The Radio Repair Business is booming!  
Good Radio Service and Repair Shops are needed every-  
where as millions of new sets are in use. Trained men  
are wanted for opportunities in Police, Aviation and  
Marine Radio, F. M. and Standard Broadcasting and  
Television. Manufacturers are looking for men who  
know Radio as production reaches new peaks. GET  
THE FACTS ABOUT YOUR FUTURE IN RADIO.  
MAIL THE COUPON TODAY for my FREE BOOKS.

Radio job. Just mail the coupon for a FREE Sample Lesson and my  
big FREE book, "How To Make Money In Radio, Electronics, Tele-  
vision." It tells how I train you at home during spare hours by put-  
ting you to work building, testing, repairing Radio equipment. The  
Sprayberry Course teaches you Radio by working with 8 big kits of

Radio parts I supply. You build a powerful 6 tube superhet Radio, a 16-range test  
meter, perform over 175 interesting, PRACTICAL experiments. My lessons are  
easy and interesting — you need no previous experience in Radio. I start you at  
the beginning ... and give you valuable "bench" experience that sticks with you.

**LEARN HOW TO BUILD-TEST-REPAIR RADIOS By Working with YOUR HANDS!**

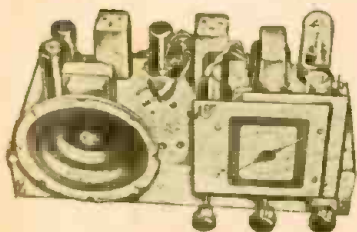

You really learn Radio the PRAC-  
TICAL way ... when you build this  
big, powerful 6-tube Superhet  
Radio from parts I send you.

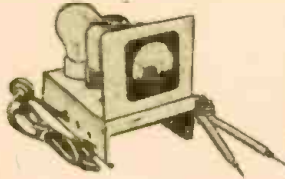

give you a fine, moving  
coil type Meter—with parts  
for a complete analyzer and  
Circuit Continuity Tester.  
"Trouble-shoot" with pro-  
fessional accuracy.

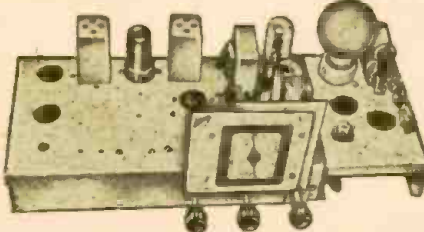

You don't have to buy expensive  
ready-made equipment. You get val-  
uable experience building this Signal  
Generator and Multi-purpose Tester.

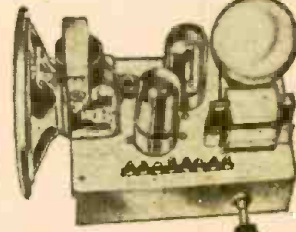

You construct this recti-  
fier and filter, resistor and con-  
denser tester, and really get on  
the Practical end of Radio.

**LOW COST RADIO TRAINING STUDY AT HOME  
IN SPARE HOURS**

Sprayberry Training costs suprisingly little! Easy  
monthly payments, if desired. Everything you need  
is furnished — nothing else to buy. With Sprayberry  
Training to back you up, you will be able to step  
into your own profitable Radio Service Business or  
go on to a big opportunity in Radio, Electronics or  
Television. The equipment I send you is yours "for  
keeps" — to use in your business or job. I have  
trained thousands of successful Radio men — and I  
can help you, too. Get the facts about Sprayberry  
Training — it's your first step to success, security  
and a bigger income in a field where you'll really  
enjoy your work. Fill out and mail coupon TODAY.  
I'll rush my two FREE books to you by return mail.

**VETERANS:** Approved for G. I. Training  
under Public Laws 16 and 346.

**Sprayberry Academy of Radio**  
F. L. SPRAYBERRY, President  
Room 2038, Sprayberry Bldg., Pueblo, Colorado

**RUSH COUPON Today!**

SPRAYBERRY ACADEMY OF RADIO  
F. L. SPRAYBERRY, President  
Room 2038, Sprayberry Bldg., Pueblo, Colorado  
Please rush my FREE copies of "How To Make Money In  
Radio, Electronics and Television" and "How To Read Radio  
Diagrams and Symbols." No salesman will call.

Name \_\_\_\_\_ Age \_\_\_\_\_

Address \_\_\_\_\_

City and Zone \_\_\_\_\_ State \_\_\_\_\_

CHECK HERE IF A VETERAN  
(Mail in an Envelope or Paste on Penny Postcard)



Trained Radio men can step into their own  
profitable Radio Service Shop — or —



New developments are constantly opening  
new big pay job opportunities in Radio.

# SEQUENCE

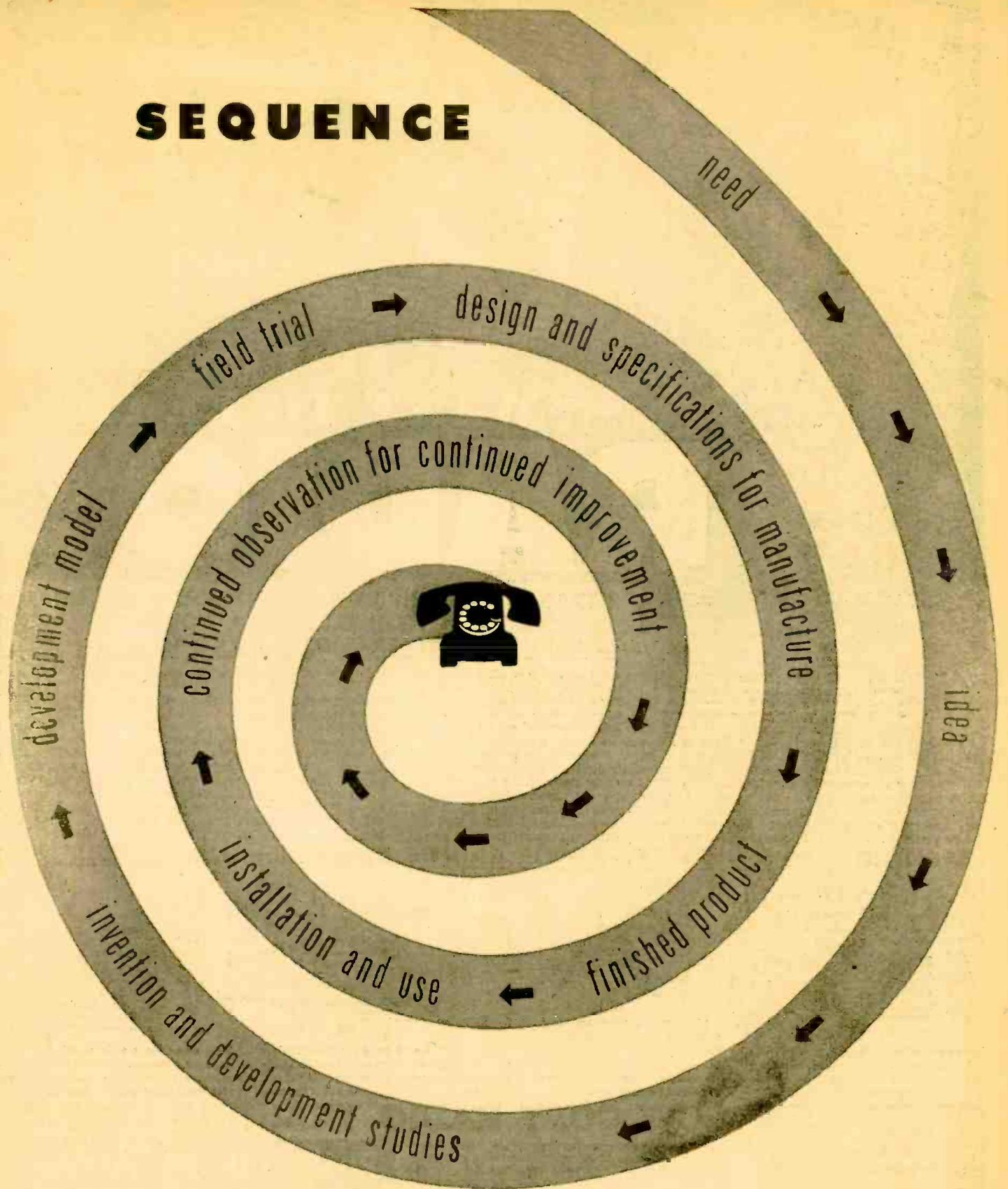

At Bell Telephone Laboratories, more than 2300 scientists, engineers, and their associates are continually exploring and inventing, devising and perfecting for improvements and economies in telephone service.



**BELL TELEPHONE LABORATORIES**



TELEVISION

RADIO

ELECTRONICS

# Stop! Do You Want More Money A GOOD JOB or A BUSINESS OF YOUR OWN...

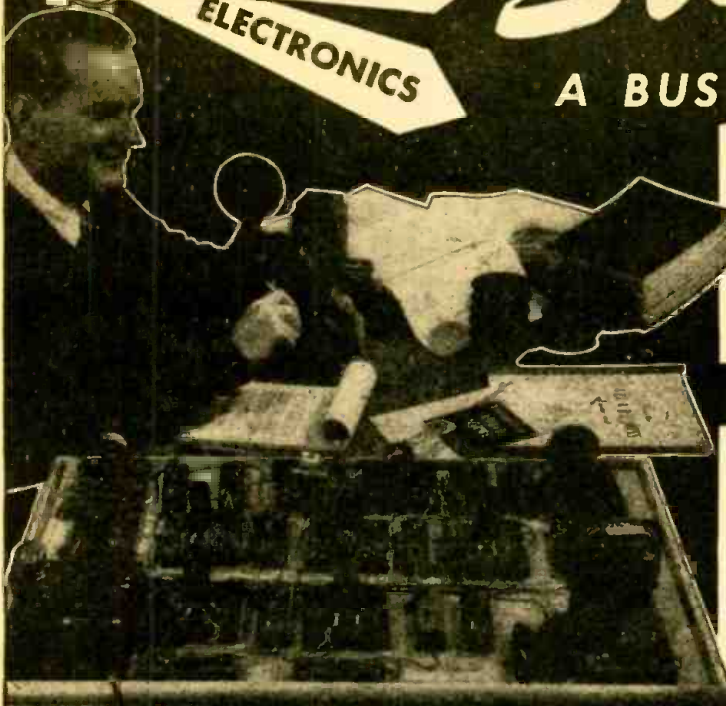

As a HOME STUDENT, you receive a modern Home Laboratory that provides the practical experience you need — including 16 mm. HOME MOVIES to speed your progress.



If you choose to get your training in our new, modern Chicago Laboratory, you will work with lots of Radio-Electronic equipment under the personal supervision of some of the finest instructors in the field.

**VALUABLE EMPLOYMENT SERVICE.** When you complete either training, our effective Employment Service helps you get started toward a real Radio-Electronic future. Mail the coupon below today . . . do not delay.

## DeForest's Training, Inc.

CHICAGO, ILLINOIS

Associated with the DeVry Corporation  
Builders of Electronic & Movie Equipment

**... Then You Can't Afford to Pass Up This OPPORTUNITY**

For more than sixteen years we have been helping men like yourself . . . men who sought opportunity . . . men who wanted to get ahead. We believe we understand your problem as we have understood the problems of thousands of others.

**NO ADVANCED EDUCATION**

**NO EXPERIENCE NECESSARY**

Fill in the coupon below and you will get, absolutely FREE, facts concerning our work, as well as information showing how we prepare YOU to get started in America's great opportunity field of Radio and Electronics. You'll see HOW you can tie in your future with a field that includes Television, FM Radio, Aviation Radio, Pre-Radar, Industrial Electronics, Broadcast Radio, 2-Way Train Radio, etc. You'll see HOW you may cash in on a grand opportunity to have your own business, or a real job— doing really interesting work!

### TAKE YOUR CHOICE

- 1.** Our new, modern Chicago Training Center offers some of the finest RADIO-ELECTRONICS-TELEVISION training facilities in the nation. We will find comfortable living quarters for you.
- 2.** You can get similar practical training in your spare time at home. You use 8 big kits of Radio parts and assemblies — giving you valuable practical experience at home from working out dozens of fascinating Radio-Electronic circuits. You also get instructive MOVIES RIGHT IN YOUR HOME.

**VETERANS!** Both our (1) Chicago Laboratory and (2) Home Training are accepted under the "G. I. Law."

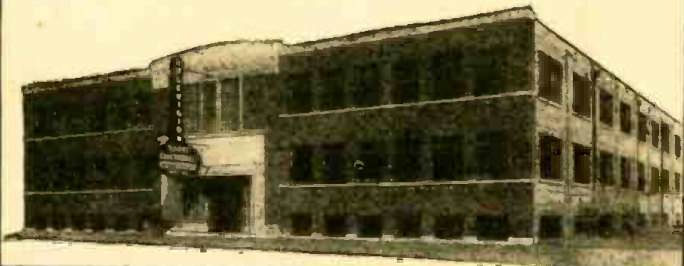

### MAIL THIS OPPORTUNITY COUPON NOW

Mr. E. B. DeVry, President  
 DeForest's Training, Inc.  
 2533 N. Ashland Ave., Dept. RC-E3  
 Chicago 14, Ill.

Please show me how I may get started toward a good job or a business of my own in Radio-Electronics.

Name ..... Age .....  
 Address ..... Apt. ....  
 City ..... Zone ... State .....

If under 16, check here for special information.
  If a discharged veteran of World War II, check here.

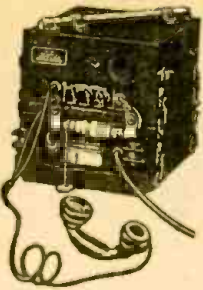

### SCR 610 PORTABLE TRANS-RCVR.

Covers the 11 and 10 meter amateur bands. Narrow band FM with crystal control. Uses the finest reactance tube modulator in use today. This Unit operates on 6, 12, or 24 volts, and makes an excellent portable or mobile rig. Less xtals .....\$39.50

### SPEAKER-DRIVER UNITS

Response from 2000 cps to 18,000 cps. Heavy duty magnet (4 lbs). 2" voice coil, with 1 1/2" cone, 8 ohm impedance. Makes an excellent tweeter for high fidelity reproduction. New, with spare cone ass'y. ....\$9.95

### 12 & 24 VOLT FILAMENT TRANSFORMERS

- (All primaries 110v, 60 cycle)  
#517 Output: 12 volts @ 10 amp, or 24 volts @ 5 amps .....\$2.75  
#2217 Output: 24 volts @ 3 amps. Size: 3" x 3 1/4" x 3" .....\$1.50

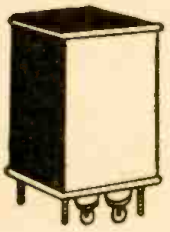

### TRANSFORMERS

- (All primaries 117 V. 60 cy) Filament Xfmrs:  
#5058: sec # 1: 6.3V @ 2 A CT sec #2: 6.3V @ 2 A CT .....\$2.15  
#5126: 5 V @ 3 A CT, 5 V @ 3 A CT, 5 V @ 6 A CT .....\$2.25  
#5100: 6.3 V CT @ 1.2 A, 5000 volt test .....\$1.35  
#5085: 6.3 V NCT @ .6 A, 6.3 V NCT @ 1.5 A .....\$1.40  
#5057: 6.3 VCT, @ 1 A, 5 VCT @ 9 A .....\$2.15

VCT @ 3 A, 5 VCT @ 9 A .....\$2.15  
#UX 6899: 5 V @ 5.5 A, % 5 V @ 5.5 A .....\$24.50  
29,000 V test .....\$24.50  
Doughnut fil. xfmr: Input: 117 V, 60 cy. Output: 2-5.1 V. wdgs @ 5 Amp. 15,000 volt insulation. Electrostatic shielding. 7" x 5" x 7 1/2". Amertran .....\$ 7.50  
Power xfmr. Pri: 117v, 60 cy. Sec: 330-0-330 v. @ 85 ma. 5v. @ 8 amp. 6.3 v. @ 3 amp. 6.3 v. @ 7.5 amp. ....\$1.95  
Power Pair: Xfmr 470 v.c.t. @ 60 ma. 6.3 v. @ 1.65. 5v. @ 2 amp. PLUS a 6hy 50 ma. choke. Both for only .....\$1.75

### CHOKES

- 6 Hy @ 150 Ma .....\$1.50  
6 Hy @ 300 Ma .....\$3.25  
1 Hy @ 800 Ma, 7.5 ohms .....\$8.95  
Dual choke, 2 Hy @ 100 Ma .....\$ .90  
Dual choke, 7 Hy @ 75 Ma, 11 Hy @ 60 Ma .....\$1.50  
8.5 h. @ 125 mila Ma .....\$1.50  
25 h. @ 65 Ma .....\$1.10

### RELAYS

Keying relay, SPST. 4-12 vdc. 1/2" contacts handle 500 watts at 3,000 volts. Type 107. Size: 3 1/2" x 2 1/2" x 1 1/4". New, each .....\$1.95  
4PST. 24 vdc. 1/2" contacts. # CR 2791-G100 K4. 2" x 1 1/2" x 1 1/4" .....\$1.15  
SPDT. 110 vdc. # CR 2791-B100P36 .....\$1.00

### OUTPUT TRANSFORMER

Western Electric KS 9196. 9,000 ohms push-pull plates to 9 ohm voice coil. Handles 250 watts. III-FI. Freq. response: -3 db @ 50 cycles. -1.25 db @ 100 cycles. 0 db @ 1000 cycles. -.3 db @ 10,000 cycles. -3 db @ 50,000 cycles. wt.: 14 1/2 lbs. New .....\$3.95

### HEADSETS

P-20 Headsets. 10,000 ohm impedance. Similar to Trim #7045. With 8' cord and PL 55 plug. \$2.25  
Dynamic mike and headset combination. A high quality, efficient unit, used in B-19 tank Xmtsr. Mike & phones complete, new as shown .....\$2.75  
HS 30 HEADSET: A featherweight headset with insert type phones that cut background noises to a minimum. Low impedance (500 ohms) assures efficiency & high fidelity .....\$.85  
Matching transformer to match 500 ohms to 8000 ohms output .....\$.35  
R-15 headsets: 8000 ohms impedance, rubber cushions. Comes with 8' cord & plug PL 55. New .....\$1.95  
Used, in good condition...\$60



# "Communications"

## RADAR AIRCRAFT AMATEUR INDUSTRIAL



From BC 191 & BC 375 TU 6B. 3000 kc to 4500 kc, TU 9B-7700 to 10,000 kc, TU 10B-10,000 to 12,500 kc, TU 22 B 350 to 650 kc. Will supply closest unit to Specified Frequency at time of shipment. Each .....\$2.25

### MOTOR-DRIVEN SWITCH

Switch operates at 1800 rpm, using internal 24 VDC motor. Switch is DPDT, and was originally designed for automatic switching of YAGI radar antennae .....\$2.00  
Motor driven switch mounted in aluminum case, black crackle finish and 6 Amphenol 83-1R low loss connectors. Size: 5 1/2" x 7 x 5 1/4". New .....\$4.00

### COAX CABLE

- RG9U 51 ohm Silver Coated .....per ft. \$ .07 1/2  
RG8U 52 ohm .....per ft. .04 1/2  
COAX Connectors. Amphenol Loss type  
831R, 831AP .....ea .27

### MAST BASES

- With rubber shaft. \$1.00  
Spring type .....1.50  
Rocker arm type ... 2.00

### Decade Resistance Box

- 2 Circuit 0-1250 ohms in 250 ohm steps. Each .....\$2.00



### DYNAMOTORS

- PE 73 CM. Power supply for BC 375. Input: 28 VDC. Output: 1060 VDC @ 350 Ma. Starting relay, filter, etc., new .....\$4.95  
BD 7KM. Power supply for BC 191. Input: 14 VDC. Output: 1000 VDC @ 350 Ma. New, with spare fuses links, etc. ....5.95  
PE 101C. Input 13/28 VDC @ 12.6/6.3. Output: 400 VDC @ 135 Ma., 800 VDC @ 20 Ma. (9 VAC @ 1.21 A) .....3.49  
(Mfrs.: Write for quantity prices and Discounts on above items.)  
PE 36 Input: 28 VDC. Output: 250 VD@C @ 60 Ma. Westinghouse. with filter .....1.95  
PC 77. Input: 13 VDC. Output 275 VDC 110 Ma. 500 VDC @ 50 Ma. ....3.25  
DAG 33A: Input: 18 VDC @ 3.2 A. Output: 450 VDC @ 60 Ma. ....2.45  
DM 33 A. Input: 28 VDC @ 7 A. Output: 540 VDC @ 250 Ma. Power supply for modulator for SCR 274 N .....3.95  
Dyn. Model 2330. Input 27 VDC @ 1.75 A. Output: 285 VDC @ 75 Ma. ....1.75  
DM-21: In 14 VDC 3.3 A Out 235 VDC 90 Ma. with filter, power supply for BC312 .....2.59  
PE 55. Input: 12 VDC @ 25 amp. Output: 500 VDC @ 400 Ma. (slightly used, excellent condition) .....4.95  
MP 10-G. Power supply using 2 dynamotors. Input: 24/28 VDC. Output: 1000 VDC @ 400 Ma. 230 VDC @ 100 Ma. New, complete with enclosed starting relays, filters, etc. Bendix .....20.00  
MK II power supply. Input: 12 VDC @ 9.4 Amp. Output: 275 VDC @ 110 Ma. 500 VDC @ 50 Ma. New, complete with connecting cable and plugs .....4.75

### INVERTERS

- PE 206-A. Input: 28 VDC @ 38 Amp. Output: 80 volts at 500 volt-amps. 800 cycle. Leland Electric. New, complete, with enclosed relay, filter, instruction book .....\$12.50  
PE 218. Input: 25-28 VDC @ 92 Amp. Output: 115 volts, 1500 volt-amps, 380-500 cycle. Leland Electric. New. ....\$15.00

### 140-600 MC DIRECTIONAL ANTENNA

140-310 Mc cone and 300-600 Mc cone, each consisting of 2 end fed half wave conical sections with enclosed matching stub for reactance changes with changing frequency. New, complete with mast, guys, cables, carrying chest .....\$49.50

### MICROWAVE TUBES (Magnetrons)

- 2J32 (10 CM) .....\$15.00  
Magnet for 2J32 ..... 8.00  
2J38 with magnet ..... 25.00  
2J55 with magnet ..... 25.00  
5J31 (1CM.) ..... 17.50  
Magnet for 5J31 ..... 8.00  
2J21 .....\$15.00  
2J21A ..... 15.00  
2J22 ..... 15.00  
2J26 ..... 15.00  
2J27 ..... 15.00  
2J31 ..... 15.00  
W.E. 700A (L band) .....\$45.00  
W.E. 720BY (S band) 1000 KW ..... 25.00  
Klystron, 2K26-723, AB ..... 3.50



### CATHODE RAY TUBES

- 5BP1 ..... \$1.20  
3BP1 .....\$1.25 5BP4 ..... \$1.60  
3FP7 ..... 1.20 5BP1 ..... 1.20  
5FP7 ..... 1.75 5JP2 ..... 4.00  
RECTIFIER TUBES  
872A .....\$1.00 705A .....\$1.25

### ARC-5 ACCESSORIES

Broadcast Band RF coil ass'y. Plug-in-case \$1.00  
Single, double, mounting racks for rcvrs. ....\$1.00; \$1.50  
Shock mounts for racks .....\$ .50  
Dual rcvr. control boxes-BC496-A .....\$1.00  
3-4 mc. conversion kit for ARC-5 Xmtsr's. Consists of 1 #6029 Oscillator coil (3.4 mc) and 1-#7247 PA coil (3-4 mc). Per set .....\$1.50  
#6032 coil, master oscillator (7-9.1 mc) For arc-5 Xmtsr. ....\$1.00  
ARC #6030 Oscillator coil, 4-5.3 mc. For ARC 5 transmitter .....\$1.00  
ARC #6538 variable receiving capacitor. 62 mmf / section, 3 sections. .03" spacing, 8 rotors. Worm drive ratio 33:1. ....\$1.75  
ARC #4490, variable xmtg. capacitor, 22.4-145 mmf. .05" spacing, 11 rotors. Each .....\$1.00  
ARC 6082, Var. Xmtg. capacitor, 29.2-117 mmf, .06" spacing, 16 rotors, worm drive: 96:1. \$1.00

### CERAMICON CAPACITORS

- (Standard Brand) \$7.50 per 100  
Cap. Tol. Cap. Tol.  
3 mmf +/-5% 67 mmf +/-20%  
5 mmf +/-5% 100 mmf +/-5%  
4 mmf +/-5 mmf 115 mmf +/-2%  
8.5 mmf +/-5 mmf 120 mmf +/-2%  
11 mmf +/-5% 240 mmf +/-3%  
15 mmf +/-2.5 mmf 250 mmf +/-3%  
48 mmf +/-2% 500 mmf +/-15%-30%  
50 mmf +/-20% 1000 mmf +/-5%  
60 mmf +/-3%

### SILVER-MICA BUTTON CAPACITORS

- (Standard Brand) \$9.50 per 100  
185 mmf +/-2.5 mmf  
175 mmf +/-2%  
500 mmf +/-10%

### VIBRATOR TRANSFORMER

Input: 24 v, 12 v, or 6 v. Output: Two 120 v windings @ 175 amp. Plus 11 v winding. Ea. ....\$1.50



### CROSS POINTER INDICATOR

Two 0-200 microampere movements, 3" case, many applications .....\$2.50

### SCR 522 POWER UNIT

Power unit, type 15. Input: 12 v.d.c. @ 30 amp. Output: 300 vdc @ 280 ma, 150 vdc @ 10 ma, 14.5 vdc @ 5 amp. New, complete in wooden transit chest. \$7.89

### CONDENSERS

- SPECIAL  
Oil Condenser: 10 mfd @ 1000 VDC. ....Each \$1.25  
.25 mf @ 20000 VDC .....\$17.50  
1.5 mf @ 6000 VDC .....12.50  
.5 mf @ 25 KV .....40.00  
.01 mf @ 25 KV .....25.00

### MICA

- .08 mf @ 1500 VDC. Sprague MN60 .....\$11.50  
.03 mf @ 2000 VDC. CD 551A-50 .....12.75  
.045 mf @ 2000 VDC. Sangamo, GI .....12.75  
.00015 mf @ 20 KV. Aerovox 1970-404 .....25.00  
.0001 mf @ 20 KV. Sangamo G3 .....25.00  
.0051 mf @ 15 KV. Sangamo G 4 .....25.00  
.005 mf @ 10 KV. Sangamo G3 .....17.50  
.002 mf @ 15 KV. Sangamo .....20.00  
Isolating Capacitor Cornell-Dubilior PL 1417 106-110 mmf @ 10 KV AC (peak) Each ..... 3.50  
MFRS: Send your requirements for bathtubs, Micas, Hardware, resistors, & connectors.

### ELECTROLYTICS

- 18 mfd @ 450 VDC .....\$ .69  
22 mfd @ 450 VDC ..... 1.25  
100 mfd @ 25 VDC ..... .35  
3 x 18 mfd @ 350 VDC ..... 1.25



All merchandise guaranteed. Mail orders promptly filled. All prices, F.O.B. New York City. Send Money Order or Check. Only Shipping charges sent C.O.D.

# COMMUNICATIONS EQUIPMENT CO.

131 C. Liberty St., New York City 7, N. Y. Digby 9-4124

**WE BRING NATIONAL SCHOOLS  
TO YOU FOR **RADIO**  
HOME TRAINING IN  
**TELEVISION & ELECTRONICS****



RADIO SHOP AT NATIONAL

BROADCAST STUDIO AT NATIONAL

Partial View of the  
Facilities that Stand  
Behind Your National  
Schools Home Training

TELEVISION STUDIO  
AT NATIONAL

Since 1905

**For Over 42 Years  
One of America's  
Leading Trade Schools**

**NATIONAL SCHOOLS SHOP METHOD  
HOME TRAINING WILL START YOU RIGHT**

We will train you today to get started tomorrow in one of the thousands of opportunities opening in the field of Radio, Television and Electronics. The Home Radio Service Field continues to grow. Television is here . . . Television Broadcasting facilities are being rapidly expanded. Television sales, service, installation and maintenance requirements are more and more important from day to day. Electronics is an important factor in many applications for utility, safety, accuracy and convenience. Airlines are finding new uses for Radio bringing new benefits to air transportation. Ships at sea are employing Radar together with other conventional Radio apparatus for ship-to-shore communications and safety. Frequency Modulation is modernizing Radio Broadcasting, offering static-and-interference-free reception in the home. The list of Radio applications is almost endless, and every one represents increasing opportunities in our modern world for the **RADIO, TELEVISION AND ELECTRONICS TECHNICIAN WITH A SOLID TECHNICAL BACKGROUND.**

**LESSONS AND INSTRUCTION MATERIAL  
ARE UP-TO-DATE, PRACTICAL, INTERESTING**

It is not a question of opportunity but rather how to take advantage of existing opportunity. Only proper training can make these opportunities a reality. National Schools of Los Angeles, one of the oldest and largest technical trade schools in the United States, offers you Shop Method Home Training, a proved method that builds qualified technicians. Here is Home Training that **BRINGS RESULTS.**

Behind all training from National Schools stands a permanent faculty of experienced instructors and engineers. These men are daily teaching resident students right in our own Shops and Laboratories. From first hand experience with students here at school, our instructors understand the needs and ambitions of men like you. All of our instructors, both Home Study and Resident, have ideal facilities to make your training practical, up-to-the-minute, interesting. It takes years of experience to know how to train men, especially in the practical technical trades. Established almost 50 years ago, National Schools has a rich background of experience to help you to take full advantage of the opportunities in the Radio, Television and Electronics Industry.

**VETERANS**

During the war, National trained enlisted men under contract with the War Department. Both the Armed Forces Institute and Marine Corps Institute used our lesson texts on a wide scale. Now, we are training veterans, both resident and home study, through the Veterans Administration. If you are a veteran of World War II—and qualified for training under the G.I. Bill of Rights, check the coupon for special information.



**You Get All This Radio  
Experimental Equipment  
to Use and Keep at Home!**

**LEARN BY DOING** is the basic principle of National's Shop Method Home Training. We send you standard Radio parts for an interesting series of experiments which demonstrate the fundamentals of Radio, Television and Electronics. The very essence of this training is **EXPERIENCE**—you get actual experience by building many different types of circuits. You build a fine, long distance **MODERN SUPERHETERODYNE RECEIVER**, signal generator, low-power Radio transmitter, audio oscillator, etc. This practical work develops your knowledge of Radio step by step, makes you a practical Radio Technician.

- Here's Just a Few of the Interesting Facts you Learn with the **FREE MANUAL**
1. Routine for diagnosing Radio Troubles.
  2. Preliminary inspection of Receivers.
  3. How to Test and Measure Voltages.
  4. How to Test Speaker in Audio Stages.
  5. How to Trace the Circuit and Prepare Skeleton Diagram.
  6. Complete Reference Table for Quickly Locating Receiver Troubles.

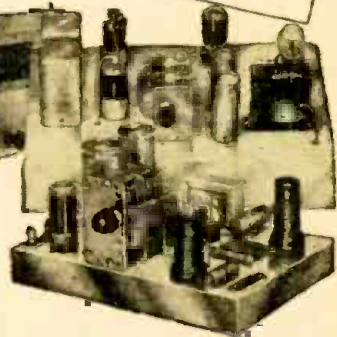

**NOW! NEW PROFESSIONAL  
MULTITESTER INCLUDED**



This versatile testing instrument is portable and complete with test leads and batteries. Simple to operate, accurate and dependable. You will be able to quickly locate trouble and adjust the most delicate circuits. You can use the Multitester at home or on service calls. It is designed to measure AC and DC volts, current, resistance and decibels. You will be proud to own and use this valuable professional instrument.

**GET THE DETAILS—SEND THE  
COUPON**

**G. I. APPROVED  
NATIONAL SCHOOLS**

LOS ANGELES 37, CALIFORNIA EST. 1905



**MAIL OPPORTUNITY COUPON FOR QUICK ACTION**

NATIONAL SCHOOLS, Dept. RC-3

4000 South Figueroa Street, Los Angeles 37, California

Mail me **FREE** the two books mentioned in your ad, including a sample lesson of your course. I understand no salesman will call on me. I have checked below the plan which interests me.

NAME ..... AGE .....

ADDRESS .....

CITY ..... STATE .....

(Include four zone number)

Veteran of World War II

# MARCH • 1948

Editorial: Radio in the Next War ..... by Hugo Gernsback 17  
 Radio-Electronics Monthly Review ..... 18, 19  
 Radio Quiz ..... by J. H. Barber, Jr. 59  
 Radio Thirty-Five Years Ago ..... 87

## Electronics

Electronics in Medicine ..... by Eugene Thompson 28  
 Cosmic Radio Signals from Sun and Stars (Cover Feature) ..... 34  
 A. C. Generator for Automobiles ..... 58  
 R.F. Sticky-Fluid Meter ..... by S. R. Winters 66

## Amateur Radio

A De Luxe Amateur Transmitter  
 by John Wonsowicz, W9DUT and Herbert S. Brier, W9EGQ 20

## Servicing

New Day Dawns for Servicemen ..... 24  
 Radio Set and Service Review (Motorola 77FM21, FM-AM Console) by R. F. Scott, W2PWG 30  
 Slide-Rule Wire Data ..... by I. Queen 52  
 Aligning a Superhet Without a Generator ..... by Albert Rees 77

## Test Instruments

Know Your Test Equipment! ..... by Sol D. Prensly 32  
 Meter Shunts ..... by Richard L. Parmenter, WIJXF 60

## Sound

Record Players Rate Good Treatment ..... by H. Leeper 25  
 Broad-Band Amplifiers ..... by R. F. Scott, W2PWG 27  
 Magnetic Recording, Part V ..... by A. C. Shaney 35  
 Electronic Mixing ..... by John W. Straede 54

## Construction

All-Voltage Power Pack ..... by Martin A. Weiner 23  
 String Music Pickup ..... by Richard L. Parmenter, WIJXF 26  
 1-Tube Pocket Radio ..... by D. E. Sawyer 62  
 All-Way FM Antenna ..... by Julian T. Dixon 68

## Departments

Transatlantic News ..... by Major Ralph W. Hallows 36  
 World-Wide Station List ..... by Elmer R. Fuller 37  
 New Radio-Electronic Devices ..... 38  
 Radio-Electronic Circuits ..... 40  
 Try This One ..... 42  
 The Question Box ..... 44  
 Technotes ..... 48  
 New Radio-Electronic Patents ..... by I. Queen 50  
 Communications ..... 82  
 Book Reviews ..... 84



Incorporating  
 SHORT WAVE CRAFT\* TELEVISION NEWS\*  
 RADIO & TELEVISION  
 \*Trademark registered U. S. Patent Office

**HUGO GERNSBACK**  
*Editor-in-Chief*  
**FRED SHUNAMAN**, *Managing Editor*  
**M. HARVEY GERNSBACK**,  
*Consulting Editor*  
**ROBERT F. SCOTT, W2PWG**,  
*Technical Editor*  
**ANGIE PASCALE**,  
*Production Manager*  
**I. QUEEN, W2OUX**, *Editorial Associate*  
**ELMER FULLER**, *Shortwave Editor*  
**G. ALIQUO**, *Circulation Manager*  
**JOHN J. LAMSON**,  
*Advertising Director*  
**ALFRED STERN**, *Promotion Manager*

## In An Early Issue

Subminiature V.T. Voltmeter  
 A Capacity-Operated Relay  
 35-Watt Hi-Fi Amplifier

## On the Cover:



The giant Wurzburg antenna used by Dr. Grote Reber to receive signals from the sun and stars.

Photomicro by Alex Schomburg from U. S. Bureau of Standards photo.



Member Audit Bureau of Circulations

RADCRAFT PUBLICATIONS, INC. Hugo Gernsback, President; M. Harvey Gernsback, Vice President; G. Aliquo, Secretary  
 Contents Copyright, 1948, by Radcraft Publications, Inc. Text and illustrations must not be reproduced without permission of Copyright owners.

RADCRAFT PUBLICATIONS INC. • PUBLICATION OFFICE 29 Worthington Street, Springfield 3, Mass. Address all correspondence to N. Y. office.  
 EDITORIAL AND ADVERTISING OFFICES 25 West Broadway, New York 7, N. Y. Telephone REctor 2-9690. BRANCH ADVERTISING OFFICES: Chicago: 308 W. Washington Street, Chicago 6, Ill. Tel. Randolph 7363. Detroit: Frank Holstein, Manager, Room 402 Lexington Bldg., 2970 West Grand Blvd., Detroit 2, Mich. Telephone Madison 7026-7. Los Angeles: Ralph W. Harker, Manager, 606 South Hill St., Los Angeles 14, Calif. Tel. Tucker 1793. San Francisco: Ralph W. Harker, Manager, 582 Market St., San Francisco 4, Calif. Tel. Garfield 2481.

RADIO-CRAFT, March, 1948, Volume XIX, No. 6. Published Monthly on 25th of month preceding date of issue. Allow one month for change of address. When ordering a change, please furnish an address stencil impression from a recent wrapper. All communications about subscriptions should be addressed to the Circulation Manager, Radio-Craft, 29 Worthington St., Springfield 3, Mass., or 25 West Broadway, New York 7, N. Y.

SUBSCRIPTION RATES: United States and possessions, Mexico, Central and South American countries, \$3.50 a year; \$6.00 for two years; \$8.00 for three years. Canada, \$4.00 a year; \$7.00 for two years; \$9.50 for three years. All other foreign countries, \$4.25 a year, \$7.50 for two years; \$10.25 for three years. Entered at Post Office, Springfield, Mass., as second-class matter under the Act of March 3, 1879. Application for transfer of entry at Mount Morris, Ill., pending.

FOREIGN AGENTS: Great Britain: Atlas Publishing and Distributing Co., Ltd., 18 Bride Lane, Fleet St., London E.C.4. Australia: McGill's Agency, 179 Elizabeth Street, Melbourne. France: Brentano's, 37 Avenue de l'Opera, Paris 2e. Holland: Technisch Bureau Van Baerle, Bemelmans & Co., Heemsteedsche, Dreef 124, Heemstede. Greece: International Book & News Agency, 17 Amerikis Street, Athens. So. Africa: Central News Agency, Ltd., Cor. Rissik & Commissioner Sts. Johannesburg; 112 Long Street, Capetown; 369 Smith Street, Durban, Natal. Universal Book Agency, 70 Harrison Street, Johannesburg. Middle East: Steimatzky Middle East Agency, Jaffa Road, Jerusalem. India: Susil Gupta (Distributors) Co., Amrita Bazar Patrika Lt., 14 Ananda Chatterjee Lane, Calcutta.

Thousands of Servicemen asked us:  
**"Why Don't You Publish a Tube Placement Guide?"**



**NOTHING LIKE IT!**

*Practical*—like all SAMS Manuals! *Complete*—the only single source for tube placement data on almost 4500 models. *Accurate*—correct information on every model. You get 192 pages of invaluable data in a handy, sturdily-bound pocket-size book. Say goodbye to tube placement identification problems—save time—get more work done faster! Now at your local job-ber for **ONLY \$1.25**

**SO WE DID!**  
**AND HERE IT IS:**  
**THE NEW PRACTICAL HOWARD W. SAMS**  
**"RADIO RECEIVER**  
**TUBE PLACEMENT GUIDE"**

It's the book you'll use every single day—in the handy pocket-size you like—that shows you exactly where to replace each tube in almost 4500 models! Covers receivers from 1938 to 1947. Each tube layout is illustrated by a clear, accurate diagram, with tubes identified by large, easy-to-read type numbers. Saves you valuable time identifying tube placement, especially where the customer has removed the tubes from the set. Eliminates irritating hit-and-miss methods and risky guessing—helps you work faster, more profitably. Completely indexed for quick, accurate reference. Handy on service calls—a big help on every job—outside or in the shop. You'll want several copies for bench and outside calls. They'll pay for themselves over and over again. Order today!

**The World's Most Practical Radio Service Manuals!**

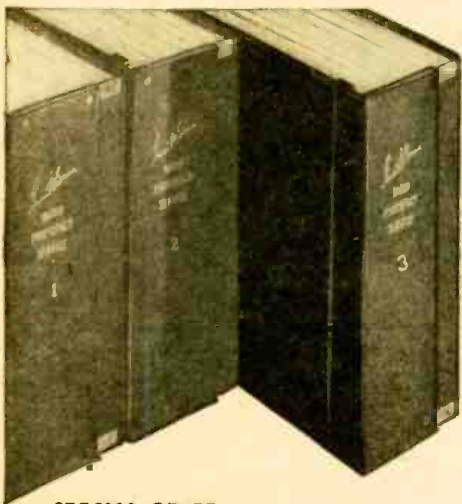

PHOTOFACT Volume 3 is ready for you—brings your post-war service data right up to January, 1948! Companion to Volumes 1 and 2—the most *practical, accurate and complete* Radio Data ever compiled. Here is everything you need for fast, efficient, profitable servicing of all post-war models—bound in easy-to-use volumes. Order your PHOTOFACT Volumes now—the Radio Service Data with the *exclusive* features that meets all your actual needs!

- Volume 1. All post-war models up to January 1, 1947.
- Volume 2. Models from January 1, 1947, to July 1, 1947.
- Volume 3. Models from July 1, 1947, to January 1, 1948.

Your Price, Each Volume, in Easy-to-Use Deluxe Binder.... **\$18.39**

**SPECIAL OFFER:** If you haven't a complete file of all PHOTOFACT Folders to date, you can trade in the individual Sets you now own for complete volumes at amazingly low cost. Write today for special offer, stating what Sets of Folders you now own (use coupon at right).

Howard W. Sams' 1947 Automatic Record Changer Manual. Only book of its kind—complete service data on all current Changers and Recorders. 400 pages. **ONLY \$4.95**



Howard W. Sams' Dial Cord Stringing Guide. No other manual like it—shows the *right* way to string the dial cords of models produced from 1938 through 1946. It's a "must" for Servicemen. **ONLY 75c**



**BOOST YOUR EARNING POWER!**

**Mail This Order Form**

to HOWARD W. SAMS & CO., INC.  
 2924 E. Washington St., Indianapolis 6, Indiana.

My (check) (money order) for \$..... enclosed.

- Send ..... SAMS' TUBE PLACEMENT GUIDE(S) at \$1.25 per copy.
- Send PHOTOFACT Volume 3 (including Sets Nos. 21 through 30) in DeLuxe Binder, \$18.39.
- Send Volume 2.     Send Volume 1 (\$18.39 each).
- Send ..... SAMS' 1947 AUTOMATIC RECORD CHANGER MANUAL(S) at \$4.95 each.
- Send ..... SAMS' DIAL CORD STRINGING GUIDE(S) at \$0.75 per copy.
- Send FREE PHOTOFACT Cumulative Index.
- Send details of your Special Trade-In Offer.

Name.....  
 Address.....  
 City..... State.....

**HOWARD W. SAMS & CO., INC.**  
 INDIANAPOLIS 6, INDIANA

Export—L. d. Auriema—89 Broad St., New York 4, N. Y.—U. S. of America  
 Canada—A. C. Simmonds & Sons, 301 King St., East—Toronto, Ontario

**PHOTOFACT SERVICE**

"The Service that pays for itself over and over again"



# ESSE Specials!

Do not fail to closely examine this list of bargains. We believe that every item listed below is a sensational value. All equipment advertised herein is unconditionally guaranteed to the customer's satisfaction to this extent: Return any item advertised within five days after delivery for full refund except transportation charges (both ways).

**C-1 AUTO PILOT** COMPLETE WITH ONE OF EACH UNIT SHOWN IN BLOCK BELOW. ANY EXPERIMENTER OR BOAT OWNER CANNOT BE WITHOUT THIS EQUIPMENT WHICH COST THE GOVERNMENT THOUSANDS OF DOLLARS BUT OFFERED YOU AT THE SMALL PRICE OF ..... **\$30<sup>00</sup>**

## C-1 AUTO PILOT COMPONENTS



**C-1 SERVO UNIT**

Use to rotate beam antenna, actuate boat rudder control, etc. Contains 24 V. motor, clutch, relays, etc. Reversible. Size overall approx. 10 1/2" x 8 1/2" x 6 1/2". PRICE **\$12<sup>50</sup>**



**C-1 GYRO**

Part of the C-1 Auto Pilot which is sold separate and may be used to conduct many interesting and amusing experiments. Operates from 24 V. DC or may be operated for short periods on 110 V. AC. Gyro will run for approx. 15 minutes after actuating. Size—approx. 8" x 8 1/2" x 8 1/2". PRICE ..... **\$8<sup>95</sup>**

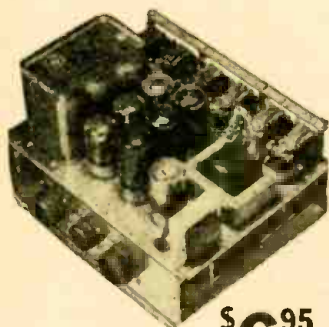

**C-1 AUTO PILOT AMPLIFIER**

Used to control operation of servo unit in response to signals received from gyro unit and control unit. The complete amplifier includes one rect. 7Y4, 3—7F7's for amplification and control, 3—7N7's for signal discrimination, 1 power transformer, 6 relays, 4 control pots, chokes, condensers, etc. Convert for use on radio controlled models, doors, etc. Operates from 24 V. DC. Size, 9 1/4" x 6 1/4" x 7 7/8".

Complete **\$6<sup>95</sup>**



**C-1 AUTO PILOT CONTROL BOX**

Used for aligning control of C-1 Auto Pilot or use for parts, etc. Contains many useful pots., toggle switches, plugs, etc. Size, 11" x 6" x 4 1/2". PRICE

**\$3<sup>75</sup>**

## RECEIVER RU-19



With plug-in coils (not included) covers a frequency range of 195-13, 575 Kc. Contains 6 tubes. Size 6 1/2" x 6 1/2" x 15". PRICE

**\$5<sup>00</sup>**

## TRANSMITTER RU-19



With plug-in coils (not included) covers a frequency range of 3000-4525 and 6000-9050 Kc. Contains 4 tubes. Size 6 1/2" x 6 1/2" x 11". PRICE

**\$5<sup>00</sup>**

## MN-26 Radio Compass

INCLUDING LOOP, CONTROL BOX AND PLUGS COMPLETE EXCEPT FOR ELECTRIC CABLES—BRAND NEW ..... **\$32<sup>50</sup>**

### ANTENNA KIT 2A-264-126

Canvas bag containing 20 ceramic insulators each 3" long (1/4" dia. with screw-in type eyelets), covered wires each 5' long, 10' long, 35' long, 2 each 25' long, 5 each 20' long, 150' long, (all having 1/8" thimbles and 6" connecting leads at each end and all stranded copper covered with weather proof insulation.) Brand new. Original crates. Useful to any ham, serviceman, or experimenter. Each kit

Special Price . . . . . **\$4<sup>95</sup>**



### 2-METER BEAM ANTENNA

Portable or fixed, manually operated or can be used with beam motor, for use in 100-156 Mc. band. Easily adapted for ham or experimental use. Contains tuning unit which matches output of transmitter to antenna, 18' steel mast with brass tube containing co-ax cable and fittings inside steel mast (OD color), "H" frame for holding dipoles, 3 sets (4 per set) dipole rods, compensator or sense antenna for "H" frame, 2 steel truncated cones used as antenna support and feed-through, 360 degrees bearing indicator, and handwheel for rotating. Brand new packed in six boxes, total weight approx. 600 lbs. Limited quantity and in much demand. Place order now

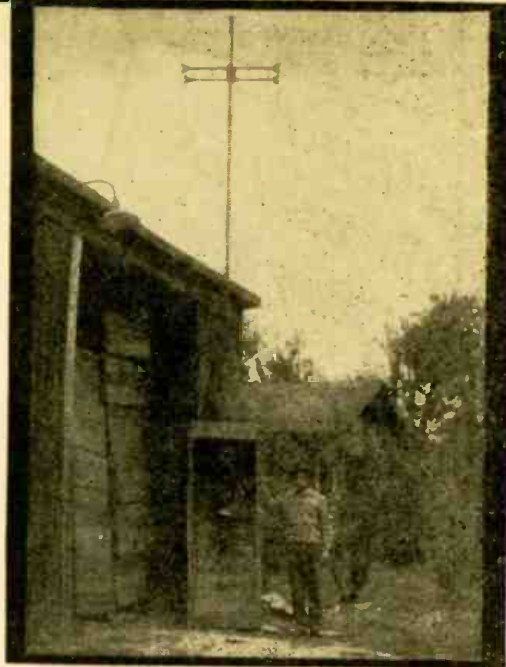

Special Price . . . **\$79<sup>50</sup>**

### BC-348 COMMUNICATIONS RECEIVER

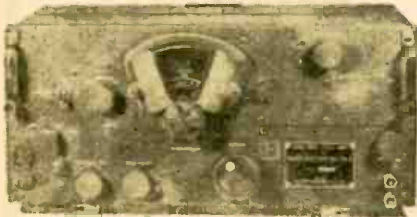

6 bands, 200-500 Kc. and 1.5-18 Mc. 2 stages RF, 3 stages IF, BFO, crystal filter, manual or AVC. Complete with tubes and 24 V. dynamotor. These receivers have been thoroughly checked in our work-shop and found in excellent condition.

BC-348, 110 V. AC power supply, including simple conversion instructions. Complete with tube. **\$9<sup>95</sup>**

Price . . . . . **\$69<sup>50</sup>**

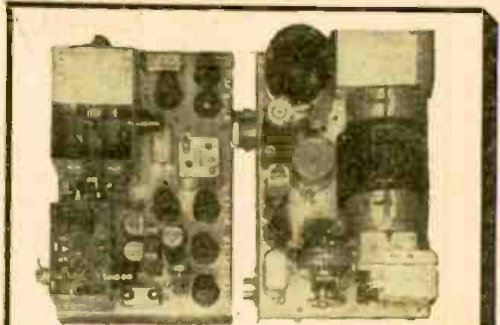

### BC-966-A IFF

Approximately 2 meter frequency operation. 14 tubes, 350 V DC dynamotor, 12 V. DC input. Contains voltage regulators and many other fine parts. Worth more for parts than price asked.

**\$4<sup>75</sup>**

### BEAM ROTATING MOTORS

USED TO ROTATE YOUR BEAM ANTENNA

Motor Completely Converted

Ready for Use

**\$17<sup>95</sup>**

★  
Motor Only

24-28 V.

**\$9<sup>95</sup>**

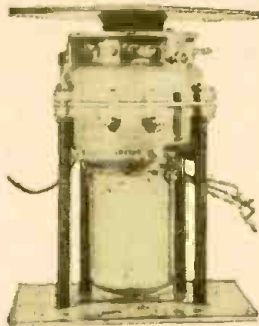

Transformer to operate 110 V. - 30 V. (New), **\$4.95**



**\$12<sup>50</sup>**

### T-39/APO-9 RADAR XMITTER

Contains many excellent parts for the VHF experimenter such as a cavity oscillator using 2-RCA 8012 tubes rated at full output to 500 Mc. Tubes are forced air cooled by 24 V. DC motor, which is easily converted for 110 V. AC operation. Other valuable parts such as a pair of 807's, 2-6AC7, 1-931 and 1-6AG7 tubes; ceramic switch, potentiometers, gears, revolution counter, etc.

# ESSE Radio Co

40-42 W. South St.  
Indianapolis 4, Ind.

Unless Otherwise Stated, All of This Equipment Is Sold As Used  
**CASH REQUIRED WITH ALL ORDERS**  
Orders Shipped F.O.B. Collect

*A Few of  
the Thousands of  
Great Money-Saving  
Buys in this  
160-Page Catalog!*

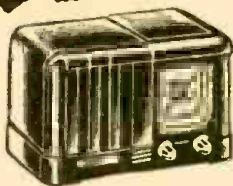

**5 Tube AC-DC Kit  
with Plastic Cabinet**

Circuit is the popular five tube AC-DC superheterodyne using a 12SA7, 12SK7, 12SQ7, 50L6 and 35Z5. Includes automatic volume control, true tone reproduction. Streamlined airplane dial, wide tuning that covers 550 to 1600 Kc, built-in loop antenna and new Alnico V speaker. Cabinet is a beautiful modern design in brown plastic. Kit contains all parts to build complete receiver.  
C24456—With **\$13.75**  
Cabinet and Tubes

**Special Value  
Resistor Set**

Kit of 100 assorted resistors, 1/2 to 2 watt. All R.M.A. color coded.  
5B155—Your Cost .... **89c**



**Close Out Sale On Standard Brand Condensers**

Servicemen! Extra special values in condensers. These prices give you over 60% discount from list. Brand new R.M.A. guaranteed nationally known makes of condensers. Order today.  
X-122—8 mfd. 450v.....34c  
X-125—16 mfd. 450v.....49c



**Volume Controls**

1.5 Meg. Volume Control, AVC taper, Audio shunt, 2' shaft.  
5B2105..... **29c**

**SPST Volume Control Switch**

Cover plate switch for use with above volume control. **15c**  
5B2106.....

**Combination Wire  
Recorder-Disc Phono Unit**

A basic unit around which the builder, amateur or experimenter may build a complete unit for magnetic wire recording and playback, as well as standard disc phono playback. You may use it to record events, speech or music for reference at any future time, or you may ERASE all sound from the wire and RE-record, as many times as you wish, on the same wire. The wire recorder uses standard spools of steel recording wire (not supplied, see list below). Measures 13x8x7 3/4". Requires area 15 1/2 x 12 1/4" for playing 12" disc records. Complete with oscillator coil, circuit diagrams and instructions for building four tube amplifier and erase and bias oscillators.



C22522..... **\$47.95**  
C16311—15 min. spool.. \$1.75    C16312—30 min. spool.. \$2.55    C16313—60 min. spool.. \$4.80

*Free!*

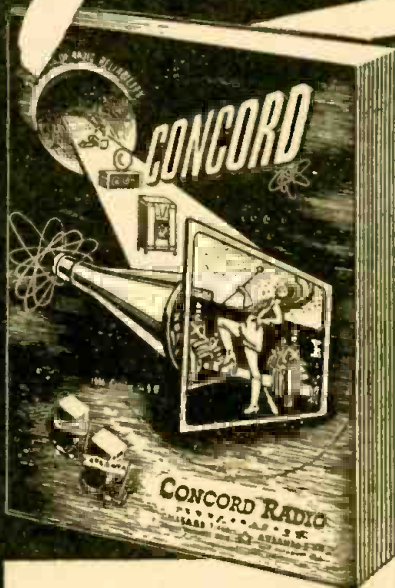

**CONCORD  
RADIO  
CATALOG**

**MAIL COUPON for FREE COPY**

The Only Complete Up-to-the-minute Catalog of  
**RADIO PARTS • RADIO SETS • AMPLIFIERS • TESTERS  
ELECTRONIC EQUIPMENT • HAM GEAR**

- Thousands of items for every need in Radio, Electronics, Television, Radar.
- Pages of Money-Saving Bargains in top-quality, standard-make Radio Parts.
- Immediate Shipment from huge stocks in Chicago and Atlanta.

**STANDARD BRAND PARTS AT LOWEST PRICES!**

RCA • AMPERITE • SIMPSON • JENSEN • STANCOR • OHMITE • SHURE • BLILEY  
DUMONT • IRC • TRIPLETT • SPRAGUE and hundreds of other well known brands

**CONCORD  
RADIO CORPORATION**

CHICAGO 7      ATLANTA 3  
901 W. Jackson Blvd.      265 Peachtree St.  
Downtown Chicago Branch: 229 W. Madison  
Lafayette Radio Corp.

Concord Radio Corporation, Dept. RC-38  
901 W. Jackson Blvd., Chicago 7, Ill.

Yes, rush FREE COPY of the comprehensive new Concord Radio Catalog.

Name .....

Address .....

City.....State.....





**NEW!**

**MAKES YOU MASTER OF FM & TELEVISION SERVICE**



Here's what you and thousands of research and service technicians have demanded . . . a frequency-modulated FM and TV sweep signal generator. With this new McMurdo Silver MODEL 909 and your oscilloscope you can visually align FM and TV receivers . . . quickly and perfectly . . . for it comes with simple but complete instructions to put you at the head of the parade in FM and TV service.

Quality and completeness are as high as price is low . . . the regular "trademark" of Silver LCETI . . . Laboratory Caliber Electronic Test Instruments at prices you can afford.

**CENTER-FREQUENCY RANGE** 2/226 mc. — 5" vernier-driven calibrated dial. A new Silver development covers 2/77, 70/154 and 151/226 mc. in 3 bands without band-switching!

**STABILITY** is extraordinary. New u.h.f. tubes give stability such that FM and TV 'scope pictures once set up will "stay put" for hours on end.

**SIZE AND STYLE** match "VOMAX" and all Silver LCETI. Power required is 105/125V., 50/60 a.c. at 35 watts. Size 12 3/4" x 7 3/4" x 6" overall.

**CO-AXIAL OUTPUT CABLES.** 3 ft., d.c. isolated, 5/125 Ω impedance for r.f.; separate horizontal synchronizing cable. Both with clips for direct connection to receiver circuits.

**SWEEP FREQUENCY** is panel-knob variable 0/9 mc. . . . to set correct sweep for FM and TV i.f. and r.f. alignment. True electronic, not distorting and troublesome mechanical sweep.

**SYNCHRONIZATION** is either power line sine wave, or saw-tooth to 'scope from 909. R.F. OUTPUT is panel-knob controllable 0/500,000 microvolts maximum. More than ample for all visual alignment with any good oscilloscope.

**MODEL 909 FM & TV SWEEP SIGNAL GENERATOR** makes you master, not victim, of today's most profitable service fields . . . at a price which is already the amazement of the industry!

**Model 909** ..... Only \$48.50 Net



**900 "VOMAX"** 51 ranges; d.c., a.c., a.f., i.f., r.f., 20 Ω /500 mc. 0/3000 V. d.c.; 0/1200 V. a.c., current 0/12 A. ; resistance 0/2000 meg Ω ; db.—10/+50. The overwhelming choice of wise research and service technicians. Only \$59.85 Net

**904 CONDENSER/RESISTOR TESTER.** 1/4 mmfd./1000 mfd.; 1/4 Ω /1000 meg Ω ; variable d.c. polarizing voltage leakage current; 0/50% power factor. Laboratory accuracy of ±3%. Measures all condensers with 0/500 V. rated d.c. volts applied. Only \$49.90 Net

**905 "SPARX" DYNAMIC SIGNAL TRACER/TEST SPEAKER.** Traces a.f., i.f., r.f. signals thru any receiver, tests pick ups, mikes, PA amplifiers. 20 Ω /200 mc. Saves time in receiver repairs as does no other single instrument Only \$39.90 Net

**906 FM/AM SIGNAL GENERATOR.** 8 ranges, ±1% accurate, 90 kc./210 mc. 0/100% AM, 0/1000 kc. FM modulation. Less than 1 microvolt to over 1 volt metered output. The outstanding signal generator buy. Only \$99.50 Net

SEND FOR COMPLETE CATALOG. See these and Silver communication transmitters, receivers, "Micromatch" Xial-controlled VFO, pre-tuned freq multiplier at your jobber.

OVER 36 YEARS OF RADIO ENGINEERING ACHIEVEMENT  
**McMurdo Silver Co., Inc.**  
 EXECUTIVE OFFICES: 1240 MAIN ST., HARTFORD 3, CONN.  
 FACTORY OFFICE: 1249 MAIN ST., HARTFORD 3, CONN.

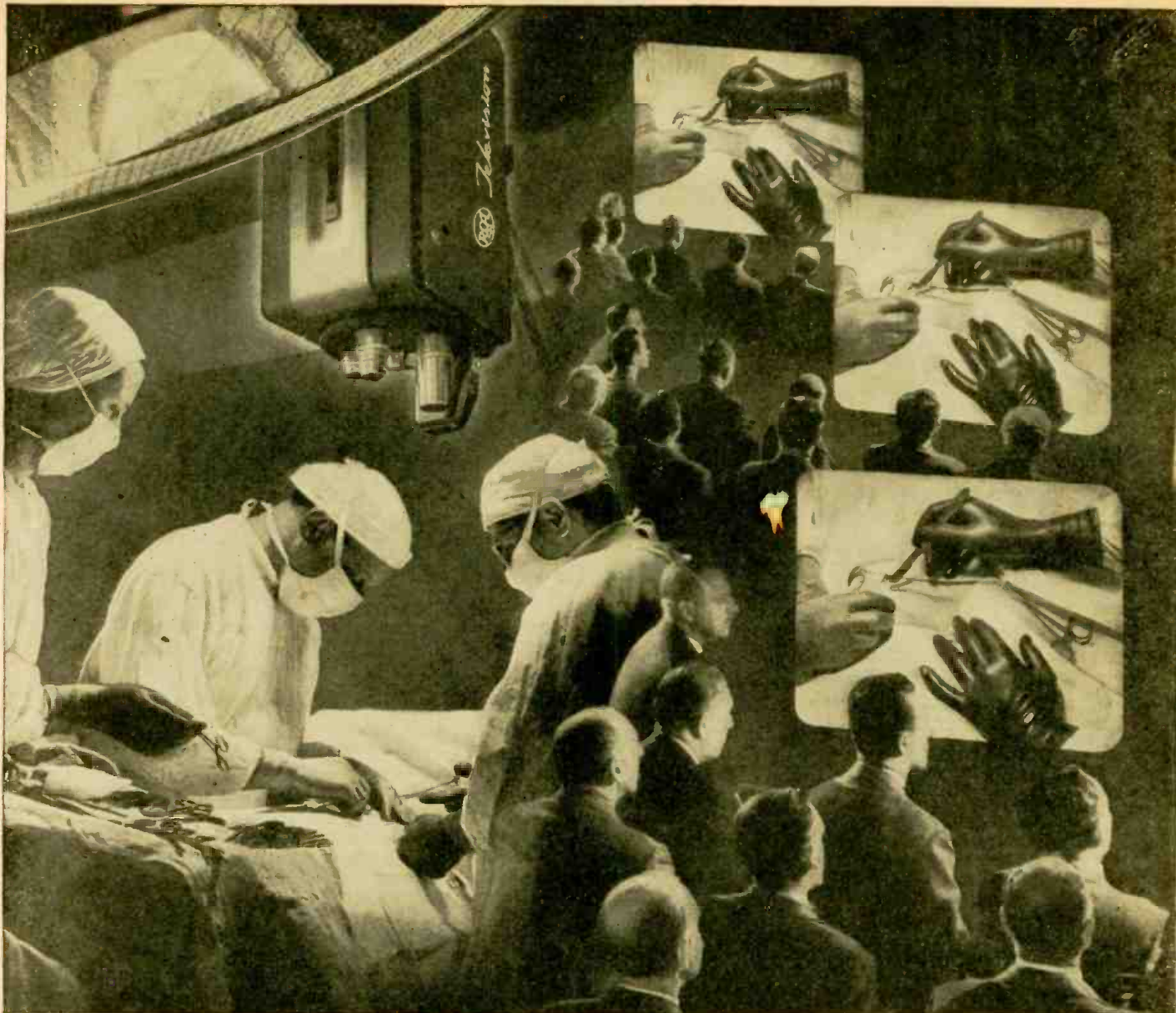

Successful telecasts of surgical operations show value of television to medical education.

## ***"Step up beside the surgeon—and watch"***

Not long ago, a radio beam flashed across the New York sky—and "carried" more than 7000 surgeons into an operating room . . .

Impossible? It was done by television, when RCA demonstrated—to a congress of surgeons—how effective this medium can be in teaching surgery.

In a New York hospital, above an operating table, a supersensitive RCA Image Orthicon television camera televised a series of operations. Lighting was normal. Images were transmitted on a narrow,

line-of-sight beam . . . As the pictures were seen the operating surgeons were heard explaining their techniques . . .

The beam was picked up at a mid-town hotel—carried to RCA Victor television receivers. And on the video screens, visiting surgeons followed each delicate step of surgical procedure. Action was sharp and clear. Each surgeon was as "close-up" as if he were actually beside the operating table.

Said a prominent surgeon: "Television as a way of teaching surgery sur-

passes anything we have ever had . . . I never imagined it could be so effective until I actually saw it . . ."

Use of television in many fields—and surgical education is only one—grows naturally from advanced scientific thinking at RCA Laboratories. Progressive research is part of every instrument bearing the names RCA or RCA Victor.

When in Radio City, New York, be sure to see the radio and electronic wonders at RCA Exhibition Hall, 36 West 49th St. Free admission. Radio Corporation of America, RCA Building, New York 20, N. Y.



**RADIO CORPORATION of AMERICA**

# RADIO IN THE NEXT WAR

*We Must Prepare Efficient Defenses, NOW . . .*

By HUGO GERNSBACK

**O**NCE AGAIN it becomes my unpleasant duty to speak of a coming war—the third time in my life.

Two and a half years after the end of World War II, we find ourselves far from peace—and we are drifting further away from it every day. I abhor war and all that goes with it as much as any lover of peace, but I do believe that when the storm signals are flying—and they are flying unmistakably today—we should heed them and prepare NOW.

Perhaps I can do no better than quote some of my former remarks on the subject. The following are excerpts from my editorial entitled "Short Waves and the Next War," in SHORT WAVE CRAFT, October, 1934 issue (five years before World War II):

It is not pleasant to talk about the next war, but all authorities are pretty well agreed upon the fact that war is with us to stay and that, for many thousands of years to come, war will be with us. The next large conflict is probably not so far away as many think, and it behooves us, in view of the circumstances, to look ahead a bit and see where short waves will fit in during the next struggle. In 1912, several years before the 1st World War started, I found it necessary to talk in a similar vein, and I was then mindful of the radio amateur and how he would fit in with the then coming struggle.

In the World War (I), short waves, as such, were not very well understood. Signalling was crude because the vacuum tube was still imperfect, and radio was not the precise science that it is today.

In the future war, short waves will play a tremendous role—especially microwaves which can be directed like a searchlight.

It will become possible for armies to be in constant touch with each other without the enemy being able to overhear the signals, for by means of reflectors the waves will be directed, so that the signals cannot possibly go over into the enemy's camp. These microwaves, also called "centimeter" waves, are of utmost importance for communication . . .

A year later also in SHORT WAVE CRAFT, November, 1935, under the heading of: "Short Waves and War," I said:

The next war will see profound changes in all branches of warfare and one of the most interesting ones will no doubt be that involving the instrumentality of short waves. SHORT WAVE CRAFT has repeatedly chronicled the latest inventions used in conjunction with short waves. These microwaves appear to pierce fog and even clouds, and work along optical lines. It will be impossible hereafter for an airplane to hide in the fog and even behind clouds, because the "mystery wave" directed against it is reflected down to earth where it is used for recording or alarm purposes.

A city, during the next war, will easily be protected

against unheralded enemy aircraft by having a barrage of such microwaves surrounding the entire city, the action being automatic in such a manner that automatic recording instruments will immediately sound the alarm when an airplane appears overhead within the confines of the city. It will be impossible, in the future, for an enemy airplane to get through such a short-wave barrage. (*Prediction of Radar*)

For communication purposes, between Army units, exceedingly short short-waves will be used; each battalion will have its own short-wave set, which will be so small that one man can easily carry it. In this manner it will be possible to keep in touch with headquarters all the time. (*Forecast of Handie-Talkie*)

Let me say at this point, that I am one of the small minority who do NOT believe that in the next war the atom bomb will be used. My reasons for this unorthodox view are simple, and I believe logical:

The United States has the bomb. We will for many decades to come be far ahead in its development—even when others have it. A technological axiom is that once you have the know-how of a complex technical process, you will—everything being equal—stay ahead. This is even truer with the atom bomb, because its technical intricacies, processes and many other developmental phases have been kept a pretty well guarded secret.

It can be said with a fair degree of certainty that the U. S. will not use the atomic bomb first on the enemy. The enemy, knowing that we will have more powerful A-bombs than he has, and certainly more of them—due to our early start—will think twice before he uses them on us. He'd have to be far more stupid than we think he is. Few countries in history have attacked another country which was known to be stronger and better equipped.

A parallel from World War II may be apropos. Germany had vast stores of poison gas, ready to use. During the battle of England, and later during the invasion of Normandy, nothing prevented Hitler from using it. But it was never used. Why? The German war staff knew very well that England and the U. S. would have drenched every large German city with poison gas in retaliation.

The atom bomb if used first on us, would bring swift and terrible punishment to the enemy. This is one of the logical reasons why I do not believe that atom bombs will be used in the next war. There are other equally good reasons, but for the purpose of this article, we need not go into that phase.

Granted all this, we nevertheless cannot afford to dwell in a fool's paradise. A city with the best imaginable fire department cannot afford to neglect its far distant water supply—without it the best fire-fighting force is impotent. (*Continued on page 64*)

# RADIO-ELECTRONICS

**PRESENTATION** of a silver plaque "to the man whose work has most benefited the radio technician in 1947" was made to Howard W. Sams by the Federation of Radio Servicemen's Associations of Pennsylvania at their banquet January 12. The plaque was inscribed:

The Federation of Radio Servicemen's Associations of Pennsylvania Award—To Howard W. Sams in recognition of his outstanding efforts in behalf of the Radio Service Industry, 1947.

Mr. Sams, in accepting the plaque, stated that he did so in the name of the employees of the PhotoFact Service, whose co-operative endeavors had made possible what success had been achieved.

**LOW-PRICE MIDGETS** of the 1939 type came back on the market last month with the announcement of a \$9.95 radio by the Tele-tone Radio Corporation. Radio dealers and repairmen—remembering the quality and repair problems of the pre-war midgets—are inclined to be a trifle dubious about the new "boon" to radio listeners.

Enthusiasm was registered in other quarters, however. Robert R. Nathan, consulting economist, Washington, D. C., wrote Tele-tone: "your leadership in bringing on the market this product at 1939 levels is one which, if followed by other leading corporations, would help break the back of the serious and destructive inflationary spiral which has weakened our whole economy."

**AN ALLERGIC TELEVISER** trapped 3 would-be burglars in Sutton, England, a recent report states. Miss Violet Tabors, owner of the televiser, told the prosecuting magistrate her receiver was

"sensitive to metal," in the manner familiar to many American television set owners.

"The screen blurred," she told the magistrate, "and I went to the window to see if a car was passing. There were three men trying to break into the window with an iron bar."

**DR. E. F. W. ALEXANDERSON**, one of America's greatest electrical engineers and inventors, retired on January 1 after 45 years with the General Electric Co. Among his various inventions, on which he holds 309 patents, are the famed Alexanderson alternator, multiple-tuned antenna, radiophone transmitter and receiver systems and a.c. rectifiers and frequency converters.

Dr. Alexanderson was born in Upsala, Sweden, in 1878, and came to this country about the turn of the century. He has received degrees from both American and Swedish universities.

**BROADCAST RECEIVERS** in the United States now total 73 million, or one for every 1.9 persons in the country, the Federal Communications Commission estimated last month on the basis of information from the radio manufacturing industry.

Radio and television set production by RMA member companies totalled 1,705,918 sets in December, according to that association's regular release. This brings the year's total to 17,695,677. Of this figure, 149,000 were television sets and 983,000 FM-AM receivers.

facsimile very soon were the New York *Times* and *Herald Tribune*.

**RECEPTION REPORTS** on American FM and other high-frequency radio stations in Australia were confirmed last month by the arrival of complete reports. These, together with photographs of the equipment, were released by the Australian News and Information Bureau.

The shortwave super-dx listener is Mr. Frank Graham, of Rosanna, a suburb of Melbourne. Since September 1946 he has logged more than 200 stations, mostly between 30 and 40 mc. The best periods for reception were from September to early December and in March and April. Stations included police, forestry and fire department transmitters and special emergency apparatus. About half the stations heard were on FM.

The set is a home-built 15-tube AM-FM receiver using American tubes throughout. Intermediate frequency is 5 mc, and the oscillator is tuned on the high side of the signal frequency. FM deviation is approximately 40 kc. All coils, including the i.f.'s, were home-wound, and plug-in tuning coils were used.

No special antenna is used for the v.h.f. bands. At present an L-type aerial 60 feet long is giving excellent results.



**FACSIMILE** via a radio was presented to the public as a regular newspaper service just at the turn of the year. WFIL-FM was the first on the air with a daily facsimile edition of *The Philadelphia Inquirer*.

A staff of 8 people is engaged in getting out the facsimile edition, including an editor and assistant editor, a writer, an artist, a copy boy, and 3 operators of the special typewriters used to produce the evenly-spaced columns required for newspaper work.

The *Inquirer* is said to have got on the air just ahead of the *Miami Herald*, which was rushing a facsimile edition to completion. Others expected to come out with



The record-breaking home-built FM receiver.

**NEXT PRESIDENT** must be telegenic, stated David Sarnoff, head of RCA, in his annual report on the state of television and radio. Mr. Sarnoff said:

"Television is likely to do more to revolutionize politics than sound broadcasting did. Political candidates may have to adopt new techniques to benefit from visual radio; their dress, their smiles and gestures, all will be important. How they look, as well as what they say, may determine to an appreciable extent their popularity. The eyes of the public will be upon them."

# MONTHLY REVIEW

**FRANK E. BUTLER**, radio engineer and inventor, and former associate of Dr. Lee de Forest, died January 6 at Toledo, Ohio, at the age of 70.

Mr. Butler was born in Monroeville, Ohio, only a few miles from the place where Thomas Edison was born. At the age of 15, he started his career as telegraph operator with what is now the New York Central Railroad. He met Dr. de Forest in 1904 and was his chief assistant for many years afterward.

In 1908, Mr. Butler organized the American Wireless Institute, the first school in the United States to teach wireless engineering and which was the forerunner of the RCA Institute. Dr. Lee de Forest said of him:

"He was one of the early pioneers in radio and deserves a great deal of



credit. He understood the principles of radio very thoroughly and was a crackerjack telegraph operator. He did very, very fine work, and for some years was my right-hand man.

"He was with me later in New York at the time we put the grid in the audion tube.

"In later years he had kept up remarkably with the developments of radio and written many fine articles, both technical and popular. His passing is sad news."

**R A D A R IMPROVEMENTS** now make it possible to record the speed of a bullet while it is still inside the barrel of a gun, Signal Corps scientists revealed last month. In addition, they say, it is now possible to detect the slightest movement of any object.

This new refinement of radar will enable soldiers to detect the position of artillery firing on them, and to pick out a moving tank from the "clutter" of motionless objects on the radar screen.

**RADIO EQUIPPED** new cars will increase in number to approximately 84% in 1948, a big gain since the last prewar year, Frank W. Mansfield of Sylvania Electric Products, Inc., stated last month. During 1947, he continued, auto radio production hit a new high of approximately 2,860,000 units, a gain of approximately 265,000 over the previous 1941 record.

Production of auto sets is divided between about five major producers who make approximately 90% of all sets. Almost all auto radios produced are sold to auto makers, Mansfield reported, stating that the industry produced 780,000 units in 1934; 1,750,000 in 1937; and 2,600,000 in 1941.

**RADIO REPAIR** complaints have "increased sharply" in some areas, the Research Institute of America revealed last month. In other areas, complaints "continue high." According to a survey conducted by the Institute, reports from Better Business Bureaus throughout the country indicate an unsatisfactory state of affairs in radio servicing, and the Bureau in Pittsburgh has gone so far as to institute an independent survey of its own, results of which are expected to be "interesting and probably alarming."

Reports of the survey printed in the New York *Radio Daily* added the information that the Associated Radio Servicemen of New York City had established a complaint department to check up on all customer complaints and correct any abuses that might be found on investigation.

**PREDICTIONS** that radioactive isotopes will provide a cure for cancer in the near future were discounted last month by Dr. Carl F. Cori, co-winner of the Nobel prize in medicine for 1947. He branded such statements as "entirely unjustified, and even wicked, because they raise false hopes."

Dr. Cori's statement was made on the eve of his departure for Stockholm to receive the half of the 1947 cash award granted jointly to him and his wife. The amount is approximately \$24,376. The other half goes to Dr. Bernardo Alberto Houssay of Buenos Aires.

**THREE-YEAR LICENSES** for FM stations were urged in a letter from the FM Association to the FCC, secretary Bill Bailey reported last month.

FM stations were granted their 1-year licenses when only a handful of stations were operating experimentally. Today, the letter points out, there are nearly 400 FM transmitters on the air and their operation has passed the experimental stage. Licensing on a 3-year basis is standard with AM and would give FM broadcasters greater security.

**ALUMINUM WIRE** is likely to increase greatly in popularity in the next few years, the American Society of Agricultural Engineers was told last month. Wartime improvements in manufacture and use of aluminum and the increase in price of copper wire were given as reasons.

Aluminum wire is half as expensive as copper, and its light weight makes it especially desirable for many applications. Its conductivity is lower—it has a specific resistance of approximately 17 as compared with 10.4 for copper—but its lighter weight permits running larger conductors.

U.S. RADIO STATIONS JAN. 15, 1948

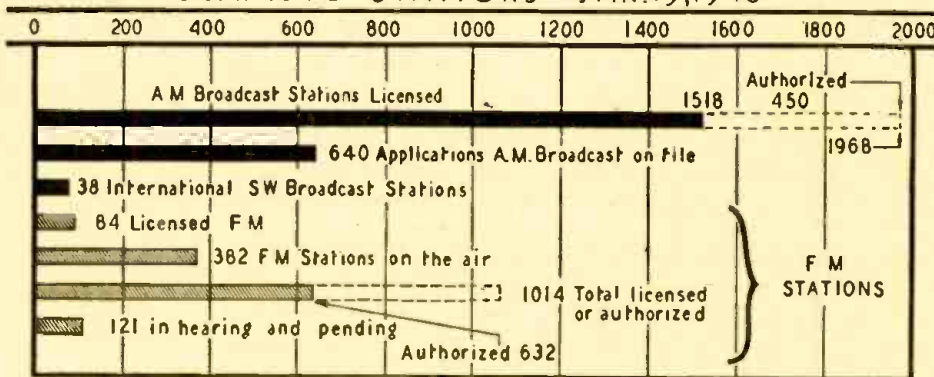

TELEVISION STATIONS

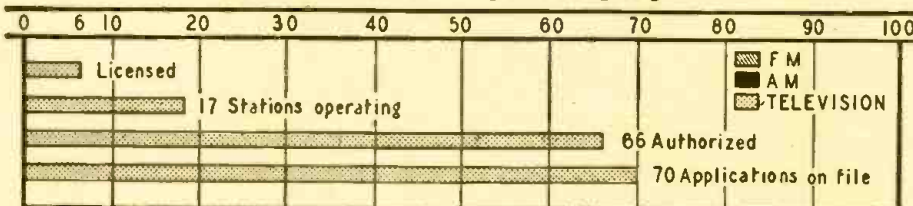

Chart above shows the new high to which the number of U. S. AM, FM and television stations has risen. Besides those shown there are over 30,000 radio-equipped police cars and an ever-growing number of mobile installations in taxis, trucks and other privately-owned vehicles. Educational stations are also at an all-time high, with 32 AM and 38 FM licenses.

# A DE LUXE AMATEUR TRANSMITTER

This dual high-power rig can be built in sections

By JOHN WONSOWICZ, W9DUT,

and

HERBERT S. BRIER, W9EGQ



Operating position. Cabinet under lamp holds speech amplifier, monitor and remote switches.

2 bands between 3.5 and 29.7 mc are instantly available. The 14-mc output is identical from either unit.

Change-over from phone to c.w. is controlled by plugging the key into either key jack. Removing the key closes the keyed circuit and, through a relay, unshorts the modulation transformer, turns on the modulator power supply, and indicates that the modulator is on by lighting the class-B meter.

## The driver unit

The dual exciter (Fig. 1) is built first. Its chassis is spaced 2 inches back and 1½ inches up from the bottom of the panel. The controls on the bottom row, proceeding from either end toward the center, are key jack, 6L6-G plate condenser crystal switch, and in the center, the unit selector switch. They can be seen on the panel in the transmitter. Directly above the 6L6-G controls are the 807 tank condenser dials, and above them the pilot lights that indicate which r.f. unit is in operation. Between the dials is the meter selector switch.

On the chassis the 807's are mounted 6½ inches in from either end along the center line of the chassis, and the 6L6-G's are 2½ inches ahead of them. The oscillator coil sockets are in the front corners. A blank socket is mounted behind them to accommodate the unused oscillator coil. (These shielded coils may be replaced with commercial unshielded ones as listed in the coil table, if desired.)

Directly behind the 807's are their tank coils, and beside the coils are the tuning condensers. Between the 6L6-G's, 5 octal tube sockets are mounted to accommodate 10 of the new-type crystals —5 to each unit.

R11, a heavy-duty potentiometer,

**B**ASICALLY, this transmitter consists of 2 r.f. units with common power supplies and modulator in one cabinet. Its nominal input of 250 watts can be varied between 15 and 450 watts with a Varitran in the primary of the power amplifier power supply, and any 2 frequencies between 3.5 and 29.7 megacycles are instantly available at the flip of a switch.

Such a transmitter cannot be built overnight, and does cost quite a bit of money, but fortunately it may be constructed a unit at a time. For example,

one exciter (Fig. 1), and the exciter power supply (Fig. 2), may be used as a complete 50- to 75-watt c.w. transmitter. Adding a power amplifier and high-voltage power supply (Figs. 3 and 4), will make a 450-watt c.w. transmitter. Still later the modulator and its power supply (Fig. 5), may be added, and finally the duplicate r.f. section, which is identical with the one shown, except that other coils may be used.

Except for tuned circuit values, and 35T's in one amplifier and T40's in the other, the r.f. units are exactly the same. Their frequency ranges overlap on 7, 14, and 21 mc; so any

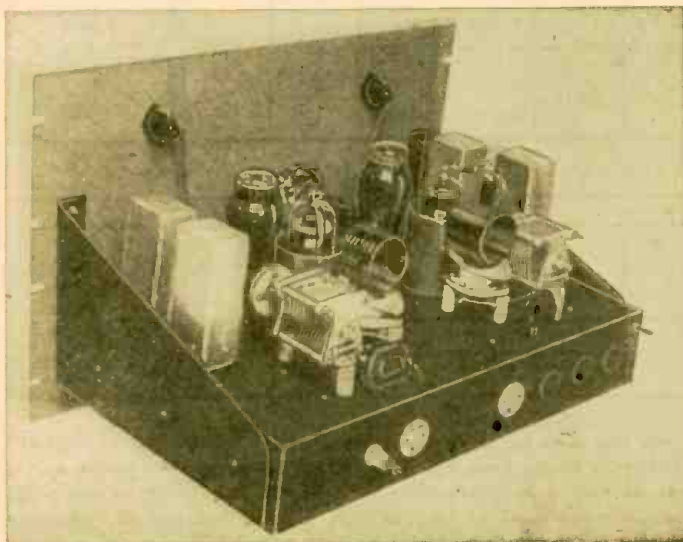

Rear view of dual exciter. Either unit is a 50-75-watt transmitter.

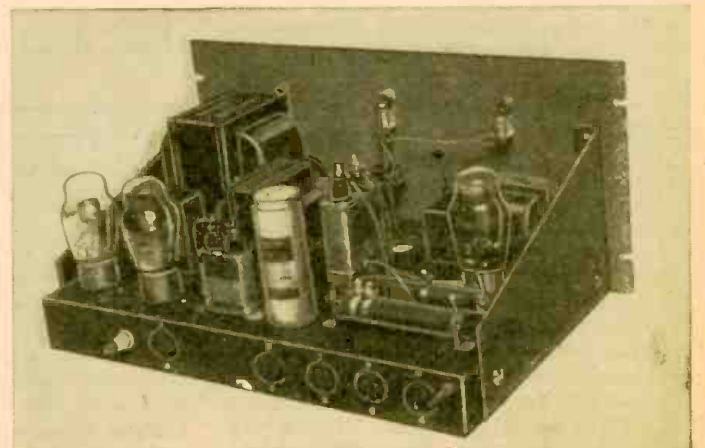

Power supply for the exciters also contains the bias supply unit.

which controls the screen voltage on the 807's, was added after the pictures of the individual stages were taken, but its knob can be clearly seen at the extreme left of the exciter chassis in the rear view of the transmitter.

Wiring is straightforward, and a close study of the diagram and photographs will make detailed instructions unnecessary. After wiring is completed, the exciter is placed to one side while the exciter power supply (Fig. 2) is constructed. No particular parts layout is necessary, and the picture shows the one used here. If the exciter is to be used temporarily as a complete transmitter, the bias pack on the right of the picture need not be constructed yet.

### Starting up the transmitter

Plug in the key and turn R11 to the minimum voltage position. Set the oscillator voltage divider approximately one-quarter of the way from the high-voltage end of the resistor. Connect the milliammeter and turn the meter switch to read the oscillator plate current, turn on the exciter power supply, press the key, and quickly resonate the oscillator plate condenser as indicated by a sharp dip in its plate current. Next switch the meter to read the 807 plate current, press the key again, and resonate the 807 plate circuit.

To prevent damage to the screen grid, connect a 40- or 50-watt, 120-volt bulb across the output terminals as soon as the stage has been resonated. Now switch the meter to the 807 grid circuit, and adjust the grid current to between 2 and 5 ma by varying the capacitance of C6 and the oscillator plate voltage. These adjustments are most critical on 28 mc, where the oscillator is quadrupling from 7-mc crystals and its output is the least. It may be necessary to adjust for optimum output on this band, and detune the 6L6-G plate condenser a trifle on other bands to reduce the grid current to the correct amount. Afterward excitation is adjusted by tuning the 6L6-G plate condenser for maximum output from the 807.

With a plate voltage of 600, a screen voltage of approximately 250, and a plate current of 100 ma, the output will be approximately 40 watts; and at 750 volts, it is approximately 50 watts. Now remove the dummy load and connect the link to the antenna (tuner) or to the final amplifier grid circuit and retune C5 for minimum plate current. When feeding an antenna, the 807 plate current can be adjusted to 100 ma; but when driving the amplifiers, 50 to 70 ma is sufficient.

Fig. 3, the diagram of the amplifiers, shows the conventional push-pull triode circuit chosen for its foolproof, efficient operation. The chassis is mounted 1 inch up from the bottom of the panel, and the pictures show the parts layout clearly. Keeping the grid circuits under the chassis makes the shielding between the input and output circuits complete and helps prevent instability. The coil sockets are mounted on their condensers with pieces of aluminum bent to shape in a small vise. The final tank con-

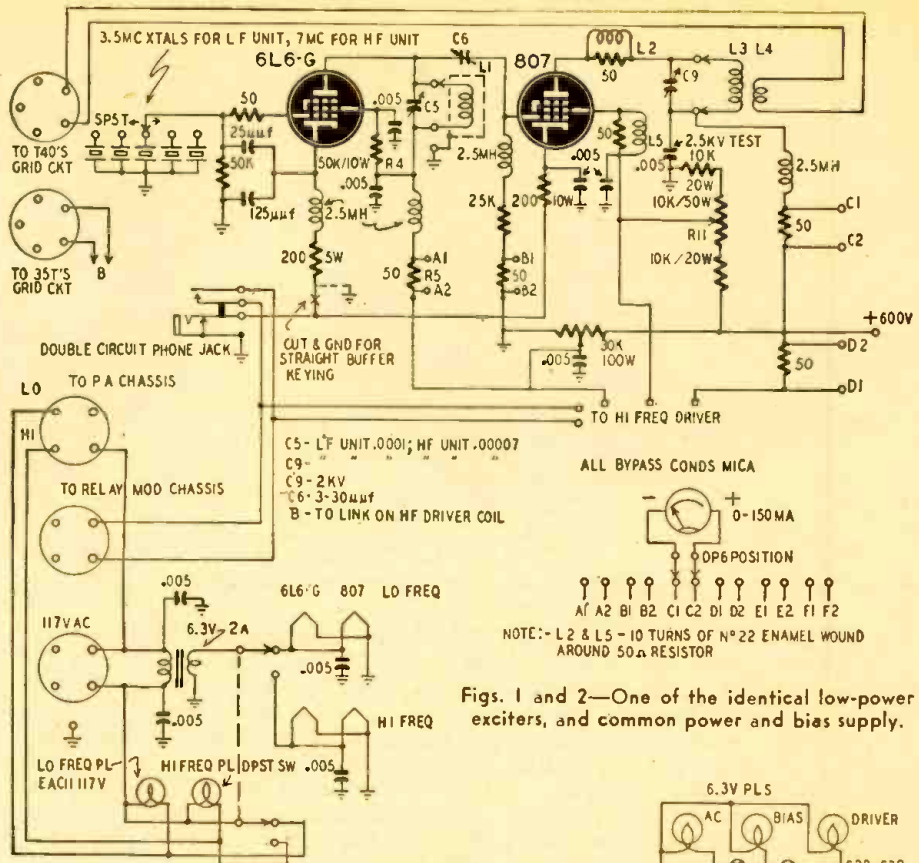

Figs. 1 and 2—One of the identical low-power exciters, and common power and bias supply.

densers are mounted on small standoff insulators, and their shafts are cut off short and coupled to the dials with good insulated couplings. This is important, because the full plate voltage appears on the rotors of these condensers.

### High-voltage power supplies

Before the amplifier can be placed in operation the high-voltage power supply (Fig. 4) and the bias supply (Fig. 2) must be constructed. Without the Varitran the power supply is a conventional 1,250-volt, 300-ma supply. With it the voltage can be varied between 15 and 1,500 volts. The Varitran, mounted so its control is centrally located on the panel, determines the arrangement of the remaining components shown in the picture. The filter condensers do not appear in the picture because they are underneath the chassis. Switches S1 and S2, or the remote switches connected across them, control the entire transmitter in normal operation. S1 controls the filaments, and S2 the plate voltages.

The bias pack (part of Fig. 2) is conventional. It is adjusted by temporarily connecting a milliammeter in series with the bleeder and setting the shorting slider until the current flowing through it is the rated current of the transformer used—100 ma in this supply. Then the other sliders are set to approximately 120 volts, negative. In this supply, voltage across the bleeder is 250, the total resistance in use 2,500 ohms, and the taps are near the center of the resistor.

Connect the amplifier input link to the output link of the exciter, with 500 or 600 volts on the 807. With the filaments and bias supply on, but with the high-voltage lead disconnected, tune the grid condenser and the 807 plate condenser

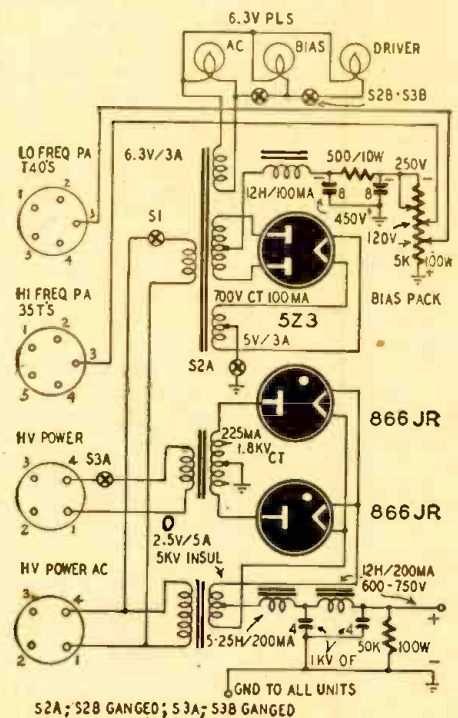

for maximum grid current (50 ma or more). Adjust the neutralizing condensers in small steps until all reaction of plate tuning on grid current is removed, after which they may be locked. Do not worry if the tubes neutralize with slightly different capacitances in the neutralizing condensers; although if the difference exceeds 10%, check for unbalance in the wiring.

After neutralization is completed, connect the high-voltage lead, tune the output circuit to resonance at low voltage, and connect a pair of 150-watt bulbs in series to the output link. With the coupling set for 300 ma of plate current at the maximum plate voltage, corresponding to 450 watts input, the bulbs will light to full brilliancy. (The plate

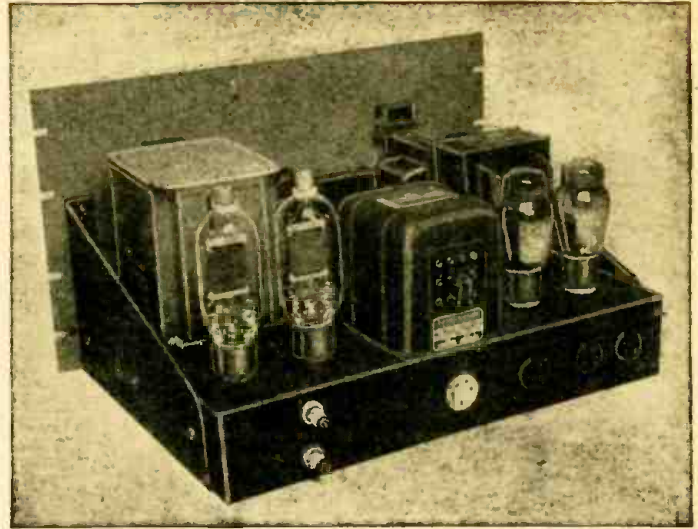
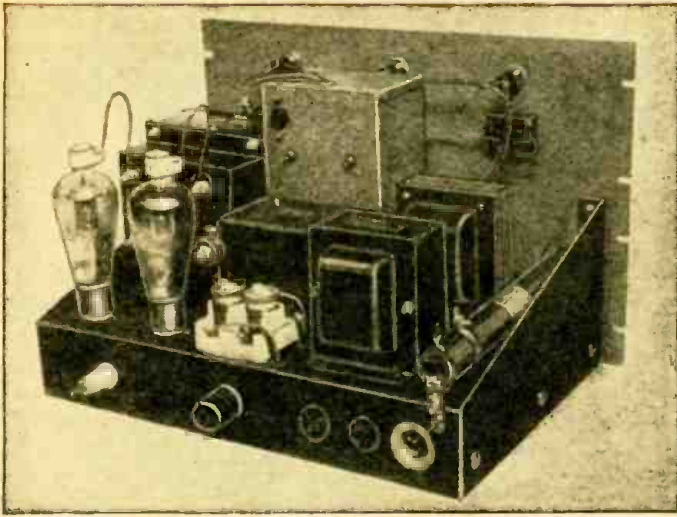

Left—High-voltage power supply. Varitran at center. Right—Modulator and its power supply.

meter reads plate and grid currents; so the grid current must be subtracted from the total to give the true plate current.) The loaded grid current should be not less than 40 ma, nor more than 70 ma, and is regulated with R11 and by moving the links in the grid coils.

The modulator and its power supply and the glass-enclosed meter panel complete the transmitter. Although TZ40's are rated at approximately 100 watts audio output at 750 volts, and the modulation transformer at 115 watts, checks with an oscilloscope show that over 300 watts input can be modulated without excessive distortion. Taps on the modulation transformer were chosen to match the 6,000-ohm plate-to-plate impedance of the TZ40's to a 5,000-ohm load.

It is possible to obtain the desired 250 watts phone input with an infinite number of combinations of current and voltage. For example, it might be 1,250 volts at 200 ma, or 1,000 volts at 250 ma, etc. Obviously, it would be very inconvenient to be constantly changing

the taps on the modulation transformer; so one ratio is chosen and stuck to.

The following method works well: the input is set to the maximum c.w. ratings of push-pull TZ40's, 1,500 volts at 300 ma, equivalent to 5,000 ohms. Naturally, the transmitter is not operated like this on phone, but reducing the plate voltage with the Varitran reduces the plate current in the same ratio, keeping the load impedance unchanged. Reducing the Varitran from the maximum position until the plate current is 225 ma drops the plate voltage to 1,125 volts, and the input to the desired 250 watts. Plugging in the key and running the Varitran back to maximum immediately gives the maximum c.w. input.

Any speech amplifier capable of giving 5 watts of good quality audio may be used to drive the modulators. The one used here has push-pull 2A3's in the output.

No antenna tuning unit was incorporated in the transmitter proper, because doublet antennas are used on 4 and 14 mc, the most used frequencies. (Continued on page 74)

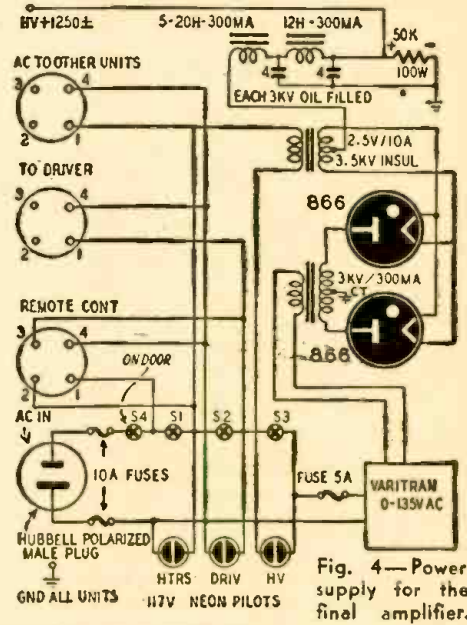
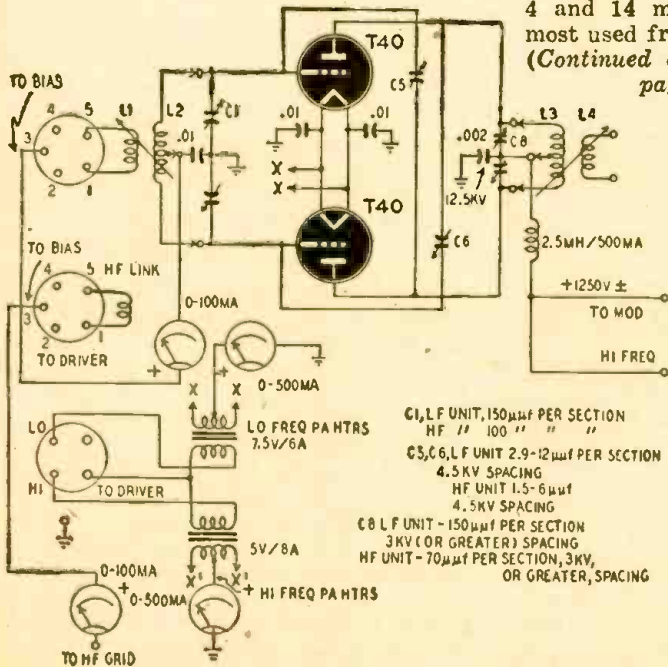
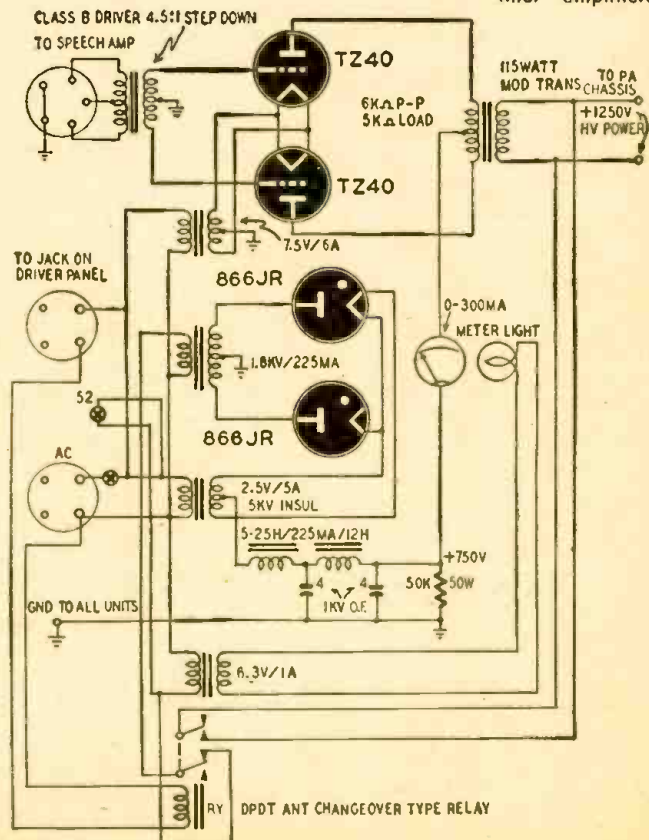

Fig. 4—Power supply for the final amplifier.





# All-Voltage Power Pack

By MARTIN A. WEINER

**Independent voltages from 0 to 600 and 0 to 80 are supplied by this unit**

**A** VARIABLE d.c. power supply will be found one of the most useful instruments on a workbench. Although the primary use of the author's equipment is to supply power for various pieces of equipment, a multitude of other uses will undoubtedly suggest themselves. The following voltages and currents are available:

**D.c. outputs:**

1. Variable 0-600 volts, current to 200 ma
2. Variable 0-600 volts, current to 100 ma
3. Variable bias 0-80 volts, current to 25 ma

**A.c. outputs:**

1. 6.3 volts @ 6 amp, 6.3 volts @ 5 amp
2. 2.5 volts @ 20 amp, 2.5 volts @ 20 amp

The hookup is shown in Fig. 1. A unique circuit using small wire-wound potentiometers as controls enables the instrument to supply variable voltages. Varying the grid voltages of the 6L6's, which act as voltage-dropping resistors varies the output voltages (see Fig. 2). The cathodes of the 6L6's are at the potential of the junctions of the 2,000- and 7,000-ohm resistors. The arms of the 10,000-ohm potentiometers vary the grid voltages from a negative to a (smaller) positive value, thus regulating the output voltages.

The B-plus control also regulates the secondary B-plus output. When a load is connected to the secondary B-plus, either control acts as vernier. Under no load, B-plus can be varied from 300 to 600 volts. With the B-plus control at the maximum position, the secondary B-plus can be varied from 200 to 600 volts. With the B-plus control in the minimum position, the secondary B-plus can be varied from 0 to 300 volts. Under load, B-plus can supply a maximum of 400 volts at 200 ma. The secondary B-plus should not supply more than 100 ma; the B-plus and secondary B-plus should not supply more than 200 ma total.

Since the filaments of the 6L6's must not be more than 90 volts positive with respect to their cathodes, a 2-winding filament transformer T2 is used. If the transformer has no center taps, one side of the filaments should be connected to the cathodes.

The biasing systems for the 6L6's require transformers with 110-volt outputs. For this purpose 6.3-volt, 1.2-ampere filament transformers T3 and T4 are used in an unconventional manner; that is, the conventional secondaries (6.3-volt windings) are used as pri-

maries and are connected to the secondaries of T2, which supply filament power for the 6L6's. The conventional 110-volt primary windings become 110-volt secondaries and are connected to the selenium rectifiers and R-C filters which deliver the d.c. biasing voltages for the 6L6's.

The bias voltage output, variable from 0 to 80 volts, is produced by T5, the selenium rectifier, and the double section  $\pi$  filter. T5 is connected like T3 and T4. The divider network is composed of a series of resistors across the entire network (J1 to J5). Voltages of from 0 to 80 are obtained by varying P3. The divider resistors supply from 0 to 40

volts (J1 to J3) and 0 to 10 volts (J1 to J2). This network may be used also for purposes such as checking meters, since from J2 to common positive J1 it is impossible to draw more than 1.2 ma; from J3, 4 ma; and from J4, 8 ma. Switch S4 grounds the common positive J1 for use as a conventional bias. With it open, the system may be used at a potential other than ground.

**The protective relays**

Fig. 3 shows the overload protection and starting circuits. The unit can warm up and become stabilized without the application of any voltage to an external (Continued on page 72)

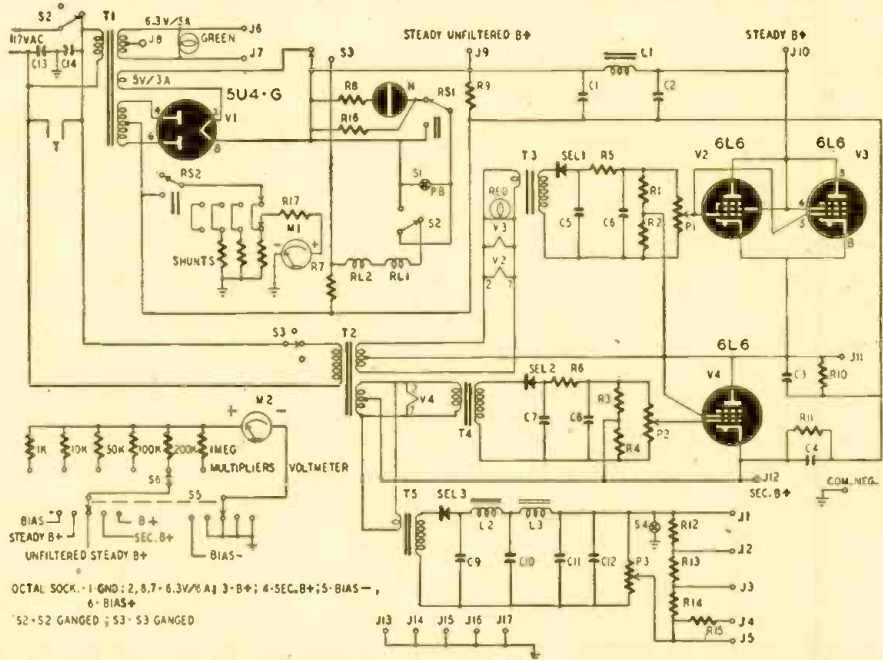
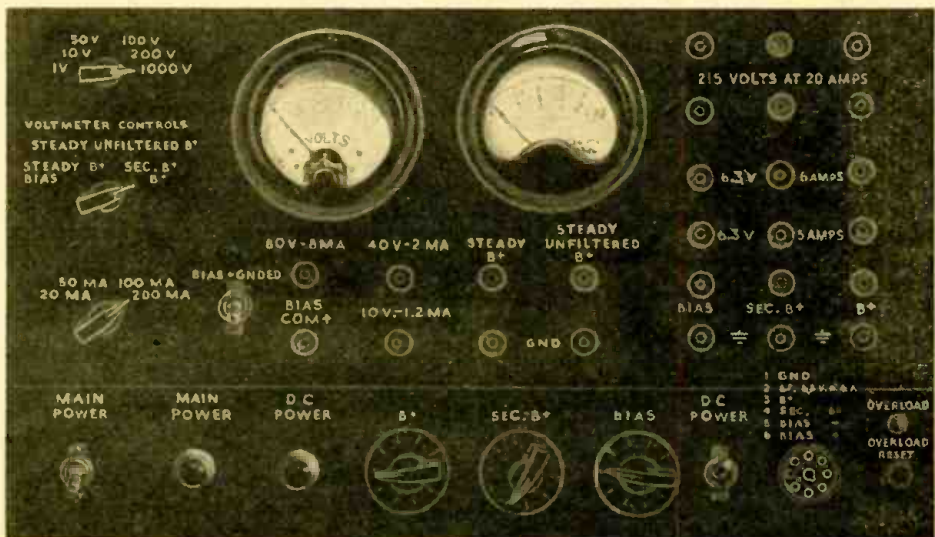
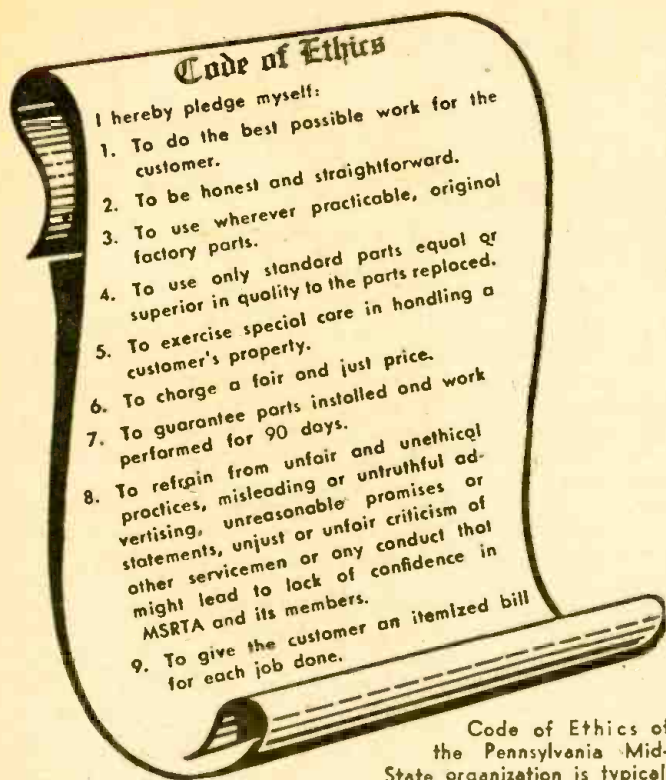

Fig. 1—Schematic of the regulated power supply. Parts list is printed at end of article.



Front view of the unit, with all controls and outputs marked. Meter at right reads milliamps.



Code of Ethics of the Pennsylvania Mid-State organization is typical.

**A**N event which radio technicians may look back upon as the most important occurrence in the history of American radio servicing took place in Philadelphia, January 11, 12 and 13, 1948. That event was the *Town Meeting of Radio Technicians*, a convention of radio repairmen sponsored by a joint committee of manufacturing and servicing groups. Prominent among the former were the Radio Manufacturers Association and the National Electronic Distributors Association; among the latter, the Federation of Radio Servicemen's Associations of Pennsylvania (FRSAP) and the Philadelphia Radio Servicemen's Association (PR SMA).

The meeting was held because both service technicians and manufacturing interests found improvement in both the commercial and technical and commercial status of the radio repairman necessary to the industry's welfare. The local

found themselves face to face with television and FM without sufficient preparation. Manufacturer and distributor were equally concerned. To sell radios, it must be possible to assure the owner that they can be kept in good working order, and it was already becoming apparent that lack of technical knowledge of FM, television and high-frequency theory, circuits and equipment hampered the technician seriously in his work.

#### How it started

A series of forums was planned in which information would be given on both the technical and business angles of radio repair. Philadelphia was chosen as the initial city. Its well-organized radio technicians association provided means to contact repairmen in the area and assured at least partial success. Lessons learned at Philadelphia could then be applied to the rest of the country.

# New Day Dawns For Servicemen

## Philadelphia meeting points way to vast gains in radio technicians' economic and technical status

technicians had been left behind as radio progressed during the war. Repairing the war-worn broadcast receiver and substituting unavailable parts had taken all their time and ingenuity, and they

A few days before the meeting, a release was sent by the Pennsylvania federation to all persons on its mailing list. It announced that the FRSAP would hold its first annual convention at the same time as the Town Meeting, and urged "all radio technicians who are interested in furthering their welfare and that of their members to have representatives present at both the Convention and Town Meeting sessions." The appeal was primarily intended for Federation members, but reached a number of organizations outside the state who had been in touch with the Philadelphia association for information and advice.

The response to the circular astounded the authors. Regularly-elected delegates were sent by radiomen's associations from Rhode Island to Maryland, and west from points within range of Chicago's television stations! The representative from South Bend, Indiana, was flown in to make sure he would arrive in time for the first session.

It soon became apparent that the most important work of the Philadelphia meeting was the formation of this group of association delegates as a nucleus for the organization of radio technicians throughout the country. The delegates accepted their responsibility almost

(Continued on page 78)



The movement for national organization was born at this meeting of delegates and technicians held in Philadelphia, January 11, 1948.

# RECORD PLAYERS

## Rate Good Treatment

By H. LEEPER

A portable record or transcription player of the type illustrated will give much better service if certain precautions are taken. This type of equipment plays records at speeds of either 78 or 33 1/3 r.p.m. The speaker is located in a detachable cover. A microphone with provision for plugging into the built-in amplifier is supplied.

Most ordinary troubles may be eliminated by following the instructions below:

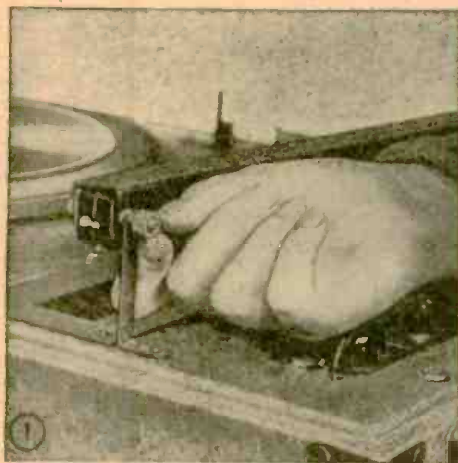

PHOTO 1.—In transporting, make sure the pickup arm is secured to its rest. In the model shown, tighten the thumbscrew provided to hold the arm in position. Other record players have similar means for protecting the pickup arm.



PHOTO 2.—When playing records, tighten the thumbscrew down against the arm itself. If it is loose, rattling or foreign noises may be heard because of its vibration.

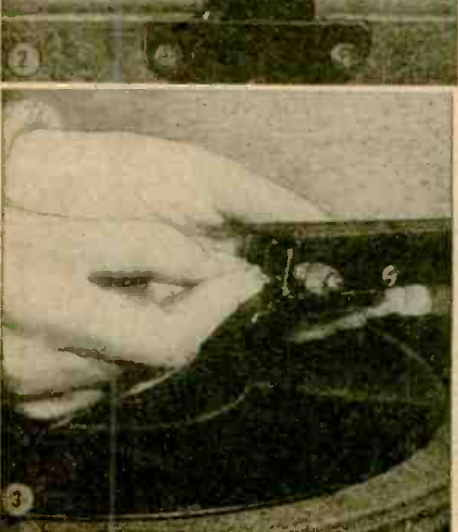

PHOTO 3.—Make sure the stylus or needle is secure in the pickup. A sapphire stylus, which is generally used, will last a long time if kept tight and not handled roughly.

PHOTO 4.—Change the speed selector according to the maker's instructions, but do not leave the lever midway between the 2 speed indicators. Doing this may damage the equipment. Some makers advise changing speeds only when the motor is running.

PHOTO 5.—Keep all papers away from the ventilator over the tubes. This ventilator permits heat from the tubes, and equipment to escape from case.

PHOTO 6.—Before closing the case for transporting, check threaded locking ring on microphone base. Make sure it is tight so that the microphone will be held in place without damage.

PHOTO 7.—When assembling the microphone for use, tighten locking ring to handle attached to the cable. The contact prongs alone might hold the assembly together for a time, but sooner or later the microphone will fall off and be damaged unless it is locked in position.

PHOTO 8.—To avoid damaging the connections when removing the microphone plug from amplifier jack, pull on the metal phone plug only and NOT on the cable.

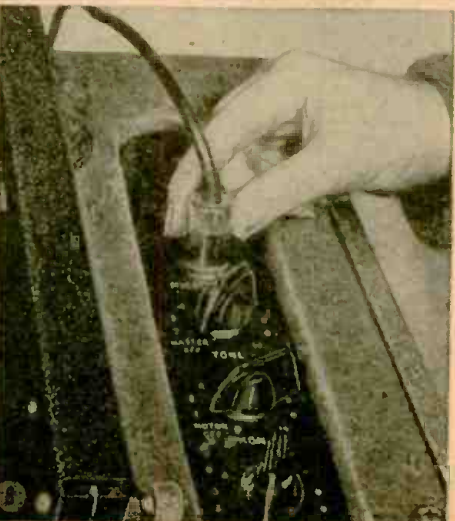



# String Music Pickup

An Easily-detachable Magnetic Unit

By R. L. PARMENTER

**T**HIS guitar pickup reproduces faithfully the sound of any steel-stringed instrument. It is held to the instrument by suction cups—obtainable at automobile accessory stores—and can be attached or taken off readily. Since it depends on the magnetic principle and not on sound vibrations, the quality of reproduction does not depend on the original instrument.

The unit is built around a piece of Alnico V magnet which is now available from many sources. The size used was  $3/16 \times 5/16 \times 2\text{-}3/8$  inches. It was pre-magnetized and polished on one narrow face. The length of the magnet is important since it must span the strings of the instrument. This  $2\text{-}3/8$ -inch length is suitable for a 6-string guitar; for a tenor guitar, which uses only 4 strings, a shorter magnet would be better.

The magnet in this case was magnetized longitudinally. While this caused some attenuation on the 2 middle (D and G) strings, it had the desirable result of building up the strength of the tones produced by the outside ones. Since the melody is usually carried by the 2 highest (B and E) strings, this was quite satisfactory; and some unusual effects in bass runs may be achieved by this build-up in bass (E- and A-string) response. If it is possible for the builder to obtain a magnet which is magnetized across the  $3/16$ -inch face, some other interesting results might be achieved.

If an already magnetized magnet is unobtainable, the builder may magnetize his magnet preferably by using a heavy-duty magnetizer in the local garage. Or a homemade magnetizer powered by a storage battery may be constructed to do the work.

## Constructing the coil

The coil form of thin fiber is glued with coil cement and made to fit the magnet slug used. Dimensions of the author's unit appear in Fig. 1. When this form has dried, remove the magnet and replace it with a small piece of wood or bakelite drilled in the center to ac-

commodate a 1-inch 6-32 machine screw. By chucking this assembly in a hand drill it is easy to wind the wire. The coil form is scramble-wound with No. 32 enameled wire. Two short lengths of flexible wire are soldered to the ends of the winding to facilitate making connections.

This winding has a d.c. resistance of approximately 30 ohms. The output will be greater if the builder can wind on more turns of smaller wire. But it is difficult to wind wire smaller than No. 36.

(By winding the coil in a suitable jig, it should be possible to use No. 36, 37, or even finer wire. If heavier wire is used, a step-up transformer such as a 3 to 1, or higher, ratio audio transformer will increase the voltage output noticeably.—*Editor*)

The completed coil and magnet assembly is glued to a  $3/32$ -inch bakelite or fiber mounting plate. The flexible wires soldered to the winding should now be soldered to the microphone cable, the outside end of the winding going to the shield of the cable. A cable clamp attached to one of the 8-32 screws on the suction cups holds the cable to the assembly. The other end of the cable terminates in a standard phone plug, connected so that the shield will go to ground in the amplifier used. The inner conductor of the cable may be inserted directly into the grid circuit since the impedance of the winding is sufficiently high.

The suction cups holding the unit to

the sounding board of the instrument are then attached to the mounting plate with small brackets. The height of these brackets will depend upon the size of the suction cups used, allowance being made for the fact that compressing the cups will lower the assembly considerably. The unit should be as close to the strings as possible without touching them. The exact height can be adjusted by the 2 nuts on the bolts which hold the suction cups.

## The instrument amplifier

The amplifier need not be an elaborate one. A high-fidelity type is preferable, but almost any 2-stage voltage amplifier with a single output tube will do. This unit has also been used with excellent results with a phono oscillator having an extra voltage amplifier ahead of the modulator.

This pickup was tested on both Hawaiian- and Spanish-type guitars. It does not alter the characteristics of rendition. Since the Spanish guitar is essentially a rhythmic instrument, the pickup should reproduce a not too sustained tone. When using a steel guitar, a sustained tone is desired and a short snappy tone would not be suitable. This pickup fulfills those qualifications.

The experimenter can build this little gadget at nominal cost. It will electrify almost any guitar and (with a few changes) many other instruments. It may be used with any amplifier used for music amplification.

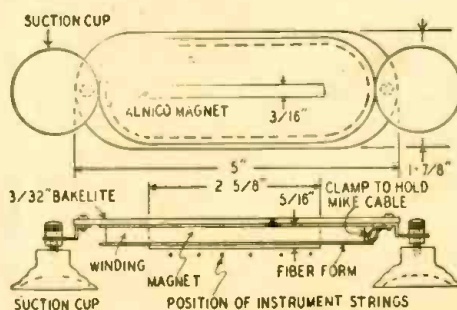

Fig. 1—Construction details of the pickup.

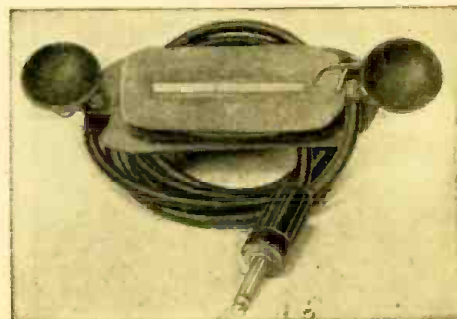

Fig. 2—Bottom view of Parmenter instrument.

# BROAD-BAND AMPLIFIERS

By R. F. SCOTT, W2PWG

**A** WIDE-BAND or video amplifier has uniform frequency response over a wide range of frequencies—from about 20 cycles or below to 6 megacycles or higher; depending on the application. Such amplifiers are commonly used in television, radar, facsimile and other circuits where complex waveforms must be passed without distortion.

Conventional resistance-coupled audio amplifiers resemble closely those designed for television or other applications which require bandwidths of several megacycles; The chief difference is that gain drops as the bandwidth is increased.

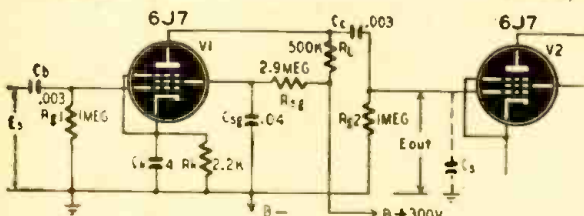

Fig. 1—Typical voltage amplifier for middle audio frequencies

Transformer coupling is not used between stages in a wide-band amplifier because it is almost impossible to design a transformer to pass such a wide range of frequencies. Triodes are seldom used. It is necessary to use tubes with high voltage gain since so much of it must be sacrificed for bandwidth.

The gain of an amplifier is its output voltage divided by the input voltage. Gain is not constant at all frequencies as will be seen.

Fig. 1 shows a typical 6J7 voltage amplifier with constants selected from a resistance-coupled amplifier chart. With these constants, the tube operates with a transconductance of 1400 micromhos. Fig. 2, the universal curve

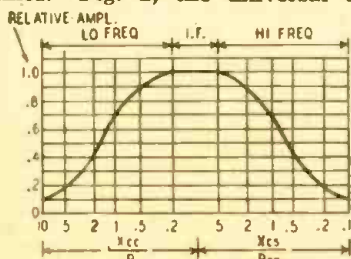

Fig. 2—Circuit capacities vs amplification.

for resistance-coupled amplifiers, shows the performance of the stage at various frequencies. Note that the curve is flat over a comparatively narrow band and then drops rather sharply at the ends. The useful limits of the amplifier extend down the ends of the curve to points where amplification is 70% that of the flat portion. The equivalent circuits of the amplifier at intermediate, low and high frequencies are shown in Figs. 3-a, 3-b and 3-c respectively.

The theoretical gain at intermediate frequencies, Gif, is

$$gm \times Req \quad (1)$$

where gm is transconductance in mhos and

$$Req = \frac{RL \times Rp \times Rg2}{RL \times Rg2 + RL \times Rp + Rg2 \times Rp} \quad (2)$$

Under these conditions, Req is the equivalent resistance formed when Rp (internal resistance), RL (plate coupling resistor) and Rg2 (grid leak of the following stage) are considered as being in parallel.

Substituting Eq. 2 for Req in Eq. 1, we find that the gain at intermediate frequencies is as shown in Example 1, on next page. This tells us that the gain is 350 over the flat portion of the curve.

But the bandwidth of the flat portion is yet to be determined.

From Fig. 2, we see that the gain of the amplifier begins to drop off on the high end when Xcs is less than 5 times Req. Xcs is the reactance of Cs. Cs is the sum of the capacitances shunting RL and Rg2:

$$Cs = Cpc + Cgc + Cgs + (G + 1) Cgp \quad (3)$$

where Cpc is plate-to-cathode capacity of V1  
Cgp is grid-to-plate capacity of V2  
Cgs is grid-to-screen grid capacity,  
Cgc grid-to-cathode capacity and G is gain of V2. Since capacitive reactance,

$$Xc = \frac{1,000,000}{6.28 \times f \times C} \quad (4)$$

where f is in megacycles and C in microfarads;

$$f \text{ (megacycles)} = \frac{1,000,000}{6.28 \times Xc \times C} \quad (5)$$

If available data does not permit solution of Eq. 3, we may assume Cs as the sum of the output capacity of the first stage, stray capacity and the input capacity of the following stage. Data on the 6J7 gives 7 and 12 μmf as input and output capacitances respectively. Assuming 13 μmf stray capacitance, Cs is 32 μmf.

Where Xcs is 5 times Req (5x250,000).

$$f \text{ (mc)} = \frac{1,000,000}{6.28 \times 1,250,000 \times 32} = .00399 \text{ mc} = 3,990 \text{ cycles}$$

and when Xcs equals Req

$$f \text{ (mc)} = \frac{1,000,000}{6.28 \times 250,000 \times 32} = .0199 = 19,900 \text{ cycles,}$$

which is the limit of useful amplification.

The gain at any high frequency, Ghf, may be found from

$$\frac{Ghf}{Gif} = \frac{1}{\sqrt{1 + (Req/Xcs)^2}} \quad (6)$$

Attenuation at low frequencies begins to develop when the reactance, Xcc, of the coupling condenser Cc is more than 0.2 of R when

$$R = Rg + (Rp \times RL / Rp + RL) \quad (7)$$

and the reactance of Cc is determined from Eq. 4.

When Xcc in the circuit of Fig. 1 is 0.2 x R, or 0.2 (1,000,000 + 333,000) = 266,000.

The frequency is:

$$f \text{ (mc)} = \frac{1,000,000}{6.28 \times 266,000 \times 3000} = .0003 \text{ mc} = 300 \text{ cycles}$$

When Xcc equals R, the low-frequency limit of the useful range is reached.

That frequency is:

$$f \text{ (mc)} = \frac{1,000,000}{6.28 \times 1,333,000 \times 3000} = .000039 \text{ mc} = 39 \text{ cycles}$$

If we apply a 0.25-volt variable-frequency signal to the input terminals of the amplifier, we may expect an output of 87.5 volts, (.25 x 350) on the grid of the following stage when the frequency is between 300 and 3,900 cycles. The gain will drop to 70% of this value at the ends of the useful range.

These calculations have been based on the more commonly-known frequency-determining factors of a resistance coupled amplifier. Several additional factors play large parts in determining

(Continued on page 45)

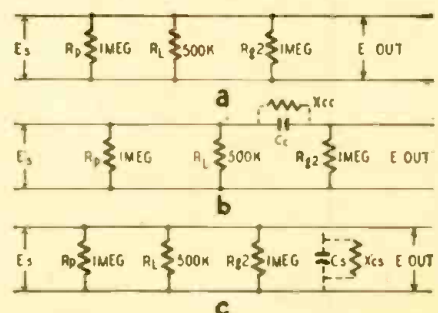

Fig. 3—Same circuit at varying frequencies.

# Electronics in Medicine

## Part I — The electronic cardiograph, its fundamental theory and notes on application methods

By EUGENE THOMPSON



Courtesy Sanborn Co., Cambridge, Mass.

A direct-writing type of electrocardiograph.

**M**EDICAL electronics embraces all those electronic devices and techniques which are employed in the diagnosis and treatment of disease. Among these techniques are electrocardiography, blood pressure and pulse recording, photoelectric plethysmography, and photoelectric colorimetry. Electrocardiography equipment serves as a basic component for a number of the techniques.

Fig. 1 is a diagrammatic sketch of the heart and the flow of blood through it. It is essentially a four-chambered mechanical force pump. Its function is to pump deoxygenated blood, which is returned to it from the body via the veins, through the lungs, where it picks up a

PULMONARY VEINS FROM LUNGS TO HEART

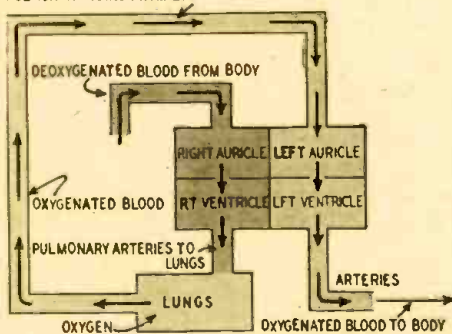

Fig. 1—Heart, in radio-style block diagram.

fresh supply of oxygen, and thence back to the body by way of blood vessels known as arteries. The chambers of the healthy heart contract in a definite, orderly, and rhythmic sequence known as the *cardiac cycle*.

### The blood circuit

Referring to Figure 1, the cycle starts as a quantity of deoxygenated blood empties into the right auricle. At this time this chamber is in its resting phase, or diastole, which lasts for 0.7 second. At the end of this filling period the right auricle contracts (systole), which lasts

0.1 second and forces the blood into the right ventricle. After doing this the auricle returns to its diastolic phase (0.7 second) to collect some more deoxygenated blood. Immediately after it receives the blood from the right auricle, the right ventricle which has been in diastole for the past 0.5 second, undergoes systole. Ventricular systole lasts for 0.3 second and propels the deoxygenated blood through the lungs, where it becomes oxygenated, and back to the left auricle. This chamber in turn squeezes the blood into the left ventricle from whence it is pumped back to the body again.

The time relationships for diastole and systole of the left auricle and ventricle are the same as those given for the right auricle and ventricle. The halves of the heart work together.

The two auricles contract simultaneously, and then the two ventricles do the same. Each of course is ejecting a different type of blood.

By far the most striking thing about the cardiac cycle is its rhythmicity. We now know that the contractions of the heart are timed and controlled by nerve impulses which arise within the heart itself. It has been demonstrated by cathode ray oscillography that nerve impulses are electrical in nature. Consequently, as these impulses stream through the heart they leave the tissue through which they pass momentarily electronegative with respect to the rest of the heart and body. The resultant shifting of this electronegative area with the passage of the nerve impulse constitutes a minute electrical current which can be detected with the aid of sufficiently sensitive recording apparatus.

### Early instruments

The first practical electrocardiographic recorder was the Einthoven string galvanometer. The basic arrangement of this device is shown in Fig. 2. Although this type of recorder is still widely used, the modern trend is away from this design and toward the more versatile electronic recording system.

Fig. 3 is a schematic diagram of a typical electrocardiograph amplifier. Although all such amplifiers are not of push-pull design, this type is capable of doing everything that non-push-pull amplifiers can do, and has several additional advantages. Among the more important of these are: push-pull can handle signals of greater amplitude than single-channel amplifiers under the same operating conditions; the power output is greater; extraneous noises, such as those produced by x-ray or diathermy apparatus, feed into the amplifier 180 degrees out of phase and hence are bucked out to a large extent; second and all even-number harmonic distortion is reduced.

Because the amplitude of the action potentials produced by the heart are 1 millivolt or less under normal conditions, an electrocardiograph amplifier must have high gain. In the unit shown in Fig. 3 this is accomplished by the 2 stages of push-pull amplification. Employment of pentodes rather than triodes results in a much higher over-all gain per stage. Furthermore, using the 6SJ7 is an excellent pentode in that it is possible to obtain a gain in the neighborhood of 80 to 100 with relatively low operating voltages (plate supply voltage 90 volts).

Another important characteristic of the heart's action potentials is their low frequency. This imposes the necessity for a long time constant in the amplifier and accounts for the higher than usual values of the interstage coupling condensers and grid load resistors.

One further complication is added because of the amplifier's low pass characteristics. An a.c. power supply cannot be used, because of two reasons. First, the a.c. on the filaments would appear on the record. Second, the d.c. plate and screen voltage would produce the same effect, unless the power supply were of

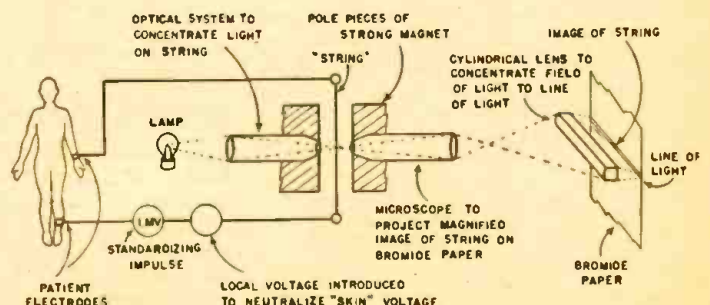

Fig. 2—Hookup of early equipment with Einthoven string galvanometer.

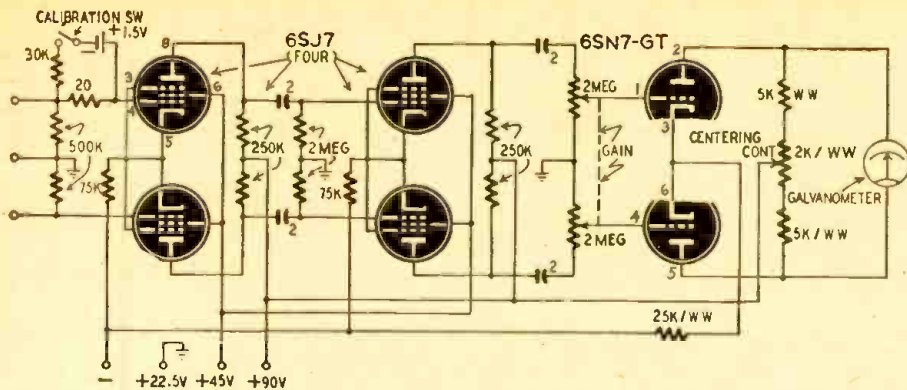

Fig. 3—Audio amplifier designed for the electrocardiograph's very low-frequency output.

such exceptional design that the ripple content would be of very negligible proportions. These difficulties are easily solved by using batteries for the filament supply, grid bias, and the plate and screen voltages.

### Pickup equipment

Two additional components are necessary to adapt the amplifier in Fig. 3 to the recording of electrocardiograms. These are: a means for picking up the heart's action potentials and feeding them to the amplifier, and a device for making a visual record of the amplifier's output.

The method by which the heart potentials are detected is simple. Flat metal electrodes about 1½ inches wide and 2¼ inches long are attached at various places on the surface of the body. These points are: (1) the left wrist; (2) the right wrist; (3) the left leg just above the ankle, and (4) any other point on the body. To make an electrocardiogram, it is necessary to use at least two of the first three electrodes. The fourth electrode is also usually required as a ground connection to by-pass extraneous noises.

Any combination of two electrodes is known as a lead. Thus, the combination consisting of the left and right wrists is called Lead I. Lead II is composed of the right wrist and the left leg, and the left wrist and the left leg comprise Lead III. A number of other leads are sometimes used for special purposes, but the 3 described here are the ones most commonly used.

Each lead requires a separate amplifier. All three leads must be recorded to permit accurate diagnosis of cardiac irregularities. In clinical practice this is accomplished in one of two ways. Either three amplifiers are employed, thus recording all three leads simultaneously, or only one amplifier is used together with a switching arrangement which permits the selection of any desired lead, and the three leads are recorded in succession. The former method, although more costly in terms of equipment required is preferable because the effect of a single given irregularity in the cardiac cycle can be observed in all three leads.

The electrodes are attached to the body by first preparing the desired area of skin by rubbing it with a paste con-

taining an abrasive and salt, to enhance the electrical contact. The abrasive breaks the tough outer non-conducting layer of skin, reducing the skin resistance and minimizing polarization and other undesirable effects. The salt increases conductivity at the contact. The electrode is placed on the treated area and held in place with a rubber strap. A wire connected to the electrode goes to one of the input grids or, in the case of the ground electrode, to the ground terminal on the amplifier. This arrangement is satisfactory for detecting the minute potential differences between any two electrodes.

After these potential differences are passed through the amplifier, a suitable recording device must be placed at the output terminals of the amplifier to produce a visual record of them. Present-day equipment uses one of two techniques to obtain this recording of electrocardiograms, either photographic or direct writing.

### Recorders

In the photographic method, a small moving coil galvanometer with a tiny circular focusing mirror cemented to the suspension is employed as the recording unit. As the output signal from the amplifier is applied to the moving coil, the latter oscillates from side to side causing the mirror to move in step with it. A beam of light may thus be projected on a moving photographic surface which travels past it, making a permanent record. This system is illustrated in Fig. 4.

Although it is widely employed at present this method has one great disadvantage. The film must be developed before the cardiologist can analyze it. In some cases, such as surgical operations, it is desirable that a visual electrocardiographic record be always available at the moment the heart produces it. A recent innovation, the direct-recording electrocardiograph, makes this possible. In place of the moving coil galvanometer, a light-weight, electro-magnetically actuated recording arm is used. This arm moves back and forth much like the voice coil in a radio loud speaker. At its end is a small self-feeding inkwriter which produces a record on moving paper tape. An even more recent improvement is a heated wiring stylus which records on a specially prepared plastic surface.

The interpretation of electrocardiograms is a task for a highly trained expert, an exhaustive discussion of this subject is obviously beyond the scope of this article. However, the foregoing will

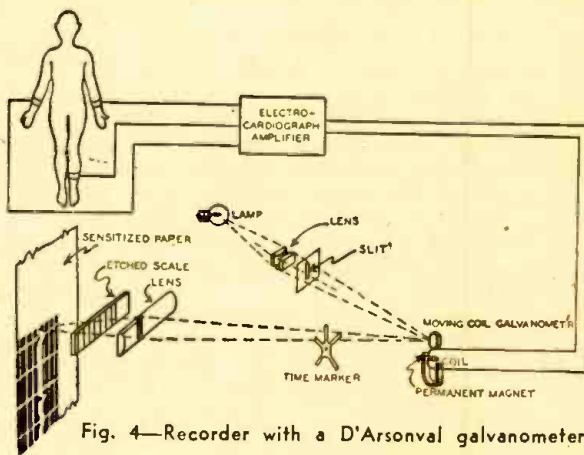
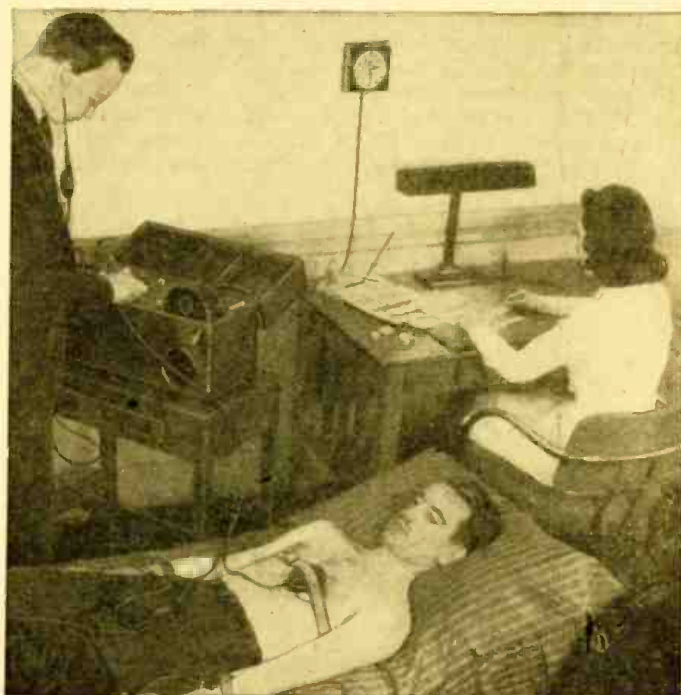

Fig. 4—Recorder with a D'Arsonval galvanometer.

give the reader some idea as to the equipment employed in cardiac diagnosis. Other electromedical equipment will be considered in later articles.



Courtesy Sanborn Co., Cambridge, Mass.

How the cardiograph is used. Third electrode is over the heart.

# Radio Set and Service Review

## Motorola 77FM21 FM-AM Combination

By R. F. SCOTT, W2PWG

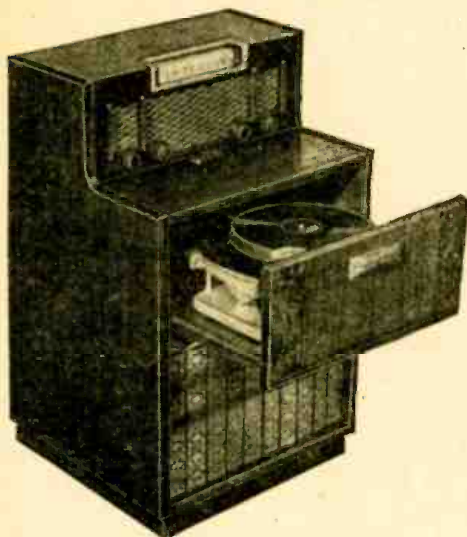

Photograph above is of the 77FM22, which differs in minor details from the 77FM21.

**T**HE Motorola 77FM21 FM-AM-phono-radio console includes one of the most interesting postwar circuits so far seen. It covers the 535-1,625-kc AM broadcast and 88-108-mc FM broadcast bands and includes an automatic record changer in a pull-out drawer-type compartment. Built-in FM and broadcast antennas are included, provision being made for use on outdoor antennas.

The unconventional co-axial-line tuner of the FM circuit is unique.

The set uses 6 tubes: 12AT7, 12BE6, 12BA6, 19T8, and 50B5; and a selenium rectifier. The a.c.-d.c.-type circuit is neatly wired on a well-built chassis. The power circuit is designed so there is little danger of electrical shock.

The AM circuit uses a loop-type antenna coil with a primary for an external aerial. The loop is connected to the signal grid of the 12BE6 converter. Mixer and oscillator sections of this tube are tuned with the conventional coil and condenser combination. The output passes through a 455-kc i.f. transformer T5 to the 12BA6 i.f. amplifier. The primary of the AM output

i.f. transformer—T6—is in series with the primary of the third FM i.f. transformer T3. At 455 kc, the primary impedance of T3 is a short circuit and does not affect the circuit.

One of the diodes of the 19T8 is the AM detector and source of a.v.c. voltage. The triode section of this tube is the first a.f. amplifier. The last tube, a 50B5, is the power amplifier and works into a 5-inch PM speaker.

Synthetic bass response is created by the resistor and condenser network between the cathodes of the a.f. tubes. This network (R1, R2, Rs, and C1) is a low-pass filter in a positive-feedback loop between the a.f. tubes. The system accentuates the third harmonic of low frequencies, and the human ear hears and accepts these harmonics, unconsciously recreating the fundamentals that are generally lost in sets of this type.

(The author has tried the circuit in one of his sets and was very much pleased with the improvement in quality.)

The FM section of the set is a *double superheterodyne* with the recently-developed permeability-tuned co-axial lines in the antenna, oscillator, and first i.f. circuits. The 12AT7 twin triode is the FM oscillator and *first* and *second* mixer. The antenna circuit is tunable to signal frequencies between 88 and 108 mc.

The input section of the 12AT7 is working as an oscillator, the output of which beats with the incoming signal to produce the first i.f. signal. This i.f. channel is variable and its signal beats with the original oscillator signal in the second section of the 12AT7 to produce the fixed 4.3-mc i.f. signal. Relative fre-

quencies in various parts of the co-axial tuner are:

$$F1 = F_s - F_o$$

$$F1 = \frac{F_s + F2}{2}$$

$$F2 = F1 - F_o$$

$$F_o = \frac{F_s - F2}{2}$$

where  $F_s$  is signal frequency,  $F_o$  is oscillator frequency,  $F1$  is variable i.f., and  $F2$  is fixed i.f.

When a 100-mc signal is being received, the oscillator operates on 47.85 mc and the variable i.f. is 52.15 mc. The fixed i.f. is 4.3 mc.

The low i.f. is made possible by the extreme high  $Q$  of the co-axial tuned circuits, which reduce image reception to a point where it is not objectionable. A more detailed account of this type of tuning system appeared in the article, "FM and Television Design," in the December, 1947, issue of RADIO-CRAFT.

The output of the second converter is transferred through a 4.3-mc i.f. transformer T1 to the oscillator grid of the 12BE6. (The band switch removes the broadcast oscillator coil from the circuit for FM reception. The 12BE6 then becomes a conventional 4.3-mc i.f. stage.) The band switch also switches the plate circuit of the 12BE6 from the broadcast to FM i.f. channels. The secondaries of T2 and T5 are in series, but this has no ill effect on the operation of the 12BA6 second i.f. amplifier. A sec-

(Continued on page 69)

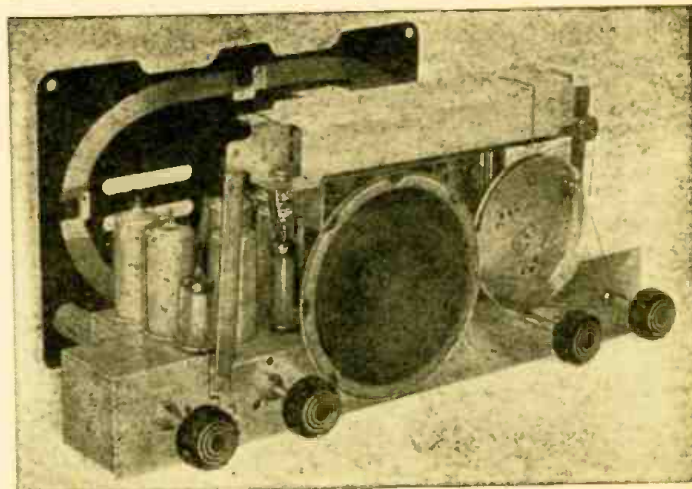
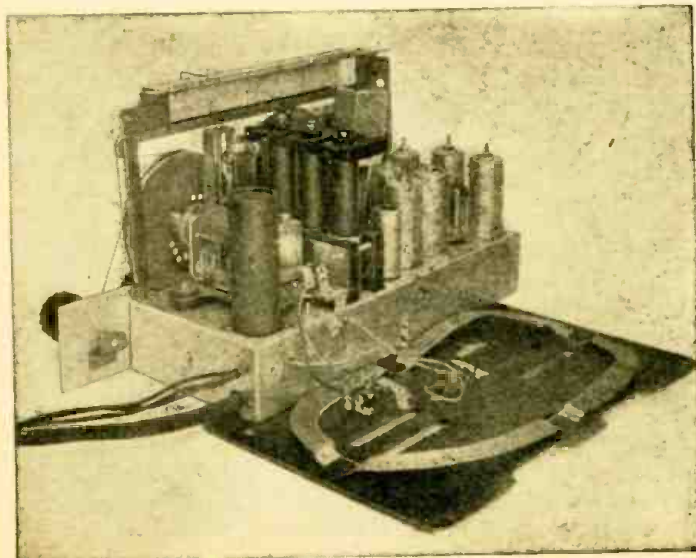

Left—Rear view, showing the co-axial tuning units of the 77FM21. Above—Controls are: radio-phono-tone, volume, BC-FM and tuning.

RADIO-CRAFT for MARCH, 1948



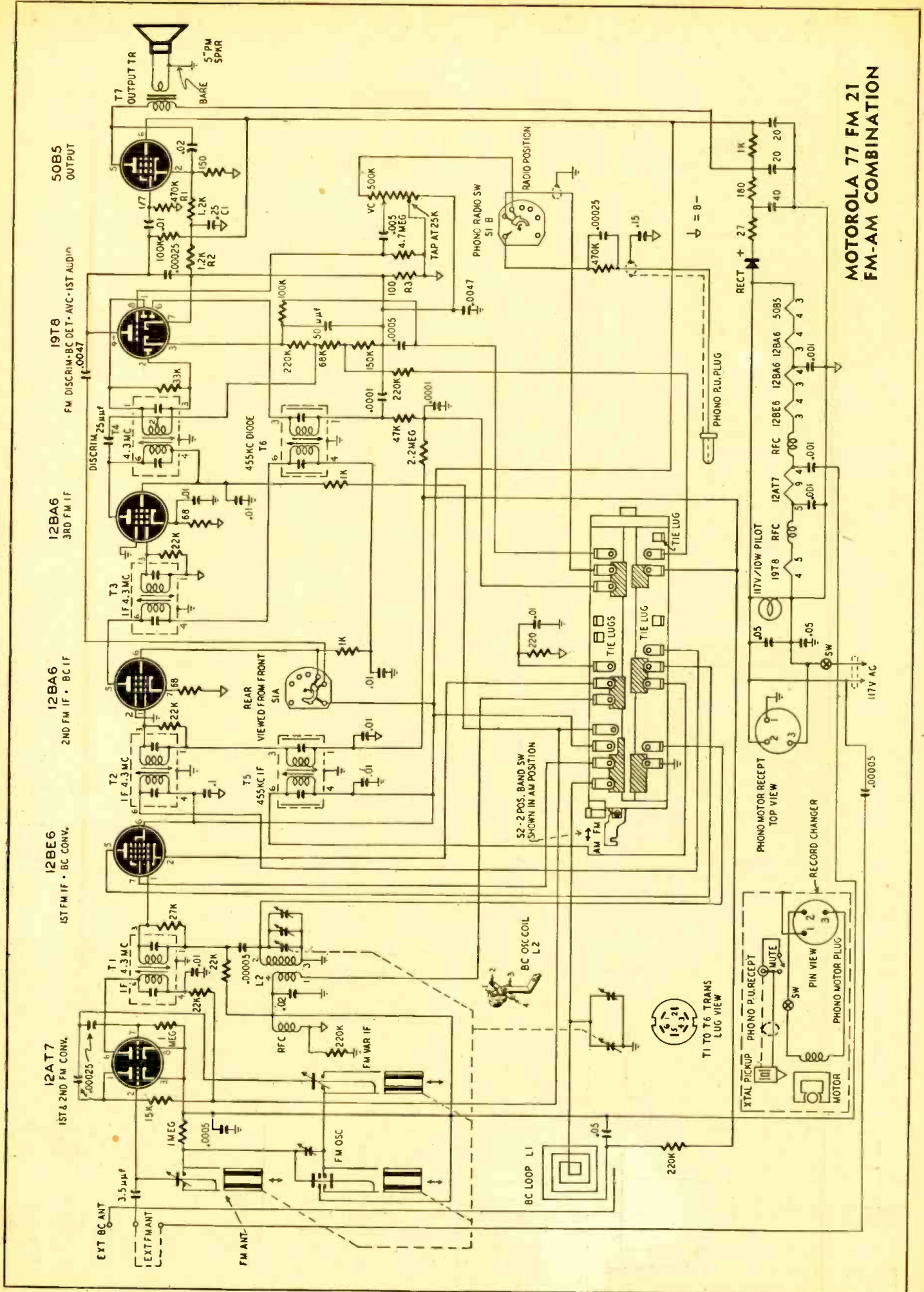

**MOTOROLA 77 FM 21  
FM-AM COMBINATION**

# Know Your Test Equipment!

## Part I—A comparison of the standard multimeter and a good vacuum-tube voltmeter

By SOL. D. PRENSKY

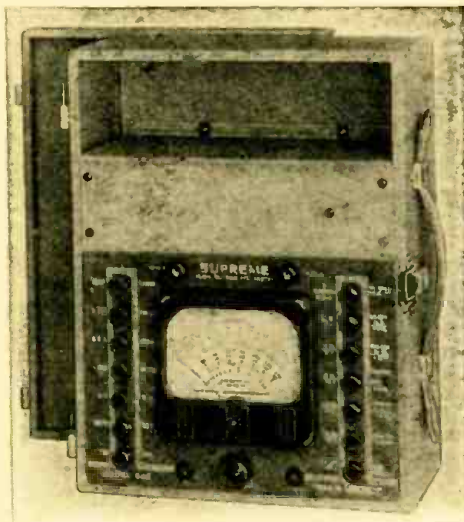

Figs. 1-a, top, and 1-b, bottom—Supreme 592 and Reiner 451, representative instruments.

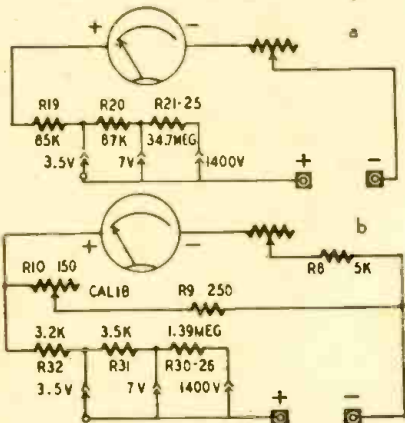

Figs. 2-a and b—D.c. voltage at 25,000 and 1,000 ohms/volt. Symbols explained in Fig. 4.

EVERY technician would like to have the perfect test instrument. But he knows that he will have to settle for something less than that. If he is wise, he knows also that the more he learns about the new instruments being produced, the better will he be able to choose the one best suited to his tastes, as he advances into the newer (and perhaps greener) fields of FM, television and industrial electronics.

The newcomer may find the answer to be a combination instrument—a vacuum-tube voltmeter in which current measurements also may be made directly with the indicating meter. The old-timer may find that a v.t.v.m. to go with his tried-and-true multimeter is his best answer to the problem.

It is now rather easy to get sensitive meters with basic ranges of 200 microamperes or less, even down to 40 or 50  $\mu$ a. These are so much more useful than the old meters with a 1-ma movement that any radioman should certainly use a meter with a sensitivity of at least 5,000 ohms per volt (200- $\mu$ a movement) or, better still, a 20,000-ohm-per-volt (50- $\mu$ a movement) meter. A 50- $\mu$ a meter is particularly useful in FM alignment, and its high input resistance as a voltmeter makes it practical for measuring a.v.c. or other high-resistance circuits. It also increases the range of the ohmmeter in which it is used, so that resistances of 40 megohms can be read, instead of the traditional 2-megohm top of the 1,000-ohm-per-volt meter.

Typical of the new multimeters available is the *Supreme Model 592* which we will select for study, breaking it down into its various functional circuits. It is a 25,000-ohm-per-volt, push-button type (Fig. 1-a). However, conclusions made about this instrument are also true, to a practical degree, for other 20,000-ohm-per-volt (or even 5,000-ohm-per-volt) instruments, push-button type or not.

A general comparison of the multimeter and the v.t.v.m. is made in Table I. This Comparison Table must be general, and therefore may not agree exactly with the specifications of any one instrument.

The multimeter can be broken down into a number of simpler instruments. These are shown in separate figures, and their basic factors are given below:

**D.c. volts section; shown in Fig. 2:**

1. The ohms-per-volt rating (in the sample case, 25,000 ohms per volt) indicates the basic sensitivity of the meter used, that is, the amount of current necessary to produce full-scale deflection. In this case it is 40  $\mu$ a.

2. Dual sensitivity, that is, the ability to select, in this case, either 25,000- or 1,000-ohm-per-volt sensitivity, obtained by shunting as the lower sensitivity is selected.

**Direct Current section; shown in Fig. 3:**

1. The lowest current range again depends on the basic current necessary for full-scale deflection.

2. Choice of multiple current ranges depends upon switching in the proper meter shunts for each range. The arrangement used in the sample circuit employs a ring-type shunt, which considerably reduces error caused by switch contact resistance, especially on the high current ranges.

**A.c. volts section:**

1. On a.c. volts (Fig. 4), the ohms-per-volt sensitivity depends on both the basic full-scale current of the meter and the characteristics of the rectifier. This component (usually of the copper-oxide type) is important in obtaining good a.c. scale characteristics, since a simple half-wave (single) rectifier would give a different scale for each voltage range. Rectifiers arranged either 2 in series, or 2 back-to-back, or sometimes 4 in a full-wave bridge connection, are therefore most common.

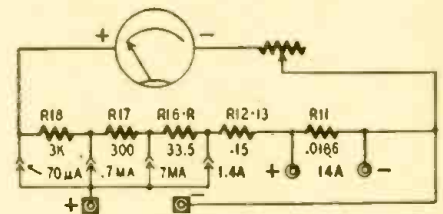

Fig. 3—Breakdown of direct current section.

2. Frequency error is inherent in this type of meter rectifier. For this reason, the accuracy can be expected to fall off rapidly, beyond the usual 5% figure, as the frequencies are increased toward the upper audio-frequency range.

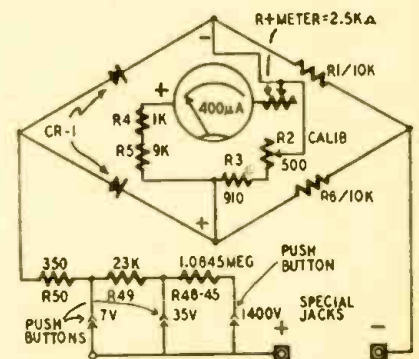

Fig. 4—Circuit for a.c. voltmeter function.

# AT-A-GLANCE COMPARISON OF MULTIMETER AND V-T VOLTMETER

Generalized Types Compared as to Essential Features and Suitable Applications

Essential Features and Applications	The Multimeter		The V.T. Voltmeter (Medium-priced type)
	Full Scale: 0-1 ma. 1,000 ohms per volt	Full Scale: 0-50 $\mu$ a. 20,000 ohms per volt	
<b>1. D.C. Volts Function</b>			
1(a). Input resistance (on 10-v. d.c. scale).	10,000 ohms	200,000 ohms	Over 1 megohm/v
1(b). Suitability for voltage measurement in high-res. circuits.	Not suitable	Satisfactory	Preferred (in cases like grid voltage)
<b>2. Direct Current Function</b>			
2(a). Practical range for small currents (microamperes).	100-1,000 $\mu$ a	5-50 $\mu$ a	Usually none
2(b). Suitability for FM limiter alignment.	Not suitable	Satisfactory	Slightly preferable when voltage reading replaces $\mu$ a
<b>3. Ohms Function</b>			
3(a). Practical upper range for ohms.	Up to 2 meg	Up to 40 megohms	Around 100 meg
3(b). Suitability for measurements such as insulation resistance.	Not suitable	Satisfactory only up to about 20 megohms	Satisfactory
<b>4. A.C. Volts (a.f. range)</b>			
4(a). Input impedance (on 10-v. a.c. scale).	10,000 ohms	Generally 10,000 ohms	Generally around 1 megohm at 1 kc.
4(b). Suitability for output measurement (up to 1 kc).	Satisfactory	Satisfactory	Satisfactory
<b>5. A.C. Volts (r.f. range)</b>			
5(a). Input impedance (on 10-v. a.c. r.f. scale).	Too low	Too low (without probe)	Generally around 1 megohm, shunted by about 10 $\mu$ mf at frequencies up to 25 mc or higher
5(b). Suitability for alignment at 10 mc (FM) to 20 mc (TV).	Not suitable	Can be used indirectly	Satisfactory for relative volts—not for wave form.

Table 1—Features and functions of the two types of meters compared. Information applies generally to all meters of the given types.

### Ohms section:

1. The maximum range in ohms also depends on the basic full-scale deflection of the meter. (In this case [a 40- $\mu$ a meter] the maximum ohms measurement is 50 megohms.)

2. Provision for measuring very low values of resistance requires that the self-contained battery be able to deliver adequate current.

3. Where there are many ranges for ohms, special care must be taken to have the zero-set circuit operate efficiently over all the ranges. In this case, where there are 6 ranges, a parallel network circuit is used. It changes as each range is switched in, thus allowing effective control by the 20,000-ohm rheostat.

The circuit varies somewhat for the different ranges; larger voltages and corresponding series resistors are switched in for higher resistance measurements. These variations are shown in Fig. 5. The lowest range, 500 ohms, is shown in Fig. 5-a. Fig. 5-b is used up to 500,000 ohms, Fig. 5-c to 5 megohms, and Fig. 5-d to 50 megohms.

### The vacuum-tube voltmeter

The indicating device of a v.t.v.m. is driven, not by the signal being measured, but by the plate current of an electron tube to whose grid the signal voltage is applied. As a result, it has some important advantages:

On d.c. ranges: much higher input resistance, and correspondingly *greater sensitivity*;

On a.c. ranges: much greater freedom from frequency errors, and a corre-

spondingly *greater frequency range*; *Much better protection* (automatically obtained), from overloads, in spite of its greater sensitivity.

On the other side of the ledger are the limitations of any device operated by an electron tube. First, there is the need to check the calibration periodically. This can be done simply by comparing with known d.c. and a.c. voltages. The second limitation concerns the provision of current ranges. The v.t.v.m. is essentially a voltage-sensitive, rather than current-sensitive, device. The technician may obtain extra current ranges on his v.t.v.m. (at a slight extra cost), or rely on the current ranges of his multimeter.

### A representative v.t.v.m.

Passing over the theory of the v.t.v.m. (which has been well covered in previously published texts), we can proceed directly to the example presented as typical of a v.t.v.m. having comprehensive ranges and wide frequency coverage. This model (Reiner 451) is shown in Fig. 1-b. The circuits are fairly representative of instruments which combine a rectifier probe with a d.c. v.t.v.m. circuit of the balanced-tube bridge type. (While values in the Comparison Table are selected for medium-class instruments, the samples, for the sake of completeness, are chosen to go a little be-

(Continued on page 80)

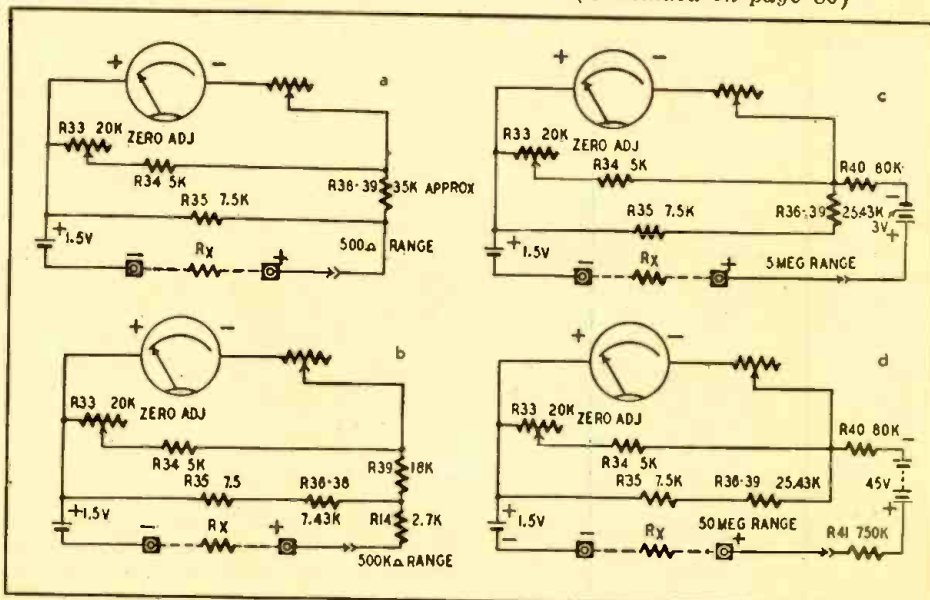

Fig. 5—Breakdown of the ohmmeter ranges; resistor and meter in series are 2,500 ohms.

# Cosmic Radio Signals

## FROM SUN AND STARS

**T**HE giant equipment illustrated on our cover and on this page is nothing more nor less than a radio receiver. Further, it is a radio which receives static only! Building a receiver to pick up static may seem pursuit of the nonessential, but the designer of this set went even further. He built it to reject practically all the crackles and pops we get on our broadcast radios and to receive static on very high frequencies only—on the wave lengths at which the sun and stars radiate.

Scientists of the Bureau of Standards believe that knowledge of this cosmic static—particularly of the radio waves generated by the sun—may be very useful to communications engineers, astronomers, and meteorologists. It may help to expand greatly our knowledge of the universe, and answer the old question: what effect have the stars and sun on this world and on human life?

Ordinary static is too well known to the broadcast listener, particularly those living within range of that great "radio center" of terrestrial static—the Caribbean thunderstorm region. Individual flashes of lightning there combine to produce steady crashing, which is transmitted over great distances.

Intensity of atmospheric noise drops off as the frequency increases, and finally ceases to be a practical problem.

At that point cosmic radio noise takes over. Heard as a low, steady hiss, it may become an important problem to the listener on high frequencies as radio equipment is improved. Already advances in design of both v.h.f. and u.h.f. equipment have greatly reduced internal noise from tubes and other components. High-frequency radio noise may then become the factor which will limit the sensitivity of FM, television, microwave telephone, and similar equipment.

FM radio signals suppress this type of static within a certain range of the transmitting station. At considerable distances from lower-power stations the strength ratio between the FM program and the cosmic noise might be such as to drown out the program completely. So the ordinary listener may find noise from the sun and stars an immediate and practical subject of interest.

The project, which uses the great Würzburg parabolic antenna shown here, will observe and analyze radio noise generated by the sun, determining the range of frequencies in the solar broadcasting spectrum and the strength at which they can be received on this planet. It will also attempt to correlate solar noise with other solar, interstellar, and terrestrial phenomena.

Two of these parabolic mirrors are now installed at the propagation laboratory of the Bureau of Standards at Sterling, Virginia. Twenty-five feet across, they can capture a large cross section of the solar energy beamed at the earth. The mirrors are controlled automatically, like an astronomer's telescope, to follow the sun constantly through the day. By using 2 receivers, different types of studies can be undertaken simultaneously, or a broader band of frequencies can be followed. The first receiver—now being installed—will be used initially for studies ranging from 480 to 500 mc.

Solar noise appears to be fundamentally the same as cosmic noise, and is heard as a steady

hiss whenever the operator substitutes a pair of headphones for his recorder. It has also an undulating component superimposed on the stable noise, with variations sometimes of great rapidity, which sound like puffs or swishes lasting a second or less. The swishes sometimes overlap, resulting in a grinding noise. This may manifest itself on the screen of a standard television set as streaking or picture jumpiness. Occasionally there are intense, prolonged bursts of solar transmission lasting several hours (see *Sunspots and Radio*, by Harlan True Stetson, in *RADIO-CRAFT*, February, 1948). These cause a radar to "go blind" when pointed in the sun's direction.

Like many other important scientific projects, the cosmic-noise study started as an amateur effort. The existence of cosmic radio waves had long been suspected—they had even been given a name, the *Jansky effect*. Among the students of this effect was an Illinois radio engineer, Grote Reber, who built a large sheet-metal parabola and for some years spent most of his nights collecting records from various parts of the sky. Among his important discoveries was that the center of the Milky Way is a powerful source of cosmic radio energy. His work attracted the attention of the Bureau of Standards, already interested in the problem of the sun's effect on radio propagation. Unquestionably the leading student of cosmic radio in the United States; he was called in to head the solar radio study project, exchanging his sheet metal parabola for the big Würzburgs. The home-built mirror, however, is still doing duty in studies of radiation from the stars. The Bureau, at present chiefly interested in the sun's broadcasts, has 2 important problems to solve in the field of cosmic noise: first, the question of intensities-vs-frequencies—in other words, on what bands are the stars and star-clouds radiating, and what bands come in strongest; second, mapping the sky's sources of cosmic signals. The Milky Way center is already known to be a strong source. Another one is in Cygnus (the Swan).

Cause of the radiations is not definitely known. It has been suggested that, because of the similarity of the sound produced in the radio receiver, it may be due to thermal agitation of charged particles. The billions of stars which constitute our galaxy, say the Bureau's scientists, throw off a large amount of material which expands and tends to fill the intervening space as a very thin gas. These atoms of gas may be ionized by starlight, producing positive and negative particles which radiate both visible light and radio waves.

(Continued on page 76)

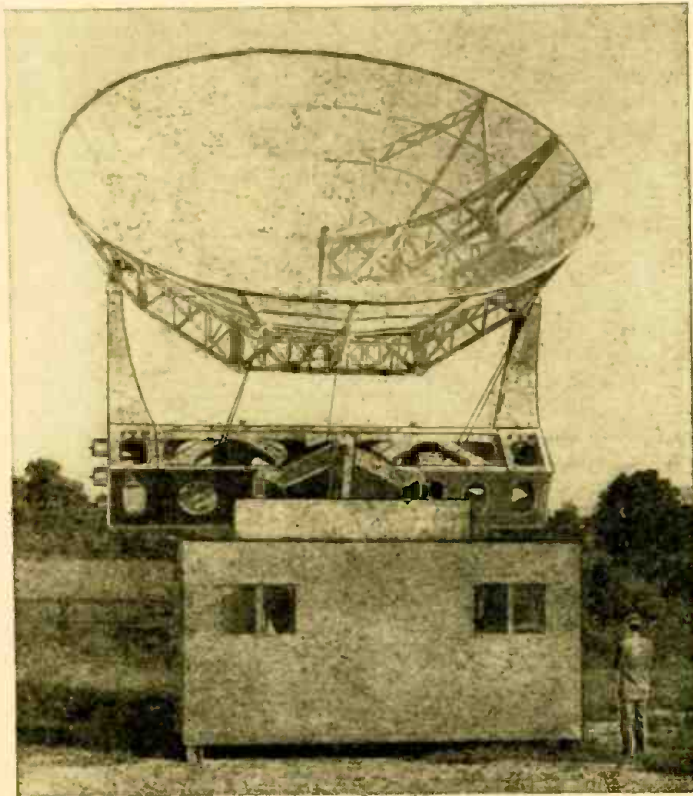

Front view of the 25-foot Würzburg antenna beamed at the sun.

# MAGNETIC RECORDING

## Part V—Construction of the recording-erase head and the tape puller

By A. C. SHANEY\*

ONE of the developments which greatly contributed to the perfection of magnetic recording was the application of a supersonic bias during recording. The term *supersonic bias* was improperly chosen, but has unfortunately already become associated through use with a special technique utilized during recording. The audio signal to be recorded is mixed with an extraneous sine-wave signal 5 to 6 times higher than the highest recorded audio frequency. Invariably this frequency is above 20,000 cycles and therefore justifies the name *supersonic*. But it is not a bias in the true sense of the word. It is merely an auxiliary supersonic frequency mixed with the audio signal.

Paradoxically, this technique which contributes most to high-fidelity magnetic recording is least understood. The theory of its operation is still a controversial matter. For those engineers who wish to delve into the technical explanations of the effect of supersonic biasing, 3 references have been cited at the end of this article. For the technician, the effect of the supersonic bias can be roughly compared to the action of a catalytic agent in a chemical reaction. For the layman, it can be compared, in a strained way, to the action of water in a water-coloring process. Its presence makes it easy to control the dispersion of the coloring pigments so that any desired degree of shading can easily be attained. Yet no trace of the water remains in the finished and dried painting. The same holds true for the

supersonic-biasing voltage. No definite trace of it can be found in the recorded signal.

It has been stated that the bias voltage persists into the final recording. A suggested experimental check involves recording the biasing frequency at a higher-than-normal speed and then

usual forms of magnetic distortion;  
2. Reduced residual background noise;

3. Increased recording dynamic range.

(Schematic circuits of the supersonic-bias system appeared in the January, 1948, issue of RADIO-CRAFT. See Page 31.)

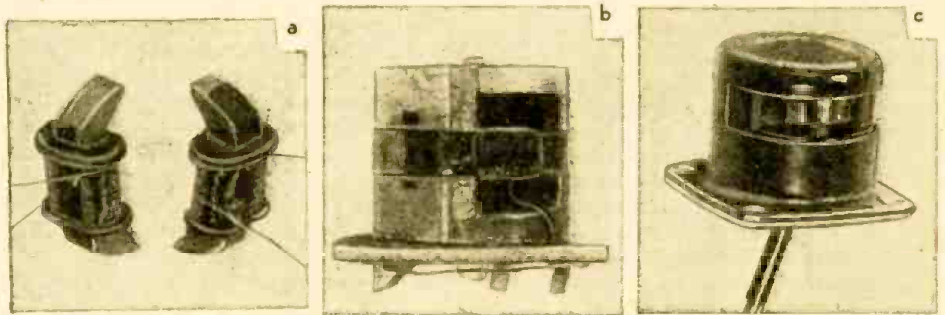

Fig. 1—Recording and playback head; a—the twin coils; b—without case; c—complete.

wave-analyzing the signal picked off the tape moving at a slower or normal speed. This procedure evidently overlooks the pronounced self-demagnetization effects in extremely short magnets! When the tape is run at high speeds, the wave length of the recorded supersonic bias voltage is naturally longer and will therefore persist on the tape. At the slower or normal speed, the supersonic signal will deteriorate rapidly and will not be definitely detectable!

Regardless of how the supersonic-bias works, there is full agreement on its effects:

1. Substantial elimination of the

### The Recording Head

One spectacular difference between magnetic recording and other forms of recording (disc or tape embossing or cutting methods) is the complete elimination of any necessity for converting electrical energy into mechanical motion. All well-known forms of cutting heads for disc or film recorders are fundamentally handicapped by the necessity of transducing electrical energy into mechanical motion of different amplitudes and at all frequencies met with in the audio spectrum. This is still an exceedingly difficult feat to ac-

(Continued on page 69)

\*Chief Engineer, Amplifier Corp. of America

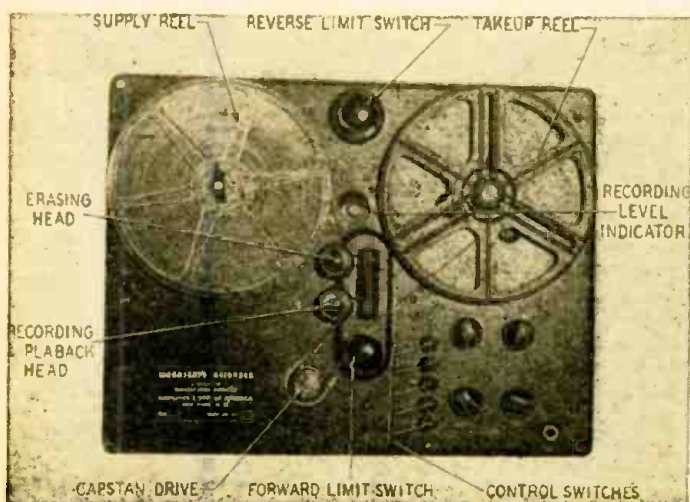

Fig. 2—Top view of tape recorder, indicating the important parts.

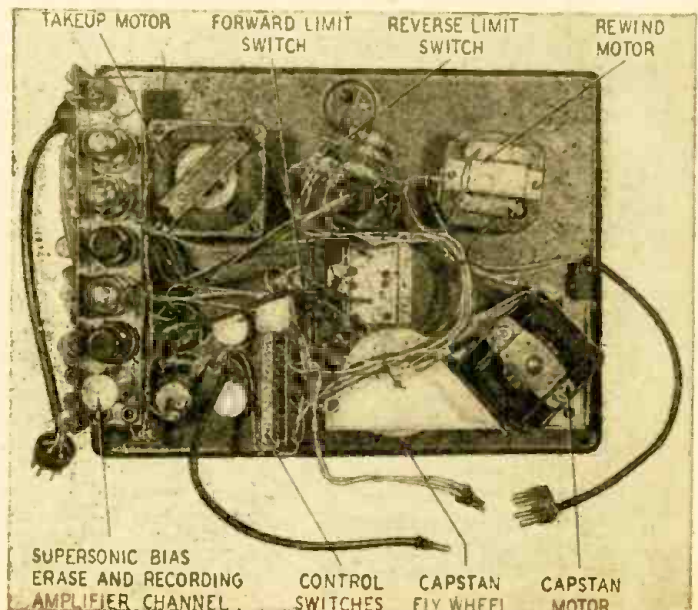

Fig. 3—Bottom view of the same recorder. Three motors are used.



# WORLD-WIDE STATION LIST

Edited by **ELMER R. FULLER**

**M**ANY changes have been made since our last issue, as will be seen upon a study of our log published this month. Dakar, French West Africa, is being heard on 11.710 mc from 1330 to 1800 but is interfered with by WRUW after 1730, and by CHOL most of the time. Both of these are on 11.720 mc. By careful tuning and a good ear, Dakar can be heard and identified in spite of the interference. Another good African is our old friend FZI in Brazzaville, French Equatorial Africa. This transmitter is heard on 11.970 mc from 0000 to 0230; 0445 to 0800; 0930 to 1030; and 1100 to 2020, and puts in a good signal most of the time. Another good 25-meter band catch is VLC7 in Shepparton, Australia, broadcasting on 11.840 mc from 2330 to 0045 and 1500 to 1615 EST. This station has some interference from a transmitter believed to be Constantine, Algeria, on their later transmission. That station is on 11.830 mc and may be heard from 0130 to 0315; 0630 to 0915; 1315 to 1400; and 1430 to 1700. He is not very strong but may be identified at times, although trouble has been experienced here in receiving the station.

Several new observers were heard from during the past few weeks. We sure welcome their reports, and hope to hear from others, as well as our old stand-bys. Reporters this month were Gill Harris of Massachusetts; Bill Moore of Pennsylvania; Charlie Edwards of Massachusetts; John Winkler of Michigan; Lars-Eric Hansson of Sweden; Tom Brandon of Alberta, Canada; and the Department of State, Washington, D. C.

Reception on the whole seems to be improving from what it was a few weeks ago. From the reports received it appears that reception from all directions is better.

## A modern grandmother

The most interesting report of the month is the one printed below:

The storm having broken down my aerial I am recalling the many short waves I have been listening to in the past couple of months. At that time a new radio was installed with a shortwave band and it has been my shut-in entertainment. I have been thrilled with the reception . . .

My first Saturday and Sunday started with the Hams talking about a Rat Race—warning others to beware of Wild Bill. I became interested and learned about the sweepstakes—but I never did hear Wild Bill—and only lately found out the reason—someone mentioned his call letters—and he is in the 7th district which

doesn't come in here . . . It seems that I have heard everybody's set-up and troubles from California to Canada and Maine to Florida . . .

My book tells me that from police headquarters and doctors offices to plantations in Cuba and the Voice of the Andes, all have a friendly hobby.

My home is only a two-room shack (as I call it) near the shore of Great South Bay, with Fire Island and the Atlantic Ocean only 5 miles away; but I'm not a Grandmother with a pussy cat, a rocker, and regrets. . . . This year welcomes my 70th spring, and there is plenty still to learn; the best is just around the corner . . .

The above is quoted in part from a letter received by your editor from Mrs. Sally G. Edmonds of Blue Point, New York. In spite of her age she has become

interested in shortwave radio, and has spent several hours of her time on the ham bands. Our hats are off to her, and to others like her who have a desire for knowledge and progressive thinking even though they have lived to see many inventions come, only to be discarded by another generation.

From Sweden comes information that Radio International in Tangier on 6.200 mc has a musical program with English announcements from 1600 to 1630, EST. Radio Italiana in Italy has a similar program in English and on Fridays play request music on 9.630 mc from 1530 to 1610.

Information about our system of observers for the short wave bands may be obtained by writing to the shortwave editor, RADIO-CRAFT, 25 West Broadway, New York 7, New York.

All schedules are Eastern Standard Time.

Location	Station	Freq.	Schedule	Location	Station	Freq.	Schedule
<b>FINLAND</b>				Munich	Munich II	7.290	Balkan beam, 1115 to 1700
Lahti	OIX2	9.500	0100 to 0130; 0610 to 0740; 1600 to 1800	Munich	Munich IV	9.540	East European beam, 1115 to 1700
Lahti	OIX5	17.800	0130 to 0200; 0500 to 0545; 0800 to 1700	Munich	Munich I	11.870	European beam, 1200 to 1400
<b>FRANCE</b>				<b>GOLD COAST</b>			
Paris		9.550	0000 to 0130; 0715 to 0845	Accra	ZOY	7.290	1045 to 1300
Paris		11.840	0030 to 0130; 0145 to 0300; 1915 to 2245; 0900 to 0915	<b>GUATEMALA</b>			
Paris		15.350	0700 to 0900; 1700 to 1715; 1915 to 2015; 2030 to 2045	Guatemala City	TG2	6.820	1800 to 2300
Paris		17.760	0700 to 0900; 1100 to 1230	Guatemala City	TGWA	9.670	1830 to 2330
<b>FRENCH EQUATORIAL AFRICA</b>				Guatemala City	TGWA	15.170	0730 to 1500
Brazzaville	FZI	6.020	1600 to 1845; 0000 to 0130	<b>HAWAII</b>			
Brazzaville	FZI	9.440	0000 to 0130; 1100 to 2020	Honolulu	KRHO	9.650	Philippine beam, 0430 to 1005
Brazzaville	FZI	11.970	0445 to 0800; 0930 to 1030; 1100 to 2020; 0000 to 0230	<b>HONDURAS</b>			
Brazzaville	FZI	15.590	0435 to 0800; 0930 to 1030	La Cetla	HRD2	6.230	1200 to 1400; 1900 to 2300
Brazzaville	FZI	17.530	0000 to 0130; 0445 to 0745; 1100 to 1700	San Pedro Sula	HRP1	6.360	1100 to 1415; 1800 to 2330
<b>GERMANY</b>				Teucisgalpa	HRN	5.870	0800 to 1000; 1300 to 1500; 1800 to 2300
Berlin		6.070	0000 to 0345				

(Continued on page 75)

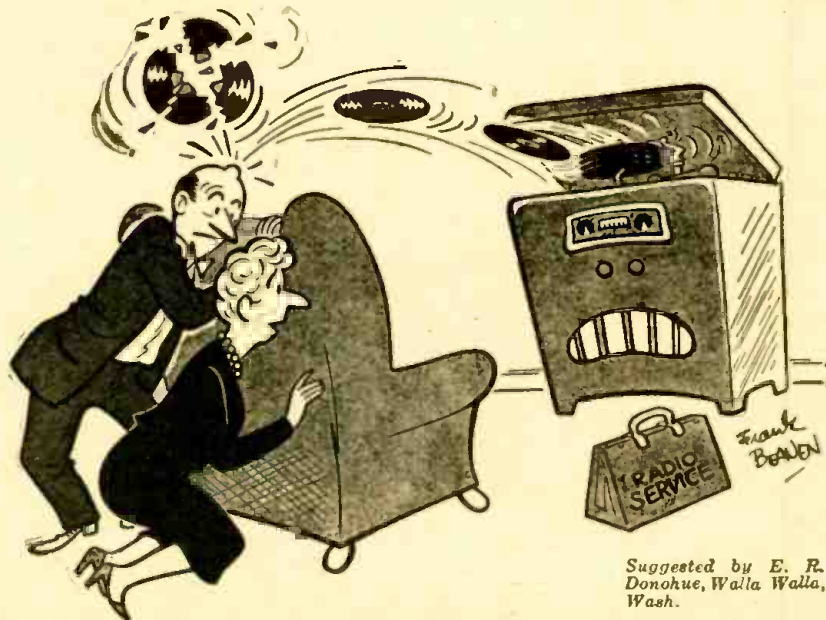

Suggested by E. R. Donohue, Walla Walla, Wash.

"There, see? . . . I put the records on and it throws them right back at me!"

# NEW RADIO-ELECTRONIC DEVICES

## TUBE TESTERS

Radio Tube Division  
Sylvania Electric Products  
New York, N. Y.

A new counter-type Model 139 and a new portable-type Model 140 tube testers provide accurate tube-testing facilities for a shop, spot-testing in the home, industrial electronic applications, and automobile and mobile radio equipments. Accurate checks of

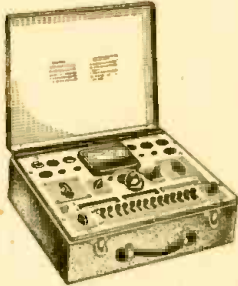

receiving-type tubes used in broadcast receivers, FM, television, industrial electronic controls, record players, and photoelectric devices may be made under dynamic conditions and without damage to tubes.

Design of the testers includes extra sockets and switch contacts for modernization as new types of tubes are developed. Test for shorts may be made without danger of grid-filament contacts due to electrostatic attraction in battery-type tubes where spacing between these elements is close. Provision is also made for noise testing.

Both instruments are supplied for 105-125-volt, 50-60-cycle, a.c. operation and are rated at 20 watts. Meter face measures 4 1/2 inches.—RADIO-CRAFT

## TRANSMITTER KIT

Micamold Radio Corp.  
Brooklyn, N. Y.

The new XTR-1 c.w. transmitter kit includes all parts and complete instructions for assembling a 3-band, 45-watt transmitter. The circuit consists of a modified tri-tet oscillator using a 6AG7 followed by a 1614 or 6L6 amplifier.

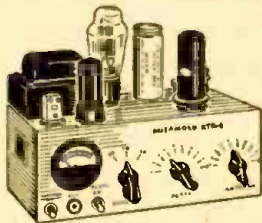

The latter may be loaded to 45 watts input on the 80-, 40-, and 20-meter bands. Band switching is used in the oscillator and amplifier circuits.—RADIO-CRAFT

## V.H.F. ANTENNA

Heintz and Kaufman, Ltd.  
San Francisco, Calif.

The new H-K folded dipole can be tuned accurately to any frequency in the 85- to 150-mc range, and is adaptable for FM reception, aviation serv-



ice, amateur 2-meter band, and mobile services in the vicinity of 150 mc.

The antenna is designed for use with a 300-ohm ribbon transmission line. For 85-mc operation the dipole is extended to 65 inches; at 148 mc its overall length is reduced to 37 inches.

Parasitic elements for the construction of beam antennas are available.—RADIO-CRAFT

## MULTIMETER

Electronic Measurements Corp.  
New York, N. Y.

The new Model 120 multi-tester is designed for servicing and general laboratory work. The voltage sensitivity is 20,000 and 10,000 ohms-per-volt for d.c. and a.c., respectively.

Ranges are: d.c.—0-3-15-60-300-1,500-6,000 volts; 0-60  $\mu$ a, 0-60-600 ma, 0-6 amp; a.c.—0-6-30-120-600-3,000-6,000 volts; —4 to +11, 10 to 25, 22 to 37, 36 to 51, 50 to 65, 62 to 77 decibels; resistance—0-3,000-300,000 ohms, 0-3-300 megohms.

The a.c. voltage measurements can be made at any frequency between 30 cycles and 1 mc. No external power source is required for a.c. measurements.

The tester is available in open-face and cabinet models.—RADIO-CRAFT

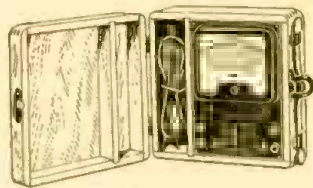

## TELE & FM ANTENNA

Collins Machine Co.  
Woodside, L. I., N. Y.

Antenna Model TFM-301R is designed for reception on television channels between 44- and 216-mc and 88- to 108-mc FM channels. It consists of 2 broad-band, folded dipoles with reflectors.

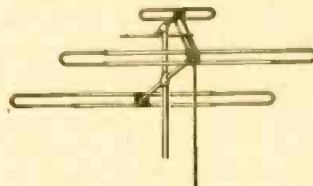

The dipoles are connected to a common transmission line having any impedance between 73 and 300 ohms. The directional pattern approximates half of the figure-8 on all television channels.

The entire unit is constructed of corrosion-resistant aluminum.—RADIO-CRAFT

## FM-AM SIGNAL GENERATOR

The Triplett Electrical Instrument Co., Bluffton, Ohio

AM signals from 100 kc to 120 mc and FM signals from 100 kc to 170 mc in 10 fundamental ranges with 0.1 volt maximum output are delivered by the new Model 3433 FM-AM signal generator. A meter is included for meas-

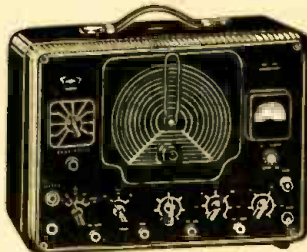

uring relative r.f. output, which is controllable with a 6-step ladder attenuator. The r.f. output can be amplitude-modulated at 400 cycles, or frequency-modulated at 2 mc or 50 mc.

Double shielding minimizes r.f. leakage and radiation. The case is 15 1/2 x 11 x 8 1/4 inches.—RADIO-CRAFT

## CAPACITOR

Cornell-Dubilier Electric Corp.  
South Plainfield, N. J.

The CR-101 is a 10  $\mu$ f, 1,500-volt, Dykanol-filled capacitor designed for applications in portable photo-flash equipment. It weighs 1 pound, and is housed in a hermetically sealed metal can 2 inches in diameter and 5 inches long. Connections are made to solder lug terminals at one end of the can.—RADIO-CRAFT



the 3- or 10-ma thermocouples and a 10-ohm, 500- $\mu$ a meter. A 10-ohm, 600- $\mu$ a meter can be used with the 30-ma unit. The 50- and 100-ma units require a 6.5-ohm, 4-ma. meter.

Only about 4 seconds elapse between application of heater current and full output from the thermocouples. Unmounted couples are 1 1/8 inches long, and 1/2 inch in diameter.—RADIO-CRAFT



## SUPERHET KIT

Allied Radio Corp.  
Chicago, Ill.

The Knight Ranger is a 5-tube a.c.-d.c. superheterodyne receiver available in kit form. It tunes from 535 to 1620 kc. The tubes are 12SA7-GT, 12SK7-GT, 12SQ7-GT, 50L6-GT, and 35Z5-GT. It is designed for classroom projects and training purposes.

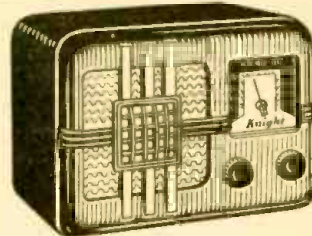

The kit is furnished complete with punched chassis, plastic cabinet, solder, and all parts including tubes and hardware.—RADIO-CRAFT

## 5-TUBE RECEIVER KIT

Senco Radio Inc.  
New York, N. Y.

The Model TA-21 is a 5-tube superheterodyne a.c.-d.c. receiver available in kit form. The tubes are: 12SA7 converter, 12SK7 i.f. amplifier, 12SQ7 de-

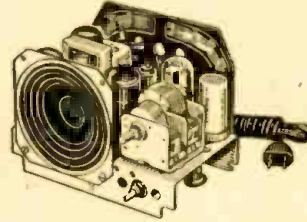

rector, a.v.c. and first a.f. amplifier, 50L6-GT power amplifier and 35W4 rectifier. It uses a loop-type antenna coil with provision for connecting an outside aerial. All sockets, mounting brackets and terminal strips are riveted to the pre-punched metal chassis.

The kit includes tubes, 4-inch PM speaker and a walnut-finished bakelite cabinet 7 inches wide, 5 1/2 inches high and 5 inches deep. Schematic and pictorial diagrams are provided.—RADIO-CRAFT

## U.H.F. THERMO-COUPLES

Field Electrical Instrument Co.  
New York, N. Y.

The new line of u.h.f. vacuum thermocouples is designed for measuring voltage or current at ultra-high frequencies. These are available with 3, 10, 30, 50 and 100 ma for 10- $\mu$ v output.

When used as a millivoltmeter, full-scale deflection may be obtained with

## ROTARY BEAM INDICATOR

Positron, Inc.  
Glenview, Ill.

The Positron is a new type of beam antenna direction indicator. Designed around an a.c. bridge circuit, it gives linear indications on the scale. This direction indicator shows the bearing of any rotatable directional television or amateur antenna. It is supplied in easily assembled kit form and operates from the 6.3-volt filament circuit in a receiver. Only 3 wires are necessary from the antenna mast to the indicator unit which may be placed near the receiver.

Installation does not require any gears, pulleys, or belts, since connection is made directly to the rotating portion of the antenna mast. It is not necessary to dismount the mast for installation.—RADIO-CRAFT

## DIPOLE ANTENNA

Technical Appliance Corp.  
Sherburne, N. Y.

The new Model 624 is an omnidirectional dipole antenna designed for reception of horizontally polarized FM and television signals.

This dipole is constructed in the shape of the letter "S" from 3/8-inch noncorrosive aluminum tubing. It comes with a 5-foot mast and 60 feet of 300-ohm ribbon transmission line.—RADIO-CRAFT

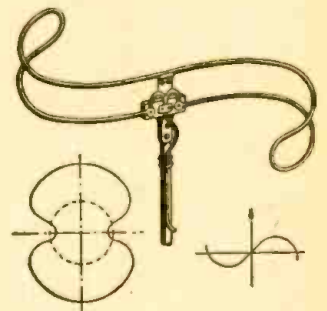

## FM RECEIVER COILS

Special Products Co.  
Silver Spring, Md.

The new Specoils FM coil kit consists of matched 88- to 108-mc antenna and r.f. coils, three 10.7-mc i.f. transformers, and one 10.7-mc discriminator transformer. The r.f. stage and converter are coupled by a special bandpass transformer that eliminates one section from the main tuning condenser.

The coils and transformers are in cans 1 1/8 inches in diameter and 1 1/2 inches high, exclusive of the tuning slugs which project through the top.—RADIO-CRAFT



# BUY from America's STOREHOUSE of QUALITY PARTS

## VOLUME CONTROLS



1000 ohm wire wound midgets - manufacturers close out - 1/4" shaft 3/8" long - list \$1.25 - over 90% off.

EACH **12c**  
SEALED Box of 252 **24.95**

## OUTPUT TRANSFORMERS

Clean stocks - long leads - mounting feet - made to fit where you need them. For 6F6-6K6 - to 4 ohm voice coil - size 2" x 1 1/2" x 1 1/2". 50L6-35L6-25L6 to 4 ohm voice coil 1 1/2" x 1 1/2" x 1 1/2". Specify quantity of each type you need at.....



**49c**

## MULTI-USE WIRE

An old favorite - back again! Stranded No. 22 tinned wire - glass "ROCKBESTOS" 1000 volt insulation - fireproof aircraft wire - a wartime development - at this low price you can use the best. 100 feet..... **45c** 1000 feet..... **3.89**



## Pep-Up PHILCO CHANGERS

Here are the two most important items in "Beam of Light" changers - and priced to give you more profit! Selenium cell only, no holder, post paid..... **1.80**

Special original equipment lamp.... **27c**

## 8/8/8 - 450 VOLT CONDENSERS

A nationally advertised triple 8 mfd. - 450 volts - inverted screw mounting - insulated aluminum can 1 1/2" x 4" - insulated leads 6" long. List price \$4.25. One time only at..... **89c**



## MIDGET I. F. TRANSFORMERS

Back again - by popular demand! RSE scores again with a new and better I.F. 1 400-500 KC range - 1 1/4" square x 2 1/2" high-ceramic based mica trimmers - high gain iron cores - pep up old receivers - ideal for new construction - and now available in either input or output types - for peak performance! Individually boxed in the colorful RSE carton. List price \$2.10. LR1 - input; LR2 - output; Specify Type.

Each	Matched Pair	Dozen	Egg Crate of 100
<b>36c</b>	<b>69c</b>	<b>3.95</b>	<b>29.00</b>



## PANEL METERS

Top Quality instruments! All new - not war surplus - boxed - seven popular types - priced right - your chance to get those meters you've always wanted!

Model 332 - 0-150 A.C. volts - 3" round flush mounting black brass case.

Model 221 - 0-30 D.C. volts - 2" round flush mounting bakelite case.

Model 324 - 0-400 D.C. volts - 3" round projection mounting - bakelite case.

Model 331 - 0-30 A.C. amps. - 3" round flush mounting bakelite case.

Model 322 - 0-150 D.C. volts - 3" round flush mounting black brass case.

Model 347 - 0-150 MA radio frequency thermocouple - 3" square bakelite case.

Model 341 - 0-500 MA radio frequency thermocouple - 3" round bakelite case.

Supply limited - order now - list models you desire.

**2.95**  
EACH

**3.95**  
EACH

# RADIO SUPPLY & ENGINEERING CO., Inc.

125 SELDEN AVE. DETROIT 1, MICH.

LOWEST PRICES

## .5-300 VOLT CONDENSERS



A name brand manufacturers close-out special - we pass the savings on to you! New fresh stock - size 3/4" x 2 1/2" - tinned leads - all guaranteed 60c List - your discount 90%.

Net Each **6c** 10 for **49c** 100 for **3.95**

## VOLUME CONTROLS

Our own private brand - made by a nationally known manufacturer - you have this same control on your shelf now - the same kind that net for \$1.09! Standard noise-free carbon construction - 3/8" bushing - 1/2" shaft, 2" long - complete with switch. Ideal all purpose replacement control - individually boxed in our colorful carton carrying the RSE quality seal of approval.



Full range of sizes - with attached switches!

10 M ohms	<b>59c</b> each
15 M ohms	
25 M ohms	<b>55.00</b> per 100 assorted
50 M ohms	
100 M ohms	
250 M ohms	
500 M ohms	
1 Meg ohms	
2 Meg ohms	
500 M Knurled Shaft	
500 M ohms less switch, 39c ea. 100 for \$35.00	

## A STAR STUDDED STOCK



And every item a "Star Studded Item" - only standard merchandise by nationally known manufacturers is ever advertised by RSE. Remember our policy - your money back if not 100% satisfied!

## PHONO PICKUP CRYSTALS

Standard types - Set Manufacturers close-out - all Guaranteed



P30-W60 - One of the newest and finest - osmium tipped permanent needle - 1.8 volts output - fits standard mounting holes. List price \$7.50 you pay us..... **2.69**



P93-W57A - stamped metal case - pin type terminals - 3/4 oz. pressure - 1.6 volt output - 5000 cycle cutoff. List price \$5.55 - Our special..... **1.98**



L70 - new postwar design - solder terminals - 1 1/4 oz. pressure - 1 volt output - 4000 cycle cutoff List price \$5.55 - we quote you..... **1.98**



L75 - another new type - 1 1/4 oz. pressure - .75 volt output - 6000 cycle cutoff. List price \$5.55 - 64% off..... **1.98**



L40 - the prewar favorite in a die cast case - used in millions of phonographs - solder terminals - 1 1/4 oz. pressure - .6 volt output - 4500 cycle cutoff. List price \$4.45 - your cost..... **1.98**

## SEND FOR FREE CATALOG



DEMAND THIS SEAL OF QUALITY

## ORDER INSTRUCTIONS

Include full remittance with orders of \$3.00 or less. Include 25% deposit with all C.O.D. orders of \$3.00 or more. All shipments sent express collect if postage is not included. Prices subject to change without notice. BE SURE TO INCLUDE SUFFICIENT POSTAGE. EXCESS WILL BE REFUNDED.

## MODEL 451A AC-DC Volt-Ohm-Meter



A dependable instrument of wide utility - sensitivity 1000 ohms per volt. Ranges: Volts AC, DC, and Output Ranges: 0-10/50/100/500/1000. Ohms full scale, 500,000. Ohms center scale, 7200.

TEST LEADS **.59**

NET complete with batteries..... **14.90**



## MODEL 312 Volt-Ohm-Milliammeter

An economy pocket meter featuring a 2" moving vane meter. Reads: AC-DC volts, 0-25/50/125/250; Mills AC-DC, 0-50; Ohms, 100,000; mfd., .05-15. Jacks provide range selection

TEST LEADS **.59**  
NET Complete with cord and plug.... **6.75**

## OZ4 TUBES



New, guaranteed, made by the only maker of OZ4's. Buy now! Hit that car radio business hard - \$2.20 List - 60% or more off - limited quantity

In colorful RSE box **88c**

Egg crate of 100 **\$.79.**

## PAPER BY-PASS CONDENSERS



Name brand condensers made by a prominent eastern manufacturer! Regular nationally advertised "jobber - serviceman line"! New, fresh, full capacity standard merchandise - not surplus - all guaranteed! Check the list prices

- our low nets - no need to figure the discount - buy 'em now, they've hit bottom!

Mfd.	Volts	List Price	Net Each	Per 100
.01	600	30c	10c	\$ 9.15
.02	600	30c	11c	\$ 9.95
.05	600	40c	14c	\$12.95
.1	600	45c	16c	\$14.95

Quantity Prices not assorted.

# RADIO-ELECTRONIC CIRCUITS

## DUAL TEST INSTRUMENT

This simple instrument is inexpensive to construct and requires nothing more than a 35Z5 tube, a small neon lamp, a fixed crystal, a potentiometer, a few condensers and miscellaneous hardware. It is divided into 2 sections: a signal

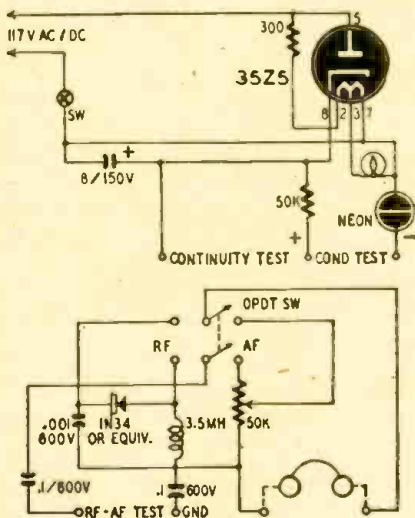

tracer and a condenser checker. A d.p.d.t. switch changes the tracer from a.f. to r.f. A potentiometer is used to reduce headphone volume if the a.f. signal is too loud.

In the r.f. position, a crystal detector in series with the headphones demodulates the carrier to give an audible signal.

In the second section, a 35Z5 half-wave rectifier supplies d.c. for testing condensers. A good condenser across the test jacks causes the neon lamp to flash momentarily. It remains lit continuously on a shorted condenser, and an open one does not light the bulb at all.

For continuity testing, the neon lamp is in series with the d.c. high voltage. Continuity across the test jacks causes it to light.

This tester can be built into a small cabinet and is small enough for portable use.

ROBERT D. JOSBURY,  
Binghamton, N. Y.

## ELECTRONIC RELAY

This circuit is the result of experiments with apparatus where the need for detecting very small changes in resistance was important. The sensitivity of this circuit is so high that, with a

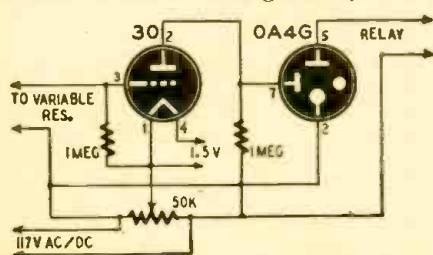

photocell connected across the input, it can easily detect the presence of cigarette smoke. Other types of variable resistors, such as carbon microphones or thermistors, can be used with similar results. It may be necessary to vary the grid leak for greatest sensitivity. Any general-purpose triode such as the 6C5 may be substituted for the type 30.

EDGAR ALEXEFF,  
Pittsburgh, Pa.

## SIGNAL GENERATOR

Here is an easily-built signal generator that can be used for trouble shooting and receiver alignment. The oscillator frequency range is from 300 to 1800 kc. Once calibrated, it is quite stable. An audio note of approximately 400 cycles is supplied by a neon-bulb oscillator. The unit uses an a.c.-d.c. power supply, but is not grounded to the line.

The coil is 140 turns of No. 28 enameled wire, close-wound on a 1 1/4-inch form. The oscillator may be a 12BE6, 12SA7, 6SA7, or similar tube. A 2,000-

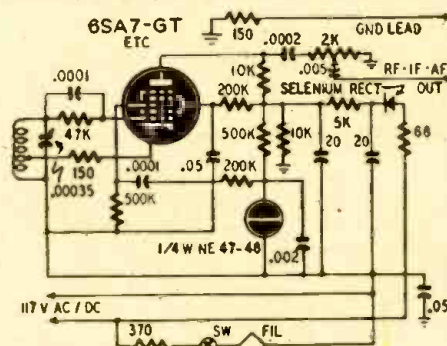

ohm potentiometer serves as an output attenuator.

CLARENCE WILLIAMS,  
New York, N. Y.

## T.R.F. TUNER

This novel t.r.f. tuner uses two 7F8 dual triodes and gives complete broadcast-band coverage. One section of the first 7F8 is used as a grounded-grid

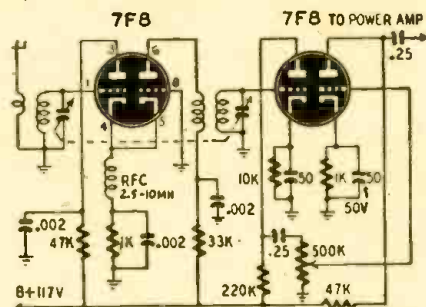

amplifier for greater circuit stability. The second tube is used as a detector and audio amplifier. Sufficient output is available to drive a pair of headphones. An additional amplifier stage may be used to power a speaker. A 2-gang, 365- $\mu$ f-per-section, variable condenser is

used for tuning, and the coils are a standard air-core-type matched set. Better results should be obtained, however, with shielded, powdered-iron-core coils.

JAMES C. SOUKUP,  
Chicago, Illinois

## AUDIO AMPLIFIER

In this 3-tube audio amplifier circuit a 35Z5 is used in an a.c.-d.c. power supply, and an inverse feedback arrangement from the plate of the 50L6 to the

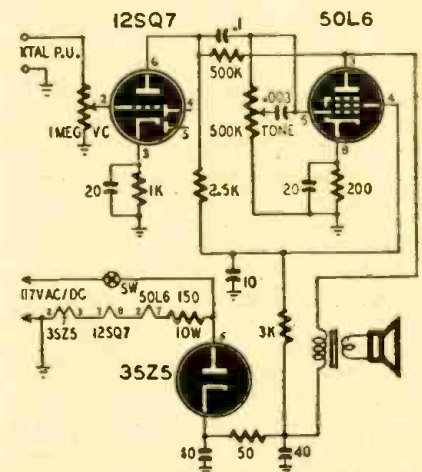

plate of the 12SQ7 improves the frequency response for good quality reproduction.

A high-output pickup should be used with this amplifier.

BILL GUFFY,  
Freeport, Illinois.

## PHONO OSCILLATOR

This battery-operated phono oscillator is ideal for rural areas. The oscillator tube is a 1T4 and is screen-grid-modulated. The oscillator coil is a Meissner 14-1028, but any equivalent coil can be used.

Although a preamplifier is desirable, it is not necessary. Sufficient output is

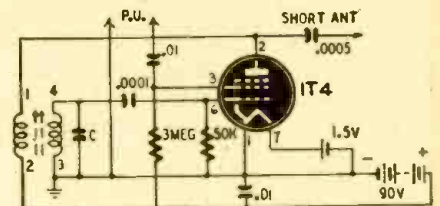

obtainable with a 3-foot antenna for pickup within a short distance.

A standard permeability-tuned oscillator coil is used and a fixed trimmer condenser across it tunes it to the desired frequency range. Final tuning is done by varying the iron core. Condenser values for different ranges are:

- 500  $\mu$ f 500—800 kc
- 150  $\mu$ f 800—1200 kc
- 50  $\mu$ f 1200—1700 kc

FRANKLIN H. STEWART,  
Lexington, Ky.

**MONEY BACK GUARANTEE** — We believe units offered for sale by mail order should be sold only on a "Money-Back-If-Not-Satisfied" basis. We carefully check the design, calibration and value of all items advertised by us and unhesitatingly offer all merchandise subject to a return for credit or refund. You, the customer, are the sale judge as to value of the item or items you have purchased.

## The Model 88-A COMBINATION **SIGNAL GENERATOR AND SIGNAL TRACER**

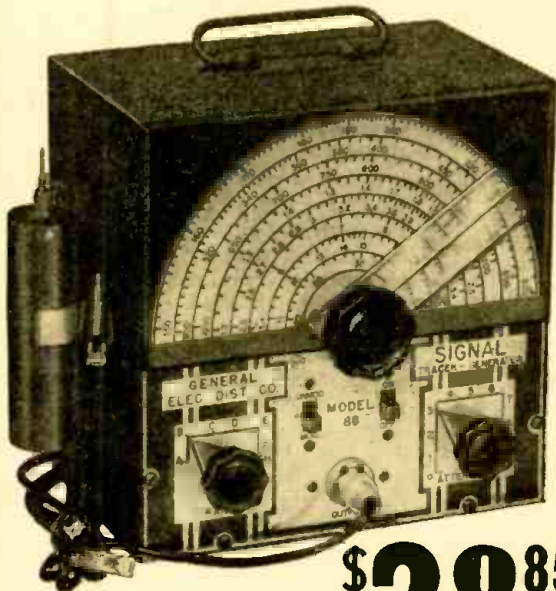

The Model 88 comes complete with all test leads and operating instructions.

**ONLY \$28<sup>85</sup> NET**

We're prepared for the demand we know will be created by this long overdue combination of the two units which have always been used together. The ultimate in signal tracing procedure is achieved by the Model 88, for the use of this model, enables you to use either the broadcast signal itself or the signal injected by the Signal Generator. This is especially useful of course when servicing "dead" or "intermittent" receivers. The Model 88 you will find is the greatest time-saver ever provided for by combining a full range Signal Generator and Signal Tracer into one unit the set up time for interconnecting, etc., is entirely eliminated.

**Signal Generator Specifications:**

- ★ Frequency Range: 150 Kilocycles to 50 Megacycles.
- ★ The R.F. Signal Frequency is kept completely constant at all output levels. This is accomplished by use of a special grid loaded circuit which provides a constant load on the oscillatory circuit. A grounded plate oscillator is used for additional frequency stability.
- ★ Modulation is accomplished by Grid-blocking action which has proven to be equally effective for alignment of amplitude and frequency modulation as well as for television receivers.
- ★ Positive action attenuator provides effective output control at all times.
- ★ R.F. is obtainable separately or modulated by the Audio Frequency.

**Signal Tracer Specifications:**

- ★ Uses the new Sylvania 1N34 Germanium crystal Diode which combined with a resistance-capacity network provides a frequency range of 300 cycles to 50 Megacycles.
- ★ Simple to Operate—Clips directly on to receiver chassis, no tuning controls.
- ★ Provision is made for insertion of phones of any impedance, a standard Volt-Ohm Milliammeter or Oscilloscope.

## The New Model 777 20,000 OHMS PER VOLT!!

# TUBE & SET TESTER



**SPECIFICATIONS:**

- Tests all tubes including 4, 5, 6, 7, 7L, Octals, Loctals, Television, Magic Eye, Thyratrons, Single Ended, Floating Filament, Mercury Vapor Rectifiers, New Miniatures, etc. Also Pilot Lights.
- Tests by the well-established emission method for tube quality, directly read on the scale of the meter.
- Tests leakages and shorts of any one element against all elements in all tubes.
- Tests both plates in rectifiers.
- Tests individual sections such as diodes, triodes, pentodes, etc., in multi-purpose tubes.
- New type line voltage adjuster.

**V.O.M. SPECIFICATIONS:**

- D.C. VOLTS: (at 20,000 Ohms Per Volt) 0 to 7.5/15/75/150/750/1,500 Volts
- A.C. VOLTS: (At 10,000 Ohms Per Volt) 0 to 15/30/150/300/1,500/3,000 Volts
- D.C. CURRENT: 0 to 1.5/15/150 Ma. 0 to 1.5 Amperes
- RESISTANCE: 0 to 5,000/50,000/500,000 Ohms 0 to 50 Megohms
- DECIBELS: (Based on zero decibels equals .006 Watts into a 500-Ohm line.) -10 to + 18 db., + 10 to + 38 db., + 30 to + 58 db.

Model 777 operates on 90-120 Volts 60 cycles A.C. Housed in beautiful hand-rubbed cabinet. Complete with test leads, tubes, charts and detailed operating instructions. Size 13" x 12½" x 6".

**\$59<sup>95</sup> NET PRICE**

20% DEPOSIT REQUIRED ON ALL C.O.D. ORDERS

**GENERAL ELECTRONIC DISTRIBUTING CO. DEPT. RC-3 98 PARK PLACE, NEW YORK 7, N. Y.**

# free radio book

RADIOS  
HAM  
P. A.

Best coupon for buying guide to the best values in Radio, Home and P. A. Equipment. Send too for the newest floor jam-packed with bargains.

## Spot-lite Values

performs comparable to large bench type units only **\$19.95**



Pocket Size FM Signal Generator Model 720

Here's a Lafayette super-value for FM servicing and alignment. Uses 4 fixed frequencies: 10.7 mc for I.F., 88 mc for the low end, 98 mc for mid-point and 108 mc for top end of F.M. band. Complete with tubes, selenium rectifier and output cable. Hammertone grey case housing. Size: 3" x 6" x 2 1/4". Wt.: 2 lbs. No. K21481.

Model 205 Automatic Record Changer

One simple control for On, Off, Reject. Plays a full stack of 10 twelve inch or 12 ten inch records at one loading. Extremely light tangent tone arm, saves record wear. Size: 11" x 11 1/2" x 7". Wt. 12 lbs. No. K22501.

fine quality tone reproduction

only **\$16.95**

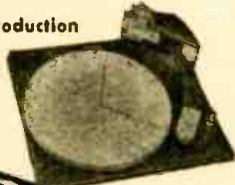

from Lafayette

MAIL NOW

New York  
100 SIXTH AVE.  
110 Federal St., Boston 10  
24 Central Ave., Newark 2

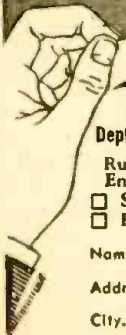

Lafayette Radio

RADIO WIRE TELEVISION, INC.  
Dept. JC-8, 100 Sixth Ave., New York 13,  
Rush Catalog #88  Flyer #C41   
Enclosed is check or money order for:  
 Signal Generator K21481. at \$19.95 ea.  
 Record Changer K22501 at \$16.95 ea.

Name.....  
Address.....  
City..... Zone..... State.....

# TRY THIS ONE

## SPEAKER REPAIRS

I have a simple method of repairing speakers with warped cones or voice coils. Apply a good radio solvent to the cone in a half-inch circle around the voice coil. Let it soak for a few minutes and remove the dust cover. By this time, the portion of the cone that has been dampened with solvent will be extremely flexible. Place shims between the coil and the pole. Allow the solvent to dry. Then apply a coat of speaker cement on the half-inch circle around the voice coil. When the cement is thoroughly dry, remove the shims and replace the dust cover. If the job has been done carefully, the speaker will probably give many more months of trouble-free service.

ELLIS W. BRAKE,  
Downs, Kansas

## SCREW STARTING TOOL

Useful for starting screws, rivets, and nuts in close quarters, this handy little tool is made by making 2 slits in the end of a thin piece of spring steel that may be obtained from a clock spring or corset stay. The slots are spaced at a distance equal to slightly more than the diameter of the screw being used. To

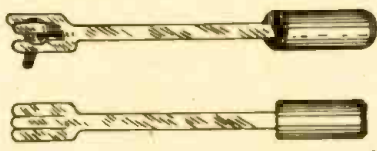

use, pull up on the center tab and insert the screw so its head rests on the outside tab and is held in place by the middle one. A suitable handle may be made from wood or plastic.

WM. GAMBONEY,  
Chicago, Ill.

## SIGNAL TRACER KINK

If the probe on your signal tracer is not long enough to reach inaccessible parts of a circuit, this extension should prove very handy. Solder a tip jack to the end of a brass tube from the inside of a ball-point pen and plug the probe into it. The tube should be insulated to avoid shorts.

FRANK RIZZO,  
Corona, L. I., N. Y.

## BINDING RADIO-CRAFT

Here is my suggestion for binding RADIO-CRAFT. Drill 3 holes along the back edge of the stack of magazines. Using a good grade of linen twine and a darning needle, pass the twine through one of the holes, tie a slip knot and pull taut. Open the stack between the first and second issues and pass the twine around the cord running through the hole. Pull the cord snug and do the same between each copy. Repeat the procedure with the remaining holes.

This method binds each issue securely to the next, and the volume will not break across the back when opened.

OLE B. RITCHEY,  
Roscommon, Mich.

## PHONO PLUG

Here is an easily made phono plug that works very well. It is made of a tube prong, a grid cap, a length of shielded wire, and a fiber washer. It

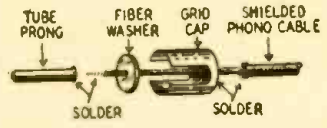

takes only a few minutes to assemble and the parts can be found in practically any workshop scrap pile.

HARRY KUNDRAT,  
Garwood, N. J.

## TEST PROD

An automatic pencil of the push-to-feed type can be converted into a small-pointed test prod suitable for trouble shooting in compact and closely wired circuits.

Select a pencil with a plastic barrel. Unscrew the tip. After removing the magazine by shaking it out through the top, cut off about 1/2 inch and solder a lead to the remainder. Slide a medium-sized sewing needle into the spring-operated collet chuck by pushing back on spring-loaded collar, and reassemble the parts. This makes an unusually good test prod.

M. R. KUHL,  
San Diego, Calif.

## SPEAKER REPAIR

Thin chamois is ideal for repairing torn speaker cones. Cut a small piece to cover the tear and fasten it in place with speaker cement. Chamois does not reduce the bass response of the speaker as more commonly used materials are likely to do.

RAY NOWACK,  
Philadelphia, Penna.

## CHANGER HOLDER

An old kitchen chair with flaring legs and the back removed makes a handy rack for servicing record changers. Placing the seat of the chair on the bench and the changer between the legs makes it easy to watch the changing cycle. The flaring chair legs will accommodate all sizes of record changers which jam.

HARRY K. AJOOTHIAN,  
Lynn, Mass.

## BINDING POSTS

If you use a storage battery around the shop, simple connectors can be made by drilling a hole in the center of each binding post and screwing in 2 self-tapping screws. Small alligator clips may be clamped on the screws for quick, clean connectors.

A. L. SKALICKY,  
Mangum, Oklahoma.

(If you insert machine screws in the holes, you can cut off the heads, add 2 nuts to each screw, and use them for binding posts adaptable for clips or spade-type terminals.—Editor)

TERMS: CASH WITH ORDER  
Address Orders to Dept. B

# AMERICAN SURPLUS PRODUCTS CO.

537 N. CAPITOL AVE.  
INDIANAPOLIS, IND.

## WAR SURPLUS BARGAINS Sold As Used Unless Otherwise Specified!

### ARC-4 TRANSMITTER AND RECEIVER

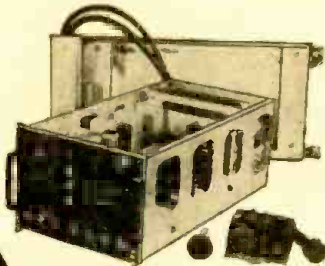

INCLUDING CASE

**\$17<sup>95</sup>**

Operates on any of its 4 predetermined crystal controlled frequencies in the range of 140 MC. Complete with tubes, remote control, junction box, shock mounting base and connecting plugs. This unit is ideal for amateur UHF or mobile telephone. Operates from self-contained 24 V DC dynamotor.

### INTERVALOMETER

Electronic timing device for releasing bombs at preset intervals. Ideal for dark room timer, model train controller, etc. Contains relays, switches, pilot light, resistors, knobs, etc. Approximate weight, 7 lbs.



**\$195**

### MARKER BEACON RECEIVER

Ideal for controlling remote circuits for model aircraft, boats, etc. Operates from 75 mc. Signal easily altered to 2 mefer band. Tubes used and included: 1-6SH7, 1-6SL7GT, 1-12SN7GT.

Also sensitive relay. Circuit diagram included inside case. Size 5 3/8" x 3 3/8" x 5 1/4". For 24 V. DC operation. Complete as shown.

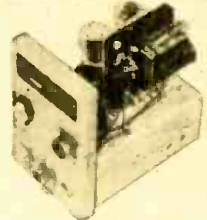

**\$3<sup>95</sup>**

### NAVY CRV-46151 AIRCRAFT

#### RADIO RECEIVER

INCLUDING CASE

**\$19<sup>50</sup>**



Four bands, including broadcast (195-9,050 KC). Circuit is six-tube superheterodyne with mechanical band change or remote operated electrical band change. Remote band change and tuning controls included, making this set readily adaptable to mobile ham use. Powered from self-contained 24 V DC dynamotor. The sets are complete with tubes, mounting rack and remote controls. No cables.

ONLY  
**\$31<sup>50</sup>**



### R5/ARN-7 RADIO COMPASS REC.

Three bands 200 to 1750 K.C. Complete with 17 tubes required. This set is ideal for conversion to home broadcast Receiver, addition to ham shack, etc. Reported sold for many times the price when brand new. A Receiver that would be hard to pick up at this price. Control head for above available.



#### ALTIMETER

Sensitive Altimeter **\$12.50 ea.**



#### Magnetic COMPASS

Luminous compass made for U. S. Army.

**\$6<sup>00</sup> ea.**

### FOR THE BEST IN SURPLUS BARGAINS! LOOK TO AMERICAN SURPLUS PRODUCTS

#### New WILLARD RECHARGEABLE STORAGE BATTERIES



New 6 volt battery in spill-proof clear plastic case, housed in metal case for easy mounting. Applicable for a wide range of uses where battery power is needed. Shipped dry. Uses standard battery electrolyte available everywhere.

Price, each.....	<b>\$4.00</b>
Lots of Ten.....	<b>3.35</b>
Without metal case, each.....	<b>3.00</b>
Lots of Ten.....	<b>2.85</b>

Your orders receive our **IMMEDIATE ATTENTION**

ALL PRICES F.O.B. Indianapolis

### RADIO ALTIMETER APN/1



A complete 460 mc. radio receiver and transmitter which can be converted for ham or commercial use. Tubes used and included: 4-12SH7, 3-12SJ7, 2-6H6, 1-VR150, 2-955, 2-9004. Other components such as relays, 24 V dynamotor, transformers, pots, condensers, etc., make this a buy on which you can't go wrong. Complete as shown in aluminum case 18 x 7 x 7/4.

**\$8<sup>95</sup>**

### OXYGEN TANKS



#### Specially Priced

These oxygen tanks, removed from surplus aircraft have a capacity of 500 lbs. pressure. Type D2, with complete regulator assembly. Size of tank 22"x5".

**\$5<sup>95</sup>**

## SURPLUS BARGAINS! AMERICAN SURPLUS PRODUCTS CO.

537 N. CAPITOL AVE.  
INDIANAPOLIS, IND.

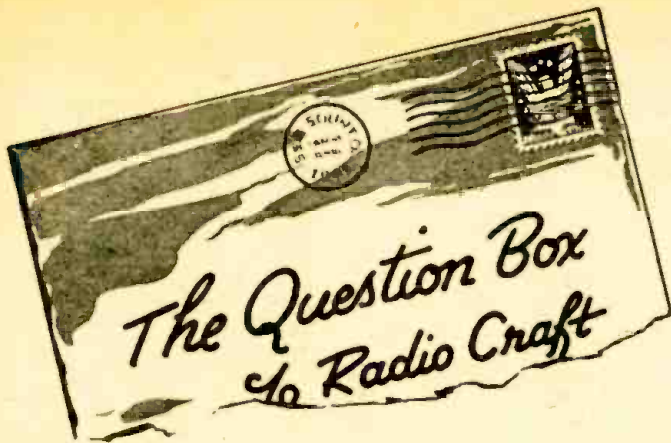

Question Box queries will be answered by mail and those of general interest will be printed in the magazine. A fee of 50c will be charged for simple questions requiring no schematics. Write for estimate on questions that may require diagrams or considerable research. Six to 8 weeks is required to draw up answers involving large schematics.

### R.F. POWER SUPPLY

I would like to have a diagram showing how an r.f. power supply may be used to supply high voltage for the cathode-ray tube in the Easy-To-Build Oscilloscope described in the May, 1947, issue of RADIO-CRAFT.—J. W., Tripp, S. Dak.

A. The diagram given shows an r.f. power supply connected to the cathode-ray tube of the 'scope in place of the high-voltage supply used in the original model. Coil-winding data for L1, L2, and L3 and technical details on the supply were given on page 52 of the May, 1947, issue of RADIO-CRAFT. The output voltage may be lowered by reducing the number of turns on L2 or by increasing the size of R1 or R2.

### SURPLUS RECEIVERS

I have 3 surplus receivers, a BC-946, a BC-454, and a BC-455 and a PE-103-A dynamotor. Please show how I may connect the dynamotor to operate the receivers. I plan to use a 12-volt storage battery for primary power. I want to operate the BC-946 separately and the

BC-454 and BC-455 together.—C.P.J., Detroit, Mich.

A. For 12-volt operation, the filament circuits of each receiver should be rewired so the heaters are in parallel. Connect a jumper between pins 6 and 7 on jack J1 of each receiver. A gain control for each receiver may be connected as shown.

Switch S1 controls the dynamotor. Do not close it until the receiver tubes have heated. S2 is the receiver selector switch.

### 600-WATT AMPLIFIER

Please print a diagram of a 600-watt final amplifier using an HF-300 modulated with a pair of 813's. I plan to drive it from a 30-watt exciter. I have a 30-watt speech amplifier suitable for driving the modulators.—J.H.S., Tampa, Fla.

A. The amplifier diagrammed will deliver about 410 watts output on c.w. or 385 watts on phone when the plate current is reduced to 250 ma. The exciter is coupled to the amplifier through a length of 72-ohm co-axial cable. Multi-match driver and modulation transformers are recommended. The latter should handle 300 watts of audio in the primary and 350 ma in the secondary. Cathode

metering is used in the amplifier and modulator.

Use 30-watt coils in the grid circuit and 500-watt or 1-kw coils in the plate circuit. The neutralizing condenser should have sufficient spacing at 6.5  $\mu$ f to prevent arcing when the amplifier is modulated. The spacing should be at least 0.375 inch.

To apply fixed bias to the final amplifier, remove the 10,000-ohm grid leak from the circuit and connect the negative terminal of a 300-volt supply to the positive side of the grid-current meter.

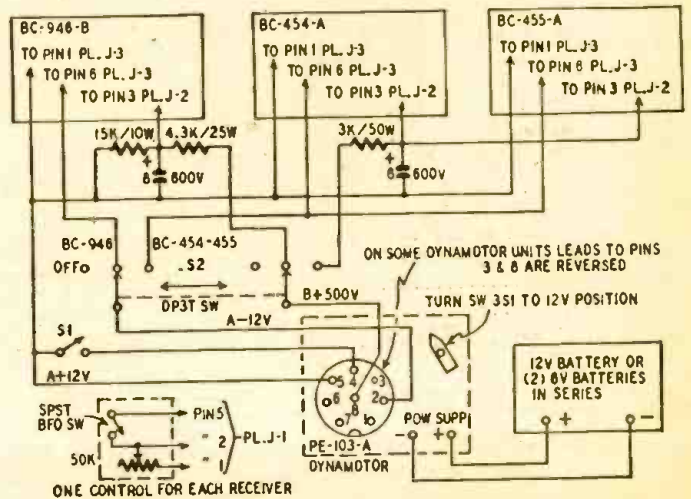
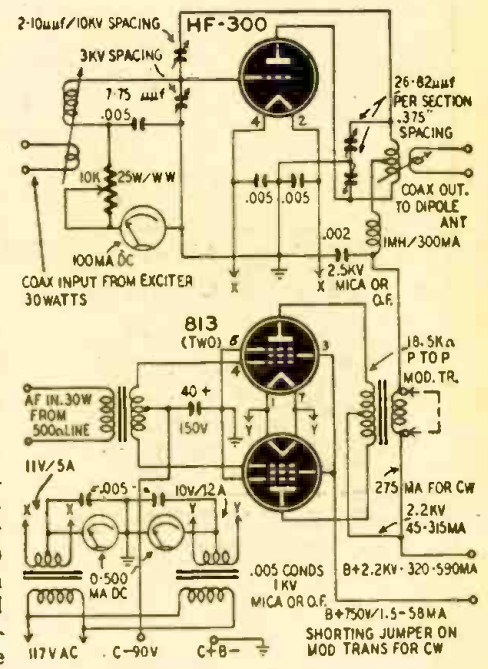
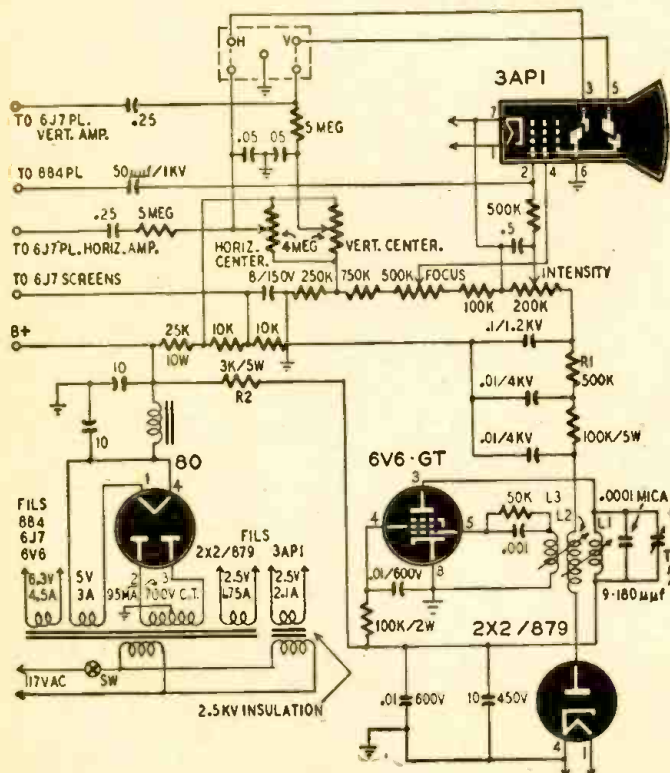

Left—R.F. power supply for use with the Easy-To-Build Oscilloscope. Above—Control panel for SCR-274-N surplus radio receivers.

# BIG MONEY IN RADIO

SEE THESE BRAND NEW  
RADIO BOOKS **FREE**

## COYNE'S *New 5 Volume Set* "APPLIED PRACTICAL RADIO"



You men who want to go places in Radio, and who know how much a solid working knowledge of the field helps to get the big money—this is IT! Over 1500 pages of down-to-earth Radio, from simplest principles to newest Television! It's all there easy to understand—how and why it works . . . how to construct, install, service, PA, short-wave, auto-radio, aviation, radio-phonographs, FM, testing instruments and trouble-shooting short-cuts, phototubes—you name it, COYNE'S got it, in "Applied Practical Radio"!

GET THIS BOOK  
**FREE**  
for LOOKING  
AT SET



Brand New!  
Explains circuits  
of latest sets.

**PRACTICAL! CLEAR! COMPLETE!**

5 big volumes—1000 illustrations and diagrams, with step-by-step photographs which "break down" the equipment for you to show what makes it "tick". Up-to-the-minute, complete, easy to follow . . . written as only COYNE books are written!

SEE IT  
FREE  
FOR  
7 DAYS

JUST OFF THE PRESS

VALUABLE BOOK FREE for Looking at 5-Volume Set

Send This Coupon  
**NOW**

You must SEE these books to know how easy it is to prepare for the big jobs in radio. Here's our special offer:—we'll send the complete 5-volume set for your 7-Day FREE Examination. And with it, we'll include our valuable, new guide for all radiomen, "150 New Radio Diagrams Explained", absolutely FREE! If you keep the 5-volume Set all you pay is \$3.00 within 7 days after the books arrive and \$3.00 per month until \$16.75 is paid—or you can pay \$15.00 cash price. If you don't want the set, return it and you OWE NOTHING. But either way you keep the "150 Radio Diagrams Book" as a gift. That book is ABSOLUTELY FREE.

SEND NO MONEY REMEMBER Coupon is not an order, just a request to see set free and get the FREE BOOK. But offer is limited, so act at once!

EDUCATIONAL BOOK PUBLISHING DIVISION  
COYNE ELECTRICAL & RADIO SCHOOL  
Dept. 38-T1, 500 S. Paulina St., Chicago 12, Ill.  
O. K., send me postpaid your new 5-volume set, "Applied Practical Radio" on 7 days free trial per your offer in Radio-Craft. Be sure to include the book of 150 New Radio Diagrams Explained, absolutely FREE.

NAME \_\_\_\_\_  
ADDRESS \_\_\_\_\_  
TOWN \_\_\_\_\_ ZONE \_\_\_\_\_ STATE \_\_\_\_\_

**COYNE** ELECTRICAL & RADIO SCHOOL (Founded 1899)  
500 S. Paulina St., Dept. 38-T1, Chicago 12, Ill.

### BROAD-BAND AMPLIFIERS (Continued from page 27)

frequency response; particularly on the low-frequency end.

#### Additional limitations

In some cases, a blocking condenser, C<sub>b</sub>, is required between the signal source and the grid of the amplifier tube. Since the reactance of a condenser varies inversely as frequency, C<sub>b</sub> and R<sub>g1</sub> will appear as a voltage divider. The voltage on the grid, E<sub>g</sub>, is found from the equation

$$E_g = E_s \times R_{g1} / \sqrt{R_{g1}^2 + X_{cb}^2} \quad (8)$$

where E<sub>s</sub> is the input signal voltage, R<sub>g1</sub> is the input grid leak and X<sub>cb</sub> is the reactance of C<sub>b</sub>. At 40 cycles, the reactance of C<sub>b</sub> is 1.3 megohm and at 2,000 cycles, it is 23,000 ohms. Using these values of reactance in Eq. 8, we find E<sub>g</sub> to be 0.152 volt at 40 and 0.249 volt at 2,000 cycles when E<sub>s</sub> is 0.25 volt. We see, again, that the reactance of a coupling condenser limits low-frequency response.

Whenever cathode bias is used, there is danger of degeneration at low frequencies. The plate current, modulated by the signal on the grid, passes through the cathode biasing resistor. If this is unbypassed, the bias varies with the grid  
(Continued on page 59)

$$G_{if} = 1400 \text{ (mhos)} \times 0.00001 \left( \frac{500,000 \times 1,000,000 \times 1,000,000}{500,000 \times 1,000,000 + 500,000 \times 1,000,000 + 1,000,000 \times 1,000,000} \right)$$

$$= .0014 \left( \frac{500,000}{2} \right)$$

$$= .0014 \times 250,000 = 350$$

EXAMPLE 1

At 40 cycles X<sub>ck</sub> = 995 ohms

$$G = \frac{350}{1 + \left[ .0014 \left( \frac{2200 \times 995}{\sqrt{(2200)^2 + (995)^2}} \right) \right]} = \frac{350}{1 + \left[ .0014 \left( \frac{2,189,000}{\sqrt{5,830,025}} \right) \right]}$$

$$= \frac{350}{1 + \left[ .0014 \left( \frac{2,189,000}{2414} \right) \right]} = \frac{350}{1 + (.0014 \times 906)}$$

$$= \frac{350}{1 + 1.2684} = \frac{350}{2.2684} = 153.8$$

At 2000 cycles, X<sub>ck</sub> = 20 ohms

$$G = \frac{350}{1 + \left[ .0014 \left( \frac{2200 \times 20}{\sqrt{(2200)^2 + (20)^2}} \right) \right]} = \frac{350}{1 + \left[ .0014 \left( \frac{44,000}{\sqrt{4,840,400}} \right) \right]}$$

$$= \frac{350}{1 + \left[ .0014 \left( \frac{44,000}{2200.9} \right) \right]} = \frac{350}{1 + .0278} = 343$$

EXAMPLE 2

**CAPITOL RADIO ENGINEERING INSTITUTE**

Pioneers in Radio Engineering Instruction — Since 1927

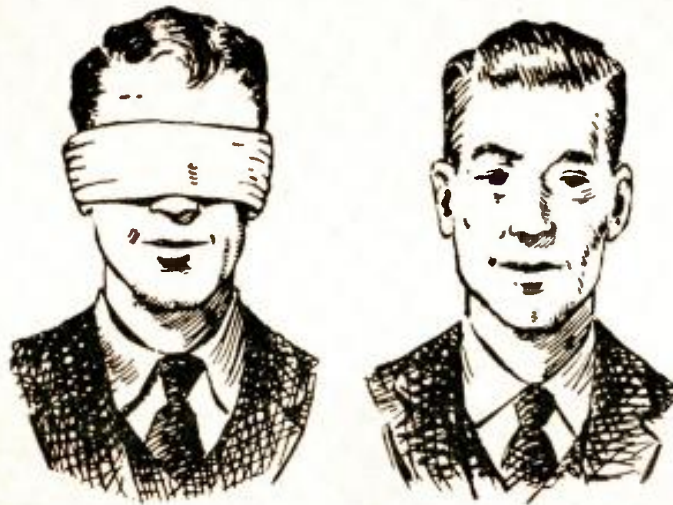

# Who Will Get the Better Job?

**The Serviceman Who Looks Ahead Will Get Ahead**

Don't play blind man's bluff with your future! Are you, like many other professional servicemen, so wrapped up in your present routine work that you are losing sight of where you will be tomorrow?

Look at the successful serviceman. You'll find that he's the fellow who looked and *planned* ahead. Today, as a member of the great radio-electronic industry, you have opportunities that few men ever enjoyed in the past. Your future success can be assured by the plans *you* make *today*.

The radio industry is expanding so fast, that it is doubtful any serviceman can truthfully say he has kept pace with all the major developments. Thousands of new men have joined the ranks of the radio industry creating new competition for you. New developments create demands for more advanced technical ability. You can't afford to be a "pre-war model". You must "re-tool" your

technical knowledge in order to keep pace.

If you are wise, you will look ahead and start now to increase your technical ability with the thorough, practical technical training for which thousands of professional servicemen have enrolled with CREI since 1927. This is real, honest-to-goodness practical engineering training that leads to better jobs presented by modern radio, electronics and television, and security in the knowledge that you are capable of coping with tough problems.

CREI courses are still available at pre-inflation prices and today give you *more thorough instruction service* per dollar than ever before—on convenient terms. It costs you nothing to read the interesting facts. Please write today.

**VETERANS:** CREI Training Is Available Under the "G.I." Bill!

**MAIL COUPON FOR FREE BOOKLET**

*If you have had professional or amateur radio experience and want to make more money, let us prove to you we have the training you need to qualify for a radio job. To help us intelligently answer your inquiry—PLEASE STATE BRIEFLY YOUR BACKGROUND OF EXPERIENCE, EDUCATION AND PRESENT POSITION.*



**Capitol Radio Engineering Institute**

*An Accredited Technical Institute*

DEPT. RC-3 16TH AND PARK ROAD, N. W., WASHINGTON 10, D. C.

Branch Offices: New York (7): 170 Broadway • San Francisco (2): 760 Market St.

**CAPITOL RADIO ENGINEERING INSTITUTE**

16th & Park Rd., N. W., Dept. RC-3, Washington 10, D. C.  
Gentlemen: Please send me your free booklet, "CREI Training for Your Better Job in RADIO-ELECTRONICS", together with full details of your home study training. I am attaching a brief resume of my experience, education and present position.

Check  PRACTICAL RADIO ELECTRONICS  
Course  PRACTICAL TELEVISION ELECTRONICS

NAME .....

STREET .....

CITY.....ZONE.....STATE.....

I am entitled to training under the G.I. Bill.





**MODEL 260  
VOLT-OHM-MILLIAMMETER**

20,000 Ohms per Volt D.C.  
1,000 Ohms per Volt A.C.

Volts, A.C. and D.C.: 2.5, 10, 50,  
250, 1000, 5000.

Milliamperes, D.C.: 10, 100, 500.

Microamperes, D.C.: 100.

Ampere, D.C.: 10.

Decibels (5 ranges): -10 to 52 D.B.

Ohms: 0-2000 (12 ohms center).

0-200,000 (1200 ohms center).

0-20 megohms (120,000 ohms  
center).

Model 260—Size 5 1/4" x 7" x 3 1/8"  
**\$38.95**

Model 260 in Roll Top Safety Case  
—Size 5 3/4" x 9" x 4 3/4". **\$43.75**

Both complete with test leads and  
32-page Operator's Manual\*

**ASK YOUR JOBBER**

**WORTH MORE...  
...COSTS NO MORE!**

For what it buys in sensitivity, precision, and useful ranges, the price of Model 260 has always purchased value far beyond that of even remotely similar test instruments. Today this famous volt-ohm-milliammeter is a finer instrument than ever, with added ranges and with a new sub-assembly construction unmatched anywhere in strength and functional design.

The price is the same. That means, of course, that your investment today buys even more in utility and the *staying* accuracy that distinguish this most popular high-sensitivity set tester in the world.

\*No other maker of test instruments provides anything to approach the completeness of the pocket-size 32-page Operator's Manual that accompanies Simpson Model 260. Illustrated with 12 circuit and schematic diagrams. Printed on tough map paper to withstand constant usage.

**Simpson**  
INSTRUMENTS THAT STAY ACCURATE

SIMPSON ELECTRIC COMPANY • 5200-5218 W. Kinzie Street, Chicago 44, Ill.  
In Canada, Bach-Simpson Ltd., London, Ont.

RADIO-CRAFT for MARCH, 1948

# HERE'S A <sup>Five Tube</sup> RADIO KIT FOR ONLY \$9.95 <sup>complete with tubes!</sup>



## CABINET FREE!

### YOU GET EVERYTHING *Yes*--EVERYTHING YOU NEED

for the complete successful assembly of this excellent radio. No other kit gives you all these features at this extra low cost:

- 5 Tube Superhetrodyne • Tuning from 520 KC to 1590 KC • P.M. Speaker • Built-In Antenna • 456 KC IF • AC DC Current • All Sockets and Terminal Strip riveted into chassis • Automatic Volume Control • Tube Complement — 12SA7, 12SK7, 12SQ7, 50L6, 35W4 • Can Be Aligned Without Servicing Instruments.

Don't delay — take advantage of this sensational value now!

Prices do not include solder and wire.

## Simple to Assemble!

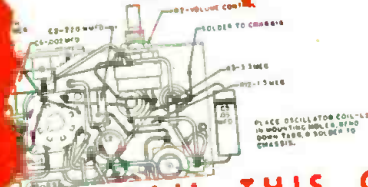

There are no complicated instructions to follow. Everything has been so simplified that you can build this 5 tube kit from only one simple diagram. Positively no previous experience in radio is required. Yes, this is the kit you've always wanted!

**MAIL THIS COUPON TODAY!**

**SENCO RADIO, INC.**  
96A WARREN STREET, NEW YORK 7, N. Y.

Please rush to me \_\_\_\_\_ kits. Enclosed find \$ \_\_\_\_\_

Name \_\_\_\_\_

Address \_\_\_\_\_

City \_\_\_\_\_

Zone \_\_\_\_\_ State \_\_\_\_\_

25% Deposit on All Orders,  
Balance C.O.D., F.O.B. New York

# SENCO RADIO, INC.

96A WARREN STREET • NEW YORK 7, N. Y. • BEEKMAN 3-6498

## TECHNOTES

### ... SILVERTONES

Many Silvertone sets, particularly a.c.-d.c. models, have a grounded dial scale made of metal foil and cardboard. Some of these sets have an ungrounded tuning condenser and a metal dial pointer. Frequently the pointer drags on the scale, causing a noise similar to that caused by dirty condenser plates. As a remedy, adjust the distance between the grounded scale and the pointer.

This also applies to a number of sets by other manufacturers.

R. RICHARDSON,  
Griffin, Ga.

### ... RCA 54B1

A condition of no a.f. output in this model is often traced to the .002- $\mu$ f audio coupling condenser. Replacement with a unit of equal value will restore performance.

OSCAR LEWIS,  
Philadelphia, Penna.

### ... CAMERA-TYPE PORTABLES

If the batteries in camera-type portable radios have a short life, check the lid controlling the switch which often bulges or cracks the cover at the point of pressure. As a result, the switch will not open when the lid is closed. To repair the cover, cement a strip of bakelite or rivet a strip of brass or aluminum to the weak point.

J. SIMRIN,  
Bronx, N. Y.

### ... ZENITH MODEL 6S-152

Fading in the Zenith Model 6S-152 is often caused by the diode load resistor, between the secondary of the second i.f. transformer and the cathodes of the 6H6, increasing its resistance. Replace it with a 400,000-ohm, 1/2-watt unit.

CLAUDE M. PREW,  
New London, N. H.

### ... RCA MODEL 29K

If, when using push-button control, operation is erratic and oscillations develop, check C19, a 2200- $\mu$ f condenser between the rear section of the band switch and the oscillator coil. This condenser is usually defective and should be replaced.

RONOLD L. CHANDLER,  
Ottumwa, Iowa

### ... DISTORTION ON LOCALS

Distortion on local stations and strong carriers is often caused by poor a.v.c. action. Leaky a.v.c. bypass condensers will cause this trouble. Replace them with high grade 600-volt units.

JOHN R. SIMPSON,  
Gainesville, Fla.

### ... P.A. AMPLIFIERS

In many high-gain amplifiers an objectionable hiss develops when the volume control is turned to maximum. This can be eliminated in some cases by connecting a 0.1- $\mu$ f, 600-volt condenser between each side of the power transformer primary and the chassis ground.

ROBERT HALL,  
Canton, N. Y.

# SENSATIONAL VALUES

The New Model 247

## TUBE TESTER

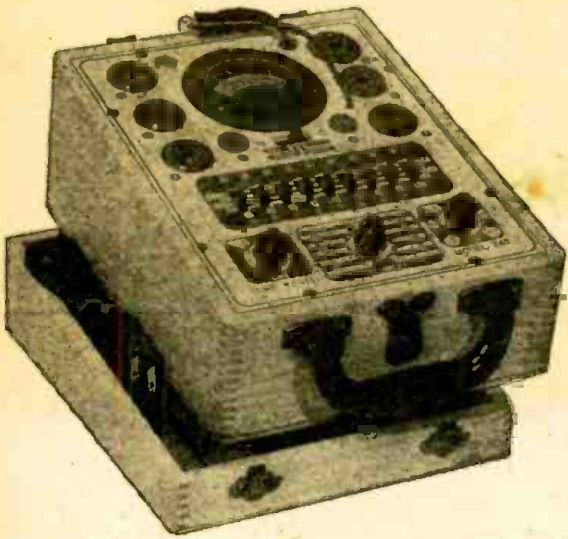

Model 247 comes complete with new speed-read chart. Comes housed in handsome, hand-rubbed oak cabinet sloped for bench use. A slip-on portable hinged cover is included for outside use. Size: 10 1/4" x 8 3/4" x 5 3/4".

ONLY

**\$29<sup>90</sup>**  
NET

**Features:** The Model 247 incorporates a newly designed element selector switch which reduces the possibility of obsolescence to an absolute minimum. Any pin may be used as a filament pin and the voltage applied between that pin and any other pin, or even the "top-cap".

The new free-point system described above permits the Model 247 to overcome the difficulties encountered with other emission type tube testers when checking Diode, Triode and Pentode sections of multi-purpose tubes, because sections can be tested individually when using the new Model 247. The special isolating circuit allows each section to be tested as if it were in a separate envelope.

The Model 247 provides a super sensitive method of checking for shorts and leakages up to 5 Megohms between any and all of the terminals. Continuity between various sections is individually indicated. One of the most important improvements, we believe, is the fact that the 4 position fast-action snap switches are all numbered in exact accordance with the standard R. M. A. numbering system. Thus, if the element terminating in pin No. 7 of a tube is under test, button No. 7 is used for that test.



### The New Model 650 SIGNAL GENERATOR

RANGES:

100 Kilocycles to 35 Megacycles on Fundamentals.  
25 Megacycles to 105 Megacycles on Harmonics.

- \* RF obtainable separately or modulated by the Audio Frequency.
- \* Audio Modulating Frequency—400 cycles pure sine wave—less than 2% distortion.
- \* Attenuation—3-step ladder type of attenuator (T pad).

\* Uses a Hartley Exciter Oscillator with a Buffer Amplifier.

\* Tubes: 6J5 as R.F. Oscillator; 6AS7 as modulated buffer and Mixer; 6SL7 as audio oscillator and rectifier.

Complete with coaxial cable, leads and Instructions.

Reduced from \$48.75

to **\$39<sup>95</sup>**



SEE and HEAR the Signal with the new CA-12

### SIGNAL TRACER

FEATURES:

- Comparative intensity of the signal is read directly on the meter—Quality of the signal is heard in the speaker.
- Simple to operate. Only one connecting cable—No tuning controls.
- Highly sensitive—Uses an improved vacuum-tube voltmeter circuit.

\* Tube and resistor capacity network are built into the detector probe. \* Built-in high gain amplifier—Alnico V speaker. \* Completely portable—Weighs 8 pounds—measures 5 1/2" x 6 1/2" x 9".

Complete with self-contained batteries and instructions

Reduced from \$34.85 to **\$29<sup>95</sup>**



### The New Model 670 SUPER METER

A Combination VOLT-OHM-MILLIAMMETER plus CAPACITY REACTANCE, INDUCTANCE and DECIBEL MEASUREMENTS.

D. C. VOLTS: 0 to 7.5/15/75/150/750/1500/7500.—A. C. VOLTS 0 to 15/30/150/300/1500/3000 Volts.—OUTPUT VOLTS: 0 to 15/30/150/300/1500/3000.—D. C. CURRENT. 0 to 1.5/15/150 Ma.; 0 to 1.5 Amps.—RESISTANCE: 0 to 500/100,000 ohms, 0 to 10 Megohms.—CAPACITY: .001 to .2 Mfd., 1 to 4 Mfd. (Quality test for electrolytics).—REACTANCE: 700 to 27,000 Ohms; 13,000 Ohms to 3 Megohms.—INDUCTANCE: 1.75 to 70 Henries; 35 to 8,000 Henries. DECIBELS: -10 to +18, +10 to +38, +30 to +58.

THE MODEL 670 COMES HOUSED IN A RUGGED, CRACKLE-FINISHED STEEL CABINET COMPLETE WITH TEST LEADS AND OPERATING INSTRUCTIONS. SIZE 5 1/2" x 7 1/2" x 3".

**\$28<sup>40</sup>**  
NET

Available for Immediate Shipment From Stock—20% Deposit Required on All C.O.D. Orders

**MOSS ELECTRONIC DISTRIBUTING CO.**

DEPT. RC-3, 229 FULTON ST.  
NEW YORK 7, N. Y.

MONTH BY MONTH  
FOR VALUE IT'S **SENCO!**

WE'VE GOT PLENTY OF TUBES!

EVERY TUBE IN CARTON		R.M.A. GUARANTEED	
Lots of 10		Lots of 10	
Type	Each	Type	Each
0Z4	69c	7Y4	44c
1A5GT	59	7X7	44
1U5	36	7AF7	44
1V	45	12A6	35
1L4	55	12A8GT	45
1T4	69	12A76	50
1S5	69	12BA6	50
2A5	65	12BE6	50
2A6	79	12J5GT	49
2X2	79	12J7GT	45
3A4	69	12K7GT	45
3Q5GT	55	12K8	65
5U4G	50	12Q7GT	45
5W4GT	40	12SA7GT	40
5Y3GT	40	12SF7	39
5Y3G	42	12SQ7GT	40
5Y4G	40	12SK7GT	45
5X4G	40	12SR7	39
6A7	50	12SJ7GT	55
6A8GT	49	24A	49
6AC5	98	26	39
6AC7	65	27	42
6AK5	74	41	40
6AG7/6AK7	89	42	42
6B7G	55	43	54
6C4	29	45	49
6C5GT	40	47	49
6C6	45	56	49
6C8G	37	57	45
6D6	45	58	45
6F6GT	45	71A	39
6H6GT	45	75	50
6J5GT	45	76	45
6J7GT	42	77	35
6K6GT	45	78	35
6K7GT	49	80	40
6K7G	50	83V	99
6L6G	79	84/6Z4	45
6Q7GT	47	85	49
6S7	59	88	49
6U7G	35	25L6GT	49
6V6GT	45	25Z5	45
6X5GT	49	25Z6GT	45
6SA7GT	44	35W4	43
6SJ7GT	44	35Y4	43
6SK7GT	49	35Z3	44
6SL7GT	49	35Z5GT	43
6SN7GT	49	35L6GT	45
6SQ7GT	44	35/51	49
6SG7	44	50L6GT	50
7B6	44	11Z6GT	89
7B7	44	50B5	42
7F7	49	32L7GT	59
		5Z3	42

- 1625 TRANSMITTING Beam Power. Amplifier. Same as 807 except 12.6 volt filament medium 7 pin base **14c ea.**
- 955 ACORN TUBE Detector Amplifier Oscillator Tube—OD3/VR150 Voltage Regulator **19c ea.**
- 336A/3B27 Half Wave High Rectifier **49c ea.**
- 829 Push Pull twin-unit, Beam power amplifier tube **99c ea.**
- 4E27/HK257B BEAM POWER AMPLIFIER. Only **\$1.49 ea.**
- 4E27/HK257B BEAM POWER AMPLIFIER. Only **\$1.95 ea.**

- VOLUME CONTROLS**
- 250,000 ohms tapped with switch 3" shaft **44c ea.**
  - 500,000 ohms tapped with switch 3" shaft **44c ea.**
  - 1 meg ohms tapped with switch 3" shaft **44c ea.**
  - 2 meg ohms tapped with switch 3" shaft **44c ea.**
  - 500,000 ohms with switch, 2 1/2" shaft **40c ea.**

**Standard Brand AC PHONO MOTOR AND PICKUP**

60 cycles, 115 volts, with Turntable. Complete **\$4.35**

**FREE** NEEDLE CUP with motor and pickup

- SPEAKERS**
- 4" P.M. Speaker **\$1.19**
  - 5" P.M. Speaker **1.15**
  - 6" P.M. Speaker **1.55**
  - 8" P.M. Speaker **2.75**
  - 12" P.M. Speaker **5.49**
  - Alnico 5 Magnet 4x6 Inch Speaker **1.89**

25% deposit on all orders, balance C.O.D., F.O.B. New York

**SENCO RADIO, Inc.**  
96A WARREN ST., N. Y. 7, N. Y.  
TEL. BEEKMAN 3-6498

# New Radio-Electronic Patents

By I. QUEEN

## LOW-FREQUENCY AMPLIFIER

Claudius T. McCoy, Narberth, Pa.  
(assigned to Philco Corp.)  
Patent No. 2,429,419

The frequency range of a resistance-capacitance-coupled amplifier is limited by stray capacitance which reduces the higher frequencies and, by the coupling condenser reactance which decreases the low frequencies. This circuit is designed to maintain a flat response over a wider range than is otherwise possible.

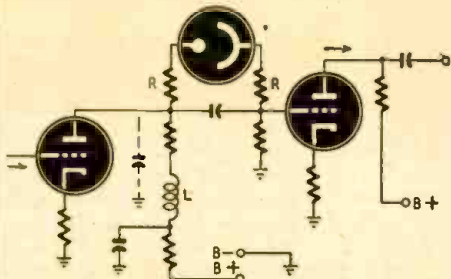

A peaking inductance L is included to extend the high-frequency range. The very low frequencies, down to d.c., are transmitted from one stage to the next through a novel shunt circuit which includes a glow lamp or regulator tube.

The regulator tube is ionized by the potential difference between plate and grid voltages as shown in the schematic. Since it is more effective in passing slow fluctuations than rapid ones, the higher frequencies pass through the coupling condenser as usual while the very low frequencies pass through the tube. For example, if the output voltage of the first stage should increase at a slow rate, the voltage across the regulator would remain constant and therefore the full voltage increase would appear across the grid resistor of the next tube.

The resistors R are isolating resistors of about 100,000 ohms each. They serve to reduce the stray capacitance between regulator tube and ground.

## SENSITIVE D.C. AMPLIFIER

Robert V. Langmuir, Schenectady, N. Y.  
(assigned to Consolidated Engineering Corp.)  
Patent No. 2,431,335

The amplification of weak direct currents must be done carefully so that external noises and other interference will not be included. When the signal is very low, grid currents and fluctuating emission may be as great or greater than the input itself.

The first stage of an amplifier is the most important because the signal is weakest at this point. This inventor has discovered that a type 38 tube makes a suitable preamplifier. Noise and grid currents are greatly reduced by operating the tube with only 5 volts on the screen and 8 volts on the plate. Grid bias is 2 volts, and the grid leak may be as high as 10,000 megohms.

Under the above conditions a gain of 100 is realized with a plate load of 0.5 megohm. The grid current will be less than 2 micromicroamperes, and the grid-cathode resistance is greater than 1 megamegohm.

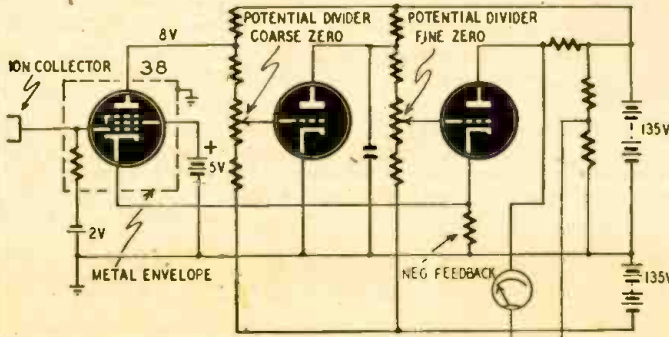

The typical high-gain d.c. amplifier shown in the schematic may be used to detect and measure very weak d.c., such as the output of a mass spectrometer. The first stage uses a type 38 tube as described above. It is enclosed within an evacuated metal envelope to reduce interference. The following stages are conventional. Grid adjustments are used to zero the output meter which is connected in the usual bridge circuit.

## TRANSMISSION LINE MEASUREMENT

John M. Miller, Washington, D. C.  
(may be used by or for U.S. governmental purposes without payment of royalties)  
Patent No. 2,424,249

A convenient method for measuring the resonant frequency of a network or transmission line. The setup shown in the figure is for measurement of a co-axial cable. At resonance a network or line is equivalent to a pure resistance; therefore it will not detune a circuit across which it is placed.

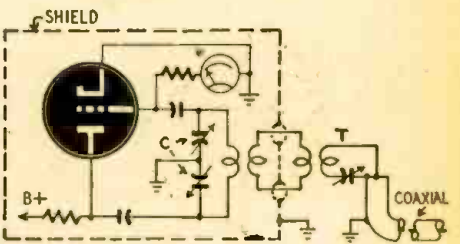

A calibrated oscillator supplies power to a tuned circuit T. The cable input is shorted temporarily, and its far end is left unterminated. The oscillator is then adjusted to the estimated frequency, and the circuit T is tuned to resonance. The line short circuit is removed, and if T is not detuned, the line length is equal to one-quarter wave length at the oscillator frequency.

If T is detuned by the line, the process must be repeated at another oscillator frequency until the resonant frequency is found.

## V.F.O. AMPLITUDE CONTROL

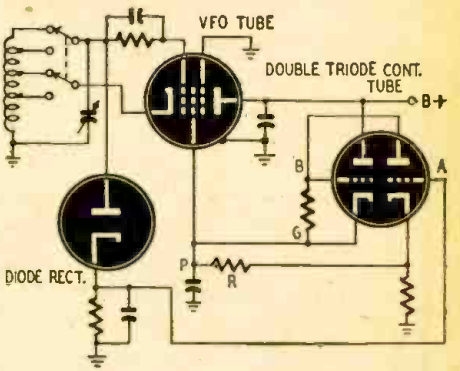

Ronald D. Scheldorf, Haddon Heights, N. J.  
(assigned to Radio Corp. of America)  
Patent No. 2,424,905

It happens that the output of a variable-frequency-oscillator circuit varies considerably as it is tuned to different frequencies. In many cases a readjustment of amplitude may be necessary after tuning.

Automatic compensation is provided by the circuit shown here. A diode rectifies the oscillator output and provides a positive control voltage (C. on pg. 76)

# NOW BUILD 15 RADIOS

COMPLETE KIT  
\$14.75



ABSOLUTELY NO KNOWLEDGE OF RADIO NECESSARY

YOU NEED NO ADDITIONAL PARTS

THE PROGRESSIVE RADIO KIT is the ONLY COMPLETE KIT

Operates on 110-120 volts AC/DC. Contains everything you need. Instruction Book, Metal Chassis, Tubes, Condensers, Resistors and all other necessary radio parts. The 36-page Instruction Book written by expert radio instructors and engineers teaches you to build radios in a professional manner. The first circuit built is a simple one-tube detector receiver. Each succeeding circuit incorporates new arrangements of detectors, RF and AF amplifiers. This kit is excellent for learning the principles of receiver, transmitter and amplifier design. It is used in many radio

schools and colleges. All of the commonly-used detectors are used, including diode, grid leak, plate and infinite-impedance. The transmitters are designed with Hartley and Armstrong oscillators, using screen-grid and control-grid modulation. Both vacuum tube and selenium rectification are employed in these circuits. The circuits are designed to provide excellent performance. Altogether, fifteen circuits are constructed, including 11 receivers, 1 audio amplifier, and 3 transmitters. The sets start with simple circuits of 1 tube plus rectifier, gradually grow more complex, and finish with several examples of radio sets using three tubes plus rectifier.

## SPECIAL FREE OFFER

Electrical and Radio Tester sent absolutely FREE with each Progressive Radio Kit. PLUS FREE membership in Progressive Radio Club. Entitles you to free expert advice and consultation service with licensed radio technicians. Write for further information or ORDER your KIT NOW!

PROGRESSIVE UNIT PRICES ON RADIO KIT	1 Kit .. \$14.75
	2 Kits .. 28.15
	3 Kits .. 41.50



## PROGRESSIVE AMPLIFIER KIT . . . . Only \$15.75

HIGH FIDELITY, HUMLESS AMPLIFIER, SEVEN TUBE PERFORMANCE

necting them to the Progressive Amplifier by means of a contact mike.

Amplifier can be readily modified to match the GE reluctance pick-up.

Separate mike and phono input. Regulated power supply maintains constant voltage supply. DC heater supply, whether amplifier is used on AC or DC, provides humless operation by eliminating cathode-heater leakage hum. Contains degenerative feedback for improved frequency response, balanced phase inversion and push-pull beam power output. Every stage thoroughly decoupled to improve low-frequency response and to prevent motor-boating. Tone and volume controls completely variable.

Seven-tube performance. Uses 2 selenium rectifiers, 2 beam power amplifiers, 1 high-mu pentode mike amplifier, 1 twin-triode phase inverter, and 1 voltage regulator tube.

### PROGRESSIVE UNIT PRICES

ON AMPLIFIER KIT (less tubes and speaker)

1 Kit	..... \$15.75
2 Kits	..... 29.92
3 Kits	..... 42.51

### PROGRESSIVE UNIT PRICES ON TUBES FOR AMPLIFIER KIT

(1-12SL7, 1-12SJ7, 1-VR75, 2-12A6's)

1 set	..... \$3.00
2 sets	..... 5.70
3 sets	..... 8.10

This newest Progressive Kit will enable you to build a newly-designed, high fidelity, humless amplifier.

Beautiful aluminum custom-punched chassis, etched tone and volume control plates.

Designed by former Western Electric engineer.

Ideal amplifier for television kit or set, FM tuner, AM tuner, microphone, phonograph, wire and instantaneous recorders.

Electrify your musical instruments by con-

## RADIO PARTS SCOOP!

NO SURPLUS—ALL PARTS GUARANTEED BRAND NEW!

**55-WATT SOLDERING IRON**  
Famous Make—UL approved  
Regular Price \$2.50  
Buy 1 for \$1.90 and save 60c  
Buy 2 for \$3.60 and save \$1.40  
Buy 3 for \$5.10 and save \$2.40

**CONDENSER KIT**  
50 Paper Tubular Condensers  
Values from .002 mfd. to .1 mfd., 400 v. DC to 600 v. DC.  
Regular Price \$5.00  
Buy 1 Kit for \$1.95 and save \$3.05  
Buy 2 Kits for \$3.80 and save \$6.20  
Buy 3 Kits for \$5.55 and save \$9.45

**RESISTOR KIT**  
100 Carbon Resistors, 1/2 watt, RMA color-coded, values from 120 ohms to 2.2 megohms.  
Regular Price \$5.00  
Buy 1 Kit for \$1.50 and save \$3.50  
Buy 2 Kits for \$2.80 and save \$7.20  
Buy 3 Kits for \$3.90 and save \$11.10

**SELENIUM RECTIFIERS**  
Regular Price \$1.10  
Buy 1 for 79c and save 31c  
Buy 2 for \$1.54 and save 66c  
Buy 3 for \$2.25 and save \$1.05

**12" ALNICO SLUG SPEAKER**  
Regular Price \$8.00  
Buy 1 for \$5.60 and save \$2.40  
Buy 2 for \$10.80 and save \$5.20  
Buy 3 for \$15.95 and save \$8.05

**MIDGET SOLDERING IRON**  
35 watts 110/120 volts  
UL approved  
Regular Price \$1.00  
Buy 1 for 69c and save 31c  
Buy 2 for \$1.30 and save 70c  
Buy 3 for \$1.80 and save \$1.20

**75 WATT SOLDERING IRON**  
Famous Make—UL approved  
Regular Price \$3.00  
Buy 1 for \$2.40 and save 60c  
Buy 2 for \$4.60 and save \$1.40  
Buy 3 for \$6.60 and save \$2.40

**6" ALNICO SLUG SPEAKER**  
Regular Price \$2.35  
Buy 1 for \$1.69 and save 66c  
Buy 2 for \$3.18 and save \$1.52  
Buy 3 for \$4.65 and save \$2.40

**10-10 MFD. 450 W. V. DC ELECTROLYTIC CONDENSERS**  
Regular Price \$1.25  
Buy 1 for 65c and save 60c  
Buy 2 for \$1.24 and save \$1.26  
Buy 3 for \$1.74 and save \$2.01

**20-20 MFD. 150 W. V. DC ELECTROLYTIC CONDENSERS**  
Regular Price 75c  
Buy 1 for 30c and save 45c  
Buy 5 for \$1.40 and save \$2.35  
Buy 10 for \$2.60 and save \$4.90

### LONG NOSE PLIERS AND CUTTERS

Exceptional quality. Hydrized for extra toughness. Diamond-tested cutters.

Regular Price \$1.95  
Buy 1 for \$1.45 and save 50c  
Buy 2 for \$2.70 and save \$1.20  
Buy 3 for \$3.60 and save \$2.25

**25000 OHM WIRE-WOUND POT.**  
1/4" shaft  
Regular Price \$1.00  
Buy 1 for 35c and save 65c  
Buy 2 for 66c and save \$1.34  
Buy 3 for 90c and save \$2.10

**ANTENNA AND RF COIL SET (BROADCAST BAND)**  
Regular Price \$1.00  
Buy 1 set for 59c and save 41c  
Buy 2 sets for \$1.10 and save 90c  
Buy 3 sets for \$1.50 and save \$1.50

**40-40 MFD. 150 W. V. DC ELECTROLYTIC CONDENSERS**  
Regular Price \$1.05  
Buy 1 for 45c and save 60c  
Buy 5 for \$2.10 and save \$3.15  
Buy 10 for \$4.00 and save \$6.50

**PROGRESSIVE RADIO TOOL KIT**  
A Progressive Electronics Special. Contains 75 watt 110/120 volt soldering iron, long nose pliers and cutters, screwdriver, insulated alignment tool.  
Regular Price \$5.45  
Buy 1 Kit for \$3.25 and save \$2.20  
Buy 2 Kits for \$6.10 and save \$4.80  
Buy 3 Kits for \$8.70 and save \$7.65

### 4 TUBE TRF MIDGET RECEIVER

Regular Price \$12.75  
7 1/2" x 5 1/2" x 4 1/4"  
Weight only 2 1/2 lbs.  
Beautiful suede finish cabinet. (assorted colors)  
Uses miniature tubes.  
12BA6, 12AT6, 50B5, 35W4  
4" Alnico V Speaker  
Buy 1 for \$11.75 and save \$1.00  
Buy 2 for \$23.00 and save \$2.50  
Buy 3 for \$33.75 and save \$4.50

### ESPEY CUSTOM-BUILT AM-FM HIGH FIDELITY RECEIVERS

Model No. 7-B. List price \$140.00.  
Your price \$82.50. \$25 deposit required with C.O.D. orders.  
11-tube AC Superheterodyne AM-FM receiver. Folded dipole antenna for FM supplied.  
Wired for phonograph operation. Requires nothing but a cabinet. Ideal for custom builders.

### FM COIL & CONDENSER KIT \$4.95

Designed for operation on 88-108 MC (new band)  
Contains 2 IF transformers, 1 Limiter transformer, 1 Discriminator transformer, 1 oscillator coil, 1 RF coil, 1 variable condenser, schematic and wiring instructions.

Excellent for schools, experimenters and radio hobbyists

## PROGRESSIVE ELECTRONICS CO.

497 UNION AVE., Dept. RC-11, BROOKLYN 11, NEW YORK

# University LOUDSPEAKERS

- can whisper, too!

And that's important because the primary purpose of any loudspeaker is to convey intelligence and not just make a loud noise. UNIVERSITY loudspeakers — with the highest conversion efficiency of any speaker of comparable size — not only give *maximum* sound output with *minimum* power input, but reproduce every detail and inflection of the voice at all levels from a whisper to a shout.

A JOB-RATED SPEAKER  
FOR EVERY APPLICATION!

### MODEL LH REFLEX TRUMPET



is typical of types available for every requirement—voice, music, paging and talk-back.

### MODEL SAH DRIVER UNIT

One of several high efficiency models with continuous power capacities up to 25 watts. All unconditionally guaranteed for one year.



### PAGING; CALL-BACK SPEAKERS



Available in many types and power ranges. Compact design, highest efficiency.

### SUPER POWER SOUND PROJECTOR

Many sizes—100, 150 and 300 watts with ranges up to 15 miles. Finest sound quality even at full power.



### EXPLOSION, SUBMERGENCE PROOF



for use in mines, refineries, railroads, marine, etc. Immune to live steam, salt-spray, or complete immersion.



UNIVERSITY LOUDSPEAKERS · INC.

80 SO. KENSICO AVE., WHITE PLAINS, N. Y.

# Slide-Rule Wire Data

By I. QUEEN

WIRE data is often necessary in radio work. Design and repair of r.f. and a.f. coils often call for the following information: How many turns of a given size wire can be wound per inch, its resistance per thousand feet, and its safe current carrying capacity. Handbooks generally carry wire tables computed to several decimals. This high precision makes it more difficult to consult the tables and is unnecessary for most ordinary radio work.

In addition to the fact that a large number of decimals cannot be handled conveniently, the extreme precision of these tables does not hold for every case. Turns per inch varies slightly with different manufacturers in accordance with insulation thickness used. Resistance varies with surrounding temperature and is usually given for 20 or 25 degrees Centigrade. Finally, the maximum safe current depends upon conditions of heat dissipation. Ordinarily, a rating of 1500 circular mils per ampere is recommended, but higher or lower maximum currents may be specified.

We may therefore conclude that high precision in wire tables is unnecessary in most radio work, and that wire computations must be applied intelligently if they are to be of any value.

Wire problems may be solved simply with a slide rule. The equations are easy to memorize and the accuracy is good for ordinarily used wire sizes. For relatively large or small wire the error rises to several percent. It is easy to find the data with a slide rule without having to locate and consult a wire table.

1. Turns per inch (T) for enamelled wire

$$T = \text{antilog of } \left[ \frac{4.6 + N}{2} \right]$$

Example: N = No. 26 wire

$T = \text{antilog of } \left[ \frac{4.6 + 13}{10} \right] = \text{antilog of } 1.76.$  A single setting of the rule shows that the antilog of 1.76 is 57.5, which is the answer. Wire tables give the figure as 58 turns per inch.

2. Resistance per 1000 feet (R) at 25 degrees Centigrade

$$R = \text{antilog of } \left[ \frac{N}{10} - .98 \right]$$

Example: N = No. 30 wire

$R = \text{antilog of } [3 - .98] = \text{antilog of } 2.02$

The antilog of 2.02 is 104.8; the answer is 104.8 ohms. The tables give 105.2 ohms.

3. Maximum safe milliamperes (M)

This equation is based on a rating of 1500 circular mils per ampere.

$$M = \text{antilog of } \left[ 4.8 - \frac{M}{10} \right]$$

Example: N = No. 27 wire

$M = \text{antilog of } [4.8 - 2.7] = \text{antilog of } 2.1$

The antilog of 2.1 is 126, so the answer is 126 ma. Tables give 130 ma.

Most slide rule users are acquainted with the method for finding logarithms. The procedure for finding antilogarithms of numbers is the opposite.

To determine the antilogarithm of a number, say 1.81, find the decimal part, 81 on the logarithm (L) scale of the rule. This decimal part corresponds to the number 646 on the regular scale. The whole number part, 1, plus one gives the number of figures before the decimal in the answer. The answer would be 64.6 in this case.

The above problems are generally the only wire problems which are likely to be of concern to radiomen. Each formula is simple and easy to remember.



Suggested by:  
W. E. Brown,  
New Orleans, La.

Frank  
BEAVEN

"Have I been getting too many cigarette commercials?"

RADIO-CRAFT for MARCH, 1948

# ALLIED'S NEW **FREE** 1948 RADIO CATALOG

**172 VALUE-PACKED PAGES**

*Send for it now!*



## The Preferred Radio Buying Guide

It's off the press—the new 1948 ALLIED Radio Catalog! Get the Radio Buying Guide that's used by thousands of expert servicemen, engineers, soundmen, Amateurs, builders and experimenters. The new ALLIED Catalog—radio's biggest book—brings you 172 pages packed with the widest selections of the newest and finest equipment, at really low, money-saving prices! Here's everything in radio for everyone in radio: new Television and home receivers, packaged Sound Systems and P. A. equipment, latest Amateur receivers and station gear, test instruments, builders' kits, thousands of parts, tubes, tools, books—the world's largest stocks of nationally-known equipment. Take advantage of ALLIED'S speedy, expert shipment and the personal attention of seasoned old-time radio men. Get the details, too, of radio's newest and most liberal Time Payment Plan. Send today for your FREE copy of ALLIED'S newest, greatest Catalog—the preferred Radio Buying Guide!

**LARGEST STOCKS • QUICK, EXPERT SERVICE**

Get your **FREE** copy of  
Radio's most complete Catalog  
Use the coupon below—**NOW!**

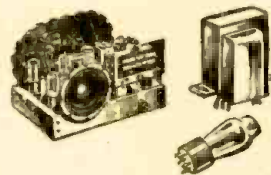

### MORE THAN 10,000 ITEMS

Everything in radio for everyone in radio! Complete lines of all leading makes of parts and equipment—all from one great, centralized source. For newest developments and best values, see your ALLIED Catalog.

### TELEVISION & HOME RADIOS

A special selection of outstanding models—table radios, consoles, combinations, FM-AM—plus new Television, offered first by ALLIED at real savings. Hand-picked models—the choice of experts!

### AMATEUR STATION GEAR

Here's heaven for the Ham! You'll find everything you need for your shack in the new ALLIED Catalog. See all the latest releases in receivers, transmitters, parts, station equipment—biggest Ham listings in radio!

### NEW P. A. EQUIPMENT

Packaged, ready-to-use Sound Systems; amplifiers guaranteed for one full year, everything in speakers, microphones, P. A. accessories, intercom and recording equipment—leading headquarters for Soundmen!

RADIO'S LEADING,  
BUYING GUIDE!



THE WORLD'S  
LARGEST  
RADIO  
SUPPLY  
HOUSE . . .

★ **ALLIED  
RADIO**

*Everything in Radio  
and Electronics*

ALLIED RADIO CORP.  
833 W. Jackson Blvd., Dept. 2-C-8  
Chicago 7, Illinois

Send FREE New ALLIED Catalog.

Name.....

Address.....

City.....Zone.....State.....

# LEONARD'S

WINTER PRICES

BEST VALUE HAZELTON

## MULTI TESTER RANGES

AC Volt ..... 0-1500  
DC Volt ..... 0-1500  
DC Mills ..... 0-150  
Resistance 0-300,000

**\$11.75**



## ELECTRONIC MEASUREMENTS VOLOMETERS



101A Model 101B 3" METER \$17.50 NET  
OPEN FACE 4" METER \$20.95 NET  
OPEN FACE PORTABLE  
101AP 3" Meter \$21.50 net  
101BP 4" Meter \$24.95 net

## LATEST STAR MEASUREMENT TUBE TESTER

Quick operation—with Rotary Selector and lever switches tests all tubes up to 117 volts. Also tests individual sections such as diodes, triodes, pentodes, etc.



**\$29.95 NET**

## RECORD CHANGERS

WEBSTER 56—Automatic Stop ..... \$26.66  
DETROLA ..... 14.50  
SEEBURG—2 Post ..... 22.95

RCA CRYSTAL MIKE with table stand ..... **\$4.95**

12" P.M. SPEAKER 20 OZ. ALNICO MAGNET **7.75 NET**

6L6 Push Pull or Push Pull Parallel 50 watt. Completely shielded. 250 mill primary 5000 ohms—acc. 2-4-8-15-500 ohms. H-57—Special Lim. Quan. .... **\$5.19**

## PHONO MOTOR and PICKUP KIT

SPECIAL **\$4.95**

Complete

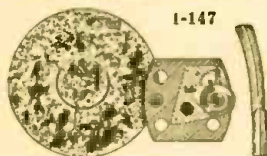

Crystal pick-up—Top quality constant speed motor. Motor Assembly only. \$3.95  
Send 25% deposit with order—balance Express Collect. Orders under \$5.00 send check or money order plus postage.

**LEONARD RADIO INC.**  
69 CORTLANDT ST.  
NEW YORK 7, N.Y.

# ELECTRONIC MIXING

By JOHN W. STRAEDE\*

INPUTS from a number of signal sources, such as from phonograph pickups, microphones, and photoelectric cells, may be combined in various ways. Signal voltages can be averaged as in parallel mixing where isolating resistors are used; they can be added in series mixing (though this is sometimes difficult to arrange without having 1 return lead liable to hum pickup); and they can be applied separately to the grids of 2 tubes whose plates are connected together. This system, electronic mixing, has both advantages and disadvantages. Its chief advantage is that the adjustment of 1 volume control does not affect the other input; while its chief disadvantages are that 2 tubes (or the twin-triode of Fig. 1) are re-

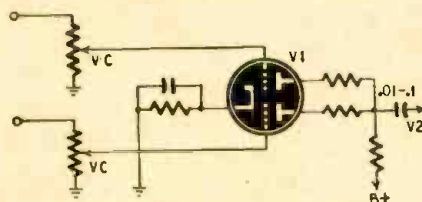

Fig. 1—A simple circuit with triode tubes.

quired, and the gain is low. Each tube acts as a load on the other so that the gain is always less than half the amplification factor.

### Gain different

In the circuit (Fig. 2), the gain from one input is large while the gain from the other is small, adapting one input for a microphone while the other is suitable for a phonograph pickup.

Only 1 pentode tube is used, the higher-level signal being fed to the screen

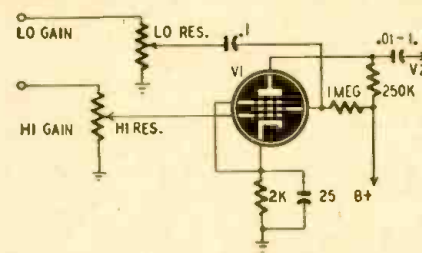

Fig. 2—Convenient input for phono and mike.

grid. Omission of the screen grid bypass condenser usually causes serious loss in gain, but this difficulty is overcome by

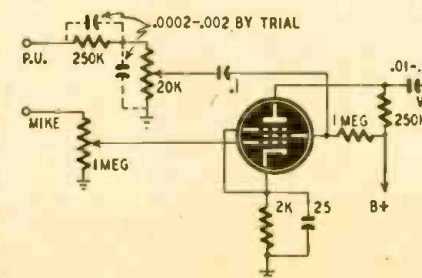

Fig. 3—Circuit adapted for crystal pickup.

\*Lecturer in electronics and electro-acoustics, Melbourne Technical College, Australia.

keeping the impedance of the extra input low. The slight increase in the high-frequency response of the microphone when the pickup volume control is turned down is not noticeable to the ear. Gain from a microphone is good, the ac-

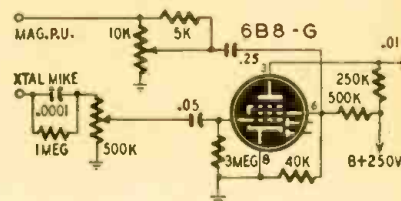

Fig. 4—Equalization used on the microphone.

tual gain (in the order of 100) depending upon the voltages used.

A crystal or other high-impedance pickup must not be connected directly to the low-resistance volume control. Doing so ruins the bass response of a capacitive source (such as a crystal pickup), or the high-frequency response of an inductive source. To prevent this frequency distortion, either a series resistance or a step-down transformer is used. The former system is the more popular although the gain is decreased.

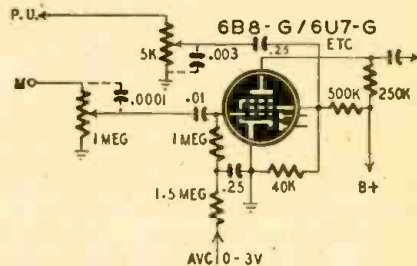

Fig. 5—An automatic volume limiting circuit.

Frequency response is corrected by connecting condensers across the series resistor or across the volume control. A circuit for a crystal pickup is given in Fig. 3.

### Sensitivity ratio

The ratio of sensitivities of the 2 inputs is approximately 16 to 1 for tubes such as 6J7-G, 6SJ7, 6C6; and about 8 to 1 for 6B8-G, 6U7-G and 6G8-G. The greater the gain of the tube when connected as a triode, the greater the sensitivity ratio. This ratio is not critical if cathode bias is used, because the volume controls can be used to vary the input signals. It is more important when a.v.c. or some other limiting system is used.

In the circuit of Fig. 4, adapted for a small amplifier, a simple high-frequency equalizer is connected between the microphone and its volume control, and a magnetic pickup of about 10,000-ohm impedance (1,000 ohms d.c. resistance) is connected to the screen grid. By arranging the total shunt impedance on this pickup to be approximately 5,000 ohms, its response was flattened within

(Continued on page 76)



# New SUPREME 1948 and F.M. Manuals



## F.M. and Television

Use this giant-size manual of factory instructions for troubleshooting, repairing, and alignment of any recent F.M. and Television set. Covers every popular make, including F.M. tuners, AM-FM combinations, and all types of television receivers. Detail circuit diagrams, theory of operation, test hints, alignment data. This is the material you need to fix any modern F.M. or Television set. Don't turn this profitable work away for lack of knowledge and information. Use this newest Supreme manual to save time and money on your very next F.M. job. Data presented on 192 large-size pages, 8½ x 11 in. Sturdy, manual-style binding. Special price. **\$2.00**

## New 1948 Manual

Be prepared to repair quickly all new 1948 receivers. In this big single volume you have clearly-printed, large schematics, needed alignment data, replacement parts lists, voltage values, and information on stage gain, location of trimmers, and dial stringing, for almost all recently released sets. A worthy companion to the 7 previous volumes used by over 120,000 shrewd radio servicemen. New manual covers models of 42 different manufacturers. Giant size: 8½ x 11 in. 192 pages + Index. Manual-style binding. **\$2.00** Bargain price, only...

## BIGGEST BARGAIN IN RADIO DIAGRAMS

Make these two new mammoth volumes your money-saving source for data on all recently released receivers. Learn about modern circuit developments, be ready to repair any new radio no matter how complex. You pay only \$2.00 for each of these large manuals. With these two volumes on your workbench there is nothing else to buy, nothing else to pay—a whole year of radio diagrams and service data yours for a couple of dollars total. Again Supreme Publications beats all competition and gives radio servicemen greatest bargains in service information. Read about other volumes for previous years described at the left and below. **No-risk** examination granted to servicemen.

## FIND ALL RADIO FAULTS DOUBLE-QUICK

You can speed-up and simplify radio repairs with SUPREME PUBLICATIONS Manuals. Service radios faster, better, easier, save time and money, use these most-often-needed diagram manuals to get ahead, earn more per hour. For the remarkable bargain price (only \$2 for most volumes) you are assured of having in your shop and on the job, needed diagrams and other essential repair data on 4 out of 5 sets you will ever service. Every popular radio of all makes from old-timers to new 1948 sets, including F.M. and Television, is covered. Clearly printed circuits, parts lists, alignment data, and helpful service hints are the facts you need to improve your servicing ability. Save hours each day, every day, begin to earn more by making repairs in minutes instead of hours. Let these manuals furnish you with diagrams for 80% of all sets. There is no need to spend large sums for bulky, space-wasting manuals, or to buy additional drawings every few weeks; be wise, use SUPREME Manuals to get the most in diagrams and service data for the smallest cost.

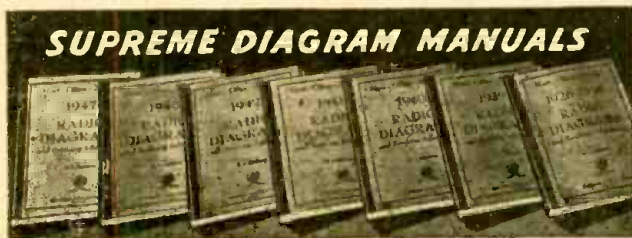

1947 1946 1942 1941 1940 1939 1926-38  
**MOST-OFTEN-NEEDED RADIO DIAGRAMS** 240 Pages  
 Each manual has between 192 and 208 pages of diagrams and service hints; large size, 8½x11". Price, each, **\$2.00** Price \$2.50

### Post-War Automatic Record Changers

Service expertly all new (1945-1947) record changers. Follow simplified factory instructions to make needed adjustments and repairs. Hundreds of photographs and exploded views; thousands of test hints; service instructions for all popular makes. Large size: 8½ x 11". 144 fact-filled pages. At your jobber or postpaid, only... **\$1.50**

### Pre-War Record Players, Changers, & Recorders

Just what you need to repair quickly thousands of pre-war automatic record changers, manual units, pick-ups, wireless oscillators, recorders, and combinations. Hundreds of mechanical and electrical diagrams. Instructions for adjustments and repairs. Most popular units of all makes. 128 large pages. 8½x11 inches. Price, only... **\$1.50**

## SATISFACTION GUARANTEED

**Most Popular Models Made by:**  
 R.C.A., Zenith, Philco, Sears, Fada, Emerson, Belmont, Detrola Radio, Majestic, United-Motors, G.E., Westinghouse, Arvin, Stewart-Warner, Admiral, Delco, Stromberg-Carlson, Western Auto, Wards, Sparton, Motorola, Gamble, Crosley, and many others.

Select the Diagram Manuals and Record Changer Books you want to examine. See listing in left-hand column. Send the convenient no-risk trial coupon. Use the manuals in your own home or shop for 10 days at our risk. You must be completely satisfied, or return manuals and receive your money back. Write today—24-hour service.



## NO RISK TRIAL ORDER COUPON

SUPREME PUBLICATIONS, 9 S. Kedzie Ave., Chicago 12, ILL.

Ship the following manuals on trial under your guarantee of satisfaction or money-back.

- New F.M. and Television Manual @ \$2.00
- Post-War Record Changers..... @ 1.50
- Pre-War Record Players..... @ 1.50
- I am enclosing \$....., send postpaid.
- Send C.O.D. I am enclosing \$..... deposit.

- 1948
  - 1947
  - 1946
  - 1942
  - 1941
  - 1940
  - 1939
  - 1926-1938 @ \$2.50
- PRICED AT ONLY **\$2.00** EACH

Name: .....

Address: .....

SEND COUPON OR WRITE ORDER IN A LETTER

See Your Radio Jobber or Send Coupon →

# Supreme Publications

PUBLISHERS OF RADIO BOOKS, MANUALS, AND DIAGRAMS

9 South Kedzie Ave.

Chicago 12, Illinois

RADIO-CRAFT for MARCH, 1948

# RADIOMEN'S HEADQUARTERS - WORLD WIDE MAIL ORDER SERVICE!!!

## 1948 MODEL MUTUAL CONDUCTANCE TUBE TESTER ..... \$49.95

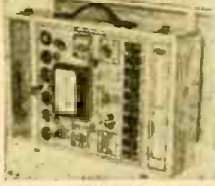

No possibility of good tubes reading "Bad" or bad tubes reading "Good" as on dynamic conductance testers or other ordinary emission testers. Attractive panel and case equal to any on the market in appearance . . . Large 4 1/2" meter . . . Calibrated micromho scale as well as a Bad-Good scale . . . Front panel fuse . . . Individual sockets for all tube base types—voltages from .75 volts to 117 volts and complete switching flexibility allow all present and future tubes to be tested regardless of location of elements on tube base . . . Indicates gas content and detects shorts or opens on each individual section of all local, octal and miniature tubes including cold cathode magic eye and voltage regulator tubes as well as all ballast resistors. Name of the nationally known manufacturer withheld because of special price offer. \$49.95  
 Model "C"—Sloping front counter case. . . . . \$49.95  
 Model "P"—Handsome hand-rubbed portable case. . . . . \$4.95  
 Built-in roll chart with either of above \$5.00 extra.

## ARMY BC-312 COMMUNICATIONS RECEIVER

This receiver covers the frequency range of 1.5 MC to 18 MC in six direct reading bands. The dial, that is driven with split gears to prevent backlash, has 4500 logging divisions per band with approximately 600 divisions on the 20 and 40 meter ham bands and 1000 divisions on 80 meters. Two stages of RF before the converter in this set give it a very high signal to noise ratio and maximum sensitivity. Outstanding features of this receiver are: BFO with pitch controls send-receive relay, jacks on the front panel for headphones and speaker output, and mike and key inputs. All tubes designed to operate any sort of external equipment when actuated by a received signal from a similar set elsewhere. Originally designed for 12 volt operation, power supply is not included, as it is a cinch for any amateur to connect this unit for 110V AC, using any supply capable of 400V DC at 135 MA. The ideal unit for use in mobile or stationary service in the Citizen's Radio Telephone Band where no license is necessary. Instructions and diagrams supplied for running the RT-1248 transmitter on either code or voice in AM or FM transmission or reception, for use as a mobile public address system, as on 80 to 110 Mc. FM broadcast receiver, as a Facsimile transmitter or receiver, as an amateur television transmitter or receiver, for remote control relay hookups, for Gellner-Mueller counter applications. It sells for only \$29.95 or two for \$53.90. If desired for marine or mobile use, the dynamotor which will work on either 12 or 24V DC and supply all power for the set is only \$15.00 additional. \$6.50

## PE-109 32-Volt DIRECT CURRENT POWER PLANT

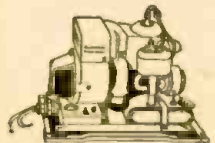

This power plant consists of a gasoline engine that is direct coupled to a 2000 watt 32 volt DC generator. This unit is ideal for use in locations that are not serviced by commercial power or to run many of the surplus items that require 24-32V DC for operation. The price of this power plant is only \$58.95. We can also supply a converter that will supply 110v AC from the above unit or from any 16-32V DC source for \$29.95.

## GENERAL ELECTRIC RT-1248 15-TUBE TRANSMITTER-RECEIVER

TERRIFIC POWER—(20 watts) on any two instantly selected, easily pre-adjusted frequencies from 435 to 500 Mc. Transmitter uses 5 tubes including a Western Electric 316 A as final. Receiver uses 10 tubes including 655's, as first detector and oscillator, and 3-7H7's as IF's, with 4 slug-tuned 40 Mc. IF transformers, plus a 7H7, 7E8's and 7F7's. In addition unit contains 8 relays designed to operate any sort of external equipment when actuated by a received signal from a similar set elsewhere. Originally designed for 12 volt operation, power supply is not included, as it is a cinch for any amateur to connect this unit for 110V AC, using any supply capable of 400V DC at 135 MA. The ideal unit for use in mobile or stationary service in the Citizen's Radio Telephone Band where no license is necessary. Instructions and diagrams supplied for running the RT-1248 transmitter on either code or voice in AM or FM transmission or reception, for use as a mobile public address system, as on 80 to 110 Mc. FM broadcast receiver, as a Facsimile transmitter or receiver, as an amateur television transmitter or receiver, for remote control relay hookups, for Gellner-Mueller counter applications. It sells for only \$29.95 or two for \$53.90. If desired for marine or mobile use, the dynamotor which will work on either 12 or 24V DC and supply all power for the set is only \$15.00 additional.

## 14-TUBE UHF SUPERHET RECEIVER—\$39.95

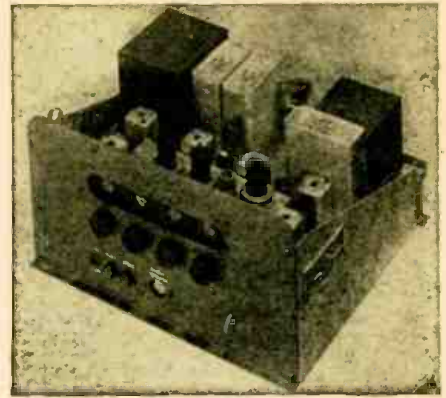

This beautifully constructed receiver was designed especially for Signal Corps communication service, and is one of the finest and most sensitive sets ever manufactured. Operating from 110V 60 cycles, this set has two tuned RF stages, tuned converter and oscillator, five I.F. stages, using iron-core IF's, a diode detector, tuning eye, and a two stage amplifier that will drive a speaker or phones. The frequency range is 158-210 Mcs. It is a simple matter to operate on other bands by making a slight alteration in the tuning coils. A complete set of tubes is included with each receiver, along with a circuit diagram and parts list. The high-voltage power supply delivers 150 milliamperes, and is well filtered by a heavy-duty choke and three 7 Mfd. oil-filled condensers. This buy of a lifetime cost the government about \$700. Amateurs and experimenters will never again be able to purchase fine equipment at such a tremendous saving! See January *Radio-Craft*, Page 57, for complete conversion to television receiver.

## AT LAST YOU CAN AFFORD A LABORATORY STANDARD MICRO VOLTER

The famous Measurements Corp. Model 78B, 5 Tube Laboratory Standard Signal Generator (that sold new, FOB Boonton, N. J., for \$310.00 net), is available in perfect condition for 25 to 60 cycle, 115 V AC operation. Until now this is the sort of top-flight lab equipment that discriminating buyers have only vainly hoped would be released at a bargain price. Worth every cent the manufacturer asks, but available FOB Buffalo while our limited supply lasts for only \$79.95. Such companies as Admiral Corp. and John Meek, Inc., have ordered from us and repeated many times on these 78 generators for use in their labs and production line testing. "REMEMBER THAT A STANDARD IS ONLY AS RELIABLE AS ITS MAKER."



Model 78B Standard Signal Generator. Two Frequency Bands between 15 and 250 megacycles.

RT1463 7 tube amplifiers containing 3-7F7, 1-7Y4, 3-7N7, 4 potentiometers, numerous resistors, filter and bypass condensers, filter chokes, power and audio transformers, and six sensitive plate relays. A military development that provided amazing stepless control proportional to correction required for ailerons, rudder and elevator, in the original application. A control amplifier of the ordinary type would deflect the rudder by some arbitrary amount when the ship was blown off the course, to port or starboard. The result would either be that the correction was insufficient and the plane continued off course, or the correction would be too great, starting a series of tacklings and would greatly increase fuel consumption and elapsed time in reaching the objective. This phenomenal unit, with its 3 amplifiers and six 5000 ohm relays in bridge circuits, will accurately control any 3 operations, related or unrelated, in minutely adjustable uniquely quantitative variations in either forward or reverse directions. 9 1/2 x 7 1/2" black crackle aluminum case. Brand new in original carton. \$12.95, or used \$9.95.

## SCR-274N COMMAND SET

The greatest radio equipment value in history

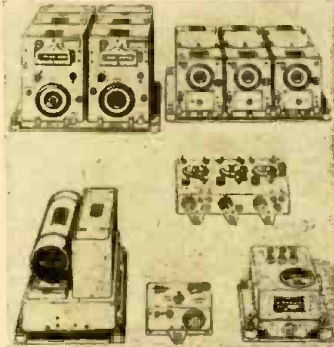

A mountain of valuable equipment that includes 3 receivers covering 190 to 560 KC; 3 to 6 MC; and 6 to 9.1 MC. These receivers use plug-in coils, and consequently can be changed to any frequencies desired without conversion. Also included are two Tuning Control Boxes; 1 Antenna Coupling Box; four 28 V. Dynamotors (easily converted to 110 V. operation); two 40-Watt Transmitters including crystals, and Preamplifier and Modulator. 29 tubes supplied in all. Only a limited quantity available, so get your order in fast. Removed from unused aircraft and in guaranteed electrical condition. A super value at \$29.95, including crank type tuning knobs for receivers. Without these knobs the receivers can't be tuned, and are only useful for parts. Don't buy without knobs!

## SCR-284 TRANSMITTER-RECEIVER

This medium power transmitter and the accompanying 7-tube very sensitive receiver are naturals for 80 or 40 meter operation (phone or CW), on either fixed stations or mobile applications. These units are brand new and come complete with 17 tubes, key, microphone, 200 KC calibrating crystal and instructions and diagrams for use with up to 100 watts input to the final stage on 40 or 80 meters for either phone or CW, using vehicle or 110 Volt power supply. Your cost ..... \$39.95



Aluminum gear box 18x8x7 that contains two powerful electric motors and two matched gear trains, 62 gears in all varying in size from 1/2 to 4 inches in diameter. This unit is readily converted to rotate a beam antenna or any other similar usage. . . . \$3.00  
**BRAND NEW 110 V AC INPUT POWER SUPPLY**, in grey enameled shock-mounted case 9" x 10" x 16". Several heavy duty resistors, 3 chokes, 4-1000 V and 600 V oil-filled condensers, 1 relay, 2-5U4's, 3 voltage regulator tubes, safety interlock, and several fuses are included in this regulated power supply at the bargain price of ..... \$9.95

## DUE TO POPULAR DEMAND WE REPEAT THESE TERRIFIC BARGAINS

- Three assorted new MICROPHONES, including push-to-talk type ..... \$1.49
- Ten assorted R. F. Chokes including high frequency types ..... \$ .35
- Five assorted AUDIO or FILTER CHOKES ..... \$ .99
- One Hundred assorted RESISTORS ..... \$1.95
- Ten assorted JAN CABLE CONNECTORS, including many popular types ..... \$ .99
- Six assorted OIL FILLED CAN TYPE CONDENSERS, all with mounting brackets ..... \$1.49
- Ten assorted METAL & BAKELITE KNOBS—(no wooden knobs) ..... \$ .39
- Six assorted VARIABLE CONDENSERS, including butterfly types ..... \$1.49
- Six assorted POWER and AUDIO TRANSFORMERS, all new ..... \$1.98
- Six assorted isolantite and bakelite R. F. COILS, shielded and unshielded ..... \$ .99

The above ten assortments totaling over \$12.00 at the unbelievable bargain prices listed can be purchased together as one lot at a super-special total price of only \$10.00.

Minimum order \$3.00—All prices subject to change—25% deposit with COD orders

**BUFFALO RADIO SUPPLY, 219-221 Genesee St., Dept. 3 C. BUFFALO 3, N. Y.**

Cable Address: BUFRAD

RADIO-CRAFT for MARCH, 1948

# RADIOMEN'S HEADQUARTERS WORLD WIDE MAIL ORDER SERVICE!!!

**RADIO SERVICEMEN!!** Buffalo Radio Supply's lower prices mean increased profits for you. Order all of your needs from us and receive in return courteous service and first class merchandise at the lowest prices in the country. Here are a few of our typical bargains.

**SELENIUM RECTIFIERS**—The new miniature rectifier that more and more manufacturers are using. Order some of each type so you will be ready when these receivers require servicing. Make extra money by installing them in old sets. All types are rated at 150 volts RMS and will withstand an inverse peak of 350 volts. The 25 ma unit is for phono osc and bias supplies and for converting relays.

25 ma .....	\$ .45	10 for \$4.00	100 ma .....	\$ .75	10 for \$7.00	200 ma .....	\$1.05	10 for \$10.00
75 ma .....	\$ .70	10 for \$6.50	150 ma .....	\$ .80	10 for \$7.50			

**SPEAKERS**—These PM speakers are the finest that are available. All have heavy oversize Alnico V magnets.

3 1/2" .....	\$1.15	6 for \$6.60	5" .....	\$1.10	10 for \$9.50
4" .....	\$1.15	6 for \$6.60	6" .....	\$1.50	6 for \$8.70

## AUTO RADIO DEALERS! ATTENTION!

A famous nationally advertised brand of auto radio which will fit any car and every pocketbook. Six tube superhet with three gang condenser and 6 1/2" speaker. Dealer Price \$32.20 for sample, or \$29.97 each, in lots of two or more.

Here is an item that no serviceman that repairs auto radios can be without. Nationally advertised ATR battery eliminator that supplies perfectly filtered 12 V DC or 6 V DC at 14 amperes from 110 V AC. \$36.00

## BUFRAD CAR RADIO ANTENNAS

All of our car radio antennas are made of triple plated Admiralty Brass Tubing, complete with low loss shielded antenna leads and have high quality fittings.

- SIDE COWL—BR-1**, 3 sections extend to 66". Your price—single units—\$1.50; in lots of 12—\$1.35 ea.
- SKYSCRAPER—BR-2** has 4 heavy duty sections that extend to 98". Your price—single units—\$2.45; in lots of 12—\$2.25 ea.
- TILT ANGLE—BR-3**, may be adjusted to all body contours. 3 sections extend to 66". Single unit price—\$1.50; 12 lot price—\$1.25 ea.
- VERSATILE—BR-4**, single hole fender or top cowl mounting may be adjusted to conform with all body contours. 4 sections extend to 56". Single unit price—\$2.90; 12 lot price—\$2.75 ea.
- THE MONARCH—BR-5**, single hole top cowl mounting, 3 sections extend to 56". Single unit price—\$1.90; 12 lot price—\$1.75 ea.

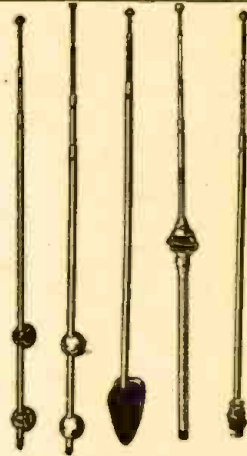

BR1 BR2 BR3 BR4 BR5

**BENDIX SCR 522**—Very high Frequency Voice Transmitter-Receiver—100 to 156 MC. This job was good enough for the Joint Command to make it standard equipment in everything that flew, even though each set cost the Gov't \$2500.00. Crystal Controlled and Amplitude Modulated—**HIGH TRANSMITTER OUTPUT** and 3 Microvolt Receiver Sensitivity gave good communication up to 180 miles of high altitudes. Receiver has ten tubes and transmitter has seven tubes, including two 832's. Furnished complete with 17 tubes, remote control unit, 4 crystals, and the special wide band VHF antenna that was designed for this set. These sets have been removed from unused aircraft and are guaranteed to be in perfect condition. We include free parts and diagrams for the conversion to "continuously variable frequency coverage" in the receiver.

The SCR 522 complete with 24 volt dynamotor sells for only \$37.95. The SCR 522 is also available with a brand new 12 volt dynamotor for only \$42.95.

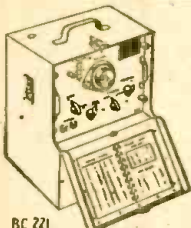

BC 221

**BC-221 FREQUENCY METERS** with calibrating Crystal and calibration charts. A precision frequency standard that is useful for innumerable applications for laboratory technician, service man, amateur, and experimenter at the give away price of only \$36.95.

100 KC crystal calibrator kit containing everything that is necessary to construct a 100 KC osc. that will supply 100 KC marker points to your receiver so that it may be used for frequency determination. The 100 KC crystal is worth far more than the price that we are asking for the complete kit.

Kit 100K Plate and fil voltage supplied by receiver ..... \$9.95

Kit 100KA Same as above, including 110 VAC or DC self-contained power supply ..... \$12.95

Dual meter—one 50 uA and one 200 uA movement in the same case. This meter is ideally suited for use as a combination modulation percentage and carrier shift indicator. If desired the movements may be removed from the case and used separately. All meters are in perfect operating condition but a few have cracked glasses. This super value costs only ..... \$1.75

## CLOSING OUT

THE FOLLOWING DESIRABLE ITEMS AT SACRIFICE PRICES TO MAKE ROOM IN OUR WAREHOUSE FOR INCOMING STOCK

**5 INCH RECEIVER INDICATOR SCOPE.** This unit, originally sold by Western Electric for \$2500.00, includes a 13 tube receiver with 7 IF stages; 2 tube multivibrator sweep generator; 2 tube sweep amplifier; video amplifier; pedestal impulse and sweep generator, and 115 volt, 60 cycle supply with 2 x 2 for high voltage. Equipped with more than 15 tubes of the 43 originally used and including a brand new scope tube in original carton. Makes a wonderful laboratory instrument and is better adapted for television than any other war surplus item. Reduced close-out price as is. Formerly \$69.95, now \$39.95.

**5" "SO" RADAR P.P.I. SCOPE,** complete with 9 tubes including 807 tube in final power stage that provides deflecting current for magnetic yokes. Selsyn motor and self-contained 110 V. power supply designed to run on the AC supply on LST and PT boats. Various ranges from 2 to 80 miles. The most satisfactory scope available for navigational radar or panoramic television applications.—Nationally advertised as surplus at \$100.00. Our price, only \$39.95.

**947A ONE KILOWATT HIGH FREQUENCY TRANSMITTER.** This relay-controlled transmitter includes a 115V, 60 cycle power supply, protected by 3 magnetic circuit breakers, that alone is worth more than the price we are asking for the whole rig, even on today's surplus market. On the front panel are six 3 1/4" GE or Weston meters, including 250 MA, 50 MA, 1000 MA, 150 V AC and 1500 V DC at 1000 ohms per volt for screens and plate. The rack-type 21" x 15" x 36" unit contains six amplifier and rectifier tubes aggregating over \$60.00 at VAA current wholesale prices. Western Electric's price to the Government was \$1500.00. Shipping weight 500 lbs. Your cost at closeout price as is. Formerly \$69.95, now only ..... \$39.95

## TAKES ALL THREE BIG BARGAINS

**\$9.95**

- AUDIO AMPLIFIER** Undreamed of value. Uses 6V8's. Has 4 microphone inputs brought to jacks at rear panel. Various output impedances available at rear panel connections. Steel case with chrome handles. 9" long x 9" high x 6" deep. Tubes included. New in original carton. Shipping weight 20 lbs. **SUPER SPECIAL—\$4.95** while supply lasts.
  - RADIO HEADSETS** Latest supersensitive type with rubber earpieces. Every pair guaranteed perfect. \$5.99 per pair OR 3 PAIRS FOR \$1.00.
  - HOME WORKSHOP AT BARGAIN PRICE** Accurate and precise 2 speed guaranteed hobby lathe; the essential machine for the home workshop. Sturdy enough for light production work or factory standby service. Supplied with 56" of beltting for connecting to any available electric motor or power take-off, such as on a jeep or tractor. Also included in this unbelievable offer are such accessories as a 1/2" drill chuck with specially hardened tool steel jaws, a 4" electric furnace high speed grinding wheel, a cotton buffing wheel with a large supply of buffing compound, and a 4" steel wire scratch brush. Your cost \$6.00. Sole export agent. Distributor inquiries invited.
- NO C. O. D.'s—ORDER NOW—DON'T DELAY

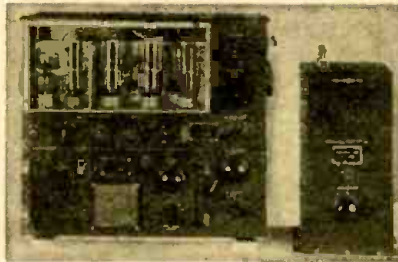

## GENERAL ELECTRIC 150 WATT TRANSMITTER

Cost the Government \$1800.00  
Cost to you \$44.50!!!!

This is the famous transmitter used in U.S. Army bombers and ground stations, during the war. Its design and construction have been proved in service under all kinds of conditions, all over the world. The entire frequency range is covered by means of plug-in tuning units which are included. Each tuning unit

has its own oscillator and power amplifier coils and condensers, and antenna tuning circuits—all designed to operate at top efficiency within its particular frequency range. Transmitter and accessories are finished in black crackle, and the milliammeter, voltmeter, and RF ammeter are mounted on the front panel. Here are the specifications: **FREQUENCY RANGE:** 200 to 500 KC and 1500 to 12,500 KC. (Will operate on 10 and 20 meter band with slight modification). **OSCILLATOR:** Self-excited, thermo compensated, and hand calibrated. **POWER AMPLIFIER:** Neutralized class "C" stage, using 211 tube, and equipped with antenna coupling circuit which matches practically any length antenna. **MODULATOR:** Class "B"—uses two 211 tubes. **POWER SUPPLY:** Supplied complete with dynamotor which furnishes 1000V at 350 MA. Complete instructions are furnished to operate set from 110V AC. **SIZE:** 21 1/2" x 23 1/2" x 10 1/2" inches. Total shipping weight 200 lbs., complete with all tubes, dynamotor power supply, five tuning units, antenna tuning unit and the essential plugs. These units have been removed from unused aircraft but are guaranteed to be in perfect condition.

## BRAND NEW INVERTERS AND DYNAMOTORS

PE 6A: A 24 to 32 V DC input, to 80 V AC regulated output converter ..... \$12.95  
PE 19A: A 24 to 28 V DC input, to 80 V AC at 800 cps output ..... \$9.95  
(We include a stepup transformer with each of the above so that 110 V AC is available from either.)  
27 V DC input 285 V DC @ 75 MA output ..... .98c  
27 V DC input. Output 300 V @ 150 MA, 150 V @ 15 MA and 12 V @ 5 Amp. .... \$5.95  
12 V DC input. Output 300 V @ 150 MA, 150 V @ 15 MA and 12 V @ 5 Amp. .... \$12.00  
13 or 28 V DC input. Output 800 V DC, 400 V DC @ 135 MA, and 9 V AC ..... \$15.00  
(By running on 6 V AC, 60 cycle input, with a small amount of DC for field excitation, the above dynamotor will provide a good source of 12, 24, 400 or 800 V DC.)

**BUFFALO RADIO SUPPLY, 219-221 Genesee St., Dept. 3 C. BUFFALO 3, N. Y.**

## GIBSON GIRL EMERGENCY TRANSMITTER SCR 578A & B

Automatic or hand operated transmitting on 500 kc. No batteries required. Automatically transmits SOS signals. A wonderful buy **\$19.95** at .....



Complete with box kite, parachute, 300 ft. extra antenna wire, extra lamp, 2 bulbs, 2 balloons (4 ft. dia.) hydrogen generator, 2 inflating tubes, instruction manual. Complete in large waterproof, felt lined carrying bag \$29.95

## RADIO COMPASS SUPER-HET RECEIVER R-5-ARN7

Complete with 15 tubes. Frequency range from 200 to 1750 kc. 115V, 400 cycles, power supply inc. Can be modified for broadcast reception. **Special \$19.95**

## FIELD TELEPHONES EE-8 & RM-29

Ideal for farm, warehouse, garage extension, or similar use; works on 2 flashlight cells. With handset, generator, ringer etc. In strong case. New **Only \$14.95**



Used \$9.95

72 inch ANTENNA, 37-50 meg. matching section; excellent for 10 meter band. Containing cylinder is 5" long, 3 1/2" diameter, with coaxial cable loading coil. Can be adapted for FM and television. Good for mobile or fixed station. New. Special .....

WHIP ANTENNA AN-131A half wave 40 to 48 meg. 10 1/2 ft. long. Comes in 8 all brass sections, connected on a spring steel cable. Good for FM reception, mobile or fixed station; can be converted to fishing rod. In original sealed carton. Brand New. Only \$1.49  
RECEIVER AN/CRW 2 and 2A—3 tubes (12SN7) including 28 volt DC dynamotor, 3 sensitive relays. Can be used for controlling purposes .....

## STANDARD LIP MICROPHONE T-45

complete with PL291A plug; ready for use. Instruction book included. New .....



THROAT MIKE T-30—double throat type; PL291 plug. M199 neckband. Works into any 200 ohm impedance input circuit. Instruction sheet included .....

MS-23 Headset, 8000 ohm impedance, PL 54 plug 98c

MS-33 Headset, 600 ohm impedance 98c  
KELLOGG operator transmitter microphone T-28E, adjustable swivel and extension bracket, with special 10 ft. EB2628-8 cord. New .....

Telephone Receivers R-14; high impedance, light weight, watch case type, double magnet, black bakelite cap; no headband .....

HEADSET P-19 with 2 R-15, 24,000 ohm high impedance receivers; includes 2 rubber cushions, PL-55 plug, & ft. cord. New .....

HANDMIKE T-17B: 200 ohm, single button carbon mike, push button switch. Ideal for home transmitter or portable rig; 5 ft. rubber cord, plug and dust cover; brand New .....

HANDSET TS-13—200 ohm carbon mike, 2500 ohm earphone, 6 ft. rubber cord, 1-PL55 and 1-PL68 plugs attached. New \$2.95  
HANDSET TS-15A—200 ohm, same as above; can be used in intercom, radio & telephone work. Used .....

Brand New motor driven Gear Box—2—DC 24 volt motors snunt wound. Can be used as a low voltage AC motor from 8 to 24v input. Complete with micro switch, 50 gears and control box .....

## RADIO COMPASS RECEIVER BC-433G

Complete with 15 tubes; frequency range from 200 to 1750 kc. 115V, 400 cycles; power supply included .....

### Write for Quantity Discounts

Prompt Delivery—Write Dept. RCM  
25% Deposit Required on C.O.D. Orders  
Shipped F.O.B. New York. Minimum Order \$2.00

## TOM ALLEN

564 ATLANTIC AVE.  
BROOKLYN 17 NEW YORK

## ALL MERCHANDISE IS WAR SURPLUS AND IS SOLD AS USED UNLESS OTHERWISE SPECIFIED

CABLE—single conductor, 7 strand #10 gauge, rubber insulated, armored with 18 strands steel wire, with heavy outside rubber cover; overall diameter 3/8"; reels contain approx. 6,000 feet; weight 3300 lbs.; has many uses in wire communication; 100 ft. min. 15c foot. Discount for larger quantities.

TUNING UNITS, BC-746—with 2 crystals; transmits on 3655 KC and receives 4110 KC; includes RF coil and antenna coil with variable padder; mounted on 1 base, wired and ready to plug in; carrying case included. Brand New .....

THIGH CLAMP transmitting key J-45—with 5 ft. cable and PL55 plug .....

PLUGS—PL55 and PL68, each .....

## RADIO RECEIVER BC-1023A

Ultra High Frequency, covering 62 to 80 mc range. An extremely sensitive relay, works on 4/10 of a mill. Contains 4 tubes—12SH7—6SQ7—6SC7—6U6TG. New \$3.95



G.E. 50 watt ceramic tube sockets; for 211-838-250T.H. and other type tubes. New each ..

PARACHUTE 12 ft. in diameter, with over 70 sq. ft. of orange colored silk or nylon. Can be used for wearing apparel and many other things. Also included 192 ft. heavy white nylon cord, 15 ft. of 1 1/4" webbing, 8 safety snap buckles. Brand New .....

SA-26U Beautiful black plastic microphone switch; 2 1/2" long, 1" diameter; push button make and break, press to signal. Screw type, can be used with or without base. Good for interoffice buzzer, closet lights, doorbells, phonograph recorder. Can be mounted or used by hand. Each .....

Quantity prices on request.

# A. C. Generator for Automobiles

THE old problem of how to maintain adequate charge in the automotive storage battery used to operate mobile radio equipment and public address systems appears to have been

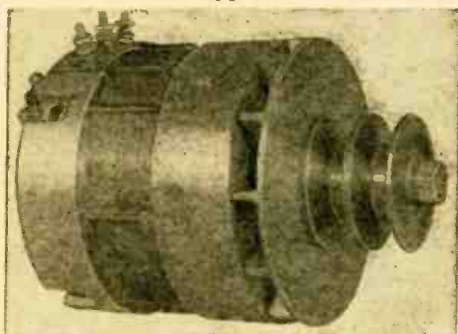

The alternating-current motor car generator.

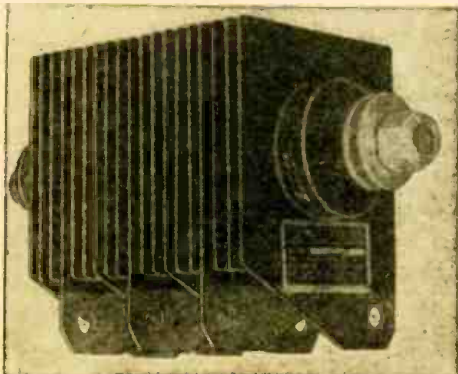

Rectifier shown in the schematic at right.

solved through the use of an a.c. alternator to replace conventional d.c. generating equipment. Application of the alternator in combination with a voltage regulator and dry disc rectifier results in obtaining much higher electrical output at all engine speeds.

This new a.c. generating system was developed by The Leece-Neville Company, of Cleveland, Ohio.

The use of d.c. in automotive equipment came about as the simplest solution to the problem of a portable power supply: the wet cell type battery.

To eliminate the constant design compromise required in a d.c. generator, and at the same time solve the problem of a flat output curve for wide variations of engine speed, the designers turned to an alternator. Output of the alternator is taken from a 3-phase stator, thus eliminating sparking and brush wear, the 2 major problems of commutation in a d.c. generator. The stator is Y-connected, giving a voltage conversion factor of 1.732 times that of any single leg. This a.c. output is applied to the 3-phase full-wave rectifier unit, composed of pre-aged magnesium-copper-sulphide plates which in effect re-

place the commutator of a d.c. generator, since d.c. output is obtained.

The control unit of the system is composed of 3 sections: a voltage regulator; load limiter; and load relay. The voltage regulator and load limiter are connected to control the field current of the rotor as a function of load voltage or current regardless of engine speeds above 575 r.p.m., and load demands within the capacity of the system, where the alternator ratio is 2:1.

The Leece-Neville a.c. generating system provides a flat performance curve of 60 amperes from 11 1/2 m.p.h. up to a maximum speed of 120 m.p.h., with a 35-ampere capacity at engine idling speeds. This is in comparison with the heavy-duty generator system most commonly in use with the following performance: maximum output of 40 amperes from 19 1/2 m.p.h. to 53 m.p.h., and an 18-ampere output while idling at 450 revolutions per minute.

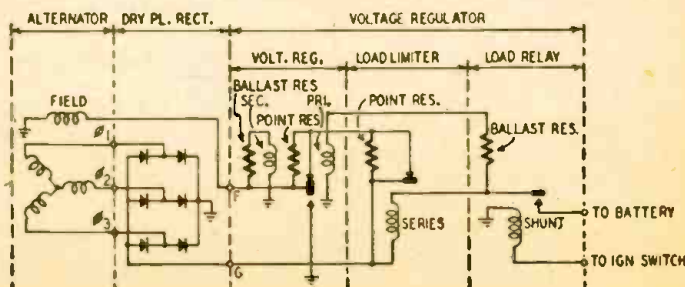

## BROAD-BAND AMPLIFIERS

(Continued from page 45)

signal, thus reducing the gain of the stage. The cathode bypass condenser, Ck, is selected to present a low-impedance path to audio frequencies. Its reactance at the lowest desired frequency must be very low compared with that of Rk, if frequency distortion is to be avoided. If the reactance is appreciable at any frequency, the gain of the stage varies as degeneration develops. The gain of an amplifier with degeneration is

$$\text{Gain} = \frac{G_2}{1 + \left[ \frac{gm (Rk \times X_{ck})}{\sqrt{Rk^2 + X_{ck}^2}} \right]}$$

where G is actual gain

G<sub>2</sub> is gain without degeneration,

gm is transconductance of the tube,

X<sub>ck</sub> is reactance of cathode bypass, and

Rk is cathode biasing resistor.

The effects of the cathode bypass condenser can be seen by determining the reactance of Ck at 40 and 2000 cycles. Substituting these values and solving Eq. 9, we find that at 40 cycles, the gain is reduced to 153.8. The gain is 343 at 2000 cycles and can be neglected. See Example 2.

The screen bypass condenser, Csg, and the screen dropping resistor, Rsg, have the same effect on gain as the cathode condenser and resistor, but on a smaller scale. The impedance in the screen circuit can be neglected if the time constant of the screen circuit, (Rsg x C) is equal or greater than 3/f where R is in ohms, C in farads and f is the lowest frequency to be passed without attenuation. In the circuit in Fig. 1, Csg is large enough to pass the lowest frequencies without appreciable degeneration.

The total loss in gain at 40 cycles (as opposed to the theoretical loss of 30% from the original equation) is the product of the all reductions in gain. These are 0.7 (reactance of interstage coupling condenser), 0.608 (reactance of Cb) and .439 (reactance of cathode bypass condenser). At 40 cycles, the gain is 0.7 x 0.608 x 0.439 or 0.186, which amounts to approximately 15.2 volts with a .25-input signal at 40 cycles. This will probably explain why those bass notes don't come through; even when you have a good pickup and speaker.

In the next article we will discuss methods of applying compensation to the circuits to extend the useful amplification range as far into the high- and low-frequency, audio and video ranges as may be desired.

Navy television experiments 150 feet below the ocean at Bikini may open a new chapter in the field of sub-surface scientific studies, predicts Captain Engleman, project officer at the experiments. Areas never seen by man may now be compelled to give up their secrets to the television-equipped researcher.



## Better Products for the Radio Industry

### Field Chass EZ • Phono Turntable Stand Spray Kit • Electronic Chemical Lab.

#### G-C FIELD CHASS EZ

Holds almost any radio chassis in position! Has special reversible hooks for flanged type chassis or, to tilt chassis back if necessary. Made with slide adjustment—takes only 5 seconds to install. No parts to lose—will never wear out. A real convenience for the radio serviceman!  
No. 5207 Serviceman's Kit ..... List \$2.95



#### G-C PHONO TURNTABLE STAND

Steel stand on which you can place any phono turntables. Ideal for repairmen, easily adjusted, sturdy steel construction.



No. 5205 ..... List \$6.65

#### G-C FELT-KOAT FLOCK FINISH SPRAY KITS

Now it's easy to supply flock for refinishing turntables, cabinets, grilles, etc. Kit contains specially designed spray gun, 2 colors flock, undercoats, thinner, brush, instructions, etc.  
No. 180-2 ..... List \$10.75



#### G-C ELECTRONIC CHEMICAL LABORATORY

Ideal for experimenters, servicemen, etc. 19 different bottles and chemicals in steel rack (free rack).  
No. 998 ..... List \$11.12



Have you seen the new G-C "Speedex" Wire Strippers... write for illustrated literature.

RADIO DIVISION DEPT. D

G-C Products are available at leading distributors. Write for your copy of our new illustrated catalog.

## GENERAL CEMENT Mfg. Co., Rockford, Ill., U. S. A.

Manufacturers of over 3,000 products • Sales offices in principal cities

**NOW *Soundex* FOR YOUR SILENT PROJECTOR Economically**  
\$5.95  
Convert your 16mm silent projector to sound (regardless of make) with Apex sound head & radiofilm adapter. Guaranteed excellent performance. Write today for free information.  
APEX VIDEO • 12209 U Branford St. • Roscoe, Calif.

**RADIOMEN SERVICEMEN BEGINNERS MAKE MORE MONEY EASILY — QUICKLY**  
\$250. WEEKLY POSSIBLE  
We Show You How Information Free  
**MERIT PRODUCTS**  
216-32V 132 AV. SPRINGFIELD GARDENS 13. N.Y.

### RADIO QUIZ

By JOE H. BARBER, JR.

Check your radio knowledge. Another quiz will appear in an early issue.

1. A filter placed in a line to attenuate high frequencies has an attenuation of 3 db per octave from 300 to 9,600 cycles. How many db down would a 4,800-cycle frequency be in relation to a 300-cycle frequency?

2. A Geiger-Müller counter is an electronic device used to (a) detect radio code transmission, (b) detect radioactivity, (c) measure the frequency of high-frequency alternating currents.

3. Dr. Lee de Forest is best known for his invention of (a) the radio aerial, (b) the safety diving helmet, (c) the audion tube.

4. If you were trying to figure out the approximate impedance of a loudspeaker voice coil at 400 cycles and knew the d.c. resistance of the voice coil, would you (a) multiply the d.c. resistance by 400, (b) divide by 2, (c) multiply by 1.4?

5. Radio waves travel at the speed of (a) 1,100 feet per second, (b) approximately 186,000 miles per second, (c) the number of seconds squared times 16.

6. A cold-cathode rectifier generally

contains (a) a plate, grid, and heater; (b) a cathode and one or more plates; (c) a plate, 3 grids, a getter, and a cathode.

7. A Rochelle salt crystal phonograph pickup in an electrical circuit is generally considered (a) a voltage-generating capacitive reactance, (b) a voltage-generating inductance, (c) a straight resistance.

8. The audio amplifier in a home radio set has a total of 2% harmonic distortion at its rated power output. From the standpoint of distortion, the amplifier would be rated as (a) an average amplifier, (b) a very poor one, (c) a very good one.

9. A customer wants you to build him a good quality audio amplifier for his home radio-phonograph. Money is no object to him. Would you build him a class-A, a class-AB2, or a class-C amplifier?

10. The resistance of tungsten filament lamps (increases) (decreases) as the filament is heated, and the resistance of a carbon filament lamp (increases) (decreases) when it is heated.

(See page 77 for answers)

Congratulations To The

# 25 WINNERS

in the big  
**TELEX MONOSET CONTEST**

**1st Prize**

\$100 and a TELEX Monoset to  
**HOWARD A. STAMBAUGH**  
5543 28th Ave. N.E.  
Seattle 5, Wash.

**2nd Prize**

\$50 and a TELEX Monoset to  
**G. E. HORA**  
4350 W. 25th Place  
Chicago 23, Ill.

**3rd Prize**

\$25 and a TELEX Monoset to  
**LUTHER B. HOFFMAN**  
678 Princeton St.,  
Palmerton, Pa.

**TELEX MONOSETS TO THESE 22 RUNNERS-UP**

- Ethel Atkins, Grand Rapids, Mich.
- Robert J. Banks (W8KOS), Grand Rapids, Mich.
- Louis Berkowitz, Allston, Mass.
- James R. Boyd (W8WDL), Toledo, Ohio
- Herbert S. Brier, Gary, Ind.
- W. H. Cooney (W8LM), Conneaut, Ohio
- Harry Greene, Long Island City, N. Y.
- Chris E. Hobson (W3AER), Wilkensburg, Pa.
- T. Huntley (W6LIP), Encino, Calif.
- George C. Lefevre, Carlisle, Pa.
- E. W. Melin (W2JTA), Montclair, N. J.



**TELEX Monoset**

- Successor to the Headphone
- Comfortable Stethoscopic Design
- Built-in Volume Control
- High Fidelity—Featherweight

- Gail H. Moreland, Wichita, Kan.
- Norman E. Nelson, Milwaukee, Wis.
- Rev. Palmer H. Plourde (W7KFD), Bisbee, Ariz.
- Ed. G. Raser (W2ZI/W2ZQ), Trenton, N. J.
- P. M. Ross (WBNX), Carlstadt, N. J.
- Virgil F. Schaffer Jr., Minneapolis, Minn.
- Albert A. Scharwachter, Oceanside, Long Island, N. Y.
- E. V. Schwartz (W6DMB), Los Angeles, Calif.
- Capt. W. A. Trembly, UAL, Burbank, Calif.
- Dr. Arthur W. Woods, Birmingham, Ala.
- Otto L. Woolley, Colorado Springs, Colo.

TELEX thanks the many radio fans who sent in opinions. Even though you didn't win, we know you're glad to have tried the new Monoset.

For a really modern rig—transmitting or receiving—get a TELEX Monoset today!



## RECORDS

**LATEST & HARD-TO-GET BACK NUMBERS**

Some slightly used and some brand new—Victor, Bluebird, Columbia, Okeh, Decca, Capitol, etc. Such artists as Glenn Miller, Benny Goodman, Harry James, Bing Crosby, Frank Sinatra, Gene Autry, Duke Ellington, Fats Waller, Guy Lombardo, Andrews Sisters, Kate Smith, Ink Spots, Mills Bros., etc.

**BIG PROFITS** Your opportunity to cash in on this new field that is sweeping the country. Specify the type of music that sells best in your territory such as Swing, Sweet Music, Cow-boy, Hill-billy, Polkas, Blues, etc. Your price \$13.50 per hundred records, f.o.b. Chicago. All shipments made within 48 hours.

**CHAS. HOODWIN CO.**  
4419 Broadway, Dept. C7, Chicago 40, Illinois  
World's Largest Dealers in Used Records

## ROTA-BASE

NEW HANDY LAB. DIAL actually gives a "prong" picture of radio tube connections, INSTANTLY, ACCURATELY. No more valuable time lost thumbing pages or on fussy readings. Filament, grid, plate, cathode, etc., to more than 300 tube types are shown. NOW ONLY \$1.00 postpaid, or sent C.O.D. plus postage. Order TODAY, money refunded if you are not delightfully pleased.

**REED MFG. CO.**  
113508 Burbank Blvd. N. Hollywood, Calif.

Television tubes which can be swung from side over a 60-degree angle have been introduced by one manufacturer. Instead of moving chairs into position directly ahead of the receiver, the viewing tube can be pointed at any desired part of the room. Another manufacturer is producing a liquid lens which not only magnifies the picture but is claimed to make viewing possible over a 180-degree angle without appreciable distortion.

### METER SHUNTS

It is often necessary to make meter shunts, especially when one meter is switched to several circuits. Since it is not always feasible to mount the shunt directly on the meter switch, the use of 2-terminal mounting strips makes a neat arrangement. Copper-wire shunts can be soldered to the mounting terminals, but resistance wire is almost impossible to solder. Screw-type terminals must be used with these shunts which are mounted as shown in Fig. 1.

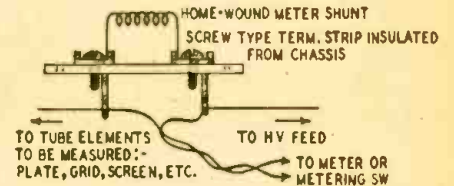

Fig. 1—Mounting for resistance-wire shunts.

A 2-gang, multiposition switch is usually used to connect the meter to the different circuits (Fig. 2). Its insulation should be sufficient to withstand whatever voltages may be encountered.

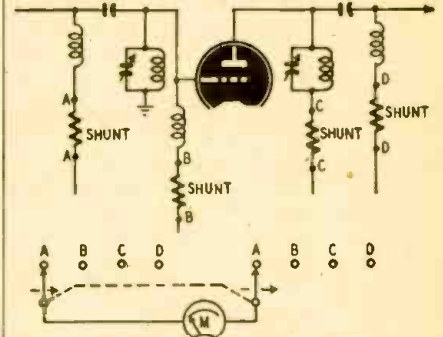

Fig. 2—Various points where meter is used.

To extend the meter to a desired range, connect it in series with a dry cell and a variable resistor (Fig. 3). Vary the resistor until the meter reads full scale. Connect the shunt across the meter and adjust it to reduce the reading to such a value that full-scale deflection with the shunt indicates the current range desired (Fig. 3). For example: to extend the range of a 50-ma meter to read 150 ma, vary the resistor so that the meter reads full scale. Then

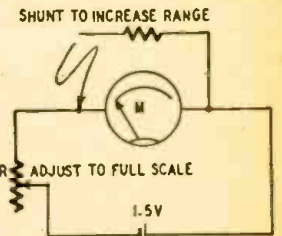

Fig. 3—Calibration hookup. adjust the shunt across the meter terminals to reduce the reading to 16 2/3 ma. With this shunt, the range is now extended to 150 ma. (Meter ranges should be extended to read approximately 33% more than the maximum current that will flow in the circuit.)

The value of the variable resistor in the calibration equipment is important and should be large enough to prevent burning out the meter. With a 1 1/2-volt cell and a 1-ma meter, its resistance should be at least 1,500 ohms, but 2,000 ohms allows more flexibility for variation. For more sensitive meters, use correspondingly higher values of resistance.

RICHARD L. PARMENTER, W1JXF,  
Middleboro, Mass.

**"Cash in"**  
on your Practical Experience...

**BE AN FCC LICENSED RADIO TECHNICIAN AND GET IN ON THE "GROUND FLOOR" OF THESE GROWING, PROFITABLE NEW FIELDS**



**THESE EMPLOYERS NEED FCC LICENSED RADIO TECHNICIANS NOW!**

- TAXICAB FLEETS • BUS AND TRUCK FLEETS • POLICE AND FIRE DEPTS. • RAILROADS •
- GAS AND ELECTRIC COS. • HIGHWAY PATROLS • AIR LINES • TELEPHONE COS. •
- FORESTRY DEPARTMENTS • GAS AND OIL PIPE LINES

Thousands of new jobs are opening up—FM Broadcasting, Mobile Communication Systems, Television. These are only a few of the new radio fields which require *FCC licensed* technicians.

These new fields offer to radio servicemen exceptional opportunities to become specialists, to obtain dignified, high-paying employment, to get out of the rut of "fixing radios," to rise above run-of-the-mill, commonplace, radio servicing.

**Your FCC "Ticket" Is Recognized in ALL Radio Fields as Proof of Your Technical Ability**

More than ever before an FCC Commercial license is a sure passport to many of the better paying jobs in this New World of Electronics.

Get your license without delay. Let Cleveland Institute prepare you to pass the FCC license examinations, AND TO HOLD THE JOBS WHICH A LICENSE ENTITLES YOU TO, using CIRE streamlined, postwar methods of coaching and training.

**WHAT OTHER EX-RADIO SERVICEMEN SAY**

"I took the commercial operator's license examination for 2nd class Radiotelephone, and passed O.K. I expect to transfer to the Communication Department of the California-Oregon Power Company, where I will be working on five Motorola FM 250v transmitters and 30 Motorola mobile units of 30w power."  
Student #2739N12

"For over the past month I have been working as Radio Technician with the Philadelphia Radio Police Dept. where we have been designing and installing new equipment. . . . I am very interested in your course and want you to know that the knowledge I have gained has been very valuable to me in my job."  
Student #4748S15

"I left Electronics Laboratory to maintain radio for the Red Cab Company of this city. I am finally using my 2nd class license and am starting out in two-way radio."  
Student #2739N12  
"You may be interested to know that I am employed at the local broadcast station, where I am a transmitter operator. I took and passed the FCC examinations last February."  
Student #2745N12

"I have and am enjoying the course very much; don't know of any other course offered that fulfills its intended purposes as well as the one you offer, and I shopped around a great deal before taking your course. I have been working on Police Radio Station WPFS in Asheville for five months since getting my 2nd class ticket."  
Student #2858N12

**FREE BOOKLET**—Tells you the Government requirements for all classes of FCC COMMERCIAL licenses. (Does not cover Amateur License examinations). Use coupon below for Booklet B.

**OTHER CLEVELAND INSTITUTE HOME STUDY COURSES OFFER COMPLETE TECHNICAL RADIO TRAINING FROM LOW-LEVEL TO COLLEGE-LEVEL, FOR THE RADIOMAN WITH PRACTICAL EXPERIENCE!**

**COURSE A—MASTER COURSE IN RADIO COMMUNICATION**

A complete course covering the technical fundamentals of radio-electronics, for the radioman who wants a general review. Includes preparation for Broadcast station employment.

**COURSE B—ADVANCED COURSE IN RADIO COMMUNICATION ENGINEERING**

A genuine college-level radio engineering course, completely mathematical in treatment. For the advanced radioman with considerable practical experience and training.

**COURSE C—SPECIALIZED TELEVISION ENGINEERING**

An advanced college-level course for the radioman who has had formal training equivalent to Courses A and B (see above). Without preliminaries, every lesson is devoted to television subjects.

**COURSE D—ADVANCED RADIO TELEPHONY FOR THE BROADCAST ENGINEER**

An advanced, specialized course covering broadcast station engineering and operation. Without preliminary preparatory fundamentals, this course enters immediately into the heart of the subject matter. Covers the engineering knowledge and the technical duties required of the studio control operator, the master control operator, and the transmitter operator.

**FREE CATALOG**—Describes all Cleveland Institute home study courses—tells of CIRE unique, post-war methods of training. Use coupon below for Catalog A.

**CLEVELAND INSTITUTE OF RADIO ELECTRONICS**

Contractors to the Canadian Broadcasting Corporation

RC-3 TERMINAL TOWER

CLEVELAND 13, OHIO

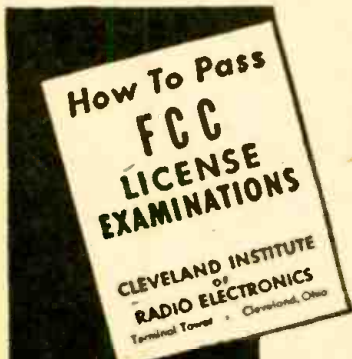

**Don't Delay—Write Today!**

Approved for Training under "G-I Bill of Rights"

**CLEVELAND INSTITUTE OF RADIO ELECTRONICS**  
RC-3 TERMINAL TOWER, CLEVELAND 13, OHIO

Gentlemen:  Please send me your Booklet B, "HOW TO PASS THE FCC COMMERCIAL LICENSE EXAMINATIONS," and information about your home study course for preparation for FCC License Examination. (Does not cover Amateur License examinations.)  
 Please send me your Catalog A, describing all of your home study radio-electronics courses. I desire training in course  A  B  C  D

Veterans check for enrollment information under G-I Bill. NO OBLIGATION — NO SALESMEN.

NAME .....  
ADDRESS .....  
CITY ..... ZONE ..... STATE .....

# SPECTACULAR VALUES IN BRAND NEW RADIO PARTS ELECTRONIC EQUIPMENT from MID-AMERICA

Never before such amazing values in brand-new radio parts and electronic equipment! Shown here are just a few of the **BIG BARGAINS** Mid-America has to offer now! Order from this ad—and ask for Mid-America's **BIG BARGAIN BULLETINS**. You'll save money on everything!

## FM TRANSMITTER



Used as indicator for altitudes up to 4000 ft.—but readily adapted for signalling, control circuits, etc. Contains dynamotor for operation from 27.5 volts. Complete with all 14 tubes: 2-12H6, 2-955, 2-9004, 4-12SJ7, 3-12SH7, and VR-150-30. Two antennas, altitude indicator, limit switch, connectors, instruction manual. MA-2198. **\$3795**

## Secondary Frequency Standard

Used to identify band edges and frequencies of unknown signals. Unique assembly uses 2-12SL7GT and 1-12SA7. Frequency divider and multiplier circuits provide 1000-cycle modulated outputs on 50KC and 200KC with harmonics up to 18MC. Complete with tubes, schematic diagram, less 200KC crystal. MA-OSC-3T. **\$295**

## DACO Tube Tester

Tests performance, leakage and shorts in ALL receiving tubes, even sub-miniature and acorn. PLUS provision for tubes that may be invented. Durable construction is fully shielded; dust-proof case, high-visibility meter. Illuminated chart; no books or charts to be misplaced. Simple, fast operation with positive contact slide-switches; tests EVERY tube element. 110 volt AC. 16 1/2" x 14 1/2". **\$2950**  
MA-2193

## PORTABLE DACO TUBE TESTER

Same construction and operating features as counter model. Enclosed in sturdy case with durable black leatherette covering. **\$3250**  
12 1/2" x 12 1/2". MA-2194

## FM and HAM ANTENNA



AN-104-B, 1/2-wave at 100-156 MC; formerly used with SCR-522, 274-N, ARC-5. A pair make an excellent broad-band dipole for FM reception. Coaxial connector in base. Very sturdy; use anywhere. **39c**  
MA-2153

## Special Filament Transformer

115-volt, 60 cycle primary; 3 secondaries: 1.5V-10 amp, 6.3 VCT-5.5 amp, and 6.3VCT-1 amp. Hermetically sealed for long life; insulation tested at 5000 volts. Porcelain insulated connector lugs. **\$295**  
MA-2066

## FREE BULLETINS

Order these values now—right from this ad! Send 25¢ deposit—we ship COD for balance plus postage. Write, too, for Mid-America's **BIG BARGAIN BULLETINS** that list hundreds of latest, greatest buys—many hard-to-get items—ALL AT UNBELIEVABLE LOW PRICES. Mail orders and catalog requests to store address, attention Desk RC-38

**MID-AMERICA CO. Inc.**  
STORE: 2412 S. MICHIGAN AVE., CHICAGO 16, ILL.  
WAREHOUSE: 2307 S. ARCHER AVE., CHICAGO 16, ILL.

# 1-TUBE POCKET RADIO

By D. E. SAWYER

As a little set for pocket or semi-fixed use, this receiver performs very well. Using only the self-contained loop antenna, broadcast stations within 25 miles or so are received with plenty of volume for comfortable listening. At night, using a 10-foot length of wire as antenna, stations hundreds of miles away have been logged.

The circuit consists of a 1T4 regenerative detector resistance-coupled to a 1S4 power amplifier. Because of the small size of the tuning condenser, the tuning is restricted to the range between 900 and 1500 kc. If desired, small mica capacitors can be added by a switch arrangement to cover the entire broadcast band. (Permeability tuning should solve this problem, if a couple of loop turns in series with the tuning unit would supply enough signal pickup and tickler coupling.)

Practically all the parts will be found in the average experimenter's junk-box, with the possible exception of the batteries, which can be purchased from any hearing-aid concern. Two Mallory RMB3 mercury cells form the A-battery and 1 Eveready 412E is the B. Their small size helps to make the receiver compact. The mercury cell deserves a note or two here. Despite its small size, the life of one of these cells is about 5 times that of a typical penlight battery, according to some comparison tests we made a few weeks ago. The mercury cell has an almost flat discharge curve until the end of its life, when it drops to a very low value within a few minutes. This end point for the 2 mercury cells in this receiver is reached after approximately 6 hours of steady use. The life of the Eveready 412E B-battery is about 20 hours.

The case of the receiver is constructed of 3/16-inch oak wood and measures 5 1/4 x 2 3/4 x 1 1/4 inches. Only the 2 sides containing the controls and phone-tip jacks are mounted on the bottom plate before the receiver is wired. The other sides are added afterward. Escutcheon plate screws, being the smallest screws we could obtain, were used to hold the case together after the proper edges were treated with wood glue. After trimming and sanding operations the grain of the wood was brought out by a light application and polishing with *Two-In-One* light brown shoe polish.

The 2 mercury cells are first wired together in parallel and then slipped

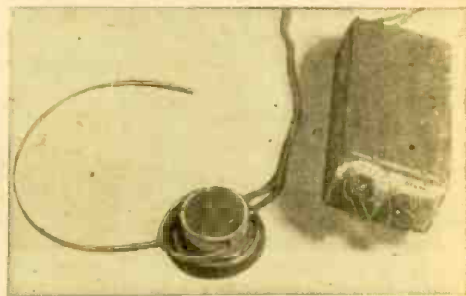

This radio slips easily into a jacket pocket.

into the set as a unit. It was thought impractical to make up clips for the batteries because they do not have to be replaced often. When they do have to be changed, a few minutes with a soldering iron does the trick.

Although the radio is compact there is plenty of room for all the parts, so the wiring is not difficult. It is advisable to add the B-plus lead to the B-battery last, for it is extremely easy to short

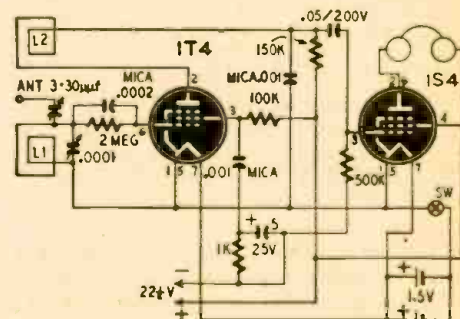

Regenerative circuit with loop coils is used.

A-plus to B-plus with the soldering iron when the tube bases are being wired. This burns out both tubes.

The coils (wound as loops) should be the last unit installed. The loop form consists of 4 nails driven into a board and marking the corners of a rectangle 4 1/4 x 2 3/4 inches. Both grid and plate loops are wound with No. 30 enamel-covered wire. The grid loop has 28, and the plate loop 12 turns. After each loop is wound, it is held together by small pieces of



Interior view. B-battery can be seen under the two Mallory cells.



**OIL FILLED CONDENSERS**

1 Mfd. 600 VDC...35c	7 Mfd. 330 VAC...\$1.25
2 Mfd. 600 VDC...35c	0.1 Mfd. 7500 VDC...1.50
10 Mfd. 600 VDC...98c	2x.1 Mfd. 7000 VDC...2.00
2 Mfd. 1000 VDC...69c	.02 Mfd. 8000 VDC...98
SPECIAL 16 Mfd. 400 VDC W.E.	.....98
1 Mfd. 5000 VDC Solar	.....2.95

SBPI CathodeRay Tubes, 5" Green Screen. Brand new in Original Cartons. Priced so low you'll want a Few. Each **\$1.45**

**Wire Wound Potentiometer**

100,000 ohm. precision made. G.R. type, 25 watt, 6" diameter. Brand new. **\$1.95**  
Heineman Circuit Breakers 3 & 5 amp. sizes. **95c**



**STEEL CHASSIS**

10 x 17 x 3.....\$1.38	11 x 17 x 3.....\$1.86
5 x 10 x 3.....87c	13 x 17 x 3.....\$2.22
7 x 13 x 2.....96c	7 x 7 x 2.....63c
10 x 14 x 3.....\$1.35	4 x 17 x 3.....99c

**STEEL CANS AND BOXES**

4 x 4 x 2.....68c	12 x 7 x 6.....\$1.58
4 x 5 x 3.....78c	15 x 9 x 7.....\$2.35
6 x 6 x 6.....99c	11 x 12 x 8.....\$2.25

**1/2 INCH STEEL PANELS**

3 1/2 x 19.....66c	10 1/2 x 19.....\$1.22
5 1/2 x 19.....87c	12 1/2 x 19.....\$1.46
8 1/2 x 19.....\$1.10	14 x 19.....\$1.62

**1/2 INCH ALUMINUM PANELS**

3 1/2 x 19.....\$1.38	8 1/2 x 19.....\$2.25
5 1/2 x 19.....\$1.74	10 1/2 x 19.....\$2.87

**Full Wave Bridge Rectifiers**

Type B: Up to 144 VAC in, up to 96 VDC out @ 1.2 amps. Signal Corps. #9D0612B **\$2.50**  
Type A: Up to 54 VAC in, up to 39VDC out @ 1.2 amps. Signal Corps. #4D0238 **\$1.50**  
Resistors — 100 Watt — Ferrule Type — 25,000, 30,000, 40,000, 50,000, 100,000 ohms. Each **25c**



**NATIONAL CO. PRODUCTS**

AR-16 Exciter Coils air-spaced: For 5, 10, 20, 40, or 80 meters with end, center or swinging link. Plug in type. Each \$1.15  
XB-16 Socket for Above. 33c  
TMK-500 Condenser 50-50 mmfd. .077" spacing 3000V Peak. **\$4.15**  
STD-50 Split Stator Double Bearing 50-50 mmfd. .026 Air Gap. **\$2.56**  
High Freq. Permeability Tuned RF coils  
AR-2 75-220 MC. 1.71  
AR-5 37-110 MC. 1.46  
YR-50 Coil Form Only 1.01  
10.7 MC Transformers for AM or FM superhets  
1 FL FM Discriminator @ 1.5DB. 6.90  
1 FM IF with 150 KC Band with Pass Band. 6.45  
1 FN IF with 100 KC Pass Band 1.5 DB. 6.45  
1 FO FM Radio Discriminator. 6.98  
ACN Dial. Swell for Freq. Monitors & VFO's  
Dial Bezel Size 5"x7 1/2"  
Five Blank Ranges for Direct Calibration **\$3**  
5:1 Ratio Velvet Vernier Drive

**Almost Complete line of National Co. Products In Stock**

Keying Unit. McEroy Model G-813. Complete with Tubes, 117N7GT, 1A7GT, 117Z6GT—Photo Tube, Exciter Lamp. Designed for Army Operator Training Schools. Mounted on Handsome Wooden Case. **BRAND NEW \$19.95**

cs Differential Relay 2 amp. contacts 110 VAC 8000 Ohm each coil. Bina to close; will take up to 250 VDC on each coil. Swell for Balanced or Bridge type circuit where limited current or power is available. Will withstand 12G Vibration at 35000 Ft. **95c**

If not rated 25% with order, balance C.O.D. All prices F.O.B. our warehouse New York. No order under \$2.00. We ship to any part of the globe

**LEEDS RADIO CO.**

75 Vesey Street Dept. RC3  
Cortlandt 7-2612 New York City 7

**METERS**

0-1 Ma D.C. Gruen 2" Round Metal Case. **\$1.95**  
0-30 Ma D.C. Westinghouse 2" Round Bakelite Case. **1.95**  
50 Millivolt movement 3" Round Bakelite with arbitrary scale. **1.95**  
APC-25 Air Trimmers. Screw Driver adjusted 12 plates, 25 mmfd. Silver Plated 15c ea. 10 for **1.25**  
APC-50 Air Trimmers. Screw driver adjusted 12 plates, 50 mmfd. Silver Plated 15c ea. 10 for **1.25**

**RADIO TRANSMITTER & RECEIVER APS-13 17 Tubes**

410 - 420 Mc; Light weight fully enclosed. 30 Mc. IF, complete with tubes 5-6J6; 9-6AG5; 2-2DE1; 1-VR-105; Schematic supplied with each unit. **Only \$11.95**



**Real Values**

832 Tubes Brand New Fully Guaranteed **\$2.15**  
In 23A X-Tal Diodes **SPECIAL \$1.00**  
Ouncer Transformer. Mike to Grid 25:1 Ratio Low to High Impedance. 35c Each 3 for **\$2.95**  
De Jur Wire Wound 20,000 ohm Pot. 12 Watts. 49c  
Arc's Silver Plated Banana Plugs per dozen. 10c  
24 Volt GE Relay 200 amp Silver Plated Contacts 39c  
6 Volt Rayonet Base Pilot Assemblies, with Dimmer, Red or White. Each. 19c  
39" Telescopic Antenna. 25c  
Octal Sockets Low Loss Bakelite. 08c

**ATTENTION!!**

**ALL SCR-522 OWNERS**

Remote Control Boxes for SCR 522's. Brand New in Original Packing; Consists of 5 push button switches, 5 Western Electric Pilot Assemblies, with Pilot Bulbs and Dimmer, and lever Switch all finished in Black Crackle. Order yours Today **\$1.25 ea.** for only.....  
Antenna Plug 46-PS-1 for 522A 150 ea.

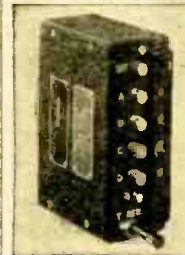

tape and removed from the form by pulling out the nails. The 2 loops are taped together with the plate loop on top. This unit is then set into the top inside circumference of the case. Putting the loops inside the case avoids almost all the annoying hand capacitance effects we would have if the loops were on the outside of the case. If no "plop" or gentle rushing sound is heard in the phones when the regeneration control is advanced, reverse the plate loop connections.

Operation is simple. Advance the regeneration control slightly past the point where the "plop" or rushing sound is heard. Vary the tuning condenser and you should hear a series of whistles. Each one of these whistles is a station. Back down the regeneration control, at the same time rotating the tuning condenser to keep the whistle at its lowest pitch, until the whistle disappears and the station is heard.

This little receiver does a good job on the locals with no external antenna; when dx is wanted, attach a wire to the 3-30-µmf trimmer screw and adjust for best results.

**A RELAXATION-TYPE AUDIO OSCILLATOR**

I built this code-practice oscillator to use with a semi-automatic key. It uses a selenium rectifier to supply d.c., a neon bulb, and a few other easy-to-get parts.

Operation of the oscillator is simple. The neon bulb requires a high voltage to ignite it, but the voltage may drop considerably below this point before it goes out. With the key and headphones circuits closed, d.c. from the rectifier flows through the phones and charges the condenser to the ignition point of the neon bulb, when it fires and discharges the condenser through the phones, neon bulb and resistor. The bulb goes out and the process repeats. Tone is determined by the neon bulb and the associated resistor and condenser values.

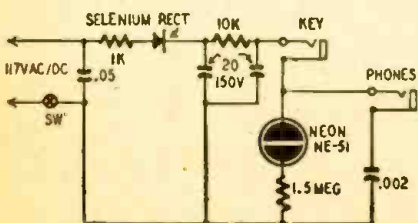

GEORGE R. MACDONALD,  
East Millinocket, Me.



World famous Amcon dependability plus new, gleaming Plastic Cases! Better performance as well as better appearance! For Amcon plastic-encased Capacitors make any chassis look better — help build your reputation for top-notch work Amcon Plastics are the quality Condensers that look the part!

ASK YOUR JOBBER FOR THE "3 STAR PERFORMERS" CATALOG.



**RADIO IN THE NEXT WAR**

(Continued from page 17)



If you are an experimenter, ham or otherwise—if you have a yen for self-constructed apparatus, you'll appreciate both of these handy, popular works. They are practical, easy-to-follow books, designed entirely for the man who likes to put things together. The methods recommended for constructing each piece of equipment have been proved sound and effective by actual experience. The instructions are written in a style easy to follow; supplemented with helpful illustrations—photos shot from various angles, carefully drawn schematics, etc.; also a list of parts. These two books (descriptions follow) are but two of the ten volumes of the RADIO-CRAFT LIBRARY SERIES, all topnotch, up-to-date reference works which you should own. The cost, 50c per copy, is trifling when you consider the wealth of benefit you get out of each. Order them today—fill out the coupon below.

**NO. 35—AMATEUR RADIO BUILDER'S GUIDE**

This book is a treat for the ham who gets a kick out of building his own equipment. The results will be a credit to any ham shack. Just look at the range of apparatus described. The first section is devoted to high-grade superhet receivers; the second section to various type transmitter circuits, ranging from a small flea-power rig that may be stowed away in a little bag to a deluxe job running well over a quarter-kilowatt. A small microwave transmitter is included. The last section is devoted to station accessories such as rotary antennas, preselectors, and frequency meters. The following are actual chapter heads: *Miniature Communication Set; An Advanced 13-Tube Set; Economy Receiver; 50 Watts on C.W.; Beam Power 3; 430 mc with a 6F4; A.C.-D.C. Transmitters; Power-Supply Design; Roof-Top Rotary Beam; A Signal Booster; A.C.-D.C. Frequency Meter.*

**NO. 36—RADIO TEST INSTRUMENTS**

You will find many good reasons why you should use this book to help you build test instruments:

- To supplement your factory-built instruments with a more complete line.
- To have stand-by instruments on hand while regular ones are out on jobs.
- To provide small portable instruments for outside jobs and thereby permit the commercial instruments to stay on the bench.
- To gain valuable experience building your own instruments.

You will be surprised at the variety of instruments in each field covered in this book. Chapter heads tell their own story: *A Versatile Tester; Electronic Multichecker; A Compact Multimeter; Portable Shop; A Sensitive Tracer; Midget Signal Tracer; Triode-Probe Tracer; The Capacitester; A Capacitance Meter; Capacity Bridges; The Transigenerator; A Wide-Range Generator; Simple Audio Generator; Dynamic Tube Checker; Modernizing Old Testers; V.T.V.M. Adapter; Meterless Voltmeter; V.T.V.M. & Oscillator.*

**SEE YOUR RADIO DEALER. IF HE CAN'T SUPPLY YOU**

**MAIL THIS COUPON**

RADOCRAFT PUBLICATIONS, Dept. 38  
25 West Broadway, New York 7, N. Y.

Send me the volumes (50c each, postpaid) checked. My dealer is unable to supply.

- No. 35—Amateur Radio Builder's Guide       No. 36—Radio Test Instruments
- 8 OTHER BOOKS 50c EACH**
- No. 29—Handy Kinks and Short Cuts       No. 33—Amplifier Builder's Guide
- No. 30—Unusual Patented Circuits       No. 34—Radio-Electronic Circuits
- No. 31—Radio Questions and Answers       No. 37—Elementary Radio Servicing
- No. 32—Advanced Service Technique       No. 38—How to Build Radio Receivers

I enclose.....

Your Name ..... Address.....  
(Print Clearly)

Radio Dealer's Name ..... Address.....

Therefore, having the best atom bomb now, WE MUST SAFEGUARD IT ENERGETICALLY. By that is meant, safeguard the country that produces it. I may put it this way: *An atom bomb is not more powerful than the people who guard it.*

It is true that in some respects there is—as yet—no defense for the atom bomb. It IS possible for a foreign power to plant time A-Bombs in strategic points all over the U.S. This, however, is not so simple in practice as it looks. Nor would the damage done by such bombs be as extensive as those dropped from overhead.

What about A-bombs dropped from V-2-like guided missiles? Again a possibility—but not for another 10 to 15 years. Certainly not if the missiles come from more than 1,000 miles away. The art has not progressed so far that a city can be hit with any degree of certainty from 1,000 miles away, at the present state of long distance missile development.

What about airplane-dropped A-bombs? This is the more reasonable avenue open to the enemy, as we ourselves proved at Hiroshima and Nagasaki.

What other means are there? One of the simplest would be via submarine. Special submarines carrying in their hold one or more A-bombs, could approach our coastal cities and bombard us by means of small airplanes or guided missiles carried by the submersibles. All this seems like a good possibility right now.

What then is our first line of defense? Radio, of course. At this moment we are wide open to an astute enemy—far more than before Pearl Harbor. We have no real air force—with all that goes with it—to speak of. Says General H. H. Arnold in a recent article: "Although the Air Force was able to activate 55 of these groups (of 70 combat groups) by the end of last year, there are funds to sustain the remaining 15 on a skeleton basis only. The Air Force budget for 1948 will permit the maintenance of only 40 combat groups—not much better than half the minimum requirement for the safety of the country."

But during the next war, no air force can wait till the enemy flies over the U.S. We need—desperately—a far flung net of search radar installations at all strategic points. These are in the following order of urgency:

1. The coast of Alaska.
2. The 60th parallel throughout Canada.
3. Our northern boundary paralleling all of Canada.
4. Our Atlantic and Pacific coasts.

These radar installations should be of the latest and most efficient design, and they should be of the automatic recording type. In addition they should all be synchronized with effective anti-aircraft guns. This forces the enemy into the stratosphere, giving our radar posts a much better time factor for interception.

tion by our own Air Force.

In the two oceans—the Atlantic and the Pacific—our Navy should soon be on a most effective patrol duty. We probably have sufficient destroyers now for anti-submarine duty. Again radar—which won us the submarine war against the Germans in World War II—will be used effectively, even better, with our past experience plus supersonics and vastly improved instruments, during the next war.

Suppose that the enemy uses atom bombs against us first. There is, of course, always the possibility that he may. With early, efficient safeguards as outlined above, it will make his task much more difficult. That some A-bombs will fall on the U.S. is certain in such a case—that they will create untold havoc too, is equally certain. But it will only be a fraction of what would be in store for us without our safeguards and adequate defenses.

How will we retaliate? All of the following is not science-fiction (a term which I coined): We already have developed long distance planes to fly 5,000 miles without refueling. We are well ahead in radio guided missiles that can be launched from the long distance mother planes. Each mother plane can launch several of such radio guided missiles. These are robots—carry no human crew. They will be launched many miles from the targets, thus do not endanger the crew of the mother ship which thus incurs no risk as in flying over the target into anti-aircraft fire.

So small are these robot missiles they are most difficult to shoot down. *Moreover, they are now television equipped.* By radiotelevision the operator in the mother ship can *actually see the target* under the robot-missile and explode its A-bomb at the exact point and time desired.\*

To further confuse the enemy, if he sends up fighter planes to shoot down the robots, many of the latter can be dummies—without A-bombs. If for instance three times as many dummies are used as A-bomb ones, the chances that a greater percentage of loaded ones will explode over the target are vastly improved.

Thus A-bomb saturation and complete annihilation of the doomed city is certain—without much loss of life for our side.

All this is technologically feasible today—it is not a future development.

I sincerely hope that this article may serve as a terrible warning to all concerned—there is still time to turn back the holocaust-clock. But we can no longer afford to remain unprepared—the isolation era for America is long past. The next Pearl Harbor may finish us as a nation.

\*The idea of a television controlled airplane to drop bombs over a distant target was first described by me in *The Experimenter* (November 1924 issue) under the title of "The Television Controlled Airplane."

Radar is now being used in their work by the Canadian Mounted Police, recent reports indicate.

"The Kit for the Millions"

NO TECHNICAL KNOWLEDGE REQUIRED FOR ASSEMBLY!

# TRANSVISION

... Tops in *quality* ... Tops in *value!*

## TELEVISION KITS

BUILD YOUR OWN *Custom-Quality* TELEVISION SETS!

### 12" TELEVISION KITS—

Standard and DeLuxe Models

Picture size 1½ times larger than with 10" tube . . . A big 75 square inch picture!  
Sharp, steady picture achieved with advanced Transvision television circuit. Picture has remarkable brightness even in lighted room (no darkening of room is required). IDEAL FOR HOME or COMMERCIAL INSTALLATIONS.

**12" TRANSVISION TELEVISION KIT . . .**  
Standard Model . . . FEATURES: 12" picture tube . . . Picture size 1½ times larger than with 10" tube . . . RF Unit designed for 13 channels: factory wired and pre-tuned for 7 channels (no areas have been assigned more than 7 channels; however if desired, up to 6 more channels may be added at very nominal cost) . . . 4 mc bandwidth for full picture definition . . . High fidelity F. M. sound reproduction . . . picture size 75 square inches . . . 9000 volts second anode potential for brightness and contrast . . . maximum picture, sensitivity (better than 50 microvolts) . . . 22 tubes and 12" picture tube, antenna, lead-in wire, etc. (Cabinet extra, if desired).  
LIST \$289.00

**12" TRANSVISION TELEVISION KIT . . .**  
DeLuxe Model with Superb Built-in F.M. RADIO. Same characteristics as the Standard Model, plus the following ADDITIONAL FEATURES:—50-216 mc continuous tuning . . . Covers the entire F.M. band and all 13 television channels . . . Cut-off switch eliminates unused tubes when set is used only as F.M. receiver . . . LIST \$359.00



12" KIT (Table Model)

**ALL TRANSVISION KITS ARE COMPLETE**  
—Nothing more to buy! . . . All Transvision Television Kits are COMPLETE with all tubes, including picture tube, wired and pre-tuned RF units and IF's, high gain folded dipole antenna with 60 ft. lead-in cable, wire and solder.

**TRANSVISION TELEVISION CABINETS**  
Beautiful, sturdily built cabinets with handsome rubbed wood finish. Fully drilled.  
12" Table Model Cabinet . . . LIST \$44.95  
12" Console Cabinet with compartment for record changer . . . LIST \$99.50  
7" Table Model Cabinet . . . LIST \$32.50

**FM RADIO CONVERSION UNITS:** All Transvision 12" STANDARD Television Kits can now be had equipped with superb FM Radio at the following small additional charges:  
For 12" KITS ALREADY ASSEMBLED, FM Conversion Unit . . . LIST \$12.50  
For new 12" KITS (non-assembled), FM Conversion Unit . . . LIST \$7.95



15" Picture Enlarging Lens



### TRANSVISION Television Picture Enlarging Lenses

Engineered by Transvision, these lenses enlarge and clarify the picture. Have wide angle of vision. When placed about 1" from Picture tube, the lens almost doubles the picture area; when placed further away, it increases the enlargement still more. Optically ground and polished; 50% greater light transmission than equivalent glass lens; 1/3 weight of glass lens of similar magnification power. All lenses equipped with adapter for installation on cabinets.

15" LENS (125 sq. in. picture) . . . List \$36.95  
12" LENS ( 75 sq. in. picture) . . . List \$25.95  
10" LENS ( 52 sq. in. picture) . . . List \$19.95

### TRANSVISION ALL-CHANNEL R.F. UNIT

**FACTORY PRE-WIRED and TUNED**  
For use in Building your own custom-made television receiver . . . for any 7", 10", 12", 15", or 20" Kit.

**TRANSVISION ALL-CHANNEL R.F. UNIT** . . . LIST \$37.95  
Same R.F. Unit, plus FM Band . . . LIST \$49.95

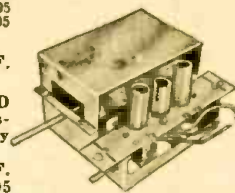

ALL-CHANNEL R.F. UNIT

### TRANSVISION FEATHERWEIGHT SOLDERING IRON

**NOTE THESE NEW, REMARKABLE FEATURES:** Weighs only 3 ounces (without the cord) . . . Delivers working output of 200 watt iron at fraction of current normally consumed by heavier irons . . . Heats up in 20 seconds . . . Finger-tip button control . . . Cool grip . . . Retains heat (with switch off) up to one minute . . . Featherweight permits long periods of soldering without fatigue . . . Economical—intermittent control feature prevents tip corrosion and necessity of frequent cleaning . . . Long, thin tip permits soldering in tight corners . . . Tips are interchangeable to suit work at hand . . . For operation on 110V. AC, 60 cycles. Complete with 6 volt transformer . . . LIST \$13.95

All prices listed above are 5% additional west of the Mississippi. All prices are fair traded.

See your local distributor or for further information write to Dept. R.C.—



Featherweight Soldering Iron

**TRANSVISION, INC.**  
385 NORTH AVE., NEW ROCHELLE, N. Y.

## BONAFIDE VALUES

 <p><b>SHURE T17B</b> Push Button Carbon Mike <b>89<sup>c</sup></b> With Cord and Plug Value \$12.00</p>	 <p><b>SHURE CRYSTAL MIKE</b> <b>\$6<sup>95</sup></b> With Stand, Base and 7 Ft. Cable Value \$18.50</p>
---	---

Webster #50 Changer .....	\$21.49
Webster #56 Changer Automatic Stop .....	25.95
Seeburg Changer, "2 post" .....	21.97
Maguire Changer 2 post Automatic Stop .....	11.95



**2 TUBE PHONO OSCILLATOR**  
Complete with tubes, 35Z5, 12SK7. Use with record player, and tune in on any radio.  
Complete. All Wires **\$4.75**

3 Tube PHONO AMPLIFIER Volume and tone control ALL WIRED with Tubes.	\$4.95
ASTATIC OR SHURE Pick Up.....	2.25
A.C. Phono Motor .....	2.25

Telescopic Aerial—8 ft., 8 Section—Brass—With Mounting Bracket	1.79
With Heavy Shielded Lead .....	2.19

25% Deposit, Bal. C.O.D. Plus Charges  
Write for Latest Catalog

**BONAFIDE RADIO CO.**  
89 1/2 Cortlandt St., Dept. I, N.Y.7,N.Y.

## ANOTHER *New* BROWNING DEVICE

### FM TUNER Model RV-10

Small, compact, easily mounted high fidelity FM tuner. Armstrong FM circuit. Range: from 88 to 108 MC.

Frequency meters. WWV standard frequency calibrator Oscilloscope. Power supply and square wave modulator Capacitance Relay. FM-AM Tuners. FM Tuner.

KNOW THE ENTIRE BROWNING LINE • ENGINEERED FOR ENGINEERS

Write Dept. J for Catalog



**BROWNING** LABORATORIES, INC.  
WINCHESTER, MASS.



**TINY RADIO!**  
**FITS IN YOUR HAND**  
REALLY WORKS TOO!  
Unbreakable RED plastic Cabinets. NOTUBES. BATTERIES OR ELECTRIC "PLUG-INS!"  
Works on new Patented "Permacrystal" and Roto-Tuner! EASY TO USE! SHOULD LAST FOR YEARS!  
GUARANTEED TO WORK on local radio programs by following directional or send only \$1.00 (bill, money order or check) and pay postman \$2.99 plus postage on delivery. COMPLETE READY TO PLAY—MARVELOUS GIFTS—BARGAIN PRICES! GET YOUR TINY RADIO NOW!

ONLY \$3.99 Postpaid  
PAKETTE PRODUCTS CO., Inc., Dept. RC-3, Kearney, Neb.

## PEN-OSCIL-LITE

Extremely convenient test oscillator for all radio servicing: alignment • Small as a pen • Self powered • Range from 700 cycles audio to over 600 megacycles u.h.f. • Output from zero to 125 v. • Low in cost • Used by Signal Corps • Write for information.

GENERAL TEST EQUIPMENT

38 Argyle Ave. Buffalo 9, N. Y.

# R. F. Sticky-Fluid Meter

By S. R. WINTERS

**A**N electronic timer for determining precisely the sticky or glutinous quality of paints, oils, lacquers, catsup, jellies, and other nontransparent fluids has been developed by P. J. Franklin of the National Bureau of Standards. This new apparatus employs electronics for measuring time differences with split-second accuracy, and is of potentially great value in determining the swiftly changing viscosity of opaque fluids in sundry manufacturing processes.

This timer is used in conjunction with a standard instrument known as the falling-ball viscosimeter. In this instrument, a closed tube, surrounded by a constant-temperature water jacket and containing a metal ball immersed in the liquid whose viscosity is to be measured, is quickly inverted. The ball's rate of fall determines the thickness of the fluid. The descent of the ball requires precise timing—and that is done by the electronic timer.

Passage of the ball through 2 coils around the viscosimeter tube is used to trigger a radio-frequency oscillator, thereby starting and stopping a timing device. The coils are link-coupled to the output of a 1400-ke oscillator, as shown in the schematic. Small padding condensers tune each coil to the exact frequency, so that the amount of detuning

is the same as the ball drops through each one.

The radio-frequency voltage from each start-and-stop coil is rectified by the separate diodes of a 6SQ7 tube. The resulting change in cathode current is amplified by the triode section of the 6SQ7 radio tube to insure adequate voltage variation to operate a pulse-sharpening circuit. The latter uses two .04-watt neon bulbs in series with a load resistor. When the voltage in the plate circuit reaches the ignition point of the neon bulbs, they fire and a sharp pulse develops across the load resistor. These bulbs contain a minute quantity of radium to insure uniform ignition voltage. They have the further advantage of remaining ignited, until the output voltage of the triode has dropped to a low point. This permits only 1 pulse to take place with the passage of the ball through each coil. Both pulses are placed on the grids of a trigger pair, which, on the first pulse, shuts a relay, thus starting a clock, and on the second pulse throws open a relay to stop the clock. The time of descent of the falling ball of a viscosimeter, as determined with this electronic circuit for one direction of travel, was found to be reproducible within .01 second for a falling period of 2.5 seconds.

Two 2050 tubes—small screen-grid



The two coils may be seen just inside the two square plastic pieces in the glass cylinder.

RADIO-CRAFT for MARCH, 1948

thyatron—make up the trigger circuit. Though the circuit is puzzling at first glance, operation is fairly simple. If current flows through the lower 2050 on the schematic, its plate-cathode voltage drops to a low value (approximately 10 volts) and there is a large voltage drop across the 15,000-ohm resistor in its plate circuit. Meanwhile the top tube is passing no current. Consequently, there is no voltage drop across the plate resistor and relay, and the 1- $\mu$ f condenser is given a negative charge on its bottom plate and a positive charge on the top one (as shown in the schematic).

A pulse applied now to the grid circuit will have no effect on the bottom

der methods involved troublesome handling and cleaning after the material had thickened.

Although the opacity of the material being studied obviated the use of visual timing, the falling-ball apparatus with the electronic timer proved superior to any other tried method. Therefore, it is anticipated that many industries will adopt this system of measuring the viscosity of opaque fluids. Paint and lacquer manufacturers will find the new apparatus useful wherever the measuring device must be enclosed to avoid the evaporation of volatile solvents. The oil and asphalt industries will also find this equipment valuable because the opacity

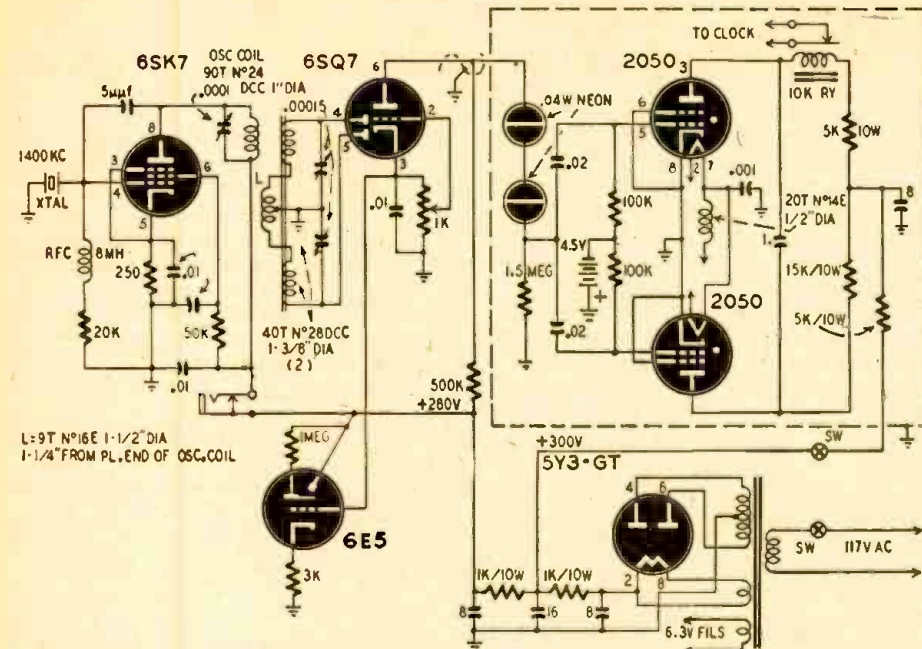

tube—already drawing current—but can fire the top one. As soon as the top tube starts to draw current, its plate voltage falls. Thus, the negative charge on the bottom plate of the condenser is discharged, making the plate momentarily negative. The bottom tube stops conducting and the top one continues to conduct until another pulse is received, when the cycle is repeated.

This novel split-second electronic timing gadget is intended for use in a manufacturing process involving over-and-over measurements of the viscosity of opaque fluids maintained within a well-defined temperature range. Several ways of measuring the relative stickiness of liquids have been used in the Bureau of Standards laboratory. These, for the most part, were based upon the rate of flow through a capillary tube or through a small orifice. These methods depend upon the rate of rotation of a cylinder or paddle wheel within a cup holding the fluid. Capillary tubes were found to be impractical for determining the viscosity of opaque liquids, because they required constant refilling and were bothersome to clean after the material had set. On the other hand, if the rate of flow through an orifice is employed as a basis of measurement, holes of progressively increasing size are necessary as the fluid becomes less glutinous or more viscous during the process of manufacture. The paddle wheel or cylin-

der methods makes nonvisual timing an absolute necessity. For similar reasons, manufacturers of catsups, jellies, and other liquid foods will adopt the falling-ball, electronic-timing apparatus as practical equipment in studying the swiftly changing viscosity of fluids in various manufacturing processes.

### QUICK EMISSION TESTING

At times when a tube checker is not available, it is possible to make an approximate test of a tube's condition by using an ohmmeter. This test is suitable for many purposes and is easy to make.

To test the tube, turn the receiver on and, with the meter set for a high range, place the negative probe on the grid terminal and the positive probe on the chassis. After noting the reading, which should be very high, reverse the probes and check the meter reading again. If the second reading is in the order of 50,000 ohms or less, the tube's emission is still high. However, if both readings are high and nearly alike, then the tube is weak or has virtually no emission at all.

Inconclusive results from this test may be due to low grid resistance, oscillation, or other factors. In such cases, either disconnect the grid lead or move the tube to a different socket where conditions are more stable.

MARCEL STRUDLER,  
Tel Aviv, Palestine.

## Technicians Everywhere agree that when BETTER AMPLIFIERS are made, it's A. C. Shaney who's "a-goin' to make them"

A. C. Shaney, long known as the outstanding designer of high-quality amplifiers, and his associates at the Amplifier Corp. of America, are getting ready to announce the completion of the finest line of public address and electioneering amplifier equipment ever produced.

New standards of quality and workmanship, new circuits, new materials, and new manufacturing processes have been combined to make this soon-to-be-announced amplifier line the answer to all requirements. Specifications and performance ratings of these popular-priced models will equal or surpass those formerly found only in high-cost, custom-built equipment. And Amplifier Corp. of America will guarantee every amplifier for 5 full years—an expression of confidence that only the country's leading and most thorough manufacturer of the most modern amplifier designs would dare make.

You can't afford to buy any amplifier until you have investigated the new concept in amplifier design and construction offered by A. C. Shaney and the Amplifier Corp. of America.

Join the many thousands who are "watching and waiting" for the latest in amplifiers from

### AMPLIFIER CORP. of AMERICA

398-10 Broadway, New York 13, N. Y.

A postal card will put you on our mailing list to be among the first to know.

## SPEAKERS SPECIAL

4" P.M. Alnico #5	.....	\$1.15
5" P.M. Alnico #5	.....	1.15
6" P.M. Alnico #5	.....	1.55
5" P.M. Alnico #5	.....	1.60
6" P.M. Alnico #5	.....	1.90

### RESISTOR KITS \$1.45

100 assorted carbon and W.W. resistors  $\frac{1}{2}$  watt to 10 watt wide range of values—all standard items.

### CONDENSER KITS \$1.75

50 assorted paper by-pass and mica condensers—all new—good value.

### PHONOGRAPHS

Model C-100 plays 10" 12" records — leatherette cabl. net	Model C-201 plays 10" 12" records. Lightweight portable carrying case
.....	.....
\$14.75	\$16.45

$\frac{1}{2}$ meg. vol. control with switch L shaft	.....	.35
Selenium rectifier 100MA	.....	.69
6 ft. AC line cords	.....	.13
G.I. or Alland Motors	.....	2.50
L-70 Crystal Pick-ups	.....	1.89
#47 Pilot light — 10 for	.....	.60
40 x 40—150V. solar	.....	.45

**WIRE** Cotton on Rubber Covered — All Colors #20 Stranded — Per 1000 ft. **\$4.95**  
Spool

WRITE FOR LATEST CIRCULAR  
All Prices F.O.B. N.Y.C. 25% Dep., Bal. C.O.D.

### THE ROSE CO.

Dept. C, 88 West Broadway, New York 7, N. Y.

### WANTED:

**WILL PAY \$1.00 PER COPY**

for the following copies

**OFFICIAL SHORT WAVE LISTENER MAGAZINE**

• June-July 1935 • April-May 1936

Copies must be in good condition.

Radio-Craft, 25 West Broadway, New York 7, N. Y.

# SENCO★2 STAR SPECIALS!

## ★ THE 14B AMPLIFIER

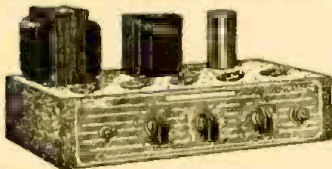

The 14B Amplifier has two input channels—1 microphone and 1-phonograph.  
 Output—14 watts at less than 3% distortion.  
 Peak watts—25 watts.  
 Five Tubes—1-6SJ7GT, 1-6SL7GT, 2-6VE6T and 1-5Y3GT.  
 Push-Pull output Class AB.  
 Low Hum level—37 DB below rated output.  
 Separate control for each input allows 100% mixing.  
 Separate Tone Control.  
 Output Impedance 4-8-15-250 and 500 ohms available at terminal strip.  
 Microphone gain—122 DB.  
 Phonograph Gain—82 DB.  
 Frequency Response 30-12,000 cycles±2 DB  
 Operates from 50-60 cycles  
 105-125 volt source.  
 Power consumption 80 watts.

**\$19.95** LESS TUBES

## ★ 5 TUBE AC SUPERHETERODYNE RADIO PHONO COMBINATION

featuring Angle Dial for easy tuning



This model is a five tube superheterodyne receiver, giving seven tube performance by the use of multipurpose tubes, covering the frequency range of 540 to 1700 kilocycles. Standard Broadcast and incorporating the features of beam power output, tone control on both radio and record player operation, super-sensitive, high efficiency, permanent-magnet dynamic speaker, automatic volume control, loop aerial and numerous other features producing improved performance.  
 (Complete with tubes)

**\$29.47**

25% deposit on all orders, balance C.O.D., F.O.B. N.Y.

**SENCO RADIO, Inc.**

96A Warren St., N. Y. 7, N. Y. Tel. Beckman 3-6498

## Just off the Press! 1948 Radolek RADIO PROFIT GUIDE



**NEW COMPLETE RADIO PROFIT GUIDE FREE**

RADIO REPAIR PARTS • TOOLS  
 SOUND SYSTEMS • TUBES  
 PHONO EQUIPMENT & SUPPLIES  
 TEST INSTRUMENTS • ETC.

Big, new ENLARGED complete catalog showing thousands of Radio Bargains sent to you immediately. Helpful, money-saving buying information. Send coupon today!

**BIG VALUES, LARGE STOCKS, FAST, DEPENDABLE SERVICE.**

**FREE...SEND TODAY**

RADOLEK CO., Dept. C-038  
 601 W. Randolph St., Chicago 6, Ill.  
 Please send your Free Profit Guide Catalog and regular Supplements.

Name .....  
 Address .....  
 City ..... Zone ..... State .....

**SAVE AT RADOLEK**

# ALL-WAY FM ANTENNA

By JULIAN T. DIXON

THIS antenna has been found to give optimum reception of each of several FM broadcast stations located in different directions from the receiver. Its response is substantially independent of direction. Its gain is the same as that of a properly oriented dipole. It is an Alford loop comprising 4 folded-dipole elements arranged in a square, half-wave length on a side. Transmitting antennas of this basic type have been described previously and are in use at many FM broadcast stations.

The antenna components are made of readily available and inexpensive sections of twin-lead transmission line. The 4 folded-dipole elements A are made of 300-ohm line and have a terminal impedance of about 300 ohms. The terminals of the dipoles are connected to a junction in the center of the antenna through equal lengths B of 300-ohm line. The B sections may be made long enough to provide sufficient slack to prevent pulling the dipoles out of shape.

Since the B sections are effectively in parallel at their junction, the impedance there is one-fourth of 300 ohms, or 75 ohms. The standard receiver input impedance is 300 ohms; consequently a quarter-wave length section C of 150-ohm line is used to step up the 75-ohm impedance at the junction to the 300-ohm impedance of the line D to the receiver. The D section may be of any length sufficient to reach the receiver.

It was found that an antenna constructed according to the dimensions shown worked well over the entire FM broadcast band, 88 to 108 megacycles, although it was cut specifically for 100 megacycles. S-meter readings indicated an improvement of as much as 17 decibels over the dipole previously used, for signals from stations which were not in the broadside direction of the dipole. For signals arriving from the dipole broadside direction, the loop gave an equal input to the receiver.

Less fading due to reflection of the signal from airplanes overhead was noted with this loop, as compared with the dipole. This improvement is attributed partly to the fact that the loop has some directivity in the vertical plane, giving maximum response at zero degrees elevation and decreasing to zero response at 90 degrees. Signals reflected from airplanes above the horizon are thus rejected to some extent. Signals arriving from the dipole minimum direction had been especially subject to flutter fading due to the reflected signal being received from airplanes which were broadside to the dipole. This condition was remedied by the omnidirectional response of the loop in addition to its vertical plane directivity.

The loop must be mounted in the hori-

zontal plane and the C and D sections should drop away vertically from the junction of the B sections for a distance, preferably, of 5 feet or more. The dipole elements may be suspended conveniently from the ends of 2 light diagonal wooden supports. For an attic installation, four nails can be driven into the rafters as supports.

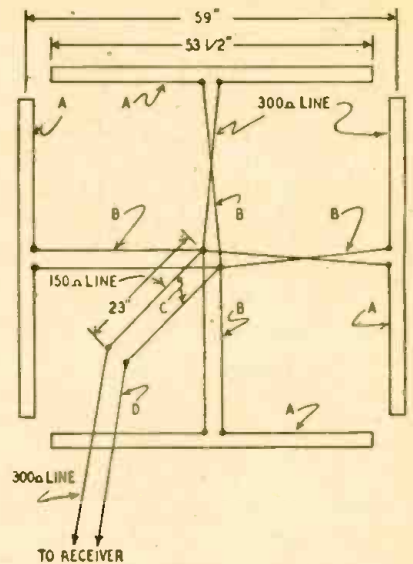

Care should be taken to connect the components exactly as shown. The 180-degree twist in 2 of the B sections as shown provides the required 180-degree phase relationship of opposite dipoles while maintaining an in-phase condition around the perimeter of the loop.

The dimensions of the antenna components in wave lengths are given below for the convenience of those who may wish to construct similar antennas for use on other frequency bands.

Section	Length
A	0.45 wave length
B	0.25 wave length (or more)
C	0.193 wave length (see note)
D	any length

Note: Length of C section is 0.25 wave length multiplied by 0.77, the velocity constant of the 150-ohm line.

A Teleran experimental installation is being made near Washington, D. C., for operational tests of the new navigational aid. Teleran is a name coined from the words TELEvision-Radar-Air-Navigation. The unique system of air navigation and traffic control combines ground search-radar and television to furnish the pilot a constant "aerial road-map" on a screen on his instrument panel. This composite pictorial presentation of route, terrain, traffic, and weather data clearly identifies all mountains and other obstacles to aviation, and is expected eventually to make all-weather flying a practical reality.

## RADIO SET AND SERVICE REVIEW

(Continued from page 30)

ond 12BA6 is an additional i.f. stage working into a Foster-Seeley discriminator. The discriminator uses 2 of the diodes in the 19T8. Output is applied to the a.f. system through a volume control common to AM and FM detector systems. The built-in FM antenna consists

loop antenna. Tone quality is fairly good, and reproduced the FM transmissions adequately.

On FM, the tone quality is very good for an a.c.-d.c. set with 6-inch speaker. The highs come through crisply with very little fuzziness. Sensitivity is fair

and noise rejection good but not exceptional. We received weak images from 2 near-by FM transmitters at twice the fixed i.f. above the signal frequency. (These images do not seem to be strong enough to interfere with transmitters on these channels. We could not check this point because images did not fall on the frequency of any other FM station in this locality.) On FM, it was

necessary to retune the receiver tested at least once during the first 10 minutes because of warm-up drift. Dial calibration is good on both bands. The record changer worked well without previous adjustment. The phono-radio switch has 2 tone-control positions for phono and 2 for radio.

The 117-volt pilot lamp eliminates many of the objections to using low-voltage pilots in a.c.-d.c. circuits.

The operating instructions supplied with the set were surprisingly good and quite complete, especially the special record changer pamphlet.

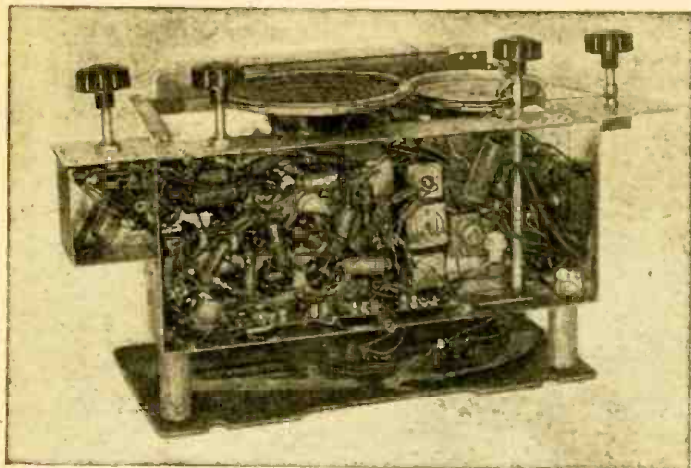

Bottom view of the 77FM21. Selenium rectifier is seen at right.

of a length of wire built into the line cord. This may be removed from the circuit and replaced with a 300-ohm FM antenna.

Note that *no limiters* precede this conventional discriminator. The manufacturer claims that the oscillator is so stable that drift is negligible. Under these conditions the discriminator can be tuned to the exact center of the i.f. channel and the a.f. output is nil for any amplitude modulation that may be on the carrier.

The AM selectivity and sensitivity are good for a set of this type using a

## MAGNETIC RECORDING

(Continued from page 35)

comply without distortion. All forms of disc recording are doubly handicapped by the further necessity of re-converting mechanical motion back to electrical energy during playback. Magnetic recording's complete freedom from this basic handicap partially explains the excellent results achieved by this relatively new recording medium.

In magnetic recording, the output of the recording amplifier is simply fed to the recording head, which creates magnetic fields of varying intensity, polarity, and frequency *without any moving part* (other than the magnetic tape which is passed at a constant speed across the recording gap of the recording head).

The construction of a typical recording head is illustrated in Fig. 1. Fig. 1-a shows the twin coil and core assembly used. The laminated core is made of exceedingly high-permeability material. Mumetal is most commonly used, although Permalloy or similar metals should also be satisfactory.

The twin-coil construction reduces hum pickup from external fields and also reduces leakage during recording and playback. Fig. 1-b shows the twin coils after assembly and clamping. Fig. 1-c is the finished recording-playback head after it has been slipped into its aluminum housing, which also serves as a tape guide. The one very critical point in the construction of this type of head is control of the recording gap, which should be in the order of .0005 inch. Minute variations produce major deviations in response and output level.

The term *erase* is another improper selection as it connotes scraping, rubbing, or the removing of material. German scientific literature uses *obliterate* to describe elimination of previously recorded signals. This term is not completely explanatory either, for it may imply defacement. The electronic-magnetic erasing process resembles the smoothing of sand-writing more than any other mechanical analogy. The

(Continued on page 70)

PLEASE TEAR OUT  
THIS ADV. AS REMINDER

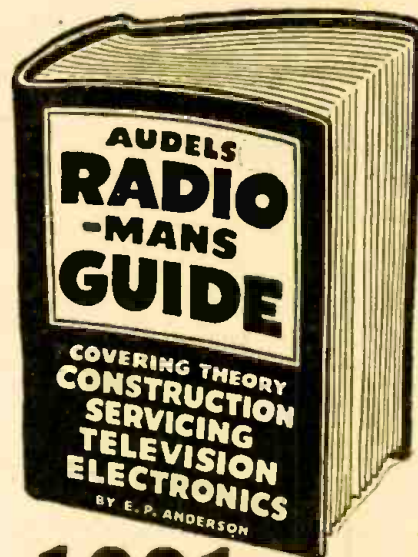

## 1001 RADIO FACTS AND FIGURES

AUDELS RADIOMANS GUIDE—914 Pages, 633 Illustrations, Photos, Wiring Diagrams, 38 Big Chapters, covering Radio Theory, Construction, Servicing, Including Important Data on Developments in Television, Electronics and Frequency Modulation, Review, Questions and Answers, Calculations & Testing. Highly Endorsed—Indispensable for Ready Reference and Home Study.

**\$4 COMPLETE • PAY ONLY \$1 A MONTH**  
Step up your own skill with the facts and figures of your trade. Audels Mechanics Guides contain Practical Inside Trade Information in a handy form. Fully illustrated and Easy to Understand. Highly Endorsed. Check the book you want for 7 days' Free Examination.

Send No Money. Nothing to pay postman.

CUT HERE  
**MAIL ORDER**

AUDEL, Publishers, 49 W. 23 St., NEW YORK 10, N. Y.

Please send me postpaid for FREE EXAMINATION books marked (x) below. If I decide to keep them I agree to mail \$1 in 7 Days on each book ordered and further mail \$1 monthly on each book until I have paid price—otherwise, I will return them.

- |                          |   |     |
|--------------------------|---|-----|
| <input type="checkbox"/> | RADIOMANS GUIDE, 914 Pages . . . . .                      | \$4 |
| <input type="checkbox"/> | ELECTRICIANS EXAMINATIONS, 250 Pages . . . . .            | 1   |
| <input type="checkbox"/> | WIRING DIAGRAMS, 210 Pages . . . . .                      | 1   |
| <input type="checkbox"/> | ELECTRIC MOTOR GUIDE, 1000 Pages . . . . .                | 4   |
| <input type="checkbox"/> | ELECTRICAL DICTIONARY, 9000 Terms . . . . .               | 2   |
| <input type="checkbox"/> | ELECTRICAL POWER CALCULATIONS, 425 Pgs. . . . .           | 2   |
| <input type="checkbox"/> | HANDY BOOK OF ELECTRICITY, 1440 Pages . . . . .           | 4   |
| <input type="checkbox"/> | ELECTRONIC DEVICES, 216 Pages . . . . .                   | 2   |
| <input type="checkbox"/> | ELECTRIC LIBRARY, 12 vol., 7000 Pgs., \$1.50 vol. . . . . | 1   |
| <input type="checkbox"/> | OIL BURNER GUIDE, 384 Pages . . . . .                     | 1   |
| <input type="checkbox"/> | REFRIGERATION & Air Conditioning, 1280 Pgs. . . . .       | 4   |
| <input type="checkbox"/> | POWER PLANT ENGINEERS Guide, 1500 Pages . . . . .         | 4   |
| <input type="checkbox"/> | PUMPS, Hydraulics & Air Compressors, 1658 Pgs. . . . .    | 4   |
| <input type="checkbox"/> | WELDERS GUIDE, 400 Pages . . . . .                        | 1   |
| <input type="checkbox"/> | BLUE PRINT READING, 416 Pages . . . . .                   | 2   |
| <input type="checkbox"/> | SHEET METAL WORKERS Handy Book, 388 Pgs. . . . .          | 1   |
| <input type="checkbox"/> | SHEET METAL PATTERN LAYOUTS, 1100 Pgs. . . . .            | 4   |
| <input type="checkbox"/> | AIRCRAFT WORKER, 240 Pages . . . . .                      | 1   |
| <input type="checkbox"/> | MATHEMATICS & CALCULATIONS, 700 Pgs. . . . .              | 2   |
| <input type="checkbox"/> | MACHINISTS Handy Book, 1500 Pages . . . . .               | 4   |
| <input type="checkbox"/> | MECHANICAL Dictionary, 968 Pages . . . . .                | 4   |
| <input type="checkbox"/> | AUTOMOBILE GUIDE, 1700 Pages . . . . .                    | 4   |
| <input type="checkbox"/> | DIESEL ENGINE MANUAL, 400 Pages . . . . .                 | 2   |
| <input type="checkbox"/> | MARINE ENGINEERS Handy Book, 1280 Pages . . . . .         | 4   |
| <input type="checkbox"/> | MECHANICAL DRAWING GUIDE, 160 Pages . . . . .             | 1   |
| <input type="checkbox"/> | MECHANICAL DRAWING & DESIGN, 480 Pgs. . . . .             | 2   |
| <input type="checkbox"/> | MILLWRIGHTS & Mechanics Guide, 1200 Pgs. . . . .          | 4   |
| <input type="checkbox"/> | CARPENTERS & Builders Guides (4 vols.) . . . . .          | 6   |
| <input type="checkbox"/> | PLUMBERS & Steamfitters Guides (4 vols.) . . . . .        | 6   |
| <input type="checkbox"/> | MASONS & Builders Guides (4 vols.) . . . . .              | 6   |
| <input type="checkbox"/> | MASTER PAINTER & DECORATOR, 320 Pgs. . . . .              | 2   |
| <input type="checkbox"/> | GARDENERS & GROWERS GUIDES (4 vols.) . . . . .            | 6   |
| <input type="checkbox"/> | ENGINEERS and Mechanics Guides . . . . .                  |     |
| <input type="checkbox"/> | Nos. 1, 2, 3, 4, 5, 6, 7 and 8 complete . . . . .         | 12  |
| <input type="checkbox"/> | Answers on Practical ENGINEERING . . . . .                | 1   |
| <input type="checkbox"/> | ENGINEERS & FIREMANS EXAMINATIONS . . . . .               | 1   |

Name \_\_\_\_\_  
Address \_\_\_\_\_  
Occupation \_\_\_\_\_  
Employed by \_\_\_\_\_ R.C.F.

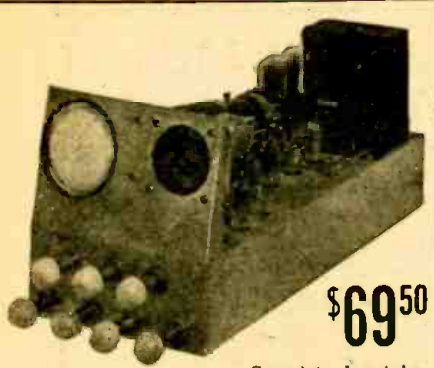

Complete, less tubes

## ESPEY Television Kit

Learn television with the unique, modern, low-priced ESPEY Television Training Kit. FREE with every kit—a new pictorial type instruction book, containing easy-to-follow, step-by-step assembly instructions. No previous knowledge necessary to build — and LEARN from — this ESPEY kit.

### FEATURES

- 18 tubes, including 15 miniatures.
- 3 stage, stagger tuned pix i.f.
- 2125 Mc sound i.f. Trap tuned.
- Balanced FM discriminator.
- Portable—weighs only 17 lbs.
- Uses 3" low-cost cathode ray tube. Magnifier makes 4" picture.
- Can be aligned with ordinary test oscillator and V. T. Voltmeter.

KIT INCLUDES all i.f., power, blocking oscillator transformers, chokes, capacitors, resistors, speaker, and sockets riveted into place on punched and welded chassis. Tubes are easily available through your distributor.

(\*Prices 5% higher west of Rockies)

For full details write to Dept. C

**ESPEY MANUFACTURING COMPANY INC.**  
220 EAST 72nd STREET-NEW YORK 21, N. Y.

**\$25.00 Value for Only \$1.89**

8000 ohm Dual, Headset H-16/U—most sensitive phones built—noiseproof—may be used as a sound powered intercom—Also used with simple Xtal to make a complete radio receiver—light, durable, efficient, molded, soft neoprene earcups, shaped to snugly and comfortably envelope the entire ear. Everyone BRAND NEW. Complete with illustrated manual. Send money order or check today. Special per pair \$1.89. Plus 25c each for postage. WRITE FOR BULLETIN R H



**NIAGARA RADIO SUPPLY CORP**  
160 Greenwich St., New York 6, N. Y.

**TUBULAR ELECTROLYTICS**  
Fresh stock Fully guaranteed

20 mfd. 150 V. ....	10 for \$1.79
20-20 mfd. 150 V. ....	10 for 2.49
8 mfd. 450 V. ....	10 for 1.85

Postage extra. 25% deposit on COD.  
Write for our free bargain lists featuring "AMERICA'S BEST BUYS"  
**POTTER RADIO CO.**  
1312-1314 McGee St. Kansas City 6, Mo.

## MAGNETIC RECORDING

(Continued from page 69)

erase process is nothing more nor less than a special type of demagnetization which completely removes previously recorded signals without affecting the magnetic tape in any other way whatsoever. This makes it possible to use the same tape over and over again, a unique advantage enjoyed by magnetic recording which cannot be claimed for any other recording process.

For ideal demagnetization (complete erasure) a previously magnetized particle should be subjected to a varying magnetic field of sufficient intensity to produce complete saturation and then passed through a cyclic, gradually decreasing field which ultimately leaves the particle in a neutral state. To accomplish the demagnetizing process, an erasing head is employed (similar in general construction and appearance to the record-reproduce head of Fig. 1).

By feeding a relatively high voltage (125 v) to the erase head, which is constructed with a larger noncritical gap, sufficient stray flux is produced near the gap to subject the tape gradually to an increasing and then a constant decreasing field. With an erase frequency of 30,000 cycles and a tape speed of 7½ inches per second, each particle is subjected to over a hundred gradually decreasing cyclic fields within 1/40 inch, which is more than adequate to erase any material on the tape completely.

### Tape-handling mechanism

One of the most important prerequisites of all recording systems is maintenance of an exactly constant speed during both recording and playback. For disc and photographic recording processes variations in speed result in flutter or wow. The same is true of magnetic recording when the tape speed varies. This is referred to as *instantaneous speed variation* to differentiate it from the change of lineal speed encountered in disc recording as the needle moves laterally toward or from the center of the record. (Speed variations in the order of 2.6 to 1 are normally encountered in 12-inch discs and 2.3 to 1 in 10-inch discs. This always results in loss of high frequencies and increased distortion toward the inside of a record.)

Tape recorders always employ a capstan drive (a term derived from a ship's capstan) which provides a constant linear speed because the diameter of the capstan does not vary during recording or playback. This is another unique advantage not found in disc recording-reproducing equipment.

In addition to providing a constant linear speed, the tape-handling mechanism must provide facilities for supplying the tape to the recording-reproducing head and some suitable take-up means. (Here it must be confessed is the only disadvantage of magnetic tape recording—the tape must be rewound after recording and playback in much the

same manner as movie film—if one decides to stretch a point and call it a disadvantage.)

Fig. 2 (top view of a standard model) and Fig. 3 (bottom view of the same unit) show how the basic tape-handling requirements are met. It will be noted that 3 separate motors are used, one each for capstan constant-speed drive, take-up, and high-speed rewind. (A 1-hour program on tape normally traveling 4 inches per second can be rewound in 30 seconds!)

The supply reel at the left (Fig. 2) normally pivots on the shaft of the rewind motor. The take-up reel is pulled by the take-up motor which drags against the tape to tension it against the tractive surface (corprene, a special combination of cork and neoprene) of the capstan. The tension on the tape normally keeps the forward limit switch closed. This switch cuts the power off

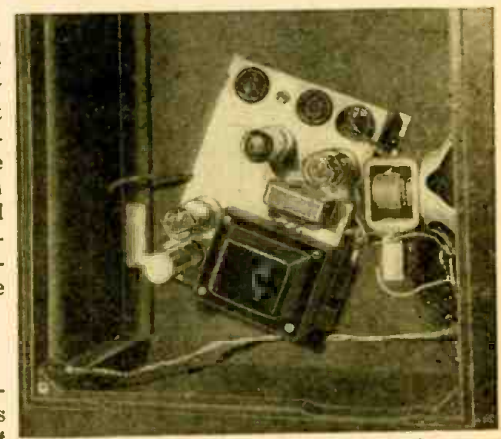

Fig. 4—Playback monitor amplifier. The two open sockets are for connections to other units.

the capstan and take-up motors should the tape run out while the machine is unattended.

In rewind the tape passes directly from the take-up reel back to the supply reel through the reverse limit switch. The rewind motor runs at 1,800 r.p.m. and stops automatically when the tape is completely rewound, the reverse limit switch applying a d.c. braking current to the field coils of the rewind motor.

Mechanical placement of the various components is not critical. The only basic requirement is to provide a sufficient wrap of the tape around the capstan tractive surface. With a 180-degree wrap, the corprene surface will develop a 23-ounce pull. Normal operational pull in standard machines is approximately 6 ounces. Magnetic tape breaks at a pull ranging from 96 to 144 ounces so that there is an average safety factor of 20! (Magnetic wire breaks within a range of 32 to 48 ounces. Paper is 3 times stronger!)

It should be noted that the 23-ounce pull of the capstan will not break the tape should the supply spool deliberately be held back by hand.

Fig. 4 shows the placement of the monitor amplifier and speaker in the

(Continued on page 77)



## TRANSATLANTIC NEWS

(Continued from page 36)

covers an area of 10 acres, and at the 60 receiving posts in the main monitoring room as many transmissions on any frequency in the 15-100 kc and 0.1-27 mc bands can be tuned in simultaneously, listened to and, if need be, recorded. The antennas are situated 400-600 yards from the electrically noisy monitoring room and an ingenious system is used for conveying their output to it.

To describe this amplified antenna system adequately would need the best part of a whole issue of RADIO-CRAFT, but here is a brief outline. For frequencies between 0.1 and 16 mc, 7 octave-band amplifiers are used. An octave-band amplifier is one with an almost level response to all frequencies within a 2 to 1 ratio. A part-octave amplifier is used for the frequencies from 16-27 mc and a very-wide-band amplifier for those from 15-100 kc. The amplifiers are situated in a building close to the antenna field. Each is fed by its own antenna system, connected to it by coupling and matching units. The 7 octave-band amplifiers (0.1-0.2, 0.2-0.4, 0.4-1, 1-2, 2-4, 4-8, 8-16 mc) and the part-octave (16-27 mc) amplifier are arranged in 2 groups of 3 and one group of 2, the output of each group being carried by a buried co-axial cable to the monitoring room. A separate cable serves the 15-100-kc amplifier.

At the monitoring room the output of the cable of each group is fed to an r.f. distribution unit with 60 separate outputs. Every operator has a 4-position r.f. selector switch by means of which he connects his receiver to the r.f. distribution unit dealing with the frequency of the station assigned to him by the supervisor. He then tunes in the station in the ordinary way. But that is not all. If the station assigned to him is too weak or too difficult for some other reason for satisfactory reception with his apparatus, he calls the engineers at Crowsley, some 3½ miles away, and asks them to receive the signal and pass it to him.

At Crowsley there is a much more elaborate antenna system, containing 30 long-wire, semivertical, 12 Beverage, and 5 rhombic antennas. The sensitive communication receivers fed by them are handled by engineers. The required signal is picked up, if it is not unreceivable, and passed at a.f. to the operator calling for it.

### FIVE DOLLARS A WORD

Highest price ever paid for a radio manuscript was possibly the \$500 given to Albert N. Giddis for his 100-word prize winning essay in the recent John F. Rider contest for servicemen. Mr. Giddis, who has for 15 years been the service manager of Gaumont Bros., oldest radio dealers in Lowell, Mass., wrote on the subject "Why Rider Manuals Mean Successful Servicing."

Under the terms of the contest, which specified a prize for the winner's distributor, Henri Jappe, parts jobber of Boston, also received an award of \$100.



*Musical Distinction*  
WITH  
**ABSOLUTE FIDELITY  
AMPLIFICATION**  
DESIGNED BY A. C. SHANEY

A new amplifier development now enables you to clearly identify all the instruments in a full orchestra! After 20 years of audio research and development, we can now place in your hands a new means to make the most fascinating, uplifting, and enjoyable journey into the realm of perfect sound reproduction—through the medium of the most satisfying musical amplifier the world has ever known.

If you are one of those discriminating persons for whom anything less than the best is a disappointment, you are one for whom the ACA-100DC Amplifier was designed. Send for literature.

**AMPLIFIER CORP. of AMERICA**

SURPLUS SPECIAL—Small 110 v. AC open frame motors, ½" shaft, 2700 R.P.M., 1/70 H.P., mfd. by BARBER COLE—\$2.00 ea. MAN CO.

## "A. M." SPECIALS!

CAPACITORS	
1130 mfd. 50 volt	1.25
1500 mfd. 50 volt	1.65
2000 mfd. 50 volt	1.95
500 mfd. 200 v.	1.75

SWITCHES	
Slide switch: Stackpole DPDT	.15
SPDT momentary, center off position, long bat handle	.29
4 pole DT 10A, 125 v.	.50
SPDT center off position, 6A, 125v.	.29
Toggle Bat Handle DPST	.35

CONDENSERS	
3 Gang Variable Condenser 50 MMFD per section Ceramic Insulation	.95
4 Gang Variable Condenser 50 MMFD per section Ceramic Insulation	.85
Condensers, Variable, dual 2.5 to 10 mmf.	.45
2 Gang 250 mmf per section ¼" shaft, mycalex insul.	1.00
Condensers, Variable, Ceramic Insul. shaft 5/16x¾" L	
C115-10-45 mmf with coil, tunes to 31 mcs	.50
C122-7-27 mmf with coil, tunes to 58 mcs	.50
C105-11-115 mmf	.35
15-330 mmf ¼" shaft Brass Plate, Ceramic	.75

OIL FILLED CONDENSERS:	
.03 mfd. 7500 v. DC	1.15
.30 mfd. 2000 v. DC	.65
1 mfd. 2500 v. DC	1.25
1 mfd. 1200 v. DC	.65
4 mfd. 2000 v. DC	2.75
10 mfd 1500v. DC	3.15

MISCELLANEOUS	
PL259A Coax Connector and Socket, Silver Plated for RG8U and RG11U	\$ .60
Right Angle Adapter M359A	.30
Mica Trimmers: Variable 3-30 Mmfd 4 gang	.20
Variable Ceramicon 4-30 mmf. 7-45 mmf.	.25
Filament Transformer: 5 volts @ 4 amp. 110 volt Pri. open frame, Porcelain standoffs, Mfd. by G.E.	1.00
0 to 15 DC Milliammeter, Simpson 3½" Bakelite case	2.95
Pilot Light Assy. 1" Ruby Jewel complete with 110 v. AC Candelabra base bulk	.40
12 v. Edwards' Buzzer complete with push button	.40
7 foot, telescoping antenna	1.00
Rectifier, Copper oxide, Full wave 110 VAC input, 100 VDC @ 1 amp. output	3.50
Solenoid, 6VDC Complete with plunger and mtg. Bracket	1.25
Microphone, T 17 with push to talk switch Cord and plug	.39
Sound powered phones, TS 10K (unused) Pr.	25.00

### SYNCHRONOUS MOTOR

½" shaft 110 v. AC 60 cy. 4/5, 1, 1 1/5, 1 1/2 RPM. 2.2 watts. Mfg. by Hayden Mfg. Co. **\$1.75**

No sale less than \$2.00. All prices FOB New York City. Add 25c to cover postage. 20% Deposit required with all orders. All Prices subject to change without notice.

**A. M. RADIO SALES COMPANY** 345 CANAL ST. NEW YORK CITY 13, N. Y.

## BUILD YOUR OWN FM TUNER OR FM RADIO

FM—Condenser & Coil Kit—(88 to 108 Mc)

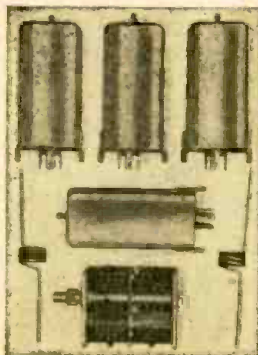

- Variable Condenser
  - Discriminator Coil
  - Oscillator Coil
  - Two I.F. Coils
  - Limiter Coil
  - Antenna Coil
  - Schematic Diagram
  - Instructions
- \$4.95**

This Kit contains the vital parts needed to build an FM Tuner or Radio and for modernizing Pre-War FM Sets; all other parts needed are standard.

**BROOKS RADIO DISTRIBUTING CORP.**

80 VESEY STREET • DEPT. A • NEW YORK 7, N. Y.



### FASTER SIGNAL TRACING!

# Signalette

MULTI-FREQUENCY GENERATOR

Generates R.F., I.F. and AUDIO Frequencies, 2500 cycles to over 20 megacycles, using new electronic multivibrator radar principle. Completely self-contained—fits coat pocket or tool chest. Just plug into A.C. or D.C. LINE AND CHECK RECEIVER SENSITIVITY, AUDIO GAIN, R.F. and I.F. touch-up, auto radio aerial peaking or shielding, breaks in wires, stage by stage, signal tracing, tube testing by direct comparison, etc., etc. Sturdy construction, handsome appearance! See at your distributor or write for details. Shipping wt. 13 ozs.

Recognized Jobbers—wire, write for details of territory open!

PRICE  
**\$9.95**

at distributor  
or F.O.B.  
Cincinnati

**CLIPPARD INSTRUMENT  
LABORATORY, INC.**

Dept. C 1125 Bank Street,  
Cincinnati 14, Ohio

## TECHNICAL KO's

### OIL-FILLED CONDENSERS

.05 MFD	1000V	\$.28
.05	500V	.14
.1	2500V	.45
.1	7500V	1.85
2x.1	7000V	4.75
.12	15000V	6.95
.25	1000V	.35
.25	4000V	2.75
.25	6000V	4.00
10x.25	600V	1.00
.5	600V	.28
.5	1000V	.37
.5	2000V	.40
.75	2000V	.55
.77	330VAC	.35
1.0	1000V	.45
2.0	1000V	.60
4.0	600V	.55
4.0	1000V	1.00
6.0	1000V	1.25
6.0	2000V	1.75
8.0	600V	.85
8.0	1000V	1.75
10.0	600V	1.00
30.0	330VAC	2.35

### TRANSMITTING MICAS

.000025	2500V	\$.11
.00005	1600V	.12
.00005	2500V	.14
.00005	5000V	.85
.000067	2500V	.20
.00007	2500V	.20
.00025	2500V	.25
.00025	5000V	.87
.0004	2500V	.22
.0005	2500V	.22
.00072	5000V	.89
.0008	5000V	.89
.001	2500V	.22
.0015	5000V	.95
.002	2500V	.27
.002	3000V	.66
.0025	1200V	.15
.00275	2000V	.28
.003	2500V	.30
.004	2500V	.36
.005	3000V	.66
.006	2000V	.35
.008	1200V	.15
.01	1200V	.16
.02	600V	.11

- Nat'l Brand Choke 12H-80MA-250 Ohms. \$1.09
- Nat'l Brand Choke 10H-100MA-250 Ohms 1.09
- Resistor Kit Assorted 1/2 & 1W. .100 for 1.49
- Bathtub Kit 3x.1, .5, .05 etc. 10 for .59
- Condenser Kit .01-.00001 .100 for 3.00
- Micas .002, .005, etc. All Values .08
- .01 150V Paper (Midget) . . . . . 60 for 1.00
- .02 1600V Paper . . . . . 5 for .60
- .1 600V Paper . . . . . 10 for 1.00
- 12SQ7 Metal. . . . . \$ .32 12K8 Metal. . . . . .25
- 6V6 Metal. . . . . .89 6L6 Metal. . . . . .95
- Power Xformer 850VCT, 750VCT @ 200 MA, 5V @ 4A, 6.3V @ 5A . . . . . 4.14

\$2.00 min. order F.O.B., N.Y.C. Add postage  
50% deposit, balance C.O.D. with all orders.  
Manufacturers inquiries invited.

**TECHNICAL RADIO PARTS CO.**  
265 Greenwich St. Dept. RC-9 N.Y. 7, N.Y.

## ALL-VOLTAGE POWER PACK

(Continued from page 23)

circuit. No voltage will be applied until the overload reset is pressed. Pressing the momentary switch S1 (overload reset) sends current through the relay coils, turns off the indicator lamp, and closes the relay switch RS1 which keeps the relay coil circuit complete after S1 is released. When the unit delivers current, the voltage E1 is lowered; and when the output reaches 250 ma, E1 is reduced to the point where current through RL is insufficient to keep the relay closed, and opens the relay coil circuit. The switch RS2 of the second relay works simultaneously with RS1, and connects the negative side of the power supply to ground through the milliammeter. Relay 2 has a smaller current rating, assuring the simultaneous operation of both relay switches, its coil RL2 being in series with RL1.

Any size relays up to 10 ma can be used by selecting a suitable value for the resistor in series with RL1 and RL2. Most sensitive relays of this type have screw adjustments. Because sensitive relays with s.p.d.t. switches were not available, the 2 s.p.d.t. relays are used. The screw adjustments of the relays, as well as the series resistor R7, are adjusted so that the relays open when 250 ma are drawn. The resistor used was 45,000 ohms, rated at 10 watts.

If an overload circuit of this type is not desired, the unit should be fused.

When the relays are open, the neon bulb N is connected through the relay coils to the negative end of the power supply and through the 300,000-ohm resistor built into neon unit to the positive side of the supply, lighting the neon. The 400,000-ohm, 1-watt resistor is connected across the neon unit to prevent neon glow when it is not in the circuit (relays closed). The neon is very sensitive and would glow otherwise.

The main power switch S2 is a d.p.d.t. connecting the unit to the 117-volt a.c. line. When S2 is turned off, the other half of the switch opens the relay coil circuit, cutting the power going to any

external circuit and also shorting out the neon. This indicator would otherwise stay lit because the filter condensers remain charged for a short period after the main power switch is turned off.

### The power switches

The main power switch energizes T1, lighting the green pilot light which is the main power indicator.

The d.c. power switch S3 energizes T2, lighting the red pilot light, energizing the 6L6 filaments, their biasing systems and the bias voltage circuit. Closing this switch also closes the filament circuit of the 5U4G rectifier tube. When the switch is turned off, the relay

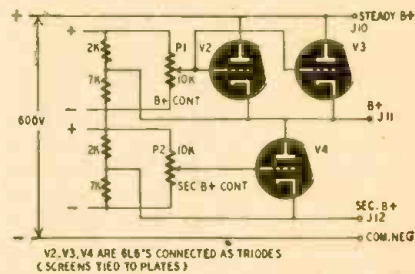
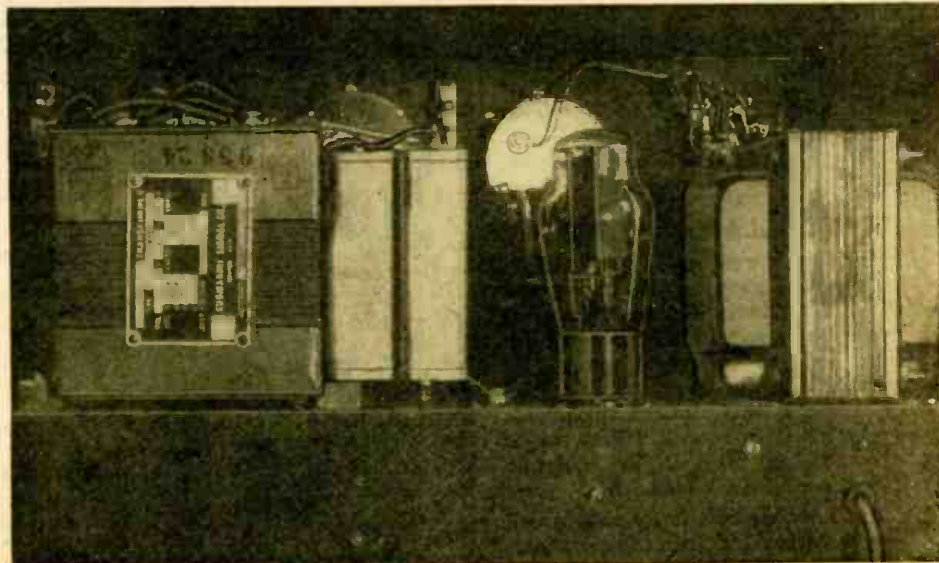

Fig. 2—The voltage-regulating components.

coils are short-circuited, thus disconnecting the power supply from the external circuit.

When either of the main power and d.c. power switches is turned off the relay coils are de-energized. If the relay coils were left energized with the B-plus and secondary B-plus controls in low position, both voltages would rise slightly, because, if either switch is turned off, the 6L6 bias voltages drop almost instantaneously, causing the voltages to rise. Also since the oil filter condensers tend to hold their charges, especially if the instrument is under a light load, d.p.d.t. switches are used in the equipment. If the unit is under load with the controls in the low position, the instrument should be turned off with either of the switches. The power plug should



Rear view. Large unit at left contains other windings than those actually used in the pack.

not be pulled since the voltages may rise before they fall to zero. If the external apparatus is critical with respect to voltage, it may be damaged by the temporary voltage rise. If the switches are used, there is no such danger, the power being immediately disconnected from the load.

The d.c. power switch is introduced only to permit the filament transformers to be used alone; that is, the rectifier, 6L6's, and d.c. sources are all disconnected, eliminating power waste. The d.c. power switch may be omitted by connecting its circuits as if the switches were on.

The conventional rectifier and  $\pi$  filter require no explanation. The 2-megohm resistors serve as bleeders. A 16- $\mu$ f input filter condenser is used to obtain higher voltage. Electrolytics are not recom-

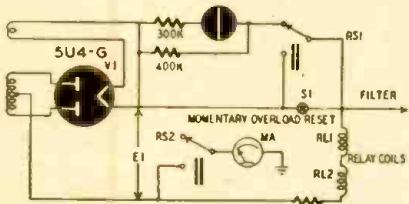

Fig. 3—Hookup of the two protective relays.

mended since such 600-volt condensers have a tendency to blow in the vicinity of 600. Oil condensers have less leakage, are not polarized, and may sometimes be obtained as surplus more cheaply than their electrolytic equivalents.

### The metering system

Two meters, a milliammeter and a voltmeter, are used. If only one is used, the voltmeter is the more useful. The 6-range voltmeter M2 with a 1-ma movement has the following ranges: 0-1, 10, 50, 100, 200, and 1,000 volts. If only a single-range voltmeter is desired, it should have a range from 0 to 600 volts. The double-pole, 5-position switch is used for voltmeter switching to the various outputs. It should be checked to make certain that the adjacent contacts are not shorted by the rotating switch arm. Using available switches, it was found necessary to cut down the arm to eliminate this short-circuiting.

The milliammeter has 4 ranges: 0-20, 50, 100 and 200 ma. A double-pole, 4-position switch is used for range switching. A double-pole switch protects meter M1, which is disconnected during the range switching. The 200-ohm resistor in series with the meter permits the use of larger ohmage shunts which are easier to match. Their actual value will, of course, depend on the meter's internal resistance. The maximum potential drop across the meter is only 4 volts at full scale on any range. All multipliers and shunts are made by matching resistors in series or parallel combinations. No more than 2 resistors are used. Multipliers are 1,000 ohms per volt for the 1-ma movement. All resistors are 1/2 watt, except the 200-ma shunt which is 1 watt.

The 6.3-volt, 5-ampere filament winding T1 can be used to supply external filaments. The surplus unit used on this job also included a 6.3-volt, 6-ampere

center-tapped transformer and a 2.5-volt, 20-ampere transformer with 2 center-tapped windings. These connected to the terminals marked T. These low-voltage a.c. windings can serve other purposes beside powering filaments. (Incidentally, many of these transformers may be purchased as surplus at very low prices.)

An octal socket (omitted from the schematic for simplicity) is connected to various parts of the unit for easier connections to external circuits. It may be seen near the lower right corner in the photograph. Wiring is not critical. A standard 10 x 17 x 3-inch chassis is used with a Masonite or fiberboard front panel. The potentiometers, octal socket, overload reset, overload indicator, main and d.c. power switches, and red and green pilot lights are mounted on the chassis. The rest of the controls and pin jacks are mounted on the panel. A small hole is drilled for the neon bulb which is cemented into place.

The filament transformers should have an insulation rating of at least 1,000 volts. The 20- $\mu$ f capacitors used in the filter circuits must be properly insulated. If dual 20's which have wax outsides and a metal ring mounting are used, they must be insulated from ground. This can be done by taking off the metal ring, putting a ring of friction tape on the capacitor, and then replacing the ring around the tape. Without such insulation, the high voltage may damage the capacitor. All components must be well insulated, since arcing may occur at 600 volts. The 6.3-volt, 1.2-ampere transformer center-taps are not used and should be insulated.

The 3 rectifiers (Sel. 1, 2, and 3) used in the bias circuits are ordinary selenium receiver-type, 100-ma units.

Before actual construction is started, the builder should understand the instrument thoroughly. He can then do a better job and get in a well-built, efficient piece of equipment for his time and work.

### POWER SUPPLY PARTS

- T1—Power transformer, 425-0-425 v, 200 ma, 6.3 v, 5 amp, 5 v, 3 amp
- T2—Filament transformer, two windings, 6.3 v, 3 amp each
- T3, T4, T5—Filament transformer, 6.3 v, 1.2 amp
- T—Filament transformers with appropriate pin jacks—See text
- L1—Choke, 10 henry 200 ma (225 ohms)
- L2, L3—A.c.-d.c. filter choke (450 ohms)
- R1, R3—2000 ohms
- R2, R4—7000 ohms
- R5, R6—1500 ohms
- R7—45,000 ohms, 10 watts—See text
- R8—300,000 ohms, 1 watt (built into neon unit)
- R9, R10, R11—2 megohms
- R12—10,000 ohms
- R13—30,000 ohms
- R14—40,000 ohms, 1 watt
- R15—10,000 ohms, 1 watt
- R16—400,000 ohms, 1 watt
- R17—200 ohms
- C1—16  $\mu$ f 600 v, oil
- C2, C3, C4—8  $\mu$ f 600-v oil
- C5, C6, C7, C8, C9, C10, C11—20  $\mu$ f 150-v elec.
- C12, C13, C14—0.1  $\mu$ f, 400-v paper tubular
- V1—5U4-G
- V2, V3, V4—6L6
- Sel. 1, Sel. 2, Sel. 3—Federal Selenium rectifier (100 ma)
- P1, P2—10,000-ohm wire-wound potentiometer
- P3—5000-ohm wire-wound potentiometer (4 watts)
- M1—20-ma meter
- M2—1-ma meter
- S1—S.P.D.T. momentary switch
- S2, S3—D.P.D.T. toggle switch
- S4—S.P.S.T. toggle switch
- S5—2-pole, 5-position switch
- S6—Single-pole, 6-position switch
- S7—2-pole, 4-position switch
- RL1, RS1, RL2, RS2—Relay with S.P.D.T. switch—See text
- J1, J2, J3, J4, J5, J6, J7, J8, J9, J10, J11, J12—Red pin Jack
- J13, J14, J15, J16, J17—Black pin Jack
- N—Neon bulb, 1/2 watt (with built in 300,000-ohm resistor)
- Red and green pilot light sockets and bulbs
- Multipliers and shunts—See text
- Miscellaneous—5 moulded octal sockets, chassis 10 x 17 x 3, 110-v plug, knobs, wire, solder, hardware, etc.
- All Resistors are 1/2 watt unless otherwise specified.

# MAKE MONEY!

## ASSEMBLING COIN RADIOS

Thousands of dollars have been made during the past year by wide awake radio service men who have installed coin radios in Hotels, Hospitals, Motels and Tourist Cabins. Great demand—No experience necessary.

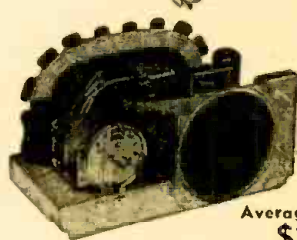
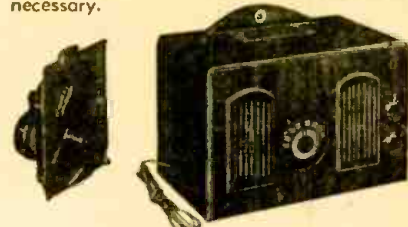

Just  
**3**  
Steps

Average Profit  
**\$25 Per Set**

Much More If Operated on a Rental Basis!

We supply complete chassis with 6 tubes, quarter coin slot and one or two hour timer ready to place in walnut cabinet. Furnished with foolproof lock and coin box. Fill out order blank and mail to:

**EICHEL ELECTRONIC CORP.**  
EVANSVILLE 8, INDIANA

## FILL OUT...MAIL

**EICHEL ELECTRONIC CORP.**  
EVANSVILLE 8, INDIANA

PLEASE SHIP ME

NO.	PLEASE SHIP ME	AMT.
	Cabinets with lock @ \$ 6.75	
	6 Tube Chassis @ 16.65	
	5 Tube Chassis (including plastic auxiliary case) @ 16.50	
	Timers @ 6.50	

I understand either of the above chassis with the timer and cabinet include all of the parts for your latest model coin operated radio.

NAME .....

STREET NO. ....

CITY AND STATE .....

**The Amazing INTER-new TALKIE**

FOR OFFICES, STORES, HOMES, FARMS  
LOWEST COST—EASIEST TO INSTALL

Beautiful Black Slide or Walnut Size, Plastic cabinet. We only 2 Bulb SETS ON ANY DESIRABLE MODEL! NO BATTERIES! A REAL LOUDSPEAKING SYSTEM! ANYONE CAN HOOR THEM UP IN A MINUTE! Almost silent! Operates for 30 or 45 hrs per year. Low cost.

**GUARANTEED FOR 3 YEARS**

Just the thing for filling intervals between meals, born, garage, shop, in house, office, front door, in kitchen, etc.—at 2,000 ft. erect. SAVES STREPS, TUNE AND MONEY. Set of 2 with \$0.99 wire and all instructions. ONLY \$19.95 complete. Terms with \$1.00 per \$0.50 CASH DIRECT. Send \$2.00 deposit. Balance C.O.D. express and insured. 10 U.S.A. only. MONEY BACK GUARANTEED. Also 3-bulb station systems, \$12.95 per station.

**PAKETE RADIO CO., INC.**  
Dept. RG-3 KEASNEY, NEVADA

**TELEVISION RECEIVER—\$1.00**

Complete instructions for building your own television receiver. 16 pages—11"x17" of pictures, pictorial diagrams, clarified schematics, 17"x25" complete schematic diagram & chassis layout. Also booklet of alignment instructions, voltage & resistance tables and troubleshooting hints.—All for \$1.00.

**CERTIFIED TELEVISION LABORATORIES**  
5507-134th Ave., Brooklyn 19, N. Y.



**WORLD-WIDE STATION LIST**  
(Continued from page 37)

Location	Station	Freq.	Schedule
<b>ICELAND</b>			
Reykjavik	TFJ	12.260	Sundays, 0900 to 0930
<b>INDIA</b>			
Delhi	VUD3	3.340	1200 to 1245
Delhi	VUD3	6.100	1200 to 1245
Delhi	VUD3	7.290	0800 to 1100; 1730 to 1825; 2100 to 2300
Delhi	VUD5	9.590	0900 to 1230
Delhi	VUD11	15.290	2215 to 0030; 0125 to 0150; 0200 to 0400; 0500 to 0700
Delhi	VUD10	17.830	0430 to 0700; 0745 to 0800; 2215 to 0215
<b>IRAN</b>			
Teheran	EQB	6.130	0930 to 1400; 2230 to 2315
Teheran	EQC	9.680	1200 to 1430
<b>JAMAICA</b>			
Kingston	ZQI	4.700	1630 to 1830
<b>JAPAN</b>			
Tokyo	JLW	7.280	Home Service, 0300 to 0900; 1600 to 1800; 2200 to 0230
Tokyo	JLG2	9.510	0300 to 0830
<b>KENYA</b>			
Nairobi	VQ7L0	10.730	0500 to 0600; 0830 to 0915; 0945 to 1100
<b>LEBANON</b>			
Beirut	FXE	8.030	0000 to 0115; 0515 to 0800; 1030 to 1600
<b>LUXEMBOURG</b>			
		6.090	0010 to 0030; 1400 to 1630
<b>MALAYA</b>			
Singapore		4.780	0345 to 1000; 2330 to 0130
Singapore		6.770	0330 to 1200
Singapore		7.220	2330 to 0130
Singapore		9.550	0315 to 0515; 0530 to 1100
<b>MARTINIQUE</b>			
Fort de France		9.700	1780 to 1845; and later
<b>MEXICO</b>			
Guadalajara	XEJG	4.820	2200 to 2400
Mexico City	XEUW	6.020	0700 to 0100
Mexico City	XEUZ	6.130	1500 to 0030
Mexico City	XEWV	9.500	0800 to 0200
Mexico City	XETW	9.550	0700 to 0100
Mexico City	XEYU	9.800	sked unknown
Mexico City	XEQX	9.800	0700 to 0045
Mexico City	XETW	6.040	0745 to 0045
<b>MOROCCO</b>			
Rabat	CNR3	9.080	0145 to 0500; 1315 to 1900
<b>MOZAMBIQUE</b>			
Lourde Marques	CR7BU	4.920	1330 to 1600; Sundays, 1000 to 1500
<b>NETHERLANDS</b>			
Hilversum	PGD	6.020	1745 to 2330; Tues, 0300 to 0430; Wed and Sat, 1030 to 1200; 1600 to 1730
Hilversum	PCJ	9.590	2100 to 2200; Sun and Wed, 2200 to 2300
<b>NETHERLAND INDIES</b>			
Bandoeng		4.790	0730 to 0800
Batavia	PMC	18.130	1100 to 1130
<b>NEW CALEDONIA</b>			
Noumea	FK8AA	6.200	0200 to 0400; 0430 to 0500
<b>NICARAGUA</b>			
Managua	YNDS	6.760	0800 to 1000; 1700 to 2330
Managua	YNOW	6.850	0800 to 2400
Managua	YNQW	6.910	schedulo unknown
<b>NORWAY</b>			
Oslo	LKJ	9.540	0300 to 0315; 0500 to 0745; 1000 to 1700
<b>NOVA SCOTIA</b>			
Halifax	CHNX	6.130	0700 to 2300
Sydney	CICX	6.010	0530 to 2200
<b>PALESTINE</b>			
Jerusalem	JCKW	7.220	2330 to 2000
<b>PANAMA</b>			
Colon	HP5K	6.000	0730 to 2300
Panama City	HP5L	6.030	1800 to 0030
Panama City	HP5H	6.120	0630 to 2400
Panama City	HP5A	11.700	0700 to 2300
Panama City	HP5G	11.780	0630 to 2230
<b>PERU</b>			
Lima	OAX4Z	5.890	1630 to 2330
Lima	OAX4V	5.910	1800 to 2400
<b>PHILIPPINES</b>			
Manila		11.840	East Asia beam, 0430 to 1005
<b>POLAND</b>			
Warsaw		6.100	1100 to 1800
<b>PORTUGAL</b>			
Lisbon	CS2WD	6.150	1330 to 1800
Lisbon	CSX	6.370	1230 to 1800
Lisbon	CSW7	9.730	1900 to 2000
Lisbon	CSW6	11.040	1230 to 1530; 1600 to 1800
<b>PORTUGUESE GUIANA</b>			
Bissau		7.100	1345 to 1730
<b>SALVADOR</b>			
San Salvador	YSN	7.310	1300 to 1500; 1900 to 2300
<b>SOUTH AFRICA</b>			
Capetown	ZRK	5.880	2345 to 0130; 1100 to 1800
Capetown	ZRL	9.610	0300 to 0700; 0900 to 1030
Johannesburg	ZRH	6.100	2345 to 0130; 0900 to 1100
Johannesburg	ZRG	9.520	0900 to 1045
Johannesburg	ZJT	9.900	0315 to 0715; 0900 to 1110
<b>SOUTHERN RHODESIA</b>			
Lusaka	ZQP	3.910	1030 to 1200
<b>SPAIN</b>			
Alicante		7.950	0700 to 1000; 1400 to 1800
Madrid	EAQ	9.370	1330 to 1600; 1830 to 2200
<b>SPANISH MOROCCO</b>			
Teluan		6.060	0230 to 0300; 1330 to 1500
<b>SRINAM</b>			
Paramaribo	PZH5	5.840	1800 to 2045
<b>SWEDEN</b>			
Stockholm	SBU	9.530	2000 to 2100

**TUBES! TUBES! TUBES! THOUSANDS OF TUBES**  
**LOWEST PRICES!**

[NEW, STANDARD BRANDS—QUANTITY PRICES ON REQUEST—MINIMUM ORDER \$5.00]

TYPE	PRICE	TYPE	PRICE	TYPE	PRICE	TYPE	PRICE	TYPE	PRICE	TYPE	PRICE
1A3	.98	6AG7	.99	6Y6G	.89	37	.69	802/RK25	1.49	1851	1.25
1A5	.49	6AK5	.69	6X4	.98	38	.89	803	8.95	2050	.90
1A7GT	1.10	6AL5	.99	6X5	.89	39/44	.59	804	6.75	2051	.49
1B24	2.49	6AQ5	.98	7AE7	.75	41	.69	805	3.75	5514	3.95
1B38	4.50	6AT6	.75	7B7	.69	45	.64	807	1.25	7193	.39
1G4	.98	6AU6	.89	7C4	1.50	46	.65	808	2.50	8001	4.95
1G5	.44	6B4	1.29	7C5	.89	47	.90	809	1.50	8005	3.25
1G6	.98	6B6G	.89	7F7	1.25	50B5	.89	810	5.95	8011	2.95
1H4G	.98	6B8	.99	7L7GT	1.39	50L6GT	.75	811	1.95	8012	4.95
1L4	.88	6C4	.64	10Y	.69	70L7	.89	812	3.15	8016	1.65
1R4/1294	1.29	6C5	.51	12A6	.89	71A	.69	812H	6.90	8020	5.95
1T4	.58	6C6	.75	12A7	1.10	75	.69	813	5.95	8025	2.95
1H5	.99	6C21	12.95	12A76	1.10	75T	2.39	814	4.39	9001	.89
1N5GT	1.10	6D4	.89	12B6	.89	76	.75	815	2.25	9002	.49
1LN5	1.92	6D6	.75	12BE6	.89	77	1.75	816	2.95	9003	.49
1R5	1.10	6F4	1.35	12C8	.89	78	.75	829A/B	2.95	9004	.49
1S5	1.10	6F5	.51	12H6	.44	79	1.10	830B	5.25	9005	.49
2A3	1.39	6F6	.79	12J5	.69	80	.53	832A	2.25	9006	.49
2C22	.69	6F6G	.80	12K8	1.25	82	.98	833A	34.50	E50	.79
2C26A	.75	6F7	.98	12SA7GT	.99	83V	.89	836	1.15	H F100	6.95
2C34	.98	6F8	1.10	12S67	.89	84	.75	837	2.50	H Y75	1.25
2C40	2.60	6G6	1.10	12SH7	.89	85	.69	838	3.75	H Y615	1.25
2C44	1.75	6H6	.49	12S17	.79	100TS	3.00	841	1.75	OZ4	1.25
2D21	.75	6J4	1.50	12SK7	.69	117L7	1.89	845	3.75	PK60	.79
2E22	1.50	6J5	.49	12SL7	1.10	117Z3	.89	860	3.00	PK72	3.50
2E25	3.95	6J6	.49	12SN7GT	.79	117Z6GT	1.10	861	50.00	T20	1.95
2E30	2.25	6J7	.89	12SO7GT	.99	121A	2.65	866A	.75	TZ40	2.95
2J32	20.00	6K6	.49	12SR7	.79	205B	4.50	872A	1.95	V70D	6.90
2J33	20.00	6K7	.59	12X3	.98	211	.98	874	1.95	VR78	.75
2J35	4.85	6K8	1.25	14A7	1.10	215A	3.00	884	.75	VR90	.75
2J35J	1.10	6L6	1.25	14B7	1.10	217C	2.10	823	.49	VR105	.75
3A4	.49	6L6G	1.20	14H7	1.25	250TH	12.95	954	.49	VR150	.69
3B7	.98	6L7	.98	14J7	1.25	304TL	2.49	955	.49	ZZ25	1.95
3B22	4.95	6N7	.98	14R7	1.10	307A	6.25	956	.75	Z02	2.95
3B24	.98	6Q5	.98	15E	1.50	316	.89	957	.49	ZAP1	1.95
3D6/1299	.89	6Q5G	.98	23D4	.49	371A	1.39	958A	.49	ZAP2	1.95
3E2	2.95	6Q7	.89	23D6	.98	371B	3.00	959	.49	ZBP1	1.95
3Q4	1.10	6R7	.98	24G	.69	394A	4.50	991	.50	ZCP1	1.89
3Q5GT	1.10	6SA7	.90	25AGGT	.75	417A	19.95	1005	.39	ZBP2	1.89
3S4	.43	6SC7	.85	25L6GT	.75	446A	1.25	1006	.39	ZBP3	2.49
4C35	7.95	6SF5	.79	25Z5	.75	450TH	12.95	1613	.95	ZBP4	4.95
4E27/257B	4.95	6SG7	.79	25Z6	.98	703A	7.50	1614	1.75	ZBP5	4.95
5R4Y	1.15	6SM7	.39	28D7	.75	705A	1.85	1616	1.39	ZCP2	3.95
5T4	1.25	6SJ7GT	.69	30	.78	713A	1.65	1619	.98	ZFP7	4.50
5U4	.44	6SK7	.79	32L7	1.50	715B	4.95	1622	1.75	ZBP7	2.95
5V4G	.58	6SL7	.89	34	.98	717A	.69	1624	.98	ZDP4	14.95
5W4	.98	6SN7GT	.69	35L6GT	1.10	721A	3.95	1625	.49	ZEP4	17.95
5Y3	.60	6S07	.89	35Y4	1.10	723A/B	5.50	1626	.49	ZGP4	19.40
5Y4G	.59	6SR7	.89	35W4	.69	725A	12.50	1629	.59	ZBP4	50.00
5Z3	.89	6SS7	.75	35Z3	.89	725A	2.25	1631	1.49	ZBP4	29.95
5Z4	.89	6U5	.98	35Z5	.69	800	2.25	1631	1.49	10FP4	42.20
6A6	.75	6V6GT	.99	36	1.10	801A	1.10	1641/RK60	.79	12JP4	49.50
6AC7	.99									15AP4	110.00
6AG5	.89									20AP4	270.00

20% DEPOSIT WITH ALL ORDERS UNLESS RATED

**NIAGARA RADIO SUPPLY CORP.** 160 GREENWICH STREET  
NEW YORK 6, N. Y.

Location	Station	Freq.	Schedule
Stockholm	SDB2	10.780	1000 to 1055; 1230 to 1330; 2000 to 2100
Stockholm	SBP	11.700	0140 to 0220; 0600 to 0800; 2000 to 2100; Sun, 0215 to 1100
Stockholm	SBT	15.150	0145 to 0645; 1000 to 1100; 1230 to 1330; 2000 to 2100
<b>SWITZERLAND</b>			
Berne	HER3	6.160	0245 to 0715; 1200 to 1700; 2030 to 2250
Berne	HEK3	7.38	

# HARD-TO-GET PARTS

## POWERFUL ALL-PURPOSE INDUCTION MOTOR

IDEAL FOR EXPERIMENTERS—101 USES



Sturdily constructed to precision standards, this self-starting shaded pole A.C. induction motor is powerful enough for a number of uses. Some of these are: Automatic Timing Devices, Current Interrupters, Electric Fans, Electric Chimes, Window Displays, Photorell Control Devices, Electric Vibrators, Small Grinders, Buffers and Polishers, Miniature Pumps, Mechanical Models, Sirens, and other applications.

Consumes about 15 watts of power and has a speed of 3,000 r.p.m. When geared down, this sturdy unit will constantly operate an 18-inch turntable loaded with 200 lbs. dead weight—THAT'S POWER!  
Dimensions 3" high by 1 1/2" deep; has a convenient mounting stud; shaft is 3/16" long by 3/16" diameter, and runs in self-aligning oil-retaining bearings. Designed for 110-220 volts, 50-60 cycles, A.C. only. Shp. Wt. 2 lbs.  
ITEM NO. 147  
YOUR PRICE ..... \$2.95

### ULTRA MAGNET

LIFTS MORE THAN 20 TIMES ITS OWN WEIGHT

LITTLE GIANT MAGNET

Lifts 5 lbs. easily. Weighs 4 oz. Made of ALNICO new high-magnetic steel. Complete with keeper. World's most powerful magnet ever made. The experimenter and hobbyist will find hundreds of excellent uses for this high quality permanent magnet. Measures 1 3/4" x 1 1/4" x 1/2" high. Shp. Wt. 1/2 lb.  
ITEM NO. 150  
YOUR PRICE ..... \$1.50



### GENUINE MICROPHONE TRANSMITTERS



Regular telephone transmitters taken from a large telephone supply company's overstock. Work perfectly on 2 dry cells. Can be used on P.A. systems, call systems, intercommunications and short-line telephone circuits. House-to-house, or farm-to-farm "phone lines, also to talk through your own radio or to concealed telephone pick-ups. Useful replacements on battery-operated rural telephone lines.

THESE ARE GENUINE TRANSMITTERS, MADE BY KELLOGG, WESTERN ELECTRIC AND STROMBERG-CARLSON, excellent in appearance and operation. A remarkable value and one seldom offered in these times. Shp. Wt. 1 lb.  
ITEM NO. 160  
YOUR PRICE ..... \$2.10

### WATTHOUR METER



Completely overhauled and ready for immediate service. Designed for regular 110-volt, 60 cycle, 4-wire A.C. circuit. Simple to install; 2 wires from the line and 2 from the meter to your house. G. E. P. Wayne, Sankamo or other available make Shp. Wt. 14 lbs.

ITEM NO. 33  
YOUR PRICE ..... \$7.50

### AMAZING BLACK LIGHT!!

Powerful 250-Watt Ultra-Violet Source

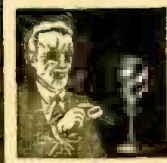

The best and most practical source of ultra-violet light for general experimental and entertainment use. Makes all fluorescent substances brilliantly luminescent. No transformers of any kind needed. Fits any standard lamp socket. Brings out beautiful opalescent hues in various types of materials. Swell for amateur parties, plays, etc. to obtain unique lighting effects. Sub only. Shp. Wt. 2 lbs.  
ITEM NO. 87  
YOUR PRICE ..... \$1.95

### WESTERN ELECTRIC BREAST MIKE

This is a fine light-weight aircraft carbon microphone. It weighs only 1 lb.

Mike comes with breastplate mounting and has 2-way swivel adjustment so that it can be adjusted to any desired position. There are 2 woven straps; one goes around neck, the other around chest. Straps can be snapped on and off quickly by an ingenious arrangement.

This excellent mike can be adapted for home broadcasting or private communication systems. By dismantling breastplate, it can be used as desk mike.  
Comes complete with 6-foot cord and hard rubber plug. Finished in spherulized plate, non-rustable. Shipping weight, 2 lbs.  
ITEM 152  
YOUR PRICE ..... \$1.49



# COSMIC RADIO SIGNALS

(Continued from page 34)

A notable feature of the radar method of exploring the heavens is that such areas of activity may be located even though they may be hidden (as in the case of the Milky Way center) by dense dark clouds which would baffle astronomers. The "electron telescope" may extend the knowledge of the astronomer as much as the electron microscope has already broadened the horizons of the searcher into the realm of the infinitesimally small.

Practical applications of the new study are expected to be immediate. For example, a radio sextant might be built which would shoot the sun by noting the direction of arrival of solar noise. Such an instrument would be a boon to navigation in foggy areas. Knowledge of solar radiation conditions would also be valuable in short-range forecasts of radio propagation. But by far the greatest value of the study is likely to be the gaining knowledge of things not now understood and possibly not dreamed of theory.

For example, when Grote Reber pointed his radio telescope at the Milky Way center, he rather expected to find a center of radio noise intensity. Most galaxies have a dense central nucleus, but the center of ours—if it exists—is hidden in dark clouds presumably of cosmic dust. The burst of signal strength from that area confirmed the suspicions of astronomers, and proved that the radio telescope could make discoveries denied even to Palomar's great light lens. But no one knows the cause of the intense source of signals in the constellation of Cygnus. Investigation of this and other discoveries which are almost certain to be made is likely to give us a new grasp of the universe, and will more than likely help to give us better radio reception right on this earth.

# ELECTRONIC MIXING

(Continued from page 54)

2 db for the range 80 to 3500 cycles. Pickups such as the Garrard Model E and the Webster magnetic may be used.

## Automatic volume limiting

In many good amplifiers it is customary to provide an automatic limiter to prevent overloading and distortion. Usually part of the output is rectified and applied as bias to a control tube. A.v.c. or a.v.l. can be used quite successfully with this electronic mixing system as the sensitivity varies with bias to approximately the same degree for each input. The circuit is shown in Fig. 5.

If very large signals are to be handled by the microphone input and no a.v.c. voltage is available, grid leak bias should be employed or the a.v.c. voltage can be generated by the diode section of a 6B8-G tube, the diode being fed from the plate of the same tube.

# OPPORTUNITY AD-LETS

Advertisements in this section cost 25¢ a word for each insertion. Name, address and initials must be included at the above rate. Cash should accompany all classified advertisements unless placed by an accredited advertising agency. No advertisement for less than ten words accepted. Ten percent discount six issues, twenty percent for twelve issues. Objectionable or misleading advertisements not accepted. Advertisements for April, 1948, issue must reach us not later than February 24, 1948.  
Radio-Craft • 25 W. 87th St. • New York 7, N. Y.

YOU CAN ACCURATELY ALIGN SUPERHETERODYNE receivers without signal generator. Complete instructions \$1. Moneyback guarantee. Chas. Gates, Pecos 2, Texas.

AMATEUR RADIO LICENSES, COMPLETE CODE and theory preparation for passing amateur radio examinations. Home study and resident courses. American Radio Institute, 101 West 63rd Street, New York City. See our ad on page 88.

RUBBER STAMPS, ETC., FOR SALE. COOKSON, Box O-RC, Puxico, Missouri.

MAGAZINES (BACK DATED)—FOREIGN, DOMESTIC, arts, books, subscriptions, pin-ups, etc. Catalog 10¢ (refund). Ciccone's, 863 First Ave., New York 17, N. Y.

TESTING EQUIPMENT, ALL TYPES AND MODELS. Expertly repaired and calibrated. Free estimates. METROPOLITAN ELECTRONICS, 42 Warren St., N. Y. 7, N. Y.

WRITE DEPT. RC 20 FOR OUR LATEST FREE Bargain list of Radio and Electronic parts. R.C. Radio Parts and Dist. Co., 733 Central Ave., Kansas City 6, Kansas.

LANCASTER, ALLWINE & ROMMEL, 436 ROWEN Building, Washington 5, D.C. Registered Patent Attorneys. Practice before United States Patent Office. Validity and Infringement Investigations and Opinions. Booklet and form "Evidence of Conception" forwarded upon request.

LEARN ELEMENTS OF RADIO AT HOME. IDEAL course for beginners. \$15.00. Write Waca Radio School, 1421 Sixth Street, S.E., Minneapolis 14, Minn.

RECORDINGS—BIKINI ATOMIC TEST. STATE ABLE Day or Baker Day. \$4.75 Each. Sound Snap, 479 Parkwood, Columbus 8, Ohio.

RECORDER AND PATBACK AMERTYPE "COM-MAND" Model A Recorder carrying case 110V AC 60 Cycles eight hour recording on vinylite tape. Original purchase price \$850. Make reasonable offer. Pilot Marine Corp., 29 Broadway, N.Y.C.

26 YEARS' EXPERIENCE RADIO REPAIRING AT your fingertips. I've perfected simple system you can follow step by step. No formulas or calculations. Cuts repair time to minimum. Total price \$2.00 postpaid or COD. Moneyback guarantee. Rosa Radio, 14615-J Grandriver, Detroit 27, Michigan.

WE REPAIR ALL TYPES OF ELECTRICAL INSTRUMENTS, tube checkers and analyzers. Hazelton Instrument Co. (Electric Meter Laboratory), 140 Liberty Street, New York, N. Y. Telephone—Barclay 7-4239.

6V DYNAMOTOR FROM 12V SURPLUS. NO REWINDING. Original output. Instructions 50¢. Satisfaction guaranteed. Paul Hawkins, 1306 E. 27, Kansas City, Mo.

PHONOGRAPH RECORDS—MARCH, 1948. Phonograph records 20¢. Catalogue. Paramount, KP-313 East Market, Wilkes-Barre, Penna.

RADIOMEN, SERVICEMEN, BEGINNERS—MAKE more money easily. \$250 weekly possible. We show you information free. Merit, 216-32L, 132nd Avenue, Springfield Gardens 13, New York, New York.

# NEW RADIO-ELECTRONIC PATENTS

(Continued from page 50)

at the grid of triode A. This bias varies with the strength of v.f.o. output. Note that the plate of triode A is connected to B+ through the internal resistance of the other triode.

The a.c. component of the control voltage is amplified by A and then appears at the grid of B. The output load of this latter triode is in its cathode circuit R, with point P positive compared with ground. P is connected directly to the v.f.o. screen grid.

To illustrate the operation of this circuit, consider a case where the v.f.o. is tuned to a band whose output is weaker than normal. The positive bias at A is reduced together with the plate current of this triode. Since this current flows through resistor G, there will be a lower negative bias on the grid B and a greater current through the cathode load R. This, of course, increases the positive potential at the v.f.o. screen grid and brings the power output back to normal.

AM survivors among broadcast stations in the next 5 years will be only the clear-channel 50,000-watt or more powerful stations, Judge Roy Hofheinz, who is president of stations KTHH and KOPY of Houston, Texas, told a conference of radiomen recently.

### HUDSON SPECIALTIES CO.

40 West Broadway, Dept. RC-3-48, New York 7, N. Y.

I have circled below the numbers of the items I'm ordering. My full remittance of \$..... (include shipping charges) is enclosed (NO C.O.D. ORDERS UNLESS ACCOMPANIED WITH A DEPOSIT.) OR my deposit of \$..... is enclosed (20% required) ship order C.O.D. for balance. NO C.O.D. ORDER FOR LESS THAN \$5.00. BE SURE TO INCLUDE SHIPPING CHARGES.  
Circle Item No. wanted:  
147 159 160 87 152 33

Name .....

Address ..... Please Print Clearly

City ..... State .....

## ALIGNING A SUPERHET WITHOUT A GENERATOR

Superheterodynes can be aligned properly without a signal generator. If the receiver has a padder adjustment, another receiver is needed to determine its oscillator frequency, but nothing but a screwdriver is needed for receivers with no low-frequency oscillator adjustment.

This method has been tested thoroughly. On cheap receivers it sometimes gives better results than adjusting the i.f. stages to the proper frequency with a signal generator. That is because, in these sets, the oscillator frequency is sometimes different from what it should be. This is caused by aging of parts in the oscillator circuit.

The procedure for receivers with an adjustable padder is as follows:

Step 1. Tune the receiver to be aligned to a station near the low-frequency end of the dial.

Step 2. Place another receiver near the one to be aligned and tune to a station higher in frequency by the nearest possible amount to the intermediate frequency of the set. For example, if the set being aligned has an i.f. of 460 kc, tune it to a 550-kc station and tune the auxiliary receiver to a station at 1010 kc.

Step 3. Adjust the oscillator padder of the set being aligned until the beat note from the oscillator is heard in the auxiliary radio with as low a pitch as possible.

Step 4. Without changing the tuning control, adjust the i.f. trimmers until the 550-kc station is received well.

Step 5. Turn the tuning control to a station in the high-frequency part of the set's tuning range and adjust the oscillator trimmer to tune the station in at the proper point on the dial.

Step 6. Turn back to the 550-kc station, readjust oscillator padder till the station is at its correct dial reading.

Step 7. Adjust the r.f. trimmers to make reception as good as possible.

The results may be improved by returning to step 3 and repeating adjustments through step 6.

For receivers with no padder adjustment, steps 2 and 3 are omitted.

ALBERT REES

## CHIP CHASER

Unable to locate a chip chaser for my recorder, I made one from a few inexpensive parts. I mounted a windshield-wiper arm and blade on one end of a short length of 1/4-inch rod. The other end of the rod was threaded and mounted on a heavy block. (I used a steel bench block 3 inches in diameter.) The wiper blade will have to be shortened to suit the diameter of the records. A 4-inch wiper is sufficient for 10- or 12-inch records. For better results, replace the rubber blades with chamois skin.

ROY T. HORTON,  
Woodside, N. Y.

(Take care that the added drag does not cause variations in turntable speed.—Editor)

RADIO-CRAFT for MARCH, 1948

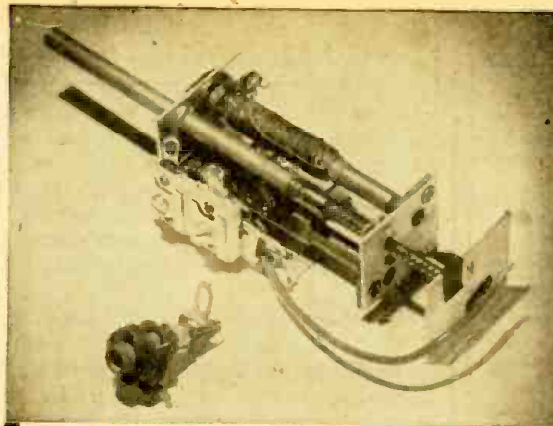

## SET-BUILDER'S SCOOP!

**Tuning Unit--  
Newest Type,  
Permeability**

Complete, including separate iron core oscillator, tracking coil, and built-in mica trimmers. May be used to cover the broadcast band in either AC or AC-DC receivers. Has worm gear drive for iron slugs, rigid metal frame only 1 3/8" x 1 3/4" x 3 7/8". Extra long tuning shaft. Moisture proof coils wound on plastic forms.

Nothing equal at twice the price. Full instructions included. **\$1.25**  
Shipped C.O.D. or postpaid with cash order within U. S. A.

**WATTERSON SALES CO.**

P. O. BOX 840

DALLAS 1, TEXAS

## EASY TO LEARN CODE

It is easy to learn or increase speed with an Instructograph Code Teacher. Affords the quickest and most practical method yet developed. For beginners or advanced students. Available tapes from beginner's alphabet to typical messages on all subjects. Speed range 5 to 40 WPM. Always ready—no QRM.



**ENDORSED BY THOUSANDS!**

The Instructograph Code Teacher literally takes the place of an operator-instructor and enables anyone to learn and master code without further assistance. Thousands of successful operators have "acquired the code" with the Instructograph System. Write today for convenient rental and purchase plans.

**INSTRUCTOGRAPH COMPANY**

4701 Sheridan Rd., Dept. RC, Chicago 40, Ill.

## MAGNETIC RECORDING

(Continued from page 70)

cabinet. A complete set of schematic circuits for this recording amplifier, playback amplifier, and motor control circuits appeared in the February, 1948, issue of RADIO-CRAFT.

It is hoped that this series of 5 articles on "Elements of Magnetic Tape Recording" have been both informative and interesting to RADIO-CRAFT readers. Material for constructing tape recorders is coming rapidly onto the market. Tape pullers, recording heads and supplies of tape may be obtained from the Brush Development Co., the Amplifier Corporation of America and possibly others by the time this is printed. The author will be glad to answer all queries asked by readers.

### REFERENCES

- Toomin, H., and Wildfeuer, D.: "The Mechanism of Supersonic Frequencies as Applied to Magnetic Recording," Proc. I.R.E. (Nov., 1944), Vol. 32, No. 11, p. 664.
- Holmes, L. C. and Clark, D.L.: "Supersonic Bias for Magnetic Recording," Electronics (July, 1945), Vol. 18, No. 7, p. 126.
- Wetzel, W. W.: Review of the present Status of Magnetic Recording Theory, Audio Eng. (Dec., 1947), Vol. 31, No. 11, p. 12.

## ANSWERS TO QUIZ ON PAGE 59

1. Down 12 db; 2. (b); 3. (c); 4. (c); 5. (b); 6. (b) 7. (a); 8. (c); 9. build a class A amplifier; 10. tungsten increases, carbon decreases.

## NOW!

You can get the math you need for solving everyday radio and electrical problems



Radiomen and electricians know that the language and the habit of mathematics are essential for real progress in their chosen field. They know mathematics is a tool that they are helpless without.

NOW out of the U. S. Navy Radio Material School at Naval Research Laboratory comes a complete home-study book that is so thorough and so detailed that any reader "who can perform arithmetical computations rapidly and accurately is capable of mastering the principles laid down in this text."

## MATHEMATICS for ELECTRICIANS and RADIOMEN

by N. M. Cooke, Chief Radio Electrician, U.S. Navy  
604 pages 6 x 9, \$4.50

This book teaches you mathematics from elementary algebra through quadratic equations, logarithms, trigonometry, plane vectors and elementary vector algebra with direct applications to electrical and radio problems. It teaches you how to apply this mathematical knowledge in the solutions of radio and circuit problems. In other words, it gives you the grasp of mathematics you need and then shows you how to use your knowledge.

Based on over 8 years' experience teaching mathematics to U. S. Navy electricians and radio operators, the book gives you 600 illustrative problems worked out in detail and over 3000 practice problems with answers so you can check your work.

### ---10 Days' Free Examination---

McGraw-Hill Book Co., Inc., 330 W. 42nd St., N.Y.C. 18  
Send me Cooke's Mathematics for Electricians and Radiomen for 10 days' examination on approval. In 10 days I will send you \$4.50 plus few cents postage, or return book postpaid. (We pay postage if remittance accompanies order.)

Name .....

Address .....

City and State .....

Position .....

Company ..... RC-3-48

# A Better Cone Buy Leotone

## PORTABLE A.C. AMPLIFIER (Lic. by W.E.)



Here is a professional type HIGH FIDELITY unit at an amazingly low price. Wide freq. response for use with Musical Instruments, Speech or Phono input, FM Tuners, etc. Features: 8" Alnico PM speaker; 2 inputs (magnetron crystal); vol. & tone controls, Beam Power output. Beautiful, sturdy 2 tone brown leatherette case (13 1/2" x 15 1/2" x 7 1/2"). Shpg. wt.

12 lbs. List price—\$64.50.

**LEOTONE'S PRICE—While They Last \$24.95**  
In lots of 3—ca. 21.50

**TUBES:** Perfect condition, but in unsealed cartons. Most types in stock at up to 80% off list. Every tube guaranteed 90 days.

220, 28, 27 or 34 ..... .29  
275, 76, 77, 78, 89, 6H6 or 6K7 ..... .39  
235, 38, 37, 39, 84, 5Y4, 5U4, 6B7, 6CS, 6FS, 69, 6T7, 6K8, 6U7, 6SA7, 12SJ7 or 12SQ7 ..... .49  
21A7, 1N5, 1H5, 1R5, 6L6, 6U5, 6X5, 7A7, 7CS, 7C6, 7Y4, 50 or 50B5 ..... .59

**TUBE CARTONS:** Plain white.  
Miniature (1 1/2" sq. x 2 1/2") Per 100 ..... .98  
GT size (1 3/4" sq. x 3 1/2") Per 100 ..... 1.28  
Medium (1 1/2" sq. x 4 1/2") Per 100 ..... 1.49  
Large (2" sq. x 5") Per 100 ..... 1.79

**T-30 THROAT MIKE** with neckband, 2 buttons set in rubber exclude all outside noise. Requires 50-100 ohm mike transformer & 4 1/2V. battery. EVERY ONE BRAND NEW. SPECIAL, EACH .39, 12 for 2.98  
**THROAT MIKE CORO & SWITCH ASSEMBLY (CD-508)** for use with above mike ..... ea. 39c

**ALNICO MAGNETS** Powerful ALNICO MAGNETS in many shapes & sizes Always in stock. Write for latest illustrated supplement MARCH SPECIAL—ROUND BAR, polished. O.D. 3/8" x 2" ..... .29

**FULL WAVE SELENIUM RECTIFIERS.** Bridge type. 18V. AC max. input @ 1 amp. 20 min. duty; 600 ma continuous. 3 1/4" x 5 1/2" ..... 1.28

**INTERPHONE CONTROL BOX (BC-600).** Brand new metal cased unit containing 3 jacks, 50K control, toggle switch, terminal block & mtg. hardware in metal case 4" sq. x 2" ..... .49

**AC-DC BLOWER MOTOR.** Bakelite housed 24 blade 2" fan, 7000 RPM quiet ball-bearing motor operates on 110V. with 100V bulb (or equiv) in series or on straight 27V. With 2 mtg. brackets. O.D. 3" x 4 1/2" ..... 3.95

**GLIDE PATH RECEIVER R-80/ARN-5A.** Used in instrument landing, 332-335mc. Every unit in perfect condition with complete schematic. Less tubes & crystals. Shpg. wt. 16 lbs. 4.95  
R-80 schematic diagrams only .10



## NEW "JUMBO" RADIO PARTS ASSORTMENT

AMATEURS! SERVICEMEN! EXPERIMENTERS! If you want real value, don't miss this outstanding buy in new & dismantled radio & electronic parts! **17 POUNDS OF COILS, TRANSFORMERS, HARDWARE, SPEAKER REPAIR PARTS, RESISTORS, CONDENSERS, WIRE, etc., etc. All these AND MORE for only \$2.95**

1/2 MEG VOLUME CONTROLS with switch. 1/4" shaft ..... .45  
**TUBE SHIELDS,** for GT or octals. Open top, nitr. on O.D. 1-3/16" x 2-7/16", ea. .04; 16 for 49c  
**DYNAMOTOR (DM-36D)** .28V. DC to 220V. DC. 80ma. With complete filter system. 6 1/2" x 4 3/4" x 9" Only ..... .98

Get on our mailing list—Always something new!

**PROMPT EXPERT SERVICE ON ALL SPEAKER AND PHONO PICK-UP REPAIRS**  
Min. Order \$2.00—20% Deposit Required on All Orders.  
Please Add Sufficient Postage. Write Dept. RC-2

# LEOTONE RADIO CO.

MAKERS OF CONES AND FIELD COILS  
65-67 DEY STREET, NEW YORK 7, N.Y.  
WORTH 2-0284-5  
12,000 SQ. FT. OF RADIO PARTS

## NEW DAY DAWNS FOR SERVICEMEN

(Continued from page 24)

without fully realizing it. They drew up a code of ethics for radio technicians, and made representations to the manufacturers, not as spokesmen for the technicians of the organized section of Pennsylvania, but in the name simply of the radio repairmen of the country.

### The Town Meeting program

While the nuclear group was holding its meetings, the Town Meeting of Radio Technicians was registering greater success than its sponsors had dared to dream. More than 1500 radiomen registered to hear John Meagher of RCA Service Co. and Ray Robinson of Philco tell how to service television receivers, Robin Compson of WCAU-TV describe home installation and customer instruction, and other prominent engineers cover various phases of antenna installation, FM circuits, and high-frequency test instruments.

Technical knowledge is of little use to a radioman if he cannot make a living. Therefore business experts told the assembled radio technicians how to put their shops on a business basis; how to set up a system to tell them if they were making money, and what to do if they were not. Especially important in proving that a repairman might imagine himself on the road to prosperity while actually losing money was a paper "How I Spent \$91,000 to Earn \$90,000 in TV Service." Advertising and public relations were also included in the subjects discussed.

Altogether a total of 16 down-to-earth papers on the technical and business angles of radio servicing were presented to the assembled radio technicians. Considerable enthusiasm was expressed for everything but the papers on test equip-

ment and its use. Some servicemen considered their presentation too abstract and not always aimed at the technician whose day-to-day familiarity with the equipment under discussion made discussion of certain points superfluous while requiring especially thorough coverage of others.

### Lessons of the meeting

The assembled technicians left the Town Hall as thoroughly convinced of the value of organization as of improving their technical and business knowledge. No less convinced were a number of the speakers, notably the president of the Radio Manufacturer's Association, Max Balcom, who spoke at the opening night. The abuses complained of by customers were confined to a small minority of radio technicians and service shops, he pointed out, but nevertheless one unscrupulous radio shop could impair the public confidence in radio repairmen throughout an entire community.

The radio industry is now confronted in some cities with the threat of licensing, Mr. Balcom continued. "We in RMA believe that if this threat materializes the industry will be jumping from the frying pan into the fire," he stated. "We believe that radio technicians themselves are best able to rid their ranks of the men and the abuses that bring discredit upon a vocation and in industry. Manufacturers will be able and willing to help wherever and however they can, but in the end it will be up to technicians such as yourselves to complete the job."

### The Philadelphia story

This good sense was exemplified by the example of the Philadelphia Radio

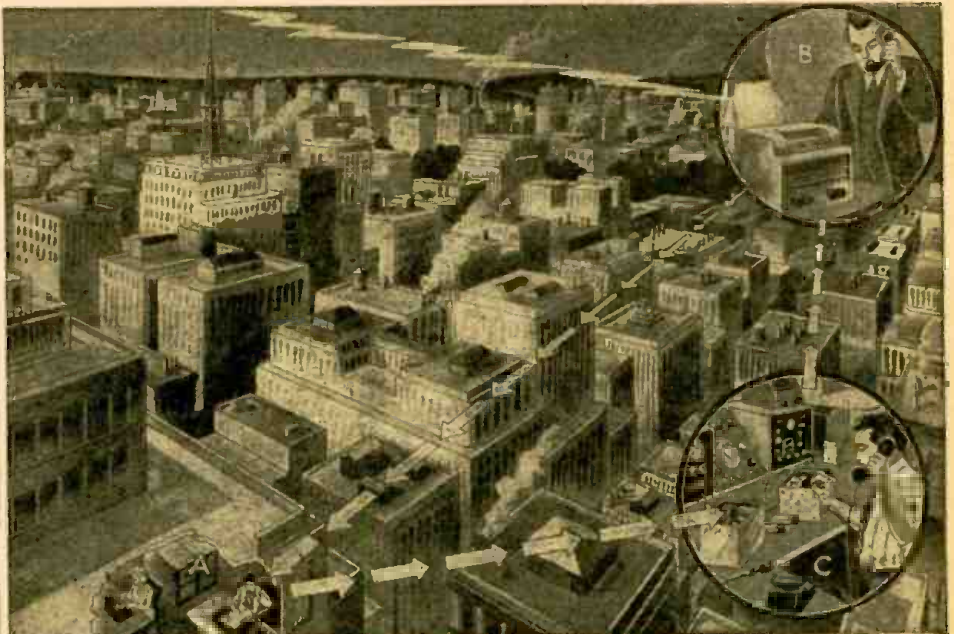

How the Philadelphia Radio Servicemen's Association builds up customer confidence. Broadcasting daily spots over KYW, the PRSMA asks radio owners to phone them complaints against any servicemen in the city. When complaints are received at the PRSMA office (A) from an owner (B) the repairman (C) is contacted and asked to get in touch with the set owner, who is also notified. The PRSMA finds that practically all cases can then be adjusted directly.



Servicemen's Association. Seventeen years ago, when the group was formed, Philadelphia was considered one of the worst cities in the United States for radio repair. Articles on evil practices of some Philadelphia concerns appeared in leading radio magazines, and the honest repairman was in as bad reputation as the racketeer.

One of the first acts of the new association was to advertise that all complaints against radio repairmen—*Whether members of the group or not*—would be taken care of by the organization. Followed a campaign to clean up Philadelphia by the radio technicians themselves, it was necessary actually to put a few radio racketeers in jail. The situation was cleaned up, as is shown by the fact that Philadelphia was selected as the outstanding city of the United States by the co-ordinating committee of manufacturers and electronic distributors who chose the location for the first Town Meeting of Radio Technicians.

The manufacturers further showed their good will at the RMA's Board of Directors' Chicago meeting January 23, in which they pledged the association to "co-operate with organizations of radio repairmen" to spread wider technical knowledge as well as ethical standards. The organization also voted to co-operate in holding 5 meetings with the radio technicians—similar to the Philadelphia meeting—every year, and recommended that its member manufacturers supervise their authorized service dealers more closely, withdrawing franchises should unethical practices be discovered.

### New York City organizes

The newly formed New York City association is another example of how the radioman can benefit himself by organization. Literally kicked into existence by a City Council proposal to license all types of radio technicians, the association had a particularly bad start. While it was still a struggling infant of a few weeks, a local paper and radio station launched another of the periodical "exposés" of radio repairmen. (See editorial *War on Servicemen* in Feb. issue.) Normally the radiomen would have had to bear this abuse in silence. But officers of the new association got on the telephone at once and—somewhat to their surprise—the radio station in question immediately offered them time to present the radio technicians' side of the case. Since that time the radiomen have had access to two New York City stations and have been the subject of part of the program "Room 416" by John McCaffery on WNBC.

Following the example of older organizations, the New York group set up a grievance committee to handle customer complaints of unfair treatment by radio servicemen, and sent out a release asking radio owners to report all such complaints to the committee chairman, Jack Edel. The repairman has always insisted that such charges are greatly exaggerated, but they were not prepared for the result of their appeal to the radio-using public. Only a dozen complaints had

drifted in a week after the appeal to the public had been sent out!

### Benefits of organization

The radio technician will find that he can help himself in a number of ways by organizing into a local Radio Technicians Association:

1. He can obtain technical information as a group that he could never hope to obtain individually. Many companies are willing—even pleased—to send competent engineers moderate distances to address groups of technicians, if they can be assured of an audience large enough to make the effort worth while.

2. By subscribing to a Code of Ethics, he can have a clear understanding with the public and his fellow-technicians as to what his conduct may be and what is to be expected of him. By displaying the Code in a prominent place in his shop, he can build up public confidence in him and his associates.

3. By uniting with his fellow-technicians, he can present a solid front against attacks by irresponsible "investigators" and others, and can obtain facilities for presenting his side of the case that would be denied him as an individual. If considered advisable, he can through his organization carry on advertising campaigns for the purpose of customer education, in the local papers or otherwise.

4. Through a grievance committee he can handle and settle such complaints against him as do arise, thus preventing them from establishing standing bad-will and negative advertising influence against him.

5. In federation with other technicians on a State-wide or national basis he can negotiate with the radio manufacturers as a group on discounts, trade practices, etc. On a local or State basis he can co-operate with manufacturers and distributors in organizing educational forums like the Philadelphia Town Meeting.

6. Finally, through the good-fellowship engendered through meeting with brother technicians he can reduce or eliminate the spirit of rivalry, jealousy and cut-throat competition which has done much to drag down the level of the radio repair business in so many towns and cities, and raise the status and prestige of the radio technician to that of other local business groups.

### SIMPLE SPEAKER Baffle

A speaker baffle is often desirable when a set has been removed from its cabinet for testing and repairs. An emergency baffle may be made from a cardboard cylinder or an oatmeal box. When the cylinder is placed in front of the speaker, it lengthens the sound path and builds up the bass notes.

In some instances, a set in its cabinet may have a bothersome hum which is inaudible when the speaker is removed from its baffle. This simple baffle will

## FREE RADIONIC CATALOG



CHECK FULL OF BUYS!

RADIO & TELEVISION PARTS - KITS  
PUBLIC ADDRESS INTER-COMMUNICATORS  
RECORDERS RECORD CHANGERS  
TEST INSTRUMENTS TUBES  
AMATEUR EQUIPT  
CHANCELLOR RADIOS  
HARDWARE TECHNICAL BOOKS

A MUST for all  
• Service Dealers  
• Amateurs  
• Experimenters  
• Industrials  
• Institutions  
• Government Agencies

### RADIONIC EQUIPMENT COMPANY

170 NASSAU ST., NEW YORK 7, N.Y.

Tribune Theatre Entrance  
Tel. WOrth 2-0421 • Cable "CHANSLOR"

RADIONIC EQUIPMENT CO., Dept. 103  
170 Nassau Street, New York 7, N. Y.

Send at once your free catalogs, supplements and bargain lists as published—listing Products of leading manufacturers of radio-electronic parts and equipment.

NAME .....

P.O. BOX or STREET .....

TOWN ..... STATE .....

Come to the Great

## SHOPS OF COYNE

where you learn by doing



## RADIO ELECTRONICS-TELEVISION in a Few Short Weeks

To Succeed in Television, You Need All-Around Radio Training!

Trained Radio men needed now. Get Radio training and be ready for a real future. Learn on actual equipment at Coyne. Free employment service to graduates. Many earn while learning. If you are short of money, ask about Student Finance Plan. Now added Training in Electric Refrigeration. We are also equipped to train those who qualify under G. I. Bill. Men with Physical Disabilities may qualify for training at no cost to them for tuition and subsistence.

SEND COUPON FOR FULL DETAILS

B. W. COOKE, President  
COYNE ELECTRICAL & RADIO SCHOOL  
500 S. Paulina St., Dept. 38-8H, Chicago 12, Ill.  
Send Big Free Book; also details about Coyne Part-Time Employment and Student Finance Plan.

NAME ..... AGE .....

ADDRESS .....

CITY ..... STATE .....

make it possible to make a quick check on the response of the receiver without returning the set to the cabinet.

WALLACE BUSBY,  
Port-of-Spain, B. W. I.

## OUTSTANDING SPECIALS!!

Immediate Delivery from Stock

The New  
Model B-45  
Battery  
Operated

### SIGNAL GENERATOR

for servicing AM, FM and Television Receivers. H.F. frequencies from 150 Kilocycles to 30 Megacycles (150 Kc. to 12.5 Mc. on Fundamentals and from 11 Mc. to 50 Mc. on Harmonics). Complete with shielded test lead, self-contained battery and instructions. NET ..... \$27.75

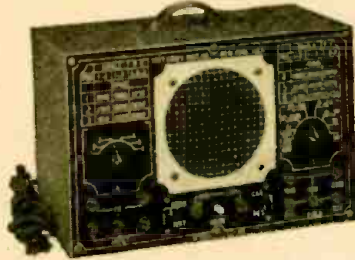

The New Test-Craft

### COMBINATION TEST SPEAKER

A new combination test speaker, plus resistor substitutor, plus condenser substitutor, plus resistor tester, plus condenser tester, plus output meter. Substitute voice, call, output transformer and field permits testing of set speaker for shorts and opens. Field impedances 500, 1000, 1500 and 2500 ohms. Net Price ..... \$27.50

**Metropolitan ELECTRONIC & INSTRUMENT CO.**

Depl. RC 42 WARREN ST. N. Y. 7, N. Y.

## MARCH SPECIALS

### HEAVY DUTY TOGGLE SWITCHES

DPST—15 A 125 V ball type handles.....	49c
DPST—12 A 125 V bat handle.....	39c
DPST—20 A 250 V ball type handle.....	69c
DPST—30 A 125 V bat handle.....	39c
SPST—5 A 125 V bat handle.....	29c
DPST—20 A 125 V foot switch handle.....	39c
SPST—.75 A 125 V momentary push button.....	19c

### MICRO SWITCHES

Microswitch type YZ-3RT1 switches normally open types.....	39c
Microswitch type P.B. switches normally open types.....	39c
D.P.S.T. push button switches normally open 6 A 125 V.....	39c

RCA Sapphire tipped cartridge #38610	
List price, \$5.55, your cost.....	\$2.25
Lots of 10.....	\$1.95
RCA Replacement Cartridge #31050	
List price, \$4.20, Your cost.....	\$1.85
Lots of 10.....	\$1.75

### TUBE SPECIALS

IR 4 1294 .25c Sylvania 1299.....	25c
RCA 6B8C—3.20 list, cost.....	29c

### STANDARD CHASSIS IN STOCK

Cnd. Pl. Number	Black Number	Depth	Width	Height	Your cost
160	161	5"	7"	2"	.60
170	171	7"	7"	2"	.75
172	173	7"	9"	2"	.85
176	177	7"	12"	3"	1.05
184	185	7"	17"	3"	1.15

Write for other sizes in stock

10% Cash with Order

**ALMO** Phone LO 3-9255

Covers the Globe

509 ARCH STREET  
PHILADELPHIA, PENN.

## KNOW YOUR TEST EQUIPMENT

(Continued from page 33)

yond the middle group. The 2 scales of the multimeter chosen make comparison with both higher- and lower-grade multimeters possible and add to the generality of the table. Specifications are given below:

Ranges (without special amplifier)  
D.c. volts: 0-2.5, 10, 25, 100, 250, 1,000 volts;  
A.c. volts: 0-2.5, 10, 25, 100, 250, 1,000 volts.  
In the audio and supersonic frequencies, the scales give absolute values (to within 5%) up to 2 mc.  
In the radio frequencies, relative voltage values can be used up to over 100 mc.  
Direct current: 0-2.5, 10, 25, 100, 250, 1,000 ma.  
Ohms (in 5 ranges): Lowest range 0-1,000 ohms, with 10 ohms at center scale;  
Highest range 0-1,000 megohms, with 10 megohms at center scale.  
Input impedance: d.c. volts—11 megohms on all ranges,  
A.c. probe—approximately 1 megohm, shunted by less than 10  $\mu$ mf.

age is applied to the grid of VT2, the meter connections to R35 and R37 are reversed by the function switch.

### A.c. vacuum-tube voltmeter

The a.c. circuit breakdown (Fig. 8) shows the circuit components involved when the FUNCTION SELECTOR is set to the A.C. VOLTS position. The d.c. vacuum-tube voltmeter measures the rectified output of any a.c. voltage applied to the probe diode VT1. The resistors R7 to R12 inclusive serve as d.c. load resistors for the signal diode of the 6H6. (The a.c. component of the pulsating d.c. output voltage of the signal diode is bypassed by C3.) The filtered rec-

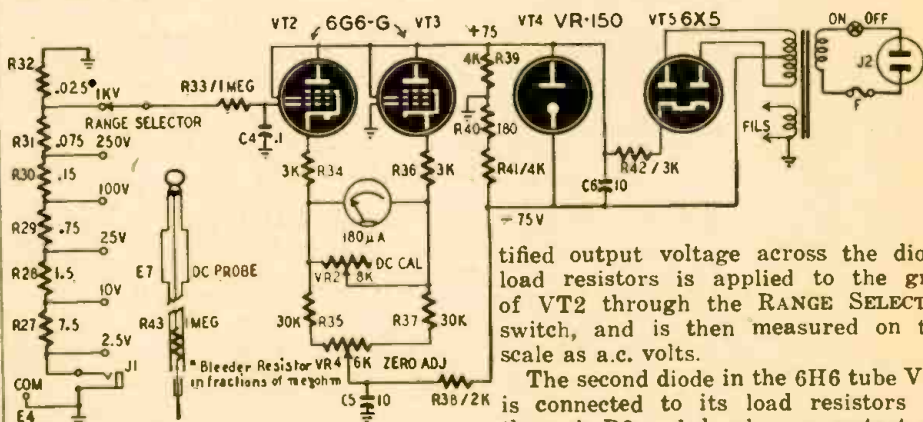

Fig. 7—Direct-current circuits of v.t.v.m.

(A special amplifier is supplied as extra equipment for greater a.c. sensitivity below 5,000 cycles.)

### D.C. voltage section

The d.c. voltage breakdown (Fig. 7) shows the circuit elements involved when the FUNCTION SELECTOR is set to NegDCV or PosDCV. Two 6G6-G tubes, triode-connected, with load resistors in their cathode circuits, are connected in parallel across the output of the 150-volt d.c. power supply. The resistors R34, R35, and part of VR4 serve as load resistors for VT2. The resistors R36, R37, and the remainder of VR4 serve as load resistors for VT3. The sliding contactor of VR4 is connected to the negative side of the power supply through the R-C filter R38, C5, across the cathode load resistors. When the ZERO ADJUST control VR4 is adjusted, current through the 180-microampere meter connected between these 2 points drops to zero. There is then 5 volts of negative bias on the grids of tubes VT2 and VT3, since their cathodes are held at 5 volts positive to ground. When a negative d.c. voltage is applied to the grid of VT2, the plate current of VT2 decreases, and the voltage drop across R35 becomes less than the voltage across R37. Current then flows through the meter and its calibrating shunt VR2, which is adjusted at the factory to produce full-scale deflection of the meter when 2.5 volts d.c. is applied through the d.c. probe to the grid of VT2. When a positive volt-

age is applied to the grid of VT2, the meter connections to R35 and R37 are reversed by the function switch.

ified output voltage across the diode load resistors is applied to the grid of VT2 through the RANGE SELECTOR switch, and is then measured on the scale as a.c. volts.

The second diode in the 6H6 tube VT1 is connected to its load resistors R1 through R6 and develops a contact potential across these resistors which is negative to ground. By applying the same amount of negative contact potential to VT3 as is applied to the grid of VT2, from the signal diode, the effect of diode contact potential is overcome, and practically no change in the ZERO ADJUST control setting is required when changing voltmeter ranges.

### Current and resistance

The circuits for measuring current and resistance will not be considered in detail. For d.c. milliamperes, the meter part of the instrument is used alone in a circuit essentially the same as the one given for the d.c. current section of the multimeter. The circuit for obtaining the resistance ranges is essentially similar to the d.c. voltage arrangement of the v.t.v.m. previously given. This circuit is modified so that the meter reads the voltage drop across the unknown resistor, obtained by sending a current through the unknown resistor from a battery in series with it and a standard resistor. Since this voltage drop will be proportional to the resistance, the scale of the meter can be calibrated directly in ohms for each resistance range.

In summary: the fundamental ability of the v.t.v.m. to measure voltage, while drawing only a negligibly small current from the circuit under test, puts it in a class by itself. This ability of the v.t.v.m. also accounts for its applications under conditions where the multimeter, at best, has limited use: such cases, for example (to mention only some important ones), as the measurement of grid



## LAKE DELUXE CHANGER

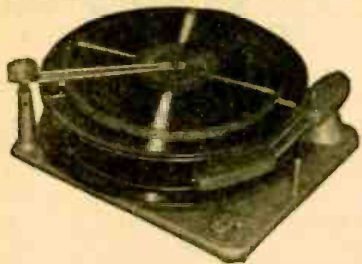

Revolutionizes the Industry!  
**A SENSATIONAL SELLER!**

### 11 OUTSTANDING FEATURES:

- Positive Intermix
- Service Adjustments
- Eliminated Wear
- Minimizes Record Wear
- Single Knob Control
- Plays ALL Records
- Completely Jam-proof
- Records Gently Laid on Spindle—not dropped
- Automatic Shut-off on last record
- Pick-up arm may be grasped at any time and changer will not be thrown out of adjustment
- Resonance-free ball bearing tone arm
- Easily operated—any child can do it

Dimensions: 13 13/16" W x 12 1/4" D x 7 3/4" H No. 116A4 ..... **YOUR NET \$2873**

**FREE DEALERS AND SERVICEMEN:**  
Write for our NEW 16-page 1948 illustrated catalog on radio parts, tubes, accessories, cabinets, sets, electrical appliances, etc. Get on our mailing list today!  
Dept. C

## LAKE RADIO SALES CO.

615 W. Randolph Street, Chicago 6, Ill.



**WIRELESS PHONO OSCILLATOR:** Two-tube, slug tuned, complete with tubes, cord and plug. (Pictured above) Play records through your radio with wireless. Easy to install.  
Shipping Wt. 3 lbs. .... **\$5.90**

**CODE-PRACTICE OSCILLATOR:** Learn code easily with the help of this two tube, compact code oscillator. Complete with tubes, pitch-changing switch, cord and plug and terminals for speaker or earphones and key.  
Shipping Wt. 3 lbs. .... **\$5.80**

**C.O.D. ACCEPTED**

**RJS PRODUCTS**

925 CONCORD AVE., AKRON, OHIO

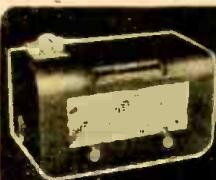

# STEADY PROFITS

YOUR OWN BUSINESS  
with **CORADIO**  
The Coin Operated Radio

Place these specially built radios that play 1 or 2 hours for 25c in the thousands of available hotel rooms, tourists courts, etc. They yield immediate profits and steady income. Install Coradio, the finest made. Limited capital required. Send for further information. Write today.

**CORADIO** Coin Operated Radio  
108 W. 31 Street Dept. RC. New York 1, N. Y.

# Communications

## ORGANIZATION BETTER THAN LICENSING

Dear Editor:

As secretary of the Rhode Island Radio Businessmen's Association, a group of servicemen banded together in a nonprofit organization, I read your article "Should Servicemen Be Licensed?" with great interest.

Our organization was formed for the purpose of: 1. creating a better understanding between the public and the serviceman; 2. maintaining a just level of prices commensurate with the skill and ability required for correct servicing; and 3. raising the radio technician to his proper professional level.

Each of the members displays the association emblem. Radio and newspaper advertising is used to acquaint the public with the fact that the emblem is their guarantee of satisfaction. All the members give a 90-day guarantee on all repairs. In the case of a dispute, the

customer has recourse to a Board of Governors set up by the association, who study the facts and render an impartial decision. Only men of high caliber technically and morally are accepted as members, and we acquaint them through lectures with fair-profit business methods. In addition, we sponsor educational lectures and technical demonstrations to keep up to date with the newest developments in the field. By doing so, our members can maintain their places as professional men who can give the most to the public.

As brother members, we foster a more friendly and cooperative spirit among ourselves, which in itself can do much toward overcoming some of the existing evils in the radio servicing field.

G. G. COSTANTINO,  
Providence, R. I.

## WANTS LICENSING, PLUS ORGANIZATION

Dear Editor:

Your editorial in the December, 1947, issue, "Should Servicemen be Licensed," caused some comment among the fellows in our shop. The consensus of the 15 men in various stages of radio and television service experience is as follows:

1. Servicemen should be licensed, preferably by an organization of servicemen. It has been difficult to handle some of the administrative problems which arise, so we suggest that all electronic technicians and servicemen affiliate with unions of skilled men in this field, such as Local 1085, *International Brother-*

*hood of Electrical Workers, AFL*, of which we are members.

2. Qualifications for recognition as an electronic technician or serviceman would consist of:

- a. Graduation from a recognized radio-technician or service course, plus 1 year continuous apprenticeship in the field. Armed Forces schools will be given credit but apprenticeship must be served in civilian capacity; or
- b. Three years bona fide, continuous experience in the field. Nine months

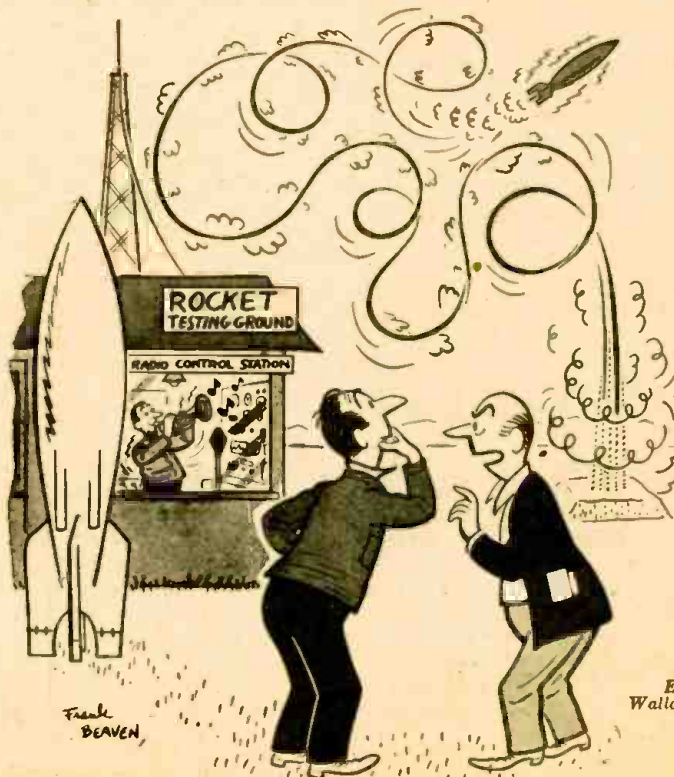

Suggested by:  
E. R. Donohue,  
Walla Walla, Wash.

"It's Elmer again, playing jive over the control system!"

RADIO-CRAFT for MARCH, 1948

in each calendar year to count as a full year in accrediting a technician.

### 3. Training:

Just to "be" an organization is insufficient—we have recently passed legislation in our union to establish a training system so that technicians can keep abreast of current techniques and apprentices can be shown the practical aspects of the subjects they were taught in school. Our local is composed of sound, radio, and television servicemen.

### 4. Standardization:

Under this item would come fair trade practices. Based on the fact that

a service technician would have to be qualified or licensed by such an organization as is proposed, standards similar to the *Oelrich Standard Rate Book* will have to be set up and adhered to by members.

### 5. Publicity:

The customer must be acquainted with the fact that a serviceman's time, labor, overhead, parts, and experience are worth fair compensation, and that the organization is looking to its own best interests by protecting the consumer.

BEN LEEDS,  
Brooklyn, N. Y.

## BETTER REMEDIES THAN LICENSING

Dear Editor:

Should radiomen be licensed? I say no, unless appliance men are licensed. One of the reasons given for licensing radiomen is danger of shocks or fires from improperly repaired radios. Another is that some radiomen overcharge on repairs.

Hazard of a.c. or d.c. radios in plastic or wooden cabinets comes from the bolts which hold the chassis. I have found them welded to the tops of ranges and radiators. I do not blame the repairman for that. In many older homes with open wiring and in some new ones where plumbing repairs have been made, the ground connection is open and the repairman is not to be blamed for that, either. A shock may easily be received from an open neutral when one comes into contact with a water pipe or a radiator. Shocks or fire hazards from these causes account for practically all cases. Only a negligible number are due to carelessness of the repairman.

The remedy is a stricter regulation by the fire underwriters as to what the manufacturer puts on the market.

## LICENSES CONTRA FREE ENTERPRISE?

Dear Editor:

I have very positive views on the question "Should Servicemen Be Licensed?" Why is there any reason to license radio servicemen? When your car needs repairs, you take it to your garage mechanic. And when your watch doesn't run, you take it to a reliable watch repairman. Does your watch or car always run well after these men have worked on it? Do you think that if they had a state or federal license, they could have done a better job? And if I had a license, could I do a better job of repairing radios? To these questions, I say NO.

The most important qualification of a good repairman is plenty of actual experience. I studied radio for 2 years and repaired the sets of friends and neighbors before I advertised for any busi-

ness. After this study and experience, I might have passed a test for a license. Would that have made me a radio expert? No, it takes years of experience to become one. One radio manufacturer puts a label on the back of his set reading: "When in need of repairs, take this set to a serviceman displaying this sign." I have one of those signs. Does that make me a better repairman? No.

The serviceman has to take a lot of hard knocks with empty pockets while he is learning the business. People in his neighborhood know him; and if they are willing to risk their sets, O.K. If he can't learn, he will soon fade out. Too much regulation stifles free enterprise. Leave the radio serviceman alone!

H. B. WORKMAN,  
Waverly, Ohio

## WANTS WORLD-WIDE COMMUNICATIONS

Dear Editor:

I am a 29-year-old Argentine radio technician and amateur. I have been in radio since 1936, and am an old friend of your publication RADIO-CRAFT.

This letter is to send my best 73's to you and all the personnel of your editorial staff, and would also like to send

my heartiest greetings to all your readers.

I would like to interchange through RADIO-CRAFT, letters, ideas, and technical publications with amateurs, operators and technicians. Write in English, Spanish, or French.

JOE MARIA FRANCISCO,  
Buenos Aires, Argentina

**STOP!** Can you beat these outstanding buys of guaranteed merchandise anywhere else? Don't know? Well then

**LOOK** below!

### TELEVISION-CATHODE RAY HIGH VOLTAGE

#### 2000 volt D.C. Power Supply

For a remarkably low price, we are offering a completely filtered television or cathode ray 2000 volt D.C. power supply. Why bother with bulky and dangerous 60 cycle supplies or expensive R.F. power supplies when you can purchase a complete 2000 volt D.C. power supply (not a kit), ready to plug into the 110 volt A.C. power line. The ridiculously low price has been made possible by a fortunate purchase of high quality components. These units are brand new, completely tested and guaranteed. Here are the advantages:

- Low cost
- 2000 volts D.C. at 1 ma.
- Safe
- Small size
- Completely wired and tested
- Ready to connect to your television set or other equipment
- Will operate from 110 volts, 25 to 60 cycles.

PRICE ..... \$7.95

### RECORD-SCRATCH FILTER

One of the smallest, most efficient scratch filters we have seen. Note these desirable features:

- Suppresses needle scratch on all records—approximately 25 db. attenuation
- Old records sound new again
- Scratch frequency range adjustable within the range of 4500 cycles
- On-off cutout control
- Very compact—housed in a shielded aluminum container only 1½" square by 3½" long
- Can be quickly attached to any radio or record player without tools. Full instructions.
- Exceptionally Priced—only \$1.65

### RADIO KITS

All kits have been designed to be simply and inexpensively constructed. The kits contain all the required parts except wire and solder for their construction into an efficient working unit comparable with the best post-war type of units. The simplified diagrams furnished make it possible for any radio student experimenter, or amateur to construct these kits.

#### FIVE TUBE AC-DC SUPERHET KIT:

Furnished in a brown plastic cabinet of artistic design, cabinet size (9"x5"x6"). Variable condenser tuned with 2 double tune I.F. Tubes used: 1-12SA7, 1-12SQ7, 1-12SK7, 1-35Z5, and

1-50L6.....PRICE \$12.45  
(Including 5 Standard Tubes)

#### SIX TUBE 3 WAY PORTABLE KIT:

For operation on 110 volt AC or DC and battery. Superheterodyne circuit. Full vision dial. High gain loop. Cabinet of Blue Aeroplano cloth finish, size 13x9½"x7". Tubes used 1A7, 1H5, 3Q5, 117Z6 and 2-1N5.

PRICE..... \$13.75  
Not including tubes or batteries. Extra for kit of Tubes \$3.75.

#### SIX-TUBE 2-BAND SUPERHETERODYNE KIT

In a walnut wood cabinet, contains all parts (except wire and solder) to construct a high grade 2-band superheterodyne receiver covering regular broadcast and short wave bands. Tubes consisting of 2-6SK7, 1-6SQ7, 1-25Z6, and 25L6 included.

Price..... \$16.45

#### THREE-TUBE PHONO AMPLIFIER

Complete with tone and volume control.

Price, completely wired, less tubes..... \$2.95  
Price, complete with 12SQ7, 50L6, 35Z5 tubes..... \$3.95

#### PHONO OSCILLATOR

Wireless phono oscillator transmits recordings for crystal pickup or voice from carbon mike to radio without wires.

Price, completely wired, less tubes..... \$2.95  
Price, complete with 12SA7, 35Z5 tubes \$3.95

All Prices Are F. O. B. New York City **Have you seen our complete catalogue?** WE SHIP ANYWHERE PROMPTLY

## RADIO DEALERS SUPPLY CO.

135 Liberty St., New York, N. Y.

## GOVERNMENT SURPLUS

If you cannot get to the Government Sales of War Surplus Radio Equipment, the next best thing to do is to buy our SPECIAL \$25.00 GOVERNMENT RADIO SURPLUS ASSORTMENT.

We buy large quantities of these items all over the country, divide those items we don't have in large quantities into choice assortments for which we know you would gladly pay \$25.00 if you could see them.

On a deposit of \$5.00 we will ship you COD (balance \$20.00) freight collect, a large quantity of Government Surplus Radio Items subject to your inspection. If, after inspection, you are not more than satisfied, return to us, freight charges collect and all it will have cost you will be freight charges one way. We will then refund your initial payment of \$5.00. You should be able to dispose of a few of the items that you may not need for the entire cost.

This is the cheapest way we can sell you War Surplus Radio Material. Our warehouses are filled with thousands of choice Government Surplus Radio Items. Lot of them we do not have in sufficient quantity to advertise nationally and the cost of inventorying, itemizing, corresponding, etc., would only increase their cost to you; therefore we make this offer. If you wish to mention a few items you desire, we will endeavor to include them in the assortment.

**THE ABELL DISTRIBUTING CO.**

7 E. Biddle Street, Baltimore 2, Maryland

## NEW SERIES 16

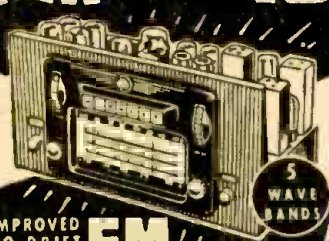

IMPROVED NO-DRIFT

FM

in the Sensational 1948

**MIDWEST RADIOS**

Separate Chassis Like This Powerful Series 16 AM-FM Model or Beautiful Radio-Phono Consoles Available

**The SYMPHONY GRAND**

**RADIO-PHONOGRAPH AM-FM CONSOLE**

A truly magnificent instrument that offers new, improved No-Drift FM, 5 Wave Bands, Automatic Intermit Record Changer that handles both 10" and 12" records, 14 1/2" Panasonic Speaker, and exclusive Midwest Tri-Magnadyne Coil System and Color-Ray Tone Selection. Luxurious cabinets. Other Console and Table Models with Series 16, 12, and 8 Chassis.

EASY TERMS

30 DAYS TRIAL

SEND FOR FREE CATALOG

BUY DIRECT FROM FACTORY AND SAVE!

FILL IN COUPON AND MAIL TODAY OR JUST SEND YOUR NAME AND ADDRESS ON A POSTCARD

**MIDWEST RADIO CORPORATION**  
Dept. 38-B 709 Broadway, Cincinnati 2, Ohio  
Please send me your new FREE 1948 Catalog

NAME .....  
STREET .....  
CITY ..... ZONE ..... STATE .....

# BOOK REVIEWS

**RADIO TECHNIK, Theory and Practice**, by Dr. J. Durwang. Published by Wepf & Co. Verlag, Basel (Switzerland). Stiff cloth covers, 6 1/2 x 9 inches, 216 pages. (In German.) Price 12 Swiss francs.

A textbook for radio students and experimenters, this is the fifth and enlarged edition of the former work. This book on radio theory and practice encompasses in a clear manner electrical and radio phenomena and is of particular interest to the student.

No attempt has been made to cover all the various branches in an exhaustive manner; rather the fundamentals are given briefly and concisely so the student or experimenter may become well grounded in radio.

Of particular interest are a number of mechanical analogies of radio components, particularly the radio tube. Several of these are quite novel and original, as for instance a mechanical model explaining the motions of electrons in a triode tube. Others give mechanical equivalents of wave motions, etc.

There is an excellent chapter on the technique of television, although it is much too short, in the opinion of this reviewer.

Another short chapter treats on ultrashort and decimeter waves, which include radar in its various fundamentals. —H.G.

... from nuclear physics to medicine and microwaves.

The essays have been well chosen, though the book might have been even better if some of the editor's comments had been omitted, and the space devoted to longer excerpts from the scientific papers presented. A saving grace is the superb bibliography, which covers 18 pages.

Some of the articles are: The Exploration of Space, by Edwin P. Hubble; Are the Planets Habitable? by Henry Norris Russell; Movies and Color Photography, by C. E. K. Mees; The Electron Microscope, by James Hillier; The Spectroscope, by George R. Harrison; Within the Atom, by Hans Bethe; The Atomic Nucleus, by Isidor I. Rabi; Isotopes in Atomic Research, by Harold Urey; Fungi—Friends and Foes, by Elvin Charles Stakman; The Science of Heredity, by T. S. Painter; The Human Eye, by Selig Hecht; The Science of Hearing, by Harvey Fletcher; Atomic Energy and Medicine, by Stafford L. Warren; Microwaves, by Lee Alvin DuBridge; Direct Lift Aircraft, by Igor Sikorsky; Medical Research During the War, by Alfred N. Richards; Progress in Aviation, by Jerome C. Hunsaker, etc.

Among the authors we find eight Nobel Prize winners, the heads of several universities and others who have made a name for themselves in various branches of science.—H.W.S.

**THE SCIENTISTS SPEAK**, Edited by Dr. Warren Weaver. Published by Boni & Gaer. Stiff cloth covers, 5 1/2 x 8 1/2 inches, 370 pages. Price \$3.75.

This opportune book comprises 79 essays by leading scientists and covers almost every niche in modern science

**MOST-OFTEN-NEEDED 1948 RADIO DIAGRAMS and Servicing Information**, by M. N. Beitman. Published by Supreme Publications. Flexible fiber covers, 8 x 10 1/2 inches, 191 pages. Price \$2.00.

A collection of the more popular man-



Suggested by Anna Frahm, Waterford, Wis.

"Don't you have one with a better-looking announcer?"

ufacturers' schematics of the last year, presented in the regular form of the Supreme Publications series. A useful book for the part-time serviceman, student, or others who have use for schematics, but may not do enough professional radio servicing to justify possession of the more extensive complete radio manuals.

**PRINTED CIRCUIT TECHNIQUE**, by Cleo Brunetti and Roger W. Curtis. National Bureau of Standards Circular N 468. Published by the Superintendent of Documents, Government Printing Office. Flexible fiber covers, 8 x 10 inches, 43 pages. Price 25c.

A systematized compilation of present knowledge on the subject, much of this matter has appeared in various papers and periodicals. The book is no rewrite, however, but a well-handled and thoroughly integrated presentation of the subject. Its publication at this time should be a valuable service to designers and manufacturers of printed-circuit apparatus.

**HOWARD W. SAMS 1947 AUTOMATIC RECORD CHANGER SERVICE MANUAL** (including Wire, Ribbon, Tape, and Paper Disc Recorders), compiled and published by Howard W. Sams & Co., Inc. Stiff board covers, 8½ x 11 inches, pages not numbered. Price \$4.95.

This new book offers solutions to some of the mechanical problems the radio serviceman encounters in servicing automatic record changers. It gives complete details on 41 different types of changers and a number of electromechanical devices associated with recording and reproducing sound. To name a few; we find the Webster and St. George wire recorders, Mail-A-Voice, Soundmirror, and the G.I. recorder-changer. A cross reference chart identifies the manufacturer and model number of changer used on different makes and models of postwar radio sets.

The first 24 pages are devoted to operation and maintenance of drive motors, fundamentals of changer operation, and types of phonograph cartridges. The remainder of the book deals entirely with explanations, service notes, photographs, and exploded drawings of the various pieces of equipment. This material is presented in the style familiar to users of PhotoFact Folders.—R. F. S.

**THE STRANGE STORY OF THE QUANTUM**, by Banesh Hoffmann. Published by Harper & Brothers. Stiff cloth covers, 6 x 8½ inches, 239 pages. Price \$3.00.

Written in popular language for a nontechnical audience, this book nevertheless introduces the reader to an interesting world he never dreamed of. He examines the Bohr theory and becomes familiar with such terms as Balmer's ladder, Heisenberg's uncertainty principle, Dirac's and Schrodinger's equations. The quantum number of Max Planck weaves through them all, to unify them dramatically in what the author chapter-heads "The Strange Denouement."

If the reader is not too clear in his mind as to the exact nature of the electron and the validity of certain natural laws after reading the book, he at least has the satisfaction of knowing that the very scientists who have dug most deeply into these secrets of the universe are themselves not far beyond him on the road to exact knowledge.

**F-M SIMPLIFIED**, by Milton S. Kiver. Published by D. Van Nostrand Co., Inc. Stiff cloth covers, 5¼ x 8½ inches, 347 pages. Price \$6.00.

This book was written so to present the facts about FM as to indicate and bridge the gap between AM and the newer FM techniques. It explains fully and in simple language the theory of FM and the operation of the various circuits encountered in receivers and transmitters.

The author has divided the book into 5 sections covering FM fundamentals, receiver principles, transmitters, receiver alignment, and commercial receivers. The last section has chapters on the servicing of FM receivers which should be of value to the radio serviceman.

The book uses many diagrams and circuits to illustrate the various topics explained in the text and includes several complete circuits of commercial receivers and transmitters.

**DICTIONNAIRE RADIOTECHNIQUE ANGLAIS-FRANCAIS**, by L. Gaudillat. Published by the Société des Editions Radio (Paris). Paper covers, 5 x 7 inches, 77 pages plus short appendix. (Text material in French.) Price 120 francs.

Four thousand radio, electronic, and television terms and expressions used in American and English literature are translated into their French equivalents. The 6-page appendix consists of tables converting inches to millimeters, various English units of quantity to their metric equivalents, Fahrenheit to Centigrade, and American and British wire gauges expressed in millimeters.

**THE RADIO HANDBOOK**, Eleventh Edition, edited by R. L. Dawley, published by Editors and Engineers, Ltd. Stiff leatherette covers, 8½ x 11½ inches, 512 pages. Price \$3.00.

Oldtimers in amateur radio hardly need an introduction to this book, although they are not likely to recognize it in its new format. The publishers have brought it out in olive leatherette in the standard 8½ x 11½-inch magazine size.

Much of the theoretical material and associated illustrations are taken directly from previous editions. One attractive feature is that all constructional material seems to be new and in print for the first time, unlike previous issues which contained much material reprinted from *Radio*. Photographic illustrations are attractively handled by the photogravure process.

Much of the new material is devoted to circuits and design material on narrow-band FM, v.f.o.'s, rotary and directional antennas, converters, and preselectors. A chapter on converting surplus equipment is included.—R.F.S.

**B-A BARGAIN SPECIAL**

**'Tops' in Headphones**  
At a Fraction of Original Cost

8000-ohm impedance, highly sensitive. Best quality Alnico magnets in molded black bakelite cases, concealed terminals. Headband fully adjustable, leather covered spring steel 12" cord with PL54 plug attached at side out of way. Jack and rubber cord supplied to extend length to 5½ ft. Extremely lightweight, only 9 oz., with removable rubber ear cushions of comfortable design Brand New—a 13.50 Value.

Stk. No. 17A37, Special Per Pair **\$1.95**

**ORDER NOW**, from this ad Add Postage



**RADIO Electronic**  
1947 SUPPLIES APPARATUS

**FREE Catalog**  
Many other BARGAINS in this BIG NEW 1948 B-A Catalog.

Latest developments in Radio and Electronic parts and devices, newest Ham gear.

Write if you have not received it—Cat. No. 481 FREE on request.



**B-A BURSTEIN-APPLEBEE Company**  
1012-14 M'GEE STREET.  
KANSAS CITY 6, MISSOURI

**COMMAND RECEIVERS (274N SERIES)**  
Complete with tubes

BC-946: 520 to 1500 KC	Used	New
BC-453: 190-550 KC	\$4.95	\$12.95
BC-454: 3 to 6 MC	3.95	6.95
BC-455: 6 to 9 MC	3.95	5.95

**COMMAND TRANSMITTERS**  
(274N Series) Complete with tubes and crystal

BC-457: 4 to 5.3 MC	Used	New
BC-458: 5.3 to 7 MC	3.95	5.95
BC-459: 7 to 9.1 MC	3.95	5.95
BC-456 MODULATOR	BRAND NEW	\$2.95

**RADIO PARTS**

Assorted—100 mica condensers	\$1.19
100 Resistors ¼ to 1 watt	.95
100 Tubular bypass condensers, assorted	.01
to .1, all 600 Volt	4.69
Electrolytic condensers 50-30, 150 Volt. 10 for 2.89	
½ Meg. Volume Controls 1" shaft with switch.	10 for 3.00
½ Meg. Volume Controls 1" shaft without switch	10 for 1.95
Crystal Pick-up, new light	ca. 1.79

**TUBES**

6V6	12SR7	5R4	12SL7GT	49c
6X5	1625	12BE6	6Y6	
6AG7	12AT5	12AG6	10A6 Neon	Lots of 50 10% Discount
35W4	6AT6	12CG6	10A6	
12AT6	6SF7	6SJ7	6MG	
Amperite 10T1			8GG6	

**SCOPE TUBES**

3AF1	3FF7	\$1.19
5FP7	7BP7	

All Shipments F.O.B. Chicago  
20% deposit required on all orders

**ARROW SALES INC.**, Dept. D  
59 WEST HUBBARD ST. CHICAGO 10, ILLINOIS  
Telephone: SUPERIOR 5575

**ELECTRONIC VOLT-OHM-METER**  
110 VOLTS AC 20 RANGES

**\$11.85**

0 / 5 / 10 / 50 / 100 / 500 / 1000 / 5000 volts DC and AC. 0-1,000,000,000 ohms in six overlapping ranges. Sensitivity: over MILLION OHMS per VOLT on 5 volt range.

POSTPAID

Complete kit includes all component parts, tubes, punched and drilled chassis and beautifully enamelled panel. Easily assembled and wired.

Special slideback circuit developed during war by scientist at the California Institute of Technology gives amazing sensitivity and flexibility while completely eliminating necessity of batteries and expensive meter. Each instrument is individually calibrated. Dial scale over nine inches long!

In addition to performing the usual volt-ohm functions, this instrument easily measures these voltages: SUPERHET OSCILLATOR, AVC, AFC, TRUE GRID BIAS AT THE GRID, BIAS CELLS without affecting the circuit. Measures the exact leakage resistance of INSULATION, TUBES, CONDENSERS. It can be used with a signal generator for SIGNAL TRACING.

**STERLING ELECTRONIC COMPANY**  
BOWLING GREEN, KENTUCKY

**Do you need BINDING POSTS?**

The XL PUSH POST with its Spring Action assures Constant Contact and quick connection.

Manufactured in All Aluminum Type M at 12c each.

Aluminum Body, Bakelite Top Type B1 at 15c each.

Types CP or NP. ALL BRASS—STAINLESS STEEL SPRING & PIN PROVEN BY 240 HR. SALT SPRAY TEST as NON-CORROSIVE at 28c each.

Manufacturers and Dealers Liberal Discounts

**X. L. RADIO LABORATORIES**  
420 West Chicago Ave., Chicago 10, Ill.



# RADIO SCHOOL DIRECTORY

PREPARE NOW FOR SKILLED JOBS IN RADIO AND ELECTRONICS

## PRACTICAL TECHNICAL TRAINING

SPECIALIZE in 6 months to 3 years

### COURSES

- SERVICE**  
6 to 12 Months
- Electricity
  - Welding
  - Refrigeration
  - Heating
- TECHNICIAN**  
1 to 2 Years
- Electricity
  - Radio
  - Electronics
  - Refrigeration, Heating and Air Conditioning
- PROFESSIONAL**  
3 Years
- Electrical Engineering Bachelor of Science Degree Major in Machinery or Electronics

Train in Electronics, Radio, Electricity for a substantial career in industry—or a business of your own. Prepare in one year to be a Technician—or in two additional years secure a Bachelor of Science Degree in Electrical Engineering with major in Electronics. More than 35,000 former students in industries the world over. 1,538 students now enrolled from 48 states and 13 overseas countries. Faculty of 72 specialists. Write for catalog and Personal Guidance Questionnaire.

Terms start April, July, September

**MILWAUKEE**  
**SCHOOL OF ENGINEERING**  
A TECHNICAL INSTITUTE

Dept. RC-348

North Broadway, Milwaukee, Wis.

## BLISS Electrical Training

Intensive 32 weeks' residence course in fundamentals of industrial electrical engineering, including radio and electronics. Extensive laboratory, shop work. Prepares for electrical technician and engineering aids in communications, power, manufacturing, business machines, sales, service. 54th year. Catalog. Classes begin March 22; July 26.

**7543 Takoma Avenue, Washington 12, D. C.**

## RADIO ENGINEERING!

Complete Radio Engineering Course. Bachelor of Science Degree. Courses also in Civil, Electrical, Mechanical, Chemical, Aeronautical Engineering; Business Administration, Accounting, Secretarial Science. Graduates successful. 64th year. Enter March, June, Sept., Jan. Write for catalog.

**TRI-STATE COLLEGE** 2438 College Ave. ANGOLA INDIANA

## CORRESPONDENCE COURSES IN RADIO and ELECTRICAL ENGINEERING

**ELECTRICAL ENGINEERING** Get good grasp of wide electrical field. Prepare yourself at Low Cost, for secure future. Modern course. So simplified anyone can understand quickly.

**RADIO ENGINEERING** Extra fine course in radio, public address, photo-electric work. Trains you to be super-service man, real vacuum-tube technician. Servicemen needed badly. Diploma on completion. Many graduates earning big pay.

Send postcard for free Copies of school catalog, full details, all experimental kits, etc. **\$25** Either about deferred payment plan, experimental kits, etc.

**WRITE** Lincoln Engineering School, Box 931C-109, Lincoln 2, Nebr.

**RCA INSTITUTES, Inc.**  
Offer thorough training courses in all technical phases of **Radio and Television**

**VETERANS:** RCA Institutes is approved under G. I. Bill of Rights For Free Catalog Write Dept. RC-48

**RCA INSTITUTES, Inc.**  
A Service of Radio Corporation of America  
75 VARICK STREET NEW YORK 15, N. Y.

## Radio Technician and Announcers

A practical 15-month course in First Class Radiotelephone Operation and Announcing is offered by Don Martin School of Radio Arts. Most stations these days require combination men. We specialize in this type of training and maintain a placement bureau for our graduates. Serving the industry for 10 years, the School of Radio Arts can train you. Write for our catalogue outlining the courses offered. Classes can be arranged so you can do part time work on the side.

APPROVED FOR VETERANS  
**DON MARTIN SCHOOL OF RADIO ARTS**  
1655 North Cherokee St. Hollywood 26, Calif.

## CAREERS in RADIO

INTENSIVE COURSES—Thorough, technical education for progressive men and women.

Licensed by the State of New York

1. **RADIO TECHNICIAN**—The MRI General Course. Includes F.M. & Television. Prepares For FCC Broadcast Licenses.
2. **RADIO & TELEVISION SERVICING**—Prepares for employment as Repairman on Standard Broadcast, F.M. & Television Receivers.
3. **RADIO COMMUNICATIONS**—Prepares for FCC Operators' License. Leads to position as Merchant Marine or Flight Radio Officer; Commercial Operator.
4. **FUNDAMENTAL RADIO MATHEMATICS**—The MRI Preparatory Course. Required pre-training for students lacking a basic mathematical background.

### MELVILLE RADIO INSTITUTE

MELVILLE BUILDING  
15 WEST 46TH ST., N. Y. 19, L. D. 4-0340  
"The Radio School Managed By Radio Men"

### MELVILLE RADIO INSTITUTE

MELVILLE BUILDING  
15 West 46th St., N. Y. 19, N. Y.

GENTLEMEN: RC

Send me FREE information about your school.

Name.....

Address.....

MAIL THIS COUPON NOW

## A CAREER WITH A FUTURE! TELEVISION

Shop Work • Shop Techniques • Theory  
FULLY EQUIPPED LABORATORIES

- RADIO SERVICE & REPAIR
- F. M. & TELEVISION
- TRANSMITTER COURSES

Preparing for F. C. C. LICENSES

- RADIO TECHNOLOGY

A Junior College Level Course preparing for positions in Radio-Electronic Engineering Field.

MORNING • AFTERNOON • EVENING CLASSES  
MODERATE RATES • INSTALLMENTS

Available Under G. I. Bill  
COME IN AND SEE OUR STUDENTS AT WORK

**DELEHANTY SCHOOL OF**  
**RADIO • ELECTRONICS • TELEVISION**  
105 EAST 13 ST., N. Y. 3, N. Y. • DEPT. T  
LICENSED BY STATE OF NEW YORK

## FM — RADIO — TV TRAINING

Free Booklet Now Available

This new booklet gives you the facts you want to know before you enroll in any school. Profusely illustrated, interesting and factual. Enables you to check why WRCI SPECIALIZED TRAINING METHODS are outstanding in the West; why WRCI laboratory trained specialists are preferred for responsible high paying positions in the fields of Radio Communications and Radio-Television Servicing. Choose your school with care; read this 16 page booklet before you enroll anywhere. Our course is approved for veteran training. Non-veterans invited. Accredited by American Society for Trade and Vocational Education. Write today for Bulletin T.

WESTERN RADIO COMMUNICATIONS INSTITUTE  
631 West Ninth Street, Los Angeles 15, Calif.  
Specialized Training in Radio-Electronics



## RADIO COURSES

Preparatory, Service, Broadcast, Television, Marine Operating, Aeronautical, Frequency Modulation, Radar.

Classes now forming for the summer term  
June 1. Entrance exam May 17.  
Veterans. Literature.

**COMMERCIAL RADIO INSTITUTE**  
(Founded 1920)  
38 West Biddle Street, Baltimore 1, Md.

## LEARN RADIO!

IN ONLY 10 MONTHS  
PREPARE FOR A GOOD JOB!  
COMMERCIAL OPERATOR (CODE)  
BROADCAST ENGINEER  
RADIO SERVICEMAN

Television Servicing—15 Months

Veterans get \$130.00 Equipment  
SEND FOR FREE LITERATURE  
BALTIMORE TECHNICAL INSTITUTE  
1425 Eutaw Place, Dept. C, Baltimore 17, Md.



**SHORT CUT** **CODE SPEED**  
Be an Expert

Learn to be a Telegraph or Radio Operator. Thousands of men needed. Intensely interesting work—good pay. Learn at home or wherever you are, quickly, easily, with the famous Candler Code Speed System. Book of particulars Free.

**FREE BOOK**

CANDLER SYSTEM CO.  
Dept. 3-C, Box 928, Denver 1, Colo.



# RADIO SCHOOL DIRECTORY

(Continued)

## TELEVISION 1948!!

Train at an Institute that pioneered in TELEVISION TRAINING since 1938. Morning, Afternoon or Evening Sessions in laboratory and theoretical instruction, under guidance of experts, covering all phases of Radio, Frequency Modulation, Television, lead to opportunities in Industry, Broadcasting or own Business. Licensed by N. Y. State. Approved for Veterans. ENROLL NOW FOR NEW CLASSES

## RADIO-TELEVISION INSTITUTE

480 Lexington Ave., N.Y. 17 (46th St.)  
Plaza 3-4585 2 blocks from Grand Central

## Make Good in at Hollywood Experts Help You RADIO-TELEVISION Home

Direct from Hollywood, nerve-center of broadcasting, Television, Radio and Sound activities, comes R-T-A's time-proven and tested home training. Here at last—easy to learn, home instruction that quickly qualifies you for steady, good pay work or your own Radio business. 10 big kits of radio parts given at no extra charge. Get full details at once! Send postal for FREE BOOK "How to Make Good in Radio-Television." R-T-A APPROVED FOR VETERANS.

RADIO TRAINING ASS'N OF AMERICA, Dept. RCC, 5620 Hollywood Blvd., Hollywood 28, Calif.

## AUDIO ENGINEERING SCHOOL

A Practical 9 Months Course in Sound Fundamentals, Recording and Sound Transmission Measurements; in a Laboratory Containing Transmission Sets, Oscillators, Square Wave Generator and Intermodulation Analyzer, and other Equipment. Complete Recording Studios and Assimilating Broadcast, Motion Picture and Commercial Sound Recording.

For Information Write,

H. M. TREMAINE, Director

## SCHOOL OF SOUND RECORDING AND TRANSMISSION ENGINEERING

1655-A Cherokee, Hollywood 28, Calif.

## RADIO

TECHNICIAN and RADIO SERVICE COURSES

## FM and TELEVISION

## AMERICAN RADIO INSTITUTE

101 West 63rd St., New York 23, New York

Approved Under GI Bill of Rights  
Licensed by New York State

## Radio Thirty-Five Years Ago

In Gernsback Publications

## HUGO GERNSBACK

Founder

Modern Electrics .....	1908
Electrical Experimenter .....	1913
Radio News .....	1919
Science & Invention .....	1920
Radio-Craft .....	1929
Short-Wave Craft .....	1930
Wireless Association of America .....	1908

Some of the larger libraries in the country still have copies of ELECTRICAL EXPERIMENTER on file for interested readers.

## FROM MARCH 1914 ELECTRICAL EXPERIMENTER:

- A New Wireless Relay by *Henri Mea*
- Construction of an Improved Loose Coupler by *H. Winfield Secor*
- New "Electro" Loading Inductance
- A Pocket Wireless Set
- Now the Radio Detective
- Sending Time by Wireless
- Wireless Receiving Set Without Aerial or Ground by *H. Gernsback*
- A Switch-Board for Wireless Stations by *H. C. Graham*
- A Unique Receiving Transformer by *J. Fink*

RADIO-CRAFT for MARCH, 1948

## A STABLE OSCILLATOR

By Alfred Haas

NEEDING an oscillator capable of output on audio and radio frequencies, and which would use untapped coils, I developed the circuit shown in the diagram. It covers the range from 50 cycles to 10 mc with low distortion and harmonic output.

The oscillator uses a 6N7 dual triode, and works as follows:

Assume a positive pulse transmitted from P2 to G1. With the triode V1 in a cathode-follower arrangement, the signal appears with the same phase on the cathode. With G2 grounded, the pulse is reproduced on the plate of V2 in phase with the original signal pulse and oscillation will be sustained.

The amplitude of this signal is large, exceeding the straight portion of the characteristic curve and resulting in distortion and harmonic output. To improve the wave form, a variable inverse feedback arrangement was introduced. Moving the slider of the potentiometer toward G1 introduces some of the signal voltage on the cathode into the triode V2, resulting in a decrease in output signal. Oscillation amplitude is also decreased; it can even be reduced to zero. The 6E5 tube is used as an oscillation indicator, and permits oscillation to be set near the starting point where the wave form is nearly pure.

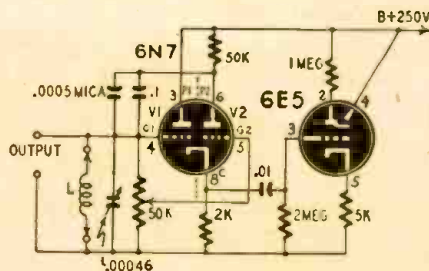

The variable condenser is used for tuning and may be built into the oscillator. It will have little effect at audio frequencies. Coils of various types may be used to give several frequency ranges, provided that they have a reasonable Q; and suitable condensers may be shunted across the coils to tune them at low frequencies. The upper frequency limit is approximately 10 mc, and is due to the fact that the voltage gain of the amplifier section V2 falls below unity at this point.

The stability of the oscillator is good if the inverse feedback is not decreased too much; and the signal amplitude is constant due to the a.v.c. action of G2.

A billion dollars may be the value of 1948 radio and television set production, Stanley Glaser of Crosley predicted last month. The estimate, read as part of an annual statement, was based on 1947 figures, and looks forward to production of 600,000 television receivers in 1948.

FM receivers are expected to reach 2,000,000 as compared with a 1947 production of 1,000,000, according to the estimate. It is probable that 75% of these will be table models.

# RADIO TUBES

For immediate shipment

R.M.A. Guaranteed  
Below Distributor Costs  
Individually Sealed Cartons

Type	Price
6K6GT	.40
6K5GT	.46
6V6GT	.46
6SA7GT	.46
6SJ7GT	.46
6SK7GT	.46
6SQ7GT	.46
6X5GT	.40
12SA7GT	.46
12SQ7GT	.46
12SK7GT	.46
12SJ7GT	.46
35L6GT	.40
35Z5GT	.32
50L6GT	.46

RATED ACCOUNTS—2% 10 DAYS

ALL OTHERS 2% C.O.D.

10% DISCOUNT ON LOTS OF 50 OR MORE

## RAVAC ELECTRONICS CORP.

432-4th Avenue  
New York 16, N. Y.

## SIGNAL - TRACER - GENERATOR

- \*PENCIL PROBE
- \*HIGH GAIN TRACER
- \*BUILT-IN DETECTOR
- \*SIG. INJECTOR GEN.
- \*AC-DC OPERATION

ONLY \$1650

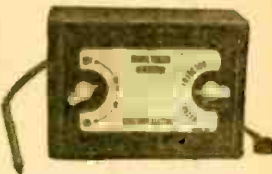

Ready to operate—Signal Tracer with loudspeaker operation—Signal Generator—Multivibrator—Puts out strong A.F., I.F., R.F. signal 1000 cycles to 25 megacycles.

## PHONO-OSC... AMPLIFIERS



PHONO - OSC - AMPLI - FIERB 3525, 12SQ7, 50L6  
Hi-Gain, Hi-Fi, AC DC Amp. Complete ..... \$4.69

Wireless Phono-Osc. Mike or Phono inp. Complete with tubes ..... \$4.49  
Wired ..... \$4.49

## YORK DISTRIBUTORS

523 Knickerbocker Ave., Bklyn. 21, N. Y.

## ANOTHER New BROWNING DEVICE

FM -AM TUNER Model RJ -12  
Superb FM reception; quality AM reception. Single antenna for both bands. Separate RF and IF systems on both bands. Armstrong FM circuit.

Frequency meters, WWV standard frequency calibrator Oscilloscope. Power supply and square wave modulator Capacitance Relay, FM-AM Tuners, FM Tuner.

KNOW THE ENTIRE BROWNING LINE • ENGINEERED FOR ENGINEERS

Write Dept. J for Catalog



BROWNING LABORATORIES, INC.  
WINCHESTER, MASS.

★ = ★ = ★ = ★ = ★ = ★ = ★ = ★

**SERVICE WITH A STAR**

New **LOW** price . . .  
same **HIGH** quality

**THE**  
**STAR**  
**TESTER**  
VOLT—OHM—  
MILLIAMMETER  
**\$24<sup>25</sup>**



An all-around tester with high quality features at an amazingly low price. Built for versatility and handiness. Gives you easy, accurate reading, with a 4 1/2", 400 microampere meter. Case is metal, crackle finished. Comes complete with batteries, test leads, and instructions for use.

**DESIGN DATA**

- 5—DC VOLTAGE RANGES—0 to 1000 volts
- 5—AC VOLTAGE RANGES—0 to 1000 volts
- 5—OUTPUT METER RANGES—0 to 1000 volts
- 4—DC CURRENT RANGES—0 to 1000 ma.
- 3—RESISTANCE RANGES—0 to 5 megohms
- DECIBEL RANGES — -10 to +54

You are using the best when you "Service with a STAR." Contact your dealer today or write us direct.

Literature available on all STAR products. Write for your copies today!

★

**STAR MEASUREMENTS CO.**

442 East 168th St., Dept. C-3, New York 56, N. Y.

★ = ★ = ★ = ★ = ★ = ★ = ★ = ★

## INDEX TO ADVERTISERS

A.M. Radio Sales Company . . . . .	71	Pakette Radio Company, Inc. . . . .	66, 73
Abell Distributing Company . . . . .	84	Potter Radio Company . . . . .	70
Tom Allen . . . . .	58	Progressive Electronics Company . . . . .	54
Allied Radio Corporation . . . . .	53		
Almo Radio Company . . . . .	80		
American Condenser Company . . . . .	63		
American Surplus Products . . . . .	43		
Amplifier Corporation of America . . . . .	67, 71		
Apex Video Company . . . . .	59		
Arrow Sales, Inc. . . . .	85		
Audel Publishers . . . . .	69		
Bell Telephone Labs. . . . .	6		
Boland & Boyce Publishers, Inc. . . . .	Back Cover		
Bonafide Radio Company . . . . .	66		
Brooks Radio Distributing Company . . . . .	71		
Browning Laboratories . . . . .	66, 87		
Buffalo Radio Supply . . . . .	56, 57		
Burstein-Applebee Company . . . . .	85		
Capitol Radio Engineering Institute . . . . .	46		
Certified Television Laboratories . . . . .	73		
Cleveland Institute of Radio . . . . .	61		
Clippard Instrument Laboratory, Inc. . . . .	72		
Commercial Radio . . . . .	88		
Communications Equipment Company . . . . .	8		
Concord Radio Corporation . . . . .	14		
Coradio . . . . .	82		
Coyne Electrical and Radio School . . . . .	45, 79		
Deer & Taylor Company . . . . .	81		
DeForest's Training Institute . . . . .	7		
Eichel Electronic Corporation . . . . .	73		
Espey Manufacturing Co., Inc. . . . .	70		
Esse Radio Company . . . . .	12, 13		
General Cement Manufacturing Company . . . . .	59		
General Electronic Distributing Company . . . . .	41		
General Test Equipment Company . . . . .	66		
Greylock Electronic Supply Company . . . . .	81		
Hallicrafters Company . . . . .	Inside Front Cover		
Charles Hoodwin Company . . . . .	60		
Hudson Specialties . . . . .	76		
Instructograph Company . . . . .	77		
Lafayette Radio . . . . .	42		
Lake Radio Sales Company . . . . .	82		
Leeds Radio Company . . . . .	63		
Leonard Radio, Inc. . . . .	54		
Leotone Radio Corporation . . . . .	78		
McGraw-Hill Book Company, Inc. . . . .	77		
McMurdo Silver Company . . . . .	15		
P. R. Mallory & Company, Inc. . . . .	Inside Back Cover		
Merit Products . . . . .	59		
Metropolitan Electronic & Instrument Co. . . . .	80		
Mid-America Company . . . . .	62		
Midwest Radio Corporation . . . . .	84		
Moss Electronic Distributing Company . . . . .	49		
Murray Hill Books, Inc. . . . .	2, 3		
National Plans Co. . . . .	75		
National Radio Institute . . . . .	1		
National Schools . . . . .	9		
Niagara Radio Supply . . . . .	70, 75, 81		
Opportunity Adlets . . . . .	76		

### RADIO SCHOOL DIRECTORY

(See Pages 86, 87)

American Radio Institute			
Baltimore Technical Institute			
Bliss Electrical School			
Candler System Company			
Commercial Radio Institute			
Delehanty Institute			
Don Martin School of Radio Arts			
Lincoln Engineering School			
Melville Radio Institute			
Milwaukee School of Engineering			
RCA Institutes			
Radio Training Association of America			
Radio Television Institute			
School of Sound Recording and Transmission			
Tri-State College			
Western Radio Communications Institute			

RJS Products . . . . .	82		
Radio Corporation of America . . . . .	16		
Radio-Craft . . . . .	64, 67		
Radio Dealers Supply Company . . . . .	83		
Radionic Equipment Company . . . . .	79		
Radio Publications . . . . .	88		
Radio Supply & Engineering Company . . . . .	39		
Radio Wire Television . . . . .	42		
Radolek Company . . . . .	68		
Ravac Electronics Corporation . . . . .	87		
Reed Manufacturing Company . . . . .	60		
The Rose Company . . . . .	67		
Howard W. Sams & Company, Inc. . . . .	11		
Senco Radio, Inc. . . . .	48, 50, 68		
Simpson Electric Company . . . . .	47		
Sprague Products Company . . . . .	4		
Sprayberry Academy of Radio . . . . .	5		
Star Measurements Company . . . . .	88		
Sterling Electronic Company . . . . .	85		
Supreme Publications . . . . .	55		
Technical Radio Parts Company . . . . .	72		
Telex, Inc. . . . .	60		
Tradio, Inc. . . . .	74		
Transvision . . . . .	65		
Universal General Corp. . . . .	88		
University Loudspeakers, Inc. . . . .	52		
Watterson Sales Company . . . . .	77		
Wright, Inc. . . . .	88		
X.L. Radio Laboratories . . . . .	85		
York Distributors . . . . .	87		

## REPAIRMEN!!! LOOK!!!

Standard Parts Kit—The parts you ALWAYS need . . . in one HANDY Kit.

Tube set—50L6, 35Z5, 12SA7, 12SK7, 12BQ7 . . . . .	List you pay	
	Price only	
	\$ 7.45	\$ 2.75
Tube set—50B5, 35W4, 12AT6, 12BA6, 12BE6 . . . . .	8.05	2.75
1 Condenser 20/20 @ 150 Volts . . . . .	1.50	.45
1 Condenser 20 @ 150 Volts . . . . .	.87	.25
1 Condenser 8 @ 450 Volts . . . . .	.87	.28
1 Condenser 16 @ 450 Volts . . . . .	1.28	.49
1 each .01, .02, .05, .005 @ 600 Volts . . . . .	1.25	.36
1 Vol. Control: 1/2 meg. and switch . . . . .	1.15	.47
1 5-in. Alnico #5 P.M. Speaker . . . . .	4.50	1.39
1 Kit 100 carbon resistors, 1/2 and 1 watt . . . . .	5.00	1.79
1 AC Cord with plug . . . . .	.40	.19
1 set of 2 I. F. Trans. (456KC) and "matching" osc. coil . . . . .	3.50	1.19
1 — 50L6 Output Transformer . . . . .	1.50	.39
3 Octal Sockets . . . . .	.45	.10
	<b>\$37.77</b>	<b>\$12.65</b>

Yes, \$37.77 worth of most popular parts ONLY \$12.65 "per kit" (above parts and other items may be purchased separately).

All parts new—popular brands—Guaranteed  
Write for Free Catalog  
Send 20% deposit—Bal. C.O.D.

**COMMERCIAL RADIO**  
36 BRATTLE STREET  
BOSTON 8, MASS.

## GIANT PENNY SALE

### PAY 1¢ MORE — GET 2

Over \$150,000 worth of merchandise set aside for this special sale. Stock up now for the entire year. Save yourself \$\$\$\$.

**ALL ITEMS GUARANTEED**

For example, a High Voltage Western Electric Transformer, input 115V, 60c-output 1200 V @ 12ma, 2 1/2" x 3 3/4" x 5 1/2" and weighing 5 lbs., sells for \$2.25. YOU GET 2 for \$2.26.

Filter Chokes, Resistors, Ceramic Sockets, High Voltage Transformers, Relays, Selenium Rectifiers, Westinghouse Meters, Connectors, Rheostats, Condensers, Tubes and hundreds of other parts.

**WRITE FOR SPECIAL 1c SALE CATALOGUE—for the BUYS OF A LIFETIME!**

Sale Runs through March 30.

## Universal/general corp.

365 Canal St., Dept. C-R, New York 13, N. Y.

## Get Started in Radio

### 10 "HOW-TO-DO-IT" BOOKS



Get a solid foundation in radio by means of these 10c timely text books. Each clearly written, profusely illustrated, contains over 15,000 words. You'll be amazed at the wealth of information packed into these handy books. Excellent for reference—ideal for technical library. Your money back if not satisfied.

**5 BOOKS for 50c**  
**10 BOOKS for \$1.00**

**Sent to You Postpaid**

No. 1—How To Make Four Doerle Short Wave Sets	No. 6—How To Have Fun With Radio
No. 2—How To Make The Most Popular All-Wave 1 and 2 Tube Receivers	No. 7—How To Read Radio Diagrams
No. 3—Alternating Current for Beginners Aerials	No. 8—Radio for Beginners
No. 4—All About Radio Dials	No. 9—Simple Electrical Experiments
No. 5—Beginners' Radio Dials	No. 10—Television

Remit by check or money order—regulator letter if you send cash or stamps.

**RADIO PUBLICATIONS**  
25A West B'way, New York (7)

## VERIFIED SPEAKERS

"They Glorify the Tone"

**WRIGHT Inc.**

2234 University Avenue      St. Paul 4, Minnesota

RADIO-CRAFT needs more photos of service shops and service benches. We will pay \$6.00 for each 6x8- or 8x10-inch glossy photo accepted. Do not "dress up" your bench, but take a bona-fide photo, preferably with men working.

# Uniform Resistance

Mallory carbon controls are accurate in overall resistance value



You will find no variation in the resistance values of Mallory carbon controls. Frequent, critical inspections reject the imperfect, and pass only those carbon elements of the resistance values specified on the labels.

resistance, accurate tapers, silent operation and long life. Mallory gives you all four, and more, too. The Mallory trade mark is your assurance that the volume control, vibrator or capacitor you buy is the finest that can be made.

Recently dozens of controls from leading manufacturers were tested competitively for overall resistance value. Mallory controls averaged within 2% of specified resistance, the closest tolerance of any group in the test.

In volume controls you look for uniform



Every carbon element that goes into Mallory controls is individually inspected to be sure that its resistance value is the same as specified on the labels.

## The Mallory 1485 Control Deal

This attractive metal cabinet contains the 15 Controls and 9 Switches that will take care of 90% of your service calls. Its arrangement makes inventory control almost automatic—saves you frequent trips to the distributor's counter. It contains a rack for your Radio Service Encyclopedia. You pay only for the Volume Controls and Switches; the cabinet is included in the deal at no extra cost to you. Check your Mallory distributor on this special offer.

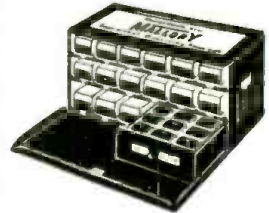

Visit us at  
Booths 84, 85, 86  
I. R. E. Show  
Grand Central  
Palace  
New York  
March 22-25

P. R. MALLORY & CO., Inc.  
**MALLORY**

CAPACITORS . . . CONTROLS . . . VIBRATORS . . .  
SWITCHES . . . RESISTORS . . . RECTIFIERS . . .  
VIBRAPACK\* POWER SUPPLIES . . . FILTERS

\*Reg. U. S. Pat. Off.

**APPROVED PRECISION PRODUCTS**

P. R. MALLORY & CO., Inc., INDIANAPOLIS 6, INDIANA

# NOW!

## AT YOUR JOBBER'S THE RADIO DATA BOOK— OVER 1000 PAGES!

All data and basic knowledge  
in radio and electronics  
digested into 12 sections...  
in a complete, quick to find,  
easy to read, handbook form.

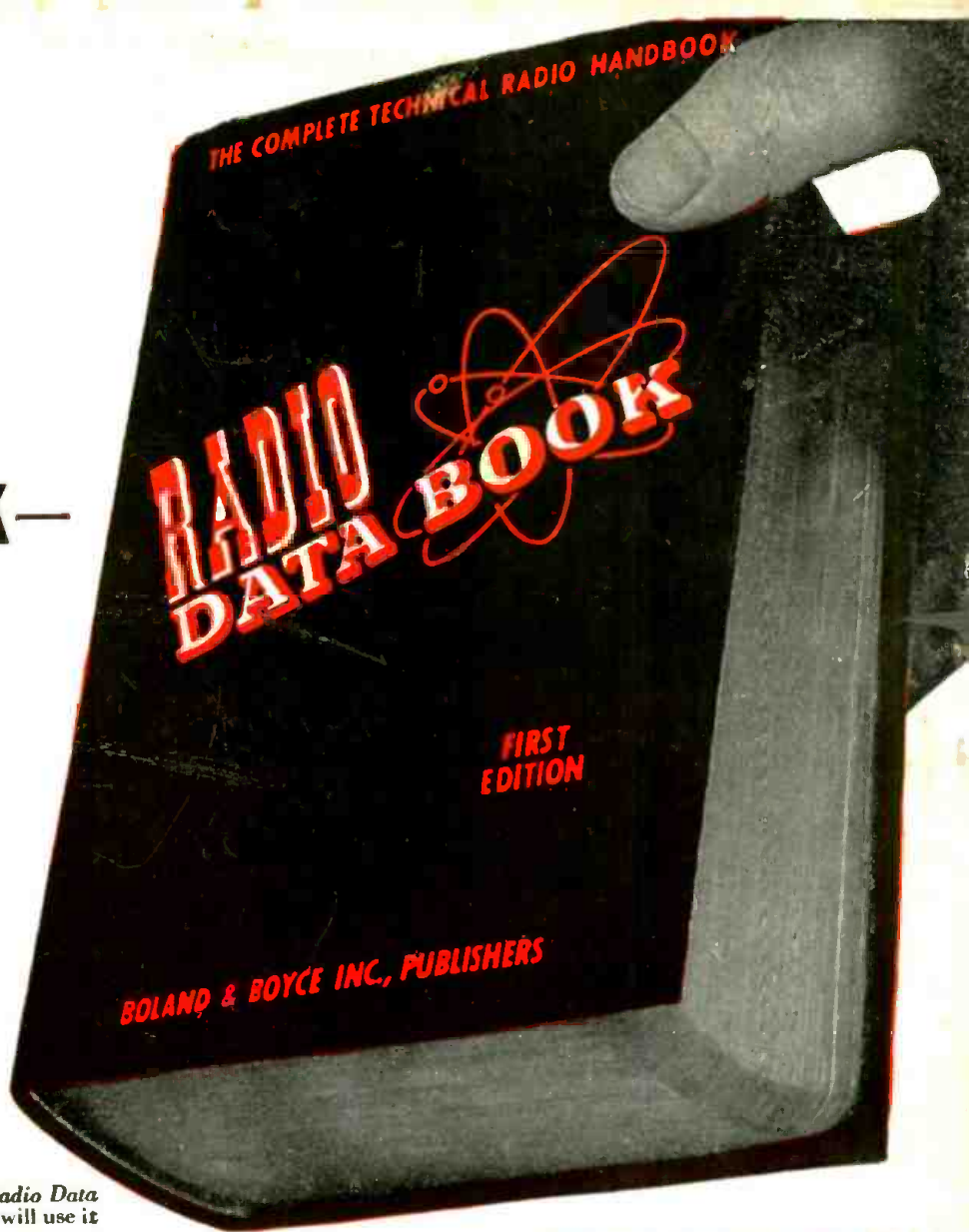

Plan every operation in radio and electronics with the *Radio Data Book*. This new radio bible will be your lifelong tool... you will use it every day, on the board, at the bench, in the field! Use it for construction, troubleshooting and testing. The RADIO DATA BOOK will be your invaluable aid in design, experiment and in layout. It will help make your production better, faster and easier. In any and every operation in radio and electronics, you will use the RADIO DATA BOOK!

The RADIO DATA BOOK is a work of complete authority, prepared by engineers with many years of practical experience. They have been assisted by the Boland & Boyce staff of editors skilled in preparing electronics manuals for the U. S. Signal Corps for many years. These men have worked for several years gathering material for this book... all the knowledge of radio principles and operation... all the statistics... all the newest developments in electronics... every possible angle and detail. Eighteen months were spent digesting this material into the most concise, the clearest, and the most readable form. The result is this invaluable manual... The RADIO DATA BOOK. Whether you use this book for general reference, for scientific instruction, or for education, one thing is certain—the practical help, the daily usefulness you will derive from it will prove to be worth many, many times its astonishingly low price!

Advanced Sale... first printing, Only 10,000 available... To make sure to get your RADIO DATA BOOK, mail your order **NOW!**

Handsomely bound in RED and GOLD

12 complete books in one only \$5.00! Less than 42c per book

### Contents

Each section is a COMPLETE coverage of its subject... 12 sections... 12 books in ONE! 1000 pages... Schematics... Accurate photographs... Specially prepared drawings... White on black charts... Diagrams... Isometric projections and exploded views.

- Section 1. THE 150 BASIC CIRCUITS IN RADIO.**  
Every circuit is analyzed and explained in a Johnny-on-the-spot reference for any occasion.
- Section 2. COMPLETE TEST EQUIPMENT DATA.**  
Know more about the test instruments you now have... Find the new ones you want to buy... They're All in here—impartially described!
- Section 3. TESTING, MEASURING AND ALIGNMENT.**  
Simplified operation of the Oscilloscope... See what's happening inside any radio circuit... Dynamic alignment—AM, FM and TELEVISION made easy with the Oscilloscope... Scientific use of the Vacuum Tube Voltmeter, Signal Generating Equipment and other basic instruments.
- Section 4. ALL ABOUT ANTENNAS.**  
AM-FM-Television... design, installation, characteristics, construction and feed.
- Section 5. SOUND SYSTEMS.**  
Planning, installing and servicing a PA System. A complete chapter on every component... How to select and combine components... estimating costs... even acoustic requirements!
- Section 6. ELECTRICAL AND PHYSICAL CHARACTERISTICS OF RADIO COMPONENTS.**  
Know the size, the power, the shape! A quick reference on the construction and design of any circuit or equipment.
- Section 7. COMPLETE TUBE MANUAL: Receiving, Transmitting and Commercial.**  
A flick of the pages brings you to all the data and ratings of any tube model.
- Section 8. CHARTS, GRAPHS AND CURVES.**  
Quick calculation devices... Plotting curves, nomographs, rules and tables for speedy solutions to radio problems.
- Section 9. CODES, SYMBOLS AND STANDARDS.**  
Handy reference to all radio symbols and abbreviations; code symbols, phrases and characters... Where you want them... When you want them!
- Section 10. 50 TESTED CIRCUITS DESIGNED FOR OPTIMUM PERFORMANCE.**  
Find any circuit you want with complete parts lists and specifications... One tube receivers to complete AM, FM and Television receiver circuits... Amplifiers... Transmitters... Test Equipment and Control Circuits... All with the latest engineering refinements.
- Section 11. DICTIONARY OF RADIO AND ELECTRONIC TERMS.**
- Section 12. RADIO BOOK BIBLIOGRAPHY.**

### MAIL THIS COUPON TODAY!

TO YOUR PARTS JOBBER OR DIRECTLY TO  
**BOLAND & BOYCE INC., PUBLISHERS**  
460 BLOOMFIELD AVE., MONTCLAIR, N. J.

Please send me a copy of **RC-3**

**THE RADIO DATA BOOK** Enclosed is \$5.00.

NAME .....

ADDRESS .....

CITY ..... ZONE .....

STATE .....

## BOLAND & BOYCE INC., PUBLISHERS