

RADIO CRAFT

In this issue—

Advertising for Servicemen

Signal Tracer-Oscillator

A Four-Tube FM Receiver



RADAR TRAPS
AUTO SPEEDERS
SEE PAGE 22

NOV
1947

30¢
CANADA 35¢

RADIO-ELECTRONICS IN ALL ITS PHASES

"THE hottest ham performance ever at this price . . ." That's the verdict of amateurs who have had a chance to try Hallicrafters new Model SX-43.

This new member of the Hallicrafters line offers continuous coverage from 540 kilocycles to 55 megacycles and has an additional band from 88 to 108 megacycles. AM reception is provided on all bands, except band 6, CW on the four lower bands and FM on frequencies above 44 megacycles. In the band of 44 to 55 Mc., wide band FM or narrow band AM just right for narrow band FM reception is provided.

One stage of high gain tuned RF and a type 7F8 dual triode converter assure an exceptionally good signal-to-noise ratio. Image ratio on the AM channel on band 5 (44 to 55 Mc.) is excellent as the receiver is used as a double superheterodyne. The new Hallicrafters dual IF transformers provide a 455 kilocycle IF channel for operating frequencies below 44 megacycles and a 10.7 megacycle IF channel for the VHF bands. Two IF stages are used on the four lower bands and a third stage is added above 44 megacycles. Switching of IF frequencies is automatic. The separate electrical bandsread dial is calibrated for the amateur 3.5, 7, 14, and 28 megacycle bands.

Every important feature for excellent communications receiver performance is included.

Model SX-43



FEATURES FOUND IN NO OTHER RECEIVER AT THIS PRICE

- ALL ESSENTIAL AMATEUR FREQUENCIES FROM 540 kc to 108 MC
- AM - FM - CW RECEPTION
- IN BAND OF 44 TO 55 MC: WIDE BAND FM OR NARROW BAND AM . . . JUST RIGHT FOR NARROW BAND FM RECEPTION
- CRYSTAL FILTER AND EXPANDING IF CHANNEL PROVIDE 4 VARIATIONS OF SELECTIVITY ON LOWER BANDS
- SERIES TYPE NOISE LIMITER
- TEMPERATURE COMPENSATION FOR FREEDOM FROM DRIFT
- PERMEABILITY ADJUSTED "MICROSET" INDUCTANCES IN THE RF CIRCUITS
- SEPARATE RF AND AF GAIN CONTROLS
- EXCEPTIONALLY GOOD SIGNAL-TO-NOISE RATIO
- SEPARATE ELECTRICAL BANDSPREAD CALIBRATED FOR THE AMATEUR 3.5, 7, 14 AND 28 Mc BANDS

BUILDERS OF *Skybone* AVIATION RADIOTELEPHONE



hallicrafters RADIO

THE HALLICRAFTERS CO., MANUFACTURERS OF RADIO AND ELECTRONIC EQUIPMENT, CHICAGO 16, U. S. A.

Sole Hallicrafters Representatives in Canada: Rogers Majestic Limited, Toronto-Montreal

**I WILL SEND YOU
BOTH FREE**

NEW 64 PAGE BOOK

64-page illustrated book describes many fascinating jobs Radio, Television, Electronics offer, shows big kits of Radio parts I send you, tells how I give you practical experience building real Radio circuits at home in spare time, how you make extra money fixing Radios while still learning; contains letters from many men I trained, telling what they are doing, earning. FREE. Mail Coupon below!

SAMPLE RADIO LESSON

I will also send you my Lesson, "Getting Acquainted With Receiver Servicing," FREE, to show you how practical it is to learn Radio at home in spare time. It's a valuable Lesson. Study it—keep it—use it—without obligation! Tells how "Superhet" Circuits work, gives hints on Receiver Servicing, Locating Defects, Repair of Loudspeaker, I.F. Transformer, etc. 31 illustrations. Mail Coupon below!



SEE FOR YOURSELF HOW I TRAIN YOU AT HOME TO BE A RADIO TECHNICIAN

Do you want a good-pay job in Radio—or your own money-making Radio Shop? Mail Coupon for a FREE Sample Lesson and my FREE 64-page book, "How to Be a Success in RADIO—Television, Electronics." See how N.R.I. gives you practical Radio experience at home—building, testing, repairing Radios with BIG KITS OF PARTS I send!

Many Beginners Soon Make Good Extra Money in Spare Time While Learning

The day you enroll I start sending EXTRA MONEY manuals. You LEARN Radio principles from my easy-to-grasp, illustrated lessons—PRACTICE what you learn with parts I send—USE your knowledge to make EXTRA money fixing neighbors' Radios in spare time while still learning! From here it's a short step to your own full-time Radio Shop or a good Radio job!

Future for Trained Men is Bright in Radio, Television, Electronics

It's probably easier to get started in Radio now than ever before because the Radio Repair business is booming. Trained Radio Technicians also find profitable opportunities in Police, Aviation, Marine Radio, Broadcasting, Radio Manufacturing, Public Address work. Think of even greater opportunities as Television and Electronics become available to the public. Send for free books now!

Find Out What N.R.I. Can Do for You

Mail Coupon for Sample Lesson and my 64-page book. Read the details about my Course. Read letters from men I trained, telling what they are doing, earning. See how quickly, easily you can get started. No obligation! Just MAIL COUPON NOW in an envelope or paste it on a penny postal. J. E. SMITH, President, Dept. 7MX, National Radio Institute, Pioneer Home Study Radio School, Washington 9, D. C. Our 33rd Year of Training Men for Success in Radio

I TRAINED THESE MEN

Averages Better Than \$3,000 A Year
"I now have a shop and am doing fine. I average better than \$3,000 per year, and certainly give NRI much of the credit."—RAYMOND F. DAVIS, Ashburn, Georgia.



Made \$612 in 12 Mos. Spare Time
"Soon after I finished my experimental kits lessons I tackled my first Radio service job. I made \$612 in past 12 months in spare time."—J. W. CLARK, Wilmington, N. C.

VETERANS

You can get this training right in your own home under G. I. Bill. Mail coupon.

Build Radio Circuits Like These With Kits I Send



Good for Both FREE

MR. J. E. SMITH, President, Dept. 7MX
National Radio Institute, Washington 9, D. C.
Mail me FREE, without obligation, Sample Lesson and 64-page book about how to win success in Radio—and Television, Electronics. (No salesman will call. Please write plainly.)

Name
Address
City State
(Please include Post Office zone number)

Approved for Training under GI Bill

Opportunity now FOR YOU!

NATIONAL SCHOOLS SHOP METHOD

HOME TRAINING in **RADIO**

TELEVISION and ELECTRONICS

A PRACTICAL RESIDENT TRADE SCHOOL

With Its Own Shops and Laboratories

FOR OVER 40 YEARS

TODAY, OPPORTUNITIES IN THE RADIO, ELECTRONICS AND TELEVISION INDUSTRY ARE TAKEN FOR GRANTED

We see them everywhere: The Home Radio Service Field continues to grow. Television is here . . . Television Broadcasting facilities are being rapidly expanded. Television sales, service, installation and maintenance requirements are more and more important from day to day. Electronics is an important factor in many applications for utility, safety, accuracy and convenience. Airlines are finding new uses for Radio bringing new benefits to air transportation. Ships at sea are employing Radar together with other conventional Radio apparatus for ship-to-shore communications and safety. Frequency Modulation is modernizing Radio Broadcasting, offering static-and-interference-free reception in the home. The list of Radio applications is almost endless, and every one represents increasing opportunities in our modern world for the **RADIO, TELEVISION AND ELECTRONICS TECHNICIAN WITH A SOLID TECHNICAL BACKGROUND.**

NOT JUST ANY TRAINING WILL DO

It is not a question of opportunity but rather how to take advantage of existing opportunity. Only proper training can make these opportunities a reality. National Schools of Los Angeles, one of the oldest and largest technical trade schools in the United States, offers you Shop Method Home Training, a proved method that builds qualified technicians. Here is Home Training that **BRINGS RESULTS.**

Behind all training from National Schools stands a permanent faculty of experienced instructors and engineers. These men are daily teaching resident students right in our own Shops and Laboratories. From first hand experience with students here at school, our instructors understand the needs and ambitions of men like you. All of our instructors, both Home Study and Resident, have ideal facilities to make your training practical, up-to-the-minute, interesting. It takes years of experience to know how to train men, especially in the practical technical trades. Established almost 50 years ago, National Schools has a rich background of experience to help you to take full advantage of the opportunities in the Radio, Television and Electronics Industry.

HERE'S JUST A FEW OF THE INTERESTING FACTS YOU LEARN WITH THE FREE MANUAL

1. Routine for Diagnosing Radio Troubles.
2. Preliminary Inspection of Receivers.
3. How to Check Power Supply.
4. How to Identify Various Stages of Receivers.
5. How to Trace the Circuit and Prepare Skeleton Diagram.
6. How to Test and Measure Voltages.
7. How to Test Speaker in Audio Stages.
8. How to Test Detector, I.F., R.F., and Mixer Stages.
9. Complete Reference Table for Quickly Locating Receiver Troubles.

VETERANS

During the war, National trained enlisted men under contract with the War Department. Both the Armed Forces Institute and Marine Corps Institute used our lesson texts on a wide scale. Now, we are training veterans, both resident and home study, through the Veterans Administration. If you are a veteran of World War II—and qualified for training under the G.I. Bill of Rights, check the coupon below for special information.



RADIO SHOP AT NATIONAL

BROADCAST STUDIO AT NATIONAL

Partial View of the Facilities that Stand Behind Your National Schools Home Training

TELEVISION STUDIO AT NATIONAL



We Bring **NATIONAL SCHOOLS** to You



Begin Training at Home
Later Come to Our Shops and Laboratories in Los Angeles
—If You Prefer

National's Master Shop Method Home Training in Radio, Electronics and Television is **COMPLETE** in itself. No other training is necessary; but, some men do prefer to take a short experience course here in our resident shops and laboratories, at the end of their Home Study training. They find it helpful to spend a short period of time in our modern Broadcasting Station, or our New Television Laboratories and Studios, or our Extensive Radio Servicing Shops—as well as other departments covering every specialized phase of the Radio Industry.

You are welcome to take advantage of this additional instruction if you wish. If you are interested, check the coupon below. Full details will be sent you by return mail. National Schools' **OUTSTANDING FACILITIES MAKE IT POSSIBLE TO OFFER THE FINEST POSSIBLE TECHNICAL TRADE TRAINING IN RADIO, TELEVISION AND ELECTRONICS.**

You Get All This Radio Experimental Equipment to Use and Keep at Home!

LEARN BY DOING is the basic principle of National's Shop Method Home Training. We send you standard Radio parts for an interesting series of experiments which demonstrate the fundamentals of Radio, Television and Electronics. The very essence of this training is **EXPERIENCE**—you get actual experience by building many different types of circuits. You build a fine, long distance **MODERN SUPER-HETERODYNE RECEIVER**, signal generator, low-power Radio transmitter, audio oscillator, etc. This practical work develops your knowledge of Radio step by step, makes you a practical Radio Technician.

G. I. APPROVED NATIONAL SCHOOLS

LOS ANGELES 37, CALIFORNIA EST. 1905



MAIL OPPORTUNITY COUPON FOR QUICK ACTION

NATIONAL SCHOOLS, Dept. 11-RC

4000 South Figueroa Street, Los Angeles 37, California

Mail me **FREE** the two books mentioned in your ad, including a sample lesson of your course. I understand no salesman will call on me. I have checked below the plan which interests me.

NAME AGE

ADDRESS

CITY STATE

(Include your zone number)

- I am interested in home study only.
- Send information on your Combined Home-Study and Modern Resident Shop Training.
- Veteran of World War II.

THE COMPLETE TECHNICAL RADIO HANDBOOK

RADIO DATA BOOK

FIRST EDITION

BOLAND & BOYCE INC., PUBLISHERS

NEW!

in 1,000 pages:

All data and basic knowledge in radio and electronics digested into 12 sections... in a complete, quick to find, easy to read, handbook form.

Plan every operation in radio and electronics with the *Radio Data Book*. This new radio bible will be your lifelong tool... you will use it every day, on the board, at the bench, in the field! Use it for construction, troubleshooting and testing. The RADIO DATA BOOK will be your invaluable aid in design, experiment and in layout. It will help make your production better, faster and easier. In any and every operation in radio and electronics, you will use the RADIO DATA BOOK!

Handsomely bound in RED and GOLD

The RADIO DATA BOOK is a work of complete authority, prepared by engineers with many years of practical experience. They have been assisted by the Boland & Boyce staff of editors skilled in preparing electronics manuals for the U. S. Signal Corps for many years. These men have worked for several years gathering material for this book... all the knowledge of radio principles and operation... all the statistics... all the newest developments in electronics... every possible angle and detail. Eighteen months were spent digesting this material into the most concise, the clearest, and the most readable form. The result is this invaluable manual... The RADIO DATA BOOK. Whether you use this book for general reference, for scientific instruction, or for education, one thing is certain—the practical help, the daily usefulness you will derive from it will prove to be worth many, many times its astonishingly low price!

Advanced Sale... first printing, Only 10,000 available... To make sure to get your RADIO DATA BOOK, mail your order **NOW!**

12 complete books in one only **\$5.00!** Less than 42c per book

CONTENTS

Each section is a COMPLETE coverage of its subject... 12 sections... 12 books in ONE! 1000 pages... Schematics... Accurate photographs... Specially prepared drawings... White on black charts... Diagrams... Isometric projections and exploded views.

- Section 1. **THE 150 BASIC CIRCUITS IN RADIO.**
Every circuit is analysed and explained in a Johnny-on-the-spot reference for any occasion.
- Section 2. **COMPLETE TEST EQUIPMENT DATA.**
Know more about the test instruments you now have... Find the new ones you want to buy... They're All in here—impartially described!
- Section 3. **TESTING, MEASURING AND ALIGNMENT.**
Simplified operation of the Oscillograph... See what's happening inside any radio circuit... Dynamic alignment—AM, FM and TELEVISION made easy with the Oscillograph... Scientific use of the Vacuum Tube Voltmeter, Signal Generating Equipment and other basic instruments.
- Section 4. **ALL ABOUT ANTENNAS.**
AM-FM-Television... design, installation, characteristics, construction and feed.
- Section 5. **SOUND SYSTEMS.**
Planning, installing and servicing a PA System. A complete chapter on every component... How to select and combine components... estimating costs... even acoustic requirements!
- Section 6. **ELECTRICAL AND PHYSICAL CHARACTERISTICS OF RADIO COMPONENTS.**
Know the size, the power, the shape! A quick reference on the construction and design of any circuit or equipment.
- Section 7. **COMPLETE TUBE MANUAL: Receiving, transmitting and Commercial.**
A flick of the pages brings you to all the data and ratings of any tube model
- Section 8. **CHARTS, GRAPHS AND CURVES.**
Quick calculation devices... Plotting curves, nomographs, rules and tables for speedy solutions to radio problems.
- Section 9. **CODES, SYMBOLS AND STANDARDS.**
Handy reference to all radio symbols and abbreviations; code symbols, phrases and characters... Where you want them... When you want them!
- Section 10. **50 TESTED CIRCUITS DESIGNED FOR OPTIMUM PERFORMANCE.**
Find any circuit you want with complete parts lists and specifications... One tube receivers to complete AM, FM and Television receiver circuits... Amplifiers... Transmitters... Test Equipment and Control Circuits... All with the latest engineering refinements.
- Section 11. **DICTIONARY OF RADIO AND ELECTRONIC TERMS.**
- Section 12. **RADIO BOOK BIBLIOGRAPHY.**

MAIL THIS COUPON TODAY!

BOLAND & BOYCE INC., PUBLISHERS
460 BLOOMFIELD AVE. MONTCLAIR 3, N. J.

Please send me a copy of

THE RADIO DATA BOOK Enclosed is \$5.00.

NAME.....

ADDRESS.....

CITY..... ZONE.....

STATE.....

BOLAND & BOYCE INC., PUBLISHERS

NEVER!..NO, NEVER!

NOT IN ALL THE HISTORY OF RADIO, AN OFFER LIKE THIS!

Belltone
PORTABLE
Self-powered Battery Radio

KIT

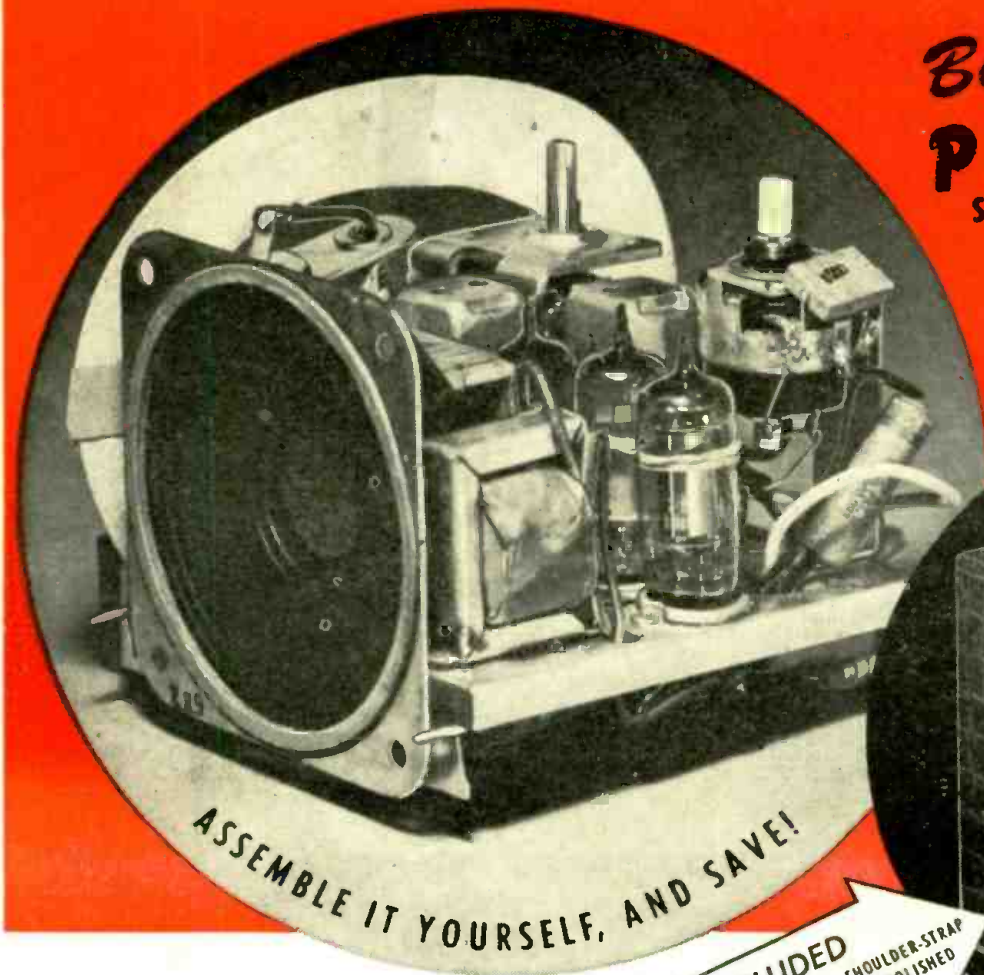

ASSEMBLE IT YOURSELF, AND SAVE!



BELLTONE GIVES YOU PLENTY OF SIMPLIFIED DIAGRAMS AND INSTRUCTIONS!

You get the Case, Knobs, Antenna, Tubes

EVERYTHING!...

(EXCEPT WIRE, SOLDER, BATTERIES)
1 Set of Batteries at only \$2.55

We urge you to bear in mind that this is NOT, definitely NOT, an ordinary portable, but a tiny, wonderful, beautiful, powerful set—which you can easily build yourself—quickly. Wait till you see the attractive case, covered in simulated leather, with adjustable shoulder strap. You'll want several. Use them as gifts.

INCLUDED
THIS BEAUTIFUL, SHOULDER-STRAP
CARRYING CASE WITH POLISHED
BRASS FITTINGS.

IT'S TINY
6 1/2" HIGH BY 4 1/2" WIDE
BY 4 1/2" DEEP. THAT'S ALL!

HERE'S WHY THE SET IS SO EXTRAORDINARY AT THE PRICE!

It has a 3 1/2" ALNICO V PM speaker. Uses standard, easy-to-get, long-lasting batteries—easy to change. It plays with the lid open or closed. Has 4 tubes. Weighs 3 1/2" lbs. (approx.) when complete and operating, case and all!

only
\$14⁹⁵-

WE PAY THE POSTAGE ANYWHERE IN THE U.S.A.

USE THIS ORDER COUPON NOW! START BUILDING YOUR SET RIGHT AWAY!

BELLTONE RADIO & TELEVISION CORP. DEPT. C

583 Ave. of Americas

New York 11, N. Y.

Sirs: Send me _____ portable kits for which I am enclosing MONEY ORDER CHECK for \$ _____

Battery Kit @ \$2.55

SEND TO _____

ADDRESS _____

CITY _____ STATE _____

BELLTONE RADIO AND TELEVISION CORP.
583 AVE. OF AMERICAS, NEW YORK 11, N. Y.

RADIO-CRAFT for NOVEMBER, 1947



**I Put You to Work with Your Hands to LEARN RADIO!
You Build Receivers! You Make Typical Defects Occur
and Make Tests to Prove the Theory!**

**YOU GET
8 BIG KITS OF RADIO
PARTS & EQUIPMENT
including
2-BAND SUPER
RECEIVER!
and 16 RANGE METER
FOR TESTING**

F. L. SPRAYBERRY, PRES-
IDENT of the SPRAYBERRY
ACADEMY OF RADIO. This
is the man who directs
your study. His years of
experience and Radio
"know-how" assure you of
the finest in home Radio
Training!

**LEARN RADIO
to MAKE MONEY!**

LOW COST TRAINING—EASY PAYMENT PLAN!

**You Learn at Home How to
Build and Test Dozens and
Dozens of Circuits — Simple
and Complex!**

**YOU DO
OVER 175
INSTRUCTIVE
EXPERIMENTS**



**YOU BUILD
ALL THESE TESTERS
..... AND MORE!**

I give you a fine,
moving-coil type
Meter Instrument on
Jewel Bearings
— with parts for a
complete Analyzer
Circuit Continuity
Tester. You learn
how to check and
correct Receiver
defects with professional speed and
accuracy.



You'll get
valuable ex-
perience and
practice
building this
Signal Gen-
erator and
multi-
purpose
Tester.
Makes a
breeze out of fixing Radios and you
don't have to spend money on ready-
made Equipment.



Soldering, wiring, connecting Radio
parts . . . building circuits with your
own hands — you can't beat this
method of learning. When you con-
struct this Rectifier and Filter, Re-
sistor and Condenser Tester, etc., you
get a really practical slant on Radio
that leads to a money-making future.



**Set has Long and
Short Wave Tuning.
All Sprayberry Equip.
is yours for KEEPS.**

SPRAYBERRY HOME TRAINING is PLANNED to MAKE MONEY for you FAST!

I train you with regular professional Radio Equip-
ment. I tell you exactly what to do . . . how to do
it. You handle Radio Parts, see them operate,
learn what they're for. With the fine Kits I supply,
you learn how to build Radio Circuits, construct
your own Test Equipment. I'll show you how to
cause typical Radio defects so you can watch and
see how they act. You learn the latest methods for
trouble-shooting and repair. All this adds up to

the finest kind of "bench" experience. And you get
it right in your own home. In no time at all, you'll
be ready for a business of your own or a good job
in Radio, FM, Television,
Radar, Industrial Elec-
tronics, etc. Now's
the time to get
started!

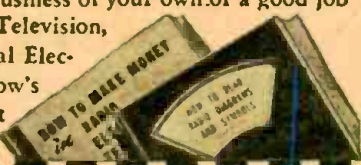

**SEND FOR MY
VALUABLE
FREE BOOKS!**

VETERANS

Get Sprayberry training without
cost under G.I. Bill. Check cou-
pon.

F. L. Sprayberry, Pres.
SPRAYBERRY ACADEMY OF RADIO,
20117 Sprayberry Bldg., Pueblo, Colo.

Please rush my FREE copies of "How to MAKE MONEY in RADIO, ELEC-
TRONICS and TELEVISION" and "How to READ RADIO DIAGRAMS and
SYMBOLS."

Name Age

Address

City State

Check here if Veteran.

(Mail in envelope or paste on penny postcard)

READ WHAT
GRADUATE SAYS:

"One Job Nets About
\$26.00" "Since last
week I fixed 7 radios, all
good-paying jobs, and right
now I am working on an
amplifier system. This job
alone will net me about
\$26.00. As long as my
work keeps coming in this
way, I have only one word
to say and that is "Thanks"
to my Sprayberry training
and I am not afraid to
boast about it." ADRIEN
BENJAMIN, North Grove-
nordale, Conn.

RADIO-CRAFT for NOVEMBER, 1947



ESSE Specials!

[Unless otherwise stated, all of this equipment is sold as used.]

BC-348 Power Supply (for 110V.)	8.95
BC-348 Communication Receiver	47.75
BC-375 GE MOPA Trans.	
Trans. & 1 tuning unit	17.50
TU-6B, TU-5B, TU-7B, TU-8B, TU-10B at	3.95
TU-9B & TU-26B at	2.45
Antenna Tuning unit BC-306A	3.95
BC-221 Freq. Meter	
Used	34.95
New	47.50
Used, with modulator	57.50
PE-103 Dynamotor (New)	8.95
BC-357 Marker Beacon	1.75
274N Command Set (ARC-5) Components	
Modulator with dynamotor	4.75
Rec. 3-6 Mc. (BC-454)	5.00
Rec. 190-550 Kc. (BC-453)	5.00
Rec. 6-9.1 Mc. (BC-455)	4.50
Trans. 3.4 Mc. (BC-456-A)	7.95
Trans. 4-5.3 Mc. (BC-457A)	5.00
Trans. 5.3-7 Mc. (BC-458A)	5.00
Trans. 7-9.1 Mc. (BC-459A)	5.00
Turbo Amplifiers (1 dozen)	10.00
Radar Trans. T-39/APQ	11.50
BL Selenium Rectifier (New) at	1.25
HRU-28 70 Amp. 28 V. Gen. Gas Driven	49.75
Collins AN/ART-13 Trans.	74.50
Navy ARB or CRV-46151 Rec.	19.75
SCR-625 Mine Detector (New)	54.95
AN/PRS-1 Mine Detector (New)	9.50
Beam Rotating Motors	
Motor only 24-28 V.	8.95
Motor with mounting plates, etc.	19.50
Power Supply transformer (110V. to 30V.)	4.95
ARN-1 Rec.	4.95
Radio Set SCR-510 (New)	49.75
ARC-4 Trans. & Rec.	22.50
T-17 Microphone (New)	1.35
T-17 Microphone (Used)	.75
Willard Lead Acid Cells	
6 V. (New) (Charged)	3.00
In metal carrying case	4.00
HS-33 headphones (New) 600 Ohm	1.60
HS-33 headphones (Used) 600 Ohm	.75
Telegraph Keys (New)	.45
Intervalometers	.95

AIRCRAFT SUPPLIES:

Magnetic Compasses at	6.00
Sensitive Altimeters at	10.00
Gyro Horizons at	7.50
Landing Lights, 24 V. Retractable (600 watt) at	2.95
CRV-46151 Aircraft Rec. with dyna. (4 bands including broadcast. "195-9.050 Kc. "6 tubes Super-heterodyne, 24 V.) at	19.75
2 cyl. 170 amp. 28.5 V. gasoline generator	139.50
Radio Compass SCR-269F (New) Complete with all components & instructions	75.00
Power Supply for SCR-269F (Inverter)	15.00
MN-26 Radio Compass, Bendix (New)	95.00
Tents: 16'x50', 12' apex	
4' sidewalls (New)	116.50
Kit of 12 assorted crystals	2.95
Kit of 10 potentiometers (New)	1.95
Kit of 25 assorted tube sockets (New)	1.35
Triplet Model 650-SC AC Voltmeter and output meter I-56-J New Test Set	7.50
Localizer Receiver BC-733D	12.45
Intervalometer (contains relays, switches, pilot light, resistors, knobs, etc.)	2.25
Interphone amplifier AN26/AIC	4.85
McElroy Code Equipment Recorder	35.00
Selsyn indicators. Operates from 15-25 V. 60 cy. AC supply.	
5" complete with Selsyn Transmitter	11.50
3" complete with Selsyn Transmitter	9.50
Selsyn transformers for Selsyn indicator	2.75
Telrad Freq. Standard (New)	19.50
Model 18-A; checks signals on range of 100 Kc. to 45 Mc. High degree of accuracy. Self-contained power supply for 110, 130, 150, 220 and 250 V. 25-60 Cy. AC.	

PANEL METERS--BARGAINS

Round Bakelite Case
Brand new in Original Boxes

1. 0-500 Ma. DC 3 1/2" Westinghouse	3.50
2. 0-300 Ma. DC 2 1/2" Westinghouse	2.50
3. 0-5 Amp. RF, 3 1/2" Westinghouse	4.50
4. 0-7.5 V. AC, 3 1/2" Westinghouse	3.50
5. 0-3 Amp. RF, 2 1/2" Westinghouse	3.50
6. 0-10 Ma. DC, 0-300 Ma. DC--Combination, 2 1/2" Westinghouse or GE	3.00
7. 0-2 V. FS Rect. Type 2000 Ohm/V. Volume Level Meter, 2 1/2" Westinghouse	3.00
Rubber Life Rafts	
Large size--5-man.	22.50

ESSE Radio Co Unless Otherwise Stated, All of This Equipment Is Sold As Used
130 W. New York St. CASH REQUIRED
Indianapolis 4, Ind. WITH ALL ORDERS
 Orders Shipped F.O.B. Collect

Now IN YOUR OWN HOME *Learn*

RADIO ELECTRONICS

The Practical
 "HOME-TESTED"
Modern "A-B-C" Way



YOU USE ALL OF THESE RADIO PARTS
 TO BUILD AND OPERATE
7
 DIFFERENT RADIO RECEIVING CIRCUITS

WITH THE HELP OF

- A** EIGHT Big Kits of Actual "Learn-by-Doing" Radio Parts and Assemblies with which you make 133 fascinating SHOP METHOD EXPERIMENTS in your own home! Imagine building 7 different Radio Receivers that operate!
- B** A 16 mm Home Movie Projector and Twelve Reels of "Learn-by-Seeing" Home Movie Films . . . for picture-clear, fast understanding of Radio Fundamentals!
- C** Modern, well-illustrated, Loose-leaf Lessons, prepared in clear, simple, understandable language . . . to guide you throughout your training!

THEN GET THE HELP OF
 OUR EFFECTIVE
 EMPLOYMENT
 SERVICE

NO PREVIOUS RADIO OR ELECTRICAL EXPERIENCE NECESSARY

DeForest's Training, Inc. provides every major home study aid to help you learn Radio-Electronics rapidly and thoroughly . . . to give you the experience and confidence needed for a responsible, Good-Pay Job, or to Start a Business of Your Own! Here is a REAL opportunity field for YOU . . . when you are a trained Radio-Electronics man! Just think of the tremendously exciting future ahead of FM Radio, Aviation and Broadcast Radio, Sound Motion Picture Equipment, Servicing and Sales of Radio Equipment, etc. Put yourself in this picture . . . See how you can benefit from a PRACTICAL training in this fascinating work! Think, too, of the coming possibilities ahead of Radar, Facsimile and Television. Send TODAY for the interesting, opportunity-revealing book, "Victory for You!" See how others probably no more talented or ambitious than you, have advanced in earning power after this training . . . how YOU can do it too! Mail the coupon NOW!

INCLUDING:

1. Simple Receiver
2. Two Tube Receiver
3. Tuned Radio-Frequency Receiver
4. Short Wave Receiver
5. Aviation Band Receiver
6. 4-Tube Superheterodyne
7. 5-Tube Superheterodyne with Magic Tuning Eye

... PLUS SCORES OF OTHER FASCINATING, INSTRUCTIVE RADIO-ELECTRONIC EXPERIMENTS

VETERANS!

Big things are happening at DeForest's Training, Inc. for veterans! See how you can prepare yourself WITHOUT COST for a GOOD JOB or a BUSINESS OF YOUR OWN in the vast Radio-Electronic opportunity field.

16 MM MOVIE PROJECTOR
 YOU USE "LEARN-BY-SEEING" MOVIES

DEFOREST'S TRAINING, INC. INCLUDES INSTRUCTION IN MOTION PICTURE SOUND EQUIPMENT, FM RADIO AND TELEVISION . . . RESIDENTIAL TRAINING IN OUR MODERN CHICAGO LABORATORIES ALSO AVAILABLE—ASK US FOR INFORMATION!

DeFOREST'S TRAINING, INC.
 CHICAGO 14, ILLINOIS



E. B. DEVRY, President
 DeFOREST'S TRAINING, INC.
 2535-41 North Ashland Ave., Dept. RC-D11
 Chicago 14, Illinois, U.S.A.

Send FREE "VICTORY FOR YOU!" BOOK, showing how I may make my start in Radio Electronics.

Name _____ Age _____
 Address _____ Apt. _____
 City _____ Zone _____ State _____

If under 16, check here for special information. If a discharged Veteran of World War II, check here.

HERE COME NEW OPPORTUNITIES . . .



JUST OUT! FM

(Published in Nov.)

By John F. Rider & Seymour D. Uslan

CHAPTER HEADS

- Fundamental Considerations
 - Frequency Modulation
 - Essentials of F-M Transmitters
 - Transmitters of Today (Wide Band and Narrow Band)
 - The Transmission of F-M Signals
 - F-M Receiving Antennas
 - The F-M Receiver
 - Alignment of F-M Receivers
 - Servicing of F-M Receivers
- Over 300 Fact-Packed Pages

TWO EDITIONS:
 (Same but for covers) **\$1.80**
 Paper Cover Stack.....
 Hard Back Cloth..... **\$2.70**

TRANSMISSION AND RECEPTION

A thorough explanation of all manufacturers' products—transmitting and receiving; regular broadcasting, railroad, police, and "ham" equipment. Wide medium and narrow band is considered.

For radio servicemen, who can look to F.M. as a big part of their future profits, for the "ham" who is considering narrow band F.M.—for the student who is grooming himself for activity in the electronic field, this new book explains both the theory and servicing of F.M. receivers. Its text provides an equally valuable hand-book for engineers.

Daily, your opportunities for greater freedom, greater personal independence increase, if you have the technical know-how to take advantage of the fast-growing manpower needs of the electronic industries. Rider Radio Books are down-to-earth—practical, written in an easy-to-understand style. Their value has been proved in servicing shops, "ham" shacks, engineering labs, public libraries, government and private schools and colleges. They are authoritative, they are practical, they are yours for personal advancement and independence. Order today!

JUST OUT! TWO NEW RIDER 99'S

(Published in Nov.)

PA INSTALLATION AND SERVICING
 Provides the answers on what to do and what not to do in making low power public address installations. All embracing in scope.

UNDERSTANDING VECTORS AND PHASE
 Considering the importance and wide use of vector presentations as a short-hand method of conveying the latest technical information in the radio field, it behooves every man in the technical branch of the industry to possess an appreciation of the significance of vectors. This book is a must for every student and serviceman if he is to keep pace with and understand advances in the radio art.

Each Over 130 Pages..... Each **ONLY 99¢**

WATCH FOR EARLY RELEASE OF ADDITIONAL RIDER 99'S

INSIDE THE VACUUM TUBE

By John F. Rider. A new approach and technique that makes its message easy to understand. A solid, elementary concept of the theory and operation of the basic types of vacuum tubes based on the electro static field theory. The book, which covers diodes, triodes, tetrodes, and pentodes, presents a clear physical picture of exactly what is happening in a vacuum tube.

A goldmine for the student; a must for servicemen, amateurs and engineers. 425 Pages—\$4.50.

SERVICING BY SIGNAL TRACING

Explains approved system of diagnosing faults in radio receivers and all kinds of communication systems. The method was introduced by the author of the book, John F. Rider. The system has won endorsement by individuals and associations the world over as well as technical branches of our government. 360 Pages—188 Illustrations—\$4.00. Spanish edition—\$4.00.

A-C CALCULATION CHARTS

By R. LORENZEN. Students and engineers will find this book invaluable. Simplifies and speeds work involving AC calculations. Contains 146 charts: Covers AC calculations from 10 cycles to 1000 megacycles. —\$7.50.

THE METER AT WORK

How each type of meter works and how each is used in the field to best advantage. Covers whichever phase of the subject the reader is interested in. 152 Pages—138 Illustrations—\$2.00.

THE CATHODE-RAY TUBE AT WORK

By JOHN F. RIDER. Presents a complete explanation of the various types of cathode-ray tubes and what role each element within the device plays in making voltages and currents visible. The only book of its kind! 338 Pages. 450 Illustrations—\$4.00.

SERVICING RECEIVERS BY RESISTANCE MEASUREMENT
 Discusses series and parallel combinations of resistances, and the distribution of currents and voltages, providing the basis underlying the circuit arrangements used in various types of radio receivers. 203 Pages—94 Illustrations—\$2.00.

ALIGNING PHILCO RECEIVERS

Complete and detailed information for aligning every Philco model from 1929 to 1941.
 VOL I—1929 to 1936—176 Pages.....\$2.00
 VOL II—1937 to 1941—200 Pages.....\$2.00

UNDERSTANDING MICROWAVES

By VICTOR J. YOUNG. Foundation for understanding microwave radio and radar. Explained simply Design and Operation of waveguides, magnetrons, klystrons, antennas, etc. Section I covers theory; Section II, terms, ideas, and theorems. 385 Pages. Liberally Illustrated. \$6.00.

THE OSCILLATOR AT WORK

Shows how various oscillator circuits function and methods to improve their performance. Also describes the r-f and a-f oscillators used as signal sources. Covers laboratory test methods, and other related tests. 256 Pages—167 Illustrations—\$2.50.

AUTOMATIC FREQUENCY CONTROL SYSTEMS

Basic operation of discriminator and Automatic Frequency control circuits is detailed in first part of book. Descriptions of systems used in commercial receivers are fully described in second part. 144 Pages—102 Illustrations—\$1.75.

VACUUM TUBE VOLTMETERS

Explains the theory upon which the functioning of the different types of v-t voltmeters is based, and also the practical applications of these instruments. Includes a bibliography consisting of 145 international references. 180 Pages—111 Illustrations—\$2.50.

AN HOUR A DAY WITH RIDER SERIES—96 PAGES.(each) \$1.25

D.C. VOLTAGE DISTRIBUTION IN RADIO RECEIVERS—The applications of Ohm's law, practically interpreted in terms of how circuits are employed in radio receivers.

ALTERNATING CURRENTS IN RADIO RECEIVERS—An exposition on fundamentals of alternating currents and voltages and where they appear in receiving systems.

RESONANCE AND ALIGNMENT—The importance of the subject in relation to all communication systems, and the clarity of this text, have sold over 60,000 of this title.

AUTOMATIC VOLUME CONTROL—An easy to understand explanation of how AVC is utilized in radio receivers.

CHECK THE BOOKS YOU NEED AND GET THEM TODAY!

RADAR 80 Pages 8½" x 11" Only **\$1.00**
 Easily Understood
 NON-TECHNICAL, BUT AUTHENTIC

The complications have been removed in this entertaining book revealing the "mysteries" of Radar. By John F. Rider, Lt. Col. Signal Corps (Ret.) and G. C. B. Rowe, both of whom worked on Radar literature for the last three years of the war. In "Radar" they explain the simple facts and interesting applications of one of the most talked-of scientific developments of our time.

JOHN F. RIDER PUBLISHER, INC.

404 FOURTH AVENUE, (Division B) NEW YORK 16, N. Y.

EXPORT AGENT: ROCKE-INTERNATIONAL CORP., 13 East 40th Street, New York 16, N. Y. Cable ARLAB

Publishers Exclusively for the Radio and Electronic Industry

Publishers of RIDER MANUALS



(Radio News Photo)

Mr. Serviceman: Don't Be a
"Pre-War Model!"

Add CREI Technical Training
 to Your Present Experience
 to do a Better Job—Make
 More Money—or to Start
 a Business of Your Own

CREI Offers Every Serviceman a Planned Program of Modern Technical Training that Enables Him to Handle Intricate, New Radio-Electronic Equipment

During, and now after the war, *thousands of new men* have entered the servicing field, creating new and tough competition for the serviceman who hasn't planned ahead. New developments in AM, FM receivers, Television, Facsimile plus the many new industrial uses for electronics create demands for more advanced technical ability. Where do you fit into this picture?

If you are wise, you must match strides with radio developments. Every man in radio today has the opportunity to see the amazing progress that is taking place, as well as to see the unlimited opportunities available to men with *modern* technical training. CREI can show you the way by convenient spare time study, at home . . . by providing the "tools" you need to build a secure foundation for your future success based on our proved method of practical training in radio-electronics and television.

There's a CREI course for you. If you are a beginner or an "old-timer" you will find just the training you need and can understand at CREI. You can "go all the way with CREI" from introductory basic principles to advanced training, on to specialized engineering subjects. CREI courses offer you more today than ever before, yet are still at pre-inflation prices.

It is up to you to decide if in the next 5 years you will be a "screwdriver" mechanic or a trained electronics engineer. It costs you nothing but a few moments time to read the facts. Send the coupon now.

VETERANS! CREI TRAINING AVAILABLE UNDER THE "G. I." BILL!

Capitol Radio Engineering Institute
An Accredited Technical Institute

DEPT. RC-11, 16TH AND PARK ROAD, N. W., WASHINGTON 10, D. C.
 Branch Offices: New York (7): 170 Broadway • San Francisco (2): 760 Market St.

**SAMPLE LESSON
 FREE**

Now, see for yourself! Mail the coupon for free sample lesson and see how simple it is to study at home and improve your ability the CREI way.

"ELECTRON PHYSICS AND ELECTRON THEORY"—This interesting lesson from the Radio-Electronics course discusses modern theories of the composition of matter, including *atomic energy*, and their relation to present-day radio and electronics.

"PICK-UP TUBES—ICONOSCOPE AND IMAGE DISSECTOR TUBES"—An informative lesson from the Television course. These are the fundamental pick-up tubes of the television camera. It precedes the study of the Orthicon and the Image Orthicon.

MAIL COUPON FOR FREE BOOKLET & SAMPLE LESSON



CAPITOL RADIO ENGINEERING INSTITUTE
 16th & Park Rd., N.W., Dpt. RC-11, Washington 10, D. C.

Mail me ONE FREE sample lesson and your 24-page booklet, "CREI Training for Your Better Job in Radio Electronics". I am attaching a brief resume of my radio experience, education and present position.

Check One PRACTICAL RADIO-ELECTRONICS
 Course: PRACTICAL TELEVISION

NAME _____

STREET _____

CITY _____ ZONE _____ STATE _____

I am entitled to training under the "G. I." Bill.

NOVEMBER • 1947

Editorial: Microtubes	by Hugo Gernsback	17
Radio-Electronics Monthly Review		18
Radio Thirty-Five Years Ago		93

Electronics

Highway Radar		22
Magnetism, Part II—Elements of Tape Recording	by A. C. Shaney	30
Acceleration Pickup Tube	by S. R. Winters	35

FM and Television

How to Construct a 17-Tube FM Receiver	by Frank Santangelo	21
FM and Television Design, Part I	by Milton S. Kiver	32

Amateur Radio

250-Watt FM-AM Transmitter, Part V	by Harry D. Hooton, W3KPX	34
--	---------------------------	----

Servicing

Advertising—for the RADIO Repairman	by Paul W. Streater	24
Radio Set and Service Review (The Sentinel Model 286 PR)		36
Wire Recorder Servicing		68
Repairs—or Wreckers?	by Gerald Evans	92

Test Instruments

Signal Tracer—Signal Generator	by Fred Whalen	23
Signal Calibrator	by I. Queen, W2OUX	31

Construction

Carrier Radiophone, Part II—Receiver and Modulator Unit	by Bob White	26
---	--------------	----

Sound

Adventure in High Fidelity	by James R. Langham	25
Portable P.A. Amplifier	by J. C. Hoadley	28
A Remote Microphone		38

Departments

Transatlantic News	by Major Ralph W. Hallows	37
World-Wide Station List	Edited by Elmer R. Fuller	40
Technotes		50
New Radio-Electronic Devices		54
The Question Box		56
Radio-Electronic Circuits		60
Try This One		62
New Radio-Electronic Patents	Conducted by I. Queen	64
Communications		94
Book Reviews		97

RADIO CRAFT

AND POPULAR ELECTRONICS

Incorporating
SHORT WAVE CRAFT TELEVISION NEWS
RADIO & TELEVISION

HUGO GERNSBACK
Editor-in-Chief

FRED SHUNAMAN, *Managing Editor*

M. HARVEY GERNSBACK,
Consulting Editor

ROBERT F. SCOTT, W2PWG,
Technical Editor

I. QUEEN, W2OUX, *Editorial Associate*

ELMER FULLER, *Shortwave Editor*

ANGIE PASCALE, *Production Manager*

G. ALIQUO, *Circulation Manager*

JOHN J. LAMSON,
Advertising Director

ALFRED STERN, *Promotion Manager*

In An Early Issue

FOUR-TUBE FM RECEIVER
SHORT WAVE PROPAGATION
SELLING HOME RECEIVERS

On the Cover:



The radar speed metering system used by Connecticut State Police to study highway speed conditions.

Chromatone by Alex Schomburg from photo by Warren Z. Illes.

Member Audit Bureau of Circulations



RADCRAFT PUBLICATIONS, INC. Hugo Gernsback, President; M. Harvey Gernsback, Vice President; G. Aliquo, Secretary

Contents Copyright, 1947, by Radcraft Publications, Inc. Text and Illustrations must not be reproduced without permission of Copyright owners.

RADCRAFT PUBLICATIONS, INC. • PUBLICATION OFFICE 29 Worthington Street, Springfield 3, Mass. • EDITORIAL AND ADVERTISING OFFICES 25 West Broadway, New York 7, N. Y. Telephone REctor 2-9670.

BRANCH ADVERTISING OFFICES: Chicago: 308 W. Washington Street, Chicago 6, Ill. Tel. Randolph 7363. Detroit: Frank Holstein, Manager, Room 402 Lexington Bldg., 2970 West Grand Blvd., Detroit, Mich. Los Angeles: Ralph W. Harker, Manager, 606 South Hill St., Los Angeles 14, Calif. Tel. Tucker 1793. San Francisco: Ralph W. Harker, Manager, 582 Market St., San Francisco 4 Calif. Tel. Garfield 2481.

RADIO-CRAFT, November, 1947, Volume XIX, No. 2. Published Monthly on 25th of month preceding date of issue. Allow one month for change of address. When ordering a change, please furnish an address stencil impression from a recent wrapper. All communications about subscriptions should be addressed to the Circulation Manager, Radio-Craft, 25 West Broadway, New York 7, N. Y.

SUBSCRIPTION RATES: United States and possessions, Mexico, Central and South American countries, \$3.50 a year; \$6.00 for two years; \$8.00 for three years. Canada, \$4.00 a year; \$7.00 for two years; \$9.50 for three years. All other foreign countries, \$4.25 a year, \$7.50 for two years; \$10.25 for three years. Entered at Post Office, Springfield, Mass., as second-class matter under the Act of March 3, 1879.

FOREIGN AGENTS: Great Britain: Atlas Publishing and Distributing Co., Ltd., 18 Bride Lane, Fleet St., London E.C.4. Australia: McGill's Agency, 179 Elizabeth Street, Melbourne. France: Brentano's, 37 Avenue de l'Opera, Paris 2e. Holland: Technisch Bureau Van Baerle, Bemelmans & Co., Heemsteedsche Dreef 124, Heemstede. Greece: International Book & News Agency, 17 Amerikis Street, Athens. So. Africa: Central News Agency, Ltd., Cor. Rissik & Commissioner Sts. Johannesburg; 112 Long Street, Capetown; 369 Smith Street, Durban, Natal. Universal Book Agency, 70 Harrison Street, Johannesburg. Middle East: Steimatzky Middle East Agency, Jaffa Road, Jerusalem. India: Susil Gupta (Distributors) Co., Amrite Bazar Patrika Lt., 14 Ananda Chatterjee Lane, Calcutta.

TELEVISION IS GROWING!



Dr. Lee de Forest

No longer is Television just a laboratory marvel. It is rapidly spreading over the nation. Practically every radio manufacturer has Television models in production. New stations are being licensed. Television is already *big business*.

Are You Ready?

Who will get those new high paying jobs? Who will step into key positions in a rapidly growing industry? Not inexperienced radio men. Not untrained electricians. But men who know Television and can be relied upon to operate and maintain expensive equipment!

American Television—A Great Training Institution!

American Television has pioneered in Television research. Its directors have made fundamental contributions to the industry. Dr. Lee de Forest, our Director of Research and Training, is known throughout the civilized world as the "Father of Radio" through his invention of the radio tube. U. A. Sanabria, President and founder of American Television, Inc. invented the Interlace Scanning System which is now the standard of all Television. Most recently, a revolutionary new circuit which corrects a common television defect known as "ghost images" has been developed by J. M. Sanabria, head of American Television's Manufacturing Division.

Most Elaborate Training Laboratories

Every modern type of equipment obtainable has been installed for instruction purposes in what we believe to be the most extensive and elaborate Television training facilities in the world. You will find complete operating studios with the new sensitive cameras and their associated equipment. A corps of highly qualified instructors will guide your study.



Start Learning TELEVISION at Home—FREE!

Prepare yourself for the endless opportunities in Television the new "American" way. Now, for the first time, you may discover in advance of entering school, just how your abilities fit into Television. If you qualify under the simple rules, you will be given a complete preliminary home study Television course absolutely free and without obligation.

Your success with the course will not only help you to decide for yourself what phase of Television you like best but will also aid us in qualifying you for residence training.

We prefer that all new resident students take this free course as it provides excellent preparation for residence study. However, there is no obligation on your part to enroll for residence training when you complete the home study course.

We urge you to take advantage of this splendid opportunity at once. Just write your name and address on a penny postcard and say: "I am interested in your free Television Course". Do it today! This offer is necessarily limited.

Approved for Veteran Training



American Television, Inc.

5050 BROADWAY

CHICAGO 40, ILLINOIS

OUTSTANDING FEATURES

- Continuous frequency coverage from 550 kc. to 55 mc. Bandswitching in 5 ranges. Bandspread tuning at any frequency.
- Seven tube superheterodyne (plus rectifier and voltage regulator).
- Automatic Noise Limiter.
- Built-in loudspeaker and A.C. power supply.
- R. F. stage with panel controlled antenna trimmer.
- Operates from 105-130 volts, 50-60 cycles A.C. (Provision for battery operation.)
- Housed in a streamlined gray cabinet.

AMATEUR NET. \$89.50



HERE IT IS - THE NEW NC-57

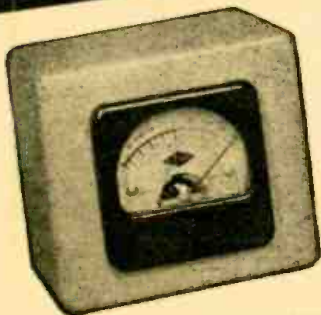

The SM-57 Signal Strength Meter has been designed as an accessory to be used in conjunction with the NC-57.

To meet the needs of the many hams who have asked for a sensitive, first-rate bandswitching receiver in the lower price bracket, complete with speaker and power supply in one cabinet, the National Company has developed the brand-new NC-57.

The CW operator will enjoy the stable operation and excellent signal-to-noise ratio of the NC-57. The phone operator will be pleased with the tone quality and selectivity.

The SWL will log DX stations with ease and clarity. In fact, any operator now operating a communications receiver will find the NC-57 essential as a standby. In this price class, the new National NC-57 is an outstanding value. See and hear one at your local distributor's ham shack this week.

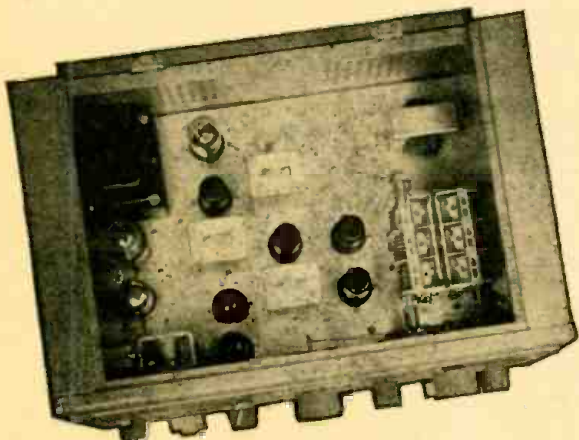

INTERIOR OF NC-57

**National
Company, Inc.**
Dept. No. 75
Malden, Mass.

MAKERS OF LIFETIME RADIO EQUIPMENT

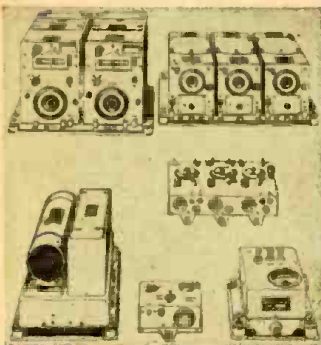

SCR-274N COMMAND SET

The greatest radio equipment value in history

A mountain of valuable equipment that includes 3 receivers covering 190 to 560 KC; 3 to 6 MC; and 6 to 9.1 MC. These receivers use plug-in coils, and consequently can be changed to any frequencies desired without conversion. Also included are two Tuning Control Boxes; 1 Antenna Coupling Box; four 28 V. Dynamotors (easily converted to 110 V. operation); two 40-Watt Transmitters including crystals, and Preamplifier and Modulator. 29 tubes supplied in all. Only a limited quantity available, so get your order in fast. Removed from unused aircraft and in guaranteed electrical condition. A super value at \$29.95, including crank type tuning knobs for receivers. Without these knobs the receivers can't be tuned, and are only useful for parts. Don't buy without knobs!

RAYTHEON VOLTAGE REGULATOR—Will maintain a constant 110V AC at the load even though the line voltage varies from 95 to 130 volts. (Exposition of the principle involved is covered thoroughly in the recent article on Magnetic Amplifiers in Sept. Electronics). The regulation is 1/2 of 1% with a 75 Watt load and is very close with heavier loads within reason. Shipping Wt. 20 lb. Your cost—\$8.95.

RT-1579 consists of a three stage (cascade 6SJ7s and 6F6 output stage) high gain, high fidelity amplifier with 60 cycle, 110V power supply on the same 13 1/2 x 14 1/2 chassis, which is protected by a substantial steel cover over tubes and parts. Made by Western Electric with typical quality components such as a husky power transformer and oil condensers, this unit is obviously intended to give years of trouble-free service with no more need for repairs than a telephone. Disconnecting one wire each, from the special input and output filters, will result in as high a fidelity amplifier as can be obtained. Your cost with tubes, diagram and parts list included—\$14.95.

We also offer the RT-1579 with a Raytheon Magnetic Voltage Regulator already installed beneath the cover. Imagine an amplifier complete with tubes, built to Western Electric quality standards, and immune to line voltage variations besides, making it perfectly suited for the most difficult industrial, circus, carnival, or commercial installations, offered for the total price of only \$19.95, our price for both units.

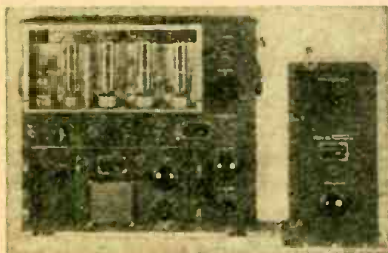

GENERAL ELECTRIC 150 WATT TRANSMITTER

Cost the Government \$1800.00
Cost to you \$44.50!!!!

This is the famous transmitter used in U.S. Army bombers and ground stations, during the war. Its design and construction have been proved in service, under all kinds of

conditions, all over the world. The entire frequency range is covered by means of plug-in tuning units which are included. Each tuning unit has its own oscillator and power amplifier coils and condensers, and antenna tuning circuits—all designed to operate at top efficiency within its particular frequency range. Transmitter and accessories are finished in black crackle, and the milliammeter, voltmeter, and RF ammeter are mounted on the front panel. Here are the specifications: **FREQUENCY RANGE:** 200 to 500 KC and 1500 to 12,500 KC. (Will operate on 10 and 20 meter band with slight modification). **OSCILLATOR:** Self-excited, thermo compensated, and hand calibrated. **POWER AMPLIFIER:** Neutralized class "C" stage, using 211 tube, and equipped with antenna coupling circuit which matches practically any length antenna. **MODULATOR:** Class "B"—uses two 211 tubes. **POWER SUPPLY:** Supplied complete with dynamotor which furnishes 1000V at 350 MA. Complete instructions are furnished to operate set from 110V AC. **SIZE:** 21 1/2 x 23 x 9 1/4 inches. Total shipping weight 200 lbs., complete with all tubes, dynamotor power supply, five tuning units, antenna tuning unit and the essential plugs. These units have been removed from unused aircraft but are guaranteed to be in perfect condition.

BENDIX SCR 522—Very High Frequency Voice Transmitter-Receiver—100 to 156 MC. This job was good enough for the Joint Command to make it standard equipment in everything that flew, even though each set cost the Gov't. \$2500.00. Crystal Controlled and Amplitude Modulated—**HIGH TRANSMITTER OUTPUT** and 3 Microvolt Receiver Sensitivity gave good communication up to 180 miles at high altitudes. Receiver has ten tubes and transmitter has seven tubes, including two 832's. Furnished complete with 17 tubes, remote control unit, 4 crystals, 24 volt dynamotor and the special wide band VHF antenna that was designed for this set. These sets have been removed from unused aircraft and are guaranteed to be in perfect condition. We include free parts and diagrams for the conversion to "continuously-variable frequency coverage" in the receiver. The cost of this unit is only \$37.95.

BRAND NEW 12 VOLT DYNAMOTOR for SCR 522—\$12.00. 24 volt dynamotor—\$6.00. Used SCR 522, less dynamotor, remote control unit and antenna—as is—\$19.95. Wide band VHF antennas—\$1.95.

BRAND NEW BC 348 COMMUNICATIONS RECEIVER

Featuring coverage from 200 to 500 Kc. and 1500 to 18,000 Kc on a direct reading dial with the finest vernier drive to be found on any radio at any price—high sensitivity with a high degree of stability—crystal filter—BFO with pitch control—standard 6 volt tubes. Contains a plate supply dynamotor in a compartment within the black crackle finished cabinet, the removal of the dynamotor leaves plenty of room for the installation of a 110V, 25 or 60 cycle power supply. These receivers, which make any civilian communications receiver priced under \$200.00 look cheap and shabby by comparison, are only \$69.95 brand new. Power supply kit for conversion to 110V 25 or 60 cycles, is only \$8.50 additional.

Minimum order \$3.00 — All prices subject to change — 25% deposit with COD orders

FREE!!!! THIS MONTH ONLY
A HIGH GRADE CRYSTAL PICK-UP WITH THE PURCHASE OF EACH PHONO MOTOR AT \$4.95.



MICROPHONES—All nationally known brands. Bullet crystal—\$5.45; Bullet Dynamic—\$7.45; Mike Jr.—60c; Handy Mike—90c; Label Mike—93c; SHURE T-17 MIKES, with push to talk switch—99c.
20 ASSTD COIL FORMS, including 11 ceramic, 3 polystyrene, and 6 fiber, all useful sizes—50c.
VARIABLE CONDENSERS: 350 MMFD, 5 gang—\$1.95; 4 gang—\$1.49; 3 gang—83c; 2 gang—79c; 7.5 to 20 MMFD—1750v spacing, extra long shaft Hammarlund—69c; miniature variables, 25 MMFD—39c; 50 MMFD—49c; 75 MMFD—59c; 100 MMFD—69c; 140 MMFD—79c.

TRANSMITTING RF CHOKES, 4 PIE, 350 Ma.—25c or 5 for \$1.00.

INTERRUPTION FREQUENCY COILS for super-regenerative receivers or the tremendously popular FM adapters for standard broadcast sets. Iron core with a resonant frequency of 50 KC—39c; Air Core, 100 KC—29c.
30 MC IF TRANSFORMERS, double slug tuned—25c.

VIDEO AMPLIFIER PLATE COILS—Slug tuned—25c.
REMOTE CONTROL UNIT: Aluminum case 4x3x2" containing 2 potentiometers, triple pole switch, 4 knobs, gear mechanism, counter and phone jacks—59c.

MODULATION TRANSFORMERS—30 watt, open-type, \$1.95 40 watt, cast aluminum case, \$2.95; Class "B" input transformers, cast aluminum case, \$1.95; Transceiver audio transformers, 65c; Transceiver modulation transformers, 65c.

PUBLIC ADDRESS AMPLIFIERS—25 watts peak outPut. This unit has separate input circuits for microphone and phono. The gain of the microphone circuit is 122db. The phono circuit has a gain of 82db. The frequency response is flat from 50 to 12,000 cycles. A \$65 value for only \$32.
Miniature pliers set contains one of each of the following: Needle nose, flat nose, parrot nose, standard nose. All contained in a leatherette case. Your cost—\$1.98.

ATR battery eliminator—Handy for servicing car radios or any other purpose requiring 6 or 12v at 14 amps. Net price—\$36.
SOCKET WRENCH SET consisting of 5 sockets ranging in size from 5/16 to 1/2" and a handle—79c.

AUTOMATIC WIRE STRIPPERS will strip up to 1000 wires per hour, a handy tool for any service job—\$3.52.
Six Foot Asbestos Insulated Flat Iron Cord, one end has a male plug, the other end has a standard flat iron socket. Your price—70c each or 10 for \$5.

LINE FILTERS—Each unit contains two 2 mfd. oil filled condensers and a 15 amp. iron core choke. This filter has innumerable uses such as oil burner line filter, etc. A ten dollar value for 98c.

FLUORESCENT LIGHT BALLASTS, Single 30 or 40 watt, \$1.68; Dual 40 watt high power factor, \$3.75.

HEADPHONES—Highest quality Signal Corps headsets with 12" cord and Plug \$1.25. 5" rubber covered patchcords with phone plug and socket—45c.

MICROTUBES

A New Milestone in Electronic Developments

By HUGO GERNSBACK

THE Tube Laboratory of the National Bureau of Standards has just announced a new "rice-grain" radio tube—now known as the *microtube*. This new subminiature radio tube is only slightly larger than a rice grain and only a bit wider than a book match, illustrated on this page.

This constitutes possibly one of the greatest electronic developments in a decade. It certainly is a milestone in radio from every point of view. The development is so revolutionary that at this time it is impossible to foresee just how far it may lead us into further radio progress.

Complete technical details of the new tube cannot be given at this time because the new microtube has important military applications that cannot be revealed at present.

One of the important contributions which the National Bureau of Standards has made is in the reduction of microphonic noises and internal tube noises. As every radio technician knows, microphonics has been one of the great irritants in radio work and the Tube Division of the National Bureau of Standards is to be congratulated on this accomplishment, which ranks in importance with the reduction of tube size itself.

The Bureau mentions that these tubes will create profound effects in industrial and commercial fields, such as, for instance, in electronic computing machines. Present-day models of such machines use as many as 18,000 tubes in a single machine and some of the newer present models as well as others now being projected require as many as 2,000 radio tubes. It can be seen that by using microtubes a tremendous amount of space will be saved. This is true also in every type of radio where saving of space is an important factor.

Incidentally, the new tubes have an expected life of 15,000 to 20,000 hours.

While at this time of writing the tubes are not available commercially, they are now being developed by a large tube manufacturer who is working under a development contract.

Other important future projections of the new microtube can be readily made now that the new subminiature tube is a reality.

General David Sarnoff in 1921 predicted the eventual use of a wrist-watch size radio. General Sarnoff was serious when he made his prognostication, which

now moves into the status of a distinct possibility. Indeed, a 5- or more tube superheterodyne watch size radio receiver now can be built with these new microtubes. There is no problem today as to the rest of the components which can easily go into a space the size of a man's wrist watch. The only thing that might baffle a constructor would be the batteries. However, this need not worry us too much either, because we can immediately think of a battery substitute.

Remember, these tubes do not use much current; therefore, we can imagine a miniature electric generator, powered by a watch-spring motor, using the recently perfected, most powerful Alnico V magnet. Such a subminiature generator becomes a distinct possibility. You merely wind the watch in the ordinary manner and the generator will keep running for a short period. It then can be rewound for more power. Thus, we will have a self-contained radio receiver compressed into the size of an ordinary watch. The face that normally is the crystal now becomes the loudspeaker diaphragm or cone, then by holding the wrist radio to the ear we should have clear and sufficiently loud reproduction to enjoy whatever program we wish to listen to.

Much smaller radios than these can be envisaged also for military purposes, such as subminiature radars, proximity fuses, handie-talkies, and a host of others. It has been said that World War II was won chiefly through the instrumentality of radio and elec-

tronics. The submarine war could not have been won if it had not been for our superiority in radar and associated other electronic techniques. Instant communication was a most important factor in winning the war. Radar for tracking down enemy aircraft was THE reason that made possible the aerial victory in the Battle of Britain. Without it there would not have been enough airplanes at the right spot at the right time, and the Battle of Britain certainly would have been lost.

If another war should come, we may rest assured that again radio and electronics will be the outstanding factor. Controlled missiles, in the so-called push-button war, could not be possible without radio-electronics.

The guided missiles now being perfected to protect our shores and to intercept other missiles will all contain the new microtubes. Indeed, the guided missile that can be followed from

(Continued on page 91)



The above illustration is a considerably enlarged view of the National Bureau of Standards' new Microtube. At the right are rice grains, at the left a book-match for comparative size.

RECEIVING LICENSES were a subject of civil dispute in a remote Canadian area last month. Residents of Atikokan and Steep Rock Lake in Northern Ontario were aroused because 50 persons were fined \$10 each for operating radio receivers without a license. The contention of residents is that the Canadian Broadcasting Co.—whose expenses the licenses are supposed to pay—gives no service to the area, and therefore has no moral right to collect from radio users. Listeners of the region have to depend on American and independent Canadian broadcasters for their radio entertainment.

Canadians have always had to pay for broadcasting licenses, but when the Canadian Broadcasting Company was formed the license fees were increased to help pay its program expenses.

AIRCRAFT ENGINE troubles now can be located and identified during flight with an *electronic engine analyzer* announced last month by the Sperry Gyroscope Co.

According to Sperry, the instrument provides continuous visual analysis of the complete aircraft power plant during flight. The flight engineer can view on its cathode-ray-tube screen at any time patterns which show engine vibration, ignition system performance, and synchronization between magnetos and engines. Malfunctions and imminent failures are not only detected but located and identified.

Simply stated, the equipment consists of vibration pickups screwed into the cylinders and generators which produce a voltage proportional to engine speed, a 13-tube amplifier and sweep circuit and the cathode-ray indicator. Two switches, condition selector and cylinder selector, permit localizing malfunction to various cylinders or identifying it as due to given conditions. A 3-inch cathode-ray tube is used.

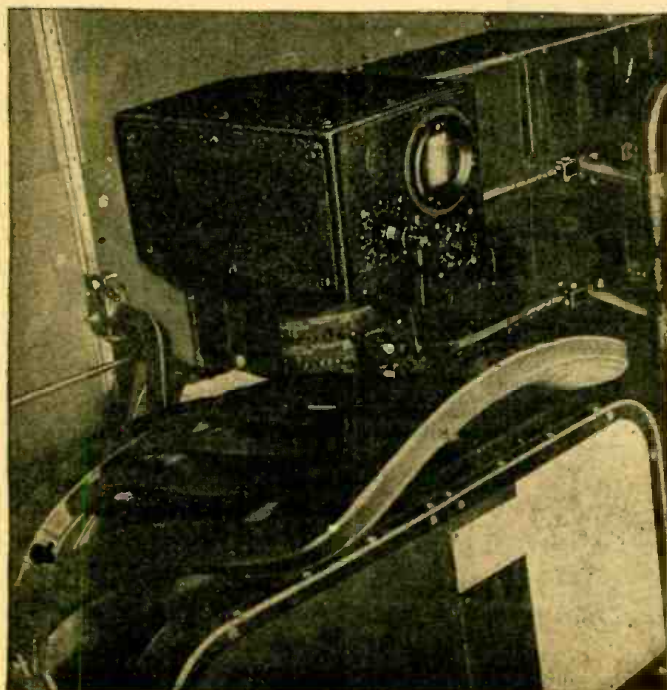

The new Sperry analyzer which spots engine troubles in flight.

RADIO-ELECTRONICS

A CAMERA SHUTTER operating with electrically polarized light and having no moving parts can make exposures of .00000004 (four hundred-millionths) second. Devised for photographic studies of electrical discharges, it was described to the American Institute of Electrical Engineers last month.

The device uses an all-electrical shutter, the heart of which is a Kerr cell. The polarized light used cannot pass through the cell except when it is supplied with an electric field. The speed of operating, therefore, depends upon the rapidity with which a required voltage can be applied to the cell electrodes.

The ordinary Kerr cell is composed of 2 flat plates or electrodes immersed in a fluid which becomes doubly refractive upon the application of an electric field. Many fluids may be used, but scientists have found that nitrobenzene seems to have the highest Kerr constant.

When this cell is placed between polarizers crossed for minimum transmission of light, the arrangement becomes an optical shutter. In the Kerr optical shutter, a voltage applied to the electrodes alters the state of polarization of light and permits transmission through the second polarizer.

ULTRASONICS proved its worth as a laundering means in a demonstration at Pennsylvania State College last month. Results of the test show that these high-frequency vibrations can provide the mechanical force of a standard washing machine.

In the demonstration, a dirty cloth in a bucket of soapy water was given an ultrasonic wave treatment. Areas of the cloth which had been exposed to the waves came out clean.

Work on ultrasonic laundering has been started here under the direction of Dr. Pauline Beery Mack, director of the Ellen H. Richards Institute, and Dr. Harold K. Schilling, director of the Acoustics Laboratory.

Research on ultrasonic waves for washing clothes is also being carried on in Great Britain. One theory is that dirt is held to clothes by electrical attraction, and that sound waves will help shake the dirt loose.

MAGNETISM can be used to reveal simply and cheaply whether a metal rod containing iron is identical with a standard specimen, it was stated last month by D. E. Bovey of the General Electric Company.

The instrument which applies magnetism to metal analysis is called a *metals comparator*. It consists of a balanced circuit and a solenoid. The other leg is a variable resistance that can be changed until the circuits from the 2 legs are in balance.

In use, the standard specimen is inserted in the solenoid first and a balance obtained. Then the rod of unknown properties is inserted in the coil. If the balance holds, it is identical with the specimen in composition and characteristics. In searching the stockpile for an identical metal, one rod after another is tested until one is found that holds the balance. Rods can be tested as fast as they can be inserted in the solenoid.

The instrument has been used to differentiate between annealed and unannealed steel bars. It has been used also to sort finished metal parts, including plated parts, on the basis of composition or heat treatment.

A GIANT WURZBURG radar is being erected by the Bureau of Standards, under the direction of Dr. Grote Reber, it was announced last month. The installation will be used to detect solar and cosmic radiation that penetrate the earth's atmosphere.

(The Giant Wurzburg was the acme of Nazi radars. It has a parabolic reflector 25 feet across, and operates on frequencies between 550 and 600 mc. It was described and pictured in RADIO-CRAFT of December, 1945.)

Much has been learned about radiations "from the outside" with the help of new efficient shortwave antennas, and it is hoped that the Wurzburg parabola may pick up yet undetected waves.

A 3-DAY CONVENTION of the Hudson Division of the American Radio Relay League at Asbury Park, N. J., Sept. 26 to 28, was attended by 1,400 hams, YL's, XYL's and guests. Featured were contests, discussions of amateur topics and door prizes; the first was a complete \$1,026.00 ham station including a Temco transmitter and a Collins receiver. Special items for the YL's included a fashion show, dancing exhibition and a Bendix washer door prize.

MONTHLY REVIEW

SUPERSONICS as a detector of flaws in metal castings may be much more effective through new methods of application. The improved method was described last month to the San Diego meeting of the Institute of Electrical Engineers by Donald C. Erdman of Burbank, California.

In the method described by Mr. Erdman, a small quartz crystal is used as a transducer, a device to convert electrical energy into pressure waves, or returned pressure waves into electrical energy. Extremely short blocks of radio-frequency power are fed to the transducer, with intervals between the blocks to permit the receipt of returned waves if there are any. The method is similar to the echo techniques used in radar, in which electric impulses are reflected by obstacles back to the antenna from which sent. When high-frequency sound waves are sent through metal, waves that hit a hidden flaw within it are reflected back.

In inspecting small metal objects, the quartz crystal and casting are separated but both are placed under water. This permits the supersonic beam to be directed into fillets and curved surfaces, he said. When large objects are being inspected, their surfaces are usually flat enough to allow the quartz crystal to be placed directly against the part being tested.

ARTIFICIAL CRYSTALS are now being used to replace hard-to-get quartz as frequency controls in many long-distance telephone carrier circuits, the Bell Telephone Laboratories revealed last month.

The new crystals, ethylene diamine tartrate, are familiarly known as EDT. Although these crystals differ markedly from quartz in chemical composition, both are piezo-electric in character; that is, they can convert mechanical energy to electrical energy, or they can reverse the process.

In commercial production the artificially grown crystals weigh about 1 pound and are about 6 inches in length and 2 x 3 inches in cross section.

The first seeds of crystal from which subsequent crops are harvested are only 1/3 inch across. They are obtained by evaporating a saturated solution of the chemical in a dish, just as sea water can be evaporated to obtain salt.

These are then swished slowly back and forth in a solution of the chemical which is kept supersaturated. Slowly, more crystal is added to these seeds—that is, they grow. The entire growing process must be very precisely controlled. Temperature variations, for example, must be kept within 1/10 degree.

A crop of crystals can be harvested every 3 months, and the seeds cut off from the new growth and replanted in the solution to start another crop.

In the search for a quartz substitute, Bell chemists and physicists investigated more than 100 crystals before they selected EDT.

In a few years, the artificial crystals are expected to replace as much as 90 per cent of the natural quartz used in long-distance telephone systems—and do as good a job as its scarce, natural brother. Some New York to St. Louis circuits are already operating with synthetic crystal units.

TO OUR READERS

SINCE 1929—for over 18 years—RADIO-CRAFT has sold at 25c per copy. For several years now almost all important magazines in the U. S. have found it necessary to increase their prices due to ever-increasing costs of paper, printing, and wages.

The Publishers of RADIO-CRAFT had hoped that it would not be necessary to increase the price of your magazine, but continuous advances in operating costs—some as high as 200%

above pre-war costs—finally forced the adoption of a new price schedule, a move which is sincerely deplored.

Beginning with this issue the price on U. S. newsstands goes to 30c, Canada to 35c. Proportionate increases in subscription prices have also been effected.

As soon as economic conditions permit it, price reductions to the former level will be made.

THE PUBLISHERS.

FM LIGHT-BEAM signal transmission is described in U.S. patent 2,423,254, issued last month to Michael Rettinger of Encino, California, and assigned to the Radio Corporation of America.

Central feature of the invention is a prism through which white light is projected, coming out in the familiar rainbow spectrum. A photocell most sensitive at the red end of the spectrum and least sensitive to violet light is used as the receiver. The rainbow beam is projected so that the central part of it falls on the photocell.

The prism is so connected in a magnetic circuit that modulation causes it to pivot, shifting the spectrum projected onto the photocell at audio frequency and causing a proportional upward fluctuation of the photocell current as the beam moves toward the red and a downward fluctuation as it moves toward the violet.

Since the amplitude of the light beam is held constant, the analogy with radio FM is exact. In each case, the frequency of the waves is changed, and the greater the deviation from normal carrier frequency, the stronger the signal.



Examining a rack of crystals in process of growth. They are formed in the tank below.

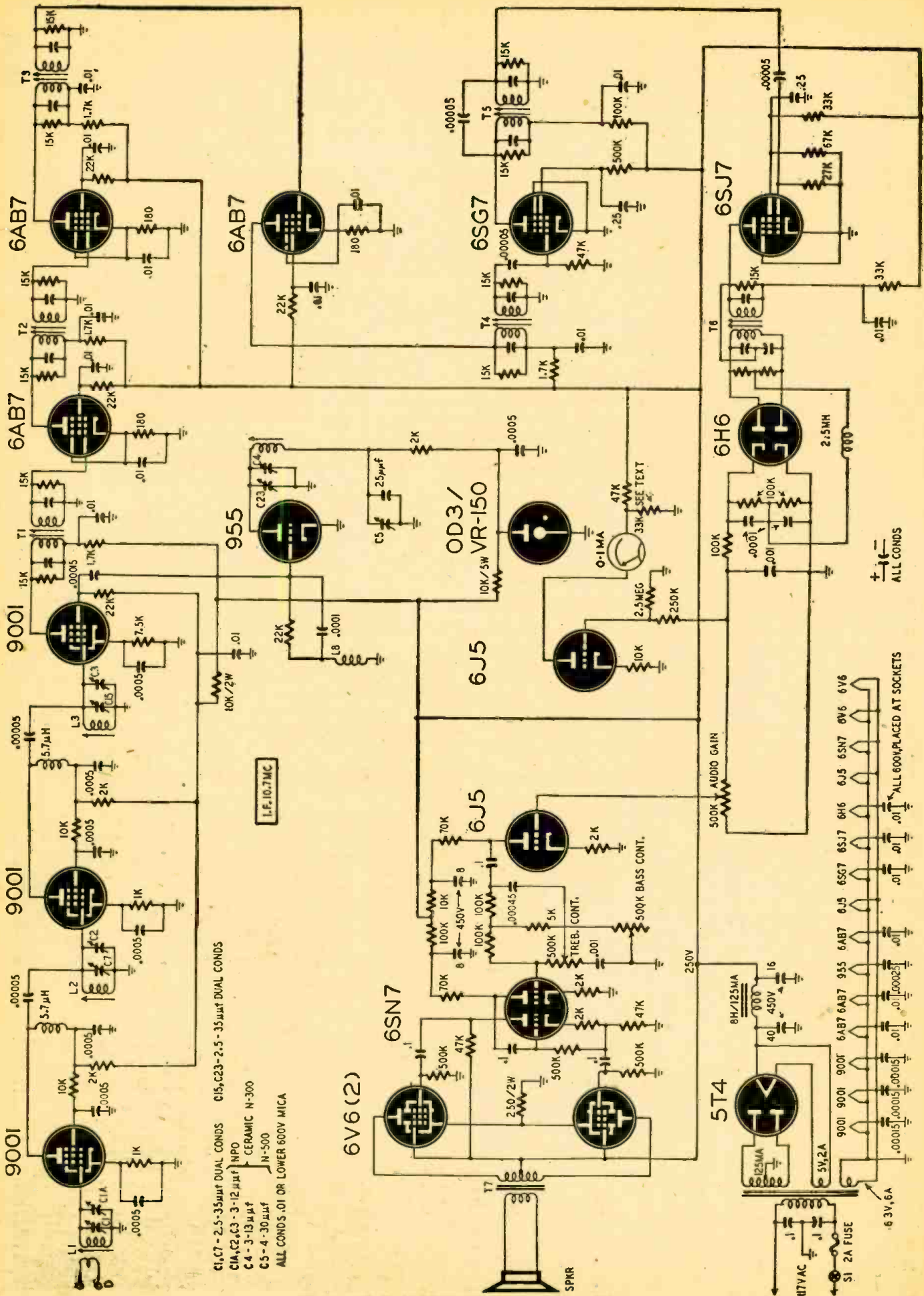

C1, C7 - 2.5-35μF DUAL CONDS C15, C23 - 2.5 - 35μF DUAL CONDS
 C1A, C2, C3 - 3-12μF NPO CERAMIC N-300
 C4 - 3-13μF N-500
 C5 - 4-30μF ALL CONDS .01 OR LOWER 600V MICA

17-TUBE FM RECEIVER SCHEMATIC

We are happy to present this instead of the 4-tube set mentioned on the cover. It will come next month

How to Construct a 17-Tube FM Receiver

By FRANK SANTANGELO

THE advantages of FM in fidelity and in noise reduction are so well known as to require little discussion. Only an efficiently designed receiver will obtain the most sensitivity without sacrificing the stability or the signal-to-noise ratio of the receiver. The equipment described here resulted from an attempt to design a receiver that would operate with maximum efficiency on the new 88-108-mc FM band.

A number of things which are unimportant at lower frequencies have a significant effect on the stability of a high-frequency receiver and must be considered when constructing one.

The 17 x 9 x 2-inch chassis on which you build such a receiver should be of a heavy-gauge material to assure mechanical stability.

The components and their placement must be chosen with extreme care. Improper layout of parts can be the cause of spurious oscillation. Poor grounds may cause instability, especially in high-frequency circuits. By using ground clamps on metal tubes, any interaction which might exist between their shields due to poor grounding may be eliminated. These are just a few of the numerous things which have a decided effect on both the mechanical and electrical stability of a receiver.

Two stages of radio-frequency amplification are used to give the desired gain. The r.f. circuits are located in the grid of each tube, and the plates are capacity-coupled to the grid of the following tube.

The oscillator is of the tuned-plate grid-feedback type. Its output is injected into the screen of the mixer. A stable high-frequency oscillator circuit with temperature compensation and voltage regulation helps to assure the utmost in frequency stability.

Because the new band has a total band width of 20 mc, an intermediate frequency of at least 10 megacycles must be used to have signal images fall outside the band.

The new National 10.7-mc i.f. transformers were decided on. Three stages were used to obtain the gain required for good limiter saturation on weak signals. These transformers are designed so that the user may resistance-load them to suit his particular application. It was necessary to load the windings of each transformer with a 15,000-ohm resistor to obtain the proper band width.

Automatic volume control was tried and found to offer no advantage; rather it tends to prevent saturation of the limiter on weak signals. Series limiting is used with transformer coupling be-



Completed receiver on its bass-reflex cabinet.

tween the limiters. A shield is placed under the limiter coupling transformer to prevent any possible feedback between this and the first i.f. stage.

The first limiter has a time constant of 2.35 microseconds and the second a time constant of 1.35 microseconds. These time constants seem to give effective limiting for auto ignition, which is extremely severe in this locality (Somerville, Mass.). The Travis discriminator uses a National-type IFL discriminator transformer.

The output of this discriminator has a de-emphasis circuit whose time constant is 100 microseconds, which is necessary for proper high-frequency de-emphasis. The discriminator meter amplifier is a 6J5 with high-impedance input connected to the output of the discriminator. The meter in the plate circuit of the tube is adjusted to give a half-scale reading on background noise (off-station hiss) by varying the 33,000-ohm, meter-to-ground resistor. When this is done, a zero center is auto-
(Continued on page 76)

TUNING UNIT HOUSING DETAILS

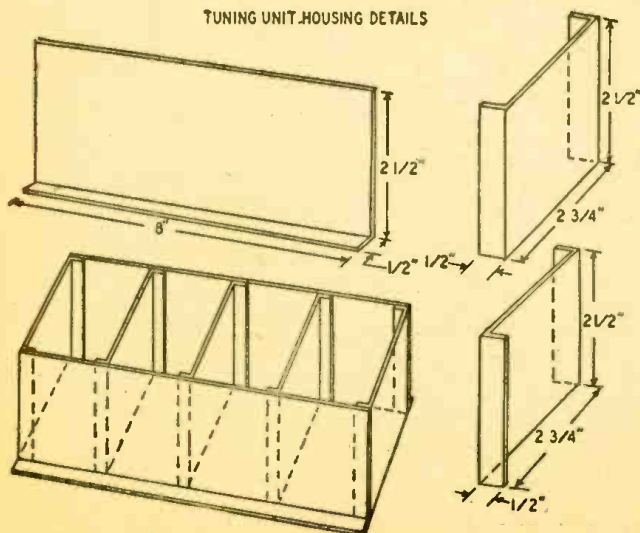

Left, Fig. 1—Construction details of housing for tuning unit. Below—An under-chassis view of the receiver, a very well-engineered job.

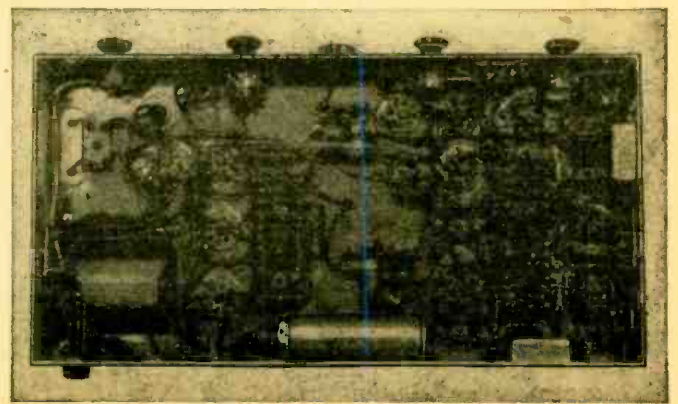

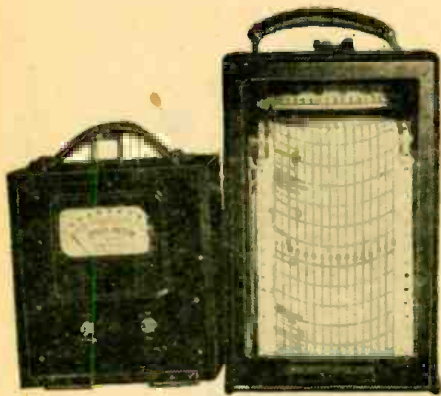

The indicator-amplifier and recorder units.

Highway Radar

Connecticut system makes absolutely accurate records of automobile speeds

CONNECTICUT speedsters protesting that "they were doing only forty" will soon find themselves arguing with radar. So says Captain Ralph Buckley, traffic division head of the Connecticut State Police. Inconspicuous radar speed meters are already being operated alongside Connecticut highways in a series of tests which will probably result in the adoption of radar speed control throughout the state.

The radar device is known as the

Electro-Matic Speed Meter, and is a local Connecticut product, being manufactured by Eastern Industries Ltd. of Norwalk. It is a small, portable device composed of 3 units. Largest of these is the transmitter-receiver, the radar set proper. The dipole antenna is enclosed in the set, behind the bakelite front panel on which the words "Electro-Matic Speed Meter" appear. A second unit is the indicator-amplifier, and the equipment is completed by a 6- or 120-volt power supply.

The instrument operates on the Doppler effect. When a series of waves is sent toward an object moving toward the transmitter, the length of the reflected waves is shorter than the wavelength as measured at the transmitter itself. This is because the moving object has moved part of a wavelength toward the transmitter in the interval between each wave. The greater the speed of the object, the greater the difference between the frequency of the transmitted and received wavelengths.

(The same effect can be noted if the source of signals is itself moving toward or away from the receiver, or if

the transmitter is stationary and the receiver moves. It is especially noticeable in sound, and many listeners have noticed that the pitch of a fast-approaching train's whistle is higher than the same whistle when the train is moving away from the listener.)

The direct signal from the transmitter and the received signal are mixed in the receiver, and the difference frequency (which tells the speed of the moving object) is fed to the indicator-amplifier, where it is read on a meter calibrated directly in miles per hour or registered on a graphic recorder.

If the car is moving at a steady speed, the indicator will swing up as it comes into the field covered by the instrument, remain there a short instant, and then drop as the car passes by. During this short period of approach at constant speed the reading is taken. By varying the angle the transmitter-receiver makes with the road this action may be adjusted to give the most positive reading. If a graphic recorder is used, a slight flattening of the top of the curve produced by each car indicates the point at which the steady speed is read.

Range depends to a great extent on the height of the instrument. On the ground, it is from 75 to 100 feet. At a height of 3 feet, this range increases to 150 feet, and at 30 feet the zone extends to 350 feet. For practical use, a range of 150 feet has given the best results, and the speed meter is mounted preferably at a height which will give approximately that range.

Turning the transmitter-receiver unit slightly away from the traffic also produces more positive results by limiting the field and decreasing sensitivity for cars on the far side of the roadway. The device should be mounted as near the roadside as convenient, though

(Continued on page 80)

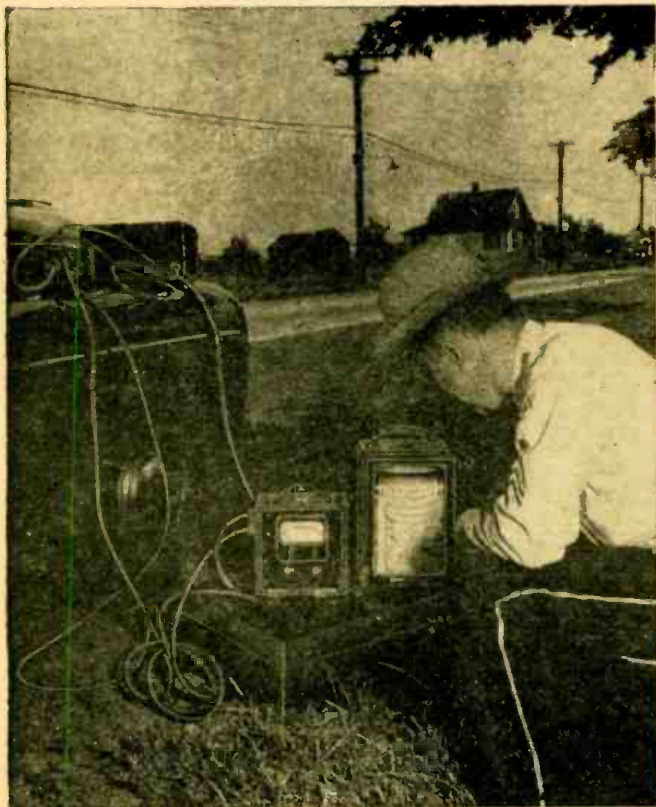

The radar transmitter-receiver is on the car's trunk compartment.

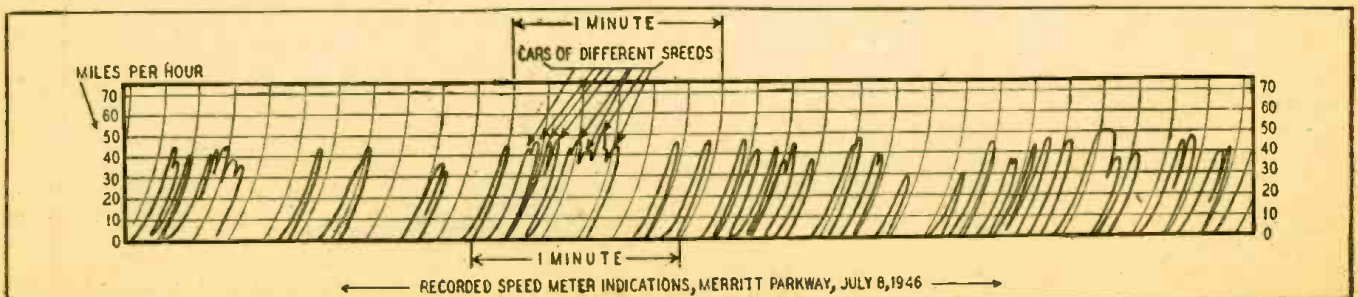

SIGNAL TRACER—SIGNAL GENERATOR

Two of the most useful service functions combined in a single instrument

By FRED WHALEN



The r.f. probe is based on a tube adapter.

A COMBINATION signal tracer and signal generator such as this one can develop into an almost indispensable instrument for the serviceman or experimenter. It is constructed from standard parts, many of which can be found in the junk-box. It is used for r.f. and a.f. signal tracing, and its oscillator generates signals in the i.f. range as well as over the broadcast band.

The circuit, Fig. 1, uses 5 tubes. Of these, four are on the chassis and 1 is in an r.f. probe.

For r.f. signal tracing, the probe picks up a signal from a set under test, rectifies and feeds it to the grid of the 6Q7 a.f. amplifier stage through the 500,000-ohm input gain control. The 6Q7 is resistance-coupled to a 25L6 power amplifier.

For a.f. tracing, use a probe made from a piece of low-capacitance microphone cable fitted with pin tips for plugging into the a.f. input jacks. The audio level is controlled by the 500,000-ohm control in the grid circuit of the 6Q7. Leads from the voice-coil winding of the output transformer are connected to pin jacks on the panel so that an external speaker may be used or tested with the tracer. The external speaker may be used in parallel with the built-in speaker or may be used alone by opening the speaker switch below the pin jacks. High-impedance output is available through a pin jack coupled to the plate of the 25L6 through a .05 μ f blocking condenser.

The a.f. amplifier can be made to oscillate by throwing the oscillator switch to modulator position. No transformers are required in this system. Feedback between the plate of the 25L6 and the grid of the 6Q7 develops oscillations at a frequency determined partially by the setting of the input gain control.

The 6K7 r.f. signal-generator tube is connected in a conventional electron-coupled oscillator circuit. A tapped broadcast oscillator coil, designed for use with 175-kc i.f.'s, is tuned with a

365- μ f variable condenser shunted with a small trimmer to tune to the low end of the band. The i.f. range is covered by switching in a .0006- μ f fixed trimmer. To modulate the oscillator with a constant tone, throw the oscillator switch to the modulator position. The r.f. gain control is coupled to the plate of the 6Q7 through a .02- μ f condenser. The voltage developed across the gain control modulates the suppressor of the r.f. oscillator. If external modulation is desired, a phono pickup is connected to the a.f. input jack and the oscillator switch turned to the external position.

The tracer has a built-in, fixed-tuned circuit consisting of a standard antenna coil and a 450- μ f trimmer that is adjusted to tune in a local broadcast station. The tip of the r.f. probe is inserted in the r.f. input jack. The 6SF5 detects the signal and passes it to the 6Q7 where it is amplified and modulates

the r.f. oscillator or goes to the 25L6.

The r.f. probe is made from a tube adapter with an octal socket in one end and a banana plug in the other. A phone-tip adapter slips over the banana plug and matches it to the tip jack in the panel. This also provides a sharp point for signal tracing. Three-wire cable and a plug made from a discarded 6H6 complete the circuits between the probe and the tracer. One of the wires is a common ground connection. The others carry plate and heater voltages to the 6SF5 probe tube. Power supply is normal. It

(Continued on page 90)

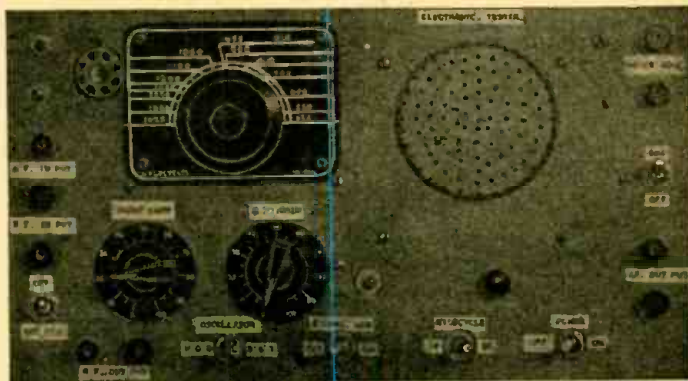

Front view of the tracer-oscillator with all controls designated.

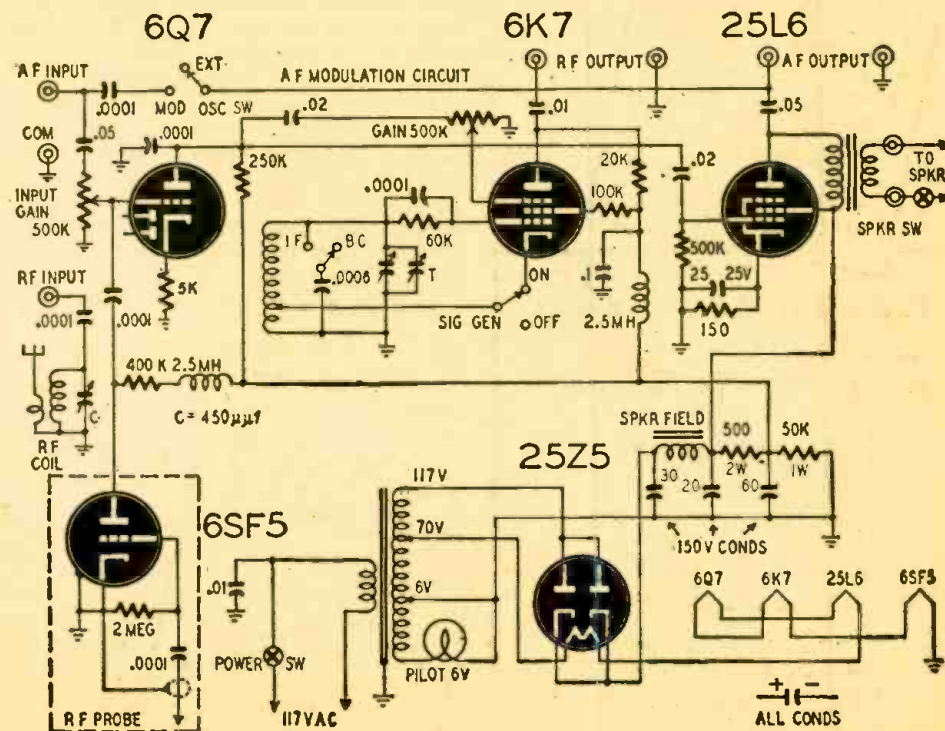

Fig 1—Schematic diagram. The instrument is simple electronically in spite of its versatility.

Advertising-

for the RADIO repairman

By PAUL W. STREETER

"WHAT has he got that I haven't got?" is a question many radio repairmen ask themselves when

repair jobs enough to more than pay the entire advertising cost.

they look at the success their competitor seems to be enjoying. The answer usually is a combination of skillful advertising and technical ability. Technical ability can be acquired only by study and actual practice. Advertising that "clicks" can be written after study and actual practice, too.

Keep it short!

Every organization which specializes in maintenance and repair work depends on some form of advertising to create new business. The major automobile and oil companies have spent many millions of dollars on advertising to persuade the public to have their dealers take care of automotive repairs. This policy has paid off. Radio repair shops can also use advertising to create new business.

Newspaper ads generally try to say too much. It is much better to write a simple ad, with a cut to illustrate the point, than to try to get a complicated story across. Most newspaper readers buy the paper for everything except the ads. A majority of readers do not *consciously* read them. A simple ad with short, concise copy and a cut will bring in business that the complicated ad will miss. Cuts are very helpful, and should be used liberally. A great many papers have them available, and they can be used without charge. They may or may not pertain to radio. One of the most effective ads this writer has used stresses proper timing, and carries a cut of a hockey player.

Advertising does not mean just a single-column, 1-inch ad in the local paper. The term covers a vast territory, of which newspaper ads are only a small, although in some cases, an important part. Many different types of advertising may be used. Their relative merits will be discussed in this article.

White space makes an ad stand out. White space should be used with medium-sized type, however, as large type crowds it. This writer has had the unfortunate experience of having some ads set with white space specified, but imperceptible because the typesetter used too large type. But by constantly hounding the newspaper, satisfactory results will be obtained.

Newspaper advertising is probably used (or MIS-used) by radio repair shops to a larger extent than any other medium. Newspaper ads can be effective if ads with outstanding appeal are prepared. Most radios brought in by newspaper advertising are those that have failed completely, although there is a much larger market for radio repairs among owners whose radios are functioning, but erratically. Advertising properly slanted toward these potential customers will increase the number of

The best place for any newspaper ad is the bottom of the front page. Many of the smaller papers do run ads in that spot. An ad generally decreases in effectiveness the farther it is from the front page. One exception has been that radio repair ads appearing on the same page with the theater programs are unusually effective. If newspaper advertising is carried on a monthly contract basis,

(Continued on page 74)

NO MORE TROUBLE



When I Fix Your Radio
It Stays Fixed!

Repairs Are Guaranteed 90 Days.

SLIM'S RADIO SHOP
"Repairing Radios Since 1927"
89 S. Main (Next to Jewelry Store) Phone 296-R
FALLON, NEVADA

This Fellow Knows All About Your Feet But . . .



I Know All About Fixing Your Radio
Radio Is My Business
— Not a Sideline!

SLIM'S RADIO SHOP
"Repairing Radios Since 1927" Phone 296-R
89 S. Main (Next to Jewelry Store)

It's Results That Count!

769 Satisfied Fallon Customers

After Operating Here for Just **9** yrs.

All my work is guaranteed

SLIM'S RADIO SHOP
89 S. Main (Next to Jewelry Store) Phone 296-R
"Repairing Radios Since 1927"

PERFECT TIMING . . .
it's important
to your
RADIO
too!



Your radio must be in precise adjustment for good results. Noisy reception and lack of sensitivity are due to poor alignment.

Let Me Adjust Your Radio for
PEAK PERFORMANCE

SLIM'S RADIO SHOP
89 S. Main St. Next to Jewelry Store Phone 296-R
"Repairing Radios Since 1927"

IS YOUR RADIO
NOISY? WEAK?

I Can Make It Like New

All Repairs Guaranteed **90** Days

Pickup and Delivery Service

SLIM'S RADIO SHOP
Next to Jewelry Store Phone 296-R
Repairing Radios Since 1927

The Best Costs No More

Every Radio Repaired to Conform to Original Factory Performance

You Must Be Satisfied
REPAIRS GUARANTEED 90 DAYS

Slim's Radio Shop
89 S. Main Next to Jewelry Store Phone 296-R
Repairing Radios Since 1927

RADIO
Is My Business . . .



Not a Sideline!

Repairs Are GUARANTEED 90 Days

Slim's Radio Shop
89 S. Main (Across from Signboards) Phone 296-R
Repairing Radios Since 1927

Adventure in High Fidelity

By JAMES R. LANGHAM



IT WAS some time before the war when we first became really conscious of that term. I say "we" but actually the XYL didn't cotton too much to the idea. We had a vintage phonograph amplifier with 2A3's, a creaky old interstage xformer, and a mess of 56's; and it sounded pretty good. That's what she said.

"Oh, it's not bad for what it is," I argued. "But there's a lot of distortion in it—my ear is pretty keen, you know—"

"Ha!"

"Look at this circuit," I urged. "Beam power tubes and 15 db of feedback. Distortion less than 1% and . . ."

"How much would it cost?" The XYL is always practical, which is at times a little discouraging.

"Not too much. We can use the same interstage and drive it with a 6C5. Of course it'll mean a new output

xformer to handle those mills, and this old power supply is on its last legs, and I thought I might as well get a new chassis. . . ."

"How much?"

"Around 8 or 9 bucks."

That was O.K., and the XYL even punched socket holes and wired up the filaments and grounds. I went in for engineering then, and so the feedback resistors were all calculated. We took pains with the wiring too—no kinks in the leads, all corners squared up, and the whole thing laced up with sail twine. I was proud of it.

I don't know why it is but people always drop in to call just as I finish a job, and, since I was younger then and full of confidence, I tried it out anyhow.

"Excuse me," I interrupted. "But do you mind if I hitch this up and try it

"I yanked those beam bottles out of there and put in triodes."

out? You see I've just finished wiring it and . . ."

Oh, that was fine. Sure, they said, go ahead. They'd like to hear some nice music. The XYL had been shaking her head at me but then she shrugged with that "Go ahead, you dope!" expression.

I plugged in the a.c. lead and tied in the speaker and pickup leads and flipped the switch. I was just selecting a record when the damndest squeal I ever heard started coming out of that speaker. It built up to a very high pitch and a very, very high intensity. You know, the sort

(Continued on page 84)

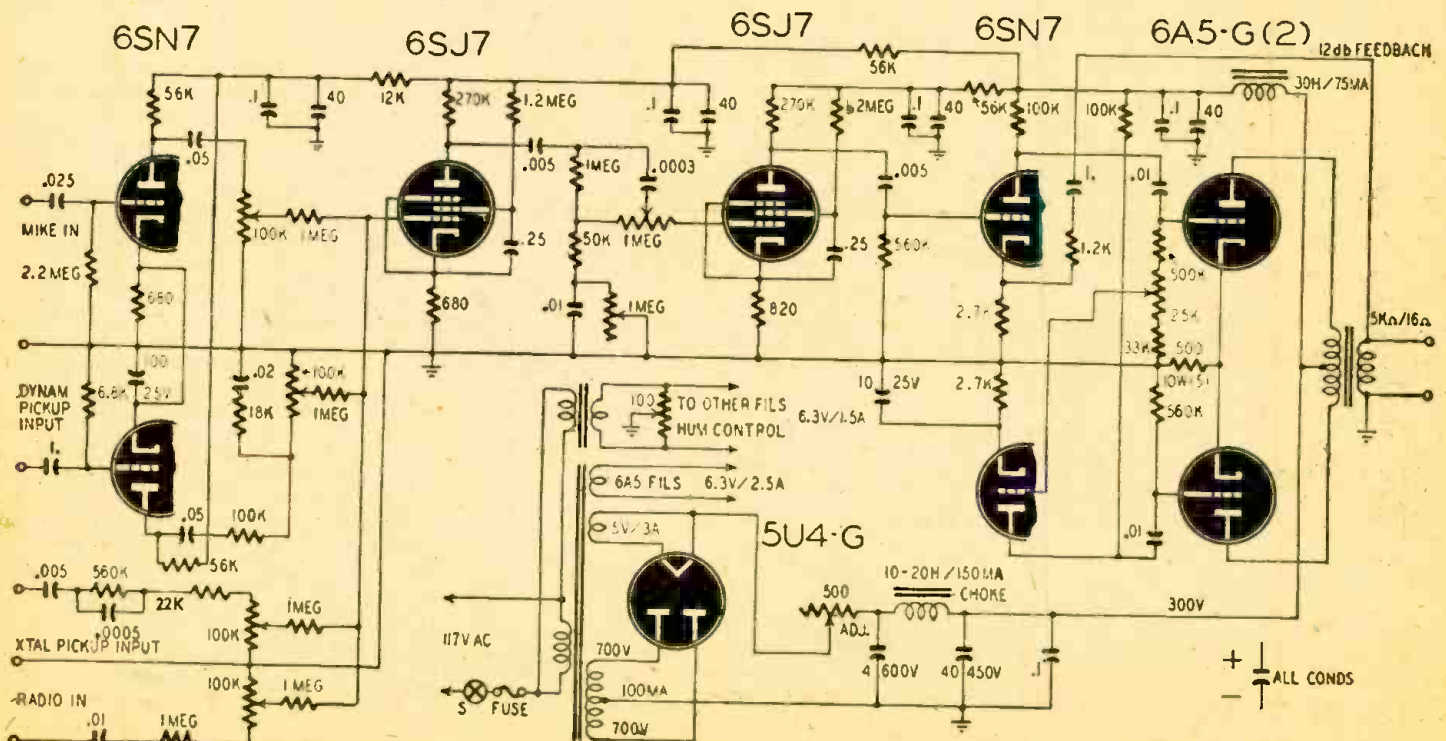

The final high-fidelity amplifier circuit, as it looked at the end of the series of experiments which are described in this article.



Speaker and pilot appear on receiver panel.

Carrier Radiophone

PART II—Receiver and modulator unit

By BOB WHITE

THE power that can be used in carrier-current transmitters without causing interference is very low. (The FCC has recently closed down a number of "carrier" systems as operating illegally and causing interference to other services.) Therefore it is necessary to use an extremely sensitive receiver. Many war surplus low-frequency, a.c.-operated receivers are perfect for this purpose. The only change that need be made for reception of carrier-current signals is to substitute an electric power line for the regular aerial. The antenna post of the receiver is connected to one side of the power line through a 0.01- μ f, 600-volt paper condenser, and the ground post or chassis to the other side of the line through a similar condenser. It would be best so to arrange the circuit that the condensers would be across the line only when the receiver is turned on. Also, the equipment should be protected by a small fuse.

For those who would rather gain experience through the construction of their own carrier-current receiver, the details of a simple 4-tube tuned radio frequency receiver are given below.

The receiver (Fig. 1), is of standard design. The only change necessary for the reception of low-frequency airplane radio beacons is the use of a regular aerial instead of the electric power line

aerial. The 5Z4 tube is used as a full-wave rectifier in the power supply, the 6F6 pentode power amplifier operates a 5-inch dynamic speaker, the 6J7-GT is a grid-leak-type regenerative detector, and the 6K7-GT supercontrol tube is used as a tuned r.f. amplifier.

The receiver can be constructed on a metal chassis 8 x 5 x 1 1/2 inches. Plan the arrangement of parts and then proceed to drill holes and mount parts.

I.f. transformers T1 and T2 should be for about 370 kilocycles. An i.f. transformer of a little higher frequency can be used if sufficient turns are added to each secondary to make it tune the correct range. A transformer of lower frequency can be altered and made to work by removing an equal number of turns from both the primary and secondary of both transformers. The internal wiring of the i.f. transformers will have to be modified for use as r.f. transformers.

The transformers each have a trimmer condenser connected across both the primary and secondary windings. Disconnect the trimmer from the primary, and connect it in parallel with the other secondary trimmer (C8, C9, C13, C14). The primaries of the i.f. transformers

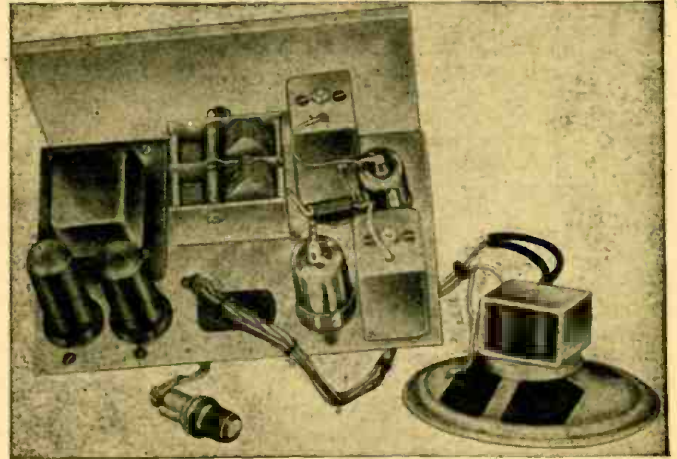

Chassis view of receiver. Pilot lamp and speaker are on cables.

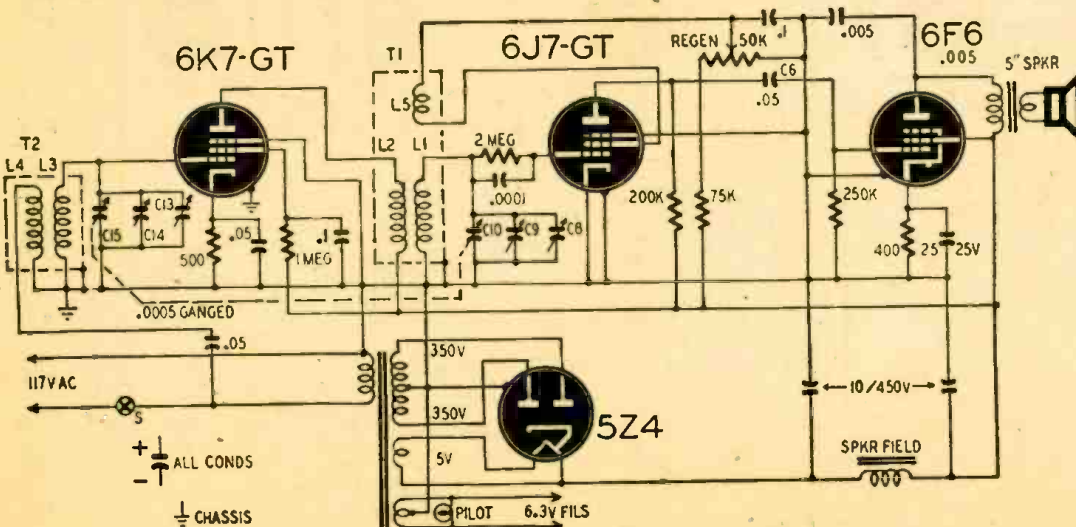
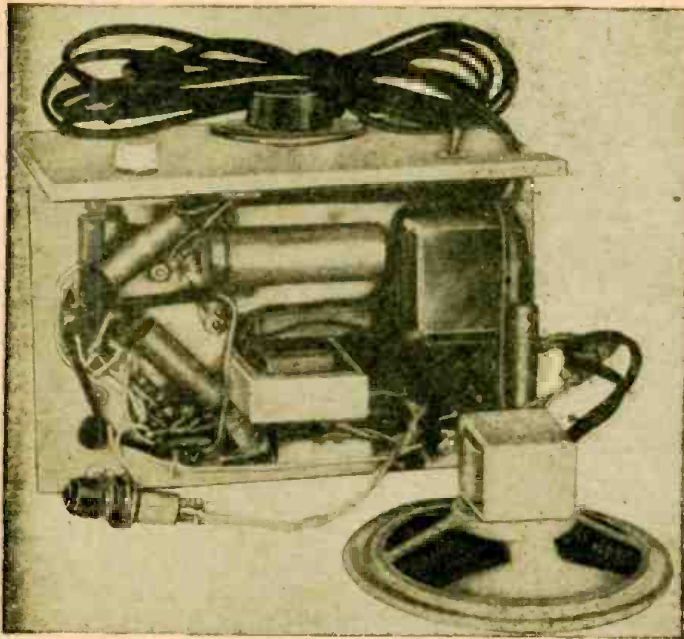

Fig. 1—Receiver schematic. As line is connected to chassis, no external ground may be used. Line fuses are advised.

T1 and T2 are windings L4 and L2, respectively, and the secondaries are L3 and L1 respectively. The leads from both windings can usually be determined by the colored wires used. Red is connected to B+ in T1 and to the chassis in T2,

blue is connected to the plate of the 6K7-GT in T1 and to the 0.05 "antenna" condenser in T2, green is connected to the grid leak in T1 and to the control grid (cap) of the 6K7-GT, and black is connected to the chassis in both transformers. The i.f. transformers are modified so that they may be tuned over a range of frequencies with the 2-gang 500 μ f per section condenser C10-C15.

The regeneration coil L5 is wound on the opposite side of the secondary L1 from



Bottom view of receiver. The top view is shown on preceding page.

the primary L2 in transformer T1. The actual number of turns will depend upon the type of transformer used, but approximately 100 turns should be satisfactory. This winding may be jumble-wound with No. 34 insulated wire.

The wiring is very simple. A thorough check of all your work is very vital. Don't omit grounding all the shield pins of the tubes.

The chassis is mounted in a wooden case 9 x 9 x 7 inches. The case resembles a speaker cabinet with the speaker and pilot lamp mounted in front and the controls hidden in the back.

To operate the receiver, advance the regeneration control until the thud of oscillation is heard. Tune across the band and so regulate the regeneration that the receiver is kept in the sensitive condition constantly. If the receiver should fail to regenerate, reverse the leads going to winding L5 of the i.f. transformer T1. Failure of the receiver to regenerate across the entire band is remedied by adding more turns to L5.

Turn on your carrier-current transmitter and tune the signal in on the

that the signal is maximum; then, adjust the trimmer in T2 for maximum signal. Repeat this process several times to align the receiver perfectly. Although tuning by ear is satisfactory for this adjustment, some form of output indicator is preferred.

To receive c.w. signals, keep the receiver regenerating so that the incoming signal and oscillation of the detector will combine to produce an audible tone. Phone stations are received with the regeneration control set just out of oscillation. When the transmitter is not distant from the receiver, 2 signal peaks may be noticed. This problem can be solved by reducing the antenna coupling control on the transmitter.

Phone communication

The desire to talk back and forth over the power lines finally made it necessary to construct a modulator for the carrier-current transmitter. The amplifier described here and shown in Fig. 2 has very good fidelity. It could be used in almost any low-power transmitter, and

with the substitution of a suitable output transformer for the modulation transformer could also be used in a small public address system.

The modulator is constructed on a metal chassis 5½ x 7 x 2 inches. Use thorough shielding at the input stages. A grid-cap shield for the metal 6J7 tube must be included to prevent oscillation through the two 6V6-GT push-pull tubes. The 6SN7-GT tube serves as phase-inverter amplifier stage and input 1 amplifier stage. Input 1 is for a phono pickup or any other sound source with a fairly large output voltage. Input 2 is intended for use with a dynamic or crystal microphone. The high-gain amplifier stage allows pickup of sounds many feet away. The center-tapped volume control is connected so that the center position is neutral. Toward position P the phono amplifier is heard, and toward position M the high-gain microphone stage is heard.

The secondary winding of the modulation transformer T1 is connected in series with the B+ supply to the 807 r.f. amplifier stage. One lead from the secondary of the modulation transformer is connected to the P.A. B+ output post of the power supply; the other lead is connected to the P.A. B+ jack of the transmitter. The value of the impedance of the secondary is found by dividing the operating voltage of the r.f. ampli-

(Continued on page 70)

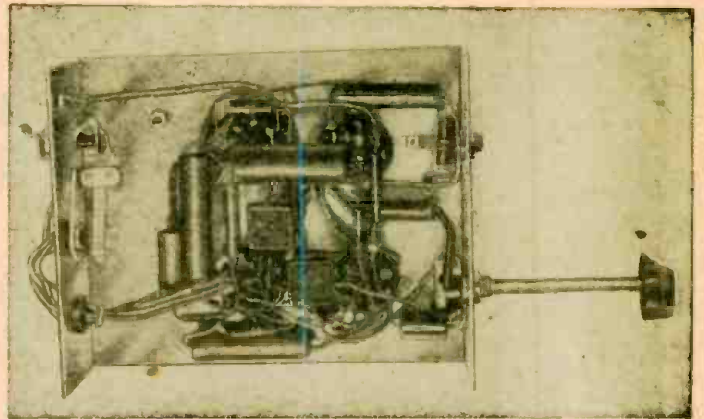

Under-chassis view of the 10-watt modulator shown on page 70.

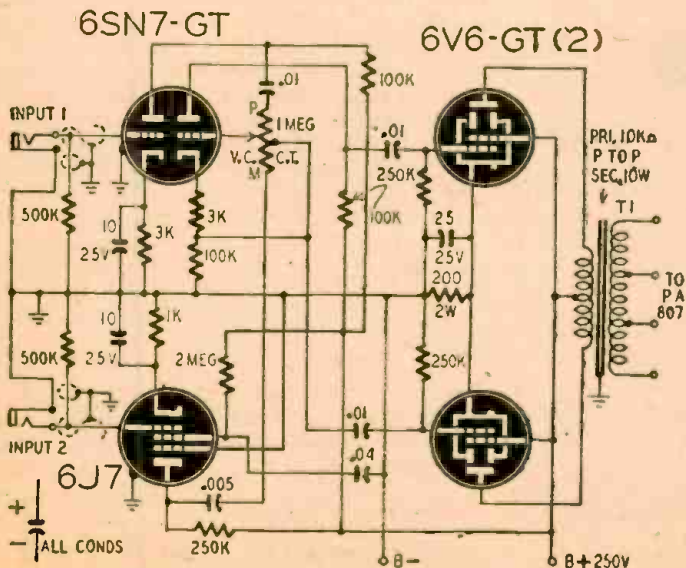
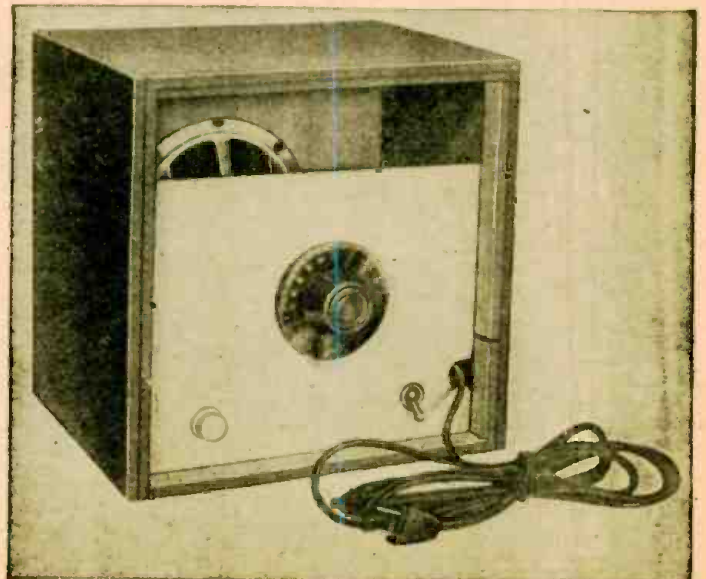
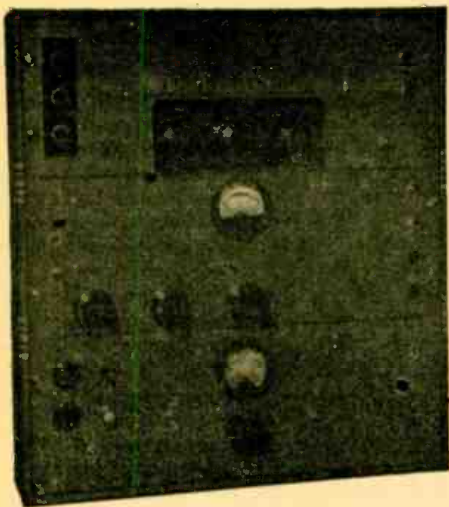

Fig. 2—Modulator schematic. Output is approximately 10 watts.



Tuning controls of the carrier-current receiver are at the rear.



PORTABLE P. A. AMPLIFIER

Here is a 50-pound, three-section unit with a conservatively rated output of 15 watts at low distortion levels

By J. C. HOADLEY

THIS amplifier is equally well adapted to portable recording, remote preamplifier service for feeding a telephone line, or for public address systems. Its characteristics are strictly high fidelity from a frequency-response and distortion standpoint, and it has a particularly versatile response compensation system. It has a gain of approximately 115 db with negligible hum and distortion, yet weighs less than 50 pounds.

The amplifier unit features:

1. Three low-impedance input channels, one of which may be switched to high impedance.
2. A preamplifier unit which may be used separately as such, and which will provide an output impedance of from 50 to 500 ohms for line work.
3. A power amplifier which delivers

14.5 watts at 2.5% distortion to either a 500-ohm line or to various voice-coil impedances, with 4 output jacks, an output level indicator for monitoring and recording use, and a switch for use with dual recording turntables. A separate low-gain input is provided for operation from crystal pickups.

4. Self-contained, husky, well-filtered power supply with plate-current metering of the 2A3 output tubes and bias controls for balancing them.

5. Several 115-volt outlets for convenient connection of a lamp, turntable, motor, or other devices which are controlled by the power switch.

The unit is mounted in a portable carrying case (see photo) 19 x 20½ x 5½ inches which was originally made to house a professional recording turntable. The amplifier was broken into 3

units and mounted on three 6¼ x 18 x ½-inch aluminum panels which were sprayed with dull gray lacquer.

The top deck houses the preamplifier and mixer stages and consists of a complete 3-channel remote line amplifier with individual gain control for each channel.

Three 6J7 preamplifier stages with miniature high-fidelity input transformers allow input impedances from 50 to 500 ohms. See Fig. 1.

An impedance of 50 ohms was chosen for use with dynamic microphones. This value has several advantages. Dynamic microphones are extremely rugged and are insensitive to vibration, temperature, and humidity. They have a smooth, wide-range frequency characteristic, which can be varied by changing the sound's angle of incidence upon the microphone diaphragm. The 50-ohm impedance allows microphone lines up to 400 or 500 feet without serious frequency discrimination. One preamplifier may be switched from low impedance to high impedance to accommodate crystal microphones or low-level crystal pickups.

The 6J7 stages are followed by 6C5 stages which control gain and plate circuit mixing individually. Notice the series isolation resistors which eliminate shunting of one tube by its neighbors and the attendant distortion. As a triode cannot work into a resistance lower than its plate resistance, distortion would be serious in a 3-channel mixer.

The mixed output is fed to an output voltage amplifier. This 6C5 stage has a switch which allows its plate circuit to be shunt-fed to a plate-to-line output transformer or switched directly to the grid of the power amplifier which is located on the middle deck.

The preamplifier, when switched to the miniature high-fidelity transformer 500-ohm output, will supply 5 volts across 500 ohms, which is +8 db (based on a zero of .006 watt across 500 ohms). For negligible distortion, it should be run at an average level of not over +2 db (2.2 volts).

The main amplifier

The preamplifier output is first introduced into a gain control which is

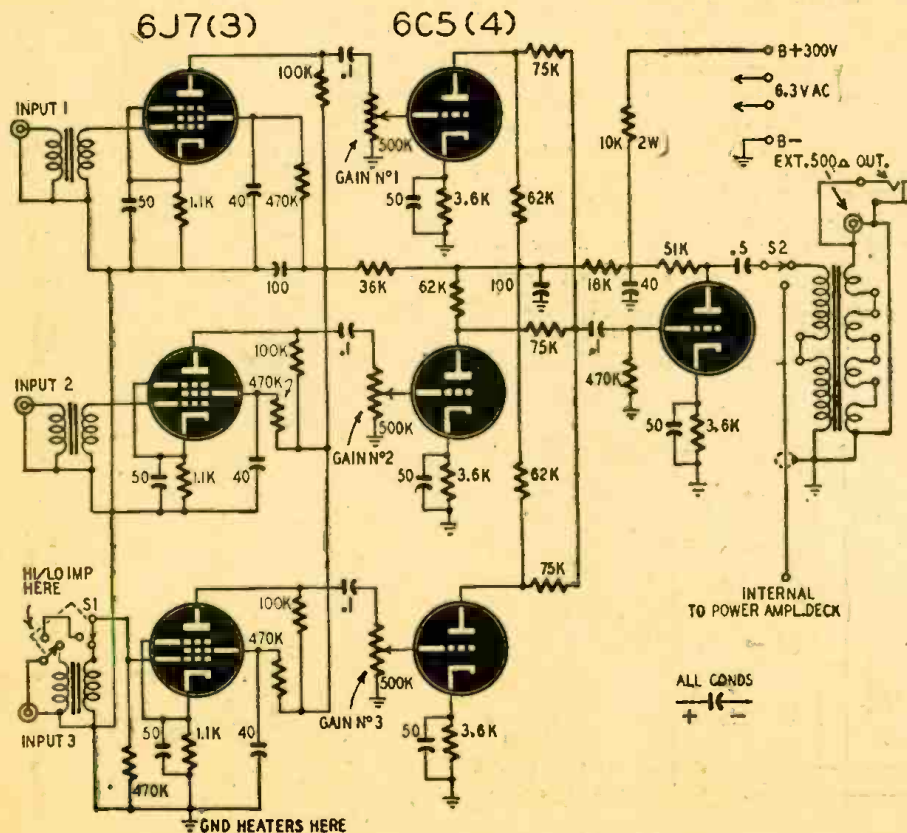

Fig. 1—The three-channel preamplifier and mixer circuit employs transformer output.

the master gain control for the pre-amplifier section. It becomes a volume control for an external input when S-3 is switched to the external position (see Fig. 2). Following this control are 2 triode stages with a 6SN7 tube. Around this amplifier section is a variable negative feedback network. A 5-position switch enables the operator to select any of 4 preset response characteristics. The fifth position provides variable high- and low-frequency compensation.

Position 1 is the flat position and the amplifier is flat plus or minus ½ db from 30 to 15,000 cycles.

Position 2 provides an NAB standard recording characteristic (high-frequency increase starting at 1,000 and rising 15 db at 10,000 cycles).

Position 3 is the variable one, with a variable bass control allowing a 12-db boost at 60 cycles and a high boost control allowing a 15-db boost at 8,000 cycles.

Position 4 is a flat position with a low-frequency rise starting at 100 cycles and up 8 db at 20 cycles.

Position 5 has an inductive 50-cycle boost of 20 db to compensate for the low-frequency attenuation introduced in modified constant - velocity recording when playing back with a magnetic pickup. These different characteristics which can be selected at will provide an enormous amount of versatility.

The second voltage amplifier stage is shunt-fed by a high-fidelity driver transformer to the grids of the push-pull 2A3 output amplifier tubes. The grid returns are brought out separately so that the fixed bias on each tube may be adjusted to make the plate currents of the output tubes equal.

This is essential in a high-quality output stage, especially when a high-fidelity output transformer is used. More than a few mills unbalance in the output transformer primary winding will result in a loss of low frequencies, due to d.c. saturation of the core material, and an increase in distortion, due to imperfect cancellation of second-harmonic distortion which would result from a push-pull connection.

The output transformer contains 2 output windings and is of the high-fidelity type with an advertised response flat from 30 to 20,000 cps. The first winding has a selection of voice-coil impedances, from 1 to 20 ohms. The second winding allows various line impedances, from 50 to 500 ohms. The impedance selected was 7.5 ohms for the voice coil output which was brought out to a jack on the panel for connection to a speaker. The 500-ohm line output was brought out to a second jack on the right side of the power amplifier panel.

As it was desired to use Brush RC-20 crystal cutters, an output was coupled directly to the 2A3 plates through 0.5-microfarad condensers, and connected through a telephone-type switch to 2 Jones output plugs.

Metering and monitoring

This switch has 3 positions. In the normal position, it connects the 7.5-ohm winding directly to the output plug. In

the right and left positions, it connects the 2A3's output to cutter plugs 1 and 2, respectively, and simultaneously introduces a 100-ohm resistor in series with the 7.5-ohm output. This allows the speaker to be used for monitoring when recording, without feedback to microphones. It reduces the speaker output to a comfortable level when recording. If headphone monitoring is preferred, the phones may be plugged into the 500-ohm output jack.

The output-level meter is connected across the 7.5-ohm winding and includes a 0-1 milliammeter and a 1N34 ger-

manium crystal diode. The meter is calibrated in terms of the proper voltage for recording with crystal cutters. It reads 6 volts full scale. This indicator was connected to the 7.5-ohm winding because it causes negligible loading on this low impedance, whereas a more sensitive meter would have to be used across the 500-ohm winding or the high-impedance cutter lines. In case low-impedance or 500-ohm cutters are used, the 15-ohm or 500-ohm winding may be connected to the switch in a similar manner.

(Continued on page 66)



Rear view of preamplifier. There is plenty of decoupling capacity.

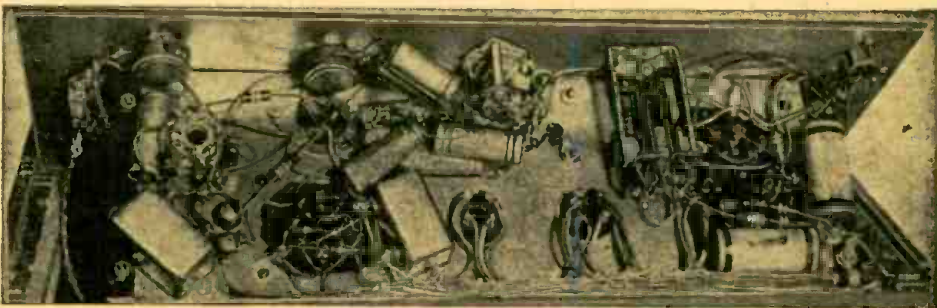

An under-chassis view of the power amplifier in the photo below.

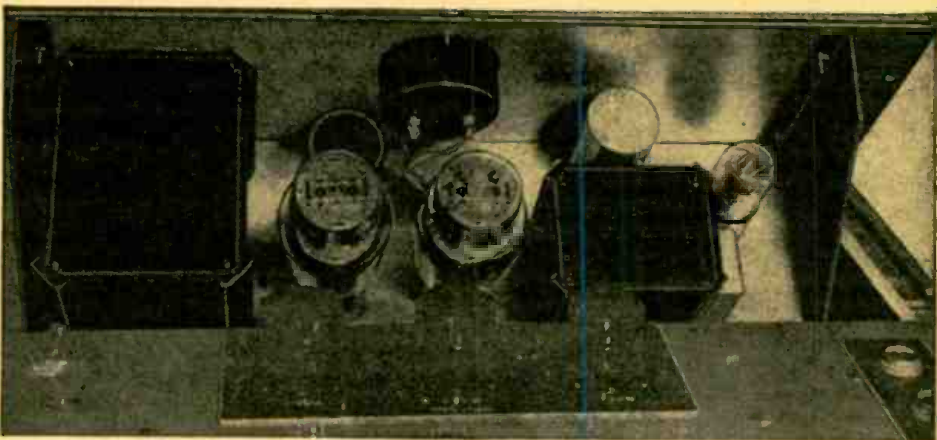

The power amplifier, rear view. Note size of audio transformers.



The power supply has a separate rectifier for the bias voltages.

Magnetism -

Part II - Elements of tape recording

By A. C. SHANEY*



Fig. 1.

WHEN Sir Humphrey Davy in 1820 magnetized a bit of soft iron by running a current of electricity around it, he started Michael Faraday thinking of the possibility of converting magnetism back into electricity. Faraday logically reasoned that if electricity magnetizes, magnetism should electrify.

It took him nearly 11 years to discover that magnetism could produce electricity only if *motion* (work) was involved.

Faraday's discovery (simple as it may seem) made obsolete the Voltaic piles—then the major source of electricity—and opened a whole new electrical era of dynamos, generators, and, incidentally, magnetic recording!

Sixty-seven years later, in 1898, Valdemar Poulsen patented the first magnetic recording instrument, which he named the "Telegraphone." In its original form the Telegraphone was crude, inefficient, and somewhat impractical. It appeared that magnetic recording would never compete with older and comparatively better developed recording processes. As a result, it received very little attention—virtually none from American engineers.

During the last war, investigation of captured enemy equipment disclosed that the Germans had brought the art of magnetic tape recording up to a usable level. Subsequently, stepped-up American war research brought the process out of the laboratories and made it commercially available not only as an excellent recording medium, but one which offers highly desirable and unique advantages over disc recording processes. Fig. 1 illustrates such a typical magnetic tape recording and playback unit.

Basic principles

Sound waves are converted into corresponding electrical energy by a microphone and then intensified through an amplifier. This electrical energy is then

fed to a recording head which converts electrical energy into magnetic fields of varying intensity. A magnetically coated tape is brought into close proximity to the recording head which magnetizes sections of tape with a magnetic pattern similar to the original sound wave. During playback, the magnetized tape is passed close to a pickup head (identical to the recording head which is usually employed for both functions). The magnetic flux on the tape passes through the pickup head and induces minute electrical energy into its coil structure. This electrical energy is then again amplified (by the recording amplifier if desired) and fed into a loudspeaker where electrical energy is converted back into sound waves similar to those originally picked up by the microphone. (This oversimplified explanation is technically correct, but not complete in detail.)

Fundamental elements

The important elements which enter into magnetic tape recording and playback processes include the following:

1. Recording amplifier,
2. Supersonic biasing oscillator and isolation amplifier,
3. Recording head (magnetic modulator),

4. Recording tape (magnetic carrier),
5. Playback head (magnetic detector),
6. Playback amplifier,
7. Erasing head (magnetic obliterator),
8. Supersonic erasing oscillator and amplifier,
9. Tape handling mechanism,
10. Combination switching circuits.

The interrelation of these elements in the recording, playback, erasing, and tape handling processes have been initially indicated, for simplicity's sake, by block diagrams. Fig. 2 shows both the fundamental and auxiliary elements in a typical magnetic recording process.

The following auxiliary recording elements are included:

1. Preamplifier (for amplification of microphone output),
2. Pre-equalization (to equalize the response of the recording amplifier to match the overload response characteristics of the recording tape),
3. Mixing network (to mix the supersonic bias voltage with the audio signal without causing detrimental interaction),
4. Power supply.

Fig. 3 indicates the fundamental and (Continued on page 78)

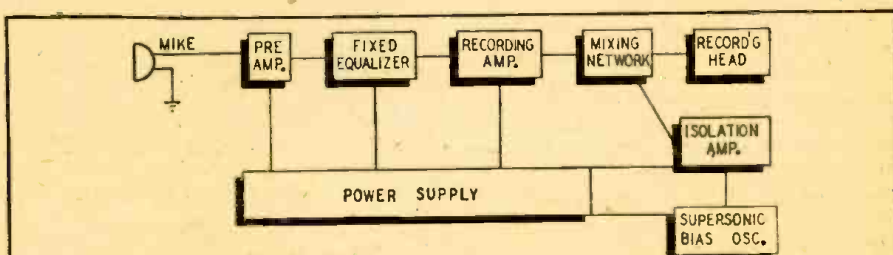

Fig. 2—Block diagram representation of typical recording process.

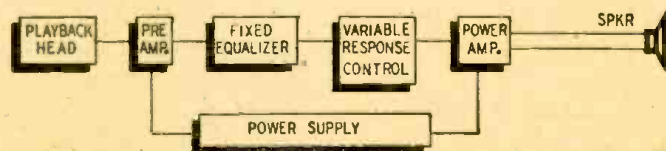

Fig. 3—The arrangement of elements in magnetic playback equipment.



Fig. 4—Elements which are utilized in the magnetic erasing process.

*Chief Engineer, Amplifier Corp. of America.

Signal Calibrator

A 2-frequency crystal oscillator ▶

By I. QUEEN, W2OUX

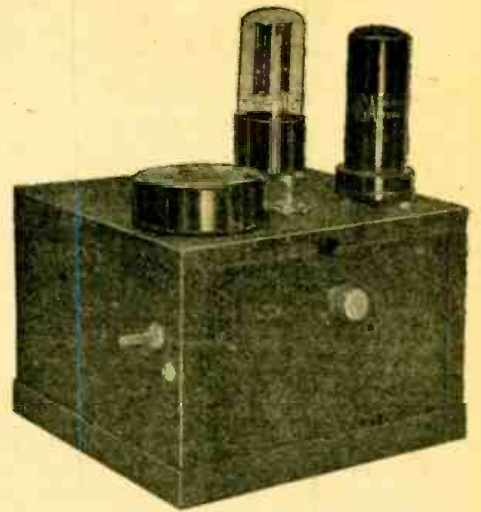

THIS handy signal calibrator can be used to good advantage by servicemen, amateurs, and experimenters. The entire calibrator is built complete with power supply, 5¼ x 5 x 3½-inches, within a metal box, although a box about half the size will accommodate it. Photographs and a schematic are shown.

A 117Z6 voltage doubler provides plate and screen voltages for the oscillator tube, and a small 6.3-volt transformer supplies 6F6 heater. Connect the metal box to B-minus through a condenser and not directly, to avoid possibility of a short when connecting it to a grounded circuit.

Two frequencies are available: 100 kc and 2 mc, determined by the toggle switch at the top of the box. Surplus 100-kc crystals are now on the market at very low prices. Generally the frequency is slightly on the high side of 100 kc, and it can be tuned exactly by a parallel condenser of about 35- μ mf maximum capacitance. This is done by listening to harmonics of the crystal on a short-wave receiver. The 100th harmonic will fall near the 10-mc signal of WWV. The parallel condenser is then adjusted until the 2 signals zero-beat in the receiver. (The crystal used here was found to be so nearly exact that a condenser was not necessary.)

A Hartley circuit is used for the 2-mc signal. The coil is close-wound with 60 turns of No. 28 enameled wire on a ½-inch form. The cathode tap is at 20 turns from the cold end. This coil is slug-tuned. A 650- μ mf ceramic condenser is connected across it for better stability of the harmonics in the ultra-high range. Final tuning to 2 mc is by adjusting the slug which extends through the metal box. It is done by zero-beating the 5th harmonic with the 10-mc signal from WWV. The 8-millihenry choke coil shown in the schematic is not necessary when the Hartley circuit is used. Since it is necessary when the crystal oscillator is used, however, it is left in the circuit at all times.

The power supply is only partly filtered, leaving sufficient modulation to produce a low hum for listening on a receiver which does not have a beat oscillator.

This calibrator has many uses. A broadcast receiver can be lined up and the dial calibrations checked at multiples of 100 kc, 600, 700, 800, etc. A piece of shielded wire can be connected between the antenna post of the receiver and the output terminal of the calibrator, or the small aerial fixed to most small sets can be used. Amateur variable-frequency oscillator rigs and monitors can be calibrated accurately at 100-kc intervals. High-frequency sets

can be aligned or calibrated by listening to the harmonics from both fundamental signals.

To determine the frequency of a signal, the nearest harmonic of 2 mc should be tuned in first. Because of their wide separation, there should be little trouble in determining which harmonic it is. Then, for closer work, the 100-kc oscillator is turned on and the intervals are counted until the unknown frequency is reached.

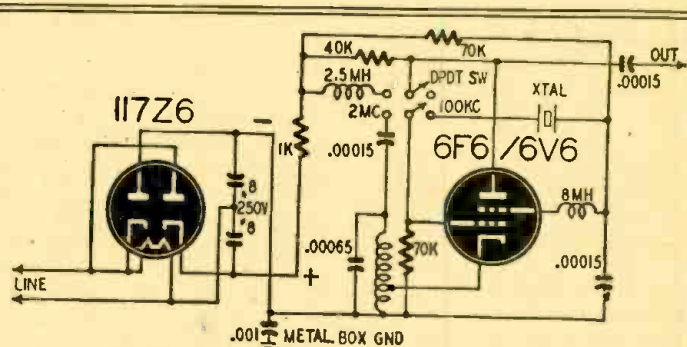

The signal calibrator consists of a crystal and Hartley oscillator.

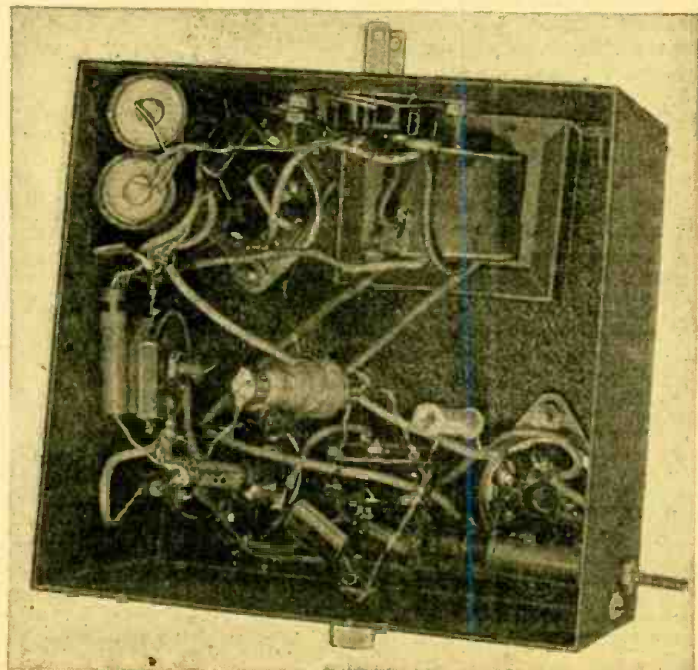

Under-chassis view. The Hartley coil is at the lower right corner.

FM and Television Design

Part I—Tubes and circuits as used in high-frequency r. f. amplifiers

By MILTON S. KIVER

THE current swing is toward the high and ultra-high frequencies for commercial broadcasting. The new FM band extends from 88 to 108 mc; television starts at 44 and reaches up to 216 mc. These ranges include only those frequencies which now have commercial broadcasting. Naturally, other commercial work is being done on frequencies much higher than 216 mc. Color television is but one instance.

When we examine the circuits of receivers designed for these higher frequencies, we encounter many design features which differ from the conventional design of the low-frequency, standard AM receiver. The experimenter who de-

sires to construct high-frequency receivers and the serviceman who is going to repair high-frequency sets must understand why certain circuits assume the form they do. In this article we will analyze the more common modifications to determine their advantages over their low-frequency counterparts.

circuit and its loading resistor. (See Fig. 1.) To get a wide-band characteristic, loading of the tuned circuit is necessary, for as we load such a circuit, we flatten its response. A uniform 6-mc response requires loading resistors from 2,000 to 10,000 ohms. Since the tuned elements themselves, without the shunting resistor, have an impedance considerably greater than the resistor, placing the two in parallel will result in an over-all value which does not differ much from the value of the resistor. The value of shunting resistor, therefore, should be as high as possible to maintain high circuit impedance. It is not so obvious that the value of R for any desired band width is governed directly by the shunting capacitance of the circuit.

In any amplifier, the total capacitance across the circuit (whether it be a plain load resistor or a coil) is the sum of any inserted capacitances, plus the wiring capacitance and interelectrode capacitance of the tube. In low-frequency circuits it is possible to disregard the tube interelectrode and wiring capacitances and consider only the physically inserted capacitor. At the high frequencies, however, there is little or no inserted capacitance and we rely solely upon the tube and distributed wiring capacitance to resonate the coil.

electrode capacitance, the greater the L to C ratio, the higher the shunting resistance and, as a final consequence, the higher the stage gain. Thus, through the very fact that at the higher fre-

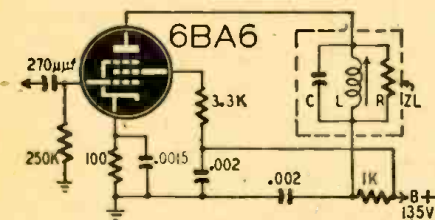

Fig. 1—Components of the r.f. plate load.

quires to construct high-frequency receivers and the serviceman who is going to repair high-frequency sets must understand why certain circuits assume the form they do. In this article we will analyze the more common modifications to determine their advantages over their low-frequency counterparts.

Miniature tubes

The miniature tube is a familiar sight these days. Its advantages are compact size, lower interelectrode capacitances, and higher mutual conductances. The connecting leads within the tube are short, reducing internal losses. Finally, most of the miniature tubes have no formal base, with its attendant leakage losses. This is especially significant as we increase the signal frequency. In television circuits, band widths extend for 4 to 6 mc. The higher mutual conductance and lower interelectrode capacitances of the miniature tube improve amplification. To see how both these quantities tend toward improved response, remember that the gain of an amplifier is equal to the product of the mutual conductance of the tube and the load impedance. Mathematically, this is expressed as: $\text{Gain} = g_m Z_L$. A high value of g_m results in a high stage gain. In a wide band r.f. or i.f. amplifier, Z_L is the impedance formed by the tuned

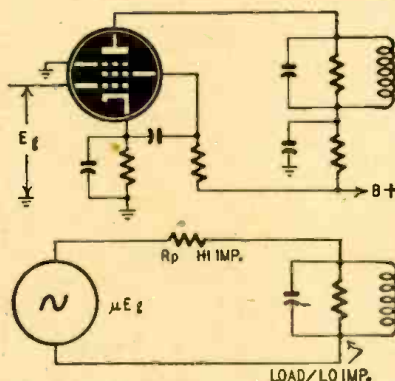

Fig. 2—Action of pentode in h.f. circuit.

Amplifier gain, as we have seen, is dependent upon tube g_m and load impedance Z_L . Load impedance is determined mainly by the shunting resistor, the resistor which is needed to broaden the circuit response. The value of the load resistor (for any given band width) is, in turn, determined by the L to C ratio of the tuned circuit. Consequently, the smaller the tube inter-

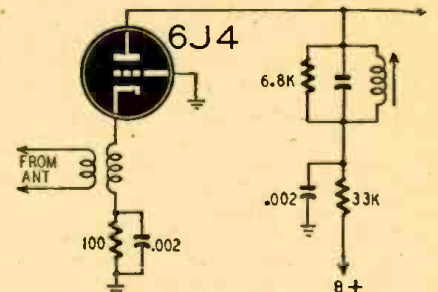

Fig. 3-a—An r.f. grounded-grid amplifier.

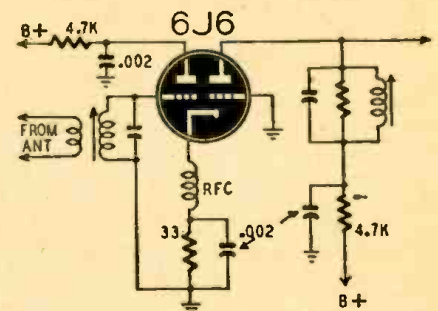

Fig. 3-b—Cathode coupling with dual triodes.

quencies the tube interelectrode capacitance assumes greater importance, we find that it must be given more attention as a circuit element. The miniature tubes, because of their smaller element size, have less interelectrode capacitance. Use of a smaller tube also results in shorter leads from the elements to the circuit. This is often just as beneficial as reduced internal capacitance.

The resurgent triode

Several years ago the triode was regarded as passé so far as the modern superheterodyne receiver was concerned. Yet today we find triodes used extensively in the high-frequency sets coming off the assembly line. In the RCA Model 630TS 10-inch television receiver, 3 double triode tubes (6J6's) are employed in the r.f. section. In the Philco FM receiver, a double triode (7F8) is used as a high-frequency oscillator and mixer. The triode, far from being obsolete, is coming back stronger than ever. Many ask, "Why?"

The reasons are these: In a sensitive receiver, tube and circuit noise are most important in the r.f. amplifier and

mixer stages. Every tube and resistor in a circuit generates a certain amount of noise due to the random motion of electrons within them. In a resistor this is known as *thermal noise* or *thermal agitation*; in a tube it is known as the shot effect. The amount of noise voltage produced is not very large, generally less than 15 microvolts. This voltage is important in the r.f. end of the receiver because many signals entering the system may be of the same order of magnitude as the noise voltages or not much greater. The noise voltages, then, must be kept as small as possible and the signal be given maximum amplification.

The tube generating the smallest amount of internal noise is to be preferred. The noise generated in a tube varies in direct proportion to the number of grids in that tube. Thus, the noise energy produced by a pentode is about 3 to 5 times as great as that by a triode. The ratio between the noise voltages of pentagrid converters and triodes is even greater. Another impor-

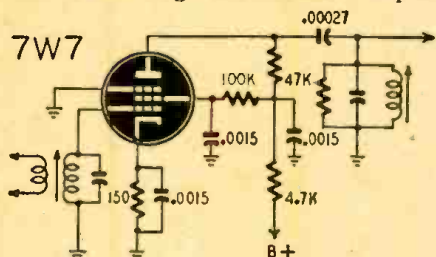

Fig. 4—High-frequency r.f. pentode amplifier. Important fact is that the noise output of a tube operated as a converter (or mixer) is always greater than the corresponding noise output when the tube is used as a straight class-A amplifier. Thus, if we use an r.f. amplifier with a low noise factor and high amplification, we can boost most incoming signals to the point where they override easily the more bothersome converter or mixer noise.

Pentodes have always been considered superior to triodes as amplifiers. This, of course, in standard AM receiver circuits. In receivers designed for television, the situation is slightly different. First, the newer types of triodes designed for high-frequency operation have a greatly reduced grid-to-plate capacitance. This makes them less likely to oscillate. Second, the gain of a triode in television circuits is comparable to that of a pentode. This behavior is explained when we examine the conditions that exist in wide-band amplifiers. At broadcast frequencies the impedance of the resonant circuit (in the output of a stage) is high since it is sharply tuned and not loaded down by any external resistors. In a television circuit the loading resistors (to produce the desired band spread) reduce the impedance of the tuning circuit to a value somewhere between 2,000 and 10,000 ohms.

Fig. 2 shows what happens if we use a pentode tube with a circuit of this type. The actual circuit is shown in Fig. 2-a and the equivalent circuit in Fig. 2-b. The amplified signal divides between the plate resistance of the

pentode and the tuned output circuit. Since the pentode's internal resistance is considerably greater than the impedance of the tuned circuit, most of the amplifier signal is lost in the tube. Consequently, the over-all gain is low. It thus becomes possible to get approximately the same gain from a triode as a pentode. Also, the triode generates less noise than a pentode. In areas where the received signal strength is low, this is an important factor.

In FM receivers the tuned circuits have fairly high impedances. A pentode as an amplifier in the r.f. stage is capable of providing more gain than a single triode. However, with the new double triodes such as the 7F8 or 6J6, we can achieve as much gain as a pentode with approximately the same number of components. In addition, we must not forget the low noise factor of the triode.

R.F. amplifier circuits

In using triodes as r.f. amplifiers, several circuit arrangements are possible. In Fig. 3-a, the tube is connected as a grounded-grid amplifier. The grid is grounded and the input signal is fed into the cathode. In an arrangement of this type the grid remains at ground potential, and the cathode potential fluctuates in accordance with the input signal. Since the plate current of a triode is determined by the potential difference between the cathode and grid, it makes little difference which electrode is kept fixed and which fluctuates. There is an added advantage in grounding the grid since it acts as a shield between the input and output circuits

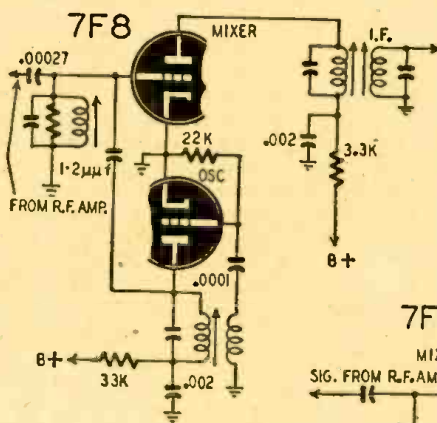

Figs. 5-a, 5-b — Converter circuits with dual triodes. Both grid and cathode injection are employed.

and prevents the tube from oscillating.

In Fig. 3-b, a dual triode (either a 6J6 or a 7F8) is functioning as a cathode-coupled amplifier. (If a 7F8 tube is used, tie both cathodes together.) The input signal is fed into the grid of the first triode. The varying current passing through the un-bypassed inductance causes the cathode voltage to vary with respect to ground. Since this cathode is common to the second triode, the plate current of this tube will vary. Note that this second tube is connected as a grounded-grid amplifier. The gain

of this combination is as good as a single pentode. The double triode, however, has the advantage of having a high input impedance and of isolating the following oscillator, thus preventing any of its voltage from feeding back to the antenna and radiating to nearby receivers.

In such amplifiers, the antenna circuit is well isolated from the mixer and the amount of oscillator signal radiated to nearby receivers is negligible. With a single intervening pentode, the isolation is not quite as effective and radiation may occur. This can be particularly troublesome to nearby television receivers.

A pentode r.f. amplifier is illustrated in Fig. 4.

Converter or mixer circuits

A common combination is the use of a double-triode for mixing and generating the oscillator voltage. Typical diagrams are shown in Figs. 5-a and 5-b. The oscillator voltage can be injected either at the mixer grid or the mixer cathode. The incoming signal is applied, as usual, to the mixer grid. Still a third variation of the circuit of Fig. 5 is the cathode-coupled mixer shown in Fig. 6. The incoming signal from an r.f. amplifier is coupled into the grid of one of the triodes of a 6J6 tube. Due to the impedance of the coil in its cathode circuit, the cathode potential varies with respect to ground. The second triode of the 6J6 is the oscillator with the grid coil coupled to the inductance in the cathode circuit. The intermediate frequency appears in the plate circuit of the first triode, from which point it may be passed on to the i.f. system.

In many FM receivers and all television sets, the oscillator frequency is above that of the signal. The difference between the two is of course equal to the i.f. Inserted capacitance is reduced to an absolute minimum and in most instances forms only a small portion of the total capacitance across the resonated coil. The remainder of the capacitance is that of the tube and wiring. Note that this reduction in in-

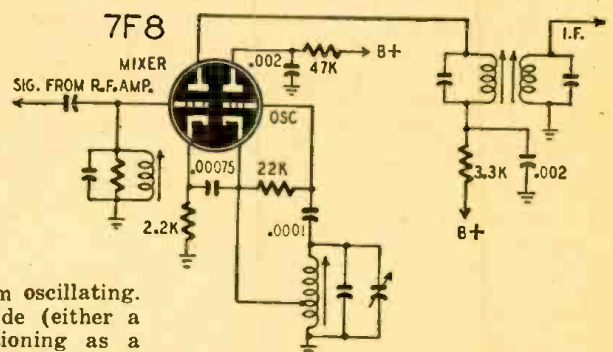

serted capacitance is necessitated by the high frequency and the desire to obtain as high an L/C ratio as possible to increase the output. As the set warms up, especially the oscillator circuit, the interelectrode capacitance changes enough to cause an appreciable drift in oscillator frequency. There are 2 ways to minimize this drift: First, we can in-

(Continued on page 86)

250-Watt FM-AM Transmitter

PART V—The modulator, modulation indicator, and power supply

By HARRY D. HOOTON, W3KPX

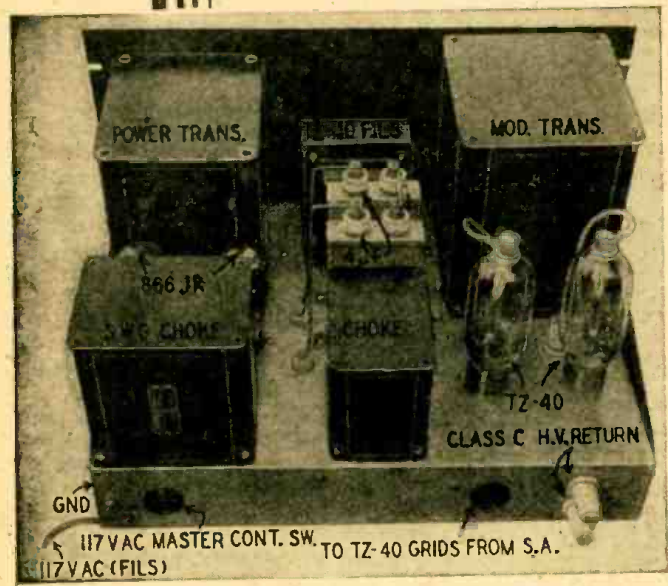

The power supply and modulator are mounted in one chassis unit.

THE modulation percentage indicator is a dual-diode type similar to the circuits which have been described in amateur publications from time to time. The circuit consists of a 6H6 rectifier tube, and 0-1 d.c. milliammeter, a tuned circuit, and a few resistors and capacitors, as shown in Fig. 1. Operation of the modulation indicator is very simple: The pickup loop, a single turn of insulated wire, is placed against the transmitter cabinet side 8 to 10 inches away from the final amplifier tank coil. The transmission line from the pickup loop to the modulation indicator tuned circuit *must* be shielded to prevent r.f. pickup from the buffer stages; if r.f. from the buffer finds its way into the unit, false modulation percentage readings will be indicated. With the switch thrown to the right, the 0-1 d.c. milliammeter will indicate the carrier level. Adjust the variable resistor until the milliammeter indicates exactly 1 ma. Once set, the adjustment will remain unless the coupling loop in the final amplifier compartment is moved (if operation on several bands is contemplated, the necessary r.f. pickup may be obtained by wrapping 3 or 4 turns of well-insulated wire around 1 of the feeders to the antenna instead of using the loop). Now, throw the switch

to the right; the meter should return to zero with the carrier on. If the meter does not return to zero with the carrier on, this indicates noise or modulation, possibly hum, on the carrier. With the meter at zero, modulation will be indicated by a lift of the needle; modulation at the 100% level is indicated when the needle swings from zero to 1 ma during speech operation. If the needle swings past 1 ma, over-modulation is indicated. With the compression in effect, the needle will rise rapidly to 0.7-0.8 ma but will become "stiff" for the remainder of the scale. As a further check on the modulation percentage, the class-B, TZ-40 modulator plate current milliammeter is shunted to indicate approximate percentage of modulation; this feature will be discussed later.

The class-B, TZ-40 modulator stage (Fig. 2) is very simple. The driver transformer is mounted on the speech amplifier chassis. Connections between the driver transformer secondary and the TZ-40 grids are made with twin-conductor shielded cable and plugs. The shield serves as a common conductor. As the two chassis are mounted in the rack one directly above the other, the

twin-conductor cable is only about 8 inches in length. The modulation transformer is a 500-watt unit designed to match the TZ-40 plates to a variety of r.f. load values. Any good modulation transformer with the proper impedance values and rated 175 watts or higher will be suitable.

The modulator chassis also includes the modulator power supply. The power unit consists of a power transformer rated at 2,320 volts a.c., center-tapped, at 300 ma, a pair of 866 Jr. rectifiers, 2 filter chokes, two 4- μ f filter capacitors, and the necessary filament transformers. The d.c. voltage output from the power supply unit is 1,000 volts at 300 ma.

The modulation meter

As mentioned above, the TZ-40 plate-current milliammeter is shunted to indicate approximate modulation percentage. To make the shunt, connect in the TZ-40 plate-current line a d.c. milliammeter with a full-scale rating of 250 ma. Using an oscilloscope for measurement purposes, note the modulator plate current at 100% voice modulation of the carrier. With 250 watts input to the final r.f. amplifier, the modulator plate current will kick up to about 150 ma at 100% modulation, the exact value depending upon the compression control setting. Now, remove the 250-ma meter from the modulator plate-current line and connect in series with the 250-ma unit a variable resistor of about 10,000 ohms, 10 watts, and another d.c. milliammeter of 100-ma, full-scale rating which has been heavily shunted by a length of shunt wire. It is best to have the insulation removed from the shunt

(Continued on page 42)

Fig. 1 — The modulation percentage indicator is also usable to monitor the transmitter and adjust compression.

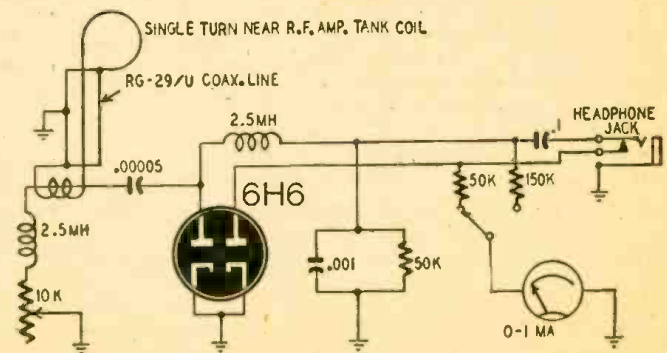

Acceleration Pickup Tube

By S. R. WINTERS

A NOVEL electronic tube for determining precisely the swiftly changing accelerations of an airplane (or various points on a plane) in flight has been designed by Dr. Walter Ramberg of the National Bureau of Standards. This brand-new addition to the audion family bears the label *vacuum-tube acceleration pickup*. It has already been applied in measuring accelerations of flesh-and-blood pilots, as well as dummies, when they are subject to violent changes in speed during crash landings or when thrown from pilot seats in speedy jet-propelled aircraft.

This new electronic tube, 6 years in the making, is a double diode which has a surface resemblance to the garden variety of radio tubes. In design it represents a material departure. This tube utilizes the effect of accelerations on the relative position of the electrodes in the diode; in conventional designs this tendency is restrained because it would cause electrical noise or "microphonics." The new addition to the tube family has a fixed, indirectly heated cathode with 2 plates, one on either side. These plates are mounted, so to speak, like rubber bands in that they "deflect in response to acceleration normal to the plane of the plates." This reduces the plate resistance of one diode and increases that of the other, producing a change in the plate current in proportion to the acceleration. The ratio of the 2 currents is registered on a conventional oscillograph.

The above-mentioned elastic mounting of the plates is intended to afford a fundamental mechanical vibration frequency of 800 cycles a second—assurance that this electronic tube will record accelerations with frequencies up to 200 cycles per second. Practical trials at the Bureau of Standards have shown that this latest tube (of which not quite a hundred have been constructed) has the desired natural frequency with an output in proportion to acceleration normal to the plates. For instance, the output for an acceleration of the order of 10 gravities is of adequate magnitude to register directly on a conventional oscillograph, without requiring an auxiliary amplifier.

Calibration procedure

Tubes were calibrated up to accelerations of well over 20 gravities on a spinning table. A very interesting method was used to calibrate it at 2 gravities. The tube was simply placed on its side

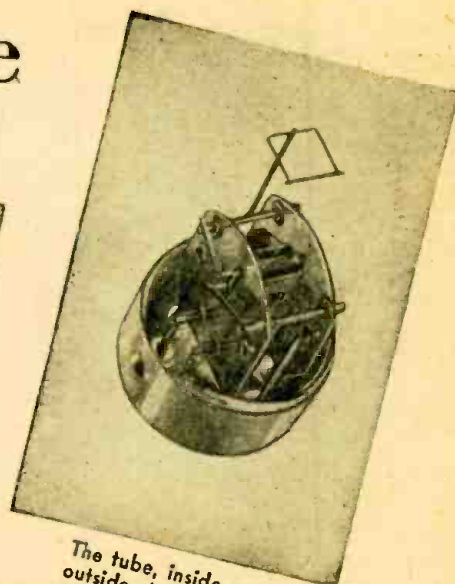
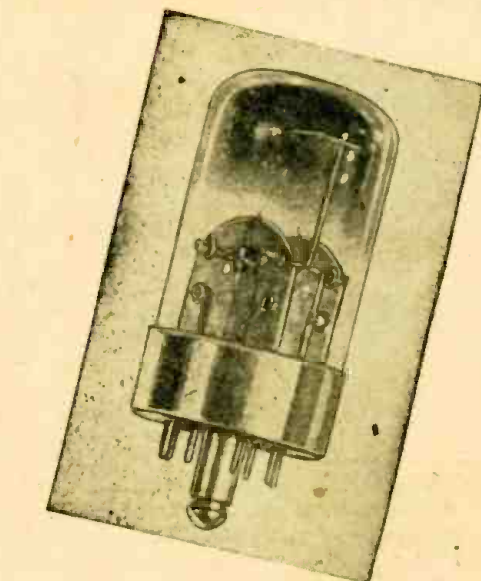

The tube, inside and outside. Acceleration plates are inside the large baffle plates.

with the plates in a horizontal position, then turned through 180 degrees, so that the top plate was on the bottom. In the first position the top plate P1 is bent toward the cathode with the force of gravity and P2 bent away from it with the same force. Thus the current through P1 is greater, and through P2 less, than with the tube in an unaccelerated position, such as it would be if upright and stationary. With the tube turned so that P1 is the bottom plate and P2 the top one, the condition is reversed. The ratio of currents through the 2 sections of the tube, as measured in the Wheatstone bridge circuit of Fig. 1, corresponds to an acceleration of 2 gravities.

The fundamental frequency was fixed through trial-and-error procedure by connecting the Wheatstone bridge output to a cathode-ray oscilloscope, gently tapping the pickup with pencil or finger, and then matching the output on the oscilloscope with the output of known frequency of an audio-oscillator.

In common with characteristics of other vacuum tubes, the new tubes had certain inherent drawbacks. The zero or reference point, for example, of most of the tubes tested, displayed a tendency to drift gradually with time. Furthermore, a 15-minute warming up period was necessary to attain equilibrium. However, we are told that these drawbacks should not be significant in registering swiftly changing accelerations over a brief period of time.

Use of this novel electronic tube is suggested in services in which advantages of high output, high capacity, and linearity outweighs such drawbacks as zero-point drift, warm-up time, relatively large power consumption of 7 watts for the tube and Wheatstone bridge, and the necessity of filtering to displace natural frequency response.

The high output, as well as the high natural vibration frequency, of this tube renders it feasible to record swiftly without an amplifier. This is

obviously a desirable factor in flight testing of small aircraft, where space and weight are rationed. Likewise it makes for less complicated laboratory tests when amplifying channels are not readily accessible.

The high capacity of the tube is desirable for registering accelerations over a broad range and in avoiding damage from abrupt high accelerations. The linear values of this pickup are such as to allow the filtering out of high-frequency response, irrespective of amplitude, and afford a record proportional to acceleration.

To summarize, the vacuum-tube pickup is another electronic research tool. It

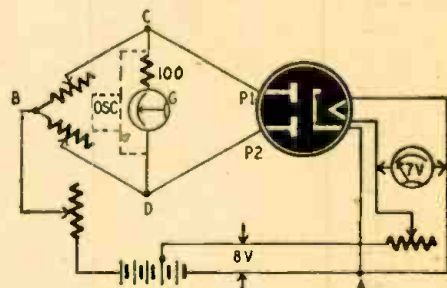

Fig. 1—How the pickup tube is hooked up.

is a convenient means for measuring accelerations from 5 to 40 gravities. It combines high sensitivity with high natural frequency, making it possible to record rapidly varying accelerations directly without the complication of an intermediate amplifier. Its disadvantages are that it is more subject to zero drift; requires a warming-up period of about 15 minutes before reaching equilibrium, and requires a filter to remove response at its natural frequency.

The development of this important electronic tube is credited largely to the Bureau of Standards, although Sylvania Electric Products, Inc., and the Army and Navy were co-operative agencies when a "birth certificate" for the tube was sought in 1941.



Radio Set and Service Review

Sentinel Treasure Chest Model 286 PR

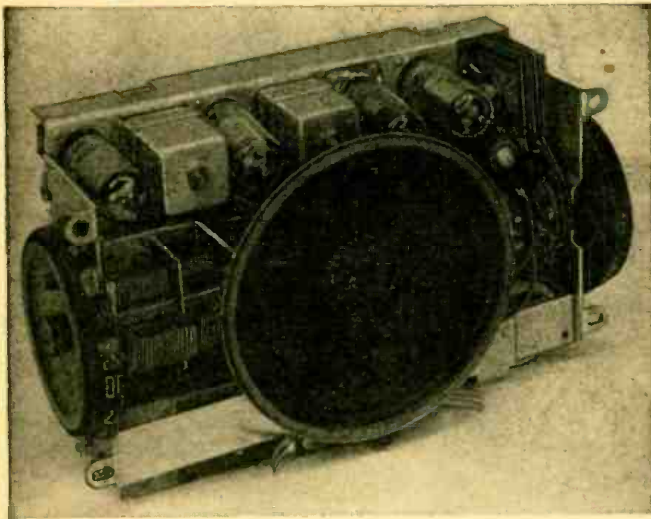

THE Sentinel Treasure Chest—probably so-called because its 2-tone plastic cabinet resembles milady's jewel box—is a 4-tube, a.c.d.c.-battery portable broadcast receiver. It is installed in a maroon case with a gold-plated speaker grill, the color combination harmonizing well with the glossy black hinged lid and back cover.

The case is 8¼ inches long, 4½ inches high, and 5 inches deep. It weighs only 5½ pounds complete with batteries. When it was first placed on the market, it was announced as the "tiniest" 3-way portable yet offered to the public. Its size, little larger than the smallest battery portables, makes it very convenient to carry on long trips.

Two edge-mounted controls are a special feature of the set. The slow-motion dial at the right of the set simplifies tuning. Volume control and power selection switch are at the left, mounted on concentric shafts. The large thumb-operated control discs operate easily with fingertip pressure.

The Treasure Chest brings in local and distant stations with good volume and selectivity, though no preselection is used. This—combined with the slow-motion action of the tuning dial—makes tuning easy (Continued on page 82)

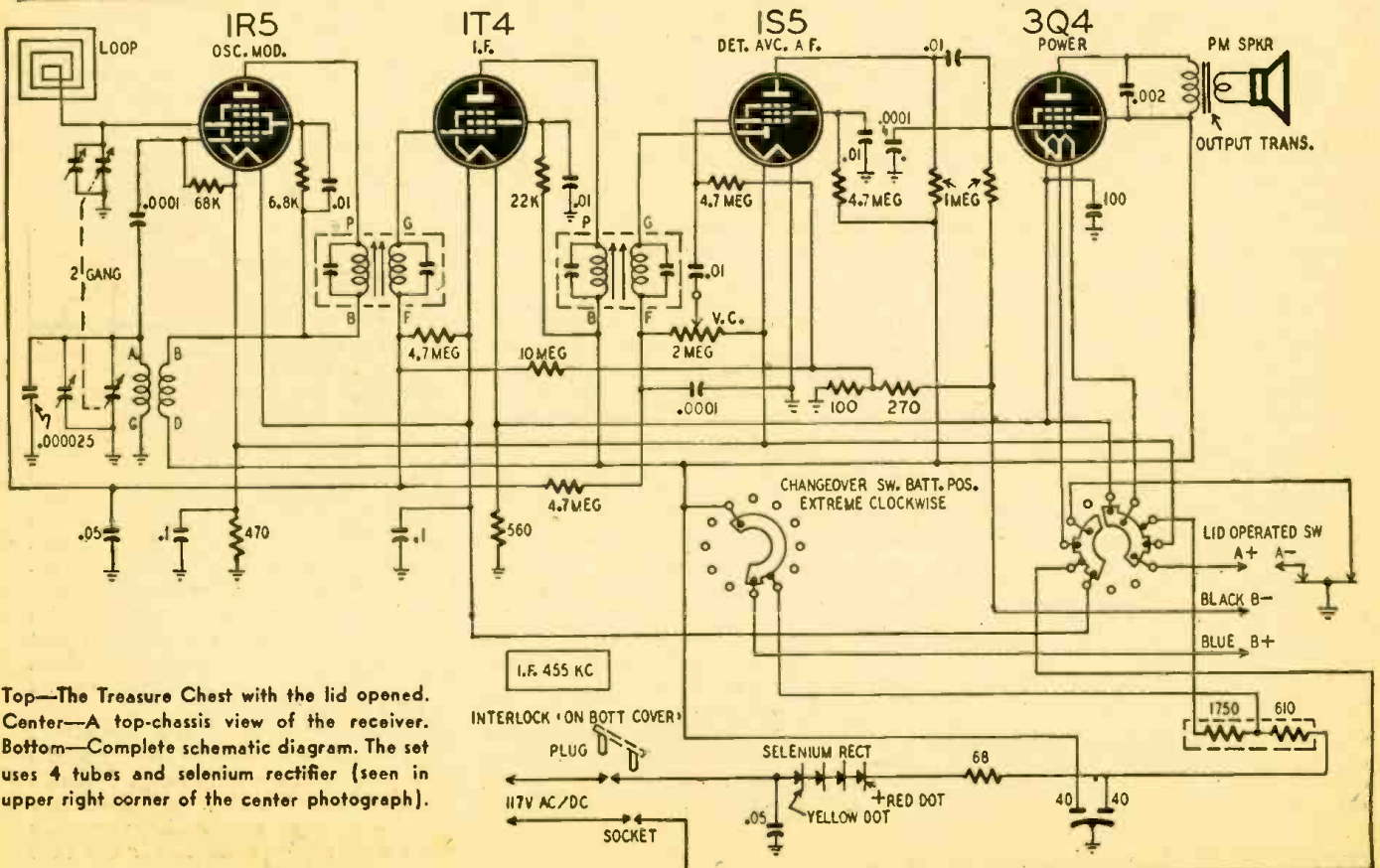

Top—The Treasure Chest with the lid opened. Center—A top-chassis view of the receiver. Bottom—Complete schematic diagram. The set uses 4 tubes and selenium rectifier (seen in upper right corner of the center photograph).

Transatlantic News

By Major Ralph W. Hallows

RADIO-CRAFT EUROPEAN CORRESPONDENT

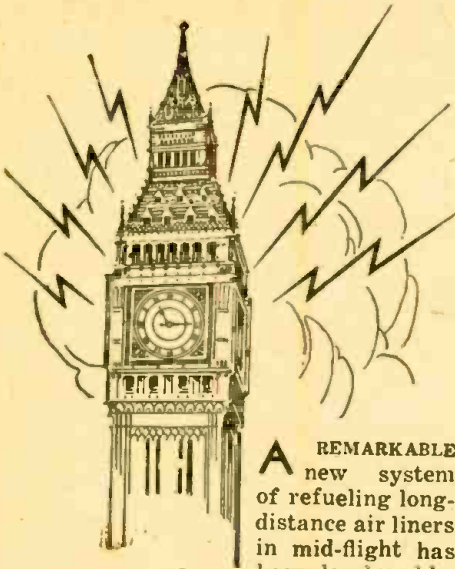

A REMARKABLE new system of refueling long-distance air liners in mid-flight has been developed by

British South American Airways. Successful test flights have been made every week during this summer on the South Atlantic route, and it is intended to employ the new method on the North Atlantic route next year. Bound for Bermuda, the air liner has been leaving London carrying 7 tons less gasoline than needed for the nonstop trip. The 7 tons saved leave room for an extra 7 tons of profitable freight. The basis of the whole system is an entirely novel application of radar aids. Here is how it is done.

You remember that highly successful wartime radar setup known as Rebecca-Eureka? Eureka was a radar beacon dropped with parachute troops and installed by them at the point required. It contained a transmitter, which emitted pulse-trains when triggered off by impulses sent out by Rebecca. In the war Rebecca was airborne and served to enable the aircraft carrying it to "home" on Eureka. In the refueling system now being developed, a modified form of Eureka is also airborne, being carried both by the air liner and by the flying tanker from which it is refueled.

On leaving the London Airport, the air liner sets a course for the Azores, using the Gee radar navigational system for the first 300 miles and Consol or Loran after that, if weather conditions make position-fixing by direct methods impossible. The flying tanker is based on Santa Maria in the Azores. The course of the liner having been plotted by radio and radar, a rendezvous (38° 30' N, 29° 0' W, southwest of Fayal, is typical) is decided upon and radioed to the liner, the expected time of meeting being also given. Each aircraft carries both Rebecca and Eureka. An hour before the predicted foregathering, each switches on Rebecca. They thus "home" on each other and always know each other's position, regardless of cloud or fog. In due time visual contact is made and the refueling begins. The first contact is always made with a weighted line trailed by the tanker, which must be a good conductor of electricity. Thus any potential difference between the two aircraft is wiped out, and there is no fire risk from sparks during the refueling.

Thanks to radio and radar, refueling in the air has been accomplished without the slightest hitch on every trip. The system has enormous possibilities and may well be applied to much longer flights. There is, for example, no reason why a passenger liner or a freighter should not be refueled two or even three times in the course of a long, nonstop journey. A much smaller amount of gasoline would then be carried on starting, and the take-off weight of the aircraft could be made up of a smaller proportion of unprofitable fuel and a larger proportion of highly profitable passengers and goods. Once again the thermionic tube offers to mankind an inestimable benefit!

V. h. f. police radio

Some months ago I described a v.h.f. diversity-transmission, diversity-reception system which had been devised to enable police automobiles to keep in constant touch with their headquarters. The system was originally developed by technicians employed by the British Home Office. It has proved completely successful and is now being installed over the greater part of this country. So big is the demand from police headquarters all over the country that the Marconi Company has found it worthwhile to design and market a special range of transmitting and receiving equipment for use both at police centers and in patrol automobiles. The automobile set, operated from the car battery, is so compact that both transmitter and

receiver are easily stowed in the rear luggage compartment. The microphone, receiver, and controls are on the dashboard. The working carrier frequencies are between 75 and 100 mc. The carrier frequency of the stationary set at headquarters is crystal-controlled. The crystal frequency is low, but a succession of tube circuits select and amplify the 18th harmonic, which becomes the carrier frequency, delivered with a power output of 50 watts to the antenna. Both transmitter and receiver use the same antenna and are placed close to it to minimize feeder length. Remote control may be used up to 3 miles over ordinary telephone lines. This facilitates diversity-transmission and reception. The automobile part of the equipment includes a loudspeaker for traffic control purposes. This can be connected to the microphone and the a.f. amplifier with a switch on the dashboard. The mobile transmitter is also crystal-controlled and has a power output of 10 watts.

Radio taxicabs

The university town (a place in England is not as a rule called a city unless it is the site of a cathedral) of Cambridge has a large population and extends over a considerable area. Some of the colleges are a mile from one another, and most of them are the best part of that distance from the railroad depot. The biggest fleet of taxicabs in Cambridge is owned by a lady, who used

(Continued on page 81)

PN-TYPE CRYSTAL PICKUP ▶

The new Brush Model BR-903 pickup cartridge has several outstanding features. It uses a crystal of the PN type (ammonium dihydrogen phosphate) which, unlike rochelle salt, is very rugged. It withstands humidity of 90% and temperatures of about 160° F continuously without harm. In fact, PN crystals can be immersed in boiling water for 10 minutes without damage.

The new cartridge operates with a needle pressure of only 1/2 ounce and has low needle talk. Its sapphire stylus is replaceable.

A load of 5 megohms is recommended. The total cable capacitance between cartridge and load should be kept low, for example 100 μf. This will allow about 2 feet of shielded cable. Under these conditions approximately 1 volt will be obtained across the load at 300 cycles.

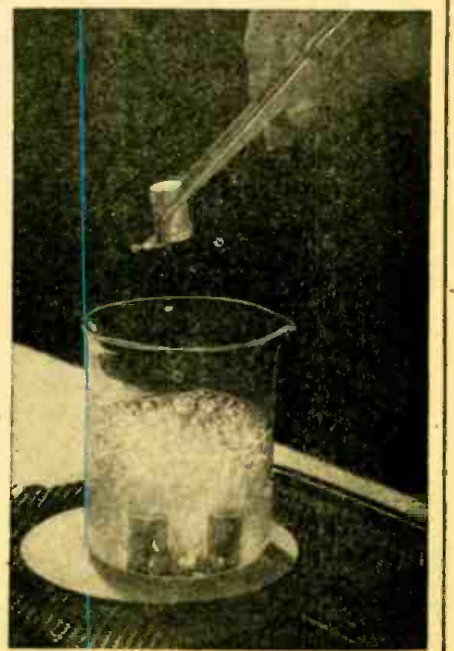

FOR FASTER SOLDERING

2 NEW WELLER
SOLDERING GUNS

with

Solderlite



The new Weller Soldering Guns with Solderlite plus the fast 5 second heating help make service work more profitable for radiotelevision and appliance service men, electrical maintenance men, electric motor rewinding and repair shops automotive electrical service. A useful and time-saving tool for laboratory workers, experimenters, hobbyists, telephone installation and maintenance men. See your radio parts distributor or write for bulletin direct.

824 Packer St., Easton, Pa.

WELLER
MANUFACTURING CO.

In Canada: Atlas Radio Corp., Ltd., 560 King St., N. W., Toronto, Ont.
Export Dept.: 25 Warren St., New York 7, N. Y.

A Remote Microphone

INTERESTING new features, mechanical as well as electrical, are found in the *Ultramike* illustrated here. A wireless microphone, sending out a signal on the broadcast band, the unit is entirely self-contained in a case no larger than the ordinary mike stand. The stand contains the 1½-volt filament and 45-volt B-battery as well as the 1-tube oscillator. Another feature is that no screws are used in construction, everything being put together with rivets and tabs.

The circuit is electron-coupled, the screen, cathode, and grid forming a Hartley oscillator. The tapped oscillator coil is tuned to any desired frequency between 1250 and 1650 kc with a variable slug. A plate loading coil is self-tuned roughly near the center of this range. Power is supplied by the plate to an aerial of several feet of wire.

The grid leak, instead of returning to ground, goes to the high end of the 45-volt B-battery through a 100,000-ohm resistor. This is claimed to give more positive oscillation, as current is high when the set is turned on. When oscillation begins, the negative voltage built up on the grid produces normal bias on the grid.

The microphone is a special condenser type, and is connected directly between grid and ground. There is also a grid condenser of .0004 µf in series with the oscillator coil.

A very interesting feature is that the device is intended to be used as carrier-current device. The user is instructed to attach the antenna clip to any convenient radiator, water pipe, electrical conduit or other "ground." Loud signals then will be received on all radio equipment connected to or situated near the same "ground" system, while very

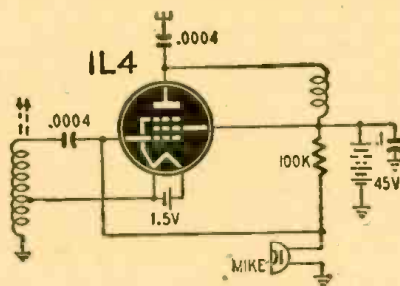

little energy is radiated directly through space. Thus the useful range is increased while danger of interference to radios outside the building is actually reduced.

The Editor obtained the following results in his home:

Three different radio sets in 3 differ-



Two views of the new wireless microphone.

ent rooms in the apartment were tuned to 1200 kc. Then the Ultramike was adjusted with the tuning knob. With the mouth close to the mike and speaking in a rather low voice, the voice came out very well on all 3 different radio sets, although separated by walls (some of steel wire lath).

VERIFIED SPEAKERS

"Let the Guarantee Protect You, Too"

WRIGHT
Inc.

2234 University Avenue

St. Paul 4, Minnesota

SENSATIONAL VALUE



...announcing for the first time

The New Model 247

TUBE TESTER

Tests yesterday's tubes, today's tubes and tomorrow's tubes. The Model 247 features a newly designed *element switching system* designed to accommodate all future tubes as they are announced.

Features: It is impossible to insert the tube in the wrong socket when using the new Model 247. Eight separate sockets are used, one for each type of tube base made. If the tube fits in the socket it can be tested.

The Model 247 incorporates a newly designed element selector switch system which reduces the possibility of obsolescence to an absolute minimum. Any pin may be used as a filament pin and the voltage applied between that pin and any other pin, or even the "top-cap". Please note this is not a variation of the commonly used "floating-filament" arrangement but instead represents a real advance in design, inasmuch as it provides a true "free-point" system. Tubes having tapped filaments and tubes with filaments terminating in more than 1 pin are truly tested with the Model 247 as any of the pins may be placed in neutral position when necessary.

The new free-point system described above permits the Model 247 to overcome the difficulties encountered with other emission type tube testers when checking, Diode, Triode and Pentode sections of multi-purpose tubes, because sections can be tested individually when using the new model 247. The special isolating circuit allows each section to be tested as if it were in a separate envelope.

The Model 247 provides a super sensitive method of checking for shorts and leakages up to 5 Megohms between any and all of the terminals. Continuity between various sections is individually indicated. This is important, especially in the case of an element terminating at more than one pin. In such cases the element or internal connection often completes a circuit.

One of the most important improvements, we believe, is the fact that the 4 position fast-action snap switches are all numbered in exact accordance with the standard R.M.A. numbering system. Thus, if the element terminating in pin No. 7 of a tube is under test, button No. 7 is used for that test. This feature will be appreciated especially by servicemen who, when using other tube testers, have been compelled to first try various positions to locate the correct element and then have had to look up charts in order to learn which pin is used for that particular element.

Model 247 comes complete with new speed-read chart. Comes housed in handsome hand-rubbed oak cabinet sloped for bench use. A slip-on portable hinged cover is included for outside use. Size: 10¼" x 8¼" x 5¼".

ONLY

\$29⁹⁰

20% deposit required on all C.O.D. orders.

MOSS ELECTRONIC DISTRIBUTING CO.

DEPT. RC-11, 229 FULTON STREET, NEW YORK 7, N. Y.

TRANSVISION

Offers Another
Great Value!

Model FM-1

F. M. RADIO

8-TUBE RECEIVER

KIT

covering the entire F.M. Band
(87.5 to 108.5 mc)

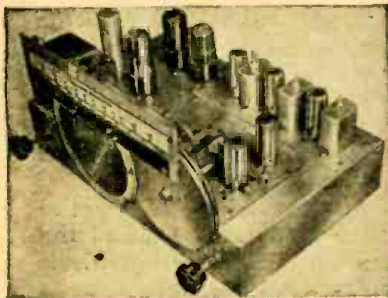

When wired, this KIT makes an F.M. Radio Receiver of the highest quality and fidelity, and of a retail value of from 2 to 3 times the cost of the kit!

No technical knowledge required . . . We provide complete instructions for easy, rapid assembly.

Features:

- Covers entire F.M. Band from 87.5 to 108.5 megacycles.
- NO PERCEPTIBLE FREQUENCY DRIFT from a cold start.
- Complete with wired Transvision FMF-2 tuner front end and Transvision FM 107R IF Amplifier, 10" PM speaker and a matched set of 8 tubes: (3-6AK5, 1-6CA, 1-6V6, 1-6V3, 1-6AL5, 1-6SN7).
- All component parts are of the highest quality.
- For operation on 110 volts, 50-60 cycles AC.

MODEL FM-1 . . . TRANSVISION 8-TUBE F.M. RADIO KIT with Speaker and Tubes. List \$64.95

Beautiful furniture-finish cabinet available at low additional cost.

ALSO . . . BASIC ESSENTIAL PARTS of the TRANSVISION 8-tube F.M. Radio Receiver available separately.

Prices fair traded . . . List prices 5% higher west of the Mississippi River.

See your local distributor, or for further information write to:

TRANSVISION INC. Dept. R. C.
385 North Ave., New Rochelle, N. Y.

WORLD-WIDE STATION LIST

Edited by ELMER R. FULLER

A LARGE part of our observers' time seems to have been spent on the 10- and 20-meter amateur bands during the past few weeks. Conditions on these frequencies have been very good at times during the fall and show signs of very good dx during the winter months. Reports this month have been received from Bill Duggan of Goshen, New York; Orville F. Gardiner of the Veterans Hospital in Palo Alto, California; Charles C. Fox of Evansville, Indiana; Charles O. Lockett of Roselle, New Jersey; Marvin Blasser, W5NFZ, of ??? (I'd like to answer your letter, but no address is given, and I did not find your call in the summer issue of the *Amateur Call Book*); John A. Shanks of Russellville, Tennessee; John Winkler of Big Rapids, Michigan; Dwight Thomas of Waco, Texas; Donald G. Thompson and Carl Slutter of Scranton, Pennsylvania; Central Telegraph Office in Athens, Greece; and the Australian Radio Services.

Australia is now being heard by North American listeners on VLB on 9.54 mc from 0700 to 0815 and at the same times over VLC7 on 11.84 mc. VLA7 on 17.800 mc from 1900 to 2015 and to the west coast over VLA8 and VLC6 on 11.76 and 9.615 mc from 1000 to 1100; and over VLA5 on 15.32 mc; VLB8 on 21.60 mc; and VLG6 on 15.24 mc from 2245 to 2345.

Among the hams heard are TG9RV in Guatemala; KX6USN on Bikini Atoll in the Marshall Islands; VR6AA on Pitcairn Island; KP6AB on Palmyra Island; XADT in Leghorn, Italy; CN8BA in French Morocco; F8MY in Paris; J9CRP in Kwajalein, Marshall Islands; VK9NK in New Guinea.

A transmitter in Burma has been heard in eastern United States on 9.540 mc at 0845 EST and ZIK2 in the British Honduras on 10.600 mc at 1330. An Italian transmitter has been heard on 15.120 mcs at 0730 hours. OTC in Belgian Congo from 2100 to 2300 hours on 9.745 megacycles. A station thought to be in Moscow has been reported to us on about 15.200 megacycles at about 2300 to 2430 hours, when they were still on. A man and a woman were heard speaking at frequent intervals.

For the benefit of new readers and to answer dozens of letters received each month, please read this carefully. If you desire to become one of our short wave observers please send to me your name and address with a description of your receiving equipment and a report of what you have received during the past month. We cannot make appointments on just your name and address. Tell us as much about your reception as you can in your first letter. One thing that makes us want to say "no" to your application is the requesting of a listening post certificate to "hang on the wall of your den" and "it would look swell over my receiver." These certificates are issued to observers in return for the service which they have given as such, not as decorations. Your record as an observer is considered before a certificate is issued to you. Please send your reports and applications to Elmer R. Fuller, Short Wave Editor, c/o RADIO-CRAFT, 25 West Broadway, New York City 7. Best of luck, lots of fb dx, om and yl and of course, to all of you, xyl's!

All schedules are Eastern Standard Time.

Freq.	Station	Location and Schedule	Freq.	Station	Location and Schedule
2.390		QUARRY HEIGHTS. CANAL ZONE; 0530 to 0700; 1000 to 2305	4.780	VV4RO	VALENCIA, VENEZUELA; 1630 to 2130
2.500	WWV	WASHINGTON, D.C.: U. S. Bureau of Standards; 1980 to 0900	4.780	HJAB	BARRANQUILLA, COLOMBIA; 1700 to 2255
3.075		TOKYO, JAPAN: 0400 to 0900	4.790		BANDONG, NETHERLAND IN-DIES; 0730 to 0800
3.310	YV1RO	TRUJILLO, VENEZUELA; 1700 to 2130	4.810	VV1RL	MARACAIBO, VENEZUELA; 0530 to 2230
3.340	VUD3	DELHI, INDIA; 1200 to 1245	4.810	HJBB	CUCUTA, COLOMBIA; 1700 to 2200
3.370	YV1RT	MARACAIBO, VENEZUELA; 1730 to 2230	4.820	XEJG	GUADALAJARA, MEXICO; 2200 to 2400
3.380	YV5RY	CARACAS, VENEZUELA; 0930 to 2230	4.820	HJED	CALI, COLOMBIA; 1900 to 2300
3.390	YV4RK	MARACAY, VENEZUELA; 1800 to 2230	4.830	VV2RN	SAN CHRISTOBAL, VENEZUELA; 1100 to 2130
3.390		COLOMBO, CEYLON; 0600 to 1200	4.840	YV1RZ	VOLERA, VENEZUELA; 1630 to 2145
3.400	YV5RW	CARACAS, VENEZUELA; 0530 to 2230	4.850	HJCA	BOGOTA, COLOMBIA; 1900 to 2200
3.420	YV2RC	MERIDA, VENEZUELA; 1800 to 2130	4.860	PRC5	BELEM, BRAZIL; 0600 to 1100; 1530 to 2000
3.440	YV1RU	MARACAIBO, VENEZUELA; 1900 to 2130	4.880	HJFH	ARMENIA, COLOMBIA; 0600 to 2200
3.460	YV4RP	VALENCIA, VENEZUELA; 1730 to 2130	4.890	HJCH	BOGOTA, COLOMBIA; 1800 to 2200
3.480	YV4RQ	Puerta Caballo, VENEZUELA; 1700 to 2130	4.920	CR780	LOURENCO MARQUES, MOZAMBIQUE; 1330 to 1500; Sundays, 1000 to 1400
3.490	YV3RS	BARQUISIMETO, VENEZUELA; 1630 to 2130	4.920	YV5RN	CARACAS, VENEZUELA; 0600 to 2230
3.500	YV5RX	CARACAS, VENEZUELA; 0930 to 1400; 1530 to 2230	4.920	HJAP	CARTAGENA, COLOMBIA; 0800 to 1300; 1700 to 2200
3.510	YV6RC	BARQUISIMETO, VENEZUELA; 1800 to 2130	4.940	HJCW	BOGOTA, COLOMBIA; 0645 to 1115; 1600 to 2115
3.530	YV5RS	CARACAS, VENEZUELA; 0530 to 2230	4.950	VQ7LO	NAIROBI, KENYA; 1100 to 1400
3.910	ZQP	LUSAKA, SOUTHERN RHOESIA; 2230 to 1300	4.950	HJCC	BOGOTA, COLOMBIA; 1900 to 1400; 1700 to 2300
3.930	HC5EH	CIUDAD CUENCA, ECUADOR; 1300 to 2230	4.960	HJAE	CARTAGENA, COLOMBIA; 1800 to 2230
4.040		PONTA DEL GADA, AZORES; 1700 to 1900	4.970	YV5RM	CARACAS, VENEZUELA; 0530 to 2230
4.100	HCJB	QUITO, ECUADOR; 1800 to 2330	4.990	YV3RN	BARQUISIMETO, VENEZUELA; 1630 to 2230
4.700	ZQI	KINGSTON, JAMAICA; 1630 to 1830	5.000	WWV	WASHINGTON, D. C.: U. S. Bureau of Standards; continuously day and night
4.750	YV1RV	MARACAIBO, VENEZUELA; 0530 to 2130	5.300	DTYC	MUNICH, GERMANY; 0900 to 0930
4.770	YV1RY	CORO, VENEZUELA; 1600 to 2130	5.530	OAXIB	PUIRA, PERU; 1800 to 2330
4.780		SINGAPORE, MALAYA; 1730 to 2230; 2330 to 0130			

(Continued on page 44)

MONEY BACK GUARANTEE — We believe units offered for sale by mail order should be sold only on a "Money-Back-If-Not-Satisfied" basis. We carefully check the design calibration and value of all items advertised by us and unhesitatingly offer all merchandise subject to a return for credit or refund. You, the customer, are the sole judge as to value of the item or items you have purchased.

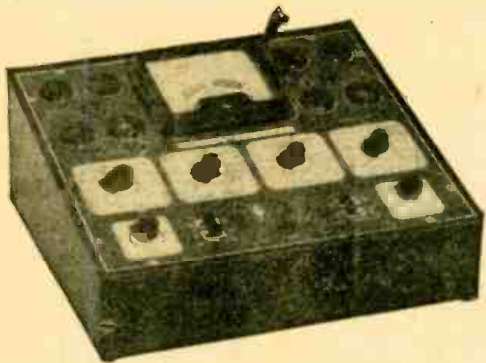

The New Model 60-T TUBE and SET TESTER

A COMPLETE TUBE TESTER

Tests all tubes including the new post-war miniature octals such as the 12AT6, 12AU6, 35W4, 50B5, 117Z3, etc. • Tests by the well-established emission method for tube quality, directly read on the scale of the meter • Tests shorts and leakages up to 3 Megohms in all tubes • Tests leakages and shorts of any one element against all elements in all tubes • Tests both plates in rectifiers • Tests individual sections such as diodes, triodes, pentodes, etc., in multi-purpose tubes.

\$49⁸⁵ Model 60-T operates on 90-120 Volts 60 Cycles A.C. Housed in sloping leatherette covered cabinet. Comes complete with test leads, tube charts and detailed operating instructions.
NET PRICE

EXTRA: WE CAN NOW SUPPLY THE MODEL 60 HOUSED IN A BEAUTIFUL HAND-RUBBED OAK CABINET. COMPLETE WITH PORTABLE COVER MAKING IT SUITABLE FOR EITHER BENCH OR OUTSIDE USE. ONLY \$2.75 ADDITIONAL. SPECIFY MODEL 60-C

A COMPLETE MULTI-METER

- 6 D.C. Voltage Ranges: 0 to 7.5/15/75/150/750/1,500 Volts
- 6 A.C. Voltage Ranges: 0 to 15/30/150/300/1,500/3000 Volts
- 4 D.C. Current Ranges: 0 to 1.5/15/150 Ma. 0 to 1.5 Amps.
- Low Resistance Ranges: 0 to 2,000 Ohms (1st division is 1/10th of an ohm.)
- 2 Medium Resistance Ranges: 0 to 20,000/200,000 Ohms
- High Resistance Range: 0 to 20 Megohms
- 3 Decibel Ranges: -10 to +38, +10 to +38, +30 to +58 DB.

The New Model 650-A A. C. Operated SIGNAL GENERATOR



- Operates on 110-120 Volts 50 to 60 Cycles A.C.
- R.F. Frequencies from 100 Kc. to 35 Mc. on Fundamentals in 5 bands by front panel switch manipulation. One additional band provides Harmonics from 30 to 105 Mc.
- Audio Modulating Frequency — 400 Cycles Pure Sine Wave. Distortion less than 3%.
- Attenuation: Features a newly designed 3-step ladder type of attenuator (T pad). The first step provides lowest output and can be multiplied by 10 and by 100 by turning the multiplier switch.
- Hartley Excited Oscillator Electron coupled to a Buffer Amplifier. Frequency stability is assured by modulating the amplifier stage.

Complete with coaxial cable, test leads and instructions. Heavy gauge grey crystalline cabinet with beautiful two tone etched front panel. Size 9 1/2" x 10" x 6".

\$39⁹⁵ NET

The New Model 670 SUPER METER

A Combination Volt-Ohm-milliammeter plus Capacity Reactance, Inductance and Decibel Measurements

D.C. VOLTS: 0 to 7.5/15/75/150/750/1500/7500.

A.C. VOLTS: 0 to 15/30/150/300/1500/3000 Volts.

OUTPUT VOLTS: 0 to 15/30/150/300/1500/3000.

D.C. CURRENT: 0 to 1.5/15/150 Ma.; 0 to 1.5 Amps.

RESISTANCE: 0 to 500/100,000 ohms 0 to 10 Megohms.

CAPACITY: .001 to .2 Mfd. (.1 to 4 Mfd. (Quality test for electrolytics).

REACTANCE: 700 to 27,000 Ohms; 13,000 Ohms to 3 Megohms.

INDUCTANCE: 1.75 to 70 Henries; 35 to 8,000 Henries.

DECIBELS: -10 to +18, +10 to +38, +30 to +58. The Model 670 comes housed in a rugged, crackle-finished steel cabinet complete with test leads and operating instructions. Size 5 1/2" x 7 1/2" x 3".



\$28⁴⁰ NET

The New Model CA-11 SIGNAL TRACER



Simple to operate . . . because signal intensity readings are indicated *directly on the meter!*

- ★ SIMPLE TO OPERATE — only 1 connecting cable — NO TUNING CONTROLS.
- ★ HIGHLY SENSITIVE — uses an improved Vacuum Tube Voltmeter circuit.
- ★ Tube and resistor-capacity network are built into the Detector Probe.
- ★ COMPLETELY PORTABLE — weighs 5 lbs. and measures 5"x6"x7".
- ★ Comparative Signal Intensity readings are indicated directly on the meter.

meter as the Detector Probe is moved to follow the Signal from Antenna to Speaker.

★ Provision is made for insertion of phones. The Model CA-11 comes housed in a beautiful hand-rubbed wooden cabinet. Complete with Probe, test leads and instructions.

\$18⁷⁵ NET

The New Model 450 TUBE TESTER

Speedy operation — assured by the newly designed rotary selector switch which replaces the usual snap, toggle, or lever action switches.

SPECIFICATIONS

- Tests all tubes up to 117 volts. • Tests shorts and leakages up to 3 Megohms in all tubes. • Tests both plates in rectifiers. • New type line voltage adjuster. • Tests individual sections such as diodes, triodes, pentodes, etc., in multi-purpose tubes. • Noise Test-detects microphonic tubes or noise due to faulty elements and loose internal connections. • Uses a 4 1/2" square rugged meter. • Works on 90 to 125 volts 60 cycles A.C.

EXTRA SERVICE—May be used as an extremely sensitive condenser Leakage Checker. A relaxation type oscillator incorporated in this model will detect leakages even when the frequency is one per minute.



\$39⁵⁰ NET

GENERAL ELECTRONIC DISTRIBUTING CO. DEPT. RC-11, 98 PARK PLACE, NEW YORK 7, N. Y.

LEONARD'S

FALL PRICES

BEST VALUE HAZELTON

MULTI TESTER RANGES

AC Volt 0-1500
 DC Volt 0-1500
 DC Mills 0-150
 Resistance 0-300,000

\$11.75



ELECTRONIC MEASUREMENTS VOLOMETERS



101A 3" METER **\$17.50** NET
 Model 101B
 OPEN FACE 4" METER **\$20.95** NET
 OPEN FACE PORTABLE
 101AP 3" Meter \$21.50 net
 101BP 4" Meter \$24.95 net

NEW! "PREMIER"

BANDSPREAD DIAL

SIGNAL GENERATOR \$54.75

Model 570



The "Premier" Model 570 is the ONLY low-priced Signal Generator with a MICROMASTER BAND-SPREAD DIAL, equivalent to a scale length of approx. 60"—a major feature for logging, sharp and critical tuning.

- AIR TRIMMERS ON ALL BANDS.
- TRIPLE COPPER PLATED SHIELDING.
- Range 75KC-50MC on fundamental, and 50-150MC on 3rd harmonic, useful for aligning FM and Television Receivers.
- Accuracy better than 1%.
- Special geared straightline frequency tuning condenser provides linear calibration over entire dial range. Complete with co-axial cable.
- Overall size 12" by 12 1/2" by 5 1/2"; shpg. wt. 21 lbs.

RECORD CHANGERS

WEBSTER 56—Automatic Stop \$26.66
 DETROLA 14.50
 SEEBURG—2 Post. 22.95

RCA CRYSTAL MIKE with table stand **\$4.95**

KENYON Power Transformer

325 mill—400 v. CT—6.3 at 4.5 amps. Fully shielded. 5 v. at 6 amps. **\$5.95**

6L6 Push Pull or Push Pull Parallel 50 watt. Completely shielded. 250 mill primary 5000 ohms—sec. 2-4-8-15-500 ohms. **\$5.19**
 H-57—Special Lim. Quan.

PHONO MOTOR and PICKUP KIT

SPECIAL **\$4.35**

Complete

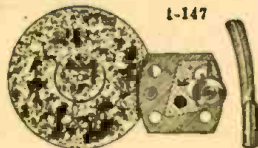

Crystal pick-up—Top quality constant speed motor. Motor Assembly only. \$3.95
 Send 25% deposit with order—balance Express Collect. Orders under \$5.00 send check or money order plus postage.

LEONARD RADIO INC.
 69 CORTLANDT ST.
 NEW YORK 7, N.Y.

250-WATT FM-AM TRANSMITTER

(Continued from page 34)

wire so the final shunt value can be determined accurately. Place the series circuit, consisting of the 2 meters and the 10,000-ohm resistor, across a low d.c. voltage source, say a 45-volt B-battery; and adjust the series resistor until the 250-ma meter reads the same as the 100% modulation TZ-40 plate-current value. The shunt across the 100-ma meter is now adjusted for full-scale deflection on the 100-ma unit. *Caution: Always disconnect the d.c. voltage source when making adjustments on the shunt; otherwise the 100-ma meter will burn out.* Once the correct shunt value has been determined, the shunt wire can be wound in the form of a small coil and connected permanently across the milliammeter terminals. The shunted 100-ma unit is now connected in the TZ-40 plate-current line to indicate modulator plate current and approximate percentage of modulation. In that portion of the scale between 75 and 100 milliamperes, the meter indication coincides almost exactly with modulation percentage, thus affording a quick visible check.

The compression control

The compression control is the 500,000-ohm potentiometer in the grid circuit of the 6SQ7 (see last month's schematic). Adjustment of the compression control is not critical, but it must be made carefully. Turn the gain control to normal operating position and advance the compression control until a definite flattening of the voice peaks is noticed. Now, reduce the compression control slowly and, at the same time, readjust the gain control slowly up or down, as the case may be, until the compression just "takes hold" at 85 to 90% modulation. If an oscilloscope is available, the correct adjustment can be carried out very easily as a definite flattening of the wave form will be visible long before the average listener's ear notices any distortion.

If the aural method of adjustment must be used, monitor the transmitted wave with a pair of headphones plugged into the monitoring jack on the front panel, or by short circuiting the antenna and ground terminals of the communications receiver and tuning in the emitted signal. Adjust the compression to a point just below where distortion of the audio component of the signal is heard.

It is essential to become familiar with the compression control by the record player test, as described in last

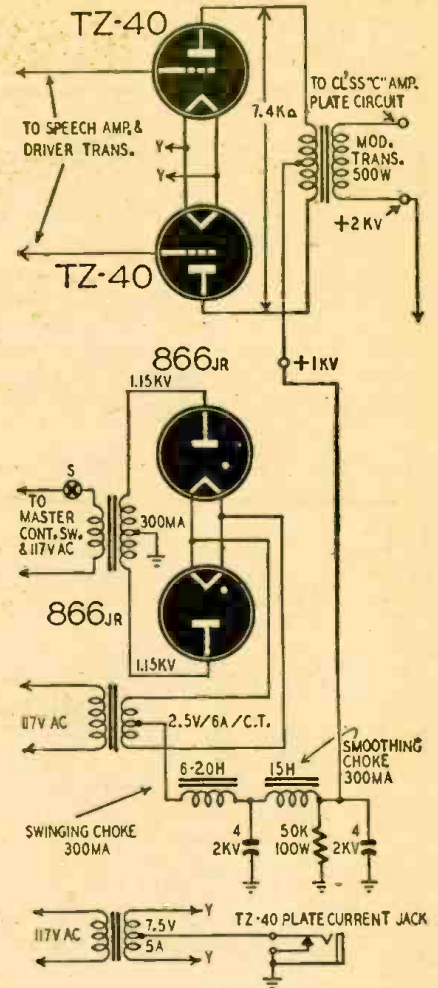
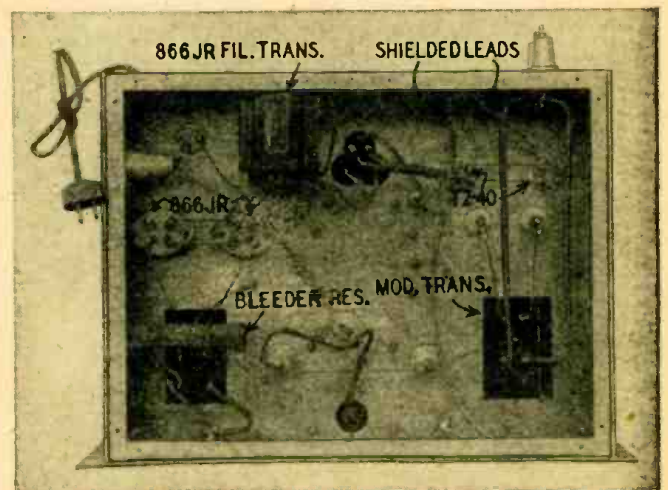

Fig. 2—The power supply and modulator unit.



Under-chassis view of the unit. High-voltage leads are shielded.

month's article, before the transmitter is placed on the air. Incorporating the monitor circuit in the speech amplifier permits accurate adjustments of the compression control.

The compression effect may be removed from the signal by turning the compression control to its OFF position.

HOT RADIO VALUES at SUN RADIO!



HAM AND POLICE SUPERHET TUNER

Brand New. Complete with 7V7 (1st IF & Osc.) 7V7 (2nd IF), 7V7 (Audio) and 7V7 (BFO). Frequency 2.4 to 16.2 mc. Filament voltage required 6.3 AC or DC—2.1 amp. Plate voltage required 335V DC—30 MA. Only 4 1/2 x 9 1/2 x 3 1/2 inches, and weighs only 6 1/2 lbs. Ideal for Ham and Police \$14.95



WAVEMETER

We're closing out the last few of these precision wavemeters which tune from 150-210 mc and which contain a high quality resonant cavity wavemeter, oscillator, heterodyne amplifier, electric tuning eye, complete with 19 tubes, 110 v AC power supply. The tubes alone far exceed your close-out costs of only \$17.95



V.H.F. TRANSMITTER

Here is one of the greatest offerings in war surplus! Hundreds sold at \$20 and now closed out at an amazingly low price. Brand new. Battery operated (67 1/2 v B and 1 1/2 v A). Frequency 80 to 105 mc. Complete with 2-1G4 tubes and full instruction manual. Ready to go on the air. Less Batteries \$6.95



SPERRY AMPLIFIER

Brand new servo amplifier containing two beam power output tubes (1632) similar to 2516, two twin triodes (1633 and 1634) similar to 68C7, two mica condensers, dozens of color coded half watt resistors, two dual and four section bathtub condensers, three transformers, two wafers switches, one volume control, four octal sockets. Easily convertible \$3.95



BC 684 F.M. 35 WATT TRANSMITTER

Brand new, complete with eight tubes, crystal control, 10 channel pushbutton, non-linear modulation coil . . . less coverplate, crystal and power supply \$17.95



NEW U.S. NAVY SPEAKERS

Stromberg Carlson and RCA waterproof speakers. Brand new in original cartons. 25 Watt PM driver unit with line matching transformer and projector mounted in heavy duty round metal baffle. Ideal for communication receivers and sound systems at lowest price ever Offered \$14.95



BC645 UHF RECEIVER TRANSMITTER

"The citizen's Radio" covers 450-500 mc. Consists of complete transmitter, modulator system and receiver, 15 tubes, and simple complete conversion instructions for 420 mc operation. Brand new \$14.95

WALKIE TALKIES

Set \$129.90



SCR195 Walkie Talkies, brand new, weight 27 1/2 pounds including knapsack. Range up to 25 miles in open country. Frequency 52.8 to 65.8 MC. Transmitter and receiver with regular hand set. Complete ready to operate with spare parts. Each \$69.95



VM RECORD CHANGER

Brand new. Mixes 10 and 12" records. \$16.95

Wood Base for above \$3.49



PORTABLE AMPLIFYING MEGAPHONE

U. S. Army Signal Corps Surplus! Complete in portable carrying case with electric megaphone and microphone, pistol grip and trigger switch. Additional hand microphone and switch. Portable tripod stand. Combination amplifier and batter case. Projects voice up to 1/4 mile. \$59.95



WESTON OHM METER NO. 689

A beautiful instrument for accurate work. Scale 0-10 ohm and 0-100 ohm scaled to read 1/20 of an ohm with ease. This 2 1/2" round meter is housed in a black bakelite case 1 1/2" x 2 1/4" x 1 1/2". Complete with heavy duty felt lined leather case and lock. Special \$14.95



5-GANG TUNING CONDENSER

Brand new 5 gang, 365 mmfd. per section . . . a truly precision built condenser with ceramic insulation. A \$13.50 value in the greatest offering ever made in tuning condensers. For only \$2.95



TS13 HANDSET

Combining a 200 ohm carbon mike and 2500 ohm earphone with butterfly switch for listen and talk. Has 6" flexible rubber cord with 1-P155 and PL68 plugs attached. Brand new \$2.95

A. C. VOLT-METER

\$3.49



D. C. WILLIAMETER

Brand new General Electric 2" round panel meters 0-300. \$2.97

Brand new G.E. 3" square panel motor 150 v ideal for checking primary voltage.

SUN RADIO
OF WASHINGTON, D. C.
938 F STREET, N. W. WASH. 4. D. C.

100 WATT BENDIX TRANSMITTER TA12



CHECK THESE VALUES: Three 807 Tubes, four Master oscillators. (These can be easily changed to cover 20-40-80 meters and by using crystal for the transmitter.)

Four separate output tanks. One 4 position selector channel switch having seven sections which changes the ECO, IPA and output tanks simultaneously. All the controls are mounted on the front panel. The housing is cast aluminum; shields and case are sheet aluminum. Dimensions 11 x 12 x 15 inches, weighing 35 1/2 lbs. Complete, simple instructions for conversion furnished. Complete with tubes \$49.95

SUPERHETERODYNE RECEIVER

This crystal fixed frequency receiver comes with full conversion instructions for variable tuning, heterodyne receiver, crystal cast. A highly selective superheterodyne receiver, 116 v. A.C. power supply built in. Noise Suppressor, 80 Rectifier, Diode Amplifier; 6K8 Output 1/2 inches. Comes complete, brand new, with one set of 7 tubes and two sets of tubes \$16.95

Extra set of tubes \$2.95



RADAR RECEIVER BC-1068A

Guaranteed excellent condition. It is a Hot receiver for Ham and Television experimenters, tunes 1.4 to 210 mc, contains 2 R.F. and 5 I.F. stages. Complete with 110 volt AC power supply and 14 tubes \$39.95



BC-221 FREQUENCY METER

A heterodyne frequency meter complete with tubes, crystal, calibration chart and guaranteed accuracy of 0.1% or 500 cycles, whichever is greater. Better than two dial divisions per kc. Fundamental ranges are 125-250 and 200-400 kc. Can be used with 110 v. AC power pack, batteries or vibrator pack, batteries or vibrator generator or converts to VFO. These are slightly used but Guaranteed \$37.50

With Modulation \$54.30

SYLVANIA NEWS

RADIO SERVICE EDITION

NOV.

Prepared by SYLVANIA ELECTRIC PRODUCTS INC., Emporium, Pa.

1947

NEW SYLVANIA OSCILLOSCOPE BOASTS 7-INCH CATHODE RAY TUBE—IS ONLY \$124.50!

Wide Variety Of Uses — Excellent For Rapid Receiver Alignment and Trouble Shooting



Panel is heavy aluminum finished in silver gray, with type and decorations hand screened. Each finish coat and the silk screening are separately baked under a carefully controlled process—for long life and maximum beauty. Here's an impressive, versatile instrument for your establishment.

Now! For little more than you would pay for a smaller instrument, you can obtain a big beautiful, 7-inch Oscilloscope that's the last word for servicing. Excellent for audio circuit analysis, transmitter checking, filter circuit and hum analysis.

CHARACTERISTICS AND SPECIAL FEATURES

Large 7-inch cathode ray tube provides "Jumbo" patterns.

A new push-pull deflection circuit provides clearer patterns, less distortion and more gain.

Observation of a wider variety of phenomena is made possible by the addition of a Z axis input for intensity modulation. This feature is useful in studying pulses and portions of cycles, and leads to many applications in industry.

Panel binding post provides 6.3 volt AC .3 ampere supply for convenient external use.

Subdued red-jeweled panel lamp assembly with removable cap for easy replacement of lamp.

Extra-long, heavy-duty line cord.

Externally accessible line fuse at rear of cabinet.

Power Supply: 105-125 volts, 50-60 cycle, 35 watts.

Accelerating potential 1400 volts.

Horizontal Sweep: Left to right with frequency from 15 to 30,000 cycles. Synchronizing signal sources: internal (vertical), external, line frequency.

Deflection Factor at 1000 cycles

AMPLIFIERS: Vertical 21 volt rms per inch peak to peak deflection.

Horizontal 25 volt rms per inch peak to peak deflection.

DIRECT: Vertical 15 volts rms per inch peak to peak deflection.

Horizontal 18 volts rms per inch peak to peak deflection.

Amplifier frequency response is flat to within 3 db. from 7 cycles to 140 kc. at full gain.

Input Impedance

AMPLIFIERS: Vertical .5 megohm; 26 mmfd.
Horizontal .5 megohm; 33 mmfd.

DIRECT: Vertical and Horizontal 3.9 megohms; 20 mmfd.

INTENSITY MODULATION: .5 megohm; 30 mmfd.

For more complete information, write

Sylvania Electric Products Inc., Radio Division, Emporium, Pa.

SOLD THROUGH YOUR SYLVANIA DISTRIBUTOR

SYLVANIA ELECTRIC

MAKERS OF RADIO TUBES, CATHODE RAY TUBES, ELECTRONIC DEVICES, FLUORESCENT LAMPS, FIXTURES, WIRING DEVICES, ELECTRIC LIGHT BULBS

SPECIAL OFFER DURING

Testing & Aligning TELEVISION RECEIVERS



servicing by EAR
Translating by full analysis

GET ARTICLES SUCH AS THESE EVERY MONTH

Our readers have given the articles illustrated here unprecedented acclaim. They are unanimous in their indorsement of RADIO MAINTENANCE as an aid in their work—a reference in their libraries—and a vital tool in their shops!

Part I the Oscillograph...how to use it.

With its oscillating action of a carbon on the top of the oscillograph, it causes the alignment of waveforms along the oscillograph and a frequency output generator.

When using an oscilloscope, the first step is to have a good ground. The oscilloscope should be connected to a common ground point. The oscilloscope should be connected to a common ground point. The oscilloscope should be connected to a common ground point.

Adjustment of the oscilloscope is done by turning the knobs on the front panel. The oscilloscope should be connected to a common ground point. The oscilloscope should be connected to a common ground point.

The Oscillograph - How to use it

servicing FM receivers

201 FM Stations Are Now On The Air! or 201 Stations FM Set: Will Be Produced in 1977

This is the first of several articles designed to acquaint the serviceman with the latest information required for testing, repairing, and aligning FM receivers which are now rolling off the production line.

16

ISSUES OF FOR ONLY

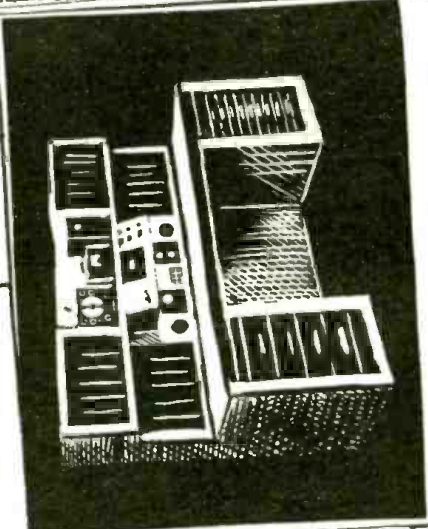

Modern Bench Construction

by Robert A. Sweet

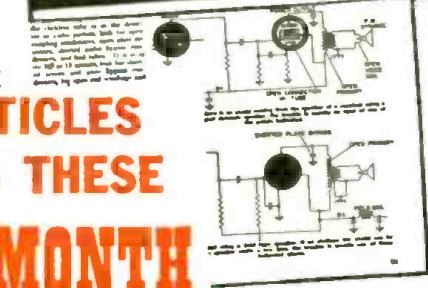

Modern Bench Construction is a series of articles designed to acquaint the serviceman with the latest information required for testing, repairing, and aligning FM receivers which are now rolling off the production line.

Radio Maintenance has filled a breach that has existed in the radio field for a long time. Already 30,000 servicemen read Radio Maintenance every month because it is devoted entirely to the radio service-technician.

The Radio Maintenance staff specializes in the preparation of articles on every phase of radio maintenance in series form which may be filed and used for reference. The leading articles cover everything for the radio serviceman on Television, FM and AM; Test Equipment; Electronic Appliances; Tools; Antennas; Alignment;

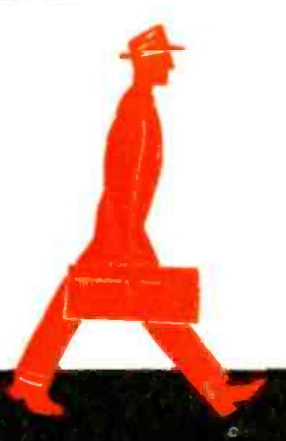

OCTOBER AND NOVEMBER

ANTENNAS...
f-m and television

the industry PRESENTS

CIRCUIT ANALYSIS

OVER THE BENCH

REVIEW OF TRADE LITERATURE

RADIO MAINTENANCE

RADIO MAINTENANCE

\$3.00

SAVE \$1.00 BY SUBSCRIBING NOW
UNDER THIS SPECIAL OFFER

Troubleshooting; Repair; Construction; Pickups and Sound Amplification and Reproduction Equipment. Also, in RADIO MAINTENANCE each month there are departments on hints and kinks, the latest news of the trade, review of trade literature, radio-men's opinions, new products and news from the organizations. All articles are presented in a step-by-step precision style, clearly illustrated with schematics, accurate photographs, specially prepared drawings, white on black charts, color diagrams, isometric projections and exploded views.

RADIO MAINTENANCE MAGAZINE
460 Bloomfield Avenue, Montclair, N. J.
SPECIAL OFFER COUPON
Please send me 16 issues of RADIO MAINTENANCE for only \$3.00

CHECK ENCLOSED BILL ME LATER

Name _____
Address _____
City-State _____
Occupation _____
Title (Service Mgr., etc.) _____
Employed by _____

*Business or professional classifications are required to serve you better. Each subscriber will profit by writing one of the following classifications in space indicated.

INDEPENDENT SERVICEMAN—DEALER SERVICEMAN—SERVICE MANAGER—DEALER—DISTRIBUTOR—JOBBER
State your trade or occupation if not listed

Same day Service

If you send payment now, thus eliminating billing expense, we will add one issue free!

BOLAND & BOYCE INC., PUBLISHERS

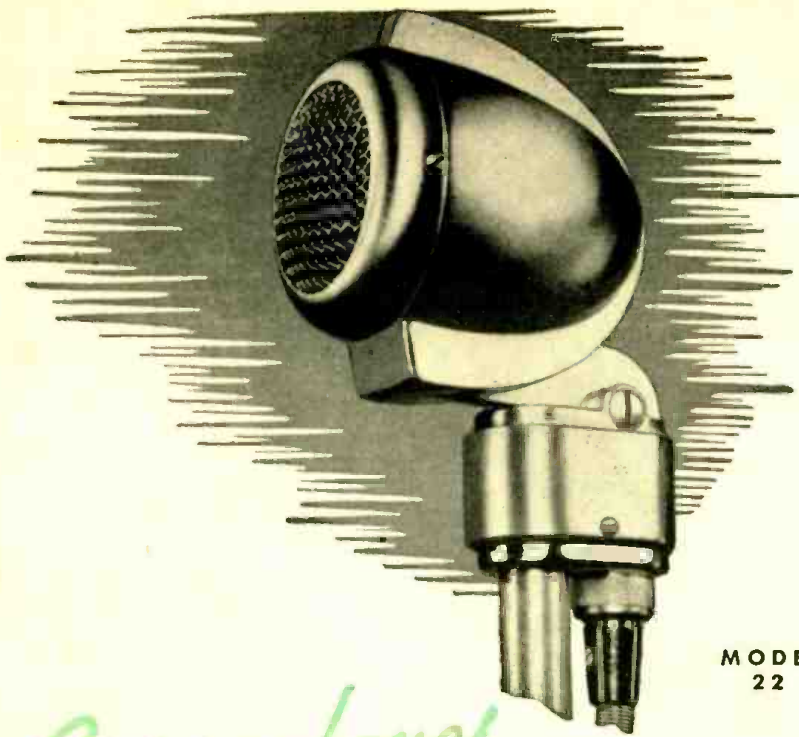

MODEL
22

Microphones
of **DISTINCTION**

● When you select a TURNER Microphone for better performance you automatically choose the leader in style and dependability. The accurate pickup, smooth response, and enduring reliability of TURNER design and construction is recognized the world over. Where performance counts most you'll Turn to TURNER.

THE MODEL 22—This handsome streamlined unit gives "smooth-as-silk" performance. Adds distinction to any installation. Ideal for both voice and music pickups. Widely used for all-around recording, public address, call system, and communications work. 90° tilting head permits semi- or non-directional operation. Available in a choice of high quality crystal or dynamic circuits. Complete with 7 ft. removable cable set. Ask your dealer.

WRITE FOR COMPLETE MICROPHONE CATALOG



Microphones
by **TURNER**

THE TURNER COMPANY

902 17th Street N. E. • Cedar Rapids, Iowa

MICROPHONES LICENSED UNDER U.S. PATENTS OF THE AMERICAN TELEPHONE AND TELEGRAPH COMPANY, AND WESTERN ELECTRIC COMPANY, INCORPORATED. CRYSTALS LICENSED UNDER PATENTS OF THE BRUSH DEVELOPMENT CO.

TECHNOTES

... MODULATION HUM

Modulation hum, especially noticeable on weak carriers, is commonly encountered in a.c.-d.c. sets with B-minus returns isolated from the chassis through a condenser. Check this condenser and those in the a.v.c. circuit for leakage. If resistance is 20 megohms or less, replace these with high-quality units. The same type of defect can be caused by an open control-grid resistor in the r.f. or first detector stages.

JOHN R. SIMPSON,
Gainesville, Fla.

... AUTO RADIOS

If you have an auto radio with loctal tubes, that is noisy or refuses to play, check the construction of the sockets. Often these sets have molded loctal sockets of flimsy construction and the contacts break loose and do not make contact with the tube pins. Use well-built, high-quality sockets as replacements.

WILLIAM PORTER,
Indianapolis, Ind.

... STROMBERG-CARLSON 1121 FM-AM

If the converter is suspected of giving trouble and trouble is not in the tube, try replacing the 5,200-ohm, 4-watt section of the Candohm that supplies screen voltage to the 6SB7. The correct replacement is part No. 149,002. Failure of this part seems to be a common occurrence in this model.

WILBUR J. HANTZ,
Cleveland, Ohio

... RCA 811

Complaint: Intermittent distortion that sounds like an open filter condenser or incorrect bias voltages. This condition develops after the set has warmed up, and may therefore be missed in a check-over.

Check the screen voltage on the 6K7 i.f. amplifier. The voltage should be 80 volts or higher. If it is not, replace the 82,000-ohm screen grid resistor with a 1-watt unit.

C. H. MITCHELL,
Chicago, Ill.

... ZENITH 6R687R (Chassis 6B06)

Noise and drift, particularly on the low-frequency end of the dial, is often caused by small particles of rust on the variable condenser plates. Replace with part No. 22-1241.

B. BUEHRLE, JR.,
Ferguson, Mo.

... PHILCO 46-1201

When feedback develops at high volume, on phonograph operation only, check the condition of the two rubber grommets on the pickup arm where it connects to the support post. If the rubber in these grommets has hardened, they will transmit audio vibrations from the cabinet and motor plate to the crystal cartridge where they are picked up and fed back into the audio system.

(Continued on page 52)

Don't Murder

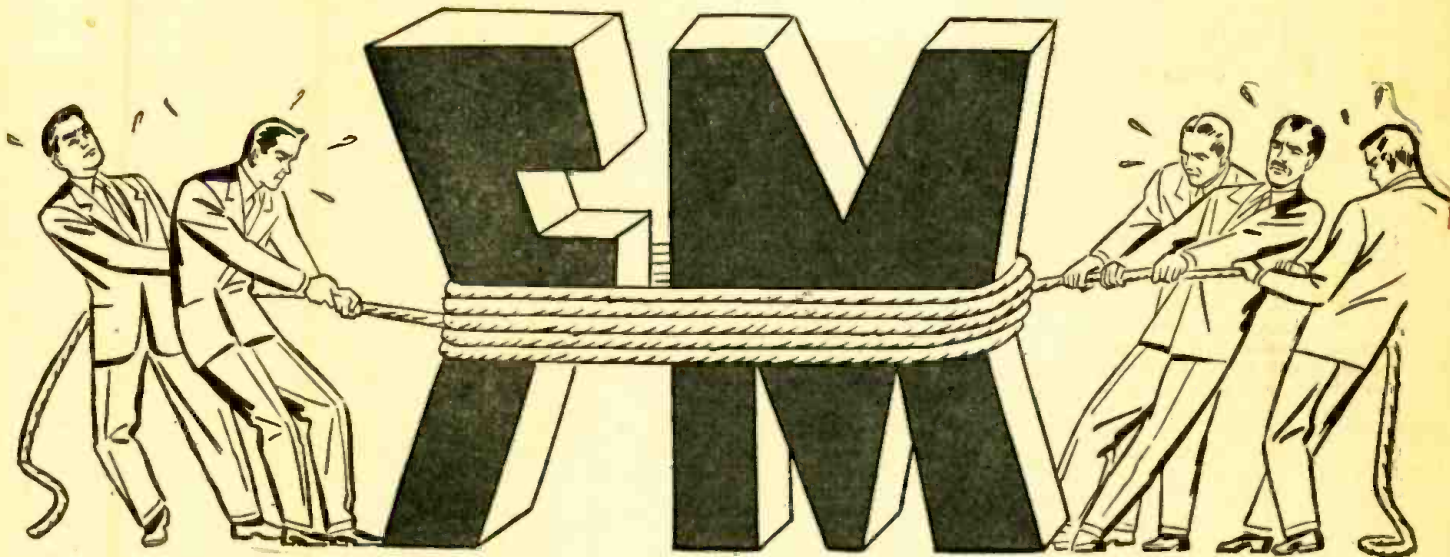

Don't mess around with second-rate FM gadgets
... when FM DEMANDS the high quality of

Pilotuner

Mr. Dealer! We earnestly urge: USE THE AMAZING FM PILOTUNER AS YOUR STANDARD OF COMPARISON, in testing ALL FM receivers and "tuners".

That's how you can avoid inferior, "rat-trap" equipment that simply will not and can not do justice to FM.

FM stations throughout America have acclaimed the PILOTUNER with all the raves in the book. It DOES THE JOB . . . because it's a QUALITY product, backed by Pilot Radio's unsurpassed practical experience in making FM sets.

Remember—we INVITE and WELCOME legitimate competition. We deplore ONLY that FM equipment which lacks integrity . . . which can do no good for the dealer, the consumer—or for FM itself.

The fate of FM—the glorious, most modern kind of broadcasting—is in your trust. Guard it well! Join the swing to the BEST FM . . . headed by the original PILOTUNER.

PILOT RADIO CORPORATION, 37-06 36th ST., LONG ISLAND CITY, N. Y.
Makers of PILOTONE VINYLITE RECORDS • PIONEERS IN SHORT WAVE • FM • TELEVISION

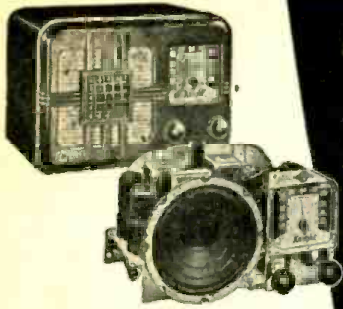

**Low-Cost Knight "Ranger"
5-Tube Kit Complete with Cab-
inet, Loop Antenna and Tubes**

It's here! The first ultra-modern 5-Tube AC-DC Superhet kit at so low a price! Here's what you get—full broadcast band coverage (550-1600 Kc.); built-in loop antenna; latest 5" PM dynamic speaker; handsome walnut plastic cabinet. Unbelievably easy to build; no special tools required. Sockets are riveted in place on chassis base; just assemble, wire and slip into cabinet. Outstanding for power and tone quality. Highest grade components only. Complete with all parts, tubes and full instructions. Nothing like it at the price! Shpg. wt. 10 lbs. **\$14.95**
No. 83-275. Complete, only.....

**RADIO BUILDERS and
EXPERIMENTERS!**

**ALLIED
is Your Headquarters
for Radio Kits!**

ALLIED and the Radio Builder

The typical ALLIED-Knight Kits presented here are the result of over 20 years of experience in engineering efficient, easily-assembled kits. Every kit is proved for circuit design, good mechanical layout, and high quality components. KNIGHT Kits are easiest to assemble: complete instructions include both pictorial and schematic diagrams; panels are drilled, screenprinted and calibrated; chassis is formed and all holes are punched for you—no holes to drill; every last part required is included. When you buy a KNIGHT Kit, you get top design, top quality and top value.

High-Fidelity Kits for Radio Reception or Record Playing

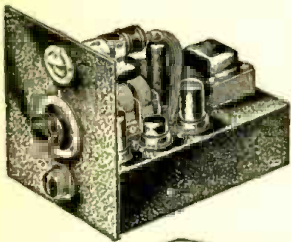

TRF BROADCAST TUNER. An easy-to-build high-fidelity TRF Tuner Kit. Features broad band reception for higher fidelity than obtainable in standard superhet circuits. Linear diode detection for quality demodulation; separate diode AVC for constant signal. Cathode follower output circuit. "Magic Eye" tuning. Vernier dial, 0-100, 5-1 ratio. Built-in power supply. Complete with all quality parts, including 5 tubes plus rectifier, punched chassis (10 x 6½ x 3") and panel, matched coils and detailed 4-page instruction booklet. For 110-125 volt, 60 cycles AC. **\$24.25**
83-221. NET, only.....

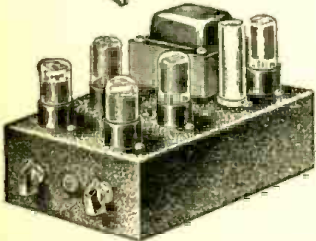

10-WATT HI-FI AMPLIFIER. One of the finest high-fidelity audio amplifiers ever designed for home construction—a perfect companion for tuner above, or for use with crystal phono pickup. Inverse feedback for wide response ± 1.5 db from 20 to 10,000 cps. Minimum distortion. High impedance input; volume and tone controls; large output transformer matches any 6-8 ohm PM speaker. Complete with all quality parts, including 4 tubes plus rectifier, punched chassis (10 x 6½ x 3"), and detailed 4-page instruction booklet with large, clear schematic and pictorial diagrams. **\$21.75**
83-222. NET, only.....

POPULAR 2-METER TRANSCEIVER. It's easy to build this powerful, compact 2-meter transceiver. Fine engineering brings unusually high output efficiency. Supplies current for single button carbon mike. Output transformer for any PM speaker or headphones. Requires 250 v. at 75 ma., and 6.3 v. at .65 amp. for power. Kit complete with all parts: punched and formed cadmium plated chassis, 5 x 9 x 2", clearly marked 6 x 9" steel front panel with black crackle finish, tubes, wire, solder, etc. Includes easy-to-follow instructions. Requires Amateur license to transmit. Kit complete, less mike, speaker and power supply. **\$18.25**
83-220. NET, only.....

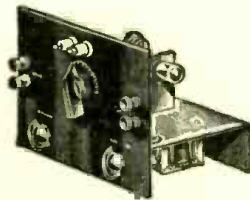

For Additional KNIGHT Kits, see ALLIED'S 164 Page **FREE Catalog!**

**ALLIED
RADIO**

*Everything in Radio
and Electronics*

ALLIED RADIO CORP., Dept. 2-L-7.
833 W. Jackson Blvd., Chicago 7, Ill.

- Send Kit No. 83-275
- Send Kit No. 83-221
- Send Kit No. 83-222
- Send Kit No. 83-220
- Send FREE 164-Page ALLIED Catalog.

Enclosed

Name.....
Address.....
City.....Zone.....State.....

TECHNOTES

(Continued from page 50)

Replace the grommets with units made of live rubber.

HARRY L. ASHBY,
Gary, Indiana

... OSCILLATIONS

Oscillations and birdies in a.c.-d.c. sets often can be traced to filter condensers, although they may measure up to their rated capacity. These condensers develop a high r.f. resistance. This is a common fault that can be cured with new condensers.

D. E. COLVIN,
Churchville, N. Y.

... SPEAKER REPLACEMENTS

I have noticed a large number of speaker replacements and complaints of poor tone on new sets using 4-, 5- and 6-inch PM speakers. In most cases, the complaints and replacements were completely justifiable.

When the set is assembled at the factory, the chassis usually is inserted in the cabinet so that the speaker presses against the front of the cabinet. When the chassis screws are tightened, this occasionally increases the pressure on the speaker frame at one or more points, distorting its shape. This is especially true of sets which have a dial partially supported by the speaker frame. Stresses in shipping and contraction and expansion during the first few hours of operation will distort the speaker sufficiently to affect its tone, and in some cases cause contact between the voice coil and the pole piece.

As a cure, tune in a station as perfectly as possible and adjust the set for medium or low volume. Use long-nose pliers or diagonal cutters, whichever is best in the particular situation, and bend one or two adjoining speaker frame supports slightly one way or the other for best tone adjustment. The correct amount of bend is easily discernible as the tone is checked. This method provides a permanent cure if care is used in reinserting the chassis of the cabinet. Do not force the chassis hard against the front of the cabinet with the chassis screws. There is usually a large tolerance in the mounting holes in the cabinet and it should not be necessary to drill new ones.

J. D. RIDGWAY,
Milledgeville, Ill.

... SELENIUM RECTIFIERS

When replacing the rectifier tube in a.c.-d.c.-battery portables with a selenium rectifier, check the circuit to see if filament voltage for the battery-type tube is obtained from the B-supply. If so, a suitable dropping resistor should be inserted in series with the filaments, because selenium rectifiers deliver a higher output than the usual rectifier tubes. The output voltage is approximately 5½ volts higher than a 35Z5.

JOHN W. COOK,
Williamsburg, Va.

This Book Makes You a Record Changer Service Expert!



Ready Now! Your Howard W. Sams 1947 Automatic Record Changer Service Manual

Hundreds of you have written to me personally in the past year, describing your crying need for reliable service data on Automatic Record Changers. Long before these letters began to come in, we foresaw the tremendous expansion of the Record Changer service field and began working on the problem. NOW—I am proud to announce the publication of the Howard W. Sams 1947 AUTOMATIC RECORD CHANGER SERVICE MANUAL. There is no other book like it. It makes you a service expert on Changers—helps you tackle and lick any kind of mechanical Changer problem. The Manual covers MORE THAN 40 POST-WAR MODELS—all of them DIFFERENT. The information is absolutely accurate, complete, authoritative—based on our actual study of the equipment. Everything you need to know is presented in giant-size exclusive “exploded” views, photos from all angles, completely keyed parts lists, and full text explaining disassembly, adjustments, change cycle data, service hints and kinks, and parts replacement. And for the FIRST time in any publication, you get complete, accurate data on leading WIRE, RIBBON, TAPE, and PAPER DISC RECORDERS! I honestly believe that no progressive Serviceman can afford to be without this Manual. Your copy is ready now—see it at your local jobber. Own it. Use it. It's the best investment you can make today to increase your earning power.

Howard W. Sams

★ **BIG PLUS VALUE**—the only single source of timely, accurate Service Data on leading Wire, Ribbon, Tape, and Paper Disc Recorders.

★ **DeLuxe Volume.** Hard Cover; opens flat. 400 pages of clear, accurate data that makes you a Record Changer Service Expert!

THERE'S NOTHING LIKE IT! ONLY

\$4.95

DON'T MISS PHOTOFACT SETS NOS. 23, 24 and 25!

PHOTOFACT Sets Nos. 23, 24 and 25 feature the exclusive new uniform “Standard Notation” schematics—the greatest service data development in 20 years! Each and every diagram is drawn to the same basic set of clear, uniform, easy-to-understand standards. Here's what the new “Standard Notation” Schematics mean to you: Makes circuit analysis simpler, quicker, fool-proof, more accurate! No more time wasted puzzling over odd-looking diagrams! No more trouble with varying symbols and confusing styles! Just ONE CLEAR STANDARDIZED STYLE FOR ALL CIRCUITS—SAVES YOU

TIME—HELPS YOU EARN MORE. Only PHOTOFACT offers you the “Standard Notation” Schematics. Order Sets Nos. 23, 24 and 25 today—and see the amazing advantages!

- FREE:** PHOTOFACT Cumulative Index—your guide to all post-war receivers.
- FREE:** How to File Folder—shows 5 good ways to file PHOTOFACT Folders.
- Get these PHOTOFACT Aids FREE at your parts jobber—or write us direct.

WITH EXCLUSIVE NEW
“Standard Notation”
SCHEMATICS

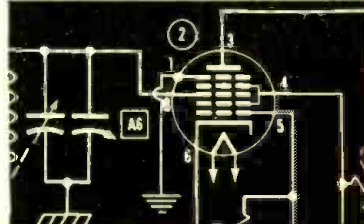

NEW! Howard W. Sams DIAL CORD STRINGING GUIDE



There's only one *right* way to string a dial cord. And there's only one book that shows you how. It's the Howard W. Sams DIAL CORD STRINGING GUIDE. Here, for the first time, in one handy pocket-sized book, are all available dial cord diagrams and data covering 1938 through 1946 receivers. Licks the knottiest dial cord problem in a matter of minutes. This low-cost book is a “must” for servicing. You'll want two copies—one for your tool kit and one for your shop bench. Order them today. **ONLY .75c**

BOOST YOUR EARNING POWER!

Mail This Order Form to Your Parts Jobber Today or send directly to HOWARD W. SAMS & CO., INC., 2924 E. Washington St., Indianapolis 6, Ind.

My (check) (money order) for \$..... enclosed

- Send.....SAMS' 1947 AUTOMATIC RECORD CHANGER MANUAL(S) at \$4.95 per copy.
- Send PHOTOFACT Set No. 23. No. 24. No. 25 (at \$1.50 per Set).
- Send.....SAMS' DIAL CORD STRINGING GUIDE(S), at \$0.75 per copy.
- Send PHOTOFACT Volume 1 (including Sets Nos. 1 through 10) in Deluxe Binder, \$18.39.
- Send PHOTOFACT Volume No. 2 (including Sets Nos. 11 through 20) in Deluxe Binder, \$18.39
- Send FREE PHOTOFACT Aids.

Name.....

Address.....

City.....State.....

HOWARD W. SAMS & CO., INC.
INDIANAPOLIS 6, INDIANA

Export—Ad. Aurora—89 Broad St., New York 4, N. Y.—U. S. of America
Canada—A. C. Simmonds & Sons, 301 King St., East—Toronto, Ontario

PHOTOFACT SERVICE

“The Service that pays for itself over and over again”

New

RADIO-ELECTRONIC DEVICES

SOUND-POWERED TELEPHONE

United States Instrument Corp.
Summit, N. J.

The new sound-powered telephone hand set does not require batteries. It is particularly useful to television antenna installation crews. When the



antenna is being tuned and adjusted for directivity, the man at the set is able to talk to the man making the adjustments. Hand sets may be connected to the transmission line or to a separate line as desired. The units may be used between points up to 30 miles apart.—RADIO-CRAFT.

D.C. AMPLIFIER

Amplifier Corp. of America
New York, N. Y.

The Model ACA-100GE direct-coupled amplifier is designed for use with the G-E variable reluctance pickup. It includes a special built-in preamplifier and prequalizer. Regulated d.c. is used on the filaments of the input tubes.

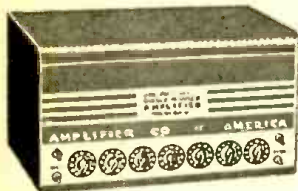

The amplifier develops 23 watts with less than 1% total harmonic distortion. At 12 watts, the distortion is less than 1/2 of 1%. Frequency response is ± 1 db from 20 to 20,000 cycles, and overall gain is 117 db.

A standard 500,000-ohm input is provided in addition to the special pre-amplifier. The amplifier has balanced output terminals for 8, 16, 20, and 500 ohms. In-between terminals provide additional output impedances of 2, 4, 5, 10, 80, 125, 160, and 175 ohms. A non-discriminating scratch suppressor and push-pull expander are included in the circuit.

The unit consumes 150 watts, weighs 40 pounds, and its over-all dimensions are 17 1/2 x 10 x 10 inches.—RADIO-CRAFT.

RESTAURANT RADIO

Music Menu, Inc.
Los Angeles, Calif.

The Music Menu is a coin-operated radio designed for use in cafes, grills, snack bars, and other public places where patrons may wish to tune in their favorite radio program during meal times.

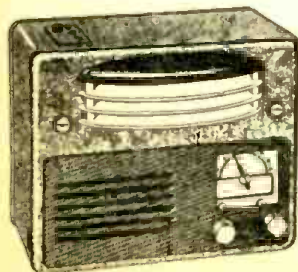

The sets use a standard 6-tube super-het circuit, tuning from 540 to 1700 kc and operating from 117-volt 50- or 60-cycle lines. There is a built-in master volume control and external volume and tuning controls. A timing motor times the operation from 1 minute to 2 hours depending on whether the unit is set to accept pennies, nickels, dimes or quarters. Up to 24 coins may be inserted at one time.—RADIO-CRAFT.

65-WATT TETRODE

Eitel-McCullough, Inc.
San Bruno, Calif.

The new Eimac 4-65A is a small, instant-heating, transmitting-type tetrode with a 6-volt filament making it suitable for mobile applications. Its metal plate has a 65-watt dissipation rating. The plate voltage range is 400 to 3,000 volts. With 40 watts input (400 volts at 100 ma) for class-C c.w. or FM phone applications, less than 2 watts of grid drive will develop 28 watts plate output. In the same applications, the tube will deliver 200 watts output with 2,000 volts on its plate.—RADIO-CRAFT.



V.H.F. CRYSTAL CONTROL

Bliley Electric Co.
Erie, Penna.

The Model 2A crystal-controlled oscillator uses a 6AG7 tube with direct output on 6, 10, and 11 meters and sufficient power to drive a 2-meter tripler stage. It is mounted on a small chassis that may be added to existing equipment or may be included in the design of new apparatus. A single crystal socket, band switch, and tuning control are readily accessible. Power and

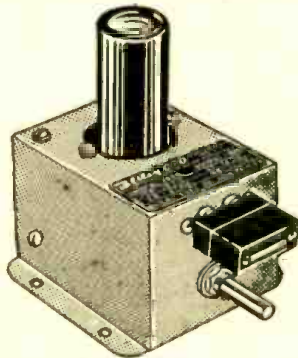

output terminals are on the rear of chassis. Crystals in the 13.5- to 15-mc range are used for 27- to 30-mc coverage, and 24- to 27-mc crystals for from 48 to 54 mc.—RADIO-CRAFT.

'SCOPE PROJECTION LENS

Allen B. DuMont Laboratories, Inc.
Passaic, N. J.

The Type 2088 projection lens is for projecting oscillograms on a large screen for lectures and demonstrations. It is designed for use with oscillographs using 5RP-A cathode-ray tubes with extra-brilliant images.

The lens is a 2-element, symmetrical objective lens with a 7.7-inch focal length and a relative aperture of f:3.3. It projects a pattern of an area up to 3 inches square to distances beyond 8 feet, resulting in a screen image up to about 12 feet square.

The telescopic lens barrel has a mounting flange with 4 holes aligned with holes in the front panel of DuMont

oscillographs designed or adapted for the 5RP-A tube.—RADIO-CRAFT

VARIABLE A.C. SUPPLY

Electronic Apparatus, Inc.
New York, N. Y.

The Model AC-1135 delivers variable a.c. voltages between 0 and 135 volts

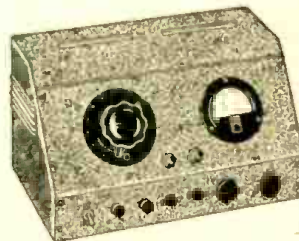

at a maximum of 7.5 amperes with 115-volt, 50- to 60-cycle input. An output voltmeter is provided to meter the 2 output circuits. Each circuit has an individual on-off switch and a closed-circuit ammeter jack.—RADIO-CRAFT.

FLASH TRANSFORMER

United Transformer Corp.
New York, N. Y.

Three new transformers have been developed for photo-flash applications. The type PF-1 has a 117-volt primary, a secondary delivering up to 2,200 volts d.c. after rectification, and a filament winding for a 2x2 rectifier tube. This unit is designed to work into condenser banks of 30 to 100 μ f.

The PF-2 has a primary for use with 4- or 6-volt batteries and a full-wave vibrator. The rectifier filament is heated by the battery. The secondary is rated at 2,200 volts.

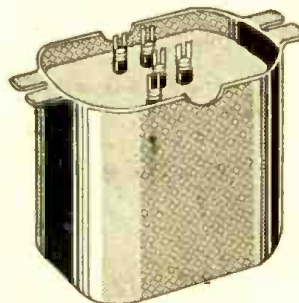

The PF-3 is a trigger transformer which delivers a 15-kv peak used to control the firing of a flash tube.—RADIO-CRAFT.

TEST INSTRUMENT

General Test Equipment Co.
Buffalo, N. Y.

The Pen-Oscil-Lite is a self-contained r.f. and a.f. signal generator no larger than a fountain pen. It emits a high-pitched note that begins in the audio range and can be picked up through the radio-frequency spectrum up to 56 mc or higher. This wide range makes the device useful for signal tracing in PA as well as radio equipment.

It consists of a small vibrator, powered by a penlite cell in the case, which radiates a highly directional signal from the instrument's probe-like tip. A signal can thus be injected into a desired circuit without coupling to adjacent circuits. The drain on the cell is approximately 20 ma.—RADIO-CRAFT

MINIATURE-TUBE PULLER

Oliveri Tool Co.
Chicago, Ill.

The Amo miniature-tube puller inserts or extracts miniature tubes from sockets

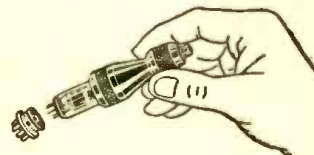

that may be located in hard-to-reach places. It helps to prevent tube breakage, loss of time, and burned fingers. It has a heat-resistant rubber cap, an aluminum body, and a thumb-operated plunger release.

To insert a tube, press the Amo down on the tube and lift up. Eject the tube with the release button. Reverse the procedure to insert tubes.—RADIO-CRAFT.

IMPEDANCE VECTOR GRAPH

Sound Apparatus Co.
New York, N. Y.

The vectorgraph is designed to record automatically impedance components as functions of frequency. It can be used to measure the input impedance of loudspeakers, microphones, recording heads, circuit elements, transmission lines, transformers, networks, and other circuits and components. It is used also for measuring attenuation and propagation constants of filters, lines and networks, and the admittance of high-impedance circuits.

The impedance range is 80, 160, 400, 800 and 1,600 ohms, and the admittance range is 8, 16, 40, 60 and 400 micromhos. The frequency accuracy is $\pm 2\%$.

The unit consists of a 20 to 20,000-cycle oscillator, a recorder, and a link unit. The recorder and oscillator may be used for plotting frequency-response curves. The recorder may be used alone as an a.c. recorder with flat response from 20 to 20,000 cycles.—RADIO-CRAFT.

AUDIO OSCILLATOR

Barker & Williamson, Inc.
Upper Darby, Penna.

The Model 200 audio oscillator uses a modified Wien bridge R.C. oscillator, a 2-stage feedback amplifier, and a



built-in power supply. It is designed for distortion or frequency measurements and other applications where frequencies between 30 and 30,000 cycles are required. Coverage is in 3 ranges: 30 to 300 cycles; 300 to 3,000 cycles; and 3,000 to 30,000 cycles. Voltage output is 11 volts on 500-ohm load.

Frequency response is better than ± 1 db on full range, stability better than 1%, and calibration is $\pm 2.5\%$. The unit operates from 117-volt, 60-cycle lines. It weighs 12 pounds and is housed in a steel cabinet 11 1/4 x 7 1/4 x 9 1/2 inches.—RADIO-CRAFT.



LCETI

Laboratory Caliber Electronic Test Instruments

*Why the smart technicians demand
SILVER test instruments*

You . . . and every serious service technician . . . have long dreamed of your shop equipped with the same caliber of laboratory instruments found in the factories making the radios you must service. Today's complex AM, FM and Television receivers can't be efficiently serviced by anything less.

Under war pressure McMurdo Silver devised new techniques to lift the manufacture of laboratory-type instruments out of the costly model-shop. He discovered how to put them on the low-cost, high-volume production line. The result is instruments of laboratory precision, accuracy, dependability . . . at prices far below what you'd expect to pay. These are the same identical Laboratory Caliber Electronic Test Instruments the big manufacturers, universities and the government select.

Can you afford less than the best — when the best costs you less?

MODEL 906 FM/AM SIGNAL GENERATOR: 8 ranges calibrated $\pm 1\%$ accurate, 90 kc. thru 210 mc. 0-100% variable 400 \sim AM; 0-500 kc. variable FM sweep built-in. Metered microvolts; variable 0-1 volt. Strays lower than \$500 laboratory generators. Only \$99.50 net.

"VOMAX" UNIVERSAL V.T.V.M.: The overwhelming choice of experts. 51 ranges, d.c., a.c., a.f., i.f., r.f., current, db., and resistance. Visual signal tracing to 500 mc. New 5" pencil-thin flexible r.f. probe. Only \$59.85 net.

MODEL 904 CONDENSER/RESISTANCE TESTER: Measures accurately $\frac{1}{4}$ mmfd. thru 1,000 mfd.; $\frac{1}{4}$ " thru 1,000 meg Ω . Internal 0-500 V. variable d.c. polarizing voltage. Measures condensers with rated d.c. volts applied. Only \$49.90 net.

MODEL 905 "SPARX" SIGNAL TRACER: Visual and audible tracing; also tests phono pickups, microphones, speakers, PA amplifiers. Is your shop test-speaker, too. 20 \sim thru 200 mc.; PM speaker; mains-insulated transformer power supply. Only \$39.90 net.

OVER 36 YEARS OF RADIO ENGINEERING ACHIEVEMENT

McMurdo Silver Co., Inc.

1249 MAIN ST., HARTFORD 3, CONNECTICUT

SEND FOR COMPLETE CATALOG. See these and Silver communication transmitters, receivers, "Micro-match", Xtal-controlled VFO, pre-tuned freq. multiplier at your jobber.



Question Box queries will be answered by mail and those of general interest will be printed in the magazine. A fee of 50c will be charged for simple questions requiring no schematics. Write for estimate on questions that may require diagrams or considerable research. Six to 8 weeks is required to draw up answers involving large schematics.

QUESTION SIMPLE OSCILLOSCOPE

Please print a diagram of an oscilloscope using a 5BPI with single 6J7's as deflection amplifiers and a gas triode as sweep generator.—R.R., Philadelphia, Pa.

A. The oscilloscope circuit below is simple yet it has many features of more complex circuits.

The power transformers should be placed beneath the chassis, well removed from the 5BPI. Don't forget that voltages on the cathode-ray tube and its control circuits can be DANGEROUS!

QUESTION METER DATA

I have a 1-ma d.c. meter with a scale calibrated from 1 to 10 and an internal resistance of 50 ohms. What size shunt should be used to increase its range to 100 ma? What size multiplier is needed to use it as a 10-volt voltmeter?—F.E.M., Chicago, Ill.

A. The required shunting resistance for the meter is found by dividing the

meter resistance by $N - 1$ where N is the factor by which the meter range is to be increased. The internal resistance of this meter is 50 ohms, and you desire to increase its range 100 times. The shunt resistance is: $50 / (100 - 1) = 50 / 99$ or 0.505 ohm.

The meter draws 1 ma at full scale. There is a drop of .050 volt across its resistance. For a 10-volt scale, it is necessary to drop 9.95 volts across the multiplier resistance. From Ohm's law: $R = E / I$; the resistance therefore is $9.95 / .001$ or 9,950 ohms.

QUESTION TUBE CHARACTERISTICS

In a certain vacuum tube, a change of 4 volts grid bias or 14 volts on the plate will produce a change of 2 ma in the plate circuit. What is the mu of the tube? What is its plate impedance and mutual conductance?—F.E.M., Chicago, Ill.

A. The mu of a tube is the ratio of a change in plate voltage to a change in grid voltage, in the opposite direction,

to keep the plate current constant. The mu equals change in plate voltage divided by the change in grid voltage; or in this case, $14 / 4 = 3.5$.

The plate resistance of a tube is the result of dividing a small change in plate voltage by the corresponding change in plate current. The quotient is expressed in ohms. In your problem, the plate resistance is $14 / .002$ or 7,000 ohms. The current change is in amperes.

The mutual conductance or transconductance of a tube is the change in plate current (in amperes) divided by the change in grid voltage causing it, when all other electrode voltages are constant. The mutual conductance is: $.002 \text{ amper} / 4 \text{ volts} = .0005 \text{ mhos}$ or 500 micromhos.

QUESTION WIRELESS INTERCOM

I would like to have a diagram of an a.c.-d.c. intercom using no more than 4 tubes if this is practical. The unit is to be used to communicate between floors in my home.—A.M., North Bergen, N. J.

(Continued on page 58)

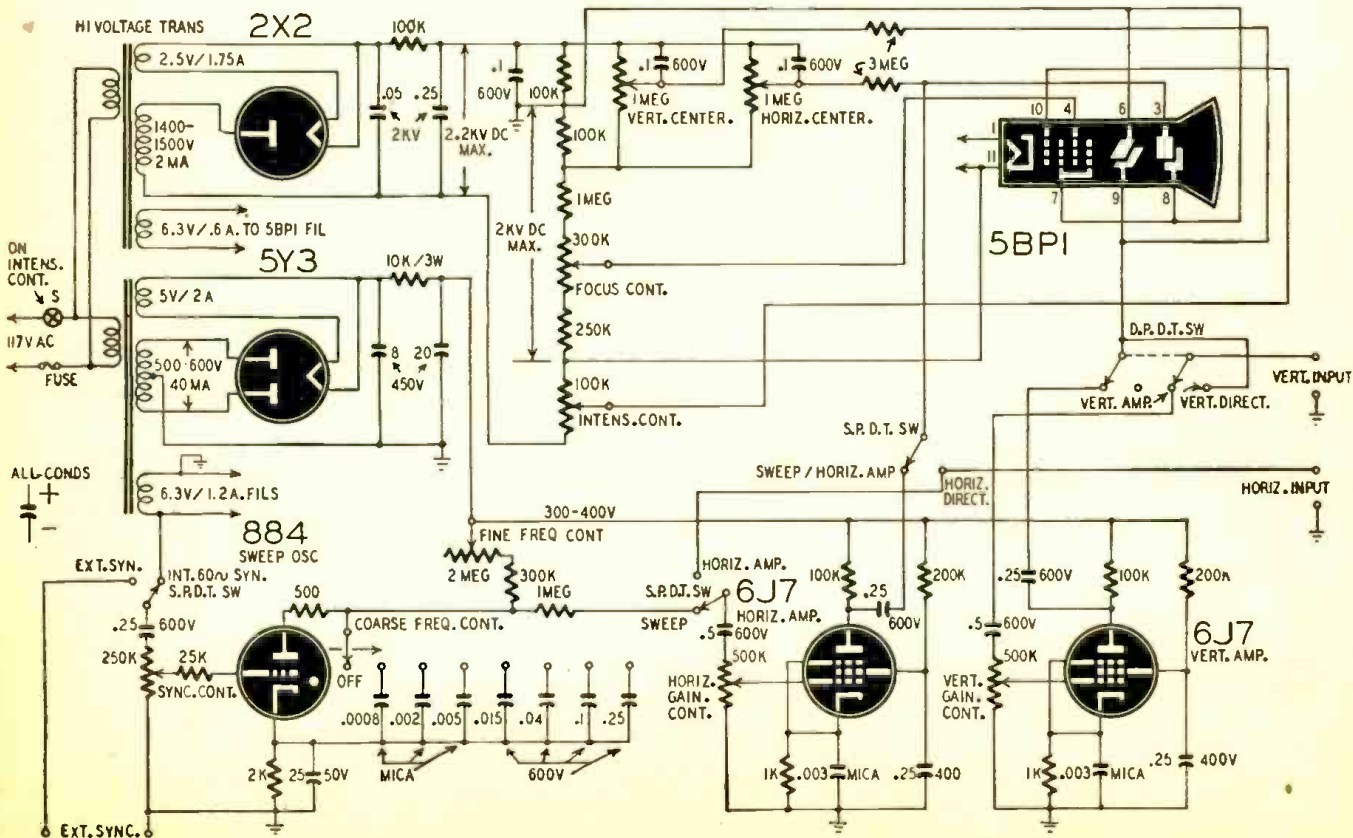

Now

YOU CAN HAVE IMPROVED No-DRIFT FM
in the Sensational New 1948

MIDWEST RADIOS

**NEW SERIES
16*
SUPER DELUXE
AM-FM
CHASSIS**

Here is the finest radio Midwest has ever produced in its 28 years of manufacturing—a world-ranging, 5-band radio with improved Midwest No-Drift FM . . . plus Standard Broadcast and 3 short wave bands, Television Audio Switch-over, and Color-Ray Tone Selection. The Series 16* Super De Luxe Chassis is a powerful, magnificently-toned radio that challenges comparison for performance, sensitivity, selectivity, and advanced engineering features. Supplied with satin stripe copper finish panel—ready to mount in your present cabinet. Send today for the FREE 1948 Midwest Radio Catalog. Buy your radio direct from the manufacturer on Easy Terms and 30 Days Trial and SAVE!



14 1/2"
PANASONIC
SPEAKER

**5
WAVE
BANDS**

*SERIES
16 CHASSIS USES ALL
THESE LATEST-TYPE TUBES

**30
DAYS
TRIAL**

**LOW
FACTORY-
TO-YOU
PRICES**

**EASY
TERMS**

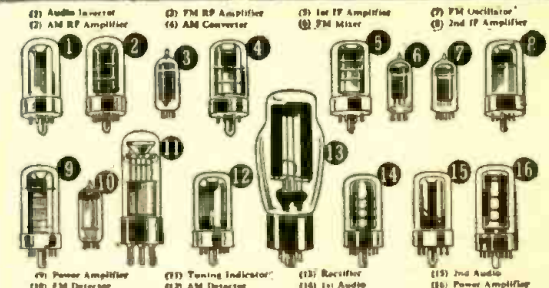

A COMPLETE LINE OF FINE RADIOS AND RADIO-PHONOGRAPHS . . . Available in Separate Chassis Like the Powerful Series 16* AM-FM Model above, or in beautiful Radio-Phonograph Consoles like this:

Scores of NEW Features such as the Exclusive MIDWEST TRI-MAGNADYNE COIL SYSTEM and COLOR-RAY TONE SELECTION.



SYMPHONY GRAND AM-FM RADIO-PHONOGRAPH CONSOLE with NEW Intermix AUTOMATIC RECORD CHANGER

Our Finest! A superbly beautiful musical instrument . . . a masterpiece of furniture design and radio engineering that offers the sensational Midwest NO-DRIFT FM, Automatic Intermix Record-Changer, Exclusive Color-Ray Tone Selection, World-ranging 5-Band Reception, Television Audio Switch-Over, and many more new and exclusive features.

Rush for Free Catalog!
FILL IN COUPON AND MAIL TODAY OR JUST SEND YOUR NAME AND ADDRESS ON 1c POSTCARD

MIDWEST RADIO CORP.
Dept. 38-L, 909 Broadway
Cincinnati 2, Ohio

Gentlemen: Please send me your new FREE catalog and details of your liberal 30 Days Trial.

Name _____
Address _____
City _____ Zone _____ State _____

MIDWEST RADIO CORP.
Dept. 38-L • 909 BROADWAY • CINCINNATI 2, OHIO

BC 223 TRANSMITTER

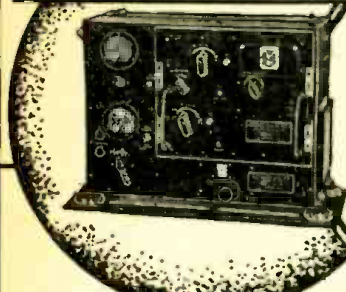

One of the most desirable military transmitters, 4 crystal-controlled frequencies and master oscillator. Meters for Osc., Ant., and total current. Uses 46 speech amplifier, 2-46 modulators, 801 each as oscillator and power amplifier. Practically no conversion necessary, plug in crystal, mike and connect power supply and it's ready to operate. Brand new, with tubes and tuning units to cover 2000 K.C. to 5250 KC. **\$14.95**

BC 4558—BRAND NEW 6 TUBE Superheterodyne AIRCRAFT RADIO

Built by Western Electric superheterodyne, 3 gong condenser, R.F. stage, two I.F. stages, tunes 6-9.1 MC. Offered brand new in original carton for the price others ask for used war-weary sets, with six new tubes. 3-12SK7, 1-12SR7, 112AC6, 1-12K8. Our price..... **\$4.95**

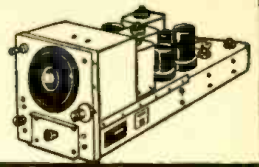

Specials



BC-605 INTERPHONE AMPLIFIER

The famous tank interphone, thousands bought for intercommunicating systems, call systems, etc. Uses two 1619 tubes (2.5V fil. 6L6's) used, in excellent condition, lowest price ever offered, with tubes..... **\$2.95**

PUSH BUTTON TUNER

A ten push button assembly, operating a 4-gang silver plated variable condenser. Each shielded section has silver plated APC type ceramic air trimmers. Drum dial manual tuning. An outstanding surplus value at lowest prices ever offered..... **\$2.50**



RG-8/U FLEXIBLE COAXIAL CABLE

RG-8/U is the ideal cable for feeding receiving and transmitting antennae for all frequencies up to 250 mc, and can be used up to 3,000 mc and down to dc. Prices at less than WAA wholesale. This is the last big lot - order while available.



Only **4¢** PER FT.

ELECTRONIC KITS

- Kit of assorted mica and silver mica condensers, all marked..... 25 for \$1.00
- Kit of assorted ceramic condensers..... 20 for \$1.00
- Kit of Patentmeters long shafts, 600 ohms to 200M ohms for..... 10 for \$1.95
- Kit of tube sockets, miniature, loctal, octal..... 20 for \$1.00
- Experimenter's Kit, a paradise of condensers, coils transformers, resistors, etc., all useful parts. 5 full pounds for..... \$1.00
- Resistor Kit 1/2-1.2 watt, all excellent sizes, color coded..... 100 for \$1.95
- Kit of Amphenol Connectors, excellent for converting military sets..... 10 for \$1.00
- Kit of Selenium Rectifiers..... 4 for \$1.00
- Kit of transmitter crystals, assorted between 2000 and 6000 KC in holders..... 4 for \$1.00
- Kit of R.F. Chokes, excellent assortment..... 10 for \$1.00
- Kit of screw driver type Patentmeters..... 10 for \$1.00
- Kit of Bathtub Bypass Condensers .1 M.F.D. to 1 M.F.D..... 20 for \$1.00

- 455 KC slug tuned I.F.'s sq. can. 39c, 3 for \$1.00
- 4-gang 147 MMF silver plated variable condensers, long shaft, a buy at..... \$1.00
- Choke, 20 henry 50 MA, cased..... \$1.00
- HS30 miniature type headphones, similar to hearing aids with band and cord..... \$1.00
- 12 MFD 150V Mallory electrolytics, extra special..... 6 for \$1.00
- Tuning Unit, BC-746 contains receiver ant. coil, tuning condenser, and crystal, transmitter crystal, slug tuned tank coil sockets, etc. Ideal foundation for Walkie-Talkie or small amateur rig..... \$1.00
- Dynamotors, Western Electric, 24V input, 220V at 80 MA output in original carton..... \$1.50
- U.H.F. Loctal Sockets, Mica filled cinch..... 10 for \$1.00
- Technical Manual on BC312 and BC34 Receivers, instructions and circuit diagrams, etc..... \$.50
- Technical Manual on BC375 and BC191 Transmitters..... \$.50

WE WILL SHIP C.O.D. NO ORDERS UNDER \$2.00



The HEATH COMPANY

DEPT. C • BENTON HARBOR MICHIGAN

A. The simple unit described here should meet your needs. When transmitting, the speaker serves as a microphone working into the grid of the 12SK7 speech amplifier. The plate current of the 12SA7 is plate-modulated by means of the large choke in the plate circuit of the 50L6. When receiving, the 12SA7 is a regenerative detector with the 12SK7 and 50L6 as a.f. amplifiers. The speaker is capacitance-coupled to the plate of the 50L6. The values of the fixed and variable condensers C1 and C2 between L1 and the line should be adjusted for best performance. Total capacitance between 0.0001 and 0.002 μ f should work well. The oscillator coil L2 is a 132-kc b.f.o. coil. L1 consists of 20 to 50 turns of No. 28 d.s.c. wound around the center of L2.

THE QUESTION BOX

(Continued from page 56)

POWER LINE ANTENNA

Here is an antenna system that can be placed inside the chassis of the receiver, with no visible outside wire.

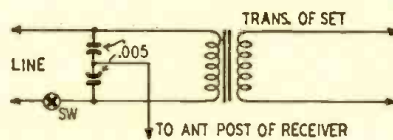

Locate the 117-volt line cord running to the power transformer. Untwist a part of this cord and bare a spot in each strand about an inch long. Then to

each bared spot solder one terminal of a 0.0005 condenser. Connect the two remaining condenser terminals together with a short jumper wire and insulate all joints. Solder a short piece of wire from the jumper and connect to the antenna post of the receiver. In this way your electric light lines are used for the antenna system.

STEWART HENRY,
Dalhousie, New Brunswick

(In most cases, a single condenser connected to one side of the line cord will give better results. Try the plug both ways in the wall receptacle to determine which way gives best reception. If more selectivity is required, try reducing the size of the condenser to .00025 or .0001.—Editor)

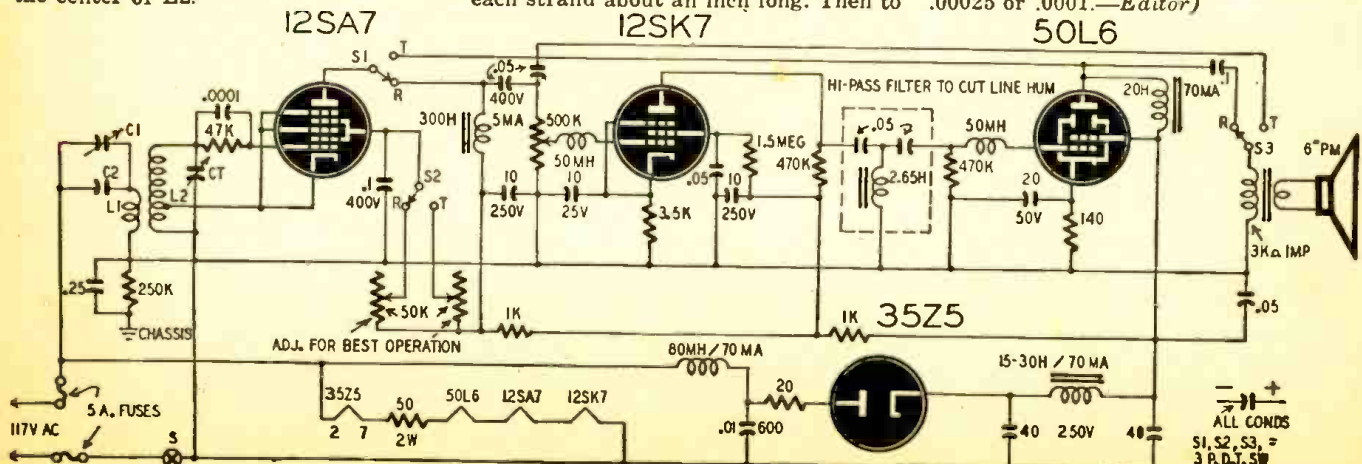



Stop!

IN BUYING RADIO PARTS Demand This SEAL of QUALITY of America's Radio Storehouse



LOWEST PRICES • HIGHEST QUALITY • NO WAR SURPLUS

GENERATOR CONDENSERS



PHILCO part No. 61-0177—5 mfd.— $\frac{1}{2}$ " x $1\frac{1}{2}$ "—4" lead-slotted mounting strap for easy installation—Standard Merchandise—not war surplus—Present list price \$1.00.
Our special—over 83% off **14c**

OUTPUT TRANSFORMERS

Clean stocks — long leads — mounting feet — made to fit where you need them.



For 6F6-6K6—to 4 ohm voice coil—size 2" x $1\frac{1}{2}$ " x $1\frac{1}{2}$ ".
50L6-35L6-25L6 to 4 ohm voice coil— $1\frac{1}{2}$ " x $1\frac{1}{2}$ " x $1\frac{1}{2}$ ".
Specify quantity of each type you need at..... **49c**

CATHODE CONDENSERS



10 Mfd. at 25 working volts— $\frac{1}{4}$ " x $1\frac{1}{4}$ " tubular type—aluminum cans—overall cardboard sleeve—tinned leads—quality construction by a national manufacturer—backed by the famous R. S. & E. guarantee—list price 7¢. Priced to make you money at 12¢ each lots of 100 for..... **108**
lots of 10 for..... **900**

MIDGET I. F. TRANSFORMERS



100-500 Kc range— $1\frac{1}{4}$ " square x $2\frac{1}{2}$ " high—ceramic based mica trimmers—high gain iron cores—pop up old receivers—ideal for new construction. List price \$2.10—up to 88% discount—stock up now for future use.

Each **29c** Dozen **339** Hand-red **2500**

AEROVOX GL 8-600



Genuine Aerovox 8 mfd.—600 volt working—inverted screw mounting—aluminum can $1\frac{1}{2}$ " x $\frac{1}{2}$ "—6" insulated leads. List Price \$4.00—quantity limited—order now on this one time item at only..... **99c**

MODEL 451A AC-DC Volt-Ohm-Milliammeter



A dependable instrument of wide utility—sensitivity 1000 ohms per volt. Ranges: Volts AC, DC, and Output Ranges. 0-10/50/100/500/1000; Ohms full scale, 500,000; Ohms center scale, 7200.

NET complete with batteries **1490**

MODEL 312 Volt-Ohm-Milliammeter



An economy pocket meter featuring a 2" moving vane meter. Reads: AC-DC volts, 0-25/50/125/250; Mills AC-DC, 0-50; Ohms, 100,000; mfd. .05-15. Jacks provide range selection.

NET Complete with cord and plug..... **675**

Start Your Own
RADIO SERVICE SHOP
as low as **9950**

Complete Starting-In Business Stocks of
TEST EQUIPMENT, TUBES, PARTS, TOOLS, EVERYTHING

Write, Wire, Phone for Full Details

PHONO PICKUP CRYSTALS

Standard types—Set Manufacturers close-out—all Guaranteed



Webster F2—Replaces L26-L40-L70 etc.—pin type terminals—1 oz. pressure—1 volt output—5000 cycle cu **149**
List price \$5.00—you pay us....

SHURE P93—W57A—pin type terminals— $\frac{1}{4}$ oz. pressure—1.6 volt output—6000 cycle cut off. List price \$4.45—our Special. **198**

Astatic L-70—new post war design—solder terminals— $1\frac{1}{2}$ oz. pressure—1 volt output—4000 cycle cutoff. List price \$5.55—we quote you... **198**

Pep-Up PHILCO CHANGERS

At last! All the parts you need to restore brilliant tone and volume to "sick" changers! You'll need all three items—sell your customer a 100% reconditioning job—Selenium cell only, no holder..... **\$1.80**
Sapphire needle only, no mirror..... **\$1.20**
Special original equipment lamp..... **.27c**
RECONDITIONING KIT—all three above items—postpaid—special at..... **321**

RADIO RULE



Here is a clear 6" plastic rule—a necessity for radio students, draftsmen, hams, all who desire cleaner, more precise work—National advertised at \$2.00. Order yours today postpaid only..... **35c**

SEND FOR FREE CATALOG

MULTI-RANGE MILLIAMMETERS

Two types—for A.C. or D.C. measurements

MODEL 671—for A.C. current. Seven switch selected ranges of 0-5, 10, 25, 100, 250, 500, and 1000 milliamperes.

MODEL 675—for D.C. current. Eight switch selected ranges of 0-1, 5, 10, 25, 100, 250, 500, and 1000 milliamperes.

Here are two meters you can't afford to pass up—just the thing for radio servicing, transmitter trouble-shooting, general lab and experimental work.

A One-Time only Special buy at **795**



606B-VOLTAGE TESTER



Checks voltage and polarity. Range: 0-440 AC-DC volts—definite indications for 115, 220, and 440 volt lines. Separate polarized vane for AC or DC indication. Built in test leads. Excellent for checking wiring, fuses, general factory installation and maintenance. Every plant—every electrician needs several at this low price. Regular net 16.67 **895**
Special at.....

VOLTMETERS



Panel meters by Triplett! Top quality instruments—new—boxed—five popular types—priced right—your chance to get those meters you've always wanted—

MODEL 332—0-150 A.C. volts—3" round flush mounting black brass case.

MODEL 231—0-150 A.C. volts—2" round flush mounting bakelite case.

MODEL 237—0-150 A.C. volts—2" square flush mounting bakelite case.

MODEL 221—0-30 D.C. volts 2" round flush mounting bakelite case.

MODEL 324—0-400 D.C. volts—3" round projection mounting—bakelite case.

Supply limited—order now—list models you desire. **295** EACH

RESISTANCE LINE CORDS



Standard 3 terminal 135 ohm AC-DC cords—sturdy construction—flexible— $5\frac{1}{2}$ " long—complete with plug—for sets having approximately 69-75.2 volts drop in the filaments—Regular list price 1.17—**Only 33c**

RADIO SUPPLY & ENGINEERING CO., Inc.

125 SELDEN AVE. DETROIT 1, MICH.

Include full remittance with orders of \$3.00 or less. Include 25% deposit with all C.O.D. orders of \$3.00 or more. All shipments sent express collect if postage is not included. Prices subject to change without notice.
BE SURE TO INCLUDE SUFFICIENT POSTAGE. EXCESS WILL BE REFUNDED.

SYMBOL OF VALUE

SENCO

BRAND NEW WILLARD # 20-2 2 VOLT STORAGE BATTERY

Used in General Electric model #530 charge A PACK Portables. Suitable for all Farm Radio sets. Individually boxed. List Price \$2.49. Special each.



\$2.49

100,000 RADIO TUBES

Every tube guaranteed. Every tube in carton.

Type	Each	Lots of 10 Each	Type	Each	Lots of 10 Each
1U5	36	30	12C8	70	60
1V	45	39	12J5GT	49	39
1L4	55	49	12J7GT	45	39
2A5	65	55	12K7GT	45	39
3Q5	55	50	12Q7GT	45	39
5U4G	55	40	12SA7GT	40	32
5W4GT	40	36	12SQ7GT	40	32
5Y3GT	40	37	12SK7GT	45	35
5Y4G	40	37	12SJ7GT	55	50
5Z3	40	37	24A	49	39
6A7	55	45	26	39	30
6A8GT	59	44	27	42	38
6AC7	65	60	41	45	40
6C5GT	40	35	42	47	42
6B7	55	49	43	59	49
6C6	45	37	45	49	39
6C8G	37	29	47	39	29
6D6	45	37	57	45	39
6F6GT	45	40	58	45	39
6H6GT	45	40	71A	39	29
6J5GT	55	50	75	50	40
6J7GT	42	38	76	45	39
6K7GT	49	40	77	35	27
6Q7GT	47	42	78	35	27
6U7G	35	25	80	40	38
6V6GT	59	49	84/6Z4	45	36
6X5GT	49	40	25L6GT	60	50
6SA7GT	44	37	25Z5	59	47
6SJ7GT	44	37	25Z6GT	55	43
6SK7GT	44	37	35L6GT	60	50
6SL7GT	55	47	35W4	45	40
6SN7GT	55	47	35Z3	44	35
6SQ7GT	47	42	35Z5GT	49	39
6SG7	44	39	50L6GT	55	45
6ZY5G	45	40	117Z3	55	45
7B7	44	35	117Z6GT	99	89
7C6	44	35	12A76	55	45
7C7	44	35	12BA6	55	45
7Y4	44	35	12BE6	55	45
7X7	44	35	50B5	42	32
7AF7	44	35	32L7GT	60	50
12A8GT	54	45	OZ4	59	50

LEADING BRAND AC PHONO MOTOR

60 cycles, 115 volts with Turntable with Standard Make Crystal Pickup.



Complete \$4.35

VM MIXER CHANGER

Model 200B, 2 Post.

Sensational! Plays 10" and 12" records intermixed with no adjustment. Light, crystal pickup. One control knob for on, off, manual, automatic, press to reject 110 Volt, 60 cycle, noiseless motor. **\$15.95**

OAK RECORD CHANGER

AC 110 Volts 60 cycle 2 Post—Plays 10-12" or 12-10" records. Lightweight Crystal Pick-Up, Noiseless Motor. **\$17.45**

MALLORY

6V-4 PRONG AUTO VIBRATOR **\$1.19**

40 x 40 Electrolytic Cond. 150V. \$.49
50 x 30 Electrolytic Cond. 150 V. \$.49
30 x 20 at 150 V. and 20 mfd at 25 Volts .45

120 Mil Power Transformer
Primary 110 V. Secondary 6.3 Rectifier 5 V. H.V. 600 V C.T. **\$3.25**

225 Mil Power Transformer
Primary 110 V. Secondary 6.3 Rectifier 5 V. H.V. 600 V C.T. **\$4.25**

25% dep. on all orders. Bal. C.O.D., F.O.B. N. Y. C.

SENCO RADIO, Inc.

96 WARREN ST., N. Y. 7, N. Y.
TEL. BEEKMAN 3-6498

TRY THIS ONE

NOVEL MIKE CASE

A useful and practical application for surplus Army flashlights is to use them for mounting small carbon microphones.

Assembly is simple. Remove the lens,

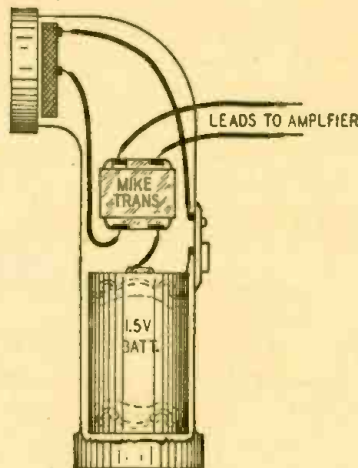

bulb, and reflector. Replace the reflector with the microphone, and install a small mike transformer and a single flashlight cell. Connect the switch, mike, and battery as shown and bring a shielded lead from the secondary of the transformer through a small hole in the case. The flashlight makes a handy case for the mike and eliminates the external transformer and battery.

NED FLEISHMAN,
Fayetteville, N. C.

(These flashlight cases can also be used for mounting crystal headphone units or dynamic speaker-microphones, many of which are available from surplus stocks. The small push-button switch is ideal for push-to-talk operation—Editor)

SAFETY TERMINALS

This simple and practical device provides a safety covering for exposed high-voltage terminals.

It consists of a piece of clear plastic cut somewhat larger than the over-all dimensions of the terminal strip with holes drilled to permit screw-driver tightening of each terminal. The cover is mounted on bushings to space it from 1/2 to 3/4 inch from the chassis. Changes

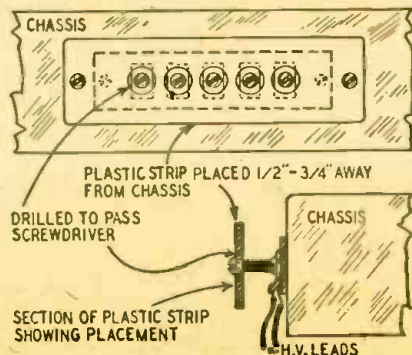

can be made readily, yet the terminals are protected against accidental contacts.

OTTO L. WOOLLEY,
Colorado Springs, Colo.

SIMPLE DIAL DRIVE

I was called upon to repair an old friction-drive radio dial and found no replacement or spare parts available. I removed the bushing and shaft from an old volume control and fastened it in a hole in the front panel. This hole was placed so the end of the shaft was just below the bottom edge of the dial. I slipped a piece of heavy rubber hose over the shaft so it made firm contact with the rim of the dial. The friction provides positive action between dial and shaft.

EUGENE KAAGE,
St. Louis, Mo.

(If the dial is fairly large, tuning will be slow, thus making this system an excellent one for use on homemade short-wave receivers.—Editor)

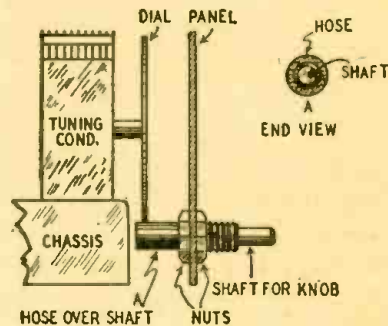

SOLDERING ALUMINUM

It is easy to make solder stick to aluminum if you can clean the surface and prevent re-formation of oxides.

This is the method that I use. Float a pool of fluxless solder on the surface to be soldered and move the tip of the iron back and forth in the pool while applying firm pressure. The vigorous scraping motion loosens the aluminum oxide and it floats to the top of the solder. The surrounding solder readily adheres to the pure aluminum surface since air is excluded, thus preventing oxidation. This method should work with other metals that form troublesome oxides, providing the oxides can be scraped off.

E. JOHNSON,
Brooklyn, N. Y.

METER OR DIAL SCALES

Whenever I need an evenly divided scale for a meter or dial, I find it simple to make one out of polar co-ordinate graph paper. I select a circle of the desired diameter and cut it out, removing segments where necessary. This gives a finely divided scale that is hard to beat.

N. SCHVEDMAN,
Bronx, N. Y.



AMAZING VALUE!

BRAND NEW 5" CATHODE RAY TUBES
(5 CP 1)

\$1.95
EACH IN ORIGINAL CARTON

ADD 35c TO COVER HANDLING AND POSTAGE

GENUINE GOVERNMENT SURPLUS



AIRCRAFT TRANSMITTERS
only
\$330

BC-457-A, 4 to 5.3 MC and BC-458-A, 5.3 to 7 MC. These transmitters are companion sets to the 453, 4, and 5 receiver series. They are used, but in excellent condition. It's really built rugged and makes an excellent 55 watt transmitter. With tubes.

Shipped Express Collect

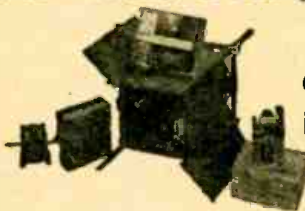

RADIO CONTROLLED BOMB-FIN
\$985

This unit was originally used to control a guided Bomb; it contains a 24-volt Willard rechargeable battery pack, which operates a gyroscope, and low geared reversible motor. The unit also contains a precision built 5-tube RF Receiver complete with dynamotor.

Shipped express, charges collect

NEW MINE DETECTOR



MODEL AN-PRS-1

SHIPPED EXPRESS CHARGES \$9.50 EACH COLLECT



REEL CONTROL BOX BC-461

For use with Antenna Reel RL-42B. Contains a 2 way switch, pilot light and a counting mechanism that counts to 1000.

\$.75

Add 25c to cover handling and postage



ELECTRIC ANTENNA REEL

Antenna Reel RL-42B used to wind in a trailing antenna on aircraft, operates on 24 volts AC or DC. Motor can also be adapted as a beam rotor.

Shipped express charges collect **\$250**

Reel control Box BC-461, as described in this ad, is used in conjunction with this unit.

50" Flexible Shaft for use with above reel..... \$1.00

82" Flexible Shaft for use with above reel..... \$1.50

BENDIX CONTROL BOX

\$1.00



Model 3616, makes an excellent set up for an inter-com. set. Contains 3 multiple type w a f e r switches, one panel type fuse, one volume control, one master 2 pole double

throw switch, one lock type sending and receiving telephone key, one local remote transmitter control, one single pole switch, one 24-volt Leach relay with 2 contacts.

Add 25c to cover handling and postage



PHANTOM ANTENNA
85c

A transmitting antenna, for use on approximately 450 MC. Complete with standard coax connector. A weatherproof unit.

Add 25c to cover handling and postage

BC-434 F



CONTROL BOX

Contains 3 band dial, a reostat, to control 3 grain of wheat dial lights, an audio volume control, a milliammeter, jack plug, switch, and resistors.

\$125

Add 25c to cover handling and postage

MORE REAL VALUE

N-6-A Gun Sight, containing a f 1.9 lens system plus a mirror and many other valuable parts... **\$100**

Add 25c to cover handling and postage

Throat Mike, complete with cord and switch..... **.95**

Add 15c to cover handling and postage

DYNAMOTORS

DM-32-A, Input 28 volts at 1.1 amps, Output 250 volts at .06 amps.

Add 35c to cover handling and postage

DM-36-C, Input 28 volts at 1.4 amps, Output 220 volts at .08 amps.

Add 50c to cover handling and postage

\$100 EACH

24" Headphone cord, complete with lugs..... **.09**

74" 4 conductor shielded cable, with PL 108 plug on each end..... **.15**

Continuity Tester, with 12 extra penn light cells..... **\$1.95**

Add 15c to cover handling and postage

Microphone switch and cord..... **.25**

Head Set H-16/U, 8000 ohm impedance..... **\$1.85**

Add 25c for handling and postage

NO C.O.D. ORDERS

MINIMUM ORDER \$2.00 • ALL PRICES F.O.B. OUR WAREHOUSE • MICHIGAN SALES ADD 3% TAX

N. SILVERSTINE CO.

6532 EAST McNICHOLS ROAD
DETROIT 12, MICHIGAN

Surplus

Bargains

In New Jersey...
.. it's **VARIETY**..

Sensationally New

TRANSMISIONS

12" TELEVISION KIT

STANDARD MODEL
—Picture size 75 square inches. 22 tubes and 12 inch picture tube. High fidelity FM sound reproduction. Advanced television circuit provides exceptionally clear pictures.

DELUXE MODEL—with Superb Built-in FM Radio.

12" Standard Television Kit.....\$289.50*
12" Deluxe Television—FM Radio Kit..... 359.50*
7" Television Kit..... 159.50*
(*Complete with tubes, less cabinet)

Cabinet for 12" Television Receiver..... 44.95

DEALERS' PRICES ON REQUEST



NEW!

PREMIER Model 570

MICROMASTER Band Spread Dial SIGNAL GENERATOR

For testing and aligning BROADCAST, SHORT-WAVE, FM and TELEVISION RECEIVERS. Exclusive Band Spread Dial geared to the tuning condenser and main dial, giving a total scale length of approximately 60 inches. Three-color dial directly calibrated in Kilocycles and Megacycles. Range: 75 KC—150 MC. Size: 12 1/2" x 12" x 5 1/4".

COMPLETE WITH TUBES AND CO-AXIAL CABLE.

\$5475 NET



6" PM SPEAKERS \$7.49
5 FOR

1/2 meg. VOL. CONTROL with SWITCH (Claro-stat) 1/2" length shaft. 10 for \$4.59

1/2 meg. VOL. CONTROL without SWITCH (Claro-stat) 1 1/2" length shaft. 10 for \$2.49

TAPPED OSCILLATOR COILS for 12SA7-6SA7.....15c each, 10 for .99
DUAL 30 mmf. AIR TRIMMERS..... 10 for 69c
50 mmf. AIR TRIMMERS..... }

Bargain! Guaranteed!

100 Assorted Bypass Condensers, 600V Value \$11.00. SPECIAL \$6.95

SUPERIOR Model 670

Super-Meter

A Combination Volt - Ohm Milliammeter plus Capacity Reactance Inductance and Decibel Measurements.

Complete with test leads and instructions..... \$28.40



Full line of Weston-R.C.P.-Supreme Superior-E.M.C.-Test Equipment

Write Dept. RC-11, 20% Deposit with order required. Please add sufficient postage. Excess will be required.

Variety **ELECTRIC CO., Inc.**
601 Broad St., Newark 2, N. J.

New Radio-Electronic Patents

By I. QUEEN

PRECISE LECHER MEASUREMENTS

Glenn R. Frantz, Pt. Washington, N. Y.
Allen F. Pomeroy, Bernardsville, N. J.
(assigned to Bell Tel. Laboratories, Inc.)
Patent No. 2,419,208

Low wavelengths are conveniently measured by Lecher Wires. The r.f. current is introduced along a transmission line which is shorted at some point. A detector is connected across the line and its distance from the short is varied until it shows a voltage node. The detector is moved further along the line until another node is indicated. The distance between consecutive nodes equals 1/2 wavelength. For very short wavelengths, a wave guide is

to measure. Each reflector is equipped with a handle so that it may be inserted or withdrawn from the guide. The probe is movable over a limited distance, the position being measured by calibrated scales.

To make a measurement of wavelength, v.h.f. energy is introduced into the guide, and the reflector A is inserted. If the wavelength equals the average or medium value for which the equipment is calibrated, the probe will pick up no voltage at C, exactly 4 half-wavelengths from A. At this point the scales indicate the average wavelength of the equipment. If the wavelength is higher, the probe must be moved back, say to D, to obtain a null. The length CD is 4 times the change of wavelength. The new wavelength is read on the upper scale.

For still higher precision, A is withdrawn and B inserted. Now the probe must be moved back to E for a minimum pickup. CE equals 11 times the

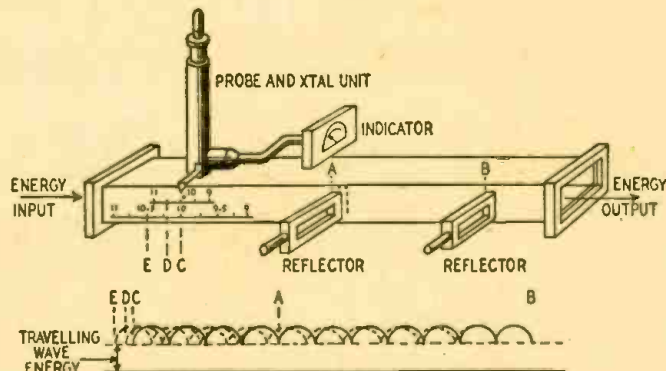

used instead of a transmission line. The detector is coupled to a probe inserted into the guide.

The relative error of a measurement of length increases at short lengths. This invention reduces the error by measuring over a distance of several wavelengths. As shown, 2 reflectors are used to short-circuit the guide. The distance between them is equal to any number of half-wavelengths at the average or median wavelength which it is proposed

change in wavelength because this reflector is 11 half-wavelengths from C. The lower scale is now observed for actual wavelength. It is clear that this scale will have more widely spaced and readable calibrations due to the fact that the actual wavelength change has been multiplied by 11 instead of 4.

Still greater precision is obtainable by placing a reflector still further from the probe.

FM-AM DETECTOR

Frederick C. Everitt, Brecksville, Ohio
(assigned to Radio Corp. of America)
Patent No. 2,422,087

Both FM and AM have advantages of their own and several manufacturers are now selling receivers which can be switched to pick up either type of broadcast. Each requires a different band width and a different intermediate frequency, so there must be 2 separate i.f. channels. This patent discloses a single detector stage which can be used on both, however.

Output from the 2 i.f. channels are combined and connected across 2 i.f. transformers in series. One is tuned to the 4.3-mc FM channel and the other to the 455-kc AM channel. Each transformer has negligible impedance at the frequency of the other, so it is not necessary to switch or short one out while the other is effective.

When the 2 switches are in the FM position (as shown), the plate voltage is dropped to about 25 by the plate resistor, and at the same time an R-C network is placed in the grid circuit. Therefore the triode acts as a limiter. When the switches are

The detector circuit is rather unconventional. The cathode coil has an inductance of about 200 μh and a natural frequency of 4.2 mc. Its reactance varies with frequency when FM broadcasts are being picked up. The deviations from the center frequency of 4.3 are thus translated into amplitude changes of voltage on the cathode. Since the 2 diode plates are normally at ground potential, their potential (with respect to the cathode) changes in the same way. Currents therefore flow through the diode resistors. One diode is used as a detector, the other as a.v.c. supply.

An important advantage of this system is that there is no loading of the i.f. transformer secondaries when AM broadcasts are received. The grid circuit does not carry current. This gives better selectivity and sensitivity. On the other hand, the triode produces no gain since its load is in the cathode circuit.

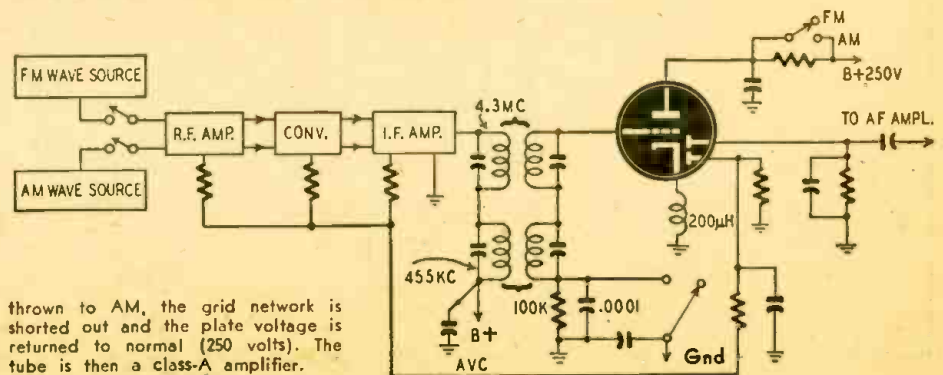

thrown to AM, the grid network is shorted out and the plate voltage is returned to normal (250 volts). The tube is then a class-A amplifier.



Use my 19 years of Radio Experience To Double Your Earning Cut Servicing Time in 1/2

30 LECTURES COMPLETE \$3.00 ONLY

GET Ahead in radio servicing by using ideas and tricks of an expert. Add years of valuable experience to your present radio knowledge. Improve your servicing ability double-quick; lick every problem; avoid costly mistakes. Use this new giant 3-in-1 lecture-

manual of practical facts, time-saving hints, hundreds of circuits, suggestions, "know-how" tips, and explanations. Solve the hard cases in a jiffy. Find the cause of every puzzling radio defect or fault. Use M. N. Beitman's 19 years of successful radio experience to your own advantage.

SOLVES ALL ADVANCED SERVICING PROBLEMS

Let these lectures show you how to improve your store or shop, how to obtain free advertising for your business, what to charge, and how to keep records. Down-to-earth practical help on the business side of radio. Many lectures describing circuits, operation, and application of modern radio test equipment of every type. Meters, volt-ohmmeters, vacuum tube voltmeters, tube testers, analyzers, signal generators, oscilloscopes, signal tracers, condenser testers, Q-meters. Testers of R.C.A., Supreme, Weston, Precision, Superior, Meissner, Feiler, Biley, and other makes completely described. Also fourteen lectures on radio circuits and advance troubleshooting. See list of topics at left. Material on television. Frequency Modulation lecture originally delivered by Westinghouse Engineers.

KNOWLEDGE TO PUT YOU ABOVE COMPETITION

Complex and unusual radio faults may waste hours of your valuable time. The author has foreseen all possible problems (above the elementary level) and provided explanations and practical solutions in this unique on-the-job manual. Keep it on your work bench to aid and guide you on tough repairs. Use the thousands of hints and advanced servicing suggestions to speed up routine jobs. No other training book or course can compare to this new manual. Published in September, 1947. Be first to use it and forge ahead of others. Learn to do complicated repairs in minutes instead of hours.

LECTURE-COURSE WORTH \$60 YOURS FOR ONLY \$3.

Think what it would have cost you to attend in person the 30 lectures completely printed in *Advanced Radio Servicing* manual. Perhaps \$60, maybe even more figuring carfare. But in this giant volume you have every word of all lectures, plus illustrations of every slide used, and many additional photographs and charts. And the special bargain price for the complete 30 lectures in the giant manual, as shown at the top of page, is only \$3.00, full price. Take advantage of this remarkable bargain and secure on "no-risk" trial this practical radio training that will add years to your own experience. Send coupon today. Examine and use material for 10 days under our satisfaction or money-back guarantee.

Guarantee
We guarantee you complete satisfaction or will refund your total remittance.
SUPREME PUBLICATIONS

NO RISK TRIAL ORDER COUPON

SUPREME PUBLICATIONS, 9 S. Kedzie Ave., Chicago 12, ILL.

Please send manuals checked below and at right. You guarantee complete satisfaction or will refund my money.

- Advanced Radio Servicing \$3.00 (New manual of 30 lectures)
 I am enclosing \$..... send postpaid.
 Send C.O.D. I am enclosing \$.... deposit.

- 1947
 1946
 1942
 1941
 1940
 1939
 1926-1938 @ \$2.50
- PRICED AT ONLY \$2.00 EACH**

Name:.....

Address:.....

BOOK 1. BUSINESS SIDE OF RADIO SERVICING

Four complete lectures by M. N. Beitman. Discussion of radio service problems. Opening and operating a radio store and shop. Selecting the right location. Store arrangement. Tested advertising ideas that cost little—bring big results. Window display suggestions. Service department. Model shop. What to charge. Bookkeeping and records.

BOOK 2. USING TEST EQUIPMENT

Visual and aural time-saving methods. Meters, volt-ohm-milliammeters, related circuits. Vacuum tube voltmeters. Voltage and resistance point-to-point servicing. Tube testers (emission, leakage, dynamic, and mutual conductance types). Using a signal generator. Cathode ray oscilloscope as a servicing tool. Tuned signal tracers. Simplified signal tracing technique. Condenser testers. Bridges. Advanced test equipment. Twelve illustrated lectures on every type of modern test equipment.

BOOK 3. RADIO CIRCUITS AND SERVICING

Fourteen easy-to-follow lectures on radio testing and making repairs. Tests for audio voltage and power amplifiers. Audio corrective circuits. Inverse feed-back. Phase inverters. Understanding impedance. Loud-speakers and output transformer matching. Function and adjustment of tuned circuits (a non-mathematical treatment for servicemen). Detector and AVC circuits. Troubles in R.F. and I.F. stages. Superhet converters and alignment hints. Power supplies: AC-DC, A.C., and doubler types. Television facts. F.M. fundamentals and receiver description. Trouble-shooting and alignment in F.M. receivers. All 30 lectures of all 3 books, only \$3.00, see top of next column for more details. Send coupon today.



1947. Newest SUPREME PUBLICATIONS Diagram Manual has all recently released popular sets. Large clear schematics, needed alignment data, parts lists, voltage values, and information on gain, trimmers, dial stringing. Covers 327 models of 52 makes. Large size. \$2.00. Send coupon for Manuals wanted. Price postpaid, only.....

1946 1942 1941 1940 1939 1926-1938
Each manual has between 192 and 208 pages. Radio Diagram Manual 240 pages. Large size: 8 1/2 x 11". Manual style binding. Price, each Manual only.. \$2.00 Price, only \$2.50

See Your Radio Jobber or Send Coupon →

Supreme Publications

PUBLISHERS OF RADIO BOOKS, MANUALS, AND DIAGRAMS

9 South Kedzie Ave.

Chicago 12, Illinois

RADIO-CRAFT for NOVEMBER, 1947

65

No More Guesswork



with OHMITE Little Devil

COMPOSITION RESISTORS

You never have to guess about the resistance and wattage of any Little Devil resistor. Every unit is not only color-coded but individually marked for quick, positive identification. Millions used in critical war equipment. Standard RMA values from 10 ohms to 22 megohms, in 1/2, 1, and 2-watt sizes. Tol. $\pm 10\%$. Also $\pm 5\%$ in 1/2 and 1-watt sizes.

Available Only Through OHMITE Distributors

Ohmite Manufacturing Co.
4896 Flournoy St., Chicago 44, Ill.



EVERY UNIT
CLEARLY
MARKED!

OHMITE

PORTABLE P.A. AMPLIFIER

(Continued from page 29)

The meter may also be used to judge the level being fed to a remote speaker located at some point where it cannot be heard. The amplifier can develop 11 volts across 7.5 ohms (or 74 volts across 500 ohms) without serious distortion, and the series meter resistance can be changed to indicate this value.

The lower deck contains the power supplies and the plate current meter (see Fig. 3). Screw-driver adjustments are brought out to the panel for the output tube bias adjustment, and between them is located a 3-position switch. This switch connects the meter to either or both plates. The bias is adjusted so that each tube draws 55 ma.

When connected to both plates, the meter becomes a distortion indicator. When the total plate current swings more than 20 ma, serious distortion will

and 10-henry filter choke. The power transformer has a bias tap which is rectified by an 80 tube and filtered with an R-C filter. The various voltages are brought out to a terminal strip located on the side of the case. The amplifier decks are connected separately to it so that they are individually removable.

The chassis were made of 1/16-inch aluminum held to the panel by cut down rack panel brackets (see photographs).

The negative plate supply bus is not grounded in the power supply deck at all, but is fed directly to the 2 amplifier decks. It is grounded to each deck in 1 place only. The 6.3-volt heater supply is grounded in the preamplifier deck in one place only. This is essential to elim-

(Continued on page 82)

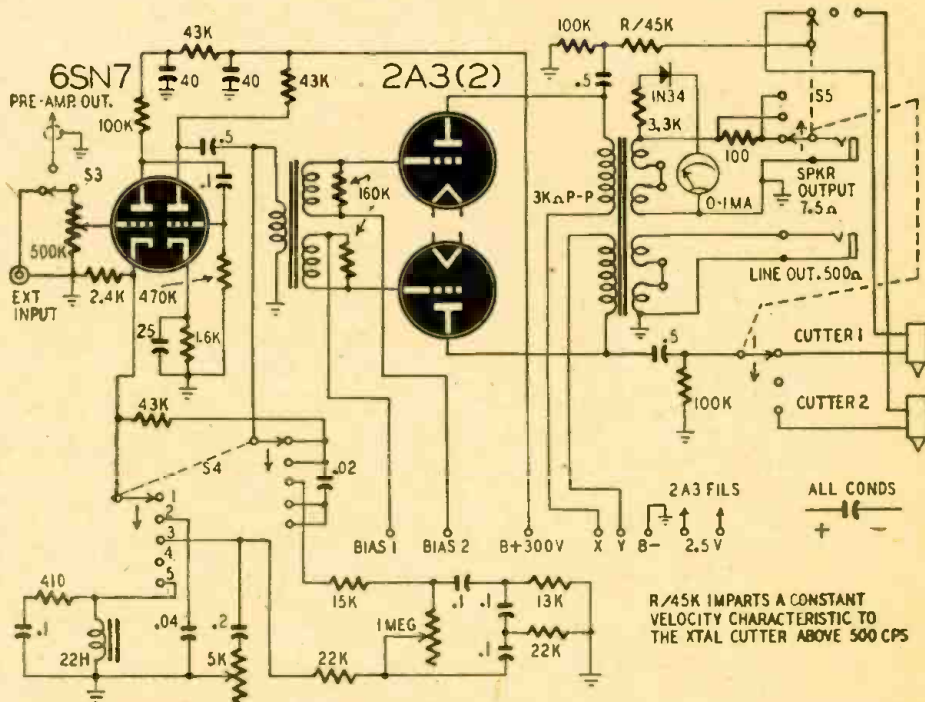

Fig. 2—Power Amplifier section. The driver plate is shunt-fed through a 43,000-ohm resistor.

result, as the output tubes will draw excessive grid current.

Power supply

The power supply panel also contains the main power switch, a fuse, indicator lamp, and two 117-volt outlets for a lamp or for 2 recording or playback turntables.

The high-voltage supply consists of 325 volts at 160 ma, using a 5U4G rectifier tube and filtered with 80 microfarads of capacity and a 15-

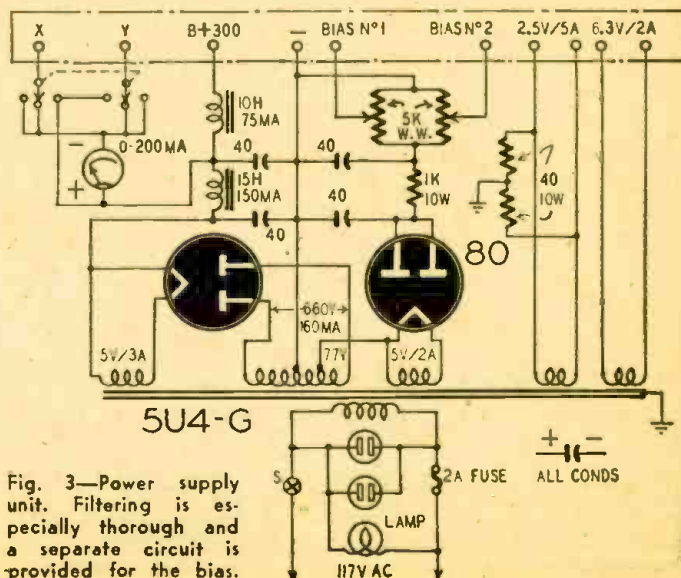

Fig. 3—Power supply unit. Filtering is especially thorough and a separate circuit is provided for the bias.

NOW YOU TOO CAN BUILD 15 RADIOS

COMPLETE
KIT ONLY

\$14.⁷⁵₀



**ABSOLUTELY NO KNOWLEDGE OF RADIO NECESSARY
YOU NEED NO ADDITIONAL PARTS!**

THE PROGRESSIVE RADIO KIT is THE ONLY COMPLETE KIT. Contains everything you need. Instruction Book, Metal Chassis, Tubes, Condensers, Resistors and all Radio parts. The 36-Page Book written by Expert Radio Instructors teaches you to build radios in a Professional Manner. You start with two 1-tube receivers. Then you will build three 2-tube receivers. You will continue by building six 3-tube receivers. You will then make a 3-tube public address system which will permit you to address large audiences. Finally you will build three different 3-tube transmitters so that you can get a real thrill out of being "on the air." Before you are done with this kit, you will have built 11 Receivers, 1 Public Address System and 3 Transmitters.

RADIO PARTS SCOOP!

NO SURPLUS — ALL PARTS
GUARANTEED BRAND NEW!

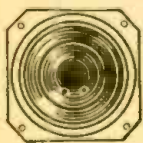

SPEAKERS
6-INCH PM ALNICO V
SPEAKERS **\$1.69**

CONDENSERS

DUAL 20/20 MFD ELEC-
TROLYTIC CONDENSERS
150 V.D.C.

29c



COILS
MATCHED ANTENNA
AND RF COILS FOR
BROADCAST BAND
SET:

53c

RECTIFIERS

SELENIUM
RECTIFIERS

79c



SPECIAL FREE OFFER!

Electrical and Radio Tester sent absolutely FREE with each Progressive Radio Kit. PLUS FREE membership in Progressive Radio Club. Entitles you to free expert advice and consultation service with licensed radio technicians. Write for further information, or ORDER your KIT NOW!

MAIL COUPON TODAY!

PROGRESSIVE ELECTRONICS CO., Dept. FP-3
22 HAVEMEYER STREET, BROOKLYN 11, NEW YORK

SIRS: Please send me the following:

- Progressive Radio Kit Complete\$14.75
- 6" Alnico V Speakers (\$1.69 each)
- Electrolytic condensers (29c each)
- Sets Antenna & RF coils (53c per set)
- Selenium Rectifiers (79c each)
- Enclosed find check or money order (Postage Prepaid) TOTAL
- SEND C.O.D. (I will pay postage)

NAME

ADDRESS

CITY

ZONE

STATE

Send additional information on Radio Kit.

ANOTHER MOSS SENSATIONAL VALUE!!

a Multi-Range VOLT-OHM MILLIAMMETER **AND** ALL-WAVE SIGNAL GENERATOR



BOTH FOR ONLY 34.⁸⁵

Don't pass up this amazing introductory offer! Rush your order now for this sensationally low-priced combination. Skeptical? . . . of course . . . but rush your order anyhow. We guarantee to refund your money in full if the units do not meet with your complete approval after a 10-day FREE trial.

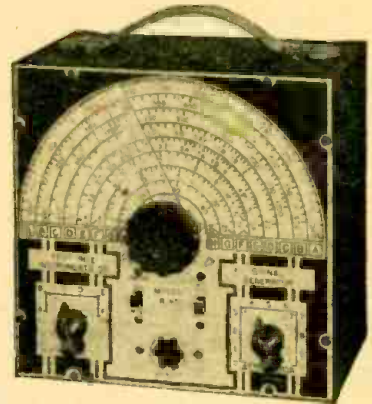

Specifications of Model M-50

- Accurate Pocket size V.O.M. using full size D'Arsonval meter.
- 4 A.C. VOLTAGE RANGES: 0-15/75/300/1500 volts.
- 4 D.C. VOLTAGE RANGES: 0-15/75/300/1500 volts.
- 2 D.C. CURRENT RANGES: 0-15/150 MA.
- 2 RESISTANCE RANGES: 0-10,000 ohms; 0-1 Megohm.
- Attractive modern black & white panel.
- Beautiful hand-rubbed oak case. Complete with test leads and all operating instructions.

Specifications of Model B-45

Generates RF frequencies from 150 Kc. to 50 Mc. Modulation is accomplished by grid-blocking action—equally effective for alignment of amplitude and frequency modulation as well as for television receivers. Self-contained batteries. All calibrations etched on front panel for DIRECT READING. Beautiful processed dualtone front panel in heavy gauge crystalline steel cabinet. Complete with test leads and batteries.

20% deposit required on all C.O.D. orders.

MOSS ELECTRONIC DISTRIBUTING CO.

229 FULTON STREET
Dept. RC-11, NEW YORK 7, N. Y.

WIRE RECORDER SERVICING

In servicing wire recorders, says *Sylvania News* in a recent article on that subject, several simple points should be checked. They are listed as follows:

A. Mechanical

1. No loose parts.
2. No varying friction or "drag" in the mechanism to make the wire tension change.
3. All adjustments set so that no loose windings develop and the wire is properly wound.
4. Brakes set properly.
5. Head oscillates to wind the wire uniformly.

B. Electrical

1. No opens or shorts in the recording head.
2. Check bias for frequency and voltage.
3. Check recording current.
4. Check rest of amplifier in normal way.
5. Make sure the wire rests properly in the groove of the recording head.

Heart of the recorder, says the article, is the magnetic recording and playback head, shown in the illustration. It consists of 2 coils which can be wound on separate cores or on a common one as in the sketch.

Functions of these coils are; Erase coil to provide enough energy to erase a signal on the wire, and provide the proper supersonic bias for proper recording. The bias is primarily used to

raise the recording head to a linear portion of the wire hysteresis curve. Record coil provides the required magnetization which is impressed onto the wire. For playback the record coil is

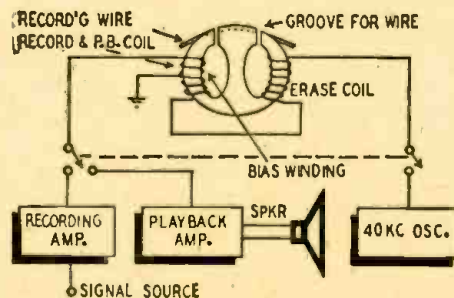

generally used to pick up the signal from the wire.

Essentially, in recording, the varying input signal varies the amount of magnetization on the wire. This variation of magnetization of the wire in playback induces voltage in the playback coil which in turn is amplified and provides the necessary signal for listening. As shown in the figure, when the wire passes over the erase or record coil, it passes over a small gap. The wire effectively short circuits the magnetic circuit and is thus magnetized in the process. In general, the erase gap is in the order of 5 to 10 times as great as the record gap. The gap distance for the record circuit is approximately 1 to 2 mills. (0.001—0.002 inch).

BRAND NEW—OR "LIKE NEW" We Sell Only the Finest SURPLUS EQUIPMENT

BRAND NEW BC-348 Revt. \$59.50
In Original Factory Cartons.

BC-221 Frequency Meter In 100% top-notch condition. Fully Guaranteed. With tubes, etc. \$39.95

COLLINS ART-13 TRANSMITTER, Complete with cable connectors, control unit and dynamotor. Like new \$119.50
Pay a little more—get the FINEST!

SCR-522 RCVR Just like new . . . \$15.90
SCR-522 XMTR Just like new . . . \$18.90
Both Complete With Tubes!!

BRAND NEW G.E. Oil Condensers
1-mfd. 6000 work. volts \$4.95

COMPLETE MARINE OR HAM STATION, with Xmitr & Rcvr. In Gray cabinet.

BRAND NEW, Mike, spare parts, etc., included? 150-watts output, 110v AC input. Cost \$1,900.00. Our Price \$285.00

Everybody says our Surplus is the Best. We do not deal in Junk. 4-Hour Mail Order Service. Send 20% Deposit, Balance C.O.D.

Write for Free Bargain Catalog

OFFENBACH & REIMUS CO.
372 Ellis St., San Francisco 2, California
Telephone: ORdway 3-8551

The gap width in the record coil determines the frequency response of the head and wire. Generally speaking, a larger gap gives more lows but less highs; therefore, an optimum value is selected, the upper and lower frequency limits depending to some extent on the applications desired.

**Prepare
NOW**

for a Better Job *in*
the Field of Radio!



In This New World of Electronics Better Training Means Better Opportunities!

TODAY, the new war-developed techniques offer greater opportunities than ever existed in the early days of broadcasting! Micro-Wave Relay Systems, Television, FM Broadcasting, Mobile Communication Systems for Trains, Automobiles, Busses, Trucks, many Industrial Applications—these are just a few of the new techniques which offer marvelous, exciting opportunities to you who are alert—and are qualified!

**Don't Delay—
Write Today!**

Let Cleveland Institute Take Over Your Personal Up-Grading Problem! Qualified, competent instructors, ample, personalized instructional aids, orderly, progressively arranged study assignments in recognized, approved technical texts—these are only a few of the many superior advantages of CIRE's plan of personalized spare-time home study training for professional self-improvement.

CLEVELAND INSTITUTE COURSES OFFER COMPLETE TECHNICAL TRAINING RANGING FROM LOW-LEVEL TO COLLEGE-LEVEL.

- A. Master Course in Radio Communication. Covers complete preparation for broadcast station employment including preparation for FCC License Examinations.
 - B. Advanced Course in Radio Communication Engineering. A college-level Radio Engineering Course.
 - C. Specialized Television Engineering. Including post-war Television Techniques.
- All Courses Include**

The Remarkable Workbooks of Instructional Aids, prepared by the instructing staff of Cleveland Institute. Choose the course best suited to your needs—Start with the section you are qualified to enter—Use the economical CIRE "Pay-As-You-Go-Plan."

ENROLL FOR INDIVIDUAL SECTIONS OF COURSES, IF YOU PREFER.

If you need only highly specialized training, you can study one or more of the following sections instead of a complete course.

1. Mathematics of Radio.
2. Fundamentals of DC and AC Theory.
3. Essentials of Radio Communication.
4. Communication Networks.
5. Advanced Radio Telephony for the Broadcast Operator.
6. Audio and Radio Components and Systems (Design of Receiver and Transmitter Equipment).

**CLEVELAND INSTITUTE
OF RADIO ELECTRONICS**

Contractors to the Canadian Broadcasting Corporation

RC-II, Terminal Tower
CLEVELAND 13, OHIO

Approved for Training under "G-I Bill of Rights"

(MAIL THIS COUPON)

Cleveland Institute of Radio Electronics, RC-II, Terminal Tower, Cleveland 13, Ohio.
Gentlemen: Please send information about your home courses in Radio Electronics.

I desire training in A B C
 I have had experience in broadcasting servicing
 operating mfg. CAA Army-Navy
 amateur other I am a
 High School Grad. College Degree
 Check here for Veteran Enrollment Information.

NAME
 ADDRESS
 CITY
 ZONE STATE



Get your

FCC Commercial Radio Operators' LICENSE NOW!

IT'S EASY IF YOU FOLLOW OUR PLAN!

Thousands of new jobs are opening up—FM, TELEVISION, MOBILE COMMUNICATIONS SYSTEMS, are only a few of the radio fields which require licensed operators.

TIME IS IMPORTANT TO YOU!

You can get your License quickly with NILSON'S MASTER COURSE in RADIO COMMUNICATION and exclusive CIRE Workbooks of Instructional Aids. Saves you many hours or random, undirected study.

Assures a MINIMUM of time in getting your ticket.
FREE BOOKLET tells you the Government Requirements for all classes of commercial licenses—Sent immediately upon receipt of coupon.

**Don't Delay—
Write Today!**

Approved for Veteran Training under "G-I Bill of Rights"

**CLEVELAND INSTITUTE
OF RADIO ELECTRONICS**

Contractors to the Canadian Broadcasting Corporation

RC-II, Terminal Tower
CLEVELAND 13, OHIO

MAIL THIS COUPON

CLEVELAND INSTITUTE OF RADIO ELECTRONICS
RC-II Terminal Tower, Cleveland 13, Ohio

Gentlemen: Please send information about your Home Study Course for preparation for FCC Commercial License Examinations (this course does not cover amateur license examinations).

Name _____
 Address _____
 City _____ Zone _____ State _____
 If a Veteran check here

MAKE MONEY!

ASSEMBLING COIN RADIOS

Thousands of dollars have been made during the past year by wide awake radio service men who have installed coin radios in Hotels, Hospitals, Motels and Tourist Cabins. Great demand—No experience necessary.

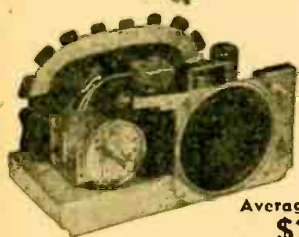
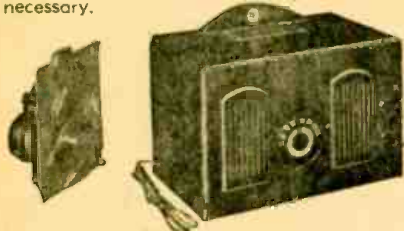

Just
3
Steps

Average Profit
\$25 Per Set

If Sold Outright

Much More If Operated on a Rental Basis!

We supply complete chassis with 6 tubes, quarter coin slot and one or two hour timer ready to place in walnut cabinet. Furnished with foolproof lock and coin box. Fill out order blank and mail to:

EICHEL ELECTRONIC CORP.
EVANSVILLE 8, INDIANA

FILL OUT...MAIL

EICHEL ELECTRONIC CORP.
EVANSVILLE 8, INDIANA

No. PLEASE SHIP ME: Amt.

Cabinets with lock @ \$6.75	
6 Tube Chassis @ \$16.50	
Timers @ \$6.50	

I understand the above three items include all the parts for your latest model coin-operated radio.

Name.....

Street No.....

City and State.....

Amazing! POCKET OR PURSE SIZE RADIO

WORLD'S SMALLEST RADIO KNOWN!
We only 1/2 lb. Beautiful Silver Black plastic case. Has Inductive Slide Tuner—W4 Crystal Diode—NO TUBES, BATTERIES OR ELECTRIC PLUG IN! NEEDED! Should last for years!

GUARANTEED TO PLAY

NEW 1948 MODEL

on local stations if complete instructions sent are followed. Use it at home, in bed, in many offices, hotels, cabins—most anywhere! HUNDREDS OF SATISFIED CUSTOMERS ALL OVER THE WORLD!

SEND ONLY \$1.00 (Cash, M.O. Check) and pay postman \$2.99 plus delivery fees on arrival or send \$3.99 for Post Paid delivery. Complete set shown—ready to play with self contained personal phone. **WONDERFUL GIFTS FOR CHILDREN!** Order now at this low bargain price—Prompt shipment on orders sent now—today! Be the first to get YOUR Pocket Radio! (All foreign orders \$5.00 U. S. cash with order).

Pa-Kette Radio Co., Inc. Dept. RC-11 Kearney, Nebr.

\$3.00 FOR CARTOON IDEAS

RADIO-CRAFT prints several radio cartoons every month. Readers are invited to contribute humorous radio ideas which can be used in cartoon form. It is not necessary that you draw a sketch. Address **RADIO CARTOONS, RADIO-CRAFT, 25 West Broadway, New York 7, N. Y.**

17-TUBE FM RECEIVER

(Continued from page 21)

matically obtained (point of zero voltage); therefore, tuning the receiver through an FM carrier will indicate positive and negative voltage swings.

The output of the 6J5 first audio amplifier is fed through a network designed to give treble and bass compensation. Due to the loss in gain in this network, one half of a 6SN7 tube is used to give additional gain, and the output of this stage is fed to a negative-current feedback triode phase inverter. The output of this phase inverter is used to drive 2 push-pull 6V6 tubes.

To take advantage of the wide frequency response obtainable through frequency modulation, a high-fidelity audio system must be used. An amplifier capable of reproducing this extended range is not too difficult to construct but is of little value without high-fidelity output components capable of reproducing this extended range properly. A UTC linear standard output transformer and the new Jensen Model RD-151 articulated coaxial speaker unit are used in the author's model, and the results are excellent.

Some construction details

The tuning unit housing is constructed as shown in the sketch appearing in Fig. 1. Two double-section 35- μ mf tuning condensers (Cardwell ER35AD) are mounted on the upper left side of the housing and coupled with a flexible coupling. Before mounting these condensers, 2 stator plates must be removed from all sections but the high-frequency oscillator section in order to insure proper tracking. The shield plates of the housing are constructed in such a way as to isolate completely one stage from another and form 4 shielded compartments in which the various tube sockets and associated wiring are placed. Insulated feed-through bushings are mounted on the upper right side of the 3 compartment-forming shields to couple one stage to another. The high-frequency coil forms are mounted on the left shield plate directly beneath each condenser gang. These coil forms are slug-tuned; therefore a hex nut must be soldered to the end of each slug screw to make tuning accessible from the side of the unit with an open end wrench. Construction of the coils is shown in Fig. 2. All are constructed on National XR50 forms. Directly across each condenser gang is mounted a 13- μ mf trimmer condenser having a zero temperature coefficient. The oscillator tube is placed inside the unit to help keep wiring leads short and also as an aid to stability because in this location only its own heat affects the stability of the receiver.

Since it was desired to have a slide-rule tuning dial and also a pinch-type drive, the dial shown was made up of a Crowe 535 and a National BM dial.

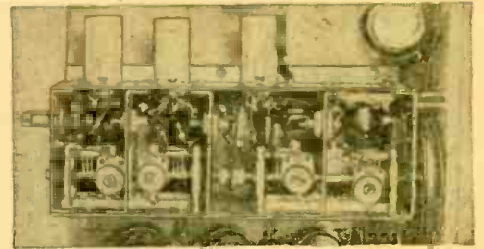

Heart of the set. The shielded tuning unit.

The pinch and steel scale from the National BM were used. The constructor may follow his own taste in this matter however. The lettering and scale number-

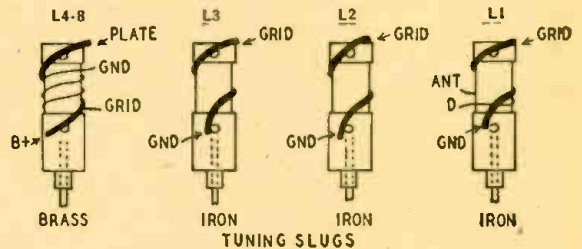

Fig. 2—How coils are wound. All are on National XR50 coil forms.

bers were put in with red cellulose paint and a ruling pen, as scales for the new FM band were not available.

Receiver alignment

The first step in adjustment of an FM receiver is discriminator alignment. A stable signal generator is set to 10.7 mc



Front view of the set. The dial is home-built.

(center frequency of the transformer used) and its *unmodulated* output connected between grid and ground of the last limiter tube. Then connect a sensitive vacuum-tube voltmeter across the cathodes of the discriminator tube. Tune the primary tuning slug of the discriminator transformer for maximum output as indicated on the v.t.v.m. Then rotate the secondary tuning slug until zero output voltage is obtained. Rotating the tuning slug to either side of this zero

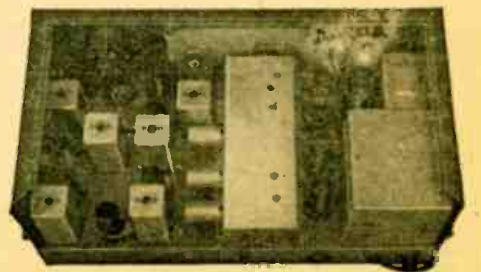

Rear-chassis view of the 17-tube FM receiver.

voltage point will give an increase in output voltage but of opposite polarity.

To check the discriminator alignment, shift the signal generator 50 to 100 kc to either side of the center frequency (zero voltage point). This should give equal but opposite meter variations. If the readings are not equal, repeat the alignment procedure. (Center frequency is that frequency to which the discriminator was tuned and gave zero voltage output.)

The signal generator is now set back to center frequency and its output leads are connected between grid and ground of the mixer tube. A microammeter is inserted in series with the ground end of the first limiter grid resistor. The sensitivity of the meter to use depends upon the output capabilities of the generator and just how far out of alignment the transformers are. A meter with a 0-200-microampere movement should be sufficient for the job.

Each transformer is now tuned for maximum indication of the microammeter, starting at the first-limiter input transformer and working back toward the mixer. Tuning of these transformers should be repeated 2 to 3 times to assure exact peak adjustment and symmetrical response of the i.f. stages to the incoming frequency-modulated signal. Symmetrical response of the transformers is checked by shifting the generator frequency 50 to 100 kc to either side of the i.f. center frequency and noting the readings on the microammeter. They should be equal for a given frequency shift to either side.

The microammeter is now removed from the grid resistor of the first limiter and inserted in series with the ground end of the second limiter's grid resistor. With the signal generator set back to center frequency, the limiter coupling transformer should be peaked for maximum reading on the microammeter. Again check for over-all symmetrical response of the i.f. system by shifting the generator 50 to 100 kc to either side of the center frequency. Look for an equal but opposite meter reading at the output of the discriminator. The signal generator is now set for a frequency of 105 mc and maximum output, and connected to the antenna terminals of the tuning unit. The microammeter is placed back in series with the ground end of the first-limiter grid resistor so that it may serve as a resonance indicator. With the tuning slug of L6 set approximately half way into the coil, proceed with the alignment as indicated in the chart below.

Step	Set Dial Generator to	Adjust for Correct Dial Settings	Trim or adjust for Maximum Output as Indicated on the Microammeter
1	105 mc	C4	C1, C2, C3
2	90 mc	C5	L1, L2, L3
3	Repeat steps 1 and 2		
4	98 mc	L4	
5	Repeat steps 1 and 2		

If the desired signal is outside the limits of the variable padder C5, it will be necessary to adjust L4 to bring the signal within the limits of this padder.

TERRIFIC SAVINGS ON "AKRAD" CONDENSERS

Special Introductory Offer —
LIMIT: ONE KIT TO EACH CUSTOMER



Why do we make this offer?

First, remember, this is OLSON's and we're famous for **BARGAINS**. Second, we're busting to have you try our new "AKRAD" Condensers. They're absolutely **TOPS**: hermetically sealed in aluminum; tough insulating film resists shorts; will take surges without puncturing; extra-low leakage, super-long shelf life; fully resistant to temperature and humidity changes; leads can't loosen. "AKRADS" take plenty of overloading without breakdown. They last and last and **LAST**.

GUARANTEE:

Use five Olson "AKRADS" on your toughest jobs. If not 100% satisfied, send back the remaining Condensers to **OLSON RADIO WAREHOUSE, INC.**, 73 E. Mill St., Akron, Ohio — and we will refund **EVERY CENT YOU PAID**, and the postage too.

Look what you get!

Quan.	Mfd	Volts	Utr	Total
2	10	25	.75	1.50
2	25	25	.85	1.70
5	20	150	.85	4.25
5	40	150	1.10	5.50
5	20-20	150	1.20	6.50
5	8	450	.85	4.25
5	16	450	1.35	6.75
29			TOTAL	\$31.45

A Regular \$31.45 List Value for only

\$9.95
POSTPAID*

*When Remittance is made with order, we pay postage.

DON'T MISS IT! MAIL THIS COUPON TODAY!

OLSON RADIO WAREHOUSE INC.

73 E. Mill St., Dept. 103, Akron, Ohio

Send me one Kit of 29 Olson Guaranteed "Akrad" Condensers. (Limit One Kit to a customer.)

I enclose \$9.95; Olson pays postage.

Send my order C.O.D. I will pay postage.

NAME _____

ADDRESS _____

CITY _____

STATE _____

SPECIALS!

BC-645 TRANSMITTER-RECEIVER
BRAND NEW ... 15 tubes interrogator-transmitter designed for airborne use, 435 to 500MC frequency range, 5-tube tuned line transmitter with 30 Watts peak-impulse power output on either two channels. With some modifications the set can be used for 2-way communication, voice or code, on the following bands: ham band: 420-460mc; fixed and mobile: 450-460mc; citizens radio band: 460-470mc; television experimental: 470-500mc; complete with all tubes including WE Dooknob tube. Size 10 1/4" x 13 1/2" x 4 1/2". Net wt. only 25 lbs. Your cost only **\$14.95**

TWO FOR ONLY \$27.00
DYNAMOTORS FOR ABOVE Model PE-101-C **3.95**

TRANSMITTERS (274 N series)
all brand new in original cartons complete with tubes and crystal
BC-696 3-4mc ... \$7.95 BC-458 5.3-7mc ... 5.95
BC-457 4-5.3mc ... 5.95 BC-459 7-9.1mc ... 5.95
Write, Wire, Phone for Quantity Prices
All shipments F.O.B. Chicago.
20% deposit required on all orders.
Write for complete catalog
ARROW SALES, INC.
Dept. 0
59 WEST HUBBARD ST.—CHICAGO 10, ILLINOIS
Telephone: SUPERIOR 5575

S.S.S.

"Servicing by Signal Substitution"

Learn about this modern dynamic approach to radio servicing with **ONLY BASIC TEST EQUIPMENT**.

... Fully described in a 120 page book available from your Precision Distributor or factory at 35¢.

... Schools are invited to inquire regarding quantity orders from our Educational Division.

PRECISION
APPARATUS COMPANY INC.
ELMHURST 4, N. Y.

Manufacturers of fine Test Equipment
RADIO • TELEVISION • ELECTRICAL • LABORATORY

TRAIN FOR GOOD PAY IN A FIELD THAT ISN'T CROWDED!

New! Different! Easy to Understand! Opportunities Everywhere!

Learn **ELECTRIC MOTOR REPAIR**

This Big Training Course Book Teaches You Every Step of the Work . . . for only \$5 complete

Get where the real profits are—in Electric Motor Repair! There are more motors than any other type of electrical equipment. Good repair men are scarce and well paid. Now, for the first time in modern training history, you can learn this work at home, QUICKLY, in spare time, for only \$5. **ELECTRIC MOTOR REPAIR**, the big new 570-page training course book, is especially written for beginners. No previous training is needed. Start training now for better pay and big opportunities in a field that isn't crowded.

Based on this big book alone, you can TRAIN FOR PROMPT, PROFITABLE SERVICE ON PRACTICALLY ANY MOTOR IN COMMON USE!

**570 PAGES . . .
OVER 900
ILLUSTRATIONS**



PRACTICE FROM IT for 5 full days!

ELECTRIC MOTOR REPAIR BOOK teaches you the work from the very beginning. Over 900 specially prepared diagrams and pictures make your training easier and **TWICE AS FAST**. You learn every step of the work from motor trouble diagnosing to repair—from simple motor cleaning and adjustments to complete rewinding. Covers every type of motor in common use and **BOTH** mechanical and electrical motor control systems. Quick reference guides show exactly how to handle specific jobs. When a certain type of motor comes in for repairs, just look it up. The book shows exactly what to do, exactly how to do it. Duo-Spiral Binding divides book into 2 sections so text and related illustrations can be studied together.

"BORROW" IT AT OUR RISK!

ELECTRIC MOTOR REPAIR is the ideal, easy-to-understand book for beginners. Hundreds of motor repair shops use it for training new helpers and for daily use at the bench. Send coupon today! Practice from **Electric Motor Repair** for 5 full days. If not more than satisfied—if you're not fully convinced that, at last, here is the ideal training for YOU, just send the book back. Every cent of your money will be cheerfully refunded **AND NO QUESTIONS ASKED!**

5-DAY MONEY-BACK GUARANTEE



YOU CANNOT LOSE!

Dept. RC-117, Murray Hill Books, Inc.,
232 Madison Ave., New York 16, N. Y.

□ Send me a copy of "ELECTRIC MOTOR REPAIR" for which I enclose \$5 (\$5.50 foreign); or □ send book C.O.D. for this amount (No foreign C.O.D.'s) and I will pay postman \$5 plus postal charges when he delivers it to me. If book is not satisfactory for any reason, I'll return it within 5 days and you guarantee to refund my \$5.

NAME
ADDRESS
CITY & ZONE STATE.....

ADVERTISING (Continued from page 24)

it is generally possible to specify the page on which the ads shall appear. Advertising handled on such an arrangement is also more economical.

It is imperative that ads be changed periodically, since the oftener an ad is repeated, the less effective it becomes. Therefore, copy should be frequently changed. This can be quite a chore, but after some practice and by observing the advertising of other firms it will become easier. I visit the public library and find that an hour or two spent reading ads in the out-of-town papers provides enough ammunition to write ads for as long as 2 months. Newspapers are picked at random, from Portland, Oregon, to Portland, Maine. No ad is copied verbatim, but the ideas are modified for my ads, some of which are written on the spot.

Some words should be avoided in writing advertising copy because they are misleading. One example is the word "serviceman," which this writer used for years with fair results. However, it has become associated with members of the Armed Forces. For that reason, the words "serviceman" and "service" are no longer used. Technical terms should likewise be avoided. With this in mind every ad should be looked over after it is written. Every word and sentence should be scanned closely so no misleading ideas will creep into the copy.

Use a slogan!

All radio repair advertising should hinge on a *catch phrase*. Every bit of advertising should carry it. It should be the keystone of all public appeals and appear whenever the shop's name appears. In selecting a catch phrase to use in advertising, brevity and originality should be the important factors. Study your competitors' advertising, and be very careful to have yours different in every respect. Then repeat and repeat your own catch phrase until you are blue in the face. Keep that catch phrase in constant use in all advertising. Some examples of catch phrases are:

- "Repairing Radios for—Years"
- "RADIO Is Our BUSINESS—Not a Sideline"
- "All Repairs Guaranteed For—Days"
- "Our Sincere Effort Is To Please You"
- "Guaranteed Workmanship"
- "Quality Repairs"
- "Radio Repair Specialists"
- "We Can Repair Any Make, Any Model"

If you have a nickname, use it! People are human, and they much prefer to know you as "Red" or "Slim," rather than as "Mr. Doaks." Be a regular guy in your ads, and take your potential customer to your bosom. Talk to him as you talk to your neighbors—he is your neighbor. Above all, talk "to" him, not "at" him. You need not be a spell-binder, but your ads represent YOU and you should make the most of the oppor-

tunity they offer. Failure to do so means that you are wasting good money and time on ineffective advertising.

It pays to remember always that the average man with a defective radio under his arm knows nothing about it except that it doesn't work. He is not interested in what makes it work. He just wants to hear programs and is much more interested in how soon he can get it fixed. He will take it only to the one man he believes CAN repair it. He paid hard-earned wages for his set, and he will not risk taking it to someone in whom he has no confidence. If you want that customer to come into your shop, you must gain his confidence; so write your ads to appeal to *him*. If you can assure him that you do good work and will stand back of it, he will bring it to you rather than take it to someone he does not know. All repair advertising *must* keep that fact in mind.

A potential customer comes into your shop because of a definite urge. Advertising creates that urge. If he is confident that you can and will cure his trouble, you will find him an agreeable fellow to do business with. He will not haggle over price, and will give you plenty of time to do a good job. If he is satisfied, he will be the best kind of an ad. His confidence can be gained with the proper kind of advertising, but you will have to keep forever at it—and back it up with quality work to retain it.

Build your reputation!

Be simple, direct, and *honest*. Do not advertise anything that you cannot live up to. If you guarantee your work, do it right in the first place, and put a definite guarantee *in writing* on it before it leaves the shop. Then advertise that your work is guaranteed for a definite period of time. An occasional job will bounce back in your lap, but if it does, take care of it graciously and *thoroughly*; and the time spent will bring in more business.

Some of the radio tube manufacturers have advertising *mats* available for radio repair shops to use in newspaper ads. In general, these are not as satisfactory as ads written by you—to appeal to your neighbors. But they do incorporate good ideas for ads, and should be studied.

Other advertising aids can be used. In the smaller towns, one of the most effective advertisements per dollar invested consists of movie trailers run in the local theater. Select subjects carefully, and avoid trailers of a technical nature. The accompanying sound track or screen lettering boosting the local shop must be carefully written to be sure it will not be misleading, since it may sound much different than it looks in writing. Contact the manager of the local theater before ordering trailers since he invariably has tie-ins with the film makers and his suggestions in the selection of sources may be valuable.

Several firms make trailers especially for radio shop advertising. Among these are Alexander Film Company, Colorado
(Continued on page 76)



A. A. Ghirardi
POSITIVELY
GUARANTEES
to help you repair any
radio ever made EASIER
BETTER & FASTER

or refund every cent of your money!



GUARANTEED
TO HELP YOU LEARN
Professional RADIO-
ELECTRONIC REPAIR,
at home, without
an instructor

GUARANTEED
TO HELP YOU REPAIR 9
OUT OF 10 RADIO TROU-
BLES Twice as Fast, without
costly test equipment



A COMPLETE RADIO SERVICE COURSE. . . . only \$5 Complete

Once in a lifetime, a technical book is written that is so important, so complete and easy to understand that it is used almost universally by members of an entire profession — and Ghirardi's MODERN RADIO SERVICING is exactly that kind of a book. It gives a complete course in radio-electronic repair work by scientific methods. Included is a thorough explanation of Test Instruments, how they should be used and why—even how to build your own; Receiver Troubleshooting Procedure and Circuit Analysis; Testing and Repair of All Components; Installations; Adjustments, etc., etc.—also How to Start and Operate a Successful Radio-Electronic Service Business. 1300 pages. 706 helpful illustrations. Self-Test Review Questions make study easy. Only \$5 (\$5.50 foreign).

THIS BIG BOOK ELIMINATES NEEDLESS TESTING . . . on 4 jobs out of 5!

There's no magic about it! Just common sense! Over 400 pages of Ghirardi's 744-page RADIO TROUBLESHOOTER'S HANDBOOK contain tabulated and indexed listings of common trouble symptoms, their causes and remedies for almost every radio in use. Actually, it gives specific trouble listings for over 4800 home receivers, auto radio and record changer models of 202 manufacturers! Just look up a defective radio's make and model. The HANDBOOK tells exactly what the trouble is likely to be—exactly how to fix it. 9 out of 10 jobs can be handled by this method—in ½ the usual time BECAUSE TEDIOUS TESTING IS ELIMINATED. Over 300 more pages contain service hints, alignment data, tube information, graphs, diagrams and charts to help you fix ANY RADIO EVER MADE in far less time and at greater profit! Only \$5 complete (\$5.50 foreign). 5-DAY MONEY-BACK GUARANTEE.

. . . NO PREVIOUS EXPERIENCE NEEDED!

COMPLETE BASIC RADIO-ELECTRONICS for beginners

Sales records prove that more Radio-Electronic beginners have gotten their start from Ghirardi's 972-page RADIO PHYSICS COURSE than from any other book or course ever published. It's a complete radio course in book form—so head and shoulders above anything else that it is used as the basic text by thousands of students and by schools in 82 different countries of the world! Everything is explained as simply as A-B-C. Over 300 pages are devoted to Basic Electricity alone. 508 illustrations help you learn fast. \$5 (\$5.50 foreign).

GUARANTEED
TO HELP YOU LEARN
COMPLETE BASIC
RADIO-ELECTRONICS.
. . . for beginners!



Let Ghirardi's TROUBLESHOOTER'S HANDBOOK save you time on common radio service jobs! Let his MODERN RADIO SERVICING train you for complete, professional electronic work. Get BOTH BIG BOOKS at special price of only \$9.50 for the two. See coupon.

MAIL ORDER rush coupon!

DEPT. RC-117, MURRAY HILL BOOKS, INC.
232 Madison Ave., New York 16, N. Y.

- Enclosed find \$..... for books checked; or send C.O.D. (no foreign C.O.D.'s) for this amount plus postage. It is understood I may return books for refund within 5 days if not fully satisfied.
- RADIO TROUBLESHOOTER'S HANDBOOK \$5 (\$5.50 foreign) MODERN RADIO SERVICING \$5 (\$5.50 foreign)
- MONEY-SAVING COMBINATION OFFER: Both of the above big books, only \$9.50 for the two (\$10.50 foreign).
- RADIO PHYSICS COURSE \$5 (\$5.50 foreign).

Name

Address

City & Zone..... State.....



BC-348

COMMUNICATION RECEIVER

Excellent selectivity, sensitivity and stability makes this the most outstanding of any receiver yet available from government surplus. This Receiver will give outstanding performance wherever used. Built to withstand vibration and features gear driven 100-1 ratio vernier tuning control. Six bands—500 Kc. and 1.5-18 Mc. Two stages RF, 3 stages IF, BFO, crystal filter, manual or AVC. Complete with tubes and 24 V. DC dynamotor. Easily converted to 110V AC operation. These Receivers are used, but can hardly be told from new. Guaranteed operation. Supply limited.

Price \$48.75

**AIRCRAFT TRANSMITTER
T19-A.R.C. 5**

Ideal to make over for master oscillator. Priced complete with tubes. Has built-in crystal for dial calibration. Used but in good condition. 3-4 MC or 4-5.3 MC. FREE Mounting Rack with order of two or more.



Price \$4.95

**NEW WILLARD RECHARGEABLE
STORAGE BATTERY**



New 6 Volt battery in spill-proof clear plastic case, housed in metal case for easy mounting. Applicable for a wide range of uses where battery power is needed. Shipped dry. Uses standard battery electrolyte available everywhere.

Price, each \$4.35
In lots of ten, each \$3.35
Without metal case, \$3.85
In lots of ten, each \$2.85

AIRCRAFT RECEIVER R-23 ARC-5

This Receiver is very selective and sensitive; has RF stage and BFO. Offered complete with tubes 12K8, 3-12SR7, 12SR7 and 12A6, also dynamotor which snaps on Receiver Chassis. Used but good condition. 10-55 MC Receiver as above. Each... \$4.95



FREE Mounting Rack with order of 3 or more.

INTERPHONE AMPLIFIER RL-9



Convert to high fidelity phone Amp. or speech Amp. Complete with tubes and dynamotor, for 24 V. DC operation. Used but in good condition.

Special Price
Each \$3.95

TERMS: CASH WITH ORDER

**AMERICAN SURPLUS
PRODUCTS CO.**

537 N. CAPITOL AVE.
INDIANAPOLIS, IND.

Springs, Colorado, Filmack Corp., 1327 South Wabash Avenue, Chicago 5, Illinois; and United Film Productions, 1558 Vine Street, Hollywood, California. Any of these firms can furnish trailers with sound tracks or lettering to suit individual needs. One or two firms furnish the trailers outright, or they may be contracted for with a periodic change of copy to insure their not going stale. A postcard to any of these firms will bring all the information needed.

Broadcast your ads!

If there is a local broadcasting station in town, one or two daily spot ads will bring future business. If they are slanted to stress poor or distorted reception, they will be very good advertising. The station's engineer and advertising agent will have many good ideas.

Broadcasting, newspaper, and theater advertising require a constant change of copy, and are a periodic monthly expense that should be charged to overhead. They can be highly effective and, if properly prepared, will bring in lots of business. For best results with any of the above forms of advertising, a weekly change of copy is imperative.

I have tried one advertising stunt with success in a small town located 60 miles from broadcasting stations. It consists of mimeographed weekly Listener's Guides made up for free distribution in local stores and gas stations. They contain complete listings of popular radio programs, together with station frequency and time. These Listener's Guides are made up from information gladly furnished by the broadcasting stations. The local paper does not list the radio programs and a real need is being filled as well as business for the radio shop being brought in. A small paragraph at the bottom of the sheet gives the radio shop credit.

Tell the tourists!

Many smalltown radio shops find road signs an efficient means of advertising. Such signs, properly made and placed on the main roads leading into town, will pay for themselves in a short time, and maintenance costs will be negligible for a considerable period if the signs are well constructed and painted.

Road signs should be placed where they can be seen by approaching traffic. A Sunday afternoon spent in-

vestigating road signs, their makeup and location, will be well worth the gasoline and time. The type of traffic using the highway should be studied. If it is tourist travel, signs advertising auto radio repairs will bring considerable work of this nature, provided the shop is equipped to handle it on short notice. Most tourist work has to be handled quickly, since these customers will not wait. Farm to market traffic, on the other hand, will respond to signs dealing with home radio repairs.

The ideal location for a road sign is on a curve, where it can be seen by occupants of cars approaching the curve. Property owners should be contacted before placing signs, and their permission obtained. Ordinances should be studied, too, since most states and counties have ordinances covering the placing of such signs a minimum distance from the highway boundary. Signs should be neat, simply worded, and not too large. If placed some distance from town, the distance to town can be shown on a smaller sign attached to the road sign. This will draw attention. Average cost of a well-constructed and painted road sign should be in the neighborhood of \$15 for one 3 x 5 feet, plus the cost of placing it.

Many shops have public address systems installed in the shop's truck. These can bring in business, but it should be noted that they can also kill business if operated in neighborhoods where people are sleeping during the daytime. A survey should be made and use of the public address system avoided during hours that wage-earners or children might be napping. It is regrettable that a few owners of this equipment have been so short-sighted in their operations that some communities have found it necessary to ban them.

A more effective way to use the public



Suggested by: Morley Burtene, Chicago, Ill.

"I don't care if it is FM—I want one that plays in the P.M.!"

address system is to donate its services for local sports events, to be used for announcing, etc., with an occasional plug for the local radio shop. The radio shop public address system can be a real community asset if properly handled.

Other advertising means will come to mind. Their value can be gauged, as can all advertising, by the usual yardstick of customer appeal and the ability of the advertising to reach the greatest number of potential customers at the lowest cost. The best advertising is useless if it does not draw the attention of potential customers and get a favorable reaction. Advertising that reminds the potential customer that the old set needs repairs is not as effective as that which will go one step farther and persuade him to have it repaired. Properly written and displayed advertising can do just that. Coming events, such as elections and world series ball games, can be used as the basis for some of that advertising. Advertising those events a few days or a week in advance, can goad some radio owners into action.

Got to have the goods

To sum up, the best advertising any radio repair shop can ever get is the workmanship turned out. Much business will result from satisfied customers. But business can be expanded tremendously by a thoughtful advertising campaign designed to produce a favorable customer reaction. The advertising can be slanted to reduce customer resistance to the point that when the customer does walk into the shop, he will leave some of his hard-earned wages in the till.

Handling customers in the shop requires study, too. The best advertising in the world will only bring about customer contacts. A smile and intelligent handling is appreciated by the average person. Small favors take only a minute. For example, if you feel that it pays to test tubes free, do so. Be the best radio repairman in your community. Try to blow your own horn as much as possible, but do it softly, and let the customers who walk out happy really play a loud tune on it for you. If you do that, you will find the cash register playing a long, loud tune too.

Get Started in Radio



10 "HOW-TO-DO-IT" BOOKS

Get a solid foundation in radio by means of these 10c timely text books. Each clearly written, profusely illustrated, contains over 15,000 words. You'll be amazed at the wealth of information packed into these handy books. Excellent for reference—ideal for technical library. Your money back if not satisfied.

5 BOOKS for 50c
10 BOOKS for \$1.00

Sent to You Postpaid

- | | |
|--|-------------------------------------|
| No. 1—How To Make Four Doerle Short Wave Sets | No. 6—How To Have Fun With Radio |
| No. 2—How To Make The Most Popular All-Wave 1 and 2 Tube Receivers | No. 7—How To Read Radio Diagrams |
| No. 3—Alternating Current for Beginners | No. 8—Radio for Beginners |
| No. 4—All About Aerials | No. 9—Simple Electrical Experiments |
| No. 5—Beginners' Radio Dictionary | No. 10—Television |
- Result by check or money order; register letter if you send cash.

RADIO PUBLICATIONS

25A West B'way, New York (7)

Santa Rides Again!

Send for this

FREE

also

SUPPLEMENT

and

GIFT GUIDE

Lafayette Radio
SUPPLEMENT/GIFT GUIDE
No. 86 3-1941-8

Radio Wire Television Inc.

VALUE-PACKED WITH XMAS SUGGESTIONS FOR YOUR LIST • FOR YOURSELF

- ★ sensational super-bargains in the latest developed P.A., "ham" equipment and a raft of new radio parts; all the things you've been hankering for and can now afford at Lafayette's special, reduced prices.
- ★ the new miracle Lafayette FM tuner that adapts any radio to receive FM—the best buy on the market.
- ★ a great new console combination with automatic record player in a rich cabinet; you can buy it now for less than a C-note.
- ★ popular brands of small home electrical appliances—all hard-to-get but easy to buy at Lafayette.

... and lots more.

Lafayette Radio

RADIO WIRE TELEVISION, INC.

100 Sixth Ave.,
New York 13, N. Y.

42 E. Fordham Rd.,
Bronx 58, N. Y.

110 Federal St.,
Boston 10, Mass.

24 Central Ave.,
Newark 2, N. J.

**MAIL COUPON
NOW FOR
FREE
COPY**



LAFAYETTE RADIO Dept. JK7
100 Sixth Ave., New York 13, N. Y.

Rush new Supplement & Gift Guide #86S.

Name.....

Address.....

City..... Zone..... State.....

"blooping" in order to silence the splice.

Magnetic tape records provide unlimited playback facilities without deterioration of valuable disc records. A single playing of a record is all that is needed to copy it onto tape which may in turn be played many hundreds of times without touching the original discs or fussing with needles. Also, for the first time, record enthusiasts may indulge in what was heretofore exclusively reserved for commercial and motion-picture technique—corrective re-recording, which is a process of re-recording an already recorded program and simultaneously applying frequency and amplitude correction, like accentuating high frequencies, or eliminating low frequencies, or vice versa, or making soft passages louder or still softer, or controlling loud passages. Special re-recording technique also may be employed to provide noise suppression while copying from an abnormally scratchy record.

Special effects

Musical enhancement, in all its phases, formerly confined to advanced sound laboratories only, also may be applied. For example, controlled compression may be employed during recording and complementary expansion during playback to recreate the original dynamic range of live programs.

Narration may be added before, after, or during any program to catalog, identify, or explain special passages or unusual points of interest in a valuable collector's item for educational or other purposes. Passages, solos, or sections may be repeated during a continuous program.

An extraordinary feature of magnetic tape recording (as compared to disc recording) is ease of erasure of any program and reuse of the tape to record anew. This process can be carried on indefinitely.

From an economy viewpoint the process is unusually attractive for no tape is ever wasted. Cut-out sections may be respliced, erased, and reused in one simple operation.

To clear up any prevailing misconceptions about the process, the following facts should be kept in mind:

1. Under ordinary conditions of storage, recorded tape should last indefinitely.
2. The magnetic coating on the tape does not rust when stored in damp climates.
3. The magnetic properties of the tape are not affected by dropping a reel. (Reels were dropped 20 feet without damage to the tape—the reels did bend out of line, but were easily straightened.)
4. An appreciable amount of magnetic energy in actual contact with the tape is required to erase any program material. Bringing magnetizable material in close proximity of the recorded tape does not affect the tape.
5. Erasure of used tape is complete, (Continued on page 80)

ENGINEERED FOR EFFICIENT FM AND TELEVISION RECEPTION



WARD Magic Wand FM AND TELEVISION AERIALS

Magic Wand Aerials for FM and television offer electrical efficiency possible only through the enthusiastic teamwork of Ward's top-drawer experimental laboratory, and production facilities.

As the world's largest producer of aerials for car and home, Ward also is pioneering in educating 33 million present, and prospective, FM and television receiver owners that a good outdoor dipole antenna is necessary if quality reception is to be enjoyed. Watch for our hard-hitting ads in the Saturday Evening Post and leading newspapers.

In addition to developing outstanding FM, television and automotive aerials, Ward also has design and production capacity available to take care of special aerial needs. Submit your aerial problems to us now for an efficient, and economical, solution.

As Advertised in the Saturday Evening POST

THE WARD PRODUCTS CORP.
1323 E. 45th Street, Cleveland 3, O.
Division of The Gabriel Company
EXPORT DEPT., C. W. Brandes, Manager
4900 Euclid Ave., Cleveland 3, O.
IN CANADA: Atlas Radio Corp.
560 King St., W., Toronto, Ont.

WORLD'S LARGEST MAKER OF AERIALS FOR CAR AND HOME

RED HOT SPECIALS

Limited quantity for immediate shipment—
while they last
8,000 OHM DUAL HEADSET H-16/U

Priced at **\$1.89**

Include 25c to Cover Cost of Postage



Light, durable, and efficient phones featuring a permanent magnet with an 8000 ohm transformer built into each unit. Molded soft neoprene earcup shaped to snugly and comfortably envelop the entire ear. Steel headband with new type adjustable sliding brackets allow earcups to be extended or retracted. Cover plates constructed of lightweight magnesium. No removable parts to become loose or lost. Especially suited to hams and commercial operators, recording engineers, aircraft pilots and similar exacting applications. Hi-impedance, extremely sensitive. May be used as sound powered interphones without use of a battery. Can even be used with simple xtal to make a complete radio receiver.

Carbon Throat Microphone

This microphone will work into any 200 ohm impedance input circuit. Has adjustable strap to fit any neck. In operation this microphone is strapped around the throat thereby facilitating full freedom of both hands and head movement. Ideal for ultra high frequency mobile work for hams. Can also be used as a hi-grade Carbon Mike by simply drilling three holes in case. Sensitivity of this mike equal to mikes costing \$10 and \$15. Supplied with strap, 10' cord and plug. Your Cost

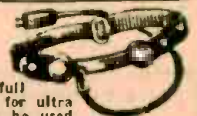

49c

Combination Offer
Both Items **\$2.25**
Include 25c to Cover Cost of Postage

20% deposit on all orders unless rated.

NIAGARA RADIO SUPPLY CORP.
160 GREENWICH ST., NEW YORK 6, N. Y.

All prices F.O.B. N. Y. C. Write for latest Bulletin 108C

NOW *Save*
FOR YOUR SILENT PROJECTOR
Economically



\$5995

Convert your 16mm silent projector to sound (regardless of make) with Apex sound head & radiofilm adapter. Guaranteed excellent performance. Write today for free information.

APEX VIDEO • 12209 U Branford St. • Roscoe, Calif.

WAR SURPLUS BARGAIN



WILLARD RECHARGEABLE 2-VOLT STORAGE BATTERY

Compact, spill-proof, clear plastic case 5 x 4 x 3-in. Built-in hydrometer. Powers portable and ham radios, autos, tractors, model trains. Gang several for higher \$ 75 voltages. Uses standard electrolyte. Money-back guarantee. **2** add 25c postage

Allender Co. Dept. 142, 1966 E. Forest, Detroit 17, Mich

Build Your Own Signal Tracer and Save!!

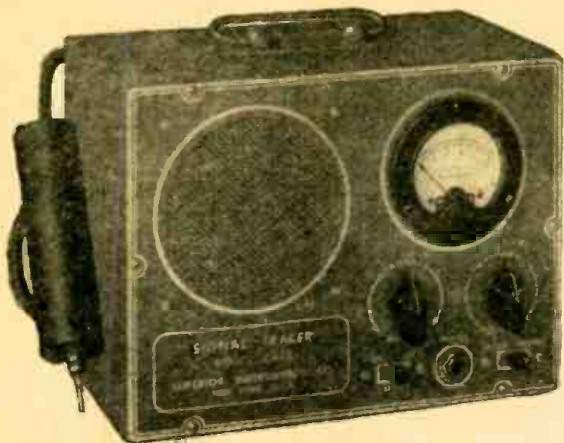

MODEL CA-12 Kit includes ALL PARTS assembled and ready for wiring, circuit diagram and detailed operating data for the completed instrument.

\$24.85 NET

20% DEPOSIT REQUIRED ON ALL C.O.D. ORDERS

We are pleased to announce we have obtained an exclusive franchise to distribute the well known Model CA-12 Signal Tracer in kit form. The Model CA-12 sells regularly for \$34.85, here is your opportunity to save \$10 with the added advantage of complete familiarity of design and operation made possible when you build your own instrument.

THE MODEL CA-12 KIT COMES COMPLETELY ASSEMBLED. Can be wired in 30 minutes. Components and circuit guaranteed to meet the following:

FEATURES:

- ★ COMPARATIVE INTENSITY OF THE SIGNAL IS READ DIRECTLY ON THE METER—QUALITY OF THE SIGNAL IS HEARD IN THE SPEAKER.
- ★ SIMPLE TO OPERATE—ONLY ONE CONNECTING CABLE—NO TUNING CONTROLS.
- ★ HIGHLY SENSITIVE—USES AN IMPROVED VACUUM-TUBE VOLTMETER CIRCUIT.
- ★ TUBE AND RESISTOR CAPACITY NETWORK ARE BUILT INTO THE DETECTOR PROBE.
- ★ BUILT-IN HIGH GAIN AMPLIFIER—ALNICO V SPEAKER.
- ★ COMPLETELY PORTABLE—WEIGHS 8 POUNDS—MEASURES 5 1/2" x 6 1/2" x 9".

GENERAL ELECTRONIC DISTRIBUTING CO. Dept. RC-11, 98 Park Place
NEW YORK 7, N. Y.

TRANSATLANTIC NEWS

(Continued from page 37)

to be driven to the verge of distraction by the problem of getting a car quickly to the place where it was urgently wanted. Then she bethought herself of the radio systems used during the war by tank commanders for controlling formations of armored fighting vehicles. Why not apply one of them to the control of taxicabs scattered over a large area? Once formed, the idea was quickly put into practice and it has proved a magnificent success. At the center there is something like a wartime operations room, containing a large-scale table map of the area. Every cab has its own number, and a small metal block, bearing a corresponding number, indicates on the map the position of each car at any time. Indicators on the blocks also show whether a cab is engaged in doing a job or available for hire.

The equipment is a suitably modified v.h.f. tank radio. There is a master transmitter and receiver at the center and each cab carries its own transmitting and receiving equipment, with a small loudspeaker and a hand microphone on the dashboard. All drivers call up the center at regular intervals when they are free, reporting at once when they are hired or have finished a job.

The idea is one that might well find wide appreciation and application. Thousands of tank radios are being offered

cheap as war surplus, and it is a simple matter to make the necessary modifications.

Solar radio

Radiations from the sun on 3 specially marked frequencies, 200 mc, 90 mc, and 60 mc, have been under observation for some time now in this country and in Australia. The main radiation at these comparatively low frequencies takes place from sunspots and from *prominences*, those gigantic spouts of flaming gas which may rise several hundred thousand miles above the sun's surface. It has been calculated that the 200-mc radiation from near the base of a prominence may be equivalent to the output of a 1,000,000-kilowatt transmitter. Radiation from the higher parts of a prominence is of lower frequency. That at 90 mc corresponds to a height of 90,000 kilometers, and that at 20 mc to a height of 200,000 kilometers. It seems likely that this solar broadcasting plays a considerable part in the radio blackouts which are associated with periods of great sunspot activity. During the almost world-wide blackout on March 8 this year, there was at first strong radiation on 200 mc; in less than 3 minutes the 90-mc radiation began, as the prominence rapidly gained height. Between 4 and 5 minutes later the 60-mc radiation began to be recorded.



HERE'S a new and highly profitable business that's a dead natural for

the radioman who wants to supplement his income with a minimum investment in both time and money. Today, individuals like yourself, all over the country, are realizing big dividends with TRADIO, the radio functionally-designed for coin operation in hotels, tourist camps, hospitals, etc. And they're doing it right in their own backyards, too.

● Big Earnings, Steady Income

TRADIO has pioneered in this new and flourishing post-war field. Get in on the ground floor and assure yourself of financial security for life.

Tradio ★ Tried ★ Tested ★ Proven

TRADIO sells to operators only through franchised distributors. No routes are sold. We'll put you in touch with the distributor in your territory if you'll phone Asbury Park 2-7447 or write Dept. U-11.



TRADIO, Inc. ASBURY PARK
NEW JERSEY

Just Out!



GREAT NEW CONCORD Radio Catalog

The ONLY Complete Up-to-the-minute Catalog of Radio Parts · Sets · Amplifiers Testers · Ham Gear · Electronic Equipment
Mail Coupon for FREE Copy

Ready now — the greatest, latest complete presentation of radio, electronic and television equipment and supplies in Concord history! Packed from cover to cover with thousands of items — 160 pages of everything in Radio and Electronics. Special bargain section of hundreds of money-saving values. Scores of NEW ITEMS from famous makers. Mail coupon for FREE copy at once!



SPEAKERS
with 3 ohm VC's at retail buys
X150M, 5" Round PM . . . \$1.14
X151M, 4"x6" Oval Alnico V PM . . \$1.19
X152M, 4" Dynamic 450 ohm field . . . \$1.29



RF & DC Meter Values
0.4 Amp. RF, Built-in thermocouple, GE type DN-58, 2 1/2" round, X168M — Each . \$1.95
0-35 V DC, Red mark at 28.5 V, Simpson type K25, 2 1/2" round, 5B4205, \$1.95

ELECTROLYTICS All Nationally Known Makes

Number	Mf.	WV	Each	Number	Mf.	WV	Each	
X154M	8	450	24c	X153M	20-20	150	49c	
X155M	8, 8	450	39c	X160M	40	450	65c	
X156M	10	450	27c	X161M	60-30	150	25c	
X157M	10-10	450	47c	X162M	16	500	39c	
X158M	16	450	29c	X163M	100	50	15c	
X159M	20	160	22c	X164M	100-100	60-20	60	19c

CONCORD

RADIO CORPORATION
CHICAGO 7 ATLANTA 3
901 W. Jackson Blvd. 265 Peachtree Street
LAFAYETTE RADIO CORPORATION

CONCORD RADIO CORPORATION, Dept. RC-117
901 W. JACKSON BLVD., CHICAGO 7, ILL.
Yes, rush FREE COPY of the comprehensive new Concord Radio Catalog.

NAME _____
ADDRESS _____
CITY _____ STATE _____

RADIO SET AND SERVICE REVIEW

(Continued from page 36)

even on the high frequency end of the band.

Circuit is the conventional super-heterodyne with 4 miniature tubes and a selenium rectifier. The tube line-up is: 1R5 converter; 1T4 455-kc i.f. amplifier; 1S5 detector-a.v.c.- first a.f. amplifier; 3Q4 power amplifier. The 3Q4 drives a 4-inch PM speaker.

A single 67 1/2-volt B-battery and a pair of standard 1 1/2-volt flashlight cells supply current for battery operation.

The tube filaments are connected in parallel through the power selector switch and heated by the 1 1/2-volt cells in parallel. When the set is a.c.-d.c. operated, the filaments are connected in series through the switch and the filament current supplied from the selenium rectifier through a 2,360-ohm dropping resistor:

The set is easy to service. The bottom cover is removable for battery replacement or for removing the line cord for a.c.-d.c. operation. A dime or other thin coin is inserted in the slot of a quick release screw in the bottom cover. A half turn unlocks the cover for removal. Four screws hold the chassis in the case. When these are removed, the chassis slides out without having to remove knobs or unsolder the loop antenna. Spring contacts inside the case and on the chassis connect the antenna to the set when it is in the case.

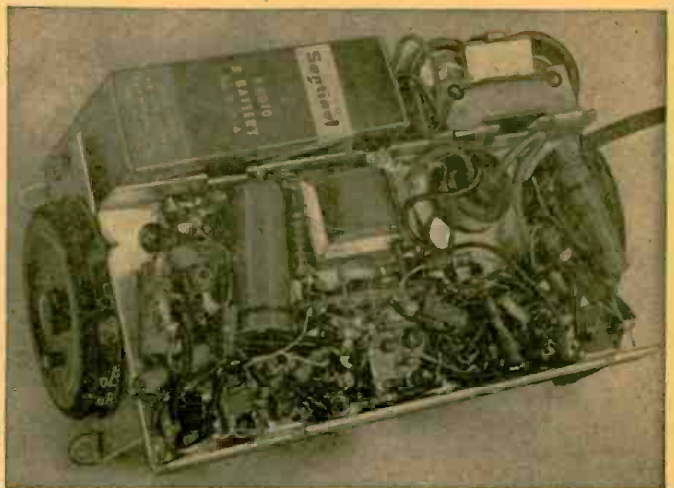

An under-chassis view of the receiver, showing battery placement.

The 1620-kc oscillator trimmer is adjusted with the chassis out of the case. Bridge the antenna terminals with a 1-megohm resistor and connect the output of the test oscillator across this resistor. The 1400-kc loop antenna trimmer is adjusted with the set in the case. The test oscillator signal is fed into a 2- or 3-inch loop consisting of 5 to 10 turns of No. 20 to 30 wire. This loop is coupled loosely to the loop antenna and the trimmer adjusted for maximum output. A cut-plate variable condenser with the oscillator section smaller than the r.f. section is used, so there are no padding problems in the alignment procedure.

The diagram shows an interlock switch to break the a.c. line when the bottom cover is removed. This switch was not present on the model tested, although provisions were made on the cabinet for mounting it.

PORTABLE P.A. AMPLIFIER

(Continued from page 66)

inate any hum which may be due to ground loops.

The hum level of the finished unit is extremely low. This is partly due to the unusually high filter capacitor values, and to the careful grounding and excellent shielding.

The close positioning of the components, together with the negative feedback system, made the unit prone to oscillation. Therefore certain precautions were taken.

A bottom plate was bolted to the preamplifier deck. This bottom plate provides electrostatic, electromagnetic, and thermal shielding. The plate was cut from a photograph ferrotype tin which was chrome-plated. The chrome side faced down to reflect the heat of the output tubes. Ventilation holes are provided in the back of the case.

The speaker and recorder lead wires must be shielded or oscillation may result, especially when the frequency-

response switch is in a high-boost position.

When the unit was completed, it was subjected to exhaustive tests and found to be excellent. It has served as a public address system, driving two 12-inch speakers with excellent quality. The response adjusting system made it easy to eliminate acoustic feedback in all cases.

The unit has been used as a remote amplifier to feed program material to a telephone line in broadcast work. In this instance, a patch cord was used to patch the auxiliary 500-ohm output of the preamplifier to the output amplifier so that the level meter and a speaker could be used for monitoring without loading the 500-ohm output of the preamplifier. Several concerts have been recorded with sufficient quality to use the recordings as masters from which to have shellac and vinylite pressings made.

RADIO and ELECTRONIC SUPPLIES for ALL PURPOSES

RADIO KITS

All kits have been designed by a reputable radio engineer with a background of many years experience with some of the leading manufacturers in the radio industry. The kits contain all the required parts except wire and solder for their construction into an efficient working unit comparable with the best post-war type of units. The simplified diagrams furnished make it possible for any radio student experimenter, or amateur to construct these kits.

FIVE TUBE AC-DC SUPERHET KIT:

Furnished in a brown plastic cabinet of artistic design, cabinet size (9"x5"x6"). Variable condenser tuned with 2 double tune I.F.'s. Tubes used: 1-12SA7, 1-12SQ7, 1-12SK7, 1-35Z5, and 1-50L6 **PRICE \$12.45**

(Including 5 Standard Tubes)

SIX TUBE 3 WAY PORTABLE KIT:

For operation on 110 volt AC or DC and battery. Superheterodyne circuit. Full vision dial. High gain loop. Cabinet of Blue Aeroplane cloth finish, size 13 x 9 1/2 x 7". Tubes used 1A7, 1H5, 3Q5, 117Z6 and 2-1N5. **PRICE \$13.75**

Not including tubes. Extra for kit of Tubes 3.75

THREE TUBE PHONO AMPLIFIER

An assembled unit ready for installation using tone and volume control and six feet of rubber cord **PRICE \$2.95**
(Not including Tubes)

PHONO OSCILLATOR

Wireless phono oscillator transmits recording for crystal pick-ups or voice from carbon mike through radio without wires. Can also be used as an intercomm by using P.M. speaker as mike. Price (excluding tubes) .. **\$2.95**

11 TUBE FM and AM CHASSIS

- Wave bands covered BC 540 KC to 1700 KC—FM 88 MC to 108 MC
 - Antenna System BC built-in loop—FM built-in folded dipole
 - Outside ant. terminal—balanced 300 ohm impedance
 - Power output undistorted 8 watts
 - 11 tubes
- | | | |
|------------------|-------|--|
| 1—6BA6 | 1—7F7 | PRICE
\$87⁵⁰ |
| 1—7Q7 | 2—7C5 | |
| 1—7AH7 | 1—5Y3 | |
| 1—7AG7 | 1—7C6 | |
| 1—7A6 | 1—7F8 | |
| 10" P.M. Speaker | | |

PORTABLE SIGNAL GENERATOR

Army Type 1-198-A

Frequency range 8-15 mc. Fully stabilized. Can readily be converted to Broadcast Band or any other frequency range by simply changing one coil. Attenuation consists of 4 position multiplier switch with variable potentiometer. Internal modulator can be turned off. Manufactured by Monarch. Excellently designed, fully shielded. Operates from 110 **\$11.95**
volts 60 cycle line

TELEVISION-CATHODE RAY HIGH VOLTAGE

2000 volt D.C. Power Supply

For an unbelievable low price, we can supply a completely filtered television or cathode ray 2000 volt D.C. power supply. Why bother with bulky and dangerous 60 cycle supplies or expensive R.F. power supplies when you can purchase a complete 2000 volt D.C. power supply (not a kit), ready to plug into the 110 volt A.C. power line. The ridiculously low price has been made possible by a fortunate purchase of high quality components. These units are brand new, completely tested and guaranteed. Here are the advantages:

- Low cost
- 2000 volts D.C. at 1 ma.
- Safe
- Small size
- Completely wired and tested
- Ready to connect to your television set or other equipment
- Will operate from 110 volts, 25 to 60 cycles.

PRICE \$7.95

At small additional cost, we can furnish these units to operate from 110 or 220 volts D.C. lines or 220 volts A.C.—any frequency. Write for quotation, giving us your requirements.

MAGNETIC RECORD CUTTER and PICKUP
PRICE \$2.95

Resonated at approximately 5000 cycles effectively reducing objectionable needle scratch without altering the brilliancy of reproduction.

Contains a HI-Q SERIES resonated circuit Tested by means of an audio oscillator and an oscilloscope to give 22 1/2 db attenuation at 5000 cycles with very low signal loss at low frequencies. Attenuation may be regulated by means of a SPECIAL MINIATURE gain control.

EASY TO ATTACH
Just two wires to clip on to the leads coming from phone pick up. Compact. Price **\$1.65**

A SCIENTIFICALLY DESIGNED SCRATCH FILTER

RADIO DEALERS SUPPLY CO.

135 Liberty St., New York, N. Y.

Available, a large stock of radio parts, test equipment, etc., at attractive prices. Write for free catalogue.

All Prices are
F. O. B.
New York City

WE SHIP
ANYWHERE
PROMPTLY

LOOK BOYS!! GOOD OLD SPEMCO "HI-FLEX" CRYSTAL MIKE CABLE IS BACK FROM WAR . . .

Oak Leaf Clusters on the medals already won by Hi-Flex are . . . high tensile strength, conductor made of seven strands of No. 31 special "Spemco" tinned alloy, ALL RUBBER INSULATION, approximately 25 MMF, O.D. 250.

LIST PRICE, 12c PER FT. (NO. 1009-A)

Hi-Flex in our opinion has incorporated every worth while improvement known to the industry to date. We have selected the finest of materials, combined with skillful engineering and workmanship, which insures an outstanding product. It is especially constructed and will not break down when subjected to hard usage. This cable will deliver consistent uniform response, regardless of climatic conditions.

Should your jobber be unable to supply Spemco Hi-Flex write direct, sending your order and the name of your jobber. The order will be shipped at once to the jobber you choose.

SPECIALTIES MFG. CO. [SPEMCO PRODUCTS] 4149 CASS AVE. DETROIT 1, MICH.

RADIO ITEMS OF THE MONTH

An aviation guiding system now helps pilots in thick weather by projecting on the windshield points of light resembling the field landing lights, in exactly the spots the pilot would see them. The inventors state that the blind-flying pilot feels far more sure of himself

when he can "see" the landing lights than when he has to read his data from a number of dials.

View through the windshield is otherwise unobstructed, so that if the pilot can get sight of the visual landing aids he will be reassured by seeing them in exactly the same positions as the ra-

diated light dots on his C-R tube.

Marine radar equipment to a value of more than a million dollars has been installed in nearly a hundred merchant vessels during the year, reports George F. Shecklen of the Radiomarine Corporation of America.

TWO "MUST" BOOKS

FOR
YOUR
LIBRARY



**RADIO-CRAFT
LIBRARY SERIES**

ONLY

50¢ Each

SEE YOUR DEALER
IF HE CAN'T SUPPLY
YOU

MAIL THIS COUPON

RAD-CRAFT PUBLICATIONS, Dept 117
25 West Broadway, New York 7, N. Y.

Send me the volumes (50c each, postpaid) checked. My dealer is unable to supply.

I enclose \$.....

NO. 31—RADIO QUESTIONS AND ANSWERS

NO. 34—RADIO-ELECTRONIC CIRCUITS

8 OTHER NEW BOOKS—50c EACH

NO. 29—HANDY KINKS AND SHORT CUTS

NO. 30—UNUSUAL PATENTED CIRCUITS

NO. 32—ADVANCED SERVICE TECHNIQUE

NO. 33—AMPLIFIER BUILDER'S GUIDE

NO. 35—AMATEUR RADIO BUILDER'S GUIDE

NO. 36—RADIO TEST INSTRUMENTS

NO. 37—ELEMENTARY RADIO SERVICING

NO. 38—HOW TO BUILD RADIO RECEIVERS

Your Name
(Print Clearly)

Address

Dealer's Name

Address

Here is a wealth of practical circuit information unequalled anywhere—over 200 useful diagrams of receivers, amplifiers, testers, intercoms, etc., complete with parts values! Life-savers for experimenters—time-savers for engineers. Both books are indexed for quick reference. Printed in large, easy-to-read type. Bound in smart, flexible, modern covers. Send for both volumes. These are but two of the books in our popular RADIO-CRAFT Library Series listed on the right. They represent the best 50c value in the radio field.

NO. 31—RADIO QUESTIONS AND ANSWERS

This book is a collection of the most common questions relating to circuits: "What circuit should I use for a battery-operated audio amplifier?" "—for a burglar alarm?" "I would like to convert my milliammeter into a volt-ohm meter." . . . etc., etc. The diagrammed answers are simple, direct, practical, and of general application.

Receivers, tuners and audio amplifiers are given most space. Other questions include transmitters, meters, test equipment, interphones, power supplies, phonograph amplifiers, and PA Systems. A number of questions dealing with fundamentals of radio are also covered. The questions are grouped under familiar classifications, as well as indexed, for your convenience.

NO. 34—RADIO-ELECTRONIC CIRCUITS

This is an excellent follow-up book to RADIO QUESTIONS AND ANSWERS. It represents the circuit ideas of the radio experimenter rather than of the editors.

Receivers and amplifiers top the list in popularity. Among the many circuits given are those for a one-tube superhet; an all-wave portable receiver; an r.f. regenerator and several different superregenerators. Other circuit diagrams with brief descriptions included are Intercommunication Systems—Power Supplies—Balancing Circuits—V.T. Voltmeters—Phono Amplifiers—Short Wave Adaptors—Electronic Relays. This book will find a place on every progressive radio man's bookshelf, because of the many odd and useful circuits which are not to be found elsewhere.

TRACER PROBE

I have found that handy probes for signal tracers can be made from microphone plugs such as the Signal Corps PL-68 or equivalents. The barrel of a plug of this type has ample room for mounting small ceramic resistors, crystal rectifiers, or condensers that may be required.

A portion of the outer conductor and insulation is removed to permit the inner conductor, which is about the diameter of a standard phone tip, to be used as the contact point.

CHARLES MCCLURE,
Paducah, Ky.

PHONO MOTOR

Being unable to obtain a 6-volt phono motor, I dug down into the junk box and found a defective a.c. rim-drive motor and turntable, a 6-volt automobile fan motor, and an automobile heater rheostat.

The a.c. motor was replaced by the 6-volt d.c. motor to complete the motor and turntable. The rheostat was placed in series with the motor to control its speed. The completed job draws about 2½ amperes and works very well.

This method should work wherever a low-voltage d.c. phono motor is needed.

D. L. FUQUA,
Fairfield, Iowa

HIGH FIDELITY

(Continued from page 25)

of thing that raises all the hairs on the back of your head and sets your teeth on edge.

Duet of the banshees

Naturally I jumped for the volume control but it was turned down all the way so I yanked the a.c. plug and the squeal died away lingeringly. The company took their fingers from their ears and regarded me indignantly. The XYL's glance was not indignant; it wasn't even curious. She just looked at me with a completely blank stare as though I were some stranger she would rather not meet.

I tried to laugh it off. "Oh, I know what's happened. I'm feeding back the wrong phase from the voice coil, and I've got positive feedback instead of negative." I tried to smile reassuringly at the XYL (to hell with the company) and she smiled back. Encouraged, I said, "It won't take me a minute to change that."

I started carrying the chassis over to the table and then had to stop before I pulled the speaker and turntable along. The company, who had just sat down again, started nervously to their feet, but the XYL tossed me a screw driver and they sat down once more.

I flopped the chassis upside down on the table and began digging inside. The company kept giving me jittery glances and remarked that they hadn't intended staying but just thought they'd drop in for a minute and—

"Oh, stick around a minute or so.

I'd like you to hear this." I really did. I was challenged. It was an easy change to make and it wasn't more than a minute before I carried the chassis back and began plugging things in. The company got up with a wary look. The sort of look an elderly aunt gives a small boy with a firecracker.

I smiled to reassure them, and it started again. It built up in the same way but the pitch was lower. Unfortunately the intensity was every bit as high. The a.c. plug stuck in the wall a

interstage xformer, so I yanked it out and rigged a phase inverter and managed to get 15 db of feedback. I ran a response curve and looked at the wave form on a scope—things looked pretty good. The speaker came back with a new cone, and I carried the whole business home and hitched it up again.

The XYL was inclined to be stubborn about it. It didn't sound so hot to her so I showed her the curves. She shook her head. "I don't listen to curves. The 2A3's sounded better."

It's a mistake to try to prove things to women by talk. You have to show them. I put the interstage xformer back into the old 2A3 job and then rigged the 2 amplifiers side by side. With a switch I could key from one to the other. This'll show her, I thought. There'll be a whale of a difference.

There was a whale of a difference but instead of showing her it showed me. The 2A3's did sound better. A damn-sight better. Keying from one amplifier to the other

made it perfectly obvious to both of us.

It should have held me but it didn't. I took the thing back to the technical school and worked on it some more. I studied up on steep-fronted waves and phase distortion. Transient distortion and intermodulation distortion were new to me, so I really worked. I redesigned and rewired that cussed thing. I used VR tubes for plate and screen regulation, ran a single ground system, matched the output tubes—delved into things deeply.

The perfect amplifier

I ended up with a super amplifier. The response curve was down 3 db at 12 cycles and 37 kc; there was 22 db of feedback from the voice coil back to a cathode; a 2,000-cycle square wave would go through the thing and come out as pretty as you please; it had up to 18 db of boost at 50 cycles and 5 kc and a microphone stage. The fellows at the school all agreed it was a well-engineered amplifier. We hitched it up to the school's co-axial speaker and it sounded great. At louder than 4½ watts it drove us out of the auditorium. It overloaded at around 13 watts.

I called home from school and told the XYL to invite some company that liked music for that night. "This 6L6 job sounds great, honey!"

She sounded a little dubious over the phone but she seemed O.K. when I got home and she listened to it. The company came and listened to records and

(Continued on page 88)

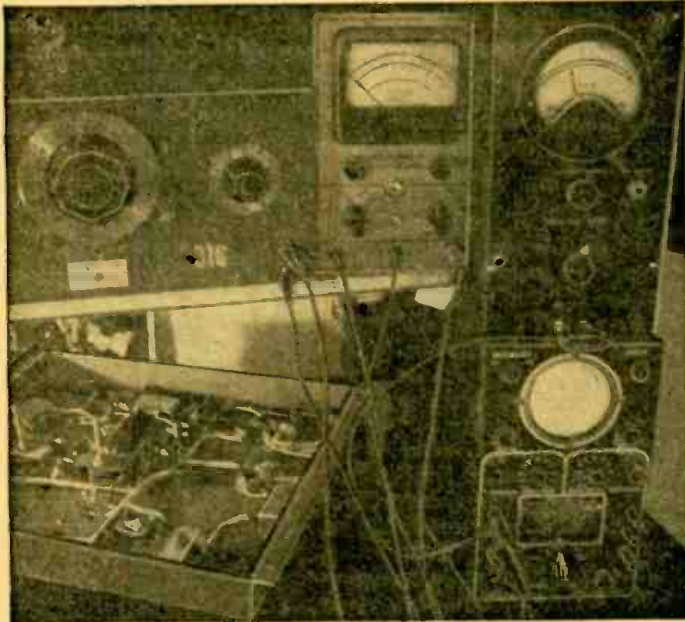

The amplifier (bottom up) and some of the instruments used on it.

little and by the time I turned around the XYL was at the door waving goodbye to the company.

Things got a little unpleasant around then because it seems the company had been rather special friends of the XYL. Presently, however, I managed to switch her line of thought from the sociological to the technical. That was better but not much. She went over and pushed at the speaker cone. "Wise guy, huh. You've bent the voice coil. See? It rubs."

"I think it was already warped. It needed a new cone anyhow."

She gave me one of those looks. "Better go back to 2A3's."

I spent the rest of the evening fiddling around alone while the XYL went to bed and read. I listened to the amplifier with headphones from then on because there's no sense in antagonizing people. Anyhow my results were very discouraging; switching feedback polarity should have given negative feedback on one position but both polarities made with the banshee shriek. One high soprano and one baritone banshee. Breaking the feedback loop stopped the squeal but brought up the distortion like anything. I checked resistor values and tried again. I was in a pretty nasty frame of mind when I went to bed.

The next day I took the amplifier over to the technical school. I became more analytical and discovered that anything over 7 db of feedback was too much—it would squeal. Anything less sounded lousy.

Of course I thought about that old

LEEDS The house you have known for 25 years

LABORATORY POTENTIOMETER

Wire wound 100,000 ohm, 25 watt, 6 inch diameter; made to General Radio Co. specifications. **\$1.95**



CERAMIC stand offs: base and head brass; plated; 5" high 1" dia. Oval base 3"x1½". Special 20c. 10 for \$2.50
 Eury metal binding posts ½" head. List 90c, your cost 5c; per dozen 50c
 G.E. 200 amp RELAY, 24-v coil 39c
 SIGMA 4 Ma, 2000 ohm. Plug in relay 95c
 BUSSMAN 8 AG 1/100 amp instrument fuse; per dozen 50c
 300 ohm twin lead indoor or outdoor cable; per 100 ft. 2.95
 52 ohm RG 8/U coaxial cable; 100 ft. 4.50
 PL-259 Silver plated coaxial connector 15c

BC-438 FREQUENCY METER

110 V. AC operated Range 195 to 215 megacycles; complete with tubes, crystal, calibration curves and schematic; only **\$9.95**



VARIABLE CONDENSERS

100MMFD double bearings, silver plated, Isolantite insulation; shaft extended at each end for ganging. 29c—10 for \$2.50
 25 MMFD balanced Stator 1 hole mtg. Isolantite insulation. Polished plates. Swell for VHF. 29c—10 for \$2.50

MICA CONDENSER

Aerovox type 1590-II-229 low loss Bakelite case. Cap. 0.4 MFD 600v efr. 18 amps at 3000 KC. 25 amps at 1000 KC. Very special 95c

OIL FILLED CONDENSERS

0.1 Mfd 7500v DC GE \$1.50
 2x0.1 Mfd 7500v DC GE 2.00
 3x0.2 Mfd 4000v DC Tobe98
 .02 Mfd 8000v DC Aer98
 2x0.1 Mfd 600v DC CD25
 10 Mfd 800v DC GE98
 7 Mfd 380v AC GE 1.25
 2 Mfd 2000v DC CD 1.75
 16 Mfd 400v DC WE98
 2 Mfd 1000v DC Aer79
 1 Mfd 5000 VDC Solar 2.95

RADIO TRANSMITTER & RECEIVER APS-13

17 Tubes

410 - 420 Mc;

light weight,

fully enclosed,

30 Mc. IF. complete with tubes

5-6J6; 9-6AG5;

2-2D21; 1-VR-105; Schematic supplied with each unit

Only **\$11.95**



Ounceer Mike to Grid 25:1 low to high impedance. 35c

1N21-B Crystal Diodes. 35c each. 3 for \$1.00

Telescoping Antenna 39-inch 25c

Telegraph Key J-37; ¼" silver contacts 49c

Heinemann 5 amp circuit breakers. 95c

BEST BUYS OF THE MONTH

BC-1066A; U.H.F. 2 band receiver, battery operated using 2-957's and 1-D8GT. Schematic included; mtd in wooden carrying case. Easily converted to an F.B. 2 meter receiver. For the price of the G.R. dials & locks \$3.95

Crystal Mike, guaranteed perfect; complete except for holder. An extraordinary value 69c

832 TRANSMITTING TUBE, special \$2.15

If not rated 25% with order, balance C.O.D. All prices F.O.B. our warehouse New York. No order under \$2. We ship to any part of the globe.

LEEDS RADIO CO.

75 Vesey St., Dept. RCN

COrtland 7-2612

New York City, 7

HI-FI AMPLIFIER DIAGRAMS



NOW YOU

can build and service the latest **HIGH FIDELITY** amplifiers using the easy to follow, tested and proven circuits contained in **PRACTICAL AMPLIFIER DIAGRAMS!**

The only complete book of its kind on the market. 45 one to eleven tube amplifiers with phase inversion, inverse feedback, bass boost, treble boost, compression and expansion recording amplifiers, multi-channel amplifiers, pre-amplifiers, portable P.A. amplifiers, and many others!

ALSO Big Section On Servicing All Type Of Amplifiers included!
102 large 8 1/2 x 11 inch pages spiral bound.

Available NOW at your dealer for only \$2.00 or send coupon below TODAY!

Os-tronic Publications
312 W. Pico Street
Los Angeles, Calif. Inclosed find \$... Check P.O. Order

Please send postpaid **PRACTICAL AMPLIFIER DIAGRAMS**. I may return this book within 5 days for full refund if not fully satisfied.

Name

Address

City Zone State

LEARN

ELECTRICITY OR RADIO

... in the **GREAT SHOPS OF COYNE**
Train in a Few Short Weeks

Here at Coyne in a few short weeks you can train for your big opportunity in Electricity or Radio. You train on actual full-size Electrical or Radio equipment. 48 years training experience. For Veterans and non-veterans.

NOT A "HOME-STUDY" COURSE

All Coyne training is given here in our big Chicago shops. Not a Correspondence course.

VETERANS! Coyne is authorized to train Veterans under the G.I. Bill. Coupon brings details.

FREE BOOK—Two great opportunity fields—rush coupon for free illustrated book on whichever course you prefer—no obligation. Tells how Coyne helps you get better jobs.

Your Choice of 2 Great Fields
B. W. COOKE, Pres.
COYNE ELECTRICAL SCHOOL, Dept. 87-78H
500 S. Paulina St., Chicago 12, Ill.

Send **FREE BOOK** and full details on course checked:

ELECTRICITY **RADIO**

NAME

ADDRESS

CITY STATE

TELEVISION RECEIVER—\$1.00

Complete instructions for building your own television receiver. 16 pages—11"x17" of pictures, pictorial diagrams, clarified schematics, 17"x22" complete schematic diagram & chassis layout. Also booklet of alignment instructions, voltage & resistance tables and troubleshooting hints.—All for \$1.00.

CERTIFIED TELEVISION LABORATORIES
5507-13th Ave., Brooklyn 19, N. Y.

A new "self-servicing" radio has the components of each stage mounted in plug-in cans. If there is trouble in any stage, the whole section (less tube) is simply pulled out and another inserted.

FM AND TELEVISION DESIGN

(Continued from page 33)

corporate special temperature-compensating capacitors which vary with temperature change in a direction opposite to that of the tube capacitance. To use these compensating capacitors effectively, we must reduce changes in value, caused by temperature changes, of all other components in that circuit to a minimum. This calls for careful construction, which is generally not economically adaptable to current mass production methods.

A second solution, which has much in its favor, is the use of an oscillator functioning at a frequency half that required for mixing. The second harmonic is then used in the mixer for the production of the i.f. voltage. The ad-

counteract the effect of cathode lead inductance, 2 cathode terminals are provided. Let us analyze this latter aspect more closely because it directly concerns the man who is going to construct or repair a set.

The schematic diagram of a tube with its cathode lead inductance is shown in Fig. 7. Even though the cathode terminal is grounded directly to the chassis, at the tube base, it must be realized that there is inductance in the internal wire connecting the cathode prong to the cathode structure itself. It is this inductance (shown for convenience outside the tube) which is labeled L_K in Fig. 7. The tube current passes through this inductance and, in so doing, develops a voltage. At frequencies below 60 or 70 mc, the inductance of this short length of wire is negligible and may be disregarded. At frequencies of 100 mc or more, sufficient voltage is developed across this inductance to make itself felt.

The voltage E_K , being in the cathode of the tube, will affect both the grid and plate circuits.

So far as the plate circuit is concerned, this voltage is of little significance. But to the grid circuit it acts somewhat as a feedback voltage which decreases the effective input impedance.

To eliminate the effect of the lead inductance voltage on the grid circuit, manufacturers have designed tubes having 2 cathode terminals. One terminal is used exclusively for the completion of the plate circuit path, the other for the grid circuit. In the circuit of Fig. 8, a 6AG5 tube is shown as an r.f. amplifier. Even though both terminals are grounded, they are still kept separate.

The grounded ends of the grid coil and condenser connect to terminal 2; for the plate circuit, the grounded ends of the plate and screen by-pass condensers connect directly to terminal 1. In this manner the alternating currents in each circuit are kept separate. The d.c. component of the current divides equally between each terminal, but this is not important since the d.c. component does not contribute to the decrease in input impedance.

When d.c. cathode bias is to be obtained with a tube of this type, the circuit is arranged as shown in Fig. 9. Bias is required only in the grid circuit; hence the cathode resistor and con-

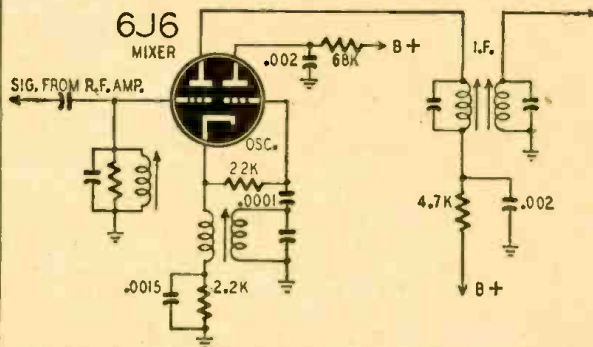

Fig. 6—This cathode-coupled converter circuit employs a 6J6.

vantage gained by cutting the oscillator frequency in half is the increase in inserted capacitance to the point where the tube and wiring capacitances form only a small portion of the total capacitance shunting the coil. In this way, changes in their effective values have negligible effect on the oscillator frequency. Harmonic oscillator operation is used in Zenith FM sets.

Triode mixers and oscillators are extensively used in FM and television receivers. Some manufacturers prefer to use the recently developed 6SB7 pentagrid converter, but they do so at the expense of increased noise.

Two cathode terminals

Some high-frequency tubes have 2 cathode terminals at the tube base even though there is but one internal cathode. One example is the 6AG5 tube. Why a tube should require 2 cathode terminals can be traced directly to its behavior as the input frequency is increased. At low frequencies, the input impedance of a tube is normally so high as to be considered infinite. As we raise the frequency of the applied signal, the input impedance drops and at 100 mc a conventional tube may have an input impedance of several hundred ohms. (See Table 1.)

The decrease in input impedance is due chiefly to 2 factors: electron transit time, and cathode lead inductance. Both factors are approximately equally responsible for the decrease. To reduce transit-time effect, the electrodes are situated closer together and the operating voltages are raised somewhat. To

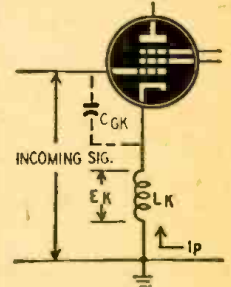

Fig. 7—Cathode effect.

denser attach to terminal 2. The d.c. plate current returns to the cathode via terminal 2, whereas the r.f. component of the plate current is by-passed directly to terminal 7.

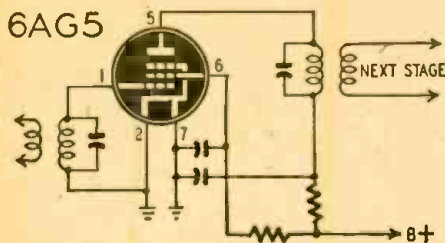

Fig. 8—How two cathode terminals are used.

The purpose of this arrangement should be borne constantly in mind when constructing or repairing circuits containing these tubes. If, for some reason, we inadvertently connect the cath-

Tube Type	Input Impedance	
	50 mc.	100 mc.
6C6	2000 ohms	450 ohms
6D6	2300 ohms	500 ohms
56	1900 ohms	350 ohms
6AC5	3000 ohms	750 ohms
6L7	2900 ohms	650 ohms
1851	3000 ohms	750 ohms
1852	3000 ohms	750 ohms
6K7	7100 ohms	1900 ohms
6SK7	7100 ohms	1900 ohms

ode terminals together, the result is a decrease in input resistance and the over-all sensitivity of the receiver will also decrease. It is important to note, too, that often the schematic diagram of the receiver containing such a tube

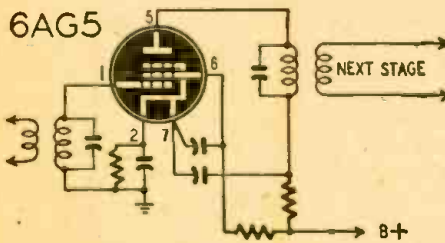

Fig. 9—D.c. bias for two-cathode circuit.

does not indicate clearly the 2 separate terminals. Servicemen are only too familiar with the fact that many diagrams differ from the receiver as laid out on the chassis, and these differences must be watched especially sharply in v.h.f. and u.h.f. circuits.

This is the first of a series of two articles on high-frequency FM and television circuits. The second will appear in an early issue.

IMPROVED RECORD PLAYER

A number of portable record players or phono amplifiers have speakers enclosed on all sides except for the small mounting hole in front. This often causes low volume and poor tone quality. In most cases, it is possible to drill three or four 1-inch holes in the back of the case immediately behind the speaker. This improves the tone and also helps dissipate heat from the amplifier often mounted in the speaker enclosure.

THOMAS J. AMBROSE,
New Haven, Conn.

FOR THE FIRST TIME!

New GE pickup with Tone Arm



Your choice of Studio Transcription Model 160GE (for records up to 16") or Program Phone Model 120GE (for records up to 12") tone arm, complete with new, popular GE Variable Reluctance Pickup Cartridge. Provides decreased distortion, reduced record wear, less needle scratch, and less needle talk. Originally developed to operate with ACA-100GE amplifier, but will give excellent results with any sound system equipped with proper preamplification. Response is guaranteed to be clear from 30 to 10,000 cycles. Send for literature and prices.

AMPLIFIER CORP. of AMERICA
398-10 Broadway • New York 13, N. Y.

RANGEMASTER

MODEL 10
BY BRADSHAW
A COMPLETE SERVICE INSTRUMENT

The model 10 RANGE MASTER covers 22 ranges. Three direct reading capacity ranges. Three A.C. current ranges for checking current drain of electric motors and appliances. All in One Rugged, Compact, Attractive Unit COVERS THESE RANGES
A.C. VOLTAGE: 1-10-100-500-1000 Volts
D.C. VOLTAGE: 10-100-500-1000 Volts
A.C. CURRENT: .15-1.5-15 Amps
D.C. CURRENT: 1-10-100-1,000 Milliamps
RESISTANCE: RX10 RX100 RX1,000 Ohms
CAPACITANCE: .001-.1 .01-1 .1-10 Mfd.
Available in Kit Form \$17.95
Factory Assembled \$23.50
Test Leads85

Available at your local dealer. If not write to us. SEND FOR DESCRIPTIVE LITERATURE
BRADSHAW INSTRUMENTS CO.
942 Kings Highway, Brooklyn 23, New York
DEALERS INVITED

ELECTRONIC VOLT-OHMMETER

\$11.85
110 VOLTS AC 20 RANGES
0/5/10/50/100/500/1000/5000 volts DC and AC. 0-1,000,000,000 ohms in six overlapping ranges. Sensitivity; over MILLION OHMS per VOLT on 5 Volt range.
POSTPAID
Complete kit includes all component parts, tubes, punched and drilled chassis and beautifully enameled panel. Easily assembled and wired.
Special slideback circuit developed during war by scientist at the California Institute of Technology gives amazing sensitivity and flexibility while completely eliminating necessity of batteries and expensive meter. Each instrument is individually calibrated. Dial scale over nine inches long!
In addition to performing the usual volt-ohm functions, this instrument easily measures these voltages: SUPERHET OSCILLATOR, AVC, AFC, TRUE GRID BIAS AT THE GRID, BIAS CELLS without affecting the circuit. Measures the exact leakage resistance of INSULATION, TUBES, CONDENSERS. It can be used with a signal generator for SIGNAL TRACING.
STERLING ELECTRONIC COMPANY
BOWLING GREEN, KENTUCKY

Do you need BINDING POSTS?

The XL PUSH POST with its Spring Action assures Constant Contact and quick connection. Manufactured in All Aluminum Type M at 12c each. Aluminum Body, Bakelite Top Type B1 at 15c each.
Types CP or NP. ALL BRASS-STAINLESS STEEL SPRING & PIN. PROVEN BY 240 HR. SALT SPRAY TEST as NON-CORROSIVE at 26c each.
Manufacturers and Dealers Liberal Discounts
X. L. RADIO LABORATORIES
420 West Chicago Ave., Chicago 10, Ill.

NOW AVAILABLE!

Amplifier for GE pickup



New circuits for the first time enable you to attain full benefit from the new General Electric Model DL 1RM 6C Variable Reluctance Magnetic pickup. Employs an exclusive, humless (DC on heaters) pre-equalized pre-amplifier to produce the most satisfying musical amplifier the world has ever known. If you are a perfectionist, you are the one for whom the ACA-100GE was designed. Send for technical literature.

AMPLIFIER CORP. of AMERICA
398-10 Broadway • New York 13, N. Y.

BONAFIDE VALUES

SHURE T17B Push Button Carbon Mike \$98.00 With Cord and Plug Value \$12.00
SHURE CRYSTAL MIKE \$6.95 With Stand, Base and 7 Ft. Cable Value \$18.50

HAZELTON INSTRUMENT CO. MODEL 100

Pocket Multimeter 2" Movement, 1000 ohms PV, A.C. Volts 0-15, 150, 1500; D.C. Volts 0-15, 150, 300, 1500; Ohms 0-3000, 300,000; Mils 0-1.5, 15, 150 \$9.95

DETROLA AUTOMATIC RECORD CHANGER

Plays 10- and 12-inch records. Enjoy almost 30 minutes of uninterrupted music. Special Low Price \$14.69
Webster 56 With Automatic Stop.....\$25.95
Seeburg 2 Post Changer..... 23.97
Maguire Changer, Automatic Stop..... 11.95
A. C. Motor & Astatic L-70 Pickup..... 4.75
5" PM Alnico Speaker..... 1.39
3" Heavy Slug Speaker-Nylon Cone..... 1.98
1/2 Meg. Vol. Cont. & Sw-Lots of 5..... .48
Federal Selenium Rect.-100 Mills-Lots of 6..... .69
100 IRC Resistors Assorted Sizes & Watts... 1.79

25% Deposit, Bal. C.O.D. Plus Charges Write for Latest Catalog

BONAFIDE RADIO CO.

89 1/2 Cortlandt St., Dept. C, N. Y. 7, N. Y.

12 lbs. RADIO PARTS \$2.00

A gold mine of parts for repairmen, amateurs, and experimenters... sockets, condensers, resistors, transformers, coils, hardware, wire, etc. An outstanding bargain in usable parts! Send \$2.00 cash, check or M.O. today!
(Pay small express charges on receipt.)
Electronic Distributors, Inc. Dpt. C11, 620 W. Randolph St., Chicago 6, Ill.



HOTEL STRAND

Atlantic City's Hotel of Distinction

The Ideal Hotel for Rest and Relaxation • Beautiful Rooms • Salt Water Baths • Glass enclosed Sun Porches • Open Sun Decks atop • Delightful Cuisine • Garage on premises • Open All Year.

Write for Literature

Exclusive Pennsylvania Ave. and Boardwalk

HIGH FIDELITY (Continued from page 85)

saw my curves. They said it was marvelous.

"Just a matter of engineering," I told them and tapped a cigarette on the back of my hand.

The next day we invested in a recorder turntable and lead screw arrangement, and I bridged the crystal cutter across the output. It was grand. Make our own records. Sunday symphony stuff. Not cheap but fun.

Then I bowed to the little woman and did some cabinet work. Threw away the apple boxes and cartons and rigged it up really nice. Then we fussed with pickups and styli and speakers for awhile. Then the war was on us—personally that is.

Back to the old love

During a leave I came home to find the damndest hookup you ever saw. The XYL had pulled the cabinet away from the wall far enough to stick that old, no-good, beat-up, lousy, dusty 2A3 amplifier in there and had a switch rigged up to shift outputs to the recorder and speaker from the 6L6 job to the old one. "How come?"

She looked at me apologetically. "It sounds better."

"It can't. It can't sound better."

"It does."

"Show me."

She did. She hunted through the broadcast band till she found some music with plenty of highs. She cut it on a 12-inch disc and flipped the switch each 30 seconds. To make sure there was no mixup I whistled a brief peep into the mike each time she started the cut with the 6L6 amplifier. Then she played it back the same way—that is, switching so that the stuff recorded through the old deal was played back through the old deal and vice versa.

It was true. That lousy old battered 2A3 job made a cleaner cut than this lovely, well-engineered 6L6 amplifier. Recording and playing back made it obvious. There was a bunch of stuff like bells in the music—the XYL says it was a celeste but it sounded like bells—and over the old job it sounded like bells. The 6L6's made it sound—well, you could tell they were meant for bells but they didn't sound just right.

I had only 5 days but right away I snaked those amplifiers out of that cabinet and carried them over to the technical school. There must be something wrong with that amplifier. I spent the rest of the day running a complete set of curves and that 6L6 job was clean as a whistle. Square waves looked square, response was flat, everything was as it should be.

I gave up. I yanked those beam bottles out of there and put in triodes. I used 6A5's which are the same as 2A3's except for a 6-volt heater cathode which simplifies the hum problem. I ran them strictly in Class A—not A'—and managed about 18 db of feedback. I used the same output xformer and it runs pretty cool, as does the power supply.

You Get ALL 5 at Walter Ashe

"SURPRISE" 1
TRADE-IN ALLOWANCES

SUPER BARGAINS 2
IN SURPLUS EQUIPMENT

SHIPMENT 3
THE SAME DAY... OFTEN THE SAME HOUR FOLLOWING RECEIPT OF YOUR ORDER

BIGGER-THAN-EVER 4
STOCKS OF UP-TO-THE-MINUTE COMPONENTS and PARTS

AHEAD 5
OF THE PARADE "SERVICE... FACILITIES... VALUES"

Now Walter Ashe offers you extra special deals on top condition, slightly-used Test Equipment at savings that will amaze you. Tell us your requirements and we'll quote you on the deal of your choice on good-as-new merchandise now in stock. A wide selection available. Wire, write or phone today.

TIME PAYMENTS AVAILABLE

Got some used Test Equipment you'd like to trade in? Then Walter Ashe is the man to see. Your trade-ins worth more at the Walter Ashe Store. For top allowances on your used Test Equipment, see Walter Ashe first... before you make that trade!

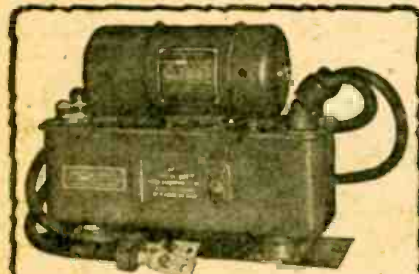

PE-103 DYNAMOTOR

A Once-In-A-Lifetime Bargain!

HAMS, EXPERIMENTERS, P. A. MEN or anyone else who needs a High Voltage, High Current mobile power supply. HERE is the answer to your problem. This choice piece of U. S. ARMY SURPLUS equipment offered at a small fraction of its original cost. In fact, nothing on the market like this unit in price or quality. 5 or 12 volt D.C. input. Delivers 500 Volts D.C. at 100 M.A. Complete with heavy duty rubber covered battery cable, complete filtering and overload circuits, brand new, in original over-sea shipping crates. SHIP. Wt. 8 1/2 lbs. Only \$9.95

USED HS-23 HEADPHONES

YES, we still have HS-23 Headphones in stock. They have been classified O-2 by the W.A.A. which means used, but in good condition. They are the regular 8000 ohm impedance phones that have been advertised at much higher prices. They are without boxes and show signs of being slightly used, but are in every respect electrically equal to a brand new pair. We were fortunate in buying a large quantity of these A-1 used headphones and being able to offer them to you at this amazingly low price. Complete with leather head band. SHIP. Wt. 2 lbs. Only 98c



YOUR FAVORITE BRANDS OF TEST EQUIPMENT

Hickok	Melnsner	Triplet
Jackson	McMurdo Silver	R.C.A.
Precision	Special Products Co.	Billiey
Simpson	Industrial Equipment	Weston
Waterman	Cornell-Dubilier	Sprague
Du Mont	Coastwise Electronic	Supremo
Feller	Monitor Plezo	Superior

WJWD WWTM WOPGI WOUH W9NRF WQDF W0YD W0KES
All Prices F.O.B. St. Louis.

1948 CATALOG
A NEW BIGGER BETTER
WALTER ASHE CATALOG
of all that's new and best in Radio and Electronics. For "priority" delivery of your copy have your name placed on our mailing list.

Walter Ashe RADIO CO.
1125 PINE ST. • ST. LOUIS, MO.

RADIO-CRAFT needs more photos of service shops and service benches. We will pay \$6.00 for each 6 x 8-inch or 8 by 10-inch glossy photo accepted. Do not "dress-up" your bench, but take a bona-fide photo, preferably with men working.

With triodes the curves weren't as nice-looking. Response was down 3 db at 35 cycles and 15 kc, and the upper corners of a 2-kc square wave are just slightly rounded. There was no apparent distortion. It overloaded around 8½ watts.

(Incidentally the curves on the old 2A3 amplifier were lousy.)

"Triodes sound best!"

Anyhow I carried both jobs back home again and rigged them to the switch the way the XYL had them and we went through the same routine of testing on recording and playback.

At last we had an amplifier that really sounded good. It was noticeably superior to the old job and the XYL admitted it. "Looks like sonar work has taught you some things about audio!"

I grinned sheepishly. "Those aren't 6L6's any more, honey. I put in triodes."

Now the war is over and radio magazines are playing up intermodulation distortion as the most important thing. I can't give you figures on our outfit because no quantitative test was ever run on it. A fellow came around once and stroked a sort of dinner chime arrangement into the mike and then listened to the playback. He said he couldn't hear any spurious tones and therefore I had little or no intermodulation distortion. As I understand it, intermodulation distortion is the result of unbalance (that was why I hadn't run it Class AB) and my output is balanced pretty carefully. On the school's analyzer, my measured wave-form distortion is less than 1% but I think that's unimportant. I heard a 2A3 job lately with a measured 8% distortion and it was hard to tell the difference when it was keyed back and forth with our rig.

Now I say this and I'm not kidding: You can build yourself a lovely beam-tube amplifier that will display awfully pretty curves but if you want something really clean, if your interest is in the sound rather than the curves, then stick to triodes. The human ear is a peculiar thing and it hears a good deal of what it wants to hear. Witness the apparent bass that comes from a set with a 3-inch speaker. An engineer (or semi-engineer) can look at curves and think he's hearing good stuff. Take a music lover or don't show the engineer the curves and try a keying test and I think you'll find the same thing I did. Triodes sound better!

W8GFK

ALUMINUM PLATE

Your call cast in aluminum with black background and polished. 1½" letters. Plate size 2" by 6¼". 3 styles: P for panel mounting, L for car license and D for desk use. \$1.75 each, post-paid.

P. & H. SALES CO., Dept. R
619 Jasper Street Kalamazoo 31, Michigan

PEN-OSCIL-LITE

Extremely convenient test oscillator for all radio servicing; alignment • Small as a pen • Self powered • Range from 700 cycles audio to over 800 megacycles u.h.f. • Output from zero to 125 v. • Low in cost • Used by Signal Corps • Write for information.

GENERAL TEST EQUIPMENT
28 Argyle Ave. Buffalo 9, N. Y.

B 19 TRANSMITTING and RECEIVING SET

MARK II—3 Sets in 1 (15 Tubes)

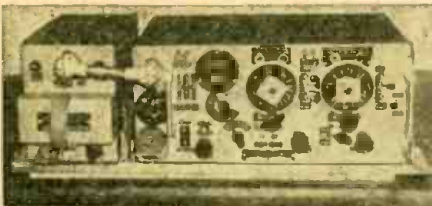

Complete transmitting and receiving set consisting of "A" Set; "B" Set; "IC" Set; Two Antenna Systems with spares; Five Dynamic Headset-Microphones; Three Control Units with Cables; 12 Volt D.C. Power Supply; Variometer; 15 Spare Tubes; Spare Parts in Case; Instruction Book; and Miscellaneous Items.

This set provides the following facilities:

"A" SET—Transmitting and Receiving from 2 to 8 megacycles, which include the 40 and 80 meter amateur bands. Superheterodyne Receiver and MOPA Transmitter with 807 Power Amplifier Output 25 Watts, phone and 35 Watts CW.

"B" SET—Radio transmitting and receiving on 280 to 240 megacycles.

"IC" SET—Intercommunication.

This equipment is guaranteed to be brand new.

Price: SET Complete.....\$46.50

Price: Less 12 Volt Power Supply..... 39.95

Price: AC Conversion Diagram..... .50

WE CAN FURNISH ANY ITEM FOR B 19 SETS. Terms: F.O.B. Lima, Ohio—25% Deposit on C.O.D. Orders.

FAIR RADIO SALES

223 S. MAIN ST. • LIMA, OHIO

LAKE DELUXE CHANGER



Revolutionizes the Industry!
A SENSATIONAL SELLER!

11 OUTSTANDING FEATURES:

- Positive Intermix
- Service Adjustments
- Eliminated
- Minimizes Record Wear
- Single Knob Control
- Plays ALL Records
- Completely Jam-proof
- Records Gently Lowered on Spindle—not dropped
- Automatic Shut-off on last record
- Pick-up arm may be cradled at any time and changer will not be thrown out of adjustment
- Resonance-free ball bearing tone arm
- Easily operated—any child can do it

Dimensions: 13 13/16" W x 12¼" D x 7¾" H No. 116A4YOUR NET **\$2873**

SERVICEMEN—RETAILERS

Join our customer list today. Write today for our new 16-page illustrated catalog NR-116. It's free. Get on our mailing list.

LAKE RADIO SALES CO.

615 W. Randolph Street, Chicago 6, Ill.

TUBULAR ELECTROLYTICS

Fresh stock Fully guaranteed

20 mfd. 150 V. 10 for \$1.79
20-20 mfd. 150 V. 10 for 2.49
8 mfd. 450 V. 10 for 1.85

Postage extra. 25% deposit on C.O.D.

Write for our free bargain lists featuring "AMERICA'S BEST BUYS"

POTTER RADIO CO.

1312-1314 McGee St. Kansas City 6, Mo.

Every Radio Serviceman Needs This **FREE**

68 PAGES

AC-DC

BALLAST

TUBE MANUAL

To get YOUR FREE COPY of this indispensable manual (value \$1.50) merely mail in to JFD Factory 12 flaps from JFD Radio Dial Belt envelopes; include 10¢ in postage to cover mailing cost. (Buy your JFD Dial Belts and Belt Kits from your nearest parts jobber.)

JFD's new 68-page Ballast Manual is a treasury of information for Radio Servicemen and Dealers — Lists more than 3000 radio ballasts — ACDC Ballasts for Fluorescent lights and electrical appliances — 220 volt to 110 volt Stepdown Ballasts.

Send 12 Envelope Flaps to:

J.F.D. MANUFACTURING CO. INC.

4109-4123 FT HAMILTON PKWAY, BKLYN 19, N. Y.

FREE

RADOLEK
RADIO & ELECTRONIC PARTS
BUYING GUIDE

UP TO THE MINUTE BUYING INFORMATION

Radio Repair Parts
Sound Systems • Tools
Kits • Phone Equipment
Tubes • Test Instruments
Experimenters Supplies

REGULAR SUPPLEMENTS
KEEP YOU POSTED

Catalog sent immediately upon request. Price and Data Supplements, issued regularly, assure you of up-to-the-minute information—give exact and current data you need for profitable buying. Send the coupon today for this helpful buying service.

BIG VALUES, LARGE STOCKS,
FAST, DEPENDABLE SERVICE.

FREE...SEND TODAY

RADOLEK CO., Dept. C132
601 W. Randolph St., Chicago 6, Ill.

Please send your Free Profit Guide Catalog and regular Supplements.

Name

Address

City Zone..... State.....

SAVE AT RADOLEK

**Radio's Newest
MULTI-PURPOSE INSTRUMENT
MEGACYCLE**

METER Model 59

The Model 59 consists of a grid-dip oscillator connected by a flexible cord to its power supply. The instrument is a variable frequency oscillator, an absorption wave-meter, an oscillating detector and a tuned circuit absorption detector.



Circular
on
Request

FREQUENCY:
2.2 Mc. to 400 Mc.; seven plug-in coils.
MODULATION:
CW or 120 cycles; or external.
DIMENSIONS:
Power Unit, 5 1/8" wide; 6 1/8" high; 7 1/2" deep.
Oscillator Unit, 3 3/4" diameter; 2" deep.
POWER SUPPLY:
110-120 volts, 50-60 cycles; 20 watts.

MEASUREMENTS CORPORATION
BOONTON NEW JERSEY

**Get a new
ELECTRIC SOLDERING IRON
FREE**
... and assemble your own
MAGI-KLIPS
Radio & Electronic, Experimenter's Kit



This is the same MAGI-KLIPS Kit—complete with all parts—that we sell ready assembled for \$29.75.

In knocked-down form with full instructions for assembly, it is now available at the new low price—

\$19.75

... complete with a new Electric Soldering Iron—the ideal iron for wiring your un-assembled MAGI-KLIPS Kit.

Remember, you build 18 different experiments with your MAGI-KLIPS Kit. You actually teach yourself radio and electronics and have a lot of fun at the same time.

RADIO RECEIVER, HOME BROADCASTER, PHOTO-ELECTRIC RELAY, CODE PRACTICE OSCILLATOR, SIGNAL TRACER, REMOTE CONTROL RELAY, Phonograph Transmitter, Intercommunication Amplifier, Code Transmitter, Radio Frequency Oscillator, Telephone Line Amplifier, Electronic Switch, Phonograph Amplifier, Temperature Control Relay, Contact Detector, Electronic Metronome, Interval Timer (one-shot), Interval Timer (repeating).

Send for your copy of FREE booklet, "Electronics Made Easy."

DEER & TAYLOR COMPANY

Dept. C 1342 Milvia St. Berkeley 9, Calif.

SIGNAL TRACER-SIGNAL GENERATOR

(Continued from page 23)

uses a tube-tester transformer to supply the filaments and the plate of the rectifier. The filaments of the tubes are connected in series and wired across the 70-volt tap of the transformer. Equivalent tubes with different filament voltage ratings may be used if they are wired in series and are connected to the proper tap on the transformer. All the tubes should have the same current rating. The tracer can be used for hours if a reliable, good-sized, tube-tester transformer is used.

A power supply of this type is an advantage since the chassis is isolated from the line, permitting connection between the tester and a.c.-d.c. equipment without regard to line polarity of either.

The tracer-oscillator can be used for other purposes such as a radio, phono amplifier, phono oscillator, and code oscillator. The first three uses are readily understood since these are applications of technique used in servicing with the unit. To practice code, connect a telegraph key and small mica condenser

between the a.f. input and a.f. output jacks. Tone and volume are controlled with the input gain control.

This versatile instrument can be constructed on almost any chassis that is handy. The author used an old 3 x 7 x 12-inch chassis, and the panel was made from a piece of 7 x 12-inch masonite.

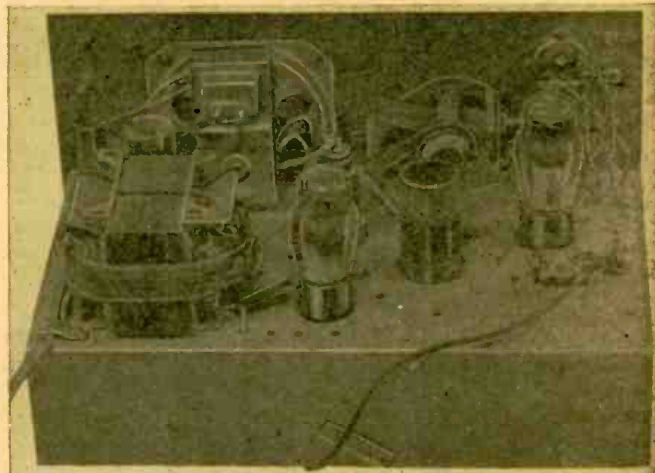
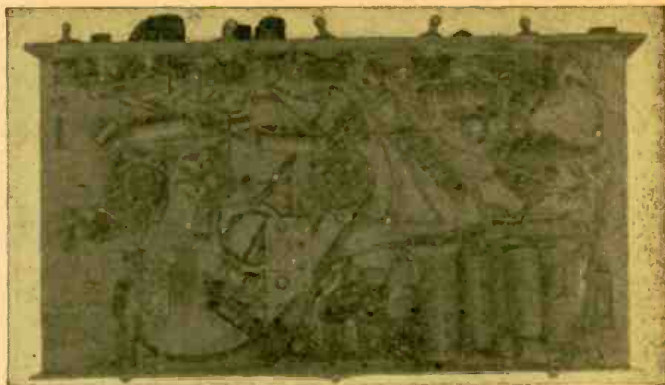

Under-chassis and rear views of the unified servicing instrument.

TELEVISION INTERFERENCE CLASSIFIED

Television interference has been classified according to channels by F. J. Bingley, chief television engineer of the Philco Corporation. He finds that certain types of interference are characteristic of one or more bands and give little or no trouble on others. Interference, as he finds it, is encountered as follows:

Channel 1 (44-50 mc) — Considerable diathermy interference; some F-2 and adjacent channel interference.

Channel 2 (54-60 mc)—Direct diathermy interference; diathermy and industrial heating harmonics; amateur harmonics, and some direct amateur interference; some interference due to insufficient image rejection from channel 5; some interference from FM.

Channel 3 (60-66 mc)—Some upper-adjacent channel interference from

channel 4; some off-channel diathermy interference.

Channel 4 (66-72 mc)—Some cases of sound from channel 3 interfering with channel 4 image; FM interference in old sets; occasional diathermy interference.

Channel 5 (76-82 mc)—Local oscillator interference from channel 2 in new sets, from channel 4 in prewar sets; occasional diathermy interference; some instances of interference from Navy radio operations noted in Washington, D. C., area.

Channel 6 (82-88 mc)—No experience.

Channels 7 through 11 (174-204 mc)—No experience.

Channels 12 and 13 (204-210, 210-216 mc)—FM harmonics; some interference from diathermy and industrial heating equipment.

MICROTUBES
(Continued from page 17)

headquarters by means of television becomes now a distinct possibility due to the microtube.

For the pocket radio set, which has been in the developmental stage for several years now, the microtube will also become the most important factor due mainly to the great saving of space that can be achieved even over the present-day miniature tubes, still far too big, as we have pointed out a number of times.

There may also come a complete revolution in our radio receiver techniques. Some years ago we used to manufacture a radio tube that had all the elements of three tubes contained in one glass envelope. This tube proved too expensive to manufacture and is no longer made. But with the new microtube, an entirely new possibility, which the writer advances now, seems economically sound and feasible.

Instead of using five separate tubes in a superheterodyne receiver, five separate microtubes could all be placed into one envelope much smaller than the present-day standard tube. The new tube unit would merely have extending from the base the usual tube prongs, and instead of having five tubes we would have only one. This new multiplex tube therefore would be five tubes in one.

It would save an enormous amount of space in every radio set and it still would be cheaper than separate tubes. The wiring would become much simpler, the connections shorter, the weight less, and the cost would be reduced.

Then, if one of the multiple microtube units fails, the entire multitube simply would be discarded and a new one plugged in. It would save the serviceman an enormous amount of servicing time if all radio sets would adopt such a multiple tube.

In this discussion we have merely scratched the surface of this new epoch-making development. In the next few years the microtube can be counted on to revolutionize many branches of radio and electronics, television not excepted.



Suggested by: Lyman Campbell, Vernal, Utah
"And now for some dinner music"

**ANOTHER
TOP VALUE OFFER**

Portable Kit Model B-4

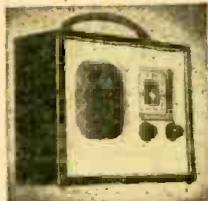

Introducing our new Kit Model B-4, a 4 tube portable receiver which operates on self-contained batteries. Approximate size: 8 x 6 3/4 x 4. Uses the following tubes: 1R5, 1U4, 1S5 and 3S4. Power switch is conveniently located on front of set. Alnico V permanent magnet dynamic speaker. Case covered with weather tested aircraft material. Price of kit complete with tubes **\$9.95**

Kit Model S-5



Model S-5 uses the universally accepted superheterodyne circuit containing the following tubes: 12SA7, 12SK7, 12SQ7, 50L6, 35Z5 and tubes from 550 Kc. to 1600 Kc. Price of kit less tubes **\$10.95**

All kits accompanied by a detailed, illustrated instruction sheet.

Many other kit models available. Write for catalog M.

RADIO KITS COMPANY

120 Cedar Street New York 6, N. Y.

Amsco Presents

1947 GREATEST VALUE SERVICE KIT

Kit includes assortment of:

- | | |
|---|--------------------------------|
| 100 Resistors, 1/2 and 1 watt. | 25 Connectors & Plugs. |
| 50 Condensers, paper, mica, electrolytic and can. | 10 Jacks (Phone) & Tip. |
| 100 ft. Spaghettil var. sizes. | 12 Padder Condensers. |
| 12 Knobs, round and bar. | 12 Terminal Boards. |
| 2 lbs. Hookup wire. | 25 Ceramic Insulators. |
| 20 Fuses. | 2 Panel Lights (1 neon) |
| 6 Volume Controls. | 1 Screw Driver. |
| 10 Tube Sockets | 1 Tube Puller. |
| 1 lb. Hardware (screws, nuts, lugs, etc.) | 2 Allen Wrenches. |
| 12 ww resistors, 10 watt. | 2 Panel Fuse Holders. |
| 10 Switches, toggle, gang, and rotary. | 4 Binding Post Strips. |
| | and many other valuable items. |

Your Cost **\$9.95** Complete

FREE "Experimenter's Kit" "1 Pr. Headphones" or "1 tip mike" with first 500 orders.

WRITE FOR OUR LATEST CIRCULAR FEATURING LOWEST PRICES ON RADIO & ELECTRONIC PARTS & EQUIPMENT.

AMERICAN SALES CO.

1811 W. 47th St. Chicago 9, Ill.

See CANNON-BALL HEARING AID for Radio Reception



Easily attached to any Radio for private reception with or without loud speaker. Write

C. F. CANNON CO.
SPRINGWATER, N. Y.

Headset Headquarters

**SAVE MONEY
EXPEDITE
REPAIRS!**



UNIVERSAL REPLACEMENT COILS
(Adjustable Iron Core)

ANTENNA • RF • OSCILLATOR
The EAGLE Universal coils, by the turn of a screw, can be adjusted to the exact inductance of the coil to be replaced. The coils will track accurately with other coils in the receiver without additional padding, etc.

ONLY 75c EACH!

If your local distributor is out of stock, send your order to us, enclosing payment and his name and address. Merchandise will be shipped POSTPAID anywhere in the U.S.A. SEND FOR FREE COMPLETE COIL CATALOG

EAGLE ELECTRONICS, INC.
IRVINGTON, NEW YORK

Free Radionic Catalog



Radionic Equipment Co., Dept. 111
170 Nassau Street
New York 7, N. Y.

Please send me a FREE copy of your 1947 Catalog. I understand it has thousands of items illustrated, described and priced and will be a great help to me in my search for "hard-to-find" radio equipment, CHANCELLOR Portable and Phono Radios.

Name

Address

City State

MAIL TODAY

BA BARGAIN SPECIALS

The FINEST in HEADPHONES



Type P23. The Choice of the Air Corps headphones, highly sensitive, 8000 ohm impedance, bipolar magnets. Extremely comfortable sponge rubber ear cushions—stainless steel leather covered headband—concealed terminals—Six Foot Cord with PL55 plug. EVERY ONE BRAND NEW in Original Factory Cartons.

Stock No. 5A134 \$13.50. value. **\$2.95**
An Outstanding Buy, Only.....



12 1/2 Ft. ANTENNA TELESCOPES DOWN to 1 Foot 4"

"Just it" for mobile equipment, portable receivers and transmitters. Ruggedly constructed—smooth telescopic action from 16 inches to 12 1/2 feet. Base is 7/8" in dia. with 3/8" threaded shank. By adding eyelets it makes an ideal compact fish pole. An Outstanding Value **\$1.95**
No. 38A39, Only.....

ORDER NOW, from this ad Add Postage

BURSTEIN-APPLEBEE Company
1012-14 MCGEE STREET,
KANSAS CITY 6, MISSOURI

"TIK" for KITS

Servicemen • Amateurs • Jobbers

Look at these values

Mica Condensers, Assorted	100 for	\$3.49
Allen Bradley, etc., Volume Controls	50 ohm, to 1 meg	\$2.59
Carbon Resistors, Color Coded.		\$2.50
1/2, 1 & 2 Watt	100 for	\$2.98
Wire Wound Resistors, Ward Leonard, etc.	5 to 75 Watt	\$1.89
Fuses, Buss & Littelfuse	100 for	\$2.49
Assorted Oil filled condensers, tubular and bath tube type, 400 V, 600 V, 1000 Volts	12 for	\$3.98
Octal and 4 prong Ceramic Sockets (without rings)	100 for	\$3.59
Condensers .05 mfd, 2,000 volt to .25 mfd 3,000 WVDC		\$2.98
Precision Wire Wound Resistors, Shallcross, Mepco, etc., 1/4, 1/2 and 1 Watt	15 for	

SPECIAL COMBO KIT

OUR INTRODUCTORY OFFER
Excellent Assortment

Big Value
Tremendous Savings

This kit includes a quantity of items listed in the above kits, PLUS many others. It's our New Customer Special.

\$10.98

Minimum order \$2.00
25% deposit required on all C.O.D. orders.
Add Postage Write Dept. RCN

"TIK" 55 WALKER ST.,
NEW YORK 13, N. Y.
phone CAnal 6-7485

ROTA-BASE

NEW HANDY LAB. DIAL actually gives a "seeing" picture of radio tube connections. INSTANTLY, ACCURATELY. No more valuable time lost thumbing pages or on lengthy readings. Filament, grid, plate, cathode, etc., to more than 300 tube types are shown. NOW ONLY \$1.00 postpaid, or sent C.O.D. plus postage. Order TODAY, money refunded if you are not delightfully pleased.

REED MFG. CO.

11350X Burbank Blvd. N. Hollywood, Calif.

Repairmen—or Wreckers?

It might be advantageous to the radio serviceman to hear what his competitor tells a customer about a previous repair job done on a radio. Too little is said about the under-chassis appearance of a radio set after it has been repaired two or three times. There are a lot of servicemen. Some of them have been hard at it for 20 years or more. If they have been at it that long, they are good men. No screw-driver mechanic can survive in this business that long. They have a good reputation, and sooner or later the customers are going to take their word as law in the radio business.

The great majority of radiomen follow the line of least resistance when radios come in for repair. Their work might be summed up as follows:

How not to service

A set comes in for reconditioning. It is an a.c.-d.c. type, has a bad 40/20- μ f, 150-v condenser, a noisy volume control, a leaky coupling condenser between the 12SQ7 and 50L6-GT. The quickest way out of the radio business is just to follow this procedure: Do not bother to remove the old 40/20 condenser; just pile in any 20- and 50- μ f separate condensers that might be in stock. Any place in the radio will do. Add 6 inches more wire to them if necessary. It is O.K. if the leads hang down out of the chassis—the cabinet will keep them up anyway after the radio is installed.

Apply the soldering iron intentionally or accidentally to other parts around soldered joints, especially condensers and resistor ends. The owner then can readily see that some work was done for the money. If the volume control will play at near full volume, just pass it as it is. But if it is so bad that it can't be set even in the high position, replace it. Just take a pair of cutters and cut the lugs off the old control and switch,

then solder the entire mess on the new control with all possible solder for a good plaster.

Pile condensers over tube sockets, two or three high, the more the better. If a condenser is replaced, especially the paper tubular type, just cut the leads off at the tube sockets; don't bother to clean off the socket terminals. Just hold the new condenser in place and plaster. The object is to get out of the radio business with least possible effort.

If an i.f. transformer is suspected, just check the plate terminals for voltage. If you find the resistance of the 2 primaries to be 8 and 30 ohms, the secondaries 7 and 10, there may be a couple of strands broken in the winding which indicates 30 ohms. Perhaps two strands are holding. One is anyway. So forget the whole matter. Should a primary be burned out, that calls for real ingenuity. Just be sure the new transformer has the same frequency as the one removed; don't bother to get one wound with litz wire just because the old one was so wound. A 39c special will pass plate current just as well as a litz-wire iron-core type. If the old transformer was a large type, and one in stock is one-third the size, just mount it alongside the remaining large unit. You can say they are making them better at half the size. Don't bother to drill holes to mount. One hole will always fit, so fasten it securely with one nut and let the other lug take care of itself.

Let the gang condenser stay corroded, the dial glass and dial dirty. Cleaning dial glasses is a job for a housemaid. Besides denatured alcohol and a brush cost money.

Good servicing

In all seriousness, parts can be installed in a radio to duplicate the clean factory appearance of the original



The well-fitted-up and efficient service shop of L. B. Worden and Co., Utica, New York.

equipment. Leads and wires can be properly placed, parts removed can have wires unsoldered and untied instead of leaving the cut ends on the terminals. Exact duplicate parts are rarely available, in fact it is not advisable to try to carry them in stock, except where a standard part will not fit, or perform its duty. But if a radio uses a large aluminum can condenser, do not replace it with a cartridge type; it looks and is cheap. Avoid questionable parts. The finest may cost a little more, but will not need replacing by the time the radio has some other part out at a later date. Inferior parts will cause pyramiding of costs on succeeding jobs, and dissatisfaction will very certainly result sooner or later.

Install mounting strips where needed. Do not leave connections suspended in midair; all tubular condensers should be tied down at each end, likewise all resistors. Knurled volume control shafts are made to split at the knob end. Fill all holes with solder where wires tie into terminals, but don't allow it to run down and form a lump. Tube types should not be changed in a radio unless the new tube type will equal the old in performance and life, or the old type has been discontinued. Then be careful to make the job so neat that the next repairman will know that it was done by an expert and will not question the accuracy. The very cleanest and smoothest soldering is none too good here. Never unsolder parts to test them if there is any possible way to do so otherwise. Most parts show it, even if they are removed at one end.

It will require more time to do jobs this professional way than just to throw the parts into the set. At first it may be that no higher rate of charge can be made. But eventually this kind of service will enable the serviceman to get a better grade of business, and a higher return for his repair work. Attending to little details will work wonders in the long run.

Most repairmen do just what they have to, skip dials that slip a little, speakers that rattle a little, dump parts into a radio so that there are 18 or 20 electrolytic condensers in a set where 4 or less might be in use. An alarming number of radiomen neglect troubles that should be remedied. Such methods will make the public suspicious of us all.—Gerald Evans.

500 FORMULAS TO SUCCESS

MANY million dollar firms started with a single formula, for which they paid a big price. Here you have 500—no less—tried and tested formulas, recipes and processes for making things... all at the ridiculously low price of 25c. Here is your opportunity to start a business with but a few dollars' capital and with undreamed of profits in prospect. You can also use these formulas in your own home to cut household expenses to the bone. Or you can put them to use in your workshop to cut costs as much as 1000%.



Quit paying out many dollars in profits to manufacturers, wholesalers, and dealers, when you can make the same thing yourself for a few cents. It's so easy when you follow our simple instructions.

66 PAGES, 3200 WORDS IN TEXT
Send for "500 FORMULAS AND RECIPES" today. Enclose 25c, that's all! You won't be asked for another cent now or later. Sold on a money-back guarantee.

NATIONAL PLANS COMPANY
P. O. BOX 26 R, STATION N, New York 23, N. Y.

Radio Thirty-Five Years Ago

In Gernsback Publications

HUGO GERNSBACK Founder	
Modern Electrics	1908
Electrical Experimenter	1913
Radio News	1919
Science & Invention	1920
Radio-Craft	1929
Short-Wave Craft	1930
Wireless Association of America	1908

Some of the larger libraries in the country still have copies of **ELECTRICAL EXPERIMENTER** on file for interested readers.

- From November, 1913, **ELECTRICAL EXPERIMENTER**
- An Experimental Radiophone Arc Set, by *H. Winfield Secor*
 - Coherer Receiving Sets by *Henry Scott*
 - New French Wireless Apparatus by *H. Gernsback*
 - Music Via Wireless
 - How to Make an Interference Preventer
 - A Compact Radio Test Buzzer
 - Wireless Telegraph Apparatus
 - Cryptogram Wireless
 - Amateur Wireless Phone System
 - Radio Receiving Set for Time Signals
 - 5 K. W. Wireless Set

There's a new kind of TAPE RECORDER

a-coming!
—and A. C. Shaney
is "a-fixin' to build it"
at Amplifier Corp. of America

Technicians want a better kind of magnetic recorder... and they are going to get it! For there is a recorder in the making at the Amplifier Corp. of America today, that promises to revolutionize the industry's thinking about magnetic recording of the future. It is cleverly designed, beautifully constructed and most amazing in its performance. Its fundamental design is one of the truly exciting secrets of our time. A new approach, new circuits, new materials, and new processes combine in this recorder to achieve a triumph of modern engineering. It may not be the first magnetic recorder off the line, but it may well be the first completely new one. And recording men know that A. C. Shaney and his associates at Amplifier Corp. of America have what it takes to build the kind of a magnetic recorder that engineers, technicians and music lovers are waiting for.

That's why so many thousands today are "watching the news" from

Magnephone Division
AMPLIFIER CORP.
of **AMERICA**

398 Broadway, New York 13, N. Y.
A postal card will put you on our mailing list to be among the first to know.

Radio technicians of Rochester, N. Y., are holding a 2-day meeting November 15 and 16, to which all radio maintenance men of New York and New England are invited. Meeting is sponsored by the Rochester Radio Technicians' Guild.

Ruf-Koat Dial Belt Kit Alignment Kit Lite-Koat Kit

**G-C NO. 5025
PROFESSIONAL
ALIGNMENT KIT**

Complete alignment and neutralizing kit in steel box. Has every tool to service any set. 30 tools.
List \$19.95

G-C RUF-KOAT

Only wrinkle finish that will air dry, no baking required. Ready to use, gives professional wrinkle finish.
No. 60-2—1/4 pt. ... List 45c

**G-C LITE-KOAT
KIT**

"Glow in the dark." Luminous safe coating—emits light in dark. For office, home, etc. No. 184-0 Deluxe Kit. List \$2.50

**G-C SERVICEMEN'S
DIAL BELT KITS**

Easy to install. The best belts for all sets. Supplied in kits of assorted popular belts with steel box. No. G-25—kit of 25 belts List \$6.70

Sold by all jobbers

WRITE FOR OUR CATALOG TODAY!

RADIO DIVISION DEPT. D

GENERALCEMENT Mfg. Co., Rockford, Ill., U.S.A.
Manufacturers of over 3,000 products
Sales offices in principal cities

NOVEMBER SPECIALS

FM. COND., 6-COILS and INSTRUCTIONS ..	\$4.95
TELEVISION or FM ANTENNAS, list price \$14.50	7.25
VIEWTONE TELEVISION POWER TRANSFORMER	10.75
TELEVISION or FM LEAD-IN WIRE, 300 ohms (per 100 ft.)	2.25
COAXIAL CABLE, RG59U, 72 ohms (per 100 ft.)	6.90
Radio Kit—build your own six-tube super. Complete with cabinet (less wire)	11.95
WEBSTER RECORD CHANGER, Model No. 56	33.50
WEBSTER RECORD CHANGER, Model No. 50	22.75
DETROLA RECORD CHANGER	13.50
ELECTRIC PORTABLE PHONO., lists for 24.50	12.95
INTERCOMM. SYSTEM, master and station ..	17.97
PHONOGRAPH AMPLIFIER, including 3 TUBES	3.70
BROOKS INVERTER, 50 Watts, 110 Volts ..	8.95
SUPERIOR VOLT-OHM MILLIAMMETER, Model No. 670	28.40
SOLDERING IRON, 100 Watts	1.90
SOLDER (1 pound)55
ELECTRIC PHONO. MOTOR, with 9" Turntable	2.95
CRYSTAL PICK-UP ARM	1.75
AUTO VIBRATOR, standard for 700 Radios ..	1.19
PM SPEAKER, 4", Alnico No. 5 Magnet95
PM SPEAKER, 5", Alnico No. 5 Magnet	1.22
DYNAMIC SPEAKER 5", 450 ohms, including Out. Trans.	1.95
VOLUME CONTROLS, 1/2 or 1 Meg. with switches39
OUTPUT TRANSFORMER, match 5DL639
RESISTANCE CORDS, 135, 180, 220, 290, 390 ohms49
I.F. COIL, 456KC49
OSCILLATOR COIL, 456KC19
SELENIUM RECTIFIER, 100 or 150 mil.95
VARIABLE CONDENSER, 2-Gang, 420/162 ..	.68
RADIO CHASSIS, punched for 6 or less tubes	.29
LINE CORDS, approved 6 FT. 18 gauge14
TOGGLE SWITCH, SPST, 5/16" or 7/16"15
TOGGLE SWITCH, DPST, 5/16" or 7/16"25
TOGGLE SWITCH, DPDT, 5/16" or 7/16"40
LOOP ANTENNAS, assorted sizes, oval shape	.29
RESISTORS (100 assorted)	1.50
KNOBES (100 assorted)	4.50
SOCKETS (100 assorted)	5.00
PILOT LIGHTS (100 assorted)	4.50

Special Notice!
All TUBES and CONDENSERS, same price as advertised in the September issue of RADIO-CRAFT

BROOKS RADIO DIST. CORP.
DEPT. A
80 VESEY ST., NEW YORK 7, N. Y.

2 Fall LEOTONE Specials

CRYSTAL MICROPHONE UNIT. Famous make sensitive diaphragm crystal unit. Small size (1 3/4" O.D., 1/4" deep) ideal for LABEL or CONTACT mike or PILLOW SPEAKER. Rubber shock mid. metal frame. Less housing .69



PRECISION RESISTORS. -1%, wire-wound. Standard makes. Ohmages: 2.35, 11, 24.5, 100, 130, 405, 840, 1740, 2500, 3300, 5290, 7800, 30K, 96.5K, 50K, 2500K--36 ea.; 3 for 1.00

TUBES: Perfect condition, but not in sealed cartons. Most types stocked up to 80% off list. Every tube guaranteed 90 days.
Nos. 20, 26, 27, 46 or 5629
Nos. 42, 45, 75, 76, 77, 78, 80, 89, 535, 68G or 6K739
Nos. 35, 36, 37, 38, 84, 5Y4, 6AB, 6C5, 6DB, 6F8, 6J7, 6N7, 6U7, 6SA7, 6SK7, 12BA7 or 12SK749
Nos. 1A7, 1H5, 1N5, 1R5, 6AB, 6AU, 6X5, 7A7, 7C5, 7G6, 7Y4 or 5059
TUBE CARTONS: Plain white. GT size (1 1/2" sq. x 3 1/2") Per 1001.25
Medium size (1 1/2" sq. x 4 3/8") Per 1001.49
Large size (2" sq. x 5") Per 1001.79
NIDGET AUDIO TRANSFORMER (1" x 1 1/2" x 2") Excellent interstage or audio osc.49

ALNICO MAGNETS

Powerful ALNICO MAGNETS of every size and shape always in stock. Write for latest fully descriptive illustrated supplement.

EXPERIMENTAL TUBES. 20 asstd. receiving types for testing, research, etc. Filament tested 1.00
LEATHER CARRYING CASES. Brand new (from Weston No. 689 meter). Eby black cowhide, velvet lined. Perfect for meters, camera, binoculars, etc. Snap lock and key; 24" carrying strap. 6 3/4" x 3 1/2"1.49



UTC "COURIER" INPUT TRANSFORMERS (7/8" x 1 3/16"). Dynamic mike or low impedance pick-up to grid5.00
12 for49
3" MAGNETIC SPEAKER for Majestic portables or general replacement2.25
VARIABLE CONDENSERS. 120 pfd. 2" Kang. Half-bearing shaft, O.D. 3/4" x 3/4"75
RADIO HARDWARE TREASURE. An assortment of approx. 1000 screws, nuts, washers, etc.49

SPECIAL!! - GIANT "GRAB-BAG" RADIO PARTS KIT. A real buy in new and dismantled radio and electrical parts for the Serviceman, Amateur and Experimenter. 120 POUND S of resistors, condensers, sockets, transformers, wire, speaker accessories, hardware, etc. An amazing value at **1.95**

4 TUBE SERVO AMPLIFIER (2-7C5, 7F7, 7Y4) 110V, 400 cycle (see July, '47 Radio-Craft for conversion to Phono & Mike Amplifier). Black bakelite finish, slide-in chassis, 8 3/4" x 4 1/2" x 3 3/4". Less tubes1.49
CO-AXIAL CABLE CONNECTOR PL-259 (83-18P). With coupling ring. Cable to O.D.1.23
RCA Victor Power Transformer for models R-37, 45, 52 or 75. Unshielded5.95
6.3V. FILAMENT TRANSFORMER. Rated 2 amps. Heavy 500 leads. 2 3/4" x 2 1/2"75

HANDY KITS FOR SERVICEMEN

- #1-R.F., ANTENNA & OSC. coils. 10 asstd.98
- #2-SPEAKER CONES: 15 asstd. to 1 1/2" diameter & free horn (magnets incl) Less voice coils2.00
- #3-MOULDED BAKELITE CONDENSERS: 50 asstd. .0001 to 2mf. 200-600 WV. 2.95
- #4-TUBULAR BY-PASS CONDENSERS: 50 asstd. .001 to .25mf. 200-600 WV. 2.49
- #5-KNOBS: 25 asstd. setscrew, spring & push button. Wood & bakelite98
- #6-WAFER SOCKETS: 12 asstd. 4 to 7 prong25
- #7-VOLTAGE DIVIDERS: 10 asstd. multi-tapped. High wattages included1.98
- #8-SHIELD CANS: 15 asstd. for coils, tubes, transformers, etc.98
- #9-MICA PADDERS & TRIMMERS: 15 asstd. incl. multiple & ceramic base69
- #10-VOLUME & TONE CONTROLS: 10 asstd. wire-wound & carbon. Less switches1.49
- #11-WIRE-WOUND RESISTORS: 15 asstd. ohmages, 5 to 20 watts98
- #12-DIAL WINDOWS: 12 asstd. flat & moulded acetate & convex glass1.29
- #13-BAKELITE COIL FORMS: 18 asstd. Popular sizes up to 3" diameter98
- #14-HIGH RESISTANCE UNITS: 15 asstd. carbon & wire. Ferrule end. 25K to 5 mcg.49
- #15-SPEAKER REPAIR KIT: A real money & time saver. Contains: 25 asstd. paper rings, 10 spiders, 25 voice coil forms, 3 yds. 1/2" strips, 20 chamois leather segments, kit of 10 shims & tube of speaker cement2.49
- #16-METAL CASED BY-PASS CONDENSERS: 10 asstd. paper wound, multi-section. 200-600 WV.49
- #17-RESISTOR ASSORTMENT: 20 asstd. carbon & wire-wound. 1/3 to 5 watts49
- #18-RADIO CEMENT & SOLVENT: 3 oz. each of all purpose cement & thinner, with brush69
- #19-SHAFT EXTENDERS, REDUCERS, COUPLINGS: 10 asstd. most popular types for servicing1.29
- #20-SPRING ASSORTMENT: 60 asstd. & tension for dials, switches, etc.98
- #21-SPEAKER CONE RINGS: 50 asstd. cardboard mtg. rings. 3" to 1 1/2"1.49

PROMPT SERVICE ON ALL SPEAKER & PHONO PICK-UP REPAIRS. DEPT. RC-11
MINIMUM ORDER \$2.0020% DEPOSIT REQUIRED ON ALL ORDERS PLEASE ADD SUFFICIENT POSTAGE

LEOTONE RADIO CO.
MAKERS OF CONES AND FIELD COILS
65-67 DEY STREET, NEW YORK 7, N.Y.
WORTH 2-0284-5
12,000 SQ. FT. OF RADIO PARTS

Communications

A SUCCESSFUL EXPLORER OF THE WAVES

Dear Editor:

Just a line to let you know I like your magazine. Herewith a photo of the *All-Wave Explorer* which I built recently. I tried to dress it up a little—successfully, I hope. This is only one of a number of things I have constructed from circuits printed in your magazine.

I would like to correspond through RADIO-CRAFT with readers in England and Australia. Am an electrical engineer by profession.

HAROLD DAVIS
Indianapolis, Ind.



Right—The Explorer. The rod projecting out of the picture is the antenna, 18 inches long.

MORE ON CRYSTRONS AND CONTRA-POLARITY

Dear Editor:

I am deeply appreciative of the "assistance" rendered me in my experiments with the CRYSTRON tubes. See COMMUNICATIONS, August, 1947. Without that help so generously proffered, I believe there might have been even more trouble encountered than there was.

Since wearing the pajamas made of the material that counteracts the contra-polar frequencies set up within me (from the radioactivated cells scattered so profusely on those portions of my body cephalicwise from my head), we have found that I can sleep almost shut off (although a faint glimmer still flickers around my eyeballs). This sleep lasts for about 30 minutes—no more.

A few days ago we completed an experimental rig that permits me to sleep almost 2 hours before it is necessary

to bleed off the radioactive charge that builds up on my skin directly under the C-P (contra-polar) pajamas. When this concentration of energy reaches a point we call R9, it is immediately necessary to spray my entire person with a mixture of powdered metallic cadmium dust and redistilled heavy water, at the same time switching on the contra-polar sublimating unit (a complex system of Gamma-, Beta-, and Kappa-ray squelching circuits, marked with an X in the photograph). This unit has the same effect on these radioactive rays that a phosphor has on an X-ray; it lowers its frequency so that it becomes benign.

In the photograph you will notice a flexible pipe, marked P1. This is the bleeder pipe that removes these discouraged rays into the condenser. You may notice the co-axial cable entwined

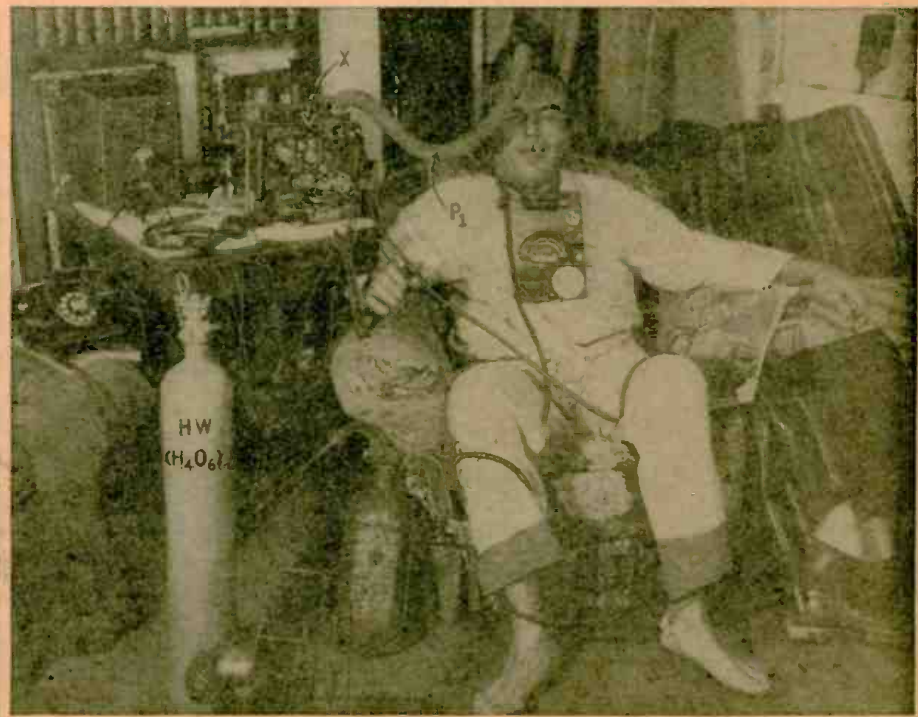

Authentic photograph of Mr. Thomas and the equipment described in the accompanying letter.

around my legs and torso. This is an auxiliary bleeder that takes over those stray rays that drip down over my body during the discharge process. As you may notice in the photograph (which was taken in the dark with an F2 stop in a Hypex Serolian MagnaKam [Mark LLL] picked up in Jugoslavia in 1944) the emission from my eyes is much greater than that from the rest of my body surface or other objects within range of the radiation.

This is a sort of safety valve, for whenever this degree of radiation is reached the object at which I happen to be looking disintegrates slowly, falling away into a kind of bluish powder. Naturally, when this occurs, I realize that the danger or *fissioning flux point* has arrived, and I immediately reach out and turn the release valve on the cylinder of redistilled heavy water (marked H.W.) which instantaneously slows down the neutronic and deuteronic bombardment to a point of comparative safety again. This is known as the *Sturn und Drangzeit Bitte*.

As you have probably realized by now, all this has gone through hundreds of cycles during our initial manufacture of your wonderful CRYSTRON tube, and we have again reached a dangerously low level in our "Heavy Wasser" tanks. Can you please forward to us, at once, a listing of those firms that carry large stocks of H₂O₂ on hand? We think that type is a little heavier than H₂O that we have had to use to date.

Any other hints will be gladly accepted in the spirit in which they are offered. Please feel free to advise us.

BRUCE L. THOMAS,
Ocean Springs, Miss.

MAJOR HALLOWS REPLIES

Dear Editor:

To put it mildly, Mr. Turner is talking through his hat!

The official figure for television receiving licenses in England is 18,317 as of May 31, 1947. As this includes jobbers, dealers, and experimenters, as well as manufacturers, I should put the number of private owners at not more than 16,000.

The prices Turner quotes are much below those now prevailing.

I don't think that many servicemen would agree with his belief that the servicing of television receivers is child's play! You'd need a good deal of experience and have to know just what to look for to be successful with only a volt-ohm-milliammeter.

Finally, he must have a pretty tough hide if he can laugh off the shocks you can get from the high-voltage supply of a television receiver.

RALPH W. HALLOWS,
Berkhamssted, Herts, England.

(The above is an answer to a letter by John W. Turner of London, England, which appeared last month. He stated that more than 50,000 television licenses are granted in England. As Major Hallows' figures are closely in accord with other British official statements and BBC estimates, it is apparent that Mr. Turner was mistaken.—Editor)

METROPOLITAN

is the largest specialized testing instrument house in the country. We carry approximately 5,000 testing instruments, in stock, of all nationally advertised brands. The items listed below are only a few selected models offered at specially attractive prices in order to meet the present day demand for good merchandise, at fair prices. All units factory guaranteed for one year and available for immediate delivery from stock.

The New
Model B-45

BATTERY
OPERATED

SIGNAL
GENERATOR

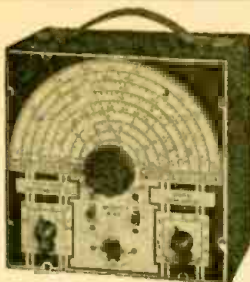

for servicing AM, FM and Television Receivers. R.F. frequencies from 150 Kilocycles to 50 Megacycles (150 Kc. to 12.5 Mc. on Fundamentals and from 14 Mc. to 50 Mc. on Harmonics). Complete with shielded test lead, self-contained batteries and instructions. **\$27.75** NET

The Model 689-IF
WESTON OHMMETER

A convenient, pocket size ohmmeter for checking circuits by the resistance and continuity method. The energy for the resistance reading is supplied by a self-contained 1.5 volt No. 2 standard large flashlight cell. Built to meet U.S. Army Requirements for Accuracy and Durability! This Ohmmeter also has a double range 0-10 and 0-1000 ohms for the accurate measurement of low resistance values.



Model 689-IF comes complete with operating instruction, test leads and LEATHER CARRYING CASE.

List price \$25.50 **\$14.85**

Our Price



The New Model 111
AC-DC QUALITY MULTITESTER



A new pocket-size volt-ohm-milliammeter with features never before available in an instrument of this size and price.

D.C. Voltmeter: 0-5-50-250-500-2500 volts. A.C. Voltmeter: 0-10-100-500-1000 volts. Output Voltmeter: 0-10-100-500-1000 volts. D.C. Milliammeter: 0-1-10-100 milliamperes. D.C. Amperes: 0-1-10 amperes. Ohmmeter: 0-500-100,000 ohms; 0-1 megohm. Decibel Meter: -8

to +55 db. The scale is calibrated for line of 500 ohms impedance. For other impedances correction charts are supplied. Model 111P, in portable case (not illustrated) including testing leads and complete instructions \$19.85 Model 111A, open face, as shown, complete with instructions \$16.85

The New Universal
COMBINATION TEST SPEAKER



A new combination test speaker plus resistor substitutor plus condenser substitutor plus resistor tester plus condenser tester plus output meter

A MUST FOR EVERY RADIO
SERVICE MAN AND ENGINEER

No need to carry the speaker to your shop in servicing any radio from the small midget to the most elaborate console. Any output tube or tubes can be matched simply by rotating input switch to listed tube and rotate field switch for proper impedance and proceed with testing. External voice coil connection permits testing of set-speaker to determine if output transformer is open or shorted. Field impedance: 500, 1000, 1500 and 2500 ohms at 175 Ma.

This unit comes housed in a rugged, battle-ship-gray, crackle-finished steel cabinet, complete with operating instructions, size 7"x11"x5", operates on 110 V. AC, 60 cyc.

\$27.50 NET

Model 570
PREMIER

Band Spread Dial

SIGNAL
GENERATOR



AIR TRIMMERS ON ALL BANDS
TRIPLE COPPER PLATED SHIELDING
EFFECTIVE LINE FILTER—pure 400
cycle modulation
(less than 5% distortion)

Range 75KC-50MC on fundamental, and 50-150MC on 3rd harmonic, useful for aligning FM and Television Receivers.

Accuracy better than 1%.
A.C.—115 volts, 50-60 cycles.
Overall size—12"x12½"x5½".

Complete with co-axial cable and operating instructions.

\$54.75 NET

ORDERS FILLED SAME DAY RECEIVED!

TERMS: 20% Deposit, Balance C.O.D. Or Full Payment with Order.

SEND FOR FREE CATALOG

We repair all types of testing instruments. Write for information.

Metropolitan ELECTRONIC & INSTRUMENT CO.

DEPT. C-11, 42 WARREN STREET
NEW YORK 7, N. Y., U. S. A.

BOOK REVIEWS

RADIO, HOW, WHEN, AND WHY TO USE IT, by Beatrice K. Tolleris. Published by the National Publicity Council. Paper covers, 8 x 10 inches, 48 pages. Price \$1.00.

A booklet written for the benefit of organizations who work in health, welfare, education, or other social service fields, this book points out the benefits and pitfalls of radio as a means of publicity. Suggestions are made on assessing the medium, selecting the type of presentation most adapted to the purpose and means of a given organization, taking advantage of existing opportunities, and working in co-operation with other organizations and individuals.

INTRODUCTION TO ELECTRON OPTICS—The Production, Propagation and Focusing of Electron Beams. By V. E. Cosslett. Published by the Oxford University Press. Stiff cloth covers, 6 x 9½ inches, 272 pages. Price \$6.50.

This book is the result of a series of lectures on electron optics given at Oxford University to undergraduates in their last year. In spite of this, mathematics has been used very moderately, and the subject is so presented that even the layman will find it readable and interesting.

Treatment is orthodox. Fundamental theory, fields, focusing by electrostatic and electromagnetic methods, and image aberrations are dealt with in turn. Then follow chapters on electron beams, the cathode-ray tube, and the electron microscope.

The last two chapters are of special interest, as they deal with applications of electron optics in transmitting and special tubes, discussing the magnetron, cyclotron, betatron, and mass spectrograph. The subject of velocity-modulated tubes receives a full chapter.

ELECTRICITY—PRINCIPLES, PRACTICE, EXPERIMENTS, by Charles S. Siskind. Published by McGraw-Hill Book Co. Stiff cloth covers, 5¼ by 8½ inches, 448 pages. Illustrated. Price \$2.60.

The author, who is assistant professor of electrical engineering at Purdue University, has written a practical and refreshing treatise on electrical principles, with many useful electrical problems and their solutions. The student can learn from this book something about practical problems of transformers, motors, and dynamos.

Direct-current circuits are discussed first; then the author takes up alternating-current circuits and some related

problems most apt to puzzle the student. Graphs are included, where necessary, along with diagrams of the circuit and the necessary mathematics. The effect of introducing inductance into a.c. circuits is very interestingly presented, with practical examples. A section deals with a.c. measurements.

Transformers are explained with special diagrams and pictures of the various types of cores and windings, so that the magnetic and electrical action can be readily grasped. Direct- and alternating-current generators receive excellent treatment.

The author gives a set of quiz questions and problems at the end of each chapter. A list of "visual aids" is included, with data on their source and the width of the film in each case. A thorough index of the subjects covered in the book is included.—H.W.S.

CONCISE CHEMICAL AND TECHNICAL DICTIONARY. Edited by H. Bennett. Published by Chemical Publishing Co. Stiff cloth covers, 6½ x 9½ inches, 1055 pages. Price \$10.00.

This large book contains 50,000 definitions, covering the fields of chemistry, metallurgy, pharmacy, plastics, mineralogy, electricity, and engineering, according to the slip cover. Radio terms are covered only incidentally, chiefly as they relate to other branches of science. Thus we have *betatron*, but not *radiotron*. *Oscillator* is not defined, but *oscillating crystal X-ray method* is. Coverage of chemical terms is very complete. Cross references appear to be exhaustive, and definitions range all the way to common-language terms like *paint*. Trade names of chemical compounds, especially in the pharmaceutical field, are included.

SCIENCE YEAR BOOK OF 1947. Edited by and with an introduction by J. D. Radcliff. Published by Doubleday & Co. Stiff cloth covers, 5½ x 8 inches, 247 pages. Price \$2.50.

Three of the articles in this year's book refer to radio: "Proximity Fuze," "Microwaves on the Way," and "Radio Navigation." Radio and electronics are not deemed important enough to have a section, the first two articles appearing under the head *Chemistry and Physics*, and the third under *Aviation*.

Other articles interesting to the radio-man are the three on atomic applications, and perhaps "Extra-Sensory Perception," which after all is a form of wireless communication!

LOOK AT THESE TUBE SPECIALS!

Why Pay More?

70% From the List Prices

Type	List	Your Cost Each	Type	List	Your Cost Each
3Q4	\$1.80	54c	6X5GT	\$1.35	41c
3S4	1.80	54c	5T4	3.20	96c
6C4	1.50	45c	6SK7	1.50	45c
6C8G	2.65	79c	25Z6GT	1.35	41c
6F8G	2.65	79c	12A6GT	2.65	79c
6SN7GT	2.20	66c	12K8	2.20	66c
6AG5	2.65	79c	46	2.20	66c
6AC7	2.65	79c	47	2.20	66c
6J6	2.65	79c	80	1.05	32c

POWER TUBE SPECIALS

Type	Your Cost Each	Type	Your Cost Each
RCA 2D21	75c	RCA 9003	85c
W.E. 275A	95c	G.E. 884	75c
Amperex 221A	1.50	Sylvania 809	1.50
Raytheon RK-60	49c	N.U. 829B	4.95
Eimac 100-TH	5.95	RCA 954	75c
RCA 2AP1	2.25	RCA 955	75c
G.E. 3AP1	3.00	G.E. 6AK5	80c
G.E. 5CP1	2.50	RCA 8014A	2.95
RCA 9001	75c	VR105 or VR150	90c

10% Cash with Orders Covers the Globe



Phone LO 3-9225

509 ARCH STREET PHILADELPHIA, PENN.



JUST OUT—the only comprehensive book for the beginner!

You need no other to get a license and get on the air. Ideal for those just getting interested or started in amateur radio. Complete! How-to-build simple equipment for a complete station on all newcomer bands. Operating instructions. Simple theory. Many study questions, including those to help pass license exams. U.S.A. regulations. Written by those masters of making-it-plain, the editors of the "Radio Handbook and the Prewar "Radio."

\$1.00 at your dealer, or \$1.10 postpaid from
EDITORS AND ENGINEERS, Ltd.
 1305 Kenwood Rd. Santa Barbara, Calif.

The New RADIO RULE

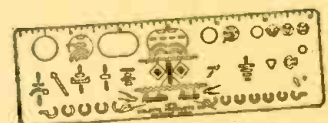

This sensational new Radio Rule was developed by a Radio Engineer for quicker, more accurate and uniform circuit diagram drawing. It is ideally suited for school and university work as well as for the experienced technician. Made from clear, laminated plastic... pocket size. Money back guarantee.

\$2.00 each
 See your Local Dealer or send Money Order to
COLLETTE PRODUCTS CO. DEPT. R-1
 8653 GRAND RIVER DETROIT, 4, MICH.

ARE YOU GETTING OUR FLYERS???

If not, PRINT your name and address on a penny postcard. It will mean dollars in the bank for you!! Ask for our latest catalog and flyer. Dept. RC

RADIO EQUIPMENT CO.,
 377 E. Main St., Lexington, Kentucky
 "YOUR FRIENDLY PARTS HOUSE"

RADIOMEN SERVICEMEN BEGINNERS

MAKE MORE MONEY EASILY—QUICKLY

\$250. WEEKLY POSSIBLE

We Show You How Information Free

MERIT PRODUCTS

216-32V 132 AV. SPRINGFIELD GARDENS 13, N.Y.

RADIO SCHOOL DIRECTORY

PREPARE NOW FOR SKILLED JOBS IN RADIO AND ELECTRONICS

CAREERS in RADIO

INTENSIVE COURSES—Thorough, technical education for progressive men and women.

Licensed by the State of New York

1. **RADIO TECHNICIAN**—The MRI General Course, includes F.M. & Television. Prepares for FCC Broadcast Licenses.
2. **RADIO & TELEVISION SERVICING**—Prepares for employment as Repairman on Standard Broadcast, F.M. & Television Receivers.
3. **RADIO COMMUNICATIONS**—Prepares for FCC Operators' License. Leads to position as Merchant Marine or Flight Radio Officer, Commercial Operator.
4. **FUNDAMENTAL RADIO MATHEMATICS**—The MRI Preparatory Course. Required pre-training for students lacking a basic mathematical background.

MELVILLE RADIO INSTITUTE

MELVILLE BUILDING
15 WEST 46TH ST., N. Y. 19, BR 9-5080
"The Radio School Managed By Radio Men"

MELVILLE RADIO INSTITUTE

MELVILLE BUILDING
15 West 46th St., N. Y. 19, N. Y.

GENTLEMEN: RC
Send me **FREE** information about your school.

Name.....

Address.....

MAIL THIS COUPON NOW

A CAREER WITH A FUTURE! TELEVISION

Shop Work • Shop Techniques • Theory
FULLY EQUIPPED LABORATORIES

- RADIO SERVICE & REPAIR
- F. M. & TELEVISION
- TRANSMITTER COURSES
Preparing for F.C.C. LICENSES
- RADIO TECHNOLOGY
A Junior College Level Course preparing for positions in Radio-Electronic Engineering Field.

MORNING • AFTERNOON • EVENING CLASSES
MODERATE RATES • INSTALLMENTS

Available Under G. I. Bill
COME IN AND SEE OUR STUDENTS AT WORK

DELEHANTY SCHOOL OF
RADIO • ELECTRONICS • TELEVISION
105 EAST 13 ST., N. Y. 3, N. Y. • DEPT. R
LICENSED BY STATE OF NEW YORK

TELEVISION

Practical and Theoretical Technicians Course, covering all phases of Radio, Frequency Modulation, Television, leads to opportunities in Industry, Broadcasting or own Business. Day and Eve. Sessions. Licensed by N. Y. State. Approved for Veterans.

ENROLL NOW FOR NEW CLASSES
Visit, write or Phone
RADIO-TELEVISION INSTITUTE

Pioneers in Television Training Since 1938
480 Lexington Ave., N. Y. 17 (46th St.)
Plaza 3-4585 2 blocks from Grand Central

PRACTICAL TECHNICAL TRAINING FOR YOU

Specialize in Electronics, Radio, Electricity, Refrigeration, Heating and Air Conditioning, or Welding. Prepare in one year for position as Technician, or in two additional years secure your B. S. Degree in ELECTRICAL ENGINEERING with major in Machinery or Electronics.

Write for booklet "Career Building"
MILWAUKEE SCHOOL OF ENGINEERING
INSTITUTE OF ELECTRONICS
RC-1147 N. Broadway and E. State, Milwaukee, Wis.

RADIO COURSES

- RADIO OPERATING
 - RADIO SERVICING — ELECTRONICS
 - REFRIGERATION SERVICING
- Personal Counselling Services for Veterans
Write for Latest Trade & Technical Catalog
Y.M.C.A. TRADE & TECHNICAL SCHOOLS
4 W. 64th Street New York City

RADIO ENGINEERING!

Complete Radio Engineering Course. Bachelor of Science Degree. Courses also in Civil, Electrical, Mechanical, Chemical, Aeronautical Engineering; Business Administration, Accounting, Secretarial Science. Graduates successful. 64th year. Enter Jan., March, June, Sept. Write for catalog.

DEGREE IN 27 MONTHS

TRI-STATE COLLEGE 2490 College Ave. ANGOLA INDIANA

RCA INSTITUTES, Inc.

Offer thorough training courses in all technical phases of **Radio and Television**
DAYS—EVENINGS WEEKLY RATES
VETERANS: RCA Institutes is approved under G. I. Bill of Rights
For Free Catalog Write Dept. RC-47
RCA INSTITUTES, Inc.
A Service of Radio Corporation of America
75 VARICK STREET NEW YORK 13, N. Y.

Radio Technician and Announcers

A practical 15-month course in First Class Radiotelephone Operation and Announcing is offered by Don Martin School of Radio Arts. Most stations these days require combination men. We specialize in this type of training and maintain a placement bureau for our graduates. Serving the industry for 10 years, the School of Radio Arts can train you. Write for our catalog outlining the courses offered. Classes can be arranged so you can do part time work on the side.

APPROVED FOR VETERANS
DON MARTIN SCHOOL OF RADIO-ARTS
1655 North Cherokee St. Hollywood 28, Calif.

COMMERCIAL RADIO INSTITUTE

A radio training center for 27 years.

RESIDENT COURSES ONLY
Broadcast, Service, Aeronautical, Television, F.M., Radar, and Marine telegraphy Courses; Preparatory Courses now forming. Literature upon request. Veteran training. Classes now forming for mid-year term. Feb. 1st. Literature.
Dept. C. 38 West Biddle St., Baltimore 1, Md.

RADIO

TECHNICIAN and RADIO SERVICE COURSES
FM and TELEVISION
AMERICAN RADIO INSTITUTE
101 West 63rd St., New York 23, New York
Approved Under GI Bill of Rights
Licensed by New York State

LEARN RADIO
Get F.C.C. License
RADIO—TELEVISION
Repairing
Classes start every month
Our organization engaged in **TECHNICAL TRAINING** for 27 Years
LITERATURE ON REQUEST
BALTIMORE TECHNICAL INSTITUTE
1425 Eutaw Place. Balto. 17, Md.
APPROVED FOR VETERANS

SOUND RECORDING SCHOOL

A practical 9 months' course in Sound Fundamentals, Recording, and Sound Transmission measurements; in a laboratory containing transmission sets, oscillators, square wave generator and intermodulation analyzer, and other equipment.
Two complete recording studios assimilating broadcast, motion picture and commercial sound recording, under the direction of H. M. Tremaine.
Approved for Veterans
DON MARTIN SCHOOL OF RADIO ARTS
1655 Cherokee St., Hollywood, Calif.

SHORT CUT **CODE SPEED**
Be an Expert

Learn to be a Telegraph or Radio Operator. Thousands of men needed: Intensely interesting work—good pay. Learn at home or wherever you are, quickly, easily, with the famous Candler Code Speed System. Book of particulars Free.
CANDLER SYSTEM CO.
Dept. 3-M, Box 928, Denver 1, Colo.

CORRESPONDENCE COURSES IN RADIO and ELECTRICAL ENGINEERING

ELECTRICAL ENGINEERING Get good grasp of wide electrical field. Prepare yourself at Low Cost, for secure future. Modern course. So simplified anyone can understand quickly.
RADIO ENGINEERING Extra fine course in radio, public address, photo-electric work. Trains you to be super-service man, real vacuum-tube technician. Servicemen needed badly. Diploma on completion. Many graduates earning big pay. Send postcard for Free Copies of school catalog, full details, all about deferred payment plan, experimental kit, etc. **\$25** Either Course
Lincoln Engineering School, Box 931C-105, Lincoln 2, Nebr.

CORRECTION

An omission and two errors occurred in the parts list of the tuner for the Portable Recorder-Player described in the August, 1947, issue. Condenser C15 in Fig. 3, tuner circuit, page 64, is a .001- μ f, 400-volt paper condenser. The last line of the first column of the parts list for Fig. 3 should read: C9, C17—250- μ f mica condenser. The second line of the second column of the parts list should be: C16—0.01- μ f, 400-volt paper tubular condenser.

We thank Mr. R. H. Heiskell of Compton, Calif., for this correction.

Some readers have stated that the General Industries Model GI-R90L recording unit has a crystal cutter. The manufacturer states that this model is available with crystal or magnetic cutting heads. Your distributor will be able to get the model with the magnetic cutter.

BIND YOUR MAGS

Technical magazines that are kept for reference can be bound in convenient volumes of four or six issues. Stack the copies carefully and drill a number of holes through the binding with a small drill. Thread fishing line or strong twine through the holes and tie it after drawing the twine tightly. For a neat job, a small jig may be constructed by drilling through a small board long enough to be used as a stencil for spotting the holes along the length of the bindings.

ELMER C. CARLSON,
Brooklyn, N. Y.



YOUR TELEPHONE TRANSMITTER AND RECEIVER, voice gateways to the telephone plant, are so essential to satisfactory service that they have been under study in Bell laboratories for seven decades.



A TELEPHONE RECEIVER is a complex system of electrical and mechanical elements. Its coils, magnets, diaphragm and cap react on each other as they convert the electrical waves of your voice to sound waves. What is the best size for the holes in the ear cap? Will $1/10000$ th inch greater thickness help a receiver diaphragm to carry your telephone voice more clearly? One way to find out is to build numerous experimental receivers and test them.

But Bell Laboratories have found a shorter way. They built an all-electrical replica, an "equivalent circuit" in which electrical resistance stands for air friction in the cap

holes; capacitance corresponds inversely to the stiffness of the diaphragm. Over-all performance of this circuit can be quickly measured and design changes economically explored. Later, a model can be built for final check.

The "equivalent circuit" was pioneered by Bell Telephone Laboratories 25 years ago. It is a useful tool in many Laboratories developments—saving time, saving the cost of machine-tooled models, encouraging experimentation. It is one more example of the way Bell scientists get down to fundamentals as telephone progress continues—and service keeps on improving for all subscribers.



BELL TELEPHONE LABORATORIES

EXPLORING AND INVENTING, DEVISING AND PERFECTING, FOR CONTINUED IMPROVEMENTS AND ECONOMIES IN TELEPHONE SERVICE

More Tapped Control Values For Your "Every Need"

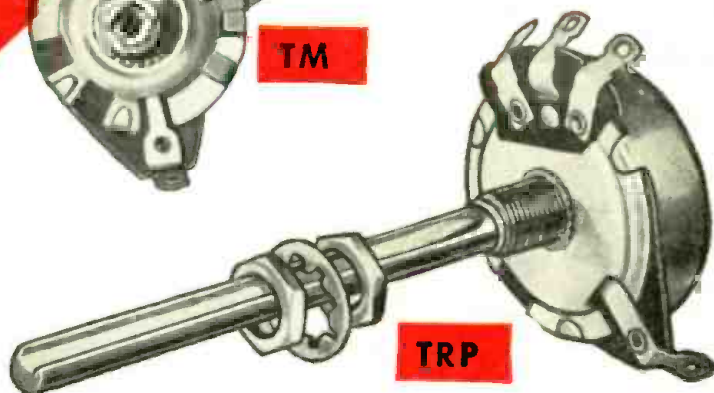
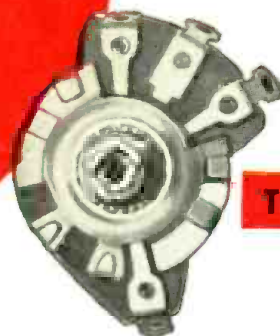
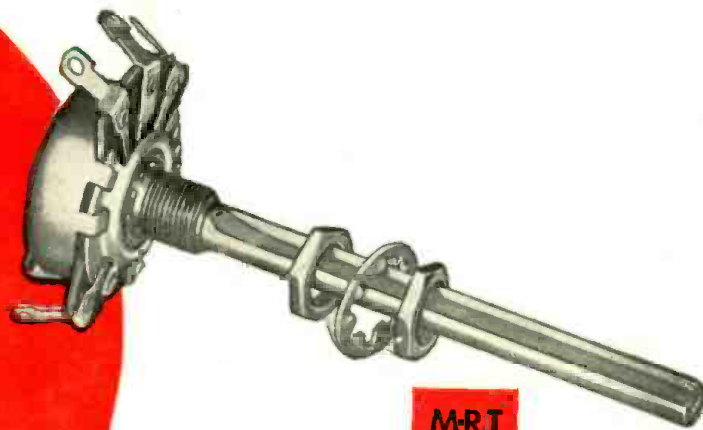

MALLORY provides every needed resistance value in its single tapped replacement controls—31 combinations of overall and tap resistances in all.

Mallory MRT Controls are available in most of the popular values, and feature an easy-to-cut channel shaft that fits all types of knobs. Mallory TMs are made in an even wider range of resistance values than the MRTs, and are used in conjunction with 30 non-wobbling, non-loosening Plug-In Shafts. They have practically universal application because they provide "special" shafts of nearly every required type.

Where shaft lengths of 3 inches or less are required, Mallory TRPs (fixed shafts)

replace large originals using set screw or spring type knobs. See your Mallory distributor.

Insist on MALLORY—the Complete Control Line

Mallory offers 33 Tapered Wire-Wound Controls ... 31 Values in Single Tapped Controls ... 10 Values in Double Tapped Controls ... 12 Clutch Type Controls ... 10 Universal Dual Controls ... and 92 Popular Special Controls.

The MALLORY "Good Service for Good Business" Plan includes ideas that will help your business grow. Ask Your Distributor about it.

P. R. MALLORY & CO., Inc.
MALLORY

VIBRATORS ... VIBRAPACKS® ... CAPACITORS ... VOLUME CONTROLS ... SWITCHES ... RESISTORS ... FILTERS ... RECTIFIERS ... BLOWER SUPPLIES.

®Reg. U. S. Pat. Off.

APPROVED PRECISION PRODUCTS

P. R. MALLORY & CO., Inc., INDIANAPOLIS 6, INDIANA