

RADIO CRAFT

In this issue—

Broad-Beam Antenna

Cathode Followers

Transigenerator



SPEED FACSIMILE
FOR HOME RADIOS

SEE PAGE 680

JULY

1946

25¢

CANADA 30¢

RADIO-ELECTRONICS IN ALL ITS PHASES



When T. Leiper raised the eyebrows of Philadelphians with his cart-on-wheels . . . he introduced our first modern network of railroads.

PANORAMIC RECEPTION

makes "blind" operation for the radio amateur as out-dated as stagecoach and wagon train.



SEE all that Panoramic Reception offers...

SEE a band up to 200 kc wide as you tune . . . SEE all activity within that band . . . phone, c.w., f.m., at a glance . . . SEE weak signals, short calls, dx. . . . SEE the characteristics of your own signal as well as others . . . SEE phone modulation or key clicks . . . SEE all these and much more with the PANADAPTOR.

ASK THE LUCKY MAN WHO OWNS ONE!

New Panoramic Handbook contains complete operating, maintenance, installation and application data. Answers all questions about the PANADAPTOR. 50c at your jobber or by mail.

Panadaptor Model PCA-2
 now available at leading radio parts jobbers. Amateur net price, complete with ten tubes and accessories, for 115 V., 60-60 cycle operation.
\$99.75
 One Year Guarantee

Panadaptor, featuring Panoramic Reception, is the exclusive and original design of Panoramic Radio Corp.

PANORAMIC



RADIO CORPORATION

CABLE ADDRESS PANORAMIC, NEW YORK

242-250 WEST 55TH ST., New York 19, N.Y.

Exclusive Canadian Representative: Canadian Marconi, Ltd.



J. E. SMITH,
PRESIDENT
National Radio
Institute
32nd Year of
Training Men
for success
in Radio.

I WILL TRAIN YOU TO START A SPARE TIME OR FULL TIME RADIO SERVICE BUSINESS WITHOUT CAPITAL

**You Build These and Many
Other Radio Circuits with
6 Kits of Parts I Supply**

By the time you've conducted 60 sets of Experiments with Radio Parts I supply, made hundreds of measurements and adjustments, you'll have valuable PRACTICAL Radio experience for a good full or part-time Radio job!

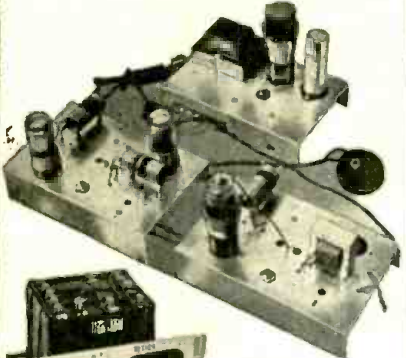

You build MEASURING INSTRUMENT above early in Course, useful for Radio work to pick up EXTRA spare time money. It is a vacuum tube multimeter, measures A.C., D.C., R.F. volts, D.C. currents, resistance, receiver output.

Building the A. M. SIGNAL GENERATOR at right will give you valuable experience. Provides amplitude-modulated signals for test and experimental purposes.



The men at the right are just a few of many I have trained, at home in their spare time, to be Radio Technicians. They are now operating their own successful spare time or full time Radio businesses. Hundreds of other men I trained hold good jobs in practically every branch of Radio. Doesn't this PROVE my "50-50 method" of home training can give you BOTH a thorough knowledge of Radio principles and the PRACTICAL experience you need to help you make more money in the fast-growing Radio industry?

Let me send you facts about opportunities in the busy Radio field. See how knowing Radio can give you security, a prosperous future... lead to jobs coming in Television, Electronics. Send coupon NOW for FREE Sample Lesson and 64-page, illustrated book. Read how NRI trains you at home in spare time. Read how you practice building, testing, repairing Radios with SIX BIG KITS of RADIO parts I send you.

**Many Beginners Soon Make Extra Money
in Spare Time While Learning**

The day you enroll I start sending EXTRA MONEY JOB SHEETS. You LEARN Radio principles from my easy-to-understand, illustrated lessons—PRACTICE what you learn by building, testing and experimenting with parts I send—USE your knowledge to make EXTRA money fixing neighbors' Radios in spare time while still learning! From here it's a short step to your own full-time Radio Shop or a good Radio job!

**Future for Trained Men Is Bright
in Radio, Television, Electronics**

It's probably easier to get started in Radio now than ever before, because the Radio Repair Business is booming. Trained Radio Technicians also find profitable opportunities in Police, Aviation, Marine Radio, Broadcasting, Radio Manufacturing, Public Address work. Think of even greater opportunities as Television, FM, and many new, war-developed Electronic devices become available to the public! Soon, there will be more Radio equipment to install, operate, maintain and repair than ever before in all history! Get the facts on all these opportunities. Send for FREE books now!

Find Out What NRI Can Do For You

Mail Coupon for Sample Lesson, "Getting Acquainted with Receiver Servicing," and my FREE 64-page book. It's packed with facts about Radio's opportunities for you. Read the details about my Course. Read letters from men I trained, telling what they are doing, earning. See how quickly, easily you can get started. No obligation! Just MAIL COUPON NOW in an envelope or paste it on a penny postal. J. E. SMITH, President, Dept. 6GX, National Radio Institute, Pioneer Home Study Radio School, Washington 9, D. C.

**I Trained
These Men** SPARE TIME
RADIO BUSINESS



"I have a spare time Radio and Electrical business of my own which has been very profitable, due to the efficient training I received from your Course. Last year I averaged over \$50 a month."
—FRED H. GRIFFIE, Route 3, Newville, Pa.

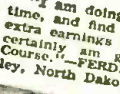

"I am doing radio work in my spare time, and find it a profitable hobby. My extra earnings run about \$10 a week. I certainly am glad I took your N.R.I. Course."
—FERDINAND ZIRBEL, Chaseley, North Dakota.



"About six months after I enrolled I started making extra money in radio. I am a farmer and just work on radios on evenings and stormy days. That brought me a profit of \$600 in the last year."
—BENNIE L. ARENDS, RFD 2, Alexander, Iowa.

**I Trained
These Men** FULL TIME
RADIO BUSINESS



"Not long ago I was working 16 hours a day in a filling station at \$10 a week. Now I have my own radio business and average over \$80 a week. The N.R.I. course is fine."
—ALBERT C. CHRISTENSEN, 116-10th Avenue, Sidney, Neb.

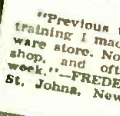

"Previous to enrolling for your radio training I made \$12 per week in a hardware store. Now I operate my own repair shop, and often clear \$35 to \$45 a week."
—FREDERICK BELL, 76 Golf Ave., St. Johns, Newfoundland.



"Am making over \$50 a week profit from my own shop. Have another N.R.I. graduate working for me. I like to hire N.R.I. men because they know radio."
—NORMAN MILLER, Hebron, Neb.

SAMPLE LESSON FREE

I will send you a FREE Lesson, "Getting Acquainted With Receiver Servicing," to show you how practical it is to train for Radio at home in spare time. It's a valuable lesson. Study it—keep it—use it—without obligation! Tells how Superheterodyne Circuits work, gives hints on Receiver Servicing, Locating Defects, Repair of Loudspeaker, I.F. Transformer, Gang Tuning, Condenser, etc. 31 Illustrations.

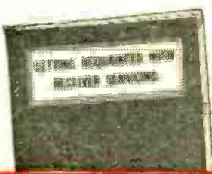

**My Radio Course Includes
TELEVISION • ELECTRONICS
FREQUENCY MODULATION**

GOOD FOR BOTH 64 PAGE BOOK SAMPLE LESSON FREE

**J. E. SMITH, President, Dept. 6GX
National Radio Institute, Washington 9, D. C.**

Without obligating me, mail your Sample Lesson and 64-page book. FREE. I am particularly interested in the branch of Radio checked below. (No salesman will call. Please write plainly.)

- My own Radio Service Business
- Spare Time Radio Servicing
- Service Technician for Radio Stores or Factory
- Aviation Radio
- Operating Broadcasting Station
- Industrial Electronics
- Public Address Systems
- Ship, Harbor, Gov't. Military Radio

(If you have not decided which branch you prefer—mail coupon for facts to help you decide.)

Name Age

Address

City Zone State

Approved for Training under GI Bill





Keep Your Name in Front with N. U. BUSINESS-BUILDERS

One of the largest and finest assortments of dealer helps and sales promotional material ever offered to radio service dealers is now available from National Union Distributors. Here are business-builders for practically every need of the radio service engineer. All are smartly designed in the most modern styles. Many are offered with personalized imprint of your name and address. Let N. U. help you advertise *your* business, find new customers and increase your sales.

Ask Your N. U. Distributor Today

National Union Radio Corp.

Newark 2, New Jersey

NOW AVAILABLE

BUSINESS-BUILDERS

- Window Decals
- Book Matches
- Dummy Cartons
- Stationery
- Job Tickets
- Embosograf Signs
- Newspaper Ad Mats
- Telephone Ad Mats
- Cartoon Cards

- Trouble Finder Folders
- Battery Cross-Indexes

TECHNICAL HELPS

- Electronic Engineers Reference Manuals
- Service Engineering Bulletins
- Uniballast Manuals
- Visual Aid Vacuum Tube Charts

COMING

- Window Displays
- Outdoor Signs
- Indoor Signs
- Imprinted Scorch Tape
- 4 Purpose Tube Decals
- Shop Coats

PLEASE PLACE YOUR ORDER WITH YOUR REGULAR RADIO PARTS JOBBER. IF YOUR LOCAL JOBBER CANNOT SUPPLY YOU, KINDLY WRITE FOR A LIST OF JOBBERS IN YOUR STATE WHO DO DISTRIBUTE OUR INSTRUMENTS OR SEND YOUR ORDER DIRECTLY TO US.



The New Model CA-11 SIGNAL TRACER

Simple to operate . . . because signal intensity readings are indicated directly on the meter!

Essentially "Signal Tracing" means following the signal in a radio receiver and using the signal itself as a basis of measurement and as a means of locating the cause of trouble. In the CA-11 the Detector Probe is used to follow the signal from the antenna to the speaker — with relative signal intensity readings available on the scale of the meter which is calibrated to permit constant comparison of signal intensity as the probe is moved to follow the signal through the various stages.

Features:

- ★ SIMPLE TO OPERATE — only 1 connecting cable — NO TUNING CONTROLS.
- ★ HIGHLY SENSITIVE — uses an improved Vacuum Tube Voltmeter circuit.
- ★ Tube and resistor-capacity network are built into the Detector Probe.
- ★ COMPLETELY PORTABLE — weighs 5 lbs. and measures 5" x 6" x 7".
- ★ Comparative Signal Intensity readings are indicated directly on the meter as the Detector Probe is moved to follow the Signal from Antenna to Speaker.
- ★ Provision is made for insertion of phones.

The Model CA-11 comes housed in a beautiful hand-rubbed wooden cabinet. Complete with Probe, test leads and instructions.....Net price

\$18⁷⁵

The New Model 450 TUBE TESTER

Specifications:

- Tests all tubes up to 117 Volts including 4, 5, 6, 7, 7L, Octals, Loctals, Bantam Junior, Peanut, Television, Magic Eye, Hearing Aid, Thyratrons, Single Ended, Floating Filament, Mercury Vapor Rectifiers, etc. Also Pilot Lights.
- Tests by the well-established emission method for tube quality, directly read on the scale of the meter.
- Tests shorts and leakages up to 3 Megohms in all tubes.
- Tests individual sections such as diodes, triodes, pentodes, etc., in multi-purpose tubes.
- New type line voltage adjuster.
- NOISE TEST: Tip jacks on front panel for plugging in either phones or external amplifier will detect microphonic tubes or noise due to faulty elements and loose internal connections.
- Works on 90 to 125 Volts 60 Cycles A.C.



SPEEDY OPERATION assured by newly designed rotary selector switch which replaces the usual snap, toggle, or lever action switches.

The model 450 comes complete with all operating instructions. Size 13"x12"x6" Net weight 8 lbs. **\$39⁵⁰** Our Net Price.....

New Model 400 ELECTRONIC MULTI-METER

A Combination Vacuum-Tube Voltmeter and Volt-Ohm Milliammeter plus Capacity, Inductance, Reactance, & Decibel Measurements



Specifications:

- D.C. V.T.V.M. VOLTS: 0 to 3/15/30/75/150/300/750/1500/3000 Volts
 - D.C. VOLTS: (At 1,000 Ohms Per Volt) 0 to 3/15/30/75/150/300/750/1500/3000 Volts
 - A.C. VOLTS: (At 1,000 Ohms Per Volt) 0 to 3/15/30/75/150/300/750/1500/3000 Volts
 - D.C. CURRENT: 0 to 3/15/30/75/150/300/750 Ma. 0 to 3/15 Amperes
 - RESISTANCE: 0 to 1,000/10,000/100,000 Ohms 0 to 1/10/1,000 Megohms
 - CAPACITY: (In MFD) .0005—.2 .05—20 .5—200
 - REACTANCE: 10 to 5M (Ohms) 100—50M (Ohms) .01—5 (Megohms)
 - INDUCTANCE: (In Henries) .035—14 .35—140 35—14,000
 - DECIBELS: —10 to +18 +10 to +38 +30 to +58
- The model 400 comes housed in a rugged crackle-finished steel cabinet complete with batteries, two sets of test leads, one set of V.T.V.M. probes and instructions. **\$52⁵⁰** Size 5 1/2" x 9 1/2" x 10".....Net



SUPERIOR INSTRUMENTS CO.

Dept. R 227 FULTON ST., NEW YORK 7, N. Y.

from **RADIO NEWS**

For the **RECORD.**

BY THE EDITOR

MUCH has been said and reams have been written about the necessity for the service engineer to apply modern scientific techniques and sound business practices to assure his success in the post war era. It takes no crystal gazer to predict that with the tremendous increase in varieties of radio models the need will be acute for some new short cut to accurate well organized service data. In the past the serviceman needed information on the products of only 36 receiver manufacturers whereas more than 1000 models of 212 radio and phonograph manufacturers will soon be on the market.

One company has already taken cognizance of this complex problem and is producing a radically different, high efficiency technical reference service. The radio service engineer who acquires this service will be provided not only with exhaustive technical data on the knowledge of a board of 30 specialists in radio, radar and radio servicing to help him solve problems relating to parts selection, shop operation, promotion, accounting and business methods.

The forward thinking of this organization assures servicemen of a pipeline to the two springs of knowledge requisite to their business success; practical well organized technical information and sound business practices. O.R.
JUNE ISSUE RADIO NEWS

Here's
YOUR
problem

Here's
OUR
answer

Save Up to 50% in Servicing Time!

In Each PHOTOFACT FOLDER You Get:

- ✓ From 2 to 12 clear photos of the chassis, identifying each component part for immediate checking or replacement.
- ✓ Complete specifications on each component, including manufacturer's part number, available replacement type or types and valuable installation notes.
- ✓ A keyed reference alignment procedure for the individual set, with adjustment frequencies and recommended standard connections.
- ✓ Complete voltage analysis of receiver.
- ✓ Complete resistance analysis of receiver.
- ✓ Complete stage gain measurement data.
- ✓ Schematic diagram.



If you think it's going to be easy to service the 1,000 or more radio sets soon to come off production lines, read no further! The Sams PhotoFact* Service is designed for men who *know* there's a tough time ahead—who need and *want* better service information.

The Sams PhotoFact Service provides such information in the form of reliable, fact-filled, illustrated folders that can save as much as 50% of your servicing time. Every post-war radio is visualized in photographs . . . every part listed and numbered . . . every servicing shortcut and installation fact fully set down! No matter how complicated the set, or how new the components, you have the whole story right in front of you.

You get a set of from 30 to 50 PhotoFact Folders at a time. Each set of folders

comes to you in a handy envelope at a cost of only \$1.50 for each group. They cover all new receivers as they reach the market.

Think of it! An absolutely fool-proof visual method of giving you the exact information you want, where you want it, when you want it, for as little as three cents per new radio model! And every bit of information is compiled by experts from an examination of the actual receiver itself — *not from standard service data!* PhotoFact Folder Set No. 1 is being published June 15. Others will follow closely. Reserve yours now!

Also, Membership in

HOWARD W. SAMS INSTITUTE

Answers to hard service problems! Economical shop practices! How to get more customers! These and many other subjects covered by 30 top notch specialists! Complete facts with PhotoFact Set No. 1.

**Trade Mark Registered*

Cut This Out and Mail It to Your Distributor! If you do not know his name and address, send it directly to Howard W. Sams & Co., Inc. 2924 East Washington Street, Indianapolis 6, Indiana, and we will see that your nearest distributor gets it.

CHECK ONE SQUARE

PLEASE PRINT

- Yes, by all means reserve every issue of the Sams PhotoFact Folder Service for me.
- Send complete information and reservation card.
- My (check) (money order) (cash) for \$1.50 is enclosed for PhotoFact Folder Set No. 1. (Publication date, June 15, 1946). (If you send cash, be sure you use registered mail.)

Name _____ Address _____
City _____ Zone _____ State _____
Company Name _____
My Distributor's Name _____ City _____

HOWARD W. **SAMS** & CO., INC. **RADIO PHOTOFACT SERVICE**

LET ME TRAIN YOU

for RADIO ELECTRONICS & TELEVISION

I'll Supply a **FULL RADIO SET**

for SIMPLIFIED INSTRUCTION — PRACTICE & TESTING

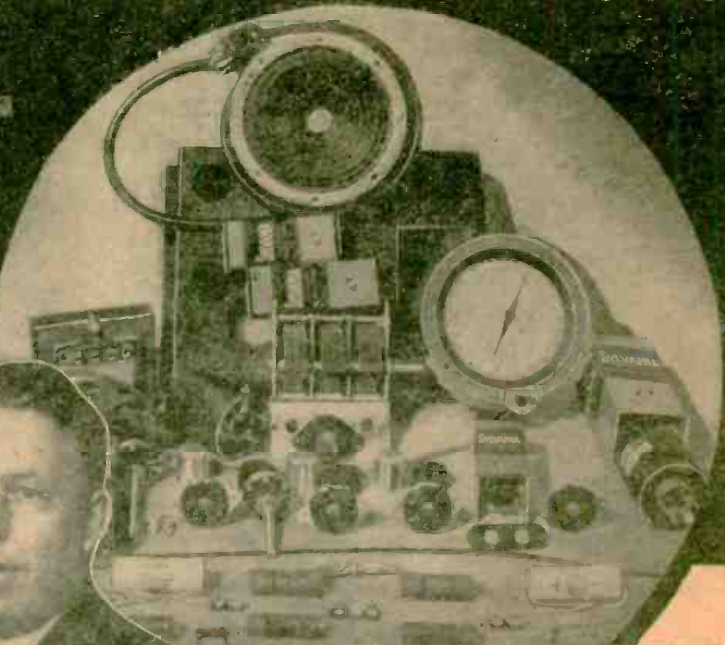

Beginners Learn FAST
START NOW! Big Developments
Ahead in F. M., Radar, Television



MAKE GOOD MONEY IN
a Business of Your Own
...or a Good Radio Job.

Mind training through hand practice with a FULL RADIO SET . . . that's the interesting way I'll teach you Radio. And it's the latest, most practical method of all to fix in your head permanently the essential money-making Radio knowledge. The offer I make you here is the opportunity of a lifetime. I'll prepare you easily and quickly for a wonderful future in the swiftly expanding field of Radio-Electronics INCLUDING Radio, Television, Frequency Modulation and Industrial Electronics. Be wise! NOW'S the time to start. Opportunities ahead are tremendous! No previous experience is necessary. The Sprayberry Course starts right at the beginning of Radio. You can't get lost. It gets the various subjects across in such a clear, simple way that you understand and remember. And, you can master my entire course in your spare time . . . right at home.

You Do Practical Experiments

There's only one right way to learn Radio Electronics. You must get it through simplified lesson study combined with actual "shop" practice under the personal guidance of a qualified Radio Teacher. It's exactly this way that Sprayberry trains you . . . supplying real Radio parts for learn-by-doing experience right at home. Thus, you learn faster, your understanding is clear-cut.

I'll Show You a New, Fast Way to Test Radio Sets Without Mfg. Equipment

The very same Radio Parts I supply with your Course for gaining pre-experience in Radio Repair work may be adapted through an exclusive Sprayberry wiring procedure to serve for complete, fast, accurate Radio Receiver trouble-

shooting. Thus, under Sprayberry methods, you do not have one cent of outlay for manufactured Test Equipment.

Succeed As a Radio-Electronician

My training will give you the broad, fundamental principles so necessary as a background, no matter which branch of Radio you wish to specialize in. I make it easy for you to learn Radio Set Repair and Installation Work. I teach you how to install and repair Electronic Equipment. In fact, you'll be a fully qualified RADIO-ELECTRONICIAN, equipped with the skill and knowledge to perform efficiently and to make a wonderful success of yourself.

Read What Graduate Says
"One Job Nets About \$26.00"

"Since last week I fixed 7 radios, all good-paying jobs, and right now I am working on an amplifier system. This job alone will net me about \$26.00. As long as my work keeps coming in this way, I have only one word to say and that is, 'Thanks' to my Sprayberry training, and I am not afraid to boast about it."—ADRIEN BENJAMIN, North Grosvenordale, Conn.

DON'T PUT IT OFF!

Get the facts about my training—now! Take the first important step toward the money-making future of your dreams. All features are fully explained in my big, illustrated FREE Catalog which comes to you along with another valuable FREE book you'll be glad to own.

FREE BOOKS

"How To Read Radio Diagrams and Symbols"

Here's a valuable and wonderfully complete new book which explains in simple, non-technical English how to read and understand any Radio Set Diagram. Provides the quick key to analyzing any Radio circuit. Includes translations of all Radio symbols. This instructive volume is yours for the asking—without obligation. Send for it AT ONCE, and along with it I will send you another big free book, describing in complete, interesting detail my Radio-Electronic training.



RUSH
COUPON
for BOTH

SPRAYBERRY ACADEMY OF RADIO
 F. L. Sprayberry, President
 Room 2076, Pueblo, Colorado

Please rush my FREE copies of "How to MAKE MONEY in RADIO ELECTRONICS and TELEVISION," and "How to READ RADIO DIAGRAMS and SYMBOLS."

Name Age.....

Address

City State.....

(Mail in envelope or paste on penny postcard)

MAIL COUPON AT ONCE!

RADIO CRAFT

AND POPULAR ELECTRONICS

Incorporating
SHORT WAVE CRAFT TELEVISION NEWS
RADIO & TELEVISION



HUGO GERNSBACK, *Editor-in-Chief*
FRED SHUNAMAN, *Managing Editor*
MAJ. M. H. GERNSBACK, *Cons't'g Ed.*
R. F. SCOTT, W4FS1, *Technical Editor*
I. QUEEN, W2OUX, *Editorial Associate*
ELMER FULLER, *Shortwave Editor*
A. PASCALE, *Production Manager*
G. ALIQUO, *Circulation Manager*
JOHN J. LAMSON, *Advertising Director*
ALFRED STERN, *Promotion Manager*

IN AN EARLY ISSUE

Improving Sound Equipment
5-Tube Superheterodyne
Instability in Apparatus
Shaping Waves and Pulses

Published by Radercraft Publications, Inc.
Publication Office: 29 Worthington Street,
Springfield 3, Mass.
Editorial and Advertising Offices: 25 West
Broadway, Tel. RE 2-9690, New York 7, N. Y.
Chicago Advertising Office: Radio-Craft, 308
W. Washington Street, Suite 1413, Chicago 6,
Ill. Tel. Randolph 7363.
Cleveland Advertising Office: 405 Erie Bldg.,
Cleveland, Ohio. Burdette Phillips, Manager.
Tel. Main 9645.
Los Angeles Advertising Office: 606 South
Hill Street, Los Angeles 14, Calif. Ralph W.
Harker, Manager. Tel. Tucker 1793.
San Francisco Advertising Office: 582 Market
St., San Francisco 4, Calif. Ralph W. Harker,
Manager. Tel. Garfield 2481.
RADIO-CRAFT is published monthly on the
25th of the month preceding that of date.
Subscription rates: United States and pos-
sessions, Mexico, Central and South American
countries, \$2.50 a year, \$4.00 for two years,
\$6.00 for three years. Canada, \$3.00 a year,
\$5.00 for two years, \$7.50 for three years.
All other foreign countries, \$3.25 a year,
\$5.50 for two years, \$8.25 for three years.
Special rates for members of the Armed
Forces in U. S., or those addressed by A.P.O.
or F.P.O. mail, \$2.00. Entered at the post
office at Springfield as second-class matter
under the Act of March 3, 1879. All com-
munications about subscriptions should be
addressed to: Circulation Manager, Radio-
Craft, 25 West Broadway, New York 7, N. Y.

Notice of CHANGE of ADDRESS should
reach us at least one month in advance. When
ordering a change, please furnish an address
stencil impression from a recent wrapper if
you can. Address changes cannot be made
without the old address as well as the new.

Foreign Agents
London—Atlas Publishing and Distributing
Co., Ltd., 18 Bride Lane, Fleet St., London,
E.C. 4.
Melbourne—McGill's Agency, 179 Elizabeth
St., Australia.

Text and illustrations of this magazine are
copyright and must not be reproduced without
permission of the copyright owners.
Copyright, 1946, Radercraft Publications, Inc.

RAD-CRAFT PUBLICATIONS, INC.:
Hugo Gernsback, *President*
Maj. M. Harvey Gernsback, *Vice Pres.*
G. Aliquo, *Secretary*

Contents July, 1946 Volume XVIII No. 10

Editorial: Secret Communication	by Hugo Gernsback	673
Radio-Electronics Monthly Review		674
Radar Rockets	by H. W. Secor	679
Radio Thirty-Five Years Ago		711

ELECTRONICS

Radio in the Atom Test	by E. A. Witten	682
New Facsimile Is Fast (Cover Feature)		680
Nomograph Construction, Part II—Charts with Complicating Factors or Constants	by Fred Shunaman	690
Cathode Followers	by Jordan McQuay	692

RADIO AND TELEVISION

Television for Today, Part II—Scanning Tube Methods	by Milton S. Kiver	683
Inside the Handie-Talkie	by Robert F. Scott, W4FS1	684
How Mine Detectors Work	by Eric Leslie	676

SERVICING

Mathematics—Radio Tool, Part II—Shunts and Multipliers; Matching Loudspeakers	by Arthur Howard & Morris Eddy	689
Radio Data Sheet No. 337 (Emerson Radio Model 501, 502, 504)		691

CONSTRUCTION

Broad-Band Antenna	by H. B. Churchill	681
430 Mc with a 6F4	by I. Queen, W2OUX	687

TEST INSTRUMENTS

The Transgenerator	by Robert E. Altomare	686
--------------------------	-----------------------	-----

DEPARTMENTS

World-Wide Station List	by Elmer R. Fuller	694
New Radio-Electronic Devices		696
Radio-Electronic Circuits		702
Try This One		704
The Question Box		706
New Radio-Electronics Patents		708
Technotes		709
Communications		728
Book Reviews		731

Biographical Portrait Drawings by Constance Joan Naar



ON THE COVER

The modern high-speed facsimile station of John V. L. Hogan appears on our cover this month. Mr. Hogan, whose many radio inventions include such devices as the now universally-used ganged condenser, sits at the controls of his new station.

See how readily YOU can train a home for BIGGER EARNINGS in RADIO ELECTRONICS



FREE KIT PACKET SHOWS HOW YOU CAN GET LOTS OF "LEARN-BY-DOING" RADIO EXPERIENCE AT HOME FROM DEFOREST'S THRILLING RADIO "Home Laboratory"

133 EXPERIMENTS

DeForest's Kit Packets show how you can get real Radio experience from the many standard Radio parts furnished you with DeForest's Training. See how you may quickly build Radio Circuits that work... how you may experiment with Photo Electric Cell "Magic"... a 5-Tube Superheterodyne Receiver... a Radio Telephone and scores of other fascinating projects. See how you get actual "shop training" at home to give you the practical Radio experience you need.

VETERANS!

Big things are happening at De Forest's for veterans! See how you can prepare yourself without cost for a GOOD JOB or BUSINESS OF YOUR OWN in the vast Radio-Electronic opportunity field.

DEFOREST'S PROVIDES ALL 3 HOME TRAINING AIDS

- A** DeVry Movie Projector and Learn-By-Seeing Movie Film
- B** Actual Radio Parts for working out 133 experiments
- C** 90 lessons prepared under the supervision of Dr. Lee DeForest—the "Father of Radio."

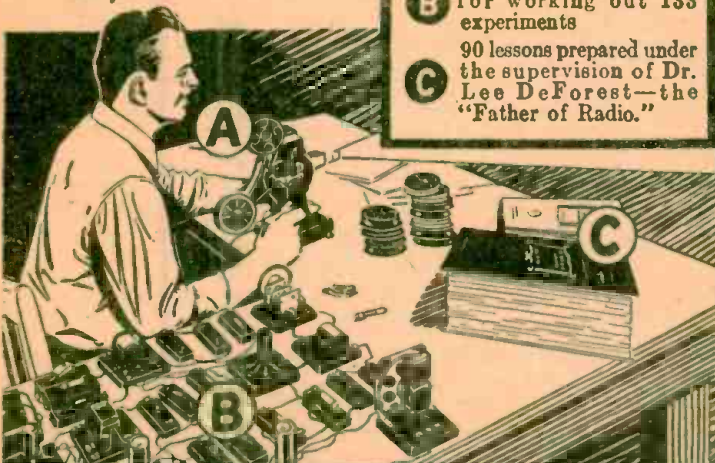

Now—you can see for yourself why DeForest's Training does such a grand job of preparing men for a bright future in one of America's most promising opportunity fields—Radio and Electronics. Send the coupon below for your free "Kit Packet" plus the big free book, "Victory For You!" that has helped so many to find the way to good pay jobs. You'll be surprised at the opportunities ahead of FM Radio, Aviation Radio, Broadcast Radio, a profitable Business of Your Own, Motion Picture Sound Equipment, and Electronics—plus the exciting future possibilities ahead of Television, Radar, etc. Train in your spare time at home—or get all of your training in our Chicago laboratories.

You Also Get EFFECTIVE EMPLOYMENT SERVICE

Upon completing your training, you get the full benefit of DeForest's Employment Service that has helped so many men to get started in the Radio-Electronic field.



DEFOREST'S TRAINING INCLUDES INSTRUCTION IN MOTION PICTURE SOUND EQUIPMENT, FM RADIO AND TELEVISION... RESIDENTIAL TRAINING IN OUR MODERN CHICAGO LABORATORIES ALSO AVAILABLE—ASK US FOR INFORMATION!

E. B. DeVry, President
 DEFOREST'S TRAINING, INC.
 2535-41 North Ashland Ave., Dept. RC-C7
 Chicago 14, Illinois, U.S.A.

Send FREE RADIO KIT PACKET and "VICTORY FOR YOU!" BOOK.



Name _____ Age _____
 Address _____ Apt. _____
 City _____ Zone _____ State _____
 If under 16, check here for special information. If a discharged Veteran of World War II, check here.

DeFOREST'S TRAINING, INC.
 CHICAGO 14, ILLINOIS

SILVER

"VOMAX"

904 $\frac{C}{R}$ BRIDGE

"SPARX"

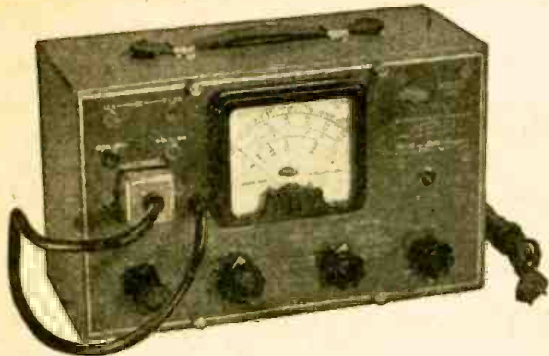

"VOMAX" is more than a multi-meter . . . more than volt-ohm-db.-milliammeter . . . more than r.f. vacuum-tube voltmeter of laboratory instrument caliber. "VOMAX" is all of these things. Born out of six years of military research and production, it is new as today. Backed by a name famous for over 35 years . . . designed by radio's only International Grand Prize winner, "VOMAX" is the standard of comparison.

RADIO MAINTENANCE engineers checked and rechecked the market for the best possible meter . . . most-used instrument in all radio service . . . to serve as heart and core of its new "Modern Test Bench." They selected "VOMAX". Your efficiency and profits will be greatest when you, too, use "VOMAX". Outstanding . . .

tested and sworn to by thousands of serious service technicians . . . ordered and reordered by the U. S. Bureau of Standards, the Naval Research Laboratory, Western Union . . . used by Sperry, Monsanto Chemical, DuPont, F.C.C. Grand Island monitoring station, C.A.A., Naval Ordnance Depots, Lapp Insulator, Stackpole Carbon, Fairchild Aviation, etc., etc. This is positive proof that "VOMAX" is the meter you must have to top smart competition. Follow the recommendation by Bendix to all BENDIX RADIO distributors and dealers . . . "Use 'VOMAX'. It's better than we hoped."

**Only
\$59.85**



Model 904 Capacitance/Resistance Bridge. $\frac{1}{4}$ mmfd/ohm thru 1,000 mfd/meg-ohms; 0-50% power factor; 0-500 volt adjustable internal polarizing voltage; 0;10 and 0-100 ma. electron-ray leakage current meter; measures resistance, capacitance under actual operating voltages! Also recommended by Bendix. Only \$49.00

"SPARX". Visual/aural dynamic signal tracer; 20 cycles thru 200 mcs.; new crystal rectifier ζ .f./a.f. probe; 65 db. a.f. amplifier; dynamic speaker Tests speakers, phono pick-ups, amplifiers, receivers from antennae thru speakers; determines presence of operating voltages, hum. Checks individual circuits and overall performance and quality quickly and positively. Only \$39.90



Get a copy of June, 1946 RADIO MAINTENANCE at your favorite jobber—or send 25c to 460 Bloomfield Ave., Montclair, N. J., for radio's newest 100% service magazine. Read all about "VOMAX" in it.

Send penny post-card for new, hot-off-the-press, catalog describing these important, fresh, postwar measuring instruments, plus 3 new communication receivers, 2 new transmitters, factory built and kits, condensers, coils, sockets, new "frequency-meter" 5 thru 500 watt, 6-band transmitting inductor, keying and quality monitor, new AM and FM signal generator covering 90 kcs. thru 170 mcs. on fundamentals! See your favorite jobber at once, for demand far exceeds supply.

OVER 35 YEARS OF RADIO ENGINEERING ACHIEVEMENT

McMurdo Silver Company

1249 MAIN STREET • HARTFORD 3 • CONNECTICUT
IN CANADA—MC MURDO SILVER DIVISION, GENERAL RADIONICS, LTD. 465 CHURCH ST.—TORONTO, ONTARIO, CANADA.

Grasp the **NEW OPPORTUNITIES** in

RADIO ELECTRONICS AND TELEVISION NOW!



Modern Radio — F M broadcast and reception — Television — Radar — Industrial Electronics; power, control, communications—new equipment and methods demand new technical ability and experience. Keep up to date with the latest.

MODERN ELECTRONIC LABORATORY FOR YOU TO USE AND KEEP



The very essence of National Shop Method Home Training is **EXPERIENCE**. You get the actual experience by working with modern Radio and Electronic equipment—building circuits and instruments. You may build a fine, long distance **MODERN SUPERHETERODYNE**, signal generator, miniature radio transmitter, audio oscillator—many other full sized, actual, operating pieces of equipment and instruments—conduct cathode ray and hundreds of other experiments. This experimental laboratory work advances with your training and you actually learn by doing. Send the coupon and get the full details of how such an offer can be made.

Shop Method Home Training By a Great Established Resident School

Get one of the thousands of **NEW JOBS** that demand new techniques and methods in modern radio. Get your share of the **NEW BUSINESS** that servicing the new sets and equipment demands. Experts agree that Radio Television and Electronics presents the next great industrial boom!

Radio is expanding farther and faster than ever with great improvements in reception. Radar is already a 2-billion dollar a year business. No one knows yet how great the Television market will be. Electronics touches almost every walk of life—in industry and in the home.

TURN YOUR INTEREST IN RADIO INTO A CAREER THAT WILL ASSURE YOUR SUCCESS. Mail the coupon below for a list of the great opportunities in this field—today and in the near future.

Get the Proper Training

The good jobs in Radio Electronics now go to the men who are equipped to handle them. It takes training and experience. National Schools, one of the oldest and best established technical trade schools in the country, makes it possible for you to get this training and experience right in your own home **IN YOUR SPARE TIME.**

Learn right! Get the latest short cuts, trade secrets, straight information.

National maintains one of the biggest resident training shops and laboratories in the United States where instructors, scientists and engineers are working constantly to improve and advance training methods. **SHOP METHOD HOME TRAINING** is a logical extension of this practical system.

A **FREE** lesson that shows you how practical and systematic—how solid, simple and easy this new training method is will be sent you without obligation. You may keep and use this lesson as you see fit. Fill out and mail the coupon below.

Investigate this Proposition

Where do you stand today in modern industrial progress? What does the future hold for you? You owe yourself this opportunity. It may never come again. With National training **YOU GET AHEAD FAST**—you may step into a good position or start a business of your own, with little or no capital, even before you complete your National course.

Fit yourself for a career of independence, good earnings, a lifetime of success and security in one of the fastest growing fields in the World. But make up your own mind. Get the information first hand. Put your name and address on the coupon and mail it today.

FREE LESSON

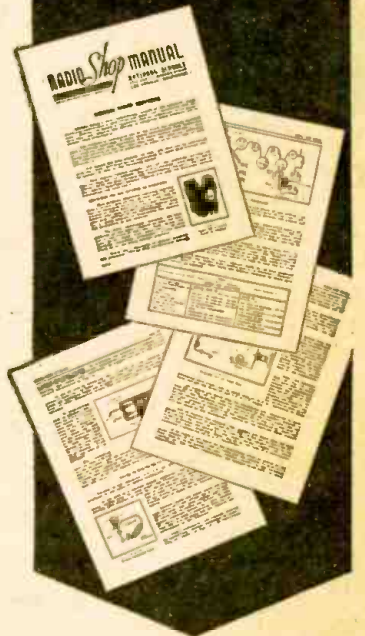

Get This Book FREE

This big book presents the facts about the field of electronics and your opportunities in it together with full information about the advanced National Training. Read it and make up your own mind that National Training will equip you for a great future. No salesman will call on you from National. The book is **FREE** with your sample lesson. Send the coupon or write,

See What National Training Has Done For These Men!

National Shop Method Home Training wins good jobs, independence and security quickly. Take the word of National men who have established records in their favorite Radio, Television, or other branches of Electronics:



Joseph Grumich, Lake Hiawatha, New Jersey writes: "My interest offer was \$5,800.00 as Radio Photo Engineer but I'm doing well where I am now engaged. I am deeply indebted to National."

Here's a statement from R. R. Wright, Blackfoot, Idaho: "Due to my training at National I was selected to instruct in the laboratory work of Navy and Marines."



From O. K. Ivy, Washington, D. C. comes this endorsement: "I believe National offers the best course to be had... Keep up the good work."

Robert Adamsen, Kearney, Nebraska, National graduate, has two radio jobs—makes double pay as a radio instructor and as engineer at Station KGFW. He writes: "I am proud of My National training and appreciate the cooperative spirit."



Read what hundreds of other enthusiastic students have written about National Training. Send in your coupon today.



NATIONAL SCHOOLS

LOS ANGELES 37, CALIFORNIA EST. 1905



MAIL OPPORTUNITY COUPON FOR QUICK ACTION

National Schools, Dept. RC-7
4000 South Figueroa Street, Los Angeles 37, California

(Mail in envelope or paste on penny post card)

Mail me **FREE** the two books mentioned in your ad including a sample lesson of your course. I understand no salesman will call on me.

NAME AGE

ADDRESS

CITY STATE

Include your zone number

Check here if veteran of World War II



CREI Home Study Training Can Equip You to Step Ahead of Competition and Gain the Confidence Born of Knowledge

CREI technical home study training prepares you for the secure radio jobs that pay good money for ability.

Yes, YOU, can be ready to enjoy the security of an important engineering position and take advantage of new career opportunities . . . *if* you prepare yourself *now*.

Join the thousands of other ambitious radiomen who have enrolled with CREI to assure themselves of secure, good-paying jobs with a planned program of advancement made possible by CREI home study training in Practical Radio-Electronics Engineering. You can study at home—in your spare time—develop your technical ability—increase your knowledge to keep pace with important developments now taking place in the industry.

By adding CREI training to your present radio experience you can safeguard your future and keep pace with such new developments as U.H.F. Circuits, Cavity Resonators, Pulse Generators, Wave Guides, Klystrons, Magnetrons and other tubes. Are you

equipped to handle them? CREI is equipped to help you, by providing the know-how and ability that is required.

In our proved method of instruction you learn not only *how* but *why*! Easy-to-read-and-understand lessons are provided well in advance, and each student has the benefit of individual guides and supervision from a trained instructor. This is the basis of the CREI method of training which many thousands of professional radiomen have completed during the past 19 years . . . training similar to that which CREI used in training thousands of radio technicians during the war for the U. S. Signal Corps, U. S. Navy and U. S. Coast Guard.

It costs you nothing to read the interesting facts . . . to learn how CREI can help you enjoy the security you want . . . the better paying job that can be yours. Write for particulars now! (CREI training for veterans is approved under the "G.I." Bill.)

• WRITE TODAY for FREE BOOKLET



"Your Opportunity in the New World of Electronics"

• Tells how CREI Courses can be adapted to your particular needs. If you have had professional or amateur experience—let us prove to you that we have something you need to qualify for a better radio job. To help us to intelligently answer your inquiry—PLEASE STATE BRIEFLY YOUR BACKGROUND OF EXPERIENCE, EDUCATION AND PRESENT POSITION.

Capitol Radio Engineering Institute

E. H. RIETZKE, President

Dept. RC-7, 3224 16th Street and Park Road N. W., Washington, 10, D. C.

Branch Offices:

New York (7): 170 Broadway
San Diego (1): 316 C Street

Chicago (2): 30 N. LaSalle Street
San Francisco (2): 760 Market Street

Member: NATIONAL HOME STUDY COUNCIL • NATIONAL COUNCIL OF TECHNICAL SCHOOLS



WHAT! THERE'S NO ONE
ON THE ENTIRE FORCE
CAN SERVICE OUR NEW
WRIST RADIOS? WE MUST
SUBSCRIBE TO RADIO
MAINTENANCE
AT ONCE!

**Let
Radio
Maintenance
Magazine
help you
keep up
with new
developments**

*"More of
everything
you want!"*

Articles monthly on:

- Television — AM — FM
- Public Address Systems
- Test Equipment — Tools — Service Kit
- Shop Layout — Service Bench
- Trouble Shooting — Alignment
- Business News

**Radio Maintenance
is not sold on newsstands**

**RADIO MAINTENANCE MAGAZINE
460 BLOOMFIELD AVE.,
MONTCLAIR, N. J.**

Special offer to Radio Servicemen

**Please send me
RADIO MAINTENANCE**

For 1 year 2.00 For 2 years 3.00

NAME _____

OCCUPATION _____

ADDRESS _____

CITY _____

ZONE _____ STATE _____

CHECK ENCLOSED* BILL ME LATER

*NOTE: By enclosing payment,
thus eliminating billing expense

WE WILL ADD ONE ISSUE FREE!

RC-7

YOU CAN GIVE BETTER, FASTER SERVICE with these

3

BALANCED
RESISTOR
ASSORTMENTS

STURDY, HANDSOME Resist-O-Cabinet

FREE WITH EACH ASSORTMENT

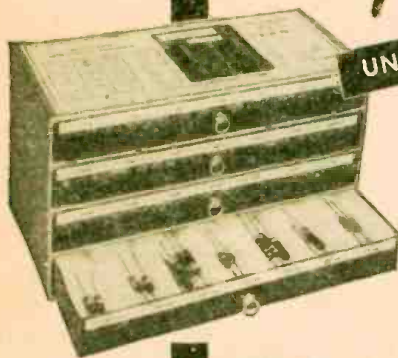

UNIVERSAL ASSORTMENT

Balanced resistor assortment. Includes 59 IRC Type BT Insulated Metallized Resistors and "universal" 10-Watt Power Wire Wound Types AB and ABA. The ABA (adjustable) type makes possible every range from a few ohms up to 10,000 ohms.



1/2 WATT ASSORTMENT

100 Type BW-1/2 and BTS Resistors. A complete assortment of most used ranges in the popular 1/2-Watt Insulated Metallized and Insulated Wire Wound Types.

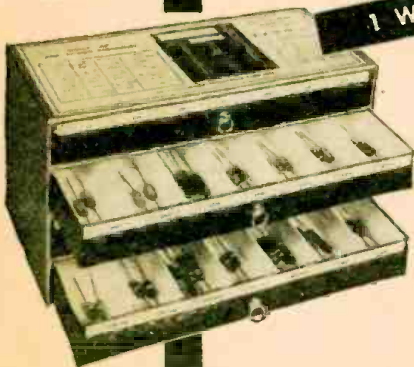

1 WATT ASSORTMENT

83 Type BW-1 and BTA Insulated Resistors. Every service engineer should have all of these top-quality 1-watt resistance ranges at his fingertips.

No one knows better than you that up-to-the-minute appearance and modern, efficient service pays off in your shop.

That's why IRC offers three Resistor Assortments to equip you for quick, easy resistor replacements on almost any job. Any one or all three IRC assortments, arranged according to type and range, are in neat, sturdy cardboard Resist-O-Cabinets that stack firmly one on top of the other. The cabinets are supplied absolutely free with each assortment ordered at standard resistor prices. Get in touch with your IRC distributor today

EASY TO STACK →

Bases of Resist-O-Cabinets are arranged for stacking so that several cabinets may be used to increase stock capacity.



INTERNATIONAL RESISTANCE CO.

401 N. BROAD ST., PHILADELPHIA 8, PA.

Canadian Licensee: International Resistance Co., Ltd., Toronto

SECRET COMMUNICATION

There are many media suitable for communications

THE art of secret, or private communication is as ancient as the human race. Ever since the dawn of civilization men have tried to perfect ways and means of communicating with each other privately or secretly—be it during peace time or in war. During the past 100 years science has enabled the communications field to expand enormously, and new means of communication have been invented in profusion.

The advent of electricity, and particularly the telegraph and telephone, have made strictly private and often secret communication easier. Thus, during war, even in the earlier days of the telephone and telegraph, special means were developed to make communication over these media as secret as possible in order that an enemy could not decipher the message. Special machines for coding purposes were invented, but few have proven to be "unbreakable."

Later on, when radio expanded, new means were found for private communication, but here also secrecy was only partial.

During peace time, for instance, when you telephone an overseas friend by the present radio transmission system, the ordinary person who has a short wave radio set cannot listen in on your conversation because the talk is split over two separate channels. Unless the listener has the combination and the special radio hook-up to combine the two messages into one, he hears only gibberish, which he cannot make out. This gives partial secrecy. Yet a radio engineer might hook up a special radio receiver to listen into anyone's Trans-Atlantic or overseas communication should he so choose. The secrecy, therefore, is not complete.

There are, of course, code machines and other means by which the secrecy can be almost perfect, but during the war it was found that *no* system could remain secret for long. All codes were eventually "broken."

This spurred on the technicians of all the warring nations as well as others to find some media which would be more secret than wire or radio.

The Germans possibly were the first to grab the ancient Alexander Graham Bell Photophone whereby one talks over a light ray without any intervening wires. The Bell Photophone was invented in 1880, and has often proven not only an interesting stunt for experimenters to converse with each other over a light ray for miles, but had also a number of commercial applications in the past. When radio amplifiers came into vogue the instrument could be perfected and made more sensitive by modern instrumentalities. Soon the Germans were using it in their so-called "Lichtsprecher" (lightspeaker) dur-

ing World War II. This is merely a refinement of the Bell Photophone.

With this instrument troops and command posts could talk over a light ray for many miles. The secrecy here was nearly perfect. Such a conversation could not be "tapped" easily between two points as long as the listener was not in a direct line between the points between which communication was carried on. Between two points, inaccessible to the enemy, it is therefore, possible to converse without much danger. It is possible to use ordinary sunlight as well as any other strong light source. The light beam is then modulated and communication established.

There are many other ways to communicate in a similar manner without using visible light rays. The Germans also early perfected a system whereby infra-red waves were used and this system also was fairly secure, particularly during night-time.

When one speaks over a visible light beam at night the position is apt to be given away to the enemy, and if he is within gun range he will try to destroy the source of the light, because he knows it is being used for communication. Not so with infra-red waves which are difficult to spot and difficult to locate, and, therefore, relatively safe.

So far, however, infra-red communication has not been satisfactory over greater distances than about ten miles. It is certain, however, that it will be improved in time; only the horizon will then limit the range of communication.

There are yet other means at our disposal as, for instance, ultra-violet ray communication. Very little about this has appeared in print and there are certain difficulties connected with it, but in due time ultra-violet radiation will also be used for secret communication.

Science does not stop here. We give a few more examples, which so far have not been described—to the best of our knowledge—

Human ears can only hear up to a certain point of the sound scale, thus any vibration beyond 15,000 cycles becomes inaudible to us. That is, for human beings, not for animals.

Thus dogs and particularly canary birds, can hear much further up in the sound spectrum than human beings. There is now manufactured a special dog whistle, which only dogs can hear. You blow it, but hear nothing whatsoever as the sound waves generated by this whistle are beyond human reach. The dog, however, hears it very well over quite a distance.

Scientists a few years (Continued on page 718)

AUTO TELEPHONE was made available last month to operators of motor vehicles in St. Louis, Missouri. Officials of the Bell Telephone System, which introduced the service, state that it is being provided on an experimental basis but under regular commercial conditions.

Three classes of service will be offered: a general two-way telephone service between any vehicle and any regular telephone or other mobile unit; a two-way dispatch service between a customer's office and his own mobile units only; and a one-way signaling service to mobile units.

The rates for a three-minute general service message within the area served by the St. Louis radiotelephone station range from 30 to 40 cents depending on the location of the land telephone. The charge for a one minute two-way dispatch call is 15 cents. The rates for most calls will not vary with the location of the vehicle. If the calling or called land telephone is outside the St. Louis service area, toll rates apply.

The radio equipment on the vehicle may be provided either by the customer or the telephone company. If furnished by the company, the monthly service charge is \$15 plus an installation charge of \$25.

The transmitting and receiving units, having a power of about 20 watts, will be located in the trunk of a car or in any suitable place on a truck. Each of the two units will be contained in a steel case approximately 10 inches wide, 18 inches long and 8 inches deep, and will weigh about 40 pounds. The single antenna for both sending and receiving will be approximately 18 inches in length, mounted on top of the vehicle.

The radiotelephone central office equipment employed in St. Louis includes a transmitting station and five

receiving stations. The antenna of the 250-watt transmitter is located on a 50-foot mast atop the Southwestern Bell headquarters building. The receiving stations are located in various sections of the city so that vehicles' relatively low-powered radio sets will be within range at all times. The receiver nearest a calling mobile unit will pick up the voice signals and send them on their way by telephone wire. Radio channels within the range of 152-162 megacycles have been assigned for the service.

THE RADIO PARTS SHOW, first since 1944, was held at the Stevens Hotel in Chicago May 13 to 16. It attracted a record attendance of 7,562 exhibitors and spectators, according to a report issued last month. This was considerably more than anticipated and is indicative of the widespread trade interest in new lines of radio merchandise. Attendance at the show was limited to manufacturers, distributors, manufacturers' representatives, publishers and a small number of guests.

Among the many products shown by radio and radio parts manufacturers, FM and television antennas were particularly noticeable. A number of entirely new products were exhibited, the most striking being a ceramic that acts as a modulated light source for a light beam telephone. As it was primarily a parts show, there were few exhibits of complete radio sets, though test instruments were well represented.



This mobile installation extends the communication facilities of the office to the car.

RADIO-ELECTRONICS

Items Interesting

RECEIVER PRODUCTION has levelled off at about a million sets monthly, according to a last month's report from the Civilian Production Administration. This amounts to approximately 90 percent of prewar production.

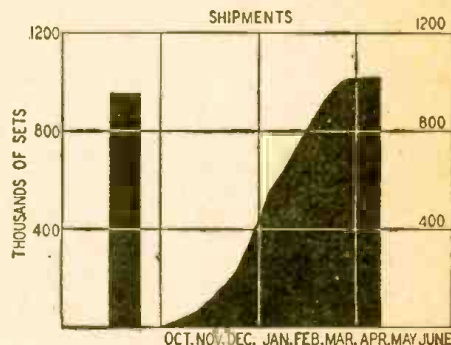

Graph shows radio shipments to April, 1946.

Construction of radios, which started from scratch last October, reached a rate of 500,000 sets monthly in the middle of January and one million in early March. The rate then remained constant for the rest of the month and through the whole month of April.

The figures are based on shipments of radios, and therefore may not exactly mirror production in all cases.

VETERANS who go into business prefer to set up radio service shops and stores or electrical appliance establishments, it was revealed last month by the Office of Small Business.

Inquiries to the office during the past year showed that nearly three times as many veterans wished to start business in these lines as in the next popular classification, apparel stores. Almost as popular as the apparel store are filling stations, grocery stores and restaurants, all of which elicited a little more than a third as many inquiries as the electrical-appliance-radio-store group.

RADIO TUBE PRICES were increased from 15 to 20 percent as of May 1st, it was announced by the OPA. The 20 percent manufacturers' ceiling price increase was given for replacement tubes, others being raised 15.5 percent. Cost to the consumer would not be affected, OPA said.

SYNCHROTRON, a new atom smasher, may split not only atoms, but the protons and neutrons themselves.

Discovered independently by Prof. Edwin M. McMillan, co-discoverer of neptunium, and the Russian scientist, V. Veksler, the new instrument will combine features of the betatron and cyclotron. It is expected to accelerate electrons to a potential of 300 million electron volts.

MONTHLY REVIEW

to the Technician

WARNING that Army surplus walkie-talkies and other radio transmitting equipment now being offered for sale *must not* be used by unlicensed persons was issued last month by the Federal Communications Commission. In many cases where equipment is offered to the general public, some people believe the sale implies a right to use the equipment. This is by no means the case, the FCC points out, and unauthorized use of such transmitters by the general public is illegal and subject to \$10,000 fine, or imprisonment, or both.

The Commission also pointed out that none of the equipment at present on sale is designed to operate in the 460-470 megacycle band allocated to the proposed Citizens' Radio Service.

SPORT BROADCASTING reached a new high in realism last month. The microphone was moved from its accustomed place at the ringside and actually inserted between the body of one of the boxers and the glove of the other. On-the-spot broadcasting!

Actually the mike was attached inside a catcher's mask worn by Stan Lomax, WOR's veteran sportscaster, in a sparring bout with Joe Louis, at his training camp in New Jersey.

Stan Lomax wished to tell his audience "how it feels to be in the ring facing the Champion," and hit on this as the best way. Translated into sound via the mike, light taps on the mask "felt" like blows from a battering-ram. The tough sports commentator managed to stay in the ring for one round, terminated by the referee when the mike broke loose from its fastenings.

A new era of sports broadcasting appears to have been opened, and we can look confidently forward to a televised scene of a fight in which both the contestants wear u.h.f. pack sets. The ra-

dio owner will then both see and hear the blows, and sportscasters will be unnecessary.

AMATEURS now have available a large number of bands. As of June 1st, all restrictions had been lifted from the old 80-meter band, giving the ham the operating frequencies of 3.5 to 4 mc that he enjoyed before the war.

The following frequencies and types of emission are now authorized:

27.185 to 27.455 mc	A0-A1-A2-A3-A4-FM
28.0 to 29.7	A1
28.1 to 29.7	A3
29.0 to 29.7	FM
50.0 to 54.0	A1-A2-A3-A4
52.5 to 54.0	FM
144.0 to 148.0	A1-A2-A3-A4-FM
235.0 to 240.0	A1-A2-A3-A4-FM

420.0 to 430.0, 1215 to 1295 mc, 2300 to 2450 mc, 5250 to 5650 mc, 10,000 to 10,500 mc, and 21,000 to 22,000 mc bands are available for A1, A2, A3, A4, A5 and FM transmissions. The peak antenna power on the 420 to 430 mc band shall not exceed 50 watts. The portion of the 144 to 148 mc band lying between 146.5 and 148.0 mc shall not be used by any amateur station located within 50 miles of Washington, D. C., Seattle, Wash., or Honolulu, T. H.

Licensed operators are permitted to operate on any frequency above 30,000 megacycles using any type of emission.

SELECTIVE ABSORPTION of very short radio waves may limit propagation at super-high frequencies, reported the recent Cambridge meeting of the American Physical Society.

Water vapor molecules absorb a wavelength of one and a quarter centimeters, while the oxygen molecules absorb a wavelength of half a centimeter.

FIRST AMATEUR CONTACT on the 2300-2450 megacycle band was claimed last month by two General Electric engineers, George H. Floyd, W6OJK/2, and Arthur R. Koch, W9WHM/2. The contact was between two buildings in the Schenectady G.E. works, and was on phone.

The ultra-high-frequency apparatus used disc-seal 2C40 "lighthouse" tubes and parabolic reflectors. One at least of the stations was a transceiver.

This is not the first amateur communication on the ultra-highs, as operation was carried on in the 5250-5650-megacycle band some months ago. (RADIO-CRAFT, May, 1946). It does mark the opening of a new ham-band.



Above—One of the two 2300-2450 mc stations.

Below—The two constructors adjust their apparatus. Wire-mesh parabolic reflector ahead.



Joe Louis and Stan Lomax meet in the ring.



HOW MINE DETECTORS WORK

Secret Wartime Device Now Described

METAL finders or treasure locators have long intrigued the adventurous experimenter's imagination. With the coming of war, the metal locator came of age. Called a *mine detector*, it was produced in the hundreds of thousands and used all over the world. Much interest was aroused in the instrument, but military

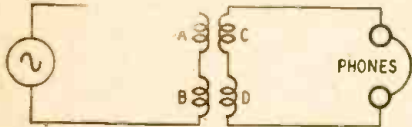

Fig. 1—Fundamental Hughes Balance Circuit

secrecy covered all details of its effectiveness, operation or even theory.

The principles underlying metal detectors were well known long before the war. Most of them work on the balanced field principle, used to detect the presence of metals at least 60 years ago (Hughes Balance Metal Detectors, *RADIO-CRAFT*, January, 1944). The detector widely used for locating metallic mines resembled the original Hughes Balance very closely, even using a relatively low audio frequency instead of the r.f. waves used by most of the later treasure locators.

The Hughes Balance, in its original form, consists of four coils. Two of these are connected in series with a source of alternating current. The others, coupled to the first two, are connected in series-opposing, so that the signal induced by A in C (Fig. 1) is cancelled out by the signal induced in D by B. If coupling between the two coils is perfectly balanced, there is no signal in the phones.

Variations in the circuit are employed in practical mine detectors and metal locators. One used in standard Army equipment consisted of three coils, two of which were connected to the transmitter and one to the receiver. The two transmitter coils were so connected and coupled that no signal was introduced into the field of the third or receiver coil. Another system, much used in radio-frequency metal locators, employs one transmitter and one receiver coil, so positioned that coupling between them is zero. Equipment using a large vertical transmitting loop and a horizontal receiving loop belong to this class.

These various balanced circuits have one feature in common—if any conducting material is introduced into the field surrounding the loops the shape of the field will be altered, and with it the

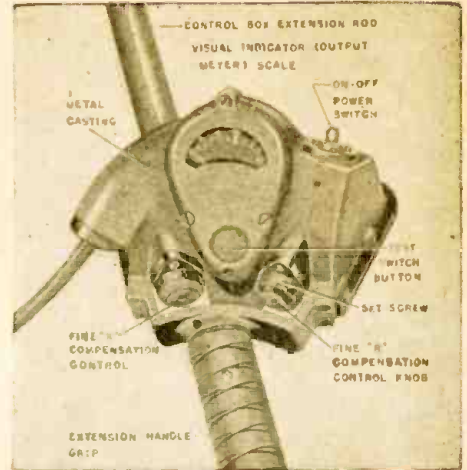

Control head, showing the visual indicator.

coupling. Thus zero coupling will no longer exist, and a signal will be heard in the output.

A disadvantage of the two-loop sys-

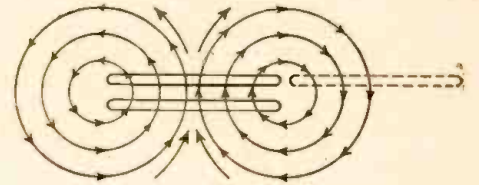
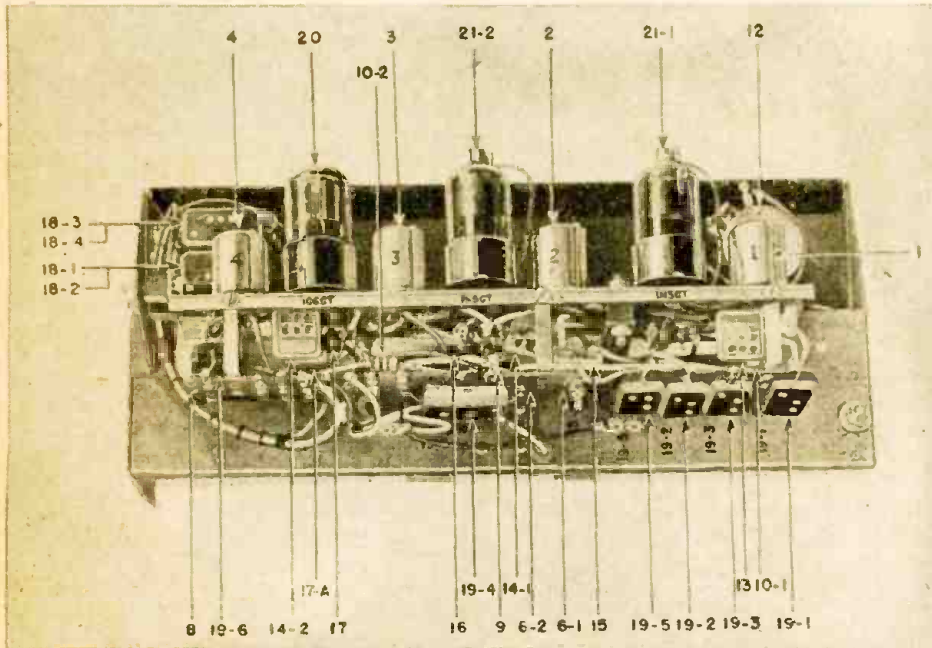

Fig. 2—Reversal of coupling between coils.

tem has been that—to get zero coupling—the two loops have been widely spaced. A common type consisted of a frame carried by the operator, on which the transmitting loop was mounted two or more feet behind his back, and the receiving loop two or three feet ahead of him. The rear vertical loop measured about two feet across and was carried approximately four feet above the ground, while the receiving loop—roughly the same size—was carried horizontally as near the ground as expedient. Such a bulky device would hardly do for military use.

To bring this device into usable form, the problem of zero coupling was attacked in a new, ingenious manner. If two flat coils are placed so that the receiving is directly above the transmitting coil, they are coupled as shown at the left side of Fig. 2. If the receiving coil is removed and laid down beside the transmitting coil, they will still be coupled, but in the opposite direction. (Note arrows showing direction of force field.) Obviously if the one coil is slowly slid sidewise from the first position, coupling will decrease to zero at some point, then reverse in direction as the two coils are further separated. The mine detector search head is based on this principle. The coils in the search head are so positioned (Fig. 3) that



The improved American mine detector with 1G6, showing positions of all components.

- | | |
|--|---|
| <p>No. Description of part.</p> <p>1—Input transformer, search coil to grid. Pri to sec ratio 1:80, pri inductance .035 H.</p> <p>2—Plate choke, 50 H at 1 ma d.c.</p> <p>3—Output transformer, pri to sec ratio 10:1, pri inductance 35 H.</p> <p>4—Osc transformer, plate to sec ratio 24:1, grid to sec ratio 12:1.</p> <p>6—10,000 ohm resistor.</p> <p>8—3,300 ohm resistor.</p> <p>9—4.7 meg resistor.</p> <p>10—1 meg resistor.</p> | <p>12—750-ohm wire-wound potentiometer.</p> <p>13—.001 μf mica condenser.</p> <p>14—.05 μf mica condenser.</p> <p>15—.0002 μf mica variable condenser.</p> <p>16—.01 μf molded paper condenser.</p> <p>17—.02 μf mica condenser, 17-a .002 mica.</p> <p>18—1 μf oil filled paper condenser.</p> <p>19-1—.02 μf paper condenser.</p> <p>19-2, 19-3, 19-5—.05 μf paper condenser.</p> <p>19-4—.25 μf paper condenser.</p> <p>20—1G6-GT tube.</p> <p>21-1, 21-2—1N5-GT.</p> |
|--|---|

coupling is zero until the field around them is distorted by introduction of a mass of metal. Then some coupling takes place and a signal is heard in the phones.

The coils shown in Fig. 3 are each wound with 800 turns of No. 29 or 30 single silk enamel covered wire. Positioning for zero coupling is found by actual experiment and the coils then sealed into place with wax.

THE CONTROL BOX

Any variations due to change in physical characteristics because of age, rough handling, or which may be introduced by electrical changes in the circuits to which they are connected, are compensated for by a pair of potentiometers, one of which balances out any stray capacity, the other coupling of a resistive nature between the two coils. These are shown in the dashed square marked "Control Head" in Fig. 4. The figure diagrams the simplest type of mine detector, which originated in England early in the war, and was afterward made in large quantities on both sides of the ocean. The potentiometers are both across the receiver coil, with a resistor or condenser in the movable arm connected to one side of the transmitter coil.

The control box is mounted on the handle of the instrument. In late models, this box also contains a meter for visual indications. A cable from it runs to the amplifier-oscillator unit, which was usually contained in a bag slung over the operator's shoulder. In the type shown in Fig. 4, this unit contains three tubes of the 1N5 or a similar type. One of these acts as a 1,000-cycle oscillator, (Continued on page 721)

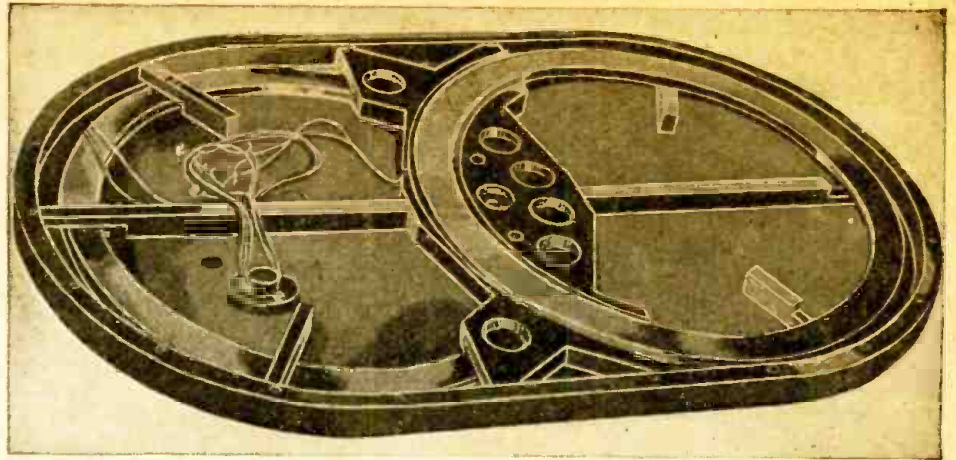

Fig. 3—The search head, showing how top coil is displaced to a position of zero coupling.

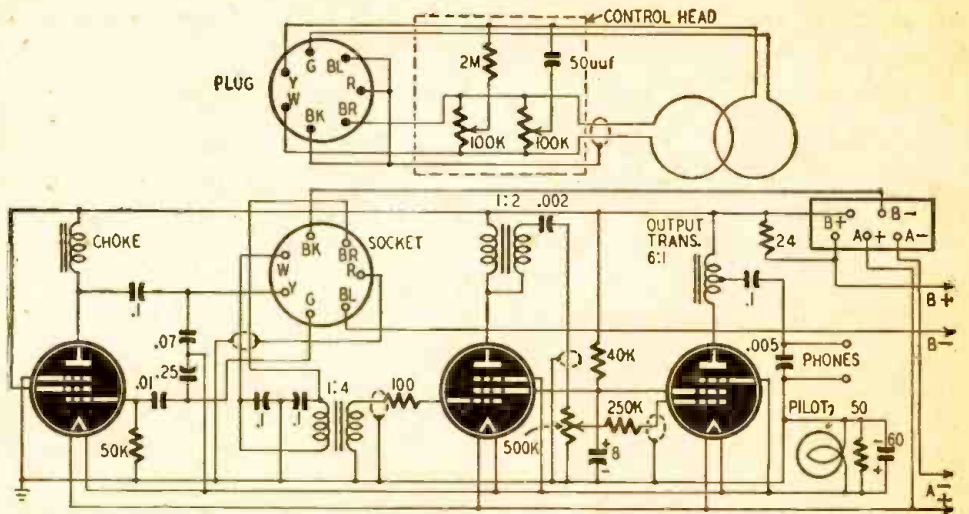

Fig. 4—Earlier and simpler mine detector. Oscillating and receiving circuit elements are tuned to 1000 cycles. "Off-On" switch is in battery unit (coded plug, at center right).

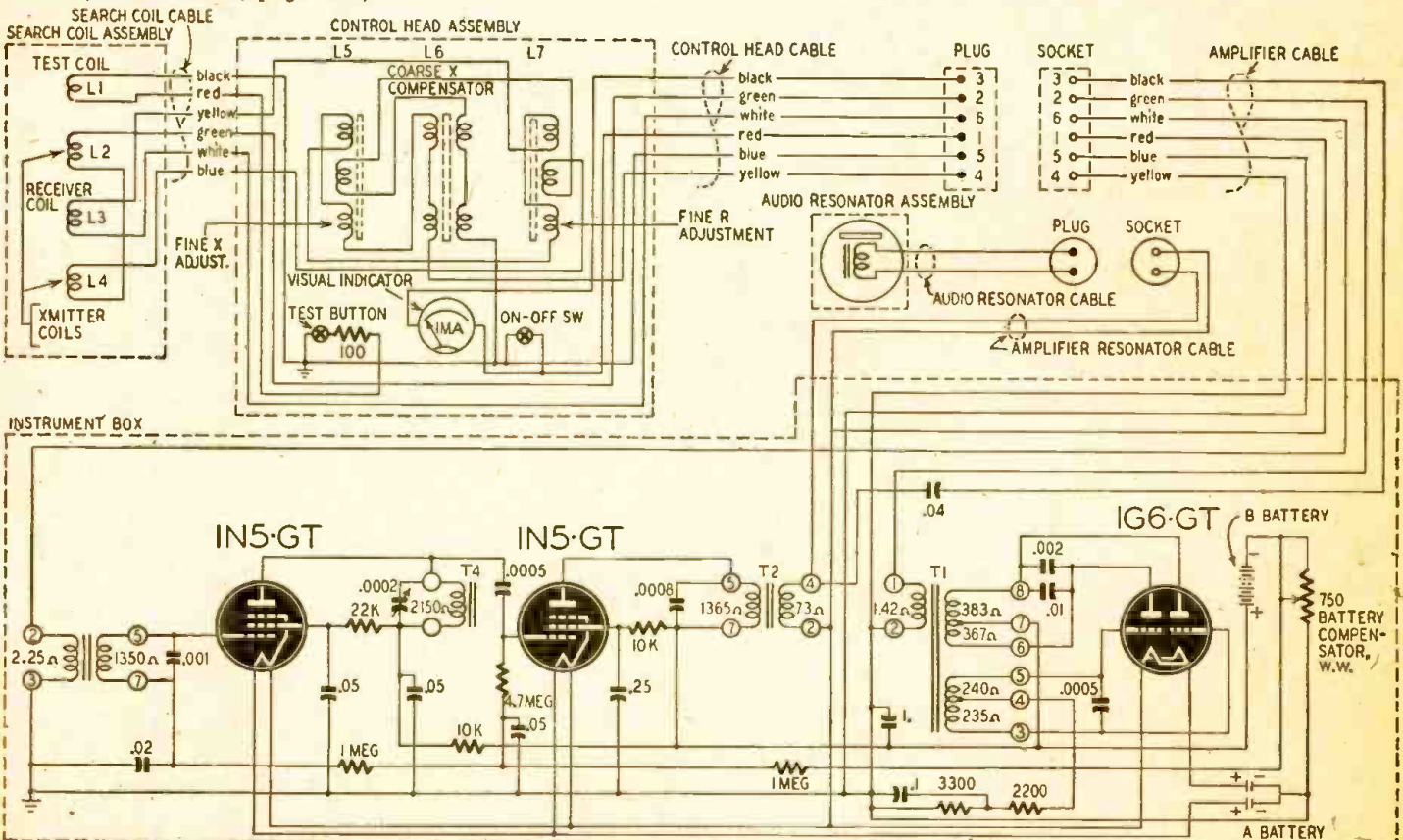

Fig. 5—Mine detector shown on opposite page. Search head has four coils, and compensators are adjusted by movable iron and brass cores.

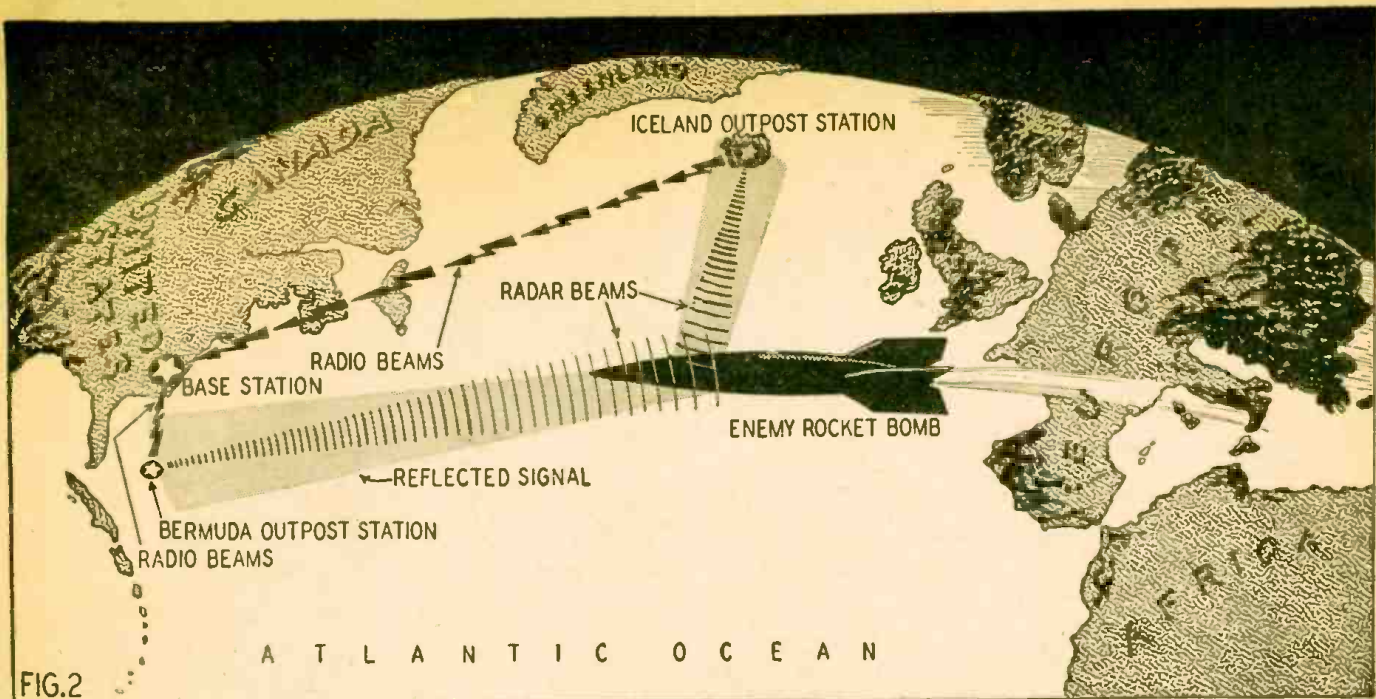

FIG. 2

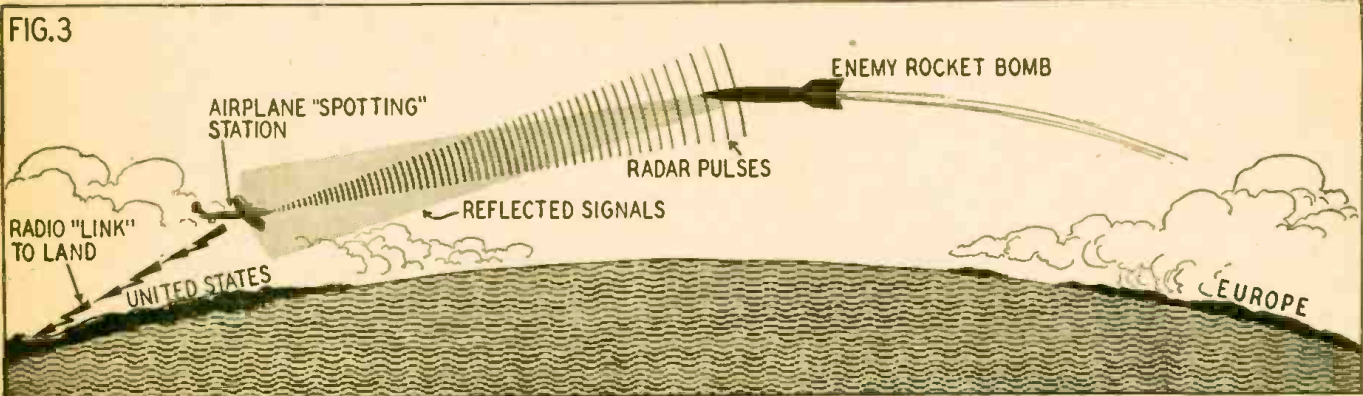

FIG. 3

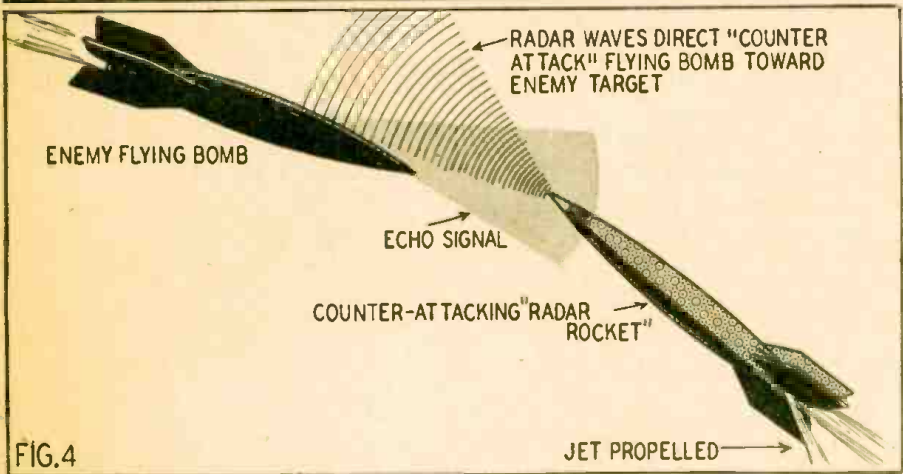

FIG. 4

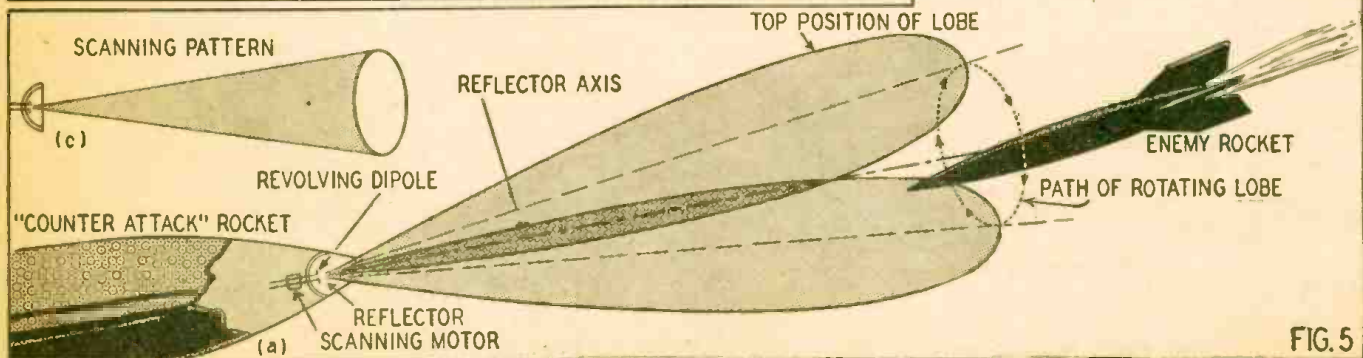
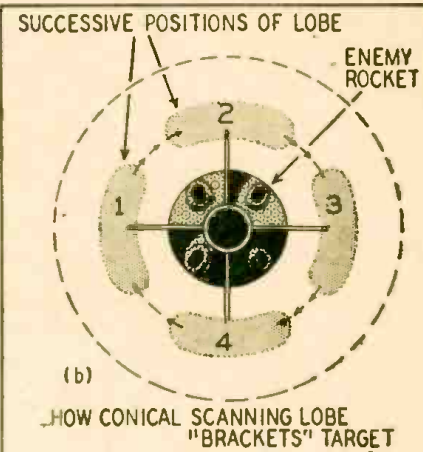

FIG. 5

RADAR ROCKETS

May Be the Answer to the Rocket Bomb

ONE of the problems now engaging the attention of our military experts is to provide a strong defensive weapon to combat flying rockets and bombs. In the next war—should one occur—the enemy will loose a barrage of long-range rocket bombs on our cities and vital industrial plants. Some of these will doubtless be atomic bombs. High speed jet-propelled fighter planes may knock down some of them, but some surer way of fighting such an attack is needed. Counter-attack rockets immediately suggest themselves.

Microwave radars can be designed to direct the counter-attack rocket so that it literally chases the enemy rocket and explodes as it nears the missile, thus destroying it before it has a chance to reach its target.

Figure 1 shows a tentative plan for the positioning of the radar apparatus in the rocket, also the disposition of the explosive and the control mechanism.

It may be objected that the tremendous speeds of rockets may not allow time for such defense, but this is not the case. Even at a speed of 3,000 miles per hour, a rocket launched from the (for rockets) close range of 500 miles would take a minimum of ten minutes to reach its target. Actually the time taken would be much longer because of the curved trajectory. Trans-Atlantic rockets would travel much more than an hour.

The time allowed for launching the counter-attack rockets can be lengthened by erecting radar *outpost listening* stations at such points as Iceland, Greenland, Bermuda and other outlying places (also at similar Pacific stations) for spotting the approach of enemy rocket bombs. (Fig. 2.) These stations would be continually on watch. The information gathered by them would be relayed automatically to the main *base station* on the mainland by radio, and counter-attack radarockets sent out to apprehend the enemy missile and destroy it before it reached within striking distance of the mainland.

Another plan is shown in Fig. 3—an

airborne long-range radar station. The flying radar station would maintain radio contact with the ground bases for transmission of target location data; an accurate location "fix" or position for the enemy rocket can be supplied at any moment, or its course may be plotted continuously. The station directing the radarocket can then combine the information received from two or more of these *spotters* to plot the coming rocket's trajectory and aim a fighter rocket in the proper direction to meet it. Electronic equipment could do all this automatically and the release would be almost instantaneous.

The radarocket would ascend rapidly, using jet propulsion. Upon approaching the target it could be detonated by the same means so successfully used in the thousands of *proximity fuze* shells employed against the enemy in the war just ended. In this device a radio wave was sent by the shell's miniature radio transmitter; reflected radio waves picked up from the enemy target (such as a plane) by the receiving set carried in the shell caused it to detonate when it came to within a distance of about seventy feet of the target.

In another plan the course of oncoming enemy missiles is plotted by radar and the launcher carefully aimed so the radarocket will intercept it. When this hoodhound of the air comes within a reasonable distance of the enemy bomb or flying rocket, it sends out a microwave which is reflected by the enemy missile (Fig. 4). These reflected waves are picked up by a receiver carried by the radarocket and keep it on the trail of the target.

This may sound far-fetched, but we have only to recall that some radars used in World War II would track an airplane in flight and automatically aim antiaircraft guns at it. These radars used conical scanning to achieve this feat.

The principle of conical scanning (Fig. 5) is that of using a reflector to concentrate or beam a pulsed signal in a *lobe pattern*—and then cause the lobe to rotate around the axis of the reflector.

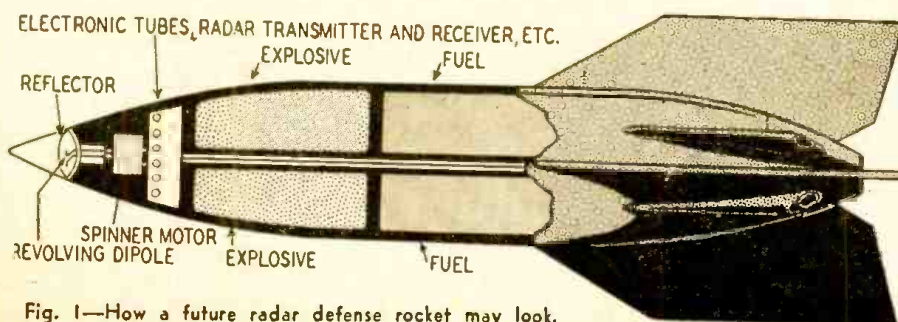

Fig. 1—How a future radar defense rocket may look.

Harry Winfield Secor was born in Brooklyn, June 11, 1887. Studied electrical engineering in Philadelphia and New York. Worked as electrical inspector and power plant engineer 1910 to 1912. Has occupied many positions in the radio technical and journalistic world, among them: assistant editor MODERN ELECTRICS, 1910 to 1912; engineering department, Western Electric Co., 1912 to 1914; managing editor, ELEC-



TRICAL EXPERIMENTER, 1914 to 1919 (engineer to Electro Importing Co. during the same time, designing several arc generators, quenched spark sets and amplifiers); managing editor, SCIENCE AND INVENTION, 1919 to 1929. Lectured weekly on radio and popular science subjects over Radio WRNY, New York, 1926 to 1929. Was managing editor of SHORT WAVE CRAFT, AVIATION MECHANICS, TELEVISION NEWS, RADIO & TELEVISION, MODEL CRAFTSMAN, etc.

During his long career in radio writing, Mr. Secor wrote a number of books, including "How and Why of Radio Apparatus," "Induction Coil and Transformer Construction," "Simple Electricity Experiments" and was co-author with S. Gernsback and Austin Lescarboura of the "Wireless Course in 20 Lessons" (used in teaching many radio students in World War I).

Hobbies: Radio and Television set receiver construction; interpreting scientific subjects for the non-engineering reader.

A tiny dipole antenna is mounted off-center in the reflector and is rotated by a small *spinner* motor. Only two successive positions (5-a) of the lobe are shown, for the sake of clearness. Note (5-b) that the rotating radio lobe projected by the dipole *brackets* the enemy target (a flying bomb for example).

Figure 6-a shows how the strength of the reflected echo signal from the target varies for different positions of the lobe, when the target is off the center-line of the reflector. When the target is on the reflector center-line (6-b) the strength of each reflected signal is of equal amplitude. Thus the pulsed signal actually scans the target.

The varying strength of the reflected signal actuates a correcting mechanism (operating the vertical and horizontal rudders, or firing "course-correcting"

(Continued on page 720)

NEW FACSIMILE IS FAST

Home Radio Newspaper Can Be Combined with FM Receiver

IT IS more than possible that the morning paper of the future may be started printing by an automatic relay set to turn on the facsimile printer at four or five o'clock in the morning, and completing news, fashions, sports, comics and picture section before breakfast time.



Mr. Hogan stands directly behind the transmitter's scanning drum.



How the newspaper is delivered from the home facsimile receiver.

Facsimile transmission is by no means new, and has been used for both wire and radio transmission of pictures, drawings and printed matter. During the war radio and wire facsimile systems transmitted maps and drawings which could not have been sent instantaneously by other means. RADIO-CRAFT in particular was interested in the "radio newspaper" and the April, 1934 number pictured such a receiver on its cover and devoted an article to the subject.

One serious drawback prevented the radio newspaper from becoming an actuality. Speed of transmission was fatally slow—from 30 to 50 words per minute. The new system developed by J. V. L. Hogan, produces copy at over 250 words per minute—faster than the pace of the average reader. The actual paper speed is 28 square inches per minute, words or picture copy. This amounts to over four 8 x 11 1/2-inch pages per 15-minute facsimile broadcast period.

The facsimile broadcaster described here is designed to operate in conjunction with an ordinary FM transmitter. A steady 10,000-cycle note is modulated by light reflected from the matter to be transmitted, the actual modulating frequencies running up to 3,000 cycles. These modulate the 10,000-cycle note, producing a band from 7,000 to 13,000 cycles. The transmission is audible as a high-pitched, varying whistle.

The varying note is applied to a standard FM transmitter and transmitted, received and detected by standard FM methods. The signal is then fed into the facsimile receiver and made to reproduce the original visible matter.

The console shown consists of two scanning drums for transmission of the material, and two monitors. The one at the left monitors the output of the transmitter constantly, (Continued on page 707)



One side of transmitter console. Photo at top shows other side.

BROAD-BAND ANTENNA

Arrays adapted to V. F. Transmissions

MULTI-ELEMENT close-spaced rotary-beam transmitting antennas are today one of the most widely used arrays for amateur operation. There are a number of good reasons why.

First of all, they're compact: they occupy a tenth the space of a long-wire system of comparable gain, and are therefore ideal for apartment house or other installations using the smallest possible space.

Another thing, they can be pointed in any great circle direction with ease, and concentrated on any given station

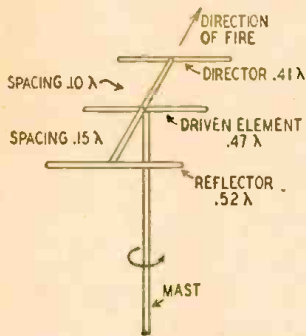

Fig. 1—3-element array, showing dimensions and spacings for 15 percent more bandwidth.

within a few moments' notice, a feat impractical if not impossible with long-wire arrays. Their gain in delivered microvolts-per-dollar is extraordinary in comparison with expensive increases in transmitting apparatus.

From a technical as well as a practical standpoint there is one serious shortcoming to the ordinary multi-element close-spaced array: its gain and compactness depend upon close spacing between antenna elements, which in turn exacts a heavy *penalty* in the form of frequency response. Erect a three-element beam for amateur operation on 28,500 kcs, let's say. Properly adjusted, it performs excellently at that frequency. But deviate from that frequency very much and gain rapidly falls off, radiation patterns shift, impedances become mismatched, and severe losses appear in the line.

This same effect applies to high-gain antennas for long distance short-wave reception alone. Let's say you've erected a rotary for extreme broadcast DX on or about 15,000 kcs. You find that Saigon comes in very well on 15,125 kcs, but experience shows great difficulty with All-India Radio on 15,450 kcs. The reason: your antenna gain has fallen way off at that frequency, with India's signals far down in static and tube noise. You may well attribute such poor reception to "conditions," but it's likely to

be your array which, performing excellently on the frequency you designed it for, simply won't work well off that frequency.

Now, there are two interesting technical features in a three-element close-spaced beam. Your director element, placed in front of the driven element (to which feeders connect) leads the signals forward when transmitting. Your reflector acts in concert to screen signals from travelling to the rear, and reinforces the forward radiation. The relationship is complex, but that's about it in simple terms.

To act as a director your first element must present capacitive reactance to the center driven element, and thus be electrically shorter. The reflector must present inductive reactance, and thus be electrically longer. As you shift frequency, your rod and element length naturally doesn't and can't change. Shift your frequency far enough and the electrical relationship between elements so radically changes that the antenna is no longer a beam but merely a collection of pipe.

If you could take a week or so off to concentrate on the higher math involved in the problem you'd find five or so interlocking variables which, with further analysis on the subject, would lead you to the fact that if certain carefully derived lengths were found and used, these variables would shift in equally opposing directions over a far greater number of frequencies. You'd thus find your useful frequency range would be broadened several times. Putting into practice these figures not only allows you to have a high-gain array on a center operating frequency, but one which will provide high gain over a good segment of the dial.

Measurements show that the average three-element close-spaced amateur array has an effective frequency response of about 2 percent of the frequency for which it's designed until a 2 to 1 standing wave ratio appears on the line, materially reducing its performance. This improved broad-band array, how-

Major Harold B. Churchill, after vagabonding around Europe for a few years, attended Princeton University. In 1930 became a floor member of the New York Stock Exchange for his own securities firm. In 1935 became active in oil well drilling and geophysical research, two years later becoming one of the editors of Time Magazine. Subsequently a contributor to



Colliers', the Reader's Digest and other publications, was attached to the Signal Corps Laboratories and the Signal Corps Publications Agency during the war, where he wrote and was in charge of the editing of technical manuals covering radio equipment. Main hobby is amateur radio operation, having held the calls 1AQA, 1BJZ, 2API, 2APO, 3ZJ, W1ZC, and his present call, W2ZC.

ever, has a measured frequency response of 15 percent before a similar standing wave ratio appears. It provides a measured gain of 5.6 db over a comparison dipole at the same height above ground (in most measurements 3 wavelengths). Measured front-to-back ratio is 16 db, horizontal pattern covering 35° each
(Continued on page 727)

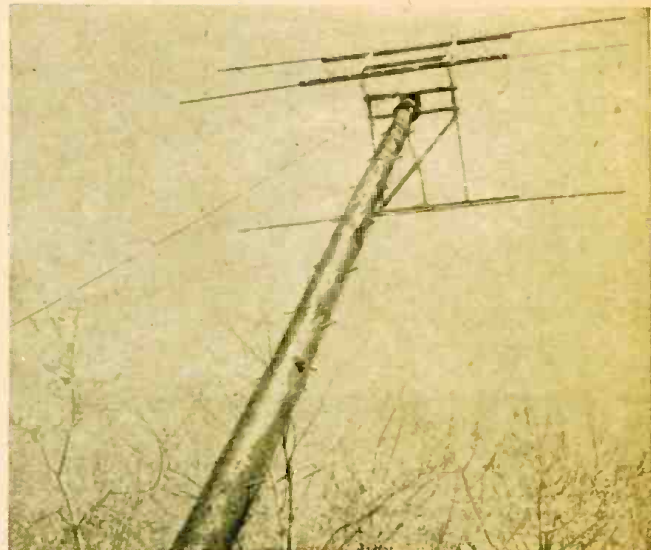

Courtesy U. S. Signal Corps, Fort Monmouth
Spacing and dimensioning can make arrays like this more versatile.

RADIO IN THE ATOM TESTS

Electronic Specialists Will Learn Much at Bikini Atoll

PROBABLY the most elaborate scientific tests ever carried out as far as the number of people, amount of equipment and total expense are concerned will be the atomic energy tests this summer. For the gigantic task of measuring and determining the amount of damage an atomic bomb can do, Joint Army-Navy Task Force One will send three elaborately equipped laboratory ships to Bikini Atoll (Fig. 1). These ships will carry

The technical staff will consist of over 1000 technicians. These men will be divided up into nine specialist groups or divisions: bomb operation; blast pressure and shock; wave motion and oceanography; electromagnetic propagation and electronics; radiological safety; radiometry; radiation; remote measurements; and technical photography.

In the field of wave motion, supersonic echo sounders will measure the vertical motion of both the target ships and the buoys at a distance from the explosion, while pressure recorders on the bottom will record water depth versus time by measurement of hydraulic pressure. In addition, seismographs will be set up on the islands around the atoll to observe the propagation of shock waves through the earth and thus obtain information on the geological structure of the atoll.

The electromagnetic propagation and electronics division will make studies of the effect of the atomic bomb explosion on the propagation of electromagnetic waves. These tests are planned to show the influence of the intense local ionization resulting from the detonation on both sky and ground wave transmission. Other experiments will show the radar reflective properties of the bomb cloud and the intensity of the atmospheric electrical disturbances developed by the explosion.

Standard Navy, Signal Corps, and

Air Force radar equipment as well as special devices constructed for the tests will be used to measure electromagnetic propagation. The area to be tested, the distance covered by the blast, and a time base are shown on the diagrammatical chart in Fig. 2.

Army Air Force "drones" will carry Geiger counter warning circuits and special transmitters to determine the effect of the bomb explosion in the 5-to-9-megacycle region. It is not known at present what effect the bomb cloud will have in radio or radar interference or reflection.

The radiological safety section is charged with protection of personnel from radiological hazards after the blast. This includes responsibility for measurement of radiological phenomena in the areas to be entered by various personnel and for tracking the movement of radioactive air and water masses caused by the explosion. The primary safety device is the Geiger counter which indicates radioactivity by a clicking sound, a cathode-ray tube or the movement of a hand on a dial. Additional safety devices are ionization chambers, specially sensitized films, and chemical capsules which indicate total radioactivity from the measurement of induced radioactivity.

Radiometry is the subject of study of another staff section. Radiometry is defined for the purposes of the atom bomb tests, as a measurement of light in the visible spectrum and adjacent wave bands (ultra-violet and infrared). This is distinguished from the staff section which is concerned with

(Continued on page 716)

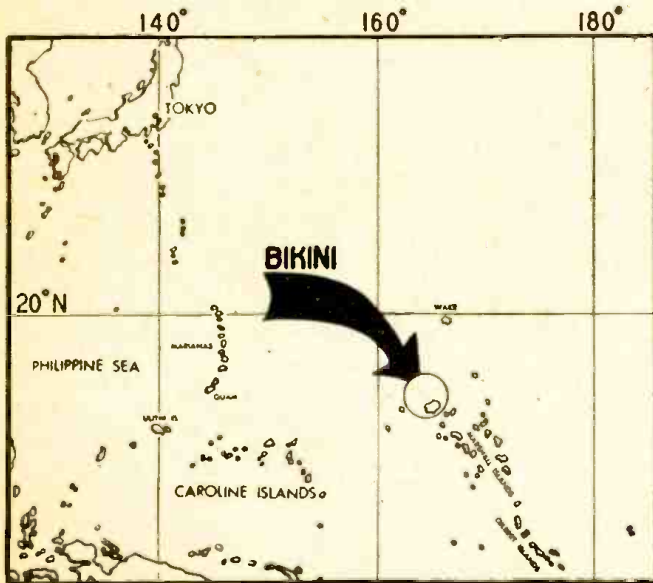

Fig. 1—Bikini was selected for its remoteness from land areas.

many of the nation's top-ranking scientists with all equipment and instruments necessary for conducting the tests. One ship will be devoted entirely to electronics and will carry such equipment as radar units of the most advanced design, Geiger counters, radiology equipment, long-range television apparatus, seismographs; all in addition to the standard radio transmitting and receiving apparatus.

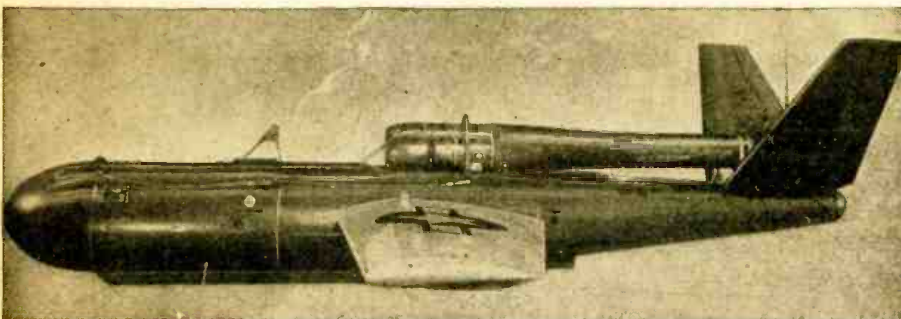

Photo A—The Kadydid, radio-controlled drone. Length, 11 ft.; span, 12 ft.; speed, 200 m.p.h.

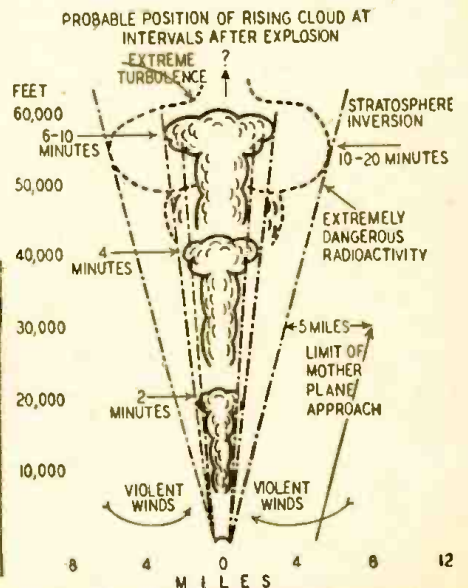

Fig. 2—How the blast is expected to develop.

TELEVISION FOR TODAY

Part II—Scanning Tubes and Methods

WE HAD a general, overall view of a television system in the previous article. Now let us concentrate on the action within a television camera. Then we will go to the receiver and examine each section in detail. The camera is chosen first because unless we understand its operation, much of what is done at the receiver is meaningless.

An *Iconoscope* camera tube is shown in Fig 1. The scene is focused by an optical lens system onto a mosaic plate within the tube.

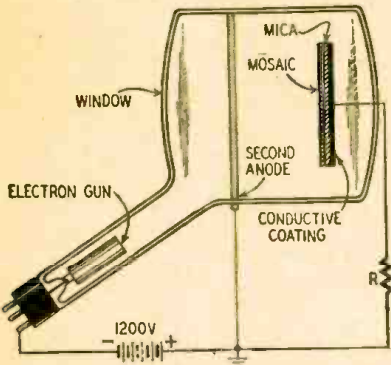

Fig 1—Cross-section of Iconoscope. Second anode is a ring around the inside of the tube.

The plate consists of a thin sheet of mica (an insulator) upon the front of which has been deposited a single layer of microscopic globules of a sensitized caesium-silver compound. In the process of construction each globule tends to dissociate itself from all the other globules, much as water acts when poured over an oily surface. Electrically, then, any change that affects one globule will not affect any of its neighbors.

Each caesium-silver globule reacts to any incident light, causing emission of electrons. Thus, the televised scene, in being converted to electrical charges, is automatically broken down into a series of minute elements, much like the grains of a photographic strip of film. This is the first step in the process of converting the light rays into equivalent electrical currents. At each point, the electrons emitted from a globule will be directly dependent upon the intensity of light. Since each globule is electrically independent from all the others, all variations in light intensity at different points in the scene will be in like measure changed to electrical charges.

The electric charge on each globule is utilized through a scanning electron beam and a conductive coating located

on the reverse side of the mica mosaic plate. The electron beam, generated in the neck of the Iconoscope, is forced by deflection coils to sweep across the mosaic plate in a series of lines as indicated in Fig. 2. As the beam passes over each globule it replaces the electrons lost due to the light rays. Since each globule tends to form a charged condenser (with the second plate the conducting surface on the other side of the mica), replacement of the lost electrons acts to discharge this condenser combination, with the formation of a pulse of current through the load resistor R shown in Fig. 1. Hence as the beam sweeps along, it sends fluctuating pulses of currents through R, each pulse varying proportionately as the original light from the scene. We have thus completed the transformation of light into equivalent electrical video currents. These currents are amplified and used to modulate a fixed carrier to form the transmitted signal to be picked up by the receiver.

ELECTRON BEAM SCANNING

The image formed on the mosaic can be analyzed by several methods. We can break the image down into a series of horizontal lines, as shown in Fig. 3-a, a series of vertical lines, as shown in Fig. 3-b, or by means of an ever-widening spiral, as in Fig. 3-c. Of these three methods (and there are many more), horizontal scanning has been adopted as standard. In this method, the scanning beam starts at the upper left-hand corner and progresses to the right until the edge of the mosaic is reached. From this point the beam must be quickly brought back to the left-hand side and the left-to-right scanning sweep begun again. The retrace motion must be as quick as possible, for during this time the beam is completely blanked out and no information appears on the screen. The sequence of left-to-right

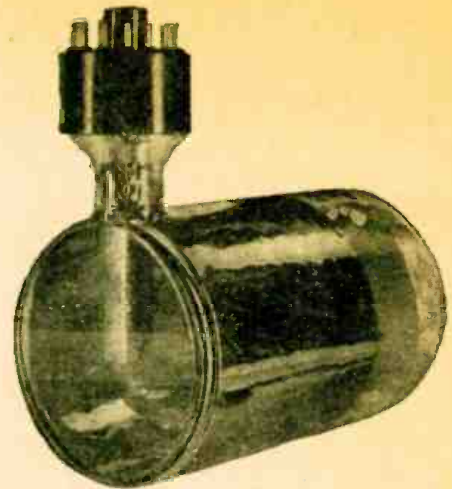

Photo A—A Farnsworth image dissector tube.

sweep of the beam, when information is being traced out on the screen, plus rapid retrace while the beam is getting in position for the next line, is repeated over and over until the bottom of the image is reached. From here the beam is brought back to the top of the image, and the entire sequence repeated. Fig. 2 indicates the method pictorially.

The above description explains the

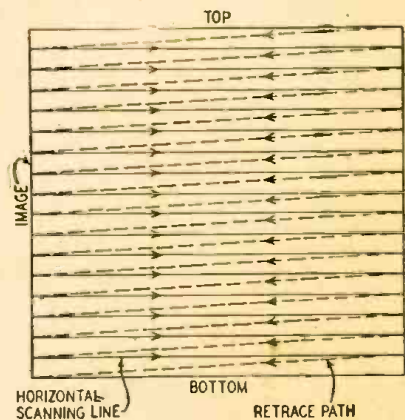
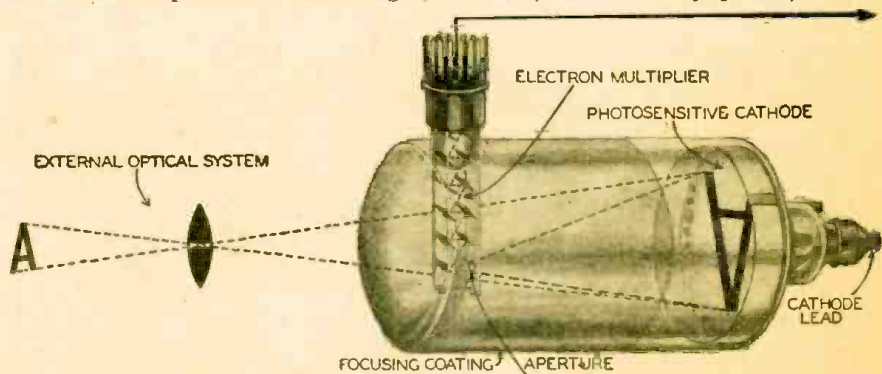

Fig. 2—Electron beam path, simple scanning.

method in use today. For ease in operation and to present a smoother image at the receiver, two modifications have

(Continued on page 712)



In the dissector tube, the whole electronic image field is "scanned" past the aperture.

INSIDE THE HANDIE-TALKIE

War's Smallest Two-Way Radiophone

THE Handie-Talkie is perhaps the most widely known and well liked radio set developed during the war. Its efficiency at short ranges and its compactness created a demand for this set in practically all branches of the service. Called by the Signal Corps "Radio Set SCR-536", the Handie-

Talkie is built into a metal case 3 5/8 x 5 3/4 x 15 3/4 inches long. This space contains a receiver-transmitter complete with batteries, microphone and earphone. Compactly built and weighing but 5 1/2 pounds, it permits the operator to use it like a French type telephone.

The SCR-536 is designed for two-way voice communication over distances up to one mile. The effective range is often decreased by terrain features like hills, steel buildings, heavily wooded areas and power lines located between the two stations. On the other hand, the range may be increased by locating the transmitter on the top of a tall building or a hill where the signal will have an unobstructed path to the receiver. Fool-proof net operation is made possible by using crystal control in the receiver and transmitter circuits. This feature permits instant operation by untrained operators who would not be able to make frequency adjustments on other types of sets. These sets may be tuned to practically any predetermined frequency between 3500 and 6000 kc by the selection of proper coil and crystal combinations. Frequency changing in these sets is done by men who have been trained to do this work.

Operation is further simplified by the omission of several conventional controls. The only ones on the set are the "on-off" switch and a fingertip operated "push-to-talk" button. The "on-off" switch is mounted inside the set and is operated by the telescoping antenna. When the antenna is fully extended, the switch is thrown on and when retracted, it is automatically turned off.

By careful selection of operating frequencies, these sets may be used in nets with such oth-

er sets as the SCR-245 and SCR-193 which employ variable frequency control and may be tuned to the frequency of the SCR-536.

HOW IT OPERATES

The receiver portion of the set uses a conventional superheterodyne circuit with a 3S4 r.f. amplifier, a 1R5 oscillator-mixer, 1T4 i.f. amplifier, 1S5 second detector, first a.f. amplifier and a.v.c. A 3S4 audio amplifier supplies approximately 0.18 watt to a small dynamic earphone.

The grid circuit of the r.f. amplifier is tuned by a series combination of



Antenna switch detail.

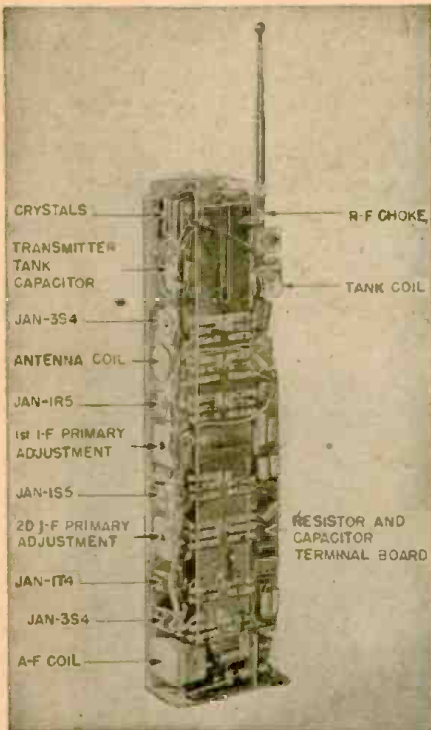

This chassis view shows the main components.

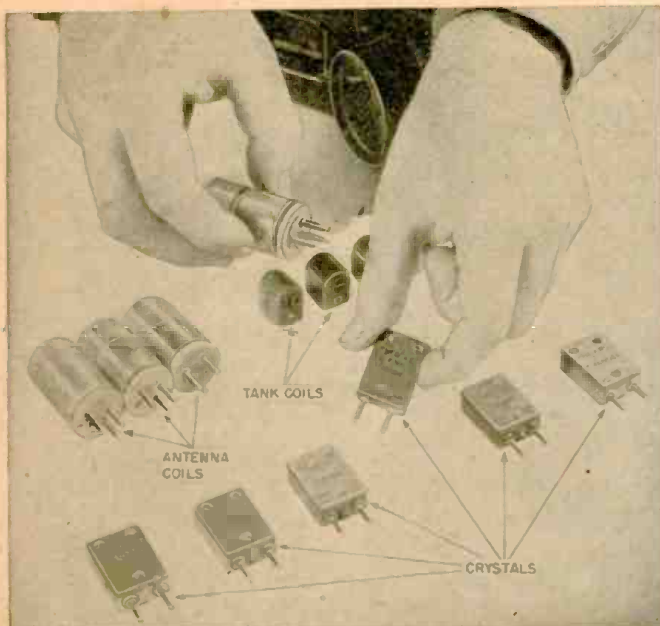

Left—Coils and crystals for changing Handie-Talkie frequencies. Below—Bottom view of set. Important features are identified.

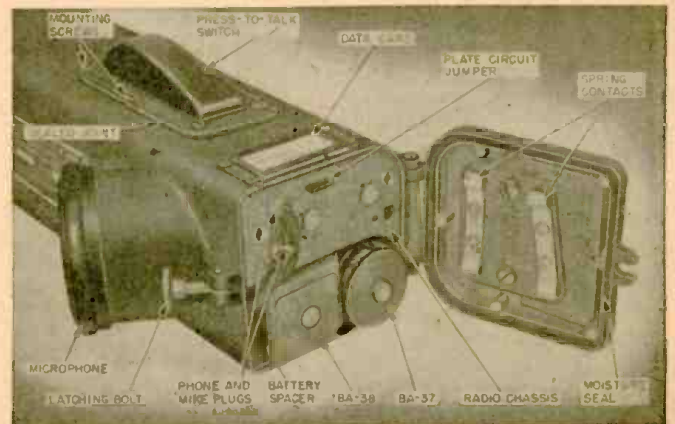

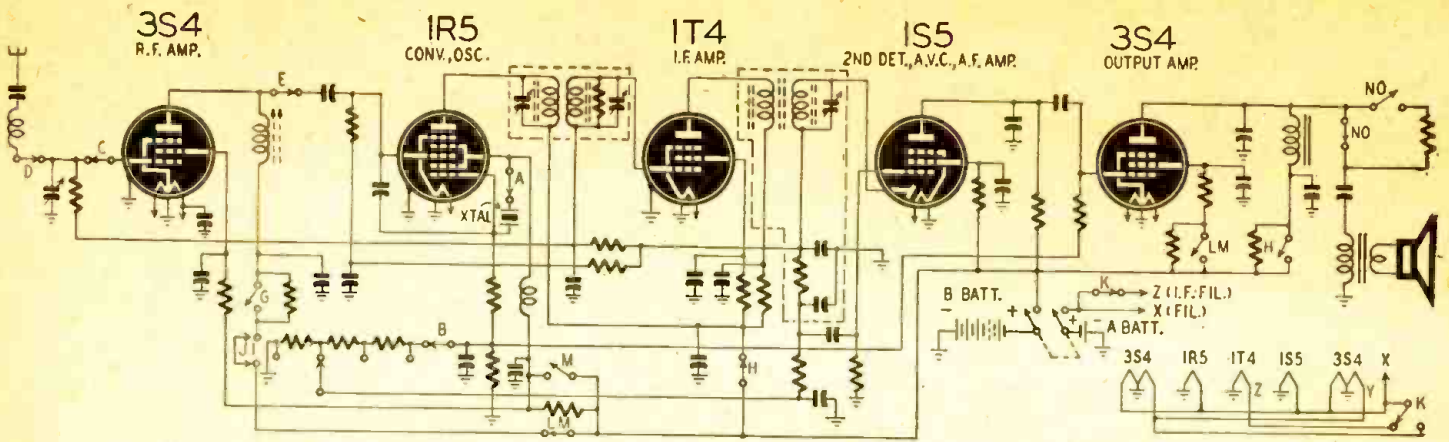

Fig. 1—Handie-Talkie switched to the "receive" position. Letters refer to switches shown in schematic form in the drawing below. Note that only one side of the two 3S4 filaments are heated when the set is used as a receiver. Tuning is controlled by the oscillator crystal.

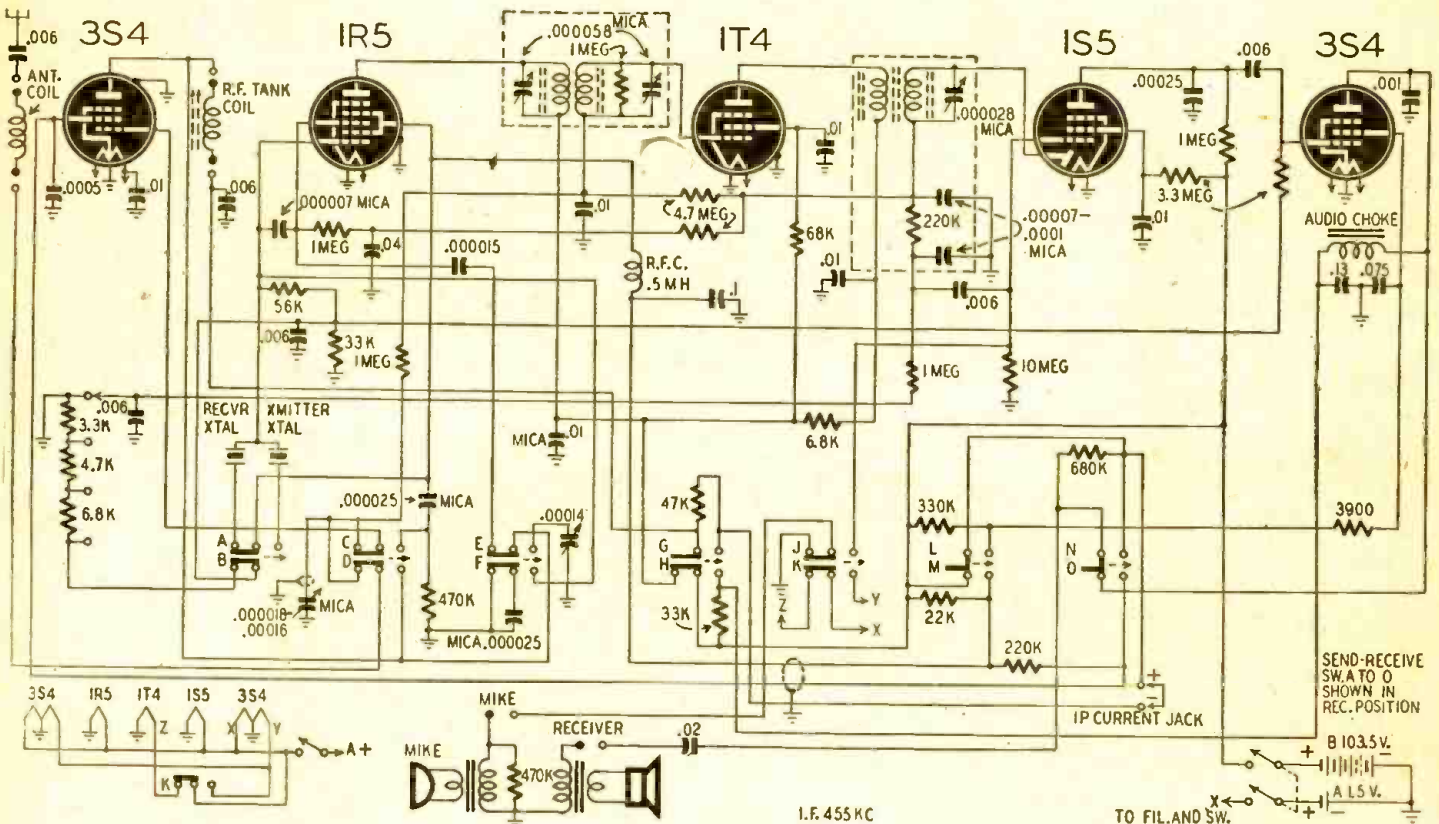
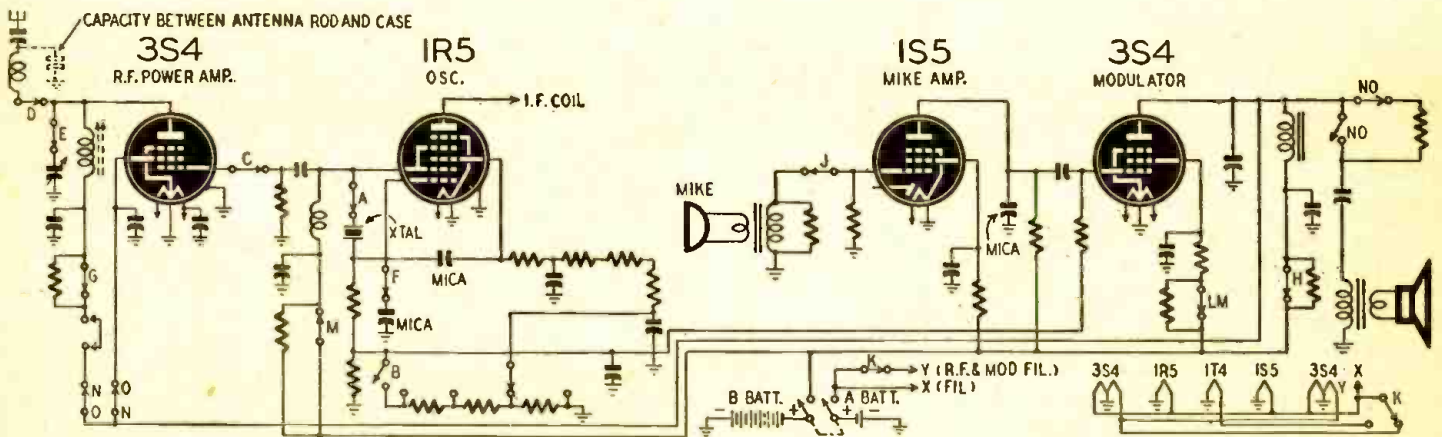

Fig. 2—Schematic of the war's most famous piece of communications equipment. Made by Galvin Motorola for the Signal Corps, it was used "in the air, on land and on the sea." Each set employs two crystals ground to frequencies 455 kc apart. The IR5 acts as a Pierce oscillator in both transmitting and receiving circuits. The 14-section changeover switch is lettered to agree with the other two figures. Early Handie-Talkies had crystal earphones, but later ones used the inductor type illustrated in these diagrams.



All photos and diagrams courtesy the Signal Corps and Galvin Mfg. Co.

Fig. 3—As a transmitter, the Handie-Talkie is a four-tube set. The IR5 functions as master oscillator in a Pierce circuit, driving one of the 3S4's as r.f. power output tube. The IS5 and the other 3S4 are speech amplifier and modulator, Heising system being used.

THE TRANSIGENERATOR

Signal Generator Employs New Circuit

NEXT to a good multimeter, the signal generator is probably the electronic technician's most useful piece of test equipment. In addition to its familiar function as a signal source for purposes of alignment, it may be used for signal substitution and in conjunction with other instruments for many types of measurements.

A well designed signal generator is an investment for the professional service technician, but is a costly item to the experimenter or beginner who has but occasional use for the instrument. He would often prefer to build his own if a reasonably efficient unit could be turned out. Unfortunately, to be at all usable, the signal generator must be a highly stable, precision device. The complex design factors make it difficult to get these desirable characteristics in a home-built model.

TRANSITRON SIMPLICITY

It is possible, however, for even the careful beginner to construct an efficient signal generator of the utmost simplicity. It is only necessary to make use of an oscillator circuit which has been repeatedly neglected by the practical

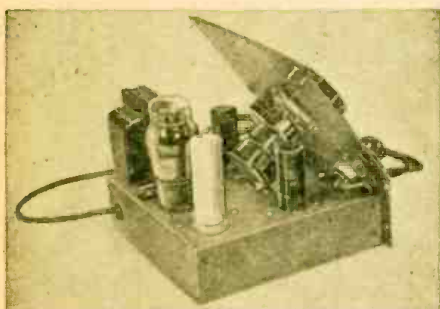

Rear view of the transistron signal generator.

man since its inception. That oscillator is the *Transitron*.

The basic circuit is shown in Fig. 1. Operation depends upon the fact that any slight change in screen voltage is transmitted in like polarity to the suppressor grid. An increase in suppressor voltage *reduces* the screen current and vice versa. Thus a negative resistance effect is observed at terminals x-y. A resonant impedance—such as an L-C tank circuit—connected between x-y will cause the circuit to oscillate at the natural resonant frequency of L and C. The article, "Transitron Oscillators," in the April, 1945, issue of *RADIO-CRAFT*, gives an excellent account of the theory and operation of this circuit.

The advantages of the *Transitron* are:

- 1—Extreme simplicity.
- 2—Unusual stability easily obtained.

3—Good wave form the rule rather than the exception.

4—Two-terminal coil usable (i.e. no critical coil tapping).

THE TRANSIGENERATOR

The above advantages have been combined in the instrument whose circuit is shown in Fig. 2. Two tubes (plus rectifier) are employed—the r.f. and the a.f. oscillators. For modulated r.f. output, the a.f. oscillator grid-modulates the r.f. circuit which then also functions as a mixer. Circuit voltages and electrode currents are given in Fig. 2. Pictorial views are shown in the photos.

THE R.F. OSCILLATOR

The r.f. unit employs the type 6SK7 remote cut-off pentode. The tuned circuit is placed in the suppressor rather than the screen circuit to permit grounding of the tuning capacitor rotor (it could have been placed in the plate or cathode circuit with no change in operation). Note that this stage operates with a plate potential of only 9 volts, while the screen potential is +50 volts to ground. Considerable deviation is allowable, but it is suggested that the constructor use the voltages shown. The r.f. output attenuator consists simply of a variable suppressor-bias resistance R1 in the cathode circuit. The 400-ohm fixed cathode resistor sets the operating point and precludes waveform distortion.

The tuning capacitor C is of the dual-gang variety; the capacity of each section ranges from 30-350 μ f. Switch S1 chooses tuning inductance L1, L2 or L2 plus L3 and hence selects the frequency range. The ranges are approximately:

Band A—160 to 660 kc; Band B—550 to 2000 kc; Band C—2 to 8 mc. Additional ranges may be added.

To obtain the ranges given, a one millihenry r.f. choke is used for L1. L2 and L3 are wound on the same $\frac{1}{8}$ -inch coil form to save space. L2 has an inductance of 25 μ h and consists of 17 turns of No. 30 enamel wire. Winding length is 3/16 inches. Inductance L3 is 120 μ h and it is wound with 120 turns of No. 30 enamel wire. The winding length is 1 5/16 inches. A permeability-tuned manufactured coil could be substituted for L2-L3 and then adjusted to give the range desired. It was considered more expedient to wind coil L2-L3, this being a simple matter.

The 8-mc upper frequency limit was considered adequate for most purposes; and the second harmonics of band C have been used to extend the range to 16 mc. Use of the third and higher harmonics is not feasible because of the *Transigenerator's* relative purity of wave form.

The r.f. output is taken directly from the suppressor grid through the 25- μ f isolating capacitor. This capacitor not only blocks d.c. but also prevents d.c.

(Continued on page 715)



Photo A—The *Transigenerator* as seen from the front.

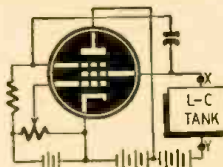

Fig. 1—Basic circuit.

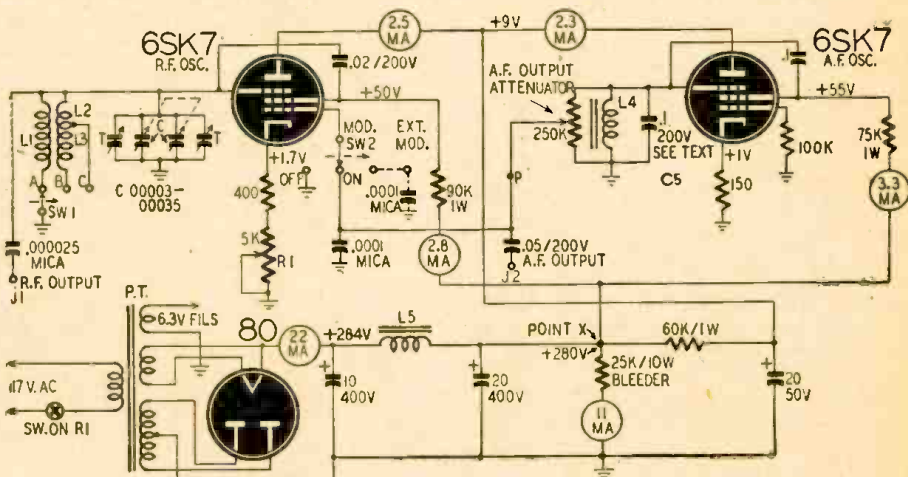

Fig. 2—Schematic of the *Transigenerator*. Single coils are used in r.f. and a.f. circuits.

430 MC WITH A 6F4

Coaxial-Cavity Transmitter for the Ultra-Highs

MICROWAVES demand designs which are not practical at lower frequencies. For example, above 400 mc, the coaxial oscillator with its relatively large conducting surface is one of the most practical circuits. Tubes used at these frequencies also show novel design. These tubes are generally triodes. At the very high frequencies, one type of construction uses *two leads* to both the control grid and the anode. The RCA 6F4 acorn is such a tube. Some advantages of these unconventional designs are:

The coaxial oscillator eliminates undesirable radiation from the coil or open lines. Such radiation results (unless the complete circuit is shielded) in lower Q, less power output and greater instability. Unfortunately, some coaxial circuits are difficult to construct and the frequency cannot be changed as readily as in other types.

The double lead tubes reduce internal lead inductance and element capacitance. As a result it is possible to obtain more external inductance in the tank coil or the lines. Amateurs who have experimented with ordinary (high C) tubes know that in some cases there is almost no inductance outside the tube which can be used to couple to the antenna. The actual and equivalent circuits using a double-ended tube are shown in Fig. 1.

The coaxial oscillator using a type RCA 6F4 described here is not difficult to construct and gives more output than the transceiver described in the May

issue. The 6F4 is designed to oscillate as high as 1200 mc with 150 volts on the plate. The principle of the oscillator is easy to understand. There are two hollow cylinders, one of small diameter and the other large. The first slides within the second to vary the effective line length and therefore the frequency. One end of the oscillator is shorted. The open ends of the two cylinders connect to the tube elements.

Not only is direct radiation (from the coaxial) eliminated, but the relatively large surface area greatly reduces circuit resistance. For further reduction, the metal parts of this oscillator were silver-plated. Another important feature is that r.f. travels only along the inner surface of the larger cylinder, leaving the outside at ground potential when suitably by-passed. No r.f. choke is required in the plate circuit.

THE COAXIAL UNIT

The essential parts of the oscillator are (see photo):

- 1—Tube and socket
- 2—Circular piece of polystyrene
- 3—Brass ring
- 4—Inner cylinder
- 5—Outer cylinder
- 6—Metal short-circuit between cylinders

1—The 6F4 tube is shown in its socket in Photo B. The 7-pin socket is a type XLA (National Co.) made of low-loss R-39 and is small enough to

fit entirely within the outer cylinder. The circuit components are mounted on the socket as shown. The grid condenser and grid resistor are side by side. One end of each is soldered directly to the grid terminal. The other end of the resistor connects to a filament terminal, while the other end of the condenser is held by a screw which passes through the socket. The second set of grid and plate leads are connected together through a 50 μ f condenser with about

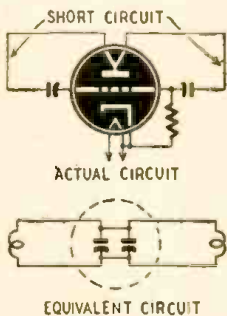
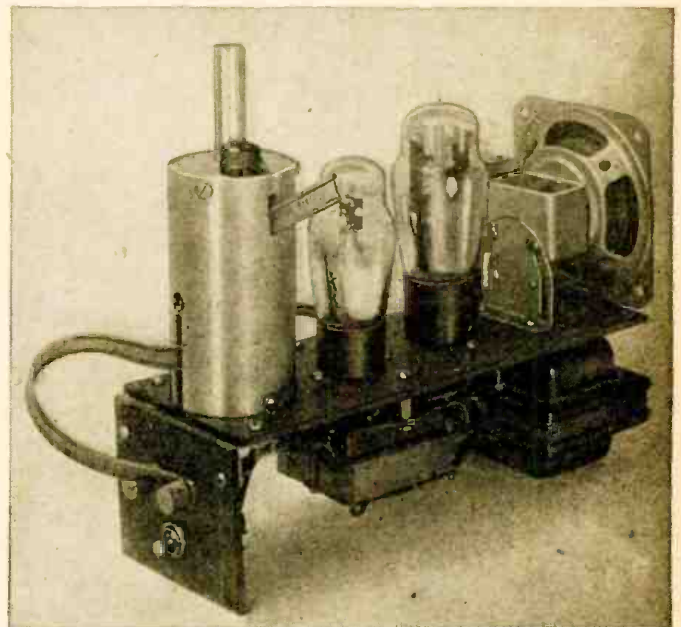

Fig. 1—Actual and equivalent circuits of 6F4 double-lead tube.



Complete transmitter. Speaker is a.f. oscillator coil and monitor.

1-inch leads. This, together with internal leads, resonates at the frequencies used, and is equivalent to the other set of lines (Fig. 1). The cathode is connected to one filament terminal. The two filament leads are made of about 7 inches of Amphenol twin-lead 300-ohm cable. This is a half-wave length section and therefore removes the necessity for r.f. chokes which are more difficult to handle. This section must be terminated with a by-pass condenser.

2—This is made of quarter-inch polystyrene approximately 1 13/16-inch in diameter. The socket is mounted on it with machine screws. The poly must be tapped for these screws. In tapping, exercise caution as the particles accumulate and harden due to the generated heat. If the tap is forced, it may break. It is better to work a little at a time and clean the tap before proceeding further. A half-inch hole is drilled through the center of the polystyrene disc.

3—This ring is 1 7/8-inch in diameter

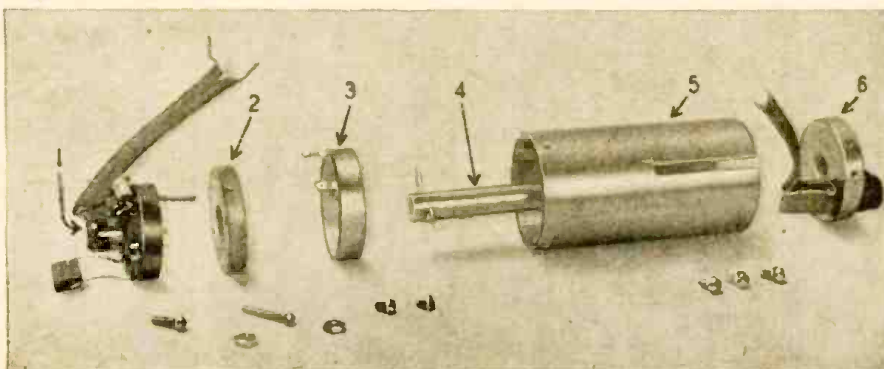

Photo A—Exploded view of resonant cavity. Numbered parts are referred to in the text.

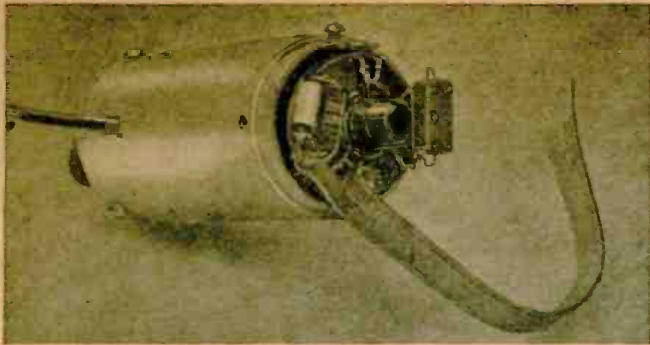
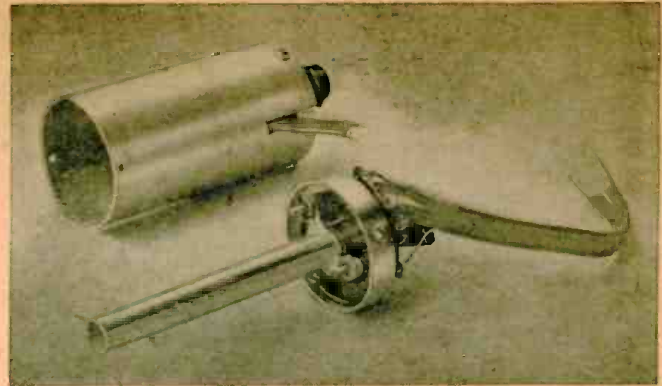

Photo B (above) and the accompanying photograph show construction details of the coaxial cavity oscillator section and 6F4 mounting.



and 5/16-inch high. Screws hold it in position around 2, the latter being tapped. The function of this piece is to slide within the outer cylinder and form the terminal for connection to the plate. Parts 3, 4 and 5 are made of silverplated 1/16-inch brass.

4—This is the inner cylinder. It is 3 1/2 inches long and has a diameter of 1/2 inch. One of the ends (left-hand end in the photo) fits into the hole through the polystyrene. A hole is drilled through this cylinder just below where it fits into the polystyrene. Through this hole is passed a piece of No. 18 wire, the ends of which are bent to form small loops. Two of the screws which hold the socket to the polystyrene also pass through these loops and are

contacts the No. 18 wire, it also makes contact with the inner cylinder. The wire should be soldered to the cylinder where it enters on both sides.

5—This is the outer cylinder, which also shields the entire unit. It is 3 1/2 inches long and has an outer diameter of 2 inches. This part, like the two others, is made of 1/16-inch brass and silver-plated. Two slots (as shown on the photo) are filed at one end. These are guides for the two screws which extend from the brass ring 3. These screws (which pass through the poly) can be tightened down against the outer cylinder after the correct position of the sliding assembly has been determined.

6—This is the short-circuiting part, made of brass 1 1/8-inch in diameter and 5/16-inch thick. A 1/2-inch hole is drilled through its center to accommodate the inner cylinder. To provide a good electrical connection the hole should be drilled carefully, and through the exact center. The large contact surface, silver-plated, reduces resistance to a minimum. This part is attached to the outer cylinder by screws which pass into tapped holes. One of these screws is long enough to pass completely through and exert pressure on the inner cylinder. Thus, when the proper position of the latter is found, it may be tight-

ened into place and a good connection assured. Schematic is shown in Fig. 2.

FREQUENCY, COUPLING, ANTENNA

With the dimensions given above, the oscillator will operate from about 400 mc to over 600 mc. This covers not only the present and prospective amateur bands (420-450) but the Citizens' Band which will probably open in the near future (460-470 mc).

Most important constants for the 6F4 tube are:
 Filament power 6.3 volts, 225 ma
 Plate voltage 150 max. volts
 Plate current 20 max. ma
 Grid current8 max. ma
 Plate dissipation 2 max. watts
 Grid voltage 50 max. volts

Its socket connections are shown in Fig. 3. It is intended for frequencies as high as 1200 mc in suitable circuits, and has a closely spaced electrode structure. At moderate frequencies it is capable of 1.8 watts output, with .2 watts of driving power.

Frequency oscillation may be checked by Lecher wires as explained in previous issues of RADIO-CRAFT. The no-load plate current may vary somewhat, depending upon the individual construction and component values, but should be 8 ma or less. With a load it should rise to about 16 ma or more. The plate will get red-hot if the maximum of 20 ma is greatly exceeded. With this set-up no appreciable drop in efficiency could be detected over the entire range of frequencies covered.

There are two possible means for coupling to an antenna with this oscillator. These are illustrated in Fig. 4. One uses a U-shaped piece of copper which can be rotated over a limited angle with the small knob and polystyrene rod at the top of the oscillator. When its sides are closest to the two cylinders, the coupling is maximum. Twin-lead or coaxial cable may be

(Continued on page 705)

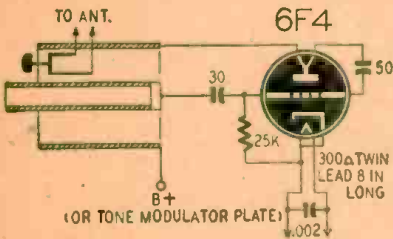

Fig. 2—Oscillator schematic. The B-plus lead connects to the plate of the tone oscillator. tightened in place by nuts. Parts 1, 2, 3, and 4 are thus held together as one unit, and make a sliding assembly. It was mentioned in 1 that one end of the grid condenser is held by a screw through the socket. Since this screw



Fig. 3.

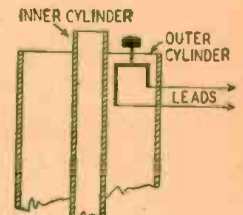
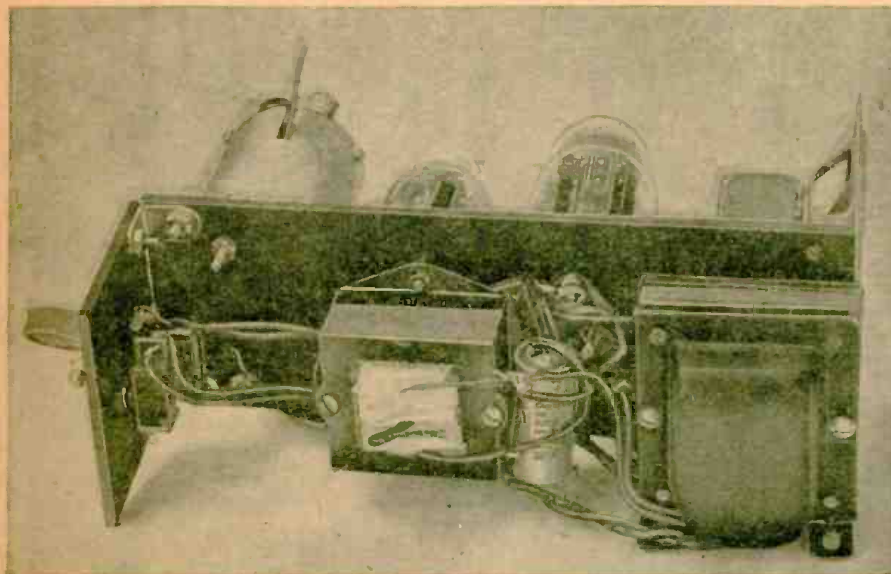

Fig. 4—Two methods of antenna coupling.



Bottom view, showing filament-line shorting condenser behind switch on left end-piece.

MATHEMATICS—RADIO TOOL

Part II—Shunts and Multipliers; Matching Loudspeakers

KNOWLEDGE of mathematics is useful in servicing electronic apparatus as well as in designing it. For example, a technician, servicing a television receiver using a 12-inch cathode-ray tube, finds the intensity of the image too low. He suspects a short circuit in the high-voltage supply. If the tube used is a 12AP4 at 7,000 volts on the second anode, with a bleeder network current of 2 ma, what resistance value across the bleeder network should he expect to find? (Fig. 1).

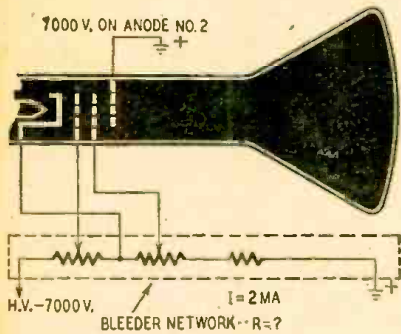

Fig. 1—A safe way to check high voltages.

The problem is readily solved with mathematics and Ohm's law.

$R = E/I$ where R = resistance in ohms, E = the voltage in volts and I = current in amperes.

Substituting—

$$R = \frac{E}{I} = \frac{7,000}{.002} = 3,500,000 \text{ ohms} = 3.5 \text{ megohms}$$

Hence, the value of the bleeder network resistance should be 3.5 megohms. Any large deviation from this figure probably denotes a short-circuit in the bleeder network.

Armed with the versatile 0-1 milliammeter, the radio worker can extend its range by using suitable shunts and resistors. To solve for their values, only paper, pencil and easy mathematics are needed.

A technician desires to increase the current and voltage ranges of his 0-1 milliammeter to 50 ma and 150 volts, respectively. The internal resistance of the meter is 27 ohms. What will the resistance values of the shunt and multiplier resistors be?

Firstly, we solve for the shunt resistor. (Fig. 2, left):

$$R_x = \frac{R_m}{n-1}$$

where R_x = the resistance of the shunt, R_m = the internal resistance of meter

and n = scale multiplication factor.

Substituting—

$$R_x = \frac{R_m}{n-1} = \frac{27}{50-1} = 0.552 \text{ ohm}$$

Now, to solve for the series multiplier resistor (Fig. 2, right), we use the following formula—

$$R = \frac{1,000 \times E}{I}$$

where R = value of the multiplier resistance, E = the desired full-scale voltage and I = the normal current capacity of meter in milliamperes.

(Note: For practical purposes the internal resistance of an 0-1 milliammeter may be disregarded when calculating the multiplier resistor, unless the scale be exceptionally low or the meter resistance large.)

Substituting—

$$R = \frac{1,000 \times E}{I} = \frac{1,000 \times 150}{1} = 150,000 \text{ ohms}$$

Thus, if we insert a shunt resistor of 0.552 ohms, the new full-scale current range will be 50 ma. Likewise, with the introduction of a 150,000 ohms series multiplier, the full-scale voltage becomes 150. With a suitable choice of

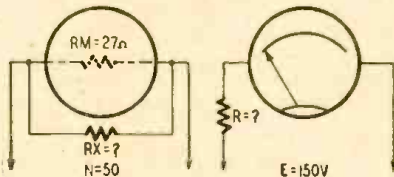

Fig. 2—Meter shunt, left; multiplier, right.

shunts and multipliers, we can build a multi-range volt-milliammeter with any desired number of ranges.

SPEAKER COMBINATIONS

At times, it is desirable to operate two or more loudspeakers from the same output transformer. The question arises: For proper matching, (impedance of output transformers equal to combined impedance of speakers), what should the impedance of each loudspeaker be?

Assume that the radio worker knows that the output transformer secondary impedance is 8 ohms, and delivers 20 watts of power (maximum). He wishes to connect two speakers in parallel. (Fig. 3). The following expression solves our problem:

$$R_s = nR_i$$

Where R_s = impedance of each speaker to be connected, n = number of speak-

ers to be connected, R_i = impedance of output transformer secondary.

Substituting—

$$R_s = nR_i = 2 \times 8 = 16 \text{ ohms}$$

Therefore, to secure proper matching, each speaker is to have an impedance of 16 ohms. Since the output power of the transformer is 20 watts, the speakers should be rated at 10 watts apiece.

Where the speakers are of different impedances, the problem is more difficult, but equally solvable with the proper mathematics. RADIO-CRAFT covered the subject in an article "Matching Loudspeakers" December, 1944.

Mathematics can be considered as a tool or instrument in radio work, comparable to the ohmmeter and tube-tester in usefulness. It has two advantages over the serviceman's other instruments; it is less costly and not as bulky.

It should be noted that arithmetic was the only mathematics required for these problems. With algebra, trigonometry, and calculus at our command, our problem-solving abilities are increased many times. With this in mind, the following bibliography is given.

Cook, Nelson M., *Mathematics for Electricians and Radiomen*. New York: McGraw-Hill, 1942.

The book covers arithmetic, algebra, slide-rule, trigonometry, logarithms, a.c. circuits, vectors, etc. The exposition is very clear and the book has answers to problems. Highly recommended for beginners.

Hogben, Lancelot, *Mathematics for the Million*. New York: W. W. Norton & Co., 1937.

Mr. Hogben takes you through from mathematics of prehistory to calculus

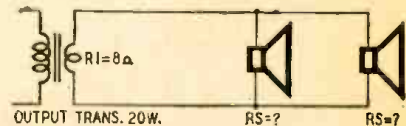

Fig. 3—Simple loudspeaker matching problem.

and statistics, against their social and cultural backgrounds. A "must" for the reader.

Jordan, Edward C. et al, *Fundamentals of Radio*. New York: Prentice Hall, 1942.

Chapter I contains a concise review of math, including logs and slide-rule. Stranger, Ralph, *Mathematics of Wireless*. New York: Chemical Publishing Co., 1940.

The author gives the reader a "nibble" of algebra, trig, calculus, etc. Explanations are very lucid and concise.

NOMOGRAPH CONSTRUCTION

Part II—Charts with Complicating Factors or Constants

THE difference between nomographic charts and ordinary graphs is that instead of having a fixed curve on paper cross-ruled in the quantities which enter a problem, any such curve can be selected by simply laying a ruler across the two lines which represent these quantities. This is why a nomogram, is "equal to an infinite number of charts." Obviously it is more useful than a fixed-curve graph in any problem in which it can be employed.

The simpler types of nomograms have already been dealt with, and the reader told how he can construct his own charts to cover any such problems. Somewhat more difficult constructions are often necessary, or may be found to give a better construction than the simple methods given in Part I.

In many nomograms, the figures which appear in the finished job are not the actual quantities being measured. This is to some extent true even in the multiplication chart, the simplest of nomograms. The two outside scales are evenly divided in logarithmic lengths, but we ignore them, and merely put down the numbers for which they stand.

We may wish, for example, to construct a nomogram showing the resistance of various kinds and sizes of wire. The formula is

$$R = kl/C.M.$$

k being the specific resistivity of the wire (varying for different metals), l the length in feet, and C.M. the area in circular mils. In this case, we calculate in circular mils but put down wire sizes in our finished chart. The specific resistivity and C.M. of all common metals and wire sizes are obtainable from tables available in many handbooks. It is necessary to construct a chart which will show the resistance for various areas, lengths and metals.

Our equation can be simplified by letting l (length) = 1. The chart will then read resistance per foot, and the equation will be

$$R = k/C.M.$$

This can be expressed in the form C.M. x R = k. C.M. and R. can then be the outside scales of a nomogram and k the center one. Laying out one of the outside lines with the C.M. areas of wire from size 30 to 40 (a 10 to 1 ratio) and the other in resistance values from 0.1 to 1.0 ohms per foot, the center line is calibrated with the help of a table of specific resistivity. Beginning with the lowest, silver (9.56) and copper (10.35) we go on to steel, approximately 100

(varying with the type of steel). The result appears in Fig. 5.

This chart is hardly satisfactory. Only half the middle scale is used. The range of wire sizes is very small. We cannot measure anything larger than No. 30. Important metals with high specific resistivity, such as nichrome and constantin, do not appear. Obviously it would be better to put the k scale outside, where it would cover twice its present length, and use the center scale for resistance in ohms. This can be done by changing our equation to $R = k \times 1/C.M.$ (A reciprocal scale like 1/C.M. can be made on a nomogram by simply turning the scale upside down) Now k and 1/C.M. can be the outside scales and R the middle one.

Since the resistivity of silver is slightly less than 10 and that of constantin near 300, our outside scales should have two cycles. This makes it possible for the C.M. scale to cover all wire sizes from 20 to 40 (most of the sizes commonly used in radio). The cen-

This resistance is .01 ohm. The base shows the resistance of a hypothetical wire with a resistivity of 1,000 and area of 10 circular mils. This is 100 ohms. Graduating this center scale in four cycles, from .01 to 100 ohms, the C.M. scale from 10 to 1,000, and spotting the k scale with the resistivity of the various metals in which we are interested, from silver at 9.56 (it is necessary to extend the scale slightly for this) to constantin at 296, we have a chart which will cover most of the sizes and materials used in radio work.

Numbers representing the wire sizes are now inserted on the C.M. scale and the circular mil figures (which are of no interest) are erased. Thus our nomogram, which started out with three sets of figures, ends up with only one, the other two scales being calibrated in wire sizes and names of metals.

If it is desired to extend the range to cover larger sizes of wire, the C.M. scale may be made into a double one. Readings may then be made from Nos. 1 to 40 (A.W.G. or B & S gage). If the figures on the R scale are read in ohms per hundred feet instead of ohms per foot, no change need be made in it. The completed graph is Nomogram C shown on page 700.

Still another type of nomogram is one in which one or more of the factors is multiplied by a constant, such as $A \times 4B = C$. Since multiplication on a logarithmic scale is simple addition, we just start the B scale at 4. If the problem were $A \times B = 4C$, the center scale would start at 4.

One of the best examples of this type of nomogram shows the inductance and capacitance required to tune to a given frequency. The formula is the well-known

$$f = \frac{1}{6.28 \sqrt{LC}}$$

The units are farads, henrys and cycles. To get the problem into microhenrys and microfarads—the practical units of radio—we can multiply numerator and denominator by 1,000,000, giving

$$f \text{ (cycles)} = \frac{1,000,000}{6.28 \sqrt{L_{\mu h} C_{\mu f}}}$$

and by dividing the 6.28 into 1,000,000 we can further simplify it to

$$f = \frac{159,000}{\sqrt{L_{\mu h} C_{\mu f}}}$$

(Continued on page 701)

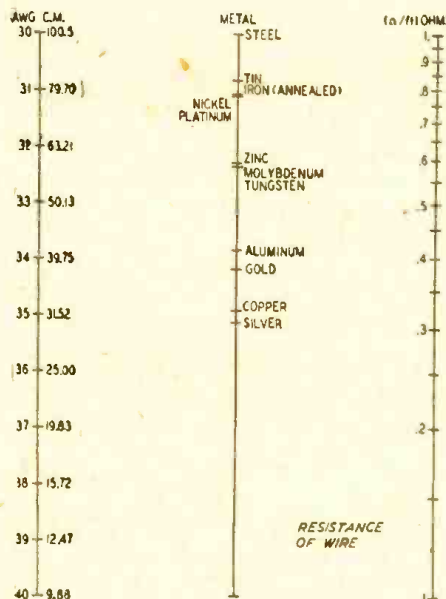

Fig 5—Crude chart showing wire resistance.

ter scale will again have a range of four cycles.

It is convenient to run down a column of wire sizes, so the C.M. scale is left as it is and the other two reversed.

Resistivity of silver is very slightly less than 10. Therefore the k scale can run from 10 to 1,000. Top of the center scale (Nomogram C) marks the resistance of a wire 1,000 C.M. in diameter and having a specific resistivity of 10.

RADIO DATA SHEET 337

EMERSON RADIO Models 501, 502, 504

DESCRIPTION

TYPE: Single-band superheterodyne
 FREQUENCY RANGE: 540-1620 kc.
 NUMBER OF TUBES: Five
 TYPE OF TUBES:

- 1—12SA7, pentagrid osc.-modulator
- 1—12SK7, first i.f. amplifier
- 1—12SQ7, diode detector, a.f. amp., a.v.c.
- 1—50L6GT, beam power output
- 1—35Z5GT, half-wave rectifier

POWER SUPPLY: a.c. or d.c.
 VOLTAGE RATING: 105-125 volts
 POWER CONSUMPTION: 30 watts

ADJUSTMENTS

An oscillator with frequencies of 455, 600 and 1425 kc is required.

An output meter should be connected across the primary or secondary of the output transformer for observing maximum response.

Always use as weak a test signal as possible when aligning the receiver.

Plug the receiver into the power supply outlet in such a way that the ground side of the power line is connected to the receiver B —.

Coil and Trimmer Locations

The first i.f. transformer (T1) is mounted on top of the chassis deck to the right of the variable condenser. The trimmers (C5, C6) are accessible through holes in the top of the can.

The second i.f. transformer (T2) is mounted on top of the chassis between the variable condenser and the speaker. The trimmers (C7, C8) are accessible through holes in the top of the can.

The trimmer for the antenna (C3) and

the trimmer for the oscillator coil (C4) are located on the variable condenser. The trimmer on the front section is for the oscillator coil.

The oscillator coil (T4) is located underneath the chassis. The loop antenna acts as the antenna coil.

I.F. ALIGNMENT

1. Rotate the variable condenser to the minimum capacity position.
2. Feed 455 kc to the converter grid (stator of the r.f. section of the variable condenser) and adjust the four i.f. trimmers (C5, C6, C7, C8) for maximum response.

R.F. ALIGNMENT

1. Connect the oscillator to a coil composed of three to four turns of wire wound in a circle approximately 12 inches in diameter. This coil should be held parallel to and in line with the loop antenna of the receiver at a distance of 15 to 20 inches.
2. Radiate a signal at 1425 kc, set the dial indicator to 1425 kc, and adjust
3. Radiate a 600 kc signal and tune in the signal on the receiver. Adjust the loose outside turn of the loop antenna for maximum response. This loose turn may be moved to either side of the center. Fasten it in the position which gives maximum response.
4. Repeat steps 2 and 3 until no further improvement is evident.

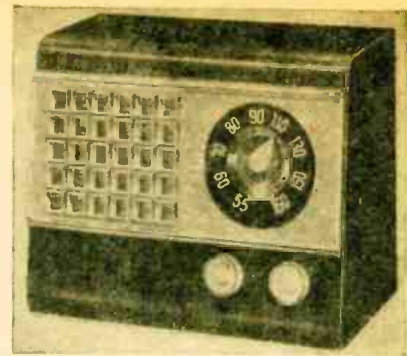

the trimmers on the variable condenser (C3, C4) for maximum response.

VOLTAGES AT TUBE SOCKET PINS

The following voltage readings are d.c. measurements taken from B — (line switch) in the indicated tube-socket pin. A 1000 ohms-per-volt meter should be used for all readings except those indicated by an asterisk (*), which should be taken with a d.c. vacuum-tube volt-

meter. Line voltage for these readings was 117 volts, 60 cycles, a.c. Measurements made with 117 volts d.c. will be lower than those given below. Take readings with the volume control set at minimum and the variable condenser closed (plates fully meshed).

TUBE	PIN NUMBER							
	1	2	3	4	5	6	7	8
12SA7			89	89	*-10			*-1.6
12SK7				*-1.6		89		89
12SQ7		*-0.7		*-1.6	-0.5	37.5		
50L6GT			110	89				6.2
35Z5GT				116		116		117

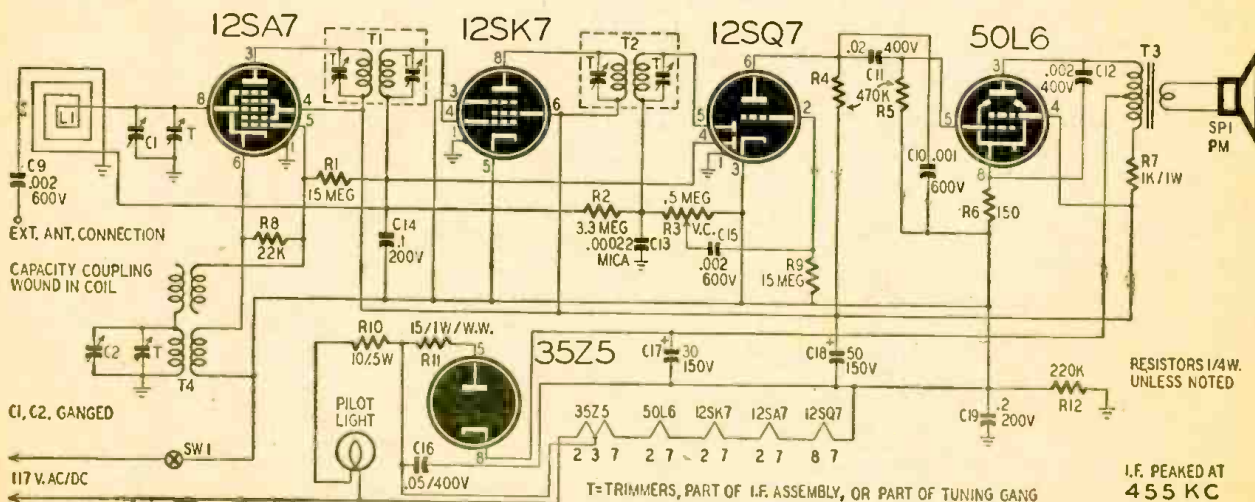

I.F. PEAKED AT 455 KC

CATHODE FOLLOWERS

Find Many Applications in the Most Modern Apparatus

IMPEDANCE matching is of great importance in radar, television, and most industrial electronic circuits—primarily to prevent unnecessary distortion of complex wave forms. High-impedance outputs of video amplifiers must feed transmission lines or other low-impedance devices *without* phase shift, polarity change, or distortion of the video signal. Ordinary transformers are useless for this purpose, because of the wide range of frequencies involved—from 30 cycles up to 4 or 5 megacycles. One of the most satisfactory impedance matching devices is the *cathode follower*.

Sometimes known as a cathode-loaded amplifier, it is not an amplifying stage since it provides less than unity voltage gain.

A cathode follower is a degenerative vacuum-tube circuit in which inverse feedback is obtained via an *unbypassed* cathode resistor. The load of the tube is adjacent to the *cathode* instead of to the plate. Input signals can be applied between ground and the control grid of a triode or pentode. Output is taken from across the cathode resistance or from across a cathode and a plate resistance (inverters).

Being degenerative, the circuit has a lower input capacitance, is much freer from amplitude and phase distortion, and is less affected in its operation by variations in supply voltage and tube aging than a conventional amplifier stage.

A cathode follower is inherently a distortionless impedance-matching or

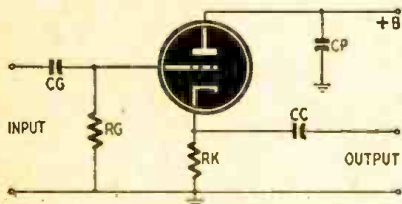

Fig. 1—The basic cathode follower circuit.

impedance-changing device, providing a low-capacity high-impedance input with a well-regulated low-impedance output *in phase* with the input signal.

THE BASIC CIRCUIT

Basic type of cathode follower is shown in Fig. 1. The stage employs a triode, and is frequently encountered in radar and certain other electronic applications.

Input circuit elements consist of a grid coupling condenser C_G and a grid resistor R_G . Plate condenser C_P bypasses any apparent or reflected resist-

ance. Voltage to the plate of the triode is maintained constant. Normally there is *no* load resistor at the plate in a cathode follower.

Resistor R_K is the all-important cathode load resistor. It is *not* by-passed by a condenser. All of the output voltage of the stage (Fig. 1) is developed across the cathode resistor R_K .

However, all of the output voltage *also* appears in the grid-to-cathode circuit. This results in a 100-percent voltage feedback opposing the input signal voltage. Thus, the net voltage

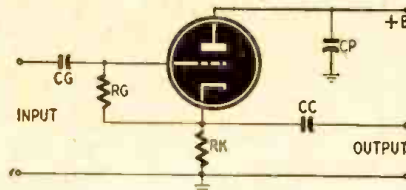

Fig. 2—Modification for large minus voltages.

gain of the stage is less than unity. And there is a reduction in the effective a.c. plate resistance of the triode.

During positive portions of the input signal, any rise in plate current through the cathode resistor R_K produces a greater *IR drop*, which makes the cathode of the triode more positive. During negative portions of the input signal there is a reverse result: a decrease in plate current causes the cathode to become less positive.

Thus the voltage across the cathode resistor (Fig. 1) follows all fluctuations of the grid, which in effect tends to reduce the voltage difference between grid and cathode.

When no signal is applied to the grid of the triode (Fig. 1) the normal small amount of no-signal plate current flows through the cathode resistor. The resulting *IR drop* establishes the amount of no-signal bias developed across resistor R_K .

Changes in the input voltage must appear in part as changes in grid bias. This changed grid bias is available as the output voltage of the cathode follower.

Since changes in plate current resulting from an input signal on the grid causes a voltage change across R_K in the *same direction* as the applied signal, no polarity inversion results. A positive-going input wave produces a positive-going output wave, and a negative input produces a negative output.

Degeneration reduces the effective input voltage below the applied value, causing less current to flow through the

capacities within the triode. Because of the high and constant input impedance, the cathode follower has a negligible loading effect on the circuit employed to drive it (if no grid current is permitted).

Output impedance of the circuit (Fig. 1) is the parallel combination of the cathode resistor R_K and the effective a.c. plate resistance of the tube. Since both of these can be made relatively low in value, the output impedance of a cathode follower can be made extremely low—often as small as 30 or 40 ohms, when required. Value of the output impedance can, of course, be chosen to match the input impedance of the following stage, device, or transmission line.

LIMITING EFFECTS

Output voltage of the basic circuit (Fig. 1) is a direct function of the input signal over its normal range of operation—determined by the nature of the tube's characteristic curve.

Within this normal range of operation, the output voltage is a duplicate of the input voltage and is essentially without distortion. When *positive* portions of the input exceed the normal range, the cathode follower continues to operate in the same manner (up to the point of grid current). Because of degeneration the grid current point is not reached as soon as in a conventional amplifier.

However, when *negative* portions of the input exceed the normal range of operation, the region of plate-current cut-off is soon reached. Any further grid voltage increase in a negative direction does *not* appear in the output wave form. This is a form of limiting or clipping.

Thus the circuit of Fig. 1 provides a distortionless output only for input voltages within the normal range of operation and for large *positive* input voltages (up to grid current point). For larger *negative* input signals, the cathode follower (Fig. 1) introduces serious distortion.

In many applications of a cathode follower where negative input voltages are never large, this disadvantage is not important, and the circuit shown in Fig. 1 will be adequate.

TRIODE VARIATIONS

In those instances where a cathode follower must reproduce large *negative* input voltages and some distortion of *positive* input voltages can be tolerated, the circuit shown in Fig. 2 is employed.

(Continued on page 725)

THE WORLD'S MOST FAMOUS BOOK FOR RADIO-ELECTRONIC BEGINNERS (No previous training necessary)



A. A. GHIRARDI
Let Radio's most widely-read technical author help you start training NOW for a fascinating, profitable future!

LEARN RADIO-ELECTRONICS EASIER BETTER FASTER for Only \$5.



HERE'S HOW TO REPAIR RADIOS THE EASY WAY!

A Definite Guide for Diagnosing, Locating and Repairing Radio Receiver Troubles

Radio servicemen everywhere say that this big 3rd edition of A. A. Ghirardi's **RADIO TROUBLESHOOTER'S HANDBOOK** helps them turn out twice as much work in a given time! Radio "inkers" and beginners who like to fix their own home sets and those of friends find this big book a quick, easy way of locating and repairing receiver troubles without extensive shop equipment. Nine times out of ten, it tells exactly how to make the necessary repairs—without any elaborate testing whatever!

NOT A "STUDY" BOOK!

Actually, this big, 744-page manual-size **RADIO TROUBLESHOOTER'S HANDBOOK** is a complete guide to the trouble diagnosing, locating and fast repairing of **PRACTICALLY EVERY TYPE OF RADIO RECEIVER NOW IN USE**. It isn't a "study" book. You simply turn to it whenever you want to fix a particular type of trouble in a particular make of radio. Its 404-page Case History Section

gives full details on common trouble symptoms, their causes and remedies for **OVER 4,000 DIFFERENT RADIO RECEIVER MODELS**. It describes the trouble exactly—tells exactly how to repair it. It eliminates extensive testing—helps you do two jobs in the time normally required for one—repair cheap sets at a profit—substitute tubes and parts profitably—train new helpers, etc., etc.

In addition, hundreds of other pages are devoted to the most modern tube chart you've ever seen; tube and parts substitution data; I-F alignment peaks for over 20,000 superhets; a big section on I-F transformer troubles—and dozens of charts, graphs, helpful hints and data compilations—all carefully indexed for quick, easy reference.

This big, beautifully bound **HANDBOOK** is only \$5 (\$5.50 foreign)—on our 5-DAY MONEY-BACK GUARANTEE. You cannot lose!

HERE'S HOW TO LEARN MODERN RADIO SERVICE WORK



... without an instructor!

A. A. Ghirardi's **MODERN RADIO SERVICING** is the only single, inexpensive book that gives a complete, easily understandable course in modern radio repair work in all of its branches. Written so simply you can understand it without an instructor! Read from the beginning; it takes you step by step through all phases of the work—or, used as a reference book by busy servicemen, it serves as a beautifully cross-indexed work for "brushing up" on any type of job that may puzzle you.

Included is a thorough explanation of all Test Instruments, telling exactly how they should be used and why (it even gives all necessary data for the construction of test equipment for those who prefer to make their own); Receiver Troubleshooting Procedure and Circuit Analysis; Testing and Repair of Components; Installations; Adjustments; etc., etc.—also How to Start a Successful Service Business; 1300 pages; 720 Self-Testing Review Questions; 706 helpful illustrations and diagrams. Only \$5 complete (\$5.50 foreign) on our 5-Day Money-Back Guarantee.

SAVE MONEY!

See coupon for special combination offer on **MODERN RADIO SERVICING** and **TROUBLESHOOTER'S HANDBOOK**—over 7,200 pages of helpful service data!

YOUR MONEY BACK
in 5 Days if Ghirardi's 972-page **RADIO PHYSICS COURSE** Book doesn't teach you Radio-Electronic fundamentals **EASIER, FASTER** and at **LESS COST** than any other book! That's how sure we are that Ghirardi's **RADIO PHYSICS COURSE** is the very best in the field!

COMPLETE, EASY-TO-UNDERSTAND BASIC TRAINING

Ask the men who **KNOW** what's good in Radio Training—the men who had to learn Radio quickly and from scratch, in the Armed Forces; the men who already have obtained good-paying Radio-Electronic jobs in industry! Nine out of ten of them (as proved by survey) will tell you that Ghirardi's famous **RADIO PHYSICS COURSE** is their first choice as the easiest-to-study, most thorough and inexpensive Radio book on the market.

MOST POPULAR FOR ARMY-NAVY AND CIVILIAN RADIO TRAINING

This same inexpensive book has given more people their basic Radio-Electronic training than any other ever published. It is more widely endorsed by men who know. Because of its sheer merit, it is more universally used for home study, and more widely employed in U. S. Army Signal Corps, Navy and civilian schools and colleges than any other book on the subject. Would you want any better proof than this?

EVEN IF YOU DON'T KNOW ANYTHING ABOUT RADIO!

Even if you've had no previous Radio or Electrical training or experience, it's easy to learn from Ghirardi's **RADIO PHYSICS COURSE**. Everything that can be done to make learning easy has been done for you. It painstakingly explains everything in detail so you cannot fail to understand. Over 500 specially prepared illustrations help you to visualize every action. You don't have to know a single thing about Radio in advance. All you need is a little spare reading time and a desire to get started **RIGHT** for a profitable future in any of Radio-Electronics!

WARNING! Paper shortages may make it impossible for us to continue meeting the tremendous demand for all Ghirardi Radio Books. Don't take chances! Order yours today while they're still available. Use this Order Form.

many branches—from service work to aviation, military, broadcasting, manufacturing, public address and many others.

SCOPE OF 36 COURSES IN ONE

Actually, **RADIO PHYSICS COURSE** gives you the scope of 36 different courses in one convenient, inexpensive big book. Nothing is omitted. Nothing is condensed. Nothing is left to chance. You learn all you need to know. You don't need to wait for monthly lessons. You progress as rapidly as you wish in your spare time and in the comfort of your own home.

A \$50 VALUE FOR \$5 COMPLETE

RADIO PHYSICS COURSE is acclaimed everywhere as the "biggest bargain" available in Radio-Electronic training. If it were broken into sections and sold as a course, you'd regard it as a bargain at \$50 or more—but you actually buy it all here complete in one big 972-page handsomely bound book for only \$5 (\$5.50 foreign) and with our absolute 5-Day **MONEY-BACK GUARANTEE**. Get the book and see for yourself. Compare it with any other book or course on the market—at any price. See how much more complete it is, how much better illustrated, how much easier to understand! You be the judge! You cannot lose!

MURRAY HILL BOOKS, INC.
Dept. RC-76, 232 Madison Ave., New York 16, N. Y.

Enclosed find \$..... for books checked; or send C.O.D. for this amount plus postage. If I am not fully satisfied, I may return the books within 5 days and receive my money back.

RADIO PHYSICS COURSE
\$5.00 (\$5.50 foreign)

3rd. Ed. **RADIO TROUBLE-SHOOTER'S HANDBOOK**
\$5.00 (\$5.50 foreign)

Special **"MONEY-SAVING"**
Combination: **MODERN RADIO SERVICING** with the **HANDBOOK**
Both books only \$9.50 (\$10.50 foreign)

MODERN RADIO SERVICING
\$5.00 (\$5.50 foreign)

Name
Address
City City Dist. No. State

REPAIR ANY KIND OF RADIO EQUIPMENT PREPARE YOURSELF FOR A BETTER JOB AT HIGHER PAY IN THE RADIO-ELECTRONIC FIELD

WORLD-WIDE STATION LIST

WITH the coming of the summer season, we can look forward to the dx to be found on the higher frequencies. The nineteen meter band is very active at this time of the year, and some fine business results should be forthcoming. Also, note should be made of 16 meter broadcast band for day and night dx, which is generally wide open at this time of year.

HCJB at Quito, Ecuador, is a very good bet on 15.110 megacycles during the early summer evenings. Reports on this and the other frequencies used by HCJB may be sent to them at Quito, Ecuador; and a very good verification will be sent to the reporter. VUD3 in Delhi, India, should be a good catch during July and August. The frequency used is 15.290 megacycles and is heard best around 6 to 7 am.

The Australians are good on the high frequencies now, and are usually heard best on 15.315 megacycles. Their transmissions are beamed to North America at 9:15 to 9:45 pm; but they are often heard at other times when beamed to other localities. Reports may be sent to the Australian News Agency, 630 Fifth Avenue, New York City.

Brazzaville is heard on 17.527 megacycles in the early morning shortly after midnight. Reception is very good in summer on this frequency; as are the

other Brazzaville transmissions. Several BBC transmissions may be heard on the 19 and 16 meter bands. Also the BBC may be heard on their 11 meter transmission on 26.100 megacycles.

RADIO TERM ILLUSTRATED



Suggested by: James Tannehill, Ft. Wayne, Ind. Dynamic Speaker.

VUD10 from Delhi, India, is being heard on 17.830 megacycles from 10:15 pm to 2:30 am; and 4 to 7 am. Other

Delhi transmitters are on 17.760 mc from midnight to 5 am; and 15.290 mc from 10:45 pm to 12:30 am; 1 to 5 am; and 6 to 7 am. A Moscow station is heard to North America at 7:15 to 8:15 am on 17.810. This is a new transmission on this frequency.

ZAA in Tirana, Albania, is being heard on 7.295 megacycles at 1:30 pm. Reception reports so far are fair, and a good signal now and then. They are worth trying for though. A new station on Borneo is at Balikpapan and is heard with strong signals on 9.125 megacycles from 7 to 9:30 am. English announcements are made at 8 am.

Our chart this month gives the complete shortwave schedule of the British Broadcasting Co., the biggest English-speaking broadcast organization outside the United States. The schedules are divided into North American broadcasts and others; but many North American listeners will note little difference between certain beams intended for them and some beamed to other countries.

This is all till next month, when we will be back with more news for you. So get your reports in. Remember all times given above are E.S.T. Reports may be sent to Elmer R. Fuller, Shortwave Editor, c/o RADIO-CRAFT, 25 West Broadway, New York City. Reports from overseas will be greatly appreciated.

Freq.	M	1 a.m.	2	3	4	5	6	7	8	9	10	11	N	1 p.m.	2	3	4	5	6	7	8	9	10	11	Mid. Cab	
6.070																									GRR	
6.110	xx												xxxx										0000000000	xxxx	GSL	
7.075	xxxxxx												xxxxxx												xxxx	GRS
7.120	xxxxxx												xxxxxx													GRM
7.230	xxxxxx												xxxxxx													GSW
7.260																			0000000000	0000000000			0000000000			GSU
7.320	x												xxxxx												xxxx	GRJ
9.510	xxxxxx												xxxxxx												xxxx	GSB
9.580																									xxxx	GSC
9.600	xxxxxx												xxxxxx												xxxx	GRY
9.625	xxxxxx																		xxxxxx						xx	GWO
9.640	xxxxxx																			xxxxxx						GVZ
9.660										xxxxxx																GWV
9.825	xxxxxx																								xxxx	GRH
9.915													xxxxxx													GRU
11.140													xxxxxx													GSN
11.680													xxxxxx						0000000000	0000000000						GRG
11.700	xxxxxx												xxxxxx												xxxx	GVW
11.750	xxxxxx												xxxxxx													GSD
11.820	xxxxxx												xxxxxx													GSN
11.930	xxxxxx												xxxxxx												xxxx	GVX
12.095	xxxxxx												xxxxxx													GRF
15.110	xxxxxx												xxxxxx													GRB
15.140	xxxxx												xxxxxx												xxxx	GSP
15.180	xxxxxx												xxxxxx													GSO
15.260	xxxxx												xxxxxx													GSI
15.300	xxxxxx												xxxxxx													GWR
15.310	xxxxxx												xxxxxx													GSP
15.450													xxxxx													GRD
17.700	xxxxxx												xxxxxx													GVP
17.715	xxxxxx												xxxxxx													GRA
17.730	xxxxxx												xxxxxx													GRV
17.790	xxxxxx												xxxxxx													GSG
17.810	xxxxxx												xxxxxx													GSV
17.870	xxxxxx												xxxxxx													GRP
18.025	xxxxxx												xxxxxx													GRD
18.080													0000000000	0000000000	0000000000										GRV	
21.470													xxxxxx													GSH
21.530													xxxxxx													GSJ
21.540													xxxxxx													GRZ
21.710													xxxxxx													GVS

0—North American Service; x—Overseas Service

*Highest
Quality*

RADIO and ELECTRONIC Testing Equipment

IMMEDIATE DELIVERY FROM STOCK GUARANTEED!



The New Model 680
**5000 OHMS per VOLT
VOLT-OHM
MILLIAMMETER**
Net Price \$27.65

A single scale is used for all voltage (both A.C. and D.C.) and current ranges. Thus all readings are plain and obvious. Radio servicemen will be delighted with this time-saving innovation. Measures: **D.C. VOLTAGES to 1500 volts; A.C. VOLTAGES to 1500 volts; RESISTANCE to 2 megohms; OUTPUT VOLTS to 1500 volts; D.C. CURRENT to 150 MA; DECIBELS to +58 D.C.** Housed in hand-rubbed oak, portable cabinet. Complete with self-contained battery, test leads and instructions.



The New REINER Model 333
MASTER TESTER
Net Price \$27.50

Lifetime guaranteed meter is at the optimum angle for easy reading and visual accuracy. Meter is hermetically sealed—positively dust-proof and moisture-proof. Includes 2 meter fuses. **6 D.C. VOLTAGE MULTIPLIERS 1% ACCURACY: 0-5-10-25-100-250-300 volts, 6 D.C. CURRENT SHUNTS: 0-5-10-25-100-250-500 milliamps.** Basic ranges of 0-120 millivolts and 0-1 milliampere.

The New REINER Model 334 MASTER TESTER

Identical to 333 but has in addition **SIX AC Voltage ranges.** Each AC and DC range is at a sensitivity of 1000 ohms per volt. AC measurements free from temperature and frequency errors throughout a range of 25 cycles to 1 megacycle. New Germanium rectifier used. Basic meter sensitivity 400 micro-amperes full scale.

Net Price
\$32.50

NEW McMURDO SILVER TESTING EQUIPMENT



McMurdo Silver
Model 905
"SPARX"
**Dynamic
Signal Tracer**
Net Price \$39.90

Frequency range from 20 cycles to over 200 megacycles. Contains isolating capacitor, resistor and one of the new radar u.h.f. crystal diodes. Loads a circuit being tested with only 3 mmfd. and higher than .5 megohm.

McMurdo Silver
Model 904
**Capacitance
Resistance
Bridge**
Net Price \$49.90

1/4 mmfd/ohm thru 1,000 mfd./megohms: 0-50% power factor; 0-500 volt adjustable internal polarizing voltage; 0-10 and 0-100 ma. electron-ray leakage current meter; measures resistance, capacitance under actual operating voltages!



McMurdo Silver
"VOMAX"
**Vacuum
Tube
Voltmeter**
Net Price \$59.85

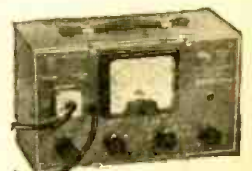

D.C. Volts at 51 and 126 megohms. A.C. and r.f. volts at 6.6 megohms. Resistance .2 ohms to 2,000 megohms. D.C. current 1.2 ma. through 12 amperes. D.B. -10 through +50 Plus visual dynamic signal tracing.

The New Superior Model 400
ELECTRONIC MULTI-METER

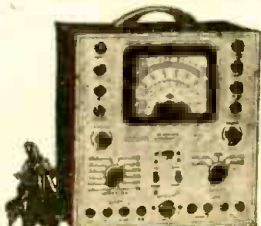

Net Price
\$52.50

DC V.T.V.M. Volts: 0 to 3/15/30/75/150/300/750/1500/3000 volts.
DC Volts: (at 1000 ohms per volt) 0 to 3/15/30/75/150/300/750/1500/3000 volts.
AC Volts: (at 1000 ohms per volt) 0 to 3/15/30/75/150/300/750/1500/3000 volts.
DC Current: 0 to 3/15/30/75/150/300/750 Ma. 0 to 3/15 amps.
Resistance: 0 to 1,000/10,000/100,000 ohms. 0 to 1/10/1,000 megs.
Capacity: .0005-.2, .05-.20, 5-200 mfd.
Reactance: 10 to 5M ohms. 100-50M ohms.
Inductance: .035-14, .35-140, 35-14,000 henries.
Decibels: -10 to +18; +10 to +38; +30 to +58.

The New SUPERIOR Model CA-11
SIGNAL TRACER



NET PRICE \$18.75

*Signal intensity readings indicated directly on meter.
*Only one connecting cable—No tuning controls.
*Highly sensitive—uses an improved vacuum tube voltmeter circuit.
*Tube and resistor-capacity network are built into the Detector Probe.
*Weighs 5 lbs. Measures 5"x6"x7".
*Provision is made for insertion of phones.

The New Model 802N Combination
TUBE & SET TESTER

NET PRICE \$58.31

D.C. Voltmeter: 0/10/50/500/1000 at 1000 ohms per volt.
Four Range A.C. Voltmeter: 0/10/50/500/1000. D.C. Milliammeter: 0/1/10/100/1000 DC Ammeter: 0/10. DB Meter: -8/15/15-to 20/20/ to 40/32 to 55 decibels.
Four Range Output Meter—same as AC Volts.



The New Model 705

**SIGNAL
GENERATOR**

Net Price
\$49.50

RANGES:

From 95 kc to 100 mc, continuously variable. Calibration accurate to 2% through broadcast bands, within 3% for high frequency bands. Planetary drive condenser, direct reading calibration, output modulated or unmodulated. Self-contained electronic modulation 400c sine wave available for external use. Special feature provided in having two degrees of modulation at both approxin. 30% and 80%.

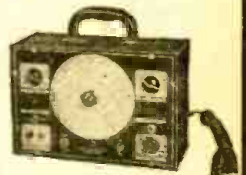

R.C.P. Model 448 Pocket Multitester.....	\$ 24.01
R.C.P. Model 424A Volt-Ohm-Milliammeter.....	28.91
R.C.P. Model 461A Sensitive Multitester.....	38.71
R.C.P. Model 664 Electronic Voltmeter.....	45.00
R.C.P. Model 488A Ultra-Sensitive Multitester.....	70.71
R.C.P. Model 668 Vacuum Tube-Volt Ohm Capacity Meter.....	73.01
R.C.P. Model 805 Tube and Set Tester.....	87.71
R.C.P. Model 665A V.T. Volt Ohm Megger Insulation Testers.....	92.61
Reiner Model 530 Squarewave Generator.....	95.00
Reiner Model 450 Vacuum Tube Volt-Ohm-Milliammeter.....	135.00
Superior Model 155 Volt Ohm Milliammeter.....	24.75
Superior Model PB-100 Volt Ohm Milliammeter.....	28.40
Superior Model 450 Tube Tester.....	39.50

Superior Model 650 Signal Generator.....	48.75
Superior Model 720 Multi-Range AC Ammeter.....	49.50
Superior Model 600 Combination Tube & Set Tester.....	62.50
SHALLCROSS Decade Resistance Boxes.....	13.50
SHALLCROSS Portable Galvanometers.....	27.50
SHALLCROSS Model 630 Wheatstone Bridge.....	75.00
SHALLCROSS Model 637 Kelvin-Wheatstone Bridge.....	100.00
SHALLCROSS Model 638-2 Kelvin Wheatstone Bridge.....	120.00
VM-Model 200-B Record Changer. List Price \$37.50.....	Net 22.50
Maguire ARC-1 Record Changer. List Price \$47.41.....	Net 24.50
Lots of 6 or more. Each.....	Net 22.90
Monitor Crystalline Signal Generator.....	57.50
Supreme Oscilloscope Model 546.....	87.95

WRITE FOR OUR FREE NEW POST-WAR CATALOGUE!

Metropolitan ELECTRONIC & INSTRUMENT CO.

Dept. C, 6 MURRAY STREET
NEW YORK 7, N. Y., U. S. A.

Cable Address: METRONICS
Phone: BARclay 7-5556

EAGLE RADIO

for better buys!

RADIO KITS

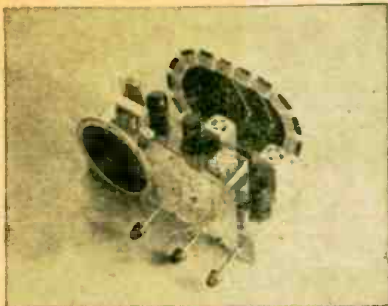

- AC-DC 5-TUBE SUPERHET.**
12SA7, 12SK7, 12SQ7, 12A6, 35Z5.
Complete with tubes.....\$16.90
- AC-DC 4-TUBE T.R.F.**
12SK7, 12SQ7, 12A6, 35Z5. Plays on
Loop. Complete with tubes....\$13.95
- AC-DC 5-TUBE, 2-BAND SUPERHET.**
12SA7, 12SK7, 12SQ7, 12A6, 35Z5. B.C.
Band and 2000 Kc to 10 Mc. Short
Wave. Complete with tubes....\$18.90
- 3-TUBE AC-DC AMPLIFIER**
Designed for use with Record Player.
Complete with tubes less speaker \$5.95
- 2-TUBE PHONO OSCILLATOR**
New Eagle Design.
Complete with tubes.....\$4.49

Approved SIGNAL GENERATOR

- 6 RF BANDS
100 to 310 Kc
320 to 1000 Kc
1000 to 3200 Kc
3.2 to 10.5 Mc
10.5 to 26 Mc
21 to
52 Mc



Net \$47.00

ELECTRONIC DESIGNS V.T. V.M. VOLTMETER- OHMMETER



DC Ranges: 0 to 3-10-20-100-300
and 1,000 volts. All ranges have
a constant input resistance of
11,000,000 ohms. Accuracy 3% ±.
AC Ranges: 0 to 10-30-100-300
and 1,000 volts. Sensitivity:
1,000 ohms per volt. Accuracy
5% ±.
Electronic Ohmmeter Ranges: 0-
1,000 ohms, 0-10,000 ohms, 0-
100,000 ohms, 0-1
megohm, 0-10 meg-
ohms, and 0-1,000
megohms. Net, \$47.50

Pocket Size VOLT-OHM MILLIAMMETER

An Approved Electronic Instrument

RANGES:
DC Volts: 15-150-300-1500.
AC Volts: 15-150-1500
Milliamperes: 15-15-150.
DC Resistance: 3000-300,000 ohms.
Net, \$18.75

ARMY SURPLUS KEYS

338 Slightly Used49c
Brand New and Boxed.....89c

Write for FREE literature on complete line of
kits. For all electronic equipment... try
EAGLE first!

Buy with Safety

EAGLE RADIO
84 CORTLANDT ST.

Dept. C New York 7, N. Y.

NEW RADIO-ELECTRONIC DEVICES

COMPARISON BRIDGE

Freed Transformer Co.
New York, N. Y.

The Model 1010 Comparison and Limit Bridge is used in laboratory and production testing of resistors, inductors and condensers. Two ranges are provided for balancing accuracy of 10 percent and 20 percent.

The circuit uses an oscillator, bridge and high-gain amplifier. Null indications are amplified and read on a 500-microampere meter. Condensers from 500 μf to 10 μf are measured at 1000 cycles; larger ones at 60 cycles. Condensers smaller than 500 μf are measured by the limit bridge method. Resistors from 10 ohms to 1 megohm are measured by the comparison method; higher values by using the instrument as a limit bridge. Inductances from 0.1 millihenry to 100 henries are measured at frequencies determined by their characteristics.

All measurements are made with .5 percent accuracy when using the 10

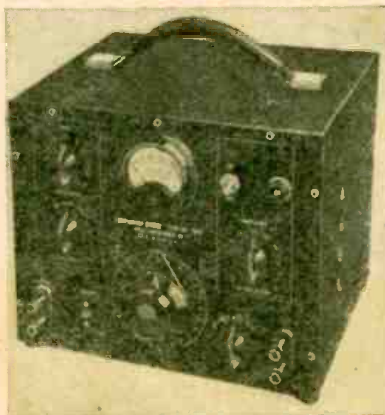

percent range. Maximum voltage across the UNKNOWN terminals is 15.

The instrument uses five tubes and is rated at 40 watts, 105 to 125 volts, 60 cycles a.c.—RADIO-CRAFT

AUDIO FREQUENCY METER

Communication Measurements Laboratory
New York, N. Y.

The Model 1800 frequency meter is designed for measuring the frequency of a.c. voltages over the entire audio frequency spectrum. When used with special attachments, it may be used as a tachometer. It is capable of measuring frequencies from 60 to one million

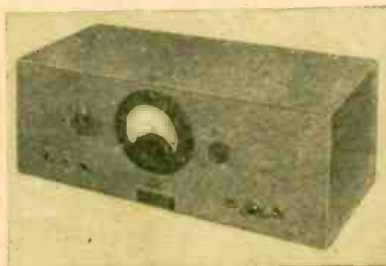

RPM or CPM with equal ease and accuracy.

Operation of the device is independent of input waveform and may be used to measure pulse voltages having a duration of 50 to 100,000 microseconds. It may be used in applications where a highly accurate audio frequency meter is desirable.

Vibration rates may be measured by the application of a suitable pickup to any stationary object subject to vibration.—RADIO-CRAFT

DIAMOND PHONO NEEDLE

The Duotone Co., Inc.
New York, N. Y.

The world's most expensive phonograph needles for home use are now on the market. They are diamond-point needles costing fifty dollars each.

By using professional diamond poi-

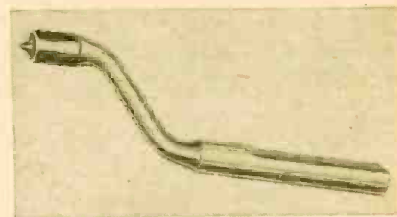

ishers, the needle tip radius has been held to a tolerance of one ten-thousandth of an inch. This needle has been under test for five years and during this time there has been no indication of wear on the tip.—RADIO-CRAFT

ELECTRONIC TIMER

Photovolt Corp.
New York, N. Y.

This electronic timer is designed to open or close electrical circuits for an adjustable time interval. It is particularly applicable for timing short inter-



vals from .05 second to 50 seconds, in five models, each with a 10-1 time ratio. A load outlet receptacle is provided for coupling the timer to the controlled circuit.

Two or more timers may be connected for operation in sequence or for re-cycling action.

The timer is operated from 100 to 130 volts a.c. or d.c. lines.—RADIO-CRAFT

CALRAD "Hard-to-get" RADIO VALUES!

V. M. TWO POST RECORD CHANGER



This Record Changer is a well-made mechanism, will play either 10-in. or 12-in. records. The pickup uses a crystal cartridge. Size 14 in. x 14 in. Packed 2 to a factory-sealed carton, factory guaranteed.

CARTON OF 2 **\$35.00** Special **\$18.95 ea.**

5 Tube Super AC-DC PARTS KIT



Kits include: Stamped Chassis—Dynamic Speakers—Output Transformer—Volume Control and Switch—2 Shielded I.F. Coils—Antenna and Osc. Coils—Two-range Super Variable—50 Octal Sockets—20 x 20 Mfd. 150 Volt Filter—5 Tubular Condensers—3 Mica Condensers—6 Resistors—6 ft. AC Cord and Plug—Circuit Diagram.

White They Last **\$8.95 ea.** Lots of 6 **\$50.00**

Approved SIGNAL GENERATOR

Model A-100

Complete

\$47.00

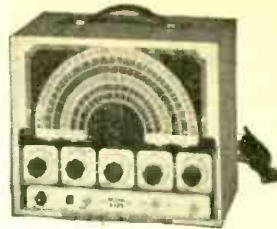

A-100 to 310 Kilocycles
B-320 to 1000 Kilocycles
C-1000 to 3200 Kilocycles
D-3.2 to 10.5 Megacycles
E-10.5 to 26 Megacycles
E2-21 to 52 Megacycles
440 Standard Audio Frequency (same as WWV) Internal modulation at 440 cycles (same as WWV). External modulation possible from 40 to 30,000 cycles.

Signal Corps TELEGRAPH KEYS



Genuine U.S. Signal Corps telegraph keys brought to you at prices below manufacturing costs! Made with switch to close contacts, polished durable enameled metal base mounted on a bakelite base; key lever is nickel-plated; contacts are brass-silver. Packed in new original boxes.

LOTS OF 10 **75c ea** CARTON OF 50 **60c ea**

WEBSTER RECORD CHANGER

Model 56

Complete

\$26.45



Built to last. Fast change cycle. Simple, fool-proof operation. Automatic shut-off. Feather light needle pressure. Longer life for records. Quiet running Webster 4 Pole motor-cushion mounted.

Webster Model 50. .ea. **\$20.95**

AUTO ANTENNAS

- 3 Section
 - 66" Long
 - Brass Tubing
 - Triple Chromium Plated
 - 2 Insulator Type Cowl
- Mounting with Lead Individually Boxed

24 TO MASTER CARTON

\$30.00

LOTS OF 48

\$55

Immediate Delivery But Quantity Is Limited

BUY NOW! LOWEST PRICES! STOCKS LIMITED!

Fully Shielded Power Transformers
50 Mfd.—6.3 Vo. @ 2 amp. C.T.—5 Vo. @ 2 amp. C.T.—650 Vo. C.T. \$2.45 ea. Lots of 10—\$22.25 ea.

Push Pull 6L6 Shielded Output Transformer
30 Watt Peak. to 2-4-6-8-16-250 and 500 ohm line. \$3.45 ea. Lots of 12. \$3.25 ea.

Push Pull Input Transformer, 10,000 ohm plate to push pull 6L6—\$1.10 ea. Lots of 12—\$1.00 ea.

Midget Universal Output Transformer—push pull plate to 2-4-6-8-10-16 ohm voice coil—95c ea. Lots of 10—85c ea.

10 Watt Large Universal Output—\$1.35 ea. Lots of 10—\$1.20 ea.

Single Pentode Midget Output—for 50L6, 6V6, 6F6, etc.—55c ea.

50 Mfd. Filter Choke 300 ohm—65c ea. Lots of 10—60c ea.

75 Mfd. Filter Choke 250 ohm—95c ea. Lots of 10—85c ea.

DYNAMIC AND P.M. SPEAKERS

4-in. 450-Ohm Dynamic—Packed 30 to Carton—\$1.75 ea.

4-in. 2500-Ohm Dynamic—Packed 30 to Carton—\$1.75 ea.

4-in. P.M. Heavy Slug—Packed 30 to Carton—\$1.70 ea.

5-in. P.M. Heavy Slug—Packed 30 to Carton—\$1.75 ea.

6-in. P.M. Heavy Slug—Packed 30 to Carton—\$2.25 ea.

TUBULAR ELECTROLYTIC CONDENSERS

10 Mfd. 50 Volt—Lots of 25—21c ea.

25 Mfd. 50 Volt—Lots of 25—24c ea.

50 Mfd. 50 Volt—Lots of 25—28c ea.

16 Mfd. 150 Volt—Lots of 25—25c ea.

20 Mfd. 150 Volt—Lots of 25—29c ea.

30 Mfd. 150 Volt—Lots of 25—32c ea.

50 Mfd. 150 Volt—Lots of 25—35c ea.

20 x 20 Mfd. 150 Volt—Lots of 25—43c ea.

30 x 20 Mfd. 150 Volt—Lots of 25—47c ea.
40 x 20 Mfd. 150 Volt—Lots of 25—55c ea.
50 x 30 Mfd. 150 Volt—Lots of 25—65c ea.
20 Mfd.—350 Volt—Lots of 25—39c ea.
10 Mfd.—300 Volt—Lots of 25—39c ea.
20 Mfd.—25 Volt—Lots of 25—39c ea.

Standard Brands. Tubular By-Pass Condensers
.001-.002-.003-.005-.006-600 Volt ... \$6.75 per 100
.025-.01-.02-600 Volt \$7.75 per 100
.05-600 Volt \$9.75 per 100
1-600 Volt \$12.00 per 100
25-600 Volt \$18.00 per 100
5-600 Volt \$22.00 per 100
4 Mfd. 600 Vo. T.L.A. Oil Condenser, screw base, Upright aluminum can, 1 1/2 in. x 3/4 in. \$4.50
list. replaces 8 mfd. 600 Vo. electrolytic.
Carton of 40 \$38.50

FINEST QUALITY MIDGET MICAS:

.001-.0001 .005-.00005 } \$5.00 per 100
.002-.00025 .006-.0005 }
Astatic Low Pressure, curved arm, crystal pickup with Sapphire Stylus Permanent Needle. has cartridge which replaces LP6-LP21-LP23. \$3.75 ea; Lots of 10—\$33.50

Standard Low Pressure Crystal Pickup. \$2.50 ea; Lots of 10—\$22.50

Signal Corps Dual Headsets—8000 ohms high impedance, with 2 rubber ear cushions, cord and phone plug. Individually boxed. \$12.50 list. net \$2.25 ea, lots of 12. \$25.

456 K.C. Antenna. Oscillator and R.F. Coils. 25c ea.

456 K.C. I.F. Coils Input & Output, medium size can \$45.00 per 100 asst.

Weston Volt ohm meter Model 663—\$49.50 with carrying case & leads.

Universal 4-Prong Electronic Vibrator... \$1.75 ea.

6-Prong Synchronous Mallyory Vibrator... \$1.75 ea.

Kit of 50 assorted Bakelite Knobs for 1/4-in. shaft, with set screws \$2.50 per kit

Midget Ceramic Trimmers—3-30 mmf.. \$6.00 per 100

Western Electric—0-200 Microammeter—3 in bakelite case. \$4.25 ea.

Tinned Copper Shielding—1/8 in., 1/4 in., 3/8 in. \$1.50 per 100 ft.

Rubber Sheathed "Mike" Cable, shielded, single Conductor 100 ft. for \$ 5.95

500 ft. for \$25.00

Moulded Octal Sockets 1 1/2-in. mfd. with metal ring \$7.00 per 100

6 ft. A.C. Cords with plug \$20.00 per 100

Volume Controls, less Switch—1 1/2-in. shaft 250,000 ohm.

1 Meg Lots of 100

2 Meg \$30.00

250 ft. Coil Underwriter Approved Zip Cord—\$4.75 per coil.

Turner Juke Box Type Crystal Microphone with 100 ft. shielded mike cable—\$9.95 ea.

Transmitting type variable Condensers, Dual Double Spaced 110 Mfd. per section \$1.00 ea.

Dual Double Spaced 170 Mfd. per section \$1.00 ea.

Single Gang Dual Spaced 440 Mfd.—\$1.00 ea.

Single Bearing Midget Condenser 14 plate—100 Mfd. 50c ea.

Midget Open Circuit Jack—Lots of 10—\$1.50

Midget Closed Circuit Jack—Lots of 10—\$2.00

Midget Double Circuit Jack—Lots of 10—\$3.00

SIGNAL CORPS JACKS

Signal Corps Jacks, fits all standard plugs.

Open circuit, Mallory type SC-1 equivalent of

Signal Corps Jack # JK 34A..... \$12.00 per 100

\$100.00 per 1000

Insulated Banana Tip Jacks, red or black \$8.50 per 100

Insulated Banana Plugs, solderless, side screw connection, red or black..... \$10.00 per 100

Standard Barrel Type Phone Plug... \$20.00 per 100

Sterling #44 Pocket Volt-Amp meter with carrying case—\$1.00 ea.

Patch Cord 4 ft. with 2 P.L. 55 Plugs—49c ea.

MAIL ORDERS FILLED: 25% deposit with order, balance C. O. D. References—Bank of America, Santa Monica & Vermont Avenues, Los Angeles, California

CALIFORNIA RADIO & ELECTRONICS CO.

Dept. No. R, 711, No. Vermont Ave., Los Angeles 27, California



The Victrola*, made exclusively by RCA Victor, gives higher fidelity and longer record life through its jewel-point pickup.

Your Victrola's jewel-point pickup

floats like a feather on water—

Instead of an ordinary, rigidly mounted needle, your Victrola radio-phonograph has a moving sapphire playing tip that fairly floats over the record.

It follows the groove with effortless ease, achieves new clarity of tone, adds longer life to records, and acts as a filter against surface noise.

Such a feather touch reduces "needle chatter," gives you all the rich warm flow of the pure music . . . the highest tones, the lowest tones, the overtones. Truly, your Victrola's jewel-point pickup brings you the ultimate in recorded music pleasure.

This pickup was perfected at RCA Laboratories—a world center of radio and electronic research—where RCA products are kept at the top of the field.

And when you buy an RCA Victor radio, television receiver, Victrola, or even an RCA radio tube replacement, RCA Laboratories is your assurance that you are getting one of the finest products of its kind that science has yet achieved.

Radio Corporation of America, RCA Building, Radio City, New York 20 . . . Listen to The RCA Victor Show, Sundays, 4:30 P. M., Eastern Daylight Time, over the NBC Network.



New Victrola radio-phonograph, with Chippendale-style cabinet, priced at approximately \$275. "Rollout" record changer handling twelve 10-inch, or ten 12-inch records. Permanent jewel-point pickup—no needles. American and foreign radio reception. An outstanding radio-phonograph combination—thanks to research at RCA Laboratories.



RADIO CORPORATION of AMERICA

*Victrola T. M. Reg. U. S. Pat. Off.

SUPPRESS RADIO NOISES FROM FLUORESCENT LAMPS!

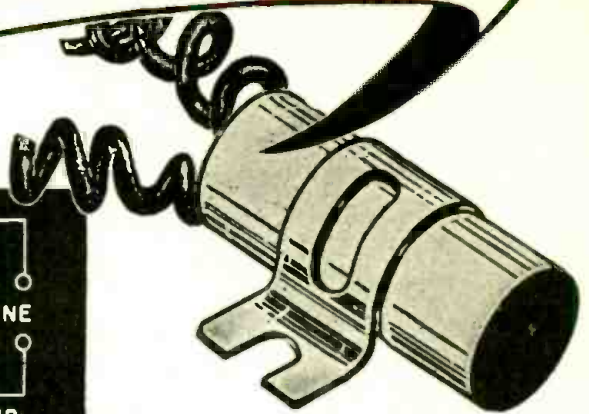
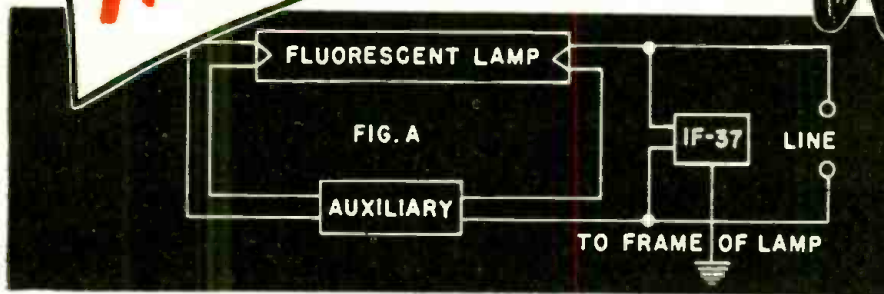

EASILY INSTALLED — HIGHLY EFFECTIVE

The most serious radio interference from fluorescent lamps is that which is conducted down the power line to receivers at remote points. Such interference cannot be avoided merely by placing the lamp at a safe distance from the radio antenna circuit. Nor can it be avoided by using shielded lead-in wire, as in cases where interference is caused, either by direct radiation from the lamp bulb itself or by radiation to the radio antenna circuit from the electric supply lines.

Yet interference conducted down the power line to remote receivers should, and CAN, be reduced.

The really effective method is to connect Sprague IF-37 Filters directly to each fixture as indicated in the above diagram. These filters are

specifically designed for fluorescent lamp interference suppression. They are recommended for single lamp fixtures, connected as shown in figure "A". One filter is required for each auxiliary.

Type IF-37 Filters are EASY to install. Inexpensive, too—only \$1.11 each, net.

RADIO DEALERS! REMOVE INTERFERENCE IN YOUR OWN STORE

The use of Type IF-37 Filters in your own store will help you sell more radios through better demonstration. Your sets may be perfect, but if your own fluorescent lamps interfere with reception your customers may assume the radio is at fault.

*Don't let noise spoil
your sales!*

WRITE

for your copy of the new Sprague Catalog No. C-306. It's the first Sprague Catalog in five years devoted to civilian radio service. In it you'll find new capacitor types and outstanding resistor improvements. Write for your new catalog today!



SPRAGUE PRODUCTS CO.

NORTH ADAMS, MASS.

Jobbing Distributing Organization for Products of the Sprague Electric Co.

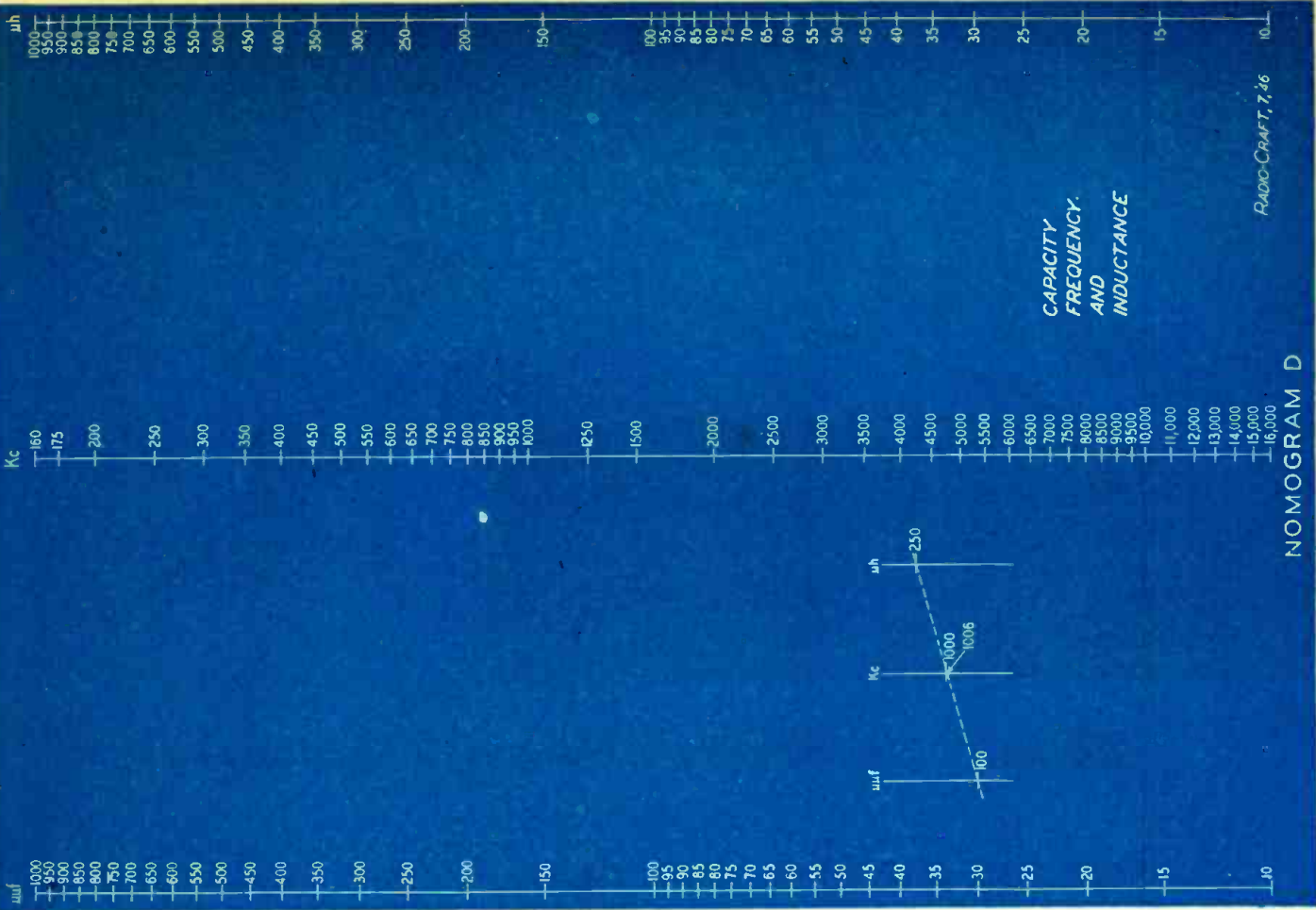
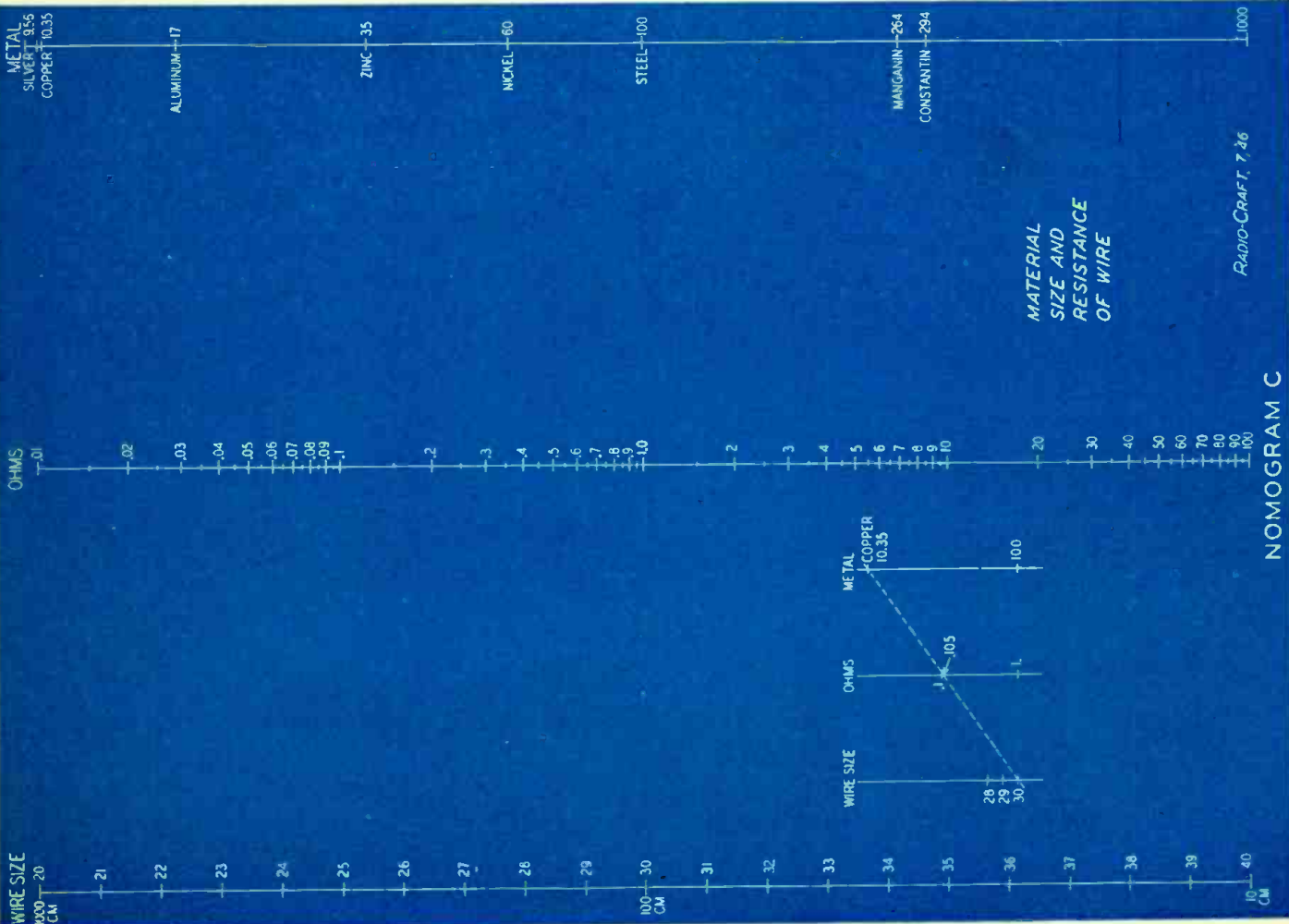

**NOMOGRAPH
CONSTRUCTION**
(Continued from page 690)

The frequency in cycles is then equal to 159,000 times

$$\frac{1}{\sqrt{LC}}$$

in microhenrys and microfarads.

On the nomogram, inductance and capacitance run in opposite direction to the frequency scale, since the greater the product of the two, the smaller is the number of cycles per second. The "product" scale will differ from those previously drawn. Though it is in the center, it will have the same number of cycles as the "factor" scales. This is because we are using the square roots of the factors. (If Fig. 2, in the June issue, were to represent the product of the square roots of numbers from 1 to 10 it would be necessary only to number the three scales identically.) Then a line drawn through any two numbers on the outside scales would show on the center one the product of their square roots. (A line through 9 and 4 would cut the center line at 6, the product of their square roots, 3 and 2.)

For most work where lumped constants are used, it is seldom necessary to calculate circuits with inductances of less than 10 microhenrys or capacities less than 10 μf . Using two-cycle paper with these quantities for a base for the two outside scales, we have a top of 1,000 microhenrys or micromicrofarads. (See Nomogram D, on opposite page.)

It is a simple matter to calculate calibration points on the center scale by our equation,

$$f = \frac{159,000}{\sqrt{L \mu\text{h} C \mu\text{f}}}$$

10 μh and 10 μf (.00001 μf) are the bases of the two outside scales. 10 $\mu\text{h} \times .00001 \mu\text{f} = .0001$. The square root of this is .01, which divided into 159,000 gives us 15,900,000 cycles, or 15,900 kc. Making the same calculations at the 100 points (100 $\mu\text{h} \times .0001 \mu\text{f}$) and at the top of the scale give us 1,590 kc and 159 kc respectively. From these we can obtain—with the help of 2-cycle paper—a complete calibration from 169 to 15,000 kc. Thus the finished chart (Nomogram D) will serve for practically all i.f., standard broadcasting and international shortwave broadcasting frequencies.

By clipping the top of our scales at 500 kc and increasing them proportionately at the bottom, the nomogram could be made to cover all frequencies from the broadcast band to 50 megacycles. This is done by starting out with three-cycle paper, then cutting the finished chart down to whatever size is necessary for mounting, publication or other purposes.

More complex charts may be constructed. A common one has four elements (A \times B \times C = D.) The straight

(Continued on page 719)

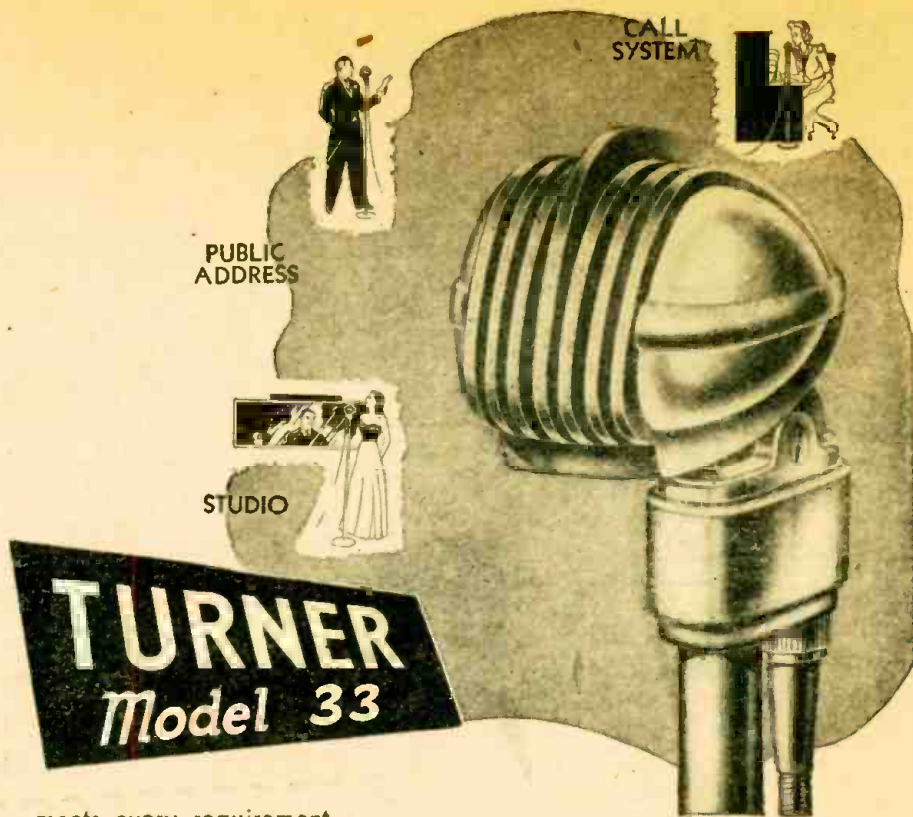

meets every requirement

for a **RUGGED**
ALL-PURPOSE MICROPHONE

Packed with power to spare — built to take rough handling and bad climate conditions — engineered for smooth response to both music and voice pickups, the Turner Model 33 is an all-around microphone for recording, P.A., call system, studio, and amateur work. A professional unit for professional results. Ask your distributor or write.

Free Turner Catalog
Write for your copy

THE TURNER COMPANY

902 17th Street, N.E.
Cedar Rapids, Iowa

Licensed under U.S. Patents of the American Telephone & Telegraph Company, and Western Electric Company, Incorporated.
Crystals licensed under patents of the Brush Development Company

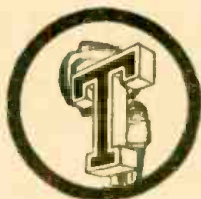

LOOK at these
Performance Features

33X Crystal

- Moisture-sealed crystal.
- 90° tilting head.
- Wind and blast-proofed.
- Barometric compensator.
- Chrome finished case.
- Level -52DB.
- Range 30-10,000 cycles.
- Removable cable set.

33D Dynamic

- Heavy duty dynamic cartridge.
- 90° tilting head.
- Wind and blast-proofed.
- Chrome finished case.
- Level -51DB.
- Range 40-10,000 cycles.
- Removable cable set.
- Choice of impedances.

INSIDE THE HANDIE-TALKIE

(Continued from page 684)

the antenna, antenna loading coil and a .006- μ f fixed mica condenser, as shown in Fig. 1. The plate circuit of this stage is loaded by a permeability-tuned coil and is capacity-coupled to the signal grid of the 1R5.

Crystal control of the receiver oscillator frequency is maintained by connecting a quartz crystal between the No. 1 grid and screen grids of the 1R5. Excessive oscillator voltage on the signal grid is reduced by a 7- μ f ceramic condenser connected between the signal and oscillator grids. This condenser neutralizes a portion of the oscillator frequency voltage by returning it to the oscillator grid out of phase with the internally coupled voltage.

The 1T4 and 1S5 are connected in the standard i.f. and second detector circuits common to most battery receivers. Midget i.f. transformers are used throughout. The secondary winding of the input transformer is loaded with a 1-megohm resistor to broaden the i.f. tuning.

Impedance coupling is used in the output circuit to prevent plate current from flowing through the earphone.

When the set is in operation, it is a receiver unless the "press-to-talk" button is depressed. A diagram of the complete set is shown in Fig. 2. All switches are in the "receive" position.

THE TRANSMITTER CIRCUIT

When the set is used as a transmitter, switching converts the r.f. amplifier and oscillator-mixer portions of the receiver to a master oscillator-power amplifier transmitting circuit. The first a.f. and power amplifiers of the receiver are converted to microphone amplifier and modulator for the transmitter.

While transmitting, the "push-to-talk" button must be depressed. The circuit of the set is then changed to that of the diagram in Fig. 3, and a crystal of a frequency 455 kc. lower than the receiving crystal is switched into the circuit. The output of the oscillator anode is capacity coupled to the grid of the 3S4 r.f. power amplifier. The r.f. tank coil is switched into the circuit and tuned by a .00014- μ f variable tuning condenser. This combination of coil and condenser is called a "tank" circuit. The antenna loading coil is connected in a pi network tuned by the tank tuning condenser and the capacity existing between the antenna and housing.

The dynamic microphone is transformer-coupled to the grid circuit of the 1S5. This tube functions as a speech amplifier and is resistance-coupled to the 3S4 modulator.

The grid return of the 3S4 modulator is tapped into the grid leak circuit of the oscillator tube, to provide proper operating bias of the modulator. The a.f. choke in the plate lead serves as the coupling choke for modulation of the power amplifier. A portion of the a.f. output of the modulator is applied

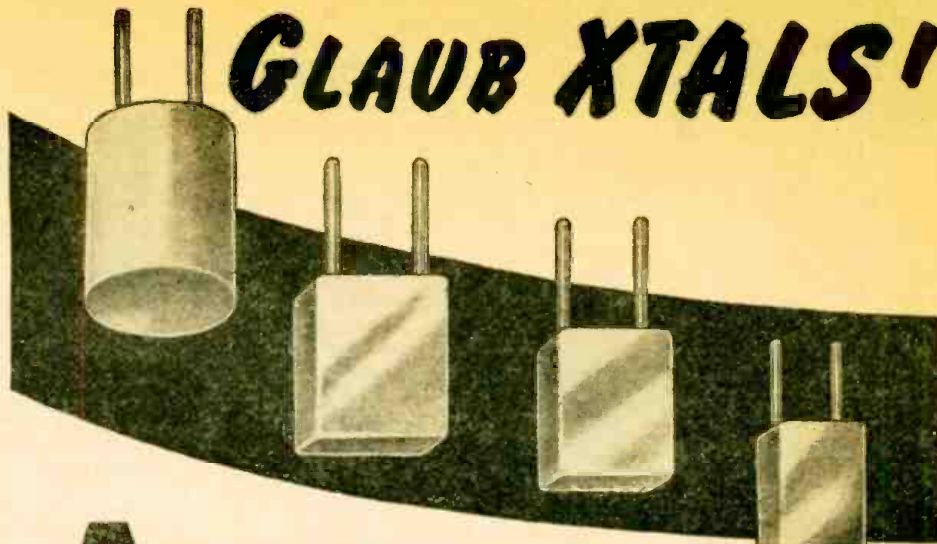

Amateurs...

DO YOU know where you are in the Radio Spectrum? With a Glaub Xtal you can be sure. Our Xtals are ground to within .03% of specified frequency and guaranteed, with a temperature coefficient of less 3 cycles per megacycle per degree centigrade. They can't be beat! Attractive, convenient holders to fit any set. A custom built Xtal to your specifications at a standard price.

DELIVERED 48 HOURS AFTER RECEIPT OF ORDER

LET US PUT YOU IN YOUR PLACE ON THE AIR!

PIONEER ELECTRIC COMPANY

Western Distributors of Glaub Crystals

3700 East Olympic Boulevard • Los Angeles 23, California

to the earphone to provide a sidetone for monitoring transmission.

The "push-to-talk" switch is made up of 14 sections, which perform the intricate switching functions which convert the receiver to a transmitter. Each section of the switch has been given a letter to simplify a study of the diagrams. In Fig. 1, all sections of the switch are shown in the receive position. All of the switching functions are evident from the diagrams.

Many of the resistors and condensers of this set are mounted in small circular "cups" that fit around the underside of the tube sockets. Terminal lugs are mounted on the rim of the "cups" so that the parts may be connected to the external circuits. Later models abandoned the cup system and used straight terminal strips, as shown in the photo on page 684.

The transmitter is easy to adjust. A crystal and plug-in coil for the desired frequency are plugged into the unit and the antenna fully extended. The "push-to-talk" switch is held down and the r.f. amplifier tank condenser adjusted to give minimum amplifier plate current. The plate current is metered by removing a jumper located at the lower end of the chassis.

The receiver is tuned by inserting coil and crystal combinations for the desired frequency. The receiver oscillator crystal is ground to a frequency 455 kc higher than the transmitter operating frequency. The receiver is then aligned by conventional methods.

(Continued on page 723)

MORE SMASH BUYS at National Radio Distributors



IMMEDIATE DELIVERY NEW POST-WAR SCOOP

5 tube AC/DC Superheterodyne Radio Kit featuring built-in loop antenna, using 12SQ7, 12SK7, 12SQ7, 50L6, 35Z5 tubes. All parts brand new and perfectly matched. Absolute satisfaction guaranteed. Including cabinet and full instructions for assembling. . . . \$13.75
In lots of three. . . . \$12.95
Kit of 5 matched tubes. . . . \$ 4.95

Hook-up wire and solder, not included in above kit.
SPECIAL-NEW MAGUIRE ARC-1 RECORD CHANGERS. Precision engineered, single control knob, plays 10 12" or 12 10" records, stops automatically after last record is played. Extra lightweight pick-up arm, features spring mounting and heavy duty rugged motor. . . . \$22.95
PAC 100 PORTABLE RECORD CHANGER CASE. dark brown leatherette covered. Will accommodate above or any other make changer. Mounting panel 15 3/4" square.
NET \$8.95



NEW POST-WAR PORTABLE RECORD PLAYER KITS

Model RP100 Player including beautiful alligator or leatherette covered portable carrying case, motor, completely assembled 3-tube amplifier using 12SQ7, 50L6, 35Z5. Crystal pickup arm, 6" PM speaker with output transformer. Will play 12" records with lid closed and features separate tone and volume controls.
Your cost, \$24.50 less tubes
Kit of 3 matched tubes \$2.95

Model RC300 Same as above with NEW Maguire Record Changer and 2-toned leatherette portable carrying case to match. Will take 10-12" or 12-10" records with lid closed.
Your cost \$44.95 less tubes

COMPLETE INSTRUCTIONS FOR ASSEMBLING

Hook-up wire and solder, not included in above kit

EXTRA SPECIAL-BY-PASS CONDENSER KIT. Consists of 100 Tubulars (all 600 Volt) in the following sizes: .001, .002, .006, .01, .02, .03, .05 and .1 Mfd. All fresh stock, fully guaranteed. Per Kit \$5.95

Please include at least 25% with C.O.D. orders. Write for New Free Catalog Now!

National Radio Distributors

1029_R E. 163 St., New York 59, N.Y.

TRY THIS ONE

PROTRACTOR DIAL

When in need of a precision dial, why not try a protractor? Its divisions are accurately spaced and make a neat appearance, as may be seen in the photo.

The metal types are usable where the readings are referred to a graph or chart for interpolation. When it is desirable to have a direct-reading dial, a celluloid protractor is most useful. A

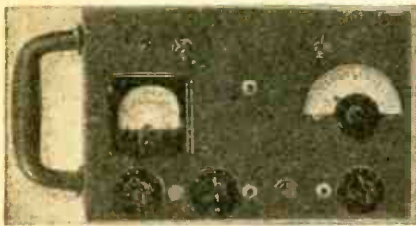

paper backing with the necessary markings and notations is placed behind the transparent dial so that the calibrations may be seen at a glance. A knob with a transparent hairline pointer increases the accuracy of the dial readings.

Three small screws or rivets may be used to fasten the dial to the panel.

HAROLD PALLATZ,
Brooklyn, N. Y.

CODED TEST PRODS

I have found that it is possible to make test prods from auto inner tube valve stems and caps.

The valve stem is cut off close to the tube and the needle removed. A nail or long tack is driven through the valve cap with a small portion of its head protruding. A piece of insulated wire is passed through the stem and wrapped around the head of the nail. The cap is then screwed on the stem.



By selecting valve stems from red and black tubes, I have a pair of shock-proof, color-coded, solderless test prods.

A. C. FROHNOPFEL,
Bartlett, Texas

FADED TUBE NUMBERS

The tube type number is often printed on the side of the glass type tubes and through frequent handling, the number soon becomes unreadable.

I overcome the handicap by dipping the glass portion of the tube in ammonia and allowing it to dry. The numbers then stand out clearly. Powdered ammonia may also be used by spreading it on the surface of the tube and then dipping into warm water and allowing it to dry.

JOHN B. ROLLS,
Verdun, Quebec.

BUZZ CURE

After replacing a power transformer in a console type receiver, I noticed a buzzing sound that was audible above the signal when the volume was turned low.

Wedging the coils on the transformer core was tried without success. I found that thin service cement applied to the

RADIO-CRAFT wants original kinks from its readers, and will award a seven-month subscription for each one published. To be accepted, ideas must be new and useful. Send your pet short-cut or new idea in today!

edges of the windings and the core laminations produced a positive cure.

CLAUDE M. PREW,
New London, N. H.

VOLUME CONTROL REPAIR

Here is one of my favorite "kinks" for repairing noisy volume controls. It is unnecessary to remove the control from its circuit.

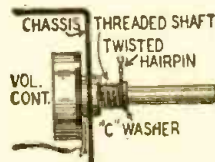

Remove the chassis from the cabinet and place a small hairpin between the "C" washer and the threaded bushing. A few twists on the hairpin with a pair of pliers will hold the pin in place. This will make a tighter fit between the rotating arm and the carbon strip.

SAUL KIRSHNER,
Montreal, Canada

TUBE SUBSTITUTION

In servicing a receiver recently, I accidentally put a 6K7 into a 6F5 socket. To my surprise, I found the reception just as good as with the original tube. The plate and suppressor were left floating with no voltage on them. Later I checked this idea on other sets with the same results. This scheme may well be used for emergency tube replacements.

LAWRENCE MOSEMAN,
Hibbing, Minn.

(Before trying this method of tube substitution, it is wise to check the underside of the socket to make sure that the unused socket holes are not used as tie-points for high-voltage leads.—*Editor*)

HANDY IRON REST

While this kink is not an original one, I find it helpful. When a hot soldering iron is left on the work bench, appliance wires are constantly coming in contact with its hot surface and becoming burned.

This inconvenience may be overcome by taking an old tube shield and screwing it just below the surface of the work bench. This makes a handy rest for the iron and it can be reached easily when needed.

A. K. MEMON,
Karachi, India

SAFETY IRON

To prevent charring wires and condensers while soldering in close quarters, take a piece of thin asbestos cloth and wrap it around the lower part of the body and tip of the soldering iron. About three-quarters of an inch of the copper is left exposed. The asbestos is bound to the iron with fine wire.

WM. A. PLEES,
Whitehall, Michigan

CORDLESS IRON

The accompanying photograph shows the method that I use to prevent having a long trailing cord on the end of my soldering iron.

The handle of a heavy rubber male plug is fitted in the handle of the iron. The line wires are attached to the prongs of the plug. The iron may then be plugged into any convenient socket.

I have mounted a heavy-duty receptacle in the top of a small metal box and fixed it firmly to the top of the work bench. The iron remains upright and takes up very little space on the bench.

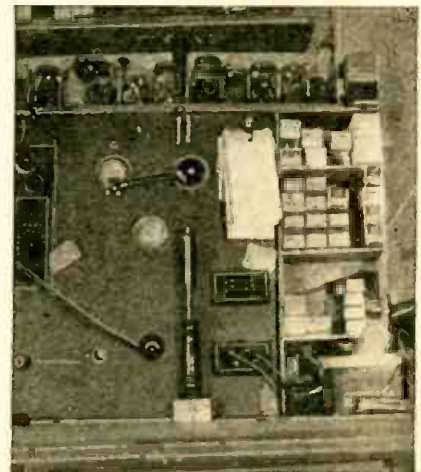

I find that the iron heats more rapidly when it is held in this position.

JAMES L. LANTERMAN,
Snyder, Oklahoma

430 MC WITH A 6F4

(Continued from page 688)

soldered directly to ends of the U. The other coupling method consists of a wire hairpin through two holes drilled in the outer cylinder (but insulated from it). As this hairpin is drawn outward the coupling decreases. Whichever coupling is used, it should be designed so that it will not interfere with the sliding assembly as it is moved up toward the top.

The simplest antenna is the half-wave dipole consisting of two portions, each about 6½ inches long. Low-impedance twin lead (75 ohms) may be used to couple the antenna to the oscillator. For best efficiency, the antenna length should be made variable. A good method is to make it of aluminum or brass with one piece of tubing sliding within another, until the correct total length is found. Since the power output is not great enough to light a bulb noticeably, the condition of optimum loading is determined by the plate milliammeter. The meter reads maximum permitted current when the coupling and loading are correct.

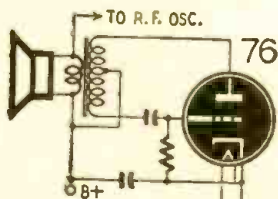

Fig. 5—Tone modulator and monitor circuit.

To carry on experiments this oscillator was used in conjunction with an audio tone modulation provided by a 76 oscillator. A PM speaker with push-pull transformer is the Hartley oscillator coil and monitor in one. The secondary connects to the voice coil. This gives a high-pitched note which can be monitored as it modulates the r.f. oscillator, (Fig. 5).

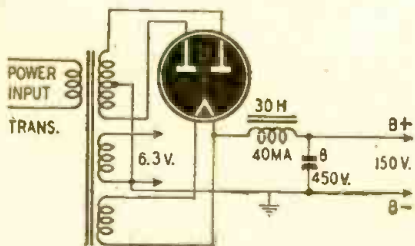

Fig. 6—The power supply and filter system.

The power supply and filter system (Fig. 6) is conventional. The transformer output is approximately 150 volts under the load of both oscillator tubes (approximately 25 ma) because of the choke input used. Since this is equal to the maximum plate voltage on the acorn 6F4 it is not necessary to reduce it in any way. The filter system provides adequately pure direct current to both tubes.

In modulating the r.f., it will be found that excessive audio input broad-

(Continued on page 724)

NEW and ALLIED'S 1946 CATALOG

Ready for you!



of Radio and Electronic Supplies

FREE

Send for it Now!

LARGEST AND MOST COMPLETE STOCKS

Today's handiest, most complete *Buying Guide!* Brings you latest, finest values in parts, tubes, kits, tools, books, test instruments, communications receivers, Ham gear, public address and other equipment. Places at your finger tips over 10,000 items of nationally known guaranteed quality. Makes available to you the world's largest and most complete stocks under one roof . . . ready for rush delivery. Enables you to get everything you need in radio and electronics from one dependable, central source. Send for this new 1946 Catalog now. Save time, work and money!



NEW RADIO SETS

Parade of new 1946 models, including phonoradios, and latest communications receivers covering broadcast, short-wave and amateur bands. Beautiful styles! Wonderful performance! Outstanding values!



HANDY RADIO BOOKS AND CALCULATORS

Radio Formulas & Data, Dictionary of Radio Terms, Radio Circuit Handbook, Radio Builders' Handbook, Simplified Radio Servicing, Radio No. 37-799, 75c. Parallel Resistance and Series Capacitance Calculator. No. X37-960 . . . 25c R-F Resonance and Coil Winding Calculator. No. 37-955 . . . 25c



OVER 10,000 ITEMS

Biggest section of quality parts and equipment for engineers, dealers, servicemen, soundmen, amateurs, builders. All leading makes, at lowest prices. Send for Free Catalog now.



NEW P.A. EQUIPMENT

Sound systems for every public address requirement. Complete listing of amplifiers, speakers, microphones, accessories. Newest developments with many exclusive features.

ALLIED RADIO CORP.

833 W. Jackson Blvd., Dept. 2-GG-6
Chicago 7, Illinois

Date

Send FREE New 1946 Catalog.

Send Six Books—Calculator No. } \$..... enclosed

Calculator No. }

Name

Address

City Zone State

ALLIED RADIO

Everything in Radio and Electronics



The Question Box is again undertaking to answer a limited number of questions. Queries will be answered by mail and those of general interest will be printed in the magazine. A fee of 50c will be charged for simple questions requiring no schematics. Write for estimate on such questions as may require diagrams or considerable research.

CONVERSION OF ARMY RADAR OSCILLOSCOPE

Recently I purchased one of the BC-412-A oscilloscopes. This "scope" was used by the Army in radar installations. I would like a diagram showing the changes necessary to convert this "scope" so that it may be used for radio servicing.—(Many Readers).

A. A diagram is shown that will enable you to convert the oscilloscope for radio servicing. The 6L6 pulse and sweep generators and the 6SJ7 spread amplifier are discarded and an 884 gas triode oscillator sweep circuit is added which permit the operator to

make coarse and vernier adjustments on the sweep frequency. Input jacks for external synchronizing voltages and for the horizontal and vertical amplifiers are used for external coupling to the "scope".

The parallel vertical amplifier is converted to push-pull for better performance. The vertical sensitivity is approximately .045 volts per inch and the horizontal amplifier has been altered to increase the gain to 0.3 volts per inch.

All leads in the input circuits of the horizontal and vertical amplifiers should be well shielded. The long leads should

have the shields grounded at several points. Hum and microphonics in the vertical amplifier may be caused by a defective 6AC7.

Extremely high voltages are used in some parts of the 'scope circuit and all precautions should be taken to avoid bodily contact with these circuits as this will result in DEATH or SERIOUS INJURY. When working on the unit, all high-voltage condensers should be discharged each time that the power is turned off. A well-insulated metal screw driver may be used to short the terminals of each of the condensers.

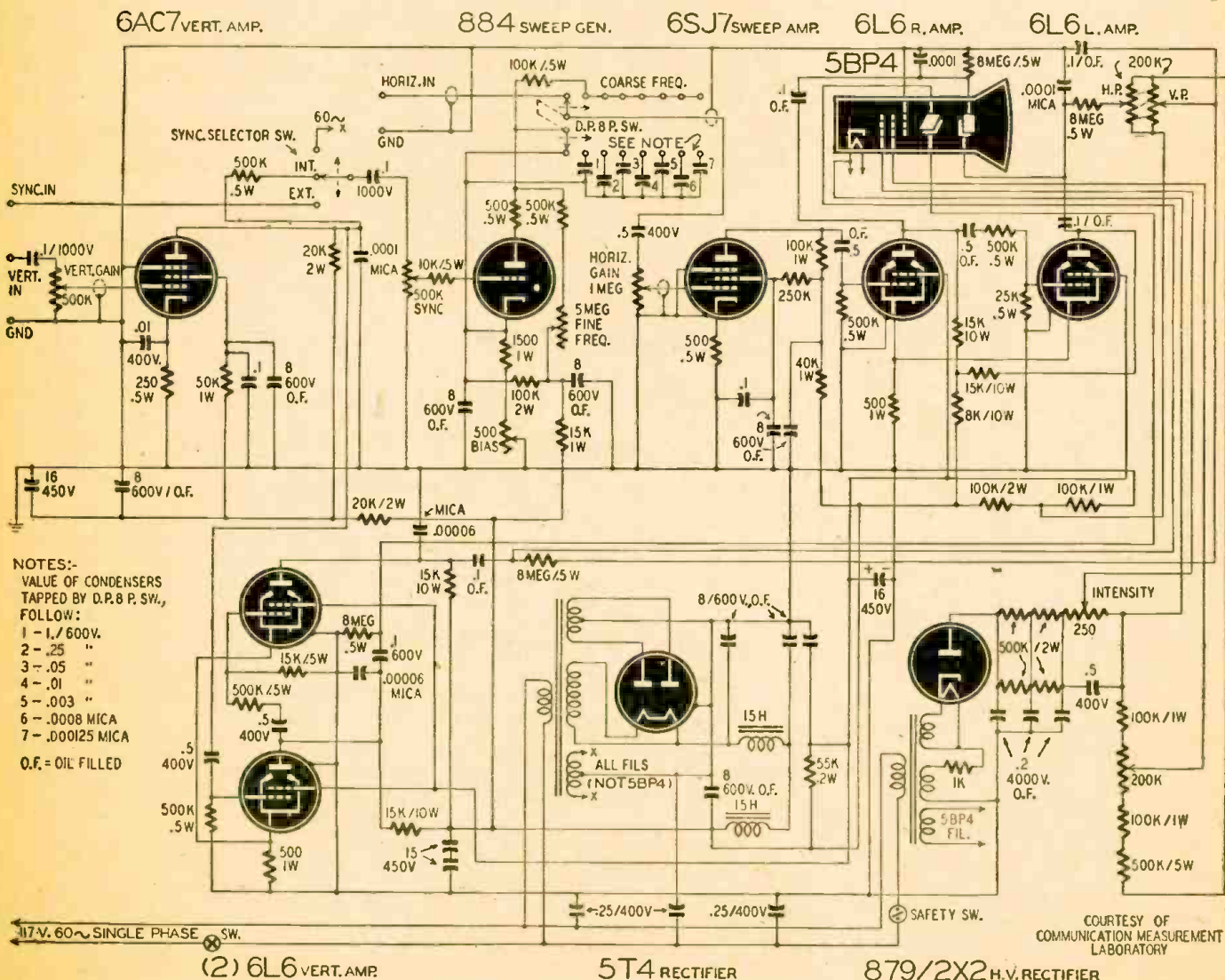

NEW FACSIMILE IS FAST

(Continued from page 680)

giving a check on what is going out over the air. The one at the right may be patched into various points in the transmitting equipment, thus affording a means of trouble shooting.

The scanner used in the Hogan apparatus is of conventional type. Copy wrapped around a revolving drum is scanned by an electric eye in terms of gradations of shade contained within a very narrow horizontal line.

To accomplish this, the electric eye is focussed upon one tiny rectangular spot so that during one revolution of the drum it scans around the cylinder in terms of this tiny spot. By moving the electric eye along the drum a distance equal to the width of the spot during each revolution of the drum, the copy is scanned from left to right in a series of slightly slanting contiguous lines from top to bottom of the page. The number of these lines in one inch is called the definition of the system. In this apparatus, it is in the order of 100 lines.

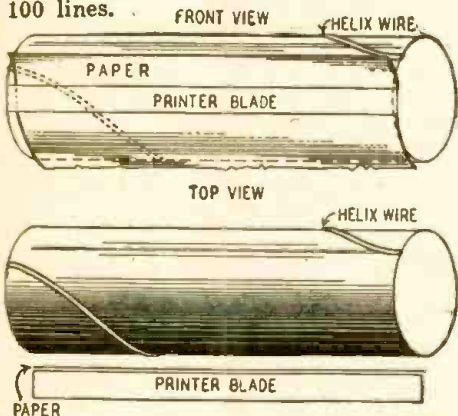

Front and top views of a facsimile printer.

Meanwhile, at the recorder, a recording element causes a marking spot of the same size to travel across and down the recording paper at the same speed as the scanning spot. Since these signals are broadcast with the speed of light, the marking spot controlled by the fluctuating facsimile signal current produces a facsimile of each tiny area in the original at the corresponding area of the recording paper.

Although scanners have been more or less alike in all systems, recorders differ greatly. Some simply reproduce the beam of light on photographic film, which is later developed. In others, a point moves across a drum on which carbon paper is spread over white recording paper. Pressure varies with the modulation, causing a heavier or lighter deposit of carbon on the backing paper. Most modern systems are electrical in nature. Current from the scanning point passes through the paper, causing a chemical darkening which increases with the quantity of current passed.

The area of the marking spot is determined by the intersection of a "helix" (spiral) wire wound around a cylinder on one side of the paper and a strip of metal (the printer blade) mounted

(Continued on page 711)

New! Complete!
FREE
CONCORD
Radio
Catalog



NEW RADIO SETS

NEW AMPLIFIERS

NEW RADIO PARTS

Electronic Equipment

HAM GEAR

STANDARD LINES! LARGEST STOCK!
IMMEDIATE SHIPMENT!

For the newest, the latest, and the best in radio sets, radio parts, amateur kits, and test equipment, mail coupon below for your free copy of Concord's first post-war Catalog. It offers a huge storehouse of everything that's new in radio and electronics . . . including the sensational, talked-about line of exclusive Concord Multiamp ADD-A-UNIT amplifiers. It contains thousands of items . . . all standard lines . . . war-born discoveries and improvements . . . all ready for same-day shipment direct to you from CHICAGO or ATLANTA.

History-Making ADD-A-UNIT Line of Amplifiers

Typical of Concord leadership is the completely revolutionary line of Multiamp ADD-A-UNIT Amplifiers, designed and engineered by Concord, sold only by Concord. Built on entirely new principles, these Amplifiers offer startling innovations not available elsewhere . . . new high standards of flexibility, fidelity, power, economy, and all-round performance almost beyond belief. Mail coupon now for Concord's New Complete Catalog showing full amplifier line . . . and complete assortments of "everything that's new in radio and electronics."

CONCORD

RADIO CORPORATION
LAFAYETTE RADIO CORPORATION

CHICAGO 7 ATLANTA 3
901 W. Jackson Blvd. 265 Peachtree Street

CONCORD RADIO CORPORATION
901 W. Jackson Blvd., Dpt. RC-76, Chicago 7, Ill.
Yes, rush FREE COPY of the comprehensive
new Concord Radio Catalog.

Name.....
Address.....
City..... State.....

INDIVIDUALLY MARKED

for Quick Identification of Resistance and Wattage

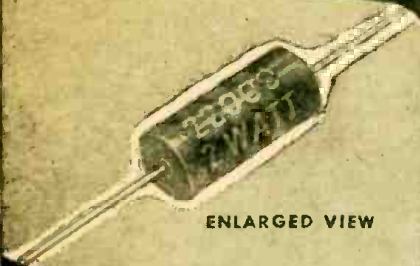

ENLARGED VIEW

1/2 Watt • 1 Watt • 2 Watt

OHMITE

Little Devil

INSULATED COMPOSITION RESISTORS

NOT ONLY are these new *Little Devils* tops in performance and service . . . but you never have to guess about the resistance and wattage of any unit. Every *Little Devil* is individually marked for quick, positive identification in your resistor stock or servicing kit. In addition all units are color coded. Available in Standard RMA values from 10 ohms to 22 megohms, $\pm 10\%$ tolerance.

Available only from Ohmite Distributors

OHMITE MANUFACTURING COMPANY
4894 Flournoy St., Chicago 44, U. S. A.

Type	Size Length Diam.	Resistance Range	Maximum Volts	List Price
1/2 Watt	3/8" x 3/64"	10 Ohms to 22 Meg.	500	13c
1 Watt	9/16" x 7/32"	10 Ohms to 22 Meg.	1000	17c
2 Watt	1 1/16" x 5/16"	10 Ohms to 22 Meg.	3500	25c

Be Right with

OHMITE

RHEOSTATS • RESISTORS • TAP SWITCHES

NEW RADIO - ELECTRONICS PATENTS

R.F. INDICATOR

George E. Colman, Red Bank, N. J.
Patent No. 2,395,850

R.F. TRANSMITTERS are tuned and modulation checked conventionally by thermocouples and meters, both of which are rather expensive and delicate. This new circuit should be of interest to amateurs and others since it enables a circuit to be correctly tuned by using only an ordinary neon bulb.

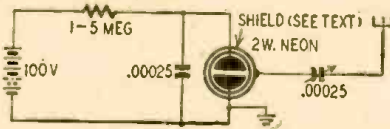

A conducting ring is placed around the neon bulb and is connected to a pickup device such as a small antenna which is introduced into the r.f. field. The small variable condenser controls the electrostatic excitation to the bulb. One of the bulb plates is grounded, and both are connected across a small condenser which equalizes the discharge so that each plate shows approximately the same glow.

An auxiliary d.c. circuit is connected and adjusted so that the neon is only slightly ionized. The added r.f. power causes a corresponding increase of ionization. Relative r.f. magnitude may be indicated by the variable condenser setting typically to reach a given degree of ionization.

Typical circuit constants are given in the diagram.

ELECTRONIC CHRONOSCOPE

Carrol R. Nisewanger and Frederick W. Brown,
Pittsburgh, Pa.

Patent No. 2,395,902

THE measurement of very small time intervals (of the order of 10 microseconds) is accomplished by this instrument. One practical application is the measurement of rate of detonation.

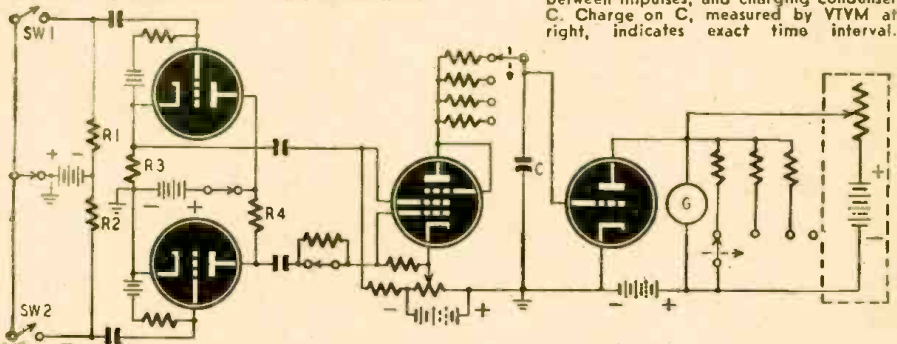

In explosive design, for example, it is often necessary to know the time interval between the instantaneous detonation at given points along an explosive.

The circuit is adapted to measure over a wide range of values by providing several values of resistors in the condenser charging and galvanometer circuits.

The circuit uses two thyatron tubes connected to a switching tube. The latter tube, a pentode, is adjusted as follows. The screen grid is biased below cut-off, but an applied positive pulse will restore the tube to a conducting condition. If a negative pulse is applied to the control-grid immediately thereafter, the tube cuts off again. The pentode circuit is equivalent to an R-C circuit which is closed and then opened. As a result the condenser C becomes charged to some value depending upon the time interval of conduction. A meter across C may therefore be calibrated in terms of that time interval.

Closing SW1 starts the interval being measured. The voltage drop across R1 transmits a positive pulse to the upper thyatron which breaks down. The voltage drop across R3 applies a positive pulse to the switching tube which begins to conduct and charge the condenser C. The completion of the interval is marked by closing SW2, which produces a voltage drop across R2. The resultant positive pulse fires the lower thyatron and there exists a voltage drop across R4. A negative pulse is therefore transmitted to the pentode control grid, cutting off the plate current.

The voltage to which C has been charged is measured by a vacuum-tube voltmeter which includes the usual balancing-out circuit. This permits setting the meter G to some reference point before measurement. Voltage across C (and therefore time interval) is indicated by a corresponding decrease of meter indication.

The circuit may be calibrated by closing the key switches mechanically at known small time intervals. To measure the rate of detonation of an explosive, each switch may consist of two fine wires placed close together. When the explosion reaches a switch, the released ions act to close it. With a slight change of circuit it is possible to utilize a circuit break to fire each thyatron.

At left, two thyatrons which switch center tube, causing current flow in interval between impulses, and charging condenser C. Charge on C, measured by VTVM at right, indicates exact time interval.

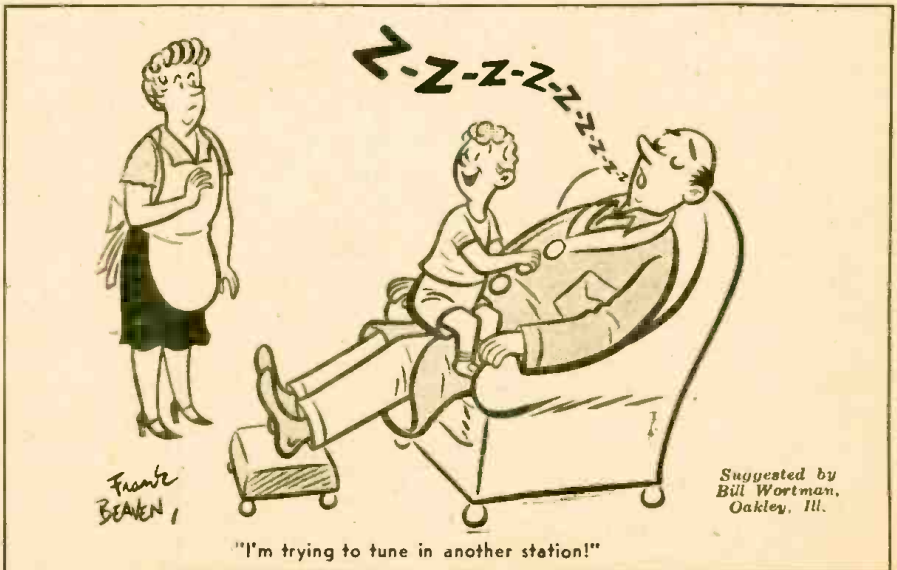

Frank BEAVEN

Suggested by Bill Wortman, Oakley, Ill.

TECHNOTES

... SPEAKER REPAIRS

When a speaker cone is warped so that it will move freely in only one direction, it may be repaired by springing it back in the correct position and blocking with wadded paper, felt or a small weight. While the cone is blocked in this position, the corrugated rim of the cone is wet with water and then allowed to dry in this position. The cone will retain this position when dry and will be free from scraping.

HUBERT WATKINS,
Gulfport, Miss.

... BATTERY POWERED RADIOS

Operating voltages of 1½-volt oscillator tubes used in many sets is very critical and cannot be determined with a tube tester.

To prevent unwarranted complaints soon after a set has been serviced, the minimum effective filament operating voltage should be determined. This is done by making up a separate extension cable for the A-plus line. A 10-ohm rheostat is inserted in the lead and the resistance increased until the tube ceases to oscillate. If it refuses to oscillate at any voltage below 1.1, it should be replaced, as it will not get all of the usable power out of a set of batteries.

In making this test, a good voltmeter should be connected directly across the filament terminals at the tube socket. A high-resistance or vacuum-tube voltmeter connected to the stator of the oscillator tuning condenser will indicate the instant that oscillation fails.

GERALD EVANS,
Ola, Arkansas

... ZENITH 85611

Sharp crackling noises while tuning this model may be caused by corroded contacts on the tuning condenser gang. Clean all bearings, fly-wheel, counter shaft and tuning condensers by applying carbon tetrachloride with an art brush. The bearings are then lubricated with a light film of machine oil.

CLAUDE M. PREW,
New London, N. H.

DELIVERY FROM STOCK

Aerovox Can Type Condensers:

GLS 450 V. 8 mfd., net \$0.89; GL 450 V. 8 mfd., \$0.89; 2GL 450 V. 8-8 mfd., \$1.33; GL475 V. 8 mfd. \$1.22; GL 450 V. 12 mfd., \$1.16; GL 450 V. 20 mfd., \$1.43; PRV 450 V. 10 mfd., \$0.95; PRV 450 V., 40 mfd., \$1.81; GL 600, 8 mfd., \$2.16.

NO SURPLUS—ALL FRESH STOCK

CINAUDAGRAPH SPEAKERS

2 In. P.M., 2ZMP, \$1.55
3 In. P.M., 30 MP, \$2.32
10 In. P.M., PM 10-12, peak watts 16, \$8.79
12 In. P.M., PM 12-13, peak watts 18, \$9.84
12 In. P.M., PM 12-16, peak watts 21, \$15.83
St. Clair Vacuum Tube V.O.M., \$49.95
Silver Vomax, \$59.85
Hickok No. 203, Electronic Volt Ohm Capacity Milliammeter, \$79.80
Simpson No. 260 V.O.M., \$33.25

RADIO EQUIPMENT CO.

377 EAST MAIN ST. LEXINGTON 34, KY.

- YOU can hold a New, Better Job in RADIO ELECTRONICS



... Use Cleveland Institute home study courses for professional self-improvement.

THIS NEW WORLD OF ELECTRONICS promises exciting opportunities for employment in new applications of new electronic developments. FM broadcasting, microwave relay systems, television, mobile communication systems for railroads, automobiles, busses and trucks—these are only a few of the post-war possibilities for new employment. **BRAND NEW JOBS IN BRAND NEW FIELDS!**

ARE YOU QUALIFIED FOR THESE NEW JOBS? That is the first question you will face. Practical experience is only a partial answer—the field has plenty of such men. Practical experience **PLUS** technical training is the best answer—the answer that will bring that better job and more pay.

YOUR FIRST STEP TOWARD THAT BETTER JOB in this New World of Electronics is your resolution to acquire a sound basic knowledge of the technical side of radio-electronics. Add this knowledge to your practical experience and place yourself **ABOVE** the competition of the "average" radioman. Cleveland Institute courses of supervised home study training are planned to do just that job.

LET CLEVELAND INSTITUTE TAKE OVER YOUR PERSONAL UP-GRADING PROBLEM. Qualified, competent instructors, ample, personalized instructional aids, orderly, progressively arranged study assignments in recognized, approved technical texts—these are only a few of the many superior advantages of Cleveland Institute's plan of personalized spare-time home study training for professional self-improvement.



Write today for free, descriptive booklet, "THIS NEW WORLD OF ELECTRONICS HOLDS OPPORTUNITY FOR YOU." No obligation—no salesmen.

Approved for Veteran Training under the G.I. Bill of Rights.

CLEVELAND INSTITUTE STUDY COURSES COVER THE FIELD OF RADIO-ELECTRONICS — TELEVISION, ULTRA-HIGH FREQUENCY TECHNIQUES, AM and FM BROADCASTING, COMMUNICATION ENGINEERING—from simple treatment of fundamentals, through preparation for FCC commercial radio operators' license examinations, up to and including complete high-level quantitative treatment of advanced radio electronics and communication engineering.

Aye, lad, CIRE is a grand school!



Cleveland Institute of Radio Electronics

Choose the course best suited to your needs, and start with the section you are qualified to enter. You pay for only the section or sections you need. Use the "Pay-as-you-go plan" patterned after ethical, educational practice. These features are unique with Cleveland Institute, and represent the best in the modern, post-war concept of home study training.

Many Cleveland Institute students of advanced engineering courses today are broadcast chief engineers. Graduates of Cleveland Institute courses are eligible for the top jobs in radio-electronics.

CLEVELAND INSTITUTE of RADIO ELECTRONICS

Contractors to the Canadian Broadcasting Corporation.

Successors to

NILSON RADIO SCHOOL, Founded 1939

SMITH PRACTICAL RADIO INSTITUTE, Founded 1934

RC-7 TERMINAL TOWER

CLEVELAND, 13, OHIO

MAIL THIS COUPON

CLEVELAND INSTITUTE of RADIO ELECTRONICS

RC-7 Terminal Tower, Cleveland 13, Ohio

Gentlemen: Please send information about your home study courses in Radio-Electronics.

NAME

ADDRESS

CITY

ZONE STATE

I desire training in

I have had experience in broadcasting servicing operating mfg. CAA Army-Navy amateur other.....

I am a High School Grad College Grad

I hold a degree in

Check here if you are a War Veteran



● For those tight spots calling for heavy-duty capacitors, you can always count on Aerovox Type-89 oil-impregnated oil-filled tubulars. They are especially ideal for use in vibrator applications; coupling and by-pass functions in transmitters; high-voltage amplifiers; in r.f. by-pass circuits; interference eliminators for motors and generators; and in test equipment. Briefly:

AEROVOX TYPE - 89

Hermetically-sealed metal-can container fully sealed against oil leakage or moisture penetration.

Case is insulated, or not connected with the capacitor section.

Center mounting strap and outer insulating tube supplied.

In 400, 600, 1000 and 2000 volt D.C.W. ratings. Choice of popular capacity values.

Sizes from 1/2 x 1 7/16" to 1 1/16 x 2 3/16".

● Ask Our Jobber ...

When you require such heavy-duty ultra-compact oil capacitors, just ask your Aerovox jobber for Type-89. Ask for latest catalog containing listings. Or write us direct.



FOR RADIO-ELECTRONIC AND INDUSTRIAL APPLICATIONS

AEROVOX CORP., NEW BEDFORD, MASS., U.S.A.
 Export: 13 E. 40th St., New York 16, N.Y. • Cable: 'ARLAB'
 In Canada: AEROVOX CANADA LTD., Hamilton, Ont.

Available Radio-Electronic Literature

Manufacturers' bulletins, catalogs and periodicals.

A SERVICE FOR RADIO-CRAFT READERS: In order to save your time, postage and incidental work in writing a number of letters to different manufacturers to secure the various bulletins offered, proceed as follows:

On your letterhead (do not use postcards) ask us to send you the literature which you designate. *It is only necessary to give us the numbers.* We will then send your request directly to the manufacturers, who in turn will send their bulletins or other literature directly to you.

237—SOUND EQUIPMENT

A catalog of sound equipment and associated equipment published by Concord Radio Corp. Includes public address equipment of all sizes as well as intercommunicators. Such sound accessories as recorders, microphones, speakers and cable are listed.—*Gratis*

238—ELECTRONIC EQUIPMENT

A 36-page illustrated catalog issued by Walker-Jimieson, Inc. Of particular interest to the manufacturer and serviceman. It includes industrial X-ray machines as well as servicing and shop equipment.—*Gratis*

239 MEASURING EQUIPMENT

Leeds and Northrup Company issues a 36-page catalog of precision laboratory equipment for d.c. measurements. This catalog is well illustrated and describes each item.—*Gratis*

240—INSTRUMENT CATALOG

Metropolitan Electronic and Instrument Co. has issued a catalog of popular servicing equipment. It contains illustrations and specifications of all instruments that are listed.—*Gratis*

241—MICA CAPACITORS

A well-illustrated catalog of mica condensers issued by Sangamo Electric Company. It includes a wide range of mica condensers for radio, electronic and industrial applications.—*Gratis*

243—INSULATING MATERIALS

An interesting manual of insulating materials prepared by William Brand & Co. Characteristics of oils, varnishes and various solids are tabulated and commented upon. Included in this manual is a catalog section that lists insulating papers, cloths, tubing, tapes and varnishes.—*Gratis to interested parties*

A "HANDIE" AID? TO BURGLARY

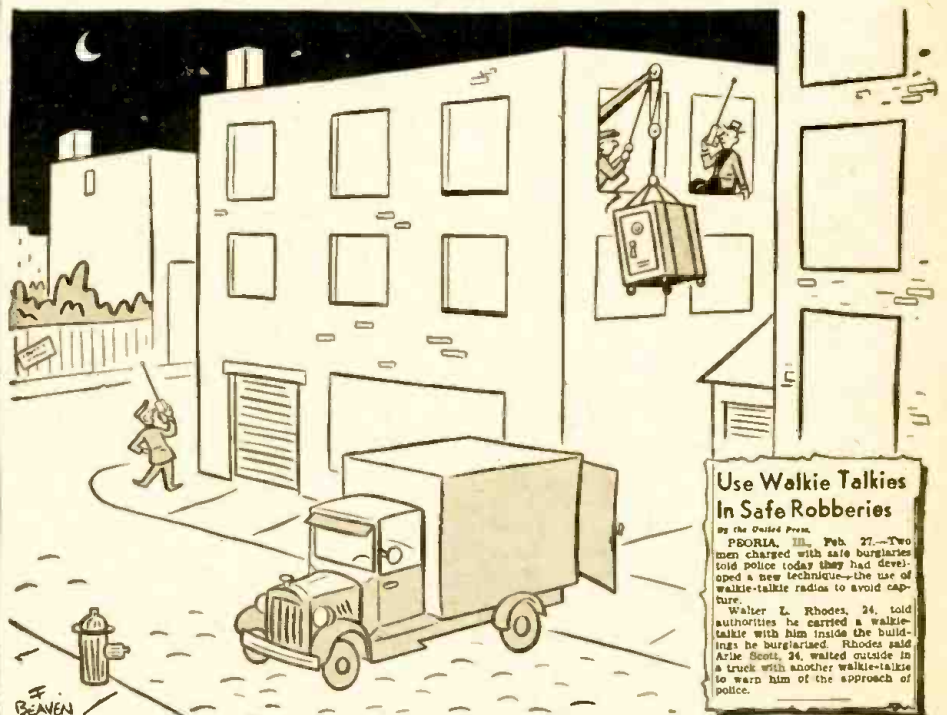

Use Walkie Talkies In Safe Robberies

By the United Press.
 PEORIA, Ill., Feb. 27.—Two men charged with safe burglaries told police today they had developed a new technique—the use of walkie-talkie radios to avoid capture.
 Walter L. Rhodes, 24, told authorities he carried a walkie-talkie with him inside the buildings he burglarized. Rhodes said Arlie Sims, 24, waited outside in a truck with another walkie-talkie to warn him of the approach of police.

The old saw "Many a true word's spoken in jest" was never better illustrated than by the above cartoon. Hardly had the Peoria story been dropped from the last editions of the newspapers than the New York City police rounded up a gang of youths accused of committing 75 robberies with the aid of handie-talkie radios.

The 20-year-old leader of the gang, it was said, was not satisfied to use only radio, but was working on an infra-red device to give the gang "invisible light" for their burglaries. Although he is a former Navy technician, there is no indication that the use of radar was planned!

The threat to public safety from the criminal use of highly mobile and portable radio is so grave that New York's Police Commissioner believes "we will have to have some kind of controls to keep such things out of the hands of criminals." He pointed out that not only handie-talkies but short-wave automobile radio apparatus similar to that used by police might also be a menace. Equipment to link moving motor cars to the telephone network can also be dangerous.

Another truism verified by the alleged youthful "scientific criminals" was the old saw about crime not paying off. The average haul amounted to \$200, to be divided among five participants. Considering the time and technique required, honest labor might have been more remunerative!

NEW FACSIMILE IS FAST
(Continued from page 707)

across the paper on the other side. By revolving the drum at the same speed as the scanning drum, this angle of intersection is caused to travel across the paper from left to right once for each revolution of the drum.

When electrolytic recording paper is used, the printer blade is stationary—the facsimile signal current flows through the paper at the instantaneous point of intersection, causing the electrolytic action between the paper and the metal of the printer blade, which produces a mark of corresponding shade at this point.

For home broadcasting the continuous, immediately visible recorder is the most practical. The only operations required of the set owner are the very simple ones of turning the recorder on and off, and tuning to the desired station. No processing is required before the copy becomes legible and, in addition, the home owner may either watch copy as it is being recorded, hot off the air, or may leave the recorder unattended during an entire day without missing his favorite program.

The receivers, Mr. Hogan believes, can be combined with ordinary FM broadcast receivers like the present radio-phonograph combinations. The facsimile section need cost little, if any, more than a good record-changer.

Radio Thirty-Five Years Ago
In Gernsback Publications

HUGO GERNSBACK
Founder

Modern Electrics	1908
Electrical Experimenter	1913
Radio News	1919
Science & Invention	1920
Radio-Craft	1929
Short-Wave Craft	1930
Wireless Association of America	1908

Some of the larger libraries in the country still have copies of Modern Electrics on file for interested readers.

A New System of Wireless Telephone, by *Victor H. Laughter*.

Pictures by Wireless.

A Helix Design, by *L. R. Wilson*.

Wireless on Aeroplane.

New Arc Apparatus.

Strengthening Wireless Signals, by *Ellery W. Stone*.

Wireless Switch, by *Harold Kerr*.

Rotary Detector, by *Raymond Rutherford*.

A Variable Condenser, by *Stanley F. Patten*.

A Simple Adjustable Detector, by *Thornton Kearfott*.

Portable Cane Wireless, by *B. Moran*.

Learner's Outfit, by "C.P.M."

Aerial Lead-In.

Improved Condenser.

ORDER NOW!
OUTSTANDING VALUES IN
MILITARY SURPLUS



U. S. NAVY MODEL
RAK-7 SHIP RECEIVER
NEW—IN CASES

Made by R.C.A. 9-Tubes; 6 Bands; 15 KC—600kc complete with power supply operating on 115v/60 cycles.

\$77.50

ARC-5 Receivers, complete	\$ 79.00
ARC-5 Transmitters, compl., less Dyn.	109.00
BC-221 Frequency meter, complete	82.50
G.E. Synchroscope new, complete	240.00
947-A Magnetron Transmitter from SCR-547	86.00
MC-363-A Range converter, 10 ampl. from SCR-547	85.00
BC-957-A Receiver Indicator from SCR-547	155.00
BA-58-A Power unit from SCR-547	116.00
BC-412 Scope from SCR-268, with tubes	59.50
BC-409 Pulse Ampl. from SCR-268 with tubes	59.50
Driver 6V6 to pair of 811's	3.00
Modulation Transformer 811's to 813	5.00
Modulation Transformer: 807 to pair of 807's	2.65
Power Transformer 115-60c 300v-ct 20ma / 5v & 6.3v fil. sec	2.25
Kenyon Fil. Transformer 115v/5v-115 A	9.95
Single and double button mike-grid transformers	1.49
1.7H .160 Amps chokes Good for choke Modulation	1.49
Steatite miniature coil forms 1/2x1/2 dia. Ceramic coil forms, adj. base 2 1/2x1 1/2 dia.	.25
Dynamotor, made by G.E. others: 28v/1.3 A input 250v/.060 A output for SCR-274 or ARC-5, used, perfect condition	7.75
Selyns, Drehl, 115v/00cps per pair	10.00
Klystrons 723A/B new	10.00
SCP1, SCP4 with tube socket	10.95
microwave fittings in stock	



BC-406. Frequency range 201 mc. to 210 mc. I.F. freq. 20 mc.; 2 mc. bandwidth. 15 tubes.

\$29.95

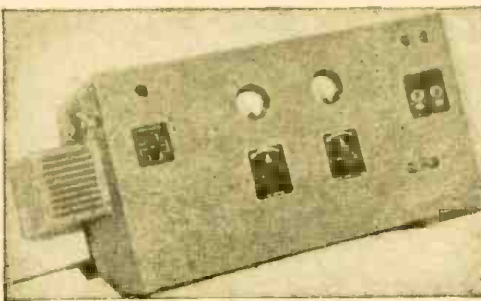

Signal Corps type BC409 from SCR-268 Radar set. Designed for 115 volts. AC 60 cycles. This unit developed the initial radar pulse and contains valuable component parts that valued individually would, in sum, cost several times the selling price of this unit. Fine buy for experimental work, or for anyone who can use the component parts. Slightly used. Following are a few of the items that make up the unit. 1—304TL (Eimac) triode 3—2 mfd. 4,000 W.V. GE Pyranol condensers. 1—3200 volt 150 MA power transformer. 1—Variac 5 amps. General Radio type CU 200. 1—5 volt 26 AMP fil. transformer (for 304 TL). 1—2.5 volt 10 Amp. fil. transformer (6000 volt insulation). 1—1 mfd. 1,000 volt GE Pyranol. 1—2 mfd. 1,000 volt GE Pyranol

2—0 to 4,000 volt. 3" volt. meters (0-1 mil. move) and misc. chokes, resistors, condensers, etc. W-1414—Complete units only. Your cost each.....\$79.50

NEW RECEIVERS B.C. 603 semi-completed, made for 603 Tank F.M. less var. cond. & front panel, no tubes.
\$4.50
In lots of 25.....\$3.50
Tech. Book & Hook-up......50

CARDWELL TRANSMITTING VARIABLE AIR CONDENSER TS-300-VS. 300 mmd. 5000V List \$40.50. OUR PRICE \$14.95
I.F. CRYSTAL FILTER UNIT FOR BC-312, BC-342. PRICE.....\$9.95
LARGE INVENTORY OF 400 CYCLE TRANSFORMERS. SEND FOR LIST.

NEW BATTERY BOX BX-4. 90v. 67 1/2 v. - 3v. - 4 1/4 v. common. A Terminals: with Cable. All wired, ready for use. Black wrinkle finish. Will hold: 2-Bell-ringer "A" batteries. 2 1/2 dia. 4-22 1/2 v "B" Batteries: 3-3/4x2 1/4x2-3/4. 1-4 1/2 v "C" Battery: 1 1/4x3 1/4. Ideal for Portable set, each **\$3.75**

All merchandise guaranteed. Mail orders promptly filled. All prices F.O.B. New York City. Send Money Order or Check. Shipping charges sent C. O. D. Send for Flyers.

COMMUNICATIONS EQUIPMENT CO.
131-C LIBERTY ST., NEW YORK CITY 7, N. Y.
TELEPHONE WH 4-7658



Transmitting Tubes at WELLS

We have a fine selection of medium power transmitting tubes of the most popular types. These are all brand new standard makes packed in their original sealed cartons and fully guaranteed. All tubes are government contract termination material and have been approved by JAN inspection. We have priced them far below actual value and suggest that your order include spares as quantities are not unlimited.

829B (Illust.)	\$4.75	3C24	\$4.00
304TL	12.50	813	9.75
803	9.00	832	7.95
807	1.25	832A	9.00
811	2.00	7193	.60

Wells' New Amateur Radio Division

Tom Kosti W9OPU, heads the new Amateur Radio Division. He has carefully selected a wonderful list of parts and equipment just released by the Government. You can save a big share of the cost of your new rig by writing Tom for his new Amateur Radio Circular. Wells' Amateur Radio Division, 4715-E West Madison Street, Chicago 44, Illinois.

USE COUPON BELOW FOR COMPLETE INFORMATION

WELLS SALES, INC., 4715-E West Madison St., Chicago 44, Illinois

Please ship the following Tubes: for which check (or M.O.) for \$..... is enclosed.

Please mail free Amateur Radio Circular.

Please send prices and information on the following items:

NAME

ADDRESS

TELEVISION FOR TODAY

(Continued from page 683)

been adopted. First, instead of sending the electron beam straight across the screen, as shown in Fig. 2, it is slanted slightly downward to achieve the effect illustrated in Fig. 4. In the first method (Fig. 2) it would be necessary to quickly drop the beam as it was moving from right to left during the retrace interval in order to place it in position for the next line. While this can be done, it is not as simple as the method of Fig. 4. In that method, a combination of vertical and horizontal deflection voltages cause the beam to travel at a slight incline. When the right-hand side of the image is reached, the beam has been lowered to position for the next scanning run and need only be moved straight across during the faster retrace period.

The second modification is in the horizontal-line scanning sequence. It is made to overcome a flickering effect that would otherwise appear. Whenever a series of related still films are projected on a screen, they can be made to appear continuous if the rate of presentation is greater than 15 per second. However, because each frame is so (relatively) slowly replaced by the succeeding frame, a definite flicker is present. By the use of special shuttering methods, we can eliminate the flicker entirely. In a television receiver we

have an analogous situation. Each complete scanning run represents the equivalent of one frame of film. If we have too few presentations per second, flicker will be evident. The object, then, is to cause the beam to scan so rapidly that never does the image light begin to fail. One solution is to have 60 full scanings per second. A better solution, however, and one that accomplishes the same effect at a lower repetition rate is the process known as interlaced scanning. (The desirability of a lower repetition rate is because the bandwidth requirements vary directly with the

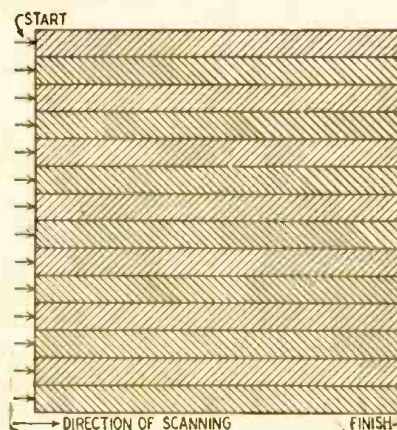

Fig. 3-a—The usual horizontal scanning path.

number of images sent per second.)

The basis of interlaced scanning is to have the electron beam cover first all the odd lines, then come back and cover the even lines. Hence, only half of each image is being sent at one time. However, the eye cannot separate the halves, and visually it appears as if the effective rate is actually 60 frames per second, whereas it is only 30. By keeping half of the image always before us, all traces of flicker are cleverly eliminated. The even lines are sent in 1/60 of a second, the odd lines in 1/60 of a second, or a full image is sent in 1/60 + 1/60 or 1/30 of a second. For each second then we get 30 frames. The use of values like 30 and 60 is directly connected to the frequency of our a.c. power mains. In England, where the power frequency is 50 cycles, values of 25 and 50 are employed.

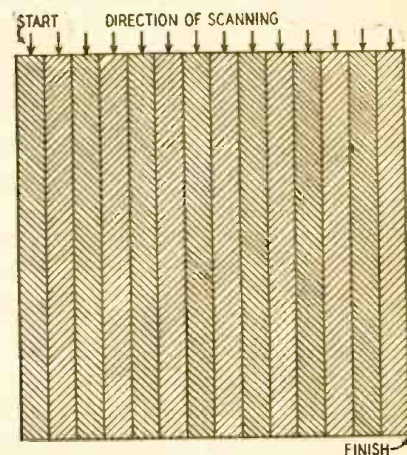

Fig. 3-b—Vertical scanning is quite as easy.

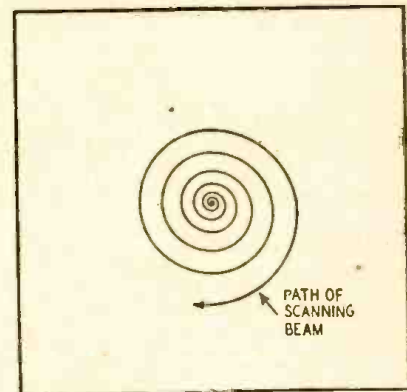

Fig. 3-c—A practical pattern in some cases.

To differentiate between the two rates, we say that the frame frequency is 30 per second, while each half of a frame (either the odd lines or the even) is known as a *field*. From above, the field frequency is 60 per second; add to this the fact that 525 horizontal lines are contained in each image or frame and we have the standards set for the present television system.

A complete scanning of an image is indicated in Fig. 5. Field 1 begins with the beam at point A. It then sweeps to the right, slowly scanning out the information until point B is reached. Now a blanking pulse is inserted into the signal, cutting off all scanning action until the beam has been brought by a horizontal synchronizing pulse to point C,

the next odd line, or number 3. This is repeated for each odd horizontal line until the end of Field 1 is reached at point D, the extreme lower right-hand corner of the image. Now the signal is again blanked out while a vertical synchronizing pulse brings the beam back to point E, the start of Field 2. Note that point E is in the middle of the image and represents a point that is 262½ lines from the start of Field 1,

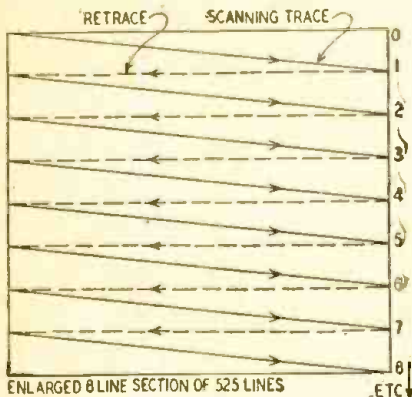

Fig. 4—Image trace, not retrace, is sloped.

point A. The rather odd figure of 262½ is due to the fact that the entire image contains 525 lines and one field is half of this amount. When the second field has completed its scanning run at G, the synchronizing pulse brings it back into position A for the next frame.

THE IMAGE DISSECTOR

The Iconoscope camera tube finds wide application, but other tubes do exist. One type, developed by P. T. Farnsworth, is the *image dissector* tube shown in Photo A. An internal view, providing more detail, is given in the drawing on page 683 and will form the basis for our explanation. The scene to be televised is focused onto the internal photosensitive cathode by an external optical lens system. Under the action of this incident light, electrons are given off in proportion to the

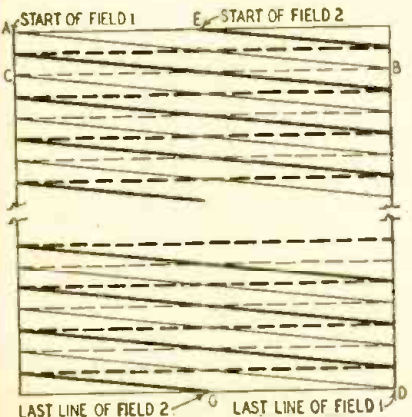

Fig. 5—Interlaced scanning prevents flicker.

light intensity at each point. The electron distribution thus leaving the cathode surface is electrically equivalent to the distribution of light and shade focused on the cathode plate by the lens. A positive voltage located at the opposite end of the tube forces this electron cloud to travel forward, while electromagnetic deflecting coils keep the

(Continued on following page)

HARRISON HAS IT!

★ HSS

Stromberg-Carlson DYNAMOTORS

Compact, well-constructed unit, excellent for mobile transmitters, amplifiers, etc. Ball bearings, good efficiency. Made for military use.

INPUT	OUTPUT
12 V at 16.8 A	A—680 V at 210 Ma
6 V at 16 A	A—300 V at 210 Ma
6 V at 21.5 A	A—265 V at 300 Ma

¾" dia. x 6½" long, 6 lb., 12 oz., with mounting plate. Brand New. **\$8.95**
HSS SPECIAL

Beachmaster POWER AMPLIFIER

250 Watts Class B 805's to 9 ohm load. Delivers 1500 Volts DC at 320 MA and 300 Volts DC at 150 MA; 10 and 8.3 Volts AC. On heavy chassis 12½" x 19". Has blower fan to cool tubes. Excellent for P.A. booster, modulator, or power supply.
 Less tubes **\$44.75**
 —HSS

HSS TUBES

Raytheon RK-63, Regular price \$22.00. Special

RK-38—\$5.95
RK-39—\$1.75

Navy tested and accepted
 805's—\$9.80.
 807's—\$1.29

Elmac 304-TL. Handle a KW coil! Slightly used in radar pulsing, tested and guaranteed.
 OK, Reg. net \$50.
 HSS Special

IN34 CRYSTAL DIODE

This is the germanium rectifier crystal specified in recent articles for noise limiters, field strength meters, etc. **\$1.80**

ROTARY COAXIAL COUPLING

Having trouble coupling to your rotary beam? Feed it efficiently through this constant impedance slip-ring coupling. Made for Signal Corps by Lapp Insulator Company, one of the best antenna system manufacturers. Surge impedance of 52 ohms will match most coaxial cable.

Head, 1¾" dia. finely machined from brass. Copper feed line ¼" dia. is 51" long. Outlets at top and bottom take standard AN coaxial plugs (or may be connected permanently). HSS

- A POSTCARD will put your name on our mailing list to receive new catalogs, bulletins.
- additional HSS bargains, and details of how you may obtain a copy of
- "ELECTRONIC PARTS AND EQUIPMENT," our new 800-page Buyers' Guide. Please mail it today!

HAM XTALS

Here is the value in ham band crystals that tops anything you have ever seen! Carefully manufactured to exacting Signal Corps specifications. Very active oscillators. Stainless steel electrodes. Neoprene gasket seals out moisture and dust. Calibration accuracy .01% over full temperature range! 40 meters—in DC-35 holder. (¼" Pin spacing.) Fits into Millen 93202 socket. 80 meters—in DC-34 holder. (¾" Pin spacing.) Fits into Amphenol 33-3 socket. Specify frequency desired with acceptable limits. Quantity limited. **90c**
 (Three or more—postpaid.)

PHOSPHOR BRONZE ANTENNA WIRE

Strong, won't stretch. 7 strands = 18 (10 ga) 100-foot coils. List price, \$6.00. **\$2.39**
 HSS

LONG WAVE RECEIVERS

Navy Model RAK 7

15 to 600 Kilocycles. 6-Tube Receiver with AVC, Noise Limiter—Band Pass Filter—Tunable Audio Filter—Band Switching—Precision Dial—3-tube Voltage regulated Power Supply for 115 V—60 cycle A.C. Optional Battery Operation. Excellent for Marine and Aviation work. Brand New in original crate, complete with power supply. Steel Chest full of spare parts. full instructions. **\$79.50**

HSS TUBES

All new, fully guaranteed
 HSS-1G (3C24/VT204) an FT Tube for VHF. 90 watts Class C output. Gov't inspected. Regular Amateur Net Price was \$9.00, reduced to \$6.00; but Harrison sells them for only \$1.69 ea., 3 for \$4.45.

★ Harrison Select Surplus

Your assurance of good, usable, guaranteed, surplus material at sensationally low prices—top value always! Come in and browse through our large, entirely separate HSS Department (Harrison Select Surplus).

HARRISON HAS IT!

ALL STANDARD LINES

NEW SKY CHAMPION

By special chartered cargo-plane, we obtained our initial stock of the new Hallcrafters S-40 Sky Champion receivers! They're going fast so rush in **\$79.50** your order. Complete

(We'll do everything possible to give you the very best service on all makes and models of receivers, transmitters, etc.—Keep sending in your orders.)

TEST EQUIPMENT

Shipments are getting bigger and better! Send us your order now for quickest delivery.

Dumont—GE—Hickok—Precision—RCP—RCA—Shallcross—Simpson—Supreme—Triplet—Weston.

TWIN

RIBBON CABLE

Amphenol's sensational new transmission line. In stock in 75, 150 and 300 ohm surge impedance. Per foot

PLASTICS PLIERS

New SPEC O all plastic long nose pliers. Light, strong, very handy

→ CQ—L. I. HAMS! ←

Our Jamaica Branch is the most handy place on the Island to get your Ham and Service material. Right at the bend in Hillside Ave. Complete stocks—plus direct lines to make our N. Y. store and warehouse stocks immediately available. Drop in—often!

BOAT OWNERS!

Immediate delivery of Islip Model MRT-10 Marine Radio Telephones, 10 Watt carrier output, 5 channel selector switch. Push-talk handset. For 6 or 12 Volt operation, 8½" x 8½" x 12", complete! Well engineered and constructed. With six crystals for three channels ... **\$195**
 Coast Guard vertical rod antenna \$45. Real radiation efficiency!

RECORD CHANGERS

Garrard ... \$65.85
 Webster No. 56-1 .. 26.66
 Webster No. 50 21.17

We are

FACTORY AUTHORIZED DISTRIBUTORS

for the top quality manufacturers and we now have in stock lots more new, latest improved production Ham gear! Visit our stores today, for everything you need. We promise you fresh, clean material—quicker—at the lowest current prices—and, above all, our sincere desire to be of friendly, helpful service.

MAIL ORDERS?—Certainly! Just list everything you want (items in this ad, or any ad, magazine or catalog) and include deposit.

73 de

Bill Harrison, W2AVA



HARRISON RADIO CORPORATION

12 WEST BROADWAY • NEW YORK CITY 7

BARCLAY 7-9854

JAMAICA BRANCH — 172-31 Hillside Ave. — REPUBLIC 9-4102

A RECORD SMASHING BARGAIN!



from the
World's Largest
Radio Supply
House

304 TH TRANSMITTING TUBES

Here is a typical money-saving offer from R.W.T. A versatile medium-mu triode now being sold at 5 times R.W.T.'s cost to you—slashed to the sensationally low price of \$9.95! Another R.W.T. achievement! Use it as a modulator—an oscillator—an amplifier! Filament: 5.0 or 10 volts. DC Plate Voltage: 3000 volts (max.). DC Plate Current: 900 ma. (max.). Plate Dissipation: 300 watts. Limited quantity only!

Now being sold at
\$50.00 elsewhere!
Your cost **\$9.95**
of R.W.T.

No matter what you need in radio parts or equipment—order from R.W.T. We have a complete assortment of over 10,000 top-quality parts at lowest prices. Write us your needs and watch our superspeed service!

FREE!

Send today for the latest bargain flyer which includes best buys in nationally known communications receivers, ham transmitting tubes, test equipment, phono graph equipment and hundreds of others.



Originators and marketers of the World Famous **Lafayette Radio**

Radio Wire Television Inc.

CUT OUT THIS COUPON NOW!

NEW YORK 13 • BOSTON 10 • NEWARK 2

R.W.T. Dept. JG-6
100 Avenue of the Americas, New York 13

Enter my order for Xmitter tube(s)
 Check enclosed Money Order Send C.O.D.
 Send me FREE copy of your latest Bargain Guide C37 and place my name on list for your New Super Catalog.

Name
Address
City Zone State

Post on Penny Postcard, Mail Today

TELEVISION FOR TODAY

(Continued from previous page)

emitted electronic picture pattern intact. In the Iconoscope, the charge remains on the mosaic, while an electron beam scans the surface. In this tube, scanning is accomplished by bringing the electronic charge distribution to the scanning aperture and then swinging the electronic image back and forth so that each section of the emitted charge has a chance to pass into the opening and subsequently cause a flow of current in the external circuit. The magnetic field shifts the whole electronic image up and down and from side to side, exactly as the scanning beam is moved in the Iconoscope, until a sample of the electronic charge has been obtained from each section of the image, in the manner dictated by interlaced scanning.

As long as light is focused on the photosensitive cathode, electrons are being emitted in a continuous stream. Hence, no matter what section of the image is being scanned at some particular moment, electrons will always be present to enter the scanning aperture.

The relatively few electrons that enter the scanning aperture at each instant would be far from sufficient to produce clear signals in succeeding amplifiers. In all probability, the random noise voltage that is part of every tube would be strong enough to mask the signal beyond the point of recognition. To overcome this handicap, an *electron multiplier* assembly is made part of the scanning system. Incoming electrons hit specially coated plates that emit several electrons for each impinging one. These electrons now go to a second plate, where again a multiplication occurs. By repeating this process eleven times, the very weak initial signal currents are amplified to a point where all masking voltages are readily overcome. Now the regular line amplifiers receive the signal and pass it on to the transmitter.

SOUND WAVES sent into the Pacific Ocean off the coast of California by Navy sonar devices bounce back from 1000 to 1500 feet below the surface when they strike a 300-mile wide oceanic layer suspended between the floor of the ocean and the surface, scientists at the Navy Electronics Laboratory of the University of California Division of War Research reported recently.

This sound-stopping layer extends from Point Mendocino, 200 miles north of San Francisco, to Cape San Lucas at the tip of Lower California, and is the deepest oceanic layer known.

Scientists are not sure what composes the layer, but one theory is that plankton, small marine animals, make up the sound barrier. Other suggestions are that the echo may be caused by larger fish feeding on plankton or that gas bubbles from the undersea life reverberate sound.

IN STOCK FOR IMMEDIATE DELIVERY

Metal Case Oil Filled Bath Tub Condensers

1 mfd.—25 mfd.—5 mfd.—600 Volts . . . ca. 12c
Dual 1.—1 mfd 600 Volts ca. 14c

Carbon Resistor Kits

Best Quality Insulated 1/2 Watt. All 5% or 10% Tolerance. In the following sizes only—
300 Ohms 5000 Ohms 50000 Ohms
500 Ohms 8000 Ohms 50000 Ohms
2000 Ohms 25000 Ohms 1 Meg Ohm
3000 Ohms SPECIFY OHMAGE.
Sold in Quantities of 100 only. May be assorted.
Per 100 \$2.95

Meissner Choke Coil Kits

10 Chokes in each Kit. Any two Chokes worth price of entire Kit. Per Kit 49c

Meters

WESTERN ELECTRIC—Basic Movement 0-1 Mil DC
Scale Marked 0-20 Kilowatt; dia. 3 3/4" . . . 3.95
GE—WESTON—0-10 Mil DC; dia. 2 1/2" . . . 2.75

Standard Make Curved Arm Pickup With L72A Cartridge

\$3.25
Lots of 3 ea 2.95
79c

Antenna Kits

Lots of 3 ea 65c

Crystal Detectors

In Ceramic Base; screw mounting complete with Cat Whisker 45c

TERMS 25% deposit; balance C.O.D. When paying in full, include postage

FOR FREE RADIO PARTS AND P. A. CATALOG, Write Dept. V5



BUILD YOUR OWN RECORD PLAYER

DETROLA AUTOMATIC CHANGER—BEAUTIFUL CABINET—AMPLIFIER AND SPEAKER.



Newest in Design—Foolproof. Plays 10" or 12" Records. Your cost net \$18.27 Changer only



Cabinet made to fit Changer Amplifier and 6" Speaker. Cabinet only net . . \$4.95

Amplifier AC 3-Tube complete with tubes and 6" Speaker. Can be installed in 30 minutes. Your cost net \$12.95

Be sure to send name for new free low price circular.
McGEE RADIO CO.
1220 BROADWAY, DENVER, COLORADO

Build Your Own RADIO RECEIVER

Learn while you build! It's easy and fun with this Kitecraft Radio set kit. Complete crystal assembly. All building and operating instructions. Base and legs of Lucite plastic. No soldering, no batteries required. Uses any type head phone, even old telephone receiver. Brings in stations clear as a bell. Thousands in use. MONEY BACK GUARANTEE. Sent prepaid or C. O. D. plus postage. ORDER TODAY!

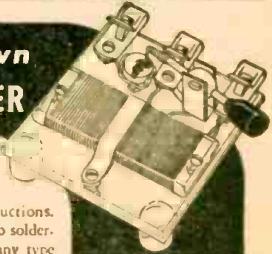

only **\$2.95** complete less phones

LACO PRODUCTS, INC., 614 N. San Vicente, Los Angeles 46, California

THE TRANSGENERATOR

(Continued from page 686)

tuning of the oscillator by the circuit to which the r.f. lead is connected. It is connected directly to male chassis mount microphone connector, J1. A single shielded cable, terminated in a female microphone connector, feeds either the r.f. or a.f. to the external circuit. This is clearly shown in Photo A. This photo also shows the general arrangement. S1 is shown in the lower left hand corner with the r.f. jack immediately to its right. The r.f. attenuator can be seen above, and slightly to the left of, S1. The National ACN dial adds finish to the Transgenerator's appearance, suggesting a professional model.

THE A.F. OSCILLATOR

The a.f. oscillator follows the same design principles used in the r.f. unit. The coil and condenser L4 and C5 (the condenser marked ".1, sec text" in Fig. 2) determine the frequency of operation, which in this case is 400 cycles. A separate a.f. attenuator is employed. It is connected directly across the tank. The a.f. output is taken from the poten-

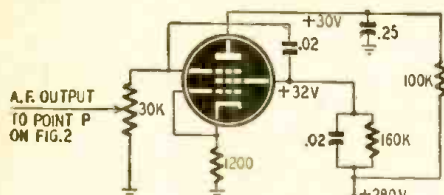

Fig. 3—Alternative R-C circuit for audio.

tiometer and feeds the microphone male jack J2 through a blocking capacitor. A cathode resistor biases both the control and suppressor grids, and with the correct plate and screen potentials given in Fig. 2, places the operating point at the center of the linear portion of the tube's operating curve. The result is an essentially pure 400-cycle note (measured distortion 3 percent) a result not too often encountered in commercial signal generators. For proper operation of the a.f. oscillator the modulation switch, S2, should be in the "off" position.

A maximum audio frequency voltage of approximately 4 volts r.m.s. may be expected at the A.F. output jack. This is ample for most purposes.

A few words regarding the L4-C5 frequency determining network is in order. Trouble may be experienced in obtaining a suitable inductance. The value of C5 is given as .1 μ f. Actually, the capacitor used measured .125 μ f. Other .1 μ f capacitors checked were also found to have an average capacity of .125 μ f. This means that an inductance of 1.27 Henries is necessary to tune to 400 cycles. Calculations show that an inductance of 1.25 Henries will resonate at a frequency of 403 cycles with a capacity of .125 μ f. This is close enough to 400 cycles.

An inductance of 1.25 Henries may not be available. The one used in the Transgenerator was obtained by placing stacked sheets of transformer laminations inside a multilayer air core coil,

PRE-EXAM TESTS

For Commercial Radio Operator FCC LICENSE EXAMINATIONS



PREPARED BY ARTHUR R. NILSON, FAMOUS CO-AUTHOR of Nilson and Hornung's RADIO QUESTIONS AND ANSWERS.

Don't Take A Chance!

Avoid Failure On FCC Commercial Radio Operator License Examinations!

USE
NILSON'S COMPLETE PRE-EXAMINATION TESTS AND COACHING SERVICE

Enables You To

REHEARSE the FCC license examinations
PRACTICE the procedure
PRACTICE the multiple-choice examination methods used by FCC
CHECK your knowledge
LOCATE your weak points
CORRECT your weak points before taking the actual examination
Use Coupon or write for Descriptive Folder
No obligation—no salesmen

Cleveland Institute of Radio Electronics

Successors to Nilson Radio School, founded 1939
Smith Practical Radio Institute, founded 1934.

RC-7 TERMINAL TOWER CLEVELAND 13, OHIO

MAIL THIS COUPON

CLEVELAND INSTITUTE OF RADIO ELECTRONICS
RC-7 Terminal Tower, Cleveland 13, Ohio

Gentlemen: Please send information about Pre-Exam Tests.

Name

Address

City Zone State

If a War Veteran, Check Here

whose previous inductance was approximately 350 millihenries. The laminations were taken from a discarded transformer and cut to fit. L4 may be seen in the lower right hand corner of chassis in photograph below.

Suggested combinations of L and C to tune to 400 cycles or thereabouts are tabulated below and may serve as a guide to the prospective constructor.

L (H)	C (μ f)	Remarks
0.5	.316	voltage output decreases
1.0	.159	
1.25	.125	
2.0	.08	distortion of wave increases
4.0	.04	

If it is impossible to obtain a suitable L4-C5 combination, an R-C tuned version of the Transtron may be employed. The circuit is shown in Fig. 3. This circuit is simpler and requires no inductance. It was not used in the Transgenerator only because it was considered more expedient to operate both plates (r.f. and a.f.) at the same poten-

tial of 9 volts (as per Fig. 2), with one common by-pass capacitor. Moreover, a suitable inductor for L4 was easily obtained.

If the values in Fig. 3 are followed closely the output waveform will also approximate a sine wave much more closely than average signal generators.

To obtain unmodulated r.f. output at jack J1, the modulation switch S2 is placed in the "off" position. For a.f. modulation at 400 cycles, S2 must be placed in the "on" position. Grid modulation of the r.f. oscillator then takes place at the audio rate of 400 cycles per second. Percentage of modulation is controllable. Two volts (r.m.s.) is necessary to modulate the r.f. oscil-

(Continued on page 722)

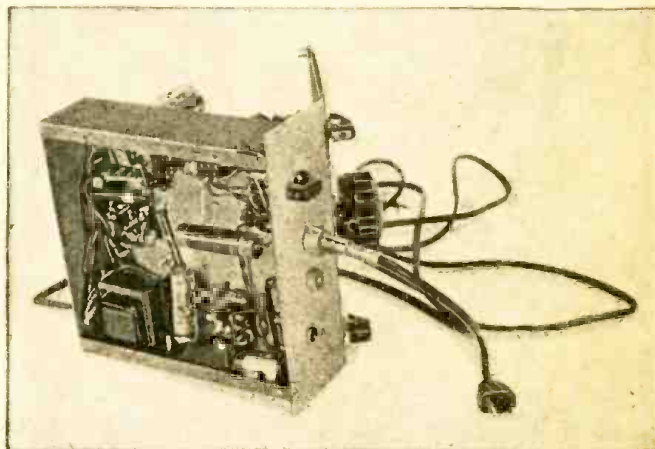

Both audio and radio frequency coils are mounted under the chassis.

SUPREME

TESTING INSTRUMENTS

AFTER A GREAT
WAR RECORD

**BACK
AGAIN!**



SUPREME MODEL 504-B TUBE AND SET TESTER

SUPREME regrets that war necessitated an interruption of service to its customers and friends. We are genuinely glad to get back into peacetime production—production for YOU.

MANY SUPREME INSTRUMENTS NOW AVAILABLE

—But not enough to take care of all orders at one time. Demand for accurate, dependable SUPREME equipment is such that we suggest you make arrangements for your needed new SUPREME models without delay.

SEE YOUR NEAREST SUPREME
JOBBER NOW!

SUPREME

SUPREME INSTRUMENTS CORP.
GREENWOOD, MISS.
U. S. A.

Export Department:
THE AMERICAN STEEL EXPORT CO., Inc.
374 Madison Ave., New York 17, N. Y.

RADIO IN THE ATOM TESTS

(Continued from page 682)

radiation or the measurements of gamma rays, neutrons, etc.

Among the instruments used by this section are: spectrographs to obtain the spectral distribution of the first flash; photo-electrical units to record the intensity of the first flash as a function of time; and bolometers to measure the total radiant energy emitted by the first flash. Unfortunately, the findings in this field only, the instruments used and the techniques employed are classified under the security regulations of the Manhattan Engineer District and will not be released for publication till some time after the tests are completed.

Four Army Air Force's B-29's will be prepared to track and photograph the cloud resulting from the blast to determine its persistency and radiological activity. Ground photographs will be made from fixed installations on 75-foot steel towers, placed at strategic points on Bikini

Atoll. All these cameras will be radio controlled.

Radio and television-equipped aircraft will play an important part in the tests. Radio-controlled drones (Photo A) carrying radiological instruments will be directed to the scene of



Photo B—The radio control room for launching and landing drones.



Photo C—AAF pilots preparing for the tests take refresher in electricity and electronics.

the blast and information will either be radioed back to the observation ships or the drones will be directed back to the ships. A new type of long-range, high-altitude, high definition television system (See RADIO-CRAFT, May 1946) installed in the nose and waist of reconnaissance planes equipped with transmitting apparatus will enable Task Force One officers to view at close hand the destruction and effects of the bomb, which would otherwise be impossible (or at least highly impractical in terms of lives.)

The drones are scheduled to fly close enough to the atomic bomb blast so that sensitive scientific and photographic instruments stowed in their cockpits will record what happens when an atom bomb explodes on its target. Each of these drones is controlled by a plane from which a Navy pilot will maneuver his drone, keeping it always in sight and able to identify it by its colored tail. The drones are red overall, with a colored fin and rudder matching a color painted on the engine cowling of the Queen Bee plane which controls its flight.

The drones will take off under the control of a Navy radio specialist in a radio control truck (photo B) parked on the carrier flight deck. When they are 100 feet in the air, the Queen Bee pilot takes over from the truck. After the explosion, the Queen Bee planes and those drones that come through the tests will fly to Roi Island where they will be landed and the data which was recorded by their sensitive instruments removed for study by the atomic scientists.

All AAF men participating in the tests are required to take refresher courses in subjects pertinent to their specialty. Radio operators and technicians will be schooled in the intricacies of radar and loran, both of which will be used in the tests. (Photo C)

TROPICAL DRY BATTERY



The new Mallory dry cell illustrated above is based on a new metal-electrolyte combination. Unlike older cells which use zinc, carbon and sal ammoniac, this one operates through the chemical reaction of zinc and mercuric acid. Less than one-third the size of the regular cell, shown at the left, it has several other advantages.

Erwood SOUND EQUIPMENT



ERWOOD *Automatic* RECORD CHANGER

MODEL 105

- Short Changing Cycle.
- All Steel Operating Mechanism.
- Single Button Control.
- Small Mounting Plate.

THE ERWOOD MODEL 105 AUTOMATIC RECORD CHANGER is a new, simple and positive design which is compact in size and lends itself to easy adaptation to the smaller types of combinations and portable record playing equipment.

The operating mechanism developed for this Changer utilizes a steel spiral which is welded to the bottom of the turntable. This gives an extremely compact, reliable operating member. Control has been simplified, a single button performs all functions.

Records are held on a single post, with push off mechanism and an offset spindle, the design of which is such that the records are subjected to a minimum of wear. Model 105

will play 12, 10" or 10, 12" records. Needle pressure is exceptionally light which reduces the sidewall wear, and assures long record life.

All operational parts are of stamped steel construction, adequately rustproofed. Operation is both simple, positive, and exceptionally quiet. Driving belts, gears, etc. have been eliminated. The heavy steel mounting plate, upon which the assembly is mounted, measures 12" x 12½"; height required over the top of the mounting plate, 4¾". During the playing operation, all operated mechanism is at rest, assuring long life and silent operation. Turntable is attractively flocked, pickup arm and mounting base are walnut hammerloid finished.

THE ERWOOD COMPANY

223 West Erie St., Chicago 10, Ill.

HAM HEADQUARTERS FOR

Equipment and Information

SPECIALS

- Dual-Vibro pack 550v-160MA 6 volt input. \$12.00
- G-E 4MFD-600, \$1.75
- C.D. 8MFD-600, \$1.50
- Sylvania Crystals, 1N23—1N27, .50
- Micamold Capacitor .002-6000 v working, \$2.40
- Complete 25 Tube F.M. Transmitter and Receiver, 2 channel job. Will Tune From 27 MC to 28.9 MC, \$35.00
- Port-Mobile Equipt. Complete 10 Meter Converter Kit, ready to wire, with Tube, \$13.50

Mail Orders Promptly Filled
Amateurs to Serve You
(20% Must Accompany All C.O.D. Orders)

Write Dept. RC
W6SCQ—W6UXN—W6NAT
W6SSU

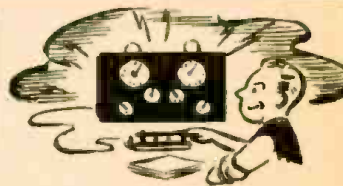

FOR YOUR NEW RIG

We Have a Good Stock of
All Standard Lines

WATCH FOR THE NEW
Port-mobile Xmtrs, from 5 to 60 watts, all in Kit form, chassis Punched. Complete with Tubes. Ready to wire.

Radio Product Sales Company

238 WEST 15TH STREET

LOS ANGELES 15, CALIFORNIA

PRospect 7471

**IT'S EXCLUSIVE!
LOW PRICED!**

**WRL GLOBE TROTTER
TRANSMITTER KIT**



READY NOW!
**LEO'S
Sensation
of the Year!**

\$59.95

Complete including all parts, chassis panel, streamlined cabinet, less tubes, coils, and meter.

Cat. No. 70-312 Kit same as above, wired by our engineers\$75.00
All necessary Accessories\$13.85 extra

Here is the latest, most outstanding transmitter value on the market today. The WRL Globe Trotter is capable of 40 watts input on C.W. and 25 watts input on phone on all bands from 1500 KC through 28 Mcacycles. Incorporates the Tritet Oscillator using a 20 meter X-tal and providing sufficient drive at 10 meters for the 807 final; Heising choke modulation; three bands, all pretuned; 10, 20, and 80 meters; metering provided for both oscillator and final stages; two power supplies, one for 807 final and modulator tubes, one for speech amplifier and oscillator stage.

EXTRA SPECIAL RECEIVER BUY!

New BC 348Q Surplus Receiver. E tubes, 200 to 500 Kilocycles. Weather, aircraft, and all ham bands except 10 meters. Cat. No. 35-61, less speaker, ONLY\$85

Here are just a few of the many well-known receivers offered by Leo:
Hallcrafters S38 .39.50 Hallcrafters SX46 .\$.115
Hallcrafters S40 79.50 Hallcrafters SX42 .\$.250
RME 45186. Hallcrafters S41Q 33.50
RME 84\$98.70 Hammarlund HQ-129X 129.
National NC 2-40C225.
Use our liberal trade-in and easy terms.

SERVICE DEALER NEEDS



WRL MULTITESTER
Steel case with 30-60% angle. Cat. No. 16-191 Less Leads\$1875

Handles AC DC Voltmeter. DO Milliammeter. high and low range Ohmmeter. 3" meter with sturdy D-Arsonval movement. Size 5 1/2 x 8 3/4.

A complete stock of tools, replacement parts, test equipment, intercom and public address systems . . . everything for the progressive service dealer.

**TUBULAR CONDENSERS!
Immediate Delivery!**

Small type, Standard Tubular By-Pass Condensers. Waterproof, Long-Life, Phenolic wrapped and Phenolic end fill. Also double waterproof seal. Manufactured to same high specifications used in the famous VT fuse. Genuine lead non-inductive foil condensers.

Unconditionally Guaranteed.

Cat. No.	Cap. 100 Mfd. 400V		Single Lots	Cat. No.	Cap. 100 Mfd. 600V	
	Mfd.	Lots			Mfd.	Lots
27-837	.002	5.40	.06	27-853	.0025	6.30 .07
27-839	.0025	5.40	.06	27-855	.005	6.30 .07
27-841	.005	5.40	.06	27-857	.01	6.30 .07
27-843	.02	5.40	.06	27-859	.02	6.30 .07
27-845	.025	6.30	.07		1000V	
27-847	.05	6.30	.07	27-861	.0025	7.20 .08
27-849	.1	7.20	.08	27-863	.0035	7.20 .08
27-851	.2	8.10	.09	27-865	.005	7.20 .08

On quantities of 500 or over condensers may be assorted to obtain an additional 5% discount with a minimum quantity of 100 of each type.

GET OUR LATEST FLYER FREE!

Packed with real buys in radio, electronic, and general merchandise.

Giant Radio Map (size 3 1/2 ft. x 4 1/2 ft.) .15c
Handy Tube-Base Calculator. 25c

Address Dept. RC-7
Council Bluffs, Iowa



SECRET COMMUNICATION

(Continued from page 673)

back found the reason why bats can fly in a dark room criss-crossed with wires yet never once fly into the wires or collide with the walls. The reason is that bats generate supersonic sounds in their throats so high that human beings cannot hear them, yet when the bat makes these sounds they are reflected from whatever objects are in its path and return to its ears. A sort of audible radar. Consequently, a bat never collides with any solid object. The scientists who investigated the bat's sounds had to translate these sounds into audible sounds for human beings, which they did by means of electronic apparatus.

Now then, it seems a short step from this to generate inaudible sounds in a simple apparatus, then modulate the sound the same as we do with a radio wave and use it as a carrier either for voice or for code.

At the receiving end these supersonic sounds are made audible to the human ear by means of special amplifiers, and communication is accomplished.

Such a system would seem to have possibilities for secret communication for war as well as peace purposes, and no doubt many applications can and will be found for it. Furthermore, as sound can be focused by parabolic reflectors, the same as light rays or infra-red rays, the system becomes more or less secret if no one is in the direct line of the transmission.

Supersonics thus may open up a new system for communication. To the best of our knowledge little communication has been carried on by this method.

We wish to advance some additional thoughts along these lines for still greater secrecy and safety from detection.

We can adopt the principle of splitting communication. Nothing prevents us from doing this, using any combination of the means described above. We can thus use a separate light ray transmitter and a separate infra-red transmitter, either side by side (or separated a suitable distance) and then send out our communication over both these channels, splitting up the communication. Then if anyone attempts to intercept the light ray itself, only gibberish results. If he succeeds in tapping the secret infra-red channel, likewise nothing intelligible can be heard.

Unless you have the "key" and know what is going on and know what types of channels and media are used, you are not likely to guess the secret at once. Not only that, but you also have to know the exact location, all of which puts additional handicaps in the way of the unauthorized listener.

At the receiving end of the key receiver the light-ray transmission and the infra-red ray transmission are combined and the speech (or code) is resolved into intelligible communication.

We need not stop here, but we can "scramble" our channels in many ways. Thus we can have infra-red plus supersonic sound. We can have radio plus infra-red, or we can have light plus radio. Thus we obtain dozens of different combinations, enhancing the secrecy many fold.

In time, particularly during war and for war purposes, there is no reason why only two channels of different media should be used. One can send out split communications over six or more different channels, and only by combining all these channels would you have a complete intelligible communication.

A fascinating new field in communication, which so far has not been exploited at all, is thus opened.



**Immediate Delivery
ON RADIO
AND ELECTRONIC
SUPPLIES**

Radio Electric Service Co. of Penna. Inc., is an old established house with the newest in parts and equipment from the finest lines in the country.

- ★ Sound Equipment
- ★ Intercom Systems
- ★ Test Equipment
- ★ Industrial Electronic Equipment
- ★ Amateur Equipment

Mail Orders Shipped in 24 Hours

**RADIO ELECTRIC
SERVICE CO. OF PENNA. INC.**

N. W. Cor. 7th & Arch Streets, PHILA. 6, Pa.
CAMDEN, N. J., ALLENTOWN, Pa.
WILMINGTON, Del., EASTON, Pa.

**Our EXPORT Dept.
Circles the Globe**

SEND FOR FREE FLYER TODAY!

"RADIO ELECTRIC" Dept. C-7
N. W. Cor. 7th & Arch Streets, Phila. 6, Pa.

Gentlemen: Send me Free Copy of your Latest Flyer.

NAME

ADDRESS

CITYZONE.....STATE.....

PASTE ON PENNY POSTCARD
AND MAIL TODAY!

For the Man Who Takes Pride in His Work

MODEL 2432 SIGNAL GENERATOR

Another member of the Triplett Square Line of matched units this signal generator embodies features normally found only in "custom priced" laboratory models.

FREQUENCY COVERAGE—Continuous and overlapping 75 KC to 50 MC. Six bands. All fundamentals. **TURRETTYPE COIL ASSEMBLY**—Six-position turret type coil switching with complete shielding. Coil assembly rotates inside a copper-plated steel shield. **ATTENUATION**—Individually shielded and adjustable, by fine and coarse controls, to zero for all practical purposes. **STABILITY**—Greatly increased by use of air trimmer capacitors, electron coupled oscillator circuit and permeability adjusted coils. **INTERNAL MODULATION**—Approximately 30% at 400 cycles. **POWER SUPPLY**—115 volts, 50-60 cycles A.C. Voltage regulated for increased oscillator stability.

CASE—Heavy metal with tan and brown hammered enamel finish. There are many other features in this beautiful model of equal interest to the man who takes pride in his work.



*Precision first
...to last*

Triplett



ELECTRICAL INSTRUMENT CO. BLUFFTON, OHIO

NOMOGRAPH CONSTRUCTION

(Continued from page 701)

edge can cross only two lines to obtain one product, so it is necessary to work such a chart in two steps. First, $A \times B = Q$, then $Q \times C = D$. Since it is not necessary to know what the product Q is (because we are interested only in D) such nomograms have an uncalibrated "reference line" which is the Q scale just mentioned. The product of A and B is located on this line with a light pencil mark, which is used with line C to give the solution on scale D .

Other nomograms (usually beyond the ability of the beginner to construct) combine multiplication with addition by making one of the factors a composite number containing one of the factors and the added term. Others represent one or the other of the quantities by a curved line, and can represent factors which vary other than in a linear mathematical manner. Some of the simpler of these may be handled in a forthcoming article.

References:

Nomograms, Carl P. Nachord, *General Electric Review*, May, 1944. Page 13.
Nomograms — How to Make and Use Them, R. Howard Cricks, *Electronics and Television & Short-Wave World* (British), November, 1940. Page 495.

Alignment Charts; Construction and Use, Maurice Kraitchik, (D. Van Nostrand Co., New York).

famous for

GREAT VALUES

Outstanding Offerings Of NEW KITS!

PHONO KIT Consists of AC Phono Motor. Pick up, all parts necessary for 3 tube phono Amplifier, including 5" P.M. speaker. Excludes wire, solder and tubes **\$16.25**

With the Above { PA-12 portable leatherette-covered all-wood cabinet **\$7.95**
Kit of tubes **\$1.85**

5-TUBE SUPERHET \$15.50

Complete with Cabinet and Tubes but excluding wire and solder.

All prices are F.O.B. New York City.

Write for our new catalog showing new test equipment, tubes and a large variety of new replacement parts. We ship anywhere in the U.S.A.—promptly.

RADIO DEALERS SUPPLY COMPANY

135 LIBERTY ST., NEW YORK 6, N.Y.

Dealers **WHY WAIT FOR YOUR RADIO?**

"BUILD YOUR OWN"

ATOMIC HEATER & RADIO CORP.
PROUDLY PRESENTS

The Finest in Radio Kits



**A COMPLETE 5 TUBE SUPERHET.
COVERS THE BROADCAST BAND FROM
550-1700 KC**

This set has been fully engineered and designed to make construction simple. All parts mounted, cabinet included.

Tubes required—two 12SK7, one 12SA7, one 12SQ7, one 35L6 and one 35Z5.

Your cost \$15.80 without tubes. Terms 10% deposit with order, balance C.O.D.

IMMEDIATE DELIVERY

ATOMIC HEATER & RADIO CORPORATION

Dept. R.C.
104 PARK ROW, NEW YORK 7, N. Y.

METERS

Portable A. C. Ammeter

Surplus New

Weston Model 528



Dual Range 0-3 Amp. and 0-15 Amp. full scale for use on any frequency from 25 to 500 cycles. The ideal instrument for all commercial, industrial, experimental, home, radio, motor and general repair shop testing. Comes complete with a genuine leather, plush-lined carrying case and a pair of test leads. A very convenient pocket sized test meter priced at less than 50% of manufacturers list.

Your cost ONLY.....\$12.50

PANEL METERS

Surplus New

Round flush bakelite case unless specified otherwise

Westinghouse NA-33, 2 1/2", 0-150 volts, A.C.\$1.98

Westinghouse NX-35, 3 1/2", 0-15 Kilovolt, D.C. 1 M.A. movement, 15 megohm external tubular wire-wound resistor. List Price \$160.

Your cost ONLY.....\$16.00

General Electric DW-44 Radio Frequency Ammeters, 2 1/2", black scale 0-1 and 0-8 Amp. Each.....\$2.95

General Electric DO-40 Dual Range, zero center, D.C. milliammeter, 3", Surface mtd. 2 1/2-0-2 1/2 and 25-0-25 M.A. Only....\$2.50

Weston Model 517, 2 1/4", 0-150 volts, A.C.\$2.95

Weston Model 301, 3 1/2", Short scale galvanometer. 10 microamperes each side of center. This instrument is ideal for use on "bridge" circuits where a sensitive null deflection indication is required. Only\$3.95

Add sufficient postage on P.P. orders. Excess will be refunded.

Maritime Switchboard
336 Canal St. N. Y. 13, N. Y.

Worth 4-8217

RADAR ROCKETS

(Continued from page 679)

auxiliary jets on either side of the radarocket).

The revolving lobe describes a circular path (forming a cone as shown in Fig. 5-c). A target located on the reflector axis line gives a resultant echo signal (on the receiver) having an identical amplitude for every position of the rotating lobe. If the target is not on the center-line of the reflector axis, the echo signal will vary in amplitude sinusoidally as the lobe is rotated. Whenever the lobe's center (or axis line) approaches the target there is an increased strength of reflected signal. As the lobe rotates further, so that its axis or center line recedes from the target focal line, a weaker signal results. The direction of the target from the reflector axis is thus indicated by the relative phase of the variation or rise and fall in strength of the received echo signal.

Fig. 7 shows two positions of the rotating lobe and the relative strengths of signals reflected from the target in different positions. (See also Fig. 4).

The preponderant strength of signal received on the radarocket (when the target is off to one side of the reflector axis) is caused to correct the course of the rocket. With the conical scanning method (which was employed on the SCR-584 Radar) applied to the flying bomb, it should hit the enemy target—once it comes within range.

When reflected signals of varying strengths are picked up on the radarocket's receiver (for a target off the centerline of the reflector axis) these signals are integrated through suitable circuits fed into an *amplidyne* control amplifier and finally impressed on an amplidyne generator (controller). The rotor of the generator turns in accordance with the degree and polarity of the impressed current and relays this position to a *servo motor* in the rear of the

radarocket. This servo may operate the vertical and horizontal rudders (or fire auxiliary course-correcting rockets).

The problem of identifying an enemy rocket poses a nice problem for the engineers. By making careful observations

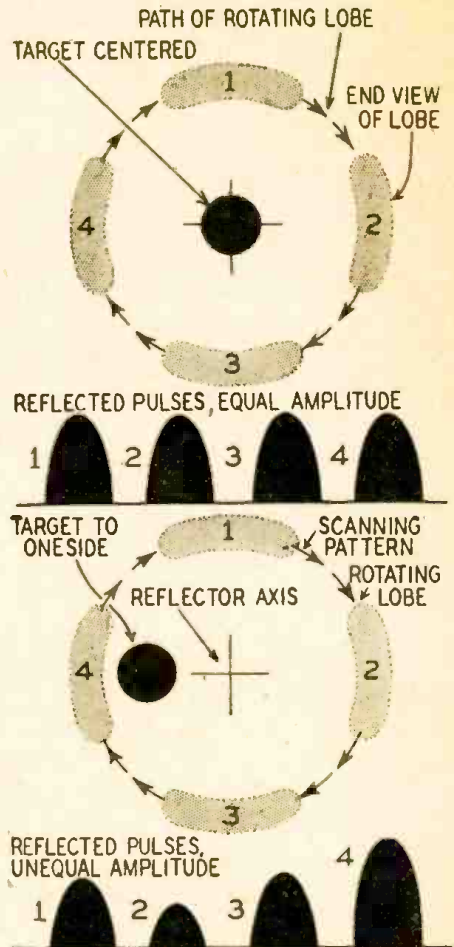

Fig. 6—Conical scanning beam and its target.

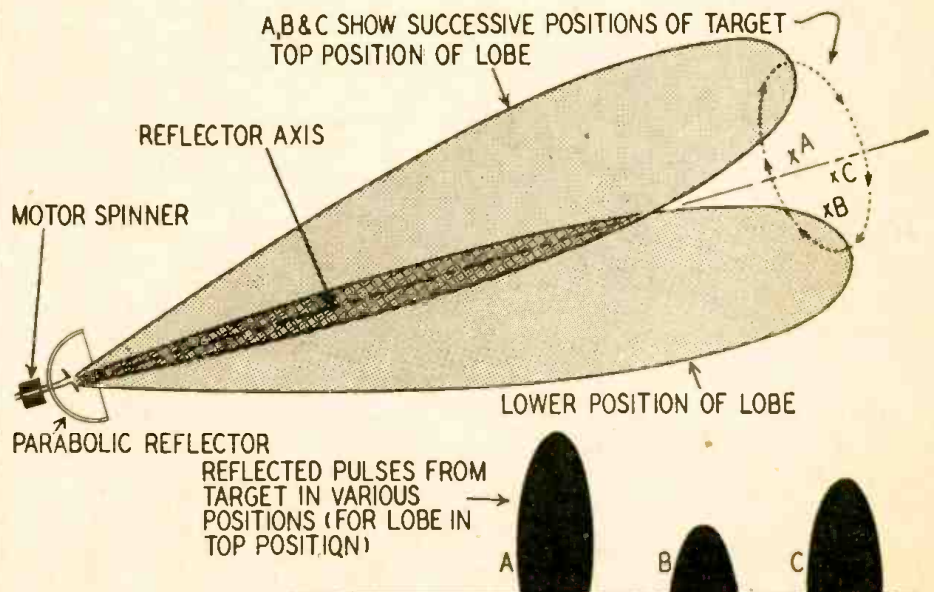

Fig. 7—Side view of conical scanning beam, showing response for three positions to target.

of the relative speed and the course followed by a rocket over a given period of time, it becomes possible to plot its probable course, and be prepared to shoot it down long before it comes near enough to be dangerous.

Planes might also be used as carrier devices, bringing rockets to within a few hundred miles and releasing them. However, if all friendly planes and rocket devices are fitted with IFF (Identification, Friend or Foe—See RADIO-CRAFT February, 1946) any flying craft which did not give a satisfactory response would at once be classified as *enemy* and counter-attack rockets sent out after it.

These precautions would be necessary only in peacetime (during periods when surprise attack might be feared). In war, all friendly planes would be grounded, and whereabouts and movements of friendly military planes definitely known. Thus any unknowns could be classed definitely as enemy.

The idea for the radarocket was discussed with an expert who had considerable experience with radar sets used by our fighter planes in hunting down enemy planes at night or in foggy weather. It seemed from the results obtained with radar in aerial warfare that the radarocket automatic direction control could be depended upon to work up to distances of about a mile.

In radar reflections the area of the target which is to reflect the wave projected against it has a great deal to do with the strength of the signal sent back to the receiver. The larger the target the stronger the reflected signal. The reflecting area of the enemy flying bomb would admittedly be rather small, but modern radar has demonstrated almost unbelievable sensitivity; in some cases the tiny periscope of an enemy submarine was a sufficient target to reflect the radar wave sent from a scout plane several miles distant.

HOW MINE DETECTORS WORK

(Continued from page 677)

and is hooked up in a Colpitts circuit. A .07 μ f plate and 0.25 μ f grid condenser and the transmitting search coil make up the oscillating circuit elements.

The other two tubes are the audio amplifier. The signal picked up by the receiver search coil is coupled to the grid of the first amplifier tube through a 4 to 1 ratio step-up audio transformer. Condensers across the primary resonate the circuit roughly to 1,000 cycles. The tube is impedance-capacity coupled to the next and last stage. A half-megohm potentiometer in the grid circuit of the second tube acts as volume control, and headphones are connected into the plate circuit through a blocking condenser. Batteries for the set consist of a pair of flashlight cells and a lightweight B unit of about 100 volts.

A later model, shown in Fig. 5, improved the original circuit in a number of details. The search head contains two transmitter and one receiver coils, as well as a one-turn winding which is shorted to upset the zero coupling between transmitter and receiver coils. This furnishes a quick test, as the operator can simply press a button on the control box and hear a signal in the phones, if the apparatus is in order. The oscillator in the newer model is a 1G6-GT, hooked up in a pushpull circuit with a 1,000-cycle transformer.

Tuning is also used in the headphone unit of this receiver, peaking it at the oscillator frequency. The earpiece is in fact called a "resonator."

The control box compensators consist of windings on retractable cores, two being used for capacity, and one for resistance compensation. Cores of the

SPEED UP REPAIRS WITH THESE G-C AIDS!

G-C is HEADQUARTERS for RADIO PARTS and SERVICE AIDS

All Types of Radio Cements, Chemicals, Coil Dopes, Compounds

G-C leads the field in supplying Radio-Electronic Manufacturers and Service Men with Parts, Tools, Radio Cements, Chemicals and Compounds. Insist on Genuine G-C Quality.

FREE STEEL CABINET

Dial Cables, Dial Belts, Packaged Hardware, Cabinet Repair Kits

SPEDEX Wire Strippers Alignment Tools Ne-O-Lite Testers

ORDER FROM YOUR JOBBER—SEND FOR G-C CATALOG

GENERAL CEMENT MFG. CO.
ROCKFORD, ILLINOIS

Electricity

Capacity range: 350 to 35,000 watts; 115 to 660 volts A.C., 50 to 800 cycles; 6 to 800 volts D.C.; combination A.C.—D.C. types.

FOR RADIO AND ELECTRONIC APPLICATIONS

ONAN ELECTRIC GENERATING PLANTS supply reliable, economical electrical service for electronics and television applications as well as for scores of general uses. Driven by Onan-built, 4-cycle gasoline engines, these power units are of single-unit, compact design and sturdy construction. Suitable for mobile, stationary or emergency service.

Model shown is from W35 series; 2000 to 3500 watts; powered by Onan two-cylinder, water-cooled engine.

D. W. ONAN AND SONS
2430 Royalston Avenue
Minneapolis 5, Minn.

Write For Folder 630 describing complete Onan Line

reactive balancers are of brass, of the resistive compensator, iron.

Still other detectors have been constructed which give different indications for different types of metal, distinguishing between magnetic and non-magnetic material. This can be done by distinguishing between lagging and leading phase angles in the currents set up by losses introduced into the magnetic field.

Thanks are due to the International Detrola

Photo Electric Unit

For numerous control applications such as burglar alarms, industrial safety controls, automatic counters and in conjunction with a chime or bell to announce entrance of people in stores and offices. For A.C. Complete with all tubes and SPDT control relay. Net. **\$9.45**

ADSON RADIO CO.
221 FULTON ST., NEW YORK 7, N. Y.

Corporation, for information and photographs, and *Electronic Engineering* (London) for material used in this article.

CHECK THESE PRICES

on first-quality radio merchandise.
Send today for our free price list.

GOVERNMENT SURPLUS RECEIVERS AND TRANSMITTERS—at prices that are a more fraction of their original cost. Send for surplus bulletin.

POWER TRANSFORMERS—Half-shell type, 110V 60 cy. Center-tapped HV winding. Specify either 2.5 or 6.3V filament when ordering.
For 4-5 tube sets—650V, 40MA, 5V filament and either 2.5 or 6.3V filament\$1.40
For 5-6 tube sets—650V, 45MA, 5V filament and either 2.5 or 6.3V filament 1.55
For 6-7 tube sets—675V, 50MA, 5V filament and either 2.5 or 6.3V filament 1.70
For 7-8 tube sets—700V, 70MA, 5V filament and either 6.3 or two 2.5 filaments 2.05
For 9-11 tube sets—700V, 100MA, 5V filament and either 6.3 or two 2.5 filaments 2.75

FILTER CHOKES: 2" mounting 200-300-400 or 500 ohms—49c. Stromberg-Carlson 500H, 250 MA, 35 ohms—fully shielded in black crackle case\$1.98

AUDIO TRANSFORMERS—Universal output, tapped for various impedances 79c
One plate to single grid—69c; One plate to P.P. grids—59c. Mike transformers—single or double button—69c.

RECORD CHANGERS—110V, 60 cy. with crystal pickup. Attractively finished in plastic and chrome—will play twelve ten- or twelve-inch records **INTERMIXED!**—the only changer on the market with this feature, at the low price of \$22.50. **AUTOMOBILE ANTENNAS**—Standard 3-section type, complete with leads—56"—\$1.50; 66"—\$2.95. **TEST LEADS**—with red and black needle-point prods—50c per set.

AMATEUR CALL BOOKS—1946 edition—lists name and addresses of licensed amateurs all over the world—\$1.25. **RADIO SOCKET WRENCHES**—High grade steel, practically indestructible. Each set consists of 7 1/2" handle and shank, with five sockets, sizes 1/4", 5/16", 3/8", 7/16", 1/2" and screw driver, all fitting into handle—special—79c per set. **LENIX AUTOMATIC BLOWTORCH**—Constructed of polished brass, comes to heat in 15 seconds. Just the thing for those heavy soldering jobs and out of doors and automotive work—only 89c. **PLASTIC** long-nose radio pliers, shock-proof and heat resisting up to 300°—89c.

CARBON MIKES—"Home Broadcast" type, can be attached to any radio—with wire and instructions—60c. Signal corps mike-midget type, has stretched duraluminum diaphragm, and is sold plated—super special—95c. **SHURE**, model T-17, hi-quality sinkle button mike, with switch in plastic handle cable and plug—\$2.75. **Best CRYSTAL MIKES**—\$1.45; **Bullet DYNAMIC MIKES**—\$7.45. **MIKE STANDS**—floor type, with heavy, gray ripple-finish base and beautifully plated tubing—adjustable from 36" to 66"—\$5.75.

MIDGET VARIABLE CONDENSERS—for short wave transmitters and receivers—25 MMF—39c; 50 MMF—49c; 75 MMF—48c; 100 MMF—54c; 140 MMF—69c. 3-Gang, 350 MMF tuning condenser—85c. **ANTENNAS**, standard AC-DC set type—50c.

NEON RADIO AND ELECTRICAL TESTER—60 to 550 volts. Indicates all kinds of current, AC, DC, or RF—comes complete with instruction booklet, outlining various tests on radio sets, including the locating of fusing, dead stakes, shorts, and making screen grid and plate circuit tests—Specially priced at 35c ea. Per doz. on attractive display card—\$3.50.

TUBULAR CONDENSERS—guaranteed one year. Prices are in lots of ten, either one type or assorted. 50MF—150V—53c; 20-20 MF, 150V—35c; 20-30 MF, 150V—46c; 20 MF—150V—23c; 10 MF—35V—23c; 25 MF—25V—23c; **PAPER CONDENSERS**, 600V—25 MF—23c; 1 MF—11c; .05 MF—11c; .02 MF—49c; .01 MF—9c; .006 MF—8c. **MICA CONDENSERS**, 1000V test, 600 WV, any standard capacity—15c.

CRYSTAL PHONO PICKUPS, Nationally advertised brand—feature very low needle pressure, less record wear—\$2.95. **LINE-CORD RESISTORS**—Universal type—will replace line cord in any AC-DC set—65c.

NOTE—Minimum order accepted—\$3.00. Please enclose at least 10¢ with all C.O.D. orders.

BUFFALO RADIO SUPPLY

219-221 Genesee St., Dept. 7C
Buffalo 3, N. Y.

Ted McElroy

World's Largest Manufacturer of
Wireless Telegraphic Apparatus

COMPLETE CENTRAL OFFICE EQUIPMENT
McElroy Manufacturing Corp.

92 Brookline Avenue • Boston, Massachusetts

ATTENTION HAMS!

Learn all about radio's latest development—**THE IRON CORE TUNER.**

Replaces 2-gang condenser and the oscillator. A complete, tracked unit. Try it yourself. Prepare to deal with it in servicing or on your job. Write for details.

MAGNA-METAL PRODUCTS CO.

70 East 46 St., New York City Mu 4-0432

THE TRANSGENERATOR

(Continued from page 715)

lator 100 percent. From this, it can be seen that only a small voltage is required to produce the 30 percent modulation required by the I.R.E. Standards Committee. A high percentage of modulation in a signal generator is often useful when checking a receiver which is so badly out of alignment that high output is necessary to force the signal through.

The capacitor which connects the S2 "on" contact to ground keeps r.f. energy out of the a.f. circuit; it has negligible effect upon the 400-cycle output.

The r.f. oscillator may be externally modulated if desired. Thus an a.f. source, such as a variable-frequency audio oscillator, phonograph pickup or microphone, may be superimposed upon the r.f. test signal, through the external modulation jack.

Fig. 2, however, includes this in dotted line form, since it is still in the "plan" stage. Clearly, Switch S2 must be changed to the single-pole three-position type. The jack will be mounted on the panel near S2. Another condenser goes from the jack to the chassis as shown.

Any small power transformer may be used. If the voltage at point "X" exceeds 280 volts, a 10-watt resistor may be used in place of choke L5. The value must be found by trial, and this can be simplified by employing a resistor with an adjustable slider. If the voltage at point "X" does not exceed 280 by more than 15 or 20 volts, it will be simpler to reduce or remove the input filter condenser. Small changes in rectifier output voltage may also be compensated for by varying the bleeder (decrease it to reduce the voltage).

GENERATOR CALIBRATION

Much can be said regarding methods of calibrating a Signal Generator. Nevertheless, so much material has appeared in past articles in RADIO-CRAFT, that it would be redundant. The constructor is referred to the following articles: "Calibrating Generators," Jack King, April, 1944, p. 412; "Signal Generator," M. E. Blaisdell, Nov., 1945, p. 121; "Signal Generator," Bob White, Jan., 1946, p. 243.

It is to be emphasized that the Trans-generator has been designed for extreme simplicity. It is apparent from the photographs, for instance, that no under-chassis shielding was necessary.

Many improvements can be thought of by the more advanced technician. For example, the r.f. and a.f. units can be isolated from one another. Then, modulation, internal and external, could be accomplished in a separate mixer tube such as the 6SA7 or 6L7. The r.f. output would then be taken from the mixer stage, isolating the signal generator from the circuit under test in a more thorough manner. This would also result in a wider tuning range. Other improvements will probably suggest themselves to the experienced technician.

HARD-TO-GET PARTS

POWERFUL ALL-PURPOSE INDUCTION MOTOR

IDEAL FOR EXPERIMENTERS—101 USES

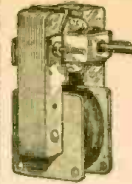

Sturdily constructed to precision standards, this self-starting shaded pole A.C. induction motor is powerful enough for a number of uses. Some of these are: Automatic Timing Devices, Current Interrupters, Electric Fans, Electric Chimes, Window Displays, Photocell Control Devices, Electric Vibrators, Small Grinders, Buffers and Polishers, miniature Pumps, Mechanical Models, Sirens, and other applications.

Consumes about 15 watts of power and has a speed of 3,000 R.P.M. When geared down, this sturdy unit will constantly operate an 18-inch turntable loaded with 200 lbs. dead weight. **WHAT'S POWER!** Dimensions 3" high by 2" wide by 1 1/2" deep! Has 4 convenient mounting studs; shaft is 7/8" long by 3/16" diameter, and runs in self-aligning oil-retaining bearings. Rated for 110-20 volts, 50-60 cycles, A.C. only. Shp. Wt. 2 lbs.

ITEM NO. 147

YOUR PRICE

\$2.95

ULTRA MAGNET

LIFTS MORE THAN 20 TIMES ITS OWN WEIGHT

LITTLE GIANT MAGNET

Lifts 5 lbs. easily. Weighs 4 oz. Made of ALNICO new high-magnetic steel. Complete with motor, the most powerful magnet ever made. The experimenter and hobbyist will find hundreds of excellent uses for this high quality permanent magnet. Measures 1 3/4" x 1 1/4" Shp. Wt. 1 lb.

ITEM NO. 159

YOUR PRICE

\$1.50



GENUINE MICROPHONE TRANSMITTERS



Regular telephone transmitters taken from a large telephone supply company's overstock. Work perfectly on 2 dry cells. Can be used on P.A., intercom, call systems, intercommunications, etc. Short-line telephone circuit, house-to-house or farm-to-farm phone lines. Also to talk through your dictaphone pick-up. Useful replacement on battery-operated rural telephone lines.

THREE ARE GENUINE TRANSMITTERS, MADE BY KELLCOG, WESTERN ELECTRIC AND STROMBERG-CARLSON, excellent in appearance and operation. A remarkable value and one seldom offered in these times. Shp. Wt. 1 lb.

ITEM NO. 160

YOUR PRICE

\$1.50

AMAZING BLACK LIGHT!

Powerful 250-Watt Ultra-Violet Source



The best and most practical source of ultra-violet light for general experimental and entertainment use. Makes all fluorescent substances brilliantly luminescent. No transformers of any kind needed. Fits any standard lamp socket. Brings out beautiful opalescent hues in various types of materials. Useful for amateur parties, plays, etc. to obtain unique lighting effects. Suits only. Shp. Wt. 1 lb.

ITEM NO. 87

YOUR PRICE

\$1.95

WESTERN ELECTRIC BREAST MIKE

This is a fine light-weight aircraft carbon microphone. It weighs only 1 lb.

Mike comes with breathe-plate mounting and has 2-way swivel-plate adjustment so that it can be adjusted to any desired position. There are 2 woven straps: one goes around neck, the other around chest. Straps can be snapped on and off quickly by a ingenious arrangement.

This excellent mike can be adapted for home broadcasting or private communication systems. By dismounting breathe-plate, it can be used as desk mike. Comes complete with 6-foot cord and hard rubber plug. Finished in shatterproof plate, non-rustable. Shipping weight, 2 lbs.

ITEM NO. 152

YOUR PRICE

\$1.49



WATTHOUR METER

Completely overhauled and ready for immediate service. Designed for regular 110-volt, 60 cycle 2-wire A.C. circuit. Simple to install: 2 wires from the line and 2 wires to the load. Sturdily constructed in heavy metal case. 8 1/2" high, 6 1/4" wide, 5" deep. Westinghouse, G. E., Ft. Wayne, Sangamo or other available make Shp. Wt. 14 lbs.

ITEM NO. 33

YOUR PRICE

\$4.95

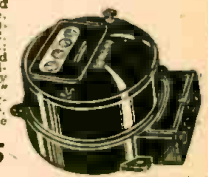

HUDSON SPECIALTIES CO.
40 West Broadway, Dept. RC-7-46, New York 7, N. Y.

I have circled below the numbers of the items I'm ordering. My full remittance of \$..... (NO C.O.D. orders unless accompanied with a deposit.)

OR my deposit of \$..... is enclosed (20% required). Ship order C.O.D. for balance. NO C.O.D. ORDER FOR 15% THAN \$3.00. BE SURE TO INCLUDE SHIPPING CHARGES.

Circle Item No. wanted: 147 159 160 87 152 33

Name

Address

City

State

INSIDE THE HANDIE-TALKIE

(Continued from page 703)

DIRECTION FINDER, TOO

In the latter days of the war, an accessory was added to the SCR-536 which permitted it to be used for direction finding for locating a command post or unit whose location is not known, or for "homing" in fog or darkness.

This is a directional loop antenna used in place of the non-directional telescoping antenna. A modification kit was also provided that permitted the operator to use external headphones.

The loop consists of two windings, a single turn secondary winding and a four turn primary winding. The primary of the loop is tuned by a 100- μ f variable condenser. The loop assembly is connected by cable to a matching transformer that matches the impedance of the loop to the input impedance of the receiver. The matching transformer screws to the antenna cap stud and consists of a tuned auto-transformer. Its output lead is equipped with a clip that fastens to the vertical antenna.

When the loop and transformer have been tuned to give maximum response from the desired station, the loop is rotated through 360 degrees. There will be two points where the signal strength drops to a sharp null. These points will occur when the loop is broadside to the direction of the signal source. This will indicate that the signal is coming from one of two directions 180 degrees apart. To determine which is the true direction, a "Sense Button" permits the body to act as a vertical antenna. Rotating the loop 90 degrees in each direction from the null will produce a stronger signal in one direction than in

(Continued on following page)

CRABTREE'S

WHOLESALE RADIO

2608 Ross Ave.

DALLAS 1 TEXAS

Scoop!!

HAMS — EXPERIMENTERS

Now you can get those Miniature Extra-Sensitive HEADPHONES at less than one-tenth their original cost to the government!

Features

- Wide frequency response, can be connected to high or low impedance outputs
- Featherweight adjustable headband, the extreme in listening comfort

Signal Corps Type HS30 and Matching Transformer

COMPLETE **\$3.49**
net

Send check or money order for postpaid shipment.

ELECTRONIC SUPPLY CORP.

4014 GREENPOINT AVE.
LONG ISLAND CITY 4, N. Y.
Stillwell 4-0231





OSCILLOSCOPE CRO-3A

EVERY service man needs this portable oscilloscope for accurate and rapid service work on AM, FM and Television receivers. We list only a few of the many uses that make it indispensable in the modern service shop: study wave shapes and transients; measure modulation adjustment of transmitters; check receiver alignment; determine peak voltages; trace electronic tube characteristics. The CRO-3A gives a sharp, clear picture and is equipped with a screen for easy daylight viewing. Write today: Specialty Division, Electronics Department, General Electric, Syracuse, New York.

Electronic Measuring Instruments

GENERAL ELECTRIC

177-D4

Buy The Niagara Way!!

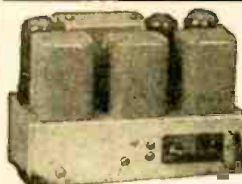

SPEECH AMPLIFIER

This is a complete speech amplifier minus tubes and power supply working from dynamic or carbon microphone to Class B grids. Noise level less than -55 db. Designed for use in Collins ART-713 Auto-tune transmitter.

\$7.95

Uses 2 6V6G's and one 12SJ7

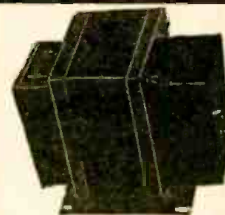

SWINGING CHOKE

Swings from 60 to 9 Henries, 50 to 400 mls. Built by Langevin. A marvelous choke for class B modulators — while they last.

\$12.75

DYNAMOTOR

12 volts DC input—delivers 235 volts at 90 mls. Complete with filter—mounted in can. 6 1/2 x 5 3/4 x 3 1/2 with cover.

\$2.95

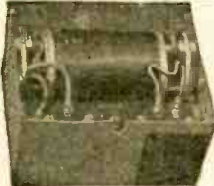

AMERTRAN TRANSTAT

Designed for adjusting filament voltages. 20 amp. up to 50 volts AC. Adjustment may be locked after setting. Terminates in an aircraft Amphenol plug mounted in a black crackle case with air louvers.

\$3.95



ADDITIONAL NIAGARA SPECIAL ITEMS

Class B Modulation Transformer used with the Collins auto-tuned transmitter. Modulates an 813 tube both plate and screen from 811 modulators. Good for as much as 150 watts of audio at \$4.95.

Western Electric Class B Driver Transformer will match 6L6 tubes push-pull to grids of any class B tubes. Limited quantity. \$3.95.

General Electric 10 Henry, 250 mls. smoothing choke. These chokes made to very rigid Gov't specifications. \$3.50.

Class B 599 watt Transformer made by N.Y. Transformer Co. Ratio 1.58:1 primary 7200 ohms, secondary 2650 ohms. For you KW boys. Come and get them for \$23.75.

Signal Generator. Navy type OAN covers from 200 kc to 2 mc, M.O.P.A. Will operate on batteries or 110 volts, 60 cycles. Comes complete with 15 feet Ant. RF can be taken from Probe or sectional ant. Special \$42.50.

Cramer Running Time Meter. 110 Volts 60 cycles—reads to 9999.9 hrs. \$4.95.

Choke—150 MA—10 Henry—20 Ohms \$1.49

807 Tubes, JAN. \$1.49
813 Tubes, JAN. \$9.95
Hewlett-Packard Audio Oscillator #200 B. freq. range 20 cycles to 20,000 cycles in 3 ranges. Complete with tubes and power supply, used, but reconditioned and guaranteed. \$75.00

NIAGARA RADIO SUPPLY 160 GREENWICH ST. NEW YORK 6, N. Y.

Send for our latest Bulletin 4C

**RCA HIGH AND LOW VOLTAGE
COMPLETE-IN-ONE-UNIT
TELEVISION POWER SUPPLIES**
\$90.00



**Cathode Ray Tubes
NEW, FACTORY SEALED, FOR
Television & Oscilloscopes**

Dumont 5BP1	\$15.00
RCA 5BP4 1/2 with special wired sockets	\$15.00
N.A. Philips 5CP1	\$15.00
Dumont 7EP4	\$29.90
RCA 9AP4	\$62.50
RCA 12AP4	\$75.00
RCA, new type, 5TP4 Projection	\$70.00
N.A.-A.D.I. polo-magnal socket with H.V. wiring	\$2.40
14-pole Di-hermal Cinch socket with H.V. wiring	\$2.40
RCA Television 5 bands switch with 5 antenna transformers	\$5.60
GE CR Power Transformer—1700 V.. 6.3 V.. 2.5 V.	\$9.90

SPECIAL TUBES, FACTORY PACKED

616	\$1.00	9003	\$1.00
6AG5	\$1.00	9006	\$1.00
6AG7	\$1.00	2V3G	\$1.50
6AL5	\$.75	2X2	\$1.00
6AC7	\$.90	6SN7GT	\$.70
6CA	\$.75	6SL7GT	\$.75
9002	\$1.00	6L6	\$1.00
		7F7	\$.90

CAPACITORS

2 MFD. 750 V. Sprague, oil filled Capacitor	\$1.50
1 MFD. 1500 V. Sprague, oil filled Capacitor	\$1.80
.02 MFD. 2500 V. Sprague, oil filled Capacitor	\$.90
.05 MFD. 3000 V. Aerovox, oil filled Capacitor	\$2.40
1 MFD. 3500 V. Cornell-Dub., oil filled Capacitor	\$1.80
.03 MFD. 7500 V. G.E., oil filled Capacitor	\$3.75
1 MFD. 7500 V. G.E., oil filled Capacitor	\$7.50
2 x .1 MFD. 7000 V. G.E., oil filled Capacitor	\$9.00
2 x .15 MFD. 8000 V. Sprague, oil filled Capacitor	\$9.00
.05 MFD. 16000 V. Sprague, oil filled Capacitor	\$9.00

Send 50c for complete catalog including diagrams for RCA, G. E., DUMONT and ANDREA Television Receivers; free with your order. No order less than \$10.
RCA Parts and Equipment Distributors
World's First Specialized House in Television
TELETRONICS SERVICE & SUPPLY CORP.
264 West 40th Street. New York 18, N. Y.

INSIDE THE HANDIE-TALKIE
(Continued from page 723)

the other. When the loop is turned to the loudest signal, an arrow on its base indicates the true direction. The thumb is then removed from the "Sense Button" and the loop turned to the original null. The operator may then direct himself toward the transmitting station by traveling in a direction perpendicular to the plane of the loop in null position.



The Handie-Talkie used as a homing device.

430 MC WITH A 6F4
(Continued from page 705)

ens the radiated wave due to undesirable frequency modulation. This is not too disadvantageous for communication but may be undesirable for experimental work. For lower modulation percentage, Fig. 7 may be used.

This transmitter can be easily adapted to voice communication by using some of the principles and circuits given in the transceiver article (May). It is stable and gives more output than can be obtained from a transceiver.

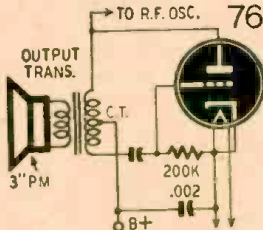
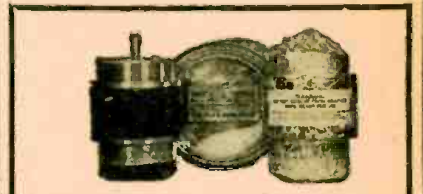

Fig. 7—This circuit gives less modulation.

With a higher value of grid resistance it can be used as a super-regenerative receiver, but because of the type of construction, it is better adapted for a semi-fixed frequency transmitting outfit. Until the final design is complete (at least) it is a good idea to leave a plate milliammeter in the circuit to indicate conditions.

"TAB"
That's a Buy

- Cathode Ray Tube new Govt. Insp. 3BP1 (Net \$15) \$6.95
- Cathode R Tube new G1 S4P1, S4P1, B4 (Net \$27.50) 9.95
- Rectifier new Gov't Insp. G.E. 872A (Net \$7.50) 4.50
- Rect. new G1 RCA 866A with Millen Cap. 2 for 2.90
- 807 new G1 with SPP-3 cap. (Net \$2.46) 1.95
- Elmac new VT127A & Cntrs. 100W150m/cs. (519) 4.95
- RCA 6J4 new G1 Insp (Net \$8.35) @ \$2.49, 2 for 4.75
- Yungol miniature 3A4 G1 Insp (L \$1.58) 2 for 1.10
- Elmac 304TL used like new tested gtd. (\$50) 13.95
- Johnson socket No. 213 for 304TL new G1 .90
- Crystal & Holder LO drift cut any freq.
- .2 to 10 mcs. active osc. gtd @ \$1.51; 4 for 5.90
- Crystal mtd aircraft 1000 KC STD .02% accy. 7.20
- Crystal mtd. LAB 100 KC STD .02% accy. 7.20
- Crystal diode 1N21 & holder two ea. in sets 1.25
- Co-Axial 52872 ohm RG811u cable 100 ft. 7.95
- CD 6mf 1500VDC wkg (LPS14.25) @ \$2.80, 2 for 5.00
- Radio Noise Filter Mallory NF1, 2 for .98
- Micro wave Ant. with co-axial cnctr. & mta. brkt. .95
- FM Television Rotatable UHF Radar Coupler. 3.95
- Micro switch leaf type 10A12BV SPNO 3 for 1.00
- G.E. DW 44 R.F. Thermomtr 0-1A, 2 1/2" B' case 3.95
- G.E. DW 52 R.F. Thermomtr 0-5A, 2 1/2" B' case 3.50
- Roller Smith 0-1 milliammtr 0-100ma (LPS10) 4.50
- GE Thermomillimtr 3" B'C 100ma RF (LPS18) 8.98
- GE DN1 Miniature 1 1/2" BC 1ma100ohms (LPS12) 3.00



AUTOSYNS BENDIX-HOBART

Brand new gov't sealed and inspected packed in overalls cans, 4 1/2" diameter, AC, 115v. 60 cy. operation. Continuous heavy duty. Precision accuracy made for gun-fire control. Cost gov't \$90 each. Wt. 5 lbs. each. "TAB" special two for \$18.

- DC Voltmtr GE 2000V 1000ohm 2 1/2" B' case. \$8.95
- DC Voltmtr 301 Weston 10000V 1000ohms. 12.95
- AC Voltmtr NA33Walsh. 150V 2 1/2" B'C. 2.95
- Carborundum #11 Dual brkt sharpening stone (\$1.70) .39 ea. 3 for \$1.00 Same #124 Fine (1.20) ea. 3 for 3.00

Kit consisting of 200 resistors 1/2W 1/2" assmtd 50 to 2 megohms. Ten dual 40mfd 150WV Tubular. 25 15mfd35WV & 100-5mfd35WV Electrolytics. Ten dual 0.5M 200WV, ten triple .05mfd 300WV all oil cond. Value \$49. "TAB" special guaranteed 9.95

- Condenser WE oil 16mfd-400VDC wkg 2 for. 2.35
- WE 15V 60Cpri. 650VDC300ma. 5V3A, 6V5A. 3.95
- Choke W sthlec cased 4Hy/930ohm wt 10 lbs. 2.95
- Choke Donjan cased 10Hy 1/4 150 ohm wt 5 lbs. 1.89
- Choke GE cased dual 30Hy85Ma350 ohm Ins. 2.00

- Daven switch 13 circuits 25 amp. cts. 2 for. 1.25
- Xtal holders CP1 complete ready for Xtal B for 1.00
- Xtal holders WE fit any Xtal complete 3 for. 1.00
- Heinman magnetic ckt bkr. 1/4 20A. 6A. .97
- Relay sen. sigma SAH 200ohm 3.5ma. 5PDT. 2.25
- Relay sen. WE 3500 ohms SPDT 5A. cts. .97
- Relay interlock 4PST 110VDC. 36 to 120A (LPS40) 7.95
- GE Start Stop switch 2 Button (LPS2.25) 2.79
- Cond. GE pyranol 3mf 1000VDC wkg 2 for. 2.90
- Oscilloscope Conversion Kit BC 412 contains all parts for sweep circuits and changes 15.75
- Additional engraved dials 3.75
- Complete Kit all parts and dials 18.50
- 3 for .75 condition used like new 1 of ea. (2) .57
- Tool boxes used LN Hvy duty 19x7x7 1/4" (84) \$5 1.89
- Raytheon 15V60CP. 2.5V 11 Arec new (22.30) 3.25
- Combination New 2RCA866A's & Raytheon tnsf. 5.90
- W.E. Crystal 1N21 new sealed in lead 2 for. 1.25
- W.E. same 1N22-2fort.50. 1N23 2fort. 80 1 ea (3) 1.98
- Cond. G.E. pyranol 4MFD-600VDC wkg. 2 for 1.90
- Cable 30cond 6c pr ft; Lead in wire 100', per 4 1.00
- Cond. 25mfd Solar 5000V wkg. (524) 39 ea. 3 for 1.00
- Resistors 100 ass't 1/2W BT 50 to 2 megohm 2.50
- TBY-2 Portable UHF transceiver 28 to 80 mcs 49.95
- Micro probe code practice set in case (\$180) 22.50
- New W.E. BC412 Oscilloscope complete gtd . 65.00

\$1 Min. orders FOB, N.Y.C. Add Postage all orders and 25% deposit. Whitehall 3-3557. Send for catalog 300. Don't wait, rush orders as quantities are limited. Buy thru "TAB" and save.

"TAB," Dept. RC7

7-A Church Street, New York 6, N. Y.

Radio and Phono Kits

- 5-Tube Super Het Kit & Cabinet—less tubes—\$13.75
- AC Phono Amplifier—6X5—6E5—6V6, less tubes 6.75
- AC-DC Phono Amplifier—less tubes 4.75

Tubes for above available

TECHNICAL RADIO LABS

341 WILSON AVE. BROOKLYN 21, N. Y.

IMMEDIATE DELIVERY

SPECIAL VALUES

- PHONO AMPLIFIER—3-Tube AC-DC. Complete. 8.95
 - Tubes & Speaker 4.35
 - BY PASS COND. KIT—20 Ass'td. .99
 - RESISTOR KIT—50 Ass'td 1/3 to 1 Watt. .99
 - DIAL CORD KIT—100 Ft. Ass'td & 8 Springs. 1.19
 - LOOP ANTENNA (High Gain) .59
 - ANT. & OSCIL. OR ANT. & RF. COIL SETS. .69
 - OUTPUT TRANS.—3000-3 or 7000-3 Ohms. .79
 - CRYSTAL PICK-UPS—3 Ohms. 2.79
- Write Today for Bargain Bulletin
RADIO DISTRIBUTING CO., Pasadena 18, Cal.

Order from LAKE!
You'll Make No Mistake!
RADIO Cabinets & Parts



NOW Available
Postwar
2 Post
RECORD-CHANGER

With luxurious brown leatherette portable case 15" L x 15" W x 10" D. Latest electronic developments make this modern record-changer the finest on the market today!

List Price.....\$49.95 Dealer's net.....\$29.97

Also blank table cabinets of walnut veneer in the following sizes, with speaker opening on left front side. (Note: 7" has center speaker grill.)

- #1 — 8 1/4" L x 5 1/2" H x 4" D \$1.95
- #2 — 10 1/4" L x 6 3/4" H x 5" D \$2.75
- #3 — 13 1/2" L x 7 3/4" H x 6 1/4" D \$3.25
- #7 — 10 3/4" L x 7" H x 5 1/2" D \$2.50

*Speaker Opening in center of front side.

All types of radio cabinets and parts are available at Lake's lower prices. A large stock is listed in our catalog.

SERVICEMEN—RETAILERS
Join our customer list today.

Order our New Catalog Today!
Get on our mailing list!

Deot. C

LAKE RADIO SALES CO.
615 W. Randolph Street, Chicago 6, Ill.

Television receivers will begin to reach the market this fall, David Sarnoff, president of the Radio Corporation of America, told the stockholders at the company's annual meeting held recently.

CATHODE FOLLOWERS

(Continued from page 692)

This circuit is not recommended where high input impedance is important.

In this arrangement, operation of the cathode follower is similar to the previous type, but the input signal appears across the grid resistor R_G , which with C_G develops grid bias when signal is applied, as in a grid leak detector. Positive input signals of high amplitude soon drive the tube into the region of grid saturation. Larger negative signals can be handled because of the lack of initial negative bias.

Output of the stage is still taken from across the cathode resistor R_K , and output voltages and impedance are of the same order as in the previous circuit.

When a circuit is required to accommodate high-amplitude input signals of both positive and negative polarities, a modified cathode follower (Fig. 3) is employed which changes biasing arrangements and results in improved operation.

A triode is used in this modified circuit (Fig. 3). The cathode resistor is divided into two parts: R_{K1} and R_{K2} .

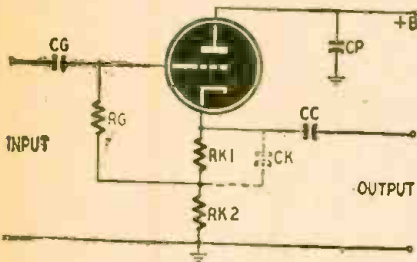

Fig. 3—Circuit for large a.c. grid swings.

The input signal appears across the grid resistor R_G and the cathode resistor R_{K2} in series. Value of R_{K1} establishes a no-signal bias which permits the triode to operate about mid-way along the tube's characteristic curve—between plate-current cut-off and grid saturation.

Grid of the tube is thus allowed to swing to greater positive and negative values without grid saturation or cut-off than was possible in either of the two previous types of cathode followers.

This circuit (Fig. 3) might appear to lack the necessary feed-back arrangement. But it should be noted that the output voltage is acting effectively in series opposition to the input voltage—the required condition for degenerative feedback.

A variation of this circuit provides output reproduction of large negative and positive input voltages.

The only difference is the addition of a cathode condenser C_K to the circuit of Fig. 3.

Another modification of the basic cathode follower is shown in Fig. 4. It supplies a matched, paraphase (push-pull) output.

Normally, there is no load in the plate circuit of a cathode follower. But in this arrangement (Fig. 4), a resistor R_P is inserted in the plate of the triode. The value of this plate resistor is ex-

LIBERTY RADIO KITS

6 Tube "Super Het" Radio Kit
Complete Including Attractive Walnut Cabinet

Diagram Furnished

Your Cost **\$16.95**

LESS TUBES

ALL PARTS MOUNTED—Uses one 25L6, one 25Z6, one 6SQ7, one 6SK7, two 6SJ7's or one 50L6, one 35Z5, two 12SJ7's, one 12SQ7, one 12SK7.

5 Tube "Super Het" Radio Kit
Your Cost **\$13.95**

LESS TUBES Complete Including Attractive Brown Bakelite Cabinet

Diagram Furnished

ALL PARTS MOUNTED—Uses one 25L6, one 25Z6, one 6SQ7, one 6SK7, one 6SA7 or one 12SA7, one 12SQ7, one 50L6, one 35Z5, one 12SK7.

10% DEPOSIT—BALANCE C.O.D.

LIBERTY SALES CO., INC.
115 WEST BROADWAY, NEW YORK 13, N. Y.
DEPT. K

OUTPUT TRANSFORMERS

TO MATCH 6V6—6F6—41—42
To 4-6-OHM VOICE COIL
HEAVY DUTY 8 WATTS

SINGLE 59c
PUSH-PULL 69c

NINE-FOOT ANTENNA HANK
RUBBER COVERED
6c each
\$5.00 per 100

SHIELDED WIRE
No. 16 O.D.—125
TINNED COPPER
\$2.50 per 100 ft.

H. A. WILLIAMS CO.
P. O. BOX 106,
COLUMBUS, INDIANA

In the Rocky Mountain Region it's
RADIO & TELEVISION SUPPLY CO.
150 Hobson Ave., P.O. Box 892
PUEBLO, COLO.

"If we don't have it, we'll not it—
or it can't be had! Phone 5729"

actly equal to that of the cathode resistor R_K .

Since the same plate current flows through both resistors, changes across each resistor will be the same in voltage but opposite in polarity. During positive-going input signals, the cathode

TRUTONE

PREPARED ASSORTMENTS
GUARANTEED FIRST QUALITY

Cat. No.	Quantity	Description	Price
1001	100	1/3 Watt Resistors, All Insulated	\$2.98
1002	100	1/2 Watt Resistors, All Insulated	3.98
1003	100	1 Watt Resistors, All Insulated	4.45
1004	50	2 Watt Resistors, All Insulated	3.98
1005	10	Wire Wound Resistors Ass'd Watts	2.98
1006	50	200 Volt Paper Condensers	2.49
1007	50	400 Volt Paper Condensers	3.49
1008	50	600 Volt Paper Condensers	4.23
1009	50	Mica Condensers	2.98
1010	20	Dry Electrolytic Filter Condensers	6.75
1011	10	Resistance and Line Cords	3.98
1012	10	Water Sockets	4.50
1013	100	Plastic and Ceramic Sockets	8.50
1014	10	25 Ft. Rolls Hookup Wire—Ass'd Colors	1.98
1015	10	50 Ft. Rolls Hookup Wire—Ass'd Colors	3.25
1016	10	100 Ft. Rolls Hookup Wire—Ass'd Colors	6.75
1017	10	Volume and Tone Controls—No Switches	1.98
1018	50	Large Bakelite Knobs Push On	6.50
1019	50	Large Bakelite Knobs Set Screw	7.89
1020	50	Small and Medium Knobs Push On	3.50
1021	50	Small and Medium Knobs Set Screw	3.75
1022	100	Small Bar Knobs	5.50
1023	100	Large Bar Knobs	6.75
1024	100 ft.	SPAGHETTI and Vinylite	.98
1025	50	Padders and Trimmers	1.45
1026	10	Coils I.F., R.F. Amp. and Osc.	3.98
1027	50	Pilot Lamps	2.49
1028	20	Toggle and Slide Switches	3.98
1029	20	Water and Ceramic Band Switches	3.98
1030	20	Auto Generator Condensers	2.98
1031	20	Auto Suppressors	2.98
1032	25	Electrical Wiring Devices, Plugs, Caps, Bases, Heater Plugs, etc.	2.75
1033	50	Electrical Wiring Devices, Plugs, Caps, Bases, Elements, Fuses, etc.	5.00

ELECTRICAL APPLIANCES AND PARTS

Double Burner Electric Stove Streamlined	OPA \$ 7.00	\$ 5.95
Electric Broiler Deluxe type	OPA	17.45 12.50
Fluorescent Desk Lamp, Brown, Blue or Rust	OPA	11.95 7.75
Fluorescent Kitchen Unit	OPA	10.80 6.75
Electric Phonograph	OPA	48.50 36.95
Replacement Stove Element 460 W.		.12
Replacement Electric Iron Element 550 W.		.55
Replacement Toaster Element		.75
Electric Iron Cord Set, Bakelite Plug		.45
Electric Iron Cord Set, Switch Plug		.89
5 ft. Extension Cord with Cube Top		.45
6 ft. Rubber Replacement Cord		.21

SEND FOR TRUTONE COMPLETE RADIO AND ELECTRICAL LIST
Terms: 25% deposit, required with order. Balance C.O.D. Merchandise sent prepaid if full remittance accompanies order.

TRUTONE PRODUCTS CO.
303 West 42nd Street, Dept. C, New York 18, N. Y.

18 YEARS IN RADIO

GET THIS
New CATALOG
By This Old Firm

Latest developments in radio and electronic parts and devices, newest ham gear, gadgets for experimenters, bargains in war surplus items.

FREE TO YOU
Mail the coupon below and get this new catalog FREE.

BURSTEIN-APPLEBEE CO.
1012 McGee, Kansas City 6, Mo.

Send me FREE catalog advertised in Radio Craft

I AM _____
STATE CONNECTION IN INDUSTRY _____
NAME _____
ADDRESS _____
TOWN _____ STATE _____

output is positive-going but the plate output will be negative-going. The two output waveforms have the same amplitude and shape.

Thus it is possible to obtain a distortionless push-pull output from a single
(Continued on following page)

IN PHILADELPHIA - IT'S ALMO RADIO COMPANY

★ PHILADELPHIA'S
NEW WHOLESALE RADIO
AND ELECTRONIC PARTS
DISTRIBUTOR!

PANADAPTOR



PANADAPTOR Model PCA-2
Here's a new and wonderful device! Enables
SIMULTANEOUS VISUAL reception of
many radio signals, continuously selectable
from a broad band of frequencies down to
a single frequency. Now, for the first time,
with the PANADAPTOR connected to your
receiver, you can see up to 200 Kc of the
band at once. It's a MUST for MODERN
radio shack! Complete with tubes and ac-
cessories, for 115 V. 60 cycles.
IMMEDIATE DELIVERY!
Your Cost **\$99.75**

PORTABLE PHONOGRAPH KIT



**ATTRACTIVE COVERED CABINET
COMPLETE WITH MOTOR-PICK-UP-
AMPLIFIER**
SIZE: 14 x 7 1/2 x 19
TONE AND VOLUME CONTROLS
uses one 50L6, one 35Z5, one 12SQ7
YOUR COST \$23.50 LESS TUBES

SIGNAL CORPS HEADSETS



Quality headset at a
BARGAIN price! 8,000
ohms impedance. Rubber
cushions. Adjustable
headband. Built to
Sig. Corps specs. 2,000
ohms D.C.

Your Cost WHILE
THEY LAST!
\$1.95

ALMO RADIO COMPANY

509 Arch Street

Philadelphia 6, Pa.

LOMBard 0513

CATHODE FOLLOWERS

(Continued from page 725)

vacuum tube operating as a cathode follower.

Triodes most desirable for use as cathode followers should have a high value of transconductance—high amplification factor, and fairly low plate resistance—to approach unity amplifica-

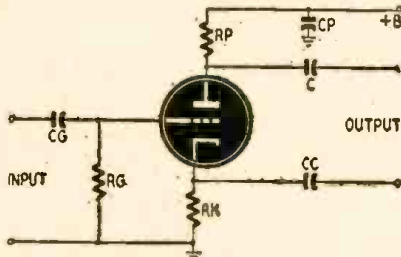

Fig. 4—Single-tube phase inverter.

tion and provide a high-amplitude voltage output.

USES OF CATHODE FOLLOWERS

Many are the uses of the cathode follower in radar, television, and industrial electronic applications.

Three of the most important ones, all related, are illustrated by the R-C coupled amplifier circuit shown in Fig. 5. Three cathode followers are used: V1 for input coupling, V3 for isolating, and V5 for output coupling.

Since a cathode follower places no appreciable load on its preceding stage, it is particularly useful as an input coupling device (V1 of Fig. 5). Negligible power is drawn from the signal source. Because of the low input distortion due to phase shift or current drain.

When d.c. as well as a.c. components of the signal waveform are to be transmitted, the cathode follower may be connected *directly* to the preceding stage without the use of a coupling condenser.

As an isolating stage (V3 of Fig. 5), a cathode follower places a low effective capacity in parallel with the grid and plate coupling resistors of the preceding stage (V2). Because of its low output terminal impedance, the cathode follower (V3 of Fig. 5) prevents phase and frequency distortion of its output signal due to input capacity effects of the following (V4) stage.

Thus a degree of separation or isolation between amplifier tubes V2 and V4 is maintained with negligible loss and without introducing distortion or otherwise affecting the signal waveform.

It is as an impedance-matching or impedance-changing device that the cathode follower is unsurpassed, and because of its low output impedance, it is most widely used in electronics as an output coupling stage (V5 of Fig. 5).

Electronically, the advantage of a cathode follower over a transformer is that the output terminal impedance of a cathode follower is *independent of frequency* over a wide range, providing distortionless transmission of the sig-

Civilian Radio Jobs Wanted

FREE WANT-AD SERVICE

By Former Soldiers, Sailors, Marines

Radio-Craft offers its help-wanted columns free for the use of honorably discharged men in the armed services. State the type of position you seek, preferred locality, your experience, education, and other details. Confine ad to 50 words, or less. Supply name and address. Army veterans send section number or photostat of discharge paper. Navy men send photostat of discharge paper. Address RADIO-CRAFT, Classified Ad, Dept. 25, West Broadway, New York 7, N. Y. Your ad will contain a box number and replies will be forwarded to you.

AVAILABLE

- RADIO OPER.** 23; Army exp.; telegraph, telephone 2/s; 30 WPM code speed. H. Puchalsky, 8 Harrison Ave., Bklyn. 11, N. Y.
- RADIO TECH.** 23, seeks start in Radio or Television field. Has completed theoretical and practical radio course in one of the prominent N. Y. schools. Adaptable and willing to learn. J. Adelsberg, 2358—84th St., Brooklyn. 14, N. Y.
- RADIO SERVICING.** desired by vet., coll. grad. telephone and switchboard repairman. knowledge of radio. Irving M. Crupar, 1605 Townsend Ave., New York 52, N. Y.
- RADIO TECHNICIAN.** 2nd class radiophone license desires good position in electronic field. Henry Radin, 682 Vermont St., Brooklyn 7, N. Y.
- RADIO REPAIRMAN** helper 2 1/2 years Radar exp. Part time preferred, all day Saturday, four o'clock on weekdays. Need experience, salary secondary. Further information write to L. Arkano, 41-69 74 St., Woodside, L. I.
- ATTORNEY;** graduate radio school; radio work in Army Signal Corps including code and radio operator; formerly law secretary federal judge; experienced in law of radio broadcasting; desires association with legal department of radio organization New York City. Alvin H. Kaufner, Box JY-3 RADIO-CRAFT, New York 7, N. Y.
- RADIO-OPERATOR** Mechanic 21, single, 3 yrs. army exp.; Loran UHF technician; trained in signal corps civilian schools; desires position with future. Elmer D. Akorberg, Plaza, N. Dak.
- STUDENT—DeForest** with apprenticeship start or as a helper. Veteran understand radio and television; willing to work three days of a wk or go in business with someone. Joe Zukauskas, 2044 N. 3rd St., Phila., 22, Pa. (Local)
- EXP'D ARMY RADAR MECH.** grad. Army radio, electronics, radar schools. M. Wagner, 1 Mesrolo St., Bklyn. 6 N. Y. EV8-2906.
- RADIO OPERATOR,** licensed, mechanical background, desires position with opportunity in Radio field of servicing. W. Briglia, 408 West 58th St., New York 19, N. Y.
- ELECTRONICS TECHNICIAN,** 2 yrs. engineering college, 1 yr. radio tech school, 1 yr. experience receiver design. Jerome B. Rockowitz, Box JY-1, RADIO-CRAFT, New York 7, N. Y.
- ELECTRONIC LAB.** technician; Navy training; 12 yrs. radio exp.; research preferred. W. Lazovick, 195 Harrison St., Passaic, N. J.
- ELECTRONICS Tech.** 2 yrs. navy exp.; nominal pay for valuable knowl., opportunity. M. Friedman, 3092 Brighton 4th St., Bklyn. 24; DE 2-4272.
- RADIO-RADAR;** electronics instructor tech.; 8 yrs. exp.; test. precision equipment. S. Gould, 1955 Sedgewick Ave., N. Y. 53; ME 5-7749.
- R.C.A. INSTITUTES—**2 yr. coll. math. maj.; seeks work electronics. M. Lockier, 4515 Grand Concourse, N. Y. 52.
- RADAR MECH.;** ham 2/phone lic., 21, theory background. M. Felber, 151 Ave. O, B'klyn. 4
- RADIO** apprentice-assistant; 1 yr. exp. parts, equipment; after 1 p.m.; student; salary secondary. J. Greenstein, 153 Broome St., N. Y. 2.
- RADIO TECH;** 24; experience repairing radios; theoretical, practical schooling; 1/c radiotelephone lic. H. Kuretsky, 563 Powell St., B'klyn 12.
- RADIO TECH.—**Jr. eng.; AM-FM. radar. repair. instructor. ham. supervisor mfg. line. S. Marsh, 120 McKibben St., B'klyn 6.
- EX-MARINE MASTER TECHNICAL SERGEANT.** Age 28, married, child, desires permanent position in electronics lab. Over 3 years radar experience. 3 years pre-war radio repair, amateur license. Graduate of two Marine Radar Schools, vocational training. Frederick H. Calvert, Route 1, Box 54, Kenosha, Wis.
- 31 YEARS OLD,** was Army radio operator and repairman. Have operated Army Broadcasting System. Have some experience in civilian radio. Would prefer work in Baltimore, Md., vicinity. Full or part time work in radio service shop. Clinton Lewis, 82 Broadway, Bel Air, Maryland.
- RADIO XMITTER ENG.** Exp'd Install Maint 1-10 KW. Xmitters 1st Cl. Phone Lic. 12 yrs. Radio Exp. Will travel. C. Langfelder, 14 Mt. Hope Place, Bronx 53, N. Y.
- ELECTRONICS. TELEVISION. AVIATION** RADIO, 3 yrs as Navy Aviation Radio Tech. 2 1/2 yrs. in Industrial Electronics. Amateur License for past eleven yrs. Have held Radiotelephone First License. Single, 29, willing to travel. Elmer C. Fischer, 5982 Brecksville Rd., Brooklyn Sta., Cleveland 9, Ohio.
- RADAR MAINT.** 3 yrs. Expert bench hand. Can repair and maintain all and any type equipment. George Rutowky, 1202 55th St., B'klyn 19, N. Y.
- GOOD THEORETICAL BACKGROUND,** 3 yrs. Army Radio, 4 yrs. H.S. elect. Hard work doesn't scare me. \$30 min. N. Oberstein, 2093 Vyse Ave., Bx. 60.
- RADIO OPERATOR,** Marines, desires experience radio, electrical fields; mechanically able, helpful. D. Slater, 80 Fort Washington Ave., New York 32.

nal waveform. Economically: a simple and inexpensive tube replaces a costly and hard-to-get transformer.

Matching of a video amplifier (having this standardized low-cost cable. to a transmission line (of very low impedance) can be accomplished practically only by a cathode follower.

Complex wave shapes are transmitted over long distances via low-impedance

the tube. The low impedance (output) of the cathode follower provides a high degree of damping which generally improves the overall performance of an audio loudspeaker. The large negative feedback of the stage results in an almost-distortionless audio signal output (if the circuit is carefully designed).

It is employed to great advantage to match high-impedance outputs to co-

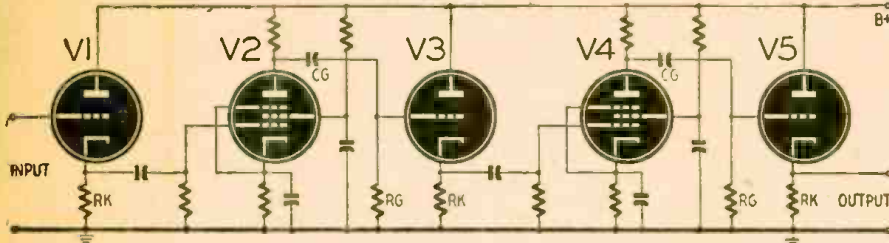

Fig. 5—R-C amplifier. Input V1, isolating stage V3 and output V5 are cathode followers.

lines or coaxial cables. A cathode follower stage provides the low-impedance transmission source.

A cathode follower can also be used as an output stage to drive a dynamic loudspeaker—see RADIO-CRAFT, April, 1945—by connecting an audio output transformer directly in the cathode of

axial or concentric lines of considerable physical length. Such a cable—because of its distributed inductance, capacitance, and resistance—represents a low impedance. Only a cathode follower can match that impedance to the high impedances encountered at the output terminals of video and pulse circuits.

BROAD-BAND ANTENNA

(Continued from page 681)

side of zero azimuth, or target, until half-voltage points are reached.

Element lengths and spacing dimensions for this array are as follows, and are further shown in Table 1 and Fig. 1.

Element Lengths

Director: .41 wavelengths

Driven or Center Element: .47 wavelengths

Reflector: .52 wavelengths

Element Spacing

Director to Center Element: .10 wavelengths

Center Element to Reflector: .15 wavelengths

For ready use, spacings and element lengths are shown in Table 1 for operation on several useful amateur, FM, and television frequencies. In all cases the center element is fed by standard 50-ohm coaxial cable, preferably Joint Army-Navy Approved RG-8 Cable, now readily available in quantity as military surplus, or from manufacturers producing this standardized low-loss cable.

Properly and carefully constructed, the array will operate with complete satisfaction over a 15 percent frequency range, or over 2,100 kcs at 14 megacycles, 4,200 kcs at 28 mcs, 7,500 kcs at 50 mcs, and so on.

Experience with this type of antenna shows that although its 15 percent frequency response factor is technically short for an idealized bandwidth for television reception, it performs exceptionally well, and is altogether superior to a single folded dipole at the same height above ground. At the time of writing, four sets are using the array, providing excellent reception 40 miles from the Empire State Building transmitting point in New York City.

Though not common among amateurs due to the fact that little data has ever been published on the subject, two three-element arrays stacked over each other and properly phased offer a considerable improvement over the one-array antenna. In a great many installations where the entire supporting mast is rotated, or the direction fixed, the use of a lower tier will give considerably greater power gain, and far more efficient use of the lower vertical angles of radiation and reception. These lower vertical angles contain the pay dirt not only for long distance contact, but for u.h.f. work. Actually, a great many antennas, though erected with precision and costly materials, are but some 30 percent effective solely because their best recep-

(Continued on page 732)

Center Frequency	Director Length, ft.	Driven Element Length, ft.	Reflector Length, ft.	Director to Driven El. spacing	Reflector to Driven El. spacing
14,000 kcs	28 ft.	32.6	35.3	6.95	10.4
28,500 kcs	13.8	16.3	17.8	3.4	5.18
50,000 kcs	7.8	9.2	11.2	1.95	2.93
52,000 kcs	7.7	8.8	9.8	1.87	2.82
56,000 kcs	7.1	8.3	9.2	1.76	2.62
97,000 kcs	4.2	4.7	5.2	1.1	1.65
146,000 kcs	2.7	3.2	3.5	.67	1.01

TABLE 1

Here's a New POWER CUTTER KIT

with a cutting range of 5/8" to 2 1/2"



Only \$7.85 Complete



Two Bruno Adjustable Hole Cutters in one convenient kit. High speed steel blades cut clean, fast holes in metal, wood, plastics. Quickly adjustable and easily sharpened. Designed by tool engineers to operate efficiently in bench drill, drill press or portable drill.

Ask your jobber, or write Department RC-7

MODEL	SHANK SIZE	EXPANSION	PRICE
100	1/4" st. shank	5/8"—1 1/2"	\$3.00
101	3/8" st. shank	1"—2 1/2"	\$5.00
790 KIT		5/8"—2 1/2"	\$8.00*

*Fair Trade Minimum \$7.85



BRUNO TOOLS
9330 Santa Monica Blvd.
Beverly Hills, Calif.

A Sensational Terminal Value!

HEAVY DUTY POWER TRANSFORMER



PRIMARY
115 volts AC, 50-60 cycles.

SECONDARIES
315-0-315 volts @ 1.20 milliamperes.
6.3 volts @ 3.6 amperes. 5 volts @ 3 amperes.

SIZE 4 1/2" high x 4" wide x 3 1/2" deep.
Net weight, 7 lbs.

GUARANTEED

\$2.95
net

FULLY SHIELDED power transformer ideally suited for P.A. amplifiers, small transmitters, etc. Made by a well-known transformer manufacturer. Conservatively rated, with clearly numbered terminal lugs.

TERMINAL
Radio Corporation

85 CORTLANDT ST. N. Y. 7, N. Y.
Worth 2-4415

PHONO CABINETS

A plastic ebony cabinet, $\frac{1}{4}$ " thick, 13 $\frac{3}{4}$ " long, 11 $\frac{1}{2}$ " wide, 3 $\frac{3}{4}$ " deep. Makes a streamlined mounting for phono playbacks, wireless record players, meter cases and automatic record changers (Utah, Emerson, and others). Very sturdy; works as easily as wood. 2- or 3-tube amplifier with 3 $\frac{1}{2}$ " speaker fits perfectly.

WHILE THEY LAST: Blanks—only \$3.69 each F.O.B. Springfield. 10% off in lots of 10. Boxes can also be ordered with motor and speaker holes already cut, and plastic grill front for an additional .50.

VICTORIA ELECTRONICS AND
SUPPLY CO.

1039 MEMORIAL AVE.
WEST SPRINGFIELD, MASS.



Scientifically
Built
Heavy bar magnets greatly increase their efficiency.

CANNON BALL

is a good Headset guaranteed to satisfy you. For sensitivity, clarity of tone, dependable performance, use a Cannon-Ball Headset. Folder R-7 illustrates complete line. Write

C. F. CANNON COMPANY
SPRINGWATER, N. Y.

Headset Headquarters



NEW TINY POCKET SIZE RADIO!

Sits in your pocket or purse—WE only 3 sets. Complete. READY TO PLAY as shown with self-contained phone for personal use. Smooth, durable black and silver plastic case. Has patented Fixed Crystal—NO TUBES. BATTERIES OR ELECTRIC PLUG IS REQUIRED. USUALLY RECEIVES LOCAL BROADCASTS CLEARLY without outside aerial wire. GUARANTEED TO WORK when connected and used according to instructions sent with each radio. Can be used in homes, offices, hotels, cabins, bed, after hours, etc.

SEND ONLY \$1.00 (cash, money order, check) and pay postman \$2.00, plus delivery fees on arrival or send \$3.00 for postpaid delivery. IDEAL GIFT FOR CHILDREN OR ADULTS ALIKE! Get your PA-KETTE RADIO TODAY—NOW. Dealers in most cities.

PA-KETTE RADIO COMPANY
DEPT. RC-7 KEARNEY, NEBRASKA

BEAUTIFUL WALNUT CABINET
CUT TO FIT MEISSNER 6-TUBE KIT Mdl 10-1199



Cabinet Mdl M-1 Your Cost \$3.95
Write for latest parts Catalogue
McGEE RADIO CO., 1330 Bdwy, DENVER, COLO.

WANTED—MANUFACTURER TO REPRESENT IN GREECE

Greek Radio and Accessories firm would like agency of firm of standing. Prepared to finance substantial export orders. Write or wire.

RADIO SOUMBASAKOS
26 SKOUFA ATHENS, GREECE

Successful 450-mile transmission of ultra-high frequency television over New York-to-Washington coaxial cable facilities has eliminated the last major obstacle to the practicability of color television, Frank Stanton, president of the Columbia Broadcasting System, declared recently.

COMMUNICATIONS

A CANADIAN COMMENTS

Dear Editor:

I would like to comment on the letter by Mr. E. B. Menzies that was printed in the April issue.

Although I am a Canadian, I feel very keenly his contempt for the American radio serviceman. I have converted quite a few sets and since September 1st, 1943 I have repaired 2000 sets in a small Canadian town. I have had numerous American sets in my place with no available diagrams for them. I thought nothing of repairing and aligning these sets—as aligning receivers is one of the many things that we learn when training. One of the prominent questions on our provincial exam is: "How would you align a receiver if you did not know the intermediate frequency?"

Ohm's Law is only one of the many things to be taken into consideration in tube replacement; interelectrode capacity, cut-off points and proper load matching are also important. In replacing a 12SA7 with a 12A8, the oscillator coil has to be considered. I believe Mr. Queen's articles on this subject were very useful, especially to new servicemen.

Well, enough on the subject. In spite of what others think about RADIO-CRAFT, just keep on making it in the same old way as it's a mighty good mag that way.

E. SCHURMAN,
Vermilion, Alberta

FIVE-CIRCUIT ERROR

Dear Editor:

There is a slight error in one of the schematic drawings in my article, Five New Circuits, which was printed in the April issue. In Fig. 4 on page 495, there are two resistors connected in series between the 12C8 diodes and ground. The drawing shows a .01- μ f condenser by-passing the 250,000-ohm resistor. This condenser should have been .0001 μ f as the one shown will ground the a.f. output of the diodes.

Also, in Fig. 1-b on page 467, there is a drawing of the exterior appearance of the receiver described in Fig. 1-a. The text mentions that an "on-off" switch is shown on the drawing. This switch, has, however, been accidentally omitted in the drawing. It should have been located in the middle of the top of the larger section of the case.

Neither of these errors is of great importance, as any good radioman would soon spot the first one anyhow, but I thought you might like to have them called to your attention in the event that you had not already noticed them. On second thought, I trust that the first error is not a mistake in my drawing, my schematics never were any too clear!

ROY M. CATER,
Washington, D. C.

20 Watt 6V or 110V Hi-Fidelity Amplifier



- Tubes: 2-6SJ7, 1-6SC7, 2-6L6G, 2-6X5
- Two Microphone inputs
- Separate control for tone, Phono, and each Microphone
- No switching necessary for battery or electric operation
- For two speakers

YOUR cost...\$81.00

ACCESSORIES:

- 2—PM12C Jensen 12-in. PM speakers \$12.50 ea.
- 1—33X Turner Crystal Microphones. 14.70
- 1—MS-12C adjustable floor stand... 5.58
- 2—Leatherette 12" wall cases..... 5.10 ea.

West Virginia's
Largest Radio
Supply House

Write for
Latest
Catalog

All Standard
Lines Carried
in Stock

WE SELL: "DEALERS ONLY"

SIGMON'S

CHARLESTON, WEST VIRGINIA

RADOLEK

Radio-Electronic Service Parts



Large stocks assure the finest and most complete selections of all available items at lowest prevailing prices. Thousands of active buyers depend on us for their entire Radio repair and replacement requirements. Because we understand service problems, every order is expedited for delivery in double quick time. Everything we do is planned for convenience and satisfaction to our customers. You will find it profitable to make Radolek your buying headquarters.

FREE BUYING GUIDES

Because of existing conditions we keep our customers right up to the minute on available merchandise by releasing supplements frequently instead of sending our regular Big Profit Guide once a year. Send the coupon now to get these Free Buying Guide Supplements as they are issued.

FREE!



FAST SERVICE!

RADOLEK CO., Dept. C-116
601 W. Randolph St., Chicago 6, Ill.

Please send FREE Buying Guide Supplements

NAME _____
ADDRESS _____

ORDER FROM RADOLEK

THE RACKETEERS WILL GO

Dear Editor:

I have just read the article on Racketeering Repairmen in the April issue. Who is to blame for this racketeering? Manufacturers of adapters and tubes should also share a part of the blame for this situation.

Personally I think the boys did one fine job working all hours of the night and day trying to keep the public supplied with radio service, and to use what parts and tubes the emergency would let us have to work with.

The critics should also take a peek at some of the products of self-styled servicemen who attempt to fix their own radios, finally wind up by taking the radios to a service shop for repairs and then squawk at the price. These men are the biggest grippers about enormous prices charged by the serviceman. They fail to realize that a great part of the labor charge goes toward straightening out the mess they have made.

These radio profiteers and racketeers will cut their own throats in time, because the public will stand for just so much of this sort of thing. They will slowly but surely weed these people out of the ranks of servicemen.

F. S. M. BAILEY,
Carrizo Springs, Texas

SERVICEMEN'S PROBLEMS

Dear Editor:

Although I am not an ex-serviceman, I think it only fair that I should be accorded the right to answer some of the assertions made by Mr. Massey on Ex-Servicemen vs. Manufacturer.

I refer particularly to the time-worn phrase, "Draft Dodger". Mr. Massey seems to apply it to everyone who was not a member of the Armed Forces. I received my entrance exam and was rejected as were many others. If it were possible to "dodge" the draft (of which I have no proof) how is he going to differentiate between those who were rejected and those who "dodged"?

Did Mr. Massey join the Armed Forces through deep-rooted patriotism, or did he find himself there without any voice in the matter? If he studies the problem, he will realize that everyone with whom he talks is a potential customer and that his attitude is incompatible with the principles of sound business. (These customers might not, for many reasons, have been members of the Armed Forces).

EDWIN SLAVIN,
Philadelphia, Pa.

(We regret that the term "draft dodger", which carries an implied insult to everyone who did not find himself in the armed services during the war, was used in this magazine. Mr. Massey, like many radiomen who find themselves in difficulties, due to their absence from their home areas during the war, no doubt felt very strongly about his problems and in his search for vehement speech, used terms which he himself probably would not care to employ after calm deliberation.—Editor)

THE SECRET'S OUT!
The New and Spectacular
ACA-100DC AMPLIFIER
Is Ready For Delivery!

DESIGNED BY A. C. SHANEY



A revolutionary development in amplifiers cleverly designed to defy obsolescence and amazing in its performance. New circuits, new materials and new processes are actually combined in this one amplifier to produce the most satisfying musical amplifier the world has ever known. If you are one of those discriminating persons for whom nothing less than the best is a disappointment, you are one for whom the ACA-100DC was designed. Send for technical literature.

AMPLIFIER CORP. of AMERICA

398 Broadway, New York 13, N. Y.

A. C. Shaney's FM-AM AMPLIFIER MANUAL is still available at 25c

Do you need
BINDING POSTS?



The XL PUSH POST with its Spring Action assures Constant Contact and quick connection.
Manufactured in All Aluminum Type M at 12c each.
Aluminum Body, Bakelite Top Type B1 at 13c each.
Types CP or NP. ALL BRASS—STAIN-LESS STEEL SPRING & PIN. PROVEN BY 240 HR. SALT SPRAY TEST as NON-CORROSIVE at 28c each.

Manufacturers and Dealers Liberal Discounts

X. L. RADIO LABORATORIES
420 West Chicago Ave., Chicago 10, Ill.

INCREASE YOUR INCOME—Doing
ELECTRIC WIRING—APPLIANCE & MOTOR REPAIRING

New, modern theory gives you better knowledge of electricity in fewer hours of study—gives you better chance for success whether doing electric wiring, servicing or repairing electrical apparatus.

APPLIANCE & MOTOR REPAIRING

Start immediately! No burdensome studying necessary. Repair vacuum cleaner by simply following easy step-by-step procedure given on cleaner work sheet. Same method used for washers, irons, toasters, motors, etc.

Complete training only \$2.95. NO EXTRAS!

DON'T WAIT! Order this training today! If not satisfied after ten days, return it and your money will be refunded.

Same trial period applies to cash or C.O.D. orders. We pay postage on orders accompanied by cash, check, or M.O.

Sunbury Engineering Works, Box 129, Dept. D, Sunbury, Pa.



PHONO AMPLIFIER
3 TUBE AC-DC
COMPLETE KIT AND \$5.95
5" SPEAKER, ONLY
with 12SQ7, 35Z5, 50L6 Tubes \$7.95
Astatic L70 Crystal Pickup, \$2.50
25% required on C.O.D. orders. Free Catalog.
Wholesale Radio Dist.

IMMEDIATE DELIVERY
RISCO SALES CO.
224 East 65 St., Dept. RC, New York 21, N. Y.

SERVICEMEN—HAMS
TUBES
PARTS—TEST EQUIPMENT

Special—Kit of 100 Resistors—\$1.75
Write For Our Latest Bulletin!

CHIEF ELECTRONICS
Mid-Hudson Valley's Only Distributor
104A MAIN ST. POUGHKEEPSIE, N. Y.

KWIKHEAT
is best
12 ways

From Tip-to-Plug
in a Class by Itself



FAST! Hot in Only 90 Seconds
COOL New Protecting Handle
SAFE! Will Not Overheat
POWERFUL (Full 225 Watts)
SAVES TIME—Less Retinuing
BALANCED! Easily Handled
DEPENDABLE—Longer Lasting
LIGHT WEIGHT (Only 13 1/2 oz.)
THREADED TIPS For Best Contact
ECONOMICAL in Operation
THERMOSTAT is Built In
SIX TIP STYLES Interchangeable

A KWIKHEAT USER WRITES—
"I am certainly convinced that Kwikheats are the best irons that can be obtained. They are really a pleasure to work with."
H. P. K. Long Branch, N. J.

225-Watt Iron with #1 Tip \$11
Extra Tips—Six Styles, each 1.25

VANATA
KWIKHEAT
THERMOSTATIC SOLDERING IRON
A Division of
Sound Equipment Corporation of California
3903 San Fernando Rd., Glendale 4, California

DUAL-SPEED PHONO MOTORS
Heavy Duty
Limited Quantity
While They Last \$15.00

MORRISON'S RADIO SUPPLY
331 Center Street Ashtabula, Ohio

RADIO-CRAFT wants articles or notes on reducing fluorescent lighting interference.

FOR ALL Electricians

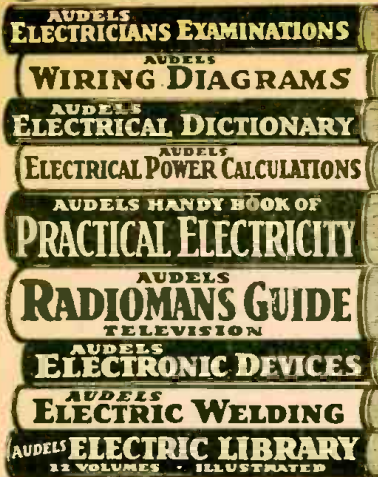

PRACTICAL ELECTRICITY at your finger ends. Answering your Questions and giving the facts and figures of your trade. Audels Electrical Guides contain Practical Inside Trade Information in a handy form. Fully illustrated and Easy to Understand. Highly Endorsed. Check the books you want for 7 days' Free Examination. Send No Money. Nothing to pay postman. If satisfied pay only \$1 a month until purchase price is paid.



ASK TO SEE THEM.

Get This Information for Yourself. Mail coupon today. No obligation unless O.K.

---CUT HERE---

MAIL ORDER

AUDEL, Publishers, 49 W. 23 St., NEW YORK 10, N. Y.
Please send me postpaid for FREE EXAMINATION books marked (X) below. If I decide to keep them I agree to mail \$1 in 7 Days on each book ordered and further mail \$1 monthly on each book until I have paid Price.

- ELECTRICIANS EXAMINATIONS, 250 Pages . . . \$1.
- WIRING DIAGRAMS, 210 Pages . . . 1.
- ELECTRICAL DICTIONARY, 9000 Terms . . . 2.
- ELECTRICAL POWER CALCULATIONS, 425 Pages. . . 2.
- HANDY BOOK OF ELECTRICITY, 1340 Pages. . . 4.
- RADIOMANS GUIDE, 914 Pages. . . 4.
- ELECTRONIC DEVICES, 216 Pages . . . 2.
- ELECTRIC WELDING, 400 Pages . . . 1.
- ELECTRIC LIBRARY, 12 vol., 7000 Pgs., \$1.50 Each

Name _____
Address _____
Occupation _____
Employed by _____ RCP

Attention!

Introducing
Our First
Post-War
Radio Kit



Ideal for Use By

**STUDENTS • SCHOOLS • HOSPITALS
SERVICEMEN • AMATEURS**

It uses the universally accepted superheterodyne circuit containing the following tubes: 12S A7, 12SK7, 12SQ7, 50L6, 35Z5 and tunes from 550 Kc. to 1600 Kc.
Model S-5 (Illustrated)—Complete Kit, including tubes, Bakelite Cabinet and four pages of diagrams and instructions . . . @ \$19.95
In addition, our previous models of meters and radio kits are still available.
Ohm-Volt Milliammeter Kit M-2 . . . @ \$14.95
Radio Kit model TRF-4-A, less cabinet . . . @ \$10.95
Radio Kit model S-6, less cabinet . . . @ \$17.95
25% Deposit on C.O.D. Orders

We carry a complete stock of parts.
Export Inquiries Invited.

Write for FREE Catalog

RADIO KITS COMPANY

Dept. M 120 Cedar St. New York 6, N. Y.

INDEX TO ADVERTISERS

Adson Radio Co.	721	Oelrich Publications	731
Mitchell Advertising Agency		Sander Rodkin Advertising Agency	
Aerovox Corporation	710	Ohmrite Manufacturing Co.	708
Austin C. Lescarboura & Staff		H. H. Teplitz	
Allied Radio Corp	705	Onan & Sons, D. W.	721
Henry H. Teplitz		Graves & Associates	
Almo Radio Co.	726	Opportunity Adlets	731
E. L. Brown Co.		Pa-Kette Radio Company	728
Amplifier Co. of America	729	Arrow Advertising Agency	
Sternfield-Godley, Inc.		Panoramic Radio Corp.	Inside Front Cover
Atomic Heater & Radio Corp.	719	Shappe-Wilkes, Inc.	
W. Montague Pearsall		Pioneer Electric Co.	703
Audel Publishers	730	Richard B. Atchison Adv.	
Grant & Wadsworth, Inc.			
Bell Telephone Labs	Inside Back Cover		
N. W. Ayer & Son			
Bruno Tools	727		
West-Marquis, Inc.			
Buffalo Radio Supply	722		
International Advertising Agency			
Burstein-Applebee Co.	725		
Frank E. Whalen Advertising			
California Radio & Electronics Co.	697		
Mitchell Advertising Agency			
Cannon Co., C. F.	728		
M. J. Werner Adv.			
Capitol Radio Engineering Institute	670		
Henry J. Kaufman & Associates			
Chief Electronics	729		
Cleveland Institute of Radio Electronics	709, 715		
Kenneth H. Kolpein			
Communications Equipment Co.	711		
Borough Advertising Agency			
Concord Radio Corporation	707		
E. H. Brown Advertising Agency			
Crabtree's Wholesale Radio	723		
DeForest's Training, Inc.	667		
McDonald-Cook Co.			
Eagle Radio	696		
Mitchell Advertising Agency			
Erwood Company, The	717		
Electronic Supply Corp.	723		
Free Want Ad Service	726		
General Cement Mfg. Co.	721		
Turner Advertising Agency			
General Electric Co.	723		
Maxon, Inc.			
Harrison Radio Co.	713		
Altomari Advertising Agency			
Hudson Specialties Co.	722		
International Resistance Co.	672		
John Falkner Arndt & Co., Inc.			
Kwikheat Div. Sound Equip. Corp.	729		
Beaumont & Hohman, Inc.			
Laco Products, Inc.	714		
West-Marquis, Inc.			
Lake Radio Sales Co.	724		
Sander Rodkin Advertising Agency			
Liberty Sales Co.	725		
Sternfield-Godley, Inc.			
McElroy, T. R.	722		
Shappe-Wilkes, Inc.			
McGee Radio Co.	714, 728		
McGraw-Hill Book Co., Inc.	731		
McMurdo Silver Co.	668		
Edward Owen & Co.			
Maedel Publishing House	731		
Magna-Metal Products Co.	722		
Equity Advertising Agency			
Maritime Switchboard	720		
Meck Industries, John	Back Cover		
Fensholt Company			
Metropolitan Elec. & Instr. Co.	695		
Mitchell Adv. Agency			
Morrison's Radio Supply	729		
Murray Hill Books, Inc.	693		
Harry P. Bridge Co.			
National Radio Distributors	703		
Burke-Wayburne			
National Radio Institute	661		
VanSant, Dugdale & Co., Inc.			
National Schools	669		
The Mayers Co.			
National Union Radio Corp.	662		
Hutchins Advertising Co., Inc.			
Niagara Radio Supply	723		
Sternfield-Godley, Inc.			
		RADIO SCHOOL DIRECTORY	
		Page 732	
		American Radio Institute	
		Sternfield-Godley, Inc.	
		Appliance Training School	
		A. L. Addison Adv.	
		Candler System Co.	
		Van de Mark Adv. Inc.	
		Commercial Radio Institute	
		Lincoln Engineering School	
		Buchanan-Thomas Adv.	
		Melville Radio Institute	
		Seidell Adv.	
		RCA Institutes, Inc.	
		Tri-State College	
		Clem J. Steigmeyer, Advertising	
		Western Radio Institute	
		Radio Corporation of America	698
		J. Walter Thompson Company	
		Radio Dealers Supply Company	719
		H. J. Gold Company	
		Radio Distributing Co.	724
		Radio Electric Service Co.	718
		E. L. Brown, Advertising	
		Radio Equipment Co.	709
		Radio Kits Co.	730
		Edward Hamburger Adv.	
		Radio Maintenance	671
		Shappe-Wilkes, Inc.	
		Radionic Equipment Co.	714
		Hirshon-Garfield, Inc.	
		Radio Product Sales Co.	717
		Barton A. Stebbins Advertising Agency	
		Radio Soubasakos	728
		Radio & Television Supply Co.	725
		Radio Wire Television, Inc.	714
		Reiss Advertising Agency	
		Radolek Company	728
		Turner Co.	
		Risco Sales Co.	729
		Diener & Dorskind, Inc.	
		Sams & Co., Inc., Howard	664
		Aitken-Kynett Co., Adv.	
		Sigmon Radio Co.	728
		Advertising, Inc.	
		Sprague Products Co.	699
		Harry P. Bridge Co.	
		Sprayberry Academy of Radio	665
		Harry P. Bridge Co.	
		Sunbury Engineering Works	729
		Superior Instruments Co.	663
		Mitchell Advertising Agency	
		Supreme Instruments Co.	716
		O'Callaghan Adv. Agency	
		"Tab" Technical Apparatus Bldrs.	724
		Mitchell Advertising Agency	
		Technical Radio Lab	724
		Teletronics	724
		Burke-Wayburne	
		Terminal Radio Co.	727
		Regent Advertising Agency	
		Triplett Electrical Instrument Co.	719
		Western Advertising Agency	
		Trutone Products Co.	725
		Terrill Belknap Marsh Associates	
		Turner Company, The	701
		W. D. Lyon Co.	
		Victoria Electric & Supply Co.	728
		Wells Sales, Inc.	712
		Turner Adv. Agency	
		Williams Co., H. A.	725
		World Radio Laboratories, Inc.	718
		Pfeiffer Advertising Agency	
		X. L. Radio Laboratories	729

RADIO-ELECTRONIC QUIZ

How thoroughly have you mastered the contents of this magazine?
Try the following quiz as a test:

1. Is radio receiver production increasing steadily? See page 674.
2. What bands are now open to amateur operation? See page 675.
3. On what principle do mine detectors work? See page 676.
4. How may an antenna's frequency response be broadened? See page 681.
5. What is an Image Dissector? See page 683.
6. How do you tune a Handie-Talkie? See page 684.
7. What is the Transitron circuit? See page 686.
8. Can you name a type of tuned circuit adaptable to 400 mc and higher? See page 688.
9. What is the resistance of constantin? See page 700.
10. How many types of waves may be used to transmit intelligence? See page 718.

Simplify Your System

with the

"RADIO SERVICE STANDARD RATE BOOK"

A manual designed

for the

Radio Service Dealer

- to assist him in determining charges for service work
- as a convenient guide for ordering replacement parts
- outlining step-by-step general servicing procedures

INCLUDES:

- Radio Tube Prices
- Radio Parts Prices
- Crystal Cartridge Digest
- Registry of Electronic Manufacturers
- Auto Radio Installation and Service
- Price Formula for Repairs of Radio Equipment
- General Servicing Procedures for Radio and Record Changers

Price: \$1.00 per copy

AVAILABLE AT YOUR RADIO PARTS JOBBER

Oelrich Publications

1627 South Keeler Avenue, Chicago 23, Illinois

OPPORTUNITY AD-LETS

Advertisements in this section cost 20 cents a word for each insertion. Name, address and initials must be included at the above rate. Cash should accompany all classified advertisements unless placed by an accredited advertising agency. No advertisement for less than ten words accepted. Ten Percent discount six issues, twenty percent for twelve issues. Objectionable or misleading advertisements not accepted. Advertisements for August, 1946, issue must reach us not later than June 23, 1946.
Radio-Craft • 25 W. B'way • New York 7, N. Y.

AMATEUR RADIO LICENSES, COMPLETE CODE and theory preparation for passing amateur radio examinations. Home study and resident courses. American Radio Institute, 101 West 63rd Street, New York City. See our ad on page 732.

FOR SALE: MEISSNER ANALYST, GOOD CONDITION. John Blackwood, Tonkawa, Oklahoma.

MAGAZINES (BACK DATED)—FOREIGN, DOMESTIC, arts, books, booklets, subscriptions, pin-ups, etc. Catalog 10c (refunded). Clicerone's, 863 First Ave., New York 17, N. Y.

FOR SALE: RIDER'S CHANALYST, HICKOK SIGNAL Generator, Tube Tester, Junior Voltmyst, Tube Condenser Analyzer, 500 Tubes, condensers and parts. E. H. DuFour, 13 Jewett Avenue, Poughkeepsie, N. Y.

USED TUBES, PARTS, MAGAZINES AND NEW Rider's Manual, Vol. 12 for sale. Send for list. W. M. Finley, Jr., Norfolk, Arkansas.

RADIO TUBES, PARTS WHOLESALER BULLETIN 3c. Penshaw Radio Co., 3313 Delavan, Kansas City, Kansas.

SURPLUS RADIO AND ELECTRONIC PARTS AND equipment, New and used. Write for free list. Highbridge, 312 Canal St., New York City 13.

CORRESPONDENCE COURSES AND SELF-INSTRUCTION books, slightly used. Sold, Rented, Exchanged. All subjects. Satisfaction guaranteed. Cash paid for used courses. Complete information and 82-page illustrated bargain catalog free. Write—NELSON COMPANY, Dept. 2-39, Chicago 4.

ELECTRONIC CONTINUITY TESTER AND OHM- meter. Newly developed circuit has a range 0-ohms to 50 megohms. Will test condensers. Building cost \$7.00. Circuit diagram 50c. Paul Anthony Labs., Manchester, N. H.

QUICKLY PREPARE FOR ELECTRICAL EXAMINATION with the Electrical Quiz Book. An Easy way to rush up on electrical knowledge. Price \$1.00. QUIZBOOK COMPANY, Dept. B, 603 Brighton Beach Avenue, Brooklyn 21, N. Y.

POWER MOWER — SENSATION. CUTS — TRIMS. Agents—Dealers wanted. Prompt shipment. Farm Products, Tr-3040 Excelsior Springs, Mo.

PLANS 1-TUBE D.C. RECEIVER (SW RECORD 7000 miles), including "Radiobuilder"—25c. Laboratories, Box 1-b, San Carlos, Calif.

JOIN NEW TECHNICAL BOOK CLUB—FREE! Members receive current literature, guidance on all book problems, premiums. No obligation. All technical, scientific, radio, television, homecraft, farming, sports, etc. Specify subject for free information. Modern Technical Book Co., Dept. MRC, 55 West 42nd St., New York 18.

RADIO-CRAFT for JULY, 1946

BOOK REVIEW

PULSED LINEAR NETWORKS, by Ernest Frank. Published by McGraw-Hill Book Company. Stiff covers, 5½ x 8½ inches, 267 pages. Price \$3.00.

This book was prepared principally for the power and communication engineer and for the engineering student. A thorough understanding of differential equations is presupposed.

The opening chapter describes the difference between transient and steady-state currents which may exist in an electrical network. This chapter is illustrated with actual and equivalent circuits showing lumped capacitance and inductance or combinations of both.

The remaining eight chapters are devoted to the various possible combinations of R-C-L that may appear in a network. Differential equations, diagrams and curves are used to fully explain the effects of currents in these circuits. A chapter on practical applications shows how measurements may be made on actual amplifiers and shows the relationships existing between each individual component and all others to determine the characteristics of the circuit under actual conditions. A number of problems are included at the end of each chapter to illustrate the fundamentals of such circuits and should be helpful in getting a better understanding of the theories of operation.

PRACTICAL RADIO AND ELECTRONICS COURSE, by M. N. Beitman. Published by Supreme Publications. Hard paper covers, 8½x10½ inches, 332 pages. Price \$3.95.

This book is designed for home-study in the fields of radio and electronics and is surprisingly thorough for a book of this kind. It has 53 easily understood lessons illustrated with 387 drawings, charts and photographs.

In the first fourteen lessons, the reader is acquainted with the various components and circuits that go into the making of the average home receiver. Diagrams ranging from a two-tube regenerative receiver to a nationally known communications receiver are used to explain the workings of the various portions of a radio set. FM, television and a.f.c. circuits are explained in separate lessons.

Servicing equipment is covered in two lessons which include schematics of the equipment and drawings showing how instruments are used for servicing.

Transmitter theory is covered in one lesson that includes photographs and drawings of low-power phone and c.w. amateur transmitters. This lesson is followed by an interesting lesson on antennas and radiation.

The remaining twenty lessons are devoted to various kinds of electronic instruments and control circuits. They are not as complete as the earlier lessons, including only the barest essentials on the operation and characteristics of the equipment described.—R.F.S.

MATHEMATICS FOR RADIO

Two volumes, prepared for home study. Book I (314 pp.) covers the algebra, arithmetic, and geometry; Book II (329 pp.) covers the advanced algebra, trigonometry, and complex numbers necessary to read technical books and articles on radio.

MAEDEL PUBLISHING HOUSE Room 117
593 East 38 Street, Brooklyn, New York

Send me MATHEMATICS FOR RADIO AND COMMUNICATION as checked below. I enclose payment therefor with the understanding that I may return the book(s) within 5 days in good condition and my money will be refunded.

Name

Address

- Book I at \$3.75 plus 6c postage
- Book II at \$4.00 plus 6c postage
- Books I and II at \$7.75 postage prepaid

Foreign and Canadian prices 25c per volume higher

NOW—A REALLY HIGH-POWERED— Radio Engineering Library

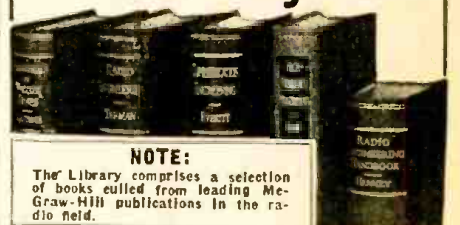

NOTE:

The Library comprises a selection of books culled from leading McGraw-Hill publications in the radio field.

- especially selected by radio specialists of McGraw-Hill publications
- to give most complete, dependable coverage of facts needed by all whose fields are grounded on radio fundamentals
- available at a special price and terms

THESE books cover circuit phenomena, tube theory, networks, measurements, and other subjects—give specialized treatments of all fields of practical design and application. They are books of recognized position in the literature—books you will refer to and be referred to often. If you are a practical designer, researcher or engineer in any field based on radio, you want these books for the help they give in hundreds of problems throughout the whole field of radio engineering.

5 VOLUMES, 3319 PAGES, 2289 ILLUSTRATIONS

1. Eastman's FUNDAMENTALS OF VACUUM TUBES
2. Terman's RADIO ENGINEERING
3. Everitt's COMMUNICATION ENGINEERING
4. Hund's HIGH FREQUENCY MEASUREMENTS
5. Henney's RADIO ENGINEERING HANDBOOK

10 days' examination. Easy terms. Special price under this offer less than books bought separately. Add these standard works to your library now; pay small monthly installments, while you use the books.

10 DAYS' FREE EXAMINATION—SEND COUPON

McGraw-Hill Book Co., 330 W. 42nd St., New York 18

Send me Radio Engineering Library, 5 vols., for 10 days' examination on approval. In 10 days I will send \$2.50, plus few cents postage, and \$4.00 monthly till \$28.50 is paid, or return books postpaid. (We pay postage on orders accompanied by remittance of first installment.)

Name

Address

City and State

Company

Position RC-7-46

RADIO SCHOOL DIRECTORY

PREPARE NOW FOR SKILLED JOBS IN RADIO AND ELECTRONICS

MAKE a place for yourself in a new world of radio and electronics—a world in which revolutionary electronic developments will require highly specialized technical knowledge. Take a good course now to fit yourself for a good paying job. The training you need can be supplied by one of the schools advertised in this publication.

BE YOUR OWN BOSS — OPERATE YOUR OWN PROFITABLE BUSINESS

HOME and INDUSTRIAL APPLIANCES

SERVICE—REPAIR—INSTALLATION

ONLY shop training course of its kind. Gives you actual shop training on washing machines, heat control systems, water heaters, toasters, vacuum sweepers, etc., etc. Learn motor rewinding, welding, plating, etc. Work on actual machines under trained instructors. Low tuition. Old established school. Most complete training course of its kind. Investigate this opportunity—its money-making possibilities and the need for trained men. Write today for details. No obligation.

Veterans ask for GI plan. Act now!

APPLIANCE TRAINING SCHOOL—Dept. 76
Division of Commercial Trades Institute
6312 N. Broadway, Chicago 40, Ill.

SENDING AND RECEIVING SPEED

Be a "key" man. Learn how to send and receive messages in code by telegraph and radio. Commerce needs thousands of men for jobs. Good pay, adventure, interesting work. Learn at home quickly through famous Candler System. Write for FREE BOOK.

CANDLER SYSTEM CO.
Dept. 3-H, Box 928, Denver 1, Colo., U.S.A.

LEARNING TO SEND AND RECEIVE

Correspondence Courses in **RADIO and ELECTRICAL ENGINEERING**

ELECTRICAL ENGINEERING Get good grasp of wide electrical field. Prepare yourself at Low Cost, for secure future. Modern, simplified, you can understand quickly.

RADIO ENGINEERING Extra fine course in radio, outfitting, etc. address, photo-electric work. Trains you to be super-service man, real vacuum tube technician. Servicemen needed badly. Diploma on completion. Tuition \$25, either course. Deferred payment plan. Get copies of school catalogs, student magazines, complete details. **SEND NOW!**

FREE LINCOLN ENGINEERING SCHOOL Box 931C-89, Lincoln, Nebr.

RADIO

Train with professionals. Complete, intensified courses: Repair & Maintenance, Communications. High-speed telegraphy. Slip transcription, FCC exams, etc.

High School Students accepted for training as Merchant Marine Radio Officers. Gov't sponsorship available to veterans.

"A Radio School managed by radio men."
45 W. 45th St., Dept. RC, New York 19, N.Y.

MELVILLE RADIO INSTITUTE

RADIO

RADIO Technician and Radio Communications courses. Register now for new classes starting first MONDAY of each month. Day and Evening Classes.

AMERICAN RADIO INSTITUTE
401 West 63rd St., New York 23, N. Y.
APPROVED UNDER GI BILL OF RIGHTS.

LEARN RAPID RADIO SERVICING

Send for Free Information: "3 Ways to Learn Radio." Approved for Training Veterans.

WESTERN RADIO INSTITUTE
1457 Glenarm, Denver 2, Colo.

RCA INSTITUTES, Inc.

Offer thorough training courses in all technical phases of **Radio and Television**

DAYS—EVENINGS WEEKLY RATES

VETERANS: RCA Institutes is approved under G. I. Bill of Rights

For Free Catalog Write Dept. RC-46

RCA INSTITUTES, Inc.
A Radio Corporation of America Service
75 VARICK STREET NEW YORK 13, N. Y.

COMMERCIAL RADIO INSTITUTE

A radio training center for twenty-five years.

RESIDENT COURSES ONLY

Broadcast, Service, Aeronautical, Television and Marine telegraphy classes now forming. Literature upon request. Veteran training. Classes now forming for July 1st.

Dept. C, 38 West Biddle St., Baltimore 1, Md.

RADIO ENGINEERING!

VETERANS can complete work here in shortest possible time. Courses also in Civil, Electrical, Mechanical, Chemical, Aeronautical Engineering; Business Administration, Accounting, Secretarial Science. 63rd year. Enter June, Sept., Jan., Mar. School now filled to capacity. No applications can be accepted until further notice.

TRI-STATE COLLEGE 2456 College Ave. ANGOLA INDIANA

these broad band close-spaced arrays stacked one over the other and spaced an electrical half-wavelength. This is shown in Fig. 2-a, while Fig. 2-b details transmission line connections.

The upper set of elements is connected

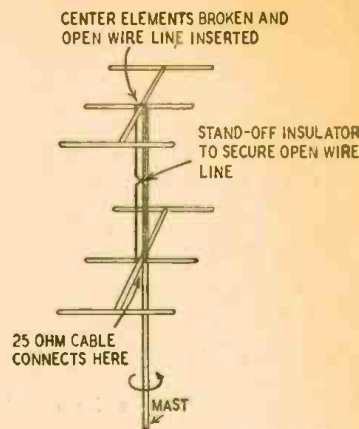

Fig. 2-a—Two 3-element arrays stacked. The 25-ohm line may be paralleled RG-8 coaxial.

to the lower set by an open wire transmission line, transposed once. Two- to six-inch spacing of the line is satisfactory, the two-inch figure for higher frequencies. The length of this connecting line should be exactly an electrical half-wavelength at the mean operating frequency. The twin antenna, now a six-element array, is simply fed by paralleling two lengths of 50-ohm RG-8 cable together to offer a 25-ohm line, or the surge impedance presented at the lower junction of the upper and lower tiers.

If the upper and lower tiers are permanently secured to the mast, six-

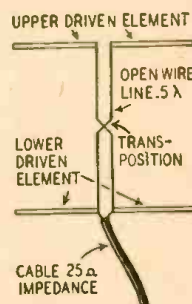

Fig. 2-b—How excited elements are connected.

multaneous rotation is possible simply by rotating the entire mast on a pivot, using circular rings attached to guy ropes to maintain the mast vertically.

In operation, this six-element twin antenna will have essentially the same broad-band characteristics of a single tier, while stacking will not alter dimensions of each section materially. The vertical angle of delivered and received signals will be reduced well into the lower region which produces loud signals at extreme DX.

Tests of this antenna at 10,000 miles show it to completely outclass a single three-element comparison rotary at the same average height and be far and away superior to a conventional four-element, close-spaced array as well as having a new freedom from narrow band operation.

BROAD-BAND ANTENNA

(Continued from page 727)

tion and transmission is concentrated at an angle above the horizon for higher than the angle of incoming signals, or optimum angle for outgoing signals.

For instance, long time surveys of the New York to Europe radio path show that the mean and therefore most effective average vertical angle for transatlantic transmission and reception to be 11 degrees for 14 mcs, 11½ degrees for 15 mcs, 9 degrees for 16 mcs, 8½ degrees for 17 mcs and 7 degrees for 18 megacycles. Average optimum angles for 28 mcs run even lower.

Few amateur antennas, and this goes for a great many amateur rotary beams, put out a major proportion of their power at these angles. Actually some

5 percent of their power accounts for their DX operation. This 5 percent may be three or four times that delivered by a simple dipole at this angle and therefore justify any claim for a 6 db increase over a dipole. But lowering the angle of delivered power to a genuinely useful figure, for instance 11 degrees on 14 mcs, produces truly remarkable results.

This increased power at the vertical angles of 5 degrees and 10 degrees, which account for the major signal power of 90 percent of our international overseas DX, and the same proportion of television and frequency modulation signals, is possible in a highly compact space by using, for example, two of

electrical pipe-line →



Microwaves make their journey from apparatus to antenna not by wire, cable, or coaxial — but by waveguide.

Long before the war, Bell Laboratories by theory and experiment had proved that a metal tube could serve as a pipe-line for the transmission of electric waves, even over great distances.

War came, and with it the sudden need for a conveyor of the powerful microwave pulses of radar. The metal waveguide was the answer. Simple,

rugged, containing no insulation, it would operate unchanged in heat or cold. In the radar shown above, which kept track of enemy and friendly planes, a waveguide conveyed microwave pulses between reflector and the radar apparatus in the pedestal. Bell Laboratories' engineers freely shared their waveguide discoveries with war industry.

Now, by the use of special shapes and strategic angles, by putting rods

across the inside and varying the diameter, waveguides can be made to separate waves of different lengths. They can slow up waves, hurry them along, reflect them, or send them into space and funnel them back. Bell Laboratories are now developing waveguides to conduct microwave energy in new radio relay systems, capable of carrying hundreds of telephone conversations simultaneously with television and music programs.

EXPLORING AND INVENTING, DEVISING AND PERFECTING FOR CONTINUED IMPROVEMENTS AND ECONOMIES IN TELEPHONE SERVICE



BELL TELEPHONE LABORATORIES

Meck Trail Blazers



Model No. 5C5-PB12

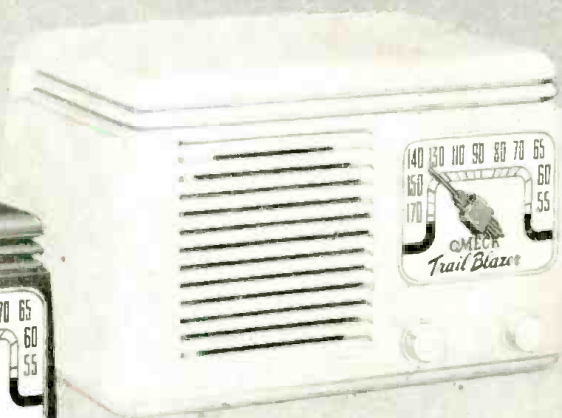

Model No. 5C5-P12

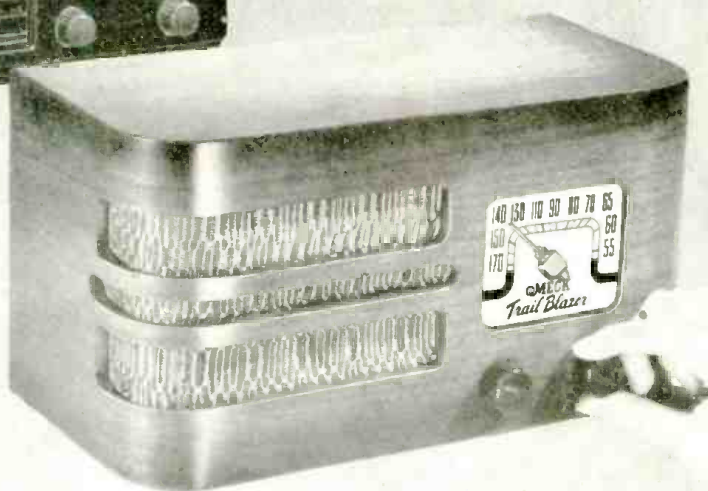

Model No. 5C5-DW9

Forerunners of the Meck complete line, these Trail Blazers are proving the superiority of Meck performance—the popularity of Meck Design. They are the logical choice of the independent dealer because of his appreciation of

the value of sound radio engineering and because of the exclusive Meck Dealer Policy. The dominating theme of Meck national advertising will continue to be "Buy from the man who knows radio best—your radio dealer."

MECK RADIOS

JMI Sales Corporation, 35 E. Wacker Drive • Chicago 1, Ill.