

HUGO GERNSBACK, *Editor*

RADIO CRAFT

▼ AND POPULAR ELECTRONICS ▼

RADIO-DEFENSIVE REFLECTOR
SEE PAGE 530

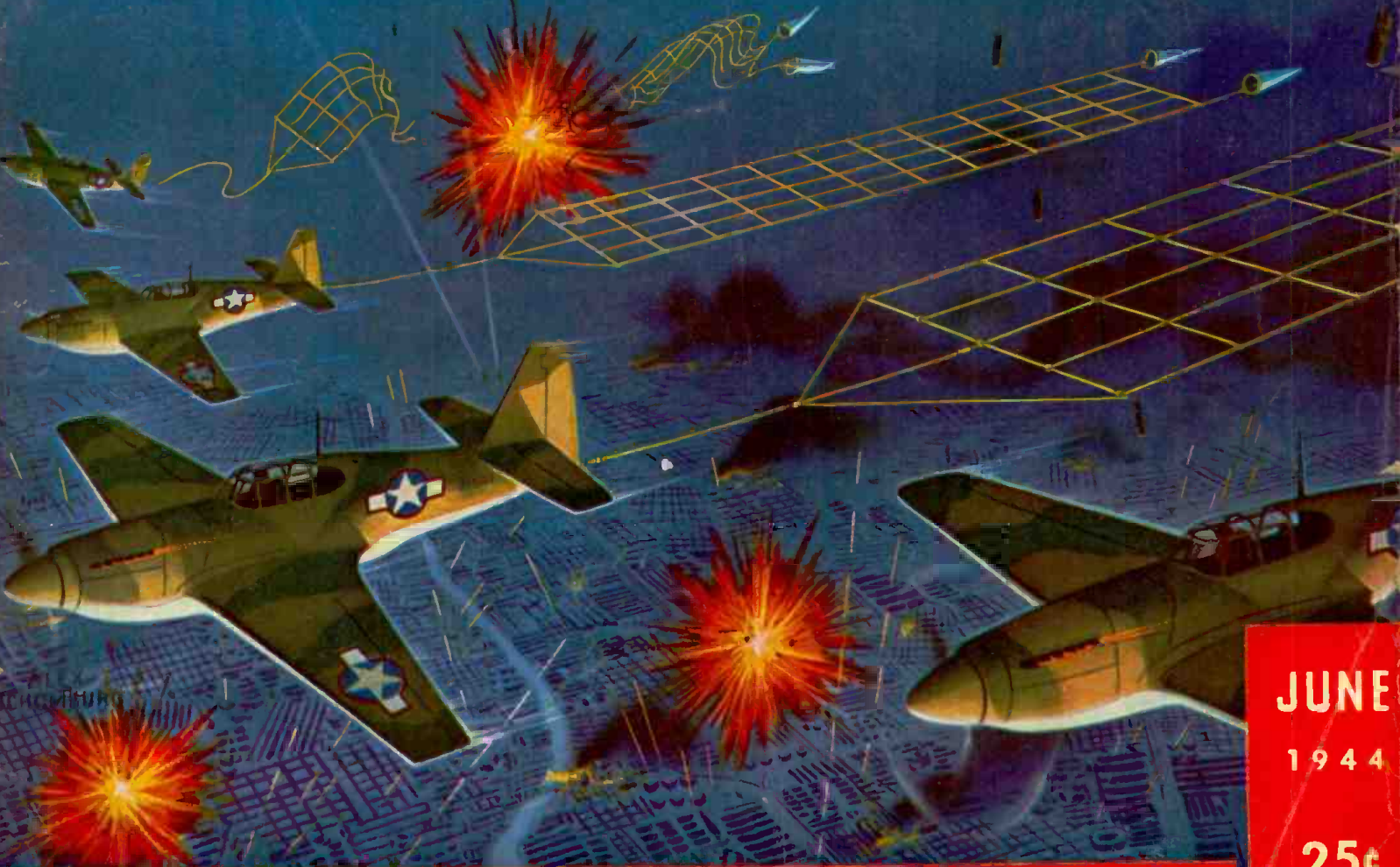

JUNE

1944

25¢

CANADA 30¢

RADIO-ELECTRONICS IN ALL ITS PHASES

HERE ONE MUST HEAR!

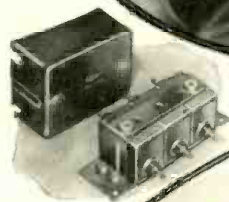

Combined Operations Demand Noise-Free Radio Channels

Upon reception and transmission of radio commands . . . upon freedom from local static's message-mangling crashes . . . may depend the timing which makes combined operations successful.

On every front, Solar Elim-O-Stat Filters are keeping speech channels clear . . . absorbing local interference where it starts . . . at motors, generators, contacts.

Severe seasoning under combat conditions gives Solar engineers war-proved products to study, helps prepare for industry's "combined operations" when world skyways, seaways and railways again are routes of neighbor-to-neighbor trade. Let Solar advise you on radio-noise suppression. Solar Manufacturing Corporation, 285 Madison Ave., New York 17, N. Y.



Solar **SOLAR** ||

**CAPACITORS &
ELIM-O-STATS**



J. E. SMITH, PRESIDENT
National Radio Institute
30th Year of Training Men
for Success in Radio

I will send you a lesson FREE to show how I train you at home in spare time for **GOOD JOBS in RADIO**

I Trained These Men



Chief Operator
Broadcasting System
"Before I completed your lessons, I obtained my Radio Broadcast Operator's license and immediately joined Station WMLC where I am now Chief Operator."—**HOL-**

LIS F. HAYES, 327 Madison St., La-
peer, Michigan.

1st Lt. in Signal Corps

"I cannot divulge any information as to my type of work but I can say that N.R.I. training is coming in mighty handy these days."—**RICHARD W. ANDERSON** (Address omitted for military reasons.)



\$10 a Week in Spare Time
"I repaired some Radio sets when I was on my tenth lesson. I really don't see how you can give so much for such a small amount of money. I made \$600 in a year and a half, and I have made an average of \$10 a week—just spare time."—**JOHN JERRY, 1337 Kalamath St., Denver, Colorado.**

More Radio Technicians and Operators Now Make \$50 a Week than Ever Before

Would you like your own Radio business, or a fascinating job as a Radio Technician or Operator? Then listen to this!

I will send you a **FREE Lesson**, "Getting Acquainted with Receiver Servicing," to prove how practical it is to train at home for Radio. This Lesson is from my regular Course. It's a valuable handbook of "inside tips." Tells how "Superhet" Receivers work—how to fix Electrodynamic Speakers—gives hints on I.F. Transformer Repair—how to locate defective soldered joints—Antenna Oscillator Coil facts—Receiver Servicing Technique, etc. It is yours **FREE** to keep and use! Just mail Coupon.

And with this Sample Lesson I'll send my free, 64-page, illustrated book, "How to Train at Home and Win Rich Rewards in Radio." It describes many fascinating Radio jobs, explains how N.R.I. trains you at home by the unique method that has turned hundreds of beginners, amateurs, and "Radio screw-driver-mechanics" into well-paid Radio Technicians and Operators!

How My "50-50 Method" Paves Way to Good Pay

My "50-50 Method"—half building, testing real Radio Circuits, half learning from easy-to-grasp, illustrated lessons—is a *proven* way to learn Radio

—right in your own home in spare time!
You get a thorough grounding in Radio fundamentals from my lessons—**PRACTICE** what you learn by building a Measuring Instrument, Superheterodyne Circuit, A.M. Signal Generator, other typical Circuits—**PROVE** what you learn by hundreds of fascinating tests!

Many Beginners Make \$5, \$10 a Week EXTRA in Spare Time

As soon as you enroll for my Course I start sending **EXTRA MONEY JOB SHEETS** that show how to make \$5, \$10 a week **EXTRA MONEY** fixing Radios in spare time. Right now, probably in your neighborhood, there's room for more spare and full time Radio Technicians. With no new Radios being made fixing Radios pays better today than ever before. This gives you a real opportunity to get started!

Big Demand for Trained Radio Technicians, Operators

There's a shortage today of trained Radio men. Broadcasting Stations, Police Radio, Aviation Radio, Public Address Systems need Radio Technicians, Operators. Radio equipment manufacturers employ thousands. Then, think of the **NEW** jobs that Television, Electronics and Frequency Modulation will open up after the war. I will train you to be ready to cash in when Victory releases the amazing wartime Radio developments for peacetime uses.

Find Out What N. R. I. Can Do For YOU

MAIL COUPON BELOW for **FREE Lesson** and 64-page book. They're packed with Radiog facts. You'll read a description of my Course—"50-50 Method"—**EXTRA MONEY Job Sheets**—6 Kits of Radio parts. You'll see letters from men I trained, and find out how **YOU** can train at home. And you'll have my free Lesson to **KEEP**. No obligation. Just mail coupon at once in envelope or paste on penny postcard! **J. E. SMITH, President, Dept. 4FX, National Radio Institute, Washington 9, D. C.**

TELEVISION ELECTRONICS FREQUENCY MODULATION

My up-to-date Course includes training in these new developments:



You Build These and Many Other Radio Circuits with Kits I Supply

By the time you've conducted 60 sets of Experiments with Radio Parts I supply—have made hundreds of measurements and adjustments—you'll have had valuable **PRACTICAL** experience.

You build this **SUPERHETERODYNE CIRCUIT** containing a pre-selector, oscillator—mixer—first detector, i.f. stage, diode detector—a.v.c. stage and audio stage. It will bring in local and distant stations. Get the thrill of learning at home evenings in spare time while you put the set through fascinating tests!

Building this **A. M. SIGNAL GENERATOR** will give you valuable experience. Provides amplitude-modulated signals for test and experimental purposes.

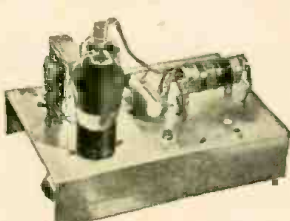
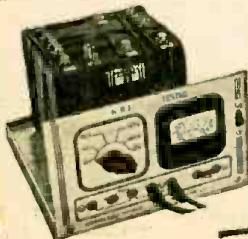

You build this **MEASURING INSTRUMENT** early in Course. Useful for work on Radios to make spare time money. It is a vacuum tube multimeter, measures A.C., D.C., R.F. volts, D.C. currents, resistance, receiver output.

GET BOTH 64 PAGE BOOK **FREE** SAMPLE LESSON

**J. E. SMITH, President, Dept. 4FX
NATIONAL RADIO INSTITUTE, Washington 9, D. C.**

Without obligating me, mail your Sample Lesson and 64-page Book **FREE**. I am particularly interested in the branch of Radio checked below. (No salesman will call. Write plainly.)

- My Own
- Radio Service Business of
- Service Technician for
- Radio Stores
- Spare Time Radio Serv-
- icing
- Gov't. Civilian Radio Job
- Aviation Radio
- Operating Broadcasting Stations
- Army, Navy Radio
- Operating Police Radio Stations
- Operating Ship and Harbor Radio

(If you have not decided which branch you prefer—mail coupon for facts to help you decide.)

Name Age
Address
City State 4FX



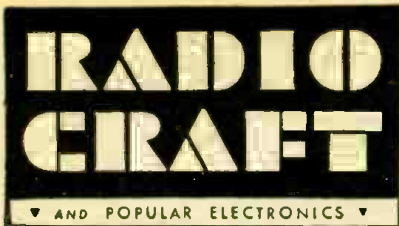

MEMBER
AUDIT BUREAU OF CIRCULATIONS



HUGO GERNSBACK, *Editor-in-Chief*
FRED SHUNAMAN, *Associate Editor*
A. PASCALE, *Production Manager*
G. ALIQUO, *Circulation Manager*
JOHN J. LAMSON, *Advertising Director*
ALFRED STERN, *Promotion Manager*



IN THE NEXT ISSUE

Power Packs Without Iron
Simpler Capacity Meters
Diffraction X-Ray Methods
Powering Small Portables
Stage-by-Stage Testing
Convenient Signal Tracer



Published by Radcraft Publications, Inc.
Publication Office: 29 Worthington
Street, Springfield 3, Mass.

Editorial and Advertising Offices: 25
West Broadway, Tel. RE2-9690, New
York 7, N. Y.

Chicago Advertising Office: Radio-Craft,
520 North Michigan Avenue, Tel. Su-
perior 7306, Chicago 11, Ill.

Cleveland Advertising Office: 405 Eric
Bldg., Cleveland, Ohio. Burdette Phil-
lips, Manager. Tel. Main 9645.

RADIO-CRAFT is published monthly,
on the 25th of the month preceding that
of date; subscription price is \$2.50 per
year in U. S. (In foreign countries, 75c
additional per year to cover postage;
Canada, 50c additional.) Special rates
for members of the Armed forces in
U. S. or those addressed by A.P.O. or
F.P.O. mail, \$2.00. Entered at the post
office at Springfield as second-class mat-
ter under the Act of March 3, 1879. All
communications about subscriptions
should be addressed to: Circulation
Manager, Radio-Craft, 29 Worthington
St., Springfield 3, Mass.



Notice of CHANGE of ADDRESS should
reach us at least one month in advance. When
ordering a change, please furnish an address
stencil impression from a recent wrapper if
you can. Address changes cannot be made
without the old address as well as the new.



Foreign Agents

London—Atlas Publishing and Distributing
Co., Ltd., 18 Bride Lane, Fleet St., London,
E.C. 4.

Melbourne—McGill's Agency, 179 Elizabeth
St., Australia.



Text and illustrations of this magazine are
copyright and must not be reproduced without
permission of the copyright owners.
Copyright, 1944, Radcraft Publications, Inc.

Contents

June, 1944

Volume XV, No. 9

Editorial: Electronics and Labor.....	by Hugo Gernsback	521
Radio-Electronics Monthly Review.....		522
That Radium-Radio!.....		556
RE: Radio Motor-Torpedoes.....		562

ELECTRONICS

X-Ray—First Tube.....		526
20 Years of Electronics.....	by Dewey D. Knowles	528
A Course in Practical Electronics.....	by Fred Shunaman	529
Industrial Electronics, Part IV.....	by Raymond F. Yates	531
FM-Controlled Vibrator.....	by I. Queen	535
Preview of Post-War Television.....		544

WARTIME RADIO

Command Sets in Modern Battle.....		524
Radio-Defensive Reflector (Cover Feature).....	by Hugo Gernsback	530
Robots of World War I.....	by A. E. Sokol	533

SERVICING

Radio Speaker Tests.....	by Jack King	537
Radio Short Cuts.....	by G. P. Rogal	538
Adapters Make Radios Play.....	by W. G. Eslik	539

SOUND

Sound Studio Treatment.....	by Don C. Hoeffler	525
Audio Distortion, Part III.....	by Ted Powell	534

CONSTRUCTION

A 28-Volt Receiver!.....	by David Gnessin	540
Reconditioning the Old Radio.....	by Gerald Chase	541
War-Time Transceiver.....	by Homer L. Davidson	543

DEPARTMENTS

World-Wide Station List.....	Edited by Elmer R. Fuller	542
New Radio-Electronic Devices.....		546
Radio-Electronic Circuits.....		548
Question Box.....		550
Try This One!.....		552
Technotes.....		570
The Mail Bag.....		572
Book Reviews.....		575

ON THE COVER



An idea for defense against electronic radio-lo-
cators is the subject of this month's cover. The
bombers are screened by light defensive wire nets
towed by fighter planes. These screens reflect the
waves sent from ranging instruments and give an in-
correct reading on their ranging devices. The
fighters are more maneuverable than bombers and
have a better chance to get out of the fire zone.
If the net is hit only a small loss is incurred.

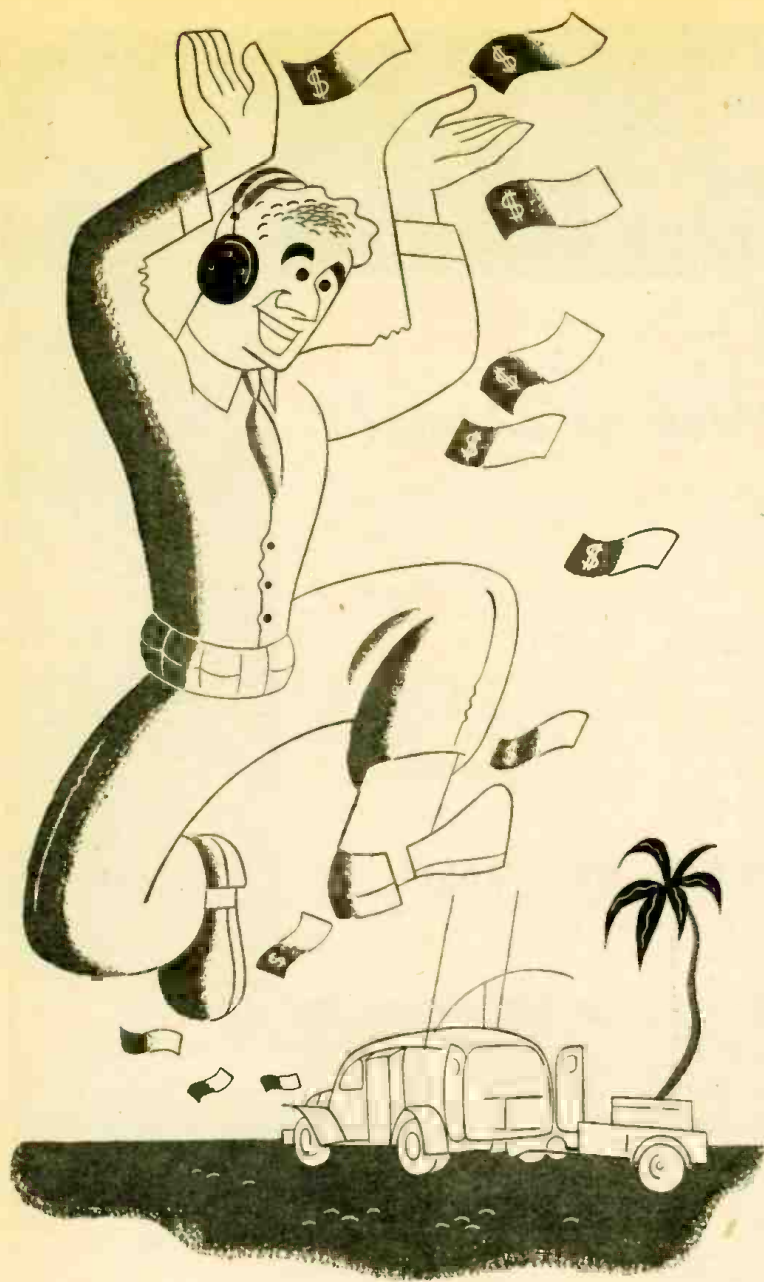

NEW LETTER CONTEST for SERVICEMEN!

**ELEVEN 1st PRIZE WINNERS
IN 5 MONTHS IN CONTEST #1!**

Yes sir, guys, the hundreds of letters received were so swell that *double* first prize winners had to be awarded each of the first four months and there were *triple* first prize winners the fifth and last month . . .

SO—HERE WE GO AGAIN!

Get in on this NEW letter contest—write and tell us your *first hand* experiences with all types of Radio Communications equipment built by Hallicrafters including the famous SCR-299!

RULES FOR THE CONTEST

Hallicrafters will give \$100.00 for the best letter received during each of the five months of April, May, June, July and August. (Deadline: Received by midnight, the last day of each month.) . . . For every serious letter received Hallicrafters will send \$1.00 so even if you do not win a big prize your time will not be in vain. . . . Your letter will become the property of Hallicrafters and they will have the right to reproduce it in a Hallicrafters advertisement. Write as many letters as you wish. V-mail letters will do. . . . Military regulations prohibit the publication of winners' names and photos at present . . . monthly winners will be notified immediately upon judging.



hallicrafters RADIO

THE HALLICRAFTERS CO., MANUFACTURERS OF RADIO AND ELECTRONIC EQUIPMENT, CHICAGO 16. U. S. A.
RADIO-CRAFT for JUNE, 1944

TOP COVER . . . *for Attack at Dawn!*

As dawn comes, lean, snarling pursuit planes roar through a lightening sky to become protective patrol above ground operations. It is "top cover" to shield the men below from air-assault, or to blast in low, screaming dives enemy installations that are blocking the advance.

The ever present, Hallicrafters-built SCR-299 Mobile Radio Communications Trucks are often the means of directing the "top cover." Operating under any conditions, these Giants of Military Radio, whether calling for "top cover" or directing the fire of artillery, "get the message through."

BUY MORE BONDS!



hallicrafters RADIO

THE HALLICRAFTERS COMPANY, MANUFACTURERS OF
RADIO AND ELECTRONIC EQUIPMENT, CHICAGO 16, U.S.A.

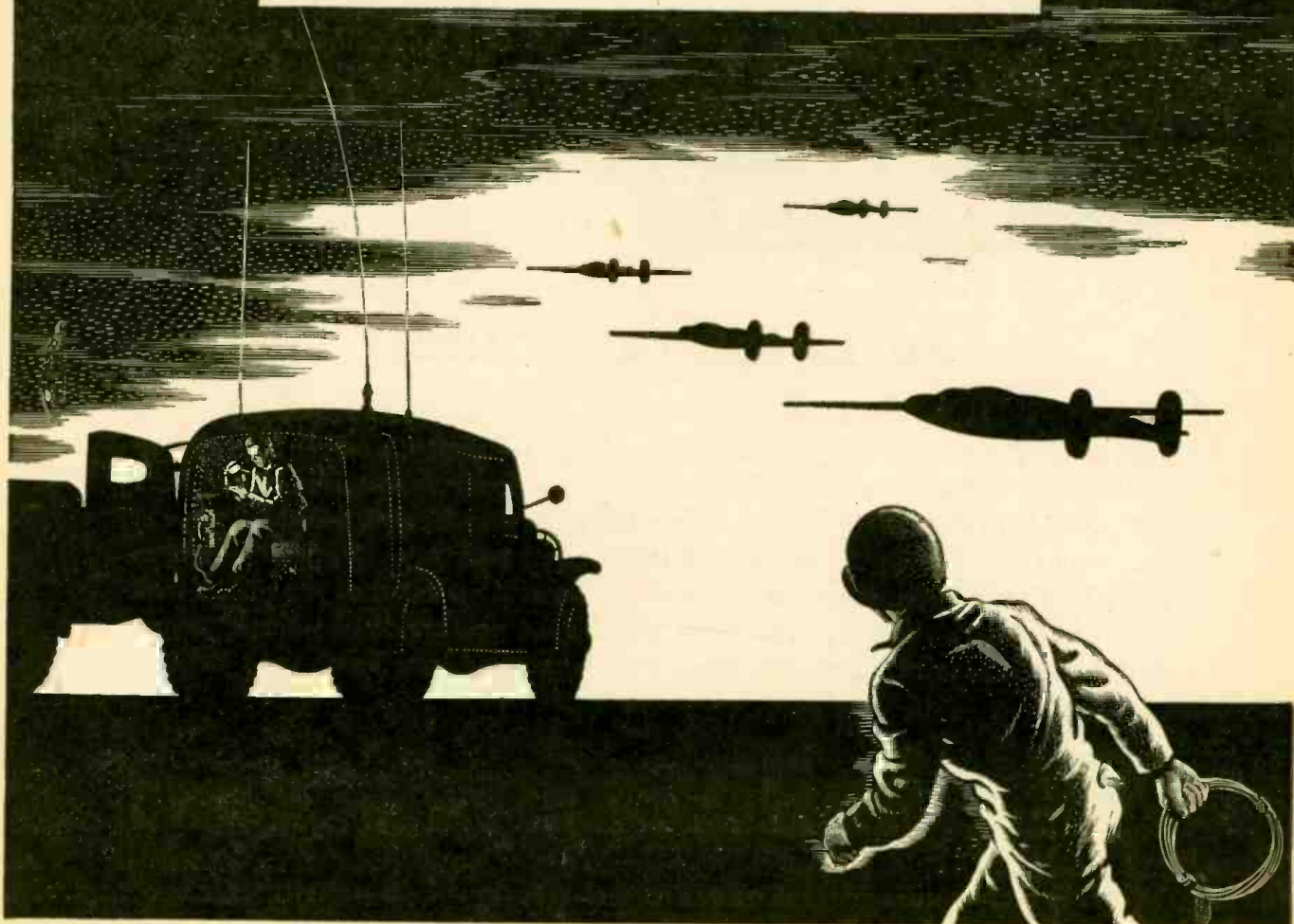

SPRAYBERRY RADIO TRAINING

Gives you Both



FULL RADIO SET SUPPLIED FOR SHOP PRACTICE!

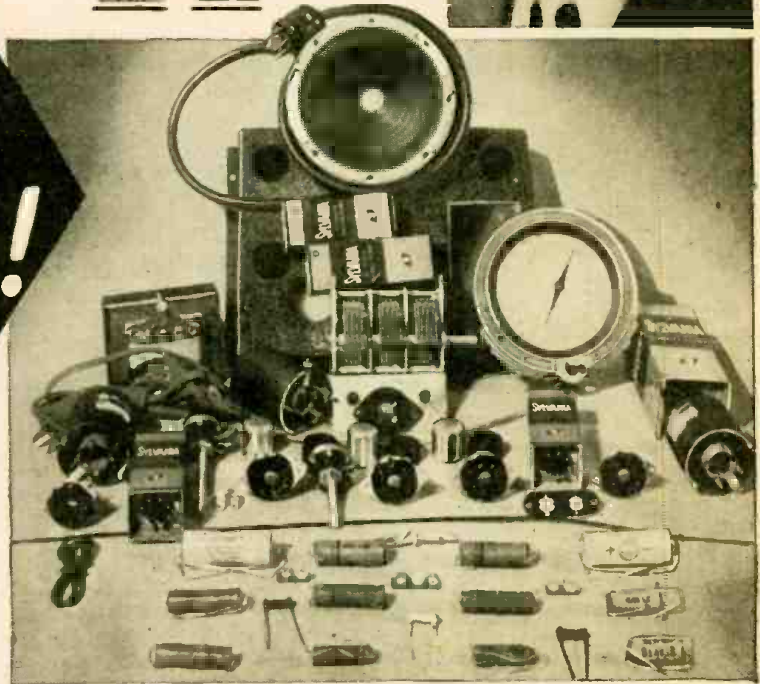

HERE'S THE ONE PRACTICAL WAY TO TRAIN FOR BIG EARNINGS AHEAD IN RADIO-ELECTRONICS & TELEVISION

The offer I make you here is the opportunity of a lifetime. It's your big chance to get ready for a wonderful future in the swiftly expanding field of Radio-Electronics INCLUDING Radio, Television, Frequency Modulation and Industrial Electronics. Be wise! NOW'S the time to start. No previous experience is necessary. The Sprayberry Course starts right at the beginning of Radio. You can't get lost. It gets the various subjects across in such a clear, simple way that you understand and remember.

I'll Show You a New, Fast Way to Test Radio Sets Without Manufactured Equipment

The very same Radio Parts I supply with your course for gaining pre-experience in Radio Repair work may be adapted through an exclusive Sprayberry wiring procedure to serve for complete, fast, accurate Radio Receiver trouble-shooting. Thus under Sprayberry methods you do not have one cent of outlay for manufactured Test Equipment which is not only expensive but scarce.

Prepares You For a Business of Your Own or Good Radio Jobs . . . Civilian or Military

My training will give you the broad, fundamental principles so necessary as a background no matter which branch of Radio you wish to specialize in. I make it easy for you to learn Radio Set Repair and Installation Work. I teach you how to install and repair Electronic Equipment. If you enter the Army, Navy or Marines, my training will help you win higher rating and better pay.

EASY TO START

You can master the Sprayberry course in your spare time. It will not interfere in any way with your present duties. Get the facts about my training now. Take the first important step toward the money-making future of your dreams. All features are fully explained in my big, illustrated Free Book. Write for it at once!

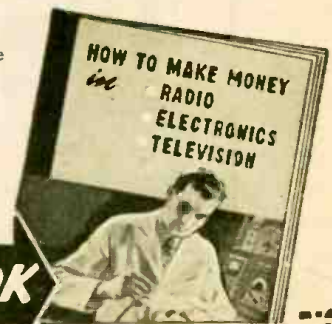

GET FREE BOOK

SPRAYBERRY ACADEMY OF RADIO
F. L. Sprayberry, Pres.
Box 500TF
Pueblo, Colorado

Please rush my FREE copy of "HOW TO MAKE MONEY IN RADIO, ELECTRONICS and TELEVISION."

Name Age

Address

City State

Tear off this coupon, mail in envelope or paste on penny postcard.

We're just little people

We're not brass hats.
We're not big shots.
We're just plain folks . . . but
We're the folks who made this country!
And we're the folks who will save it!

Save it from *two* things it's *got* to be saved from now.
The first thing is the Enemy. The second's
something that doesn't look very dangerous, but is.
It's the danger of Prices Getting Out of Hand.

Here we are this year—after we've paid our taxes—with
131 billion bucks in our pockets.
But only 93 billion dollars' worth of goods to buy.
That leaves 38 *extra* billion dollars.

Sure, the easy thing to do is to take that 38 billion
and start running around buying things we don't need,
bidding against each other . . . forcing prices up and up!

Then people want higher wages. Then prices go up some more
—and again wages go up. So do prices again.

And then where are we!

But us little guys—us workers, us farmers, us businessmen
—are not going to take the easy way out.

We're not going to buy a single, solitary thing that we can
get along without.

We're not going to ask higher wages for our work,
or higher prices for the things we sell.

We'll pay our taxes willingly, without griping . . .
no matter *how much* in taxes our country needs.

We'll pay off all our debts now, and make no new ones.

We'll *never* pay a cent above ceiling prices.
And we'll buy rationed goods only by exchanging stamps.

We'll build up a savings account,
and take out adequate life insurance.

We'll buy War Bonds until it pinches the daylight
out of our pocketbooks.

Heaven knows, these sacrifices are chicken feed,
compared to the ones our sons are making.



Use it up . . . Wear it out.
Make it do . . . Or do without.



MEISSNER OF MT. CARMEL



Beauty — and Accuracy! Top-grade personnel, brought up in a community where electronics skill has become a heritage, give Meissner products their far-famed quality. There are hundreds doing similar work.



Close Co-operation! This is a factory conference at Meissner's Mt. Carmel plant. Here production plans are worked out for maximum harmony, top efficiency.



Trouble for the Axis! Youthful vision here combines with mature judgment to keep Meissner in the forefront of electronics progress. These men are testing.

Why all eyes in the
Electronics Industry
are on
this little city
in Illinois



Precision-el—that's the name earned by Meissner personnel because of their skill at all types of precision work. Here is one of many Meissner veterans.



Just Out!
Special 1944 Bulletin!
—showing radio parts in Meissner's 1944 line. Contains complete descriptive matter, with pictures. Now, more than ever, you need to know what the market offers. Send for your copy today. The supply is limited. It's free. Write to address below.



MEISSNER

MANUFACTURING COMPANY • MT. CARMEL, ILL.

ADVANCED ELECTRONIC RESEARCH AND MANUFACTURE

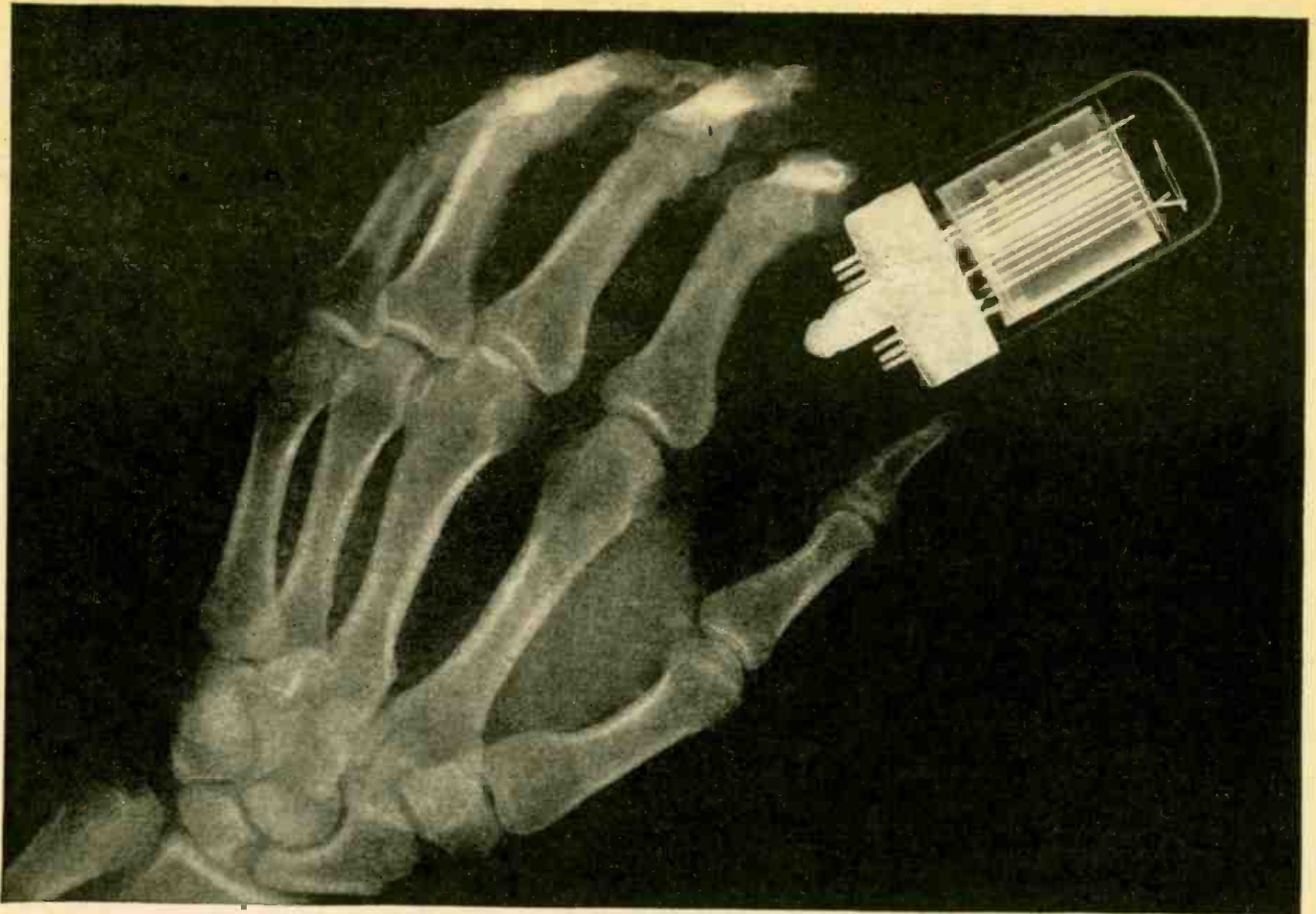

Induction Ceremony

 This is an X-ray photograph of the final step in the stiff pre-induction examination which National Union engineers are giving many of the N. U. Tubes now headed for combat duty.

Why X-ray? Because with great objectives and priceless lives at stake, it is a military necessity to know that critical-type N. U. Tubes are sound through and through—equal in every way to the ordeals they'll face in battle. Even tubes which have passed scores of operational tests with flying colors, are scrutinized by the searching eyes of the X-ray engineer. X-ray examination of the finished tubes—after all

processing has been completed—helps our scientists to know that there is *no* hidden weakness *anywhere*.

This insistence upon leaving nothing to chance typifies the uncompromising scientific standards which prevail at National Union. It is assurance that every tube which carries the N. U. trademark can be counted on to do its duty, always. Can be counted on, too, to reflect credit on the service engineers who sell them. For radio, television and electronic tubes of known dependability . . . count on National Union.

NATIONAL UNION RADIO CORPORATION, NEWARK, N. J.
Factories: Newark and Maplewood, N. J., Lansdale and Robesonia, Pa.



NATIONAL UNION

RADIO AND ELECTRONIC TUBES

Transmitting, Cathode Ray, Receiving, Special Purpose Tubes • Condensers • Volume Controls • Photo Electric Cells • Panel Lamps • Flashlight Bulbs

Electronics and Labor

. . . . *Electronic Robots are on the way . . . soon they will be in nearly every industry . . . will this add to the technological unemployment bugaboo and throw millions of workers out of their jobs?*

HUGO GERNSBACK

WE are accustomed by this time to contemplate in wonder the glory that electronics promises for the post-war period, where almost everything imaginable will be done by electronics. This is no longer news.

The thing we hear little about is what the electronic revolution will do to labor in the post-war period.

To begin with, we are in the midst of a long war and the end is nowhere in sight. Many months ago I mentioned in these pages, that the year 1946—if we are lucky—would bring us to the close of the war. I still hope that this may come true.

By that time we will have been at war over six years—not four—because we actually started to gird ourselves for war in 1940 and have been at it ever since. But six years in wartime must be considered as at least 25 peacetime years in technological progress, and some authorities will go even further than that. All this means that when peace finally does come, a very large percentage of manufacturing methods will have been completely outdated *vis-à-vis* the 1940 methods. New materials, new machinery, new devices, and particularly electronics, have caused a complete technological revolution which has already shaken all industry to the roots. Every month, every year adds to this revolution and the end cannot be foreseen.

Many well-meaning people—capitalists and bankers particularly—are fearful of the post-war period, because they have an idea that this new technological revolution will bring huge unemployment in its wake. They reason that with so many things now being done with such little manpower, when the war is over, millions upon millions of people will be idle again as in the depression of the 1930's.

Recently a well-known economist painted a dreary picture of the post-war future, mainly due to technological unemployment. It seems that there is at present a whispering campaign voicing similar opinions, some

people even going so far as to predict that there will be an actual revolution in the United States because machines will throw out men faster than they can be employed.

These well-meaning but befuddled people of this type—and there are many thousands of them at present—are as nutty as a Christmas fruit cake. They are the people who learn nothing from past lessons and can only see a mechanized country with almost total unemployment. This very unscientific and tiresome group need not be taken seriously. It is, of course, true that the machine often does create temporary unemployment, but the automobile, the airplane and hundreds of other new inventions have shown that such unemployment usually is short-lived, because new machines, new devices, new processes, in the end create more jobs than there ever were before. The automobile industry, for instance, is a good example of this. Through it hundreds of different industries were benefited—such as the steel, glass, plastics, fabrics, rubber, paint and hundreds of others, in a list too long to mention.

When the electronic production methods, which are already in use now, will be further improved and perfected in the post-war period, only a fraction of the men now needed in a great number of industries will be required.

To show what is meant, I refer the reader to the article in the May issue of RADIO-CRAFT entitled *Russia's Electron Robots*, which was a short digest of the book, *Russia's Secret Weapon*, by the Canadian author, Dyson Carter.

It is quite certain that many factories which in 1940 employed large numbers of employees, will only be using dozens, where hundreds were used before. What happens to the others that are "thrown out of work?" The answer is that the machine *always* creates new machines and new industries which in turn must be supplied with new labor, too. So many new materials, so many new processes have been

(Continued on page 571)

Radio Thirty-Five Years Ago

In Gernsback Publications

HUGO GERNSBACK Founder

Modern Electrics	1908
Electrical Experimenter	1913
Radio News	1919
Science & Invention	1920
Radio-Craft	1929
Short-Wave Craft	1930
Wireless Association of America	1908

Marconi, of wireless fame, in an interesting letter to *The London Times*, referring to "certain noxious physical effects alleged to be produced upon wireless telegraphic operators in the course of their employment.")

Wireless Recorder, by *Clarence W. Winchell*.

Wireless "Tele-Mechanics," by Our Paris Correspondent. (Article with photograph showing what was probably first gun fired by remote radio control from a distance of 100 miles.)

"Singing" Wireless. Berlin report regarding the German Telefunken Wireless Telegraph Company of a new system called "Singing sparks."

Amateur Defense of Interference, by *John Crockford*.

FROM the June, 1909, issue of MODERN ELECTRICS:

Antennae, by *Greenleaf W. Pickard* (inventor of the crystal detector).

New Eiffel Tower Plant, by *A. C. Marlowe*, Paris Correspondent.

First Aerophone Automobile. (What is probably the first photograph of an automobile radio is shown in this picture. Incidentally, speech was transmitted both ways up to two miles from this car.)

Looped Aerial, by *E. L. McCaskey*.

A Perikon Detector, by *Lewis W. Klopfer*.

No Wireless Danger (Comment by G.

WAR NEWS is obtained chiefly by means of the radio, according to a survey conducted last month among a representative group of housewives of New York State.

The survey, which was released by WSYR, Syracuse, discovered that 69% obtained their news via the radio, as against 31% who depended on the newspapers. A few used both sources.

Incidentally, it was discovered that housewives are spending more time at home than before the war, a fact which is interesting to radio advertisers. Approximately 41% of the women interviewed spent more time in the house than before, while from 6% to 9% spent less. No statement was available as to whether the smaller figure may not be greatly weighted by the fact that at least some of the women spending less time in the home are war workers who are away the whole day.

ITALIAN aliens in the United States will again receive radios which they deposited with local police authorities shortly after this country's entry into war with that country.

By the terms of the order issued by Attorney-General Biddle last month, they may obtain not only their radios, but other articles deposited by them in compliance with the Presidential proclamation regarding "strategic" possessions of aliens. It will be necessary only for the owner to be properly identified and to present to the United States Marshal for their district the original receipt given for the impounded articles.

MOVIE "chain" television was given its premiere April 10, when James Lawrence Fly introduced a television film that was simultaneously broadcast by WNBT, New York; WRGB, Schenectady; WPTZ, Philadelphia; WTZR, Chicago, and KTSL, Hollywood. The introduction by the chairman of the F.C.C. was broadcast both by sound and voice from the New York, Philadelphia and Schenectady stations.

The play, "Patrolling the Ether," was one of M-G-M's "Crime Does Not Pay" series and will shortly be released through the regular motion picture channels.



FCC chairman James Lawrence Fly as he faces the camera at the movie television premiere.

Radio-Electronics

Items Interesting

BROADCAST receiver production for 1944 will be confined to export, and cannot be expected to furnish any surplus for domestic sales, according to a statement by Bond Geddes, executive vice-president of the RMA, made last month to the annual spring conference of the association.

No slackening will take place in military radio and radar production, which is still climbing in volume, he said. Output of tubes for domestic replacement sales will be severely limited for the next sixty to ninety days, owing to increased pressure from the Army for military tubes of a miniature type. He added, however, that it should be possible to speed civilian tube production considerably at the end of that period.

Among several recent changes in production schedules reflecting the progress of the war has been a reduction in tank radar and a sharp increase in Navy orders, which now bulk up to more than half of the total. Sudden changes in the military situation might cause a change in the trends, introduce new ones, or greatly heighten or lessen demands for radio and electronic equipment.

Man power continues to pose the greatest problem facing the industry, Mr. Geddes reported, noting that the extension of the general draft to men more than twenty-six years old would hit radio manufacturers hard because of the high percentage of young technicians in the field. He added that it is considered essential that irreplaceable workers in radio and ground communications be exempted, as well as such workers in radar who are presently protected, and expressed hope that the War Production Board will be successful in its present efforts to have the exemption so extended.

FREQUENCIES used by the Armed Forces and civil government agencies now total 5,096, according to the chairman of the FCC, J. L. Fly, in a statement before a House Committee last month. These frequencies run all the way from 10 to 162,000 Kc. The frequencies do not include those used by international shortwave stations used by the OWI, as these stations are licensed to commercial broadcasting companies. The Government agency then buys up all their time and supplies the programs.

The Army leads the list of Government agencies using frequencies, with a total of 2,189. Of that total, the Army has 875 exclusive frequencies, shares 271 with other Government agencies; divides 245 with non-Government and 798 with both Government and private industry.

Navy is second with a total of 1,882 frequencies. Of that number 550 are exclusive; 276 are shared with other Government agencies; 274 with non-Government and 782 with both Government and non-Government. Third on the list is the Civil Aeronautics Authority, with 352 frequencies, of which 106 are exclusive. The Coast Guard, with 316, is fourth, sharing all but 82 of its frequencies. The Dept. of Agriculture is fifth, having been assigned 132 frequencies, of which 38 are exclusive. Mr. Fly explained that most of the Agriculture Dept. frequencies are used for fire-prevention work in forests.

The Dept. of Commerce has 30 frequencies, exclusive of the CAA, the figures disclosed. Six of those are exclusive, 18 shared with other Government agencies and six with both Government and private licensees. The FCC has 19 frequencies, 12 of which are exclusive, 3 shared with other Government departments, and 2 each with both Government and non-Government and civilian licensees.

A **MATEURS** are now being featured on the Chicago ether in a half-hour program Saturday mornings over station WWJD. The program, which will run from 7:30 to 7:45 and from 8:00 to 8:15, is sponsored by the Newark Electric Company. It will include music, spot announcements and accounts of the patriotic accomplishments of over 30,000 licensed amateur operators in the Armed Services, war plants, and in WERS, that indispensable adjunct to Civilian Defense which was established directly after Pearl Harbor.

"We feel that the amateurs will come back strong in their hobby after the war," said Samuel Poncher, president of the company, "not only because of the benevolent attitude of our government towards the amateurs, but also because of the greatly increased interest generated in the subject by the war. We will stand ready to serve the amateur and help him continue in his advocacy which has repeatedly rendered this country such service in so many times of emergency."

Monthly Review

to the Technician

LISTENERS to FM scored an interesting variety of reactions in a survey released last month by General Electric. Different geographical locations, with accompanying differences in local circumstances, were apparently responsible for the unexpectedly wide variations in reports.

Asked "What does FM reception mean to you?" 40 percent of the New York listeners stated that higher quality reproduction was its outstanding characteristic and 30 percent considered elimination or near-elimination of static the main feature. "Higher Quality Programs" was the answer given by 1 percent of the listeners. In Philadelphia 28 percent acclaimed in the higher quality of reproduction and only 8.4 the reduction of static. Higher quality programs was noted by 35 percent of the listeners! Milwaukee and Detroit agreed fairly closely on 40 percent for better quality reproduction and 16 percent for static elimination, while splitting (25 percent for Milwaukee and 20 percent for Detroit) 5 percent on the question of higher quality programs.

CHURCH SERVICES by television were started last month by DuMont television station W2XWV with an Easter service, according to a report last month by *Radio Daily*.

The Easter service was rendered especially attractive through illustration of the Scripture readings with a collection of famous paintings covering the dramatic events from Palm Sunday to Easter.

The schedule calls for broadcasting services every Sunday morning at 10 o'clock, Eastern War Time.

TELEVISION as a new and effective aid to industry after the war was predicted at Detroit last month by Ralph R. Beal of the RCA Laboratories in an address to the Engineering Society of that city.

Declaring it "indeed appropriate" to make his revelations in "one of the world's most forward-looking and busiest industrial communities," Mr. Beal envisaged television as the coming "eyes" of factories, the "means of coordinating activities in giant manufacturing plants, such as those in Detroit, and the means also of peering into places and situations that might be inaccessible or extremely hazardous to man."

It can be used to extend the eyesight of the plant manager to critical operations that ordinarily would require much time and effort to reach for personal inspection or which might even be inaccessible—thus television can aid immeasurably in plant control.

"Television cameras at strategic points can be connected by wire to receivers where production experts, foremen and supervisors can follow the flow of fabricated or raw materials and watch the progress of the

work. Such setups will be particularly valuable in mass production assembly lines, and they may be extended to include loading platforms and shipping rooms."

According to Mr. Beal, television cameras may be used in connection with chemical reaction chambers, making visible to the operator without personal risk the chain of events occurring in complicated chemical production units, and thus enable him to control the process with optimum results. Specially-built cameras may be used in furnaces to observe steps in the formation of alloys, and others may solve vital problems of analysis in important industrial processes.

"In addition," Mr. Beal declared, "television equipment may facilitate port movements of ships. The cameras located fore and aft, and on port and starboard sides of vessels, could lessen the hazards of docking and insure safety in crowded shipping lanes.

"We likewise foresee the use of television in metropolitan traffic control and along congested motor routes. Cameras may be installed permanently at busy intersections to flash to traffic headquarters running, up-to-the-minute picture accounts that should greatly aid traffic experts in easing congestion."

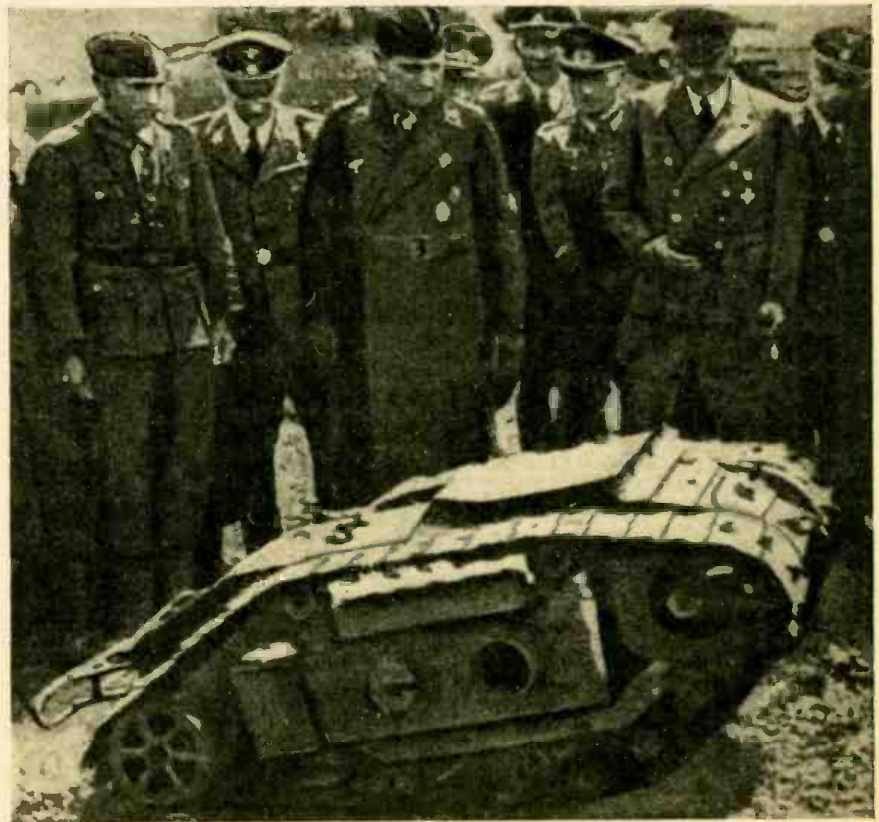

Courtesy Black Star

Latest in radio-controlled devices is the Nazi-constructed "Beetle" robot tank. Strikingly like the proposed radio jeeps illustrated on the cover of the December number of *Radio-Craft*, these tiny land-torpedoes carry from 500 to 1,000 pounds of explosives and travel at a speed of 20 miles per hour. Early "Mark I" beetles used in the Russian campaign were controlled by a cable which carried the electric impulses to the control mechanism. The "Mark II", used later at the Anzio beachhead, is fully radio-controlled.

FM BAND widening was proposed last month by the Radio Technical Planning Board panel investigating the problems of frequency spectra. The resolution recommended an increase of the present number of channels from 40 to 80 or 100, with no narrowing of the present 200-Kc. channel width.

The resolution continues the line of many of the FM broadcasters, who prefer to remain in or as close as possible to their present bands, rather than take a chance on the "wide open spaces" in the higher frequencies, which would result in some dislocation of the present set-up and difficulties for the station owners. Other authorities, also including station owners, look for the future of FM in the much freer areas higher in the frequency spectrum.

RADIO-CONTROLLED torpedo tanks are undergoing rapid improvement, according to British reports last month from the Fifth Army beachhead, south of Rome. Similar in appearance to the Mark II, illustrated below, the new B-4, photographs of which are not yet available, differs from it in one marked manner. Instead of blowing up with its charge, the new tanklet carries 1,000 pounds of explosive to the selected target, drops it and scuttles back to its "base." The charge is then exploded by radio at the desired moment.

The tank which furnished the information was disabled between the lines, and became the scene of a battle between Nazi artillery and British engineers, the Germans trying to destroy it by gunfire before it could be salvaged. The Allied sappers finally succeeded in dragging it under cover of darkness to a rear area, where it was later given a searching examination.



COMMAND SETS IN MODERN BATTLE

THE radio command set is a low-power transmitter and receiver which is used for communication at short range between planes. By means of the command sets, all planes in an entire squadron can carry on two-way conversations with each other, or even with other planes in different squadrons. Usually all landing and take-off instructions between planes and ground are also sent and received over this radio equipment.

The illustration above, is from *Battle Talk*, house organ of Western Electric Co., distributed to its 82,000 employees, and shows a bombing mission against a French channel port. At the moment when the bombardier in the leading plane shouts, "Bombs away," the pilot of the same plane sees three Messerschmitts coming in to attack. Immediately he warns the squadron over the command set "three bandits at nine o'clock coming in on high." Nine o'clock means planes to the left. The other planes personnel glancing at a watch dial before them see by this message exactly in what direction the enemy planes are coming in. If he had said "eleven o'clock,"

that would mean then that the enemy planes were coming in from the left at a sharp angle; twelve o'clock would mean planes dead straight; etc.

The other planes acknowledge the receipt of the message with the word "Roger." This is flight talk and means "message received."

The bombers' fighter protection, a squadron of P47 Thunderbolts, also hears the warning and reports back to the bombers that it is attacking. One bomber (distant center) has been crippled by anti-aircraft gunfire during its bombing run and is returning to an emergency-landing field in England. The English coast is seen at the lower left. The crippled bomber over its radio command set calls the control tower in England with the message "wounded aboard." This message is given so that an ambulance will be standing by when the crippled plane makes its landing. It is apparent that without modern radio communication, this bombing mission might have failed, with American lives and costly equipment wiped out.

The radio command receiver itself is

shown in the insert at the top left hand of the large picture. Built to both transmit and receive under conditions where fair range must be combined with compactness, at the same time being rugged enough to operate with absolute reliability in a vigorously maneuvering plane in an atmosphere of flak, it must be a masterpiece of engineering to accomplish its "ordinary" daily work.

RADIO-DEMOCRACY AWARD

Creation of the Edward L. Bernays Radio Award of \$1000 to be given the person making the greatest contribution during 1944 to democracy through the medium of radio is announced by Ohio State University.

A score of national leaders in education, government, business, and radio have approved the project, made possible through a gift by Mr. Bernays, New York public relations counsel, to Ohio State's Institute for Education by Radio.

Terms of the agreement provide that the award shall go to the individual who makes the outstanding contribution in the year 1944 in the field of radio "which furthers democratic understanding, democratic thinking and democratic action by the people of the United States."

It is specifically stated that this award shall not go to a "corporation, station, or other multiple entity," although it may go to an individual within any of these organizations.

Sound Studio Treatment

By DON C. HOEFFLER

SOUND has three notable characteristics, loudness, pitch, and tone. Loudness depends upon the amplitude of the wave, and is usually measured in terms of the pressure in bars (dynes per square centimeter), although the loudness as noted by the ear is proportional to the logarithm of the actual sound intensity. Pitch is determined by the frequency, expressed in cycles per second. Tone, or "timbre," is determined by the presence and relative amplitudes of harmonics of the fundamental frequency. Timbre is the quality which identifies a sound as speech, music, or noise.

The sounds encountered in speech lie in the frequency range from 100 to 10,000 cycles per second. The normal fundamental frequency of a man's voice is about 128

differences in the waves arriving at the microphone by reflection.

(d) The observed sound persists for a time after the original sound has ceased, due to the greater time it takes the sound traveling along the indirect routes to reach the microphone. This effect is known as "reverberation."

The magnitudes of effects (a), (b), and (c) depend primarily upon how much of the total sound energy reaching the microphone has travelled an indirect path, and this in turn is determined by the relative lengths of the direct and indirect paths, and how much of the sound energy is absorbed.

STUDIO PROPORTIONS

It is reasonable to assume, then, that the difficulties presented by the first three factors can be virtually eliminated by properly proportioning our studio. For the ideal condition.

$$L:W:H = 5:3:2$$

$$H = 5.87\sqrt{N+2.5}$$

wherein L = studio length

W = studio width

H = studio height—should be at least 9 ft.

N = number of persons normally in studio

For example, let us design a typical studio normally used by three persons:

$$H = 5.87\sqrt{3+2.5}$$

$$= 10.36, \text{ or about } 10 \text{ ft., } 4 \text{ in.}$$

$$W = 3/2 \times 10.36$$

$$= 15.54, \text{ or about } 15 \text{ ft., } 6 \text{ in.}$$

$$L = 5/2 \times 10.36$$

$$= 25.9, \text{ or about } 26 \text{ ft.}$$

REVERBERATION TIME

With our studio properly proportioned, the final problem is that of controlling the reverberation time. It may at first appear that the shorter the reverberation time the better, but this is not essentially true, because the ear normally expects a definite amount of reverberation, to improve musical and oratorical effects. Table I shows

the proper reverberation times for theaters and auditoriums of various sizes. The optimum reverberation time for a broadcast or recording studio is always less than for the corresponding theater or auditorium, because the ultimate listener receives reverberation from both the studio and the room in which the sound is reproduced. Experience indicates that the best reverberation time for studios is 7/10 of the values for auditoriums. Reverberation may be controlled by the use of acoustical treatments, some of which are tabulated in Table II.

Knowing the fixed conditions, such as windows, doors, chairs, etc., and by proper use of the following formula, we can calculate and choose the correct type and amount of acoustical treatment for our needs:

$$t = \frac{0.05v}{as + a_s1 + a_s2 + \text{etc.}}$$

wherein t = reverberation time, in seconds

v = volume of studio, in cubic feet

a = area of reflecting surface, in square feet

s = coefficient of absorption at 512 c.p.s.

The quantity "as," with each of its subscripts, takes into account the area and corresponding absorption coefficient of each object in the room which will affect its acoustical properties. This quantity will appear in the denominator as many times as there are objects under consideration. The product of the area times the coefficient is expressed in "sabines," the arbitrary unit of absorption, after W. C. Sabine, the former Harvard professor, who was the first to present acoustical problems as a simple mathematical science.

Now let us continue the design of our studio, assuming the following fixed conditions: the room has one solid varnished wood door, size 3 ft. x 7 ft.; there are two outside windows, size 2 feet, 6 in. x 5 ft.; there is one control-room observation win-

(Continued on page 566)

OPTIMUM REVERBERATION TIME FOR AUDITORIUMS

Average for Speech and Music Volume of Room, in Cubic Feet	Reverberation Time, in Seconds
1,000	0.84
1,700	0.90
2,400	0.95
4,000	1.00
5,500	1.05
8,000	1.10
12,000	1.15
16,000	1.20
22,000	1.25
30,000	1.30
40,000	1.35
70,000	1.45
90,000	1.50
100,000	1.52
120,000	1.55
160,000	1.62
200,000	1.67
300,000	1.76
400,000	1.82
550,000	1.90
800,000	2.00
1,000,000	2.05

TABLE I

c.p.s., while the female voice is about twice as high. The frequency range of musical sounds is much greater than with speech. Thus, the bass and percussion instruments have fundamental frequencies in the order of 60 c.p.s. or less, while many other musical instruments produce tones which have important harmonics extending to 15,000 c.p.s. or more. Noise is classified as those sounds which have no definite pitch, in which the energy is more or less uniformly distributed over a considerable frequency range.

EFFECT OF STUDIO ACOUSTICS

It is a well-known fact that acoustic conditions exert a considerable influence on the reproduction of sound. In an improperly designed studio, the total sound striking the microphone may differ from the sound as generated, because of reflections from nearby objects. The principal effects that these reflections have on the resultant sound are as follows:

(a) The average loudness of the sound striking the microphone is increased, because sound originally directed elsewhere is reflected back to the instrument.

(b) Since no object presents absolutely uniform reflection to all frequencies in the audio spectrum, the relative amplitudes of the various frequency components of the sound may be altered as a result of selective absorption by the reflecting surfaces.

(c) The relative amplitudes of the various frequency components of the sound may also be altered as a result of phase

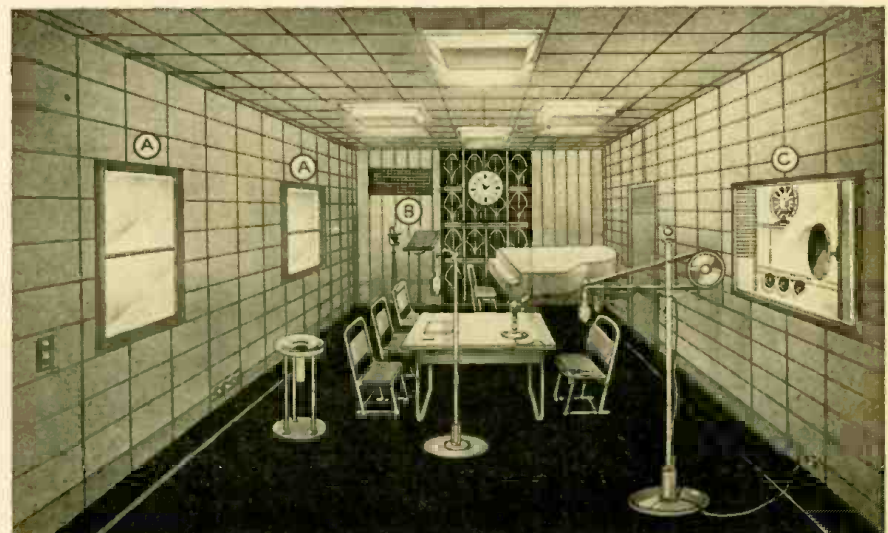

The above is a typical broadcast studio. The outside windows are indicated by the letters AA, the ventilator by B, and the window to the control room by C. The piano was not part of the author's original sketch and is therefore not included in the equation on page 566.

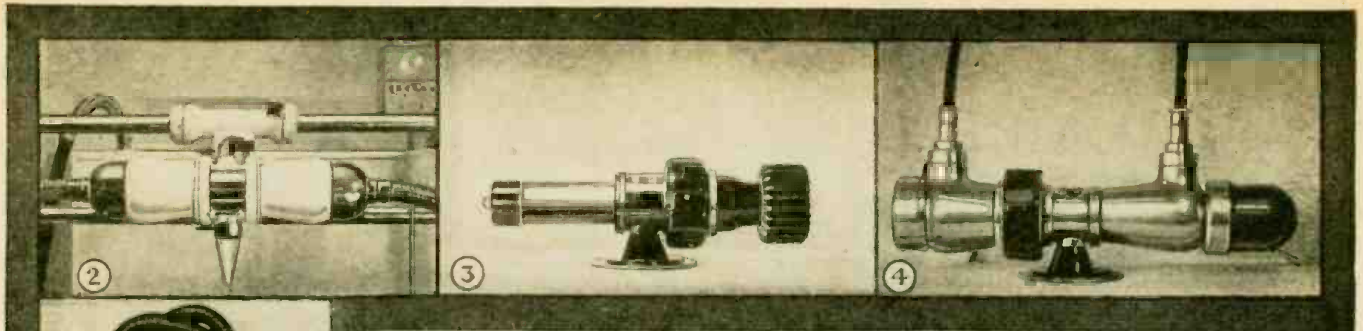

Courtesy North American Philips

1—Therapeutic tube with shockproof shield. 2—Another shockproof tube for superficial therapy. 3—An air-cooled type—note the ventilating vanes. 4—Heavy rotating-anode X-ray tube.

X-RAY—FIRST TUBE

The X-ray is the oldest of all the electron tubes. It was first reported in 1895, and was in practical use soon after its discovery. Not only has it been one of the most important of the electron tubes—it has helped scientists to find important facts about electrons and atoms, thus paving the way for much of our modern progress in the study of the structure of matter, and the world of atoms and electrons.



OLDEST of all electron tubes is the X-ray. Because it was until very recently confined almost entirely to the field of therapeutics, it has been practically ignored by the industrial electronic engineer and radioman. Its development—in spite of this apparent neglect—has been no less rapid than that of other electron tubes. Such stepping stones to progress as the hot cathode, high vacuum technique and methods of sealing glass to metal, which marked advances in other types of tubes, were no less important to the X-ray art.

With the introduction of high-voltage X-ray apparatus for inspecting numerous products, as well as for checking castings and welded joints, and diffraction machines to investigate the structure of industrial materials of many kinds, the electronic engineer finds the X-ray right in his own yard, and is forced to bring himself up to date on the subject.

X-rays were first discovered by Professor Roentgen, of the University of Wuerzburg,

while experimenting with Crookes or cathode-ray tubes, in 1895. His was no accidental discovery—he was trying to find out whether there were any ultra-violet or other invisible light rays in the cathode-ray stream. He covered one of the tubes with heavy black paper to prevent visible light from filtering through, after which he intended to bring a screen of barium platino-cyanide crystals (which fluoresce in the presence of ultra-violet light) close to the tube and observe results. This was not necessary. The screen, lying on a table in readiness for the experiment, fluoresced brightly while still several feet from the tube. The experiment was brilliantly successful before it got well started!

Roentgen made numbers of shadow-pictures with the X-rays, as he called them because of their unknown nature. One of these was of his own hand. The value of these rays for inspecting conditions in the human body was soon made apparent by such photographs, and they were put to use, even though Roentgen himself did not fully understand them.

X-RAYS ARE SIMPLE

Later investigations stripped the unknown rays of their mystery. The X-ray tube is a simple electron tube, with a cathode and anode. The cathode was invariably cold in the older tubes, so that high voltages were necessary to produce a flow of electrons. These electrons strike the anode with tremendous velocity because of the high voltage used, and create considerable disturbance among the atoms they strike. All radiomen are familiar with the phenomenon of "secondary emission" or release of electrons from a plate by electrons which strike it at high speed. This was a limitation on the screen-grid tube, for if the screen voltage approached that of the plate at any instant, it might draw large numbers of electrons from it, and special means, such as suppressor grids and beam-forming electrodes, have been used to prevent such secondary emission. A typical X-ray tube appears in Fig. 1.

Considerable energy is required to tear these electrons loose from their particular atoms. There are cases where an electron,

Fig. 1—Simple types of X-ray tubes. Drawing shows X-rays released from the target as it is bombarded by electrons from the cathode. The photo is of an older type used in therapy. A study of the photo together with the drawing makes the method of operation clear.

Photo Courtesy North American Philips

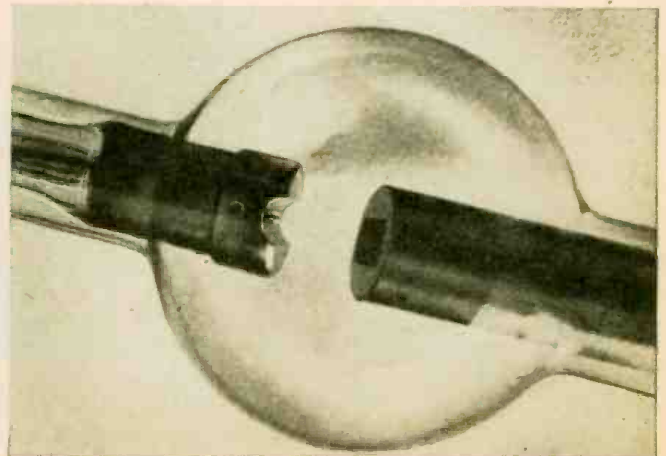
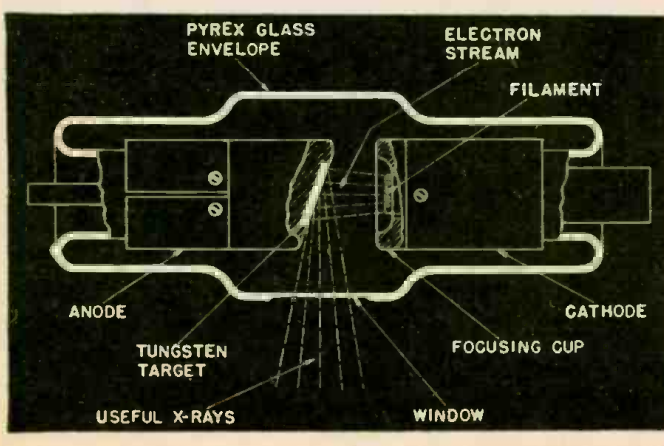

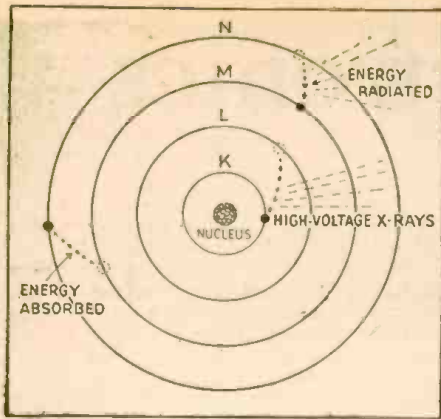
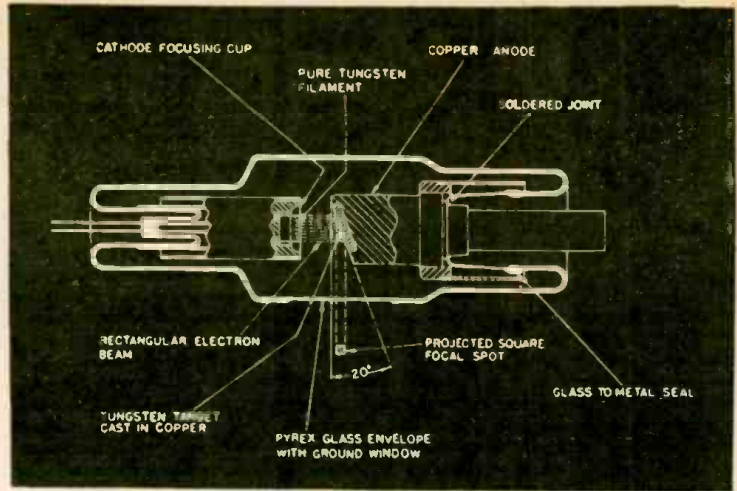

Fig. 2, left—How X-rays are produced. When an electron leaps from an outer orbit to an inner, rays are given off. Fig. 3, right—How "line focussing" is accomplished through selecting the cathode shape, angle of anode and direction of window. Spot appears below.



instead of being released from the atom, is knocked from an outer orbit into an inner one. In such cases, instead of using up energy, a certain amount is given out. This energy is radiated in the form of X-rays. Fig. 2 gives an idea of the action. There are several "shells" of electrons around the central nucleus of the atom. Whenever an electron is driven from an inner shell to one further out, energy is absorbed by the atom. If the electron is moved from an outer shell to one nearer the nucleus, energy is radiated.

"TUNING" THE X-RAY

The radiations are of various wave lengths, those caused by moving electrons from outer orbits being longer than the ones produced when an electron moves into the innermost orbit of all. Since the penetrating power of an X-ray increases with increasing frequency (shorter wave length) apparatus built for industrial use must produce rays of the highest frequency. Longer wave X-rays are used in medical work, where human flesh rather than metal castings is to be penetrated.

To produce these short-wave X-rays requires extremely high voltages. The invading electrons must be driven almost to the heart of the atoms on or near the surface of the anode, if they are to disturb the inner-orbit electrons of these atoms. The development of X-ray devices for industrial use depended therefore on progress in high-voltage technique. Before it was possible to produce and control voltages in the order of hundreds of thousands, the penetrating power of the rays was not great enough to be of much value in searching metal castings for flaws, checking welds, and doing other work which requires penetrating several inches of iron or steel. Today, apparatus in common use works at voltages from 100,000 to 400,000 volts, and million-volt X-ray apparatus is employed in a few installations.

"NOT LIKE OTHER LIGHT"

Since the X-rays are of such extreme fineness they cannot be focussed through any lens known at the present time, people believed for a long time that they were a different type of ray than ordinary light. It was held that if they were light they should be refracted when passing through a lens, or reflected from a mirror. It was not until it was proved that they could actually be reflected—from the smooth faces of crystals—that it was understood that the ordinary mirror was a rough and uneven surface to waves of such short

length, no more suitable for reflecting the rays than a piece of sandpaper would be for reflecting ordinary light.

Neither can the rays be focussed by electric lenses such as are used in the electron microscope. The result is that photographs taken by X-ray are shadow-pictures. The object to be photographed is placed

between the source of rays and the photographic plate. If a visible picture is desired, a fluorescent screen is used. It glows more or less brightly, as parts of the object being viewed stop more or fewer of the rays, and thus paints a visible shadow-picture on the screen.

(Continued on page 561)

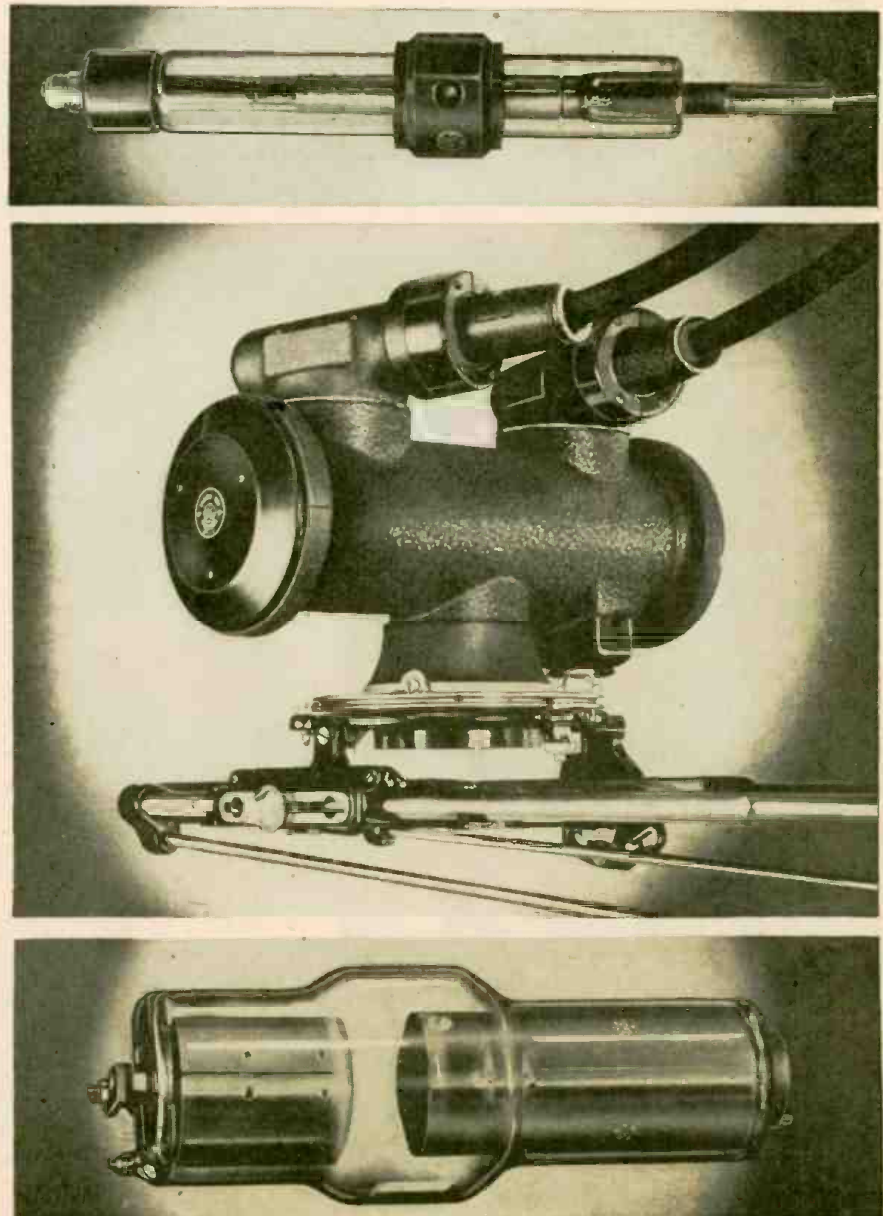

Top—A modern X-ray tube with beryllium windows. Center—A rotating-anode tube in protective metal housing. Bottom—The tube out of its casing. Rotating anode is at the left.

Photos Courtesy General Electric

20 Years of Electronics

By DEWEY D. KNOWLES*

I WAS engaged in research work on electronics twenty years ago and was fortunate enough to have a very interesting assignment. The director of research called me into his office one day and explained that he had a feeling electronic tubes might possibly be used quite extensively in industry in the future. He explained up to that time electronic tubes had been used principally for radio and to a certain extent as rectifiers, but beyond that, while he felt there would be other applications, he was quite at a loss to predict what those applications might be. I will have to admit that for some time I, too, was equally at a loss. Very little was known about electronic tubes as far as industry was concerned and I knew very little about the problems which existed in industry. It was not long, though, before there were more ideas than one man could possibly follow up and additional men were

*Manager Electronics Engineering Department, Westinghouse Electric and Manufacturing Company, Bloomfield, N. J.

assigned to this work. Most electronic tubes at that time were very small in size and a tube which would carry several amperes was referred to as a "power tube."

It might be interesting to look at some of the newspaper clippings which appeared a year or so later, simply to illustrate what the public's conception of electronics was at that time.

We had just given a demonstration in New York City of some electronic tubes together with circuits which we thought would have basic value in industry. This demonstration was given primarily to a large group of newspaper men. As a research engineer I was expected to allow my imagination "to run wild" and think of all possible kinds of applications. After this demonstration I came to the conclusion that most newspaper men would be valuable adjuncts to a research laboratory. Their imaginations put mine to shame!

The day following this demonstration the following headline appeared in the *New York Times* on April 5, 1927:

"Tube Can Start Ship on Energy of a Fly—Dew Can Put on City Lights."

The article went on to explain: "Thus it was quite possible by the use of this relay for a passing shadow or a dew drop to turn on the lights of a city, start or stop a railroad train, or maneuver a battleship."

I do not know yet why anyone should want to have a dew drop turn on the lights of New York City or why they should want a passing shadow to maneuver a battleship or stop a train, but nevertheless the idea had glamour and it was the sort of thing that was associated with electronics at that time.

TEN YEARS AGO

If we pass on to about 1932 we find that electronics "baby" (so to speak) reaching so-called "adolescence" and showing a desire to do important things and beginning to have some idea as to how to go about it.

In the *Automotive Daily News* for April 12, 1930, headlines read: "Electronic Stroboglow Aids Engine Engineers," and went on to explain a method whereby electronics could be used to inspect airplane engines either before or during flight.

The *Pittsburgh Press* of November 27, 1932, carried an article explaining the use of electronic tubes for the control of motor speeds, operating elevator doors, counting automobile traffic through tunnels and street intersections, and for many other applications, including the inspection of materials according to size and color.

We should keep in mind that prior to this time electronics had not been accepted in large plants such as steel mills to any extent. As a matter of fact, it was very difficult to even gain entrance into a steel mill as soon as they found out what you had on your mind. The head of the mill would very frequently show you the rough and ready workmen busily hoisting things about in the plant, and with a laugh would ask, "What chance would a glass tube have in such an environment?" It was not long, however, before this attitude changed and we found electronic tubes doing useful jobs in steel mills and doing them so satisfactorily that they would not listen to removing or shutting down the equipment.

ELECTRONICS TODAY

At the present time the electronics industry is one of the very largest in the country. It is definitely a deciding factor in winning the war and will unquestionably help make the peace. According to figures compiled by a New York financial house, the "total electronics business prior to the war was about \$275,000,000 a year. It went to somewhat over one billion dollars in 1942, and to well over four billions in 1943." It is my personal belief that 1944 will be considerably greater than for 1943.

It is very unfortunate that I am not privileged to describe in detail what electronics is doing to win the war. You will have to take my word for it that it is, and after the war there will be some very interesting tales to tell about what electronics has done. I definitely believe that the war will be won, other things being equal, by the countries having the most and best electronic equipment, including the recent developments which have been made mostly in this country. The use of elec-

(Continued on page 565)

Long Scales Make Small Meters Big

WHEN the Navy embarked on its gigantic ship-building program at the outset of the war, its engineers felt it necessary to retain scale lengths at least as long as in six-inch instruments—at the same time they wanted a space-saving design. They requested the industry to produce long-scale (250-degree) instruments for all our fighting ships, according to Westinghouse engineers. This called for the most ambitious,

most gruelling instrument-design program ever attempted.

Though inherently more complex than the 100-degree type, the new long-scale instruments are outstanding because they can be disassembled and repaired easily. Regular instrument repairmen without additional training can do the job with ordinary tools. The instruments are extremely rugged in order to meet the high-shock conditions encountered in

naval service. They must pass a 2000-foot-pound shock test. Here, the steel test panel (on which the instruments are solidly mounted) must withstand the blow from a 500-pound weight dropped four feet. It must take it first on top, then from the rear and then from the side. This test momentarily increases the weight of each part by 3000 times. This is equivalent to supporting the weight of two light automobiles from each instrument. Following this test the instruments must continue to operate with acceptable accuracy.

The entire output of these instruments will be required by the Navy for some time. However, it is expected that the new design will have considerable land application when available for that purpose.



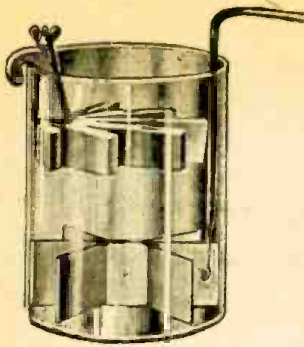

Fig. 1—Daniell gravity cell.

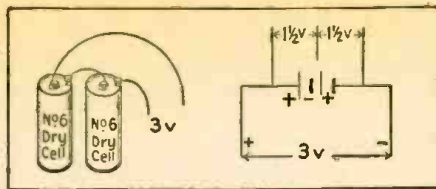

Fig. 2—The series connection.

A Course In Practical Electronics

Part III—Ohm's Law, Radio's Rule of the Road

By FRED SHUNAMAN

ELECTRONS speeding through solid matter follow certain "Rules of the Road." If we are to understand electricity, we must know what these rules are.

Every radioman knows that electricity flows more easily through some metals than others. He is well aware that large conductors of copper must be used for a large flow of electrons, and the conductors of iron—for example—would permit less current to pass. If he wishes to reduce the amount of current that will flow in a circuit, he intentionally uses a conductor of some metal such as nichrome, which has a high resistance. This is done in many filament circuits, where a resistor of nichrome wire is used to prevent too much electricity flowing through the tube filaments and burning them out.

Wire made of copper or silver—or some of the other metals whose atoms have very few electrons in their outer shells—has a very low resistance and is commonly used for conductors. Current in any circuit is limited by the resistance of the material through which it flows, since no conductor is entirely without resistance. If we want to increase the flow, we can do so only by increasing the number of piled-up electrons at one end of the wire and drawing away more of them at the other. We thus increase the electric gradient or slope of the wire, or increase the *electric pressure* on it.

BATTERY CONNECTIONS

This pressure—in the case of an electric cell—depends on the material of which the two elements are made and the nature of the electrolyte between them, practically regardless of their size or spacing. Long before the present "dry cell" became the almost universal electric battery, a common wet type known as the Daniell gravity cell was very popular. It consisted of a plate of copper in a copper sulphate solution and a plate of zinc in a zinc sulphate solution in a glass jar. The two liquids are separated by gravity only. The construction is shown in Fig. 1. This cell was so common that its pressure was taken more or less as a standard, and our VOLT was the result. The international standard set later did not exactly agree with the pressure of the Daniell cell, which is now rated at 1.1 volt.

If a plate of zinc and one of carbon are separated by an electrolyte of sal ammoniac, as in the dry cell, the electric pressure or voltage is a little greater than 1.5 volt. We can double this pressure, by connecting two cells in cascade, or *series*, as in Fig. 2. By connecting a number of cells in series, we can attain any voltage we need. An ordinary 45-volt B battery, for example, is made of 30 small dry cells.

There is one other limitation to the current flow from dry cells or other electric batteries. Even though a large number of cells be connected in series, and the terminals shorted by a very large conductor of low resistance, it must not be expected that unlimited current will flow. There is a very definite limit to the rate at which chemical action can separate electrons in the active element of the cell (the zinc) and an ordinary No. 6 dry cell is seldom used to supply currents of more than $\frac{1}{4}$ to $\frac{1}{2}$ ampere, though it may deliver 30 amperes momentarily, on short-circuit. The speed of this chemical manufacture of electricity depends directly on the area of the elements, and to double the ability of a battery to deliver current, it is only necessary to connect two or more of them *in parallel*, as in Fig. 3. This connection will make available twice the current of a single cell at the same voltage (1.5).

(Incidentally, we are here using the word *battery* in its correct sense. A battery is a number of objects used for a given purpose, as a *battery* of guns. The original electric battery was a number of cells connected together, and to speak of a single cell as a battery is corrupt practice.)

The AMPERE just mentioned is roughly the current that flows through a 100-watt lamp. Precisely, it is a flow of 6.24×10^{18} electrons per second. (The figure was written out in full in the last lesson). Curiously enough, we seldom measure a quantity of electricity, preferring to measure it by its *rate of flow*. An engineer at a hydraulic installation, interested in getting power out of a current of water, does the same, and calculates in gallons or cubic feet per second. The unit of quantity for electricity is the COULOMB, and is 6.24×10^{18} electrons. In other words, when one coulomb passes through a conductor every second, we have a flow of 1 ampere.

The rate at which electrons will flow

through a circuit depends on the pressure, or voltage, with which they are forced along, and on the resistance of the circuit. This apparently simple fact was discovered by an early experimenter and investigator, George Simon Ohm, and was put by him in the words: "The current through a circuit varies directly as the voltage and inversely as the resistance of the circuit."

That simple sentence is OHM'S LAW, probably the most important single statement in the whole science. It is reported that Thomas Edison, on the witness stand as a technical expert, was asked by a lawyer, "What is Ohm's Law?" He replied: "I do not know. Ohm's Law contains essentially the whole of electrical engineering; and I am not familiar with the whole of that subject."

To us Ohm's Law means that if we know the voltage of the electric source and the resistance of the circuit, we can calculate the current flow. If it is more convenient to measure the voltage and current, we can calculate the resistance, and it is equally easy to find the voltage if we know the current and the resistance.

To make our calculations easier, the various units have been so selected by international agreement that if a wire with a resistance of 1 ohm is connected across a source of pressure of 1 volt, a current of exactly 1 ampere will flow. It has been seen that the volt was changed somewhat from the potential of a Daniell cell, and the ohm, which started life as the resistance of a long tube of mercury in the Siemens laboratories, was also modified to fit into mathematical calculations. Thus it is possible to find voltage, resistance or current in a circuit by using three simple equations. These are:

$$I = \frac{E}{R}; R = \frac{E}{I} \text{ and } E = IR.$$

(Continued on page 554)

Fig. 3, Upper left—How cells are connected in parallel. Fig. 4, Lower left—A dropping resistor in an A.C.-D.C. radio filament circuit. Fig. 5, Right—How conductance may be used for calculating resistors connected in parallel is illustrated in this typical receiver network.

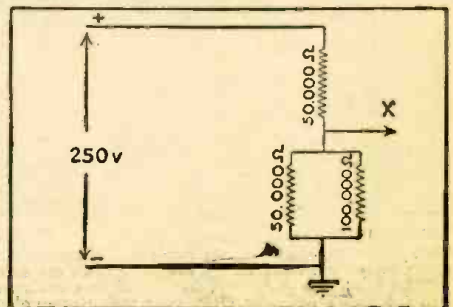
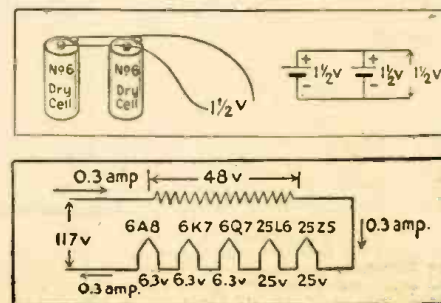

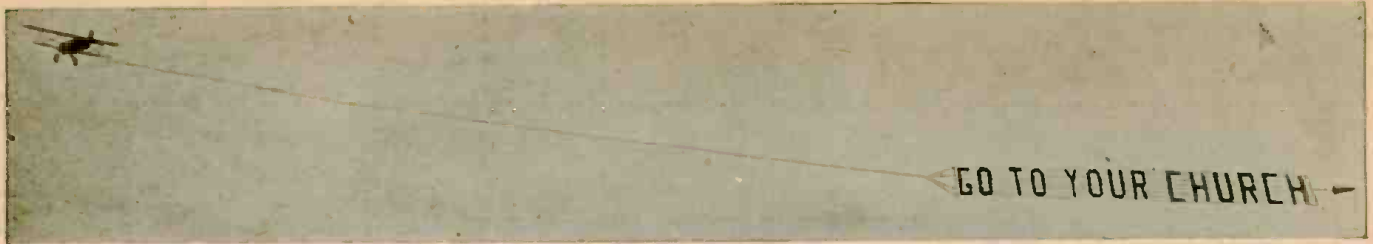

Actual photograph of the 150-foot long net sign towed by an airplane near the beach at Atlantic City, before Pearl Harbor. The letters were seven feet high and three feet wide, with a space of about three feet between each letter.

Radio-Defensive Reflector

By HUGO GERNSBACK

(COVER FEATURE)

THE history of warfare for untold ages has demonstrated that there has never been developed a military weapon for which there was not an effective answer in due time. Thus, the old Romans wore helmets and shields to counter the blows from spears and swords; likewise, the modern tank has for its answer tank destroyers in the form of powerful rocket guns such as the American "Bazooka" and self-propelled anti-tank guns that disable any tank they hit.

The airplane, which for a number of years seemed invulnerable, is now challenged successfully not only by enemy fighter planes, but by new anti-aircraft guns, which use electronic equipment and which

find the range of bombers by night as well as by day, and even when the bombers are invisible through fog or thick layers of clouds.

Before the Nazis had developed their electronic gun locators, the R.A.F. had comparatively easy going with their night bombers, because their invisibility in the dark gave them a certain amount of protection. That protection does not exist any more today. I have mentioned this in a number of my articles in previous issues of RADIO-CRAFT. I quote here a condensed version of a syndicated newspaper article

by Alexander P. de Seversky, the well-known aviation expert, who states as follows:

"The main scientific factor in wiping out the differential between daylight and darkness in aerial combat, of course, has been electronics. It provides electrical instead of optical detection of targets, thus canceling out fog, clouds, darkness and other visibility elements as barriers; and, of course, it is far more accurate than visual instruments. Even in the daytime and in good weather, cloud masses often block visibility." Major de Seversky continues: "The rapid perfection of radio-locator devices is

(Continued on page 573)

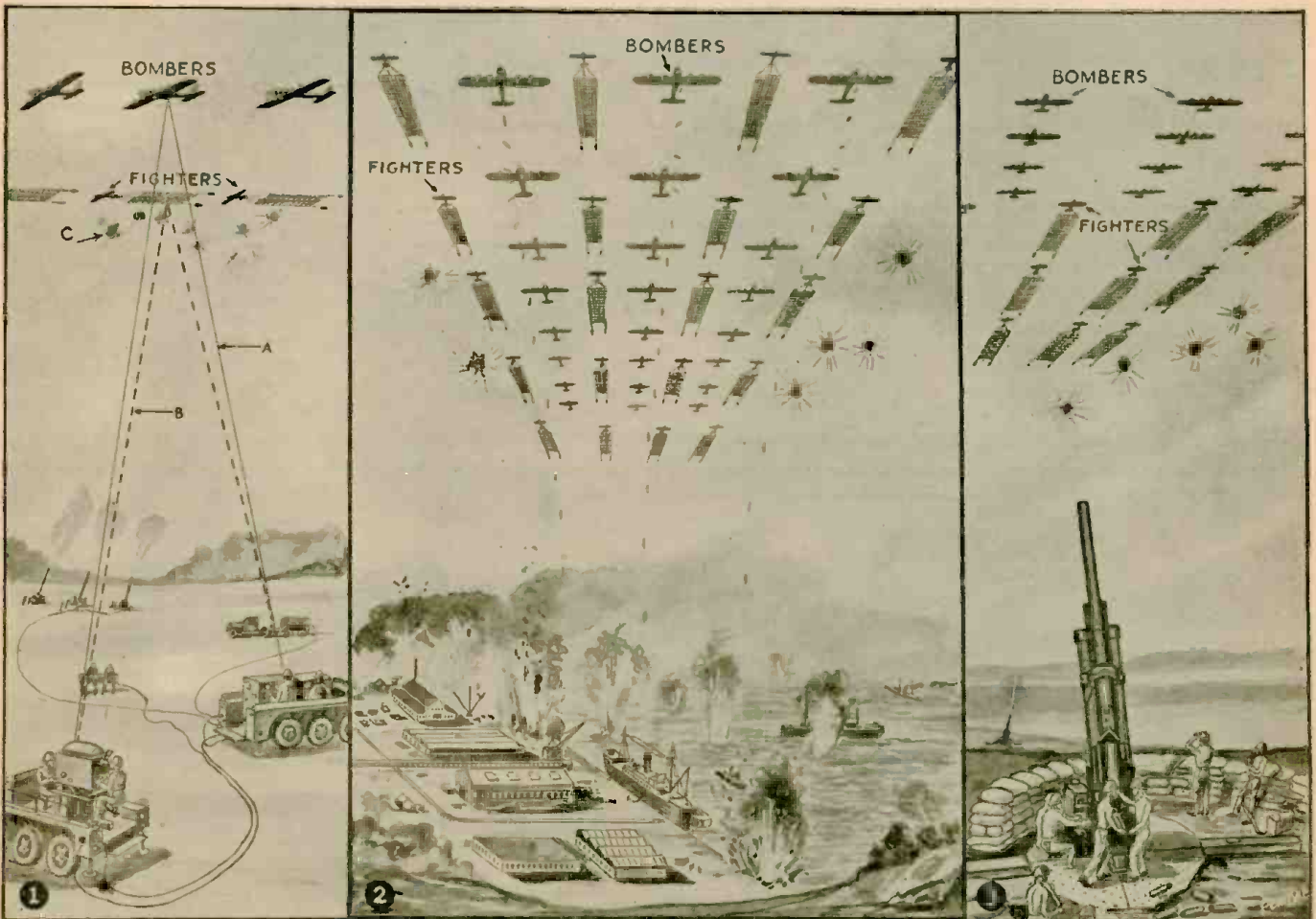

1—This shows an electronic gun director in operation while getting the range of overhead bombers. If we intercept the signal waves A, by means of Deflector Nets towed by airplanes, the result will be as shown at B. As the Deflector Nets fly between 300 and 1000 feet below the bombers, the reading of the electronic gun director will therefore be wrong. If there are enough Deflectors (invisible to the human eye at the height of 25,000 feet), the computation of the gun director will be false. The A.A. shell bursts will thus occur at C and therefore will not harm the bombers. 2—This shows a bottom view of the four-engine bombers and the Radio Reflector Nets. Even with strong glasses, it will be impossible for gun observers to know at what level the fighter planes fly. 3—Another view of bombers and fighters approaching the target, showing anti-aircraft shell bursts at the level of the fighters.

INDUSTRIAL ELECTRONICS

Part IV—High-Frequency Heating, Welding and Gluing

By RAYMOND F. YATES

ELECTRONIC heating is just now coming into the foreground, although the principles were discovered many years ago. To the young electronist seeking new fields, this fabulous method of heating without combustion offers opportunities of very large dimensions. Because of the ease with which this form of thermal energy may be generated, controlled and applied to restricted areas with high efficiency, a new tool of tremendous importance and possibilities of future growth is at hand.

Some thirty odd years ago, Dr. Northrup devised a method of heating through the agency of high-frequency currents generated by the discharge of condensers of large capacitance. Ordinary high-voltage transformers made to operate on low frequency alternating current were used. Indeed, if the young student of electronics has an old high voltage radio transformer at hand with suitable condensers, he may readily set up such a circuit and use it for heating nails or rods. The circuit is shown in Fig. 1. Neon sign transformers may also be used for this purpose and voltages may range anywhere between 8,000 and 15,000 volts. A large nail or rod of iron or steel inserted in the heating coil will soon have its temperature raised to several hundred degrees. The heating coil itself will remain relatively cool and will be heated only slightly by radiation from the iron or steel within it. Left without a charge, no sensible heat will be generated by the coil.

Such heat as is created within the charge is produced by the action of the high-frequency magnetic field generated by the rapidly oscillating discharge current coming from the condensers. In a very real sense, currents are induced in the charge to be heated. This charge or metal mass functions as a sort of "short-circuited secondary," the heavy currents induced dissipating their energy in the form of heat.

It will be clear that high-frequency magnetic fields may serve only in generating heat within good conductors such as the metals. When applied to non-conductors, such fields are incapable of producing heat.

Due to the urgent war need of producing heat in laminated wood formations intended for airplanes, a great deal of progress has been made in applying electronically produced heat to such materials. Here, however, rapidly reversing electrostatic fields have been used in place of electromagnetic fields. The fundamentals of the two methods are depicted in Fig. 2 at A and B. In the one case, the metallic article to be heated is placed inside a helical coil and in the other the non-conducting article to be heated is placed between the plates of an electrostatic condenser.

Electromagnetic methods were employed before the advent of the high-powered electronic tube. The first Ajax induction furnaces developed by Dr. Northrup, were supplied with high voltage current from a transformer. This was later supplanted by a 900-cycle generator of special construction which was used in charging a large bank of heavy capacitors.

The perfection of the high-power radio oscillator tubes gave engineers a new and important tool to use in inductive and electrostatic heating. Much modern equipment

of this sort makes use of this improvement. With the present trend toward higher and higher frequencies, it is to be assumed that the vacuum tube will eventually replace other means of generating the H.F. currents needed for such work. Fig. 3 shows a perfected circuit diagram for generation of H.F. currents with electron tubes.

Curiously enough the electronic industry itself made one of the first uses of the electromagnetic method of high-frequency heating. Years ago, it was found necessary to heat the metallic elements of vacuum tubes during the process of evacuation. This was necessary because of the relatively large amounts of gas that became occluded in the surfaces of the metals employed. Therefore the tubes were placed inside inductance coils and their metal elements raised to a red heat while the tubes were being pumped. The occluded gases, boiled out of the tube elements were swept away with the rest of the air removed by the pump.

While a great deal of behind-the-scenes research work is still going on, the electromagnetic method of heating is already solidly entrenched in the following work:

- (1) Heating of vacuum tube elements during manufacture.
- (2) Heating crankshafts for surface hardening.
- (3) Gear heating for hardening of teeth.
- (4) Fluxing tin on electroplated sheets.
- (5) Heating rods.
- (6) Melting metals in vacua.
- (7) Soldering capacitor and transformer cases.

It would appear especially that electronic H.F. generated heat has a great future in soldering operations. The RCA Victor Division of the Radio Corporation of America has already pioneered this field and has a large installation of such equipment in daily use. Fig. 4 will illustrate the simple circuit used and the place of the metal container in relation to the single loop of heavy wire carrying the H.F. current. Such a system not only works beautifully with single containers but such containers may also be placed in small groups and soldered *en masse*. The cans may also be placed on

a special conveyor belt which carries them through the magnetic field at the rate of ten feet per minute and solders no less than 2500 per hour.

It may readily be understood that the application of radio heat will not stop at the production of condenser cans. The method is too flexible and efficient for that. By designing applicator coils properly such heat may be used to solder many shapes and forms on a high quality production basis.

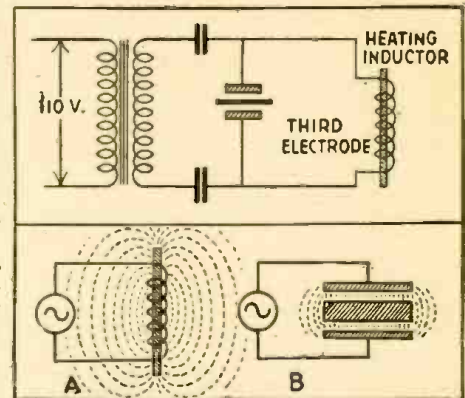

Fig. 1—This experimental unit heats nails.
Fig. 2—Inductive and electrostatic circuits.

Obviously we have just begun to use electronic soldering with its fast heat applied directly to the very spot where it is needed.

To give the reader some idea of the rapidity with which such heat can be generated in the article under treatment, we refer to the brazing of bomb cases. A purely electronic method is employed. By this is meant that the H.F. current is generated by large oscillator tubes, single turn applicator coils carrying it to the cases. Seven such cases are treated simultaneously and the temperature of each is raised 1150 degrees Fahr. in 70 seconds. This is equivalent to producing one case every ten seconds, a feat that could not be accomplished by any other known means. Such are some of the mir-

(Continued on following page)

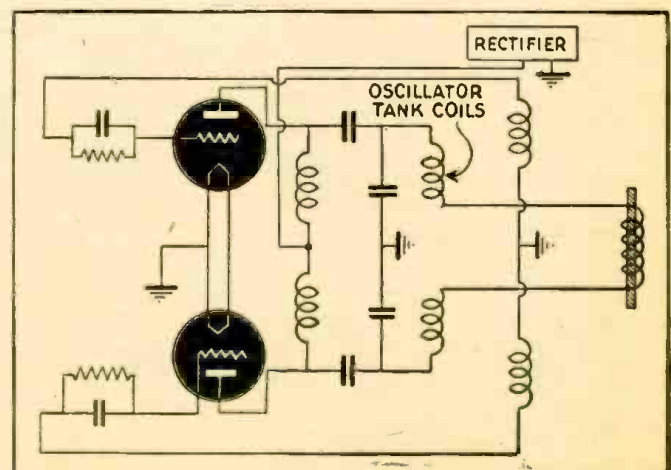

Fig. 3—A high-frequency unit for induction heating. This type uses electron tubes and is suited to operation on higher frequencies than the spark or rotary-generator heaters.

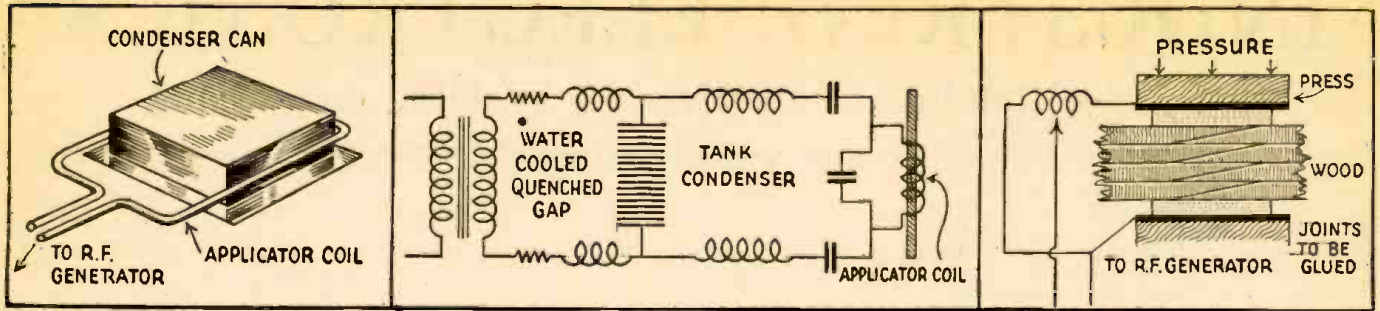

Fig. 4—H.F. heat solders condenser cans. Fig. 5—A quenched-gap type of H.F. heater. Fig. 6—A set-up for H.F. gluing of plywood.

(Continued from previous page)

aces being produced by electronic heating equipment. Little wonder at the high enthusiasm of engineers close to this budding development.

A wide range of frequency is used in electronic heating of this sort with the tendency in the direction of increase rather than decrease. In some instances frequencies as low as 15,000 cycles are sufficient while in other cases this is increased to as much as 50 megacycles. Several hundred kilowatts of power may be used.

Ordinary rotary generators may be—and indeed still are—employed for low-frequency current used in annealing, pre-heating, and some melting of metals. However, to date current produced with such equipment has not exceeded a frequency of 15,000 cycles. The range of frequencies between 15,000 and 500,000 cycles is produced either by V.T. generators or spark gap (see Figs. 1 and 5) converters. Anything beyond 500,000 cycles comes within the realm of the V.T. oscillator.

ELECTROSTATIC HEATING

Electrostatic H.F. heating has been known fully as long as electromagnetic and in a very large measure it holds just as much promise for future development and application. Such fields are employed to develop internal heat in poor conductors or insulating materials such as wood or plastic compositions. Equipment of this sort is now being used in heating the resinous glues in the manufacture of plywood and in the production of certain wooden parts used in trainer plane production. This method speeds production manifold producing heat internally. Otherwise outside heat would have to be slowly conducted to the surfaces treated with the glue. (See Fig. 6 at top of page.)

There also appears to be some prospect of using such heat in commercial cooking in the food industry. The advantages will be evident after a little reflection. When, for instance, a loaf of bread is placed in an oven, the cooking proceeds from the outside inward. The crust is overcooked while the inside of the loaf may still be relatively uncooked. With electronic heating the whole loaf, every section of it, would cook simul-

aneously. What might be called crustless bread would result. It will also be clear that the bread could be baked much more quickly and in what would amount to a cold oven.

During the past year, a great deal of promising work has been done on the problem of food dehydration employing purely electronic methods as used in the production of electrostatic fields. The samples of food to be dehydrated are placed between two condenser plates mounted in a compartment which is later sealed and pumped relatively free of air. Thus as the high-frequency field generated heat within the compressed block of vegetables under treatment, the water boiled off is carried away by the vacuum pump.

The electronic method of dehydrating food has several advantages. For one thing, 99% of the moisture content is driven out quickly and without burning or in any way adversely affecting the exterior of the compressed block of food. The speed is about ten times greater than that possible with other forms of heat. The prospects in this field are distinctly in favor of the wide use of such heat in the food industry both for cooking and dehydration.

The use of plywood in the aircraft industry would be greatly inhibited were it not for the application of H.F. heat. The reason for this high importance is easy enough to understand. Thick glue lines are distinctly to be avoided. Certain glues are also unsuited to the exacting work. Of all the adhesives tested urea formaldehyde resins are found to be best. When used with extremely high pressures that are sufficient to force even the slightest surface inequalities together, fine results are had but the resinous adhesive mentioned has one major disadvantage: it sets up slowly.

This shortcoming of the adhesive produced a made-to-order job for H.F. heating which is now employed in this work with magnificent results. All sorts of shapes and forms of aircraft spar flanges are now assembled through the use of a 30 kw. R.F. generator employed with special applicator coils.

Fig. 7 will illustrate still another ingenious wartime use of H.F. heating. The rivet problem has always been an awkward

one for the aviation industry. Now the use of explosive rivets greatly speeds riveting. The peening of the rivets is quickly done by the contact of a special H.F. applicator. Each rivet is hollow and carries a small charge of special explosive. The applicator device not only heats the rivet to set off the charge but it also plugs the opening in the rivets so that the explosion will force the edges of the rivet over.

PLASTIC WELDING

Still another use for H.F. heat has been found in the thermoplastic industry. The method employed is illustrated in Fig. 8, where two rotary applicators in the form of metal wheels contact the edges of plastic sheet material that are to be joined together. The edges are fused quickly and there is no problem of overheating or burning. Thermoplastic material will be fabricated largely with such heat in the future. Heat may easily be generated in such material through dielectric loss.

If intensive research now going on may be accepted as a guide, the application of H.F. heating to the plastics industry is only beginning. Apparently the big field will lie in the molding of plastic articles; the H.F. current supplying the heat needed for fluxing the charge. Those now investigating claim that results to date are definitely conclusive and that future molding presses designed especially for H.F. heat will not only reduce the pressures now needed but also promise an important reduction in time, with consequent savings in money.

Inside brazing of metal fabrications where it would be impossible to apply a torch offers still another field for electronic heating and several important applications have already been made, one of them being in the manufacture of propeller blades. The applicator coils do not need to be placed on the inside of the articles to be treated. The coil is simply placed as near as possible to the spot where the heat is to be applied but on the outside of the work.

Someday perhaps, even mother's range in the kitchen will draw its heat from a basement oscillator. There would then be no need for large insulated stoves, and the cooking of a whole meal could probably be done within two or three minutes.

Fig. 7—The explosive rivet makes firm joints. Fig. 8—A radio sewing machine for plastics.

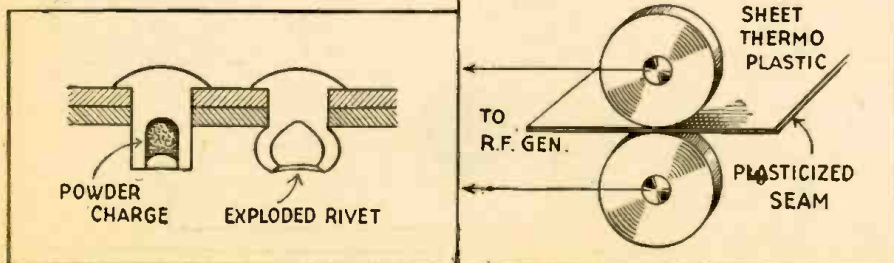

The \$64 question today is: "If you met a 'Chase Me Charlie' on the Atlantic Ocean, would you flirt with it, call a cop, or try to crush it?" The correct answer is: "You would crush it; that is, if you were a British seaman; for the 'Chase Me Charlie' is nothing more than the new nickname for the Nazi Radio Glider Rocket Bomb." This name is used contemptuously because the "Chase Me Charlies" rarely catch up with their objectives. As a matter of fact they are more often destroyed by those they chase.

Robots of World War I

Radio Controlled Motor Torpedoes Were Used in 1916

By A. E. SOKOL

THE idea of remote control of vessels or vehicles is not a new one. An electrically controlled boat was used in experiments conducted by the British torpedo ship *Vernon* as long ago as 1885. These early attempts led to no practical results, because at that time no suitable motors were available and transmission of electric power was still in its infancy. Although conditions gradually improved during the following decades, the experience gained with electric control was, on the whole, not encouraging, and only Germany continued her efforts persistently and systematically, until a product fit for combat use was developed.

Tests with remote control for torpedoes had been carried on in that country, chiefly in the Siemens plant, from 1906 on. But the use of torpedoes was soon given up and later experiments were made with surface craft, since at that early stage the required apparatus was too bulky and complicated to be carried by a torpedo.

CABLE-CONTROLLED BOATS

From the beginning the Germans had experimented simultaneously with remote control from land, ships and airplanes, using cables as well as radio waves. When the war started, the problem of control from a land station was considered perfected to such an extent that in 1915 twelve boats were ordered for use in coast defense. These were followed a little later by five additional ones, so that a total of 17 electrically controlled motorboats were built and used by the Germans during the war. They were of 6 tons displacement, 42 feet in length with a beam of 6 feet; equipped with twin gasoline engines totaling 400 h.p., they attained a speed of 28 to 30 knots; their fuel tanks permitted them to travel for about 6 hours at full speed, though their radius of action actually depended less on their fuel capacity than on the distance to which the boats were visible from the control station. The fore part of the boat contained a considerable charge of high explosive, some 300 to 450 pounds in weight, which was to detonate upon contact with the enemy, thus destroying the boat itself. Naturally, no crew was carried, the boat being directed by means of electricity transmitted to it through an insulated single-core cable of somewhere between 30 to 50 miles in length.¹

While the boats were being built, control stations were erected at Zeebrugge, Kiel, Travemunde, and other places along the North Sea and Baltic coasts. In order to give them a greater range of vision, these stations were placed on towers about 100 feet high, from which the boats could be seen and directed up to 15 miles from shore. But the first two of the boats were not ready until December, 1915, and they as well as their successors suffered from chronic motor trouble, so that actual use was delayed until 1916.

RADIO CONTROL INTRODUCED

In the meantime the control range was doubled by the interposition of a seaplane

¹Cf. P. Koppen, "Die Ueberwasserstreitkräfte und ihre Technik," Marien Archiv, Berlin, 1930.

equipped with a strong radio sender to overcome interference from the enemy. This plane, protected by a strong fighter escort, accompanied the explosive-filled craft and signaled to the shore operator the direction to give it by means of the controlling cable. The signals needed for that purpose were simple—only starboard, port, or steady.

Still later, the destroyer T-146 was equipped to take the small boat on board for more extensive trips and to control it in cooperation with the plane, thus eliminating the shore station and greatly increasing the radius of operation. But all these arrangements proved too cumbersome, and further work was done to eliminate the cable as well as the intermediaries, so as to control the boats directly from the plane by radio alone. Toward the end of 1917 these experiments were finally crowned by success, and remote control, which in the meantime had lost favor, received a new impetus. The new procedure permitted the full utilization of the 200-mile radius of action which the boats possessed, and enabled them to be used offensively instead of purely as a means of coast defense.

The success achieved by the Germans with remote control did not justify the high hopes originally placed in it. Although some German writers credit the electrically

directed boats with the sinking of a number of Allied vessels, such claims are substantiated by neither German nor British official reports.

A number of factors accounted for the lack of results. It took a considerable amount of experience and practice to insure the proper team work between destroyer, seaplane, and land station. Several of the small craft were lost during experimentation, and others had to be scuttled to prevent their capture. Recurrent motor trouble reduced the number of boats available for action. Moreover, along the Flanders coast the use of boats was hindered by the net barricades protecting the British ships and ports. Although the light craft could readily slide over them, their thin cables were easily damaged by the nets, thereby making the boats themselves useless.

AN ATTACK THAT FAILED

Such damage as the cause of failure is authenticated in at least one case. On September 11, 1916, the FL8² proceeded from Ostende to attack a group of monitors. Conditions were unusually favorable to the attacker. Nevertheless, some 3,000 yards from its goal the boat stopped. To save it from falling into British hands, the control

²The German designation FL stands for *Fernlenk*, or remote control.

(Continued on page 558)

ANCIENT WEAPON NEW ELECTRONICS AID

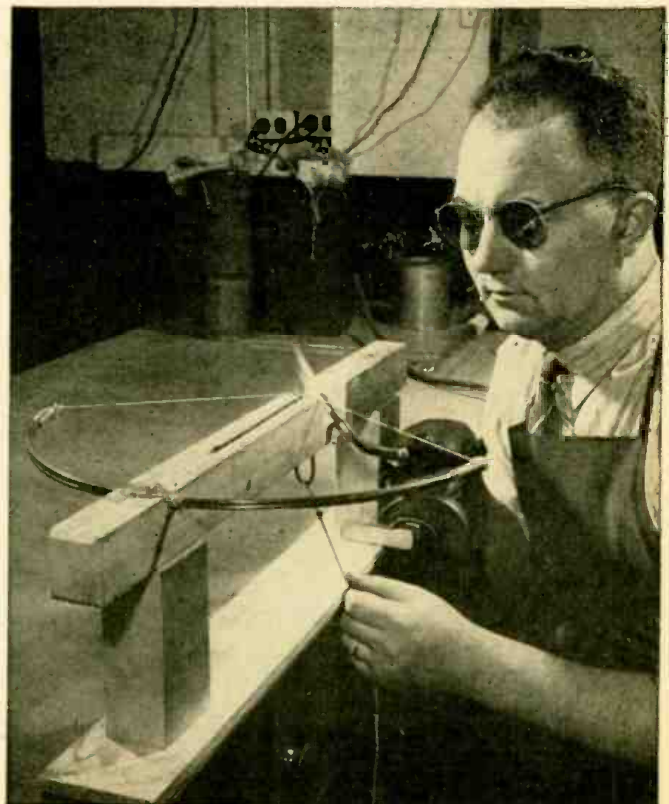

The Electron Microscope, latest achievement of science, is aided by the humble cross-bow which was rendered obsolete at the battle of Crecy, 598 years ago. The ancient instrument shoots an arrow that draws quartz filaments 1/30,000 inch in diameter, which are used to calibrate the microscope's magnifying power.

Audio Distortion

Part III—Some Little-Considered Effects

By TED POWELL

THE science of acoustics is concerned with the study of the transmission of sub-sonic, acoustic and super-sonic vibrations through solid, plastic, hydraulic and gaseous media. Such vibrations passing through material substances are subject to various types of distortion, some of which correspond to those occurring in electrical networks and some of which are peculiar to acoustics itself.

Absorption and resonance effects cause frequency distortion. Acoustic intermodulation, harmonic, and frequency modulation distortion effects are quite similar to those which exist in electrical networks. Phase-shift distortion seems to occur in more than one form in acoustics, depending upon whether the phase-shift effects are linear or non-linear with respect to frequency and whether phase-interference effects due to reverberation or to multiple-source conditions exist. Incidentally, reverberation (echo) might be likened to oscillation in an electrical network.

Other distortion effects may occur in acoustics, some being peculiar to the human auditory system.

The general points to be stressed are the effects of acoustic types of audio distortion upon the performance of a communications system. These effects will be divided up into three general groups. These are (1) the effects occurring at the microphone end of the communications system (2) effects at the speaker end of the system and (3) those occurring within the human auditory system itself.

EFFECTS AT THE MICROPHONE

1—The acoustic conditions about a microphone location which result in the least total distortion and the most realistic reproduction of the complex frequencies to be picked up and amplified is an intricate problem still in the development stage.

The reverberation times at the microphone location for the various frequency ranges must be carefully considered by proper proportioning and dimensioning of the location. Closer placement of the mike to the subject will provide a greater direct pick-up and a lesser effect due to reverberation. Proper choice and allowances for absorption constants of wall and floor materials as well as furnishings and audience; and placement and orientation of microphone all contribute to the optimum overall results of the communications system involved, especially where multiple-source sounds are concerned.

We may obtain a better balance of sounds in such a case by a change in the ratio of the distances between the mike and each of the sound sources. Monitoring such a combination of sounds will determine just what to expect and what changes to make to secure a given desired result. This is particularly of importance when picking up an orchestra. Usually, instruments of greater sound intensity are located farther away from the pick-up spot, and where the mike involved is more responsive to low fre-

quencies, instruments producing them may be placed in the background. The acoustics problem largely depends on the reverberation times for the sound signals to be handled.

2—The acoustics conditions about the speaker end of an audio system are important for similar reasons. A speaker located in a hall or room with tile, hardwood or concrete floor, plaster walls and metal ceiling will tend to make a speaker output sound unpleasantly harsh and tinny. Loss of low-frequency response and resonance-reverberation effects at the higher audio frequencies will be evident.

The same audio system feeding the same speaker or speakers in a location with heavy draperies, carpet-covered floor, plush-covered furniture and paper-covered walls will show an apparently flatter frequency response with little evidence of higher-frequency "peaks" and with a much better low-frequency response.

The acoustic constants of the latter location are superior to those of the former in that the reverberation times are such as to produce greater intelligibility for the frequency range and character of the audio signals being handled.

It must be remembered that the presence of a large number of people, the addition or removal of furnishings, or the re-decoration of a hall or room will usually have serious consequences upon its reverberation time for various frequency levels and thus alter its acoustic constants. Many an inexperienced P.A. man has had the embarrassing experience of having installed and tested a sound system in an empty hall for a beaming proprietor only to receive a frantic phone call to come back to "fix up" the same system,



"The views expressed are those of the speaker and do not necessarily reflect those of this station."

A "perfect amplifier" is not a guarantee of perfect reproduction. Acoustic conditions may be responsible for distortion effects occasionally blamed on the apparatus itself. The personal factor may also get into the equation, and cause some confusion in rating amplifiers.

which had been reduced to a muffled murmur by the absorption and masking effects of a large and noisy crowd of people in the same hall.

Similarly, a radio receiver purchased in a dealer's salon equipped with special sound-proofed rooms, may prove to be a disappointment to its buyer when listened to in the hard-walled living room of his home.

The cabinet and the baffling system housing the speaker also have a pronounced effect upon the speaker performance. Many types of absorption, reflection and resonance speaker baffling systems have been developed in order to improve speaker output. Their effectiveness depends upon (a) the speaker frequency response, (b) the frequency characteristics of the audio system feeding the speaker, (c) the acoustics about the speaker location and (d) the frequency characteristics of the auditory system of the listener rather than upon any intrinsic superiority of the baffling system itself.

THE HUMAN FACTOR

3—Acoustic distortion problem in the case of the human aural system may be roughly divided into the psychological and the physiological.

The aural sense, much as in the case of the other human senses, is subject to an effect known as "conditioning." The human sensory systems operate upon a relative or comparative basis rather than upon a quantitative or qualitative basis. This "previous-experience" effect warps the judgment and analysis of the sensations received.

A pair of ears accustomed to any anti-quoted radio receiver's limited frequency range output may react with a feeling of "tinniness" and "harshness" when listening to the output of a wide-range hi-fidelity receiver.

The conditions about the speaker location and the listener's mental and emotional state may also have some psychological effect upon his auditory system.

The physiological effects hinge about the more or less mechanical distortion effects of the auditory system itself. It is a well-known fact that people do not react to the same sounds in the same way. Their auditory systems have not the same frequency range nor the same "dips" and "highs" in their frequency response curves. Furthermore, they may not possess the same quantities of other distortion effects.

This fact explains why listeners sometimes react differently to the same singer or prefer different radio receivers. It also brings out the rather curious fact that whenever "listening" tests are made upon audio equipment, no checks are made of the frequency response characteristics of the auditory systems of the listeners in-

(Continued on page 567)

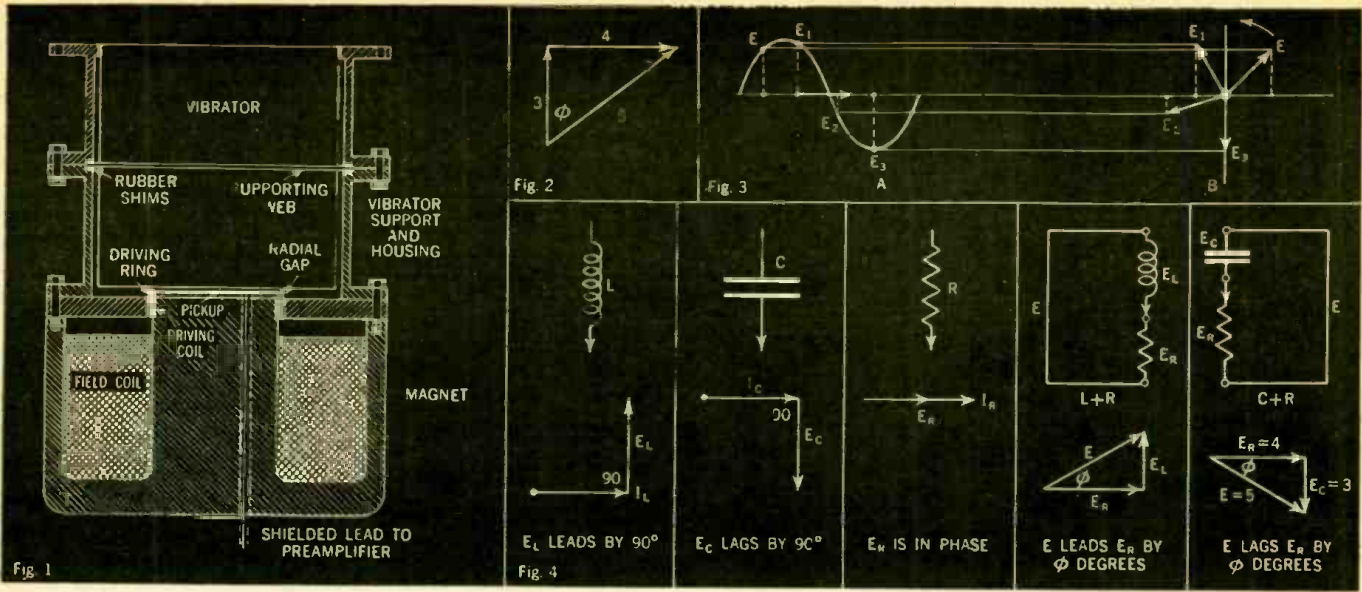

FM-Controlled Vibrator

A Discriminator Prevents Speed Change in This Instrument

VIBRATION analysis is now a very important branch of practical science. Its study is essential in aeronautics, structural strength testing, moving machinery, and the testing of the behavior of delicate instruments. A recent Bureau of Mines Report of Investigations (3702) carries an article by Mr. E. V. Potter, which describes the development of a vibrating system which is controlled electronically to unusually close tolerances. If it falls very slightly below the rated speed, the control circuit causes it to speed up. If it rises over its frequency, on the other hand, a slow-down impulse is transmitted to the driver mechanism. The control device makes use of a number of modern circuits such as a discriminator, reactor tube circuit, automatic gain control (AGC), phase shifters, and others. A knowledge of these circuits is of the utmost importance to fully understand FM, television, automatic tuning, so that a full description of them will be made.

The vibration frequencies which are investigated by this instrument may take place in the sub-sonic range and well beyond the audio range as well as through the full audio spectrum. Fig. 1 is a cross-section of one type of vibrator whose resonant frequency is 17 kilocycles. An alternating EMF of the resonant frequency of the vibrator is supplied to the driving coil, so that current is induced in the driving ring. The field coils generate a very strong magnetic field in the radial gap. The interaction of the field on the driving ring forces the vibrator up and down as the driving ring current changes.

At the bottom of the vibrator and insulated from it, an electrostatic pickup is connected. This is simply an arrangement of two condenser plates charged to a D.C. potential. Vibration causes this condenser to vary its capacity, resulting in an A.C. voltage which may be led to a preamplifier. This pickup is simply a condenser microphone in action.

The remainder of the system is electronic in effect. A concept of "phase" is essential to fully understand the circuits. Consequently, we will devote the next few

paragraphs to explain its meaning. It is by no means a difficult subject.

A SYNOPSIS OF PHASE

Suppose we have the following problem. A man walks 3 miles north and 4 miles east. We require to know his position. Obviously we cannot simply add the numbers involved, nor can we say that he is now to the north or to the east. The simplest solution is to draw Fig. 2 and measure (in the same units) the result. This length together with the direction is the complete solution.

In the case of A.C. of some single frequency we are often confronted with the problem of adding two voltage which are "out of phase." This simply means that one of them has started later than the other. Being of the same frequency they will never be "in step" or in phase, and simple addition is incorrect.

A.C. currents are often drawn as in Fig. 3a. This gives a good mental picture of what is happening. It is also possible and correct to draw an A.C. current (or voltage) as in Fig. 3b. Here the line OE

is assumed fastened at O and rotating in the direction of the arrow. Measurement of the dropped vertical line (dotted) shows that this length is always equal to the height of the sine wave in Fig. 3a at the corresponding point of the wave. Using this method of analysis of an A.C. voltage we may say that it has DIRECTION as well as magnitude or length and we are free to add voltages which are "out of phase" as in the previous example. The phase or time difference of a complete cycle is 360°.

A quantity which thus has DIRECTION as well as magnitude is known as a *vector* and the simple process of adding them as in Fig. 2 is *vector addition*. To make sure that this principle is understood we may take several practical examples, which incidentally, illustrate the fundamental principles of alternating currents.

The voltage across an inductance (L) leads in phase by 90° the current through it. Also the voltage across a condenser (C) lags in phase by 90° the current through it. The voltage across a resistance (R) is in phase with its current. In Fig. 4 we show how to add (vectorially, of

(Continued on following page)

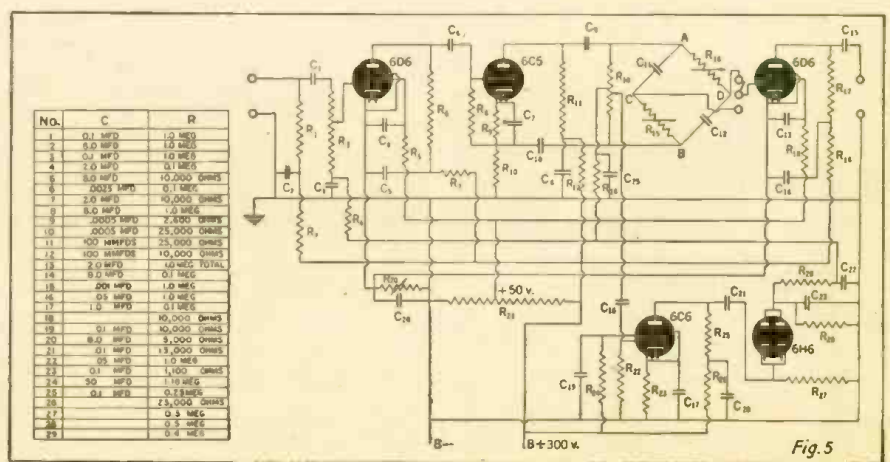

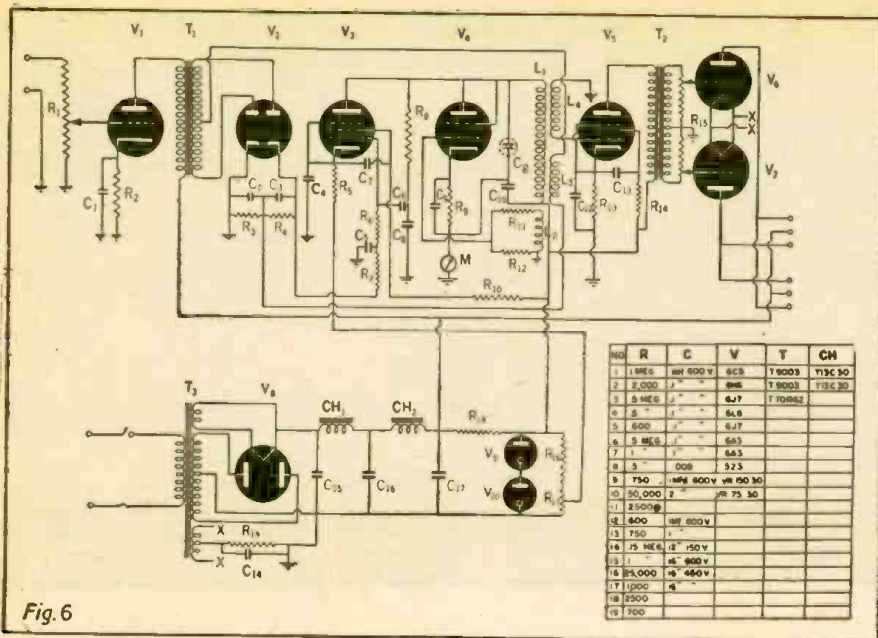

Fig. 6

(Continued from previous page)

course) several combinations of voltage with due regard to phase. The whole procedure is simplicity itself, yet is of the greatest importance. In Fig. 4 the subscript L or C refers to the inductance or capacity and the length of each component voltage may either be calculated or measured on a voltmeter. Once we have each component voltage we must add them by vectors addition. If in the case of C plus R, for instance, our A.C. voltmeter shows 3 volts across C and 4 volts across R, the meter across the entire circuit will show 5 volts.

THE PREAMPLIFIER

We will now examine the preamplifier of Fig. 5. The output from the vibrator is greatly amplified by the two 6D6's, while the 6C6 acts as a phase inverter and supplies voltage for AGC. Because the vibrator amplitude may vary slightly due to temperature and change of load, it is necessary to use the high-gain remote-cutoff 6D6's.

The AGC functions as follows: A portion of the 6C5 output is taken at R13 and fed into the 6C6 for further amplification. Its output (across R27) is applied across the 6H6 rectifier diode. Rectified current flows from 6H6 plates through R29 back to the cathodes. The plates are thus biased

negatively compared to B-, its extent depending upon the voltage received from the 6C6. This bias is applied through isolating resistors and filter networks to the 6D6's, cutting their amplification. The greater their signal output, the higher the bias. The result is a very stable, constant-gain system.

The bridge composed of the four arms C11, C12, R15, R16 is a phase-shifter, and its action will be described. Note that the A.C. output of the 6C5 flows through R10 and R11 on its way back to the cathode. Since each is of 25,000 ohms the same voltage is produced in each. If we neglect the effect of C8 which is large, and of R9 which is small and by-passed, the effect of the ground connection is to center-tap the output, so that the plate and cathode are 180° out of phase. (Such a phase-inverter is often used to provide out-of-phase EMF's for push-pull amplification without the use of transformers.)

The out-of-phase voltages are fed through C9 and C10 to the phase-shifter. The left-hand side of the bridge is symmetrical but oppositely placed to the right-hand side so that we see at once that points C and D will be 180° out of phase. Concentrating upon the left-hand side for convenience, we note that point C may be made to approach

the phase of the cathode when R15 is very small.

On the other hand, when R15 is made very large the effect of C11 is negligible so that the point C approaches the phase of the plate, as compared to ground. This means a variation of 180°, and since the single-pole, double-throw switch connects the grid to either C or D, the 6D6 may be supplied with any desired phase over a full range of 360°. The output of the amplifier thus supplies a constant voltage of any desired phase, the need for which will be shown.

CONTROLLED OSCILLATOR

The power supply, referring to Fig. 6, is shown voltage-regulated by means of two commonly-used regulator tubes. The VR 150-30 supplies an output of 150 volts over the wide range of 5-30 ma., and the VR 75-30 provides 75 volts over the same range. The total output is therefore 225 volts, regardless of load changes.

V4, the oscillator, is connected as a triode, being tuned by L1, the plate coil, to the oscillator frequency. R11 and R12 control the output strength, the latter being indicated by meter M.

The action of V3, the reactor tube, is better shown in Fig. 7a. The vector relations are shown in Fig. 7b. The plate-ground voltage e is equal to the vector sum of e_R, across R8, and e_x across C8. I is the current through this circuit. E_x is the applied grid voltage. This will, of course, be in phase with the total plate current i_p. The latter is thus drawn in the same direction. We are at once struck with the interesting fact that e leads i_p, which makes the tube an effective INDUCTANCE. The greater i_p is (assuming e constant) the smaller this inductance, and vice versa. The D.C. voltage e_{dc} controls i_p so that the final result is (a) when e_{dc} = 0 the frequency is maintained, (b) when e_{dc} is increased in a POSITIVE direction, V3 becomes a smaller inductance and the oscillator frequency INCREASES, and (c) for a NEGATIVE increase in e_{dc}, the frequency DECREASES.

In automatic tuning circuits, the above operation takes place automatically to maintain the receiver to the EXACT incoming frequency.

THE DISCRIMINATOR

The discriminator circuit is simplified in Fig. 8. The voltages A and B are equal but phased oppositely with respect to the

(Continued on page 559)

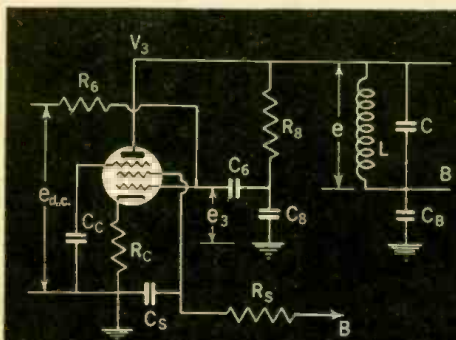

Fig. 7a

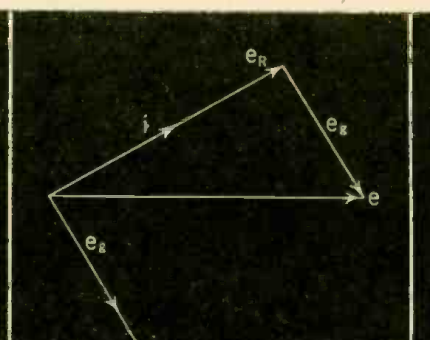

Fig. 7b

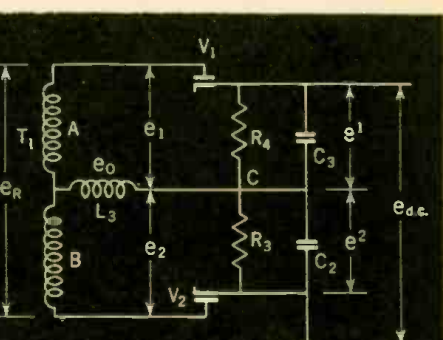

Fig. 8

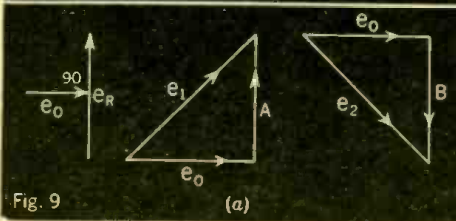
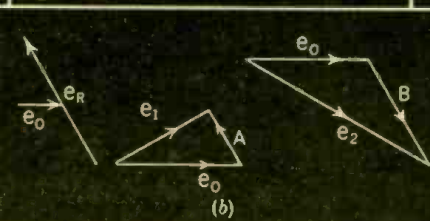
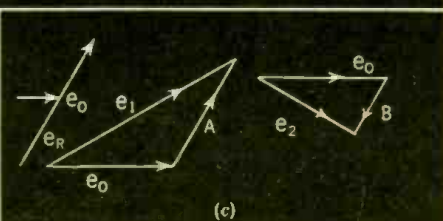

Fig. 9



(a)



(c)

RADIO SPEAKER TESTS

By JACK KING

IN the old days it was common to find a magnetic loud-speaker in a receiver or amplifier system. The limited power handling capability of such speakers and the relatively poor response on bass notes was a drawback. Other odd forms of loud-speakers, such as the gooseneck horn type, crystal and condenser varieties have now become obsolete. The crystal variety of late has found a new application in "radio pillows" which allow sick patients to hear sounds without the head being raised above the pillow. Such units are generally high impedance types and may be found in hospital sound systems.

In small radio receivers the magnetic loud-speaker is sometimes found, but usually the speaker is an electrodynamic type. In many cases a permanent magnet dynamic type—commonly referred to as a "PM" speaker—may be used. These units find wide application in portable P.A. systems as well as permanent ones because they do not require special power supplies to energize the fields.

In all cases the job of the speaker is to convert an electrical impulse into sound. The efficiency with which it does this job is dependent upon the design of the speaker and the circuit in which it is used, as well as upon the design of the baffle or cabinet and the acoustic properties of the space where the sound is to be distributed.

TESTING MAGNETIC SPEAKERS

In checking the speaker we want to know the following things: maximum power handling ability, frequency response at various points in the audio band and relative amount of harmonic distortion; power input required for a given amount of sound output.

To check the power handling ability we may use the test set-up of Fig. 1. The same test circuit may be used for magnetic or electrodynamic speakers. When dynamic speakers are checked, provision must of course be made for a suitable field supply. Otherwise the technique is identical. The audio amplifier should be of a high-fidelity type and be capable of delivering 20 watts without distortion. Needless to say, a high quality audio generator must also be used. Impedances should simulate actual operating conditions.

The speaker will have more of a tendency to rattle on low notes than on high, though some speakers have a resonant point which may be in the middle frequency range or at a high frequency, depending upon the defect. Tests may be made at several points in the audio band between 30 and 15,000 cycles. At each test frequency, the power supplied the speaker is raised by adjustment of the amplifier gain control until audible distortion is observed. At high volume levels the ear of an observer may be an unreliable judge of distortion. A crystal microphone may be connected directly to the vertical input of an oscilloscope which has a high gain vertical amplifier, or a pre-amplifier stage having a linear response with frequency may be used to build up the microphone signal to the point where it is usable by the 'scope. Amplification is desirable in order to secure sensitive indications and to permit using the mike at a distance of about 5 feet away from the speaker and on a line which is exactly at

a right angle with reference to the vertical plane of the speaker cone, as shown in Fig. 2. If desired, the output of the mike may be fed into a 100,000 ohm resistor at the end of the mike cable and the voltage across the resistor can be checked for various values of sound power fed to the loud-speaker. In dynamic speakers, the voltmeter may usual-

ly be placed directly across the voice coil. The crystal mike—if it is of reasonably good manufacture—will usually have a substantially flat response over the audio band.

The efficiency of loud-speakers may then be compared. If one speaker gives a greater output for a given value of input than

(Continued on page 564)

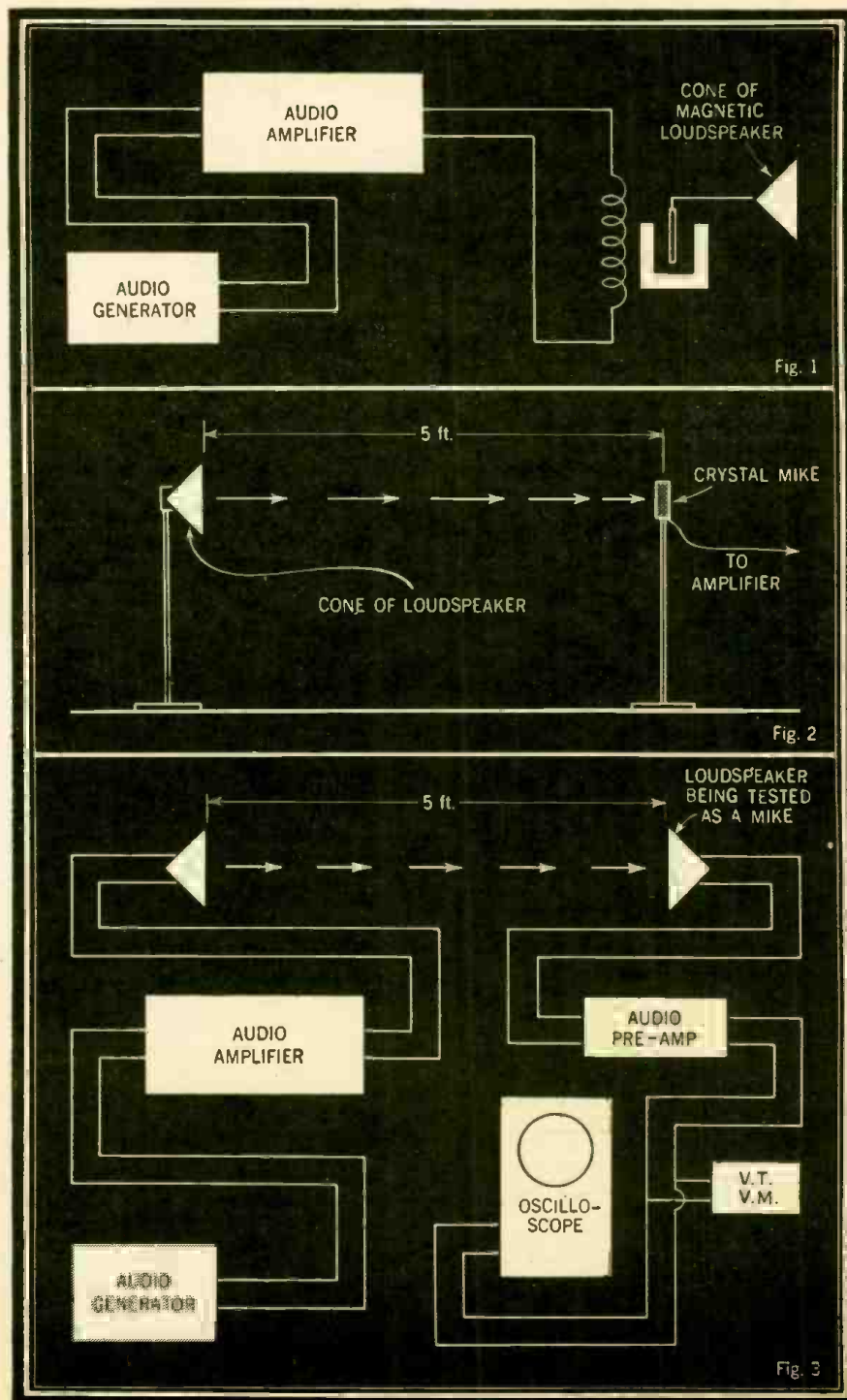

RADIO SHORT CUTS

A Number of Unconnected Ideas on Wartime Repair Problems

By G. P. ROGAL

WHAT serviceman has not cursed the modern style of dial pointer, as illustrated here (Fig. 1); the kind that was intended to glide ghostlike across the dial but which in practice usually bucks and rears and shimmies its perilous-looking path and seemingly responds to no placating influence, neither oil, nor grease, nor the various retentioning maneuvers? But cuss no more, pals. Pluck that well-chewed pencil from your ear and proceed to put a good layer of graphite on both sides and on the upper edge of the carriage, having first cleaned off the sticky grease and dirt to the bare metal. The results will astound and gratify you and the customer will take you for a genius.

Graphite is a marvellous lubricant for a number of things and as an agent in the resurrection of carbon volume controls nothing need be said about it to the old-timer. But, particularly when treating a new control, for noise, care should be taken to rub the element with a rather hard grade of "lead," otherwise the resistance of the control will be considerably lowered.

When using carbon tetrachloride for preliminary cleansing of the control, we find it best to completely immerse and swirl it about in the fluid in order that the inner contact ring—a prolific source of noise—gets its full share In these wartime days it is well to realize that since many R.F. coil primaries are not too critical as to number of turns, an open one can often be repaired instead of replaced and without fishing around for loose ends, simply by scraping some of the wire and making a new connection thereto.

An example of this idea is the De Forest 800 series in which the R.F. coils are conveniently provided with unused centre-tap lugs (Fig. 2). As it is almost invariably the plate half which opens, it is only necessary to bridge that section with any low value resistor, up to around a thousand ohms, or even short it directly and full reception is restored. There is positively no loss in performance.

In palmier days, in like circumstances, we went hell-bent to the factory for a new transformer. What war does to our perceptions! And what has happened to ye old Interior Power-Line Antenna? We had to think twice the other day when a customer demanded to receive a 600 kc. station (CFCF) sans aerial, ground, noise, everything. Also she didn't think, for a new set, that the magic eye winked at her sufficiently. We worked the miracle inside the

chassis, hooking the antenna lead to a small condenser and the condenser to the power-line. Zowie! How that set came to life and the way the magic eye winked was positively wicked! Results were not so heavenly on the short waves, but the customer never cared for that stuff anyway. All she cared for was "no wires hanging around."

As far as tube-substitution goes, in general, we don't care for it. Gets to be too much of a vicious circle these days, with tube types dropping out of circulation like ducks at a shooting gallery. The clients, too, are inclined to get vicious, about the second time out Distortion with hum! If you get that, look to the matching of your P.P. 47's first, especially if it's a Victor R21 Philco 39-330A should be ashamed of itself. A naked lead from the 370 mmf. condenser located under the automatic-tuning switch assembly puts on shorts intermittently and spoils the automatic tuning We find it's a good idea to "test" our metal tubes visually before plugging them into the tester. We have encountered a few whose prongs were entirely innocent of solder; with the leads free to wiggle around and make intermittent contact.

If your last soldering-iron quits in the middle of a big construction job, no need for you to quit. Not if you've got a live tube socket handy with filament voltage and an amp. or so of current in it, or an independent filament transformer. If you have either of these, plus a carbon from a small flashlight battery and a battery clip, you can attach these items to your test-leads or to a piece of lamp-cord or other wire, clip one lead to your work, touch your previously sharpened carbon to the joint and the heat of the small arc will be ample to flow your solder. Using 5 v. from an 80 socket in a set being repaired we did some of the fanciest soldering ever—in fact, we're not sure we don't prefer it to the regular "iron"—no weight to handle, no tinning, no muss, heat where you want it when you want it.

In older sets, stubborn cases of oscillation over part of the dial and even "double-hump" tuning on strong locals can sometimes be overcome by the simple expedient of by-passing the power line with an 0.1 mfd. 600 v. condenser. This also eliminates tunable hum. In one old Philco model oscillation over three-quarters of the band was eliminated by by-passing the hot lug on the second R.F. coil but nothing would overcome the remaining oscillation until

we by-passed the line, as mentioned. In addition, serious "double-hump" tuning was eliminated and selectivity improved by at least one-third. The usual method of eliminating "double-hump," of course, is to prevent detector overloading by reducing the detector plate voltage In some of the latest Philco models—and perhaps other makes—an annoying hum can only be eliminated by bonding the speaker frame to the receiver chassis It's a far cry from radio servicing to the larger aspects of science, but, in closing, perhaps we may be permitted to take a flight in contemplation of what may prove to be the greatest scientific discovery to date—the experimentally proven hypothesis that magnetism and electricity are not only interrelated but are one and the same force. Mr. Gernsback calls it "brehtaking"; with his rare insight into the potentialities of inventions and discoveries, does he see in Ehrenhaft's work a key to the portal of All Human Knowledge? Mankind may, we hope, eventually open that door of many locks and peer in some perspective at the mysteries beyond, though never in life we know, will he ever pass through it, finally to discover the omnipotent "reason why." But to have a key—as would now seem to be the case—is indeed a mighty accomplishment.

A model high-power FM station, dedicated to research and development of the FM broadcasting art, is being sought for the Washington, D. C., area in an application filed with the F.C.C. by FM Development Foundation, an organization which is composed of three of the best-known men in FM—Major Edwin H. Armstrong, FM inventor; C. M. Jansky, Jr., FBI engineering consultant, and Stuart L. Bailey, partner in the Washington engineering firm of Jansky and Bailey.

The station, cost of which is estimated at approximately \$150,000, would be a Class "D" outlet designed to serve an area of 18,844 square miles with Washington as the basic metropolitan area. The 43,900 kilocycle frequency is sought. The proposed site is a spot near Olney, Md., about 20 miles from the nation's capital. A 50,000-watt REL transmitter would be used, along with a General Electric six-bay antenna and Western Electric speech input equipment. Effective antenna height at the Olney site would be 920 feet above sea level. Effective radiated power of 249,000 watts is estimated with 2,956,668 persons to receive service.

The equipment to be used would substantially duplicate Major Armstrong's original FM station, W2XMN, now WFMN, at Alpine, N. J., which operates on the 43,100 kilocycle frequency. The engineering firm of Jansky and Bailey provide the only current FM broadcasting to the Washington area through its experimental station, W3XO, which is heard on the 43,200 kilocycle frequency Tuesdays through Saturdays from 7 to 10 o'clock and Sundays from 3 to 6 o'clock.—FM

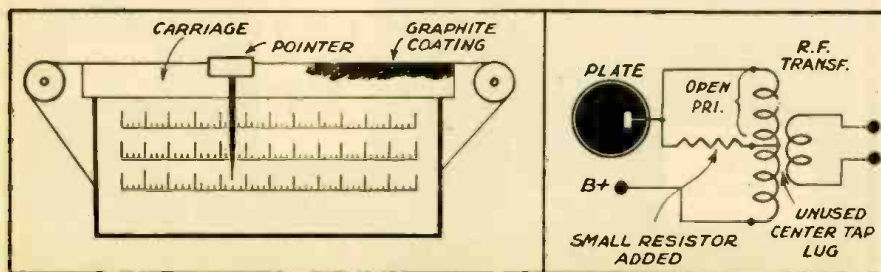

Fig. 1—Sure-fire way to tame a sticky dial. Fig. 2—Temporary repair on DeForest 800.

Adapters Make Radios Play

By W. G. ESLIK

SERVICEMEN are having severe headaches trying to substitute tubes in radios, due to the large number of radio tubes being used in the job of putting Hitler and Tojo in their places. That is (to quote *Radiocracy*), the job of "grounding" them, which we hope will be done efficiently and soon.

It is often possible to substitute one tube for another by rewiring the sockets or making adapters. In our shop, we try to make an adaptor work whenever possible, so the radio may use its original tubes as soon as they become available.

Wiring adapters is simplicity itself when done according to plan. We make use of an old tube base with the same number of pins as the tube which we are about to replace. Then we use a socket to fit the replacement tube. The type of octal and loctal sockets that have springs to hold them to the chassis may be used. The spring itself is of course removed for our purposes.

We are now ready to connect the socket to its new base. Wires about 1½ inches long are used so that there will be plenty of length to guide them through. Spaghetti tubing is used to insulate each lead from the others so that no shorting will take place. Use a good grade of cement to hold the socket to the base, and when it seems that you are finished be sure to use an ohmmeter to make sure that no wire is short-circuited to any other! There is strong likelihood of such shorting since naturally there is much criss-crossing inside. Clip off protruding wires and solder all connections.

We are now ready to test the completed socket in a tube tester, just as we would the original tube. For instance, we may use a 14Q7 tube as replacement for a 12SA7. Place the 14Q7 into the adapter and test just as you would a 12SA7. If it tests OK, it is ready to be wired into the set.

For the miniature tubes, the sockets being so small, wax is used instead of cement. Wax from old components such as condensers and transformers may be used, the mid-gate socket being pushed down into it.

A tube manual may be consulted as to wiring. Typical substitutions are shown in the diagram.

For a change involving an original grid cap tube where the new tube has its grid connection in the base, it may be necessary to shield the grid wire. In some cases the tube itself will also have to be shielded should oscillation or motorboating be encountered. For certain changes a resistor may have to be used either for pilot light or because of a slight change in filament voltage. Some are illustrated in the accompanying figure.

SUBSTITUTIONS

Following is a list of some tubes and their substitutes with resistor data where needed:

OZ4 may be replaced by a 6X5 and vice versa.

6D8 or 7A8 for a 12SA7 or 12A8. A 40 ohm, 10 watt series dropping resistor is necessary in this case.

6F6 replaced by a 6K6, 6G6, 6V6, and in an emergency, even by a 6L6 or 6U6. (Plate loads may vary slightly). Note slight changes in filament and plate current.

6X5 by a 6W5 noting the .3 amp. extra load.

12Q7 (12SQ7) by a 14R7. However, it is necessary to tie screen grid to plate transforming it to a diode-triode and use an adaptor.

12SK7 by 12K7, by socket rewiring.

These suggestions should be of aid to the serviceman who is sometimes at his wit's end

when it comes to keeping a radio set going during this period. By using his judgement and a tube manual, practically every type may be conveniently replaced by some type which may be available. Such ingenuity will be greatly appreciated by the customer.

Following the RMA procedure at this location, the charge for rewiring a socket or making an adapter as above is \$2.00 plus the cost of the replacement tubes.

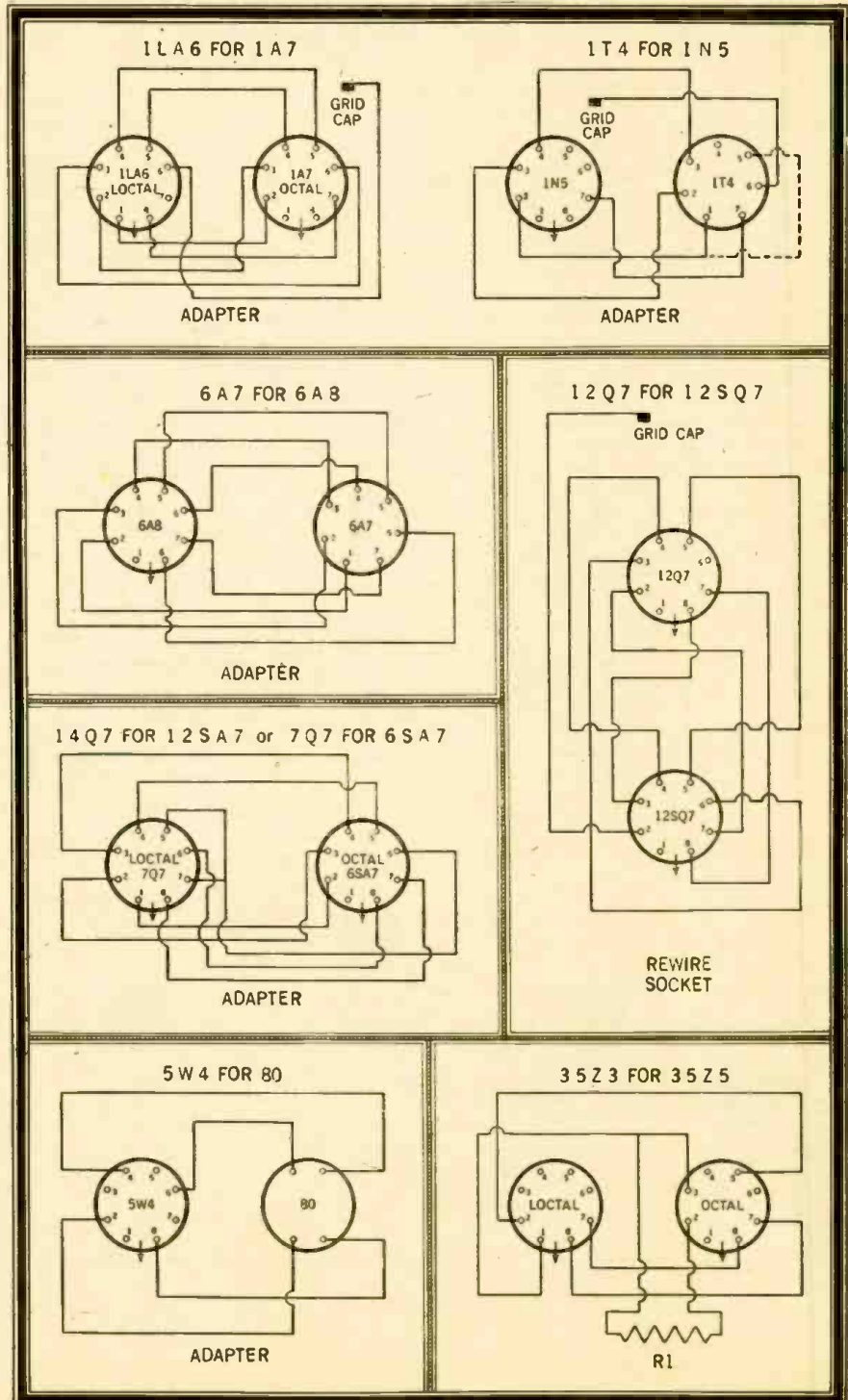

A 28-VOLT RECEIVER!

By DAVID GNESSIN

WHEN *Radio-Craft* came out with the data on the new use of a 28-volt circuit for tubes (December 1943 issue) it stirred up quite a bit of interest in circuit design. Imagine; a radio receiver (and even a transmitter, if need be) that would operate directly off of a 24- to 32-volt battery, with one source of supply for all voltages. No more power transformers, filter circuits, rectifier tubes or power supply stages would be needed in this design.

Of course, use of such equipment is limited to aircraft, mobile equipment, nautical vessels, rural districts and emergency equipment where a 24- to 32-volt battery is already installed for other functional uses. Still, that field is sufficiently large to envisage wide usage of equipment designed for these conditions.

The design shown here fits those specifications. All data was taken directly from manufacturer's releases. There is nothing *haywire* in the setup. It is commercially sound, and is engineered to give the greatest efficiency for the particular application.

Examining the design of the LOW VOLTAGE RADIO RECEIVER we note immediately the absence of the usual power supply. Let it be clearly stated here—ALL voltages; filament, plate, grid and bias voltages all come from the single 28-volt battery, or any arrangement of batteries which will deliver 24 volts to 32 volts. In the event the equipment is to operate from a 32-volt supply in continuous operation (24 hours daily) a heavy duty resistor should be placed in the filament circuit to reduce all filaments to 24 volts. This will insure longer tube life.

The filament circuit is drawn separately for clarity. It may be seen at the lower

left of the circuit diagram. Note the first two tubes, 14H7 and 14J7, are connected in series across the power supply. The next two tubes, both 14R7's, are connected the same way. The two 28D7's are each connected directly across the power supply, since they each draw 28 volts. Thus it may be seen that a single 14-volt tube may go out if a break occurs in the filament of its companion tube. In such cases a quick check for defective filament may be made by substituting the inoperative tube for another 14-volt tube operating in the circuit. *Warning:* Don't leave the tube in the wrong socket for a longer time than is necessary to check the filament circuit—and above all: Don't check a 14-volt tube in a 28D7 socket. The double filament voltage will burn out the 14-volt tube.

The receiver is a superheterodyne, with a stage of tuned R.F. and push-pull beam control is incorporated as a by-product of the detector stage. The sensitivity is good. The operating frequencies of the receiver are, of course, dependent upon the coils selected. No value for the coils is given since their inductance is set by the frequency band selected. Since they are of routine commercial design it is expected that once the band is selected the proper coils can be readily obtained. With good coils the receiver should give satisfactory response up to 100 megacycles.

The meter readings shown are all rated in milliamperes with maximum signal. Since the plate voltages will all be about the same, a little less than the supply voltage, these figures are not given. Thus, with the voltage and current for proper operation known, a check for good operation is readily available.

In brief, starting from the left side of the diagram, the description of the circuit is as follows:

The tuned radio frequency stage uses a 14H7. Only a little more than two years old in design this tube has found much popularity in R.F. and I.F. stages of television and FM receivers, where gain is so important. It is a triple grid semi-remote cut-off amplifier, identical with the type 7H7 except for heater rating. As the name implies, the automatic gain control action of this tube is limited by the semi-remote cut-off feature. However, its action in that regard is quite efficient in the medium frequency bands, dropping off at the higher frequencies, where a v. c. is not so necessary. No gain control is shown for this stage, since its bias is selected to give normal gain, with the a. v. c. to aid in caring for too weak or too strong stations.

The filter R_4, C_4 is used to keep the R.F. out of the power supply. A similar filter is incorporated in all stages up to the audio amplifier. It's really a "de-coupling" filter.

The 14J7 is a triode-hexode tube in the converter stage. Electrically this tube is the same as the type 7J7 except for heater rating. Using the cathode common to both units, the triode section of the tube acts as oscillator, while the pentode section acts as separate mixer. The injector grid is common to both sections of the tube, providing true electron coupling. The plate resistance is fairly high under these conditions, resulting in a very low plate-loading, making it possible to use highly efficient I.F. transformers to advantage. Frequency drift, shift and flutter is very low in this circuit.

Since the circuit already has a burden (Continued on page 555)

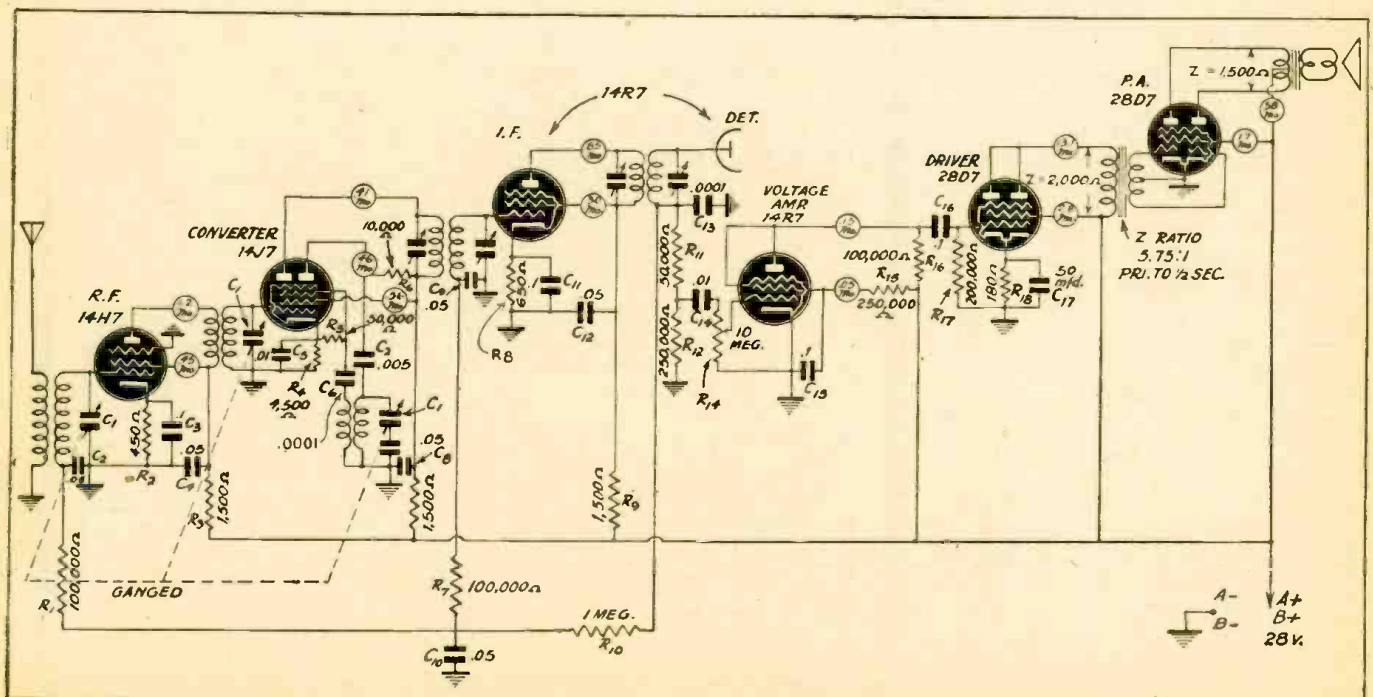

Reconditioning The Old Radio

By GERALD CHASE

HAVE thought for some time that many of the older sets, even those manufactured as early as 1930-31, could be dismantled and with the addition of a few new parts, rebuilt into receivers that would compare favorably with the average modern set. I therefore decided to try my hand at redesigning an old radio of the 1931 vintage, and the result of my work is quite satisfactory.

I used as many of the original tubes and parts as possible and so kept the cash outlay to a minimum. The total amount spent on this set was around ten dollars, but I believe this could be cut nearly in half in the United States.

In the revised circuit I included a few "extras" such as a radio-phonograph switch and a tone control as well as automatic volume control. The tone control works like a charm and I would like to give credit for it to Mr. Leon Wortman of Brooklyn, N. Y., who suggested the hook-up in the January 1943 issue of *Radio-Craft*.

The set I decided to remodel was a King 109 T. R. F. radio employing seven tubes including the rectifier. This radio had been discarded because of age and faulty components. I bought it for two dollars and at once proceeded to give it a "going over." I found the audio transformer, output transformer and speaker field were burned out and could not be used. The filter condensers in the power supply were beginning to dry up so I decided to be on the safe side and replace them with new ones. All of the fixed by-pass and coupling condensers in the revised version are new, as are many of the resistors, especially those carrying large currents.

THE REVISED CIRCUIT

The original circuit used three 24A tubes as R.F. amplifiers, a 27 as power detector and two 45's in push-pull as output. Of these tubes one 45 and two of the 24's were gassy and therefore useless. I decided to use three 35 tubes in the R.F. stages; the 27, with grid and plate tied together, as diode detector and source of a.v.c. voltage; and the one good 24 as first audio stage feeding into a single 45 power amplifier. This worked even better than I expected and I have a radio now that is as good, with regard to sensitivity, selectivity, tone and volume, as most of the modern superhets I have heard.

Since my only test instrument was a simple continuity tester, I decided to obtain a service data sheet on this particular set. The mail order house that furnished me with parts, supplied the data sheet and I was able to obtain accurate information on the operating voltages and currents of each stage. I also used my tube manual as much as possible. I advise anyone else doing this sort of remodelling to do the same, no matter what else they may have to work with.

When new components are used in parts of the set, voltages may differ from the original ones, calling for certain changes in

Top—Chassis view of the reconditioned King broadcast receiver, as remodelled. Bottom—Underchassis view of the same set, after modernization is completed.

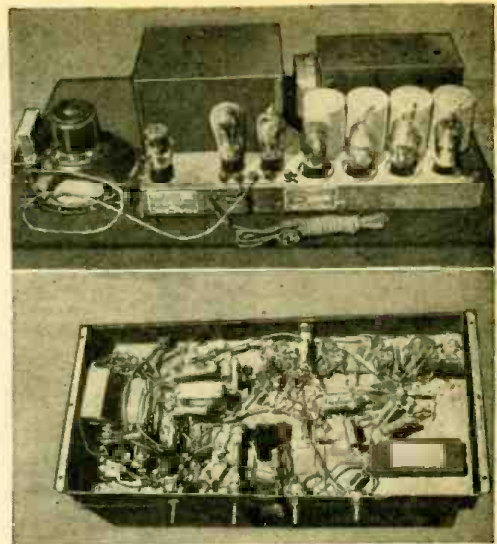

design. I used a speaker field having a resistance differing from the original and I also used different types of tubes in a revised circuit. I therefore found it necessary to change the power supply to some extent. By adding the "B" current drawn by each tube to that drawn by the "Bleeder" resistors, I estimated the total "B" current supplied by the high voltage secondary of the power transformer to be approximately 100 Ma. The resistance of the filter choke was 1000 ohms so the voltage drop across it was 100 v. Since the voltage taken from between the choke and the speaker field was 250 v., then the R. M. S. voltage at the filament of the rectifier tube would be $100 + 250 = 350$ v. Multiplying this by 1.41 gave a peak voltage of 493.5 volts which was the minimum rating for the first electrolytic condenser of 8 mfd. Similarly the minimum rating for the second condenser of 16 mfd. was 352.5 volts. To be safe I purchased condensers with ratings of 600 v. and 450 v. for C1 and C2 respectively.

The speaker I used was an 8-inch one I salvaged from an old Pilot radio. The field coil in this speaker had approximately 2000 ohms resistance as compared to 1400 ohms in the old King speaker, but both fields carried the same current—between

40 and 45 Ma.

By taking the plate voltage for the R.F. tubes and the 45 output tube from between the filter choke and speaker I got rid of about 55 Ma. This left 45 Ma. to flow through the speaker field. This was sufficient to magnetize it, but the voltage at the output of the filter circuit was 160 v. instead of 180 v. as in the old hook-up. With a bias of 1 volt and a screen voltage of 25 v. the 24A first audio tube draws around .5 Ma. This leaves 44.5 Ma. left. The screen grids of the R.F. tubes will draw a maximum current of 2.5 Ma. each at a potential of 90 v. according to the tube manual. Therefore, I decided that at a potential of 70 v. the grids would draw about 1.5 Ma. each. (The lower screen voltage decreased chances of oscillations in the R.F. stages.) The total screen grid currents would then equal 4.5 Ma. leaving 40 Ma. to be drained off by the "bleeder" circuit.

Knowing the voltage drop to be 90 v. (160 v. to 70 v.) and the current to be 44.5 Ma., I just used Ohm's Law to find that the value required for R1 was 2,022 ohms. (A resistance of 2000 ohms proved quite satisfactory.) This left a voltage drop of 70 v. with a "bleeder" current of
(Continued on page 560)

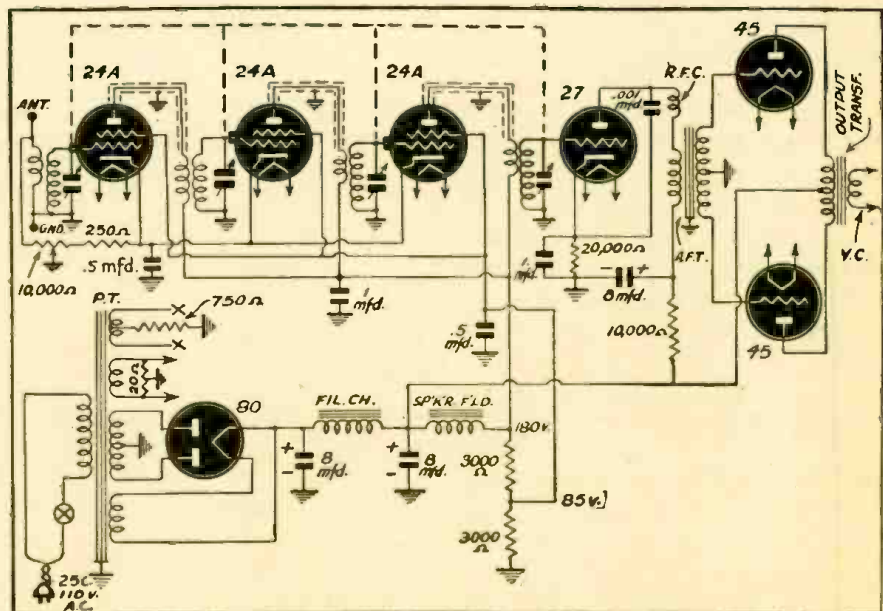

Schematic of the original old-type TRF King receiver, with its line-up of 24A's and 45's.

World-Wide Station List

Edited by ELMER R. FULLER

THE number of new stations appearing on the air during the past month is much smaller than have been heard in the past. The only new catch we have reported for this issue is BPDY on 6.100 megacycles. This is located in the Fiji Islands at Suva. We have no operating schedule, so if anyone knows any more about it, let us hear from you!

We have for this month, a list of the frequency modulated stations located in the vicinity of Chicago, Illinois. They are WGNE, 45.9 megacycles, heard daily from

3 to 9 pm; WDLN, on 47.5 megacycles, heard daily, 10:30 am to 8:30 pm; and WVZR, on 42.5 megacycles, heard Monday through Friday from 9:30 am to 2:30 pm.

Two transmitters now being used by the Allied armies in Italy are known as APH and ICA. APH uses the same frequency as AFHQ in Algiers, Africa, 8.960 megacycles; and ICA uses a frequency of 13.22 megacycles. 13.22 is also used by the army transmitter at New Caledonia. We do not know much about this station.

An unknown station reported last month

on 9.890 mcs. from 3:15 to 3:45 pm may be located somewhere in occupied or unoccupied France. It comes in fairly well, with much CW interference at times. French, German and Italian are spoken. The program consists of talks and music, and the announcer is usually a girl, with a very clear voice. All languages are well spoken.

Keep one eye on the twenty-meter band for the South American ham, who are beginning to come in during the early evening. Please report them to us.

Mc.	Call	Location and Schedule	Mc.	Call	Location and Schedule	Mc.	Call	Location and Schedule
2.500	WWV	WASHINGTON, D. C.; U. S. Bureau of Standards; evenings.	6.060	WCDA	NEW YORK CITY; Mexico beam, 7:30 pm to 2 am; European beam, 2:15 to 4 am.	6.220	—	"GUSTAV SIEGFRIED EINS"; 7:50 to 8 pm.
2.926	GRC	LONDON, ENGLAND.	6.065	SBO	MOTALA, SWEDEN; European beam, 5:15 to 5:50 pm; North American beam, 9 to 10 pm.	6.23	—	MOSCOW, USSR; heard at 8:45 pm.
3.300	YV10RX	CARACAS, VENEZUELA; late evenings and early am.	6.070	CFRX	TORONTO, CANADA; Sundays, 9 am to midnight; Monday to Friday, 7:30 am to 12:05 am; Saturday, 7:30 am to 12:45 am.	6.235	HRD2	LA CEIBA, HONDURAS; evenings.
3.470	YV7RB	VENEZUELA; relays YV5RA from 9 to 10:30 pm.	6.080	WLWK	CINCINNATI, OHIO; European beam, 12:15 to 2:30 am; West South American beam, 8:30 pm to midnight.	6.243	HIIN	CIUDAD TRUJILLO, DOMINICAN REPUBLIC; evenings.
3.510	YV3RS	BARQUISIMETO, VENEZUELA; relays YV3RA evenings.	6.090	CBFW	VERCHERES, CANADA; daily, 7:30 am to 11:30 pm (in French).	6.27	HJCR	BOGOTA, COLOMBIA; heard at 8 pm.
4.020	—	PONTA DELGADA, AZORES; 6 to 8:01 pm.	6.090	ZNS2	NASSAU, BAHAMAS.	6.280	HIIZ	CIUDAD TRUJILLO, DOMINICAN REPUBLIC.
4.107	HCJB	QUITO, ECUADOR; 7:45 to 10 am; 8 to 10 pm; daily except Mondays; Sundays, 9 am to 8 pm.	6.095	OAX4H	LIMA, PERU.	6.330	COCW	HAVANA, CUBA; midnight to 1 am.
4.70	ZQ1	KINGSTON, JAMAICA; Sunday, 6:15 to 6:55 pm; daily, 6:15 to 7:15 pm.	6.100	WKRD	NEW YORK CITY; European beam, 6:45 to 9:45 pm; 11:45 pm to 3:30 am.	6.345	HER4	BERN, SWITZERLAND; 9:30 to 11 pm daily except Saturday.
4.75	YV1RV	MARACAIBO, VENEZUELA.	6.105	HJF8	SUVA, FIJI ISLANDS; 2:15 to 4:15 am.	6.357	HRP1	SAN PEDRO SULA, HONDURAS; heard about 10:30 pm Sundays; may be on at other times.
4.76	YV4RO	VALENCIA, VENEZUELA	6.110	GSL	MANIZALES, COLOMBIA; 9 to 10 pm.	6.370	—	LISBON, PORTUGAL; home service, 4 to 8 pm.
4.765	HJF8	MANIZALES, COLOMBIA.	6.120	WOOC	LONDON, ENGLAND; North American beam, 8 pm to 12:45 am.	6.370	WKTM	NEW YORK CITY; European beam, 6 pm to 5 am.
4.78	YV3RN	BARQUISIMETO, VENEZUELA.	6.120	XEUZ	NEW YORK CITY; European beam, 7:15 pm to 3:30 am.	6.380	HIIX	CIUDAD TRUJILLO; DOMINICAN REPUBLIC.
4.79	YV6RU	BOLIVAR, VENEZUELA; evenings.	6.120	WCRC	MEXICO CITY, MEXICO; heard before midnight.	6.405	TGQA	QUEZALTENANGO, GUATEMALA; 9 pm to 2 am.
4.82	XEJG	GUADALAJARA, MEXICO; evenings.	6.120	LRXI	NEW YORK CITY; European beam, 12:15 to 2:45 am.	6.440	HIIS	SANTIAGO DE LOS CABALLEROS, DOMINICAN REPUBLIC; 6 to 8 pm.
4.92	YV5RN	CARACAS, VENEZUELA; late evenings and early am.	6.130	JZH4	BUENOS AIRES, ARGENTINA; "Radio El Mundo"; 9 to 12 pm.	6.47	COHI	SANTA CLARA, CUBA; afternoons and evenings.
4.955	HJCQ	BOGOTA, COLOMBIA; evenings.	6.130	COCD	TOKYO, JAPAN; 11 am to 2:40 pm.	6.480	TGWB	GUATEMALA CITY, GUATEMALA; 7 am to 8:10 pm daily except Sunday.
5.000	WWV	WASHINGTON, D. C.; U. S. Bureau of Standards; Standard of frequency; time, and musical pitch.	6.130	CHNX	HAVANA, CUBA; 9 pm to 1 am.	6.63	HIT	CIUDAD TRUJILLO, DOMINICAN REPUBLIC; heard at 8:45 pm.
5.620	OAX2A	TRUJILLO, PERU; heard Sundays 7:30 to 8 pm.	6.140	WBOS	HALIFAX, NOVA SCOTIA; Sundays, 8 am to 6:55 pm; Monday to Thursday, 6:45 am to 10:15 pm; Friday, and Saturday, 6:45 to 11 am.	6.715	ZLT7	WELLINGTON, NEW ZEALAND; daily at 5:30 or 6 am.
5.75	PZX	PARAMARIBO, DUTCH GUIANA; Friday, 7 to 7:30 pm.	6.145	HJDE	BOSTON, MASS.; European beam, 3:45 to 5:30 am.	7.000	WGEA	SCHENECTADY, N. Y.; Brazilian beam, 8:30 to 11:30 pm; European beam, 11:45 pm to 3 am.
5.810	KRO	HONOLULU, HAWAII; news in English at 7:45 am.	6.145	HJDE	BOSTON, MASS.; North African beam, midnight to 2 am.	7.014	CMZI	HAVANA, CUBA; 11 pm to 12:10 am.
5.875	HRN	TEGUCIGALPA, HONDURAS; 7 pm to midnight; Sundays, off at 10:45 pm.	6.145	HJDE	BERLIN, GERMANY.	7.020	—	PONTA DELGADA, AZORES; heard Sundays 4 to 5 pm.
5.88	—	CAPETOWN, SOUTH AFRICA; heard around midnight.	6.150	CJRO	MEDELLIN, COLOMBIA; 9 to 11 pm.	7.02	—	MADRID, SPAIN; 5 to 7 pm.
5.935	PJCI	CURACAO, NETHERLANDS WEST INDIES; 7:45 to 10:38 pm.	6.150	GRW	WINNIPEG, CANADA; 9 pm to 1 am.	7.070	GRS	LONDON, ENGLAND.
5.947	HH2S	PORT AU PRINCE, HAITI; 8:45 to 7 pm.	6.160	HJCD	LONDON, ENGLAND.	7.12	GRM	LONDON, ENGLAND; 8:15 pm to 4 am.
5.980	VONH	ST. JOHNS, NEWFOUNDLAND; Sundays 8:30 to 10:30 am; 1:30 to 6 pm; other days, 6:30 to 10:30 am; 2:30 to 7:30 pm.	6.160	HJCD	BOGOTA, COLOMBIA; 9 to 10 pm.	7.171	XGOY	CHUNGKING, CHINA; East Asia, South Seas, North America, and Europe; 7:35 am to 12:30 pm.
6.000	HH2S	PORT AU PRINCE, HAITI; 7:35 pm Saturdays.	6.160	CBRX	VANCOUVER, CANADA; 10:30 am to 2:30 am.	7.180	—	"STATION DEBUNK"; 8:30 to 9 pm.
6.005	HP5K	COLON, PANAMA; 8:30 to 9:30 pm.	6.165	HHBM	PORT AU PRINCE, HAITI; 7 to 10 pm.	7.185	GRK	LONDON, ENGLAND; early morning.
6.005	CFCX	MONTREAL, CANADA; Sunday, 7:30 am to 12 midnight; Monday to Saturday, 6:45 am to 12 midnight.	6.180	XGEQ	CHUNGKING, CHINA; heard mornings; girl announcer.	7.205	BBC	LONDON, ENGLAND; Far eastern beam, early mornings.
6.010	GRB	LONDON, ENGLAND; evenings.	6.180	HJCX	BOGOTA, COLOMBIA; 7 pm to 12:15 am.	7.210	—	BERN, SWITZERLAND; heard at 9:30 pm.
6.010	CJCX	SYDNEY, NOVA SCOTIA; Monday to Friday, 7 to 11 am; Saturday, 6:45 to 11 am; Sunday, 8 to 11 am.	6.190	DXG	BERLIN, GERMANY.	7.220	ZRO11	ROME, ITALY; 5 to 6:30 pm.
6.020	ZFY	GEORGETOWN, BRITISH GUIANA; 3:15 to 8:20 pm.	6.19	—	TOKYO, JAPAN; heard in the early morning.	7.230	GSW	LONDON, ENGLAND.
6.030	CFVP	CALGARY, CANADA; Sunday, 10 am to 1:30 am; Monday, to Saturday, 8:30 am to 2 am.	6.190	WGEO	SCHENECTADY, NEW YORK; 12:15 to 3:15 am; European beam.	7.230	KWID	SAN FRANCISCO, CALIF.; Oriental beam 3 am to 12:45 pm.
6.03	DXP	BERLIN, GERMANY.	6.200	ZYC7	RIO DE JANEIRO, BRAZIL.	7.24	DXJ	BERLIN, GERMANY.
6.040	WRUW	BOSTON, MASSACHUSETTS; European beam, 2:15 to 4 am; Central American beam, 7:30 pm to 2 am.	6.20	GRN	LONDON, ENGLAND.	7.250	WBOS	BOSTON, MASS.; East South America beam, 8:30 pm to midnight.
6.04	COBF	HAVANA, CUBA; afternoons.	6.200	ZYC7	RIO DE JANEIRO, BRAZIL.	7.250	KGEI	SAN FRANCISCO, CALIF.; Oriental beam, 1 am to 1 pm.
6.05	GSA	LONDON, ENGLAND.	6.20	GRN	LONDON, ENGLAND.	7.260	GSU	LONDON, ENGLAND; North America beam, 8:15 pm to 12:45 am.
			6.2	YV5RN	CARACAS, VENEZUELA; early evenings.	7.275	DXL25	BERLIN, GERMANY.
						7.290	DJX	BERLIN, GERMANY.

(Continued on page 574)

War-Time Transceiver

A Training Project Adaptable to WERS Applications

By HOMER L. DAVIDSON

AFTER completing a seven months E.S.M.D.T. radio course, the author enlisted in the Seventh Corp. Area E. R. C. radio school. This school consisted of three eight hour shifts of which four hours were on studying radio fundamentals and the latter four hours of lab. work. The lab. work sheets covered power supplies, regenerative receivers, oscillators, audio amplifiers, and small transmitters, which were constructed in a period of nine weeks (in my case), leaving three weeks open for personally selected construction. The instructor, of our class, was a good O.M. and we chose our own units.

A few of us were interested in the ultra-high frequency spectrum because of reading so much on WERS and the United States Army's Walkie-Talkie. We rounded up a few circuits and diagrams on transceiver building and added a trifle of our own ingenuity. Material was difficult to obtain, but found most of these parts in the scrap box and in old radio receivers.

CONSTRUCTION DETAILS

The chassis was a sheet of galvanized furnace metal with a $\frac{3}{4}$ -inch edge, in which holes for holding the outside panels together with metal screws were drilled. All holes were laid out and drilled before bending the chassis into place.

The outside panels were cut from glazed fiber board (Masonite) like that used on kitchen and bathroom walls. These rectangular pieces are mounted after all parts are in position and wired electrically, except the panel on which the transmit and receive toggle switches, volume control and phone jacks are mounted. It is best to mount all parts on this panel and permanently secure in place before wiring.

The eight-prong, isolantite octal tube sockets were mounted vertically, opposite each other; the vacuum tubes being mounted horizontally for compactness. A small angle-iron holds them in place. The 6J5's tube socket butts against the small variable tuning condenser, thus eliminating long leads to the small coil which was soldered directly to the prongs of the tube base. Short connections are required at high frequencies.

To destroy hand capacity the two-plate variable condenser was placed against the base of the 6J5's tube prongs approximately five inches from the front panel. A small quarter-inch fiber rod, coupler, and knob were used to extend the shaft of this small condenser, which was a three-plate band-spread capacitance with one plate removed.

The toggle switches were a D.P.D.T. and two S.P.S.T. for switching microphone headphones into the circuit.

Since we had no ultra-high frequency chokes all set to work to wind one, using a three megohm carbon resistor as a form. This space was wound full of No. 28 D.C.C. magnet wire, soldering the ends directly to the pigtales to make the choke easy to mount, self supporting and compact.

There are two transformers, one in the grid circuit and one in the plate circuit of the 6V6-GT tube. The audio transformer was a small 3 to 1 ratio on which another

winding was wound over the original primary. Remove the laminations and the first layer of heavy brown paper. Underneath the heavy brown paper lie layers of thin wax transformer paper. Removing these, you can see the windings of very small black enamelled wire. Place two layers of wax paper over this winding and wind approximately 75 turns of 36 enamel wire or wire taken from an old transformer. On our transformer it took two layers of wire, insulating between layers with wax paper. Bring out two small four-inch leads and place spaghetti over them to insure good insulation. The layers of thin wax paper can now be wound on, being sure that this winding will be protected from shorting the laminations and shell of the transformer. This transformer was dipped into transformer coil dope although it isn't necessary. The laminations were carefully put back in position, with care not to scrap the windings, as the additional winding enlarges the transformer core somewhat.

A small 7 to 30 henry choke can be used for Heising modulation. The choke used by this constructor was the primary of a small output transformer. It was mounted at the base of the modulator tube.

The volume or regeneration was controlled by a 50,000 variable resistor in the plate circuit of the detector, inserted in series with a 250,000 ohm fixed carbon resistor to drop the voltage from the 250-volt power supply. The fixed bias on the audio amplifier or modulator is accomplished by a 400-ohm carbon resistor and a 10 mfd. electrolytic condenser of 25 volts D.C. rating.

TESTING PROCEDURE

To test the small transceiver in transmitting position the D.P.D.T. switch and the microphone switch is thrown. When the operator talks into the carbon grain microphone he can hear himself in the phones, proving the audio section is functioning properly. The only instrument used to test the transmitter for oscillation and correct modulation was a very small neon glow bulb. With one side of the neon bulb hooked to the coil L1 at the antenna end the variable condenser is rotated for maximum glow. Now talk into the microphone and modulation the neon glow to pulsate.

The transmitter is now ready for antenna loading.

Loading of the transmitter is very critical, at least when using the type of condenser coupling shown. This capacity coupling was used because it would load the transmitter to maximum, although a one turn loop of 14 enamel may be loosely coupled in its place. With a small insulating screw driver the two plate trimmer is tightened until the neon glow comes in faint while modulating. The transmitter section is now ready for service.

The receiving section of the transceiver can now be tested by switching the D.P.D.T. switch to "receive," with the mike switch out of the circuit. By turning up the regeneration control the receiver should pop into a hissing noise. This background noise indicates regeneration. The tuning control is turned until oscillations take place over the whole dial. The small trimmer condenser in the antenna may be too tightly coupled and should be loosened until a setting where transmitting and receiving is obtained with satisfactory results.

ANTENNA AND POWER SUPPLY

The antenna used by us was nothing more than $\frac{1}{4}$ inch copper tubing purchased from a hardware store. It was a gas line originally. The antenna insulators were ceramic insulators until they cracked and broke. They were then replaced by mica strips. The antenna can be dismantled easily by unscrewing two small wing nuts.

This small transceiver requires 6.3 volts A.C. for the heaters and 250 volts D.C. "B" supply. A female 8 prong octal wafer socket was mounted in the rear panel so a cable with a male plug can be inserted from a full wave rectifier. The rectifier section consists of an 80 tube, high voltage transformer, three 8 mfd. electrolytic condensers, and two 30-henry chokes with condenser input filtering.

When the transceiver was completed and tested we requested permission from the instructor and school to test the unit out. A ten minute transmission was completed across the work tables. We then placed one of the units at each end of the hall and proceeded to burst the ether. The

(Continued on page 571)

Two ordinary receiving tubes are the complement of this small transceiver, one of the simplest and most straightforward which has been described in this magazine. The special transformer is a modified 3-to-1 audio unit.

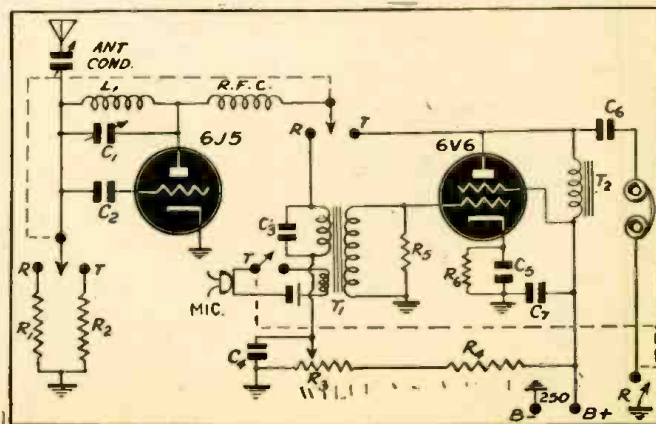

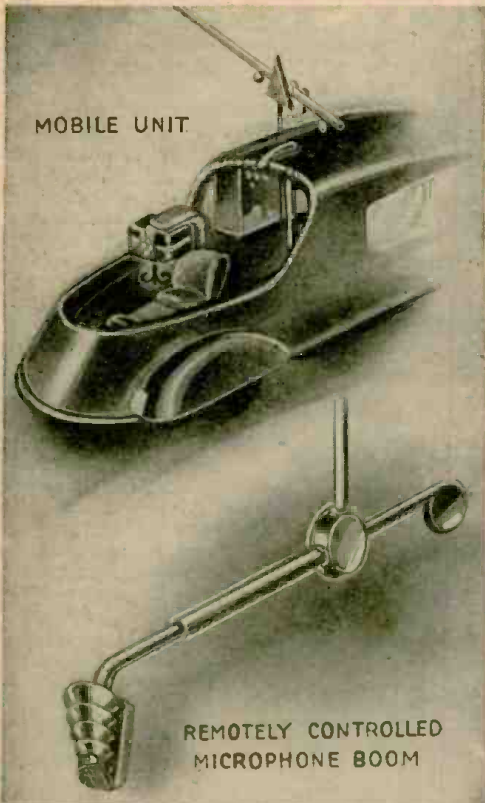
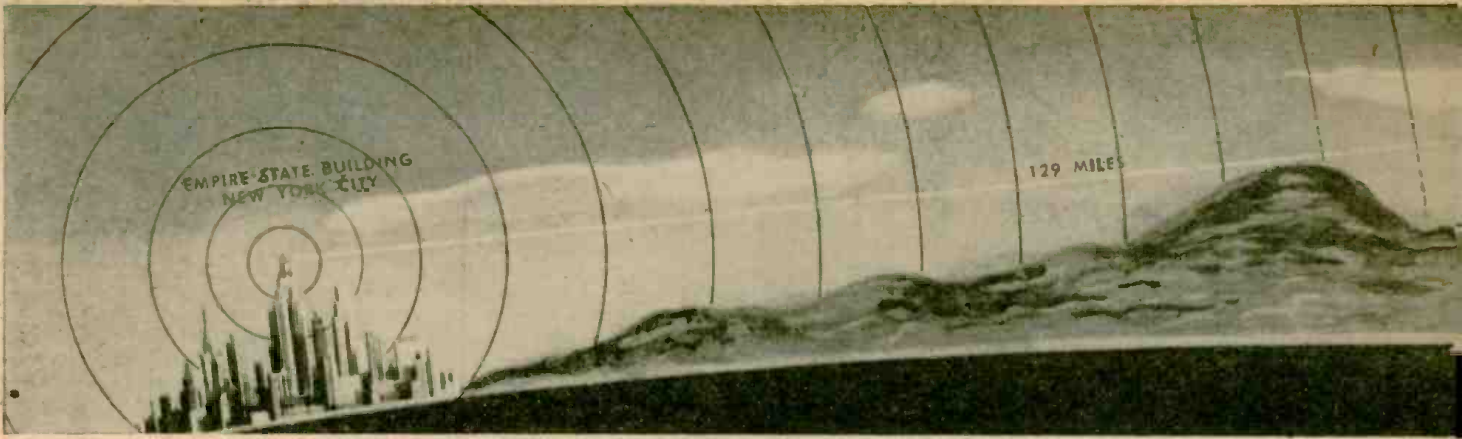

PREVIEW of Post-Broadcast and Relay Stations, Aerials

ASKED in a recent survey, "What new inventions will raise your standard of living after the war?" 877 out of 1500 people unhesitatingly answered "Television!" Such is the grip which this new art has on the mass imagination. And imagination is not confined to the future users of home television equipment, as is amply proved by the illustrations around this page. These are by no means the futuristic dreams of professional "post-war planners"—they are the sober designs of General Electric engineers, and there are excellent technical reasons for every departure from conventional practice of today.

The broadcast studio itself will be radically different from most of today's structures, if the model designed by Austin Engineers—a photograph of which appears in the lower left corner—is to be taken as typical. Among the interesting new ideas are the double auditoriums, shown at AA. The revolving stage, B, permits the rapid change of scenes necessary in certain television shows. A spacious lobby, with cut-in space for offices, is seen at C.

The aerial of the new television studio-station is mounted on the single thin mast, and the top assembly may be studied in the lower right-hand illustration. High frequencies call for the use of small reflectors which can be enclosed to protect them from the elements.

The large area around the revolving stage makes for easy storage and handling of sets and properties, while the large doors at the rear permit bringing even an airplane into the show, if necessary. Because of the two auditoriums, no time is lost between shows. While audiences are watching one performance, the second auditorium is filling up.

This broadcasting studio-station need only have power enough to beam its signals to the main transmitter, which will be situated on high land outside the city in which the studio is located. The main transmitter will not only cover the area with a

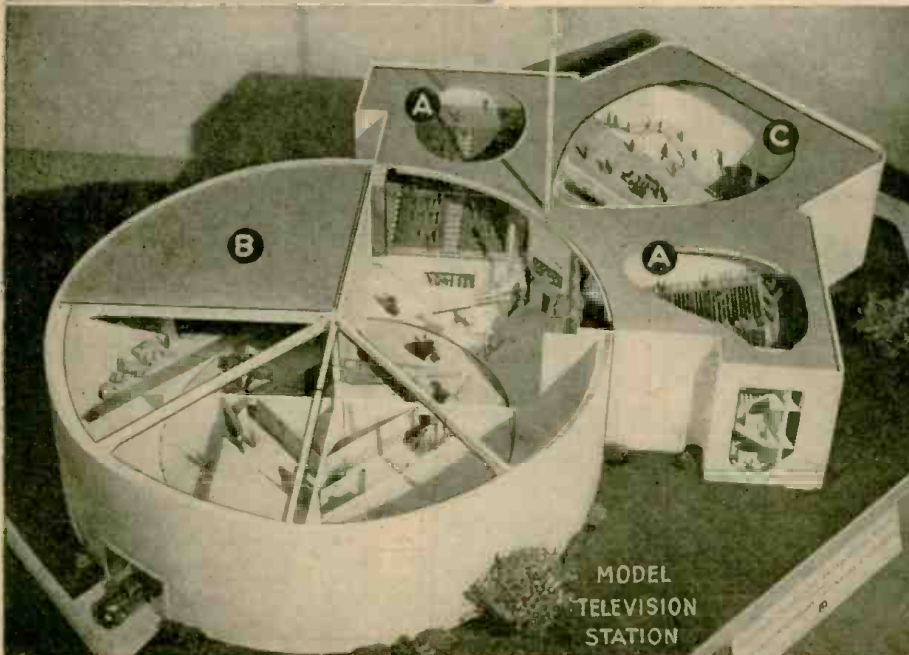

MODEL TELEVISION STATION

NEW U.H.F. TUBE FOR TELEVISION

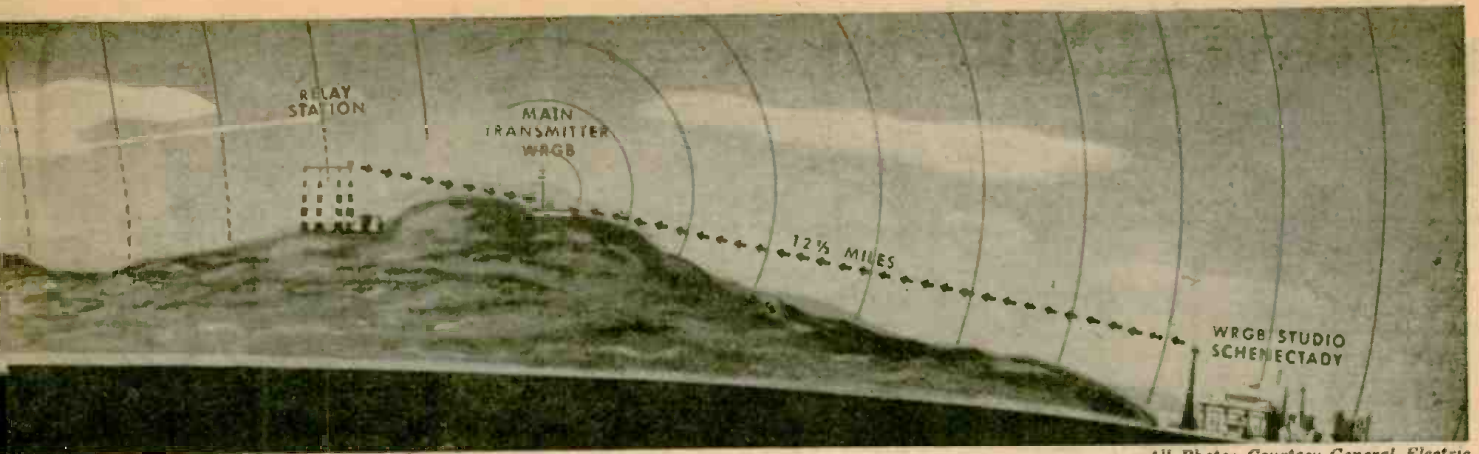

All Photos Courtesy General Electric

Var TELEVISION

Studios and Apparatus of the Future

powerful signal, but will also supply the program to a number of relay stations near the edge of its working area.

This relay system is expected to be the main feature of post-war television. It has already been proved practical, and relay hookups are in use at present. WGRB, the General Electric television station at Schenectady, receives by relay and rebroadcasts signals from New York City's WNBT. One of the most interesting features of the combination is that the relay station, in the Helderberg mountains, about 15 miles from Schenectady, is nearly a mile below the direct line-of-sight from the antenna on the Empire State Building. In spite of this, a strong enough signal is received to make relaying quite practical. The drawing at the top of the page illustrates this very well. The heavy lines indicate the area of full-strength reception—the dotted ones those areas in which some signal is received.

A special type of television re-broadcaster will be the *satellite station*. This will receive its programs from relay stations and send them out at higher power to cover the cities near which they are located. Unlike the relay stations, which will operate unattended, these stations will be staffed. Unlike the main stations, these satellites will originate no programs of their own. Free from studios and pickup problems, the stations can be comparatively small—perhaps as compact as the one shown at the foot of the tower to which Mr. James D. McLean (G-E electronic engineer) is pointing, in the lower right-hand picture.

Not only in station and antenna design are revolutionary developments expected in post-war television equipment. The dynamic nature of television programs calls for a smoothly mobile camera, following the scenes and shooting from all desired angles. The self-propelled dolly at bottom center may be the answer. Controlled by means of foot pedals, it can be anywhere at any moment. The camera, with its turret-type lenses, is so

(Continued on page 557)



MOBILE CAMERA UNIT



CAMERA



SELF PROPELLED CAMERA DOLLY

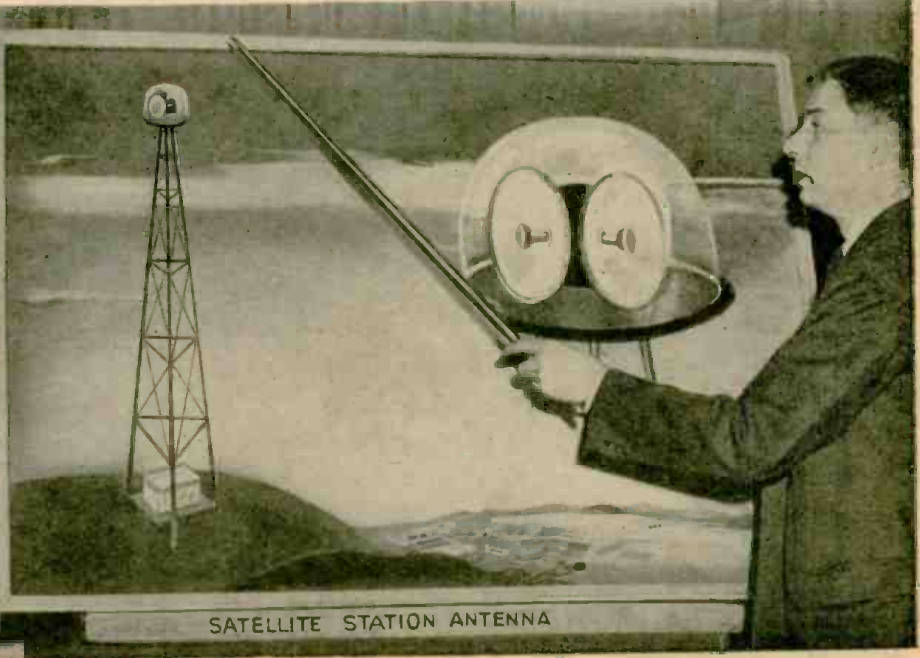

SATELLITE STATION ANTENNA

New Radio-Electronic Devices

AUDIO AMPLIFIER

The Langevin Co.
New York City

A NEW amplifier, the Langevin 101-A, is announced. Its outstanding virtue is excellent low-frequency wave form at high output levels. Volume range is excellent, inherent noise level being 68 db unweighted below full output of plus 47 VU at 2% R.M.S. harmonic distortion. With an input impedance of 600 ohms, the gain is 60db. Using bridging input, the gain is 46db. Output impedance is adjustable 1 to 1000 ohms.—*Radio-Craft*



TUNING-DIAL LOCK

The Radio Craftsmen
Chicago, Illinois

A TUNING-DIAL lock, originally engineered and manufactured for use as a tuning control for the frequency tuning unit of the famous Hallicrafters SCR-299 mobile unit, is now available to other manufacturers.

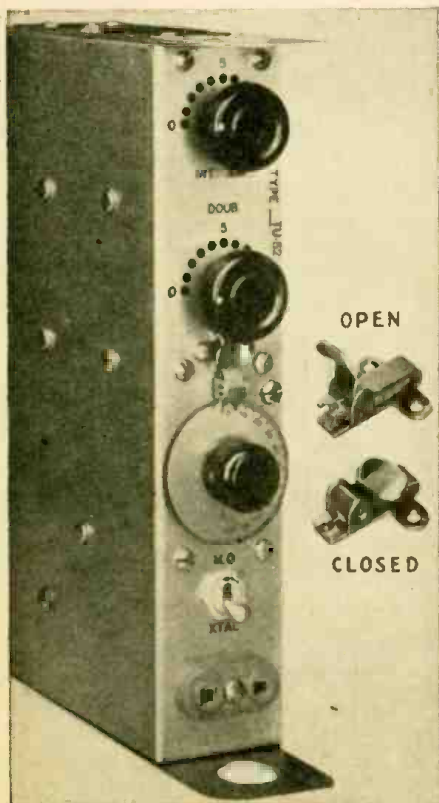

This product performs a dual function—(1) a dial lock that will accommodate a wide range of dial thicknesses—(2) a precision tuning indicator that maintains a fixed position on the dial simply by snapping the lock. Thus, speedier tuning is achieved over the ordinary set-screw type of dial lock.

Production problems are cut to a minimum as this dial lock is a metal stamping and is not affected by the prevailing scarcity of screw machine parts. The finished product is nickel-plated brass.—*Radio-Craft*

ELECTRONIC WINDING TESTER

General Electric Co.
Schenectady, N. Y.

EMPLYING the principle of balance and comparison, the instrument simultaneously tests turn-to-turn, coil-to-coil, and coil-to-ground insulation. It simulates qualitatively such procedures as resistance, impedance-balance, turn-balance, and complete high-potential tests with one voltage application.

The new instrument is particularly desirable for testing the completed windings of three-phase, low-voltage rotating machines, although it is also capable of testing the windings of single-phase, two-phase, and D.C. motors and transformers whose insulation is not designed to withstand more than 10 Kv.

When the tester is used to test a three-phase motor, the three instrument leads are connected directly to the three motor leads. After the electronic circuit in the tester is energized, any two phases of the motor (1-3, 2-3, 1-2) can be tested quickly by means of a four-position, hand-operated selector switch on the front of the meter. Short-circuits or grounds in any part of the winding are indicated on the oscilloscope by two waves dissimilar in shape and amplitude.

Single-phase motors are tested similarly, and D.C. motors by the bar-to-bar comparison methods. In both cases the divergence between the two waves on the oscilloscope indicate the presence of faults.

The tester consists of a repeating-type, surge-voltage generator, a cathode-ray oscilloscope, and a synchronously driven switching equipment—all enclosed in one steel cabinet especially designed for bench mounting. The oscilloscope is mounted at eye-level height, where it can be seen easily by the operator, and all the controls are conveniently arranged. Adequate safety protection has been built into the equipment.—*Radio-Craft*

CIRCULAR SLIDE RULE

Tavella Sales Co.
New York, N. Y.

THE Monitor Slide Rule is a circular type especially adapted for carrying in the brief case. Made of white vinylite, it is small in size, light in weight, non-moisture-or-grease-absorbing.

The scales are on a disc 6 inches in diameter, length of the outside scales 13.8 inches. The front of the rule carries the C, D, CI and Log scales. The reverse side has the A and B scales and sines and tangents.—*Radio-Craft*

BATTERY CONNECTORS

Cannon Electric Development Co.
Los Angeles, Calif.

A NEW development in quick disconnect battery connectors particularly adapted to G-1 standard batteries conforming to AN-W-B-141 specifications has been recently designed and manufactured.

Based on the screw jack principle found in many Cannon Connectors, this new fitting speeds removal of batteries and banishes shorting and fire hazards. The large handwheel which turns a gear and disengages the battery is notched and easily operated by a gloved hand in sub-zero temperatures. The pin contacts in the receptacle are so enclosed by its shell that the contacts cannot touch any outside metal surfaces during removal and hence will not short.

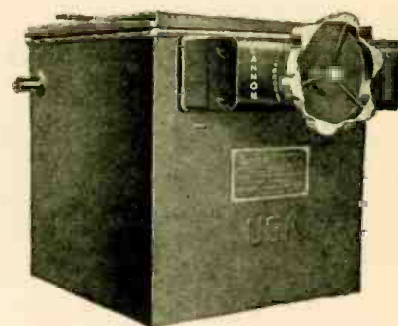

Receptacle No. 11749 also called the "Battery Kit" because it is affixed to the case, is made of aluminum alloy, finished with black acid-proof lacquer. The two pin contacts are leaded copper for 12-24 volt rating, 600 amperes continuous duty.

Plug No. 11751 shell material is moulded phenolic, and the handwheel aluminum alloy, having an acid-proof black lacquer finish. Cable outlets of 3/8 inch diameter are located on both ends of the connector, with possible alternate arrangements of cables, if desired.—*Radio-Craft*

FLUX METER

J. Thomas Rhamstine
Detroit, Michigan

A N Electronic Permeability Comparator for Permanent Magnet Testing. A new type electronic fluxmeter, this instrument was developed as an aid in production of radio and radar instruments and may be used for checking and comparing the magnetic flux of any type of permanent magnet.

Designed primarily for checking the saturation of special Alnico meter magnets, the device can be used for comparing various types of magnet steel. Different sizes and shapes of search coils may be used and may be small enough to insert in the air gap of assembled meters. This feature may at times be of considerable use in certain types of production testing.

A direct reading indicating meter shows the flux as long as the search coil is in the magnetic field.

This new permeability comparator has no moving parts besides the indicating meter and employs a special vacuum tube circuit operating from the A.C. mains.—*Radio-Craft*

SPRAGUE TRADING POST



A FREE Buy-Exchange-Sell Service for Radio Men

IMPORTANT NOTICE!

We discourage offers to buy or sell anything beyond the O.P.A. ceiling prices, and will not knowingly accept such ads for the Sprague Trading Post.

WANTED—V-O-M and a tube tester for new shop. All inquiries answered. Thomas Faria, 29 Denison Ave., New London, Conn.

WANTED—New Meisner analyst, also two heavy-duty 12" or 15" speakers. PM preferred. Cash. George Salt, 694 N. Cass St., Milwaukee 2, Wis.

FOR SALE—Jewell No. 408 4-meter analyzer. \$25. Howard H. Hofmeister, Schofield, Wis.

FOR SALE OR SWAP—New Turner RD dynamic mike complete; C-D type BN capacitor bridge complete; Dumont 5" scope new tube. Would like to get good oscillator such as Precision E-200; All-wave comm. receiver; Shure unidirectional; Astatic X-50 or K-2 or DX-112; 16" 33-78 recording & playback eqpt. with or without amplifier; also good pocket multimeter. R. N. Eubank, 1227 Windsor Ave., Richmond 22, Va.

FOR SALE—Sargent comm. receiver model 51-TR, super-het, used seven months. Also 2 Federal F-123-A tubes, new in original cartons. Arthur B. Chapelle, P.O. Box 588, Fresno 9, Calif.

WANTED—Frequency standard such as Hallcrafters HF7, Mims rotor mount, Weston No. 665 analyzer. Give full details. H. V. Cushing, 2326 25th St. S.E., Washington 20, D. C.

WANTED—Communication receiver such as Echophone, Sky Buddy, or what have you? Cash. Rush information. J. L. Troe, 8-1/C, Co. 25-b, Bldg. No. 2, U.S.N. Radio Tech School, College Station, Texas.

FOR SALE—Will sell all eqpt. & supplies from my small radio and appliance repair shop. Includes both new and used material. Write for complete list. R. W. Wood, Wood Electric Shop, 10950 Longview Ave., Detroit 5, Mich.

WANTED—Radio analyzing eqpt. such as Precision 920 multimeter; also a sig. generator, a vibrator tester, and a capacity analyzer. Thomas C. Higdon, 2515 32nd St. S.E., Washington, D. C.

WANTED—Complete instructions on Philco Volt-Ohmmeter No. 625. Will pay reasonable price. Wm. T. Paladino, 439 Greenwood St., Bridgeport 6, Conn.

FOR SALE—250-watt transmitter (pair of 805's); 6-15 watt portable-mobile transmitters; Brownline frequency meter 8-1; 200 ft. co-axial cable; Motorola 960-17 receiver; RCA 30 to 40 mc. police receiver, crystals, mikes, and associated eqpt. Write for list. Carson A. Andrick, 1357 Adams St. N.E., Washington 18, D. C.

WANTED—All commonly used types of service test eqpt. Cash. Describe fully. Clarence H. James, 532 Graham Ave., Port Arthur, Texas.

FOR SALE—Vols. 1, 2, 3, 4, Rider's manuals, \$35; 6 vols. RCA manuals, \$20; Triplet 1220 point-to-point tester, \$5; Grifing test speaker unit, \$10; RCA test oscillator, \$35; Supreme tube tester No. 35, \$45; Supreme multimeter & analyzer No. 31, \$75; Domestic Appliance Service, Bridgehampton, L. I., N. Y.

FOR SALE—Practically new No. 1250 Superior Inst. Co. Tube Tester which also tests ac-dc voltages, currents, capacities, resistances, decibels, & watts. \$25. Also Crowley X-ray, \$30. Miller Electric Co., Ellenville, N. Y.

WANTED—AD-purpose sig. generator and all-purpose multimeter for student. R. N. Harris, Box 41, New Laguna, N. Mex.

FOR SALE—Dynamometer, signal generator, and tube checker, all Superior Inst. Co. and practically new. Also: 1 ac-dc multi-tester, RCP; 1 dc voltohmmeter, RCP; 3 milliammeters, GE 0-1 ma (DC) new; 1 ammeter, GE, 0-10 A (RCP) new. Also several assorted ammeters & voltmeters, DC; about 100 asstd. tubes incl. two 6 amp. Tungar tubes; 30 ma. X-Ray tube, practically new with stand and fixtures; also a few relays, magnet switches, & misc. radio parts. Pvt. Ralph E. Saba, Mrs. Doris A. Saba, 373 Chatham St., K. Lynn, Mass.

WANTED—All types of instruments & test eqpt. for starting new shop. Chalmers Sturgill, Box 1084, Casa Grande, Ariz.

WANTED—Signal generator, any make as long as it is in good shape, ready for immediate use. C. M. Genius, 321 Edison St., Baton Rouge, La.

WANTED—RCA M1-7820 recording attachment for RCA M1-12800 16" 2-speed turntable. For Army Hospital sound system. AA-3 priority if needed. Medical Supply Officer, Station Hospital, Camp Tyson, Tenn.

WANTED—Thordarson oscilloscope foundation unit. State parts you have for sale and price. Raymond Feldman, 90 Westinghouse Elec. & Mfg. Co., Sharon, Pa.

TUBES WANTED—Urgently need 12SA7, 35Z5, and crystal pickup for record player. Cash. R. W. Nass, 15 Sherman St., Newport, R. I.

FOR SALE OR TRADE—12BK7, 2A7, 21F7, 12SQ7, 35L6/GT-G, 27, in good condition, or 12A7 with had rectifier section, or 6F5/G in medium condition. Also misc. hard-to-get parts. Write for list. R. L. Royell, 1814 Southwest 22nd Ave., Miami 35, Fla.

WANTED—Tube tester, multimeter, or combination, signal gen., analyst, and complete set Rider's manuals. Bob Meister, 456 W. E. St., Colton, Calif.

FOR SALE OR TRADE—Recorder and playback unit in portable case with pre-amplifier; crystal mike, 100 blank recording discs and 50 mailing envelopes. \$80 cash, or will trade for good communication receiver. A. G. Calatayud, 8-2/C, Bks. 11, N.A.T.T.C., Memphis, Tenn.

WANTED—Oscillator coil for wireless phono player. Any type. J. H. Odion, 11547 36th N.E., Seattle 55, Wash.

WANTED—V-O-M of reliable make, also good, accurate sig. generator, also 1.4V tubes (1A7-1N7-1H5). Cash. Ommel Cross, P.O. Box 104, Bradley, Ark.

FOR SALE OR TRADE—Weston Counter model tube tester No. 676R for all tubes through 1938. Has space and arrangement to bring up to date. Instructions included. \$22.50 f.o.b. R. N. Eubank, 1227 Windsor Ave., Richmond 22, Va.

WILL TRADE—Printing type and supplies for recording eqpt. or what have you? F. T. Self, Rt. No. 1, Asheville, N. C.

FOR SALE—Many tubes such as 34, 30, 19, 27, 80, 116, etc., as well as older types such as 76, 201-A, etc. Also etc. soldering iron and a few Weston volt-ammeters and ammeters. Thomas J. Lund, Box 12, Honeyford, N. D.

WANTED—0-1 ma. 3" or larger with V-O-M scale, also tube tester, set tester, and sig. generator. Cash. Carroll's Radio, 800 1/2 Leith St., Flint, Mich.

FOR SALE—Hammarlund HQ-120-X complete with crystal, 10" Jensen PM speaker house in matching cabinet, A-1 condition. S. Schulman, 7409 Sarena St., Detroit, Mich.

FOR SALE OR TRADE—Hallcrafters SX-25, A-1 condition, with speaker. Cash or will trade for 81K, tracer, tube tester, binoculars or guns. Edw. J. Hazlinger, 3590 E. 116 St., Cleveland 5, Ohio.

SWAP OR SELL—3-9 mfd. 3000 w.v. oil-filled paper cond., \$2.75 ea. (brand new); 1 Stancor hi-fi tone control choke, slightly used, also 2-2 gang pots; 1 heavy-duty Stancor output trans. for 616 job Dri. 3300 and 3800 ohms, sec. 500, 250, 16, 8, 4, used 100 hrs. reg. fld. Cpl. Jos. Ratkowsk, Btry. H, 245th C.A., Fort Tilden, New York.

WANTED—Two 0-3 DC voltmeters and one 0-1 milliammeter. E. M. Cooke, 136 Warner St., Marietta, Ohio.

FOR SALE—Three Oralphone intercomms, excellent condition. Model DX, 9 buttons & multicable. 3 for \$25. Ilchard Sutter, Salisbury, Mo.

WANTED—Comm. receiver for ac-dc, preferably Echophone or Hallcrafters, Echophone EC-1 if possible. Dean Barr, Box 167, Sharon, N. Dak.

WILL TRADE—Have test eqpt., hard-to-get tubes and comm. receiver to trade for U. S. or Canadian stamp collection—or will pay cash for collection. Harry Bridge, 7432 Devos St., Philadelphia 19, Pa.

WANTED—Supreme 561 and 560A. Good cash price for A-1 condition. Robert L. Bradford, 712 6th Ave. W., Decatur, Ala.

TUBES FOR SALE—New in factory-sealed cartons: 2-3Q5; 2-80; 2-1A7; 4-6SQ7; 2-6BK7; 2-25L6; 2-6H6; 3-3B5; 1-1V; 2-6D6; 2-4Z; 4-77; 4-46; 2-12AL6GT; 2-12SC7; 4-1215GT; 2-6V6; 2-1N6; 2-45; 2-83; 2-6HT; 2-12SQ7; 2-78; 2-6CS; 2-6CS; 2-6K7; 2-6K8; 2-1G4; 2-1G6. Also have N.R.A. course, \$20; and 4 JDF resistance line cards 160-290-300-180 ohms; and 1-L26 crystal cartridge. G & G Radio Service, 400 A Alameda St., Houston, Texas.

"NOT A FAILURE IN A MILLION"

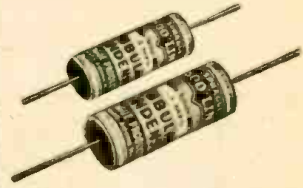

SPRAGUE "TC" TUBULARS

When there's a by-pass capacitor job to do, do it with famous Sprague TC Tubulars—and forget it. They will not let you down! We'll appreciate it if you ask for them by name.

TUBES FOR SALE—2-31; 3-2A6; 6-10; 2-12A7; 3-61A; 2-12A; 1-22; 4-6A4; 1-6Z7G; 3-2H7; 1-14. McKerrall Radio Service, 211 Garfield, Laramie, Wyo.

WANTED—Urgently need two 4523 miniature tubes. Cash for new or tested tubes. J. Alton Oliver, 48 Page St., Avon, Mass.

FOR SALE—Carter generator No. 6280-F. Input 6.3v; output 45, 67, 90, 135, and 180v. Like new. H. C. McDonnell, 202 So. Third St., Lewisburg, Pa.

WANTED—One phono motor turntable & mtg. plate, also Astatic KL-407, CL-407 pickup or similar. Kenneth C. Stovell, 535 W. 62nd St., Chicago 21, Ill.

FOR SALE—One RCA 902 cathode ray tube, cost \$7.50, sell for \$5. Also, Vibroplex in perfect condition, \$10. Prefer to sell bug locally. D. J. Basile, 2916 Louisiana Ave., New Orleans, La.

FOR SALE—Double-button carbon mike with 25' cable & transformer; General Industries 2-speed recording unit with crystal cutting head and sapphire cutting stylus; Howard No. 568 radio recording chassis and 12" Jensen speaker. Stanley Luffy, R. D. No. 1, Box 293, Verona, Pa.

YOUR OWN AD RUN FREE!

This is Sprague's special wartime advertising service to help radio men get needed parts and equipment, or dispose of radio materials they do not need. Send your ad today. Write PLAINLY—hold it to 40 words or less. Due to the large number received, ads may be delayed a month or two, but will be published as rapidly as possible. We'll do everything we can to help you—and the fact that thousands of pieces of Radio-Electronic equipment are in operation today as a result of sales or "swaps" made through The Trading Post offer convincing proof of the far-reaching effectiveness of this service. Remember that "Equipment for Sale" ads bring best results. Different Trading Post ads appear monthly in Radio Retailing-Today, Radio Service-Dealer, Service, Radio News, and Radio-Craft. Sprague reserves the right to reject ads which do not fit in with the spirit of this service. When buying Capacitors—please ask for Sprague's by name. We'll appreciate it!

HARRY KALKER, Sales Manager.

SPRAGUE PRODUCTS CO., DEPT. RC-46 North Adams, Mass.



SPRAGUE CONDENSERS KOOLOHM RESISTORS

Obviously, Sprague cannot assume any responsibility, or guarantee goods, services, etc., which might be exchanged through the above advertisements

Radio-Electronic Circuits

★ WINNING SOLUTIONS OF RELAY PROBLEM WILL APPEAR ★
IN JULY ISSUE OF RADIO-CRAFT!

TIME DELAY RELAY

The following is a diagram which may be of interest to experimenters.

It is a simple time delay relay for transmitters or amplifiers. By using a filament rheostat in the heater of almost any indirectly heated tube the time may be varied from a few seconds to over three minutes.

The relay should be one to operate well below the tube current rating. The filament voltage may be taken from the transformer feeding the other tubes provided it is not already loaded to the limit.

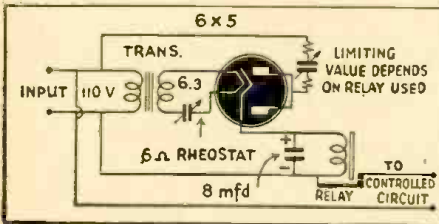

The rheostat should be one that will carry the filament current without heating up. The limiting resistor shown in the plate circuit of the rectifier tube depends on the relay used, and should be so chosen that the relay is not overloaded.

H. DAVIS,
Danville, Ky.

EXPERIMENTERS

Radio-Craft is initiating a plan to overcome the bottlenecks created by the unavailability of many standard types of apparatus. The ingenuity of the American experimenter, technician and mechanic is hereby challenged to replace, rebuild or substitute unrepairable or unobtainable equipment.

Every month one project will be announced for the readers of this page to exercise their brains on. *Radio-Craft* will pay a

FIRST PRIZE OF \$5.00

for the best answer and one-year subscriptions for all others published.

PROJECT FOR THE MONTH: Bottleneck No. 2—A simple and easily-constructed all-wave signal generator, accurate enough for fine service work, is needed on many a radioman's bench today. What can YOU do to solve this problem? Let's have circuits, photos and stories.

Suggestions from readers as to other bottlenecks are also welcome. What is your present pressing problem? If you want help with it, tell us so that we can all get to work on it.

ECONOMY FOUR

This is a four-tube superhet. using the midget type tubes. The circuit of the radio is conventional but for the power supply, which is designed to operate efficiently on a 6-volt DC source of power. Because of the low "B" drain the power supply can be designed so that the maximum drain will only be 1.5 amperes. The vibrator transformer can be easily wound to fit the core of a bell ringing transformer (try a small power transformer—Editor) by using the ratio of 6 turns per volt and No. 20 wire for the primary and No. 35 wire for the secondary. By using a fixed bias of 6 volts on the 1S4, good undistorted volume will

result even from the most powerful locals. A small neat looking job can be built that will play at least 70 hours on one charging of a storage battery.

The synchronous vibrator makes a handy and compact power pack, but of course there is no reason why a vibrator using a rectifier tube should not be used, if available. The best power pack is one lifted from an old auto radio, as there will always be hum trouble with a home-designed vibrator supply. An aerial may be loosely coupled to the loop for greater range.

CPL. DOUGLAS A. KOHL,
St. Charles, Ill.

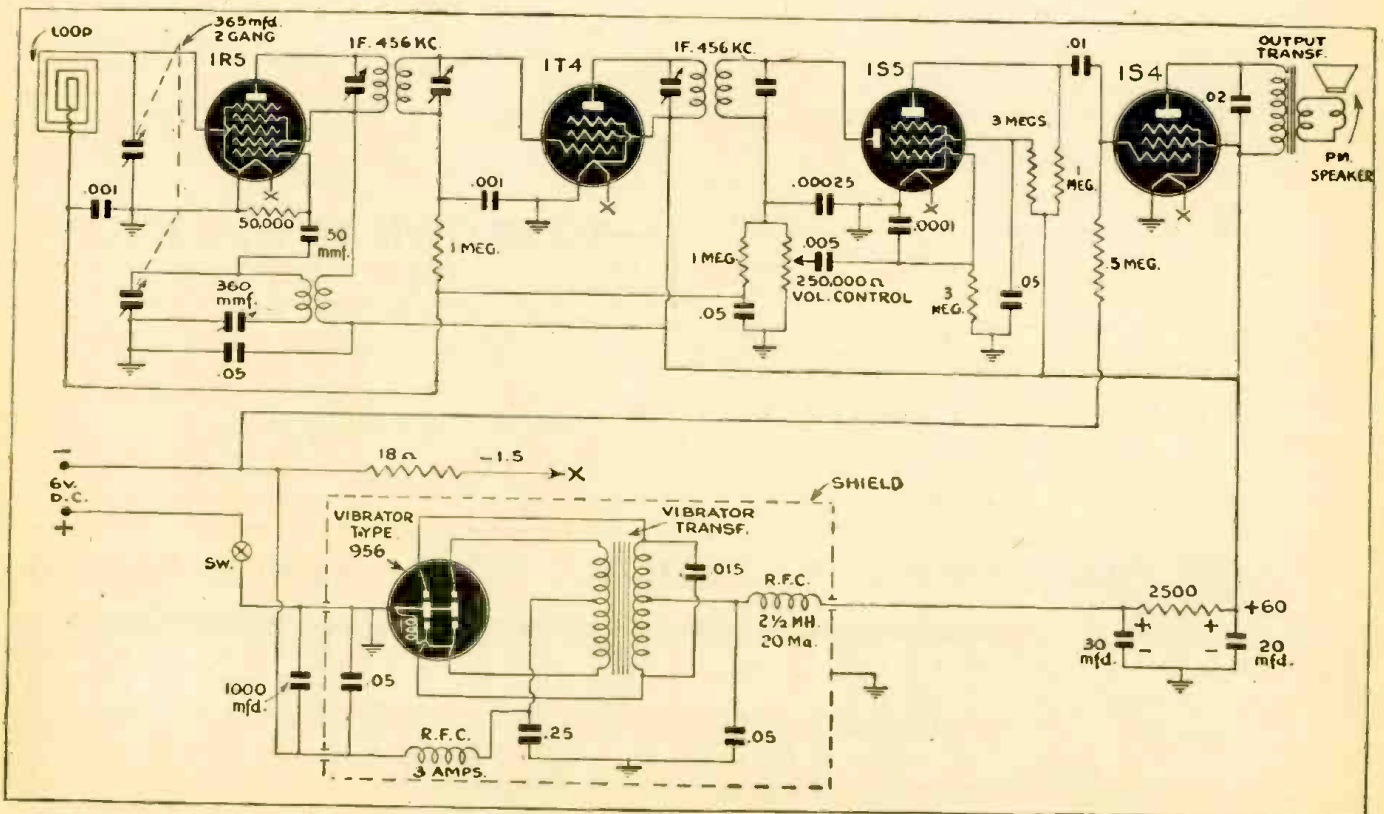

" NOW HOGARTH, WE MUSTN'T UNDER-
ESTIMATE THE ENEMY — EVEN IF OUR
SIDE IS INGENIOUS ENOUGH TO
PRODUCE THE **ECHOPHONE EC-1**"

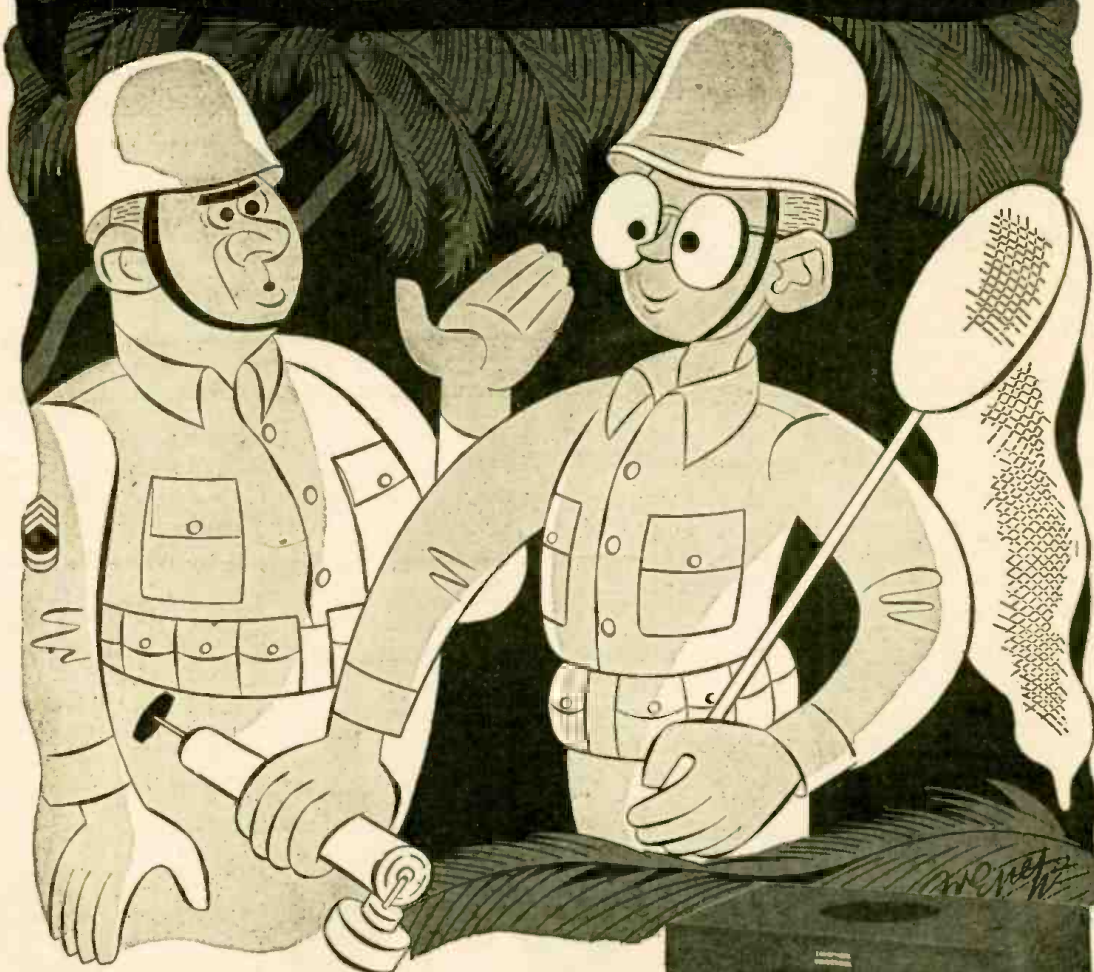

Echophone Model EC-1

(Illustrated) a compact communications receiver with every necessary feature for good reception. Covers from 550 kc. to 30 mc. on three bands. Electrical bandspread on all bands. Six tubes. Self-contained speaker. 115-125 volts AC or DC.



Echophone Radio Co., 540 N. Michigan Ave., Chicago 11, Illinois

THE QUESTION BOX

TWO-TUBE FM RECEIVER

? You omitted to publish the values of the coils shown in the "Two-Tube FM Receiver" diagram on Page 431 of the April issue. How many turns have they, and how many plates have the variable condensers shown?—F.L.S., Pasadena, Calif.

A. The grid coils may consist of 3 turns each, one-half inch in diameter. The antenna coils may be one turn, or simply hairpin loops. The number of plates in the condensers does not enter the question—they should have the capacity shown in the diagram, and must be a type manufactured for ultra-high-frequency use, with extremely low losses and low minimum capacity. The chokes (RFC) must also be carefully selected for high-frequency use. The coils are adjusted—as in other high-frequency sets—by spreading them out or closing them till they are in the band.

A SUPERHETERODYNE TUNER

? Will you kindly publish a diagram of a 4- or 5-tube tuner to use with a high-fidelity amplifier? This should work off an ordinary 250-volt power pack and use 6.3-volt tubes.—Y.S., N.Y.C.

A. The circuit on this page will work well as a tuner for a following amplifier. As shown, the two R.F. condensers are ganged, while the oscillator condenser is independent. This makes for better tuning, as it is not easy to get perfect tracking on a home-built receiver with a 3-gang condenser, even if all the coils are factory-built.

The small variable condenser between the bottom of the oscillator coil and ground is a padding condenser, and should be of the 200-500mmfd. type, as its setting will be in the neighborhood of 350 mmfd.

All values are given in ohms and microfarads, except where otherwise stated on the diagram itself. Coils are standard factory-built units, and all resistors should preferably be of 1-watt rating.

LINE OPERATION FOR 201A'S

? Is it possible to make an amplifier that will work on the A.C. line from a couple of old sets I have? These used 201A tubes. I would prefer not to use a transformer for power supply, but wish to use the audio transformers from an Atwater Kent Model 20 for coupling.—L.M.J., Norwich, N. Y.

A. An amplifier using 201A's could not be used with a transformer for filament supply. The tubes could be hooked up in an A.C.-D.C. circuit, however, using 2 25Z5's for power, as shown in the schematic. Care should be taken that the condensers across the filaments are attached with the right polarity, and the set must be carefully laid out to prevent feedback or interaction between transformers.

The circuit may not be particularly practical, as it will be necessary to obtain two new tubes to get three old ones to work, and when your present 201A's are worn out, there will be no object in buying new ones.

All queries should be accompanied by a fee of 50c to cover research involved. If a schematic or diagram is wanted, please send 75c, to cover circuits up to five tubes; over five tubes, \$1.00.

Send the fullest possible details. Give names and MODEL NUMBERS. Include schematics whenever you have such. Serial numbers of radios are useless as a means of identification.

All letters must be signed and carry FULL ADDRESS. Queries will be answered by mail, and those of general interest reprinted here. Do not use postcards—postmarks often make them illegible.

Service at present is slow—readers must not expect answers for at least three or four weeks.

No picture diagrams can be supplied. Back issues 1943, 25c each; 1942, 30c each; 1941, 35c each. 1940 and earlier, if in stock, 50c per copy.

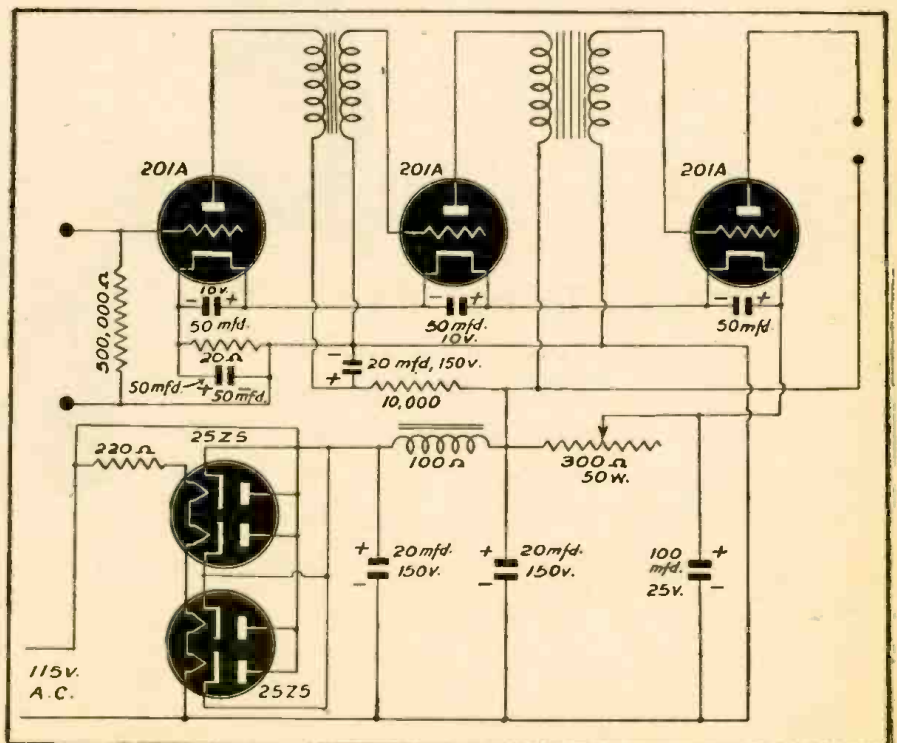
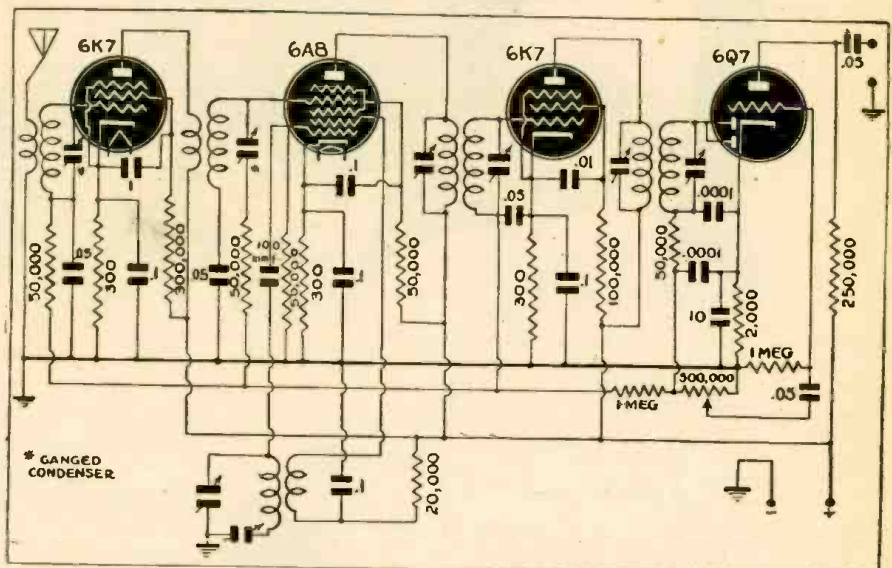

Are you properly
emphasizing the
SAVINGS FEATURE
OF YOUR PLANT'S PAYROLL
SAVINGS PLAN?



WITH the war swinging into its tensest phase, now's the time to emphasize over and over again the *savings* feature of your Payroll Savings Plan. To press home to all your people the need of building up their savings—the need of building up their savings not only in wartime but also in the years directly after the war. To point out that a bond cashed before its full maturity is a bond killed before it has given its fullest service to its

owner—or to his country!

Buying War Bonds, holding War Bonds, and keeping wartime savings mounting—all are absolutely vital. But no one of these is enough by itself. The *savings habit* must be carried over into the years of reconstruction which will follow the war. For if, at war's end, we have 'flash-in-the-pan' spending, *everybody loses*. The spender loses, you lose, and the country loses! While a working public, convinced of

the value of continued, planned saving, is the soundest possible foundation for private enterprise of every sort.

We call these bonds War Bonds—and with their aid we will win this war at the earliest possible moment! But they're Peace Bonds, too—and, rightly used, they will win for their holders, *and for all of us*, a happy and prosperous place in the years of peace to come. **WAR BONDS to Have and to Hold.**

The Treasury Department acknowledges with appreciation the publication of this message by

RADIO-CRAFT

★ **Let's All Back**
★ **the Attack . . .**
★ **with War Bonds!**

This is an official U. S. Treasury advertisement—prepared under auspices of Treasury Department and War Advertising Council

RADIO-CRAFT for JUNE, 1944

551

TRY THIS ONE!

A WHALE OF A TUBE

In the circuit of the ULTRA TRF FOUR receiver, which has been successfully constructed by the writer, and is now in daily use, there is a tube (6J8) which performs more service than has ever been compressed in a single envelope.

In place of the usual expression, "the heart of the circuit," this tube should be called the *stomach* of the receiver, for it can digest more radio broadcast fodder than a circus elephant can eat in terms of peanuts and hay. This single tube serves respectively as a RF amplifier, detector, and handles two separate circuits of RF regeneration. Its alimentary capacity is the greatest on record since Jonah was the son of a sea-cook. In fine, it is a *whale* of a tube.

By referring to the schematic, the action will be traced as follows: For sake of clarity the two portions of the 6J8 tube are shown as separate tubes. The signal, coming from a stage of RF amplification ahead, is impressed upon the control grid of the heptode half of the 6J8, where it is amplified; and then by means of the coupling coil C, is passed on to the grid of the triode half of the 6J8. Here, a portion of the signal is detected and passed on to the audio stage. But the remaining portion is reflexed back into the grid of the heptode, by means of the direct connection between the two grids, where (in the heptode), the signal is re-amplified, or regenerated.

Finally, a second stage of regeneration is introduced in the triode by means of the usual tickler coil, as shown.

Both regenerative circuits are controlled simultaneously by the 50,000 ohm potentiometer on the screen grid of the heptode. It works very smoothly and gives complete satisfaction.

The final result of all this compound and condensed action within so small a space is: high gain, high sensitivity, and high selectivity. It pulls the stations in from near and far, and weak or strong—delivering high fidelity reception and complete audio luxury to the listener.

RALPH W. MARTIN,
Los Angeles, Calif.

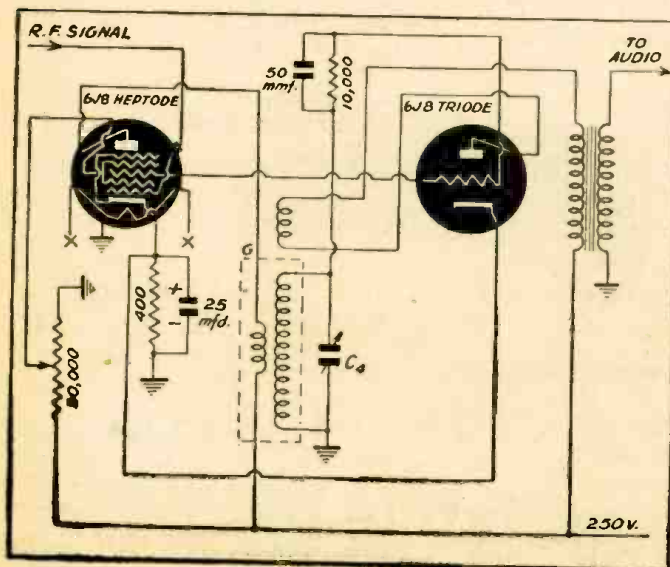

RELAXATION OSCILLATOR

Figure 1 shows a method of using the relaxation type code oscillator, illustrated in the June, 1943, issue of RADIO-CRAFT magazine, on D.C. house current. The circuit is the same, except for the substitution of a 100,000 ohm resistor for the 75,000 one used with the battery operated model. This improvement should be especially valuable at this time, due to the critical shortage of "B" batteries. If the oscillator does not work after a few seconds, try reversing the line plug.

If D.C. house current is not available at your home some method of rectifying the A.C. must be used; the simplest form of power supply for this purpose is shown in Figure 2. Almost any vacuum tube whose filament draws .3 ampere at 6.3 volts may be used in this circuit. The filament is connected to the power line through the 40 watt lamp, whose purpose is to lower the line voltage to the necessary 6.3 volts. All the grids of the tube are connected together and to the plate by jumper "A"; this "plate" is then connected to one side of the line. The other side of the line is the negative connection, which goes to point B in the circuit in Figure 1. The positive terminal, which is connected to point A, is the cathode of the tube. Filtering action is provided by the 1 mfd., 200 volt condenser connected across the output. Since the plate and grids of the tube are connected together a tube may be used in which these elements are shorted, if it is in otherwise good condition.

ROBERT HAUPE,
San Fernando, Cal.

(Extreme caution should be exercised in hooking up any circuit which connects headphones with the line—otherwise the arrangement may be dangerous. Headphones should be in perfect condition, without shorts, and all connections made through pin jacks rather than binding posts, so there will be no exposed terminal. Furthermore, the lower wire in each of these sketches should be attached to the grounded side of the electric light line.—Editor)

Left—Part of the circuit of "Mystery" Martin's 4-tube receiver, showing action of the 6J8. Below — How the neon-oscillator may be adapted to work from the line or power pack.

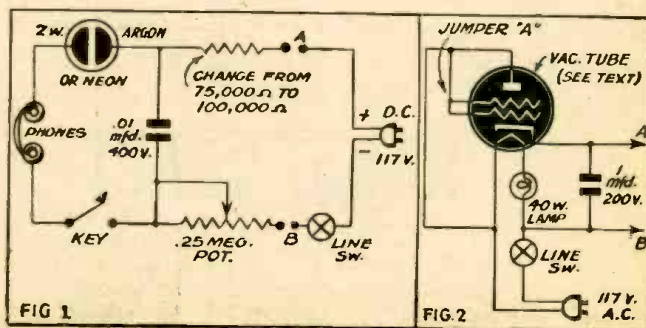

QUICK COIL WINDER

Coils having a large number of turns, such as the windings in headphone magnets, speaker coils, transformer coils, etc., can easily be made by removing the grindstone from an emery wheel and replacing it with two wooden wheels bevelled on the inside, so as not to catch the wire on the edges. Put spacers between the wheels to separate them, as illustrated.

Tightening the mounting nut will hold the parts together till the coil is wound, after which the whole form is slipped off. The inside core pieces fall out very easily, and the form can then be slipped off.

If wire from an old transformer is used, it is best to wind it off onto a spool first, using the winder for that purpose. The danger of breakage is thereby greatly reduced.

JAMES EICH,
Tampa, Florida

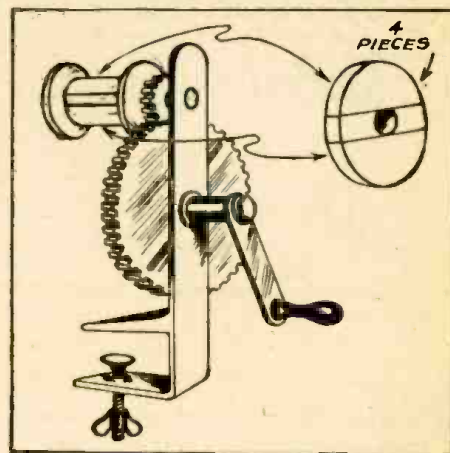

BROKEN DIAL CABLES

My home-made dial belts have helped me in more than one tough spot where I couldn't get the correct cable for a given receiver.

Simply take a long thin piece of adhesive tape, and starting with the smooth side inside, roll the sticky side against it. About 4-ply is good. Put the smooth side against the pulleys.

B. L. WOOD,
Glendale, Calif.

(A sample sent in appeared very strong and flexible, apparently quite a satisfactory emergency repair for a dial cable.—Editor)

A MESSAGE TO MANUFACTURERS

HE'S ONE OF THE 47,000 MEN . . .

**. . . who read
RADIO-CRAFT
this month**

Back in civilian life he was a radio technician . . . now he's an army major of the U. S. Signal Corps, but he continues his peacetime habit of buying his monthly copy of RADIO-CRAFT because it "Keeps him posted" on the fast-moving tempo of wartime Radio-Electronic developments. He is typical of these 47,000 men now vitally engaged in communications work for the military and essential industry, who are "bridging the gap" with RADIO-CRAFT 'til that future day when they will take important places as the engineers of the RADIO-ELECTRONIC industry of tomorrow.

The readers of RADIO-CRAFT are the Radio-Electronic Intelligentsia of America—who know all there is to know about the new promising field of Electronics.

RADIO-CRAFT

25 West Broadway, New York 7, N. Y.

— at less than —
1¢ PER READER
you can reach
47,000
Radio-Electronics men
with

**RADIO
CRAFT**
AND POPULAR ELECTRONICS

You can get a bird's-eye view of post-war Electronic and Radio merchandising by reading our new booklet, "LOOKING AHEAD." It's free to manufacturers and wholesalers who write for it on their letterhead (10c a copy to others). Send for it today.

Your best bet!

FREE
Complete
Up-to-date
BUYING
GUIDE



..for everything in RADIO and ELECTRONICS

REPAIR and REPLACEMENT PARTS AVAILABLE without priority

SAVE TIME Call ALLIED First!

The world's largest stocks are centralized in this single arsenal of supply. Over 10,000 items from all leading manufacturers . . . for the Armed Forces, Radio Training, Research Laboratories, War Industries and Service Replacements. Our experienced staff helps speed delivery. Save time—simplify procurement—call ALLIED first! Thousands do.

Write, wire or phone Haymarket 6800.

6 Radio Books for 75c

Dictionary of Radio Terms. No. 37-751 10c	Radio Data Handbook. No. 37-754 25c
Radio Circuit Handbook. No. 37-753 10c	Radio Builders Handbook. No. 37-750 10c
Radio Formulas & Data Book. No. 37-752 10c	Simplified Radio Servicing. No. 37-755 10c
All Six Books No. 37-799 . . . 75c	

Write for Quantity Prices

ALLIED RADIO CORP., Dept. 2-F-4
833 W. Jackson Blvd., Chicago, Ill.

Please send following books (.....c enclosed)

FREE 37-750 37-752 37-754
 Buying 37-751 37-753 37-755
 Guide No. 37-799 (All Six Books)

Name.....
 Address.....
 City..... State.....

ALLIED RADIO

A COURSE IN PRACTICAL ELECTRONICS (Cont. from page 529)

E represents pressure in volts, I, current in amperes; and R, resistance in ohms.

Application of Ohm's Law is simple. For example, if we have a 5-tube A.-C.-D.C. radio, using three 6.3- and two 25-volt tubes, and wish to connect them across the 117-volt line, we calculate as follows: The tubes are constructed to draw 0.3 amperes at 69 volts (for the 5 tubes). A line-cord or other resistor to pass 0.3 amperes at 117-69 volts is required. $48 \div 0.3 = 160$, and a resistor of 160 ohms is needed. See Fig. 4. This was a case where we knew the voltage at hand and the current we wanted to pass, and had to find the resistance required. It is often necessary to find the resistance of a circuit in which we can measure the current and voltage, and occasionally more convenient to calculate the voltage across a circuit from the known current and resistance than to attempt to measure it directly. Thus all three formulations of Ohm's Law are in constant use by the electronic worker.

ELECTRIC POWER

Approximately $\frac{1}{4}$ ampere flows in a 30-watt electric light bulb. The current which flows in an ordinary 2-cell flashlight lamp is practically the same. Yet one of these lamps is many times larger than the other and gives out tremendously more light. There is still another electrical quantity we have to consider. That is POWER. Light is produced in a filament-type lamp by a kind of electrical friction. A small conductor carries a large current. The bumping of electrons and the attempted counter-movement of the very heavy ions which takes place when large currents flow, heat the wire white hot and cause it to give off light.

The more friction in the filament, the greater the amount of energy which will be turned into heat. (The light we want is only a by-product of the heat in the circuit.) We can create more friction by using high-resistance filaments and forcing large currents through them. The higher the resistance and the greater the current, the more power will be used in the circuit. This is the secret of the difference between the flashlight and the house-lighting lamp. The one draws $\frac{1}{4}$ ampere at 3 volts, with a filament resistance of 12 ohms. The other has a filament resistance, (when fully lighted) of 480 ohms, and draws its quarter ampere at 120 volts.

POWER CALCULATIONS

It takes a much higher voltage to push the quarter-ampere current through the 480-ohm filament than through the little flashlight lamp. Power used in an electrical circuit can be calculated by the amount of voltage needed to force a certain amount of current through it. Power is measured in WATTS, and is the amount of work done when 1 volt causes a current of 1 ampere to flow in a circuit of 1 ohm resistance. (The watt is a purely mechanical

measure and is equal to 1 horsepower.)

746

If one watt power is put forth by one ampere flowing at a pressure of one volt, our flashlight lamp, with its quarter-ampere at 3 volts, uses only three-quarters of a watt, while the lamp which draws the same current at a rated 120 volts is a 30-watt device, as is plainly stated on the lamp itself.

New students are sometimes puzzled at the idea of power being taken out of an electric circuit. Something must disappear, if light or heat appears; yet, according to Ohm's Law, the same amount of current returns to the battery as leaves it. The answer is: Voltage, or pressure disappears. Refer again to Fig. 4, the 5-tube filament circuit just described. A voltmeter placed across the line resistor shows a 48-volt drop. The electric energy turned into heat in this part of the circuit is 48×0.3 , or 14.4 watts. A further drop of 25 volts will be found across the filament of the 25L6, which requires 7.5 watts of power to heat it.

The hydraulic engineer calculates the same way. His available power depends on the amount of current and its pressure or head (the number of feet through which he can drop it). After passing through his turbines, the rate of flow is the same as before entering them, but the water now has no head—it is at the level of the lower stream—and can exert no further power. So it is with the electron. When it reaches the level from which it was forced by mechanical or chemical means, it again becomes part of a balanced atom, and gives up no more power.

Calculation of power in electronic circuits is very important. Transformers are rated by their watt-handling capacity, and if the power used in the circuits is underestimated, burned-out transformers will be the result. The larger electron tubes are also rated by their power-dissipating ability, and a miscalculation may be very expensive. Power can be calculated by three simple formulas:

$$W = I^2R \text{ and } W = \frac{E^2}{R}$$

as well as the already stated $W = EI$. P is sometimes used instead of

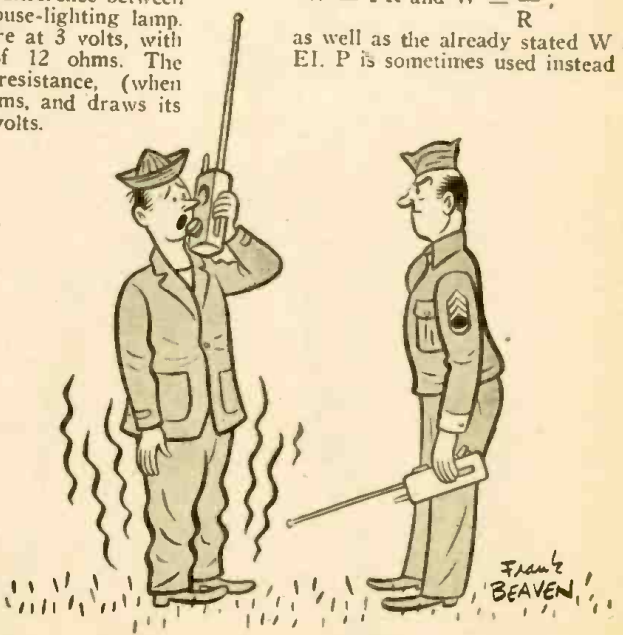

"I've got mike fright."

W in these equations, but is always calculated as power in watts. Since it is possible to find both E and I in both the first two equations, it is usually easier for the student to break them down into the easier-handled $W = EI$ when calculating power.

ELECTRICAL CONDUCTANCE

The ability of a wire to carry current, or its CONDUCTANCE, is another quality very useful in calculations. It is stated in the same terms as resistance, so a conductor with a resistance of one ohm has a conductance of one MHO, (an interesting word which demonstrates that conductance is the opposite of resistance). A resistance of 1/2 ohm has of course twice the conductance of a 1-ohm resistor, and is therefore rated at 2 mhos, while a 6-ohm resistance has a conductance of only 1/6 mho.

Conductance is particularly useful in calculating such networks as that of Fig. 5, which are very common in electronic circuits. We may have to know the voltage at X, and therefore the total resistance and current in the circuit. Since more current will pass through the two lower resistors than through the 50,000-ohm resistor alone, the resistance of the combination is something less than 50,000 ohms. Adding the conductances of the two resistors, 1/50,000 mho and 1/100,000 mho respectively, we find the total conductance to be 3/100,000 mho. The resistance then must be 100,000/3, or a little more than 33,300 ohms. Total resistance in the circuit is 33,300 plus 50,000, or 83,300 ohms, and the total current $250/83,300 = .003$ ampere ($E/R = I$). With a 3-milliamper current, the drop across the 50,000-ohm resistor is 150 volts, and across the 33,300-ohm combination, 100 volts ($E = IR$). X is therefore 100 volts from ground.

Such calculations as those above, simple as they may seem, are the key to learning everything that can happen in a D.C. circuit, and the student who really knows his Ohm's law may justly claim to understand electricity.

A 28-VOLT RECEIVER!

(Continued from page 540)

of converter functions, the automatic gain control function is not hooked to this stage. It's not necessary, and its omission lends greater frequency stability.

In the secondary circuit of the oscillator coil a small fixed tracking condenser is shown in series with the tuning condenser C_1 for that stage. No value is shown, since it varies with the band of coils selected. When the coils are selected the value of the tracking condenser can be obtained from tables.

The Intermediate Frequency stage and the Detector stage use separate elements of one tube, the 14R7 shown in the diagram as cut into two parts for clarity in design. Actually, they are in one envelope, as witness the converter tube. In the I.F. stage the pentode section is utilized as a fixed gain I. F. amplifier. Of course the a. v. c. is hooked into this stage, since here the greatest gain is obtained.

The detector stage uses the diode portion of the same 14R7, acting as diode detector. A portion of the output of the detector is used to furnish automatic gain control to the R.F. and I.F. stages. The audio output of this stage appears across the network R_{11} , R_{12} , and is tapped off between the two resistors, where it goes to the volume amplifier stage. Here R_{11} acts as a volume control, varying the incoming signal and grid bias simultaneously.

These 2 GHIRARDI BOOKS

Will help you to Diagnose, Locate and Repair Receiver Troubles

EASIER • BETTER and FASTER



ALFRED A. GHIRARDI
Radio's foremost instructor

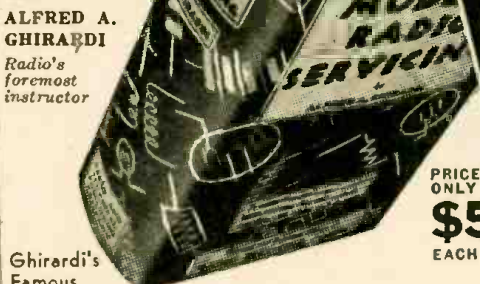

Ghirardi's Famous

MODERN RADIO SERVICING

The book that trains you quickly to MAKE MORE MONEY and get a bigger job as a Radio-Electronic repair technician BECAUSE it is by far the largest, finest, most easily understood how-to-do-it training course on the subject!

Test Instruments—Troubleshooting—Repair

"Modern Radio Servicing" is the only single, inexpensive book that gives you a thorough training in the construction and working of all types of test instruments; receiver trouble-shooting procedure; circuit analysis; testing, repair, and replacement of individual receiver parts; installation; adjustments; maintenance; service shop management, etc.

No other book can compare with this one for complete, easily understandable instruction on every phase of service work. "I recently finished a course in Radio Repair at one of the N. Y. radio schools and all my learning at this school did not help me to understand and repair radios as quickly as did this one book. I made my money back on one job alone!" writes Henry Miller of Brooklyn, N. Y.

You, too, can get a thorough and practical working training in Radio-Electronic Servicing from this famous Ghirardi book—by yourself, in spare time at home—just as Mr. Miller and thousands of others have done. Its 1300 pages and 706 illustrations help you visualize every action. The 120 self-testing review questions make your study easy. Progress as fast as you want to. It's the biggest servicing training bargain you can buy anywhere. You are protected completely by our

5-DAY MONEY-BACK GUARANTEE



3rd Revised Edition (Greatly Enlarged)

PRICE ONLY \$5 EACH!

... and the New Manual Size RADIO TROUBLESHOOTER'S HANDBOOK

744 big pages, chock-full of just the kind of time-saving, money-making, tabulated and charted servicing data that servicemen are finding invaluable.

HERE'S HOW TO TEST A RADIO IN 2 MINUTES or less!

Ghirardi's RADIO TROUBLESHOOTER'S HANDBOOK isn't a "study book." It's an on-the-job data book to be referred to in your everyday work. For example, don't waste your time on complicated troubleshooting for every ailing receiver you are called upon to repair! First, look up its model number in the big Trouble Case History Section of the Handbook which lists common troubles and their remedies for over 4,800 models of receivers and record changers.

CHOCK-FULL OF SPEED-UP DATA

Nine times out of ten the Handbook will give you the exact clue you need to repair a receiver at once—often without any testing at all! Similarly, on tubes, parts, replacements, substitutions, color codes, circuit alignment, auto radio, batteries, vibrators, ballasts, grid bias resistors, condensers, transformers, tone controls, filters, etc., etc., you get pages of quick-find, tabulated data to help do every repair job better—AND A LOT FASTER! This big new Handbook that weighs over 4 pounds is yours to use every day to make more money for only \$5 complete (\$5.50 foreign) and our Money Back Guarantee protects you. Order today!

SPECIAL MONEY-SAVING COMBINATION OFFER!

Both books for only \$9.50 (\$10.50 foreign)

A total of OVER 2,000 PAGES of the world's most helpful and profitable servicing information!

MAIL THIS COUPON NOW!

RADIO & TECHNICAL DIV. of Murray Hill Books, Inc., Dept. RC-64, 232 Madison Ave., New York 16, N. Y.

Enclosed find \$..... for books checked or, send C.O.D. for this amount plus postage (sent C.O.D. in U.S.A. only). If not fully satisfactory, I may return books within 5 days and receive my money back.

- Special MONEY-SAVING COMBINATION — Both books \$9.50 (\$10.50 foreign).
- RADIO TROUBLESHOOTER'S HANDBOOK, \$5. (\$5.50 foreign).
- MODERN RADIO SERVICING, \$5. (\$5.50 foreign).

Name
Address
City (and Dist. No.) State

REPAIR ANY KIND OF RADIO EQUIPMENT PREPARE FOR A BETTER JOB AS A RADIO-ELECTRONIC TECHNICIAN

for Permanent
Resistance
Today and
Tomorrow...

OHMITE
Resistors

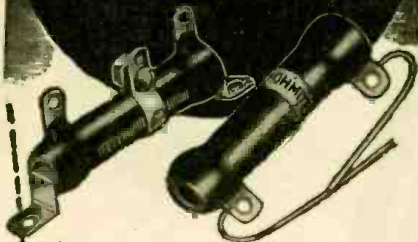

Consistent performance day after-day under a wide range of operating conditions has proved the dependability of Ohmite Resistors. This rugged quality has enabled Ohmite Brown Devils and Dividohms to keep existing installations going longer. It has also made them especially well fit for today's wartime applications... and tomorrow's peacetime needs.

Handy Ohm's Law Calculator

Figures ohms, watts, volts, amperes—quickly, accurately. Solves any Ohm's Law problem with one setting of the slide. Send only 10c in coin for handling and mailing. (Also available in quantities.)



10c



OHMITE MANUFACTURING CO.
4896 FLOURNOY ST., CHICAGO 44, U.S.A.

That Radium-Radio!



Professor Mohammed Ulysses Fips in one of his more contemplative moods, engaged in thinking up a new world-shaking invention.

In our April issue we printed an article about the revolutionary new Radium-Radio Receiver by Mohammed Ulysses Fips. Since then a terrific amount of mail was received by him in connection with the Radium-Radio, as well as the "RA-RA 4-1" tube.

Unfortunately, he could not answer all the mail because some time during the month those same naughty radio interests kidnapped poor Fips again and we haven't seen or heard from him since.

We were fortunate, however, in that he left us a good photograph which was taken in captivity after he was first kidnapped by that mysterious clique of Radioelectronic gangsters, of which Fips spoke in the April issue. This photograph, together with his best friend, Annie the Anteater, is reproduced on this page so all his admirers may see what the illustrious inventor looks like.

We are in the know—Mohammed Ulysses Fips has been the office boy of the Gernsback Publications for some 35 years. A native of the city of Iduno of Tunimaro (Central, North African coast), he was frequently decorated for his many world-shaking scientific researches. Incidentally, he is the only living owner of the exclusive Radium 4-1 medal which the grateful Government of Tunimaro bestowed upon him some years ago.

When Fips was kidnapped for the second time, it became necessary for *Radio-Craft* to inform all his correspondents of this unseizable outrage by means of the following letter:

"Thank you for your recent letter. Unfortunately, Professor Mohammed Ulysses Fips has been kidnapped again by the same devilish interests and is therefore not available. Smart as he is, he anticipated the kidnapping, so he left the following URGENT message to all of his admiring friends, to wit: "Unless you read my article appearing in the April issue of *RADIO-CRAFT* from beginning to end—PARTICULARLY THE VERY END—you cannot possibly appreciate or fully comprehend my world-shaking invention. "We would therefore urge you to carry out Mr. Fips' request to the letter. We are sure it will give you a good deal of enlighten-

ment on his work and also answer ALL your questions.

Sincerely yours,
RADIO-CRAFT MAGAZINE,
(Signed) Loo Flirpa,
Mohammed Ulysses Fips,
ELECTRONIFICATION DEPARTMENT."

The great trouble with America—as Fips sees it—seems to be that people jump at conclusions too hastily. Instead of reading an article completely to its very end, most readers read half way through it and miss the best part. This is particularly unfortunate in the great Fips Radium-Radio document because if all his well-meaning correspondents had read the entire article, few (if any) would have written to him.

Of the hundreds of letters received, we only publish a very few which will give *RADIO-CRAFT* readers some slight idea as to the terrific electronic storm that Fips let loose in our memorable April issue.

We hope that by next April 1 Fips will have been released by his Machiavellian kidnappers, otherwise, by gosh, we will turn the entire case over to the F.B.I. (Fips Bunk Institute.)

Readers may amuse themselves by trying to pick the bona fide letters from those which slyly tried to kid Fips among those published here:

TELEGRAM

Possibility your doing mutual service by advising address Mohammed U. Fips. Our company has specific service interest in special applications Fips Radium Tube. Desire interview and discussion. Please advise Western Union collect relative possibilities and definite interview earliest date.
BEN B. FOLLETT,
Harvey Wells Co.,
Southbridge, Mass.



Photo Copyright by Ewing Galloway
Mohammed Ulysses Fips and Annie, the Anteater, photographed during their imprisonment, after being kidnapped by the naughty Machiavellian Radioelectronic interests.

TELEGRAPHIC ANSWER

Retel; essential that you read my article in its entirety, particularly pages 436, 437. Stop. Then wire if you can obtain hotel accommodations for myself and Annie.

Mohammed U. Fips,
c/o RADIO-CRAFT.

Was the article on Radium-Radio Receiver an April Fool joke?—R. M. Shultz, 810—30th St., South Bend, Ind.

Your article on Radium Receiver, April issue, worth the price of the magazine. How soon will radium tubes be available to the public?—L. S. Hoovers, 500 N. Laramie Ave., Chicago 44, Ill.

Having just completed the article, "Radium-Radio Receiver" in the April issue of your magazine, I find myself vehement with mingled feeling of admiration and anger; admiration for the social-mindedness of Mr. Fips, and anger that such a social injustice as was perpetrated against him is permitted in this democracy. I'm spending the best years of my life to defend such aggression on personal liberties. It is a personal affront to those whose responsibility it is to see that democracy functions; in short "it makes me mad."

Please send me more information about the abduction of Mr. Fips. Why is it that he feels his life is not "worth a plugged nickel." Does the government offer no protection to its citizens? Any information you can give me would be greatly appreciated.—R. B. Beall, S1/c, A. & M. College of Texas.

I have just read your article in the April issue of RADIO-CRAFT and wish to say that I greatly admire your principle. It seems inconceivable that in the year 1944 you should have been mistreated as you were by a great corporation.

I can see the possibilities of your wonderful invention and take this means of encouraging you to continue your efforts. In fact, if a corporation can be organized to manufacture this equipment, I would consider investing up to \$5,000 or \$6,000 in the shares of the company. If this letter reaches you, I would appreciate hearing from you.—Anthony Carro, National Inter-Communicating Systems, 2699 West 25th Street, Cleveland, Ohio.

I have read your article in the RADIO-CRAFT entitled "Radium-Radio Receiver," and believe that your invention will revolutionize the industry.

I have been preparing to conduct an experiment and would like to know if you are in a position to build transmitter tubes. The instrument will be ultra high frequency band.

Also when you get into production, I would like to have the territory of Mexico, California, Oregon, Washington, Arizona and Nevada for distributing your product. Can raise all the finances required.—T. Quinn, P.O. Box 5297, Metropolitan Station, Los Angeles 55, Calif.

RADIO-CRAFT has been my favorite radio magazine ever since 1929. I am a regular subscriber. I find it to be the most useful book I can find on the market for the purpose of helping in many hundreds of experiments. I would like very much to get more detailed information on the Radium-Radio Receiver as shown in RADIO-CRAFT for April. Better still, I would like to get one of the RA-RA 4-1 tubes for experimental purpose. I sure had a good laugh when I read in March issue that it has been found out that a magnet had a straight line of course. I found this out twenty years ago but nobody around here would believe me. All said I was crazy. But please do all you can to get me what information there is to get on Radium-Radio and thanks a million for your generosity.—Solomon F. Ray, 1020 Oakland Ave., Durham, N. C.

I am a subscriber of RADIO-CRAFT and have read your publications for a number of years. I always believed you published true pieces, but the article on "RADIUM-RADIO RECEIVER" by MOHAMMED ULYSSES FIPS, almost floors me. No doubt but what the radium tube will work, but how is it possible for a man like this to be kidnapped and held for 2 years without the F.B.I. doing something about it?

Kindly use the enclosed envelope and let me know if the whole story is true, and not an April Fool joke.—G. R. Turner, 3820 Walnut St., Kansas City, Mo.

In April issue of RADIO-CRAFT there appeared on page 398, an article concerning Radium-Radio by M. U. Fips.

Am very much interested in the article and would like to have more information, if such a tube does exist!

Please notify as to how we can contact S. H. Mann, Engineer in Charge.—Kenneth G. Olds, Morris, N. Y.

Last week I heard about the article on "Radium-Radio Receivers" and bought a copy of RADIO-CRAFT for April.

If this article is on the up and up, I would like to invest several thousand dollars for its development; if not, I want my purchase price of 25c for the magazine refunded.—George H. Aston, Route 2, Paducah, Ky.

PREVIEW OF POST-WAR TELEVISION (Continued from page 545)

mounted that it can be turned to almost any position. A closer view of the camera may be seen at the right.

The microphone will be remotely controlled over a wide area by an operator at a small control panel. Smoother and quicker action of the mike will result.

For outdoor pickup, both microphones and cameras will be mounted on their own motor-driven portable units, each containing a miniature relay station to transmit the pickup back to the broadcast station.

The final piece in this mosaic of proposed post-war television devices will probably be the most important one. No artist's conception this, but a piece of apparatus already employed in the service of the nation. Shown

in the cut to the right of the model television station, it is a revolutionary tube which, according to G-E engineers, makes possible the use of large bands of frequencies impractical before the war. Little information is being given on the new tube, except that it is the first of a large family which will employ the same revolutionary principle.

In television the dreams of professional portrayers of "post-war radio" have been surpassed by the practical designs of hard-bitten engineers, and it is more than likely that the wildest ideas of some who have speculated on the technical future of television will be left as far behind by the coming actuality.

GET INTO RADIO ELECTRONICS

PREPARE NOW! FOR A BETTER FUTURE

LEARN AT HOME DEFOREST'S A-B-C WAY

This message is addressed to you men who are alert to both today's needs and tomorrow's opportunities for good jobs, good pay, and a wide variety of employment possibilities in the BILLION DOLLAR RADIO-ELECTRONICS INDUSTRY. Write today for DEFOREST'S BIG, FREE, ILLUSTRATED BOOK, "VICTORY FOR YOU". See how you may prepare quickly, easily—in your spare time at home—to make your start toward an interesting and profitable Radio-Electronics future.

YOU GET DEFOREST'S 3-WAY COMBINATION TRAINING—

a simple A-B-C course of instruction—an exclusive, 3-way combination of illustrated Text, Movie Training Films, and actual Shop Work in your own home. You learn-by-SEEING—and prove your knowledge by DOING. You use (A) a genuine DEVRV Movie Projector and instructive Training Films to make your preparation clearer, easier. You use (B) EIGHT big Kits of "HOME LABORATORY" Radio Parts and Assemblies for working out 133 interesting experiments. You get (C) 90 well-illustrated Loose-Leaf Lessons, prepared under the personal direction of Dr. Lee DeForest, often called "the Father of Radio." And once you are trained, DEFOREST'S EXPERIENCED EMPLOYMENT SERVICE helps you make your start.

YOU "LEARN-BY-DOING" AT HOME WITH THIS PRACTICAL EQUIPMENT



LET THEIR EXPERIENCE GUIDE YOU

PUT YOURSELF IN THIS PICTURE

Dr. Lee DeForest supervised the Preparation of DeForest's Training.

Dr. Herman A. DeVry — Visual Education Pioneer — founded DeForest's Training.

GET INTO ONE OF AMERICA'S GRAND OPPORTUNITY FIELDS

TOMORROW: FM Radio, AIR-CRAFT Radio, MARINE Radio, POLICE Radio, and other exciting branches of the Billion Dollar Radio-Electronics Industry will need trained men. Sight and Sound Motion Picture Studios and Theaters will employ trained Radio-Electronic technicians. The improvements in Radio Picture Projection—the increasing use of PUBLIC ADDRESS SYSTEMS by Industrial Plants, Stores, Offices, Schools, etc.—the peacetime uses of such war-born discoveries as RADAR—INDUSTRIAL ELECTRONICS—all of these give you an idea of the bright future of the Radio-Electronics Industry for men who are trained.

TODAY: A working knowledge of Radio-Electronics can help you to a better job and a fast pay-check in Essential Industries. It can pave the way toward a part-time or full-time Radio-Electronics Sales and Service Business of Your Own. Or—if you are eligible for military service—it can help you toward preferred Military Classifications and better pay. DEFOREST'S can help you quickly, easily, to prepare for many Radio-Electronic opportunities, in a practical, interesting way.

Free! COLORFUL DESCRIPTIVE LITERATURE

Simply PRINT your name and address neatly on the coupon below. Mail it. Get BOTH the colorful KIT SUPPLEMENT and our BIG illustrated book, "VICTORY FOR YOU". Get pages of valuable information on present and future RADIO-ELECTRONICS opportunities. See how effectively DEFOREST'S can help you—in your spare time at home—to make YOUR start toward a Radio-Electronics FUTURE!



DEFOREST'S TRAINING INC. CHICAGO 14, ILL. U.S.A.

DEFOREST'S TRAINING, INC.
2533-41 N. Ashland Ave., Dept. RC-5
Chicago 14, Illinois.

Send me BOTH your big book, "VICTORY FOR YOU" and your KIT SUPPLEMENT—showing how I may make my start in RADIO-ELECTRONICS your A-B-C-simple Home Training Way. No cost! No obligation!

Name _____ Age _____
(Please Print)

Address _____
City _____ State _____

Check Here, if Under 16, for Special Information.

POINT OF SALE
DISPLAYS

SYLVANIA SERVICEMAN SERVICE

by
FRANK FAX



BANNER—boldly printed in black and green on special Duckline fabric — 46 x 28-inch size just right for truck sides or any spot you pick inside or outside your shop. Comes with six brass grommets for reenforced hanging. Price: 40¢ each or 3 for \$1.00.



FLANGE SIGN—green and white enamel baked on heavyweight sheet metal — is weatherproof. Size: 16¼ x 11¼ inches. Five flange holes give sturdy mounting. Price: 25¢.



DECALCOMANIA—easy transfer of green, black and white design on windows — 7 inches in diameter. FREE.



If your distributor does not have these items in stock, send your order to Frank Fax, Sylvania, Emporium, Pa.

SYLVANIA

ELECTRIC PRODUCTS INC.

RADIO DIVISION

ROBOTS OF WORLD WAR I

(Continued from page 533)

plane alighted alongside the boat, the observer transferred to it and steered it back to its station.

The result was that at first the British treated this new weapon with contempt and did not deem it worthy of attention. Although the boats were small and low in the water, which made them hard to detect, the "feather" caused by traveling at high speed gave ample warning of their approach and time for protective measures. Moreover, the British had been forewarned of the new danger. On March 1, 1917, the FL7 struck the mole of Nieuport and, according to German accounts, blazed a hole of some 150 feet in it. Because a troublesome British observation post was thus eliminated, the Germans claim this as a success for their FL boats, although Admiral Bacon considers the action a German blunder.

The introduction of these craft was typical of the manner in which a new idea was given uselessly away by the enemy. The first knowledge we had of the existence of these boats was when one of them ran into the pier at Nieuport. The explosion did no damage, and sufficient fragments of the machinery were recovered to give away the principles of the design.³

A MODEST CAREER

Nevertheless, in 1917 the FL boats did embark on a career of modest achievement. Several attacks were made on monitors and destroyers, and though they did no damage they had the effect of keeping the British vessels farther away from the German-held coast. On October 28 of that year, however, the FL12 launched an attack on the heavy monitor *Erebus* which, together with other units, was operating some 25 miles off Ostende. Directed by the plane overhead, the motorboat steered right into the group of escorting destroyers, pene-

³Sir Reginald Bacon, *The Dover Patrol* 1915-1917, London, 1919, Vol. I, p. 171.

trated the heavy artillery barrage laid down by the British vessels, and struck the slow monitor fair amidships. But although the boat's heavy charge exploded upon contact, the rail around the British ship, and its bulge, rendered the explosion comparatively harmless. Only the bulge of the *Erebus* was damaged, the ship itself not even leaking. In less than two weeks' time the monitor was repaired and back in active service. Several similar attempts were made in the following months, but the boats never reached their prey.

In view of this failure, the German Navy gradually lost confidence in the cable-controlled boats and demanded their replacement by radio control. When these became available, new difficulties developed, and before they were overcome the war had ended, without an opportunity fully to test the possibilities of radio-controlled craft.

Thus, on the whole, remote control proved to be disappointing in its results. But with a little more luck, better motors, and complete radio control, the little boats might have become formidable enemies. At any rate, even their modest achievements demonstrate the fundamental practicability of remote control for war use. The field of employment is vast, along the coasts as well as on the high seas, above and under water as well as on land and in the air; the potential utility of remote control is practically unlimited.

Moreover, remote control will save human lives and, in contrast to the various "suicide" weapons developed by countries which do not rate human life very highly, it may also prove of considerable value in times of peace. All this combines to indicate that remote control of vessels and torpedoes deserves the same careful attention as that of planes, and it is to be hoped that the credit of its final perfection will go to American genius.

Condensed from the Proceedings of the United States Naval Institute, February, 1944.

SUPERMAN IS IN IT, TOO!

THAT Electronics has penetrated into every nook and corner of the entire land is no longer news. Literally every man, woman and child is already affected by the triumphant advance of the lusty new giant Electronics.

Electronics is no newcomer to Science Fiction either—even the earliest science fiction fan had an abundance of it.

In the illustration shown we now have Supertman, who goes science fiction one better, in that he not only uses the instrumentalities of Electronics but, indeed, he slings Electronics himself, with his bare hands.

The illustration from a cover of "Action Comics" featuring Superman shows him as the cathode or plate, where he himself receives the full electronic stream from an electronic tube and hurls the stream back at the villain at the switch. Unfortunately,



the text of the magazine gives us no clue as to just how Superman grabs his electrons. Yet he seems to be all puffed up about it, and from the looks of his face, the electrons certainly must tickle his palm agreeably.

FM CONTROLLED VIBRATOR

(Continued from page 536)

center tap. The vector sum voltage of A plus e_o is applied to V1, while B plus e_o is applied to the V2 portion of the double-diode. Three possible cases are shown in the diagrams of Fig. 9. In (a) voltage e_r is shown to be 90° out of phase with the oscillator voltage e_o . In (b) e_r leads by more than 90° , while in (c) it leads by less than 90° .

Case (a). Applied voltages e_1 and e_2 are equal, resulting in equal output voltages e^1 and e^2 . However, electrons flow down in R4 and up in R3, so that e^1 is negative and e^2 is positive (compared to point C). Therefore, the net voltage e_{ao} becomes zero.

Case (b) e_r now leads by more than 90° . E_1 , e_2 are no longer equal, and e^2 is larger than e^1 , so that the net e_{ao} is POSITIVE.

Case (c) e_r leads by less than 90° . E^1 is larger than e^1 . E_{ao} is NEGATIVE.

Such a circuit is used in connection with FM. A frequency (or phase) modulated EMF is applied to the discriminator. When the carrier frequency is applied to the diode, the circuit is in tune, resulting in $e_{ao} = 0$. At a frequency higher than this value, one diode receives a higher voltage than the other, resulting in a positive e_{ao} . Similarly, for a lower frequency e_{ao} is negative. For a constantly modulated frequency, e_{ao} is an audio voltage which follows exactly the original modulation and may be amplified.

COMPLETE OPERATION

We are now ready to consider the operation of the entire system. Originally the phase-shifter is adjusted so that $e_{ao} = 0$ (case a) and the oscillation frequency is adjusted for maximum vibrator amplitude.

It will be remembered that e_r bears a direct relationship to the vibrator velocity.

Now suppose that for some reason the oscillator frequency becomes slightly greater than the resonant vibrator frequency. The vibrator velocity now lags the oscillator frequency. That means that e_r begins to lag behind. Remember that a 90° phase difference was originally made. Case (c) holds, which means a more negative e_{ao} , resulting in a decreased oscillator frequency, so that the original change is nullified.

Likewise, if for some reason the oscillator frequency should be slightly less than the resonance frequency of the vibrator, the velocity of the latter will lead the driving oscillations. E_r then leads by a greater angle than under normal conditions and case (b) shows that e_{ao} is increased positively. This in turn leads to an increased oscillator frequency as desired.

Proper adjustment of all circuits results in the oscillator maintaining the frequency of the vibrator, even though the resonant frequency of the latter may vary slightly due to temperature and load conditions. As a matter of fact, it is possible to maintain the oscillator to within two-tenths of a cycle per second of the exact resonant vibrator frequency when the latter is 17 kc.!

Because of possible changes due to temperature and load it is not possible to use an oscillator of the transitron or crystal types. At times changes of 500 cycles are encountered due to these causes.

An understanding of the circuits used in this system is well worth the time of the radio and electronic worker because of their wide use in electronic devices.

IF YOU CANNOT REPLACE RADIO PARTS REPAIR THEM WITH *Walsco* PRODUCTS



Walsco RADIO CHEMICALS

- Speaker Cements
- Cements For Plastics
- Special Adhesives
- Contact Cleaning Fluids
- Noise Eliminating Compounds
- Radio Lubricants

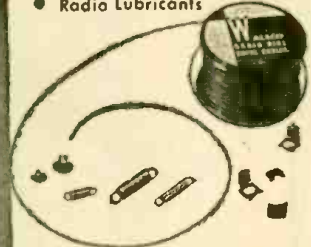

Walsco RADIO HARDWARE

- Dial and Knob Springs
- Trimounts, Set Screws

Walsco CABLES, BELTS

WALTER L. SCHOTT CO.
Manufacturers of

WALSCO PRODUCTS

For Communication Equipment Manufacturers,
Laboratories, Schools and Radio Repair Men

9306 Santa Monica Blvd., Beverly Hills, Calif.

Dept. RC-1

Of course—we are concentrating our efforts on war production—but not for a second are we neglecting the RADIO SERVICEMEN who require so many WALSCO RADIO PRODUCTS to keep the radios of their customers in perfect working order. Write today for WALSCO Catalogue No. 112, giving complete information about WALSCO PRODUCTS.

HALLICRAFTERS ★ HALLICRAFTERS

RECEIVER HEADQUARTERS for the Nation

BEFORE the war Bob Henry served the amateurs as the world's largest distributor of communications receivers.

Now Henry Radio is Hallicrafters receiver headquarters for the Nation at war. Hallicrafter Receivers can be supplied on AA-1 priority. SX-28s at \$179.50, SX-25s at \$94.50, and PM-23 speakers at \$15.00 can usually be supplied at once. It takes longer to supply other models.

Soon, it is hoped, non-priority orders can be filled and Bob Henry can become again Hallicrafters headquarters for the nation at peace.

I have stores at Butler, Missouri, and at 2335 West Blvd., Los Angeles, 25, Calif.

Your orders and inquiries are invited.

Bob Henry, W9ARA
HENRY RADIO SHOPS

Butler, Mo. and Los Angeles, 25, Calif.

COMPLETE STOCKS

I have in stock Hallicrafters receivers available for immediate delivery on priority and the following parts without priority: meter rectifiers \$1.95, meters, tubes, transformers, resistors, condensers, panels, chassis, etc. Your orders and inquiries invited.

"WORLD'S LARGEST DISTRIBUTOR OF COMMUNICATIONS RECEIVERS"



THE LATEST UP-TO-THE-MINUTE RADIO AND ELECTRONIC CATALOG IN THE COUNTRY TODAY!



Just Published!

Newest listings of amplifiers, communications equipment, radio tubes, testers, etc. • The latest developments in intercommunications equipment. • Greatly expanded listing of needed tools, especially for assembly and factory use. • Advance listings of 1944 radio and electronic books; repair and replacement parts; bargain section of values. • A brand new, up-to-the-minute catalog that should be in the hands of industrial plants, laboratories, government and military services, schools, radio servicemen and dealers (on L265), everybody engaged in vital war and civilian work.

FREE!

The Lafayette Radio Catalog No. 94 will be rushed to you upon request. Fill out this coupon NOW!

LAFAYETTE RADIO CORP.
901 W. Jackson Blvd., Chicago 7, Ill.
Dept. RC-6
Please rush my FREE copy of the Lafayette Radio Catalog No. 94.

NAME

ADDRESS

CITY..... STATE.....

Back the Attack -
Buy More War Bonds

**LAFAYETTE
RADIO CORPORATION**

901 W. Jackson Blvd.
CHICAGO 7, ILLINOIS
265 Peachtree Street
ATLANTA 3, GEORGIA

RECONDITIONING THE OLD RADIO

(Continued from page 541)

.04 amperes. By using Ohm's Law again I found the value of R2 necessary to drain off the "bleeder" current was 1750 ohms. These two resistors are each of ten watts dissipation.

A FEW PRECAUTIONS

I believe the circuit in general will be understood easily enough by everyone. Nevertheless I would like to say a few words about certain parts of it. To begin with, it was necessary to place a layer of waxed paper between the primary and secondary windings of the three R.F. coils because of the greater potential applied to the plates of the R.F. tubes. Without this paper the coils shorted and it was necessary for me to rewind two burned out primaries. I had some trouble with oscillations in the second and third stages whenever a weak station was tuned in, but this was cleared up by removing the cathode by-pass condensers. This caused a certain amount of degeneration and cut down the gain of the tubes slightly. Plate leads from all three R.F. tubes are shielded right from the tube socket to the coil. Needless to say all of the R.F. coils and tubes are thoroughly shielded also.

SUPER-CONTROL ADVANTAGES

Perhaps I should explain the reason I chose 35 type tubes for the R.F. stage instead of replacing the 24A tubes. The 35 tube is known as the super-control or variable-mu tube and is capable of handling large signal voltage without the cross-modulation or cross-talk found frequently in sets employing 24A R.F. tubes. In a 35 the control grid wires are close wound at the top and bottom. When a fairly strong signal is received the negative grid voltage becomes great enough to stop current from flowing through these close wound portions. At the center the grid wires are spaced much wider apart and offer less impedance to the flow of electrons. Thus it is apparent that it would take a much higher negative grid potential to block the electron flow through

the center of the grid than it would through the more closely wound ends. In the 24A the grid wires are quite closely wound the entire length of the grid and a fairly small value of a. v. c. voltage will cause plate current cut-off, making the tube act as a detector instead of an R.F. amplifier.

Cross modulation occurs usually when there is a powerful local station close by. In the first stage of a receiver the selectivity is broad enough so that when a fairly weak station is tuned in near the frequency of the strong local, enough of the local station's signal beats through to cause the 24A tube to act as a detector. The local station's program causes audio variations in the plate current of the tube and these modulate the R.F. variations caused by the signal of the weaker station the receiver is tuned to. Thus the undesired local program will be heard as part of the program of the other station received. The 35 tube eliminates this nuisance by its ability to handle large signal voltages without detector action. The performance of the radio is thus improved, especially when a. v. c. is used.

OTHER CIRCUIT CONSTANTS

The detector hook-up is so simple that I don't believe it needs much explaining. With the grid and plate tied together the 27 acts as a half wave rectifier, drawing current only on the positive half cycles.

When the "radio-phonograph" switch is in the phonograph position the grid returns of the 35's are grounded rather than left "free" so that these tubes do not draw excessive current.

The .05 mfd coupling condensers in the audio part were used to offer less impedance to the low frequencies and thus improve the bass response. The audio transformer does not contribute a great deal to the circuit and may be left out. If this is done C13 will connect directly to R16 and C14.

I would rather have had push-pull 45's in the output but since the output trans-

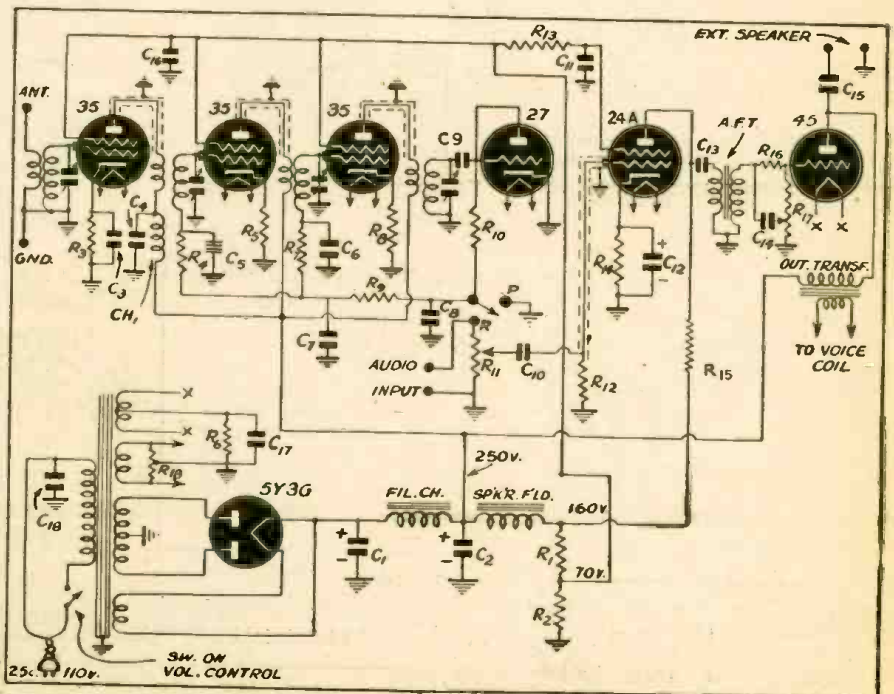

Variable-mu tubes, A.V.C. and other refinements make a great improvement in reception.

former on the speaker I used matched only a single 45, I decided to try it this way. It sounds quite well and, since adding another 45 would mean changing the power supply again, I left it as it was.

Just in case some readers decide to do a remodelling job of this sort I have included a list of parts that may be of some help to them.

Many readers will find nothing new in this article, but I hope a few will find something of interest and help to them. If so, I will be very pleased.

RESISTORS (I.R.C.)

R1—2000 ohms 10 w.
 R2—1750 ohms 10 w.
 R3—800 ohms ½ w.
 R4, R7—100,000 ohms ½ w.
 R5, R8—400 ohms ½ w.
 R6—1650 ohms 10 w.
 R9—2 meg. ½ w.
 R10, R16—50,000 ohms ½ w.
 R11—500,000 ohms vol. cont. No. 11-133
 R12—500,000 ohms ½ w.
 R13—500,000 ohms ½ w.
 R14—3000 ohms ½ w.
 R15—200,000 ohms ½ w.
 R17—500,000 ohms tone cont. No. 13-133
 R18—20 ohms, C. T.

TUBES

3—Type 35
 1—Type 27
 1—Type 45
 1—Type 24A
 1—Type 6Y3G or 80

CONDENSERS (Aerovox)

C1—8 mfd. 600 D.C.W.V. Type PRT
 C2—16 mfd. 450 D.C.W.V. Type PRT
 C3, C4, C5, C6, C7, C10, C11, C13, C15, C16—0.05 mfd. 450 D.C.W.V.
 C8—500 mmf. mica. Type 1467
 C9—200 mmf. mica. Type 1468
 C12—8 mfd. 160 D.C.W.V. Type PRT
 C14—0.005 mfd. mica. Type 1467
 C17—24 mfd. 150 D.C.W.V. Type PRT
 C18—.01 mfd. 40 D.C.W.V.

MISCELLANEOUS

2.5 mh. R.F. Choke (CH)
 S.P.D.T. Switch (radio-phonograph)
 Audio Transformer, ratio 1:3
 Output transformer, pri. imp. 8900 ohms
 8-inch speaker, field resistance 2000 ohms at 45
 Filter choke, 1000 ohms at 100 ma.

HARRISON HAS IT!

**FOR URGENT
 WAR WORK—**

HALLICRAFTERS

RECEIVERS AND
 TRANSMITTERS

TUBES
 CONDENSERS
 RESISTORS
 TRANSFORMERS

AND THOUSANDS OF OTHER
 CRITICAL ELECTRONIC PARTS!

PURCHASING AGENTS—

Call upon us for your high priority requirements of equipment and components for your production and development work.

We usually have it in stock!

**FOR THE
 HOME FRONT—**

CODE PRACTICE SET

Buzzer and key, heavily nickel plated, of single unit construction, mounted on wood base. Adjustable high frequency pitch. Complete with silk covered cord, in attractive box with code chart on cover. Works on one or two flashlight or dry cells.

Postpaid—\$2.45

6L6G First grade, \$1.37 ea.
 meter tested, 3 for \$3.75
TUBES fully guaranteed postpaid

DYKANOL CAPACITORS

Cornell-Dubilier oil filled, hermetically sealed metal cased condensers. 4 mfd. capacity. Rated at 220 Volts A.C. working. Will stand over 600 Volts D.C. Ideal for amplifiers, receivers, power packs, etc. (Filtering action equivalent to 12 mfd. electrolytic but with better safety factor, longer life). \$2.25 (3 or more shipped postpaid).

P. M. DYNAMIC SPEAKERS

5 inch, with output transformer to \$1.95
 match single plate of 8000 ohms

(Not Postpaid)

Immediate delivery of the above items, without priority, while quantities last. Place L-265 or V-3 certification on your order. SEND REMITTANCE WITH ORDER, TODAY! (Money back if not satisfied.)

HARRISON

RADIO CORPORATION

11 WEST BROADWAY

Phone WOrth 2-6276

NEW YORK CITY 7

ELECTRICITY

For Any Job Anywhere

For a dependable source of electricity on projects remote from commercial power, Onan Electric Plants are proven leaders in the field. More than half of the Armed Forces' total requirements for Power Plants are built by Onan.

Gasoline driven—single-unit Compact design sturdy construction sound engineering Suitable for mobile, stationary or emergency applications.

Over 65 models, ranging in sizes from 350 to 35,000 watts. 50 to 800 cycles, 110 to 660 volts, A.C. 6 to 4000 volts, D.C. also dual A.C.-D.C. output types.

Descriptive literature sent promptly on request. D. W. ONAN & SONS, 734 Royalston Ave., Minneapolis 5, Minn.

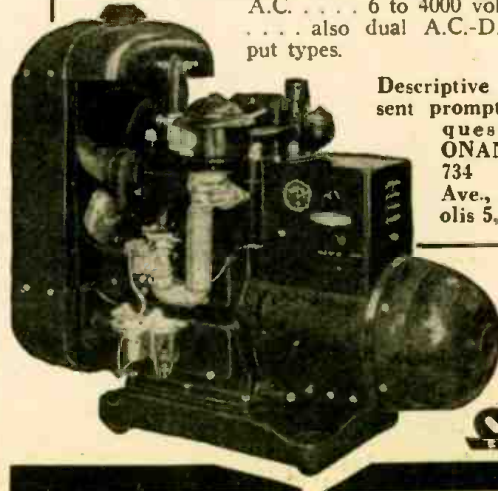

ONAN
 ELECTRIC PLANTS

X-RAY FIRST TUBE (Continued from page 527)

Because of the difficulty of focussing, the rays should come from as small an area as possible, if a clear picture is to be obtained. The ideal source would be a point. This is very hard to attain, because there are difficulties in confining the radiating part of the anode to a small area. A great deal of heat is generated by the heavy bombardment of electrons, and the target area must be large enough to conduct this heat away. A further difficulty is that the heavier metals produce X-rays of shorter wave length than do lighter ones. Thus the choice of a target material must be a compromise between a metal which will produce suitable rays and one which will conduct the heat away from the target. A common solution is to use a target of tungsten imbedded in a larger anode of copper. Tungsten is a heavy metal (atomic number, 74) and produces X-rays of short wave length, while the copper is an excellent conductor of heat.

The shape and size of the anode area bombarded by electrons can be controlled by controlling the shape of the cathode and shielding it. By placing a long cathode in a deep slot, for example, the area of bombardment can be confined to a long, narrow rectangle. The object to be photographed can then be placed at such an angle that the rays appear to be coming from a small square whose sides are the same length as the width of the rectangle. This stunt is called "line focussing" and is illustrated in Fig. 3.

Longer wave length X-ray tubes used in diffraction instruments may be made with targets of copper, molybdenum, cobalt, chromium and other metals. The ultimate is the rotating-anode tube, in which a heavy copper anode, into which is cast a tungsten ribbon target surface, is mounted on ballbearings inside the tube, and driven in the fashion of an induction motor by exciting coils producing a 3-phase field, placed outside. Constructing a heavy rotating machine inside an electron tube is one of the triumphs of vacuum-tube manufacture. The problem of lubrication alone seemed well-nigh insuperable, but these difficulties were all overcome, and the rotating anode tube is in common use. Illustrations of this type are among the photographs on the first page of this article.

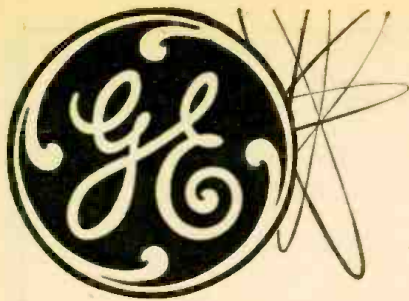

UNIMETER

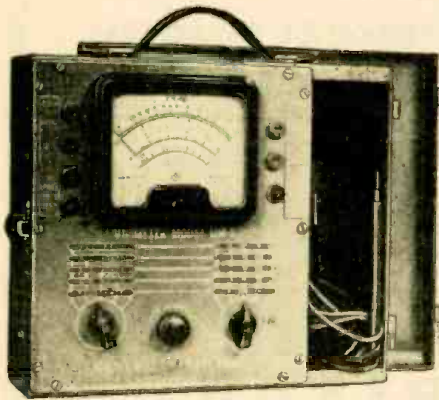

• Completely portable all-around utility instrument, ideally suited for reliable service work. Large meter calibrated to reduce the error possibility in readings makes the G-E unimeter a popular one with servicemen.

Other General Electric units available for testing electronic circuits and component parts are: audio oscillators, oscilloscopes, condenser resistance bridges, signal generators and other utility test instruments.

For complete details about the new General Electric line of SERVICE TESTING EQUIPMENT, please fill out the coupon below. . . .

**FREE
CATALOG**



**ELECTRONICS
DEPARTMENT
GENERAL ELECTRIC CO.
Schenectady, N. Y.**

Please send, without obligation to me, the General Electric Testing Instrument Catalog, R-6 (loose-leaf), for my information and files.

Name _____
Company _____
Address _____

GENERAL ELECTRIC
Electronic Measuring Instruments

Re: Radio Motor-Torpedoes

AFTER RADIO-CRAFT published Mr. H. Gernsback's article on Radio Motor-Torpedoes in the April issue of RADIO-CRAFT, we received the following interesting letter from Mr. John Hays Hammond, Jr., which is printed below.

It should be expressly noted that Mr. Hammond is probably the world's foremost authority on radio-controlled devices, having taken out more than 600 patents in the United States and abroad, on this specific art.

We need not stress the fact that Mr. Gernsback did not have access either to Mr. Hammond's records of research on radio-controlled super-torpedoes—(secret at that time)—nor to the Government files regarding the 1920 war games at the Naval War College at Newport, R. I.

It is, however, surprising how closely Mr. Hammond's letter and Mr. Gernsback's article approximate each other.

Mr. John Hays Hammond, Jr.'s, letter follows:

**HAMMOND RESEARCH CORPORATION
GLOUCESTER, MASS.**

March 31, 1944

Mr. Hugo Gernsback, Editor-in-Chief
RADIO-CRAFT
25 West Broadway
New York 7, N. Y.

My dear Mr. Gernsback:

I was very much interested in your article on radio controlled super-torpedoes. This was a project which I worked out in great detail as far back as 1916 in collaboration with the Coast Artillery of the War Department. The plans at the time were to produce torpedoes which would have a range of well over one hundred miles, and which would be driven by high power gasoline engines. The actual designs for these engines were made and the hulls of the torpedoes tested in model form in tank tests.

I am quoting following a brief description of these from the hearings before the Fortifications Appropriation Committee:

Mr. Hammond: The length of this would be about 80 feet by 7 feet in diameter. This is the point: This torpedo will carry about 1½ tons of high explosive. The modern battleship can be torpedoed and not put out of commission. For instance, the "Marlborough" was torpedoed at Jutland by the normal torpedo which carries only 400 pounds of explosive; but it continued fighting and came back at the rate of 22 knots per hour after being struck. Therefore, we must increase the explosive charges. As against a ton of high explosive, there is no ship existing that can stand up. Moreover, we want range. As you gentlemen know, having had charge of this Coast Artillery proposition, we are getting mobile artillery and moving it on trains to different points. In fact, we have given up the whole idea about having fortifications limited to single points. This is a mobile proposition and it can be carried on rails to different points and assembled at the rail head, and then have a striking radius of 60 or 70 miles from that point. If there were ships down the coast out of range of the fixed artillery, they could be attacked by these torpedoes under the control of airplanes.

Mr. Good: This would act as a torpedo?

Mr. Hammond: Yes, sir.

Mr. Good: And it would contain the power with which to propel it?

Mr. Hammond: Yes sir.

Mr. Good: You propose to place inside of this torpedo a gas engine to propel it?

Mr. Hammond: Yes, sir.

Mr. Good: Of how many horsepower?

Mr. Hammond: I want to tell you about that, and while it seems to be an expensive thing, I will show you how it is economical when compared with the cost of other weapons. (Refer to statement appended

hereto). We are going to put 3 1500-horsepower gas engines in there to give us a speed of 38 miles per hour. 38 miles per hour is as fast as any average torpedo boat destroyer, and, we can therefore run this thing through the screen of the enemy's fleet, and it would have such a high speed that it would be almost impossible to hit it. These vessels will cost \$1,000 a ton to build, and they will displace approximately 50 tons. Therefore, they will cost between fifty and fifty-five thousand dollars. Now then, for the price of one torpedo boat destroyer of the standard Navy type, there could be built 18 of these, with their accompanying airplanes.

Mr. Good: The torpedo will be entirely submerged except for the antenna.

Mr. Hammond: Yes, sir; except that pipe.

Mr. Good: And that pipe which is shown here in your model is to serve as an exhaust pipe for the engines and also as an air intake?

Mr. Hammond: Yes, sir.

Mr. Good: And what purposes does it serve with regard to receiving the wireless?

Mr. Hammond: It is not so much a question of my radio that makes me use the surface pipe, but the point is there is no motive power known today in the engineering world that can give me what I desire except the gasoline engine, and the gasoline engine of this magnitude uses thousands of cubic feet of fresh air every minute in order to run. Practically, they are not only using gasoline but eating up air at a tremendous rate. We have taken into consideration the problem of compressed air or liquified air in tanks and we find we can not carry enough to supply the engines for a long run.

We have, however, embodied this proposition, and if this (indicating on model) is shot off entirely and water starts to enter through this tube, there is an automatic cut-off in here (indicating) which is in the form of a tank cistern which closes the valve and entirely closes this (indicating) off, and when the pressure goes down below normal, compressed air in tanks begins to feed into the body of the torpedo. My engineers find we can run for a distance of 2½ miles when we have cut off all connection from the outside, so that if that were destroyed, the torpedo would have a distance of 2½ miles yet to go in a straight line.

Mr. Good: How much surface would be exposed of this air intake and antenna?

Mr. Hammond: There would be less surface than there is today in one smoke-stack of an ordinary torpedo-boat destroyer.

Mr. Good: And about how large is that?

Mr. Hammond: The scale is 1 foot to the inch, and it would be about 6 feet in length by 6 feet in height. That would be coming end on a good deal of the time, and you would not necessarily get a broadside surface.

Mr. Good: How wide is it at the top?

Mr. Hammond: About 1 foot; but from a practical standpoint you have to consider the Army and the Navy target records, and you have to go to the Navy and say, "Can you hit this thing if we build it? Frankly, can you put it out of commission?" I went to some of the best men we had on that subject, officers who had been over in the grand fleet and were practical men, and I brought them these designs, and I asked them, and they said, "No; the chances of hitting that are very small; very slight."

Mr. Good: How far beneath the surface of the water would that torpedo be arranged to move?

Mr. Hammond: The top of the hull would travel 6 feet below the surface.

Mr. Good: And that would be about the striking point—

Mr. Hammond (interposing): No; 9½ feet would be the striking point or the center of the explosive charge; but no one has ever exploded a ton of high explosive at 9½ feet against the side of a vessel. The ordinary torpedo charge is only about 400 pounds.

Mr. Good: What reason have you to suppose, Mr. Hammond, that if a vessel or torpedo of this character were constructed, it could be successfully operated by an airplane?

Mr. Hammond: Because the facts are that wherever there is an antenna which is not submerged below the water we can work. We worked at Fortress Monroe with an antenna which was only 1 foot, in effect, above the surface of the water. So there would be nothing new in the problem involved.

Mr. Good: What did you do?

Mr. Hammond: We did all our operations with that.

Mr. Good: And what did they consist of?

Mr. Hammond: They consisted of the demonstrations to the board, all the functioning.

Mr. Good: Just what did those operations and experiments show?

Mr. Hammond: Well, at Fortress Monroe I took four members of the board on my boat, and two members I had sent up in a large naval airplane, so they could get the viewpoint of a man in the air, because until a man has flown he does not realize what it is, and they went up to a height of two or three thousand feet and observed my controlling plane, which was at a height of 6,000 feet and which was steering us.

We went through the congested shipping at Fortress Monroe at a speed of 23 or 24 miles an hour. At times we had that speed when we were not going against the tide, and we were controlled through all that shipping by this airplane, which was, as I say, 6,000 feet in the air, and at times two miles away and at other times five miles away. It showed that the man in the airplane had as definite and as accurate control as a quartermaster on board would have and then we were taken against the sides of ships that were moving in and out as if they were targets, and when we were just about to strike, my men had orders to disengage their control mechanism and stop, and I know that we were so accurate that certain members of the board objected to it. They rather disliked the proximity we were coming to the targets.

Mr. Good: At what maximum rate of speed was your vessel going?

Mr. Hammond: The vessel was a 500-horsepower vessel, capable of 25 or 26 statute miles, but the bottom was dirty with seaweed and other growth, and we were probably doing from 22 to 23 miles; but I have worked at 33 miles an hour, which has been observed by General Weaver and General Davis, of the Coast Artillery.

The matter was of such interest that a game was played at the Naval War College in Newport in 1920 called the *Hammond Torpedo and the Naval War Game*. These torpedoes were of the type generally described by you in your article. The game was important as it was the first time aircraft torpedoes and fleets had been massed in a simultaneous action. The torpedoes were also as you described carried into the area of battle by special carriers and were discharged therefrom. The speed of these torpedoes was estimated at 30 knots. The amount of exposure and target surface that would be under attack by the enemy's secondary battery would be extremely small as there was practically only an intake pipe showing above the surface which also carried a small antenna.

One of the main problems was to take in sufficient air to operate 4500 horsepower of internal combustion engines. The chance of striking these torpedoes by gunfire was considered to be 1/100 of that of other small craft. If these torpedoes were rammed they were arranged to explode but it was considered that they would be destroyed if depth charges were exploded within fifty yards of them. It was considered that control planes would have to be within 5000 yards of the torpedo although I think this was rather arbitrary. It was also considered that the torpedo could be seen running in smooth water up to distances of 12,000 yards.

It was the opinion of the experts conducting these games that these super tor-

pedoes offered certain definite hindrances to the enemy's action. One of the chief features of this interference with the enemy was the fact that their screen would be largely employed at certain points of the battle in meeting these super-torpedoes. It was also pointed out that the super-torpedoes had to work in close co-ordination with destroyer attack and with aircraft.

It was found that even if the enemy beat off our control airplanes, our destroyers could take up radio control and bring the Hammond torpedoes against the capital ships. The reason for the discontinuance of the development on these torpedoes was due to the fact that Coast Artillery of the War Department changed its policy after witnessing aerial bombing off Cape Henry. As a result of this, I was forced to undertake the control of the standard naval torpedo in co-operation with the Navy Department. This work was carried out to full success and

the United States Government acquired some 200 of my patents and inventions in 1933.

Very truly yours,
(Signed) JOHN HAYS HAMMOND, JR.

Ranked as the world's second carrier communications system, the Alaska Highway's 2,060-mile, two circuit telephone-teletypewriter line, has been expanded by "C" type carrier to provide 7 talking circuits and 14 teletypewriter circuits—together with four emergency radio stations of the portable type for standby communications in case of line failure—now link Helena, Montana, with Fairbanks, Alaska, extending over rugged and mountainous wilderness along the Alaskan Military Highway.

FREE-if you subscribe now to

RADIO-CRAFT

AND POPULAR ELECTRONICS

RADIO-ELECTRONIC REFERENCE-ANNUAL

PARTIAL CONTENTS
RADIO - ELECTRONIC REFERENCE ANNUAL
ELECTRONIC THEORY AND GENERAL PRACTICE

is thoroughly covered in this book in easy-to-read language. Among the articles on this subject are: What You Should Know About Electronics—Electronic Tubes for Servicemen—The Electronic Solvex—Its theory and action—and The Photoelectric Phonograph Pickup, the principles underlying its operation.

ELECTRONIC DEVICES YOU CAN BUILD

Among the interesting and easily constructed devices selected are the following: Compact Hearing Aid—Oscillatex Automatic Key and Code Machine—Electronic Relay—Capacity and Light Operated, High Frequency Radiography, a complete home apparatus—and many other timely types of electronic apparatus.

RADIO CONSTRUCTION

Many well-illustrated, how-to-do-it articles, such as: Phone Oscillators, several types, adapted to playing records through your radio with a dynamic record player—T.R.F. Sets—Superheterodynes—Power Packs for Portable Receivers, making it possible to use your battery portable on the electric light line—A two-tube Super Midcut Amplifier, which is a palm-of-the-hand public address system—and many others.

SOUND AND RECORDING

Including detailed instructions on constructing: High-Fidelity Amplifier—Exponential Horn with perfect reproduction down to 50 cycles—Electronic Expander, Compressor—Also the Remson Technique—Semi-Pro Recording—Electronic Bass—and Treble-Expanding Circuits—Equalizers, etc.

TEST INSTRUMENTS

A complete line including: A Tube Checker with universal hookup; can check any tube regardless of the pronk to which its elements are brought out—Compact Multitester; 18 ranges of voltage, current and resistance on an 11-point, 2-gang switch—A Three Tube Signal Tracer, capable of checking R.F., I.F. and audio circuits—A Condenser Analyzer which measures both capacitance and leakage—An Electron-Ray Voltmeter which dispenses with hard-to-read milliammeters, using a G.E.S. tube instead.

SERVICING

Articles on servicing supply a multitude of methods and useful ideas, including: Dynamic Testing with Signal Generator—Modernizing a Test Set—Calibrating UHF Oscillator—And 200 other's other hints for ironing out kinks in your servicing problems.

Are you asking yourself: "What's next in Radio and Electronics?" What mysterious inventions are brewing in radio research laboratories? What effect will these wartime secret inventions have on peacetime conditions? Will the scientists take me into new, unfamiliar fields, requiring special technical education?

Keep Posted With Radio-Craft

Radio is once again at the crossroads! All must become students again of a science that has experienced a marvelous rebirth through ELECTRONICS. The question about the near and distant future now racing through your mind will be answered step by step in the forthcoming issues of RADIO-CRAFT!

You Need This Free Reference Annual, Too!

You can't plan intelligently ahead—you can't grasp the new—until you have thoroughly mastered the tried and accepted present-day radio developments. And that is where the REFERENCE ANNUAL comes to your aid. This fact-packed book is THE radio man's digest. It's the spark that bridges the gap between the RADIO-ELECTRONIC WORLD OF TODAY and the COMING POST-WAR WORLD.

And think of it—you can get it absolutely free and postpaid by subscribing to RADIO-CRAFT now—but you must act quickly as war-paper shortage competes us to limit the printing. If you are already a subscriber we can extend your subscription.

1944

IN ALL ITS PHASES

CUT OUT AND MAIL

Be sure to use coupon or mention Free Reference Annual when ordering.

RADIO-CRAFT
25 West Broadway
New York 7, N. Y.

Gentlemen:
I want to take advantage of your Special Time Limit Offer for your RADIO-ELECTRONIC REFERENCE ANNUAL—1943-1944, which you will send me ABSOLUTELY FREE and PREPAID in connection with my subscription to RADIO-CRAFT and Popular Electronics for the period checked below. No billing on this Special Offer.

I enclose my remittance of \$.....
 1 Yr. \$2.50 2 Yrs. \$4.50 3 Yrs. \$6.00
 This is a new order Renewal Extension

Name
please print clearly

Address

City State

..... Postal Dist. No. (if any)

(Canadian and Foreign subscriptions 5c extra per copy. Send by International Money Order.)

TIME LIMIT OFFER

RADIO-CRAFT WITH FREE COPY RADIO-REFERENCE ANNUAL

1 Year \$2.50
2 Years \$4.50
3 Years \$6.00

If you are already a subscriber we can extend your subscription if you will check "Extension" box.

INSIDE DOPE

Twenty pages of "hot" tube substitution tips that are not common knowledge are clearly and completely explained in the NEW RELEASE:

"SUPPLEMENT NO. 2"

(Code: GREEN)

to the

"RADIO TUBE SUBSTITUTION & CHANGE-OVER MANUAL"

Price 50 cents

SUCCESSFUL FORERUNNERS...

"Radio Tube Substitution & Change-Over Manual"

(Code: BLACK)

Price: \$1

and

"SUPPLEMENT NO. 1"

(Code: YELLOW)

Price: 50 cents

See Your Radio Parts
Jobber or Write

**OELRICH
PUBLICATIONS**

1627 S. Keeler Ave.
Chicago 23, Ill.

LOUDSPEAKER TESTS

(Continued from page 537)

a second speaker, as indicated by the vacuum tube voltmeter connected across the crystal load or to the output of the pre-amplifier, the first speaker is the more efficient from the standpoint of conversion of electrical power into sound. In making measurements, it is desirable to have a room which has sound dead walls of soft material so that reflection effects will not be bothersome.

SPEAKER RESPONSE

The response of a typical magnetic may be fair from 200 to 4,000 cycles, with a sharp slope off from 200 to 30 and 4,000 to 15,000, but a great deal depends upon the individual speaker and the baffle used with it. In plotting the response, the electrical voltage output of the mike working into the pre-amplifier is checked. It is convenient to connect the vacuum tube voltmeter to the output of the pre-amplifier rather than across the load of the crystal for the reason that indications are more easily read.

The point where chattering and distortion begins can be determined by ear. When this point is reached the V.T.V.M. can be used for checking the voltage across a small resistor which is in series with the speaker to determine the current. The power may then be found by squaring the current and multiplying by the resistance of the speaker. This will be the real power, not the volt-amperes product. The magnetic speaker load is somewhat inductive. It varies with frequency because of the inductive effect, since $X_L = 2\pi fL$.

In specifying the working conditions it is convenient to give the voltage across the speaker terminals required for maximum undistorted output at 400 cycles or some other arbitrarily selected but convenient test frequency, such as 1,000 cycles. It is also convenient to give the minimum input voltage required to give an easily understood sound output in a quiet room or space, using a specified form of cabinet or baffle. Then, with such knowledge at hand, intelligent planning of a hotel or similar installation is possible.

PERMANENT MAGNET SPEAKERS

These are used in inter-office communicators to a great extent. The test set-up previously given can be used for checking the speaker as an output device or a converter of electrical to sound energy, but a somewhat different arrangement is necessary to check the speaker efficiency as a microphone; for now its job will be to translate sound into electrical impulses. We need to create a sound pressure at the diaphragm and to measure the electrical output voltage. This voltage may be checked across a resistor or across the output of a standard pre-amplifier circuit to make the V.T.V.M. read easily. For various reasons, talking into the speaker is not good practice. The speaker in Fig. 1 may be replaced with a good quality electrodynamic type having a wide frequency range and being linear over that range. The speaker to be tested may then be set on the same level. The procedure is to set the audio generator at various test frequencies and to vary the output of the test amplifier until various degrees of sound intensity are produced. The sounds impinging upon the test speaker are then converted into electrical impulses which drive the pre-amplifier. The output of this unit is then fed into a vacuum tube voltmeter. The test set-up is shown in Fig. 3. The output of the audio amplifier is adjusted by means of the amplifier's gain control until the 'scope pattern starts to exhibit kinks and bends.

The speaker which is used for the development of the sound intensity should have adequate reserve power handling ability so that it, itself, does not introduce distortion due to quivering of the cone, rattling, overload or any other defects. The level of the signal supplied the pre-amplifier must not exceed its safe input value and should be checked with the vacuum tube voltmeter. Similar tests may be run on electrodynamic and magnetic speakers.

The sensitivity of magnetic speakers is often high, of the PM and electrodynamic, fair.

Classification by types is not a good criterion as much depends upon the design of the individual speaker and the care that went into its manufacture. If at hand, a wave analyzer or harmonic distortion meter may be used to check the distortion content at various levels of output voltage and sound intensity.

It may be desired to check the output power for various amounts of field power and to specify the characteristics of the speaker for various field powers. If the field is weak the flux density in the vicinity of the voice coil will be less and a smaller induced voltage for any degree of voice coil movement will be the result, giving lowered output. In the PM speaker the field power remains substantially constant.

It may also be desirable to specify the harmonic distortion in the output, assuming a sine wave input, for various types of field power, so much percentage ripple voltage at 60 cycles or harmonics of 60. The hum level of the speaker will directly be related to the hum current flowing in the field and voice coils. A suitable power supply designed to furnish the required power to the field should be on hand.

FM ANTENNA

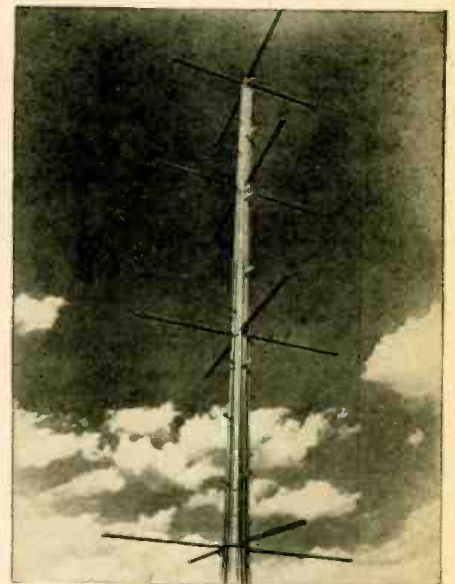

A recent installation of Andrew Coaxial Cables in the Zenith FM station WWZR located on top of the Field Building in Chicago is of special interest to radio engineers. Feeding the four bays of the turnstile antenna shown in the photograph are eight Andrew $1\frac{3}{8}$ diameter coaxial cables. These lines, as well as the $\frac{1}{4}$ diameter cables feeding power from the transmitter, are used in a "back-to-back" connection to provide a balanced 140 ohm transmission line. All cables are equipped with gas tight terminals and the entire system is constantly maintained under gas pressure.

tronics in the war would deserve hours of discussion if we were free to do so, but since that is not the case, we can only discuss those present and future applications in industry which are of such a nature that they can be divulged.

You will of course see electronics in the home in the form of radio receivers, FM receivers and television. These are so well known that little needs be said.

Electronics will make the housewife's job easier by keeping the house clean. This will come about first of all by the use of smoke precipitators in factories and mills so that chimneys will cease to belch forth great volumes of smoke and soot into the community. Those of you who have lived in soft coal districts especially will appreciate what that could mean.

Within the house itself the "Precipitron" will be used to clean the air of dirt and smoke and make the home a more comfortable and healthful place to live.

In the household refrigerator "Sterilamps" will generate ultra-violet radiations which will in turn reduce food spoilage, prolong the storage time for foods, and in other ways improve food quality.

Aside from these household evidences of electronics the average citizen may not see much of "electronics in action," but he will reap the benefits of it in the products that come out of industry, and through its use in medicine and surgery.

In medicine the three major applications of electronics are X-rays, high frequency and ultra-violet radiations.

X-ray is used to locate shell fragments, etc., in war, to diagnose body ailments, and to locate and treat cancer in times of peace. Great strides have been taken toward safeguarding the public health by the large scale diagnosis of people at induction centers, at industrial plants and schools.

Diathermy is the use of high frequency waves to heat artificially the inner portions of the body so as to stimulate the normal repair processes of nature. Nature, as you know, sets up a fever in the body when certain things are wrong with you. Diathermy enables the doctor to assist nature in this natural mechanism. It is quite likely that certain developments in the war effort will eventually advance this art.

Sterilamps and other sources of ultra-violet radiation are and will continue to be used for disinfecting the air in hospital operating rooms, nurseries and wards. They are used for protection against air borne contamination during the manufacture of serums and pharmaceuticals and the progressing of blood plasma.

Assuming now that you are comfortable in your electronically equipped home and that the doctor and the surgeon have kept you in better repair by the use of electronics, you should be in fine shape to enjoy the benefits of electronics in industry.

Probably the outstanding attribute to electronics is that by its very nature it can be made precise and fast, and these characteristics are just what we need to control processes, inspect parts, control power and perform other operations in a manufacturing plant. This field is so broad that I can only touch upon a few applications.

In the chemical industry such as synthetic rubber, petroleum products, etc., the accurate control of processes is of paramount importance. The Mass Spectrometer is an electronic device that can analyze gases accurately and quickly and the results are used to control the process and give a more uniform product. The operation of the device depends on giving each particle of

gas an electrical charge and then deflecting the particle in a magnetic field. Light weight particles will deflect more than heavy ones so that we spread the particles out into a spectrum according to their mass. Since each gas has a certain atomic weight we can tell exactly what kind of gas we have and how much. This can also be done chemically but electronics again offers the two decisive things, precision and speed.

The conversion of alternating current into direct current and the high speed spot and seam welding of sheet metals are two of the biggest applications of electronics. The conversion of alternating current into direct current (when it is done electronically) is usually done with ignitrons. This application goes back many years, but received a great impetus when the first 600 volt, 1000 kw. installation was made in the electrochemical industry at the Massona plant of the Aluminum Co. of America in January, 1939. Today there are over 3,000,000 kw. of ignitron rectifiers of the 600 volt class installed in the electrochemical service alone.

Spot and seam welding of sheet metals is also accomplished electronically by means of ignitrons and thyatrons. Here again the Aluminum Co. of America and the Budd Manufacturing Co. were among the very first to apply electronic methods.

I can remember spending a night at the New Kensington plant of the Aluminum Co. helping them to weld aluminum barrels. As I recall it, we welded more barrels in a night than could be done in a week by arc welding, and this with one of the early laboratory welders.

As you would probably guess, electronic welding is used extensively in the aviation industry and in making motor cars, and will be even more extensively used in all sheet metal work instead of riveting, clamping, etc.

The same kind of high frequency waves as are used in radio and other communication fields can be used to induce heat in metal, ceramic and plastic materials. This promises to be a very important field. It is applied to the bonding of plywood, the heating and curing of plastic materials, the annealing and hardening of metals, and to the plating of metal parts.

The war brought about an acute shortage of tin and consequently the problem of conserving the supply. The tin plate companies together with electronic engineers developed methods of obtaining complete coverage of the iron with only one-third the tin previously used by fusing the tin onto the surface electronically. All this takes place on a strip about sixty inches wide and goes through the process at about one thousand feet per minute. Speed and precision again with one-third the tin consumption.

These applications serve only as outstanding illustrations of the versatility of electronics. Electronics under the name of Carrier Current enables the power company to send control messages over the same wires that carry power to your home with a resultant saving in copper and other critical materials.

Electronics inspects and grades materials, sorts them according to color, measures and analyzes vibrations, controls the speed of motors, regulates voltage and current, and other things too numerous to mention.

It is not a cure-all and it is not magic or mysterious—but properly applied it is a useful science, here to stay and do its bit to make the world a better place in which to live.

Short-Cut Mathematics

COMBINED WITH
Practical Mechanics Simplified

NEW 2-in-1 reading course! Now you can learn the speedy, simplified system of calculation used by draftsmen, engineers, accountants, "master minds" on the stage. Learn easy way to multiply 4 figures by 4 figures without using old-fashioned multiplication; add long columns of figures this lightning short-cut method. Learn horsepower, slide rule, micrometer, logarithms, wood measure, puzzles, etc., etc. Large illustrated volume complete with answers, only \$1 postpaid. Satisfaction or refund. Amaze your friends with your magic-like mental powers.

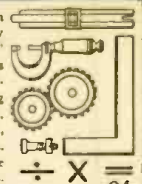

FREE Complete details... mail coupon TODAY!

NELSON CO., 323 So. Wabash, Dept. F-310, Chicago, Ill.

Please send free details about "Short-Cut Mathematics and Practical Mechanics Simplified." No obligation.

Name _____
Address _____

RADIO AND ELECTRONIC DEVICES

BURSTEIN-APPLEBEE CO.

1012-14 McGee St. Kansas City, Mo.

RADIO SERVICE DEALERS

Send for free loose leaf catalogue listing hundreds of hard-to-get items ready for immediate shipment.

BAKERSFIELD RADIO SUPPLY
P.O. Box 489
Bakersfield, California

PATENTS—TRADE MARKS

Booklet concerning Inventions & Patents Form "Evidence of Conception" with instructions for use and "Schedule of Government and Attorneys Fees"—Free

LANCASTER, ALLWINE & ROMMEL
Registered Patent Attorneys

436 Bowen Bldg. Washington 5, D. C.

Inventions Wanted

Patented or Unpatented

We have been successfully selling inventions, patented and unpatented, since 1921. Write us, if you have a practical, useful idea for sale.

CHARTERED INSTITUTE OF AMERICAN INVENTORS
Dept. 111, 631 Pa. Ave., N. W., Washington, D. C.

USED Correspondence Courses

Complete HOME-STUDY Courses and self-instruction books, slightly used. Reputed, sold, exchanged. All subjects. Satisfaction guaranteed. Cash paid for used courses. Full details & 84-page illustrated bargain catalog free. Write now.

NELSON CO., 323 So. Wabash Ave., Dept. 210, Chicago, Ill.

\$100 MOTOR-GENERATOR FOR \$17.95

MADE FOR U. S. ARMY TANKS BY WESTINGHOUSE

MAKE \$5.00 PER HOUR

and more in spare time by reworking this Westinghouse Motor-Generator into:

- 1/2-1 1/2 HP. D-C Motors
- Home Generator Sets
- Wind Chargers
- Arc Welders
- Helist Motors
- Marine Power Units
- Experimental Units
- School Equipment
- Alarms and Signals
- Farm Applications

MADE BY WESTINGHOUSE for U. S. Army. Brand new. Cost over \$100.00. 1 1/2 HP. 24-V. 2800 RPM. D-C motor; and 1-K.W., 230-V., D-C Generator. Ball-bearing. Totally enclosed. 1/2" shaft (adapter 0.5¢ extra). Wt. 125 lbs. Converted into D-C motor by changing and rewinding two 1-lb. coils No. 31 wire. Instructions furnished. Invest \$17.95 and get \$200.00 worth of experience and easy profits selling reworked units. Order now!

Only \$17.95 delivered, cash with order; also shipped C. O. D. FOB Chicago on \$3.00 deposit.

MIDLAND MOTORS, 748 W. Adams St., Chicago 6, Ill.



4 STANDARD TYPES
of Amperite Regulators replace over 400 types of AC-DC Ballast Tubes now in use. Amperites are real REGULATORS... have patented Automatic Starting Resistor which prevents initial surge and saves pilot lights... Ask Your Jobber.

AMPERITE

THE *Simplest* WAY TO REPLACE **BALLASTS**

WRITE FOR REPLACEMENT CHART
AMPERITE Co. 561 BROADWAY, NEW YORK, N. Y.

300 WAYS TO MAKE MONEY



MAIL ORDER PLANS TESTED MONEY MAKERS BUSINESS SECRETS SUCCESS SCHEMES

25c Per Copy

BRAND NEW BOOK

40,000 WORDS IN TEXT!

In "CASH IN" you get ALL the real money-makers—dozens of profitable tested mail order plans, confidential business secrets, dozens of practical tested formulas, successful tested schemes—actual experiences of men who have started on a shoestring—with less than \$10 capital.

Buyers of This Book Tell Us—
... "Biggest value I've yet to see. Book is worth at least a dollar." S. Buda, B'klyn, N. Y.
... "Your book is as good if not better than others selling at \$1.00."
George Brunet, Montreal, Can.

... "CASH IN is the best value I have yet to see in the mail order field."
Lawrence Fox, Brooklyn, N. Y.

"CASH IN" contains only tested ideas covering every type of full- or part-time enterprise—it's a "masterpiece" in business ventures.
25c a copy postpaid. Send U. S. stamps or coin.

NATIONAL PLANS INSTITUTE
P. O. Box 26R, Station N
New York 23, N. Y.

RADIO SERVICE MEN
Get Better Prices

for your work, with more satisfied customers by displaying our
MEMBER SCIENTIFIC RADIO SERVICE SYSTEM
Colorful 11 x 14" Display Card
Indicates number of common causes for each of various radio troubles.
Sent on approval. Details free.
SCIENTIFIC RADIO SERVICE SYSTEM
P. O. Box 1532-A Des Moines 6, Iowa

SOUND STUDIO TREATMENT

(Continued from page 525)

dow, size 3 ft. x 6 ft.; there is one ventilator, size 2 ft. x 4 ft.; the entire floor is covered with cork tile.

A TYPICAL CALCULATION

Solution:

- (1) The volume of the room is (10' 4" x 15' 6" x 26'), or about 4,163 cu. ft.
- (2) Referring to Table I, the desired reverberation time will then be about (0.7 x 1), or 0.7 second.
- (3) Referring to Table II, the total absorption by the performers will be (3 x 4.7), or 14.1 sabines.
- (4) The total absorption (area times coefficient) by the door will be (3 x 7 x 0.3), or 0.63 sabine.
- (5) The total absorption by the outside windows will be 2 x (2.5 x 5 x 0.027), or 0.0675 sabine.
- (6) The total absorption by the control-room window will be (3 x 6 x 0.027), or 0.486 sabine.
- (7) The total absorption by the ventilator will be (2 x 4 x 0.75), or 6 sabines.
- (8) The total absorption by the floor will be (26 x 15.5 x 0.03), or 12.09 sabines.
- (9) The total surface area to be treated is equal to the ceiling area plus the wall areas, less the area of the objects breaking its surfaces, such as doors and windows. This amounts to (403 + 858 - 71), or 1,190 sq. ft.
- (10) Substituting these values in the equation, we have

$$0.7 = \frac{208.15}{33.98 + (1,190 s)}$$

$$33.98 + (1,190 s) = 208.15/0.7$$

$$= 297.36$$

$$(1,190 s) = 263.38$$

$$s = 0.2213$$

Again referring to Table II, we see that there are several materials with an absorption coefficient approximating this calculated value. We also see that no material has absolutely uniform absorption at all audio frequencies. Therefore, it may be advisable to choose a material which has less absorption at those frequencies where our speech equipment has lowered response, in order to provide compensation, and thus flatten the over-all response curve. The remaining considerations must be the questions of initial cost, practicability, etc., which would depend upon each individual case.

A sketch of our studio appears in Fig. 1. For the sake of simplicity, the articles of furniture have not been considered in the calculations. However, it is obvious that for the most satisfactory results, due consideration would have to be given these items as well.

The technique of microphone placement and some of the problems of the public-address man will be discussed in our next article. Correspondence with persons who have special problems is invited.

$$0.7 = \frac{0.05 \times 4,163}{14.1 + 0.63 + 0.675 + 0.486 + 6.0 + 12.09 + (1,190 s)}$$

COEFFICIENT OF SOUND-ABSORBING MATERIALS

Material	Thickness, in Inches	Coefficient per Sq. Ft., at Given Freq. in C. P. S.				Material	Thickness, in Inches	Coefficient per Sq. Ft., at Given Freq. in C. P. S.			
		125	512	1,024	4,096			125	512	1,024	4,096
Acoustex "60"	1	0.10	0.54	0.74	0.55	Hair Felt, 100% Hair	1	0.12	0.51	0.62	0.56
Acousti-Celotex A	13/16	0.14	0.24	0.23	0.23	Hair Felt 0.75 lb.	1	—	0.58	—	—
Acousti-Celotex B	13/16	0.22	0.47	0.53	0.62	Hair Felt, 0.87 lb.	1 1/8	0.20	0.65	0.67	0.61
Acousti-Celotex BB	1 1/4	0.28	0.65	0.73	0.77	Hair Felt, on 1-in. Fibre Bldg. Board	2	0.18	0.71	0.79	0.85
Acousti-Celotex BBB	1 1/4	0.20	0.75	0.86	0.59	Linoleum	—	—	0.03	—	—
Acousti-Celotex C	3/4	0.14	0.30	0.45	0.55	Mesonite, Against Concrete	7/16	0.10	0.29	0.30	—
Acoustone	1/2	—	0.48	0.62	0.52	Mesonite, Separated by 1 x 2's	1 1/8	0.23	0.31	0.31	—
Acoustone	3/4	—	0.62	0.66	0.53	Marble	—	—	0.01	—	—
Acoustone	1	—	0.65	0.67	0.53	Nashkote "A"	1/2	—	0.31	—	—
Acoustone "46"	1/2	—	0.46	0.55	—	Nashkote "A"	3/4	0.11	0.51	0.68	0.68
Acoustone "60"	1	—	0.60	0.64	—	Nashkote "A"	1	0.13	0.58	0.73	0.71
Acoustone "62"	3/4	—	0.62	0.64	—	Nashkote "ALS"	1/2	0.07	0.30	0.40	0.33
Akoustolith (artificial stone)	3/8	0.10	0.30	0.42	0.42	Nashkote "B"	1/2	—	0.37	—	—
Akoustolith "A"	1	0.14	0.48	0.72	—	Nashkote "B-322"	1	0.15	0.59	0.79	0.63
Ambler Sound-Absorbing Plaster	—	—	0.14	—	—	Plaster, on Wood Lath	3/4	0.02	0.034	0.03	0.043
Acoustic Zenitherm	—	—	0.033	—	—	Plaster on Metal Lath	3/4	—	0.033	—	—
Balsam Wool	1	0.12	0.49	0.63	0.60	Plaster on Tile	—	—	0.025	—	—
Balsam Wool	2	0.23	0.58	0.69	0.66	Rock Wool, Covered with 1/2" Per. Plaster	2	0.28	0.40	0.38	—
Balsam Wool with Scrim Facing	1	0.18	0.55	0.65	—	Rug, Axminster	—	0.11	0.20	0.33	0.62
Brick Wall, Un-painted	—	0.025	0.032	0.04	0.07	Sabine Plaster	1	0.11	0.29	0.47	0.38
Brick Wall, Painted	—	0.012	0.017	0.02	0.025	Sabine Plaster	1 1/2	0.08	0.18	0.25	0.35
Bdcast. Studio Tr'tm't (Johns-Manville)	4	0.66	0.80	0.74	0.75	Sanacoustic Tile	1 1/4	0.19	0.79	0.82	0.56
Calacoustic Plaster	—	—	0.16	—	—	Transite Acous. Tile	1 1/4	0.19	0.81	0.77	0.55
Carpet, Lined	3/8	0.09	0.21	0.26	0.37	Velour Draperies, 18 oz., in Contact with Wall	—	0.05	0.35	0.45	0.36
Carpet, Unlined	1/4	—	0.15	—	—	Velour Draperies, 18 oz., Hung 4 in. from Wall	—	0.06	0.44	0.50	0.35
Carpet Pile on 1/2-in. Felt	3/8	0.11	0.37	0.43	0.25	Ventilators	—	—	0.75	—	—
Celotex, Standard	7/16	0.16	0.24	0.22	0.22	Wood, Plain	—	—	0.06	—	—
Cocoa Matting	—	0.08	0.17	—	—	Wood, Varnished	—	0.05	0.03	—	—
Cork Flooring	3/4	0.08	0.08	0.19	0.22	Wood Sheathing	3/4	0.10	0.10	0.081	0.11
Cork Flooring	3/4	0.04	0.05	0.11	0.02	Water	—	0.008	0.13	0.15	0.25
Cork Tile	1/4	—	0.03	—	—						
Cotton Fabric, 14 oz., Draped to 1/2 area	—	0.07	0.49	0.81	0.54						
Cotton Fabric, 14 oz., Draped to 3/4 area	—	0.04	0.40	0.57	0.40						
Cotton Fabric, 14 oz., Draped to 7/8 area	—	0.03	0.15	0.27	0.42						
Fibrolox	—	—	0.42	—	—						
Flaxinum	1	—	0.61	—	—						
Gimco Rock Wool, Bare	—	—	0.57	—	—						
Glass (single)	—	—	0.027	—	—						

TABLE II

Total Absorption, in Sabines
Individual Objects
Adult Person 4.7
Church Pews, per Seat 0.2-0.5
Plain Wood Seats 0.15
Seats, Upholstered Seat and Back 0.75-2.0
Seat Cushions, per Seat 1.0-2.0

AUDIO DISTORTION

(Continued from page 534)

involved. Another interesting fact is that the average ear does not respond equally to all sounds in the audio range. As the volume of any sound is decreased the very highs and the very lows are first to disappear leaving only the middle register. We are thus quick to determine whether a given sound is near or far and it is easily possible for a sound to be so deficient in high and low frequencies as to seem "far-away" even though it is comparatively loud.

The newer frequency modulation distortion effect might explain a somewhat debatable point in acoustics. For some time acoustics experts have been aware of the fact that the pitch and perhaps the quality of sounds vary somewhat with intensity. Frequency modulation distortion developed by the ear may be partially responsible for this non-linearity effect.

Another peculiar distortion effect which takes place in the aural system is known as "masking" and may be a form of the "Volume distortion" suggested by the writer. Masking is the apparent reduction of the intensity of one sound in the presence of another and stronger sound signal. In other words, the presence of intense sound frequencies lowers the aural system's sensitivity to other lower-intensity sound frequencies. This may be considered a special transient case of the "conditioning" effect already discussed.

The "bi-aural" effect concerns the fact that when listening through two ears we are enabled to judge distance and direction of sound. (This corresponds to our being able to determine distance through the use of two eyes by the automatic focussing effect.) Because of this, a movie sound picture which projects all sound from a common source although the subjects are moving about may sound unnatural. A multi-microphone pickup such as was used in "Fantasia" makes the sound effects much more realistic.

Bibliography

IRE Proceedings—(Recent Issues)
Some Problems of Disc Recording—Begun—September, 1940.
Distortion Tests by the Intermodulation Method—Hilliard—December, 1941.
Frequency Modulation Distortion in Loud-Speakers—Beer and Balar—April, 1943.
Some Recent Developments in Record Reproducing Systems—Beer and Sinnet—April, 1943.

RCA Review
Analysis and Design of Video Amplifiers—Secley and Kimbal—October, 1937.
Some Notes on Video Amplifier Design—Priesman—April, 1938, and January, 1939.
Measurement of Phase-Shift in Television Amplifiers—Barco—April, 1939.
Sound Insulation Characteristics for Ideal Partitions—Morrical—October, 1939.
A Discussion of Several Factors Contributing to Good Recording—Lynn—April, 1942.

Journal of the Society of Motion Picture Engineers
(Various past issues on sound and acoustics)

Radio-Craft
Intermodulation Distortion—A. C. Shaney—May, 1940.
Audio Amplifier Theory—Ted Powell—February to June, 1943.
Phono Pick-Up Performance—Ted Powell—September and October, 1943.

Electrical Engineer's Handbook—Pender and McIlwain—Wiley & Sons.
Third Edition—Communications and Electronics, Section 6—Electromechanical Acoustic Devices, Section 9—Acoustics.

Radio Engineering—Terman—McGraw-Hill Co.
Chapter V—Vacuum Tube Amplifiers.

Radio Engineering Handbook—Terman—McGraw-Hill Co.
Section V—Vacuum Tube Amplifiers.

BETTER RADIO THROUGH SPARK SUPPRESSION

POST-WAR America can look forward to vastly superior short-wave radio reception if auto makers adopt the war-developed technique — "spark suppression" — which eliminates radio interference from the engines of mechanized weapons, according to Delmar G. Roos, vice-president in charge of engineering for Willys-Overland Motors.

The resultant improvement in the field of high-frequency broadcasting would be of sufficient magnitude to warrant enactment of legislation which would assure peacetime application of this radio development to all new automobiles.

Such a legal requirement would bring about the "suppression" of all cars and trucks on the highway within a period of five to seven years and thus, by releasing a vast number of short-wave bands previously denied the public, would clear the

way for infinitely better radio reception.

This technique has been in effective operation for more than a year on tanks, "jeeps" and half-tracks. Previously, it was difficult to transmit and pick up dispatches on certain short-wave bands, especially when these vehicles were traveling in convoy or close battle formation, owing to the radio interference emanating from their electrical equipment.

Guaranteed Rebuilt Radio VIBRATORS—\$1.00 ea.

Send old vibrator. For very prompt delivery, enclose remittance and return postage. We rebuild any make or kind of vibrator or relay. Vibrator packs rebuilt also. Send your old vibrator to
BEST VIBRATOR CO., Box 5802-Z, Cleveland 1, O.

RADIO CIRCUIT MANUAL 1942



UP-TO-DATE OF GOVERNMENT SHUT-DOWN APRIL, '42

Complete, Correct, Compact

The Set You Are Looking For Is Here!

This Radio Circuit Manual has more listings than any other publication of its kind. Check for yourself on such makes as Lafayette, Emerson, Pilot, Philco, RCA, Stewart Warner. If time really means money to you then this completeness will save you many times the cost of the book. It is the greatest time-saver you can buy today.

No fumbling around! No turning over to another page! The big roomy pages of the Radio Circuit Manual contain everything on a single page. You will see not only schematics, but quick reference IF spot, parts lists, dial stringing, diagrams, tuning range and data, tube locations, voltage charts, trimmer locations, push button, set-ups, alignment notes, and procedures, record changer details, etc.

THE ONLY EDITED MANUAL PUBLISHED!

The diagrams are perfect. Every one was checked and rechecked to make sure of it. The printing is clear and distinct. It's a pleasure to use this manual.

The index is another feature you'll like. At a glance you can tell whether a model is the same as another. No hunting back and forth... it's right there. Big readable type numbers and model numbers help to spot quickly what you want.

Special charts on tube and battery interchangeability, lights, ohms law, color codes; also a special article on "The Methods of Substitution" by F. L. Sprayberry, to make your wartime service job easier.

If you like your service manual in handy form—so shaped that you can grab hold of it easily and store in small space... if you like a book that lies open flat so you don't constantly lose the place... then you will certainly appreciate the Radio Circuit Manual.

Everything relating to a model is on a single page. Mighty handy!

700 fact-packed pages. The actual page size is 10 x 12 3/4 inches.

\$10.00 EACH

Use this simple coupon for ordering the 1941 and 1942 Radio Circuit Manuals.

RADCRAFT PUBLICATIONS, INC.

25 West Broadway, New York 7, N. Y.

Gentlemen: Rush to me by return mail, the RADIO CIRCUIT MANUAL ordered below, which I understand are priced at \$10.00 each.

1941 Edition 1942 Edition
 I enclose remittance to the amount of \$.....
 Kindly send C.O.D. I enclose my deposit remittance of \$..... (20% required).

Name..... (PLEASE PRINT CLEARLY)

Address.....

City..... Dist. No., if any..... State.....

(If remittance is enclosed, send in form of check or money order; register your letter if you send cash.)

LIMITED NUMBER OF 1941 MANUALS LEFT

Our 1941 RADIO CIRCUIT MANUAL—the first we ever issued—proved so popular that we cleared out most of them in a short time notwithstanding a large printing. However, during a recent inventory, we discovered a small number still on hand which we are disposing of quickly. This should be good news to anyone who failed to get the 1941 edition. After all, many 1941 models must be served today, and the 1942 edition won't help at all for the earlier models. The price of the 1941 edition is the same as 1942... only \$10.00 each

CAREERS

for

ENGINEERS

at

NATIONAL UNION RADIO CORPORATION

You who join our research and engineering staff now to help us with the important war work we are doing will be embarking on a career. Our plans for the future offer unusual opportunities for able men. Our staff today forms a friendly capable team of scientists and engineers whose accomplishments have brought national recognition. You'll enjoy working with them, growing with them.

THESE ARE OPPORTUNITIES. We are adding to our staff engineers who specialize in

**ELECTRONIC TUBES
PRODUCTION
DEVELOPMENT
MEASUREMENTS
PHYSICS
ELECTRICITY
TRANSMITTING TUBES**

Our laboratories in Newark, N. J., offer ideal working conditions. We prefer that you have a degree in electrical engineering, physics, chemistry or mathematics—your experience, however, may be sufficient.

Why don't you find out whether there's a place for you with our fine staff of specialists. Write and tell us about yourself or Phone **HUMboldt 2-5252, Ext. 72**, for appointment.



NATIONAL UNION RADIO CORPORATION

50 Spring Street, Newark, 2, N. J.



OPPORTUNITIES WITH SPRAGUE

**Wanted for production and product development:
JUNIOR ENGINEERS FOR QUALITY CONTROL**

For this work, we need four or five practical men who are qualified, not only to check up on capacitor and resistor production, but who can also pick up a soldering iron or other tool on occasion and show how things should be done. Technically-informed men with better-than-average radio service or similar practical experience should find this a worthwhile opportunity.

RESISTOR ENGINEER

The man to fill this position will need a good, practical working knowledge of resistance problems and a particular leaning toward the broad electrical field rather than radio alone. The work is interesting and has to deal with further development and expansion of the most unusual and most rapidly-growing resistor line.

WRITE AT ONCE if you feel that you can qualify for either of these positions. To the right men, Sprague offers interesting work, good living conditions and salaries in keeping with experience, plus worthwhile future opportunities made possible by planned post war developments of far-reaching importance.

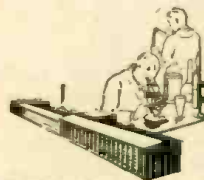

Dept. RC, Personnel Section

SPRAGUE ELECTRIC CO.

(Formerly Sprague Specialties Co.)

NORTH ADAMS, MASS.

Applicants will, of course, be engaged only in strict compliance with regulations of the War Manpower Commission.

RADIO TECHNICIANS AND ENGINEERS

We have interesting openings available for experienced radio men genuinely interested in improving themselves in this field.

Minimum requirements constitute amateur or servicing experience. Men with broader experience will assume more responsible positions along the lines of electronic research and development.

These openings afford better than average opportunities for really capable men anxious to become associated with a progressive organization which has sound post-war prospects.

Send a brief letter outlining your experience, education, and salary desired. Early interviews for qualified applicants will be arranged in New York, Boston, or Salem.

SYLVANIA ELECTRIC PRODUCTS, INC.

Industrial Relations Department

254 Essex St.

SALEM

MASS.

ENGINEER

For research and development work, we require a man who should have Physicist's training and preferably skill in Glass-Blowing. We are installing a new division, location New York, and the position should interest anyone who answers our specifications and is interested in post-war opportunities. Apply to

Box 611, c/o RADIO-CRAFT
25 West Broadway, New York City, N. Y.

RADIO WRITERS

Resident in the New York Metropolitan area. For part or full-time work on established radio magazine. Capable of writing articles on assigned radio or electronic subjects, expand or digest technical data, press releases, etc., or to carry on research work under editorial direction. Apply

Box 67, Radio-Craft
25 West Broadway, New York 7, N. Y.

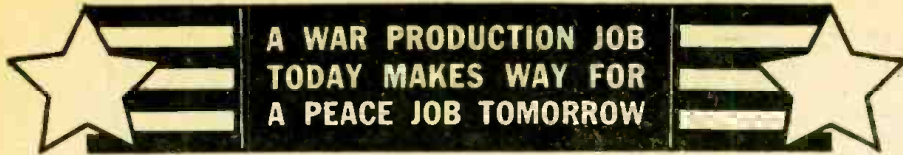

ENGINEERS

Are You Concerned With YOUR POST WAR FUTURE ?

The Federal Telephone & Radio Corporation, the manufacturing unit of the International Telephone & Telegraph Corporation with its multiple business activities extending to all parts of the civilized world, will accept applications from experienced men for immediate employment with almost limitless post war possibilities. These positions should interest those with an eye to the future and whose interest lies in forging ahead with this internationally known organization whose expansion plans for post war are of great magnitude covering all types of radio & telephone communications. Advancement as rapid as ability warrants. Majority of positions are located in the New York area!

We need the following personnel! Men with long experience or recent graduates considered.

- ENGINEERS
- ELECTRONICS
- ELECTRICAL
- RADIO
- MECHANICAL
- CHEMICAL
- TRANSFORMER DESIGN
- SALES AND APPLICATION ENGINEERS
- PHYSICISTS
- DESIGNERS
- DRAFTSMEN
- TOOL DESIGNERS
- TECHNICAL WRITERS

Look Ahead With Federal!

If inconvenient to apply in person, write letter in full, detailing about yourself, education, experience, age, etc., to Personnel Manager.

FEDERAL TELEPHONE & RADIO CORP.
39 Central Avenue
EAST NEWARK NEW JERSEY

Wanted ENGINEERS

- Radio
- Chemical
- Electrical
- Electronic
- Mechanical
- Metallurgical
- Factory Planning
- Materials Handling
- Manufacturing Planning

To be used in connection with the manufacture of a wide variety of new and advanced types of communications equipment and special electronic products.

Apply for writel, giving full qualifications, to:

C. R. L.
EMPLOYMENT DEPARTMENT

Western Electric Co.

100 CENTRAL AV., KEARNY, N. J.

Applicants must comply with WMC regulations

MECHANICAL DESIGNER:

Man having at least five years' experience designing small parts made on punch presses, screw and die casting machines for large quantity production. If not now employed at highest skill in war production plant, write:

P. R. MALLORY & CO., INC.
Indianapolis 6, Indiana

WANTED

Immediate openings now available for Draftsmen, Engineers and Salesmen . . . familiar with radio equipment and electronics!

An exceptional opportunity to connect with a large, progressive AAA-1 Chicago corporation. Permanent employment, security, under pleasant conditions for immediate and post-war advancement.

Now is the time to plan ahead for a future by making the right connection where your technical knowledge

will be appreciated and rewarded. With radio and electronics destined to occupy a leading place in the post-war future we offer an outstanding opportunity under our liberal research planning.

Our employees know of this advertisement. Your reply will be kept confidential.

Write fully, stating your experience in detail and your specialized abilities. Advise salary expected.

Address **BOX 610, c/o RADIO-CRAFT**
25 WEST BROADWAY, NEW YORK CITY, N. Y.

\$3.00 FOR YOUR IDEA

RADIO-CRAFT, as you will have noticed, prints a number of radio cartoons, which we intend to keep on publishing every month indefinitely. We invite our readers to contribute to this feature by sending in their ideas of humorous radio ideas which can be used in cartoon form. It is not necessary that you draw a sketch, but you may do so if you so desire.

RADIO-CRAFT will pay \$3.00 for each original idea submitted and accepted.

We cannot return ideas to this department nor can we enter into correspondence in connection with them. Checks are payable on acceptance.

Address all entries to RADIO CARTOONS, c/o RADIO-CRAFT, 25 West Broadway, New York 7, N. Y.

Correction

Two errors appeared in the schematic of the 1-tube A.C.-D.C. set on page 488 of the May issue. The 40-watt lamp should have been connected to the same side of the plug as the lead to the 25A7 plate. The other side of the plug should have been connected to the negative terminal of the circuit (negative ends of the 6 and 8 mfd. condensers, filament terminal and variable condenser rotor).

The 40-watt lamp was also erroneously shown as a 70-watter. This would burn out the tube, if used.

FOR SALE HARD-TO-GET ITEMS

All items are brand new, except where indicated. ALL are in PERFECT WORKING ORDER. In many cases, the parts alone total more than the price we are asking. Satisfaction guaranteed or your money back. ORDER FROM THIS PAGE. Use our convenient coupon. Includes sufficient extra remittance for parcel post charge, otherwise order is sent express collect. Any excess will be refunded. All C.O.D. shipments require 20% deposit. No C.O.D. shipments on orders for less than \$5.00. If full remittance accompanies order deduct 2% discount. Send money order, certified check, or new U. S. stamps. No C. O. D.'s to foreign countries.

THE MAGIC ELECTRIC WELDER



Here is one of the most compact, practical welders we have ever seen. Anyone can use it for shop, farm and home repairs. WELDS, BRAZES, SOLDER, CUTS ALL METALS. ANYONE CAN OPERATE IT. Repairs steel, cast iron, aluminum, brass, copper, bronze, etc. Complete with power unit, flame and metallic attachment.

ments. (Really two welders in one.) Carbons, fluxes, rods, mask included. Just plug it in any electric outlet. 110 volts AC or DC. For hobbyist or professional. GET IN ON THE GREAT WELDING BOOM. This fine set quickly teaches you welding. Low cost to operate—about 5c an hour. COMPLETE SAFETY is assured. No fumes with this outfit. SET COMES COMPLETE—nothing else to buy. Used by the U. S. Navy, American Tel. & Teleg. Co., Eastman Kodak Co., Bell Laboratories, etc. BRAND NEW OUTFIT. Guaranteed for one year. Complete simple instructions with each set. **ITEM NO. 159** **YOUR PRICE \$19.95**

WESTERN ELECTRIC BREAST MIKE

This is a fine light-weight aircraft carbon microphone. It weighs only 1 lb. Mike comes with breastplate mounting and has 2-way swiveling adjustment so that it can be adjusted to any desired position. There are 2 woven straps; one goes around neck, the other around chest. Straps can be snapped on and off quickly by an ingenious arrangement. This excellent mike can be adapted for home broadcasting or private communication systems. By dismantling breastplate, it can be used as desk mike.

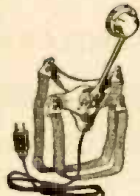

Comes complete with 6-foot cord and hard rubber plug. Finished in enameled plate, non-rustable. THIS IS BRAND NEW MIKE. IT HAS NEVER BEEN SOLD AT SUCH A LOW PRICE BEFORE. ORIGINAL LIST PRICE \$15.00. Shipping weight, 2 lbs. **ITEM NO. 152** **YOUR PRICE \$2.55**

POWERFUL ALL-PURPOSE INDUCTION MOTOR

IDEAL FOR EXPERIMENTERS—101 USES

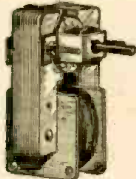

Sturdily constructed to precision standards, this self-starting, self-protected A.C. induction motor is powerful enough for a number of uses. Some of these are: Automatic Timing Devices, Current Interrupters, Electric Fans, Electric Chimes, Window Displays, Photocopy Control Devices, Electric Vibrators, Small Grinders, Buffers and Polishers, Miniature Pumps, Mechanical Models, Sirens, and other applications. Consumes about 15 watts of power and has speed of 3,000 r.p.m. When geared down, this sturdy unit will constantly operate an 18-inch turntable loaded with 200 lbs. dead weight—THAT'S POWER! Dimensions 3" high by 2" wide by 1 1/2" deep. Has a convenient mounting stud 1/8" by 3/16" diameter, and runs on self-aligning oil retaining bearings. Designed for 110-20 volts, 50-60 cycles, A.C. only. **ITEM NO. 147** **YOUR PRICE \$1.95**

LIMITED QUANTITIES! PROMPT SHIPMENTS!

It's Easy to order—Clip Coupon—Order from This Page—No Catalog Sent. (See Corresponding Ad. Page 572) MAIL TODAY—NOW!

HUDSON SPECIALTIES CO.

40 West Broadway, Dept. RC-6-44, New York 7, N. Y. I have circled below the number of the items I'm ordering. My full remittance of \$..... (include shipping charges) is enclosed. (NO C.O.D. ORDERS UNLESS ACCOMPANIED WITH A DEPOSIT.)

OR my deposit of \$..... is enclosed (20% required), ship order C.O.D. balance. NO C.O.D. ORDER FOR LESS THAN \$5.00. (New U. S. stamps, check or money order accepted.)

Circle item No. wanted 147 152 159

Name

Address Please Print Clearly

City State

Send remittance by check, stamps or money order; Register letter if you send cash or stamps.

TECHNOTES

A.C.-D.C. BATTERY MODELS

Ripple modulation is a common trouble in many makes of this type of set.

It may be cured in most cases by replacing the condenser connected from the circuit ground to the chassis.

W. A. RIEVELEY,
Vancouver, B. C.

REPLACING 117P7

When a 117P7 is needed and unobtainable I find that a 117L7 works very well by making the following changes on the socket:

Change all wires on pin 8 to pin 1; change wires on pin 6 to pin 8, and strap pins 6 and 7 together.

H. G. SHEPARD,
Colorado Springs, Colo.

A.C.-D.C. BATTERY PORTABLES

Complaint: Inoperative or weak reception on D.C. operation.

This is sometimes due to the fact that on D.C. the voltage of the rectified current is only 110, while it is much higher on A.C., so that the filament voltages are low on D.C. This may be cured by connecting a parallel resistance to bring up the voltage to the required 1.4. This resistance should be paralleled with the filament resistance only, so as not to include the filaments themselves.

The following formula may be used

$$\frac{1}{R_A} = \frac{1}{R_T} - \frac{1}{R_0}$$

where R_A is the resistance required, R_T the total resistance, and R_0 the original. Experiment with various values may also determine the correct value.

On Emerson receivers, the filament voltage is obtained from the output tube cathode. In such a case, the filter choke may be shorted and/or the grid return of the output tube changed from ground to one of the D.C. tube filament leads. The grid will then be at a more positive potential, so that its current and therefore its output voltage will increase the D.C. filament voltages. Convenient A.C.-D.C. switches may be used to change from A.C. to D.C., insuring proper operation on both.

GORDON P. BISHOP,
New Haven, Conn.

LOOSE TUBE BASES

When a tube otherwise good develops a loose base, I find the following procedure an excellent one.

Set the tube into its proper position and pour a little common nail polish remover around the glass where it enters the tube base. Let it seep through and dry and in a very short time the tube is set solidly into its base again.

When the control grid cap of a glass tube becomes loose, flow a little transparent liquid solder or Duco Household Cement around the base of the cap and over the glass. This also causes the cap to become fixed in place.

JAMES H. BELL,
Suitland, Md.

(Servicemen will probably find ordinary lacquer thinner as effective as and far cheaper than nail polish remover.—Editor)

LOCATING NOISY TUBE

It has been my experience that it is quite difficult to accurately locate a noisy tube so that it can be replaced.

Simply tapping each tube will not isolate the faulty one since some tubes are very sensitive to the slightest vibration set up in the chassis by tapping other tubes; therefore making the search very confusing.

A suggested system is to place the entire chassis on something solid (such as a concrete floor) and bear down heavily with one hand and tap each tube with equal force with the other hand. When you think you have isolated the tube, a final check is made by taking out the suspected tube and running leads from the socket to the tube. If now tapping the chassis does not produce a noise in the speaker and tapping the extended tube does; then you have definitely located the tube to be replaced.

PFC. JOE GIANNELLI,
Langley Field, Va.

AUTO RADIO-ANTENNA

I experienced a queer noise that was very puzzling for a while, in a car radio.

Severe static was apparent with speeds in excess of 20 m.p.h. On examination, I found that the small bead on the tip of the whip antenna was missing. By replacing the bead the noise was eliminated.

V. M. DEROO,
National City, Calif.

SUBSTITUTE FOR 6K5

A set requiring a 6K5 tube can be substituted by a 6F5 in some cases by changing the plate lead (from terminal No. 3 to terminal No. 4). An even better substitute is a 6Q7, which is identical but with diodes. Don't use the idle prongs.

An oscillator which seems to be off frequency may be due to a badly off frequency IF channel. A good procedure is to start aligning the second IF, then the first, with the oscillator inoperative. Finally, the oscillator is aligned. Use an accurate signal generator tuned to the specified IF frequency.

F. W. FEE,
Pleasantville, Iowa.

GRUNOW IIG

When the 6H6 detector goes "haywire" and there are no other 6H6's to be had, try using a 6.3-volt triode in the socket. No changes need be made. The grid and plate terminals of the triode are the same as the plate terminals of the 6H6 (3 and 5).

This will of course work on any set with a similar hookup (see sketch).

LEROY W. JOHNE,
Sheboygan, Wis.

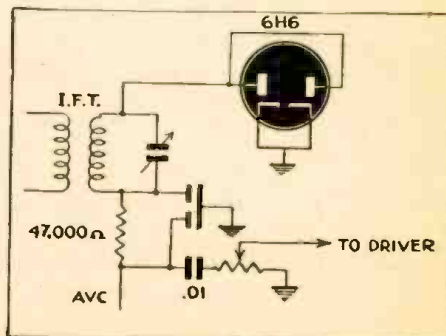

developed during this war that a complete catalog would fill a good-sized book. All this will make for more work and more employment. I might set up the axiom:

IF THE LABOR-SAVING MACHINE IS GIVEN A CHANCE, WITHOUT HUMAN INTERFERENCE, IT WILL GROW LIKE A HEALTHY TREE, ADDING NEW BRANCHES TO THE OLD ONES AS IT PROGRESSES.

One thing is certain—the electronic robot is with us and is here to stay. Moreover, it does not make any mistakes and is not affected by absenteeism. It can work day and night, seven days a week, practically unattended. In industries such as plastics, metal stamping and many others, the electronic robot can perform the work of thousands of employees with from twenty to ten per cent the former human employees. These employees are there only to watch that the machines run with perfection. Raw material still has to be handled by human hands to a certain degree, although this task is made lighter every year as well. There must also be human supervision at the end of the line when imperfect parts or articles are thrown off the production line by the robot. There must also be certain human supervision on packing when the end product finally leaves the plant by truck or by railroad car.

Of particular interest are the attendants to these machines who must not only be high-class mechanics—they must also be good radio and electronic men, so that if anything goes wrong, the electronic robot can be put into work again. The failure of one sub-robot on the assembly line may stop the entire production and waste valuable minutes or hours. Such men, therefore, must be highly trained and will be well paid for their work.

I say in all sincerity that there is hardly any industry in which the electronic robot will not make its appearance before long, and it probably will revolutionize the entire plant to boot.

The robots do not only reach into industry—yes, they even invade our offices. Just as an example, I will only quote a single instance of what is even now being done.

We have an automatic robot, known as the Hooven typewriter. One concern in New York has 160 of these machines. They actually *typewrite* the letters which are at present duplicate letters. They are neither mimeographed nor printed. The typewriters use a roll similar to that used on a piano-player, and the machine

actually types each single letter, the same as a typist would. There are no mistakes in such letters. At the present time, the addresses are hand-filled by operators, but this is not necessary because we can easily imagine a hopper attached to the typewriter which contains the name stencils. Then underneath the hopper we could readily have a simple electronic device which scans every stencil by means of a photo-electric tube, in consequence of which the name and address could be typed in by this robot. As the letter is finished, it stacks automatically. Near the top of the stack there is a pen filled with ink which is guided automatically writing the signature. This again is done by electronic means and it has already been accomplished. The signature is rapidly affixed with instant drying ink, and when the letters are finished, they are completely signed. Now they go to an automatic folding and inserting machine which also seals the envelope and either affixes a stamp on it, if this is desired, or otherwise feeds the sealed envelopes through a postal meter which imprints the stamp indicia on the envelope. The latter are then neatly packed into lots of 100, counted automatically by another robot, then are placed on trucks by human hands and dispatched.

The reader will say, "Well and good, but all these letters are exactly the same—for circular purposes—but suppose each letter is different? Won't that be impossible?"

The answer is "no." There have been granted many patents on Voice Controlled Typewriters, and while so far none that can be sold to executives have been produced commercially, the time is drawing near when it will be possible to talk into a machine which looks like a dictograph, whereby the human voice automatically transcribes the vocal sounds into typewritten letters, the machine doing the rest. Such machines will positively be in operation in the postwar period.

This brings us back to the starting point regarding the labor question. Would not such a Voice-Operated Typewriter throw all stenographers out of work? The answer to this one might better be characterized as a foolish question. Secretaries and stenographers do a good deal of other work besides operating typewriters. Where actual thinking and planning is concerned, there is not now and there never will be a robot. For that reason, no matter how many voice-controlled typewriters there are in the post-war period there will be many more secretaries and stenographers and typists than ever before.



HIGH EFFICIENCY
results in
Sound National
Defense
that is why
NATIONAL DEFENSE SOUND SYSTEMS
are equipped with
University Reflex
HIGH POWER
LOUDSPEAKERS
UNIVERSITY LABS.
225 VARICK ST. N. Y. C.



CANNON BALL
is a good Headset guaranteed to satisfy you. For sensitivity, clarity of tone, dependable performance, use a Cannon-Ball Headset. Folder R-6 illustrates complete line. Write

Scientifically Built Heavy bar magnets greatly increase their efficiency.

C. F. CANNON COMPANY
SPRINGWATER, N. Y.

Headset Headquarters

TECHNICAL BULLETINS

Technical bulletins give reliable information in easy-to-follow form, and save valuable time otherwise spent in laborious reading of numerous books. Every subject is treated briefly and concisely, yet completely. No complicated mathematics, chemistry, electricity, or theory. Each bulletin is written in simple language.

Each Bulletin consists of a set of large sheets, assembled in one packet, size 9 x 14 1/2"; weight 1/4 lb. Numerous illustrations, diagrams, charts to supplement text.

PRICE \$1.00 EACH POSTPAID
ORDER BY NUMBER

- D-111—DESIGNING AND BUILDING TRANSFORMERS
- D-112—DESIGNING ELECTRO-MAGNETS
- D-113—HOW TO DESIGN SOLENOIDS AND PLUNGER MAGNETS
- D-101—USING NICHROME RESISTANCE WIRE
- D-106—REWINDING ELECTRIC MOTORS
- D-144—ALTERNATING CURRENT CONTROLLED WITH EASILY MADE CHOKE COILS
- D-148—DESIGNING AND USING ELECTRIC RELAYS
- D-127—SMALL ELECTRIC LIGHT PLANTS
- D-134—ELECTRICAL EXPERIMENTS WITH SIMPLE MATERIALS
- D-131—MODEL MAKERS & INVENTORS GUIDE TO REMOTE-CONTROL SWITCHING
- D-137—ELECTRICAL METERS EASILY BUILT
- D-136—SMALL A.C. ARC WELDER CONSTRUCTION AND USE

Send Stamps, Cash or Money Order

TECHNIFAX

1917 S. STATE ST. RC-6-44 CHICAGO 16, ILL.

DEPT. RC-6
1917 So. State, Chicago, 16, Ill.

Enclosed find \$..... for which please send me postpaid the following Technical Bulletins:

No.

.....

Name

Street and Number

City and State

WARTIME TRANSCEIVER

(Continued from page 543)

unit was later placed on top of a Coca-Cola machine in the school's underground tunnel, about one block away and a QSO completed. Afterward they were used in a four-cornered conversation with the sets about four blocks away from each other.

Parts List

CONDENSERS

- C-1—2 Plate Midget Variable
- C-2—.00005 mfd. Fixed Mica
- C-3—.001 mfd. Fixed Mica
- C-4—.01 mfd. Fixed Mica 400 volt
- C-5—10 mfd. 25 volt electrolytic
- C-6—.1 mfd. 400 volt paper
- C-7—.1 mfd. 400 volt Paper

RESISTORS

- R-1—5 Megohms Fixed
- R-2—5000 ohm Fixed
- R-3—50,000 ohm Variable
- R-4—250,000 ohm Fixed
- R-5—500,000 ohm Fixed
- R-6—400 ohm Fixed

MISCELLANEOUS

- 1—6J5 and 1—6V6 tube
- T-1—3 to 1 audio transformer with 75 turns over primary of No. 36 enamel
- T-2—7 to 30 Henry Choke
- L-1—4 turns No. 14 bare enamel 1/2 inch diam.
- 2—D.P.D.T. Toggle Switches
- Chassis, Phone plug and tips, 1 1/2 volt batt., R.F. Choke, Nuts and Bolts, and 2-Plate Trimmer Ant. Cond.

FOR SALE HARD-TO-GET ITEMS

All items are brand new, except where indicated. ALL are in PERFECT WORKING ORDER. In many cases, the parts alone total more than the price we are asking. Satisfaction guaranteed or your money back. ORDER FROM THIS PAGE. Use our convenient coupon. Include sufficient extra remittance for parcel post charges, otherwise order is sent express collect. Any excess will be refunded. All C.O.D. shipments require 20% deposit. No C.O.D. shipments on orders for less than \$5.00. If full remittance accompanies order deduct 2% discount. Send money order, certified check, or new U. S. stamps. No C. O. D.'s to foreign countries.

ULTRA MAGNET
LIFTS MORE THAN 20 TIMES ITS OWN WEIGHT
LITTLE GIANT MAGNET
Lifts 5 lbs. easily. Weighs 4 oz. Made of ALNICO new high-magnet steel. Complete with keeper. World's most powerful magnet ever made. The experimenter's hobbyist will find hundreds of excellent uses for this high quality permanent magnet. Measures 1 3/4" x 1 1/4" x 3/8".
5 1/2 lbs.
ITEM NO. 159
YOUR PRICE **\$1.25**



GENUINE MICROPHONE TRANSMITTERS
These are regular "telephone transmitters" of the type used on wall telephones. Taken from a large telephone supply company's overstock, these fine makers offer a grand opportunity to obtain a splendid unit for little more than the price usually asked for a simple microphone button.
The amateur experimenter and telephone mechanic will find a variety of uses for these excellent microphones. They work perfectly on 2 dry cells.
Can be used on P.A. systems for voice transmissions, in call systems and intercommunications sets. With telephone receivers (radio headphones will do) they may be made into short-line telephone circuits, such as house-to-house or farm-to-farm phone lines. You can use them to talk through your own radio, or as concealed dictaphone pick-up units for listening to conversations in a distant room or building. The telephone mechanic will find them useful replacements on battery-operated rural telephone lines.
THESE ARE NEW, GENUINE TRANSMITTERS, MADE BY KELLOGG, WESTERN ELECTRIC AND STROMBERG-CARLSON, excellent in appearance and operation. A remarkable value at one seldom offered in these times. Shp. Wt. 1 lb.
ITEM NO. 160
YOUR PRICE **\$1.50**

AMAZING BLACK LIGHT!!
Powerful 250-Watt Ultra-Violet Source
The best and most practical source of ultra-violet light for general experimental and entertainment use. Makes all fluorescent substances brilliantly luminescent. No transformers of any kind needed. Fits any standard lamp socket. Made with special filter glass permitting only ultra-violet rays to come through. Brings out beautiful opalescent hues in various types of materials. Swell forlorn amateur parties, plays, etc., to obtain unique lighting effects. Bulb only. Shp. Wt. 1 lb.
ITEM NO. 87
YOUR PRICE **\$2.45**

WATTHOUR METER
Completely overhauled and ready for immediate service. Designed for regular 110-volt, 60 cycle 2-wire A.C. circuit. Servicemen use it in their shops to check current consumption of sets, soldering irons, etc. Keeps costs down if dismantled. The parts alone would bring the price. The slab, grate four train could be used as a counter on machines of various kinds. Simple to install. 2 wires from the line and 2 wires to the load. Sturdily constructed in heavy metal case. 6 1/2" high, 6 1/4" wide. W. W. Whitehouse, G. E. Ft. Wayne or other available make. Shp. Wt. 14 lbs.
ITEM NO. 33
YOUR PRICE **\$7.45**

**LIMITED QUANTITIES!
PROMPT SHIPMENTS!**
It's Easy to order—Clip Coupon—Order from This Page—No Catalog Sent.
MAIL TODAY—NOW!
(See Corresponding Ad Page 570)

HUDSON SPECIALTIES CO.
40 West Broadway, Dept. RC-6-44, New York 7, N. Y.

I have circled below the numbers of the items I'm ordering. My full remittance of \$..... (include shipping charges) enclosed. (NO C.O.D. ORDERS UNLESS ACCOMPANIED WITH A DEPOSIT.)
OR my deposit of \$..... is enclosed (20% required), ship order C.O.D. for balance. NO C.O.D. ORDER FOR LESS THAN \$5.00. (New U. S. stamps, check or money order accepted.)
Circle item No. wanted: **33 87 159 160**

Name

Address Please Print Clearly

City State

Send remittance by check, stamps or money order; register letter if you send cash or stamps.

The Mail Bag

"UNDER SIXTEENS" CAN HELP TOO!

Dear Editor:

I wish to extend my heartiest agreement with Bob Taylor, whose letter in the February issue of *Radio-Craft* bewails the fact that many communities are passing over high-school age people when they seek radio personnel. I am sixteen myself, have had experience in radio as a hobby (thanks to *Radio-Craft*), and realize what a handicapped youth can be for anyone who is interested in getting into radio activities.

Our WERS system in Needham (WKYG) is completely operated by high-

school students. As far as I can see, our organization has performed satisfactorily; we have operated in every air raid test since the license was issued.

I would like to recommend that before barring anyone for age alone, Civilian Defense agencies test his aptitude and experience in radio and see if he wouldn't be a better operator than some third class permittee.

LINDSAY RUSSELL,
Needham, Mass.

ALSO AGREES WITH BOB TAYLOR

Dear Editor:

I agree with Bob Taylor, whose letter appeared in the February issue. The Radio Defense Courses require two years of algebra and science; therefore we have the situation that students who have no knowledge of radio can qualify, but the skilled radioman who does not meet these require-

ments or is in the 10th grade is barred.

Many of the teachers in these courses know little more than some of their students, and in some instances less; they just keep one chapter ahead. The result is that some who graduate don't know OHMS.

EDWIN BOHR,
Chattanooga, Tenn.

SEES BAD EFFECTS OF LICENSING

Dear Editor:

I read the letters of P. T. Adams and F. W. Fee with some alarm. The plan these gentlemen advocate is likely to be a body blow to another type of radioman who far outnumber the "screwdriver mechanic." I refer to those people who are learning radio the hard way—studying everything they can get hold of in their spare time and building their own equipment.

Such a plan might have damaging results. A "dyed-in-the-wool" experimenter is a hard man to keep down, and faced with the impossibility of getting good parts or having to pay retail prices (which are

plenty high) for them, might well go into the already overcrowded repair business. Some of them, including me, would be forced to increase their income by actually repairing what radios they could in their spare time.

What I think would be a better scheme would be to get a higher minimum on wholesale orders, say fifteen or twenty dollars. Such a limit wouldn't bother the serious experimenter but "Mr. Screwdriver" probably wouldn't use that many parts in a lifetime.

JOSEPH C. COOK,
Modesto, Calif.

WOULD YOU LIKE TO SEE THESE, TOO?

Dear Editor:

We have been reading your magazine for two years and think it is the best going.

Please don't forget articles on construction and theory, especially public address: Not quite so much on electronics. After all, the magazine is called *Radio-Craft* and *Popular Electronics*, not *Popular Electronics* and *Radio-Craft*. Here are some subjects we would especially like to see dealt with:

The loading of various types of microphones, mike-to-line transformers, etc.

How to plot frequency curves of amplifiers.

How to construct and calibrate an oscil-

lator suitable for checking response curves.

How to hook up a meter to monitor an amplifier without having long leads in critical circuits.

Permanent magnet driver units, What is the object of those new covers you've been toying with? We feel they are too flashy and faddy for a magazine of this description.

The best articles in our opinion are those of Ted Powell, Mr. Moody and Mr. Shunaman. Best section is the Radio-Electronic Circuits.

JOHN SCRIMGEOUR,
HOWARD GOETT,
Calgary, Canada

WANTS DOPE ON ELECTRICAL REPAIRS

Dear Editor:

May I make a suggestion? Now-a-days radio men are sometimes called upon to do other things than service radios. Electrical appliances and motors, for example.

Why not set up a small department dealing with the making of "growlers" for testing motors; checking small A.C.-D.C. motors with radio instruments; discussion of the reasons for heating of fields and

armatures; why commutators need undercutting and the best method of doing it.

I am sure that others would be interested in this. I went to a lot of trouble digging out the information, and anything that would make it easier would surely be appreciated by many readers.

JAMES W. WODJICK,
Pittston, Penna.

narrowing down the margin of immunity provided by darkness." I wrote in a national magazine back in August, 1942, "Once again science is winning out over nature, in effect turning night into day."

(Those interested in electronic gun directors are referred to the article, "NEW ELECTRONIC GUN DIRECTOR," in RADIO-CRAFT for February, 1944.)

Warfare is a game of chess, because no sooner has an important war machine been checkmated, than a new game is started and counter measures against present counter measures are devised.

When the cannon was first mounted on wooden fighting ships, it was found that whole armadas could be wiped out by the heavy gunfire. This brought out the iron-clad vessel from which the present-day battleship evolved. Then it became a race for bigger and bigger ships, heavier armor and heavier and still larger guns.

The situation has a close parallel in aerial warfare. While the electronic gun director seems to be the final answer to the bomber, it won't remain long that way. Counter measures already have been tried out to nullify the gun director and other electronic ranging devices.

The April issue of RADIO-CRAFT reported the tinfoil "Flutterers" which are used both by the R.A.F. and the Nazis to confound and mislead Radar operators. These pieces of tinfoil coated paper, dropped by Nazi planes over England late last February, are intended to mislead the electronic ranging devices by deflecting their radio waves, which strike against the tinfoil and therefore give wrong bearings to the ground operators. These flutterers are obviously only a makeshift device, and if used continuously, will no longer fool the ground ranging operators.

A novel and more effective device is illustrated in these pages, and if adopted, it is certain that it will save the lives of many of our bomber crews. Instead of using a flutterer type of deflector, it is suggested that a number of fighter planes, that escort our bombers, tow light cord or rope netting, interwoven with wire, as shown in our illustrations and on our cover.

As is well known, radio waves do not need to strike a solid metal surface to be reflected. Any wire netting, no matter how light, will act as if it were a solid sheet of metal.

The idea in the present scheme is simply a plurality of these cord-wire nets, each of which has nearly as large a surface as a bomber. If these nets are towed anywhere from 300 to 1000 feet or more below the bombers, the enemy range finder radio-waves will hit these nets—BUT NOT THE BOMBERS—and reflect the waves, as shown in illustration 1. Normally, the waves would follow the path of the solid line A of the range finding instruments, while in this case, the plurality of nets will be hit by the waves and rebound in the direction of the dotted lines B. This gives a wrong range and the anti-aircraft shells will now burst at a much lower level than the bombers are flying.

It is of importance here to note that this scheme is only to be used when the bombers are nearing, and over the target, because it is in this position that they are most vulnerable. As is well known, once a bomber starts over its bomb-run, it can no longer weave sideways or dip up and down in order to evade anti-aircraft fire. The bomber must make a straight run

from which it cannot deviate, and it is this that makes for its dangerous vulnerability.

The *modus operandi* of the inverted radio umbrella therefore would be that for a short few miles, before the target is reached, the fighters by means of a simple mechanical device unroll their Radio Reflector netting, which when caught by the wind will stretch out taut as shown in the illustrations. At the far end of the netting there are two "wind socks." These catch the wind and keep the net floating at an even level.

It is true that such a net impedes the progress of the fighters somewhat, but this is of no great importance because after the fighters have passed over the target, the netting is hauled in quickly and therefore no longer impedes the progress and speed of the fighters. The nets being cheap, can also be cut off and abandoned, if desired.

Incidentally, the idea of towing aerial nets of this type is not new. Netting bearing advertising signs was flown successfully before the war at a number of beach resorts—principally at Atlantic City. The towed signs at Atlantic City had the following characteristics and measurements.

"The net-carrying banners were made of heavy muslin, strung on ropes with light, metal stays. Letters ranged from five to seven feet in height, about three feet wide, with a space of about three feet between letters. Capacity load was about 33 to 35 letters. The banner was 150 feet in length and weighed about 100 pounds. A spreader at the front end and back end kept the banner erect in the air, and a wind sock on the rear end kept it flying flat, once out in the air. A special release arrangement on a short cable enabled the pilot to drop the banner over the airport before he landed.

"The Atlantic City method of picking up the banner was to rev the motor to its highest pitch, attach the rolled up banner to the cable on the ground and then take off at as high a speed as possible."

These particular aerial signs, because they carried special metallic letters, offered a great deal of wind resistance, which is not the case with the Radio Defensive Reflectors; therefore wind resistance will not be so great. As a matter of fact, the radio net reflectors when perfected, probably will not weigh more than 75 to 100 pounds, or even less. They can be made very light by using the new nylon cords interwoven with soft aluminum or magnesium wire.

If hit by anti-aircraft fire, they will of course be damaged or destroyed, but no one gets hurt in the process. A direct hit on one of the nets is shown graphically on our cover. All that the fighter plane has to do in that case is to haul in the remainder of the net, or cut it off. By that time, its mission will probably be completed anyway.

It should also be noted that the fighters which tow their radio deflector nets cannot fly directly under the bombers after the bombs are launched.

BUT IT SHOULD BE NOTED THAT BEFORE THE BOMBS ARE RELEASED, THE FIGHTERS WITH THEIR NETS MAY FLY DIRECTLY UNDERNEATH THE BOMBERS. TO

*The above information was supplied by Mall Dodson, Director, Press Bureau, City of Atlantic City, N. J.

(Continued on following page)

YES . . .

**YOU CAN GET
HARD - TO - FIND
RADIO PARTS FROM**

LEO.

IT'S NOT LUCK . . .

. . . it's because my many years of experience have given me valuable contacts, but I've been able to find parts and other equipment for you fellows. Many items just aren't "available" elsewhere, but I've got 'em for you. Same low prices and square deal you've always had from me, too. **WRITE TODAY FOR FREE FLYER** that lists hard-to-get items. Stock won't last long, so get your share.



Free!

**GIANT WALL-SIZE
RADIO REFERENCE MAP**

While you're writing, ask me to include my special gift. It's a brand new reference map with time zones, amateur zones, all standard broadcast stations, short-wave stations, four major networks and loads of other valuable information. Printed in colors. Easily worth a couple of dollars, but I'll send it to you free! Send 15 cents to help with packing and mailing.

HALLICRAFTERS

I've always been one of the biggest distributors of Hallicrafter equipment. Now I'm looking for used Hallicrafter sets, and will pay highest cash price. I'll buy other makes equipment, too. Tell me what you have—I'll quote top price.

WRITE TODAY

LEO-W9GFQ

Wholesale Radio Laboratories

742 W. BROADWAY, COUNCIL BLUFFS, IOWA

Complete Plans

For Building Useful and Practical Things at Home. Each issue of Popular Homecraft is crammed with plans for making such beautiful and useful things as: Furniture, Bird Houses, Lamps, Outdoor Garden Furniture, Candle Equipment, etc. Covers in the work, tools, wood-working, leathercraft, copper. You'll find "how" to make almost everything from the pages of Popular Homecraft. Scores of drawings and photographs make every step simple as A B C. A real "How-To-Do-It" magazine.



Six Months' Trial \$1.00

Send \$1.00 today for trial six months' subscription. Money Back If Not Delighted.

POPULAR HOMECRAFT

637 Palmolive Building

Chicago, Ill.

Trial 6 Months \$1.00

NOW—A REALLY HIGH-POWERED— Radio Engineering Library

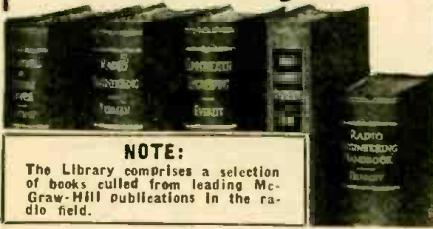

NOTE:

The Library comprises a selection of books culled from leading McGraw-Hill publications in the radio field.

- especially selected by radio specialists of McGraw-Hill publications
- to give most complete, dependable coverage of facts needed by all whose fields are grounded on radio fundamentals
- available at a special price and terms

THESE books cover circuit phenomena, tube theory, networks, measurements, and other subjects—give specialized treatments of all fields of practical design and application. They are books of recognized position in the literature—books you will refer to and be referred to often. If you are a practical designer, researcher or engineer in any field based on radio, you want these books for the help they give in hundreds of problems throughout the whole field of radio engineering.

5 VOLUMES, 3319 PAGES, 2289 ILLUSTRATIONS

1. Eastman's FUNDAMENTALS OF VACUUM TUBES
2. Terman's RADIO ENGINEERING
3. Everitt's COMMUNICATION ENGINEERING
4. Hund's HIGH FREQUENCY MEASUREMENTS
5. Henney's RADIO ENGINEERING HANDBOOK

10 days' examination. Easy terms. Special price under this offer less than books bought separately. Add these standard works to your library now; pay small monthly installments, while you use the books.

10 DAYS' FREE EXAMINATION—SEND COUPON

McGraw-Hill Book Co., 330 W. 42nd St. New York 18

Send me Radio Engineering Library, 5 vols., for 10 days' examination on approval. In 10 days I will send \$3.00. Plus few cents postage, and \$9.00 monthly till \$24.00 is paid, or return books postpaid. (We pay postage on orders accompanied by remittance of first installment.)

Name

Address

City and State

Position

Company

MAKE YOUR OWN TALKIES this new EASY way!

Own a FILMGRAPH, the modern miracle in sound. It records and reproduces on film instantly, without processing or treatment. Low cost; high fidelity. Wide volume range. You will be amazed at the simplicity of this device. No technical skill or knowledge needed to operate. Constant, automatic speed. Completely portable. We now have a few special demonstrator models which we can release to the public at sale price. Write at once for prices and circular.

COMPLETE
LINE OF
DICTATION,
TELEPHONE &
CONTINUOUS
CONFERENCE
RECORDERS

MILES REPRODUCER CO., INC. Dept. R-C
812 Broadway, New York 3, N. Y.



FADA

FACTORY SERVICE DEPT.
OFFERS you a completely equipped service organization to handle your repairs on Fada and all other make radios

FADA OF NEW YORK

928 Broadway, New York, N. Y.
Tel.: GRamercy 7-0951-2 and 0980

LARGE STOCK OF REPLACEMENTS AND CABINETS ALWAYS ON HAND

RADIO DEFENSIVE REFLECTOR

(Continued from previous page)

put it another way, while the bombers are making their dangerous bomb-runs, the nets may fly directly underneath the bombers. At a special signal from the bombardier—at the last possible moment—the fighters can then sharply veer to the right or to the left so that the released bombs do not strike the nets. At that instant, their mission is finished and now the bombers can deviate from their course again and the fighter nets are no longer needed.

Now the nets are hauled in (or set adrift) for the fighters' run to the home base.

It will be said that this scheme is impractical when enemy fighters are in the vicinity who could signal to the ground ranging crews and give an accurate indication at what level the bombers are flying. The answer to this is that it is most difficult from the air to judge accurately whether the nets are being towed at 500 feet or 1000 feet below the bombers, and it will therefore be difficult for the gun ranging crew to change their anti-aircraft shell bursts to the exact level at which the bombers are flying. Anyway, by that time the short bomb-run will be completed.

WORLD WIDE STATION LIST

(Continued from page 542)

7.295 YSO	SAN SALVADOR, EL SALVADOR; "Voice of Democracy"; nightly at 7:55 pm.
7.31 ZRO19	ROME, ITALY.
7.32 GRJ	LONDON, ENGLAND.
7.38 XECR	MEXICO CITY, MEXICO; heard at 7:45 pm.
7.435 FG8AH	POINTE A PITRE, GUADELOUPE; heard at 8:30 and 9:30 pm.
7.565 WKLJ	NEW YORK CITY; European beam, 8:15 pm to 5 am.
7.565 KWY	SAN FRANCISCO, CALIF.; 8:30 to 10:30 am daily, Sundays, 9:30 to 10:30 am.
7.575 WLWO	CINCINNATI, OHIO;—European beam, 12:15 to 4 am.
7.575 WRUA	BOSTON, MASS.; North African beam, 4:45 to 6 pm; 6:15 to 7:15 pm; 7:30 to 11:45 pm.
7.805 WRUL	BOSTON, MASS.; North African beam, 2:15 to 5:45 am.
7.820 WOOW	NEW YORK CITY; European beam, 5:15 pm to 3:30 am.
7.86 —	CAIRO, EGYPT; late afternoons.
7.950 —	ALICANTE, SPAIN; off at 6 pm daily.
8.000 —	"A E F RADIO IN ALGIERS"; heard afternoons.
8.000 —	ATHENS, GREECE; heard 3 to 6 pm daily.
8.030 FXE	BEIRUT-LEBANON (SYRIA); 1 to 4:30 pm.
8.035 CNR	RABAT, MOROCCO; heard Sunday 5 to 6 pm.
8.04 COCL	HAVANA, CUBA.
8.220 —	DAKAR, SENEGAL (French West Africa); off at 5:00 pm.
8.484 XPSA	KWEIYANG, CHINA; 7:30 am to 12 noon.
8.500 —	TOKYO, JAPAN; early mornings.
8.634 COJK	CAMAGUEY, CUBA; 5 to 6 pm; irregular.
8.70 COCO	HAVANA, CUBA; 5:30 am to 1 am.
8.83 COCQ	HAVANA, CUBA; 5:30 am to 1:30 am.
8.930 KES2	SAN FRANCISCO, CALIF.; 6:15 am to 1 pm; Oriental beam.
8.955 COKG	SANTIAGO, CUBA; 7:30 am to 11 pm.
8.960 AFHQ	ALLIED HEADQUARTERS, NORTH AFRICA; daily, early evenings.
8.960 APH	ALLIED HEADQUARTERS IN ITALY; Sundays only, 3 pm.

NEW TELEVISION PLAN

Post-war plans for world-wide television call for trans-ocean "relay" by means of filming scenes, flying the films overseas by fast plane, and rebroadcasting.

OPPORTUNITY AD-LETS

Advertisements in this section cost 20 cents a word for each insertion. Name, address and initials must be included at the above rate. Cash should accompany all classified advertisements unless placed by an accredited advertising agency. No advertisement for less than ten words accepted. Ten percent discount six issues, twenty percent for twelve issues. Objections or misleading advertisements not accepted. Advertisements for July, 1944, issue must reach us not later than May 28, 1944.

Radio-Craft • 28 W. B'way • New York 7, N. Y.

USED CORRESPONDENCE COURSES AND TECHNICAL BOOKS Bought, Sold, Rented, Catalog Free. Educational Exchange, Henagar, Alabama.

PREPARE NOW FOR TREMENDOUS OPPORTUNITIES in new fields of radio after the war. Training for Federal licenses. Write for Particulars. American Radio Institute, 44 East 23rd Street, New York 10, N. Y.

REVISED PLANS 18 CRYSTAL SETS (SW RECORD 5300 miles) including "Radiobuilder"—25c. Laboratories, 363-X Hampton, Hayward, Calif.

200 NEW TUBE SUBSTITUTIONS CHANGE-OVERS adaptor data \$1.00. Richard Jones, 1210 Dudley, Utica 3, New York.

Index to advertisers

Allied Radio Corp.	554
Amperite Corporation	566
Audel & Company	Inside Back Cover
Bakersfield Radio Supply	565
Best Vibrator Co.	567
Burstein-Applebee Co.	565
Cannon Company, C. F.	571
Chartered Institute of American Inventors	565
DeForest's Training, Inc.	557
Echophone	549
Fada of New York	574
Federal Telephone & Telegraph	569
Galvin Mfg. Co.	Back Cover
General Electric Co.	562
Hallcrafters, Inc.	515, 516
Harrison Radio Corp.	561
Henry Radio	559
Hudson Specialties	570, 572
Lafayette Radio Corp.	560
Lancaster, Allwine & Rommel	565
Mallory, P. R.	569
McGraw-Hill Book Co.	574
Meissner Mfg. Co.	519
Midland Motors	565
Miles Reproducer Co., Inc.	574
National Plans Institute	566
National Radio Institute	513
National Union Radio Corporation	520, 568
Nelson Company	565
Oelrich Publications	564
Ohmite Mfg. Co.	556
Onan & Sons, D. W.	561
Opportunity Adlets	574
Popular Homecraft	573

RADIO SCHOOL DIRECTORY

Page 576

Candler System	
Capitol Radio Engineering Institute	
Commercial Radio Institute	
Lincoln Engineering School	
Radio & Television Institute	
RCA Institutes	
Tri-State College	
Radcraft Publications, Inc.	553, 563, 567
Radio & Technical Division of Murray Hill Books, Inc.	555
Schott, Walter L., Co.	559
Scientific Radio Service System	566
Solar Mfg. Co.	Inside Front Cover
Sprague Products Co.	547, 568
Sprayberry Academy of Radio	517
Sylvania Electric Co.	558, 568
Technifax	571
University Laboratories	571
Western Electric Co.	569
Wholesale Radio Laboratories	573

(While every precaution is taken to insure accuracy, we cannot guarantee against the possibility of an occasional change or omission in the preparation of this index.)

BOOK REVIEWS

MR. TOMPKINS EXPLORES THE ATOM, by G. Gamow. Published by the Macmillan Co. Stiff cloth covers, 7 x 8½ inches, 97 pages. Price \$2.00.

Mr. Tompkins is a bank clerk, with a habit of sleeping through university lectures, and a subconscious which whisks him away to the realms of the sub-atomic during such slumber. The book is a sequel to an earlier one: "Mr. Tompkins in Wonderland."

Professor Gamow in his newer work takes his hero through a series of adventures in which the laws of probability are set aside (causing a mild sensation in his father-in-law's highball), or leads him a wild dance as an electron visiting around with the inhabitants of the outer shells of a couple of sodium and chlorine atoms.

Later Mr. Tompkins has his first view of a cyclotron. He has no sooner absorbed the first principles of atom-smashing than he gets across some of the "lower-voltage" circuits of the instrument and is precipitated into a chamber where an old wood-carver amuses himself with constructing atomic nuclei from protons and neutrons. Meanwhile he keeps in reserve a mysterious box, marked "neutrinos," though he admits that for all he knows, it may really contain nothing.

The "Mr. Tompkins" stories occupy only the first half of the book, the second half consisting of four lectures which give the key—in popular technical language—to the phenomena underlying the fantastic adventures of the sleeping Mr. Tompkins. Since the curiosity of the reader has been whetted, he is all the more likely to read the lectures which inspired the dreams.

FUNDAMENTAL RADIO EXPERIMENTS, by Robert C. Higgy. Published by John Wiley & Sons. Stiff cloth covers, 5½ x 8½ inches, 95 pages. Price \$1.50.

Sufficient theory, according to the author, is included with the experiments given to enable the tests to be performed, but the book is intended purely as a laboratory manual, not a complete textbook in any sense. The amount of theory included is, however, somewhat greater than that usually included in the average laboratory manual, which often limits itself to describing the bare outlines of the tests and leaves to the instructor the whole task of supplying the "know-why." Students who work without an instructor will find this quite a usable guide in their experiments.

The experiments take modern practice into account, and U.H.F. enters into a number of them. Communications receivers and transmitters are also subjects of experiments.

In many cases a variety of tests on one subject are indicated, making the book adaptable to classes and individuals with wide differences in the equipment and time available. The book is written with the present shortage of supplies in mind, and little difficulty will be found in carrying out the experiments with even the limited apparatus available in wartime.

An Appendix describes the construction of a radio frequency and audio frequency oscillator, vacuum-tube voltmeter and multi-vibrator used in some of the experiments, and indicates that other pieces may also be constructed without difficulty.

"ROGER WILCO," ABC of Radio for Flyers, by Lieutenant Adras P. LaBorde. A.C. Military Service Publishing Co. Stiff cloth covers, 5 x 8 inches, 124 pages. Price \$2.00.

This book is almost unique in radio texts, in that it instructs flyers who know nothing about radio theory in the operation of their plane radio equipment, and does it without trying to enlighten them as to the underlying principles of the apparatus. Such instruction has its drawbacks, but is the perfect method when students' time is limited.

A second feature—not entirely unique today—is the language of instruction, strictly colloquial and using all the expletives and slang of an Army instructor. "Talk in type," is what the blurb calls it.

Freed from the necessity of imparting technical information, the author can concentrate on such simple, but much-needed warnings as, "Don't leave that RAD-INT switch on INT while you're soloing. Hundreds of guys have done that very thing and hundreds will do it again. Why in the hell they want to leave the switch on INT when there's no one else in the ship is for the booby doctors."

In similar racy language the reader is instructed on the use of the AUTO-MANUAL switch of his receiver. Although he might not know what an interphone is, and has even less notion of A.V.C., the style of the book is sufficiently impressive to drive him into the right path.

Complete instructions on handling the set and methods of procedure are communicated, the emphasis throughout being on showing the correct course and warning against common beginners' mistakes, without wasting space in trying to explain why this should, or that must not, be done.

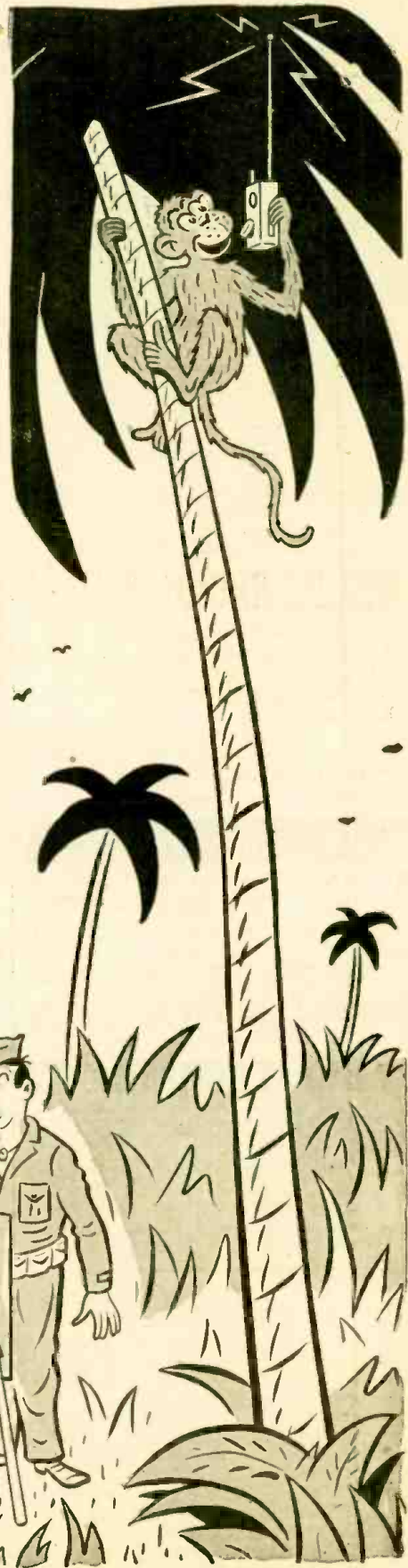

FRANK BEAVEN



"It sounds Japanese, but I can't make out what he is saying."

Radio School Directory

TO OUR READERS—NOW IS THE TIME TO TAKE UP RADIO!

NOW, more than ever before America needs trained radio men. The Army, the Navy and the Air Force are continuously on the lookout for men who have had training in radio. Scores of war industries require radio men in various capacities throughout the country. There now is and there will be a great shortage of radio men for years to come. Reputable schools of Radio advertise to help you.



Send for FREE 52-page Book. It shows that "crack" operators rely on something besides practice to develop their high speeds and proficiency. It explains the "knack" of sound-sense and sound-consciousness—the secret of speedy sending and receiving. Once you acquire these mental processes, reading code becomes almost second nature to you. The Candler System, endorsed by telegraph champions, will train you quickly to be a High-Speed Radio Operator or Amateur. If you want s-p-e-e-d and proficiency—send for this revealing book now.

CANDLER SYSTEM CO. Box 928, Dept. 3F, Denver, Colo., U.S.A.
And at 121 Kingsway, London, W.C. 2, England

COMMERCIAL RADIO INSTITUTE

A radio training center for twenty-three years.

RESIDENT COURSES ONLY

Pre-Induction, Broadcast, Service, Aeronautical and Radio telegraphy classes now forming for June 19th. Literature upon request.

Dept. C., 38 West Biddle St., Baltimore 1, Md.

RADIO ENGINEERING!

RADIO today offers great future for women as well as men. Demand for Graduates exceeds supply. Courses also in Civil, Electrical, Mechanical, Chemical, Aeronautical Engineering; Business Administration, Accounting, Secretarial Science. Tuition, living costs low. 61st Year. Cosmopolitan student body. Enter June, Sept., Jan., March. Catalog.

TRI-STATE COLLEGE 2484 College Ave. ANGOLA, INDIANA

RADIO TECHNOLOGY

RCA Institute offers an intensive two-year course of high standard embracing all phases of Radio and Television. Practical training with modern equipment. Also shorter specialized courses in Commercial Radio Operating, Radio and Television Servicing, and Aviation Communications. For Free Catalog write Dept. RC-44.

RCA INSTITUTES, Inc.
A Radio Corporation of America Service
76 VARICK STREET NEW YORK 13, N. Y.

Here's How You Can Figure . . .

—On a BETTER Job and a Secure career in RADIO-ELECTRONICS

CREI home study training in Practical Radio-Electronics Engineering equips you with the ability to go after—and get—a better, secure, engineering job.

After the war, will come the period of the "survival of the fittest". Employers can then once again afford to be "choosy" in selecting the best-trained men for the best jobs.

In our proven course of training, you learn not only how . . . but why! Your ability to solve tough problems of paper, and then follow up with the necessary mechanical operation is a true indication that you have the confidence born of knowledge . . . confidence in your ability to get and hold an important job with a secure, promising future . . . These jobs are waiting today for radiomen with up-to-date technical training.

Investigate CREI home study training now . . . and prepare for security and happiness in the coming New World of Electronics!

WRITE TODAY! If you are a professional or amateur radio-man and want to make more money—let us prove to you we have something you need to qualify for the better job opportunities that can be yours. To help us intelligently answer your inquiry—please state briefly your education, radio experience and present position.



CAPITOL RADIO ENGINEERING INSTITUTE

Dept. RC-6, 3224 16th St., N.W., Washington 10, D.C.

RADIO . . . TELEVISION ELECTRONICS TRAIN NOW for postwar opportunities in this VAST, NEW field! Classes day and evening. Call daily 9-9—Sat. 9-2, or write Dept. RC.

RADIO-TELEVISION INSTITUTE

480 Lexington Ave. (46th St.), New York, N. Y. PLaza 3-4585. Licensed by N. Y. State

Correspondence Courses in RADIO and ELECTRICAL ENGINEERING

ELECTRICAL ENGINEERING Get good grasp electrical field. Prepare yourself at Low Cost, for secure future. Modern, simplified, you can understand quickly.
RADIO ENGINEERING Extra fine course in radio, pub. Trains you to be super-service man, real vacuum tube technician. Servicemen needed badly. Diploma on completion. Tuition \$25, either course. Deferred payment plan. Get copies of school catalogs, student magazines, complete details. SEND NOW!

FREE LINCOLN ENGINEERING SCHOOL Franklin Stn., Box 61-C64 WASHINGTON, D. C. (Formerly at Lincoln, Nebr.)

NEW SOUND-ON-TAPE MACHINE

A NEW sound-on-tape machine, destined according to its inventor to fill an important place in the post-war world of recording devices, has recently been demonstrated at public showings.

The device was developed by Jay Fonda, (Chief Engineer, Fonda Corporation), who learned the advantages of this type of recording while working as a film sound man. The principle was taken from that of the film sound track—the main difference being that he applied a needle to do the work done by an intensified light. The problem of how to press the sound track on the tape with a needle without cutting it was Fonda's first problem. This was solved through the adoption of a yieldable felt bed directly under the recording needle, on the basis of which the patents owned by the Fonda Corporation were subsequently granted.

The tape, which is about twice the thickness of ordinary cellophane, runs under the needle at a rate of about 40 feet a minute and is capable of carrying 60 parallel grooves.

The first commercial model, a neat, compact unit, not much larger than a table model radio receiver, is a precision instrument which records and plays back on cellophane tape with high fidelity and low cost of operation. The tape, a little more than an inch in width, is an endless loop 320 feet long and permits up to eight hours of constant recording at a cost of only 50 cents per hour to the consumer.

When used as a reference recorder, titles of the various portions of the recording can be marked directly on the tape. Furthermore, the tape, which is easily changed, is delivered in individual cartons with printed charts for identifying the recorded material. The simplicity of operation and its ability to indicate plainly what is recorded on it, in addition to the fact that changes in magazines are required only three times in every 24 hours of continuous operation is expected by the inventor to make this a unique precision recorder of great value as a reference file for the whole range of industry (from small offices to traffic control towers at airports and monitoring of radio broadcasting), as well as for home use, and for innumerable federal, state and municipal governmental applications.

Both the recording and reproducing needles have permanent gem points which do not require changing and which eliminate shavings, thus making possible the playback of the film virtually thousands of times without loss of tonal quality.



TWO NEW ELECTRON MICROSCOPES

Two improved electron microscopes representing the culmination of four years of intensive research and engineering by the Radio Corporation of America were shown and demonstrated for the first time at the national wartime conference of the Society of American Bacteriologists at Hotel Pennsylvania, New York City, May 3 to May 5, and at the meeting of the New York State Medical Society the following week.

Meade Brunet, manager of the Engineering Products Department, RCA Victor Division, announced that one of the new

instruments shown is an advanced model of the instrument that was introduced in 1940, and which is now being utilized in important wartime research by many medical, industrial and university laboratories.

The other new instrument is in compact console form, the first of its type to be developed. It is expected to have wide application in smaller industrial laboratories, hospitals, schools and other institutions and agencies who might not ordinarily be able to utilize the "super-eye" because of limited budgets and space.

Audels RADIOMANS GUIDE

**1001 RADIO FACTS
AND FIGURES**

772 PAGES · 400 DIAGRAMS · CHARTS AND PHOTOS

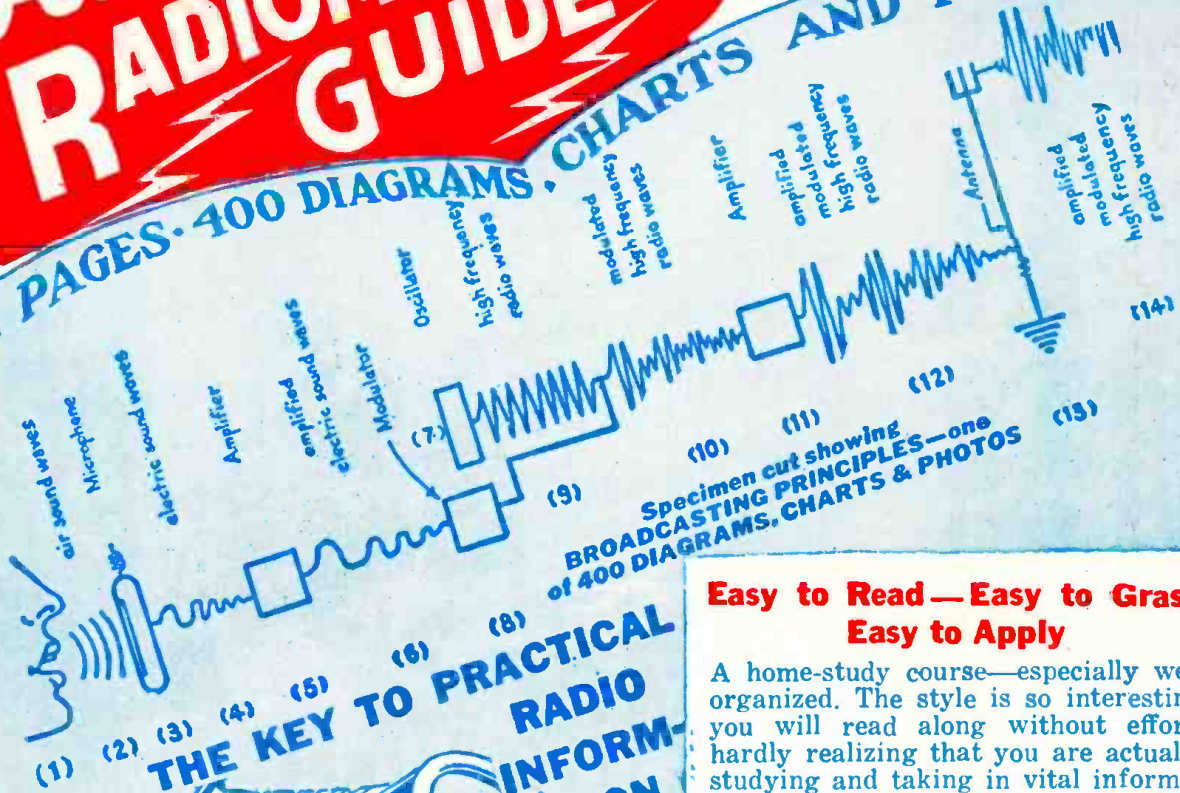

**THE KEY TO PRACTICAL
RADIO
INFORMATION**

It gives you in usable form pointers on radio, including frequency modulation, television, etc. Also valuable inside information for Aviators, Marines, Commercial Operators and Technicians, Servicemen and Students.



**Q AND A
UNIQUE
QUESTION
and
ANSWER
METHOD**

Highly Endorsed

A COMPLETE LIBRARY IN ONE BOOK

AUDELS RADIOMANS GUIDE gives authentic Principles and Practices in Construction, Operation, Service and Repairs. Covers clearly and concisely radio fundamentals—Ohm's Law—Physics of sound as related to radio science—Measuring instruments—Power supply—Resistors—Inductors—Condensers—Transformers and examples—Broadcasting stations—Radio Telephony—Receivers—Diagrams—Construction—Control Systems—Loudspeakers—Antennas—AutoRadio—Phonograph Pick-ups—Public Address Systems—Aircraft and Marine Radio—Radio Compass—Beacons—Automatic Radio Alarms—Short Wave—Coil Calculations—Testing—Cathode Ray Oscillographs—Static Eliminations—Trouble Pointers—Underwriter's standards—Units and tables. REVIEW QUESTIONS—READY Reference Index.

**Easy to Read—Easy to Grasp
Easy to Apply**

A home-study course—especially well organized. The style is so interesting you will read along without effort, hardly realizing that you are actually studying and taking in vital information. Audels Radiomans Guide gives you just the right amount of mathematics required to cope with radio problems successfully. You can solve, with the aid of this extraordinary book, practically every radioproblem that comes up. At your finger tips is a complete index for instant use.



\$4

COMPLETE

PAY ONLY **\$1** A MO.

7 DAYS' FREE TRIAL

THEO. AUDEL & CO., Publishers
49 West 23rd Street, 10, New York

Mail AUDELS NEW RADIOMANS GUIDE for free examination. If O.K. I will send you \$1 in 7 days; then remit \$1 monthly until \$4 is paid. Otherwise I will return it.

Name _____
Address _____
Occupation _____
Reference _____

**MAIL THIS
COUPON
TODAY**



©1944 RADIO-CRAFT MAGAZINE, New York

Motorola
HANDIE-TALKIE
2-WAY Radio



THE BUSIEST "**FIGHTINGEST**" RADIO IN THE ARMY

It's here... there... *everywhere*. On the fighting fronts, in the training camps... wherever there is need to *talk and listen* the two-way *Handie Talkie* is busy, working 'round the clock. This amazing radiotelephone system is no larger than a cookie carton, weighs little more than five pounds and operates on batteries. It is a vital part of our military communications system. Motorola Radio Engineers saw the need for such a unit long before Pearl Harbor. They developed it and had it ready when Uncle Sam called. It's a Motorola habit to be first!

After the war, you can look to Motorola for new pioneering that will make Motorola home and car radio better than ever

GALVIN MFG. CORPORATION • CHICAGO 51

Motorola Radio

F-M RADIO • AUTOMATIC PHONOGRAPHS • TELEVISION • F-M POLICE RADIO • RADAR • MILITARY RADIO COMMUNICATIONS