

RADIO-CRAFT

HUGO GERNSBACK, Editor

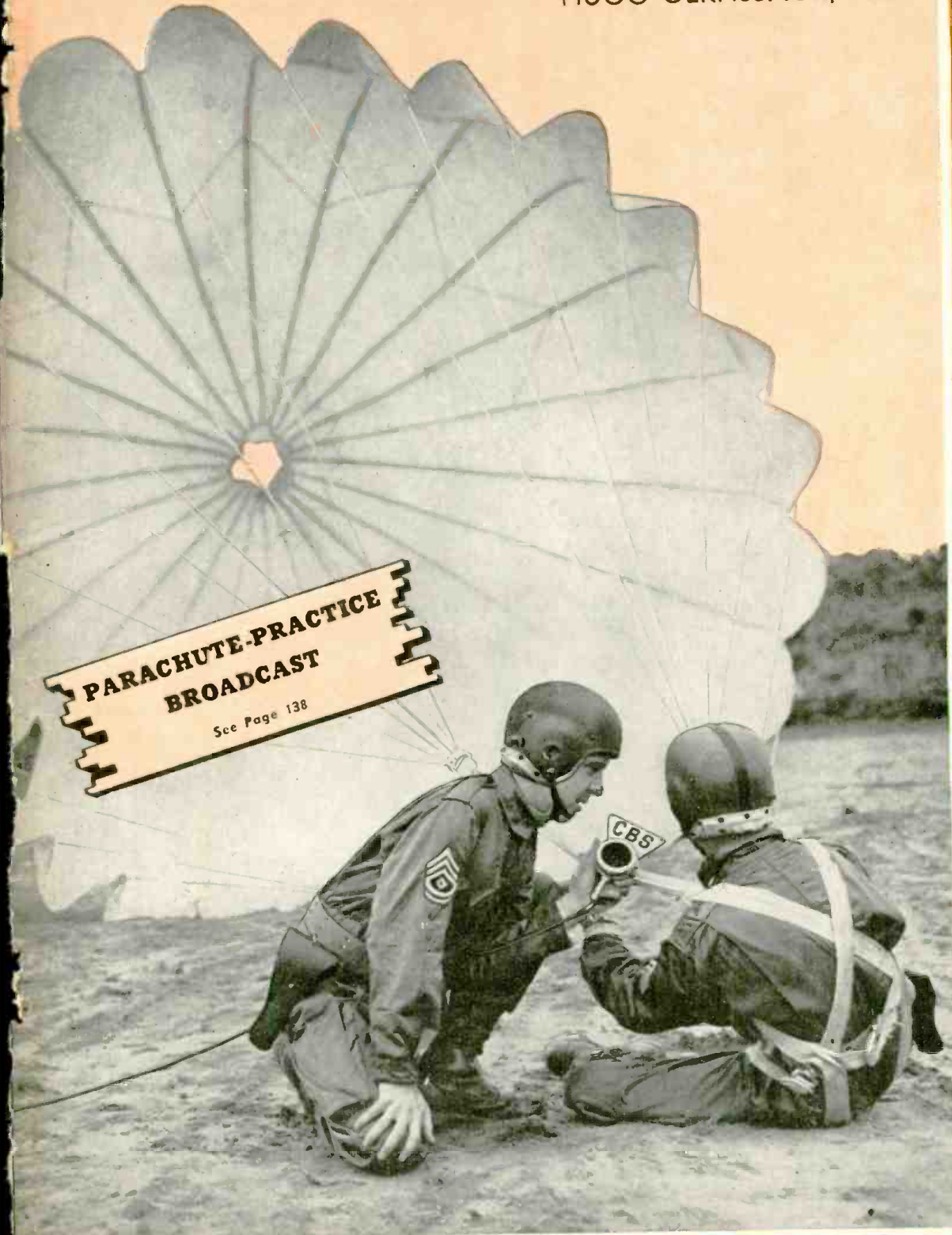

TELEVISION "FINDER"

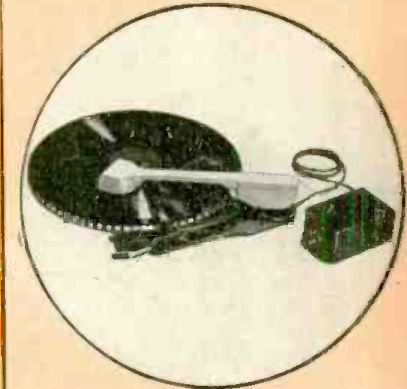

DYNAMIC PICKUP



TALKING LIGHTBEAM

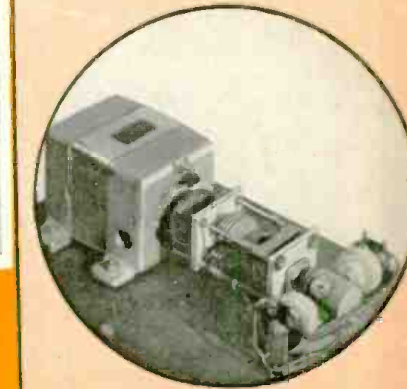

FREQUENCY MODULATOR

SEPT.

25c

CANADA 30c

1941

RADIO'S GREATEST MAGAZINE

REPAIRING METERS • HOW TO USE 2 LOUDSPEAKERS • 10-WATT AMPLIFIER

F.M. SERVICE • A.F. OSCILLATOR USES • ISOLATING DEFECTIVE STAGES

It's **HARRISON** for hallicrafters!

**FREE
10 DAY TRIAL**
to convince yourself
how good these new
receivers are!



New 1941 Super Skyrider Model SX-28. Sets a new high in quality performance. 15 tubes; two stages preselection; 80/40/20/10 meter amateur bands calibrated; 6 step wide range variable selectivity; calibrated bandspread inertia controlled; frequency coverage 550 kc. to 42 mc. With crystal and tubes **\$15950**

**HIGHEST TRADE-IN
ALLOWANCES**
Plus a
100% square deal

**PROMPT
DELIVERY**
of
practically
all models



The 1941 Sky Champion (Model S-20R) Represents the best value in the communications field. 9 tubes; 4 bands; covers 545 kc. to 44 mc.; separate electrical bandspread; battery-vibra-pack D.C. operation socket **\$4950**

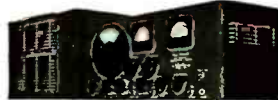

Model SX-25. Embodies every worthwhile advancement that has been made in the communications field. Tunes from 540 kc. to 42 mc. in 4 bands; 12 tubes; 2 stages of preselection. Separate calibrated bandspread dial for the 10, 20, 40 and 80 meter amateur bands. 10" heavy duty speaker. 110 volt 50-60 cycle A.C. operation, D.C. operation socket provided for battery or vibra-pack. Complete with speaker, crystal and tubes **\$9950**

**EASY
TERMS**
at
**LOWEST
COST**



The Sky Traveler (Model S-29). A universal receiver, you can take it with you anywhere. Operates on 110 volt A.C.-D.C. or from self-contained batteries. 9 tubes. Covers from 542 kc. to 30.5 mc. (553 to 9.85 meters) on 4 bands. Self-contained telescoping antenna. Weight, including batteries, 18 lbs. **\$5950**

DEALERS - SERVICEMEN!

Try our quick, dependable service the next time you need replacement parts in a hurry. Order from any catalog or advertisement.

Transformers Vibrators
Condensers Controls
PORTABLE BATTERIES, etc.

**Lowest Dealer Prices
on Quality Merchandise**

**Complete stock of modern
TEST EQUIPMENT**



The Sky Buddy (Model S-19R) designed to produce superior performance at a moderate price. 6 tubes; 4 bands; continuous coverage 44 mc. to 545 kc.; electrical bandspread **\$2950**

★Send for our latest list of new and reconditioned receivers!

HARRISON
RADIO COMPANY
•
12 West Broadway
•
New York City
•

hallicrafters receivers
+ Harrison Service
= *Your complete satisfaction*

A FREE LESSON SHOWED BILL HOW HE COULD MAKE GOOD PAY IN RADIO



BILL, YOU'RE ALWAYS FOOLING WITH RADIO-- OUR SET WON'T WORK-- WILL YOU FIX IT?

I'LL TRY, MARY, I'LL TAKE IT HOME TONIGHT



I CAN'T FIND OUT WHAT'S WRONG-- GUESS I'LL MAKE A FOOL OF MYSELF WITH MARY



HELLO, BILL-- GOT A TOUGH ONE TO FIX? LET ME HELP YOU



HELLO JOE-- WHERE'VE YOU BEEN LATELY-- AND WHERE DID YOU LEARN ANYTHING ABOUT RADIO?

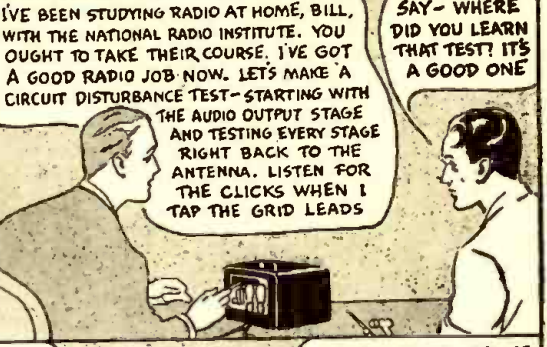

I'VE BEEN STUDYING RADIO AT HOME, BILL, WITH THE NATIONAL RADIO INSTITUTE. YOU OUGHT TO TAKE THEIR COURSE. I'VE GOT A GOOD RADIO JOB NOW. LET'S MAKE A CIRCUIT DISTURBANCE TEST-- STARTING WITH THE AUDIO OUTPUT STAGE AND TESTING EVERY STAGE RIGHT BACK TO THE ANTENNA. LISTEN FOR THE CLICKS WHEN I TAP THE GRID LEADS

SAY-- WHERE DID YOU LEARN THAT TEST? IT'S A GOOD ONE

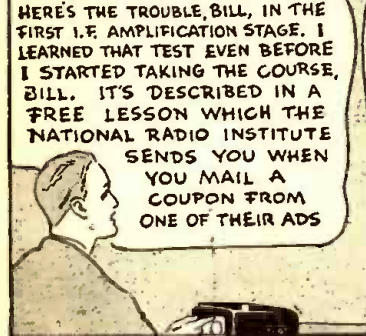

HERE'S THE TROUBLE, BILL, IN THE FIRST I.F. AMPLIFICATION STAGE. I LEARNED THAT TEST EVEN BEFORE I STARTED TAKING THE COURSE, BILL. IT'S DESCRIBED IN A FREE LESSON WHICH THE NATIONAL RADIO INSTITUTE SENDS YOU WHEN YOU MAIL A COUPON FROM ONE OF THEIR ADS



I'VE SEEN THEIR ADS BUT I NEVER THOUGHT I COULD LEARN RADIO AT HOME-- I'LL MAIL THEIR COUPON RIGHT AWAY

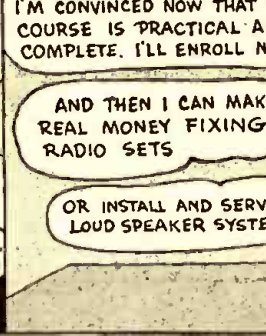

I'M CONVINCED NOW THAT THIS COURSE IS PRACTICAL AND COMPLETE. I'LL ENROLL NOW

AND THEN I CAN MAKE REAL MONEY FIXING RADIO SETS

OR INSTALL AND SERVICE LOUD SPEAKER SYSTEMS



OR GET A JOB WITH A RADIO BROADCASTING OR TRANSMITTING STATION

AVIATION RADIO, POLICE RADIO, TELEVISION, ELECTRONIC CONTROLS-- RADIO IS SURELY GOING PLACES. AND THE NATIONAL RADIO INSTITUTE HAS TRAINED HUNDREDS OF MEN FOR JOBS IN RADIO

I will send you a Lesson on Radio Servicing Tips FREE TO SHOW HOW PRACTICAL IT IS TO TRAIN AT HOME FOR GOOD JOBS IN RADIO



J. E. SMITH, President, National Radio Institute, Established 25 years



YOU CERTAINLY KNOW RADIO SOUNDS AS GOOD AS THE DAY I BOUGHT IT.

THANKS! IT CERTAINLY IS EASY TO LEARN RADIO THE N.R.I. WAY. I STARTED ONLY A FEW MONTHS AGO, AND I'M ALREADY MAKING GOOD MONEY.

THIS SPARE TIME WORK IS GREAT FUN AND PRETTY SOON I'LL BE READY FOR A FULL TIME JOB

Every man who works on a Radio Receiver, either professionally or as a hobby, should have a copy of my Free Sample Lesson, "Radio Receiver Troubles-- Their Cause and Remedy." I will send you your copy without obligation if you will mail the Coupon below. It will show you how practical my lessons are-- give you a real idea of the vast amount of information my Course gives you.

men who have been in Radio before enrolling report that my Course helped them make more money, win success. I train you too for Television, a promising field of future opportunity.



You Get This Professional Radio Servicing Instrument as part of my Course to help you make more money, do better Radio work. For full details, mail the Coupon.

Beginners Quickly Learn to Earn \$5 to \$10 a Week Extra In Spare Time

Nearly every neighborhood offers opportunities for a good part-time Radio Technician to make extra money fixing Radio sets. I give you special training to show you how to start cashing in on these opportunities early. You get Radio parts and instructions for building test equipment, for conducting experiments that give you valuable, practical experience. My 50-50 method of training-- half with Radio parts I send you, half studying my Lesson Texts-- makes learning Radio at home interesting, fascinating, Practical.

He has directed the training of more men for the Radio Industry than any one else.

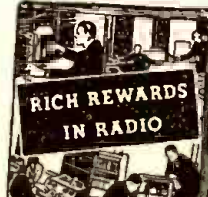

OH BILL-- I'M SO GLAD I ASKED YOU TO FIX OUR RADIO. IT GOT YOU STARTED THINKING ABOUT RADIO AS A CAREER, AND NOW YOU'RE GOING AHEAD SO FAST

OUR WORRIES ARE OVER. I HAVE A GOOD JOB NOW, AND THERE'S A BIG FUTURE AHEAD FOR US IN RADIO



Why Many Radio Technicians I Train Make \$30, \$40, \$50 a Week

N.R.I. trained Radio Technicians hold good jobs in practically every branch of Radio, selling, servicing, installing, repairing, home and auto Radio sets. N.R.I. trained Radio Operators have good jobs in Broadcasting, Commercial, Aviation, Police, Ship, Radio Stations. Many operate their own part or full-time Radio businesses, fixing, selling Radio sets. Others make good money in Public Address work and other branches of the Radio Industry.

My Course is thorough and practical. I give you basic training in Radio Theory and Engineering Practice which enables you to understand the operation and design of practically every type of Radio apparatus. You understand your work-- know just what to do-- instead of just relying on mechanical ability to fix a few common faults and make a few simple adjustments. That's why many

EXTRA PAY IN ARMY, NAVY, TOO

Every man likely to go into military service, every soldier, sailor, marine should mail the Coupon Now! Learning Radio helps men get extra rank, extra practice, more interesting duty at pay up to 6 times base pay. Also prepares for good Radio Jobs after service ends. IT'S SMART TO TRAIN FOR RADIO NOW!

MAIL THE COUPON-- get my Sample Lesson and 64-page Book "Rich Rewards in Radio" at once. They're free. See what Radio offers you as a skilled Radio Technician or Operator. Learn how practical my Course really is. Read letters from more than 100 men: I have trained telling what they are doing, earning. Mail the Coupon NOW-- in an envelope or paste it on a penny postal.

J. E. SMITH, President, Dept. 11X National Radio Institute, Washington, D. C.

J. E. Smith, President, Dept. 11X, National Radio Institute, Washington, D. C.

Mail me FREE without obligation. Sample Lesson and 64-page book "Rich Rewards in Radio," which tells about Radio's opportunities and explains your 50-50 method of training men at home. (No salesman will call. Write plainly.)

Age.....

Name.....

Address.....

City..... State.....

14X1

RADIO-CRAFT

HUGO GERNSBACK, *Editor-in-Chief*

N. H. LESSEM
Associate Editor

THOS. D. PENTZ
Art Director

R. D. WASHBURNE, *Managing Editor*



Contents **SEPTEMBER, 1941** Issue

VOLUME XIII -- NUMBER 3

Mailbag	131
Editorial: "64% of the Radio Servicemen are Gyps" Hugo Gernsback	137
The Radio Month in Review	138

SERVICING

Simplified Set Conversion	Steve Kusen	140
Operating Notes	Bertram M. Freed	145
Isolating the Defective Stage	Wm. Franklin Cook	148
RADIO SERVICE DATA SHEETS:		
No. 314—General Electric Model LB-530 Rechargeable-Battery (A.C./Battery), Portable		154
No. 315—Knight (Allied Radio Corp.) A10800		155
New Circuits in Modern Radio Receivers—No. 48 F. L. Sprayberry		156

F. M.

F.M. Service—Part I, Antenna Installation and Service Bertram M. Freed	157
---	-----

SOUND

2 Speakers are Better Than 1	F. M. Dezettel	164
Construction Details of a Modern 10-Watt A.F. Amplifier		166
Sound Engineering—No. 21	Conducted by A. C. Shaney	168

TEST INSTRUMENTS

Emergency Repair of Test Instruments	John Charles Banks	170
How to Build and Use a Practical Frequency Modulator Marion Amos		172

TELEVISION

Construction Details for a Practical Car-Television Receiver— Part I	Wm. B. Still	175
Commercial Television Inaugurated July 1		176
Television Broadcast Stations—A Listing		177

ENGINEERING

Applications of the A.F. Test Oscillator		179
--	--	-----

DEPARTMENTS, ETC.

Mailbag	131	
The Radio Month in Review	138	
Operating Notes	145	
RADIO SERVICE DATA SHEETS (See Servicing)	154, 155	
New Circuits in Modern Radio Receivers—No. 48 F. L. Sprayberry	156	
Sound Engineering—No. 21	Conducted by A. C. Shaney	168
Latest Radio Apparatus	184	
Classified Radio Directory—Section VI (Revised)	186	
Shop Notes, Kinks, Circuits	191	
Book Reviews	192	



Published by Radcraft Publications, Inc. Publication office: 29 Worthington Street, Springfield, Mass. Editorial and Advertising Offices: 20 Vesey Street, New York City. Chicago Advertising Office: RADIO-CRAFT, 520 North Michigan Avenue, Chicago, Ill.

RADIO-CRAFT is published monthly, on the first of the month preceding that of date; subscription price is \$2.50 per year in U. S. (In foreign countries, 75c additional per year to cover postage; Canada, 50c additional.) Entered at the post office at Springfield as second-class matter under the act of March 3, 1879. All communications about subscriptions should be addressed to: Director of Circulation, 20 Vesey Street, New York, N. Y.



Foreign Agents:

London—Gorrings's American News Agency, 9A Green St., Leicester Square, W. C. 2, England.
Paris—Messageries Dawson, 4 Rue Faubourg, Poissonniere, France.
Melbourne—McGill's Agency, 179 Elizabeth St., Australia.
Dunedin—James Johnston, Ltd., New Zealand.



Text and illustrations of this magazine are copyright and must not be reproduced without permission of the copyright owners.



Copyright 1941 Radcraft Publications, Inc.

YEP—THAT BUCK YARN AGAIN

Dear Editor:

First, my heartiest thanks for the splendid job you are doing, in general, in keeping up the standards of the Radio Servicemen. Your progressiveness is a great inspiration for us all to keep on our toes.

Perhaps you may find the following, written as an open letter, of some value for publication:

SOUR GRAPES FOR THE RADIO MAN (?) BUCK

Dear Editor:

Bravo, Willard Moody! You have ably expressed the thoughts of the great majority of competent Servicemen after reading Mr. Buck's masterpiece on alignment by guess and by gosh. In the words of a far cleverer one than I, "I wouldn't even ignore it!"

It honestly seemed to me that the whole affair was an attempt to vindicate to himself the lack of either a good oscillator or the ability to use it. Let's ask one simple question of Mr. Buck: "What happens when you get a set too badly out of line to get any signal through to make an image?" Where would one start, without an oscillator? Moreover, the received signal from a broadcast station is constantly varying in amplitude, and is obviously impossible to follow by ear as closely as the steady note of an oscillator. The only accurate way of aligning on a broadcast station would be with a V.T. voltmeter tied in the A.V.C. bus. Incidentally, my own pet alignment method is with both oscillator and V.T. voltmeter (a Voltohmyst).

Granting, of course, the advisability of having the columns of our favorite (this) magazine open to all for controversial subjects, it nevertheless does seem that there should be some closer check on the technical side as well as the editorial side. Suppose that all articles and circuits submitted by other than recognized experts be turned over to a voluntary checking staff for actual trial before publication.

Surely there would be plenty of men each anxious to have a turn at trying out something new, and reporting the results. I'm sure you would find enough willing to serve without pay other than the recognition, and perhaps a very slight subsidy whenever some particularly expensive job came up. The jobs could be rotated among this staff so that there would not be too much burden on each.

The article on sound which I most enjoyed in recent issues was "Independent Power Supplies" by Joel Julie (March, '41). Now, there is the sort of article that is usable. Two of Mr. Julie's circuits, however, have the same fatal error for general use, that is, the chassis must be connected to one side of the line. That is all right for small A.C./D.C. sets in wooden cabinets, well enclosed, with insulated knobs and recessed set-screws, but for an amplifier in an all-metal chassis exposed to the world... Uh, uh!!!

The solution is absurdly simple however—just use a bridge circuit such as the very ingenious one shown in Fig. 3 of Steve Kusen's article in the January, '41, issue, in which the line does not go to either side. Of course, in some cases it may be practicable to return all ground connections to a common bus isolated from the metal chassis except for a paper condenser, but this would usually be a terrific amount of work, in amplifiers already built.

Congratulations on the splendid work you are doing, and keep it up.

The above is of course too long-winded,

but you may find some of it usable. Thanks again,

Yours till Mr. Buck gets a Signallist,
ARTHUR BERTRAM, JR.,
Southern Radio Co.,
Augusta, Ga.

On more than one point, an interesting letter. Whether that idea of a staff of double-checkers could be worked out... well... that's a poser.—Editor

HOW BRITISH SERVICEMEN OPERATE

Dear Editor:

I read with great interest the letter by Vincent Gorrea in your Sept. 1940 issue. (Sorry I'm a bit late in writing, but I didn't get the magazine until a month ago and have been too busy to write.) He complains of a lot of things which evidently happen to Servicemen in America, and I would like your readers to compare his 14 complaints with the conditions British Servicemen work under. Your readers will have to refer back to the issue in question to compare the differences. Here goes:

- (1) While Servicemen here do not dress as doctors, they do have organization certificates, and what is also a union.
- (2) A charge is made for looking over the radio, whether it is repaired or not. Charge varies from 2/6 or 4/6 (65c to \$1.10) approximately.
- (3) All tubes tested by Servicemen are charged-for, usually 3 pence or about 6c; this is refunded if the new tube is bought at the store.
- (4) This question is answered by 1, 2 and 3.
- (5) This is answered by 2.
- (6) This does happen here occasionally, if the repair bill is small.
- (7) See No. 1 about Union of Servicemen.
- (8) No radio magazines here ally themselves to any one branch of radio.
- (9) Answered in No. 7.
- (10) Answered in No. 7.
- (11) A "looking over" charge is taken for granted here; nobody "kicks."
- (12) See above.
- (13) Does not happen here.
- (14) They do here.

I should like you to print this because I should like to hear from a friend of mine in Center Moriches, New York. Let's hear from you Van at my *new address, if you see this.

G. Y. BURRAGE,
Middlesex, England

*We'll forward correspondence.—EDITOR

ON RADIO PROGRAMS

Dear Editor:

As to the radio program advertising that Mr. Harold Davis of Jackson, Miss. (April R.-C.), is so bothered about, at least we Servicemen in the smaller towns would be very glad to ease his pain. Seems that Mr. Davis has forgotten the fact that many a national movement has started in a very small way and it is thus that this desire of his can be accomplished. For there is many a Serviceman who would give his eye-teeth to get ahold of some advertising that would improve his status with the public he serves.

I can think of no better way of doing this than to run a daily listing of programs to be heard on the networks with the Serviceman's signature (byline) at the column head. To be sure some means will have to be provided for accurate compilation of these programs in advance of their time. As to the expense, some of it can be shared by the Serviceman, and his local position will kill the foreign rates. Then some tube company or radio manufacturer could run a

SPRAYBERRY TRAINS YOU for GOOD PAY! STEADY WORK! ADVANCEMENT! in RADIO and TELEVISION



DON'T WAIT! START NOW!
You Can Make Money Almost At Once
You'll be quickly shown how to get and do neighborhood Radio Service jobs... for practice and profits. You easily learn Television, Frequency Modulation, Signal Tracing, Mobile Radio (Auto-Tank), Aviation Radio, Electronics, Facsimile Radio, Radio Set Repair and Installation Work. I'll Prepare You Quickly in Spare Time

At Home Or At Camp
SPRAYBERRY Training does not interfere with your present work. You will receive personal coaching service all the way. You'll be fitted to hold down a good paying job in Radio or to have a Radio business of your own.

You Get Professional Test Equipment
Plus Experimental Outfits
Includes 146 RADIO PARTS (to build complete Radio Receiver), RADIO TOOLS and a TESTER-ANALYZER. MY EXPERIMENTAL OUTFITS enable you to conduct actual experiments with your own hands.

NO EXPERIENCE NEEDED
It makes no difference what your education has been. I can fit you to become a real RADIO TECHNICIAN. Your success is my full responsibility.

THE SPRAYBERRY COURSE IS SOLD UNDER MONEY-BACK AGREEMENT

RUSH COUPON for BIG FREE BOOK

SPRAYBERRY ACADEMY OF RADIO
F. L. Sprayberry, President
420 J University Place, N. W.
Washington, D. C.

Please rush me FREE copy of "HOW TO MAKE MONEY IN RADIO."

Name..... Age.....
Address.....
City..... State.....
(Mail in envelope or paste coupon on penny postcard)

QUICK, EASY WAY TO TRAIN FOR RADIO in 8 WEEKS



I'LL FINANCE YOUR TRAINING
Mail the Coupon TODAY and I'll not only tell you about my quick, easy way to train for a good pay job in Radio, Television and Sound, BUT, I'll also tell you how you can get it and pay for it, in EASY monthly payments starting 60 days after 8 weeks' training period.

LEARN BY DOING
On Real Equipment in Coyns Shops
Simple, easy method of Practical Training. You don't need previous experience or a lot of book learning. You work on real equipment in the Coyns Shops at Chicago. This 8 weeks training prepares you for a job in service and repair work—we also offer radio operating training. Full details of this training will also be sent you when you send coupon.

EARN WHILE LEARNING, Job Help After Graduation
We help you get part time work to help with living expenses and then give you employment service after graduation.

H. C. LEWIS, President,
Radio Division, Coyns Electrical School,
500 S. Paulina St., Dept. 61-8H, Chicago, Ill.

Dear Mr. Lewis:
Please send me your Big FREE Book, and details of your PAY-AFTER-GRADUATION-PLAN.

NAME.....
ADDRESS.....
CITY..... STATE.....

SEND COUPON TODAY

RADIO TECHNOLOGY

RCA Institutes offer an intensive course of high standard embracing all phases of Radio and Television. Practical training with modern equipment at New York and Chicago schools. Also specialized courses in Aviation Communications, Radio Servicing and Commercial Operating. For Free Catalog Write Dept. RC-41.

RCA INSTITUTES, Inc.
A Radio Corporation of America Service
75 Varick St., New York. 1154 Merchandise Mart, Chicago

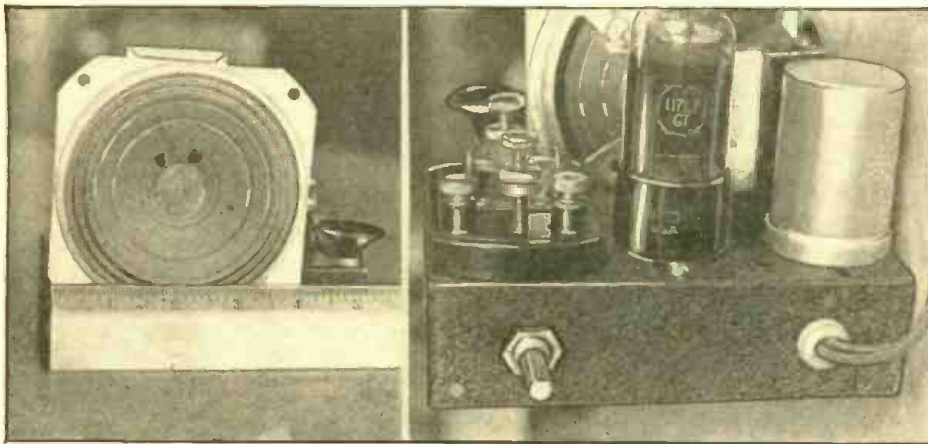

The Code-Practice Oscillator described on this page by M. J. Callaghan.

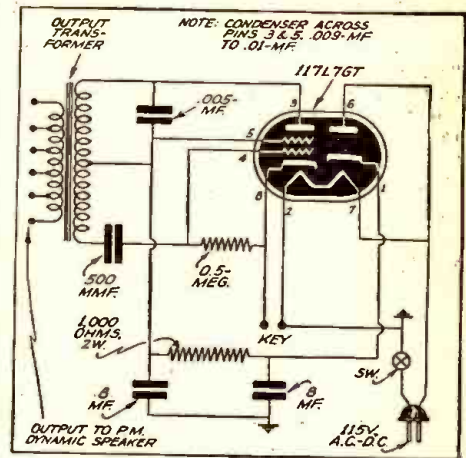

Circuit of Callaghan's Code-Practice Oscillator.

line or two for his part of the expense and if further reduction be necessary the newspaper could give an additional discount on the space consumed as it would be an additional feature for the newspaper's reader interest, and therefore other advertising would profit by its presence on the same page.

Let's keep this in the family however, and on a share-all basis, starting in the small towns where more cooperation exists between the Serviceman and his local paper. Recognition will soon be granted by the larger papers and such institutions in this district are already publishing this information gratis. Though such an indirect assistance is appreciated and helps the Servicemen as well as the rest of the radio industry, I believe the more direct method as suggested would do more people more good at less expense per unit.

MANFORD BLACK,
Henryetta, Okla.

P.S.—I take this means to advise you that any publication or other trouble will be unnecessary on your part in connection with a problem sent in by me to Mr. Shaney concerning an A.V.C. installation in an old Majestic 21. This has already been worked out by proud me, and my pride is quickly lost due to the fact that the answers are too easy once you know them.

Thank you very much for the Bass-Booster in the April issue and I for one will be very grateful for any further modernizing information you can publish. The money gained by such service work amounts to little as compared to the confidence it builds in your customers!

M. B.

CODE-PRACTICE OSCILLATOR

Dear Editor:

Building the code-practice oscillator has always been something of a problem, and very often an awkward and expensive one.

However, recent tube developments have simplified all this to a great extent, and all the bulky batteries and "B" units of a few years ago are eliminated.

The highly efficient and simple unit described in this article utilizes only one tube, a type 117L7GT. This tube functions as an oscillator and rectifier, and as its heater operates directly off the 115-volt lines, either A.C. or D.C., all bulky and expensive power supplies and ballasts or resistance cords are eliminated.

This is a neat outfit for the beginner, amateur, or even the technician, and is ideal for school or camp, or any place where code is taught to groups of students, as the signal is clear and well-defined, and of ample volume.

The parts required are few and inexpensive and are of standard values, readily found on every experimenter's bench. The P.M. speaker is perhaps the only essential item of the kit, as a dynamic speaker no matter how small its field will not operate satisfactorily in this circuit.

In addition to the P.M. speaker, a midget universal output transformer; 2 resistors, one of 1,000 ohms, 2-watt rating, and one of 0.5-megohm, ½-watt size; two 8 mf. filter condensers; and, one 500 mmf. bypass are required. Signal pitch may be determined to suit the listener's ear by substituting various condenser values across screen-grid and plate elements of the tube, or a switch arrangement may be worked out to change the tone from bass to alto at will; however, for all practical purposes a 0.005-mf. or 0.006-mf. condenser, either paper or mica, will give excellent results.

The oscillator shown in the photograph was built on a base 5 x ¼ x 3 ins., and the key itself is wired permanently on the sub-panel. The more experienced operator will want to use his key separately, and may therefore reduce the size of the chassis to the exact size of the loudspeaker, and a simple jack to accommodate the key may be mounted on the chassis.

The physical layout is not at all critical and this unit may be constructed in any manner to suit the parts on hand, or the immediate convenience of the constructor.

The diagram is simple and self-explanatory and no difficulty should be encountered by anybody in its construction. Total cost should not exceed \$3.50.

M. J. CALLAGHAN,
New York, N. Y.

HEARING-AIDS AGAIN

Dear Editor:

Mr. Cisin's article in the March, 1941, issue of *Radio-Craft*, under "Hearing-Aids" might not be "A gem of stupidity," but it does prove that the best of minds "go native" when reputation is at stake. The articles in *Radio-Craft*, by the above author, have been interestingly educational and very well suited as answers to various problems that we would otherwise have to solve. The design of a hearing-aid that will work successfully into any deafened ear is, at present, an impossibility, just because there is a lack of patience on the part of the designer, the otologist, and the manufacturer. The ears of those who are in the class with Mr. Russell and myself (call us stone deaf, near deaf, "kinda" hard of hearing or a little hard of hearing) are subject to so many different pains, noises and frequency discriminations that our reactions to sound cannot be predicted by anyone. Mr. Cisin makes the mistake of using himself as a

subject. He does not consider the fact that his ears can stand more abuse, in the form of loud sounds, and that he can hear consonants. We, on the other hand, have the ability to rapidly piece together words with only vowels and a few hisses to work with.

I'm quite sure that Mr. Russell, like myself, would much rather hear the "watch tick a foot away" with Mr. Cisin's amplifier than slam all the sound engineers in America. The trouble is, if Mr. Russell, "Earl to H.B." could do that he would have ears like Mr. Cisin's. Much like the instructor who, in addressing his new class, opened with, "Will all those who cannot hear please come up closer." Mr. Cisin's test of his amplifier on normal ears, will be rather amusing even to himself, if he gets "it." He will have another laugh at his attempt at "leading himself astray" with his words on voltage amplification. A few attempts at making me hear, by shouting, would soon convince him that it takes more than volts from his battery. There must be power consumed, even in Mr. Cisin's earpiece.

Mr. Russell's pet amplifier may not be modern as to "mike," earpiece, and size but it does have what its owner calls "it." Just what Clara Bow had. Foolproof engineering. The ability to automatically limit the input to the capacity of the output with an earpiece that can pass "volts or watts" when the automatic jams. Mr. Russell has something simple in "limiters," guess what—the hiss in his carbon mike.

Mr. Cisin's test was on a weak watch tick, and he does not seem to remember that the same gain must be there for any sound that enters the microphone. There is no one "riding gain" to a hearing-aid for street cars, traffic cops' whispers, and bosses who just dish it out as they feel, and the ear-aid must "take it."

The crystal mike is sensitive and quiet, but high-gain circuits are necessary and I have never yet seen a home-made amplifier that didn't gurgle, stutter or squeal due to lack of shielding. This same sensitivity leads men like Mr. Cisin to put too much voltage amplification ahead of a small output tube that can deliver more voltage than crystal earpieces can handle.

Now for a crack at those "Medical Martyrs" who have been testing our ears with clocks and prescribing hot boric acid baths one day and calling them dangerous the next—after we were water logged. Doctors Pasteur, Lorenz and their many equals, are never-the-less few and far between. We would hardly expect to find them "helping humanity" by sponsoring 5,000% profit sales on glorified "Skinderwiken Buttons." No, even the Medical profession, as an organization, turned thumbs down on fitting hearing-aids in the Carbon-Ball Era. The American Medical Association has too many

skeletons in its own closet to risk protecting the deaf against the unfair practices of modern sales promotion and advertising. The miniature tube hearing-aids are useful at times but their Super-Colossal performance is usually in the colorful folders, and I'll bet many a designer's face gets red when he happens to read one.

RALPH L. BROWN,
Minneapolis, Minn.

P.S.—Would it be possible for you to forward the address of Mr. Russell mentioned in this letter, and Mr. Edward J. Gear of Los Angeles who signs an article on page 536 of *Radio-Craft* for March, 1941? I have nothing to sell but merely wish to correspond with men of like interests.

Sorry, we don't give out the addresses of contributors, but we've called your letter to the attention of those you mention, and have asked them to write directly to you.—*Editor*

HAS TROUBLE WITH OLSON'S SIGNAL TRACER UNIT

Dear Editor:

I have built your "Signal Tracer Test Unit" out of a Zenith 805 and the audio section works perfectly but the R.F. section seems very weak. Will you answer some further questions for me? I am enclosing self-addressed envelope for reply.

According to July *Radio-Craft*, your diagram and list of parts do not seem to correspond. In the list of parts you list "Two IRC resistors, 60,000 ohms, 1/2-W. R1, R3" but in the diagram there are "three" 60,000-ohm resistors used. Then the list of parts gives "One IRC resistor 400 ohms, 1/2-W. R2." The diagram does not show any "R2." Also, R10 is given in the list of parts as 25,000 ohms and on the diagram as 0.5-meg. Which is correct? Are your grid leads to the 75 and 6D6 shielded? Must the R.F.-I.F. input lead be kept away from other parts as much as possible? What type of phones and how sensitive are the ones you use?

The way my Tracer is now, I am unable to drive any but the highest attainable signal from my signal-generator through the Tracer. If I cut the signal down from 1,000 to 100 or to 10 it will not come through at all.

HAROLD O. RENNER,
Renner Radio Repair,
Madison, S. Dak.

This letter was sent to the author whose reply follows.

Dear Mr. Renner:

I am more than pleased to answer your questions in regard to the Signal Tracer described in the July issue of *Radio-Craft*.

You are right, the drawing and the parts list do not correspond. This error is due to typographical errors in the drawing. The parts list is correct. The cathode resistor for the 6D6 should be R2—400 ohms. This leaves only 2—60,000 ohm resistors required. Resistor R10 should be 25,000 ohms as indicated in the List of Parts.

The grid lead to the 6D6 is left unshielded. However it should be kept away from other parts. If coaxial cable is used for the R.F. test lead it should be connected as close as possible to the 6D6 control-grid. The type 75 tube grid lead is shielded. The phones I use are 2,000 ohms.

Do not use a signal generator directly connected to this unit for testing. Hold the R.F. test probe on the grid or plate of the tube in the stage to be tested and tune the radio set for a signal. Due to the capacity the instrument will detune the stage under test. In I.F. stages there will be very little difference; in R.F. stages the detuning will be considerable.

After a little experimenting you will learn

what to expect from the instrument. I have found mine very useful.

If you have any further difficulties do not hesitate to write to me.

R. B. OLSON,
Rockford, Ill.

LICENSE SERVICEMEN?

Dear Editor:

Upon reading the open letter in *Radio-Craft* magazine of June, 1941—an article written by Mr. James H. Hanley which stated that, "Servicemen should be licensed by the government, so that the industry could be cleaned up and it would have finer technicians to do the work"—may I say that I have been a licensed electrician for many years, and have been experimenting with radio since 1918, but could not earn enough money to make a living in the radio industry. I took a post-graduate course in radio, television and refrigeration, and have been doing radio, electrical and refrigeration service.

As an electrician, I made a fine living under union conditions only, but this too, was badly handled in union organizations, because it is still not under the supervision of the government. However, as licensed electricians only, they try to compete with each other and starve to death.

I was watching several radio men trying to repair a radio receiver for about an hour, and charging as little as 50c for their services.

I would suggest that radio technicians be licensed by the government and join in a union under the supervision of the government. This would be the only cure for the radio-technical man. Under the government both departments would do the best for its members.

SAMUEL STERN,
Stern Bros.,
New York, N. Y.

P.S.—You can have this letter open for discussion, for the benefit of "R.C." readers. S. S.

THANKS TO A. C. SHANEY

Dear Mr. Shaney:

I am writing to thank you for your interest in the radio problem of my son, Jerome Fowler, who is a patient in the State Hospital.

Before his illness began he was more interested in radio than in anything else. For a good while after his illness he seemed to have lost that interest. Now it has come back; he is so anxious to get a set with phones so that he can listen-in to just what he wants. He has in mind also to get something that will make it possible for all the other patients to have the same kind of radio.

It would mean so much to all of them, if it could be worked out.

With best wishes, I am

LUTHER FOWLER,
Columbiana, Ala.

Jerome Fowler's problem was discussed in the Sound Engineering Dep't of *Radio-Craft*, July 1941, Page 28. Have any of our readers any other ideas on "Hospital Sound" they'd like to pass along to Jerome?

RADIO-CRAFT DIAGNOSED

Dear Editor:

I enjoy your publication although I feel that the scope of the articles in it is not as broad as could be desired. Too many of them are elementary, or deal with subjects familiar or old. Construction articles, generally are too simple to be of general inter-

RADIO TRAINING



Founded in 1909

PORT ARTHUR COLLEGE, a non-profit making educational institution, offers a practical radio operator's course at the lowest tuition price in its history. Each radio graduate receives two months' actual operating experience at the college's commercial broadcasting station KPAC. This station is equipped with the latest type 1000 watt high fidelity RCA transmitter—1250 kc.—directional antenna system. KPAC operates in new modern studios located on the campus. The college has never advertised jobs or positions in lieu of education. Today it is well known there is a shortage of radio operators in every branch of radio; therefore, we believe it is good common sense to mention that Port Arthur College is the sole radio school in America which owns a commercial broadcasting station with commercial advertising representatives in New York, Chicago, San Francisco, and many of America's leading cities, with active membership in the National Association of Broadcasters, and Broadcast Music Incorporated. Through these contacts the college receives from the broadcast industry alone a great many more calls for student radio operators than it is possible to supply. Authorized to teach RCA texts.

If interested, write for Bulletin R-41

PORT ARTHUR COLLEGE
PORT ARTHUR (World-Known Port)
TEXAS



ELEMENTARY MATHEMATICS

EASY — SIMPLIFIED — PRACTICAL

HERE is a book for the business man, the technician and craftsman explaining and answering every operation and meaning with interpreting illustrations and examples.

It is the key to a simple understanding of many perplexing problems in daily life. In clear, positive and definite language, the author popularizes and clarifies every subject and helps the reader to overcome any apparent difficulty in the study of mathematics.

A real home study course in mathematics for the student or the man who wants to achieve proficiency or desires to brush-up on his knowledge.

Entire Chapter on Special Mathematics for the Radio Technician

CONTENTS OF BOOK

- CHAPTER I. Arithmetic—Addition—Subtraction—Multiplication—Division.
- CHAPTER II. Factoring and Cancellation—Fractions—Decimals—Percentage—Ratio—Proportion.
- CHAPTER III. The Metric System.
- CHAPTER IV. How to Measure Surfaces and Capacity (Geometry).
- CHAPTER V. Powers and Involutions—Roots and Evolution.
- CHAPTER VI. Mathematics for the Manual and Technical Craftsman—Thermometer conversions—Graphs or Curve Plotting—Logarithms—Use of the Slide Rule.
- CHAPTER VII. Special Mathematics for the Radio Technician.
- CHAPTER VIII. Commercial Calculations—Interest—Discounts—Short Cut Arithmetic.
- CHAPTER IX. Weights and Measures—Useful Tables and Stamps.

ONLY
50c
POSTPAID

"Elementary Mathematics" can be carried readily in your pocket

TECHNIFAX

1917 S. State St. RC-941 Chicago, Ill.

Correspondence Courses in
RADIO and ELECTRICAL ENGINEERING

ELECTRICAL ENGINEERING Get good grasp wide electrical field. Prepare yourself, at Low Cost, for secure future. Modern, simplified, you can understand outright.

RADIO ENGINEERING Extra fine course in radio, public address, lic address, photo-electric work. Trains you to be super-service man, real vacuum tube technician. Exper. kits furnished. Diploma on completion. Tuition, \$25, either course. Deferred payment plan.

FREE Get copies of school catalogs, student magazines, complete details. SEND NOW!

LINCOLN ENGINEERING SCHOOL, Box 931-C33, LINCOLN NEBR.

MAILBAG

est. Too little space is devoted to high-grade, all-wave receivers.

To me, it seems you cater too much to the beginner. I'm sure a large percentage of your readers are men old in the trade, who would prefer articles dealing with design and research. No popular publication, so far as I know, has ever given its readers comprehensive articles covering the problems encountered in developing new or specialized equipment or parts. I'm sure others would find these as interesting as would I.

Having been active in the trade for over 20 years, I know many of the problems confronting Servicemen daily could be made less forbidding if these men had even a slight knowledge of design principles and operating conditions from the mathematical viewpoint.

I know hundreds of Servicemen who have difficulty handling Ohm's Law. Anything more complex than this leaves them gasping. A series of articles dealing with this subject, that is, teaching rudimentary math, and the translation of formulas into a working knowledge of the parts and circuits themselves would undoubtedly be greeted with open arms and receptive minds. For I know many Servicemen—too many, in fact, finding Xn or Xc and then placing either in relation to the capacitor or inductor under observation is something better left to the engineers. Likewise for any formulas other than Ohm's Law. Very few men, I'm afraid, if confronted with the necessity of designing, say, an I.F. transformer, would know how to proceed. Yet there are many, many times when an exact replacement is not immediately available where, by knowing how, a coil could be constructed which would serve as well as the original. Even better in some instances.

Why not ask your readers for their opinion on this subject? I'm sure the response will be surprising.

A. P. LAUNDAGIN,
Michigan City, Indiana.

Well, readers, there you have it. What do you say? You read our articles on coils, the monthly check-up by Sprayberry on new circuit designs, Shaney's analyses of new developments in audio circuits—how else would you like these subjects treated?; what else would you like to see in your *Radio-Craft*?—Editor

SERVICEMEN MAKE GOOD SALESMEN

Dear Editor:

Someone said not so long ago, "Everyone must have the ability to sell in order to live." To my mind, nothing truer could be said. Let's assume that you are a lawyer. You must sell your services to the public, in the same way as a dealer in refrigeration and "radios" sells his merchandise to the public.

In bygone days Servicemen of radios, refrigerators, other appliances, and what-not hung out their shingles for servicing only. Little did they realize, as they do today, that many sales come from service. When a radio Serviceman, for instance, sets up a business of his own today, he not only repairs "radios," but he also sells them. He knows that if a radio set is beyond the repairing stage, this same customer becomes a prospect for a new radio receiver, and through the sale of a radio set, many other appliances may be sold to the customer.

Since I have been the radio Serviceman for the oldest radio and appliance store in the city in which I live, I have been able to make sales which otherwise would have been very difficult for anyone other than a Serviceman to make.

Another thing I'd like to point out is that a customer appreciates good radio service. One amusing incident, which was also profitable, happened not so long ago:

I was on a week-end vacation several miles from home during the last election when Mrs. Mabel Whittacker Houseknecht Williams Hamilton (a gay divorcee) who lived next door where I was staying, came rushing across the connecting lawn between the two homes. Although I had never met Mrs. Mabel Whittacker . . . etc., she came directly to the company truck in which I was sitting and introduced herself. She explained that her radio was not working and since it was vital that she heard the election returns, asked whether I wouldn't please repair the set.

After I entered the spacious living room where the antique battery set was, I immediately set to work and soon located the trouble. Evidently the Serviceman, who she explained had just left an hour before, had hooked the "B" batteries to the filaments of the tubes and failed to check the set before leaving. It was an inexcusable stunt, but I tried to cover-up the best I could and explained that all the tubes were burned out. I noticed that the house was recently wired for electricity and suggested that inasmuch as I didn't carry a complete set of tubes with me, that I lend her a

HOW THE MAILBAG GROWS!

By leaps and bounds—from 2 columns to 12 columns—the Mailbag Department just keeps growing. And it's a good, healthy sign, too. It's an excellent indication that the family of *Radio-Craft* readers are taking an increasingly large interest in their magazine. This is the only way that *Radio-Craft* can continue to improve!

Keep up the good work fellers! Also, let's hear from those who merely read this Department—the silent members of our family. This is the one place in the magazine where you can speak your mind freely—and don't mince any words!

Speak Up Brothers and Ye Shall Be Heard!

home-radio from my truck until I could repair her own for her. She hastily agreed to borrowing the set, but insisted that if the radio set couldn't be repaired that day, she would call her regular Serviceman from a competitive company from my own city. Well—what could I do? That's just what I did. I installed the radio next to the old one and started on my sales line about the dependability, tone, etc., of my product. She admitted that the radio receiver was good but frankly questioned my honesty in giving her a guarantee on the set.

I talked about half-an-hour with her on the subject of honesty, and guarantees, and she finally compromised. "I don't know you very well, and don't know how honest you are," she said, and added: "Cats are a very good judge of character, and if any one of my 13 cats will allow you to get within petting distance from it, I'll buy the radio from you, for I have great faith in my cats."

It was a good bargain, and for the next 2 hours I attempted to pet her cats, without success. Finally, with a sigh of despair, I started to arise from my chair when one of Mrs. Mabel . . . etc.'s cats jumped into

my lap, curled up, and went to sleep. After about 10 minutes of my petting the cat, I suggested that Mrs. Mabel . . . etc., write me out a check, which she promptly did, covering full payment for the receiver.

The next week I took 2 quarts of milk to Mrs. Mabel Whittacker . . . etc.'s cats, along with one of our largest refrigerators and a washing machine. Well, the refrigerator had a special milk cooling compartment and, needless to say, I sold both refrigerator and washing machine for cash.

CATS ARE A GOOD JUDGE OF CHARACTER, and since then I've petted every cat I possibly could.

If you're a good Serviceman you should not have much difficulty in selling, especially if you like cats (and cats like you).

MERRIL L. WINNER

(Radio Serviceman at Schuster's, Inc.)
Williamsport, Pa.

SPRAYBERRY'S DEPT. OK

Dear Editor:

As I am engaged in the radio service business, thought you might be interested in looking at our angle of the picture.

This radio business has become so fast-moving, with new tubes, new circuits, and the "9.95" models leading the parade, that the available service books are antiquated before they are released from the publishers.

In other words, the sets are manufactured, sold and brought in to be serviced, before any dope on their construction is available through books.

Under these conditions your information on new tubes, and Sprayberry's interesting comments, are a real help to the boys who keep the sets working.

D. M. LINTON,
Bakerstown, Pa.

ARTICLES ON RADIO MATHEMATICS

Dear Editor:

I would like to make a suggestion regarding a series of articles I would like to see published. There are a great many of us who can fix a radio set but are entirely lost when it comes to the higher mathematics involved in problems of radio design. We can't all become expert designers but I feel sure that hundreds of your Servicemen-readers are also experimenters and would be interested in a series of educational articles involving radio mathematics. Will you ask for comments?

I have noted some controversy in the "Mailbag" about a suggestion to license Servicemen. I think an examination for Servicemen would be a good thing as a protection to the public from tinkerers who know nothing about a radio receiver but are afraid to say they don't (and charge like they do). I have run across some of this in my community and it makes it tough for the real radio man. Licensing could be divided into several classifications to inspire the beginner to continue his study. However it should not include a large fee which would tend to crowd out the small Serviceman and the part-time man. I fall into the latter class simply because I have not yet developed my business to the point where it will support me. I feel sure there are many others like myself who are searching for a steady job in radio and who should not be barred from their chosen profession simply because their monetary needs require them to work elsewhere than in radio part of the time. They are not all "price cutters" as they are often called and I feel the radio service profession should continue to hold a place for them.

HAROLD EISENBISE,
Lenark, Ill.

P.S.—In addition I want to compliment

you on presenting the best magazine in the servicing industry.

Thanks for the compliment (prospective advertisers please note!), and thanks for a fine letter that very fairly presents a case for licensing Servicemen.—*Editor*

MOODY vs. PACE

Dear Editor:

I wish to correct an apparent misunderstanding which Mr. Pace expresses in your columns of July *Radio-Craft*.

The first point that I want to make is that a Serviceman should have all of the education he may possibly be fortunate enough to get; no more than a grammar school education, plus some special study in algebra and trigonometry, as well as radio theory, will enable him to understand servicing and do a good job.

I am interested in keeping out of radio some of the men who—and I know from first-hand experience—can't write their name so that you can read it without effort. Mr. Pace, a high school grad., is above average. There are some college men in radio—damn few—who do servicing. There are a great many who are almost illiterate and who depress the standards of what might be a good trade.

I would like to see the Serviceman attain the status of a good electrician or carpenter—and get good pay. At present, radio men are treated as poorly as laborers. Right here in New York are good Servicemen who work from 10 to 12 hours a day, 6 days a week, for \$25. Do you call that money?

That's why I suggested a potent, strong, vigorous Radio Guild. Perhaps it would be a better idea to try for legislation to get radio Servicemen a definite status, such as that enjoyed by licensed radio operators who take examinations to prove knowledge and ability.

WILLARD MOODY,
New York, N. Y.

AGREES WITH EDITOR

Dear Editor:

I agree with you, Mr. Editor, when in the article by Mr. Wm. J. Vette of Colorado you asked: Why not sell 'em the new set? I had quite a good laugh, because all old sets of any value had good bass response, and those which had not, we can buy for \$3 apiece. Why build a \$10 bass control?

W. F. ONDER,
Kimmswick, Mo.

Mr. Vette's letter appeared in April *Radio-Craft*, Page 639.—*Editor*

ALIGNMENT BUG

Dear Editor:

You will notice from the Operating Notes I enclose, (published in a previous issue—*Ed.*) that I am a bug on alignment. I have a good reason to be. I have had a good many sets on my bench that had already been serviced unsuccessfully by my competitors, and a careful check on the alignment has straightened them out. They seem to think that as long as the set plays fairly well, the alignment is OK.

To my surprise, incidentally, I have had over a dozen requests from different parts of the country for constructional information on my Analyzer, as it appeared in my shop photo, "in R.-C." for April, 1941. I do not feel like making a dozen or so drawings of it, but if you care to publish a description and a schematic of it, I will be glad to draw it out and send you a close-up photo of it also.

Congratulations on the article in May

"R.-C." on Audio Amplifiers, by Ted Ladd, I was looking for something like that. How about putting Moody and Russell in the ring, 15 rounds to a decision? Hi! All joking aside, I read every word of their articles, and am soaking-up all the information from them that I can digest. I want to build one for myself, as I have about 75% loss of hearing, and I lose a lot of business from it. Correct, Mr. Russell, give us a chance to soak the M.D. for "Professional Services Rendered," in fitting them up with a hearing aid.

Personally, I believe the Radio Servicing Profession should be elevated to a higher plane for the good of all.

If we would all conduct ourselves as Technicians, keep our shops as clean and businesslike as an M.D.'s office, and charge for an overhaul on the same basis as a Doctor charges for a physical check-up, instead of charging 15c for a condenser, and 50c for labor, etc., I believe we would all make a comfortable living.

Mr. Gernsback certainly had an important message (Editorial, "Radiobotage."—*Editor*) for the whole of the U.S.A. in the May issue. Perhaps it will open the eyes of some who believe we are impregnable and haven't a worry in the world, from German intrigue.

Now that I have this off my chest I feel better, and hope you have at least read this letter through. *This is my first letter to you, but somehow I feel that this is my magazine (it is!—Editor).* I have been taking Gernsback magazines from 'way back to the *Electrical Experimenter*.

Lots of Good Luck and Continued Success, to The Leading Radio Magazine of Today, and Tomorrow.

R. J. SCHOONMAKER,
West-End Electric Shop,
Port Jervis, N. Y.

Thanks very much for your opinion that *Radio-Craft* is the leading radio magazine "today." Every vote counts. As to "tomorrow"—well, we'll be in there batting,—an occasional homer, we hope.—*Editor*

SHANEY'S ARTICLES OK

Dear Editor:

I have built Mr. Shaney's 23-Watt High-Fidelity Amplifier as described in March, 1940, *Radio-Craft*. The results were highly satisfactory.

Until recently I was using crystal microphones, which gave me plenty of gain. I recently purchased a Hi-Fi velocity and I find that the amplifier could use a bit more gain, especially on dialogue and solo musical instruments.

How about publishing a schematic diagram of a HI-FI preamplifier with high-impedance input and high-impedance output, to be used as a separate unit, but in conjunction with this amplifier?

The following phrase is probably old stuff to you, but I have learned a great deal from Mr. Shaney, and the other features of *Radio-Craft*. Keep it up.

ALEXANDER NADEL,
Astoria, L. I.

The amplifier you mention of course was not designed for the type of microphone you now desire to use. However a number of high-gain input stages have been described in past issues of *Radio-Craft* and may be adapted to your needs; only a single high-gain input stage is needed. For example, you may use the front end of the diagram shown in Fig. 2, Page 468 of the February 1940 issue. Or, you may use any one of the 3 high-gain input channels shown in Fig. 1, Page 531, of the March issue from which you built the 23-watt job.—*Editor*

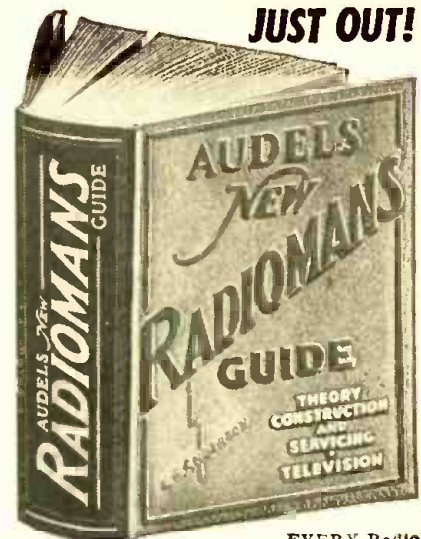

RADIO

EVERY Radio Mechanic—Service Man & Student Needs "Audels Radiomans Guide"—Just Out!
The whole subject of Modern Radio—covering the Basic Principles—Construction & Operation—Service—Repairs—Troubles—All Easily Understood. Over 750 Pages, 400 Illustrations, Parts & Diagrams—LATE TELEVISION DATA—Valuable for REFERENCE AND HOME STUDY.
To get this practical information in handy form for yourself fill in and mail coupon today.
4 COMPLETE - PAY ONLY \$1 A MO.
AUDEL, Publishers, 49 W. 23rd St., N. Y. Mail AUDEL'S NEW RADIO MANS GUIDE for free examination, if O. K. I will send you \$1 in 7 days; then remit \$1 monthly until price of \$4 is paid. Otherwise, I will return it.

Name _____
Address _____
Occupation _____
Reference _____ RCF

Be a RADIO SERVICE EXPERT
LEARN AT HOME IN SPARE TIME

The demand for radio experts grows every day. Learn this paying profession under personal guidance of qualified engineer and educator. Clear, fascinating instruction and experimental kits make learning easy. Leaders in the radio industry endorse R.T.A. methods. Spare time profits soon pay for training.

FREE book telling what R.T.A. training can do for you.
RADIO TRAINING ASS'N. OF AMERICA
1559 Devon Ave. Dept. RC-91 Chicago, Ill.

COMMERCIAL RADIO INSTITUTE

A radio training center for over twenty years. Well equipped. Excellent faculty. Practical resident courses in Radio Telegraphy, Broadcast Servicing, Industrial Television, Aeronautical, Drafting, Mathematics and Studio Technique. Placement bureau. Catalog upon request.
Dept. D, 38 West Biddle Street, Baltimore, Md.

RADIO COURSES
Start September

- RADIO OPERATING—BROADCASTING
- RADIO SERVICING—a practical course
- RADIO AMATEUR CODE ● TELEVISION
- ELECTRONICS—1 yr. day course 2 yrs. eve. Day and Evening Classes. Booklet Upon Request.

New York Y.M.C.A. Schools
4 W. 64th Street New York City

RADIO-TELEVISION

Oldest, largest Radio-Television school in West trains you for good pay job. Complete instruction including Radio Construction and Service, Broadcast Operating, Sound, Talking Pictures, Television, Public Address, etc. Flexible plan to meet specific needs of those with or without jobs. Transportation allowed to L.A. Earn room and board while learning. Request Free Catalog.

NATIONAL SCHOOLS Dept. 9-RC
Los Angeles

Are You The Man For The Job?

Every radioman has the opportunity today to advance himself to a better radio job. With wide-spread expansion programs there comes a need for men with modern technical training. CREI home study training is the proven way to more money—"5,000 other radiomen can't be wrong!"
WRITE FOR FREE BOOKLET. CAPITOL RADIO ENGINEERING INSTITUTE, Dept. RC-9, 3224 16th St., N.W., Washington, D.C.

Order your copy NOW—the only

P. A. HANDBOOK



ONLY
25
CENTS
A COPY

**MOST COMPLETE
AND AUTHENTIC
P. A. BOOK PUBLISHED**

THAT no book has yet been published which covers amplifiers and sound systems (also kindred systems) in one complete, authentic volume is almost unbelievable. Yet, it is a fact, there is no book in print which covers Public Address from A to Z. To bridge this wide-spread gap, RADIO-CRAFT have published a complete, magnificent volume on Public Address of such magnitude—so complete and authoritative—that every man engaged in radio can have both a theoretical and practical knowledge of the function and operation of sound systems. The editorial notes are so filled with instruction and replete with illustrations that the volume fully justifies its title **1940 AMPLIFIER HANDBOOK AND PUBLIC ADDRESS GUIDE**. This great HANDBOOK on Public Address should be read and studied by those who consistently build, service and sell sound equipment.

A MATCHLESS VOLUME
As complete as you would expect to find any engineering handbook—this is how the radio or P. A. man finds the **AMPLIFIER HANDBOOK AND PUBLIC ADDRESS GUIDE**. With essential technical data compiled from an exceptionally large number of sources, the volume covers nearly a hundred different subjects coordinating every conceivable branch or sub-division of Public Address.

THE CONTENTS
To actually show the scope and magnitude of the **AMPLIFIER HANDBOOK AND PUBLIC ADDRESS GUIDE**, an analysis of the contents is found at the right, showing the breakdown of the material featured within each particular section. A thorough reading of the contents shows the completeness of this book.

A Resume of the Contents of the **AMPLIFIER HANDBOOK AND PUBLIC ADDRESS GUIDE**

FOREWORD

INTRODUCTION

Definitions—decibels, frequency, input, output, impedance, etc.

SECTION I—SOURCE

Carbon microphones (single-button and double-button)
Condenser microphones
Velocity (ribbon) microphones
Dynamic microphones
Crystal microphones (sound-cell types, crystal diaphragm types)
Cardioid microphones
Contact microphones
Phonograph pickups (magnetic types, crystal types)

SECTION II—AMPLIFIERS

Voltage Amplification

Design of resistance-coupled voltage amplifiers

Commercial voltage amplifier

The Power Stage

Class A amplifiers

Class AB amplifiers

Class AB₁ amplifiers

Class AB₂ amplifiers

Class B amplifiers

When to apply class A, AB, and B amplification

Power Supplies

Half-wave rectification

Full-wave rectification

Voltage doublers

Filter Circuits

Power supply regulation, etc.

Practical Hints on Amplifier Construction

Microphonism

Placement of components

Tone compensation

Inverse feedback

Remote control methods

SECTION III—DISTRIBUTION

The Loudspeaker

Dynamic speakers

Speaker performance (frequency response, efficiency)

High-fidelity speakers

Speaker Baffles and Housings

Outdoor speaker installations

Power cone speakers

Radial (360° distribution) speaker baffles

SECTION IV—COORDINATION

Input impedance matching

Matching speakers to P.A. installations

Phasing speakers

Effect of mismatching speakers to amplifier output

A typical P.A. installation (in a skating rink)

SECTION V—USEFUL PUBLIC ADDRESS DATA AND INFORMATION

Speaker matching technique

The ABC of Db., VU, Mu, Gm and Sm

Charts and formulas useful to the practical P.A. sound man

Handy index to important articles on public address and sound

RADCRAFT PUBLICATIONS • 20 VESEY STREET • NEW YORK, N. Y.

RADCRAFT PUBLICATIONS, INC. • 20 VESEY STREET • NEW YORK, N. Y.

RC-941

Gentlemen: Enclosed find my remittance of 25c for which send me POSTPAID, one copy of your NEW—1940 AMPLIFIER HANDBOOK AND PUBLIC ADDRESS GUIDE.

Send me others, for friends, also POSTPAID @ 25c each.

Name Address

City State

Remit by check or money order; register letter
if you send cash or unused U.S. Postage Stamps.

Order Your Copy NOW—

*Clip Coupon and
Mail Today!*

RADIO-CRAFT

"RADIO'S GREATEST MAGAZINE"

. . . Chambers of Commerce
the liaison between consumers
and honest radio Servicemen?

"64% OF THE RADIO SERVICEMEN ARE GYPS"

By the Editor — HUGO GERNSBACK

FOR over 10 years now *Radio-Craft* editorially and otherwise has preached the sermon that the radio servicing business is what it is due mainly to the fact that a large percentage of radio Servicemen not only take advantage of their customers, but in many cases are downright dishonest. We have spoken a number of times of the fact that it is the dishonest Serviceman who gives a black eye to the entire servicing trade—all to no avail. As time went on the situation instead of improving steadily became worse. It has become so bad that the largest-circulation magazine in this country, *Readers Digest*, with over 3,000,000 readers a month, in the August issue carries an article entitled *The Radio Repairman Will Gyp You If You Don't Watch Out*.

Readers Digest took upon itself to send two investigators across the country in order to investigate radio repairmen. It may be said that they did a thorough and comprehensive job, the results of which, we are sorry to admit, show up the radio servicing industry in its worst light.

The two investigators used a very simple system. Traveling from one end of the country to the other, they had with them brand-new portable radio sets of two nationally-known makes, the sets being in flawless condition. Wherever they stopped they first unsnapped one of the wires inside of the set which are generally connected by means of snap-fasteners, or they pulled up a tube so it did not make contact. The set was then closed and presented to the radio repairman. The results make interesting reading not only for the layman but particularly for the Radio Industry.

The investigators visited 304 radio repair shops and found that 64 out of 100 cheated. It is significant to note that in localities under 10,000 population only 51% were dishonest, but in the larger centers 66% were found to be dishonest. In New York and its metropolitan area the tremendous dishonesty proportion of 17 out of 19 shop owners that lied and cheated was recorded. The first 36 shops visited in eastern towns sold the investigators 32 new tubes when, as a matter of fact, not a single tube was needed—all the tubes in the investigators' sets being brand new and perfect!

The article goes extensively into the entire situation and gives not only facts and figures, but case records in various cities. A particularly flagrant case was reported from Lincoln, Illinois. A repairman demanded \$2.35 for a burned-out tube which did not exist. He tested the investigators' tube but by manipulation of his testing board made it appear that the tube was short-circuited. The investigator told the repairman that he thought the tube was all right and proved it by putting it right back into the set, which played perfectly. Nevertheless, the Serviceman had the effrontery to ask for a \$1.00 service charge. The investigator came back with "What service? For telling me my good tube was blown?" At this the repairman got angry, rushed at the investigator and landed a terrific kick on his thigh.

The investigators had a grand time in catching the dishonest repairman red-handed. They used a simple system in doing this. Practically all standard tubes are marked, "Made in U.S.A." By scratching off the periods of the "U.S.A.," this then appeared as "USA". Thus it was possible to spot the dishonest repairman who charged for new tubes when they had not even changed any. Frequently they took out the set's new tubes and installed inferior kinds; at other times they deliberately burned-out the tubes in fictitious "tests."

All of this of course is not news to the radio service trade. There are hundreds of tricks as to how a radio-set owner can be tricked and cheated, and radio Servicemen—even the honest ones—know what these tricks are because they are well-known throughout the trade.

What we have always feared now has become a fact. When

the largest and most widely-distributed magazine in the United States shows up the radio servicing trade in such an unfavorable light, and when every radio-set owner who has read the article will tell those who have not read it, it is quite certain that radio servicing from now on will no longer be a picnic.

"Let the Buyer Beware"—will now be the watch-word of every radio-set owner with few exceptions.

This is most unfortunate because with a little sense the Industry could easily have policed itself, but now it seems it will have to pay dearly for it.

The investigators of the *Readers Digest*, as a remedy for the situation recommend that the chief hope for the radio-set owner, if he does not wish to be cheated, is to acquire an elementary knowledge of how a radio set works. This we do not believe is the answer, because too few people will take the trouble to study radio just because they own a set and even if they did, they still might not be able to master the rudiments of radio. Another piece of advice given by the investigators is to seek the advice of a friendly radio amateur who can recommend a competent and honest shop. This is good advice, but too few radio-set owners know radio hams, so in most cases this will not be practical.

Readers Digest also suggests that radio manufacturers should take an aggressive interest in stamping out this dishonesty. As the magazine puts it, the manufacturers "would probably sell more and better sets if the cost of keeping them were less often increased by repairmen's overcharges and swindling . . . Why should not manufacturers constantly test the integrity of their dealers by a staff of traveling investigators?"

There is good sense in this recommendation, but we do not believe that the radio manufacturers will or can do this. The main reason is the great expense involved. Of course, it could be done if all of the radio-set manufacturers were to form an association which would pay for the expenses of traveling investigators, who would visit radio repair shops constantly year in and year out. This could be done at an expense not too great for the individual radio manufacturer, but frankly we doubt if the radio set makers as a body will ever do it. In the past it has been found that it is difficult for radio manufacturers to get together on a cooperative plan of this type and scope. The main reason why they would block the attempt would probably be suspicion that investigators would pull wires playing one manufacturer against another.

To our mind a much simpler and better way in rehabilitating the radio servicing industry would be the following:

Practically every locality of any size has a Chamber of Commerce. It could send out investigators from time to time and find out quickly who is honest and who is not. The Chamber of Commerce usually has enough power through the Mayor's office or through the Police Department to publicly black-list any dishonest repairman or servicing firm.

The point however is that this might never come about if every Serviceman in town knew that the Chamber of Commerce was making frequent investigations. *Few Servicemen and few service firms would ever be black-listed.* They would all reform so fast and they would change their methods of doing business so rapidly that it would not take much time to lift this pall which hovers over every community. To be sure it would require eternal vigilance, but it would pay every Chamber of Commerce to do the investigating, which after all is not expensive for a locality. There is no question that the members of the Chamber of Commerce and the honest Serviceman would be only too happy to support such a movement, because it would benefit everyone. Incidentally, in the long run, the entire servicing industry would profit, while at present no one benefits, chiefly because of so many customers who have been burned in the past.

• THE RADIO MONTH IN REVIEW •

The "radio news" paper for busy radio men. An illustrated digest of the important happenings of the month in every branch of the radio field.



PARACHUTE PRACTICE BROADCAST
(Cover Feature)

When networks arranged for spot broadcasts from training centers of our newly-recruited Army, as part of the July 4 celebration, all phases of military training were covered, including the recently-born Parachute Jumping Corps. Above, C.B.S. announcer John Charles Daly and narrator Burgess Meredith report on the "Spirit of '41" program from Fort Benning, Ga.

BROADCASTING

TWO interesting items headlined the first page of an issue of *Broadcasting and Broadcast Advertising* magazine, last month. One: "M-Day Plans Place Radio in Vital Role"; the other: "WLW Seeks to Use 650 kw.; KSL and WSM Ask 500 kw." The former item disclosed that radio's plans for Mobilization Day—the moment the United States becomes a belligerent in the 2nd World War—call for little change from present operation of broadcast networks, but do provide for creation of a new post, to assure that plans of the Army, Navy and the Defense Communications Board will be met, viz.: Coordinator of Communications. The second item discloses that superpower station WLW, Cincinnati, which the F.C.C. some time ago compelled to take 450 kw. of its original 500 kw. off the air during regular broadcast hours, has asked permission to return to the air, during regular broadcast hours, with 650 kw., and has in fact been on the air experimentally, using the call W8XO, during the morning hours between midnight and 6 A.M., with the rated maximum capacity of the station, 750,000 watts! The Salt Lake City and Nashville stations, also now 50 kilowatters, are content to up their output only 10 times.

Radio Broadcasting awoke one day last month to learn that one of the alphabetical

departments of the Government had included it among 26 industries placed on a limited priority basis. This move by OPACS does not mean that manufacturers will be able to get, for example, aluminum. It does mean however that the Office of Price Administration and Civilian Supply has made it possible for manufacturers to obtain deliveries of other materials for which shortages are less acute. Television and Frequency Modulation, until now in the doldrums for want of sufficient supplies to assure deliveries of transmitters and receivers, can now get rolling.

The letter V—3 dots and a dash (. . . —) of the Continental and American Morse telegraph codes, last month became internationally prominent in every walk of life when British leaders of "underground" activities against the Nazis adopted it in a new "V for Victory" campaign. Letter-symbol or its dot-dash equivalent sprang up magically, in Nazi-occupied territories, in thousands of unexpected places and hundreds of different forms, including the honking of horns, etc.

The C.B.S. network last month garnered the University of Georgia's annual "Peabody Award," given for "outstanding meritorious public service." Congrats, C.B.S.

Emerson Radio Corp. last month announced that redesign of its radio set line reduced its aluminum requirements 90%.

Station WQXR, only Metropolitan New York-area station of the 4 high-fidelity stations in the United States, last month received the F.C.C.'s blessings on doubling its power to 10 kw., and going full-time (7 A.M., to midnight, weekdays; 8:30 to midnight, Sundays).

Now that WOR is on the air 24 hours a day, 7 days a week, house radio sets at the Waldorf Astoria in New York City are not shut off at 2 A.M., but remain in service around the clock, day and night. The F.C.C. has recognized that the accelerated Defense Program has resulted in several million Americans radically changing their schedules of work, sleep and play.

Credit station WHO, Des Moines, Iowa, with having made to radio broadcasting the most outstanding contribution since the advent of Wide-Band Frequency Modulation. The F.C.C. last month gave the station permission to air its 150,000-watt "Polyphase Transmitter." Hailed as a "new method of transmission," like F.M. it is old in principle; what new "angles" it may have, like wide-band F.M., we have yet to find out. A total of 5 antennas is fed by the transmitter; the home radio set perceives the change in transmission only as increased signal strength, and reduced fading and distortion. The station saves 65% in power; no change in existing receivers is required.

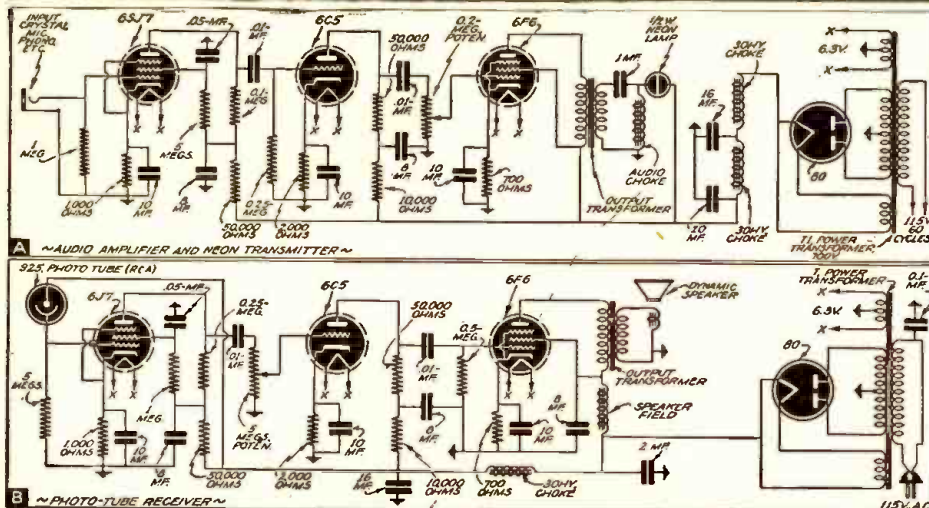
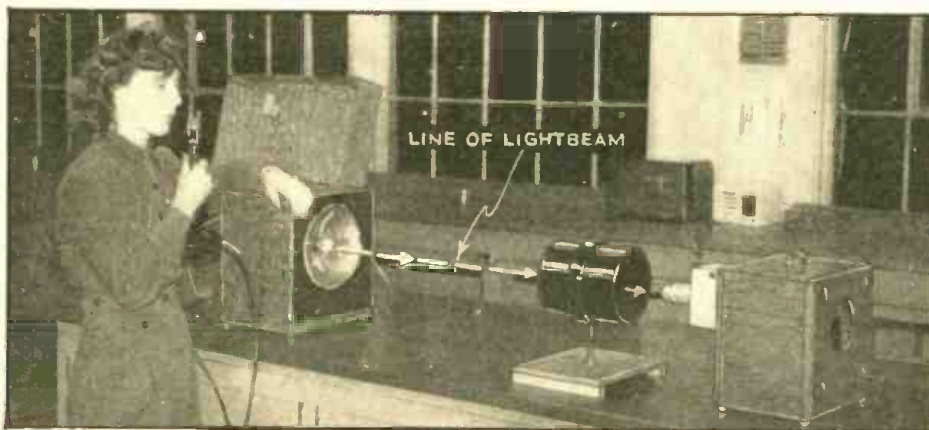

TALKING LIGHTBEAM

Students of the Boeing School of Aeronautics, Oakland Airport, Calif., last month demonstrated the equipment, pictured above, that they devised to visually demonstrate the principles of radiotelephone transmitter operation. The "transmitter" was a microphone amplifier connected as diagrammed at A; the audio output modulated a neon lamp which good tone quality demanded carefully match the impedance of the output circuit. The "receiver" diagrammed at B was a high-gain photo-cell amplifier. The lens system pictured near the photocell housing at right permitted the beam to be projected 50 ft.

ELECTRONICS

FLUORESCENT lighting, the new activity for many radio Servicemen and Servicemen-dealers, has rated an entire new building by Hygrade Sylvania Corp. Estimated cost is \$500,000 for 100,000 sq. ft.; the 2-story building is being erected in Danvers, Mass.

In the NBC Network program "Radio Magic," Dr. Orestes H. Caldwell last month described how "black light" may soon aid American defense if we apply recent developments in England. Curbstones, for example, if painted with fluorescent powder will luminesce when irradiated with invisible



TELEVISION FINDER

This device when fastened to the television camera provides an accurate view finder which in effect "monitors" the scene being scanned by the camera. The camera man therefore knows precisely what he is passing-on to his seeing audience. The illustration shows the electronic view finder with cover removed to show the working details. Note particularly the 5-in. squatted type of cathode-ray tube used in this new development by Allen B. Du Mont Labs., Passaic, N. J.



MOSCOW-NEW YORK RADIOPHOTO

Successful reception of the first radio pictures from Moscow has inspired engineers of RCA Communications, Inc., to continue with the tests, the outcome of which, it is hoped, will lead to the establishment of a regular commercial radio-photo service between the United States and Russia—a circuit of 4,615 miles. Illustrated is one of the first photos received. The Russian caption reads: "This crew during one of the enemy air raids brought down 3 German planes." The photo below shows the receiving equipment. Incoming radio impulses modulate a pen-point of light, which reproduces on a negative in a light-tight box, each line of the transmitted image. In 20 minutes a negative developed and ready for printing is completed. The pictures from Moscow, 4,615 miles away, are received at "Radio Center," Riverhead, L. I., and relayed to 66 Broad St., N. Y. C., where the machine shown below is located.

ultra-violet beams from automobiles, buses, etc. This soft light is ideal illumination during blackouts.

color television system developed by its engineers.

Uncle Sam can use YOU!—if you are an electronic music specialist. Army camps throughout the United States will soon be equipped with one of the 555 electronic organs ordered from Hammond Instrument Company by the U. S. War Department. Their reverberation control unit (see June, 1940, Radio-Craft), offsets the sound-absorbing characteristics of the Army chapels.

TELEVISION

FIRST rate card to be issued in the history of Television was released last month by the National Broadcasting Co., which means that "telly" has really gone commercial. The per-hour rate for regular evening broadcasts on weekdays, over WNBT, is \$120. "Service" spots for televised news, weather, time, etc., is \$8 per minute, nighttime; \$4, daytime. Use of the mobile transmitter on "remotes" rates \$75 more per hour; studio facilities are charged for at rates of \$75 (small studio) and \$150 (main studio in Radio City). Production costs involving talent, effects men, musicians, etc., are billed extra. The regular television service at present runs 15 or more hours per week, with several advertisers now lined-up.

Zenith Radio Corp., in its Annual Report to stockholders last month, announced that it not only is continuing its black/white experimental television transmissions but, Defense work permitting, plans soon to air a

Sample of a complete television program over WNBT one week last month (with test pattern shown for an hour before each afternoon and evening broadcast):

Mon., 9:00 P.M. WNBT mobile unit pickup of amateur boxing from Jamaica Arena.

Tues., 2:30 P.M., film, "Condemned to Live"; 9:00 P.M., film of glider meet in progress at Elmira, N. Y., The Revuers, vaudeville artists; 10:00 P.M., News.

Wed., 2:30 P.M., "Columbus," a "Chronicles of America" film; 9:00 P.M., "Stars of Tomorrow," variety show Carveth Wells, commentator, with film, "Bermuda, America's Sentinel in the Atlantic"; 10:00 P.M., News.

Thurs., 2:30 P.M., Water Circus at Astoria Pool; 9:00 P.M., film, "Easy Money"; 10:00 P.M., News.

Fri., 2:30 P.M., Baseball, Dodgers vs. Cincinnati, at Ebbets Field, Bill Colling, sports announcer; 9:00 P.M., "Minuet," dramatic sketch by Louis Parker, with Ned Weaver and Helen Claire; 10:00 P.M., News.

Sat., 2:30 P.M., Metropolitan A.A.U. basketball at Manhattan Beach.

DYNAMIC PICKUP

From Britain comes this fully-developed electrodynamic phono pickup fitted with a vertical sapphire needle. Its moving-coil winding is long and narrow, giving an extremely low moment of inertia which, coupled with the low downward pressure (about 1/4-ounce) insures minimum sapphire and record wear. It was designed by P. G. A. H. Voight, well-known British acoustics specialist.

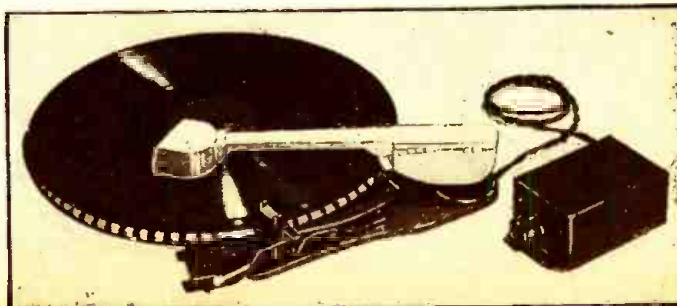

Receiving end of the Moscow-New York radiophoto experiments. The pictures from Moscow are received at "Radio Center," Riverhead, L. I., and relayed to 66 Broad St., N. Y. C., where the machine shown above is located. Its picture cylinder turns at exactly the same rate as the one in the U.S.S.R.

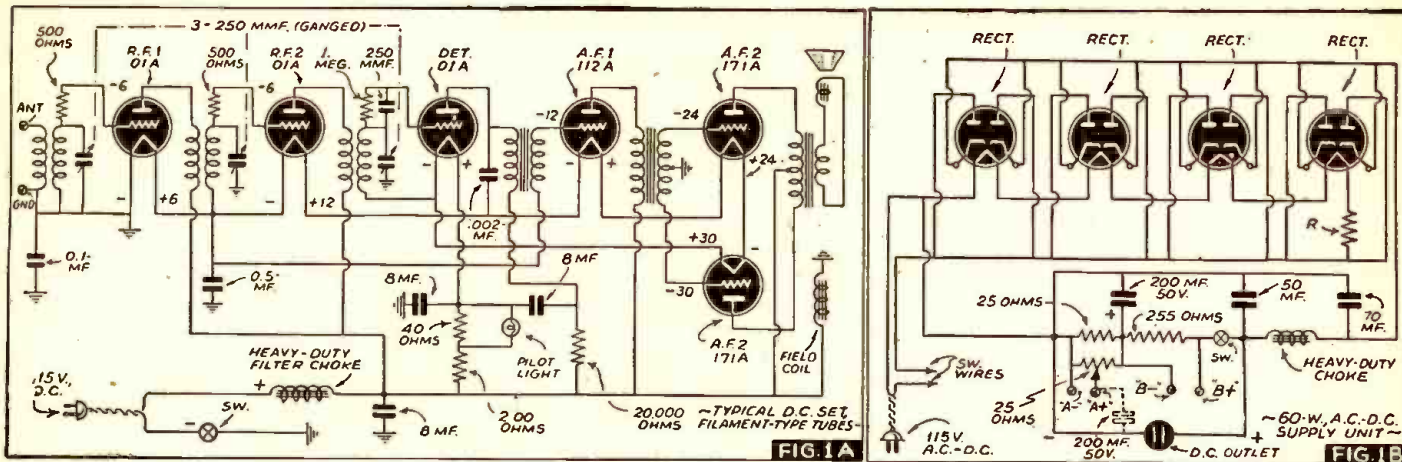

SIMPLIFIED SET CONVERSION

Such perennial questions as "How can I rewire my A.C. radio set for operation on D.C.?" (or vice-versa, as the case may be), "... on 32 volts?", "... on A.C. and/or D.C.?", "... on batteries?", etc., are answered by Mr. Kusen, who finds conversion jobs an additional source of income for his Metropolitan New York service shop.

STEVE KUSEN

THE author who has talked with many men in the radio service field finds that in many cases converting radio sets from alternating current to direct current, or vice versa, puzzles them most. In the following article, the author will show some short-cuts on how to convert such receivers.

In order to condense this article as much as possible the author will divide it into 6 sections:

- (1) Things You Ought to Know Before You Start Converting Radio Receivers;
- (2) How to Change Direct Current Sets to Work Universally;
- (3) How to Change Alternating Current Radio Sets to Work on Direct Current;
- (4) Special Circuits and Short-Cuts;
- (5) Converting Battery Radio Sets to Work on Universal Current; and,
- (6) Converting 32-Volt Direct Current Radio Sets to Work Universally.

(1) *Things You Ought to Know Before*

You Start Converting Radio Receivers.—In order to know how to convert a radio set we must first acquaint ourselves with the fact that all radio sets require direct current (D.C.) on the plates, cathodes, and grid electrodes of the tubes, in order to operate properly. We must know that a filament tube is usually found to require D.C. to heat its cathode (electron emitter), whereas the heater-type tube can use either D.C. or A.C. to heat its cathode. The reason for this is, because in the heater-type tubes, the filament, which is separate from the cathode, is used only to heat the cathode (thus it gets its name "heater"), whereas in the filament-type tube, the filament is the cathode and only in cases where the filament is very thick will it be able to operate on A.C. properly.

The cathode of a tube is the electrode which emits electrons to the plate and since the plate has a plus voltage on it, the cathode must have a minus voltage on it in

order that the circuit be completed. Should the voltage on the cathode vary, this will cause a variation in the current flowing to the plate so whenever a filament-type tube is used on A.C., we will always find that the negative side of the plate circuit connects to a nodal point in the cathode (filament); this is obtained by connecting a center-tap resistor between the 2 legs of a filament and connecting the negative side of the plate to the center-tap. We must also remember that a transformer will not operate on D.C. It must also be remembered that the field coil on the speaker also requires a direct current to energize it.

(2) *How to Change Direct-Current Sets to Work Universally.*—In Fig. 1A, you see a diagram of a typical direct-current set using filament-type tubes. In this set we have to rectify and filter all the voltage and current being drawn by the set if we want it to operate properly on alternating current (or change the tubes and rewire the set).

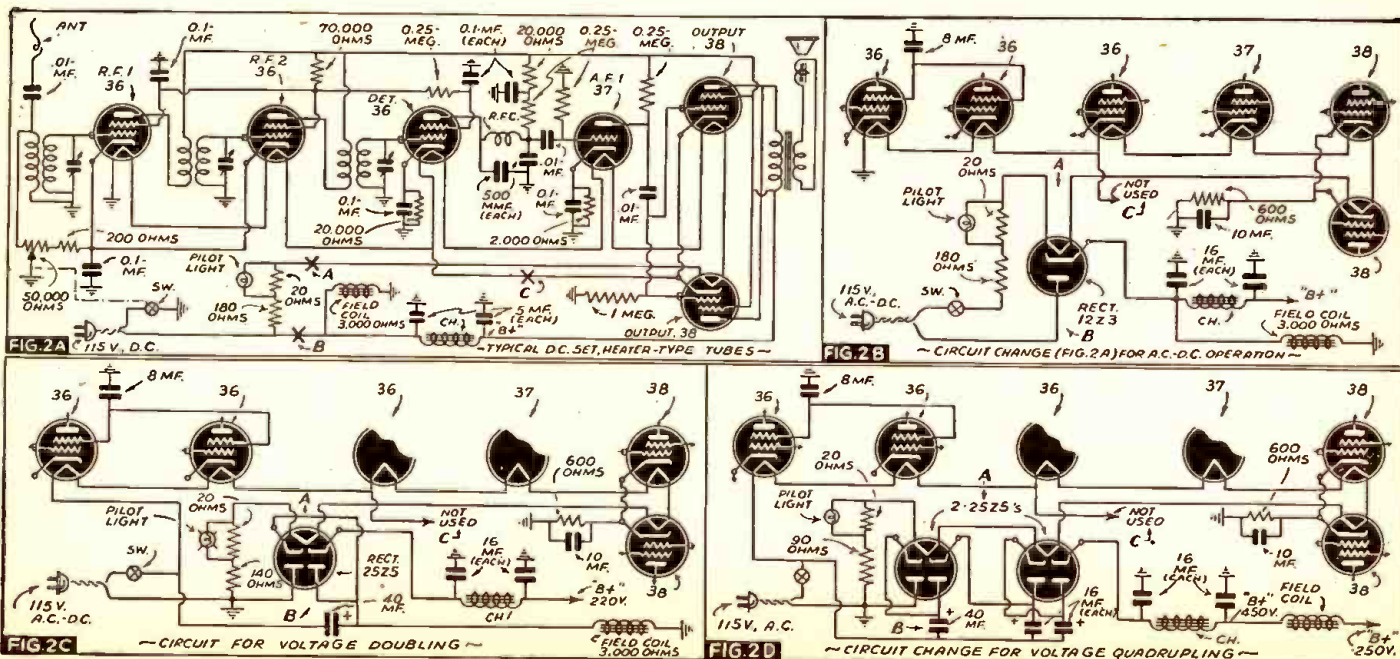

At B we see a very simple and inexpensive unit which will make any D.C. radio set drawing 600 milliamperes or less (60 watts on 115 volts, D.C.), operate properly universally, with no trace of hum. We can readily see that should more current be needed, we can easily add more rectifier tubes and condensers; we might also have to change the choke or put 2 chokes in parallel (this depends on the current drain of the set).

Some readers might think that due to the high current drawn there will be a high voltage drop in the tubes but this is not so. In fact the more tubes put in parallel the less will be the voltage drop in the tubes because (considering the tube as a resistance) the greater the number of "resistances" (tubes) in parallel the smaller the total resistance of the circuit.

To attach this unit to the radio set disconnect the wires from the main switch, short-circuiting them, and tape them up; in their place we connect the switch wires from the rectifying unit. We then plug the set into an A.C. or D.C. power outlet, and the set is ready to operate. Note that the reason that only a switch in the unit is needed is because the set draws no current until the tubes in the unit are heated.

Since the filament of the tubes draw 75% of the current flowing into the set, we can thus easily see that by substituting tubes whose filaments will work on A.C. or D.C. we would then only have to rectify 25% of the current flowing into the set and thus be able to use a smaller power supply. But changing the tubes would call for a rewiring of the set (mainly filament and grid-bias voltages). As a Serviceman's main idea is to do a good job as fast as possible and make a large profit I find that the unit described in Fig. 1B will do the job best.

Many times we come across a D.C. set which has heater tubes. Now in sets like these which draw 60 watts or less, it is suggested the unit described in Fig. 1B be used, but should the set draw more power in watts, then it is suggested that a rectifying circuit be inserted in the "B" line and the bias circuits be changed accordingly. *Note:* This is only possible if heater-type tubes are used in the set.

At A in Fig. 2 we see a typical D.C. set using heater-type tubes. Note that the bias for the output tube is obtained from a tap in the filament circuit (then note the change in Fig. 2B). In Fig. 2B we see the set shown in Fig. 2A changed to work universally.

In Figs. 2C and 2D we see how a voltage doubler or a voltage quadrupler can be connected so as to give the tubes a higher plate voltage thereby operating the tubes at their maximum efficiency. Note that, in Fig. 2D, the speaker field is connected in series with the load. This is because we have more voltage here than we need and make good use of it by dissipating it across the speaker field. Also note that on D.C. sets which have their speaker field in series with the heaters we have to change the speaker for one with a higher value of field resistance and connect it as shown in Figs. 2B, 2C, or 2D.

(3) *How to Change Alternating-Current Sets to Work on Direct Current.*—In Fig. 3A, we see a diagram of a typical alternating-current radio receiver using filament-type tubes. Now we know that a transformer will not work on D.C. We also know that any tube that operates on A.C. will also operate on D.C. so all we have to do is eliminate the transformer and rewire the set so that all the electrodes will be able to draw current from a 115-volt D.C. supply.

In Fig. 3B, we see the circuit in Fig. 3A, rewired so as to operate on D.C. Note that

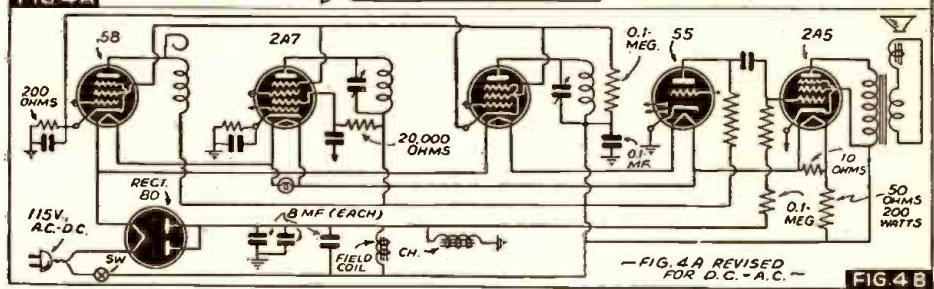
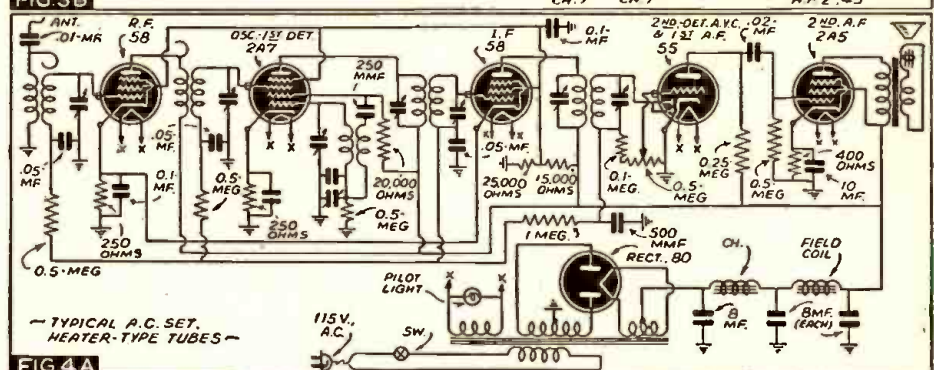
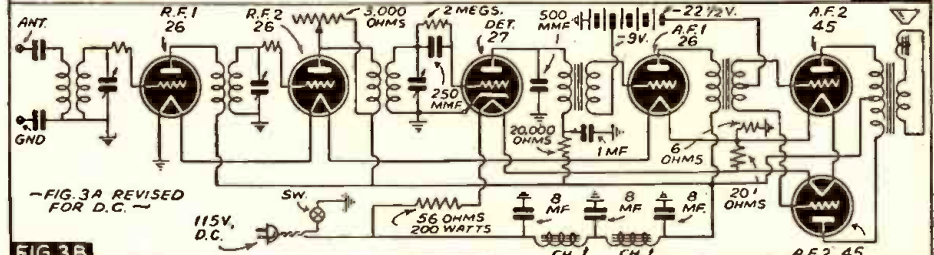
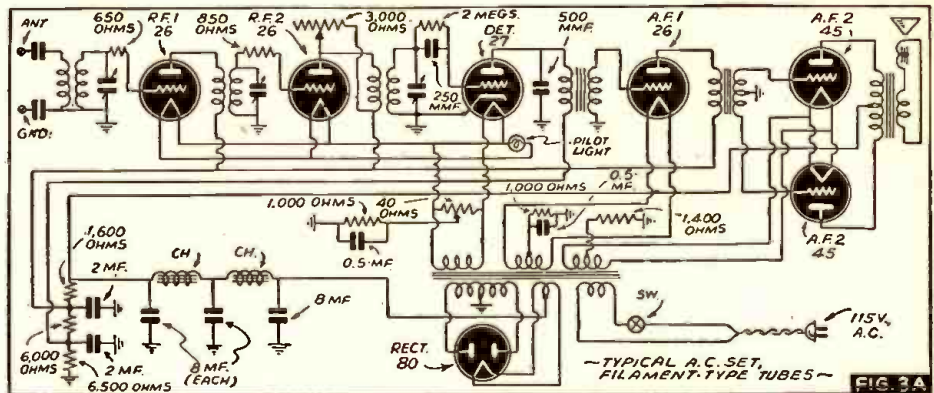

the bias for the output tube and driver tube is secured from a "C" battery and the bias for the rest of the tubes is obtained from the filament circuit. The author advises the use of a "C" battery in cases where the output tube requires a high bias such as a 45 tube otherwise all bias voltages may be obtained from the filament circuit. Also note that all plate voltages are secured directly from the line except in the detector tube where it is obtained through a series resistor.

Sets using filament-type tubes of high current drain cannot be satisfactorily changed to work universally and so I suggest that they either be wired for A.C. or D.C., but not for both.

In Fig. 4A we see a circuit of a typical A.C. set using heater-type tubes. Now in a circuit of this sort we also have to eliminate the transformer and rewire the set but here we see that the bias circuit need not be re-wired because all the tubes invariably get their bias from a self-bias resistor. See Figs. 6A, 6B and 6C for various bias circuits which may be used on A.C. or D.C.

In Fig. 4B, we see the circuit described in Fig. 4A, rewired so as to work on D.C. Note that all the plate and screen-grid volt-

ages are obtained through a series resistor. Should the output tubes require a high biasing voltage then I would suggest a "C" battery be used.

In changing A.C. sets to operate on 115-volt D.C. line supplies I always advise that the filter choke be connected in a negative lead. If this is done we are then able to get our bias voltage from the voltage drop across the choke thereby making full use of all the voltage available.

(4) *Special Circuits and Short-Cuts.*—Many times the Serviceman will come across a transformerless midget radio set that will operate on A.C. only. Figures 5A and 5C show such a circuit. Here we see 2 typical circuits used in midget "radios" which utilize a voltage doubler circuit, to secure "B" power for the set, instead of the usual half-wave rectifier.

Figure 5A shows a circuit using a push-pull voltage doubler circuit, while Fig. 5C shows a circuit using a cascade voltage doubler circuit. In Fig. 5B we see how these circuits can be rewired so as to operate universally. Note that the field is connected right across the output of the half-wave rectifier, and in place of the field we connect a 1,000-ohm resistor.

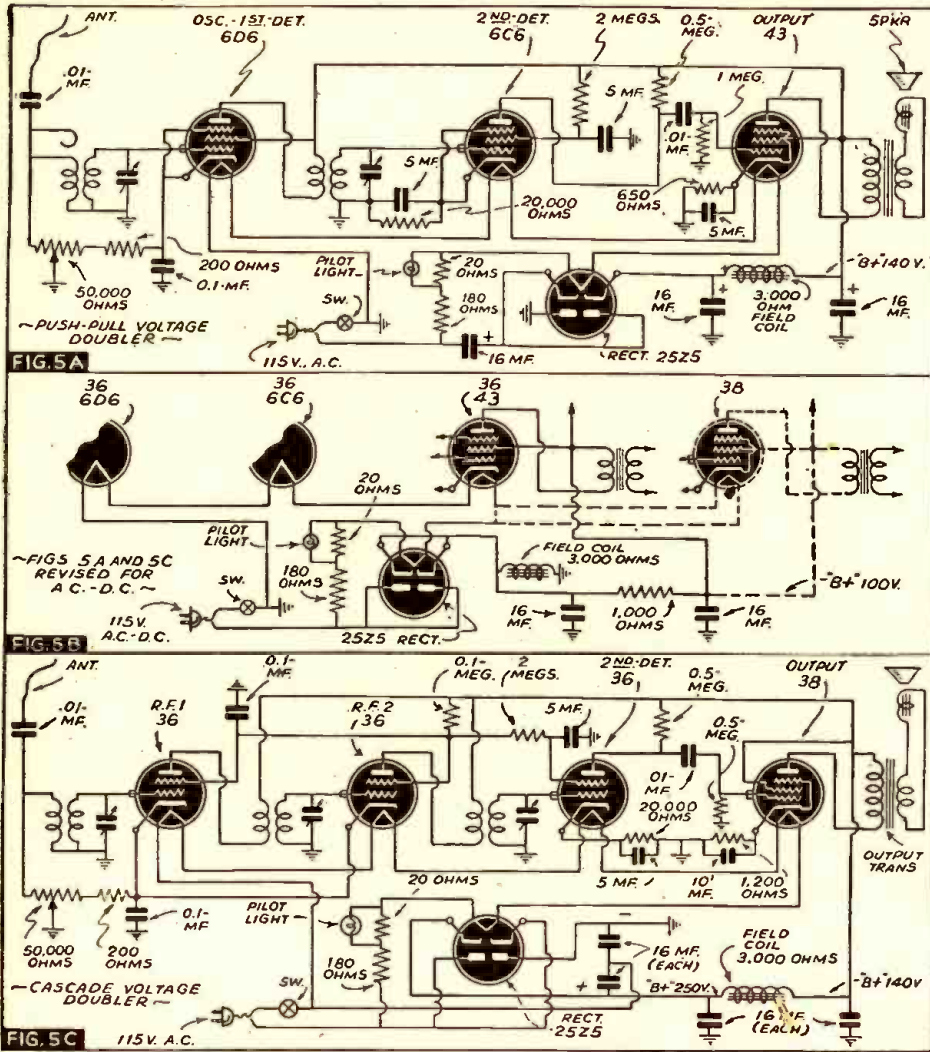

When these circuits are changed to work universally there will naturally result a slight loss of volume due to the fact that the advantage of the voltage doubler no longer exists. Whenever a voltage doubler, tripler or a quadrupler is used, and considerable hum is experienced, then the detector and the 1st A.F. tube should be connected nearest the minus (negative) leg of the "B" circuit (electrically). Whenever the advantage of a voltage doubler is desired—when a set is to be operated on A.C.—and still be capable of operation on D.C., a polarity reverser type voltage doubler should be used.

In rewiring sets from A.C. to D.C. which contain high-current-drain tubes I advise re-

moving the line dropping resistor from the radio set, and inserting this resistor in a suitable container which is asbestos lined, and reinstalling it where it will be well aired.

In order to find out the kind of line dropping resistor to use, we use Ohm's Law. For example, in Fig. 3B we have the following-type tubes: 3 type 26, 1 type 27, 2 type 45. According to the tube characteristics charts the type 26 tube requires a voltage of 1.5 volts at 1.05 amperes, the type 45 requires 2.5 V. at 1.5 A., and the type 27 requires 2.5 V. at 1.75 A.

Since we also have to get some of our bias voltages from the drop across the tubes, we will then proceed to connect them in

series in the following manner: The detector tube we connect at the extreme positive side of the line. This is followed by the output tubes, which in turn are followed by the 1st A.F., and the 2nd and 1st R.F., respectively. The detector tube is gridleak biased and is also a cathode-type tube. It therefore can be connected any place in the filament circuit but because of its heater current drain we find it more convenient to wire it if we place it at the positive side of the line. When using a filament-type detector, it shall always be placed at the positive side of the line because large A.F. voltage variation between the cathodes (filaments) of the output tubes and the ground in the filament circuit would cause this tube circuit to oscillate or hum if placed elsewhere.

Since the output tubes and the 1st A.F. tube require a high bias voltage, we therefore connect them after the detector so as to retain a high positive voltage on their respective cathodes (filaments), and this will naturally tend to make the voltage on their grid-returns (which are connected to the ground) highly negative in respect to their cathodes. This voltage will thus add to the voltage impressed upon their grids from the "C" battery.

Sometimes this voltage is sufficient to bias the tubes (depending on the tubes being used) and therefore no "C" battery need be used. See Fig. 1A. In cases where louder volume is desired the "C" battery can be used to an advantage by impressing upon the output tubes a very high bias voltage and thus operate them in a class B push-push arrangement. The 1st and 2nd R.F. tubes receive their bias voltage the same way as the output tubes except they do not have a "C" battery to boost this voltage. Note that the bias on these tubes is lower than it should be; better performance of the set will result if one or two of the new bias cells are connected in the grid-returns or if preferable a "C" battery. The filaments of all the tubes must be adequately bypassed in order to prevent A.F. or R.F. oscillation.

Ohm's Law states that in a series circuit the voltage will distribute itself evenly throughout the circuit or is the sum of all the voltages involved. The current in a series circuit is the same throughout the entire circuit as is being drawn by the smallest current drawing load in the circuit. The voltage in a parallel circuit is the same throughout the circuit as is the highest voltage in the circuit. The current in a parallel circuit will distribute itself evenly throughout the entire circuit or is the sum of all the currents in the circuit.

Therefore, since the type 26 tube draws 1.05 A., type 45, 1.5 A., and type 27, 1.75 A., we must cause the circuit involving the type 26 tubes to draw a current of 0.7-A. more,

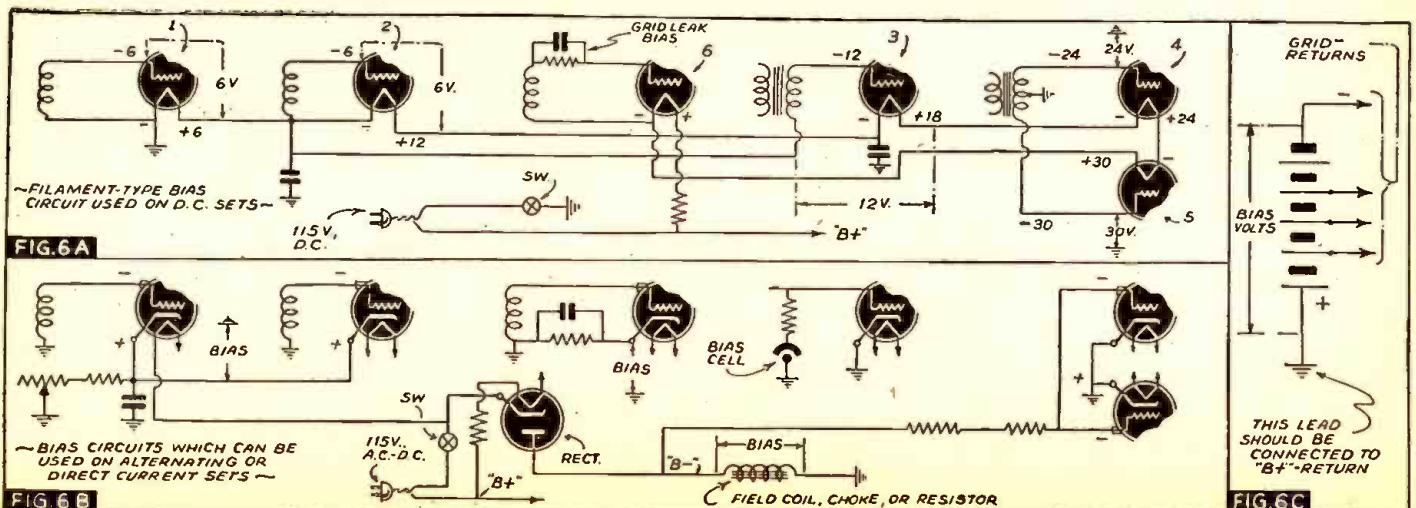

which is needed to supply the highest-current-drain tube. This we do by connecting a resistor in parallel with the circuit, which according to Ohm's Law, is

$$R = \frac{E}{I} = \frac{4.5}{0.7} = 6.4 \text{ (ohms).}$$

Now we come to the circuit involving the type 45 tubes. This circuit draws 1.5 A. thus we need 0.25-A. more to supply the needs of the whole circuit, and therefore, resorting to Ohm's Law, we find:

$$R = \frac{E}{I} = \frac{5}{0.25} = 20 \text{ (ohms).}$$

The total voltage demand of the circuit is 12 volts (this we get by adding the voltages demanded by all the tubes); the total current requirement of the circuit is 1.75 A. Since we have 110 volts (line voltages, today, average about 117.5 V.—*Editor*) we therefore have to compute a resistor which will drop 98 volts when a current of 1.75 A. is flowing through it:

$$R = \frac{E}{I} = \frac{98}{1.75} = 56$$

(ohms, to be connected in series with the whole circuit).

This method should be used in computing all such problems. Sometimes in place of a resistor we can connect a tube having the same voltage as the circuit, across the circuit, in order to make the circuit draw more current. See Fig. 4B. Even a pilot light may be used.

(5) *Converting Battery Radio Sets to Work on Universal Current.*—There are many people who own battery "radios" and sooner or later they will come to you to have their sets changed so as to work on uni-

versal current (A.C./D.C.). Or they just want the set repaired and you may not have the batteries on hand to test the set. Well, by closing the battery switch on the unit illustrated by diagram in Fig. 1A we will be able to operate any battery portable on 115 V., A.C. or D.C.

Should the set need higher voltages for the filaments of the tubes in the set then all that need be done is move the voltage control from left to right. The voltage control should always be on the left side and after the battery radio set is connected to the unit, and the unit is made to operate the control should be moved slowly to the left until the desired voltage is obtained as measured by a voltmeter connected across the filaments of the tubes. Note the way the bias for the output is obtained, simply by having a separate terminal for the "B-" lead and having a difference of 6 V. between the "B-" and "A-" leads.

(6) *Converting 32-Volt Direct-Current Radio Sets to Work Universally.*—In sets that operate on 32-volt D.C. power supply, which have to be changed to work on 115 V. A.C. or D.C., we find that all that need be done is to put a resistor in series with the set and the rectifying unit shown in Fig. 1B. This can be calculated by the simple formula

$$R = \frac{68}{32}, \text{ where } R \text{ is the resistance needed,}$$

68 is the voltage to be dissipated, W is the watts figure for the power drawn by the radio set to be changed, and 32 is the voltage needed to operate the receiver, 60 watts being the maximum watts power this unit can supply.

There are a few A.C. sets on the market which have a separate copper-oxide rectifier to rectify the current for the speaker field. In sets of this sort, when changed to work on direct current, the speaker should be changed; or, disconnected from the rectifying unit and be connected through a suitable resistor, across a 115 volt field.

TRIPLETT WED 25 YEARS



In connection with the Silver Wedding Anniversary of Mr. & Mrs. R. L. Triplett, a delegation of their sales representatives made a presentation of a handsome sterling silver tea service, and a silver placque inscribed with the names of all the domestic and foreign representatives. A collation was served in commemoration of the joyous event. Mr. Triplett is President of Triplett Electrical Instrument Co.

The Best Equipped Shop in Town

"GETS THE BUSINESS"

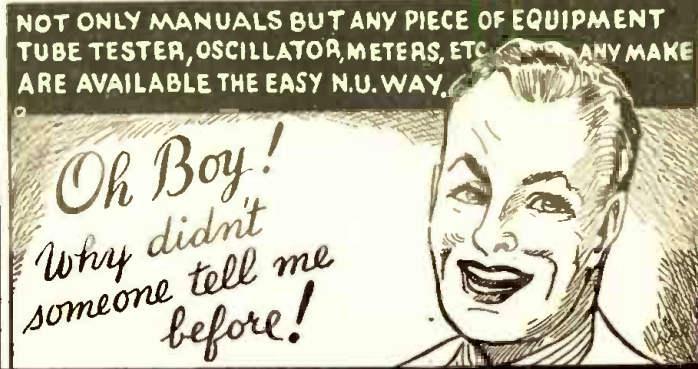
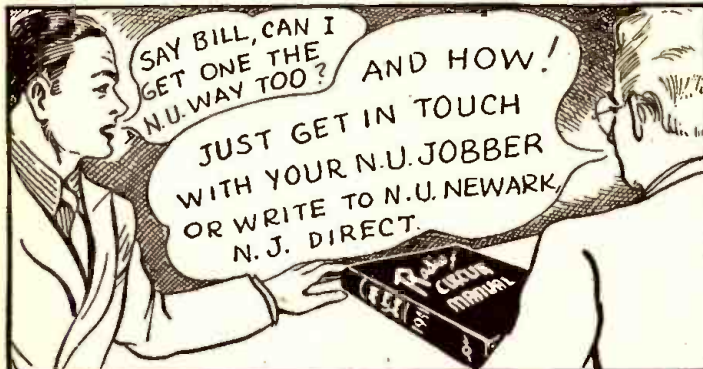
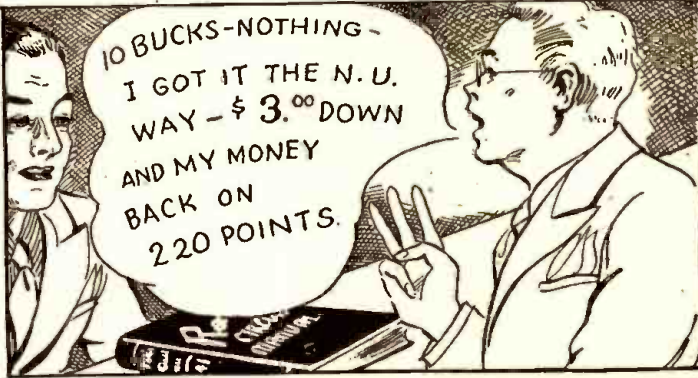
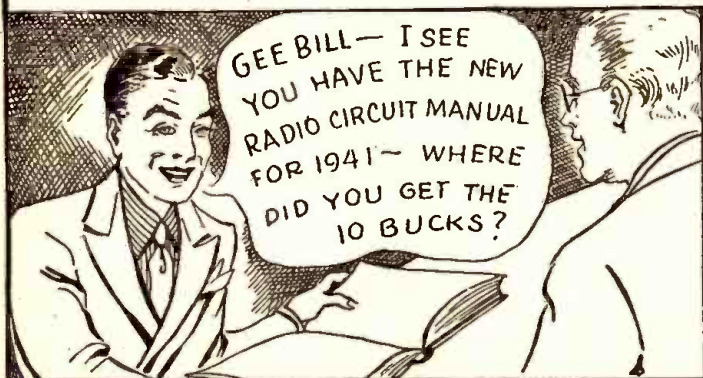

NATIONAL UNION RADIO Corp.
57 STATE STREET, NEWARK, N. J.

THE FINEST RADIO BOOK FREE

WE EVER OFFERED :-
the 1940-41 Radio-Television Reference Annual
With \$1.00 subscription to
RADIO - CRAFT

WITH our compliments, we want to send a copy of the 1940 RADIO-TELEVISION REFERENCE ANNUAL to you FREE, if you will simply take advantage of RADIO-CRAFT magazine's special subscription offer NOW. This offer is being made for a limited time only.

The 1940 RADIO-TELEVISION REFERENCE ANNUAL has 68 pages, large size 8½ x 11½, with over 170 illustrations. The contents of this book has never appeared before in handy book form. Its pages cover practically every branch of radio sound, public address, servicing, television, construction articles for advanced radio men and technicians, time and money-saving kinks, wrinkles, useful circuit information, "ham" transmitters and receivers, and a host of other data.

The Annuals have always been regarded as a standard reference work for every practical branch of radio operation and service. This 1940 edition ably sustains this reputation. Every radio man wants a copy of this valuable book. Just as this book will be of unquestionable value to you, so, too, will every monthly issue of RADIO-CRAFT. This magazine brings you big value every month. It keeps you intelligently informed about new developments in radio and television. You want the news, want it fully but concisely, want it first—that is why you should read RADIO-CRAFT regularly.

This very special offer is made for just one purpose—we want you as a regular subscriber. The Annual, whose contents appears at the right, is not sold, but a copy is FREE to you if you subscribe now.

**SAME SIZE AS
RADIO-CRAFT**

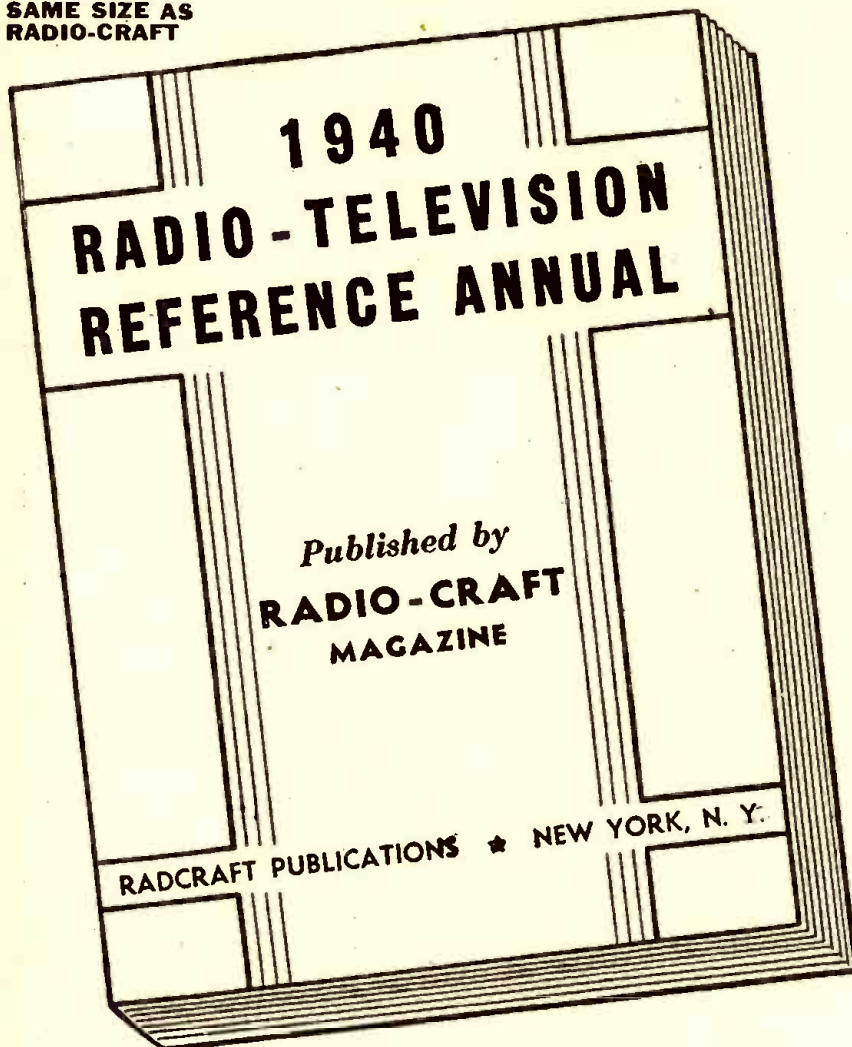

THIS COUPON BRINGS YOU THE ANNUAL

RADIO-CRAFT • 20 VESEY STREET • NEW YORK, N. Y.

Gentlemen: Enclosed you will find One Dollar for which enter my subscription to RADIO-CRAFT Magazine for Eight Months. Send me **ABSOLUTELY FREE** and **POSTPAID**, my copy of 1940 RADIO-TELEVISION REFERENCE ANNUAL.

This is a new order Extend My Present Subscription

NAME ADDRESS

CITY STATE

DON'T DELAY — MAIL TODAY! RC-941

**Read the summary of contents
in this FREE BOOK!**

THE 1940 RADIO-TELEVISION REFERENCE ANNUAL contains a collection of the best and most important articles. Covering as they do nearly every branch of radio, they form a handy reference works. In addition, many time and labor-saving kinks, circuits and wrinkles, tried and tested by practicing Servicemen, experimenters and radio fans have been included. This book cannot be bought anywhere at any price. Yet it is yours by merely subscribing. Use the convenient coupon below.

**BEGINNER'S SIMPLE INEXPENSIVE
CONSTRUCTION ARTICLES**

Beginner's Breadboard Special - a 1-Tube High-Gain All-Wave Receiver—Wiring Pointers for Radio Beginners—A Watch Charm Size 1-Tube Set—Beginner's Simple Volt-Milliammeter—Making a 1-Tube Broadcast Loop Receiver—A.C.-D.C. Power Supply for Battery Portables—A 1-Tube Short-Waver with Band Coil Switching.

MORE ADVANCED SET CONSTRUCTION

The "High-Seas 4" Broadcast Lamp Radio—How to Build a 6-Tube 1.4-Volt Short-Wave Superhet for the "Ham" or Short-Wave Fan—Build the "Lunch Box 5" Super Set - a Broadcast Battery Portable—How to Build a Plug-Together 8 Tube Broadcast Set—The "5-In-4" All-Wave Radio for A.C. Operation—An Easily-Built 3-Tube Midset Broadcast Superheterodyne Receiver.

THE SERVICEMEN'S SECTION

Bass Tone Control—Simplified Variable Selectivity—Practical Servicing Pointers—Servicing Universal A.C.-D.C. Receivers—Killing the "Intermittent" Bug—A Service Shop A.C. to D.C. Power Supply—Sideline Money for Servicemen—Adding A.V.C. to any Screen-Grid T.R.F. Receiver—Iron Particles in Speaker Air Gap.

TEST INSTRUMENTS

A Useful Neon Lamp Tester—An Inexpensive Output Meter—Making Milliammeter Multipliers—Home-Made Frequency Modulator—The Busy Servicemen's V.T. Volt-Meter.

PUBLIC ADDRESS AND AMPLIFIERS

Build this Combination A.C.-D.C. Radio and Inter-Communicator—Speaker Placement in P.A. Work—The Design and Construction of an Inexpensive All-Push-Pull 10-Watt Amplifier—Obscure Sources of Hum in High-Gain Amplifiers—How to Build a High-Fidelity 5-Watt Versatile Amplifier.

"HAM" SECTION

Ultra-High Frequency Antennas—The Beginner's Low-Cost Xmitter-Modulator Meter—Phono Monitor—The Beginner's "Ham" Receiver—2½ Meter Acorn Transceiver.

TELEVISION

How to Build a 441 Line T.R.F. Television Receiver—Useful Notes on Television Antennas.

MISCELLANEOUS

Simple Photo-Cell Relay Set Up—Making a Burst Alarm—How to Build A.C.-D.C. Capacity Relay—How to Make a Modern Radio Treasure Locator.

USEFUL KINKS, CIRCUITS AND WRINKLES

Making a Flexible Coupler—Two-Timing Chime—A Simple Portable Aerial—An Improvised Non-Slip Screw-Driver. NOTE: The book contains numerous other useful Kinks, Circuits and Wrinkles, not listed here.

(approximately)

45 ARTICLES

(approximately)

170 ILLUSTRATIONS

68 BIG PAGES

**RADIO-CRAFT
20 VESEY STREET
NEW YORK, N. Y.**

OPERATING NOTES

Because the Notes printed below are exceptionally good, submitted by a top-notch Service Engineer of recognized repute, this month's entire "Operating Notes" department has been devoted to them.

BERTRAM M. FREED

Trouble in . . .

. . . RCA-VICTOR C6-2, T6-1

Low sensitivity accompanied by resonance hiss, is a frequent complaint with these models. (The symptoms are exactly similar to those obtained when no aerial or a very short one is employed.) The wire-wound pigtail resistor in the control-grid circuit of the 6A8 pentagrid converter tube has been found open-circuited. This resistor is employed as the control-grid lead. In almost every case, the open-circuit is at the lug.

. . . RCA-VICTOR T6-9, C6-2, T6-1

An annoying hum, which is heard with the volume control in the extreme minimum position, when not occasioned by faulty filter condensers has been corrected by reversing either the voice coil or hum neutralizing coil leads.

. . . RCA-VICTOR D7-7

When located in the vicinity of one or more powerful broadcast stations, this model, a phono - radio combination, develops the complaint of radio reception heard during record reproduction. This condition is due to detection by the 6F5 1st audio tube. A small condenser of 250 to 500 mmf. capacity, connected from the control-grid of the 6F5 to chassis to bypass these R.F. currents, will usually eliminate the trouble. A slight decrease in high-frequency response results.

When a chattering or growling synchronous phono motor is encountered, try loosening and re-adjusting the 3 motor support screws, to correct.

. . . RCA-VICTOR C8-15, C9-4, D9-19, T8-4

When the complaint of distortion is encountered, occasioned by lack of grid voltage on the 6FG, check for grounded electrolytic filter condenser cans. Many of these receivers have been found with the connecting lug of the negative can (which is normally insulated from chassis) to either or both electrolytics contacting the chassis because of excess solder. All that is necessary is to clear the lug.

Intermittent reception on these models, wherein the volume level falls abruptly and strong resonance hiss is present, or only code signals may be obtained on the broadcast band, has almost invariably been traced to open-circuiting R.F., 1st-detector, or oscillator coils. The open-circuit consists of a break at the coil lug and usually is easily repaired.

. . . SPARTON 25, 26, 26 AW, 28, 30

Intermittent reception or an inoperative condition on these models is due frequently to open-circuiting I.F. transformers. These transformers are wound on wood bobbins, primary and secondary being wound in slots at opposite ends of the form. The leads for both windings are brought out to terminal lugs at each side through slotted channels. Because of the heavy, stiff leads connected to these terminal lugs, which are not firmly anchored, vibration results in the shifting of the heavy leads, and consequently, the terminal lugs. This shifting

SERVICEMEN—

What faults have you encountered in late-model radio sets? Note that Radio-Craft will consider your Operating Notes (they need not be illustrated) provided they relate to CHARACTERISTIC (repeatedly encountered) faults of a given set model. Payment is made after publication of the Operating Notes.

tears away the transformer leads. The break is difficult to note because of the fact that the entire assembly and the channels for the leads are heavily impregnated with a wax compound. To effect a repair, the fine leads must be dug out of the wax and resoldered to the terminals.

. . . STEWART-WARNER 1201-1209

A number of these receivers have been serviced for the complaint of distorted, unstable operation at station resonance at any volume level. In most cases, the Local-Distance switch must be placed in the Local position to obtain reception. This condition is caused by an open-circuited cathode section of the voltage divider as shown in Fig. 1. A 2-watt, 15,000-ohm carbon resistor may be employed for replacement purposes with assurance of future trouble-free operation upon this score. A later series of these receivers dispensed with the A.V.C. voltage divider, and secured cathode voltage for the A.V.C. tube by a tap on the main voltage divider.

A low, steady hum heard as a background to reception and even with the volume control turned to minimum position, is due to insufficient filtering in the power supply unit. The condition may be remedied by installing a filter choke in the high-voltage secondary-return, before the speaker field, which is employed also as a filter choke in the high-voltage secondary-return. An 8-mf. electrolytic condenser with a 450-volt D.C. working voltage is connected from rectifier filament to the high-voltage secondary side of the choke as shown in Fig. 2. Shunting additional filter condensers across the 2 electrolytic units in the power unit is ineffectual.

When the 3 shortwave bands of these models are inoperative and all voltages are found correct, check the trap trimmer in the plate circuit of the shortwave 1st-detector for a short-circuited condition. Because of a coupling condenser in the plate circuit of this stage, the failure of the trap-circuit trimmer will not produce a voltage discrepancy, although the plate voltage on the shortwave detector is very low in any event.

This trimmer is mounted upon the front side wall of the chassis near the shortwave 1st-detector socket. Usually, loosening the adjustment screw now more than a quarter-turn will clear the short-circuit. Where this does not overcome the difficulty, a new mica insulating spacer must be installed. Should the latter be necessary, then the trimmer must be re-adjusted for maximum output as read on an output meter, with a test

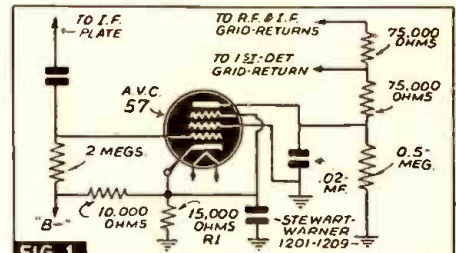

FIG. 1

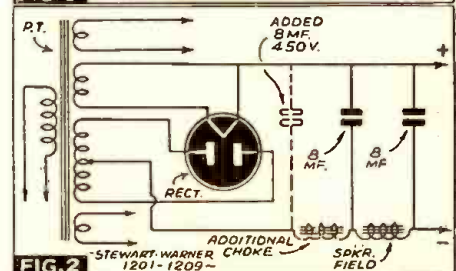

FIG. 2

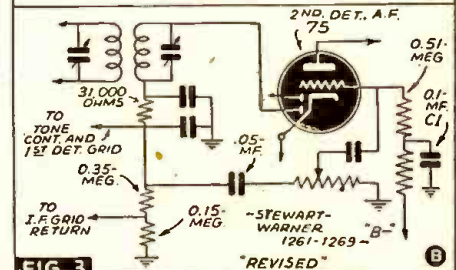
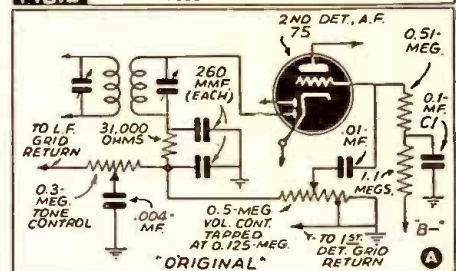

FIG. 3

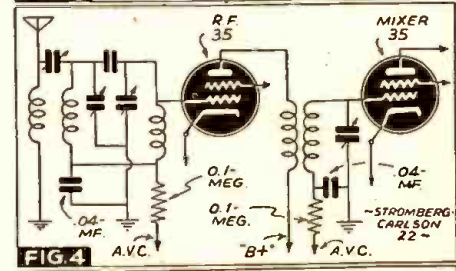

FIG. 4

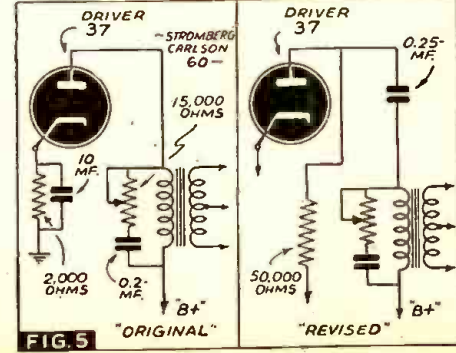
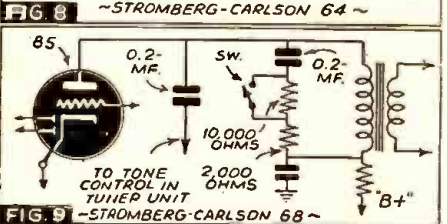
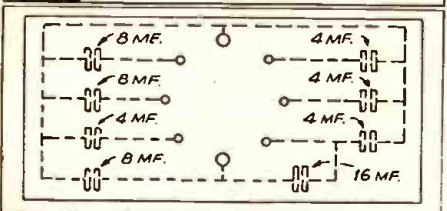
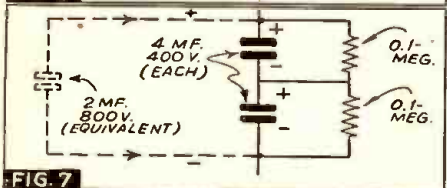
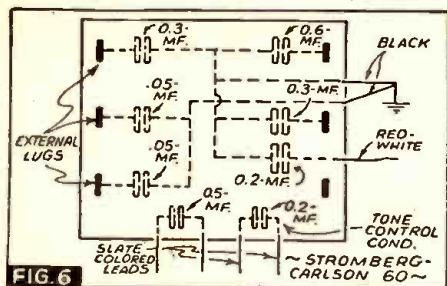

FIG. 5

SERVICING



oscillator tuned to 1,540 kc., and coupled between the control-grid of the 57 short-wave detector and chassis. Two peaks may be noted upon the output meter. The minimum capacity position of the trimmer is the correct one.

An open-circuited 0.02-mf. audio coupling condenser connected between the plate of the 56 phase "reverser" tube and the control-grid of one of the 2A5 output tubes has been traced as the cause for slightly distorted reproduction and lowered output. This condition may be checked by withdrawing each 2A5 in turn. Removal of the 2A5 which is coupled to the 55 tube will result in total inoperation. As is often the case, the open-circuited condenser is occasioned through poor internal contact of the pigtail leads.

Reception that is marred by scraping, scratching noise is often the result of corroded contacts of the wave-band switch. The symptoms described become apparent upon the slightest vibration or movement of the chassis and may be reproduced by tapping the chassis. Carbon tetrachloride applied with a small brush and application of a small quantity of Lubriplate will correct the difficulty.

STEWART-WARNER 1251-1259

Intermittent reception on either the broadcast or shortwave band, or inoperation of the shortwave band, has almost always been traced to the wave-band switch. This switch cannot be cleaned unless dismantled, but it is unnecessary to remove the entire unit from the chassis, or to unsolder any of the connecting leads. The small horseshoe washer holding the shaft of the switch in place is quickly removed by spreading. The shaft and shorting contact plate is then pushed back. The contacts should be bent up so that increased tension upon the contacts will result when the switch is reassembled. Apply Lubriplate to the contacts.

STEWART-WARNER 1261-1269

Intermittent reception, or total inoperation on the broadcast band only, has been traced to an open-circuiting oscillator coil for this band. The open-circuit consists of a break of either of the 2 fine coil leads at the lug to which the postage-stamp type condenser is connected. It is unnecessary to remove the coil to remedy this condition. The insulation from the snapped lead may be removed with a small penknife and the lead resoldered to the lug which extends into the coil form.

Noisy reception on these models, which often is attributed to loose element triodes, is likely to be caused by poor internal contact within the molded dual 260 mmf. diode load I.F. bypass condensers, also of the postage-stamp type. The value of these condensers is not critical and they may be replaced with either 250 or 100 mmf. units.

A noisy volume control is a common complaint, resulting from usual contact resistance. This condition is overcome without the necessity for replacement, in most cases, by isolating the volume control which is employed as part of the diode load circuit.

Since a tap on the control serves to supply a lower A.V.C. voltage to the control-grid of the 1st-detector tube, as shown in Fig. 3A, 2 resistors should be employed in place of the volume control. A 0.15-meg. and a 0.35-meg. carbon resistor will suffice, with the lower value unit connected in the ground and the lead connected to the tap of the volume control being detached and soldered to the junction of these 2 resistors. A 0.05-mf. coupling condenser is connected between the "high" side of the 0.35-meg. resistor and the high side of the volume control as shown in Fig. 3B.

When these receivers are serviced for a strong motorboating due to oscillation, on all bands, with the receiver otherwise inoperative, replace the 0.25-mf. screen-grid bypass condenser connected from the screen-grid terminal of the 1st I.F. tube socket to chassis.

Should the symptom of distortion at resonance on powerful stations only, be encountered, try replacing the type 6C6 1st-detector with a type 77 tube. In the event this procedure fails to clear the distortion, replace the 77 with a type 78 remote cut-off tube. This latter tube will decrease signal strength only slightly on the broadcast band, but a loss in sensitivity on the shortwave bands will be noted.

Very weak reception on the 3rd short-wave band with several dead spots may be overcome by replacing the oscillator plate resistor with a lower value unit. A 15,000-ohm resistor usually turns the trick.

When the complaint of distortion at any volume level or on any station is encountered, look for a leaky or short-circuited 0.1-mf. grid filter condenser for the triode section of the 75 tube as shown at Fig. 3. This failure lowers the negative bias upon the grid and produces the condition described.

STROMBERG-CARLSON 22, 22A

The complaint of intermittent reception, wherein volume cuts off abruptly to a lower level, and resonance hiss is strongly apparent, has often been traced to an open-circuiting 0.04-mf. bi-resonator condenser and to the 0.04-mf. 1st-detector secondary-return bypass condenser as shown in Fig. 4. Both these units are mounted upon the inner side wall of the condenser gang shield, the bi-resonator condenser located towards the front of the chassis. The open-circuit consists of poor internal contact.

Since removal of either condenser from the gang consumes a good deal of time, it

is suggested that they be disconnected from the circuit and replacement units installed under the chassis. Usually this symptom may be made to appear by rapping against the right side of the condenser gang shield. When the bi-resonator condenser is replaced, it should be remembered that the 2 slate-colored leads emerging from the unit, both connect to the same side of the condenser, the metal case of the unit being the other terminal. All that need be done in this instance is to detach the slate-colored leads from the coil lugs to which they are connected and to install the replacement condenser from one of these coil lugs to chassis, soldering a jumper from one coil lug to the second.

The symptoms of fading and weak reception have been traced to the screw passing through the 1st tuning condenser shield. This screw, employed as a 1 mmf. condenser, is connected to the stator of the second tuning condenser section and is insulated from the shield by means of a wax compound. Vibration or heat frequently causes the screw to short-circuit to the shield, producing the trouble described. To remedy the condition, disconnect the screw from the circuit. This will not affect the operation of the receiver in any degree.

The seemingly peculiar situation may be encountered with this model where 2 or 3 or perhaps 4 stations may be tuned-in throughout the entire range of the dial with each station often covering 50 or 60 kc., with much noise. This trouble is due to loose set-screws on the dial collar, which releases the condenser gang shaft. It is only necessary to tighten these screws after the gang has been calibrated with respect to dial markings to effect a repair.

STROMBERG-CARLSON 48, 49, 50, 51

Where these receivers are found inoperative and no tuning meter indication is obtained, the trouble usually lies with an open-circuited tuning meter. A voltage analysis will disclose the lack of plate voltage on the R.F. and 1st-detector tubes in this case.

When the receiver is inoperative and the tuning meter needle is found off-scale or bent, or where the celluloid window of the meter or meter coil is either charred or burned, we have an almost positive indication that the 0.3-mf. plate bypass condenser in this circuit is short-circuited. This condenser is one of several mounted in a common block directly in front of the 55 tube socket. The leads to the short-circuited section may be detached and an external 0.25-mf. or 0.5-mf. condenser should be connected in its place. The tuning meter also will have to be replaced, since it was burned out due to passage of excessive current occasioned by the breakdown of the bypass condenser. In those cases where a receiver is found inoperative only because of an open-circuited tuning meter, the above-mentioned 0.3-mf. condenser should be replaced at the same time to avoid future trouble. A new condenser costs less than a new meter.

When the condition of noisy reception is encountered with the volume control turned completely off, check the primary of the push-pull input transformer for the driver stage. A simple but effective method of accomplishing this is to shunt a sensitive voltmeter across the primary to measure the voltage drop. Noisy primary condition will be immediately manifested by the slightest voltage variations upon the meter.

These receivers are equipped with a silencing tube whose operating switch is located in the rear of the chassis. Since all of the cabinets housing this chassis are particularly heavy and clumsy, many set own-

ers find it inconvenient to move the cabinet in order to gain access to the switch. A method which has been employed with no little success, is that of installing a 6-prong adapter, whose cathode circuit is open, under the type 57 silencing tube. It will be necessary, of course, to remove the shield. A switch is installed on the front panel of the cabinet or placed within easy reach, the switch terminals being connected across the open cathode circuit of the adapter. In this manner, the silencing switch in the rear of the chassis may be left up or off at all times, with the front switch serving the function of cutting the silencing tube in and out of the circuit at will.

... STROMBERG-CARLSON 55, 56

In these models, the complaint of intermittent reception accompanied by loud popping noises has frequently been traced to intermittently short-circuiting I.F. trimmer condensers. In order to remedy this condition, it is necessary to dismantle the I.F. transformer assembly and renew the mica insulation.

When the receiver does not operate when the on-off switch is pressed to the "on" position, check the relay mounted under the power unit. The shorting contact may have become frozen or may bind in such a manner as to interfere with normal operation of the device. A visual examination will disclose the nature of the mechanical trouble which is easily rectified.

... STROMBERG-CARLSON 60

One of the most frequent complaints with this model is that of noisy reception, the cause of which lies with the primary of the push-pull input transformer. This fact may be readily checked by turning the volume control completely off, or by measuring any variation in the voltage drop across the primary with a sensitive voltmeter. In many cases the unit was replaced, but the same condition developed, since an original factory replacement was employed.

To obviate the necessity for constant annoyance and to avoid future service calls of the same nature, the new transformers were installed in a parallel plate feed circuit so that the D.C. could be kept from the primary winding. The only additional parts required for this change are a 50,000-ohm carbon resistor and 0.25-mf. condenser. No loss in volume and a decided improvement in tone quality was experienced with this circuit change as indicated in Fig. 5.

Should noise still be present when the volume control is turned completely off, and the primary of the push-pull input transformer tests perfectly, attention should be directed toward a leaky 0.2-mf. tone control condenser located in a common bypass block—whose internal connections are shown in Fig. 6—mounted directly behind the gang condenser.

Many of the first series of this model were serviced because of the complaint of hum. In most cases, the trouble was traced to poor grounding of the triple section electrolytic filter condenser unit. Scraping the paint from the chassis over that portion upon which the condenser sets and firmly tightening the mounting nut corrected the difficulty. In the new series, the electrolytic filter unit has another terminal riveted to the can for grounding purposes.

The symptoms of fading, distorted reproduction, and severe oscillation are occasioned by poor electrical grounding of the 6B7 shield, in which the mounting rivets of the shield base are not making proper electrical contact to the chassis through the cracked paint finish. Although the rivets may be hammered down to effect a repair,

soldering short pigtailed between rivets and chassis more effectively accomplishes the purpose. Since the pentode portion of the 6B7 serves as the I.F. amplifier, perfect shielding is essential.

When the receiver is tuned to short waves but the entire band is found dead, look immediately to an open-circuited shortwave oscillator coil. This coil is located within the shield to the right of the 6A7 tube together with the broadcast coil. The open-circuit has always been found at the coil terminal lugs and is easily re-soldered.

Strong oscillation over the entire short-wave band, but no signals, has been remedied by turning the screw adjustment of the 2nd I.F. transformer slightly one way or the other.

Leaky 0.04-mf. bypass condensers for the R.F. and 1st-detector secondary-return circuits produce the condition where the more powerful stations are received with distortion at the normal point of resonance, but without this distortion about 10 kc. on both sides of this point. In other words, strong signals are received at 2 peaks about 20 kc. apart.

... STROMBERG-CARLSON 64

One of the most common complaints with this model is that of an inoperative receiver with the plates of the 5Z3 rectifier heating up excessively and resulting in the blowing of the line fuse. In some cases, the receiver may be found inoperative because of a burned-out fuse. When the fuse is renewed, the receiver will operate normally. After a few hours or a few days, the fuse will again burn out. These troubles are due to the breakdown of the 1.3-mf. input filter condenser which is located within the push-pull input transformer assembly and identified by the 2 green leads emerging from the block. The short-circuited condenser should be disconnected from the circuit and replaced with any good-quality 2 mf., 600-volt paper condenser, or with the external replacements in a metal container supplied by the manufacturer to be installed upon the top of the chassis. The usual 8-mf. dry electrolytic condenser unit generally employed for replacement purposes should not be used here because of high rectifier output peak voltage, unless 2 such condensers are connected in series across two 100,000-ohm resistors as shown in Fig. 7.

As with the model 60 receiver, this model has been serviced more often for the complaint of noisy reception than for any other cause. The trouble has been traced to the primary of the 1st audio transformer, an uncased unit mounted upon the rear wall of the chassis. The noisy condition may be checked in the usual manner of shunting a sensitive voltmeter across the primary winding with the receiver in operation to determine the presence of voltage variation as indicated upon the meter. It seems that these transformers were impregnated with an insulating compound of an acid nature which produces electrolysis of the primary winding as the unit becomes heated under normal operating temperatures. The condition is one that develops over a period of time, noise due to the electrolysis becoming more and more apparent. An improved replacement unit may be obtained from the manufacturer, or a good standard transformer may be employed. Similar occurrences may be prevented by changing to parallel plate feed, as described with model 60.

The symptoms of motorboating, strong oscillation at the higher frequencies, and intermittent reception are often due to either or both the R.F. and 1st-detector-oscillator secondary-return bypass con-



SUPPLEMENT TO
**SYLVANIA'S
TECHNICAL MANUAL**

THIS supplement lists all the types of tubes announced since the Fifth Edition, Second Printing of the Sylvania Technical Manual was released.

Base views and operating characteristics are either given . . . or referred to equivalents. This saves time and space. Cross references used are clear and easy to follow.

The supplement is so made that you can glue it inside the Sylvania Technical Manual you now have. If your Manual is old or worn . . . write for another. The supplement is already glued in the new Manuals.

The cost for a complete Manual is but 35c. The supplement, as we said, is sent to you free. Mail your request for one or both to The Sylvania Tube Division, Hygrade Sylvania Corporation, Emporium, Penna.

SYLVANIA RADIO TUBE DIVISION
HYGRADE SYLVANIA CORPORATION

500 Fifth Ave., New York—Emporium, Pa.
Salem, Mass., St. Marys, Pa., Ipswich, Mass.,
Towanda, Pa.

Also makers of Hygrade Lamp Bulbs, Hygrade Fluorescent Lamps and Muralume Fluorescent Light Fixtures

ISOLATING THE DEFECTIVE STAGE

The following article reprinted from "National Radio News" is a forthright analysis of the 6 basic methods of servicing radio receivers and the manner in which these various methods are applied in everyday work. The author, technical consultant of National Radio Institute, is to be complimented upon his exceptionally "meaty" article.

WM. FRANKLIN COOK

THERE have been discussions on the "best" method of isolating defects in radio receivers. Most of these have been a waste of time because arguments over favorite methods of servicing cause one to lose sight entirely of the very important fact that the wide-awake Serviceman should make use of any and all methods he can.

Why should a Serviceman have some "pet" method of servicing? In some instances this is the result of the training of the individual, while in others the Serviceman has allowed himself to be governed by what he thinks are the limits of his test equipment. Actually, the only limits a Serviceman has are directly due to his training and his ability to apply simple reasoning to the radio trouble he has encountered. It is surprising how a few moments of thought, before touching the test equipment, can frequently lead one right into the correct method of determining the trouble.

6 STAGE-ISOLATING METHODS

There are 6 basic methods for localizing the defective stage.

Each method has advantages, in locating certain types of troubles. At times, one or more of the methods will definitely place the Serviceman at a disadvantage, if followed blindly. Hence, it is quite important that you don't fall into the error of believing that any one particular method is the only one an individual can use or should use.

The 6 basic servicing methods are:

- (1) The set analyzer (which is now becoming obsolete).
- (2) Point-to-point voltage and resistance measurements.
- (3) Signal tracing in the forward manner.
- (4) Signal substitution in the reverse manner.
- (5) The circuit disturbance procedure.
- (6) Stage muting or stage elimination tests.

Let's briefly cover the equipment necessary for each of these methods; take up some typical service problems and see just which methods will work the best in each case and then, how we can develop a combination which will quickly locate any trouble.

(1) *The Set Analyzer Method.* This method of servicing requires a plug-in analyzer. Due to the great number of different tube socket combinations, a number of adapters are necessary to go on the end of a plug, which is placed in the tube socket. The tube is then placed in the analyzer and the various plate, grid and other operating voltages are then checked; this method therefore is limited to checking supply paths and parts. In the early days of radio, when circuits were extremely simple, this method of analysis was favored a great deal. Modern complex circuits and the upset in the circuits caused by analyzer cable capacities has resulted in this time-wasting method becoming less and less favored by service experts.

(2) *Point-to-Point Measurements.* In the point-to-point voltage and resistance meth-

od, we require only a voltmeter and an ohmmeter. Voltages are measured at certain strategic points and then resistances are checked in those circuits where the voltages are found to be abnormal. This method is quite a time saver over the set analyzer method and for certain troubles results in quick diagnosis.

(3) *Signal Tracing.* Signal tracing in the forward manner requires either some type of channel analyzer or a vacuum-tube voltmeter. For some of these tests, a signal generator is essential as a signal source. This system follows the signal from the antenna to the output, so we call it the *forward* method.

(4) *Signal Substitution.* We start at the output of the radio set using this method, and work back toward the input instead of going in the other direction as in the forward manner. Instead of checking the sig-

nal of the radio receiver, providing the circuits between that point and the loudspeaker are in good condition. Hence, by starting at the output and working back toward the input, we can quickly localize the defective stage in a *dead receiver*.

Incidentally, while talking about the circuit disturbance test, just how would you apply it to the "radio" shown in Fig. 1? Some of the tubes are octal types and they have no top caps. The loctal feature of the socket prevents the tube being readily pulled out of the socket and quickly reinserted.

The output tube however, is standard and can be quickly pulled out and replaced in its socket. Then, when you come to the 7C6 tube, you can take a test lead or a piece of wire and short-circuit the grid temporarily to the set chassis. Every time you make and break the connection, you should hear a pop or thud in the output, because you are removing the "C"-bias voltage. This bias is obtained by a voltage drop across the 27-ohm section of resistor 52. Removal of the bias causes a sudden and rapid change in the plate current, creating a signal pulse which is reproduced by the loudspeaker as a thump, pop or thud.

When we come to the 2nd, a 7B7, I.F. tube, short-circuiting the control-grid to ground would not have any effect on the output because no bias change is involved. However, if we short-circuit the cathode to the set chassis, this again removes the bias and we will get our noise in the output. With the 1st I.F. tube, we can short the grid to set chassis again because we have a bias coming from the power supply. With the 1st-detector, we can short-circuit the control-grid to the set chassis also.

The only important thing to remember about this is we must change the bias to make the plate current change and our short-circuiting wire or test lead must be touched to the proper points to cause this bias change. As a general rule, short the control-grid to the set chassis when the bias comes from the power supply; and, short the cathode to the set chassis when self-bias is used.

It is of course necessary that we properly identify the control-grid, cathode and other elements for this purpose. A tube chart will help in this identification procedure.

(6) *Stage Elimination or Muting.* Although the circuit disturbance test is limited mostly to locating a "dead" stage, it is possible to isolate a noisy or hum-producing stage with no test equipment by using a similar procedure. This time, instead of listening for a thud, we listen for the noise or hum to disappear. That is, we pull out one tube at a time, starting at the input of the receiver. When we pull out the tube in the defective stage, the noise or hum will disappear, thus indicating where the trouble is.

PUTTING THE METHODS TO WORK

Now, let's take a typical radio trouble and see just which method would locate the cause of this trouble the quickest. Figure 1 shows a diagram of a typical modern set, so let us consider in turn 3 different defects which would cause weak reception, for instance.

WHAT DO YOU KNOW— —about the 6 basic methods of servicing radio receivers?

The accompanying article answers many of the questions which have been puzzling Servicemen concerning one or more of the test procedures now current. Many Servicemen have come to consider certain of these test procedures as "pet" methods, failing to realize the full value of important merits embodied in the remaining procedures; all are listed below:

- (1) The set analyzer.
- (2) Point-to-point voltage and resistance measurements.
- (3) Signal tracing in the forward manner.
- (4) Signal substitution in the reverse manner.
- (5) The circuit disturbance procedure.
- (6) Stage muting or stage elimination tests.

nal, we insert a signal from a signal generator. That is, we feed a signal from a signal generator, at the proper frequency, into the 2nd-detector, and then progressively work back toward the input of the "radio" with our signal generator. We can use just the loudspeaker as an output indicating device or we can make use of an output meter. This we call the *reverse* method.

(5) *Circuit Disturbance.* This method requires no test equipment. This particular test procedure consists of taking top caps off of tubes to listen for a squeal or thud in the output, pulling tubes out of the sockets and quickly inserting them again, or momentarily short-circuiting grid bias supply circuits.

Any of these circuit disturbances will cause a rapid change in the plate current of that particular stage, which will cause a noise signal to travel through to the output

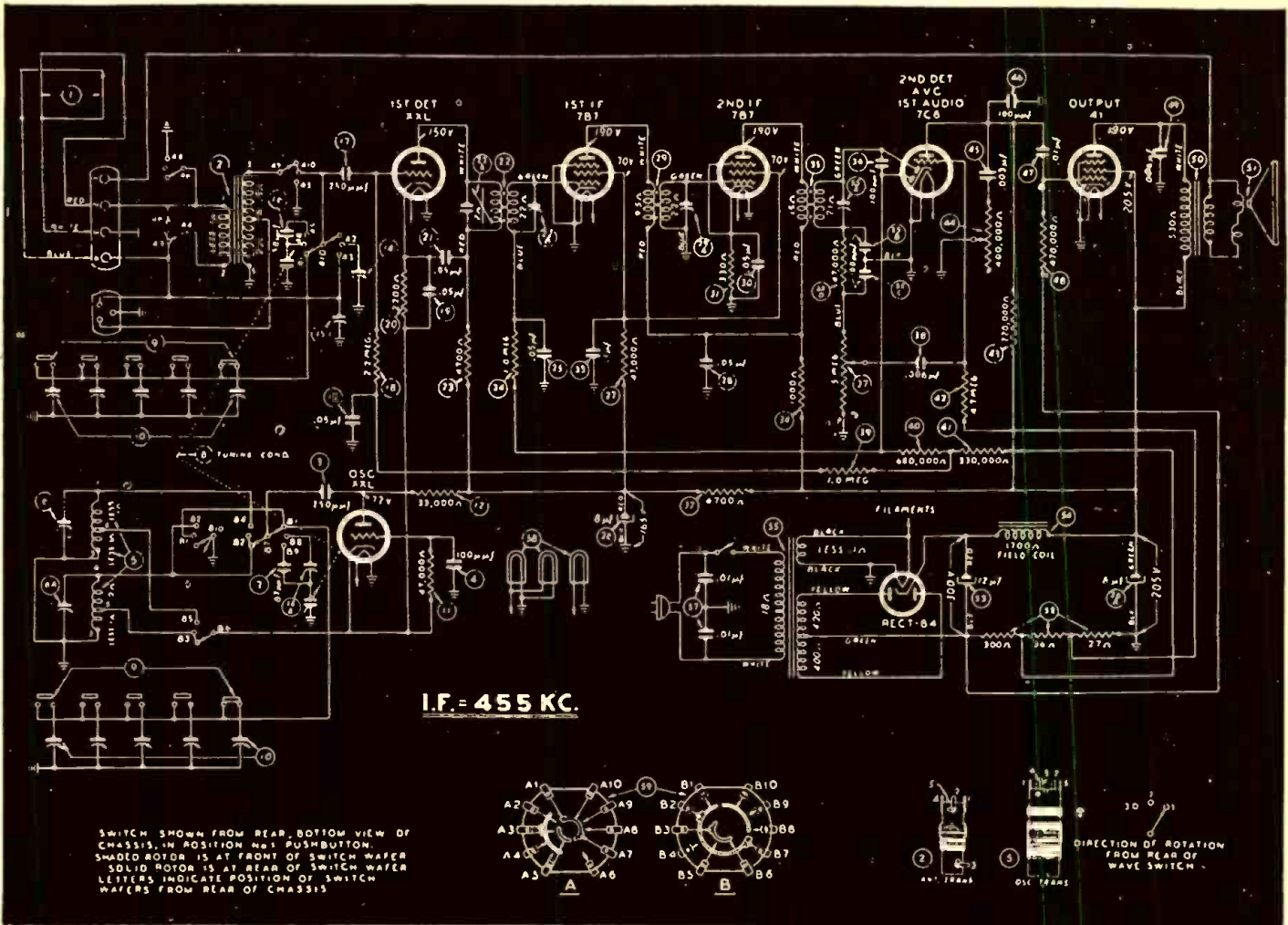

Fig. 1. Philco model 41-260, selected as a representative diagram.

(1) *Open Input Filter Condenser.* First, suppose the input filter condenser, No. 53 on the diagram is open. From your study of radio you know that an open input filter condenser results in low operating voltages so the set will be weak, or if the voltages are too low, the oscillator might stop and the set would be completely dead. In this instance, however, let's suppose that the signals come through weakly.

The *set-analyzer* Serviceman would plug the analyzer in each tube socket and measure all the operating voltages throughout the set. He would find that all the voltages are below normal thus indicating a power supply trouble.

The *point-to-point* Serviceman would make one or two voltage measurements between "B+" and the set chassis and find this voltage lower than he expected, thus indicating a power supply defect.

Using signal tracing in the *forward* manner, we would start at the input of the radio set and follow the signal through to the output with a vacuum-tube voltmeter or channel analyzer. Each stage would show some gain in signal, but it would be weak throughout. If we happen to have some stage gain figures from the manufacturer or know about what the gain should be in each stage, we would find the gain in each stage to be below normal, which would cause us to measure the operating voltages with a voltmeter.

In the *reverse* (signal substitution) procedure, we would start at the output and listen to the signal, as our source is moved back toward the input. Again we would find that each stage contributes some gain, thus indicating that there is no particular stage defect but that the trouble is an overall trouble, indicating the power supply.

Finally, the *circuit disturbance* test could be tried although this test is of greatest use in a dead receiver. In fact, without a great deal of experience, we couldn't tell very much about a weak receiver with the circuit disturbance test. The fact that a signal comes through indicates that all of the stages are functioning after a fashion, anyhow.

The *circuit elimination* method is of no value for this trouble, as no appreciable noise or hum will usually be present.

Now, it is obvious that the *point-to-point* Serviceman found this particular trouble the quickest. The least amount of time was spent because he only made one or two voltage measurements and almost immediately discovered that the trouble had to be the power supply because the voltages were so low. A resistance measurement would show that the trouble was not due to a short-circuit, and if he had had proper training he would suspect an open in the input filter condenser. By trying another condenser, he would quickly find the trouble.

Note that the fellow using the set analyzer discovered the same results, but he spent too much time taking measurements throughout the radio receiver. Some of the smarter set-analyzer Servicemen would make a measurement first of the output tube supply voltage and, if this voltage was below normal, they would know from their understanding of the circuit or from previous experience that the voltage elsewhere was going to be low also, and could thus save some time, approaching the point-to-point man in efficiency.

Notice that the signal tracer methods or the circuit disturbance tests require that the Serviceman eventually use a voltmeter, in-

dicating definitely that the basic equipment required for this type of service job would be the voltmeter and ohmmeter combination.

(2) *Open Primary in Antenna Coil.* Now let's think up a signal circuit defect to show how the other methods are used. Suppose the primary of the antenna coil opens up. Again the set would be weak. The set analyzer man would find the voltages all normal and so would the point-to-point measurer. The point-to-point man can use his ohmmeter to measure resistance, but he might measure the resistance of every single part in the set before he would come to the defective coil, unless he happens to start at the input of the set.

Using the signal tracing procedure in the forward manner, a signal measuring device would indicate a loss of signal, comparing the antenna-ground signal with that on the 1st-detector grid.

In the reverse method of signal substitution, we would be at a slight disadvantage as we would have to start somewhere near the output and work back toward the input. Using a signal generator, for instance, you could feed the proper signal frequency into the 2nd-detector and progressively move the signal generator back to the plate of the 2nd I.F., the grid of the 2nd I.F., the plate of the 1st I.F., the control-grid of the 1st I.F., the plate of the 1st-detector, the control-grid of the 1st-detector, and finally the antenna terminal. In each instance, there would be a gain in the output except in the last test, where the output would drop. This indicates trouble in the antenna coil.

In the circuit disturbance test, we would get clicks throughout the "radio" but they would be normal in intensity from all of the tubes. Of course, we would have to know

SERVICING

to obtain
Superior Performance

WITHOUT ADDITIONAL COST

ALWAYS USE

Meissner

**PRECISION - BUILT
PRODUCTS**

Progressively Engineered

for the

Servicemen

Radio Amateur

Sound Engineer

and Experimenter

Write for Free 48-page Catalog

DEPT. C-9



BRAND NEW! **INVALUABLE!**

ONLY **25¢** copy

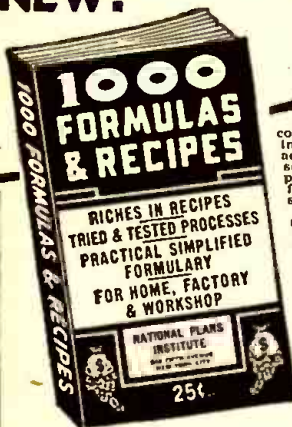

The greatest, most compact formula book in print. Contains actually 1000 trade secrets, recipes and processes for home, factory and workshop.

Check-full of money-making ideas. Has newest tried and tested formulas for making Glues, Cements and Adhesives; Cleaning Compounds; Paint and Pigments; Wood Stains; Varnishes. Disinfectants and Deodorants; Fire Proofing and Extinguishers; Glass working; Inks; Insecticides; Laundry Processes; Metal Work; Etching Fluids; Solders;

Paper Making; Photographic Processes; Preserving Essences; Extracts and Flavors; Plastics; Plating Solutions; Polishes; Preservatives; Fireworks; Soaps; Creams; Dyes; Toilet Preparations; Dentifrices and Cosmetics; Hair Preparations; Manicure Preparations; Sun Burn Creams and Lotions; Waterproofing; Waxes and countless others.

A Wonder Book of Useful Knowledge! Worth its weight in gold.

Book is up-to-date. Newest methods—latest discoveries. Remember—1000 clearly described SIMPLIFIED formulas, processes and recipes—MANY NEVER BEFORE DISCLOSED.

68 pages. Printed on good paper.

Send for your copy TODAY. Remember, great fortunes are made from formulas.

25¢ a copy, sent postpaid anywhere.

Send money order, check, unused U.S. stamps or coin.

NATIONAL PLANS INSTITUTE
246-R Fifth Avenue New York, N. Y.

SOLAR RED-CAPS
Smaller Diameter Dry Electrolytics

SPEED Servicing

Write for Catalog

SOLAR MFG. CORP. Bayonne, New Jersey

how loud they should be, but if so, we would thus be led to suspect the input circuit.

The circuit elimination test would be useless unless the open coil caused noise. As I will explain later, this would seldom happen.

In this particular case, the forward signal tracing procedure is the quickest means of finding the trouble, although the reverse procedure will also find it equally as well. Notice that the forward method requires a signal tracing instrument, while the reverse method requires a signal generator and output meter.

(3) *Open Voice Coil.* Now, if we choose some trouble in the A.F. section which will cause weak reception, such as an open speaker voice coil, then again the set analyzer and point-to-point voltage measurements would give no indication of the trouble.

The forward signal tracing method would find the signals normal in each stage, indicating that the trouble was in the loudspeaker or output transformer.

In the signal substitution procedure, signals would be weak, again indicating a trouble at the output.

The circuit disturbance test would give very weak clicks from the output tube, indicating that the trouble was in the output stage, output transformer or loudspeaker.

Here we have a case where the circuit disturbance test will quickly indicate the position of the defect, after which we could resort to another measurement or two with our voltmeter-ohmmeter combination to point to trouble in the loudspeaker.

The signal tracing procedures, either the forward or reverse, would both locate the trouble, the reverse method being the quicker, as we would find weak output from the start, rather than having to trace the signal all the way through the set to find that the trouble is in the output.

Weak reception happens to be a trouble which usually is serviced by one of the voltage measuring or signal tracing procedures. In a similar manner, however, we could assume many other difficulties and we would find that in some cases, all the methods would show up the trouble, while in others only certain tests would quickly locate the trouble. If you happen to be following one particular method of servicing in preference to all others, then you will find a certain percentage of the troubles quicker than the next man, who may be using another method. However, if you are familiar with every method of testing, you can take full advantage of basic service equipment and adapt procedures to each individual case. Let's go on and see how.

TROUBLE-MAKING PARTS

Before taking up equipment and basic service procedures, let's consider the troubles encountered by a Serviceman. He may find defects such as a dead set, weak reception, hum, distortion, oscillation, intermittent reception or any combination of these.

What parts are most generally found defective? From practical experience, I would list them in order; tubes, condensers (bypass and filter), resistors and coils.

Tubes top the list as they can and do cause any and all of the troubles mentioned above and are one of the "weak links in the radio chain." Hence, tubes must be checked.

Some Servicemen make the preliminary trouble-isolating tests first, starting the tube test with that one in the particular defective stage, while others may test all of the tubes before testing anything else. Either method may be used, but all of the tubes should be checked, if for no other reason than that the customer expects it. That is, the customer knows that there are tubes

in the radio set and he undoubtedly hopes that the trouble will be "just a bad tube." Sometimes the customer is right, the trouble is only in the tubes. By checking the tubes, you can at least satisfy the customer on this score.

Condensers are next, both bypass and filter units being frequently found bad. Variable condensers and trimmers are not often found defective, but must be remembered if the elimination procedure leads to a circuit containing them.

Now, which condensers in the set are the probable ones to break down? Generally, the condenser that breaks down will be one that is under an electrical strain, so we can concentrate our initial tests on such condensers as are connected to the plate and screen-grid circuits. This would of course include the filter condensers. Thus a condenser break-down usually causes improper operating voltage.

In intermittent cases, of course, the offending condenser could be any one in the radio set, particularly if the indications are for open condensers. Watch out particularly for open grid-return, bypass and coupling units.

In modern radio receivers, we will seldom find resistors defective, except the voltage divider, where one is used. Some types of voltage dividers, such as the metal housed ones, may develop a poor contact at one of the terminals. Most of the other resistors have practically an indefinite life and will seldom be found defective except where a break down in a tube or condenser has resulted in an excess current flow through the resistors. For instance, if plate bypass condenser 28 breaks down, then resistor 34 would pass excess current and probably would burn out.

We are finally left with coils, transformers, chokes and the speaker field all being devices containing a number of turns of wire. We do sometimes have trouble with the coils. We might have short-circuited turns, corroded contacts causing an open-circuit, or in a few instances the coil might be damaged due to excess current flowing through it from some other breakdown. However, when we are considering the usual causes for a radio-set breakdown we must take them in approximately the order—tubes, condensers, resistors, and finally, coils.

TEST EQUIPMENT NEEDED

Now, notice that the order of usually defective parts indicates the basic equipment necessary.

A good Multimeter which has voltmeter and ohmmeter ranges is an absolute essential, regardless of the method of testing you follow. A Signal Generator is also a necessity because you must align receivers and by making full use of the signal generator and output meter, it is possible to follow the reverse method of signal substitution very successfully. In addition to these 2 basic instruments, you will of course need a Tube Tester when your business is established.

The only system requiring any additional equipment is the signal tracing method by the forward series of tests, which does require some type of Channel or Stage Analyzer or Vacuum-Tube Voltmeter. Notice however, that any trouble that can be shown up by the forward method can be discovered by the reverse method of signal tracing. Hence, the forward signal tracing procedure requires special equipment which will be a time saver if you do enough business to make it worth while, but otherwise you can get along very well with the basic equipment.

Assuming you have this basic equipment, you are probably wondering how you would

know which procedure to follow. It is possible to adapt a combination of these testing procedures which will quickly localize the trouble and to thus have a basic service procedure which can be used, regardless of the trouble.

BASIC SERVICING TECHNIQUE

Consider an average radio set such as the one in Fig. 1. We have a power supply, an audio amplifier, a 2nd-detector, an intermediate frequency amplifier, a 1st-detector and an oscillator stage.

The 2nd-detector is the separation point between the R.F.—I.F. system and the audio system. Hence, if we make some type of a disturbance test or signal tracing test at the control-grid of the 1st-audio tube, we can immediately determine whether the trouble is in the audio amplifier or ahead of that point. If the set had a tuning indicator, it could be used to give this indication—if it works normally, the trouble must be in the audio section, and vice-versa. Also, a measurement of the "B+" voltage at the output of the power supply will determine if that section is working properly.

Hence, 2 tests allow us to determine the condition of the power supply or whether the trouble is in the audio or radio frequency portion of the set. Then, one or two more tests in the defective section of the receiver will usually localize the trouble definitely to a particular stage or tube, where we can concentrate our testing efforts.

It is important that this basic procedure be learned, because it can be used regardless of the trouble and is a basis of the effect-to-cause method of diagnosing.

EFFECT-TO-CAUSE REASONING

This *effect-to-cause* system is simple—you just let the operation of the "radio" tell you where the trouble is! Then you can automatically choose the proper service procedure for that trouble. The method is just one of reasoning out the possible trouble from the action of the radio set, plus the results of a test or two.

Reasoning in this manner is the important habit developed by the truly successful Serviceman. An apprentice would have trouble trying to follow such a procedure. Two improperly-operating sets could be brought in and placed before an expert who would quickly locate the trouble. To a beginner, the indications may appear to be almost the same and he may be quite puzzled by the differences in procedure followed by the experienced man.

Just why a particular procedure would be adopted in each case depends upon the experience of that individual. He may have had the same trouble come up many times in the past in that particular model radio set, and thus from practical experience he may go right to the trouble. He may just have a "hunch." *This hunch is not just a wild guess,* it is the result of his brain automatically sorting out indications and arriving at a probable solution of the case. That is, something about the output of the set may tell him definitely that the trouble is in a particular section of the radio set and from this information or from one or two tests, he can then follow the method of checking which will most quickly localize the defective item. In many instances, this process may be so automatic that he would have difficulty explaining why he followed the particular procedure in preference to another.

In practically every instance, the experienced man will make measurements which yield the most useful information. Just why would a measurement of the screen-grid and plate voltage of the output tube be a fair

indication of the condition of the power supply, in preference to some other point? Look at the diagram in Fig. 1. Notice that the connection which is made most directly and through the least amount of resistance from the power supply is that of the screen-grid of the output tube. The plate of the output tube is connected through the output transformer which has low resistance. Hence, if these voltages are normal, then the output from the power supply must be normal. If these voltages are quite low, then something is the matter with the power supply or else there is quite an overload on it. This overload could be in the power output tube itself, which would mean that this output tube is either gassy or has a lack of bias. In turn, this lack of bias condition could be caused by a leaky coupling condenser.

Notice that if we tried to measure the plate voltage on any other tube in the set we would have additional resistance in the

circuit. With a high-sensitivity meter (5,000 ohms/volt or higher) this additional resistance would not be much of a handicap as long as the various bypass condensers were in good condition. However, as a practical case, look at condenser 26 which is an 8 mf. electrolytic. This condenser could be leaky so that the plate voltage on the 1st-detector and oscillator tubes, as well as the screen-grid voltage on the 2 intermediate frequency tubes, is way below normal. Because of the 4,700-ohm resistor 32, however, the plate voltages on the remaining tubes may be almost normal. Hence, a quick check of the output shows that the power supply is OK, and as this leaky condenser would cause weak reception or maybe a dead set, we would localize our trouble about the input. A quick check of the operating potential here would show it to be much below normal, which would lead us back to this condenser.

(Continued on following page)

GET RID OF CIGAR BOX CONFUSION!

HAVE THE RESISTOR YOU WANT RIGHT AT YOUR FINGER TIPS



FREE!...

THE IRC RESIST-O-CABINET

Here's an end to cigar boxes, tin cans, jars and other unsatisfactory make-shift methods of keeping resistors. The IRC Resist-O-Cabinet is specifically designed to hold resistors systematically and safely without bending of leads. It gives you a compact resistor "department" that puts any wanted resistor right at your finger tips and gives you a visual inventory of your resistor stock in a split second. Best of all . . . it's yours without one penny extra cost . . . with any of three factory-packed IRC Resistor assortments.

IRC Type BT Metallized have won acknowledged leadership in every mechanical and electrical characteristic. They're always dependable—they stay put. 1/2-, 1- and 2-watt sizes in all ranges. Insist on IRC's and be sure to get the FREE Resist-O-Cabinet! Your jobber has yours ready.

INTERNATIONAL RESISTANCE CO.

401 North Broad Street

Philadelphia, Pa.



INSULATED Metallized RESISTORS

•SERVICING•



MODERN Radio SERVICING

Learn How with this!

Here's the world's most highly praised course in practical radio service work—all for you in this one handsome, 1300-page, home-study book. First, a big 420-page section explains all types of servicing test instruments—how they work, how to use them—also, how to build your own. Then, 900 more pages give you a thorough, step-by-step procedure in trouble-shooting, testing, aligning and repairing all makes of radio sets and other electronic devices by latest scientific "factory methods." Learn radio servicing this quick, easy, economical way. Learn WHAT to do and HOW to do it. Send for your copy today. Use the coupon below! 1300 pp., 708 illus., 720 review quest. \$4



RADIO Trouble-Shooter's HANDBOOK

Save Time with this!

Here's real help for servicemen—618 big, manual-size pages of valuable, time-saving, factory-checked servicing data right at your fingertips to help you do every servicing job quickly and accurately. It's 52 BIG SECTIONS contain 275 large pages of time-saving "case histories" on over 2,300 receivers. Alignment data for over 15,000 superhets. Servicing and installation data for all Auto Radios... Trouble-Shooting Charts... Tube, Resistor and Condenser Charts... EVERYTHING! Speed up your service work with all the vital servicing data NOW! \$3 In this one big book. 518 pp., 134 illus., 8 1/2 x 11 size.



CLIP OUT! MAIL NOW!

Radio & Tech. Publ. Co., Dept. RC-91
45 Astor Pl., New York
Enclosed find payment for:
 MODERN RADIO SERVICING RADIO TROU. SHOOT. REPAIR HANDBOOK BOTH books at \$8.50 Money-Saving Combination Price

NAME _____
ADDRESS _____
CITY _____ STATE _____

MONEY-BACK IF NOT SATISFIED!

DATAPRINTS

TESLA-LOUDIN COILS

20c Ea. in order for 10 (Data and Drawings only.)
36" Sp'k Tesla-Oudin Coil 40c (1 K.W. Exc. Trf. Data incl.)
8" Sp'k Tesla-Oudin Coil 40c (1/4 K.W. Exc. Trf. Data incl.)
3" Sp'k Oudin; 110 Vt. "Kick Coil" type.....40c
3" Tesla Works on Ford Coil.....40c
1" Sp'k Vibrator Hi-Freq. Coil 40c

NEW! 5 ft. Sp'k. Oudin Coil & Exciter Data75c

Induction PIPE & ORE LOCATOR

Induction Type, Data40c
Radio Type40c

More DATAPRINTS 40c each!

- | | |
|--------------------------|-------------------------|
| 5 Meter Superhet. | Electric Refrigerator |
| 1/2 Meter Tr. & Rec. | Wheatstone Bridge |
| 20 A.C. Probs. & Ans. | Weld. Transf. 2 K.W. |
| 20 Telephone Hook-ups | Rewinding Armatures |
| 100 Mech. Movements | String Galvanometer |
| 20 Motor Hook-ups | 20 Simple Bell Circuits |
| Television Hook-up | Steel Wire Recorder! |
| 20 Elec. Party Tricks | Water Wheels |
| Solenoids and Magnets | Water Turbines |
| —get list. | Photo Cell and Relay |
| Fry Eggs on Ice! | Ring 4 bells: 2 Wires |
| Experimental Photophone | 20 Tesla Tricks |
| Radio Control for Models | Polarized Relay |
| Diathermy Apparatus | Induction Balance |
| Inductor Organ | Electric Pipe Thawer |

Special Prices: 4 prints \$1.00; 10 for \$2.00; Single, 40c each. Get New Catalog 100 A.

The DATAPRINT Co.
Lock Box 322D, Ramsey, N. J.

(Continued from preceding page)

EXAMPLES OF EFFECT-TO-CAUSE REASONING

(1) *Dead Receiver.* As an example of effect-to-cause reasoning, consider a "dead" receiver. Regardless of the cause of the receiver being dead, the circuit disturbance test is the logical procedure to follow. This permits the trouble to be localized to some one particular stage or section of the radio set as quickly as possible, even without connecting up the test equipment.

For instance, if we don't get a click when we pull out the output tube, the trouble is obviously in this stage, in the speaker or in the power supply. A quick voltage measurement for plate and screen-grid voltages would determine whether the trouble was in the power supply or not. If both plate and screen-grid voltages are present, the trouble must be in the tube, the output transformer or the speaker. Of these 3 items, the tube would be the next most logical item to test, and finally the output transformer and the speaker.

Remember when we measured the plate voltage, we automatically checked continuity through the output transformer primary and also found out that bypass condenser 49 was not short-circuited. If the transformer was open or this condenser short-circuited, we would not have had plate voltage. You see, a voltage measurement is not only a test showing how much voltage is present, but even more important, this test shows whether or not proper continuity exists.

For instance, a very frequent trouble resulting in a dead receiver is a lack of screen-grid voltage on the I.F. tubes. If our circuit disturbance test leads us back to the 2nd I.F. tube, a quick check of plate and screen-grid voltage may show a lack of screen-grid voltage. Now, an ohmmeter between screen-grid and set chassis would probably show that condenser 33 is broken down. Resistor 27 could also be open, which could be checked with an ohmmeter back to the "B+" circuit, but notice that I made the check from screen-grid to chassis. Why? Because the bypass condenser breakdown is the more common of the two troubles.

If our circuit disturbance test leads us to the 1st I.F. stage instead of the 2nd, you might think that again we have a lack of screen-grid or plate voltage. However, notice from the circuit that any trouble that would remove these voltages from the first tube would also remove them from the second except for an open in intermediate frequency transformer 29. Hence, a lack of plate voltage on the 1st I.F. stage would probably mean that this transformer is open. A measurement of correct voltage at the 2nd I.F. plate, would prove we were right.

Of course, if you wish, you could follow the signal tracing procedure instead of the circuit disturbance test. This is certainly permissible, but it takes more time to do it. If the trouble is near the output, the reverse method would show it more quickly than the forward method, and vice-versa. Therefore, since the method of signal tracing depends mostly upon the equipment you have, you might happen to be following the wrong procedure for any particular trouble, which means that you have practically an even chance of spending more time than necessary in locating the trouble.

(2) *Distortion.* Considering distortion as another trouble, we would in all probability find that this distortion is an audio trouble or is caused by the output filter condenser. The voltages are usually, but not always affected.

For instance, a leaky coupling condenser 47 could cause distortion and voltage measurements would show this up, because this would make the grid positive, causing the output tube to draw high current, thus causing low plate voltage. Also, measurement of the control-grid voltage on this tube would show up this leaky condenser, because the grid would be positive or there would be a voltage drop across resistor 48, where we would not expect to find one.

On the other hand, an open output filter condenser will cause a loud hum, loss of low notes which results in distortion and may perhaps result in weak reception by causing inaudible oscillation in some stage. This would not be shown up by an analyzer method, however, nor would the point-to-point voltage measurement mean anything, because the voltages would not be affected. Here is a case where observations of the set action are important. Notice the defective output filter condenser causes hum, oscillation and weak reception as well as distortion, so if we find all these clues along with the distortion, we should check the condenser first.

(3) *Noise.* A noisy set or one with hum in one of the stages may be found. The circuit elimination test is quite logical for finding the defect, as removing the tube in the defective stage stops the noise or hum.

What causes noise anyway? Any sudden or sharp change in current causes noise in the output. Hence, an intermittent contact in any circuit carrying current results in noise. Notice that this contact can be anywhere in the circuit and can even be in one of the parts, such as in a tube, resistor, condenser, coil or a connection. In coils particularly, it is caused by electrolysis (corrosion).

Suppose we pull out a tube and the noise stops. How can we tell if it is in the plate or the grid circuit? If it is a plate circuit trouble, it would show up whenever current flows. So, remove the tube, then connect a resistor between the plate terminal of the tube socket and the cathode socket terminal so current can flow through the plate circuit parts. Use about a 10,000-ohm, 10-watt resistor in a power output stage or about a 50,000-ohm, 1-watt resistor in other stages. (This test does not apply to a rectifier tube—the filter condensers would be ruined.)

If the noise is caused by plate circuit trouble, it will now show up. Otherwise, insert the tube and short-circuit the control-grid signal input circuit. If the noise is still there, then the tube or one of the other circuits (screen-grid, cathode or filament) is at fault. Incidentally, don't short-circuit the bias supply when you make this grid circuit short. For instance, a short-circuit across resistor 48 in Fig. 1 will kill the signal input circuit of the output stage, but does not affect the bias to the type 41 output tube.

A similar circuit elimination or circuit muting procedure can be followed to locate hum.

(4) *Intermittent reception.* An intermittent condition is sometimes the hardest to find, but signal tracing methods can be used to indicate the defective section quickly. You can leave your signal tracer connected to the 2nd detector, for instance, and determine if the trouble is ahead of this point. That is, if the signal fades in your indicator as well as in the output, then it is between the antenna and this point. Otherwise it is between the signal tracer connection and the loudspeaker. Now, you can move the signal tracer in the correct direction, toward the location of the trouble, until you pass through the defective stage.

The signal substitution method can also be used for intermittent receivers if the set

is very intermittent. This method is not so good where the trouble only shows up once in a while, however, particularly with battery-operated signal generators, as you may have to leave the signal generator on so long that its batteries are run down. Unless the set goes dead and stays dead, the circuit disturbance or stage elimination tests could not be followed, because pulling a tube will generally shock the set back into operation.

With a sensitive voltmeter, it is possible to make a number of practical tests for intermittent trouble. With a voltmeter having a sensitivity of 5,000 ohms/volt or more, you can leave the meter connected across the automatic volume control circuit of the set. If the intermittent condition is between the antenna and 2nd-detector, then the A.V.C. voltage will change, thus indicating the defective section. (Watch the tuning indicator if one is used.) Also, if you suspect the trouble is a power supply circuit trouble, you can leave a voltmeter connected temporarily across the power supply circuit. If the voltage changes, this will be indicated by the meter.

Intermittent fading is just a case of weak reception which occurs at intervals. If you know what can cause weak reception in the defective section, you have an important clue as to the trouble. Be particularly suspicious of bypass condensers opening up. The case of a tubular condenser can be twisted with the fingers to check this, as the open usually is at the terminals. Also, a wooden dowel or rod can be used as a probe to move wires and parts. Don't be afraid to pull on leads. If you can cause the trouble to appear with any of these tests, then replace that part regardless of how it tests, and again try out the set.

CONCLUSION

Now, in conclusion, several points should be remembered. Don't "get in a rut" and try to service by only one of the 6 basic methods; use a combination of these methods

which will locate the defective stage in the quickest possible manner. Don't be afraid to experiment with methods, try them all. Adapt them to your particular equipment and personal preferences.

Remember to deal with probabilities, that is, learn to go directly to the most probable defective item first, then proceed to localize the defective stage if your first thought is wrong.

Each fault has its own characteristic sound which cannot be described, but can be recognized after being heard a few times. You can soon learn the difference between a leaky coupling condenser sound and a voice coil rubbing on a field pole. They both cause distortion, but they certainly sound different.

The teaching plan for gaining practical experience, described in at least one school course, is very important as it helps to give you this experience of actually hearing the sound produced by various defects. If you carry out this plan faithfully, you will introduce various defects in a receiver and listen to its output. Then you can try all of the service methods and see just which one locates the trouble the quickest.

Of course, we are not trying to help you service quickly just to astonish your customers. The quicker you can service a set, the more "radios" you can repair in a given length of time, and hence the greater can be your earning capacity. This is true whether you operate a spare time or a full-time business. The man who has to test every part in a radio receiver before he finds its trouble certainly cannot earn very much because he cannot handle enough receivers a day. Of course, when you are just starting out, you are bound to encounter a few unusual troubles which will take you hours or days to clear up. However, as your practical experience increases, you will find that even the most difficult troubles may be located quickly.

OPERATING NOTES

(Continued from page 147)

condensers. These are 0.01-mf. units both enclosed within a small metal-clad tubular case located under the chassis to the rear of the opening in chassis for the silent tuning plate. The metal case of the unit is a common terminal which is grounded. Instances of intermittent reception where operation may be made to stop or start abruptly by striking the chassis near this condenser is due to poor internal contact within the unit. Upon some occasions, oscillation may be experienced at the low broadcast frequencies. A 0.05-mf. bypass condenser substituted for either or both secondary-return bypass condensers should remedy this condition.

In this model, the complaint of hum or distorted reproduction has been traced to the loss in capacity of some of the sections of the plug-in type filter condenser block, or to leakage of and between sections. It is at the base of condenser block plug, both within the unit and externally, and on the socket, that leakage exists due to leakage of the block and formation of a white salt deposit of a low-resistance nature. This block, whose internal connections are shown in Fig. 8, is equipped with an 8-prong plug which fits into an 8-hole socket on the chassis and is held in position by a shield case. Replacement of the entire block is unnecessary once the leakage path is found, and those sections causing the trouble may be disconnected from the circuit and new condensers installed beneath the chassis.

STROMBERG-CARLSON 68

When the tone control on this model is exceedingly noisy, and the receiver becomes inoperative with the tone control in the extreme Bass position, the trouble is definitely due to a leaky or short-circuited 0.2-mf. tone control condenser. Since this receiver is composed of 2 units, a tuner unit and an amplifier chassis, with the tone control mounted on the tuner unit, the error is often made of looking for this condenser in the tuner unit. The former, however, is one section of a dual condenser unit located in the amplifier chassis near the 85 tube socket under the chassis. Both these sections are connected in the 85 tube plate circuit as shown in Fig. 9.

As with the model 64, an inoperative receiver with the symptom of red-hot 5Z3 plates, or where fuses continually burn out, points to a short-circuited or leaky 1.3 mf. input filter condenser contained within the push-pull input transformer assembly. A replacement unit for external mounting is being supplied by the manufacturer on early models of this series. Later models have this filter condenser mounted in a separate housing upon the chassis.

A strong 60-cycle hum with the additional symptom of a noisy tone control when the latter is rotated may be experienced with this model. This condition may appear as soon as the line switch, which is

(Continued on page 169)

BUT WHAT OF Tomorrow?

"All-out" production to meet today's pyramiding orders does not mean that Triplet has lost sight of the broader requirements of tomorrow. Instead, research and engineering programs actually have been "stepped-up" to assure constant improvements in products and processes; in addition to needed developments in new fields.

Today's demands are important, but the needs of tomorrow cannot be slighted—and are anticipated in never flagging engineering and research developments. You have assurance that in the months and years to come, new Triplet products will serve in expanded fields, where they will merit values and savings for every dollar spent in their purchase.

THE TRIPLET ELECTRICAL INSTRUMENT CO.
Bluffton, Ohio



FREE!

HAMMARLUND NEW "41" RADIO CATALOG

The latest Hammarlund catalog with complete data, illustrations, drawings and curves on the entire Hammarlund line. Address Department RC-9-1 for your free copy.

HAMMARLUND MFG. CO., INC.
424-438 West 33rd Street, New York City

Simplest WAY TO REPLACE BALLASTS

4 STANDARD TYPES of Amperite Regulators replace over 200 types of AC-DC Ballast Tubes now in use. Has patented automatic starting resistor. List \$1.00.

WRITE FOR REPLACEMENT CHART "S"
Amperite Co. 561 Broadway, N. Y. C.

AMPERITE

FREE! RADOLEK'S 1941 RADIO PROFIT GUIDE

Everything New in Radio at Bargain Prices! Radio parts—Sets—Accessories—Ham gear—Electric appliances and supplies—Public Address Systems. Don't Wait—Send for the Big FREE Radolek Profit Guide Now! Save Money at Radolek.

RADOLEK CO., Dept. C-58
601 W. Randolph St., Chicago, Ill.

GENERAL ELECTRIC MODEL LB-530 RECHARGEABLE-BATTERY (A.C./BATTERY) PORTABLE

Five-Tube Superhet.; Broadcast Band (550-1,750 kc.); A.C. or Battery Operation; 2-V. "A" Storage Cell; No "B" Batteries (Vibrator "B" Supply); Built-in Charger (Copper-oxide Rectifier); 5-in. P.M. Dynamic Speaker; Dynamic Volume Control; Power Output, 225 Milliwatts; "Beam-a-Scope" (loop) antenna (built into top cover), with External Window Antenna furnished (coiled alongside power unit); wgt., 17 lbs. (Supplementary cable available for charging from 6-V. car battery.)

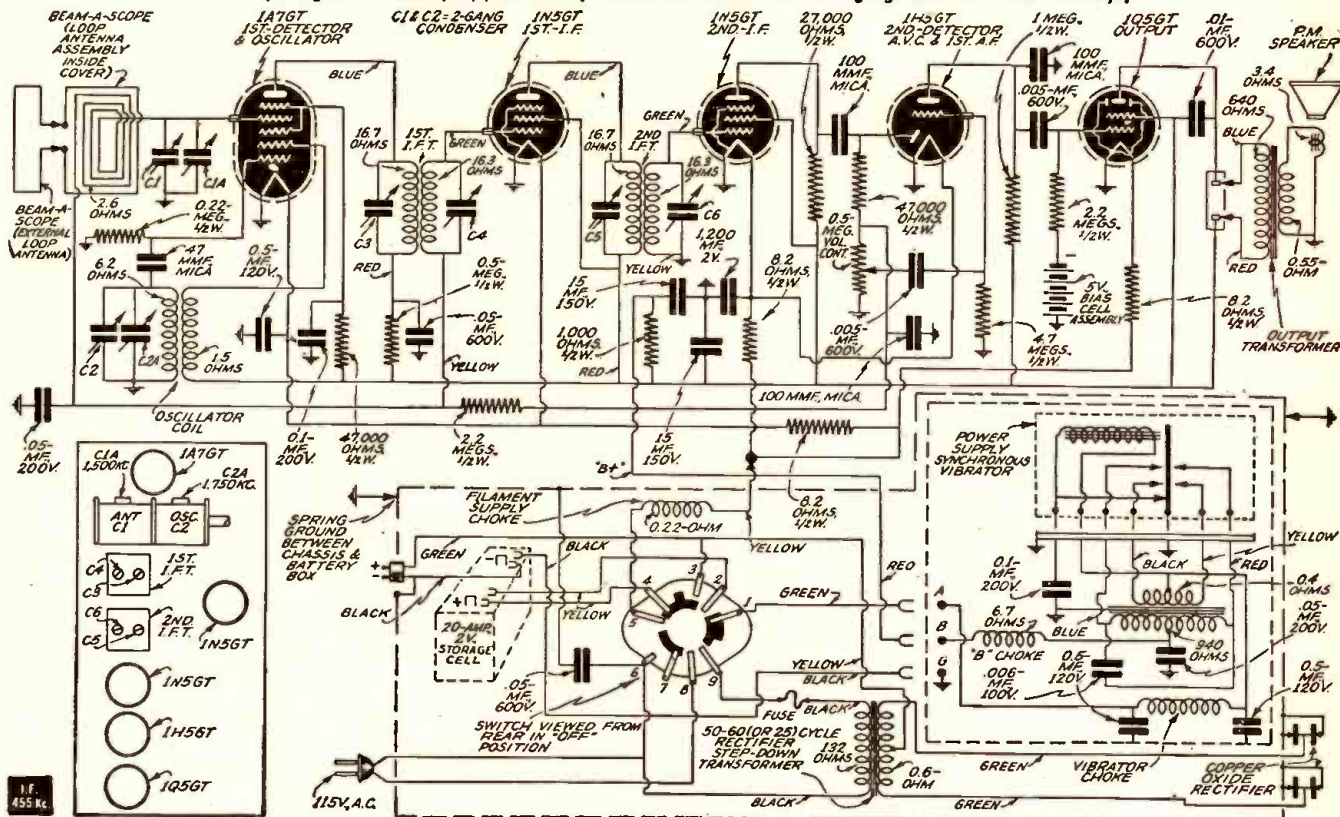

G.E. LB-530 Portable diagram. Its lead-coated steel case both shields and acid-proofs the vibrator pack, storage cell and its charger transformer.

I.F. ALIGNMENT

Connect an output meter across the voice coil. Turn volume control to maximum. Set test oscillator to 455 kc. and keep oscillator output at just-readable meter reading level. Apply signal to 1A7GT converter grid through 0.05-mf. condenser and align progressively the trimmers in the 2nd and 1st I.F. transformer cans.

R.F. ALIGNMENT

Adjust the signal generator to 1,750 kc. and loosely couple a wire from the output terminal of the signal generator so that the receiver loop will pick up the signal. Set the gang condenser to minimum capacity and adjust the oscillator trimmer, C2A, to receive the signal. After this has been done, set the signal generator to 1,500 kc. and tune the receiver until this signal is tuned-in. Adjust the R.F. trimmer 1A for maximum output. In case of bent plates in the condenser, set generator and set to 600 kc. and bend plates for max. output.

SPECIAL SERVICE INFORMATION

The following service information will be very useful in servicing receivers if a vacuum tube voltmeter, or equivalent, is available.

- (1) Stage Gains, $\pm 10\%$:
Short A.V.C. to chassis ground.
1A7GT grid to 1st IF grid. 40 at 1,000 kc.
1A7GT grid to 1st IF grid. 57 at 455 kc.
2nd IF grid to 1H5GT diode plate 8.5 at 455 kc.
- (2) Audio Gain, $\pm 10\%$:
0.08-volt, 400-cycle signal across volume control with control set at maximum, will give 50 milliwatts speaker output.
- (3) D.C. developed across oscillator grid resistor R2 averages 6.5 volts at 1,000 kc.
If a weak signal is weakened when the plugs of the External Window Antenna are inserted, reverse the plugs, to correct the phasing. Changing the position of the set, after this operation, may require re-phasing.

CHARGER CHARACTERISTICS

Replace fuse only with a $\frac{1}{4}$ -amp. G.E. Cat. No. 2548 fuse or its equivalent.

If one or more of the copper-oxide discs of the rectifier unit are defective, the charger will not operate properly. To test the rectifier unit operation, proceed as follows: Remove the 2 black leads from the negative terminal

of the battery and connect a D.C. ammeter which will read 2 amperes, in series with these leads to the negative terminal of the battery. Plug the power cord into an A.C. supply and turn the power selector switch to the "Charge" position. With the A.C. line voltage at 117 volts, the average charging current should read about 1.35 amperes at 2.1 volts battery. If line voltage is greater or battery voltage is lower than 2.1 volts the charging current will be greater. If the current is much less than this value at the rated line of 117 volts, one or more of the copper-oxide discs may be defective.

To check individual discs, the following tests are suggested. In the conducting direction, the rectifier disc should pass 0.5-ampere or more when $\frac{1}{2}$ -volt is impressed across the disc. Note: The copper-oxide rectifier disc conducts when the positive potential is applied to the copper-oxide surface. The copper-oxide is a dark blue coating, plated with nickel to afford good surface contact to the oxide.

If a D.C. ammeter is not available for measuring currents as high as 0.5-ampere, the circuit shown in Fig. 1 can be used for this check. This method requires that the resistance of 2.75 ohms be made fairly accurate and is placed in series with the rectifier disc and placed across the 2-volt storage battery. The voltage should always read 0.5-volt or less; if the voltage exceeds 0.5-volt across the disc in this circuit, it indicates a defective disc.

The reverse current flow is as important as the above test and is made as follows: Reverse the battery polarity in the above test circuit and place a milliammeter that will read 10 milliamps. in series with a lead to one of the battery terminals. This reverse current should not exceed $2\frac{1}{2}$ ma. at the applied voltage of 2 volts. If the current is considerably above this value the disc should be discarded. Precaution—A suitable meter fuse should be used in series with the milliammeter to prevent damage to the meter in case the disc under test is shorted. A rough check, if a milliammeter is not available, is to measure the resistance of the disc in the non-conducting direction on the low-resistance tap ($1\frac{1}{2}$ volts) of the ohmmeter. The resistance should measure at least 750 ohms.

Cell must be installed before set is used in any position of the Power Selector Switch.



G.E. LB-530 Portable. A 2-V. storage cell delivers "A" voltage and drives "B" vibrator.

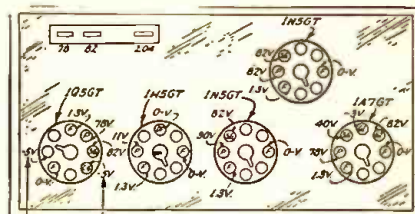

BIAS BATTERY—MEASURE WITH ZERO CURRENT VOLTMETER ONLY.
POWER SWITCH ON "A" & "B" WITH CHARGER OPERATING.
BATTERY VOLTAGE—2.1 VOLTS.
VIBRATOR "B" VOLTAGE—35 VOLTS.
OHM AT 1000 KC. ZERO SIGNAL, ZERO VOLUME.
ALL MEASUREMENTS EXCEPT BIAS BATTERY AND FILAMENT MADE WITH 1000 OHMS PER VOLT VOLTMETER, 150 VOLT SCALE.

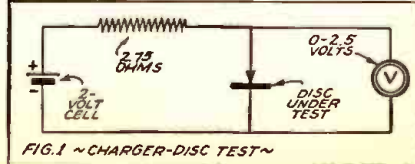
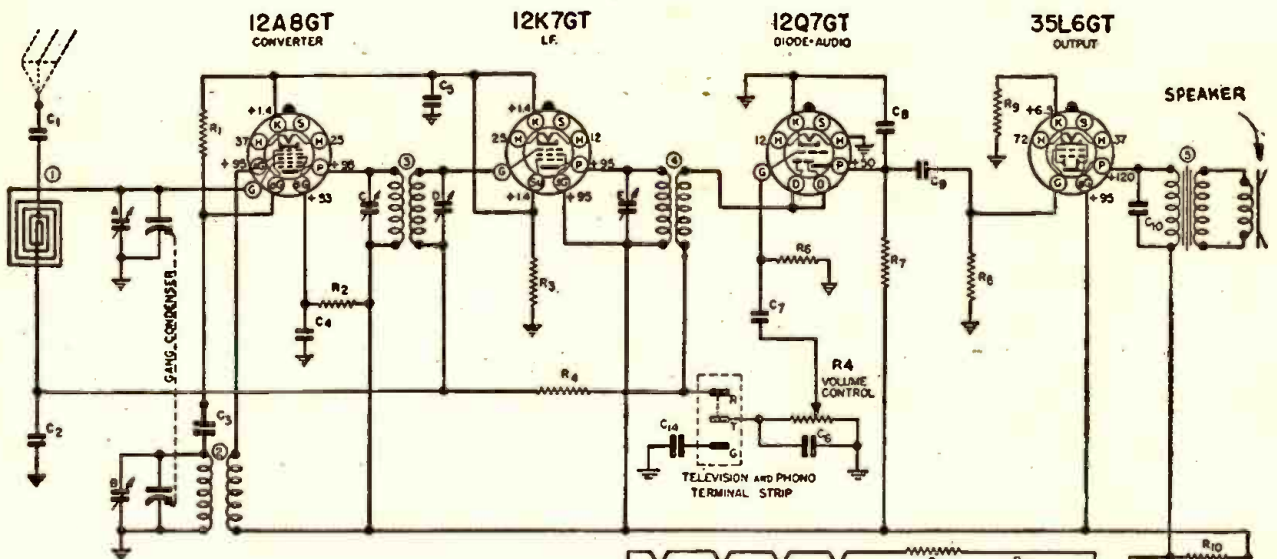

FIG. 1 ~ CHARGER-DISC TEST ~

KNIGHT (ALLIED RADIO CORP.) MODEL A 10800

Five-Tube Superhet.; Extended Broadcast Band (535 to 1,720-kc., including Police Channel); Automatic Volume Control; Mechanical Automatic Pushbutton Tuning for 4 Stations; Phono (and Television-Sound) Connection; Built-in Loop Antenna; A.C./D.C. operation.



DIAG. NO.	PART NO.	DESCRIPTION	DIAG. NO.	PART NO.	DESCRIPTION
R 1	N-1260	30,000 OHM .5W 20%	C 7	N-1344	.01 MFD. 400V.
R 2	N-1627	20,000 OHM .5W 20%	C 8	N-1447	0005 MFD. 400V.
R 3	N-1742	25 OHM .3W 20%	C 9	N-1344	.01 MFD. 400V.
R 4	N-1262	1 MEGOHM .5W 20%	C 10	N-1376	.02 MFD. 400V.
R 5	N-2087	0.5 MEGOHM VOL. CONT.	C 11	N-2005	20 MFD. 150V. ELECTRO.
R 6	N-1263	10 MEGOHM .3W 20%	C 12	N-2005	35 MFD. 150V. ELECTRO.
R 7	N-1377	200,000 OHM .5W 20%	C 13	N-1346	.05 MFD. 400V.
R 8	N-1264	500,000 OHM .3W 20%	C 14	N-1344	.01 MFD. 400V.
R 9	N-1616	250 OHM .3W 10%			
R 10	N-1617	2500 OHM .3W 20%	1	N-2123	ANTENNA COIL LOOP
R 11	N-1614	50 OHM .3W 20%	2	N-1452	OSCILLATOR COIL
R 12	N-1618	80 OHM 2W 10%	3	N-1598	1ST I.F. TRANSFORMER
			4	N-4596	2ND I.F. TRANSFORMER
			5	N-2014	6" PM SPEAKER & TRANS.
			E	N-4597	2ND I.F. TRIMMING COND.
C 1	N-1344	.01 MFD. 400V.			
C 2	N-1345	.05 MFD. 200V.			
C 3	N-1342	50 MMFD.			
C 4	N-1343	.05 MFD. 200V.			
C 5	N-1351	.1 MFD. 200V.			
C 6	N-1376	100 MMFD.			

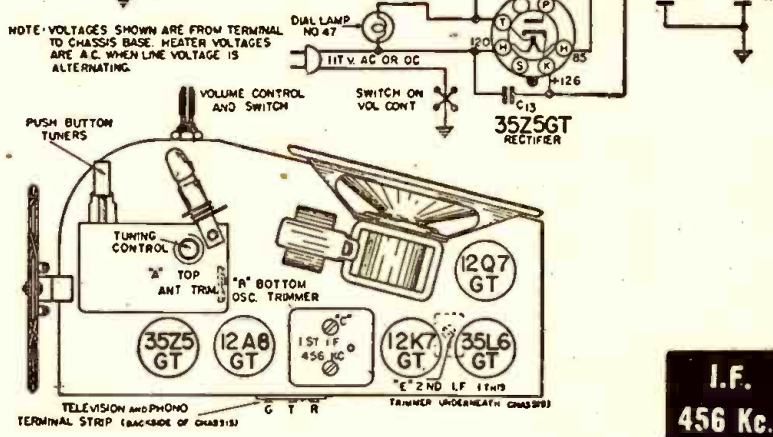

I.F. 456 Kc.

ALIGNMENT PROCEDURE

GENERAL DATA. The alignment of this receiver requires the use of a test oscillator that will cover the frequencies of 456, 600, 1,400 and 1,720 kc. and an output meter to be connected across the primary or secondary of the output transformer. If possible, all alignments should be made with the volume control on maximum and the test oscillator output as low as possible to prevent the A.V.C. from operating and giving false readings.

CORRECT ALIGNMENT PROCEDURE. The intermediate frequency stages should be aligned properly as the first step. After the I.F. transformers have been properly adjusted and peaked, the broadcast band should be adjusted.

I.F. ALIGNMENT. With the gang condenser set at minimum, adjust the test oscillator to 456 kc. and connect the output to the control-grid of the 1st-detector tube (12A8GT) through a 0.05- or 0.1-mf. condenser. The ground on the test oscillator should be connected to the chassis ground. Align all 3 I.F. trimmers to peak or maximum reading on the output meter.

BROADCAST BAND ALIGNMENT. Remove chassis from cabinet and set it up on the test bench taking care to have no iron or other metal near the loop. Do not make this set-up on a metal bench.

Connect the test oscillator to the antenna of the set through a 200 mmf. condenser. With the gang condenser set at minimum capacity, set the test oscillator at 1,720 kc., and adjust the oscillator (or 1,720-kc. trim-

mer) on gang condenser. Next—set the test oscillator at 1,400 kc., and tune-in the signal on the gang condenser. Adjust the antenna trimmer (or 1,400-kc. trimmer) for maximum signal. Next set the test oscillator at 600 kc., and tune-in signal on condenser to check alignment of coils.

OPERATING VOLTAGES

Voltages shown on the circuit diagram are from socket terminals to chassis base. In measuring voltages use a voltmeter having a resistance of at least 1,000 ohms/volt. Allowances should be made for variations in line voltage.

ADJUSTMENT OF AUTOMATIC TUNING

ADJUSTMENT. All adjustments are simply made from the front of the cabinet using an ordinary screw driver.

To make adjustments remove all 4 buttons which pull off readily. The center buttons should be removed first since by depressing the adjacent buttons with thumb and finger a firm grip may be secured on either center button. The side buttons can then be easily removed.

Loosen the screw of the desired button and with the manual tuning knob tune to any desired station. Hold the manual tuning knob in position and depress the button shaft as far as possible. With the button fully depressed tighten up the screw firmly.

Be sure the pushbutton knob is held down in position while being tightened.

After the stations are adjusted it is advisable to check each button to assure sufficient tightening.

To assure accurate adjustment, the volume

control should be set at a moderate level and the station tuned in slowly to a point of maximum volume and clarity.

It is not necessary to follow any particular sequence of stations since each button is adjustable to any station.

With each button definitely set and securely tightened to the properly selected station, the tuner is ready for operation.

OPERATION. With the set turned on to a moderate level of volume, the automatic tuner is operated by merely pressing a button set to the desired station.

Station selection may be made automatically or manually at will since the manual tuning control operates free and independent of the automatic unit.



Knight Model A 10800 A.C./D.C. Receiver.

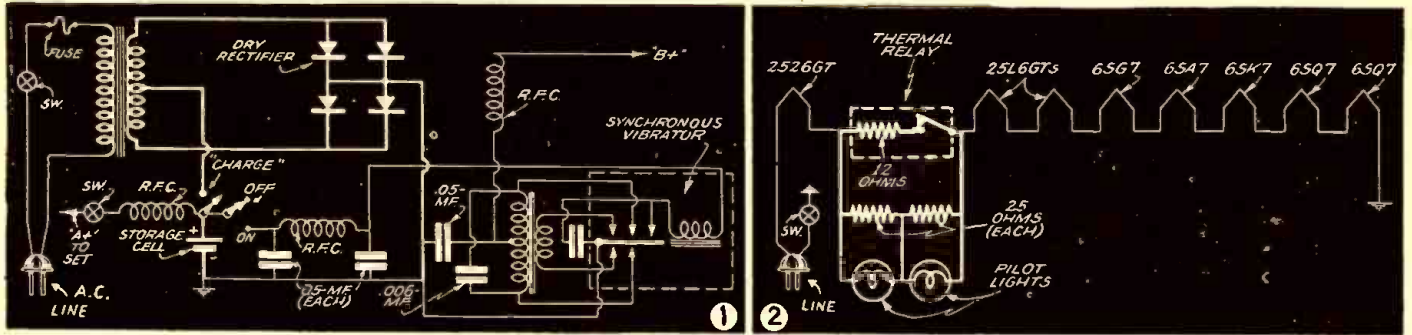

NEW CIRCUITS IN MODERN RADIO RECEIVERS

In this series, a well-known technician analyzes each new improvement in radio receiver circuits. A veritable compendium of modern radio engineering developments.

F. L. SPRAYBERRY

No. 48



(FIG. 1.) STORAGE CELL SUPPLIES ALL POWER FOR PORTABLE SET

GENERAL ELECTRIC LB-530.—A single 2-volt lead cell of 20 ampere-hour capacity operates five 1.4-volt filaments directly and powers a synchronous vibrator for high voltage, and is rechargeable from an A.C. line either during operation or when the set is out off.

A simplified circuit in which the operating selector switch has been indicated as separate switches, is shown in Fig. 1. The cell is charged by means of a step-down transformer operating a full-wave, double-section, back-to-back dry-disc rectifier at about 1.4 amperes. The charge may be continued while the set is in operation, the storage cell acting as a filter due to its constant voltage and low internal resistance properties. The charging rate just barely exceeds the total set drain so that in use the battery will remain at full charge. The set may be used for about 15 hours as a completely portable set; the storage cell is non-spillable, and uses "pill-type" specific gravity indicators.

(FIG. 2.) FILAMENT PROTECTIVE RELAY FOR A.C./D.C.-SET PILOTS

RCA 28X.—The pilot light circuit remains shorted until the filaments of the set proper, near operating temperature.

The relay is of the thermal type so that the pilot circuits (see Fig. 2) will remain

shorted until the other filaments nearly reach operating temperature. A satisfactory time delay is acquired by designing the relay so that for the usual filament current, the proper heat will develop in this time to open the pilot circuit.

The reason why the pilot lights will frequently burn-out otherwise is that they carry less current than the entire filament circuit (each being shunted by fixed resistors to carry the balance of the current) and reach full brilliance almost immediately. In this condition their resistance is maximum, a characteristic of tungsten filaments, while the other filaments have relatively low resistance until properly heated. This means that an excessive voltage will remain across the pilot lights until the other tubes reach operating temperature. Many of them will not stand up under the excessive voltage. The thermal relay thus permits more rapid heating of the regular filaments due to greater applied voltage and impresses voltage across the pilot filaments only when it will be of the correct value.

(FIG. 3.) F.M. "WIRELESS" RECORD PLAYER USES SIMPLIFIED CIRCUIT

GENERAL ELECTRIC JM-31.—A simple reactance-tube input modulator is used with an U.-H.F. oscillator for record playing by direct pick-up on any Frequency Modulation receiver.

The main oscillator coil, Fig. 3, is per-

meability adjusted but tuned by the distributed capacities of the tubes and circuit. The series resistor R10 is to prevent the reduction of "phase rotation" between the grid and plate of the modulator (1853) at low input signal levels. This method of connection permits a simpler tube and circuit to be used.

(FIG. 4.) SELECTIVE DEGENERATION BY CONDUCTIVE CATHODE COUPLING

ZENITH 5R680.—Two succeeding cathodes in any capacity-coupled amplifier will carry signals of reverse phase if not bypassed, and any network connecting them of negligible phase angle will produce degeneration.

The network in this case as in Fig. 4, is a resistance-capacity network of negligible phase rotation at low frequencies. In addition to this the relative voltage fed back at low frequencies is progressively high as the frequency is reduced and of no consequence at high frequencies. The degeneration is therefore maximum at low frequencies for this circuit, rapidly reducing as the frequency rises.

(FIG. 5.) OUTPUT CIRCUIT USES SERIES PUSH-PULL PRIMARIES

RCA 211K.—Using series primary sections permits more favorable impedance regulation for all frequencies, permits the high- and low-frequency loudspeakers to be

(Continued on page 171)

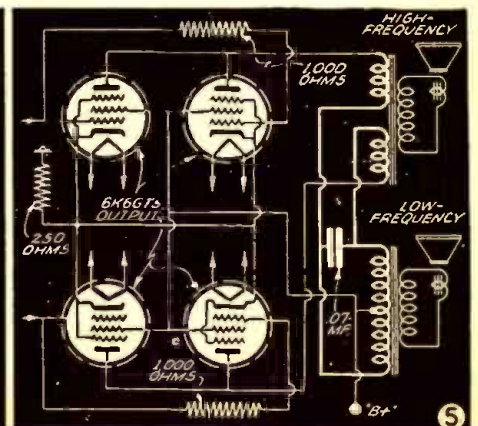
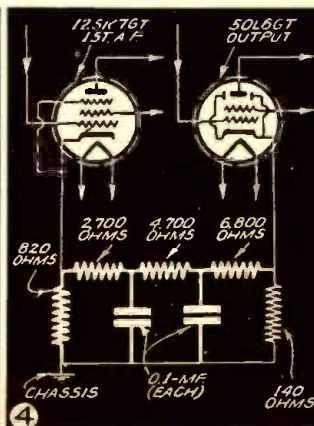
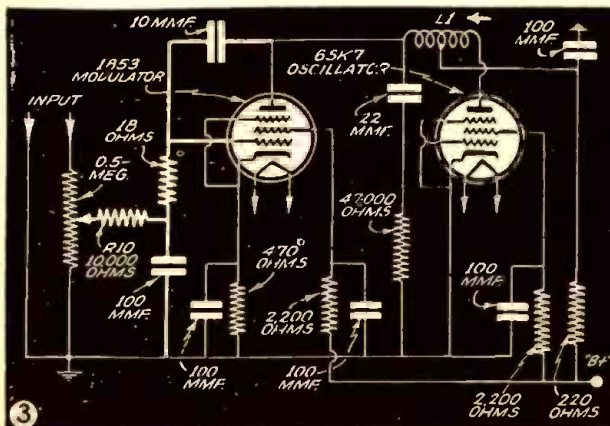

F. M. SERVICE

Entirely new problems daily face radio Servicemen called upon to install and maintain Frequency Modulation receivers. A well-known radio technician calls upon his wealth of practical experience to here present the answers to many of these servicing puzzlers. This initial article presents practical information on F.M. signal pick-up problems; a following article will deal with the actual F.M. receivers.

BERTRAM M. FREED

PART I

Antenna Installation and Service

THE advent and increasing popularity of Frequency Modulation receivers have presented new problems to the radio technician. Frequency Modulated receivers require installation and service adjustments somewhat different from standard procedures. Knowledge of these differences is essential to develop and apply these new techniques.

From a standpoint of design and circuit arrangement, F.M. receivers are similar to those with which we are already familiar. It is the fact that F.M. receivers operate on ultra-highfrequencies, that new considerations are introduced, considerations involving antenna installation, receiver alignment, oscillator stability, and insulation leakage. To facilitate discussion of the subject, the material herein is presented in 2 installments, Part I—Antenna Installation and Service, and, Part II—Receiver Service.

RECEPTION CONDITIONS ON F.M. BAND

To understand and appreciate the importance of a suitable antenna and its proper installation, a brief explanation of transmission and reception conditions on the 42-50 megacycle band is of consequence.

The strength or signal level and distance over which signals are received at the antenna depends upon several factors: power of transmitter, location and type of antenna, time of day and season of year. The theory of radio wave propagation most generally accepted is that advanced by Professors Kennelley and Heaviside, in which 2 radio waves are radiated from a transmitting antenna, (a) the ground or surface wave, and (b) the sky wave.

The surface wave follows the curvature of the earth and is absorbed by the earth, metallic deposits, steel buildings, hills, trees, and bodies of water. However, the surface wave is steady and reliable in that it travels an equal distance both day and night. When waves of a high frequency are transmitted, less of the radiated energy is transformed into surface waves (possibly because it is absorbed faster by the earth) and more of the energy is changed into the sky wave. This latter wave does not follow the surface of the earth, but travels in straight lines and behaves much like light and radiant-heat waves.

The sky waves travel out from the earth in all directions and are thought to encounter layers of ionized gas in the earth's atmosphere or ionosphere. These layers of gas reflect and bend a portion of the sky wave back to earth, so that signals may be received at considerable distances far beyond the range of the surface wave. Part of the sky wave is also absorbed or passes

directly through into the ionosphere. The amount of reflection and absorption of the sky wave is dependent upon the density and ionization of the gas layers, caused by ultra-violet radiation from the sun, which ionizes the gas molecules and produces free electrons. Since the degree of radiation from the sun and its influence is a variable factor changing with the time of day and season, the density and height of the "Heaviside Layer" above the earth is altered. For this reason, the amount of energy reflected or refracted to earth and the angle to which the waves are bent is likewise a variable factor.

The degree of reflection of the sky wave also depends upon the frequency. The higher the frequency of a propagated radio wave, the farther it penetrates the ionosphere and the less it tends to be bent and reflected to earth. At frequencies as high as 42-50 megacycles, the F.M. transmission band in which we are interested, radio waves are bent so slightly that they seldom return to earth.

Thus, it can be seen that reliable, consistent, and dependable reception of signals in the F.M. band during both day and night, because of their ultra-highfrequency nature, is limited to the surface wave, or line-of-sight propagation. For all practical purposes, the surface waves may be likened to beams of light traveling straight out from the transmitting antenna to the horizon and beyond into space. To receive these waves, the receiving antenna must be within "seeing" distance of the transmitter. The greater the height of the transmitting and receiving antennas, the greater the horizon range or area over which dependable signals may be received. Although reception of ultra-highfrequencies beyond the horizon range of a transmitter is not impossible and is frequently reported, strength of signals is not constant, and thus unreliable.

F.M. ANTENNA REQUIREMENTS

Probably the 2 greatest advantages possessed by F.M. receivers, when compared with those of conventional standard design or amplitude modulated receivers, are (1) substantial freedom from natural static and "man-made" interference, and (2) extended fidelity and dynamic range of reproduction. Most listeners are more concerned with these aspects of F.M. receiver superiority than with other claims. To derive these benefits, only one requirement must be satisfied, that of adequate signal pick-up, to operate the limiter stage of the receiver. Without sufficient signal to saturate the limiter tube, elimination or clipping of signal peaks will be incomplete, and recep-

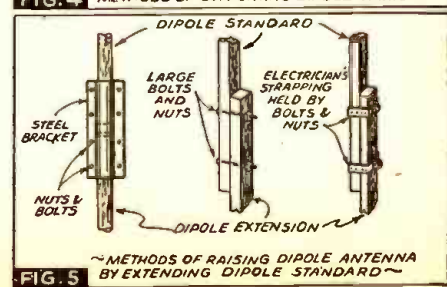
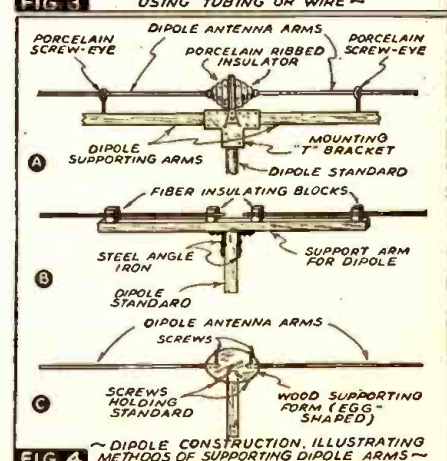
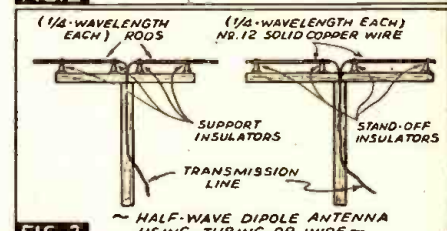
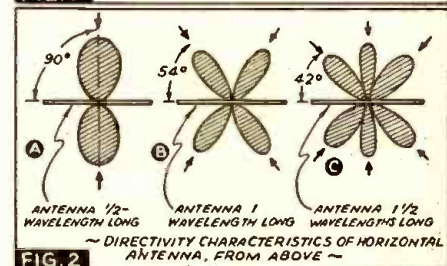
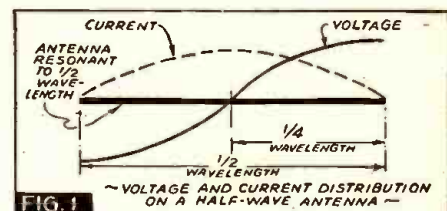

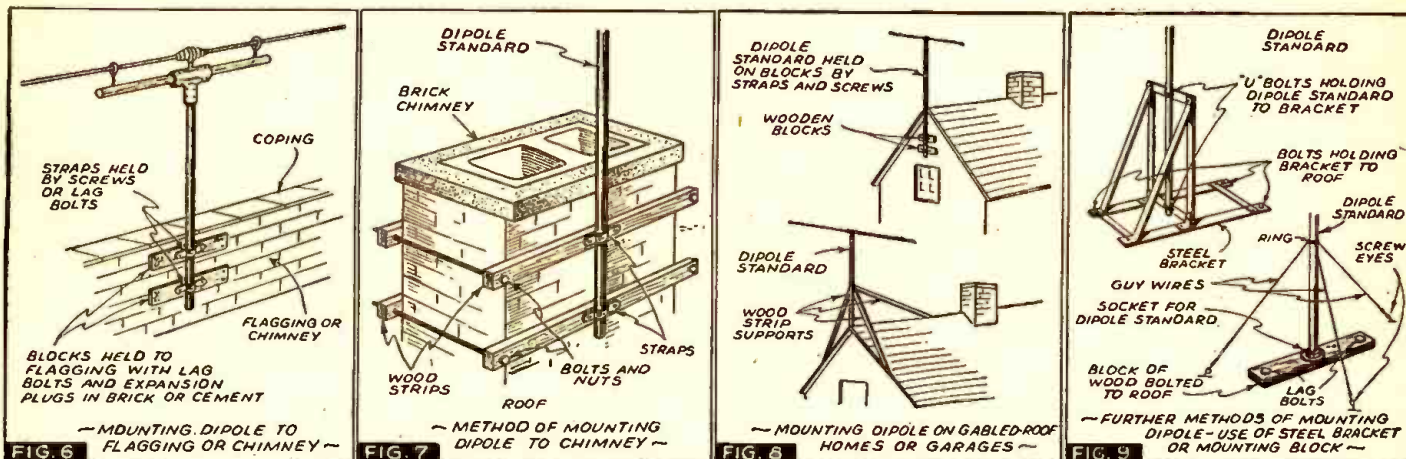

tion will be generally unsatisfactory, as a result of noise amplification and distortion.

To assure adequate signal pick-up, attention must be directed to the antenna system. Of all factors contributing to strong signal pick-up of F.M. signals, antenna height is the most important. Hundreds of tests have proven conclusively that the strength of the signal picked-up by the receiving antenna is almost directly proportional to the height of an antenna. For example, by doubling the height of an antenna, an increase of 100% in signal level is secured. For every foot the antenna is raised, a proportionate gain results. Of course, there must be a substantial increase in antenna height before a real improvement is noted.

Although the F.M. receiver provides noise reduction by reason of its limiter stage, the range over which the limiter operates is necessarily restricted. For this reason, every precaution and device must be employed to reduce, as much as possible, all noise pick-up by the antenna system. The principal sources of interference are diathermy and X-ray machines, automotive ignition, sign flashers, neon signs, oil burners, high-voltage power transmission lines, electric lighting and power plants, and all electrical apparatus of a high-frequency nature. This interference may be picked up by both direct and indirect radiation.

Locating the aerial in a noise-free area and utilizing a balanced transmission line to conduct signal voltage to the receiver, is the general approach toward solution of this problem. Increasing the height of the antenna not only serves to increase the signal strength, but aids in lowering the noise level.

LOSSES

At ultra-highfrequencies, the matter of insulation is of considerable importance. Materials such as unglazed porcelain and molded bakelite, which are satisfactory at powerline and broadcast frequencies, are relatively unfit at U.-H.F. because of losses resulting from high power factor and absorption. This is particularly true of the cheap rubber, impregnated-cotton insulated twisted-pair wire so often mistakenly used for transmission lines. Only insulated wire, insulators, terminals, and terminal blocks of the highest quality should be countenanced in the installation of an F.M. antenna to avoid all possible losses and consequent reduction in signal strength.

Fortunately, the current and voltage distribution on a half-wave doublet or dipole antenna, which is the most effective and popular type employed for F.M. reception, is such that the voltage at the center of the dipole is theoretically zero. This is shown at Fig. 1. For this reason, and since the 2 sections of the antenna are generally sup-

ported at the center, it is not absolutely essential that extremely-low-loss insulators or supports be used for this purpose.

Losses in a twisted-pair transmission line may be high due to high carbon content of the rubber insulation, and absorption of moisture by outer cotton insulation. Only lines that are sufficiently weather-proofed and storm-proofed, and use a high grade of rubber, are acceptable. Ordinary lamp cord is definitely "out" because of lack of weather-proofing. Some manufacturers supply transmission line cable especially suitable for F.M., with a high percentage pure latex rubber insulation on each wire and an outer covering of the same material. Where transmission lines must be run distances exceeding 200 feet, losses become prohibitively high. In such cases, concentric or coaxial line cables are desirable and essential. Concentric cables consist of a solid or stranded conductor, rubber insulated, enclosed in a copper braided shield, with over-all weather-proofed cotton insulation. Coaxial cable is similar with the exception that insulated beads or spacers are used to maintain a fixed clearance between the solid conductor and conducting shield. Of the two, coaxial cable possesses lower losses per foot, but is decidedly more expensive.

IMPEDANCE MATCHING

When a manufacturer's antenna kit is used, the question of *impedance matching* usually presents no problem, since these kits are available complete with dipole, transmission line, insulators, and matching transformer. The importance of impedance matching between dipole, transmission line and receiver input cannot be over-emphasized. The advantages gained by locating the antenna high in a clear area may be minimized through losses resulting from mismatch.

The impedance at the center of a half-wave antenna in free space is 73 ohms. However, because of the presence of insulators and dielectric material in the vicinity of the antenna, and the height of the antenna above a conducting ground as well as the efficiency of the ground, this value is altered considerably. As a result of these factors, the impedance of the average half-wave antenna may be taken at approximately 100 ohms.

The surge impedance per unit of length of a transmission line consisting of 2 parallel conductors, depends upon the size and spacing of the conductors, and the dielectric constant of the insulation between the conductors. The larger the conductor and the closer the spacing, the lower is the surge impedance. For example, the impedance of a twisted-pair line consisting of No. 14 rubber-covered, cotton-braid insulated wire, similar to that used in house wiring, is approximately 100 ohms. This type of wire,

when suitably weather-proofed and connected to obtain an impedance match in a manner to be described later, may be used as a short transmission line. In any event, to obtain the greatest transfer of energy from the dipole to receiver, a line of the correct impedance must be employed. Transmission line of the twisted-pair, concentric and coaxial type, of various stated surge impedances, are commercially available from large supply sources.

Of equal importance in the matter of impedance matching is that of terminating the transmission line in the correct characteristic impedance. By this is meant that the impedance of the receiver input must match that of the transmission line. Most receivers are designed with antenna inputs whose impedance varies from 100 to 300 ohms, necessitating the use of an impedance matching device in some cases to obtain maximum performance. A description of a simple auto-transformer to serve this purpose is later given.

Because of the short physical length of an F.M. half-wave antenna, and character of the transmission line, swaying in the wind may produce signal variations and noise level changes of large magnitude, sufficiently great to place these variations beyond the control of the leveling action of the limiter stage in the receiver. For this reason, the antenna and transmission line must be rigidly mounted, by whichever means are available and necessary, to prevent possible signal voltage changes and distortion as a result of reception of out-of-phase signals.

POLARIZATION

Most F.M. transmitters employ antennas which are in a horizontal plane and radiate energy which is *horizontally polarized*. To receive this signal, the receiving antenna must also be horizontally polarized to have a maximum voltage induced in it. Some few stations employ *vertical polarization*, thus making a vertical receiving antenna necessary for maximum performance.

The horizontally polarized half-wave antenna is more widely used because of an advantage insofar as noise pick-up is concerned. Since noise originates from nearby sources, and a good part of it, especially automotive ignition interference, is vertically polarized, less of this noise voltage is induced in a horizontally polarized antenna than in one that is vertically polarized.

On the other hand, the horizontal half-wave antenna is directional, the greatest signal voltage being induced when the length of the antenna is placed in a position which is broadside or at right-angles to the signal source.

Antenna polarization is important at distances relatively close to the transmitter. At farther distances, the plane of polarization of U.-H.F. waves has been known to

change as much as 90°, so that correct polarization becomes a matter of experimentation to provide best signal pick-up. Tilting the dipole at various angles from the horizontal to the vertical position, and checking receiver response to these changes, will determine which position is best. When an antenna for an F.M. receiver is installed in areas close to several transmitters, one of which may radiate vertically polarized waves, it may be necessary to utilize both a vertical and horizontal dipole to receive all signals with sufficient signal strength. Or a compromise may be effected whereby one dipole is used at some angle between a horizontal and vertical plane.

A resonant antenna, such as the half-wave dipole, possesses marked frequency discrimination by which signals at other than the resonant frequency of the antenna are sharply attenuated. Since the F.M. band of transmission covers a wide range of frequencies, from 42-50 megacycles, this frequency discrimination would prove undesirable were it not for the fact that the loading of the transmission line produces a broad frequency response. It is customary therefore to cut or design the half-wave antenna to resonate at the center of the F.M. band, at approximately 46 megacycles. It may be advisable, inasmuch as line losses increase with an increase in frequency, to resonate the antenna at 47, or possibly 48 megacycles to compensate for these losses.

DIRECTIVITY

Because of the fact that the horizontal half-wave antenna is bi-directional, this discrimination may prove undesirable when the signals of widely separated transmitters must be received at one location. The directional characteristic of a horizontal half-wave antenna is illustrated in A of Fig. 2.

As a general rule, this situation proves troublesome in urban areas or close to a number of transmitters which lie in various directions, one or more of which may be outside the directional pattern of the antenna. No such problem is presented when the receiver is far removed from this area. As a matter of fact, in the latter instance, attempts are usually made to increase the directivity of the horizontal antenna. One solution to this bi-directional effect is through the use of a vertical half-wave antenna, but this results in a loss of signal strength and an increase in noise pick-up. In some cases, an antenna designed to resonate at a frequency equal to twice or 3 times a half-wavelength, is employed to overcome the bi-directional effect of a horizontal half-wave antenna. The changes in the directional pattern from that of a half-wave are shown at B and C of Fig. 2.

It can be seen that the angle of the null points is decreased thus producing less directional effects, but the maximum signal voltage possible to be induced into the antenna are also less. In addition, the resistance of such an antenna increases considerably, from 25 to 35%, necessitating a transmission line of higher impedance and further impedance matching at the receiver. Another method is that of orientating the horizontal half-wave antenna in some compromise position, whereby adequate signal pick-up is obtained in all directions.

As mentioned previously, the half-wave dipole antenna is usually designed to resonate at a frequency in the center of the F.M. band. When calculating the length of a half-wave antenna, it must be remembered that the physical length usually averages 5% less than the electrical length. This is due to end effects occasioned by the presence of insulators, and the fact that the antenna has resistance. A simple conversion formula, which considers these end and resistive effects, for computing the physical

length of a half-wave antenna, is the factor 467.4 or 468 (which is accurate enough), divided by the desired resonant frequency of the antenna. The figure obtained is the length of the entire antenna in feet. Each half of the dipole or doublet should therefore be cut to half this amount. An antenna with each half of the dipole cut to 5 feet, 1 inch, has been found satisfactory for the reception of signals in the F.M. band.

F.M. ANTENNA TYPES AND INSTALLATION

At locations close to F.M. transmitters and where the problem of adequate signal pick-up and noise pick-up does not exist, any short length of wire will serve as the F.M. antenna. When operating conditions are favorable, an ordinary inverted-L type antenna of 20-100 feet will provide satisfactory reception of F.M. signals. Upon several occasions, an antenna comprising a 20-foot length of wire extending downward from a window was found sufficient to obtain good reception on an F.M. receiver located 25 miles from a number of transmitters. Operating conditions were ideal, however, the noise level being particularly low with the receiver in a home built on a hill with a good line-of-sight. The distance from a transmitter that such an antenna, or one of the inverted-L variety, will provide a signal of sufficient intensity and high signal-to-noise ratio, is a matter of conjecture and must be left to trial. In most instances, an antenna efficient at U.-H.F. must be installed.

The most satisfactory antenna for F.M. reception is the horizontal half-wave dipole. Essentially, this antenna consists of 2 metal-tubular rods or wires placed in line with each other, as shown in Fig. 3. The metal rods may be either copper or aluminum. Solid rods are not recommended. To obtain the requisite rigidity, only wire of a heavy gauge, either No. 10 or No. 12, should be used, supported by low-loss insulators. The transmission line must be run at right-angles to the dipole for at least a ¼-wavelength, at least 5 feet, before any bends in the line are made.

ROOF MOUNTINGS

Various methods have been devised to support the dipole arms. These are merely mechanical arrangements and usually have no bearing upon electrical efficiency. The only requirement is substantial construction. Several of these arrangements are shown in Fig. 4.

At A, a 2-piece cast aluminum bracket assembled by means of a number of bolts and nuts, is used to couple the 2 dipole supporting arms and standard. A center supporting insulator of ribbed construction is bolted to the bracket. Glazed porcelain screw-eye insulators serve to support the dipole rods at the far end of the supporting arms. The rods are threaded onto screws emerging from each end of the center supporting insulator. The transmission line is connected to these screws internally. Laminated fibre or hardrubber blocks are used to anchor the dipole rods in position in the arrangement illustrated at B; and, an egg-shaped wood form is employed for the same purpose at C.

In manufactured kits, the standards are supplied in 5 to 6 foot lengths of straight-grained knot-free material, and more than one is used to elevate the dipole as high as possible. These sections are joined by means of a 2-piece sheet-iron or cast-aluminum bracket held by bolts and nuts, screws, and electricians' strap, as shown in Fig. 5.

Methods of anchoring and supporting the antenna vary in each individual case. Generous use is made of expansion plugs, lag bolts, and electricians' strap.

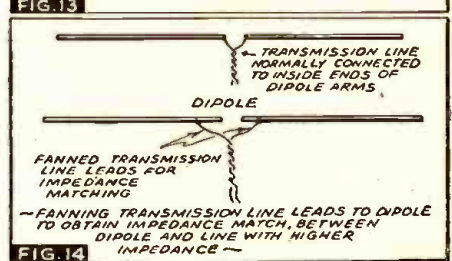
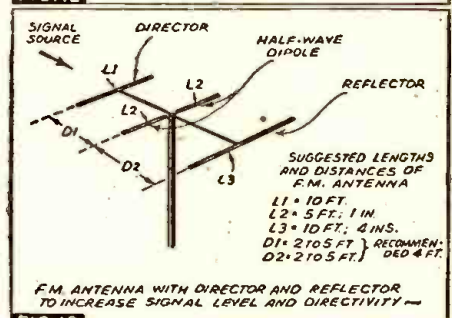
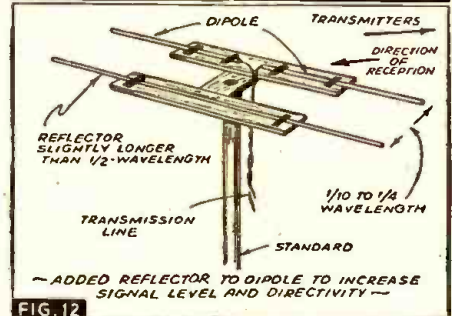
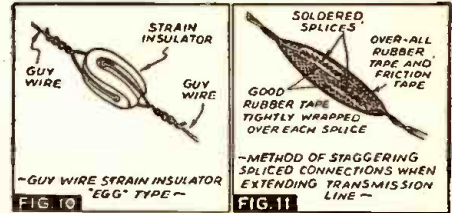

On apartment buildings and private homes, the dipole may be erected as in Fig. 6. The wood blocks are held in position with lag bolts which are fastened in expansion plugs snugly fitted into holes or openings in the brick, stone, or cement, made by a "star" drill and hammer. The standard for the dipole is mounted by straps and lag bolts. When brick or stone chimneys serve as the "foundation" for the antenna, it is essential that the construction be solid and substantial. Too often, loose bricks and cement prevent firm insertion of the expansion plugs. Also, use of the hammer and "star" drill may dislodge bricks and cement and so weaken the chimney that solid anchoring of the antenna is impossible. The dangers of a weak chimney further burdened by the weight and stress of an antenna in the wind are apparent. When such chimneys offer the only available means of support for the antenna, the construction shown in Fig. 7 has proved safe and substantial, provided suitable guys are employed. It may be seen that 4 lengths of 2 x 4 in. or 2 x 3 in. lumber are held in position by long bolts and nuts. These bolts are procurable from large hardware supply stores or may be ordered from the local blacksmith or iron-works. The dipole standard is held erect by straps and lag bolts. The problem of installing the dipole on homes with peaked sloping roofs often presents itself. When access to the chimney may be gained without danger of slipping or falling, the construction already shown in Fig. 7 is recommended. Alternative meth-

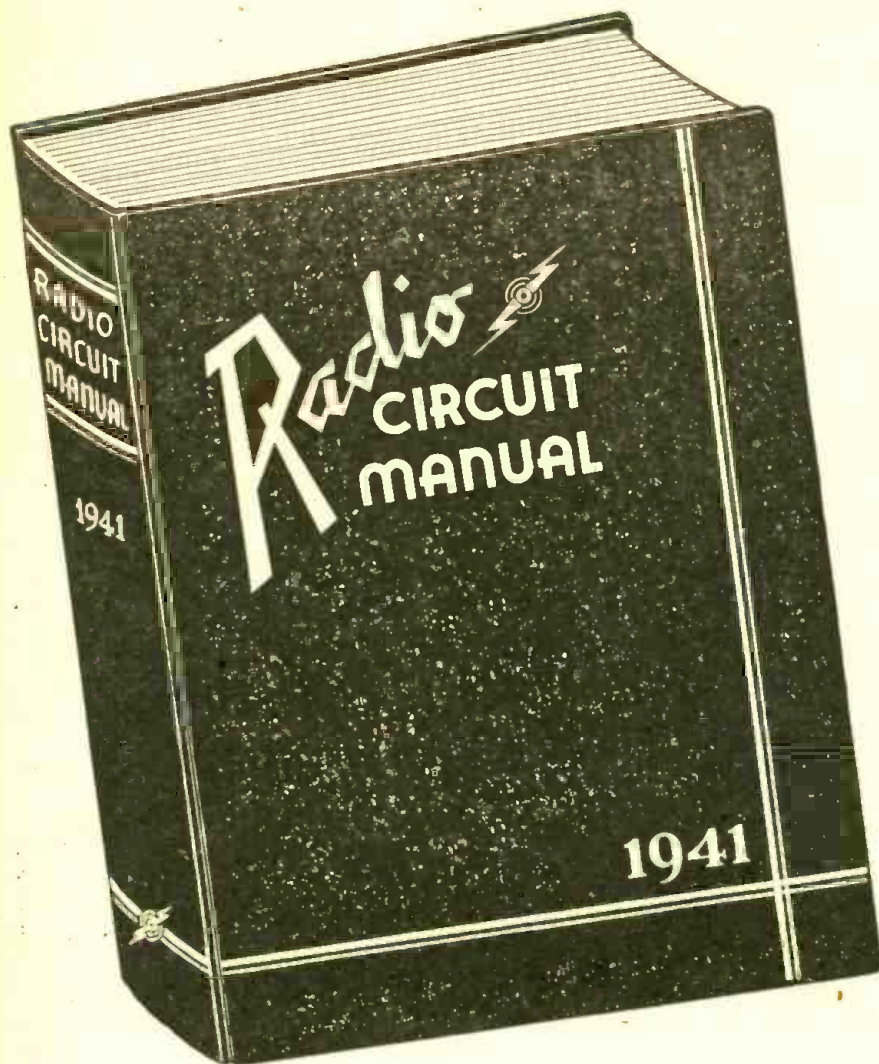

A New RADIO

**The Only EDITED Manual
Ever Published!**

**DIRECTORY OF RECEIVERS
MANUFACTURED IN 1940
AND UP TO JUNE, 1941**

OUTSTANDING FEATU

- Contains data on more than 1800 receiver models!—more than any other radio service manual.
- Only 736 pages!—less than half the bulk of any other manual and more than 1/3 lighter.
- All information is EDITED!—all non-essential data deleted and the balance checked and correlated with the schematics and sketches.
- 40% larger p of all informa (A few unaccepted.)
- I.F. peaks for cuits are bo black boxes;- accurate.
- No space wast tions and exp plifiers, elect ruments, etc ice Engineer's

A "CUSTOM-TAILORED" MA FOR SERVICE ENGINEER

Here, at last, is a Service Manual deliberately PLANNED for the Ser instead of a mere hodge-podge collection of service data, as manuals hav this RADIO CIRCUIT MANUAL is an orderly compilation of essent and service information, carefully edited and uniformly presented for venience of the busy Service Engineer. All time-consuming, non-essent weeded out, and the remaining information, vitally important to the servicing of modern radio receivers, has been laid out in a logical, which cuts time from the day's work. Because of this and other featu evident upon first observation, it has been possible to list all informati given model on a single page.

In 736 pages this Manual presents essential service data on over 1800 more than any other existing service manual on the market!

ONLY ONE MANUAL PER YE

The new technique used in compiling this RADIO CIRCUIT MANUA possible to include in a single book all the new receiver models which can produce in a single year. This factor alone represents an impo Service Engineers.

ORDER YOUR MANUAL IMMEDIATELY—NOW!

Get your copy directly from us by filling out and mailing the convenient coupon shown at left, or get it directly from your favorite distributor.

736 pages; size 13¼ x 10¼ x 2 in. thick; loose leaf, leatheroid-covered stiff binder; net weight 6½ lbs.

ONLY
10⁰⁰

This Ra time prop Circuit M and so of the other expediting ticing Ser

**RADCRAFT PUBLICATION
20 VESEY ST. NE**

RADIO-CRAFT for SEPTEMBER, 1941



← THE OLD TYPE MANUALS—Bulky, heavy, hard to handle, space consuming, less USEFUL data despite greater number of pages.



→ OUR NEW MANUAL—Lighter, compact, easy to handle, takes half as much room on the shelf, more USEFUL information despite fewer number of pages.

MANUALS NOW READY!

RADCRAFT PUBLICATIONS, INC., 20 Vesey St., New York, N. Y.

Gentlemen: Enclosed find my remittance of \$10.00, for which send me, POSTPAID, my copy of the RADIO CIRCUIT MANUAL—1941.

Name

Address

City State

RC-941

(Send remittance in form of check or money order; register your letter if you send cash.)

Type of Service Manual!

CIRCUIT MANUAL - 1941

MORE INFORMATION IN HALF THE NUMBER OF PAGES

The value of a service manual is measured not by the number of pages but by the amount of useful information. Thus, in only 736 pages this Radio Circuit Manual covers over 200 receiver models MORE than does any other competitive manual in twice the number of pages.

HOW DID WE DO IT?

By increasing the size of our page; by discarding non-essential data and editing the balance; by listing only those

receivers which the Service Engineer will definitely have to repair (no communications or export receivers, no shortwave sets or amplifiers, no electronic devices, etc.); by many months of hard work based on a definite plan of procedure and a clear understanding of the actual requirements of the Service Engineer. There is no "dead weight" information to add bulk to this Manual. Every word counts. Every minute of reading time is well spent.

RES

permits listing on one page. readable cases ex-

all superhet cir- ly displayed in none missing, all

on communica- t receivers, am- nic musical in- a 100% Serv- Manual.

QUAL

ce Engineer. In- been in the past, radio diagrams maximum con- l data have been pid and efficient asy-reading style s which are self- pertaining to a

ceiver models;—

R!

—1941 makes it the radio industry ant saving to all

PERMANENT INSTITUTION

Circuit Manual—1941 is NOT a one- circuit. Next year there will be a Radio Manual—1942, the following year, 1943 definitely—each Manual better than the last. New methods are worked out for simplifying the work of the prac- tice Engineer.

S, INC. YORK, N. Y.

SENTINEL RADIO CORPORATION MODEL 210B

VOLTAGE TABLE

Point	Approx. Voltage	Notes
1	1750 E.C.	Grid 1A7G
2	1400 K.C.	Grid 1A50
3	600 E.C.	Grid 1H5G

ALIGNMENT PROCEDURE

Be sure to follow procedure carefully and in the order given—otherwise the receiver will be insensitive and the dial will be erratic. For alignment procedure read instructions from left to right. If more than one adjustment is required, check tuning dial adjustment by tuning gang condenser until pointer reaches maximum capacity stop completely to dial calibration. If dial needle does not point exactly to last line move to correct position. Use an accurately calibrated test oscillator with some type of output measuring device. Have ground lead of test oscillator attached to chassis.

PARTS LIST

No.	Part	Description
1	11725 Cable	Signal Assembly with 4 Plug
2	10087 Cond	100 P.F. Transformer
3	10088 Cond	100 P.F. Transformer
4	10089 Cond	100 P.F. Transformer
5	10090 Cond	100 P.F. Transformer
6	10091 Cond	100 P.F. Transformer
7	10092 Cond	100 P.F. Transformer
8	10093 Cond	100 P.F. Transformer
9	10094 Cond	100 P.F. Transformer
10	10095 Cond	100 P.F. Transformer
11	10096 Cond	100 P.F. Transformer
12	10097 Cond	100 P.F. Transformer
13	10098 Cond	100 P.F. Transformer
14	10099 Cond	100 P.F. Transformer
15	10100 Cond	100 P.F. Transformer
16	10101 Cond	100 P.F. Transformer
17	10102 Cond	100 P.F. Transformer
18	10103 Cond	100 P.F. Transformer
19	10104 Cond	100 P.F. Transformer
20	10105 Cond	100 P.F. Transformer
21	10106 Cond	100 P.F. Transformer
22	10107 Cond	100 P.F. Transformer
23	10108 Cond	100 P.F. Transformer
24	10109 Cond	100 P.F. Transformer
25	10110 Cond	100 P.F. Transformer
26	10111 Cond	100 P.F. Transformer
27	10112 Cond	100 P.F. Transformer
28	10113 Cond	100 P.F. Transformer
29	10114 Cond	100 P.F. Transformer
30	10115 Cond	100 P.F. Transformer
31	10116 Cond	100 P.F. Transformer
32	10117 Cond	100 P.F. Transformer
33	10118 Cond	100 P.F. Transformer
34	10119 Cond	100 P.F. Transformer
35	10120 Cond	100 P.F. Transformer
36	10121 Cond	100 P.F. Transformer
37	10122 Cond	100 P.F. Transformer
38	10123 Cond	100 P.F. Transformer
39	10124 Cond	100 P.F. Transformer
40	10125 Cond	100 P.F. Transformer
41	10126 Cond	100 P.F. Transformer
42	10127 Cond	100 P.F. Transformer
43	10128 Cond	100 P.F. Transformer
44	10129 Cond	100 P.F. Transformer
45	10130 Cond	100 P.F. Transformer
46	10131 Cond	100 P.F. Transformer
47	10132 Cond	100 P.F. Transformer
48	10133 Cond	100 P.F. Transformer
49	10134 Cond	100 P.F. Transformer
50	10135 Cond	100 P.F. Transformer
51	10136 Cond	100 P.F. Transformer
52	10137 Cond	100 P.F. Transformer
53	10138 Cond	100 P.F. Transformer
54	10139 Cond	100 P.F. Transformer
55	10140 Cond	100 P.F. Transformer
56	10141 Cond	100 P.F. Transformer
57	10142 Cond	100 P.F. Transformer
58	10143 Cond	100 P.F. Transformer
59	10144 Cond	100 P.F. Transformer
60	10145 Cond	100 P.F. Transformer
61	10146 Cond	100 P.F. Transformer
62	10147 Cond	100 P.F. Transformer
63	10148 Cond	100 P.F. Transformer
64	10149 Cond	100 P.F. Transformer
65	10150 Cond	100 P.F. Transformer
66	10151 Cond	100 P.F. Transformer
67	10152 Cond	100 P.F. Transformer
68	10153 Cond	100 P.F. Transformer
69	10154 Cond	100 P.F. Transformer
70	10155 Cond	100 P.F. Transformer
71	10156 Cond	100 P.F. Transformer
72	10157 Cond	100 P.F. Transformer
73	10158 Cond	100 P.F. Transformer
74	10159 Cond	100 P.F. Transformer
75	10160 Cond	100 P.F. Transformer
76	10161 Cond	100 P.F. Transformer
77	10162 Cond	100 P.F. Transformer
78	10163 Cond	100 P.F. Transformer
79	10164 Cond	100 P.F. Transformer
80	10165 Cond	100 P.F. Transformer
81	10166 Cond	100 P.F. Transformer
82	10167 Cond	100 P.F. Transformer
83	10168 Cond	100 P.F. Transformer
84	10169 Cond	100 P.F. Transformer
85	10170 Cond	100 P.F. Transformer
86	10171 Cond	100 P.F. Transformer
87	10172 Cond	100 P.F. Transformer
88	10173 Cond	100 P.F. Transformer
89	10174 Cond	100 P.F. Transformer
90	10175 Cond	100 P.F. Transformer
91	10176 Cond	100 P.F. Transformer
92	10177 Cond	100 P.F. Transformer
93	10178 Cond	100 P.F. Transformer
94	10179 Cond	100 P.F. Transformer
95	10180 Cond	100 P.F. Transformer
96	10181 Cond	100 P.F. Transformer
97	10182 Cond	100 P.F. Transformer
98	10183 Cond	100 P.F. Transformer
99	10184 Cond	100 P.F. Transformer
100	10185 Cond	100 P.F. Transformer

SPECIMEN PAGE (greatly reduced)
THE ACTUAL PAGE SIZE IS 10 By 12 3/4 Inches



A new HOTEL
AWAITS YOU
in New York

This world famous establishment, formerly the American Woman's Club, is now one of New York's newest and finest hotels. Its unique facilities include six lounges, five sun-decks, music studios, library, art gallery and three popular priced restaurants. Many floors are reserved exclusively for women.

*

1200 Rooms with Bath
DAILY—Single, from \$2.50;
Double, from \$3.50

WEEKLY—Single, from \$12;
Double, from \$16

Special Floors and Rates for Students



John Paul Stack
General Manager

Henry Hudson
HOTEL
353 WEST 57th STREET * NEW YORK

*



FLIGHT THE PICTORIAL FLYING REVIEW

Brings you all the phases of world aviation and aeronautics in a non-technical yet educational manner—exciting articles which catch your breath, yet give you the fundamentals of flying and ALL related subjects.

FLIGHT keeps you abreast of all the major developments as fast as they appear anywhere.

Now, when planes and flying are of vital importance to all, you just can't do without this highly absorbing yet instructive publication. You must be "in the know!"

Partial Contents of Sept. Issue:
Radio Conquers Bombers—by Hugo Gernsback. Can New York Be Bombed? Giant Sikorsky Flying Boat The Blackburn Burn-Skin Helicopter Problem Solved—by Igor Sikorsky. The Russian Air Force! The Junkers JU 88 Bomber. Versatile R.A.F. "Lysander." "Blackburn Botha" Torpedo Plane. Why Planes Need "Air Brakes." Radio Beam Locates Planes. Build Your Own "Flight Trainer!"

Attractive three-color cover, numerous illustrations.
15¢ copy

Send 10c for a Sample Copy.

Subscription price \$1.50 a year, Canada and foreign \$2.00.

FLIGHT MAGAZINE, 20-R Vesey St., New York, N. Y.

ods of mounting the dipole are illustrated in Fig. 8. When the eaves of the building do not jut out beyond the vertical side walls, the standard of the dipole may be secured directly to the wall. Otherwise, it is necessary to build up or pile up a sufficient number of wood blocks, securely fastened to the wall and to one another, so that the standard may clear the eaves and be erected vertically.

Another method of installing the dipole employs a steel bracket or wood block which serves as the base for the dipole. This is shown at Fig. 9. The bracket is bolted to the roof and the dipole standard held to steel cross-bars by means of threaded U-bolts. The wood block which is a 12-18 ft. length of 2 x 4 in. lumber, is bolted to the roof. The dipole is mounted in a hole or socket made in the wood block. In the latter method, guy wires are absolutely essential, since this is the only means of holding the dipole erect and steady. The methods and manner of erecting the dipole antenna herein described are by no means the only possible arrangements. Others will suggest themselves.

TOWERS

Dipoles which "tower" or rise more than 5 ft. into the air usually must be supported rigidly to prevent swaying. This is done not only to assure good reception but to prevent weakening of supports and excessive straining of mooring bolts and plugs. For use as guy and supporting wires, No. 10 solid or stranded galvanized-wire "rope" should always be employed to effect a "permanent" installation.

Anchoring of the guy wires may take any number of means. Probably the simplest of all methods is the use of large eye-screws fastened securely to any solid wood mooring or to expansion plugs inserted into brick walls. Turnbuckles should be employed to take up the slack in long cables when the wires cannot be tightened otherwise by hand. Of particular importance at this point is the necessity of breaking up the guy wires by insertion of strain insulators of the "egg" variety to avoid possible resonance effects at the receiving frequency. For our purpose, guy-wire lengths should always be less than 10 feet. This is illustrated at Fig. 10. Although any system which will support the dipole is suitable, the 3-guy-wire arrangement has proved most satisfactory. In any event, the guy wires must be kept out of the field of the dipole.

The generous use of tar compounds and synthetic resins is recommended for weather-proofing lag bolts, straps, supports and dipole standards. When a steel or wood base assembly is bolted to the roof, application of a tar compound is essential to avoid leaks and seepage in inclement weather. This material is available from many supply sources.

TRANSMISSION LINE

The transmission line must be run at right-angles to the dipole for at least 5 ft. Avoid right-angle or all unnecessary bends, and doubling back of the transmission line. Tape up the line where the insulation is slit to make connection to the antenna to prevent entrance of moisture. Although it is best to keep the transmission line in one piece from antenna to receiver, when it is necessary to extend the line, solder and tape the lengths of line, but stagger the connections as shown in Fig. 11. Only high-grade rubber tape may be used at any point in an F.M. installation. Ordinary friction tape introduces high losses at ultra-high frequencies. Every means must be employed to reduce this possibility of leakage.

Anchoring of the transmission line should be accomplished without danger of snapping. Protect the line from abrasion at all points

of contact. Use standoff insulators wherever possible to keep the line clear. Insulators of the "nail-it" knob type should be avoided, since with these there is danger of bruising the insulation of the line. The transmission line may be brought into the building in various manners. The porcelain "feed-through" insulator is practical. When a hole is drilled in the window casement or frame for the line or feed insulator, it should be drilled downward from inside of building to prevent entrance of moisture. The use of the common lead-in strip should also be avoided as the insulation is usually inadequate and necessitates a break in the transmission line.

Lightning protection and installation as prescribed by National and local Boards of Fire Underwriters, and in accordance with local fire and building department codes, are essential. Technicians should familiarize themselves with these regulations, such as, height of antenna above building, type of lightning arrester and type of ground.

The ground connection for the receiver is important. Although in A.C.-operated receivers, the "ground" is obtained through the line bypass/condenser or capacity of the power transformer windings, reliance upon this grounding effect is not advised. Addition of a good ground connection often spells the difference between good satisfactory reception and noisy operation.

ANTENNA SERVICE POINTERS

After the F.M. installation is complete and reception is found satisfactory, no further thought of F.M. antenna requirements is necessary. When operation of the receiver is generally poor and it is known that the receiver is not at fault at the time of installation, we must look to the antenna installation.

The cause for unsatisfactory F.M. reception may be attributed to many factors: inadequate signal pick-up, excessive noise pick-up, incorrect polarization and directivity of dipole, and losses due to impedance mismatch and poor insulation, any or all of which tend to produce weak, noisy and distorted reception.

In areas close to transmitters, the question of adequate signal pick-up does not exist. At remote locations, this consideration is of importance. It is assumed that the dipole was erected as high as possible in the first place. The method generally employed to increase signal pick-up in this case is by the use of a reflector.

This is a metal rod, similar to that of the dipole itself, but slightly longer, placed parallel with the dipole from 2 to 5 feet behind it, as shown in Fig. 12. This procedure not only greatly increases signal pick-up from one direction, but increases the directivity of the antenna, since signals approaching from the rear are greatly attenuated. This latter result is especially advantageous when it is desired to reduce noise pick-up from a nearby source. The reflector is used just as often to obtain this effect as to increase signal level. No electrical connection exists between dipole and reflector. In instances where it is necessary to obtain a further increase in signal strength, a director is used.

The director is a metal rod slightly smaller in length than the dipole, and placed about 2 to 5 ft. in front of the dipole. This is shown in Fig. 13. Approximate lengths and distances are given.

Before installing a reflector and then a director, it is common practice to rotate the dipole to change its directivity, although it may have been positioned properly (at right-angles) with respect to the transmitter, in order to increase signal pick-up.

INTERPHONE

When 2 men are engaged in the installation of the antenna, a telephone or other

means of communication may be rigged up, so that the effect of rotating the antenna to various positions upon reception at the receiver may be ascertained. On a 1-man job, this is more difficult, since checking receiver response to the change in direction must be made after each change. The directivity of a horizontal half-wave antenna is critical, depending upon the distance from the transmitter. Directional changes of only a few degrees are often sufficient to affect signal strength considerably. These facts apply also to polarization of the antenna. The tilted position at which a stronger signal may be received must be checked after each change in polarization, but these changes are not critical.

When a transmission line is used to couple the dipole antenna to the receiver, loss in signal strength is possible due to impedance mismatch, when the surge impedance of the line is not nearly that of the antenna. The loss due to mismatch often has been found to lie with the use of a transmission line whose impedance was higher than that of the antenna. To correct this condition, the ends of the transmission line, where they connect to the dipole, may be fanned out, as shown in Fig. 14. This is possible since the impedance of a half-wave antenna, which is at a minimum at the center, increases toward the outside ends. The distance of the fanned portion of the line from the inside ends of the dipole depends upon the line impedance. It is necessary, therefore, to fan the leads out a little at a time, noting the effects upon reception, until a point is found on the antenna which matches the line impedance. This point of connection will provide maximum signal voltage transfer.

MATCHING TRANSFORMER

Another cause for loss in signal level is due to mismatch between the transmission line and the receiver input circuit. One method used to effect correct matching of the 2 impedances at this point is through the use of a matching transformer or autotransformer. The construction of such device is relatively simple.

A total of 28 turns of No. 18 enamel- or cotton-insulated wire is wound on a 1-in. form, and tapped every 2nd turn. The center-tap or 14th turn is grounded to the receiver. Referring to all taps with respect to the center-tap, there are 7 pairs of taps which connect to an equal number of turns on the coil. In other words, taps No. 1 are each 2 turns from center-tap, taps No. 2 are both 4 turns from center-tap, etc. By suitably connecting the transmission line and the balanced receiver input to the coupling coil, a correct impedance step-up or step-down match may be obtained.

When the transmission line is of lower impedance than the receiver input, it may be connected across a fewer number of turns than the number across which the receiver input is connected, to provide the step-up ratio. When the line impedance is higher than that of the receiver input, the receiver input is connected across fewer turns than the line. Once the correct impedance ratio is found, the coil may be enclosed in a suitable shield and all leads soldered to the correct taps. The nature of the autotransformer requires a balanced receiver input, wherein neither end of the primary of the antenna coil is grounded. Lack of this balanced condition will unbalance the transmission line and introduce undesirable effects. Fortunately, almost all F.M. receivers have this balanced input.

Poor F.M. reception may be the result of a high noise level, despite adequate signal pick-up. In such cases, it is assumed that the dipole has been erected high in a noise-

free zone and a balanced twisted-pair transmission line has been used to connect the dipole to the receiver. Unless the receiver has a balanced input, the advantage or purpose in using a balanced line is lost, and noise voltages induced into the transmission line may be induced into the antenna coil of the receiver. Because the conductors in a twisted-pair line are close, any voltage induced in them, whether it be signal or noise voltage, will be equal and in-phase with each other so that their polarities are always similar. Consequently, the polarity of the ends of the line which connect to the primary of the receiver input transformer are both either positive or negative. Therefore, no current will flow in the coil since there is no difference of potential, and no noise voltage will be induced because of this inductive relationship. However, some noise voltage is always transferred to the receiver because of capacitive coupling between primary and secondary of the antenna coil.

REDUCING CAPACITY COUPLING

Two methods may be employed to reduce this capacity coupling. One involves the use of an auxiliary transformer in which a grounded Faraday electrostatic shield is interposed between primary and secondary windings of the transformer. This transformer is connected between the transmission line and the receiver, and it is unimportant whether one side of the receiver input is grounded or not. The second method, and one which has been employed with success is the use of a center-tapped coil, such as the impedance matching autotransformer described, connected between the transmission line and receiver. The center-tap of the coil is grounded. The pair of taps to which the receiver input and lines are connected is best determined by trial. In any event the receiver input must be balanced or ungrounded.

Probably the most frequent cause for low signal pick-up is the unwarranted use of transmission line with low-grade rubber insulation. The losses and leakage at U.-H.F. of this type of wire are great enough to practically short-circuit the line and therefore the signal voltage. The use of line with good rubber insulation *must* be stressed. Generally, transmission line rubber insulation which possesses good elasticity and standing "plenty of stretch," may be considered "live" enough for use as a line in an ultra-high-frequency antenna system. Wire with rubber insulation which can be torn or peeled easily without stretching is "dead" rubber and usually presents high losses.

Although there is no doubt that the comparative bulk of good transmission line is unsightly from an artistic point of view when used in the interior of a building, twisted or parallel lamp cord, which is certainly more appealing, should never be used to continue the transmission line from the window to the receiver. Ordinary twin lamp-cord conductor offers high losses at F.M. frequencies.

There is much to be written of F.M. installation and service, more than space limitations will permit, but an effort has been made to include most essential requirements and considerations. To sum up briefly, the F.M. antenna system should possess the following characteristics:

- (1) Dipole as high as possible.
- (2) Good low-loss insulation.
- (3) High-grade transmission line.
- (4) Proper directivity and polarization.
- (5) Correct impedance matching.
- (6) Balanced line and receiver input.



DEALERS
SERVICEMEN
AMATEURS
BUILDERS
P. A. MEN

NEW

FREE!
RADIO'S
GREATEST
CATALOG!



212 PAGES • BIGGEST YET!

SAVES YOU MONEY
ON EVERYTHING IN RADIO



50 NEW
KNIGHT
1942 RADIOS

See the new KNIGHTS for 1942—the greatest radio line in years! New "Personal" 3-way portables; latest FM-AM models; World-wide receivers; new Plastic sets; Recorders; Photo-Radios; Auto Sets; Farm Radios. There's a model for every requirement—and the prices are amazingly low! Get this 212-page 1942 Catalog!



SAVE ON
EVERYTHING IN RADIO

NEW SOUND SYSTEMS

P.A. at its finest—systems for every application—7 to 60 watts. Exclusive new features—easy Time Payment Plan—15 Day Trial Offer.

AMATEUR GEAR

All the new Communications sets—new x-mitters—new tubes and specialized Radio equipment.

15,000 RADIO ITEMS

Complete stocks of parts; tools; test equipment; books; tubes; etc. Over 15,000 radio items—all at lowest prices!

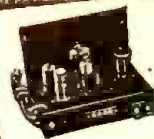

Builders' Kits

Builders need this 1942 book! New kits, diagrams, supplies—everything in radio for the builder. We'll supply parts lists for any circuit described in magazine radio construction articles.

Radio Builders' Handbook
Gives all the dope on building; easy to understand; illustrated. Only 10c

Radio Dictionary
Complete; defines commonly used radio terms. Only 10c

ALLIED RADIO

833 W. Jackson Blvd., Dept. 2-J-1
Chicago, Illinois

Send your FREE 1942 Radio Catalog.

Find 10c enclosed for "Builders' Handbook."

Find 10c enclosed for "Radio Dictionary."

NAME

ADDRESS

CITY STATE

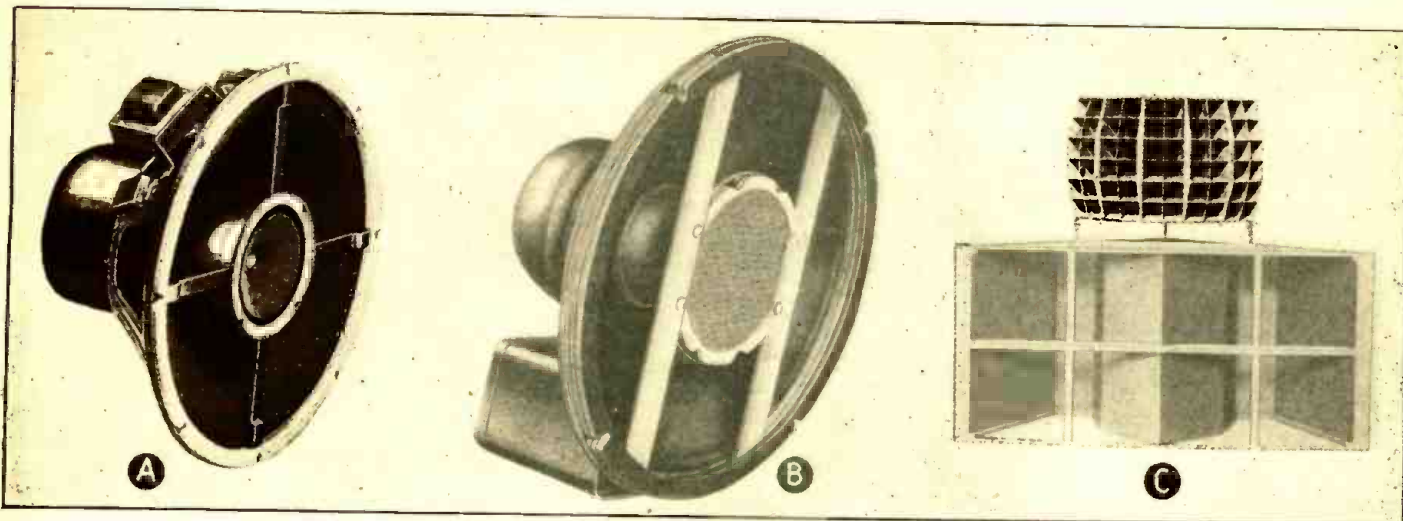

The Jensen 2-unit loudspeakers, models JAP-60 and JHP-52, shown at A, incorporate the dividing network system (cross-over at 4,000 cycles) as an integral part of the loudspeaker, and supplied with it; also incorporated is a variable attenuator for the high frequencies. Cinaudagraph's FM-12 Cinaxial speaker, shown at B, has its cross-over at 1,500 cycles; see Fig. 5. The cellular-type speaker, illustrated at C, is a high- and low-frequency dual speaker unit designed for theatre and auditorium use.

2 SPEAKERS ARE BETTER THAN 1

Modern considerations in the simultaneous use of dual loudspeakers to achieve increased fidelity in the reproduction of sound, as demanded by modern sound systems, Frequency Modulation equipment, etc., are discussed in this article. The use of "woofer" and "tweeter" units in such assemblies entails problems of frequency cross-over, impedance matching and directional characteristics with which everyone interested in high-fidelity reproduction should be familiar.

L. M. DEZETTEL

TO get off on the right foot, let us clarify the title of this article. We are not referring to the usual 2-speaker installation normally found in P.A. set-ups, where 2 or more loudspeakers are connected to the output of an amplifier either in series or parallel. In this article we are concerned with acoustic frequency response. We want to reproduce all of the frequencies that the sound amplifier or radio set is capable of passing.

Since the advent of Frequency Modulation broadcasting many loudspeaker manufacturers have improved the frequency response of single speakers by more careful design, especially of the cone, than heretofore. Single speakers are available with an extended high-frequency range not realized in previous years. But there is a limit to the range that a single cone is capable of handling.

Large-size speakers, as you already know, are able to do a swell job with the lower frequencies. When both low frequencies and high frequencies are forced upon the same cone, there is a tendency for the cone to "break up" under the strain, so to speak. This is due in part to a phase cancellation in the ripples that move from the apex to the rim of the cone at higher frequencies. Have you ever listened to the distortion occurring from the reproduction of a large number of high-frequency instruments, such as occurs in symphonic music reproduction? That was the result of the inability of the speaker to handle all of the ranges being played.

DUAL LOUDSPEAKERS

The answer to the condition mentioned above is the use of 2 speakers—one to handle the lower frequencies and one to handle the higher frequencies. These constitute

what are known as "woofer" and "tweeter" speaker combinations.

The "woofer" speaker is usually around 12 ins. or 15 ins. in diameter and an ideal set-up handles only those frequencies below about 400 cycles-per-second.

The "tweeter" speaker is generally between 5 ins. and 6 ins. in diameter, and handles all frequencies above about 400 cycles-per-second.

CROSS-OVER

A filter dividing network, operating at voice coil impedances or 500 ohms or a combination of both, is used to divide the amplifier output frequency into the 2 parts.

The dividing frequency (the figure 400 just used) is called the "cross-over" frequency. Although the ideal "cross-over" frequency is around 400 cycles, most manufacturers, for reasons of economy of component parts, use from 1,500 cycles to 2,000 cycles and sometimes higher. Figure 1 illustrates an ideal response curve for a 2-speaker set-up such as we are describing. The "cross-over" frequency is 1,000 cycles with a 12 db. per octave attenuation beyond the cutoff frequency. This graph represents an ideal situation which actually never exists, insofar as the sharpness of the cutoff point is concerned.

Let us look into the dividing network used to supply each of the speakers. The circuit in Fig. 2 is that of a parallel constant resistance (constant K) filter system that is commonly used. The values of inductances and capacities are for a 500-ohm input and output to speaker and have a 12 db. per octave attenuation each side of 400 c.p.s. The circuit will be recognized as two individual filters—one being a high-pass filter and the other being a low-pass filter.

Figure 3 is a circuit of a more ideal set-

up of the "m" derived-type dividing network. The working impedance for the value shown is 10 ohms. The cutoff frequency is sharper, and the attenuation is about 18 db. per octave. While it is a more ideal circuit, the values of the capacities required are extremely costly to manufacture.

Figures 2 and 3 represent laboratory-type filter networks, and because of the odd values used for constants, are not recommended for home construction. Actually the speaker manufacturers have devised circuits of their own engineering, which not only produce the desired results, but permit the speaker and dividing network combination to be sold at a reasonable price.

Figure 4 is a circuit diagram of a Jensen JHP-51 dual loudspeaker, in which the inductances of the matching transformer are used in the filter system. Jensen's circuits (not shown here) as used in their JAP-60 and JHP-52 speakers, shown in Fig. A, also incorporate a variable attenuator for the high frequencies. The dividing network system is an integral part of the speaker, and supplied with it. The "cross-over" frequency used is 4,000 cycles, and an attenuation of from 10 to 12 db. per octave is obtained.

Figure B is Cinaudagraph's FM-12 Cinaxial speaker using a "cross-over" frequency of 1,500 cycles. The circuit diagram of the filter network is shown in Fig. 5.

Utah is soon to come out with a concentric speaker which will be called the "Duotone." The woofer will be 15 ins. in diameter and the tweeter 6 ins. in diameter. The construction of their speaker will include a reflector plate just back of the high-frequency speaker which, they say, will widen the "beam" of the high frequencies.

H.-F. BEAM

Speaking of the "beam" of the high fre-

quencies brings us to one disadvantage in the use of a "tweeter." The higher frequencies radiate from any speaker over quite a narrow beam. The angle of this beam is usually around 10% which, as you can see, requires that you practically stand in front of the speaker to fully appreciate its reproduction. Try it sometime on your own speaker. In general, the smaller the cone the wider the beam, which is why many "tweeters" have an extremely small cone.

A more ideal set-up where expense is no object is the use of several speakers for the high-frequency range mounted at various angles from the direction of the low-frequency speaker, so that complete coverage is obtained. In large installations such as for theatres and auditoriums, the "cellular" type of speaker is used to fully cover the auditorium. In the cellular speakers, a horn-type driver unit is used, the throat of the speaker horn becomes gradually larger and is divided into individual small sections (therefore the term *cellular*). See Fig. C.

The *coaxial* or *concentric* speakers shown here have found wide favor with the public as they can directly replace existing single speakers easily. Servicemen and dealers should look into the money-making possibilities by suggesting replacements for customers already owning one of the better-type radio receivers.

This article has been prepared from data supplied by courtesy of Allied Radio Corp.

New SELF-BALANCING
DRIFT-CORRECTING
DIRECT-COUPLED AMPLIFIERS

FOR DISCRIMINATING MUSIC LOVERS

Designed by A. C. Shoney

These new amplifiers bridge the gap between the laboratory and the home, and make available for the first time, extraordinary equipment at less than ordinary prices. Built in a new way, without interstage coupling condensers or transformers. Although specifically designed to meet the strictest requirements of professional sound engineers, these direct-coupled amplifiers embody all desirable features sought by the most discriminating music lovers. Send for Literature.

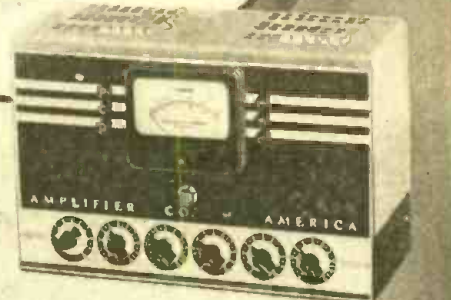

AMPLIFIER CO. OF AMERICA
17 W. 20TH STREET, NEW YORK, N. Y.

SERVICEMEN
Don't fail to read pages 160 and 161
—an announcement of great importance to you.

NEW AUDIOGRAPH Sound Catalog

AUDIOGRAPH Sound Systems represent the latest in Sound Engineering and Design—a complete line plus pre-tested accessories.

NEW LOWER PRICES

Outstanding quality and performance at prices that help you meet any competition.

WRITE FOR FREE COPY
JOHN MECK INDUSTRIES
1313 W. Randolph St., Chicago, Ill.

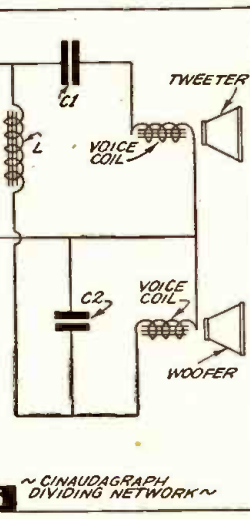
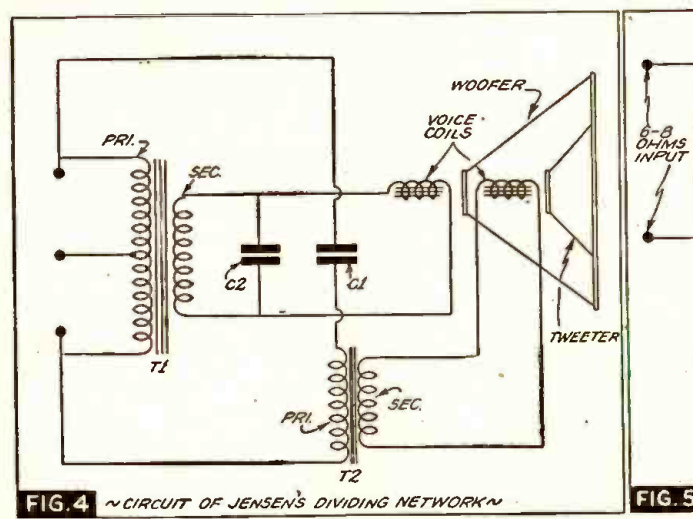
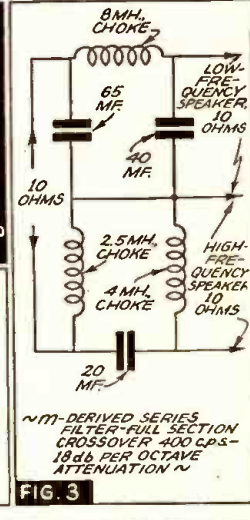
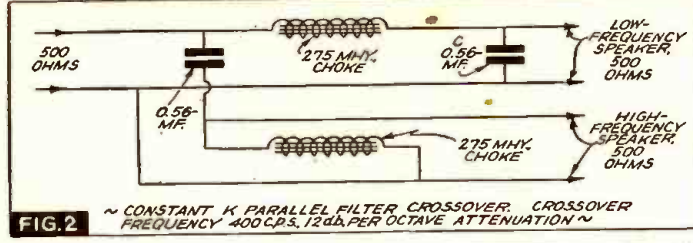
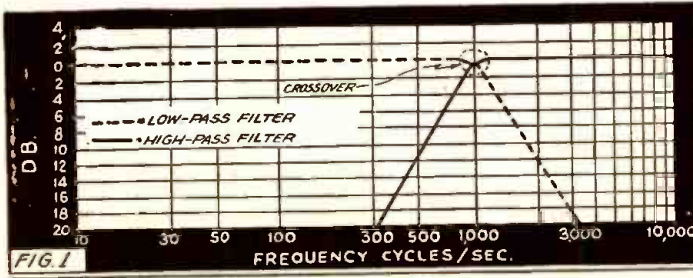

PUTTING "OOMPH" INTO RECEIVERS

To radio men who build their own or to Servicemen who modernize old sets for profit, this article will prove of inestimable value. How to increase the sensitivity and selectivity of receivers are only two of the many practical suggestions discussed. See the October issue of RADIO-CRAFT for complete details.

EVERYTHING IN RADIO

This one big book serves your entire radio needs. It includes sets, parts and supplies, public address systems, amateur equipment, testors, kits and fluorescent lighting. You'll find the nationally known favorites at the lowest possible prices. Get your copy of this big FREE CATALOG today.

BIG FREE CATALOG HAS IT!

BURSTEIN-APPLEBEE COMPANY
1012-14 MCGEE STREET, KANSAS CITY, MISSOURI

CHEST MICROPHONE

Transplate "Dispatcher" type. Leaves hands free. Handsome dialcetic black finish. Adj. neckband. Choice of single or double headset, high or low impedance. Available total of 12 different types and imp. Most attractive, lightweight, rugged, practical chest mike yet devised for operators of wired music units. At your dealer or jobber.

UNIVERSAL MICROPHONE CO., Ltd.
INGLEWOOD, CAL., U. S. A.

HIGH EFFICIENCY!

University Reflex Speakers will project sound clearly for two miles with less than 25 watts input. Write for catalogue.

UNIVERSITY LABORATORIES
195 CHRYSLER ST., New York City

University



Construction Details of a

MODERN 10-WATT A. F. AMPLIFIER

The amplifier described here offers the advantages of economy and small dimensions for an undistorted output of 10 W. The completed amplifier may be used for high-quality phonograph reproduction or in small P.A. systems. Provision is made for high-impedance microphone inputs and a high-impedance phono input; a low-pass type of tone control is incorporated in the circuit.

THIS audio amplifier is an economical unit, physically small with a good 10 watts of undistorted output and excellent frequency response.

As all components operate well within their ratings, dependable audio output is assured at all times. The amplifier is ideal as a high-quality phonograph reproducer or small P.A. system.

CIRCUIT

The tube line-up is as follows: One 6SJ7 input voltage amplifier, one 6C5 or 6N7 intermediate amplifier, two 6L6 beam pentodes in push-pull class A and a type 80 plate voltage rectifier. The option of using either 6C5 or 6N7 allows a choice of performance desired. The 6C5 gives the better frequency response while the 6N7 gives a greater gain by approximately 3 db.

Two high-impedance inputs are brought out on the front of the panel to cable connectors. A crystal microphone of high-output type should be connected to the 6SJ7 input. Other microphones, such as the dynamic or velocity may be used provided the output is as high as the crystal. The high-impedance phono-input feeds into the intermediate amplifier. Through this input the

frequency response is even better than that shown in the curve.

The volume control is unique in that it may be used for fading from phono to microphone input. This is accomplished with a center-tapped potentiometer. Zero signal is at mid-scale setting and rotation on one side regulates the volume of one channel while rotation on the other side regulates the volume of the other channel.

Circuit design is such as to provide the most gain for a good frequency response at rated output. The 6SJ7 permits the use of a short, well-shielded grid input.

The intermediate stage makes use of the plate condenser and audio transformer in a resonant circuit to boost the bass response. Besides offering higher gain the transformer provides proper coupling to the push-pull output stage. The 6L6s are operated with cathode bias in class A to give quality performance. The low-pass tone control makes it possible to reduce high frequencies, thus assuring a desirable response.

A triple binding post output strip allows the connection of one or more speakers. The secondary winding of the output transformer is tapped to provide impedances of 4,

8 and 15 ohms. Two desired output impedances can be had, by grounding the common output lead to the chassis grounding binding post and connecting the 2 desired output impedances to the 2 remaining binding posts. This arrangement will give the convenient selection of 2 output impedances against the chassis ground.

One or more speakers may be connected to the output of the amplifier as long as the combined voice coil impedances conform closely to those offered by the output transformers. For instance, two 8-ohm permanent-magnet speakers may be connected in parallel across the 4-ohm impedance output or two 15-ohm speakers may be connected in parallel across the 8-ohm output. Any single speaker of 4, 8 or 15 ohms may be directly connected to these respective impedances offered by the output of the amplifier. In the event a 5,000-ohm output is desired, connections may be made through condensers as shown in dotted lines on the diagram.

CONSTRUCTION

The following procedure should be followed in assembling the amplifier. Sockets must be mounted in their proper positions on

Specifications:

Power output—

Rated:	32.2 db. or 10 watts	(5% distortion)
	30.3 db. or 6.4 watts	(no distortion)
Peak:	34.7 db. or 18 watts	(max. distortion)

Frequency response	(6C5)	2.5 db. 70 to 15,000 c.p.s.
	(6N7)	5 db. 65 to 15,000 c.p.s.
		2.5 db. 75 to 4,000 c.p.s.

Tone control.... Treble attenuation 15 db. at 7,000 c.p.s.

Input circuits	All high impedance
Mike low-level:	Gain 107.2 db. (6C5) or 110 db. (6N7)
Phono. med.-level:	Gain 62 db. (6C5) or 66.5 db. (6N7)
	(Gain based on 100,000-ohm grid impedance)
Output impedances	4, 8, 15 ohms
Hum level55 db. below rated output
Power input	78 V.A. at 115 volts, 60 cycles
Dimensions	10 3/4 x 6 1/4 x 6 1/2 ins.
Weight (with cabinet)	13 3/4 lbs.

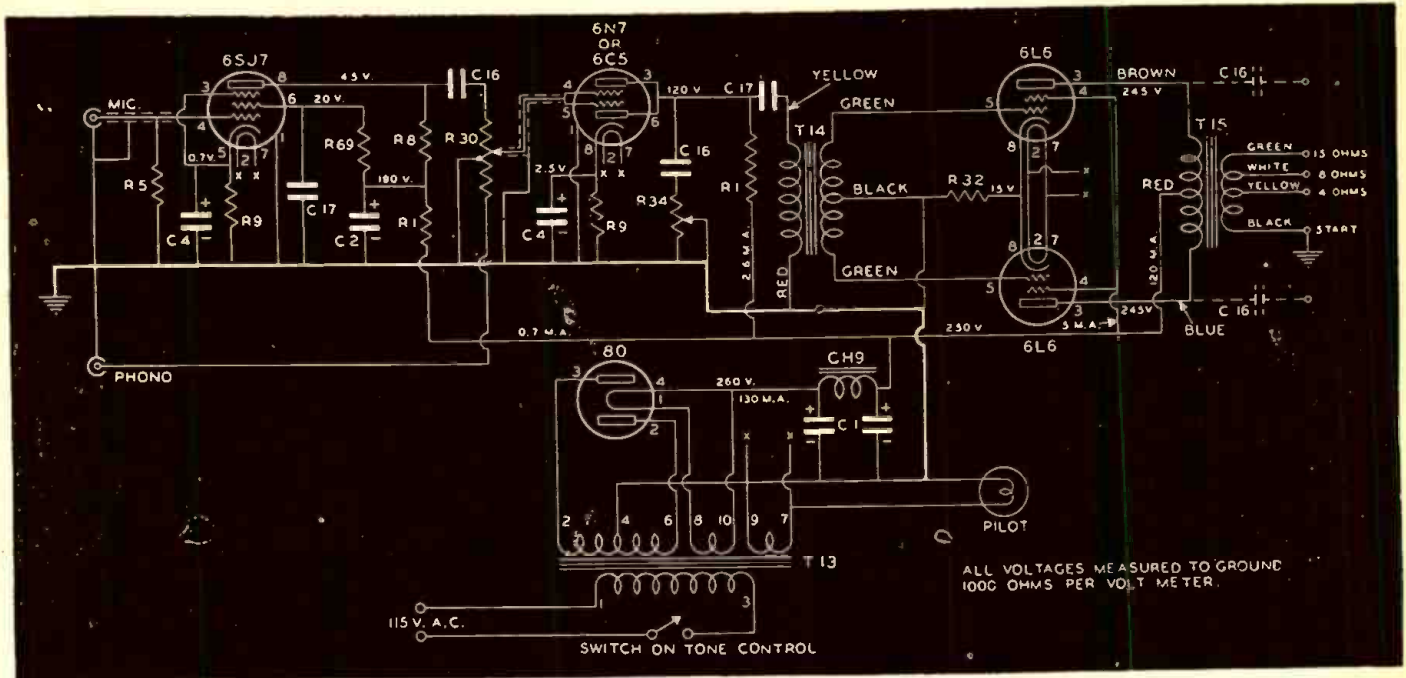

SCHEMATIC DIAGRAM OF THE STANCOR MODEL 510 AMPLIFIER

C1—8-8 mf., 450 volt, can electrolytic condenser
 C2—4 mf., 450 volt, tubular electrolytic condenser
 C4—10 mf., 25 volt, tubular electrolytic condenser
 C16—0.1-mf., 400 volt, tubular paper condenser
 C17—0.1-mf., 400 volt, tubular paper condenser

R1—50,000 ohm, 1 watt, carbon resistor
 R5—5 megohm, 1/2 watt, carbon resistor
 R8—250,000 ohm, 1 watt, carbon resistor
 R9—1,000 ohm, 1/2 watt, carbon resistor

R30—1 megohm, center-tapped potentiometer
 R32—125 ohm, 10 watt, wirewound resistor
 R34S—100,000 ohm potentiometer with switch
 R69—1 megohm, 1 watt, carbon resistor

the chassis and oriented to permit short, direct leads.

With the necessary hardware, the transformers and choke are mounted in the positions shown in the bottom-view paragraph. Power transformer T13 is mounted on top of the chassis so that its terminals protrude through the knock-out in a manner permitting the high-voltage lugs to face the rear side of the chassis. Output transformer T15 is also mounted above the chassis so that its secondary leads come through the chassis slot and the primary leads feed through the 3 provided holes. Interstage transformer T14 faces so that its primary leads come out near the front of the chassis. One of the bolts that secure transformer T15 above the chassis also mounts one side of T14 under the chassis. Filter choke CH9 is mounted below the chassis near the power transformer, but with its leads on the opposite side. The front panel and escutcheon are fastened to the chassis by mounting of the high-gain input cable connector, the 2-channel gain control, the low-gain input cable connector, the tone control, and the pilot light.

Filament leads, which may be wired first, should be twisted and placed close to the chassis, using the push-back wire provided in the kit. For the purpose of minimizing the possibility of hum, it is advisable to use a common grounding lead, which is connected to the chassis at one central point, and to which all grounded components, such as fixed condensers, resistors and shielded leads, are connected. Shielding braid is used over the lead connecting the high-gain input terminal to the control-grid of the 6SJ7 and also on the lead connecting the rotor of the potentiometer to the control-grid of the 6C5. For all soldered joints, use resin-core solder.

Most small parts are self-supported by their leads which connect directly to the proper tube socket terminals. Spare socket terminals make convenient mounting lugs. Two-lug and 5-lug terminal strips are used as junction points for condensers and resistors. The position of these mounting strips is plainly shown on the bottom-view picture.

Although the photographs are very useful

for determining the positions of the various parts, it is advisable to wire strictly by the schematic diagram. Be careful that electrolytic condensers C2 and C4 are connected into the circuit with the proper polarity.

The desired secondary leads of the output transformer are connected to the terminals of the triple binding post which is mounted on the rear of the chassis by two 6-32 nuts.

SUMMARY

This amplifier is an excellent unit for a public address system requiring 10 watts of audio power, as its small dimensions and light weight make it easily transportable. It will also be found desirable for home use where faithful reproduction of phonograph records is appreciated. The complete unit is conservative yet appealing in appearance.

Regardless of the particular service for which this amplifier is used, it will prove itself to be versatile and reliable.

LIST OF PARTS

RESISTORS

Two I.R.C., 1 W., carbon, 50,000 ohms, R1;
 One I.R.C., 1/2-W., carbon, 50 megs., R5;
 One I.R.C., 1 W., carbon, 1/4-meg., R8;
 Two I.R.C., 1/2-W., carbon, 1,000 ohms, R9;
 One I.R.C., c.-t. potentiometer, 1 meg., R30;
 One I.R.C., 10 W., wirewound, 125 ohms, R32;
 One I.R.C., potentiometer, with switch, 0.1-meg., R34S;
 One I.R.C., 1 W., carbon, 1 meg., R69.

CONDENSERS

One Cornell-Dubilier, can electrolytic, 8-8 mf., 450 V., C1;
 One Cornell-Dubilier, tubular electrolytic, 4 mf., 450 V., C2;
 Two Cornell-Dubilier, tubular electrolytic, 10 mf., 25 V., C4;
 Two Cornell-Dubilier, tubular paper, 0.01-mf., 400 V., C16;

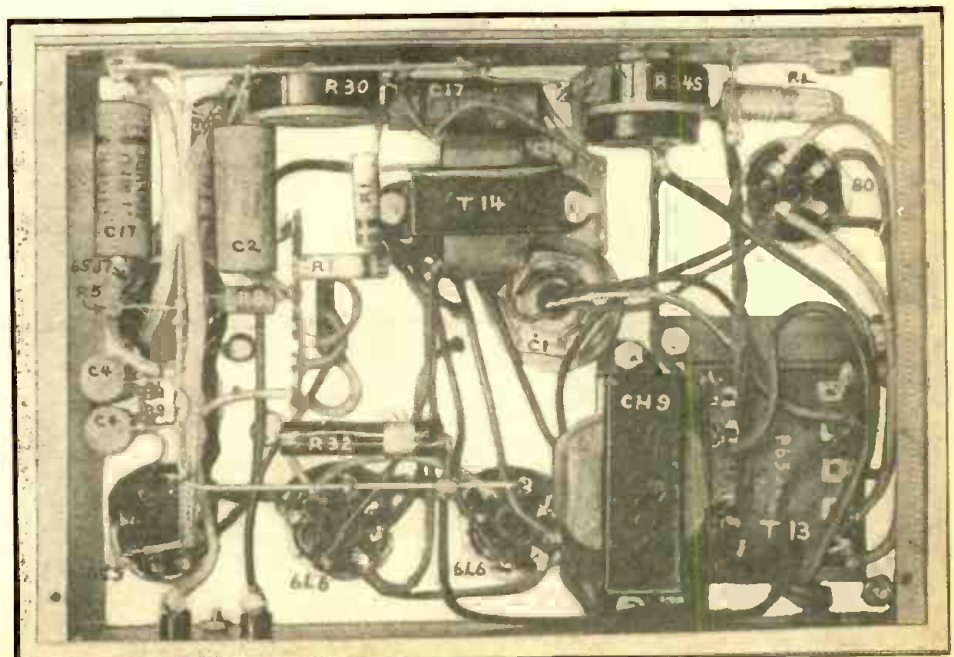

Underside-view of chassis showing the locations of the major components.

SOUND ENGINEERING

Free Design and Advisory Service
For Radio-Craft Subscribers

Conducted by A. C. SHANEY

This department is being conducted for the benefit of RADIO-CRAFT subscribers. All design, engineering, or theoretical questions relative to P.A. installations, sound equipment, audio amplifier design, etc., will be answered in this section. (Note: when questions refer to circuit diagrams published in past issues of technical literature, the original, or a copy of the circuit should be supplied in order to facilitate reply.)

No. 21

MOTORBOATING AMPLIFIER— AND CURE

The Question . . .

I built a small amplifier using one 6F5, one 6SC7 and two 6B5s, and used the high-gain inverter circuit on page 269 of November, 1939, *Radio-Craft*. It works swell if we connect a 500,000-ohm resistor from the input plate to the input grid of the 6SC7, but the volume goes down. By placing two 0.05-mf. fixed condensers in the circuit, the volume stays up, but the bass notes lose their fullness.

Without the resistor and condenser it motorboats.

Would you send me a circuit using the same tubes that will not motorboat, or a way to fix the amplifier I already have?

The high voltage is secured from a 6-volt genemotor from a Ford Majestic car radio about 10 or 12 years old.

HERMAN C. SCHMIERBACH,
Ortonville, Minn.

The Answer . . .

The motorboating that you complain of is undoubtedly caused by insufficient filtering in the plate circuit of the 1st stage. Your power supply undoubtedly has high internal resistances which provide for a common coupling in-phase circuit which produces motorboating.

When you first added the resistor from the plate of the 6SC7 to its grid, you placed a positive bias on the grid, decreased the plate voltage of the 1st triode section,

upset the inverter, and introduced a form of inverse feedback, which accounts for the decreased gain. When you added the 2 condensers in series with the resistor, you removed the first 3 troublesome conditions, but you introduced a form of frequency discriminating feedback. In other words, only the high frequencies are fed back. This produces a loss of only high frequencies, which accounts for the change in tonal character of the bass notes.

You can probably easily remedy your difficulty by adding an additional resistor (25,000 ohms) in series with the 500,000-ohm plate load of the 6SF5. The junction of both resistors should be bypassed to ground with an 8-mf. condenser. If this does not completely remove the motorboating condition, then a similar resistor-and-condenser network should be added between the "B+" 225 terminal and the junction of the 1/4-meg. plate load resistors of the 6SC7.

CALCULATING TRANSFORMER REQUIREMENTS

The Question . . .

I am just a young radio Serviceman, who is in need of some help. The other day I purchased a signal tracer of the type that has a vacuum tube and volume control in a single unit.

Now here is my trouble. In order to use my signal tracer, I have to have an amplifier. A schematic for an amplifier came with the tracer, but being "green" at the

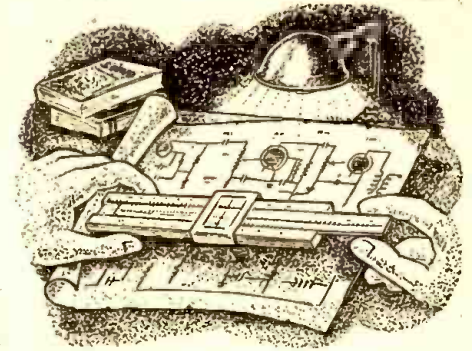

game of servicing, I don't know how to buy the parts whose values are not marked.

I have put an X over the units (see Fig. 2) that has me stumped. For instance, the power transformer leads are not marked and since there are so many transformers on the market, I don't know how to buy it. It is the same situation with the other 2 I have marked.

I would like to have such information so that I could buy one in the store.

BOB RICE,
631 N. Kick,
Shawnee, Okla.

The Answer . . .

Most circuit diagrams do not give detailed technical data on transformers and chokes, because it is assumed that the readers have sufficient knowledge to know just what type to purchase. Transformer T1, for example, can be purchased by simply requesting an output transformer to match a single 6F6 to speaker voice coil. (This should be known: the usual range is from 2 to 16 ohms. Actually, the plate impedance of the transformer should be 7,000 ohms.)

Some of the specifications for the power transformer are also obvious. For example, the 6.3-volt winding should be able to handle one 6F6G, and one 6J7GT. Both of these tubes require a total of 6.3 volts at 1 ampere. Inasmuch as the plate and screen-grid requirements of the amplifier are approximately 60 ma., the secondary of the transformer should be capable of delivering this current. If the plate and screen of the 6F6G operate at 250 volts, the high-voltage A.C. winding should be approximately 240 volts r.m.s. from each side of the center-tap. Naturally, a standard transformer should be selected which comes close to the actual requirements. A 250-volt transformer may be employed. If the output voltage is

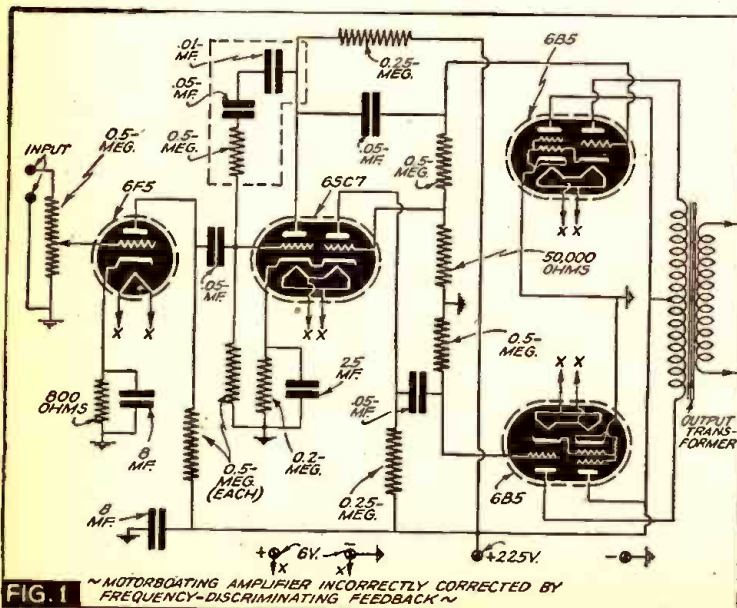

FIG. 1 ~ MOTORBOATING AMPLIFIER INCORRECTLY CORRECTED BY FREQUENCY-DISCRIMINATING FEEDBACK ~

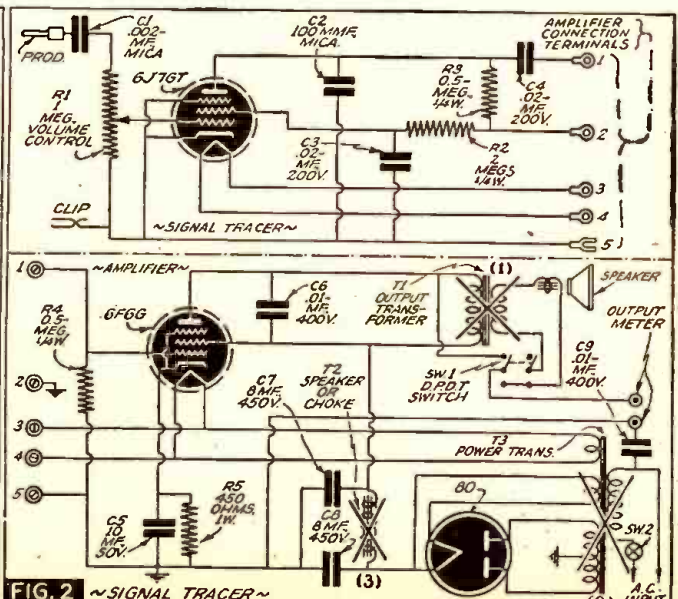

FIG. 2 ~ SIGNAL TRACER ~

excessive, it may be reduced by incorporating a series resistor, or a shunt bleeder.

The inductance of the choke is determined by the degree of hum attenuation desired. A 5- or 6-henry choke will cut the ripple down to about 5%, which should be adequate. However, a larger inductance should be used if lower hum is desired. The current carrying capacity of the choke is determined by the total current consumed by the amplifier, which as previously stated, should be approximately 60 ma.

DIRECT-COUPLED 6A3 AMPLIFIER

The Question . . .

I would appreciate it very much if you could redesign your Direct-Coupled F.M. Amplifier circuit in the December, 1940, and January and February, 1941, issues of *Radio-Craft*, to use 6A3s in the final instead of the 6L6s. I wish to use it for recording purposes, and so I will not need near the output as afforded by the 6L6s. I wonder if you would show a few circuit voltages also.

DANIEL DAWSON,
Hq. & Hq. Technical School Squadron,
Chanute Field, Rantoul, Ill.

The Answer . . .

A circuit diagram somewhat similar to the type you desire, appeared in the July, 1940, issue of *Radio-Craft*. This circuit can be redesigned in accordance with design data given in the July, 1939, issue of *Radio-Craft*, so as to conform to your particular requirements. All voltages can be calculated from the design data referred to.

OPERATING NOTES

(Continued from page 153)

part of the tone control, has been snapped on, and the tubes reach their normal operating temperature, or after a period of operation. In some instances, the hum may be cleared by snapping the line switch several times. In any event, when the above symptoms are noticed, check the tone control line switch. The shorting contact shoe of the switch will be found contacting the heavy buss-bar terminal lead within the unit. Bending the lead up or out, away from the switch contact shoe will correct the difficulty.

Where only a loud hum is heard and the receiver is otherwise inoperative, check for a grounded push-pull output transformer primary. The primary winding occasionally short-circuits to the laminations of the transformer which is of course grounded to the chassis, thus producing the difficulty. A low hum, which is heard above low signal levels, however may be traced to sections of the plug-in type electrolytic filter block which have lost capacity.

In cases where the hum is accompanied by distorted reproduction, the trouble may be due to leakage between sections of the block. This is usually caused by the formation of salt deposits at the base of the 8-prong plug of the filter block or upon the 8-hole socket. The salt deposit which is of a low-resistance nature, is the result of leakage in the electrolytic condenser block, whose internal connections are the same as the ones employed in the model 64.

When these receivers are serviced for the complaint of no control of volume with attendant distortion at resonance, no tuning meter action with needle off-scale to the left, the A.V.C. I.F. transformer, whose

(Concluded on page 178)

INTRODUCING A NEW TYPE OF MULTI-WAVE TUNER

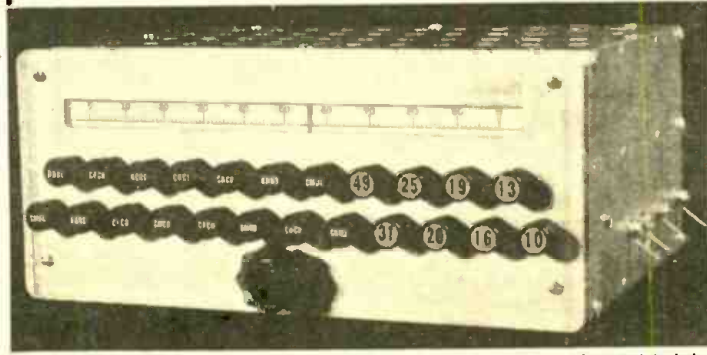

MODEL 142 as illustrated above for superheterodyne circuit—465 kc. wired and tested—complete with instructions, circuit diagrams, charts and other useful data. Patents applied for.

Immediate delivery made upon receipt of order
MICHIGAN RADIO PRODUCTS, Ludington, Michigan

A complete frequency coverage in 23 steps.
10 domestic broadcast stations—1700 kc.
Police band—160 meter
amateur band—2400 kc.
Police band—50 meter
amateur band—aircraft—
49-31-25-20-19-16-13-
10 meter bands and all
this by means of push
buttons.
Guess work in short
wave reception is elim-
inated in that this pre-
cision built product is
capable of receiving
short wave stations
with the same facility
as stations in the do-
mestic broadcast band.
• No external variable
condenser gang
necessary.
• No gang switch used.
• No oscillator padding
condensers.
• Tuning is positive
and smooth.
• Mounted in dust
proof metal cabinet.
• Overall dimensions of
tuner proper: 9 1/4" x
6 3/4" x 4 1/4".

PRICE \$15.60

WE PAY THE POSTAGE

A New Type of Radio Service Manual!

JUST OFF THE PRESS is a new type of radio service manual known as "Radio Circuit Manual—1941." It is a complete directory of radio receivers manufactured in 1940 and up to June 1941. The outstanding achievement of this manual is that all the service data and diagrams covering this period—some 1,800 receiver models—have been condensed into a book of only 736 pages! This was accomplished by the simple expediency of editing all material. (To our knowledge this is the very first edited radio service manual ever to be published.) All non-essential data have been deleted as have been data and diagrams on communications and export receivers, amplifiers, and other such allied apparatus which the Serviceman seldom, if ever, is called upon to repair. Other features include a larger page permitting (with some exceptions) all data on a given receiver to be listed on a single page; all I.F.'s boldly displayed in black squares; all pages laid out uniformly, and with a definite text sequence. The manual measures 13 1/2" x 10 1/4", only 6 1/2 pounds and is only 2" thick. (See pages 160 and 161 for further details.)

Write With This Time-Tested Pen Read This Proof Of Its Durability and Quality

No. Easton, Mass.
April 29, 1941.

Laughlin Mfg. Co.,
Detroit, Mich.
Gentlemen:

Enclosed find money order for \$1.50 for one of your ink pencils.

It may interest you to know that over 25 years ago I bought one of your pens after reading your ad in our Sunday Visitor.

I used it for 15 years and then gave it to my brother, who lost it. The pen wrote splendidly up to the time it was lost.

Yours truly,
(signed) B. F. Conroy.

An actual letter received from a satisfied customer of years ago who buys again.

**YOUR CHOICE
\$1.00 P'PAID**

Try either or both items for ten days at our risk. If not entirely satisfactory and as represented return it and we will refund purchase price.

Choose either the fountain pen or the ink writing pencil, and you will have a fine quality, durable, guaranteed, writing instrument!

The safety self-filling fountain pen is fitted with a 14 kt. solid gold iridium tipped pen. The safety self-filling ink writing pencil has a 14 kt. point also. Both are fully guaranteed 14 kt. solid gold, and for workmanship and satisfactory service.

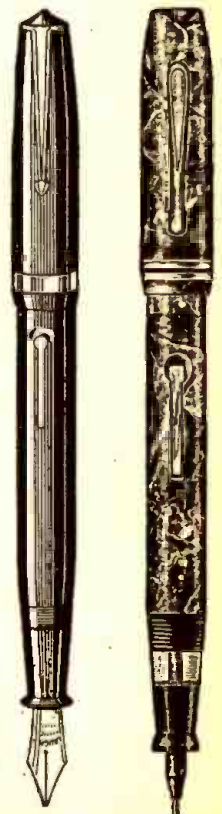

ILLUSTRATIONS
2-3 ACTUAL SIZE

DE LUXE GIFT OF BOTH IN BOX FOR \$2.00

Splendid for School—for Boys in Training Camps—for Christmas
Here's writing satisfaction! Both items in satin lined gift box—\$2.00 postpaid. Excellent for school—for boys in training (clips meet military regulations)—for birthday and Christmas gifts. Order today.

Laughlin Mfg. Co. 962 Majestic Bldg., Detroit, Mich.

LAUGHLIN MFG. CO. 962 Majestic Bldg., Detroit, Mich.

Please send the following for which payment of \$..... is enclosed:

- _____ Safety Self-Filling Fountain Pen \$1.00 postpaid.
- _____ Safety Self-Filling Ink Writing Pencil \$1.00 postpaid.
- _____ De Luxe Sets of Fountain Pen and Ink Writing Pencil \$2.00 postpaid.

Name
Address
City State

EMERGENCY REPAIR OF TEST METERS

The present inability to obtain on short notice many repair parts, and the inability to obtain quick replacements of complete units, are 2 important reasons why the following article will have exceptional value at this time to many owners of meters. It tells how the radio technician may obtain service from meters which due to any one of the number of common mechanical and electrical faults described by Mr. Banks might otherwise be temporarily out of service.

JOHN CHARLES BANKS

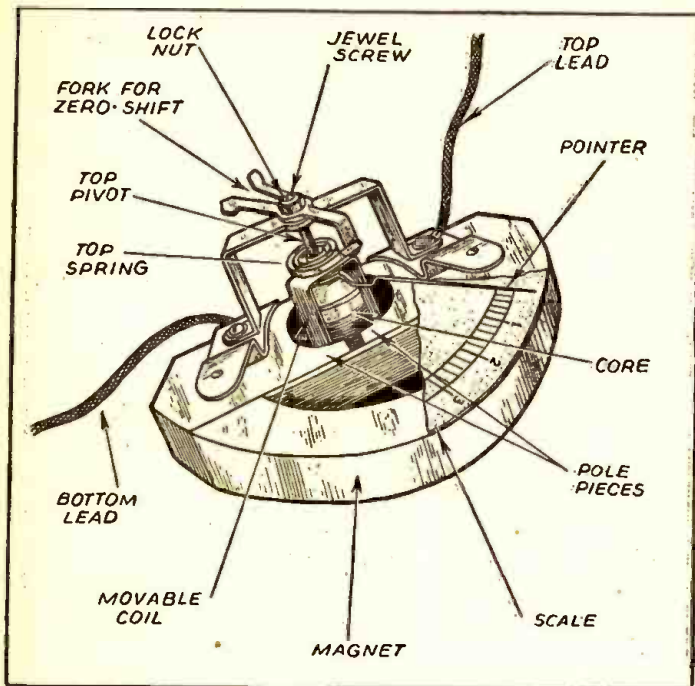

Fig. 1. Close-up of a d'Arsonval meter movement showing scale partly broken away, and the fork for zero shift. The general principle of operation is illustrated.

meter near where there is dirt, especially iron filings or worse yet, pieces of steel-wool. A permanent magnet will attract these particles, and there will be no end of trouble.

To locate the obstruction, connect the instrument to a current source, or to its part of the circuit by leads, and vary the current until the stoppage point is found. This procedure is also helpful when locating fuzz. If a piece is seen in the air-gap, remove with needle, withdrawing the latter slowly. Sometimes a non-magnetic particle will not adhere, therefore it must be pushed to the bottom. A thin strip from a visiting card is also helpful for this work. Again, the particle may be under the coil frame, between it and the core. Do not attempt to force a needle in. Cut an L-shaped piece from a visiting card, with one side of the L rather short and pointed. By pushing this portion of the piece down and under the coil, the particle can be removed, or at least moved out where it can be picked up with the needle. Do not attempt to blow into any instrument movement with the breath, for the breath carries particles of moisture.

The pointer may stick at one or more points due to the coil being too loose in its bearings. Especially if the meter is used in a vertical position, looseness allows the movable coil to fall away from the true center and touch the core or one of the pole-pieces. To rectify, the bearings must be tightened.

In Fig. 1 the top bearing, or as it is known in the art, the *jewel screw* is shown. This is held fast by a lock-nut. Loosen this nut slightly with a wrench or pliers, and with a small screwdriver tighten the jewel screw. Before attempting to move this screw, hold the pointer between the thumb and forefinger and move the movable system back and forth to see if it is loose or too tight. There must always be SOME motion, otherwise tight bearings will cause friction. If too tight, back off the jewel screw until a slight amount of motion is perceptible. Then with the screwdriver holding the jewel screw in the correct position, tighten the lock-nut. Check again for slight motion and if not just right, repeat the above operation. Never turn the screw until there is NO motion, for the pivots on the movable coil where they ride in the bottom and top jewel screws may be dulled, causing what is known as *pivot friction* throughout the entire scale.

In rare cases when jeweled bearings are loose, they allow the coil to touch the top of the core, causing friction at that point. In such instances it is better to tighten the bottom jewel screw.

The same methods may be employed in correcting trouble in the A.C. movement, a sketch of one being shown in Fig. 2. Here particles of matter get lodged in the air-damper box. Remove the box cover and examine. If bearings are too loose, the damper vane will drag on the bottom or side of the box. Tighten the jewel screw, using the same precautions as in the D.C. model. Be sure to look for hairs or fuzz around the

THE repair of electrical indicating instruments is a highly specialized art, and to the user, be he engineer or layman, the "innerds" are usually a mystery. But maybe it's just as well!

This article is not written to encourage everybody taking apart instruments in order to see what "makes them tick," and from what follows you will see why this statement is made. Its object is to help those not in this class, but instead, users confronted with a defective meter when it is badly needed. The writer has often worked on a piece of apparatus, incorporating an electrical indicating instrument, which under final test showed some defect. By being able to rectify the trouble when a replacement meter was not available the shipment was made on time. Another case might be one where an important test is to be made and another meter not on hand. Otherwise it is good practice NOT to attempt repairs.

Several defects may cause an instrument to fail in its correct operation. They are listed below, and suggestions made for the correction of these faults. A sketch of a D.C. permanent-magnet movement and another of an A.C. movable-iron type less its field coil, are shown, to make explanations more clear.

MECHANICAL TROUBLES

Some of the most common mechanical troubles are as follows:

- Sticking of movable system.
- Loose bearings.
- Tight bearings.
- Dull pivots.
- Spring convolutions caught.

Probably the most common of all instrument defects is "sticking." By that we mean the pointer is halted in its travel over the scale when current is applied, or when it does not return to zero after it has been moved.

To attempt to eliminate sticking, the first move is to remove the instrument cover. Due to the multiplicity of sizes and makes, it would be impossible to give directions. A medium or small darning needle, and some sort of magnifying glass are essential, especially if foreign matter is in the air-gap of the D.C. meter.

Sticking may be caused by one or more of several things. A tiny piece of fuzz or hair may be in the path of the pointer, either on the scale, or down at the movable coil where it interferes with its motion, or obstructing the free movement of the top or bottom hair spring. Look for this trouble also near the tail of the pointer. These hairs are best removed by tweezers.

While many of the small panel-mounting, or small portable meters have etched dials, some have paper scales mounted on brass plates. If this paper is rough at some point, often a tiny piece will partially loosen itself from the scale and stop the pointer in its travel. This obstruction can best be removed by tweezers or the point of a knife. Erasing on scales should be done only when necessary, for this often breaks the paper surface and stops the pointer.

In the D.C. meter, foreign matter gets in the air-gap, that space between the core and the pole-pieces where the coil moves. This matter often is magnetic. At this point let us caution one against having an open

Fig. 2. Magnetic-vane meter. This detailed illustration shows the manner in which the damper vane moves in the damper box. The actual construction will vary with the make and type of meter.

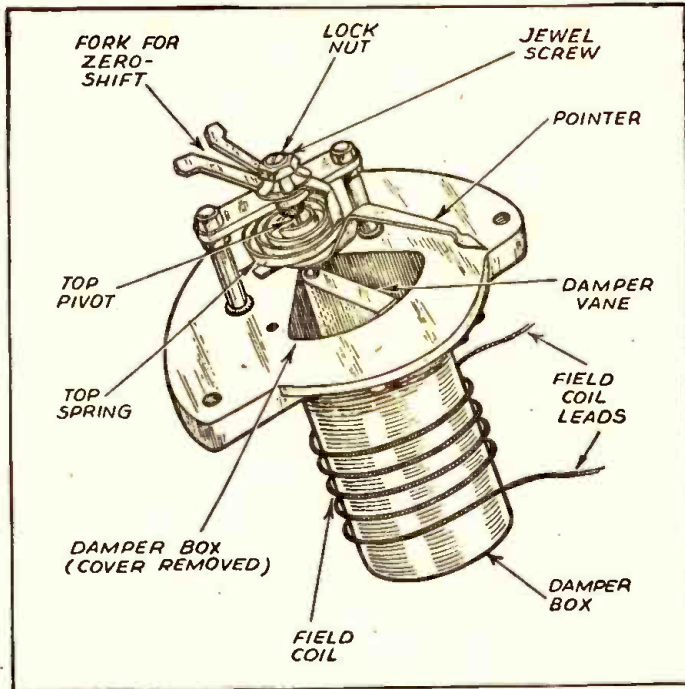

movable iron parts. Sometimes these parts are in the damper box as in Fig. 2, while others may be outside in full view.

Dull pivots may be detected by applying current so that full-scale deflection is obtained, and slowly decreasing this current to zero. Then tap the instrument gently with the finger to see if it changes its position to a lower value. There is no remedy for dull pivots other than having them sharpened or replaced by one well versed in the art.

A small hair may be on the inside of the case, and this will often interfere with the pointer travel. Look for trouble here if there is sticking.

Sometimes the pointer will fail to be on zero, or return to it after current has been applied. This can be caused by one of the spring convolutions jumping over the support, and can be rectified by removing with the needle or similar tool. Always examine the bottom spring as well as the top for this trouble.

ELECTRICAL TROUBLES

Some of the most common troubles are: Open-circuit in movable or field coil, or series resistance. Short-circuit in or around movable coil. Broken lead on ammeter with external shunt.

Of course there is always the possibility of an open- or short-circuit in any meter if it fails to give an indication. In the A.C. or D.C. meter if a voltmeter, the series resistance may be open-circuited. Then again in the former, the field coil, or in the latter the movable coil may be open or even shorted. Test for this trouble with another meter in series with a current source and a limiting resistor if necessary. This resistance or current source must be such as not to give more than full-scale deflection on the test meter when the test leads are touched together. Test the separate parts of the defective meter resistance, thus locating the portion giving trouble.

If the series resistance does not show any "opens," test the movable coil (in the case of a D.C. meter). An open-circuit may not necessarily be in the coil itself. Examine the leads connected to the movement. Some systems have one side grounded with the magnet, and if the other lead should make contact with any metal portion of the movement, a short will result. If the bottom

spring support is insulated, this may be turned in such a way that it makes contact on the grounded part. Loosen the bottom lock-nut and turn slightly to clear. Changing the bottom spring setting will alter the zero setting of the pointer, but this can be re-set by the zero adjuster.

The A.C. meter may have an open-circuit in the field coil. If one of the lead wires to or from the coil is broken, this may be repaired. It may be possible to take one of the inside, or outside turns off for contact to the lead wire, and one turn would not make enough error in the meter if it is not an instrument guaranteed to an accuracy better than 1%. The field coil is omitted in Fig. 2, but fits around the shaft of the movement and the damper box.

Another cause of open circuit is in leads. In addition to the test leads furnished with meters, ammeters with external shunts have leads which after hard usage often develop breaks, with the result that the meter does not give a deflection. If this break is very near one of the terminals, a repair will not affect the resistance enough to change calibration of the instrument; and, if the break is an another part of the cable, it can be spliced at this point. Should it be necessary to replace a lead, be sure to do so with one of the same size and length, or one of equal resistance. The meter portion of the ammeter circuit is usually of low order, and considerable altering of lead resistance will change the calibration.

New Circuits in Modern Radio Receivers

(Continued from page 156)

much more independent in their operation, and permits separation of frequencies in the transformers where each can be designed to favor its own group or spectrum.

The output circuit is shown in Fig. 5. Note that half of the primary of T1 is in series with half of the primary of T2. The high-frequency section of the group is in T1 and the impedance or bypassing of T2 cannot possibly influence the passage of high frequencies in T1 materially. The voice coils are entirely separate there being no filter required either for the purpose of frequency discrimination or for favorable impedance matching at various frequencies. A parallel-

Service Men have bought Over 100,000 SUPREME Testers

Could there be more convincing proof of SUPREME quality, accuracy, dependability and fair price than the fact that servicemen who know their test equipment have invested over \$5,000,000.00 in over 100,000 SUPREME testers?

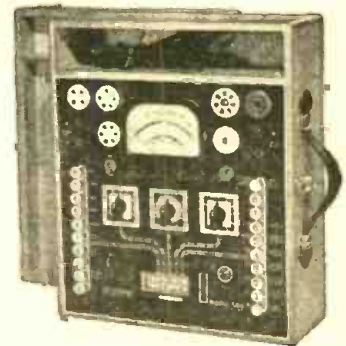

MODEL 504-A
TUBE AND SET TESTER

Our experience has equipped us to put even more value in the second 100,000 SUPREME instruments than in the first. Write Dept. RC-6 for full information on 1942's TOP line of testing equipment.

SUPREME

GREENWOOD, MISSISSIPPI, U. S. A.

SAVE UP TO 50% FACTORY-TO-YOU

9 BANDS
(ON 6 DIAL SCALES)

30 DAYS TRIAL

20 TIMES BETTER FOREIGN TUNING with SUPER BAND SPREAD RADIO.

PUT THIS CHASSIS IN YOUR PRESENT CABINET

UP TO \$50.00 TRADE-IN

WRITE for big FREE catalog. New 1942 models include Radios, Radio-Phonos, Home Recorders. Sensationally low factory-to-you prices: \$11.95 to \$212.00... up to 16 tubes. (User-Agents Wanted).

\$19.75 COMPLETE

2" SPEAKER, TUBES, PUSH-BUTTON TUNING, MAGNA-TENNA LOOP AERIAL... READY TO PLAY

MIDWEST RADIO CORPORATION
DEPT. 12-C CINCINNATI, OHIO

push-pull arrangement is used in the output circuit although the output transformers are equally suited to a single push-pull circuit.

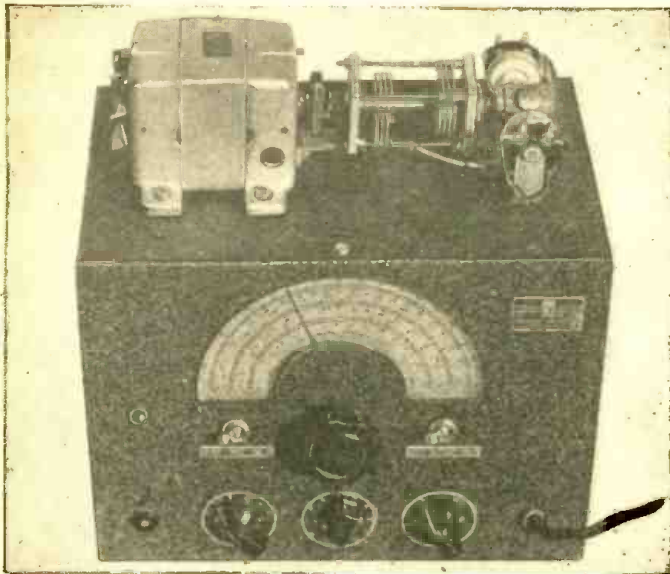

The author of this article has supplied complete construction details and applicational information for a frequency modulator for use with a signal generator and an oscilloscope. This "wobbler" was built at very little cost from parts found around an experimental laboratory and for a year has proven practical for resonance alignment and in the study of R.F. circuits.

◀ Fig. 1. View of the completed frequency "wobbler" mounted on the case of a standard oscillator to obtain short leads for frequency modulation of high-frequency signals. A metallic cover is necessary for proper shielding of the condenser. A close-up of just the wobbler appears as one of the "spot" illustrations on the cover of this issue of Radio-Craft.

How to Build and Use a Practical

FREQUENCY MODULATOR

MARION AMOS

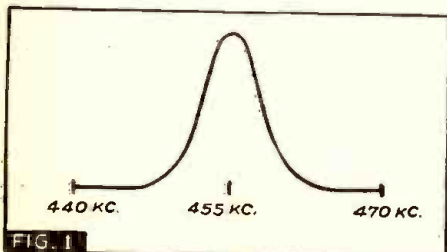

FIG. 1

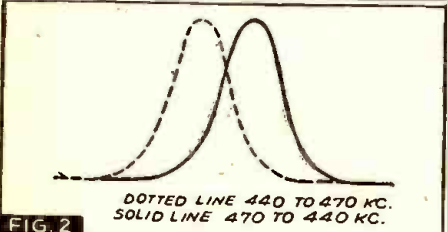

FIG. 2

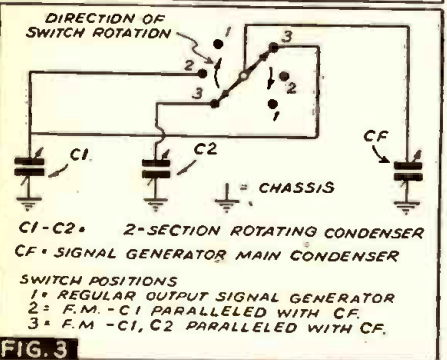

FIG. 3

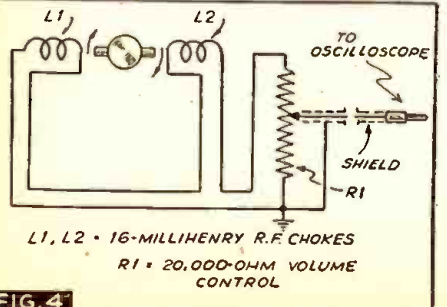

FIG. 4

THE author having constructed an oscilloscope using a Thordarson kit and the extra parts needed found himself in possession of a fairly good instrument but without any means of using it for resonance alignment and the study of radio frequency circuits.

Various types of frequency modulators were studied in an effort to find a single type that could be constructed from parts easily obtainable and still give satisfactory results.

"WOBBLE" FUNDAMENTALS

Fundamentally a frequency modulator is a mechanical or electrical device causing the output of a radio-frequency oscillator to vary in frequency across a predetermined band of frequencies.

For example if the frequency of an R.F. generator is "wobbled" over a band from 440 kc. to 470 kc. by connecting a small rotating condenser across its main condenser without varying the amplitude, and this signal is applied to a circuit whose acceptance is 455 kc., the result will be that the 455 kc. circuit will accept only a portion of the incoming signal. Likewise the output of the 455 kc. circuit will only contain that part of the 440 to 470 kc. signal that the circuit accepts or passes. If these variations in frequency, without a change in amplitude, are made at a speed of 3,600 r.p.m. for the rotating condenser which is 60 r.p.m. a second, it will be at a speed in the audio frequency range or 60 cycles a second. However since the rotating condenser in its rotation moves 15 kc. either side of the 455 kc. center frequency twice every revolution, the rate of sweep is 120 times a second or in audio frequency, 120 cycles a second.

With this in mind the next step is to apply such a signal to an oscilloscope to obtain a "picture." In order to do this, it is necessary to rectify the frequency output of the 455 kc. circuit under test. In the ordinary receiver this is accomplished by the diode 2nd-detector in a superheterodyne or by the detector in a T.R.F. receiver.

In order to correlate the foregoing a restatement of the various facts that have

been brought out in the example are in order.

HORIZONTAL & VERTICAL F.M. SWEEPS

The output of the modulated signal generator varies in frequency from 440 to 470 kc. at a rate of 120 times a second or 120 cycles.

The amplitude or signal strength does not vary.

The 455 kc. circuit accepts only that part of the incoming signal which conforms to the design or resonance features of the circuit.

The output of the 455 kc. circuit has only that portion of the original signal in it that conforms to the resonance characteristics of the circuit.

Due to the rate of speed with which the frequency modulation takes place, i.e., 120 cycles a second the output of the 455 kc. circuit is rectified and an audio frequency voltage of 120 cycles results.

This A.F. voltage of 120 cycles is applied to the vertical plates of the oscilloscope.

Thus when the acceptance of the 455 kc. circuit is very sharp or peaked the incoming signal will cause the beam of the oscilloscope to be deflected vertically only when the condenser reaches that point in its rotation between 440 and 470 kc. when the signal is 455 kc. and would result in only a vertical straight line on the oscilloscope.

However to date there has not been any circuit developed with such peaked characteristics so it is necessary, in order to obtain a true picture of the resonance characteristics of the circuit, to apply a voltage to the horizontal plates of the oscilloscope.

This is done by using the "internal sweep circuit" of the oscilloscope.

In this particular case, since the speed as noted above, of the frequency variation between 440 and 470 kc. is 120 cycles, then 120 cycles is applied to the horizontal plates of the oscilloscope causing the beam to be deflected horizontally back and forth in synchronism with the rotation of the condenser.

Thus when the signal going to the 455 kc. circuit is 440 kc. the oscilloscope beam is

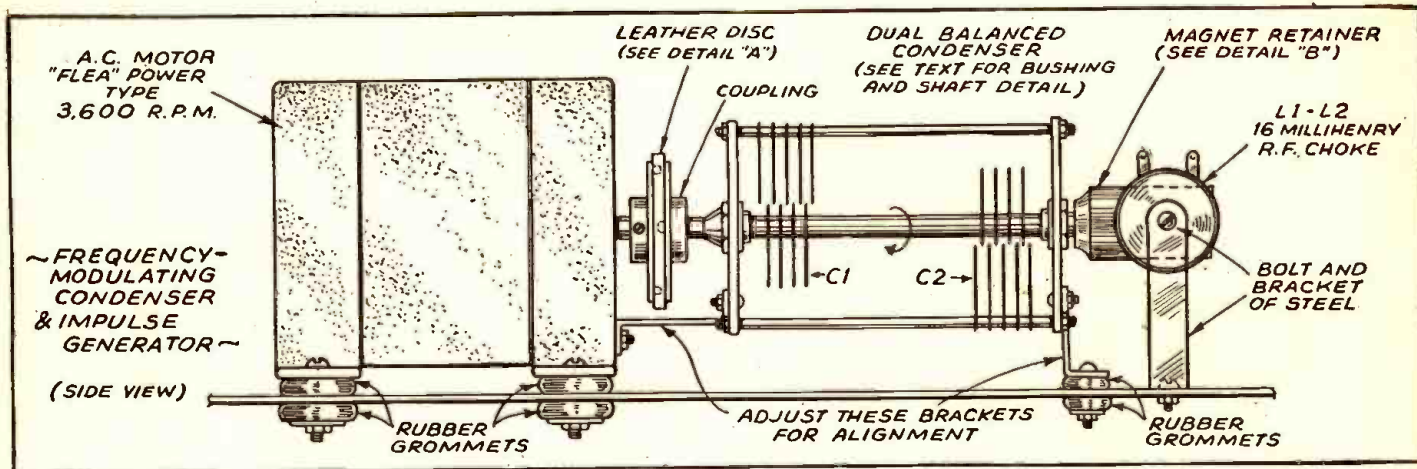

on the left-hand side of the screen, the condenser is at the beginning of its rotation at minimum capacity, the output of the 455 kc. circuit is minimum and the vertical deflection of the beam is zero.

Since the beam in the oscilloscope is being moved horizontally in synchronism with the rotation of the condenser, then as the beam moves the rotation of the condenser causes the frequency to vary, too. Thus as the beam moves horizontally towards the center of the screen, the signal generator frequency output is beginning to approach 455 kc. Since this R.F. signal is being fed through the 455 kc. circuit to the vertical plates a vertical deflection of the oscilloscope beam will be caused reaching maximum at 455 kc. As the beam moves horizontally to the right beyond the center of the screen the frequency approaches 470 kc. and the vertical displacement falls off until it reaches a minimum on the extreme right-hand of the screen.

FIGURES

Thus the curve shown in Fig. 1 will result. With perfect resonance there will be only one curve traced on the screen. However since the condenser plates in their rotation make one frequency excursion from 440 kc. to 470 kc. as they go from minimum to maximum capacity, they also make a frequency change from 470 kc. to 440 kc. as they change from maximum to minimum capacity. As a result there will actually be 2 resonance curves or traces on the oscilloscope screen as shown in Fig. 2.

By adjustment of the trimmers of the 455 kc. circuit the 2 curves are made to conform as nearly as possible in shape and height.

Now in order to lock the 2 traces on the screen it is necessary to feed an A.C. voltage to the oscilloscope in such a manner that the voltage will be developed at the same speed that the frequency modulating condenser is turning. In order to do this a small A.C. generator is built on the same shaft as the rotating condenser.

Usually this consists of 2 small coils or a pair of coils with rotating contacts connected to the end of the condenser so that the coils rotate in the field of a U-shaped permanent magnet. In this design a very simple expedient is used: the magnet is revolved and the coils are held stationary doing away with revolving contacts and making balance easier.

DESCRIPTION OF PARTS

The motor is of the small "flea power" type, squirrel-cage induction, and operating from 115 volts A.C. at 60 cycles with a speed of 3,600 r.p.m.

The condenser is a small dual condenser

with 25 mmf. per section and shaft projecting at both ends. It is not in its original form but rebuilt so the rotors are on opposite sides of the shaft for balance, and the stationary plates shifted likewise. It is imperative that a steel shaft with brass bushings provided with facilities for oiling be used because of the high rotative speed. These can be made at a machine shop at small cost, using the original parts for models. Before disassembling the condenser, inspect the shaft for through pins.

The synchronizing pulse generator, which is usually complicated and the hardest part to make, is relatively simple.

A small permanent magnet is inserted in a piece of fiber as shown. The fiber is bored for a tight fit on the projecting shaft of the condenser. The magnet can be found in novelty shops and can be of square or round cross-section.

This magnet revolves between two 16 millihenry R.F. chokes connected "series aiding" which are mounted on a steel frame with steel bolts.

As the magnet revolves, the magnetic lines of force existing around it cut through the turns of the R.F. choke coils; the voltage induced thereby is used for the synchronizing pulse for locking the images on the oscilloscope screen.

The coupling is made from a National coupling with the fiber removed and 3/16-in.-thick leather disc substituted therefor. The leather disc is not permanently attached but floats between the 2 parts of the coupling.

The condenser is attached to the motor with a small bracket at one end and attached to the case with another at the other end.

All holding-down bolts have rubber grommets inserted between them and the case.

For proper synchronization the magnet should be in a horizontal position between the coils when the plates of the condenser are fully closed.

Balancing of the condenser and magnet is comparatively simple and easily accomplished. If the condenser plates are properly positioned, the magnet properly inserted in the fiber and the condenser shaft properly aligned the combination will operate with no appreciable vibration. Set-screws should not be used because they will cause unbalance.

For connections of the frequency modulating condenser to the main signal generator see Fig. 3.

For synchronizing voltage connections see Fig. 4.

The 20,000-ohm volume control acts as a voltage divider making it possible to obtain most any voltage needed for synchronization and gives a very fine adjustment for locking the images on the screen of the oscilloscope.

These 2 controls are shown mounted on the case of the oscillator.

I would recommend reading some detailed *books on the use of the oscilloscope. This will be an aid in realizing the full possibilities of the modulator.

APPLICATIONS

However, a brief résumé of the manner in which it is used is given herewith.

The output of the signal generator is connected to the stage in the receiver to be aligned. The vertical terminals of the oscilloscope are connected across the diode load resistor.

An amplitude-modulated signal is fed into the stage at the correct frequency with modulator switch on position 1. Set the horizontal gain of the oscilloscope amplifier at zero and advance the vertical gain until there is a thin vertical line on the oscilloscope. Adjust the circuit, being aligned, for maximum length of line with the lowest

*For example, Radio-Craft Red Book No. 29, "The Cathode-Ray Oscilloscope—Theory and Practical Applications," or John F. Rider's "The Cathode-Ray Tube at Work."

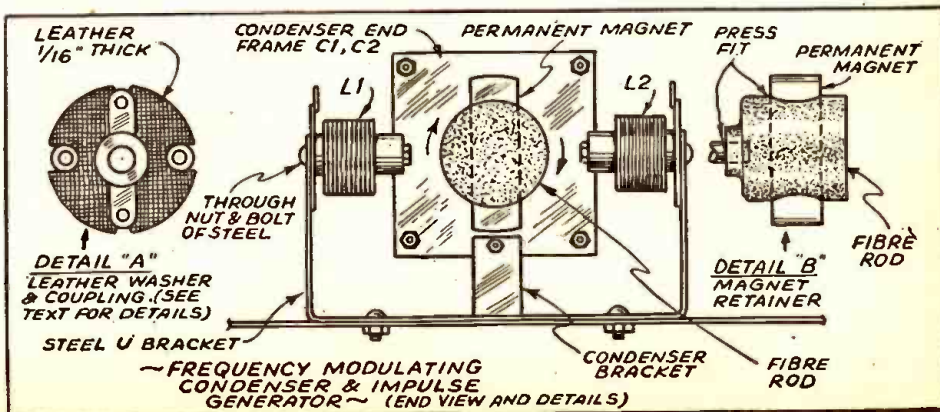

• TEST INSTRUMENTS •

A "LAB" to fit your pocket

Readrite
RANGER

MODEL 739

\$10.89

Dealer Net Price

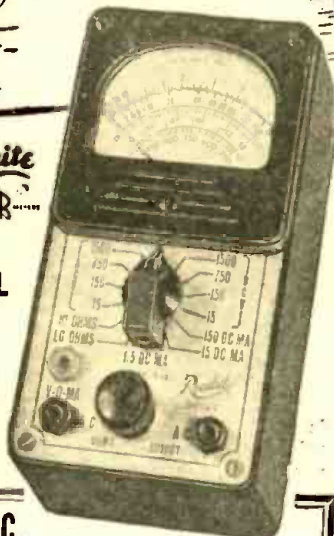

A.C. D.C. VOLT-OHM-MILLIAMMETER

Pocket Volt-Ohm-Milliammeter with Selector Switch, Mol'ed Case. Precision 3-Inch Meter with 2 Genuine Sapphire Jewel Bearings. AC and DC Volts 0-15-150-750-1500; DC MA. 0-1-15-150; High and Low Ohm Scales. Dealer Net Price, including all accessories, \$10.89. MODEL 739. DC Pocket Volt-Ohm-Milliammeter. Dealer Net Price\$8.25

WRITE FOR CATALOG
Section 169 College Drive

READRITE METER WORKS, Bluffton, Ohio

Cut your Servicing Time... use the EDITED Radio Circuit Manual—1941. See pages 160 and 161 for detailed information.

R.F. input from the signal generator.

The stage is now aligned very closely on an amplitude-modulated signal.

Shift the switch to position 2. This will put one section of the frequency modulator condenser in parallel with the signal generator condenser. Connect the synchronizing voltage to the oscilloscope. Increase the horizontal gain control. Turn off the amplitude modulation leaving the R.F. signal undisturbed. Start the motor of the frequency modulator. Set the oscilloscope horizontal sweep control to 120 cycles and the synchronizing voltage control at mid position.

Now due to the capacity added to the signal generator condenser by the frequency modulator condenser the signal generator will have to be reset to a higher frequency to get any images on the screen of the oscilloscope.

Increasing the signal generator frequency slowly, 2 curves as shown in Fig. 2 will appear. Increase the frequency of the signal generator until they coincide as in Fig. 1.

If these images do not remain stationary adjust the oscilloscope vernier horizontal sweep adjustment until they do. If there is deformation of the curve, lower the syn-

chronizing voltage. If the image will then not stay stationary, adjustment of both of these controls must be made.

If no image appears increase the output of the signal generator.

With the 2 images in coincidence a note should be made, for future reference, of the dial setting.

In the specific model shown in the pictures, a setting of 521 kilocycles corresponded to an output of 455 kilocycles, frequency-modulated over a 30-kilocycle band.

If the second half of a condenser is put in the circuit by shifting to position 3 on the frequency switch, a new higher frequency setting of the signal generator must be made.

The second half of the condenser will very rarely be needed except at low frequencies and for aligning broad-band circuits, such as F.M. I.F. amplifiers.

With the 2 images in coincidence the component parts of the circuit being aligned can be adjusted for the desired effect such as peaked with a narrow resonance curve or broadened out for widened response and band-pass effect.

MODERN 10 W. A.F. AMPLIFIER

(Continued from page 167)

Frequency-response curve of the Stancor 510 10-watt amplifier.

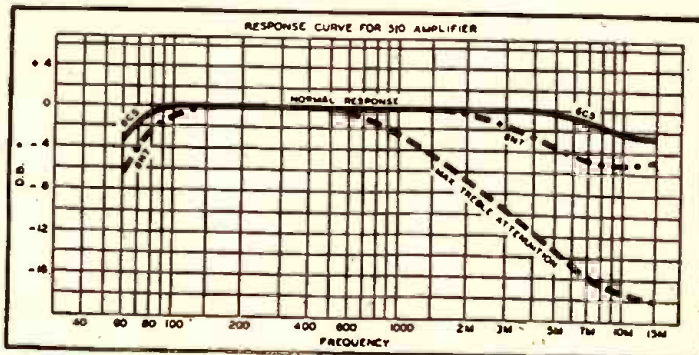

A NEW BOOK TO ADD TO YOUR TECHNICAL LIBRARY

AUTOMOBILE RADIO — Principles & Practice

by B. Baker Bryant

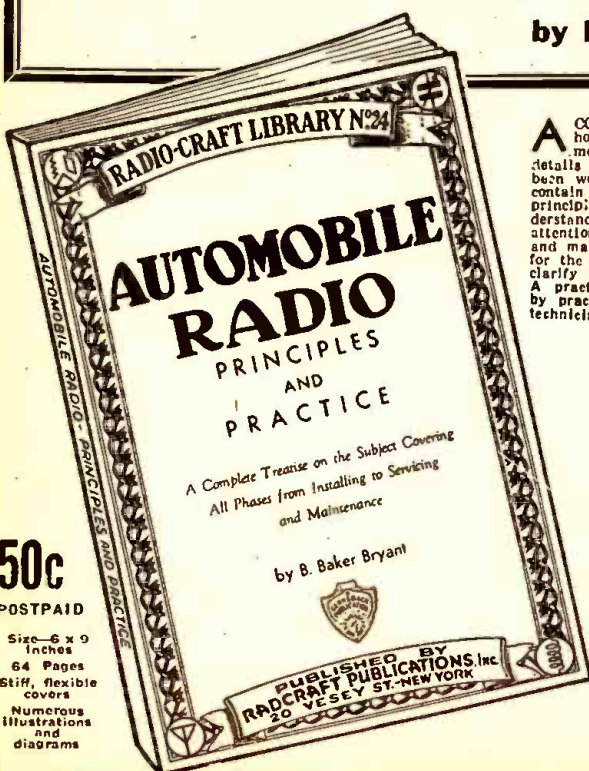

50c

POSTPAID

Size—6 x 9 inches
64 Pages
Stiff, flexible covers
Numerous illustrations and diagrams

A COMPLETE compilation of pertinent data on how to install and service the modern automobile radio receiver. All of the non-essential details which have crept into the profession have been weeded out. Each topic is treated so as to contain a precise statement of the fundamental principle involved, to assure the reader's clear understanding of this principle, without distracting his attention by the discussion of a multitude of details and mathematical expressions, which are primarily for the engineer, and tend to confuse rather than clarify a statement for the auto-radio-technician. A practical treatise based on practical experience by practical radio people for the practical radio-technician.

Brief Outline of Contents—

Introduction—The Auto-Radio Art.
Features of the Modern Automobile Receiver.
Installations of Automobile Radios and Antenna.
The Automobile High and Low Tension Electrical Systems.
Automobile Electrical Disturbances.
Vibrator Converters and Motor Generators.
Service Hints, Classified Automobile Installation Notes, and Conclusion.

Send 50c check, money order, unused U. S. stamps, or coin for your copy of "Automobile Radio—Principles & Practice"—it will be sent to you postpaid upon receipt of your remittance.

RADCRAFT PUBLICATIONS, Inc.
20 Vesey Street, New York, N. Y.

Two Cornell-Dubilier, tubular paper, 0.1-mf., 400 V., C17.

TUBES

One National Union type 6SJ7;
One National Union type 6C5;
Two National Union type 6L6s;
One National Union type 80.

BASIC UNITS

One Stancor No. P6336, power transformer, T13;
One Stancor No. A4741, interstage transformer, T14;
One Stancor No. A3872, output transformer, T15;
One Stancor No. C2304, filter choke, Ch.9;
One Stancor No. B1, standardized chassis;
One Stancor No. F4, panel;
One Stancor No. E6 escutcheon;
One Stancor No. H1, cabinet.

MISCELLANEOUS

Two input cable connectors;
Four octal bakelite sockets;
One 4-prong bakelite socket;
One triple binding post;
One pilot socket and jewel;
Two 1½-in. black bar knobs;
One 6 ft. cord and plug assembly;
One pilot bulb (brown bead No. 40);
One roll hook-up wire.

This article has been prepared from data supplied by courtesy of Standard Transformer Corp.

NEXT MONTH

At last! All about Power Factor Correction. Don't miss this important article.

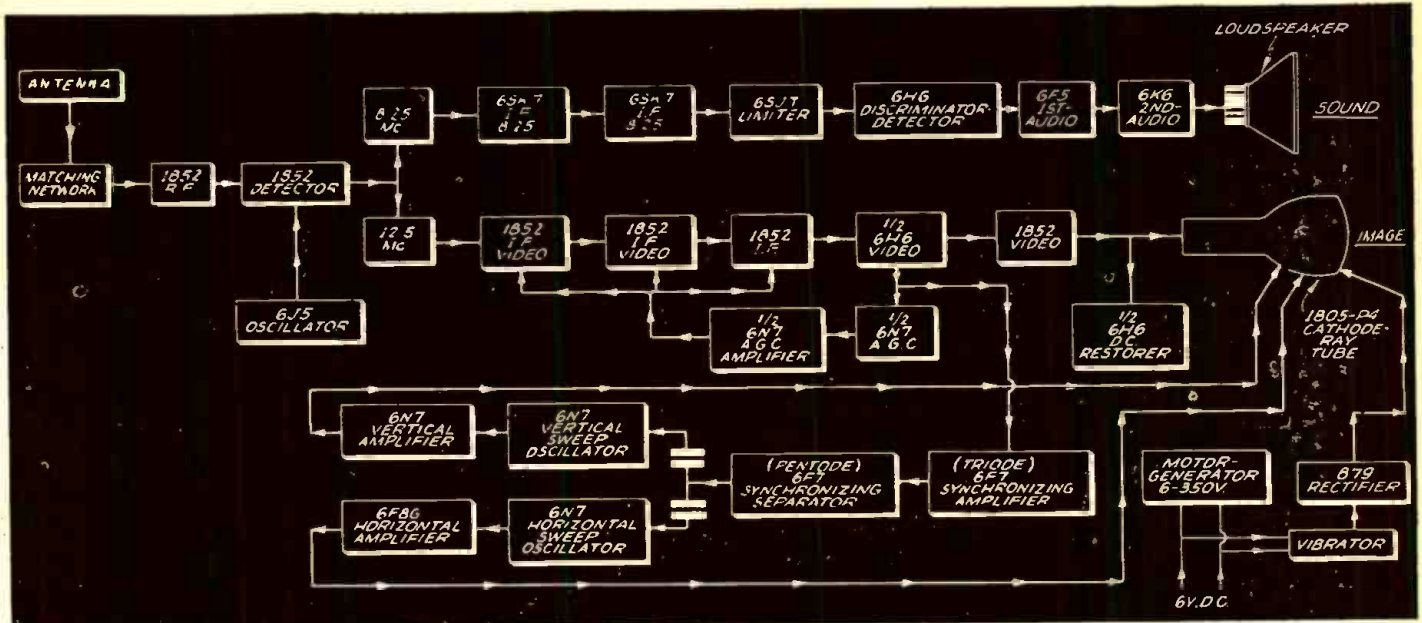

Block diagram of the 25-tube car-television receiver. The accompanying Frequency Modulation sound is reproduced by the F.M. portion of the television receiver.

Construction Details for a Practical CAR-TELEVISION RECEIVER

PART I

An entirely new market for the construction, installation and service of television receivers is opened-up with the following "How to Make It" article on a 25-tube television receiver for the family automobile. With commercial television having been inaugurated July 1, it is especially timely. Every effort will be made to answer in this multi-part article all the questions any average constructor would be likely to ask.

WILLIAM B. STILL



The cover feature of last month's issue of Radio-Craft, illustrated here, is the subject of the car-television construction article, Part I of which is presented here.

ANYONE might wonder: could it be possible to build a practical Television set for the family automobile?; and, how long would it be before the car was in the "junks"—plus the driver in the hospital—as a result of looking at the "picture" while driving? But as we are about to prescribe a practical television receiver for the car, we can say here that the set does not work while the car is in motion.

POWER REQUIREMENTS

Whereas the receiver to be described is of conventional order, it differs in many

respects from the construction of a house Television receiver. That can be easily understood because of the power supply requirements and taking into consideration the set can be used in many different locations; and as it is to be used in any number of locations and at many different signal strengths, the set must be designed with sufficient gain and a suitable type of aerial to give a satisfactory picture (image).

The receiver is a 6-volt type, operating entirely from the storage battery in the car. It requires about 25 amperes, assuming there may be 5½ volts on the generator and vibrator terminals. The chassis utilizes 25 tubes in all.

A 6-volt motor-generator supplies the low voltage to all the tubes, except the image tube. For the high voltage necessary to operate this tube we use a vibrator supply with a special transformer. As this transformer is not available, we shall describe how to add the special winding necessary for automobile operation. The power chassis is separated from the receiver proper, in order to make the tuning unit compact enough to fit in the average car.

The number of controls have been cut to a minimum. They are as follows: Brightness, Contrast, Tuning, Channel, and Volume. As the synchronizing circuits are very stable their controls do not necessarily have to be brought out to the front panel.

In order to compensate for fading we have incorporated an automatic gain control circuit which will hold the image level constant over a wide range of signal variations. This circuit requires triode tubes for op-

eration and in order to save space we use a double triode type tube (6FAG) for this purpose. As you can readily see from the diagram this is a simple D.C. amplifier circuit and works well with this set.

As we have said before, this receiver requires 25 amperes at 6 volts for operation. This may seem like a lot of current from a car battery but all cars from 1935 models have automatic generators, therefore it will be possible to use this television set for an hour or more without affecting the starting of the car. After a short run the battery will usually be recharged to its normal gravity.

However the owners of some cars might be particular, so an extra generator can be used to charge a separate 6-volt battery. A generator of this type can be bought from any automobile junk yard for a dollar or so and can be easily installed by mounting it on the motor block and driving it with the fan belt. The extra battery necessary can be installed in the trunk or under the hood. It isn't necessary to have better than a 13-plate battery. The battery leads do not necessarily have to be of the heavy type but



• TELEVISION •

they should be heavy enough so that the voltage doesn't drop more than ¼-volt with the set on.

We recommend No. 8 wire for a distance run of 8 ft. from set to battery.

BLOCK DIAGRAM

It can easily be seen from the block diagram how simple the sequence is. If we follow the signal from the antenna to the image tube and loudspeaker, the circuit operation is as follows:

The special antenna required (to be described) is fed through a suitable matching network and into the control-grid of an 1852-type tube as an R.F. amplifier; this is followed by the 1st-detector tube which is also a type 1852. A 6J5 is used as the oscillator in an electron-coupled circuit. The output of the 1852 is fed into a frequency dividing network to separate the sound and image signals. This is simply an I.F. transformer tuned to the 2 different frequencies,

that is, 8½ and 12½ megacycles.

The sound I.F. is amplified in 2 stages using 6SK7-type tubes. This raises the signal level to an amount sufficient to operate the limiter tube, even if the signal is very weak; the limiter tube is a type 6SJ7. This circuit is followed by the F.M. discriminator, and the 6H6 is used as the output.

The audio frequency amplifier is conventional, using a 6F6 1st audio and a 6K6 to operate the loudspeaker.

The "picture" frequency, 12½ megacycles, is amplified in 3 stages using 1852-type tubes. Following the 3rd I.F. amplifier is the video detector using one-half of a type 6H6 tube. Part of the video signal is fed to one-half of a 6N7-type tube in the automatic gain control (or A.G.C.) circuit. The other half of this 6N7 tube is used as a D.C. amplifier to control the control-grids of the 3 video I.F. amplifier tubes. The main video signal is fed through an 1852 video amplifier to the control-grid of the 1805-P4 C.-R. tube. Also connected to the control-grid of the

C.-R. tube is the other half of the 6H6 tube. This is the D.C. restorer. The synchronizing signal is also taken from the output of the 6H6 video detector. The synchronizing signal is amplified in one-half of the 6F7 tube, that is the triode section. The pentode section of the 6F7 is used as a sync. separator.

The output of the sync. separator is used directly to control the vertical and horizontal sweep oscillators. Two 6N7 tubes are used in a conventional discharge oscillator circuit. A 6N7 tube is used in the output amplifier for the 60-cycle sweep. This is connected to the vertical plates of the "picture" tube. A 6F8G amplifies the horizontal scanning wave and the output of this tube is fed to the horizontal plates of the image tube.

The high-voltage power supply for all tubes except the C.-R. tube is derived from the motor-generator. The latter tube gets its voltage from the 879 tube. The high voltage necessary is obtained by using a vibrator and a special transformer.

COMMERCIAL TELEVISION INAUGURATED JULY 1

JULY 1, Television inaugurated its visual broadcast service on a full-fledged commercial basis.

Two television stations in New York began this new public service immediately. Three more stations—in Los Angeles, Chicago, and Philadelphia—expect to make the transition from *experimental* to *commercial* operation in short order, and 17 other stations in various parts of the country signify their intention of going commercial as soon as it is possible for them to do so.

The National Broadcasting Company's television station located atop the Empire State Building, New York, has received the first license for commercial operation, and is rendering 15 hours of program service a week, beginning July 1. Formerly on an experimental basis with the call signal W2XBS, in its new commercial status NBC's New York television station has been assigned the call letters WNBT. As soon as other experimental television stations are licensed commercially they, too, will receive new call letters.

Columbia Broadcasting System, Inc., was authorized to begin program tests over its New York station, now identified by the call signal W2XAB, the same day.

Don Lee Broadcasting System, W6XAO, Los Angeles; Zenith Radio Corporation, W9XZV, Chicago, and the Philco Radio and Television Corporation, W3XE, Philadelphia, will continue to transmit scheduled programs over their respective stations pending the formality of shifting from experimental to commercial operation at the earliest date possible.

Allen B. DuMont Laboratories propose to begin commercial operation at its New York station, W2XWV, within a month. This same company is also pushing work on its Washington station, W3XWT, so that this outlet, too, can go on the air quickly.

National Broadcasting Company intends to proceed promptly with construction of its Washington station, W3XMB, with the prospect of test programs in the capital city by November 1. It anticipates that its Philadelphia station, W3XPP, will be completed and in operation by July 1 of next year.

Thirteen other television stations are likewise arranging to go commercial in ensuing months. Their locations are:

ALBANY	—W2XB, General Electric Co.
CHICAGO	—W9XBK, Balaban & Katz Corp.
	—W9XCB, Columbia Broadcasting System.
CINCINNATI	—W8XCT, Crosley Corp.

LOS ANGELES	—W6XEA, Earl C. Anthony
	—W6XHH, Hughes Productions, Hughes Tool Co.
	—W6XYZ, Television Productions, Inc.
MILWAUKEE	—W9XMJ, The Journal Co.
NEW YORK	—W2XBB, Bamberger Broadcasting Service.
	—W2XMT, Metropolitan Television.
PHILADELPHIA	—W3XAU, WCAU Broadcasting Co.
SAN FRANCISCO	—W6XDL, Don Lee Broadcasting System
	—W6XHT, Hughes Productions, Hughes Tool Co.

Television stations licensed on a commercial basis are required to furnish at least 15 hours of program service a week, which may include Sundays, and on each day, except Sunday, "there shall be at least 2 hours' program transmission between 2 P.M. and 11 P.M., including at least 1 hour of program transmission on 5 week-days between 7:30 P.M. and 10:30 P.M."

Persons within the reception areas of commercial television stations will be able to see on their receivers, with accompanying sound, studio productions with live talent, motion picture films, and "pick-ups" of special events outside of the studio, such as news happenings, sports, parades, etc. In making spot news visible, as well as furnishing visual education and entertainment, this new broadcast medium expects to speedily develop popularity and interest. As a result of tests with television projection on large screens, a New York theatre is already being so equipped. Lightweight portable "pick-up" equipment has been developed, and a special type of studiocraft is being evolved.

The existing *coaxial cable* between New York and Philadelphia is useful for the exchange of television programs between those cities. A similar cable is being laid between Baltimore and Washington. When the link between Baltimore and Philadelphia is added, all 3 cities will constitute outlets for television programs originating in either city. A television radio relay system is also being worked out.

In view of the impending demand for television receivers as new localities are opened to television service, the industry is seeking an orderly production consistent with requirements of materials for the national defense. In this respect the Radio Manufacturers Association is rendering continued and efficient cooperation. It was principally through its efforts that the engineering minds of the industry agreed on basic prin-

ciples which enabled the Federal Communications Commission, on April 30, to adopt rules and regulations and standards and set the July 1 go-signal for regular television service. It was to pave the way for this commercialization that the Commission last year specifically licensed some 2-score individuals and firms, which had budgeted \$8,000,000 for the purpose, to engage in preparatory experimental operation.

After 6 months of practical tests of the present television standards, the Commission will consider further changes, with particular reference to new developments. Meanwhile, program stations are encouraged to experiment with color television. To guard against monopoly in this new field, not more than 3 television stations can be under the same control.

Development of frequency modulation makes it possible to use F.M. for the sound accompanying the pictures. And the location of the television frequencies offers an opportunity to make television sets which will also receive F.M. broadcasts, and F.M. sets which will receive the aural part of television broadcasts.

Following is a listing of Television Broadcast Stations dating from Jan. 1, 1941, to the last available date, June 10. These stations are either completed, in the process of construction, or planned to be constructed.

Classification of emissions.—The heading "Emissions" on Pages 177 and 178 refer to the purpose for which the transmissions are used, assuming their modulation or their possible keying to be only in amplitude as follows:

(1) Continuous waves:

Type A0.—Waves the successive oscillations of which are identical under fixed conditions.⁷

Type A1.—Telegraphy on pure continuous waves. A continuous wave which is keyed according to a telegraph code.

Type A2.—Modulated telegraphy. A carrier wave modulated at one or more audible frequencies; the audible frequency or frequencies or their combination with the carrier wave being keyed according to a telegraph code.

Type A3.—Telephony: Waves resulting from the modulation of a carrier wave by frequencies corresponding to the voice, to music or to other sounds.

Type A4.—Facsimile: Waves resulting from the modulation of a carrier wave by frequencies produced at the time of the scanning of a fixed image with a view to its reproduction in a permanent form.

Type A5.—Television: Waves resulting from the modulation of a carrier wave by frequencies produced at the time of the scanning of fixed or moving objects.⁸

(2) Damped waves:

Type B.—Waves composed of successive series of oscillations the amplitude of which, after attaining a maximum, decreases gradually, the wave trains being keyed according to a telegraph code.

⁷ These waves shall be used only in special cases, such as standard frequency emissions.

⁸ "Objects" is used here in the optical sense of the word.

TELEVISION BROADCAST STATIONS

(as of January 1 to June 1, 1941)

Licensee and Location	Call Letters	Frequency (Mc.) (Channel)	Power Visual	Aural	*Emission
Earle C. Anthony, Inc. Los Angeles, Calif.	W6XEA	96-102 (6)	1kw.	1kw.	†A3, A5
Balaban & Katz Corp. Chicago, Ill.	W9XBK	60-66 (2)	1kw.	1kw.	†A3, A5
Balaban & Katz Corp. Portable-Mobile Area of Chicago, Ill.	W9XBT	204-216 (11 & 12)	250W.		†A5
Bamberger Broadcasting Service, Inc. New York, N. Y.	W2XBB	96-102 (6)	1kw.	1kw.	†A3, A5
Columbia Broadcasting System, Inc. New York, N. Y.	W2XAB	60-66 (2)	7½kw.	7½kw.	A3, A5
Columbia Broadcasting System, Inc. Los Angeles, Calif.	W6XCB	162-168 (8)	1kw.	1kw.	†A3, A5
Columbia Broadcasting System, Inc. Portable Area of New York, N. Y.	W2XCB	336-348	6.5W.		†A5 (Tele. Relay with W2XAB)
Columbia Broadcasting System, Inc. Chicago, Ill.	W9XCB	78-84 (4)	1kw.	1kw.	†A3, A5
The Crosley Corp. Cincinnati, Ohio	W8XCT	50-56	1kw.	1kw.	†A3, A5
Allen B. DuMont Laboratories, Inc. Passaic, N. J.	W2XVT	42-56	50W.	50W.	A3, A5 Special
Allen B. DuMont Laboratories, Inc. New York, N. Y.	W2XWV	C.P. 78-84 (4)	5kw.	5kw.	
Allen B. DuMont Laboratories, Inc. Portable-Mobile Area of New York, N. Y.	W10XKT	78-84 (4)	1kw.	1kw.	†A3, A5
Allen B. DuMont Laboratories, Inc. Washington, D. C.	W3XWT	258-270 (15, 16)	50W.		†A5 (Tele. Relay with W2XVT)
General Electric Co. New Scotland, N. Y.	W2XB	50-56 (1)	1kw.	1kw.	†A3, A5
General Electric Co. Schenectady, N. Y.	W2XH	60-86	10kw.	3kw.	A3, A5
General Electric Co. New Scotland, N. Y.	W2XI	288-294 (18)	40W.		A5
Hughes Productions Div. of Hughes Tool Co. Los Angeles, Calif.	W6XHH	162-168 (8)	10W.		†A5 (Tele. relay with W2XB)
Hughes Productions Div. of Hughes Tool Co. San Francisco, Calif.	W6XHT	60-66 (2)	10kw.	10kw.	†A3, A5
The Journal Co. (The Milwaukee Journal) Milwaukee, Wis.	W9XMJ	60-66 (2)	1kw.	1kw.	†A3, A5
Kansas State College of Agriculture & Applied Science Manhattan, Kan.	W9XAK	66-72 (3)	1kw.	1kw.	†A3, A5
Don Lee Broadcasting System Los Angeles, Calif.	W6XAO	50-56 (1)	100W.	100W.	†A3, A5
Don Lee Broadcasting System San Francisco, Calif.	W6XDL	50-56 (1)	1kw.	150W.	†A3, A5
Don Lee Broadcasting System Portable-Mobile—Area of Los Angeles, Calif.	W6XDU	50-56 (1)	318-330	6.5W.	A5 (Tele. Relay with W6XAO)
LeRoy's Jewelers (a partnership consisting of B. B., F. P., & H. Shapiro, partners) Los Angeles, Calif.		186-192 (10)	1kw.	1kw.	†A3, A5
The May Department Store Co. Los Angeles, Calif.	W6XMC	210-216 (12)	1kw.	1kw.	†A3, A5
Metropolitan Television, Inc. New York, N. Y.	W2XMT	162-168 (8)	250W.	250W.	†A3, A5
National Broadcasting Co., Inc. New York, N. Y.	W2XBBS	50-56 (1)	12kw.	15kw.	A3, A5
National Broadcasting Co., Inc. Portable Camden, N. J. and New York, N. Y.	W2XBT	162-168 (8)	400W.	100W.	A5, Special A1, A2, A3, A5, (Tele. Relay with W2XBBS)
National Broadcasting Co., Inc. Portable-Mobile Area of New York Washington, D. C.	W2XBU	282-294 (17, 18)	15W.		A5 (Tele. Relay with W2XBBS)
National Broadcasting Co., Inc. Philadelphia, Pa.	W3XNB	60-66 (2)	1kw.	1kw.	†A3, A5
Philco Radio & Television Corp. Philadelphia, Pa.	W3XPP	102-108 (7)	1kw.	1kw.	†A3, A5
Philco Radio & Television Corp. Philadelphia, Pa.	W3XE	66-72 (3)	10kw.	10kw.	A3, A5
Philco Radio & Television Corp. Portable Area of Philadelphia, Pa.	W3XP	234-246 (13, 14)	15W.		A5 (Tele. Relay with W3XE)
Purdue University West Lafayette, Ind.	W9XC	66-72 (3)	0.75W.	750W.	†A3, A5
RCA Mfg. Co., Inc. Portable Camden, N. J.	W3XAD	321-327	500W.	500W.	A3, A5
RCA Mfg. Co., Inc. Camden, N. J.	W3XEP	84-90 (6)	30kw.	30kw.	A3, A5
State University of Iowa Iowa City, Iowa	W9XUI	50-56 (1, 12)	100W.		A5
Television Productions, Inc. Los Angeles, Calif.	W6XYZ	78-84 (4)	1kw.	1kw.	†A3, A5
Television Productions, Inc. Portable-Mobile Area of Los Angeles, Calif.	W6XLA	234-246 (13, 14)	250W.		†A5 (to be used with W6XYZ)
WCAU Broadcasting Co. Philadelphia, Pa.	W3XAU	84-90 (6)	1kw.	1kw.	†A3, A5 & Special
Zenith Radio Corp. Chicago, Ill.	W9XZV	50-56 (1)	1kw.	1kw.	A3, A5
(Alterations and corrections [italic] during January.) Farnsworth Television & Radio Corp. Fort Wayne, Ind.	W9XFT	66-72	1kw.	1kw.	†A3, A5
Philco Radio & Television Corp. Portable (Area Philadelphia, Pa.)	W3XP	230-236	15W.		A5 (Used with W3XE)

†Construction Permit only. *See page 176 for classification of Emissions. (Continued on following page)

OPPORTUNITY AD-LETS

Advertisements in this section cost 15 cents a word for each insertion. Name, address and initials must be included at the above rate. Cash should accompany all classified advertisements unless placed by an accredited advertising agency. No advertisement for less than ten words accepted. Ten percent discount six issues, twenty percent for twelve issues. Objectionable or misleading advertisements not accepted. Advertisements for October 1941 issue must reach us not later than August 11th.

Radio-Craft • 20 Vesey St. • New York, N. Y.

BOOKS AND MAGAZINES

ASSURE YOURSELF OF GREATER PROFITS BY doing radio service jobs more quickly. Authentic service guides show you the way to locate and correct troubles in any radio receiver. Gernsback Official Radio Service Manuals show you how to complete more repair jobs in less time—how to earn more money by faster servicing. Radcraft Publications, 20 Vesey St., New York City.

WHAT DO YOU KNOW ABOUT AMPLIFIERS AND Sound Systems? The Amplifier Handbook and Public Address Guide covers P.A. from A to Z. Most complete and authentic book published on the subject. Contains 80 pages of vital information on Amplifiers, P.A. Systems, Speakers, Accessories, Pickups, Microphones, etc. Printed on fine coated stock, with numerous photographic illustrations and explanatory diagrams, and only 25c. See page 126.

EDUCATIONAL COURSES

CORRESPONDENCE COURSES AND EDUCATIONAL books, lightly used. Sold, Rented, Exchanged. All subjects. Satisfaction guaranteed. Cash paid for used courses. Complete details and bargain catalog FREE. Write Nelson Company, 500 Sherman, Dept. J-242, Chicago.

FLUORESCENT LIGHTING

24" FLUORESCENT BENCH LIGHT \$1.49, LESS TUBE. Harold Davis, Jackson, Mississippi.

PHOTOGRAPHY

1/100,000 OF A SECOND SPEED FLASH UNIT FOR Stroboscopic Photography, \$200.00. Apt. 63, 782 West End Ave., New York City.

RADIO

PHILCO SIGNAL GENERATOR, THORARSON CONDENSER CHECKER, RIDER MANUALS. Midwest Specialty, 55-16th Avenue, Cedar Rapids, Iowa.

SACRIFICE! 12-TUBE LINCOLN SUPER-DELUXE All-Wave Receiver, complete with 12-inch electrodynamic speaker and separate power pack. Cost originally \$145. Will sacrifice for \$25.00. Set is 1933 model, rarely used and in good working condition. Excellent sensitivity and selectivity. A resonance tuning meter, wave-band switch, photograph input terminals, an ideal set for the DX fan. Excellent tonal fidelity. All components mounted on a beautiful chromium-finished chassis. Rush! First come, first served! D. Kreissman, 1430 Ocean Ave., Brooklyn, N. Y.

WANTED—ELECTROLYTIC DETECTOR; ADAMS-Morgan wooden-case, variable condenser. Have radio sets, meters, etc.—or what do you want? R. Bernard, 40 Manning Ave., No. Plainfield, N. J.

TECHNICAL ART SERVICE

DRAFTING AND ART SERVICE—A COMPLETE Service for the Industrial and Commercial Marketers. If your business or plant can't afford a designing or drafting staff, don't let this stop you from going ahead with that new product you intend marketing, or that catalog of mechanical or electrical items which needs fine detailed drawings and highly retouched photographs. Any mechanical, electrical or radio problem can be solved for you by our associated staff of designers, draftsmen and artists, and technical copywriters. Write for any additional information as to methods and price for this service. Tec-Art Drafting Service, 228 Charlotte Terrace, Roselle Park, N. J.

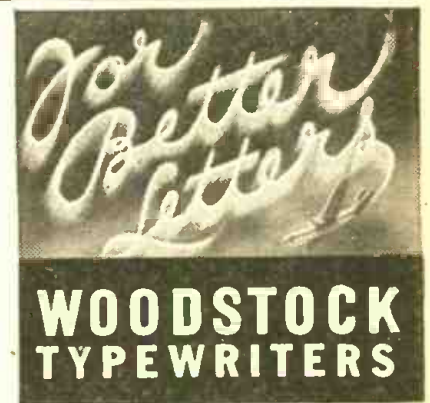

PATENTS—TRADE MARKS

Booklet concerning Inventions & Patents Form "Evidence of Conception" with instructions for use and "Schedule of Government and Attorneys Fees"—Free

LANCASTER, ALLWINE & ROMMEL

Registered Patent Attorneys 436 Bowen Bldg. Washington, D. C.

• TELEVISION •

TELEVISION BROADCAST STATIONS

(as of January 1 to June 1, 1941)

(Continued from preceding page)

Licensee and Location	Call Letters	Frequency (Mc.)	Power		*Emission
			Visual	Aural	
Television Productions, Inc. (Area of Los Angeles)	W6XLA	230-242	250W.		†A5 (Used with W6XYZ)
(Alterations and corrections [italic] during February.) General Television Corp. Boston, Mass.	W1XG	S.A.50-56	500W.		A5
General Electric Co. Schenectady, N. Y.	W2XD	162-168	40W.		A5
LeRoy's Jewelers (A partnership consisting of B. B. Shapiro, F. P. Shapiro and H. Shapiro, partners) Los Angeles, Cal.	W6XLJ	230-236	1kw.		†A3 & A5
National Broadcasting Co., Inc. Portable (Area of Camden, N. J. and New York, N. Y.)	W2XBT	162-168	400W.		A1, A2 & A5 (Used with W2XBS)
Philco Radio & Television Corp. Portable (Area of Philadelphia, Pa.)	W3XP	230-242	15W.		A5 (Used with W3XE)
(Alterations and corrections [italic] during March.) Balaban & Katz, Corp. Portable-Mobile Area of Chicago, Ill.	W9XBB	384-396	10W.		†A5 (Tele. Relay with W9XBK †A5)
Balaban & Katz Corp. Chicago, Ill.	W9XPR	384-396	10W.		†A5
Allen B. DuMont Laboratories, Inc. Portable-Mobile (Area of New York, N. Y.)	W10XKT	258-270	50W.		A5 (Tele. Relay with W2XVT)
Philco Radio & Television Corp. Portable (Area of Philadelphia, Pa.)	W3XP	C.P. covered by License 230-242 15W. †25W.			A5 (Used with W3XE)
(Alterations and corrections [italic] during April.) The Journal Company (The Milwaukee Journal) Area of Milwaukee, Wis.	W9XCV	300-312	6.5W.		†A9 (Tele. Relay with W9XMJ)
(Alterations during May.) Allen B. DuMont Laboratories, Inc. New York, N. Y.	W2XWV	78-84	1kw.	1kw.	A3, A5
Don Lee Broadcasting System Los Angeles, Calif.	W6XAO	C.P. covered by License 50-56 1kw. 150W.			A3, A5
LeRoy's Jewelers (a partnership consisting of B. B., F. P., & H. Shapiro, partners) Los Angeles, Calif.	W6XLJ	C.P. covered by License Strike all particulars			

†Construction Permit only. *See page 176 for classification of Emissions.

OPERATING NOTES

(Continued from page 169)

primary is in the plate circuit of the 6B7, will be found with leakage or a short-circuit between primary and secondary windings. Primary and secondary are wound together. Repair of the unit does not warrant the time nor labor involved and replacement is advised.

Intermittent reception accompanied by loud popping noises as reception cuts in or out, is caused by shorting I.F. trimmers and by loose or poorly soldered connections in the tuner unit. The I.F. trimmers may be repaired by replacing the mica dividing plate.

The unusual condition may be experienced with this model where reception suddenly cuts off. When the volume control is advanced to its Maximum position, it will be found that no reception can be obtained upon frequencies below 930 kc. High-frequency stations which are normally received at 1,300 and 1,500 kc. can be heard with more than 5 times the signal strength at 940 and 1,140 kc. respectively, than on the proper frequency, although these stations are also heard upon their assigned frequencies. The tuning meter will show little or no deflection upon resonance, with the needle of the meter set about half-way on the scale. All 3 shortwave bands will be found completely dead.

These symptoms are the result of a short-circuited oscillator section of the condenser gang, which is caused by grounding of the heavy buss-bar lead connected to the stator of the oscillator tuning section to the heavy flexible copper braided pigtail lead employed for bonding the gang to the chassis, or by the stator lead shorting to another buss-bar lead running to the same section of the wave band switch. Either the stator lead or pigtail should be moved to correct the difficulty. When the buss-bar lead is disturbed, however, it will be found that dial calibration will change slightly.

Upon the complaint of weak reception where it is necessary to turn the volume control to maximum position and a socket analysis discloses low screen-grid voltage on the R.F. and 1st-detector tubes, with slightly lower plate voltages, look for a leaky 4 mf. electrolytic screen-grid bypass condenser and check the 15,000-ohm screen-grid drop resistor for a carbonized condition.

This receiver has presented a problem in the East which may or may not be experienced in other sections of the country. At any time, WOR and WJZ, both powerful broadcasters, whose assigned frequencies are 710 and 770 kc., respectively, are each received at 3 points. The signal of WOR is not only heard at 710 kc., but also at 680 and 740 kc. Signal strength at these 2 repeat points is fair and the tuning meter will function at all 3 points, with the greater swing at 710 kc. On the other hand WJZ will be heard 20 kc. below and above its assigned channel. As with WOR, the tuning meter will operate at all 3 points. This produces a condition whereby both WOR and WJZ are heard almost together at a point lying just between assigned channels. In other cases, a beat frequency signal is heard at the repeat points. Careful alignment is to no avail. It seems that the trouble is due to the choice of 370 kc. as the intermediate frequency, harmonics of this I.F. signal producing the condition. Nothing can be done in the field to rectify the difficulty but to install a new tuner and amplifier chassis which employs I.F. transformers adjusted to 465 kc.

FREE!

with \$1.00 subscription
to

RADIO-CRAFT

FULL
LIBRARY SIZE

MODERN WEBSTER DICTIONARY

416
PAGES

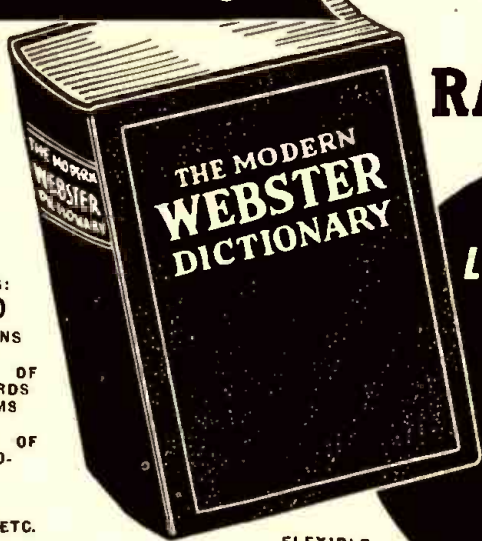

CONTAINS:
22,000
DEFINITIONS
•
DICTIONARY OF
RADIO WORDS
AND TERMS
•
DICTIONARY OF
THE AUTO-
MOBILE
•
TABLES,
TREATISES, ETC.

FLEXIBLE
IMITATION
LEATHERETTE
COVER, SIZE 5 1/2" x 8"

FILL OUT—MAIL THIS COUPON TODAY!

RADIO-CRAFT, 20 Vesey Street, New York, N. Y.

Consider: Enclosed you will find One Dollar for which enter my subscription to RADIO-CRAFT Magazine for Eight Months. Send me ABSOLUTELY FREE and POSTPAID, my copy of the MODERN WEBSTER DICTIONARY.

This is a New Order Extend my present subscription

Name

Address

City State

RC-041

(Remit by check or money order; register letter if you send cash or unused U.S. Postage Stamps)

If you will take advantage NOW of our special subscription offer of eight months for \$1.00, we will send you ABSOLUTELY FREE and POSTPAID this 416 page full library size MODERN WEBSTER DICTIONARY—useful and instructive to everyone. This self-pronouncing authoritative dictionary—a new work throughout—contains the most up-to-date words now in common use, 22,000 definitions in all. It also features a Glossary of Radio Words and Terms, Dictionary of the Automobile, Treatises on Practical Syntax, Etymology, Punctuation and Standard English by well known authorities, Metric Tables, Time, State Flowers, National Parks of the U. S., etc.

This is a time limited offer. so don't delay in returning the Coupon.

RADIO-CRAFT

20 VESEY STREET NEW YORK CITY

RADIO-CRAFT for SEPTEMBER, 1941

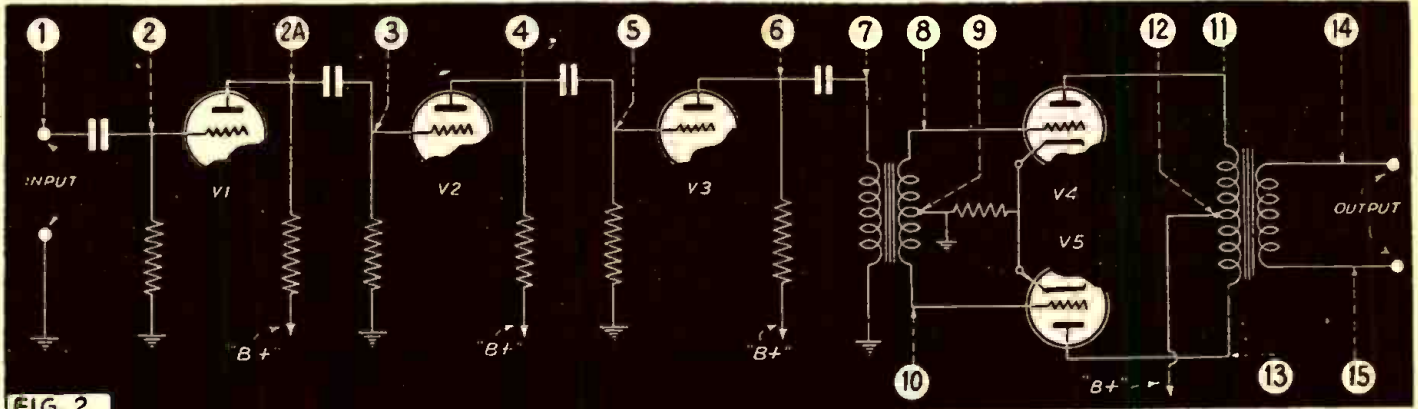

FIG. 2

Note: The input transformer feeding tubes V4 and V5 is in the text as T1; the output transformer is T2. The lower of the 2 input posts is "Gnd." in the text.

Applications of the A.F. TEST OSCILLATOR

The Audio Frequency Test Oscillator has many applications ranging from use in audio amplifier measurements to radio receiver tests. Just how to go about making these various tests, to meet everyday demands, is the subject of this article, which is reprinted from The Aerovox Research Worker. The introductory portion discusses audio amplifier tests and measurements; the conclusion completes this discussion, and describes radio receiver tests.

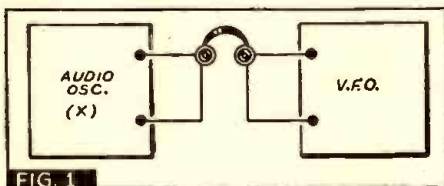

FIG. 1

THE variable-frequency Audio Oscillator may be viewed as the audio counterpart of the R.F. standard signal generator. Accordingly, we may recognize it as a standard audio-frequency generator furnishing a sine-wave voltage of controllable amplitude at any frequency which may be selected between the limits of approximately 20 and 20,000 cycles/second.

TYPES

There are 2 types of audio test oscillator in present general use. The *beat-frequency* type has been in use for a number of years and its employment of the heterodyne beat-note method of obtaining audio frequencies is widely understood. The *resistance-capacity* type is of comparatively recent appearance and its circuit arrangement is decidedly simpler than that of the beat-frequency type. Either type may be fitted with a direct-reading dial for continuous variation of the output frequency, but the higher stability and circuit simplicity of the "R.C." type allows the use of pushbuttons for rapid shifting of the frequency in small steps, and this feature is being incorporated into that type.

The basic circuit differences appearing in both types of audio test oscillator, as well as their underlying theories of operation, have been adequately explained in the periodical literature and will not be dwelt upon here.

The prime purpose of the variable-frequency audio oscillator is the generation of standard-frequency voltages of controllable amplitude throughout the A.F. spectrum, and that very ability renders it invaluable in all tests and studies requiring audio voltages at particular frequencies within that spectrum. Until comparatively recent date,

the audio test oscillator was a piece of required equipment only in laboratories engaged in research and development. At present, however, the demands imposed by modern public address amplifier systems and high-fidelity radio receivers compel its inclusion among required equipment in efficient radio service shops.

The utility of the variable-frequency audio oscillator in broadcast station maintenance is, of course, well known. It is the source instrument in such routine techniques as (1) the periodic inspection of studio and modulator "sound" channels; (2) the study and development of remote line systems, new automatic audio-frequency equipment; and often, (3) in the determination of distortion and modulation percentage tests.

In the following paragraphs we list some of the prominent applications of the audio test oscillator. We are fully aware that the instrument has multitudinous further uses and that a separate paper might easily be written on any one of those listed. It has been our aim, however, to complete the picture as closely as possible within our space limitations and to expound only those applications which are apt to find most ready demand in the workaday life of our average reader.

FREQUENCY GENERATION

The variable-frequency audio oscillator, as already pointed out, is primarily a standard-signal audio-frequency generator. As such, it makes available any frequency within the so-called A.F. spectrum; i.e., generally between 20 and 20,000 cycles per second. There are on the market at this writing a few wide-range oscillators that extend the high-frequency end of the range beyond the commonly conceived audio-frequency band—one, at least, to a frequency as high as 50 kc. to meet the demands of various wide-band channels appearing in television and allied equipment. Most standard audio test oscillators do, of course, operate considerably lower in frequency than 20 cycles, but most of the dials appearing on these commercial instruments are not graduated far below that frequency.

The voltage delivered to the output circuit is sine-wave in shape, possessing therefore very negligible distortion throughout the frequency range. The output voltage amplitude is controllable, as a general rule, by means of a gain control or attenuator built into the instrument. At any one setting of the amplitude control, the output voltage varies over only a few decibels as the frequency is varied between opposite limits of the audio-frequency spectrum, the maximum variations occurring usually below 100 cycles and above 10,000 cycles. The accuracy of the generated frequencies is sufficient for the exacting laboratory studies requiring this type of instrument, any error being never more than a very few per cent of the stated value.

Suitable flat-characteristic amplifiers are included in the audio test oscillator, and these generally are terminated by an output circuit (transformer in most cases) providing a choice of low- or high-impedance coupling.

As an audio-frequency generator, the oscillator is applied to the various tests requiring inspections of equipment at a number of quickly chosen frequencies, as will be shown in the subsequent paragraphs.

Bridge Generator.—In various A.C. bridge operations requiring an alternating current of good waveform and controllable amplitude, the *variable-frequency* audio oscillator is particularly adaptable. For example, a certain capacity measurement might require a 1000-cycle test voltage, while another type of bridge inductance measurement might indicate a 400-cycle voltage. The audio test oscillator may be set to either of these, or to any other required frequency, quickly.

Exact-Frequency Source.—The audio test oscillator, as a generator of standard frequencies, finds application in such operations as the testing of motors (particular example, the synchronous motors employed in electric clocks) that are to run at certain power-line frequencies normally encountered. The oscillator makes possible the simulation of the frequency drifts expected in the service in which the motors are to be used. In applications such as the fore-

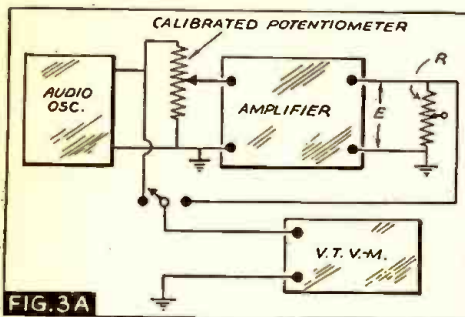

FIG. 3A

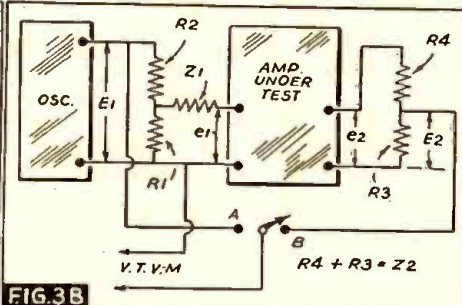

FIG. 3B

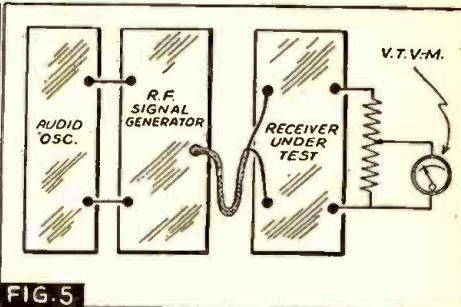

FIG. 5

going, the audio oscillator is followed by sufficient audio amplifier stages to deliver the power required to propel the small motor.

FREQUENCY IDENTIFICATION

The variable-frequency audio oscillator, as a standard-frequency generator, is well known for its function in identifying unknown frequencies within its range. Some form of comparison between the known and unknown frequencies is employed. One method is illustrated in Fig. 1. Here the signal voltage of unknown frequency is applied to one telephone of a standard headset, while the signal voltage of known adjustable frequency from the oscillator, VFO, is applied to the other telephone.

The operator adjusts the signal amplitudes until they are both approximately equal (or of slight inequality, if this arrangement is necessary to accommodate his particular difference in right- and left-ear sensitivity) and carries the frequency of VFO slowly through the audio range. Within a few cycles either side of the unknown frequency from oscillator X, a beat note is set up, becoming a slow waxing and waning condition as the exact frequency of X is approached, and disappearing entirely in favor of signal reinforcement when both oscillators are set to the same frequency. The frequency of X is read at that point from the dial of the standard oscillator, VFO.

Visual Method.—An alternative method would employ a suitable vacuum-tube mixer circuit with the 2 signal voltages being applied to separate grids and the beat-note (and zero beat) conditions being indicated by a suitable meter or "electric eye" operated in the tube plate circuit. This method is somewhat more accurate, since it eliminates the human error due to natural inability to recognize exact zero beat.

Beat-Note Applications.—The same system of frequency identification can be employed to identify the heterodyne beat between 2 radio-frequency oscillators in particular applications to be discussed later.

Identification of Sounds.—Either of the foregoing methods, *visual* or *aural*, might be used also to identify actual sound pitches, although this operation may be better carried out with a specialized instrument such as a *sound* or *wave analyzer*. If the unknown tone is sufficiently loud to be heard, it may be compared directly to the variable-frequency audio oscillator which is connected to feed a loudspeaker or headset. The operator, listening to both sounds—that of the unknown tone and the reproduced VFO signal—adjusts the oscillator to "zero beat" and reads the frequency from the instrument dial.

If the unknown tone is too weak to be compared easily with the VFO signal, it may be fed into an appropriate microphone-amplifier setup terminated by a speaker, headphones, or mixer circuit, as required by the application.

Thus the pitch of musical instruments, automobile horns, single-frequency machine noises, and the like may be determined.

A.F. AMPLIFIER MEASUREMENTS

As pointed out earlier, the variable-frequency audio oscillator is invaluable in all tests and measurements performed on audio amplifying equipment, from the simplest amplifier used in a radio receiver or hearing aid to the mammoth public address systems for outdoor coverage. It is this application that has placed the instrument in the radio Serviceman's required equipment category.

To illustrate amplifier tests and measurements, the reader is referred to Fig. 2 which shows a conventional A.F. amplifier with screen-grid, suppressor and cathode circuits of the tubes and all power supply wiring omitted for simplicity.

With the variable-frequency audio oscillator and a suitable vacuum-tube voltmeter, such measurements as gain or loss in individual stages or in the entire amplifier may be made, the response studied, and resonant points located.

Transformer Gain.—The gain of an individual transformer, such as T1, may be checked by connecting the oscillator output to point 7 and ground. The amplifier power is switched off and the oscillator set to a suitable frequency, such as 400 cycles. With the V.-T.V.M. connected between 7 and Gnd., the voltage applied to the primary is measured. The V.-T.V.M. is then transferred to bridge points 8 and 10 and the voltage reading taken there. If T1 is a step-up transformer, this last voltage reading will be higher than the first by a factor equal to the turns ratio of the transformer. If it is a step-down transformer, the secondary voltage will be lower by the corresponding turns ratio.

If the V.-T.V.M. is then connected between 8 and 9 or 9 and 10, the voltage reading will indicate the gain in each half of the secondary winding. If the secondary center-tap has been carefully placed, both readings will be identical.

The same operation may be made on transformer T2, here the VFO is connected between 11 and 13 and the V.-T.V.M. between 14 and 15. To inspect the exactness of the primary center-tap on this transformer, the VFO may be connected to 14 and 15 and its output voltage reading taken with the V.-T.V.M. The meter is then transferred successively to 11-12 and 12-13, and across each of these latter terminal combinations the voltage reading should be identical. In both of the foregoing center-tap measurements, the percentage by which the voltages across separate halves of the winding differ is the percentage by which the center-tap is misplaced. The difference between the voltages measured across primary and secondary in either of the gain measurements is a direct indication of the gain through the transformer. For example: the voltage at the output of the oscillator might be found to be 1 volt r.m.s., while that across the secondary winding is 3 volts. The gain through that transformer would then be 3.

The gain measurements may be repeated at other frequencies than 400, carefully measuring each time the voltage at the

primary (output of oscillator) and that of the secondary to determine if gain is falling off or increasing as the frequency is changed.

Tube Gain.—Tube gain may be measured in any of the stages by applying a known voltage from the oscillator to the grid and measuring the A.C. output voltage at the plate of the tube. Here again, the frequency of the signal voltage may be changed to study the frequency-gain characteristics.

As an example, it may be desired to find the actual gain afforded by tube V1. The oscillator is connected between point 2 and ground and the voltage between 2 and Gnd. measured with the V.-T.V.M. The meter is then connected between point 2A and Gnd. and a higher reading obtained there. The factor by which the applied voltage from the oscillator must be multiplied to equal the plate output voltage represents the gain afforded by the tube. For example: if the voltage delivered to the grid (point 2) was found to be 0.5-volt and that present at point 2A is 5 volts, then the tube gain is 10.

It must be remembered that in these tube and stage gain measurements, the amplifier must be placed in *operation* and steps must be taken to prevent passage of current through the oscillator output circuit from point 2 or through the V.-T.V.M. from the high-voltage point 2A. Suitable fixed blocking condensers will in general take care of both of these requirements.

Stage Gain.—The gain of an entire stage may be measured in a similar fashion with the amplifier in operation, but all components associated with the input and output circuits of the stage must be included. This would embrace input- and output-circuit coupling condensers or transformers. Thus, to measure the gain of the second stage, the oscillator is connected between 3 and Gnd. and V.-T.V.M. measurements made successively between 3 and Gnd. and 5 and Gnd. In this manner the actual gain through the entire stage is measured by noting the difference between the voltages applied to the grid of V2 and to the grid of V3.

The gain of the last stage may be measured by applying the oscillator signal voltage between 7 and Gnd. and measuring successively the voltages across those 2 points and the points 14 and 15. In this manner, both input and output transformers are included to give the true per-stage gain and not just the tube gain or the gain of tubes and 1 transformer.

The gain of each stage or any combination of stages may be investigated at various frequencies. These tests will often reveal incorrect or faulty components through the discovery of low gain values.

Overall Gain.—The gain of the entire amplifier may then be measured as shown in Figs. 3A and 3B. When a complete amplifier is to be measured this procedure is followed.

The overall gain, or better, the signal voltage required to deliver maximum output can be measured by first determining the power output limit. The simplest way

of doing this is as follows: The amplifier is connected as in Fig. 3A with an oscillator and a calibrated potentiometer. The input from the amplifier is varied from zero up. The power output of the amplifier is calculated from E^2/R and plotted against the input voltage. The rated load of an audio amplifier can be found by drawing a straight line from the origin tangent to the voltage curve. At the point from which the voltage curve drops away from the straight line, distortion begins (see Fig. 4), the amount being proportional to the displacement of the curves. The allowable distortion depends upon the particular use of the amplifier and the corresponding allowable displacement of the curve from these conditions. Figure 4 shows such a curve for an amplifier whose constants are given in the diagram.

This is a simple manner of approximating the power output of an amplifier without the use of a harmonic analyzer or expensive distortion meter. The ratio P/e at the load limit is the sensitivity of the amplifier. P is the power output in watts and e is the input voltage required to produce this output. The hum level in db. below maximum power output is given by

$$-10 \log_{10} \frac{P_p}{P_y}$$

P_p is rated power output of the amplifier and P_y is the power output with zero input. Actually the curve in Fig. 4 does not go to zero input, but the noise level at an input of .001 volt is so much greater than the output for the input voltage. This is shown by the flattening of the curve at that point.

If the range of the V.-T.V.M. is less than the voltages to be measured, a voltage divider may be used to extend the range of the voltmeter. The load resistor, R in Fig. 3A, is equal to the output impedance of the amplifier.

The arrangement shown in Fig. 3B will prove more satisfactory if the amplifier has low input impedance, such as 500 or 250 ohms. An oscillator and attenuator are used at the input and the voltage measured across the attenuator; Z_1 is equal to the input impedance of the amplifier. The input voltage is then:

$$e_1 = \frac{E_1 R_1}{2(R_1 + R_2)}$$

Then the switch is thrown to B and the voltage is measured across the output load or a portion of the output load. The output voltage is then:

$$e_2 = \frac{E_2(R_3 + R_4)}{R_3}$$

The gain of the amplifier, if it is an amplifier with transformer input, has been customarily expressed in db. and is now:

$$\text{db.} = 20 \log \frac{e_2}{e_1} + \left(10 \log \frac{Z_1}{Z_2} \right)$$

In measurements of fidelity, e_1 is kept constant while the frequency is varied and readings taken of e_2 . A curve is drawn of 20 log e_2 versus frequency.

Location of Resonant Points.—Resonant points are points of sympathetic vibration

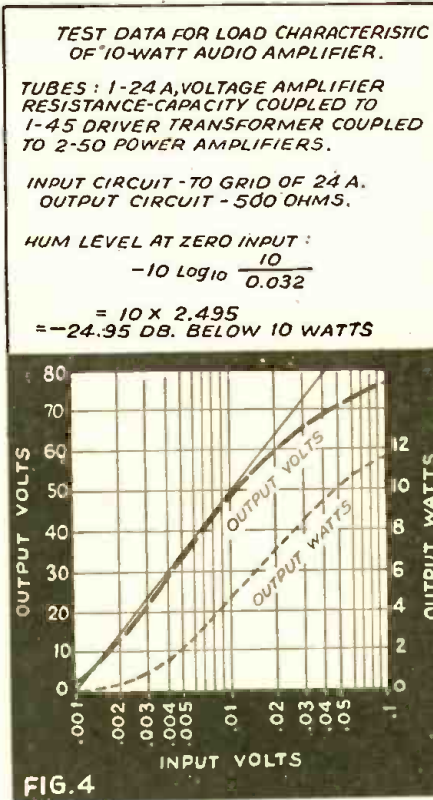

appearing in radio loudspeakers, headphones, cabinets, chassis and shielding. The ability of these mediums to vibrate, when excited by a reproduced note corresponding to their own fundamental periods, causes unpleasant emphasis of certain notes. Resonant points may be located in amplifiers by feeding to the latter a signal from the audio oscillator. With the speaker normally used connected in the output circuit and the amplifier placed into operation, the frequency of the oscillator is slowly varied from zero to maximum. The gain should be set where the output of the speaker will not be unbearable to the ears and where differences in output level may be quickly recognized.

As the oscillator frequency is varied, resonant points of vibration in speaker, chassis, shielding, or cabinet will show up as tremendous intensifications. These points are usually rather high in frequency for chassis, tube shields and the like; low in frequency for speaker cone and cabinet.

Headphones may be checked for resonant points in the earpiece diaphragms by connecting them directly to the output terminals of the audio oscillator and varying the frequency until the points of reverberation are detected.

RECEIVER TESTS

In checking the fidelity of radio receivers, it is generally desirable to inspect the entire overall frequency response which includes the radio-frequency stages as well as the audio amplifier channel.

It is customary in this type of test to connect the variable-frequency audio oscillator to the R.F. signal generator in order to modulate the R.F. output at any frequency within the audio range. The method of connection is shown in Fig. 5.

The R.F. signal generator is coupled to the receiver and a vacuum-tube voltmeter connected to the receiver output circuit across a load resistor as outlined under *amplifier testing*. The receiver is then set to admit the modulated R.F. signal, and the modulating signal carried throughout the A.F. range by adjusting the audio os-

cillator frequency. The input R.F. voltage is kept constant while the frequency is varied, and readings are taken of the output voltage at various frequencies as indicated by the V.-T.V.M. A curve may then be drawn showing 20 log e versus frequency.

The flatness of the curve is an indication of the fidelity of the receiver. The flatter the curve, the higher is the fidelity of the receiver. If it is desired to locate the probable causes of low fidelity, the audio channel may be studied separately, as outlined in the paragraphs on amplifier testing. Then the I.F. channel may be inspected by setting the R.F. signal generator to the intermediate frequency, coupling it into that channel and modulating the I.F. signal throughout the audio spectrum and plotting a curve of the output, as above. Finally, the R.F. and detector stages may be studied.

RADIO-FREQUENCY DEVIATION

Arrangements for the precise measurement of radio frequencies employ systems for comparing an unknown radio frequency with a suitable harmonic of a precision low-frequency oscillator - multivibrator unit. When the unknown signal frequency coincides with a harmonic of the standard, its value is identical with that of the harmonic frequency. However, this is seldom the case. The unknown frequency generally differs from the harmonic frequency by some number of kilocycles.

Since the standard frequency measuring assemblies employ 10-kc. multivibrators to subdivide the R.F. spectrum into 10-kc. intervals, an unknown signal will set up an audio-frequency beat note with one of these adjacent subdividing carriers. And the deviation of the unknown frequency may be determined exactly by measuring the frequency of this beat note. The exact frequency of the unknown signal may then be determined by adding the audio frequency to the nearest 10-kc. harmonic (when the unknown is observed to be higher in frequency than the harmonic with which it is beating) or subtracting it from the 10-kc. harmonic when the unknown is observed to be lower in frequency.

As an example, suppose that an unknown R.F. signal, as picked-up by a heterodyne detector circuit or radio receiver along with standard points from a secondary frequency standard, sets up a beat note with the 5,010-kc. harmonic of the standard. This beat note is measured by comparison with a variable-frequency audio oscillator, as explained in Fig. 1, and found to be 200 cycles. Rotation of the receiver or detector dial shows the signal to lie higher in frequency than the 5,010 kc. harmonic with which it is beating. We have found, then, that the unknown signal frequency is 200 cycles (0.2-kc.) higher in frequency than 5,010 kc. and is therefore 5,010.2 kc.

This method of frequency measurement is much more precise than the more common method of interpolation and is used by the Federal Monitoring Stations with an accuracy of 1 part in several million when determining the frequencies of radio stations.

In such operations as crystal grinding and the setting of self-excited oscillators, where it is desired deliberately to set the operating frequency ahead or behind a certain known frequency, the method just described is accepted as the most accurate.

Deviation of the carrier frequency of a radio transmitter may so be determined by measuring the beat note established at any time between the carrier and a precision oscillator on the station's assigned frequency.

BRITAIN'S AIRCRAFT RADIOLOCATOR

The following exceptionally informative article goes further toward explaining the operation of England's famous Radio Plane-Locator than does anything which has so far come to Radio-Craft's attention. It is reprinted here from the author's department, "Science In The News," in The New York Times, by courtesy of the publishers and of Mr. Kaempffert. Concluding the article is information released to Radio-Craft by the U.S. War Department concerning Uncle Sam's Radiolocator, and the need for trained personnel to operate this new equipment.

WALDEMAR KAEMPFERT

THE English Radio Plane-Locator, which has received such prominence lately in the daily press as a device for locating enemy airplanes at considerable distances, is an application of the radio principles embodied in (a) the "Terrain Clearance Indicator" described in detail in the January, 1939 issue of *Radio-Craft*, and (b) television reception. The English Radio Plane-Locator, referred to in Nov. '40 *Radio-Craft*, pg. 264, as a "radio searchlight," was given brief technical mention in the April, 1941 issue, pg. 586. The Nov., 1935, issue, pg. 267, carried description of a "Mystery Ray."

The following article constitutes the technical background of the view presented last month when Air Commander George Pirie, Air Attaché to the British Embassy, announced that the 24 British Consulate offices through the United States, with the knowledge and approval of the U. S. Government, would accept the enlistment applications of American radio technicians for membership in the newly-organized Civilian Technical Corps. Volunteers accepted for the Corps, it was said, would be paid, *non-combatant* employees whose work would consist solely in the servicing and maintenance of the highly technical equipment now in use by the British Army, Navy and Air forces with particular respect to "the secret weapon known as the 'Radiolocator,' now operating against enemy aircraft from hundreds of points in England," to quote Lord Beaverbrook.

Up to about 3,000 accepted volunteers will be paid \$38.65 per week as chief foremen, or \$24.12 as basic workers, plus free board and lodging, and a distinctive uniform and insignia. Enlistment affords an enviable opportunity to receive first-hand training in handling the English Radiolocator, an American counterpart of which is now in production (American enrollees in the British C.T.C. are subject to recall for similar service by the U. S. Government).

Servicemen and other radio technicians, both male and female, between the ages of 18 and 50 (eligibility limits), have applied to join the C.T.C., but more are needed, for "radiolocation" has "not so much expanded as exploded into a vast organization which is still growing rapidly." The C.T.C. will co-operate with the British Army and Navy, and the R.A.F.

—The Editors.

NOW that the British have appealed to us for technically trained men who can maintain and repair their radiolocators of aircraft, we have dug into the patent literature to discover what has been done by inventors to create artificial sense which will enable us to see through fogs and the inky blackness of moonless nights. In the light of our discoveries, which we here pass on, we cannot see why there has been so much secrecy about principles that have been known at least 10 years.

We begin with radio waves themselves. They are light waves that cannot be seen because of a length that may vary from a few inches, measured from crest to crest, to miles.

In operations rooms like this, many feet below ground R.A.F. officers and girl plotters of the Women's Auxiliary Air Force work day and night watching the movements of enemy planes over Britain.

From the gallery, the officers are able to plan the defense against enemy bombers through viewing the map below which gives a continuous record of information supplied by scattered detecting posts, including those equipped with the Radio Plane-Locator described in the accompanying article.

From these subterranean nerve-centers, the never-ending aerial battle of Britain is directed.
Photo—British Broadcasting Corp.

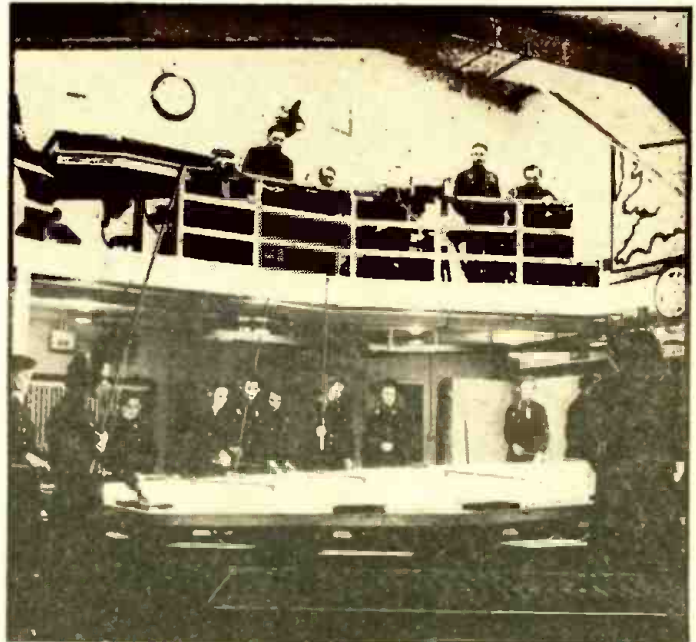

A searchlight reveals a shore or a ship by reflected light. Radio waves behave very much like light waves.

It takes time for light waves to reach an object and be reflected in this fashion. Light travels at 186,000 miles a second (radio waves too), so the reflection seems to be instantaneous. Sound, on the other hand, is much slower, so that we see the flash of a gun, fired at a distance of a few miles, long before we hear the sound. Knowing the speed of sound, it is not difficult to measure the distance of the gun merely by noting when the flash appeared and the time when the report arrived. Whether we deal with light, radio waves or sound, timing is therefore of the utmost importance in measuring the distance of an object.

INVENTORS SOLVE PROBLEM

How are we to measure the "echo" of a radio wave which flashes through space at the rate of 186,000 miles a second?

Suppose we send a radio wave into space in the hope of detecting a mountain at night or in a fog. The radio waves will strike the mountain and will then be reflected back to the station. But the transmitted and reflected waves will not necessarily be in step, or "in phase."

When the transmitted and reflected waves are in step or in phase they will reinforce each other; when they are out of step or out of phase they will cancel each other. Thus 2 sound waves that are out of step will cancel each other so that silence results. Similarly 2 light waves or 2 radio waves can cancel each other so that we detect nothing.

Radiolocation was first applied in devising what are called *absolute altimeters*, which indicate height from the ground. The ordi-

nary altimeter is simply a barometer which indicates only heights above sea-level. Suppose a pilot is soaring over a range 5,000 feet high, and his barometric altimeter registers a height of 5,500 above sea-level. If he should drop only 500 feet in a fog he would crash. The absolute altimeter sends out radio waves which are reflected by the ground, whereupon the pilot follows a spot of light on a screen or the finger of a meter, sees at once that he has only 500 feet to spare and promptly noses up.

PLANE ACTS AS MIRROR

Suppose we direct the radio beam not down against the ground but up into the air. Clearly we have a means of detecting hostile, invisible aircraft. Each plane acts as a little mirror which sends the beam back. And again the spot of light or the indicator shows the distance and location.

It was not by reversing the altimeter that the British hit on this method of locating bombers, but by studying the ionosphere, the name given to a sort of radio mirror in the sky. Without that reflecting ionosphere it would be impossible to send a radio message across the ocean without using excessive transmitting powers.

Like light, radio travels in straight lines, so that we would expect a radio message to shoot off into space. Indeed, when Marconi announced that he had sent the Morse letter "S" across the Atlantic nobody believed him.

When, later, amateurs began to use shorter waves, to cover the same distances with very little power, there was more incredulity. The mathematical physicists Oliver Heaviside in England and A. E. Kennelly in this country did some figuring and decided

that there must be a reflecting layer in the sky. The shorter waves had been reflected back by that layer, then up again and down again and so across the Atlantic.

SEVERAL LAYERS IN SKY

There are several of these reflecting layers in the sky. Professor E. V. Appleton, England's leading authority on the ionosphere, made some measurements of their heights by shooting up radio waves of different lengths or frequencies. It is said that on one occasion the reflected wave, or "echo," came from the wrong direction and at the wrong time. Like a true scientist, Appleton investigated. He found that the passenger planes that arrived at Croydon were the cause of the observed discrepancy. They were little mirrors that had sent back his beams.

The inventors of radiolocators have displayed remarkable ingenuity in juggling the waves so they will be in or out of step or phase. In one type of instrument a phase meter is used, which measures the phase differences between two waves. In another type the wave is split, part of it going to the ground and part to the receiver on board the plane. The pilot controls the two by hand, until the phase of the transmitted part is canceled out by the reflected part. This is called the "null" method.

In a modification of this null method the indicator may be a voltmeter or a sound-producing apparatus. The voltmeter can be calibrated in feet or miles, so that the distance of the reflecting object can be read off at once. The null method requires more or less constant manual adjustment to maintain the zero position. The amount of neutralization is the measure of the distance. With the voltmeter method the pilot has only to watch a pointer or spot of light; with the other he must determine the amount of balancing necessary to arrive at the distance.

Neither of these methods of shifting phase has been very successful in practice because it is difficult to measure small phase angles accurately. Moreover, in both methods waves must be counted, which also introduces complications and demands high skill.

TIME MEASUREMENT SIMPLER

Simpler and more effective is the method of measuring the time it takes for the radio wave to travel to an object and back again. Sharp impulses are sent out. Simultaneously a timing device is started. The timing device may be a cathode-ray tube, much like that used in a television set. A spot of light appears at the big end of the tube, where electron rays from the cathode strike it. The spot travels in one direction proportionately to the travel of the wave, thus producing a luminous line. When the wave is reflected the spot is deflected. The amount of its shift indicates the distance of the object. Instead of moving in a straight line the spot of light may move very rapidly, producing a luminous circle. When the reflected wave arrives, what was a spot of light becomes a dark spot which stands at a particular point and thus indicates distance.

This time-measuring method has been used with great success in enabling ships at sea to measure the depth of the ocean and to detect one another's presence at night or in a fog.

A third method depends on Frequency Modulation, which is not so easy to explain in simple language.

FREQUENCY MODULATION METHOD

Suppose we have a searchlight equipped with a shutter composed of slats. If we

open and close the slats 60 times a second we shall still see a steady light, because the eye is so slow that it cannot follow each opening and closing. Suppose we have an artificial eye also equipped with a shutter composed of slats. Clearly the receiving shutter must open exactly when the searchlight shutter is open if the artificial eye is to see. If the receiving shutter and the transmitting shutter are both closed at the same instant nothing is transmitted and nothing received. Whenever the shutters are both open something is sent and something is received. There are moments when both shutters are open and moments when both are closed, or one may be open and the other closed.

If note "C" on a piano is played, suppose the shutter of the searchlight opens 100 times a second. Then the shutter of the receiving eye must also open 100 times a second in unison. This is *frequency modulation*. It has the great advantage of avoiding interference by spurious radio waves sent out by electric discharges in clouds (static) or the ignition systems of automobiles and airplanes.

When frequency modulation is resorted to it is the rate at which the waves are transmitted and received that is shifted. It

BULLETIN

LOCAL DRAFT BOARDS AUTHORIZED TO RELEASE U. S. TECHNICIANS WHO ENROLL FOR SERVICE IN ENGLAND WITH BRITISH CIVILIAN TECHNICAL CORPS

National Headquarters of the Selective Service System has sent a memorandum to all draft boards authorizing them to release any American who enrolls for service abroad with the BRITISH CIVILIAN TECHNICAL CORPS. Local draft boards are authorized to put such Americans in Class II-B upon proof that they have been enrolled. The Bulletin is dated June 30, 1941, and signed by Lewis B. Hershey, Deputy Director.

An excerpt from the Bulletin follows: "In view of the national policy so clearly defined by these Presidential announcements and by the Act of Congress referred to above, a registrant employed in one of the services of the Canadian or British Governments, listed below may be classified in Class II-B by the local board, providing the requirements of Paragraphs 350-353, Vol. III of the Selective Service Regulations, are met.

The services referred to above include:

- (A) The armed forces of the Canadian and British Governments.
- (B) The BRITISH CIVILIAN TECHNICAL CORPS.
- (C) The Royal Army Medical Corps.
- (D) The British Emergency Medical Service."

is easier to count shifts in frequency than to count waves. A beat note is received whenever the frequency of the transmitted and received waves differ. Suppose that 2,000 vibrations a second (1,000 cycles in engineering parlance) corresponds with one mile; 4,000 vibrations (2,000 cycles) will then correspond with 2 miles. All that we need is a frequency meter to read off the distance. Instruments that rely on frequency shifts are technically called "terrain clearance indications," because they measure the absolute distance of an airplane from the ground.

Lastly, there is the reaction principle, which has found its chief use at sea to warn ships of impending collision. A generator called an *Oscillator*, equipped with a reflector, sends out a microbeam, a train of ripples. The beam strikes an object. The reflected wave strikes the oscillator and upsets its electric balance. This upsetting is tremendously amplified by means of vacuum tubes which are just like those to be found in any radio set. The method is so delicate that it presents difficulties in actual operation.

Radio plane-locators, or "Electronic Sentries," operating on the general principles described in the foregoing article, which will "call out the guard" upon the approach of enemy bombers, will soon be on defense duty 24 hours a day all along the American coastline and at Overseas Bases, the United States War Department announced in a release received by *Radio-Craft* last month!

According to an item in *The New York Times*, Uncle Sam's Radio Plane-Locators cost \$54,700 each; 40 of them are in production for use on the Atlantic and Pacific coasts, Hawaii, Alaska, Puerto Rico and the Canal Zone. In addition, 4 mobile companies will be equipped to set up 5 stations, wherever needed, on short notice. According to press reports, the sum of \$18,000,000 has been earmarked for purchase of Locators.

This closely-guarded device is said to have sufficient sensitivity to detect an airplane at distances of 50 miles. Thus a 15-minute warning would be given of the approach to our shores of a hostile airplane traveling at 200 miles per hour.

Mr. Radio Serviceman, Uncle Sam needs you! Your technical qualifications make you ideally suited to operate and maintain these Radio Plane-Locators. You may determine whether you have the remaining necessary qualifications, to do this service toward your country in aid of its Defense Program, by reading the following material released by the U. S. War Department to *Radio-Craft* last month.

Developed entirely independently by the Signal Corps radio engineers at the Signal Corps laboratory, Fort Monmouth, New Jersey, over a period of about 6 years, the U. S. Army detectors of aircraft have heretofore been classified as secret.

Details of construction and operation of the detectors are still as closely guarded as those of the Air Corps' famed bomb sight. Signal Corps officers, however, said the equipment operates on the same basic principle used by the British in their defense against bomber raids.

As part of the expansion program for aircraft warning units, the Army has called for 500 volunteers from the fields of radio engineering and electronics to learn to operate the devices and man the detector posts. Qualified experts will be commissioned Second Lieutenants in the Signal Corps Reserve and ordered to immediate active duty.

Beginning Monday, June 30, Signal Corps officers from Washington began visiting various cities to interview applicants and answer questions concerning the new science brought into existence by the war.

Applicants must be graduate electrical engineers with radio experience, or electronic physicists, unmarried and without dependents, physically qualified and between the ages of 21 and 36. They also must agree to serve, if necessary, outside the Continental United States.

Technically qualified men, regardless of their present military status are eligible for appointment as commissioned officers. Trainees, already inducted into the Army under the Selective Service Act, and officers in other branches of the Officers Reserve Corps, as well as civilians can apply.

Those who are commissioned will be stationed first at Fort Monmouth for a brief course of military instruction and later will receive training on equipment used by aircraft warning units.

In asking for volunteers for service in this new field of military science, the Army points to the value such training and experience may be in civilian aviation after the emergency passes.

• LATEST RADIO APPARATUS •

A.C./D.C. COMMUNICATIONS RECEIVER

Howard Radio Company
1735 Belmont Ave., Chicago, Ill.



HERE is a new communications receiver which can be operated from almost any powerline—105-117, 120-150- and 210-250 V., A.C. or D.C. It uses 6 of the latest-type tubes giving the equivalent of 9-tube performance. Its tuning range is continuous from 540 kc. to 43 mc. (556 to 7 meters) on 4 overlapping bands with band-spread on all bands. Employs a 3-gang tuning condenser and a stage of R.F. on all bands.—Radio-Craft

HI-FIDELITY MICROPHONE

American Microphone Co., Ltd.
1915 S. Western Ave., Los Angeles, Calif.



THIS newly-designed unit incorporates 2 dynamic generators each with a specific frequency response, the overall result producing the ideal response. The total response is from 25 to above 10,000 c.p.s. with a broad cross-over from 150 c.p.s. to 5,000 c.p.s. The frequency response may be controlled by means of a

built-in switch marked "High-Full-Low." Type D220T has 38,000 ohms impedance; type D220, 30-50 ohms.—Radio-Craft

2-VOLT STORAGE CELL FOR PORTABLE SETS

Willard Storage Battery Co.
246 E. 131 St., Cleveland, Ohio



THE development of this new 2-volt storage cell makes possible portable receivers with a single source of power—the "A" supply. The "B" power is attained through the vibrator unit operating from the "A" cell. The

new unit measures 4 ins. long, by 3 ins. wide, by 5½ ins. high; it is built in a transparent case which is acid-proof and non-spilling. The cell has a built-in CHARGE indicator in the form of 3 colored balls, the green ball sinks when battery is 10% discharged; the white ball, when 50% discharged; and the red ball, when completely discharged. All 3 float again as the cell takes charge. The new storage cell is rated as 20 ampere-hours.—Radio-Craft

NEW CARDIOID MIKE

The Turner Co.
Cedar Rapids, Iowa



To obtain cardioid characteristics, this new mike uses a ribbon velocity element and a dynamic pressure element combined through a specially-designed transformer network that properly mixes the 2 elements to obtain high sensitivity to sounds originating in front of the microphone and extremely low sensitivity to sounds originating at the rear of the mike.—Radio-Craft

LIGHTWEIGHT CRYSTAL PICKUP

Shure Brothers
225 W. Huron St., Chicago, Ill.

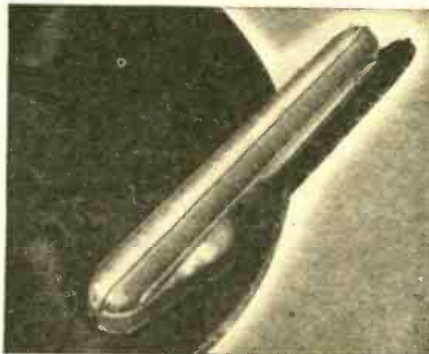

THIS "HI-LO" Crystal Pickup is a 1-ounce unit with permanent sapphire needle point. It is a high-voltage, low-pressure ("HI-LO") pickup which has the greatest ratio of output voltage to needle point impedance—1.4 V. output at 1,000 c.p.s.—with only 1-ounce needle pressure. It is an excellent replacement unit for existing pickups since it improves reproduction and practically eliminates record wear. Offset head corrects tracking error.—Radio-Craft

60-WATT "BI-POWER" AMPLIFIER

Webster-Chicago Sound Division
The Rauland Corporation
3333 Belmont Ave., Chicago, Ill.

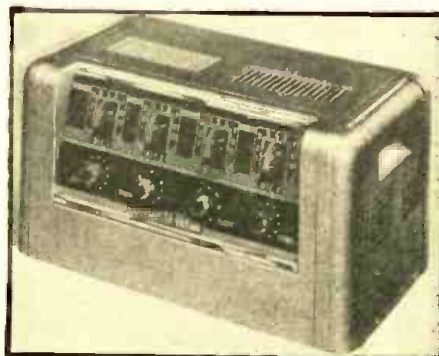

THIS unit has a newly-designed circuit, using to best advantage and in a most practical manner, the characteristics of a

unique 5-tube power output consisting of 3 rectifier tubes, types 83 and 5U4, each performing a separate function "in absolute relation to each other" and obtaining maximum efficiency from 6L6G tubes.

The unit, conservatively rated at 60 watts, incorporates such features as: 4 microphone inputs, 2 phono inputs with dual fader, complete mixing and fading on all 6 inputs, separate bass and treble tone controls, remote mixing of 3 microphones, illuminated panel, and many others.—Radio-Craft

10-WATT AMPLIFIER

John Meek Industries
1313 W. Randolph St., Chicago, Ill.



THIS 10-watt amplifier is excellent for use as a call system in restaurants, clubs; hotel lobbies, etc. The unit offers microphone and input channels each with a separate volume control. Other features include dual-action tone control: 4- and 8-ohm outputs for use with single- or dual-tone systems; provision for field current for dynamic speakers. Available with a dual speaker carrying case or mounted in an easily portable case with a single speaker.—Radio-Craft

ADD-A-UNIT SPEAKER CLUSTER

Vibracloc Mfg. Co.
325 Miguel St., San Francisco, Calif.

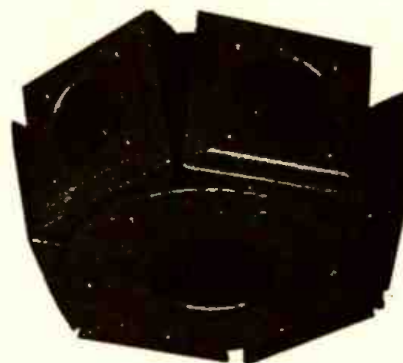

THE efficient, wide-range response and power output of this method of clustering speakers is high and should not be compared with the chandelier-type baffle, which generally is a single-unit-driven affair and directional in horizontal polarity.

Each cluster consists of a master mounting baffle, adjustable leveling hanger, oversized down baffle and the required number of "Tri-Tilt" speaker enclosures. These enclosures nest between the master and down baffles at an optimum tilt, with further adjustment possible in both the vertical and horizontal direction. Two sizes of the speaker enclosure are available; they are the types 6U and 12U. The type 6U enclosure can use up to 6-in. speakers with a 9-in. speaker used in the down baffle. The 12U enclosure can use up to 12-in. speakers with a 15-in. speaker used in the down baffle.—Radio-Craft

PORTABLE DISC RECORDER

RCA Manufacturing Co., Inc.
Camden, N. J.

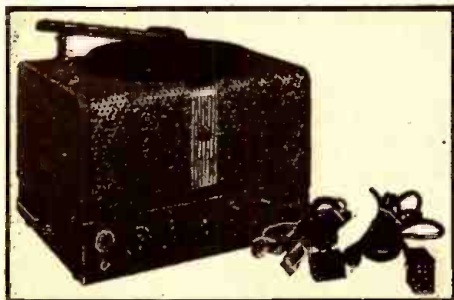

THIS new all-purpose, type OR-1 sound system is ideal for use in mobile, portable or permanent installations. It is built in 2 units, as shown. The system operates from 105-125 V., 60-cycle powerline or from a 6-V. storage battery. It delivers 15 watts output and is available with or without turntable or pick-up. Either speed 78 or 33 1/3%. The diamond-point cutting stylus has a uniform frequency response of from 30 to 10,000 cycles. The playback pickup reproduces laterally- and vertically-cut records. Dimensions: 16 1/2 x 12 x 12 ins. high.

A unique feature is the provision for preventing "flats" in the rubber-tired rim-drive wheels; the off-on switch also releases both driver wheels from friction until they are needed for this service. A switch selects the desired filter.—Radio-Craft

SELF-CHARGING BATTERY PORTABLE

Stewart-Warner Corp.
1826 Diversey Pkway., Chicago, Ill.



ILLUSTRATED is one of a group of 3 self-charging portable receivers. No special batteries are required for charging purposes. The ordinary "A" battery normally used for battery portables is automatically recharged by a special built-in charge circuit. Operating from the A.C. line, ordinarily from 5 to 7 new "A" cells would have to be purchased each year; whereas, the new battery-cell charging circuit in these receivers make it possible to use a single "A" cell for one entire year. It is claimed that a single recharge is sufficient to operate a portable set for an entire 2 weeks' vacation.—Radio-Craft

AVIATION BATTERY/ELECTRIC PORTABLE AND INTERPHONE —THE "LEARAVIAN"

Lear Avia, Inc.
30 Rockefeller Plaza, New York, N. Y.

THE "Learavian" provides complete coverage of aeronautical and broadcast frequencies in 3 bands, viz.: 195-410 kc. (airways and marine radio ranges, weather broad-

casts and traffic control), 540-1,560 kc. (standard broadcasts); and 2,200-6,300 kc. (airways communications, including private flying, airlines, Coast Guard and Army and Navy aeronautical frequencies).

In addition to a built-in loop antenna for use on the ground, the instrument also provides a special plug-in connection for use with an external antenna on board aircraft. Provision is also made for using headphones when necessary. The set measures 8 1/2 x 12 x 6 ins. deep, and weighs only 14 lbs., 3 ozs., including all batteries.

The built-in loudspeaker is cut off when phones are plugged into a headphone jack. A microphone may be plugged into another jack, and with the microphone's press-to-talk button, interphone communication between cockpits becomes available. This portable operates on self-contained drycells or from an A.C./D.C. powerline. When desired, a simultaneous radio range filter is available (at a slight additional cost), to permit selective reception of either the range signals or the weather broadcasts, and the notices for airmen now being transmitted *simultaneously* over the majority of the Federal Airways Range System.—Radio-Craft

VOLT-OHM-MILLIAMMETER

The Hickok Electrical Instrument Co.
10302 Dupont Avenue, Cleveland, Ohio

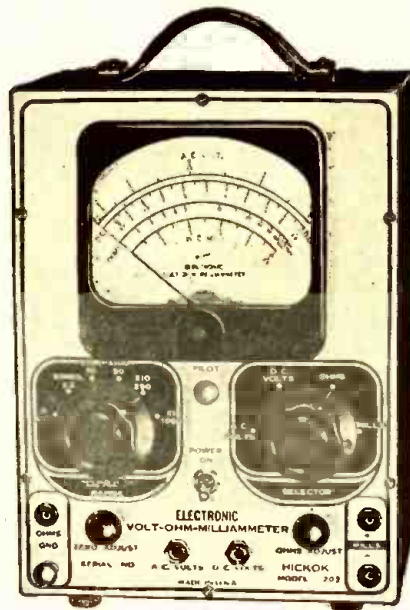

MODEL 202 is a V-O-M meter which permits measurements while the set is in operation without danger of damaging the instrument through overload. It has a self-contained power supply which operates on the 115 V. 50-60 cycle A.C. line; line voltage is regulated by means of a voltage regulator tube. The large 5-in. meter is the rectangular type with a total scale-length of over 17 ins. The ranges of the instrument are: A.C. Voltage in 5 ranges to 1,000 volts with input impedance of approximately 2.5 megohms; D.C. Voltmeter in 5 ranges to 1,000 megohms; 5 Milliampere ranges to 1,000 milliamperes.—Radio-Craft

IMPEDANCE BRIDGE

Radex Corporation
1733 Milwaukee Ave., Chicago, Ill.

THE impedance-matching bridge shown here produces a fast and accurate method of adjusting and checking coil inductances in production work to insure that all coils have identical characteristics. Setup consists of an oscillator, an amplifier, a cathode-ray indicator and the bridge proper. This

assembly requires no auxiliary equipment. Coils with inductance values under 1 microhenry and over 10 millihenries may be compared to a standard with an accuracy of 1/100 of 1%. Other electrical elements (condensers, for example) with impedances between 1/2-ohm and 5,000 ohms at 100 kc. may be similarly compared.—Radio-Craft

PORTABLE PROFESSIONAL RADIO - RECORDING - SOUND SYSTEM

Wilcox-Gay Corporation
Charlotte, Mich.

"RECORDIO-PRO" is a versatile combination recorder and phonograph, and a public address system including a P.A. tuner, of the professional type but designed for the low-price bracket. It is ideal for orchestras, musicians, schools, colleges, radio stations, professional men, etc.

The sectionalized construction of this equipment makes it easily portable. It is sold in separate units so that the Master unit may be used alone or with either or both of the turntable assemblies, according to individual needs. Provisions are made for duplicating records, for transferring material from 78 r.p.m. to 33 1/3 r.p.m., or vice versa; and for making new recordings by dubbing-in from parts of other records, or from new material combined with parts of other recordings. The use of 2 turntables affords continuous recording (for 15 mins.), if desired, without the necessity of interruptions for changing record discs. The Master unit includes a 6-watt amplifier, as well as the 2-band receiver (550 to 1,700 kc., and 5 to 18 mc.). Terminals provide for feeding the television sound channel or the output of an F.M. tuner to the audio system. Complete system incorporates 10 tubes; cutters and pickups are crystal type.—Radio-Craft

NEW "SUNLIGHT" SWITCH

United Cinephone Corporation
Torrington, Conn.



THIS new light-sensitive relay is used to control electrical circuits in accordance with the rise and fall of natural illumination, including sunlight. The user chooses the 2 lighting levels at which he wishes the load switched on and off, and adjusts the calibrated dials to the corresponding foot-candle readings. Automatic operation eliminates the necessity for resetting. Control circuit uses a type 921

photo-tube (life expectancy 20,000 hours) and 2 type 6J5 tubes (life, approx. 5,000 hours). Operates from 110 V., A.C. Case is weatherproof. Useful in factories, for window illumination control, etc.—Radio-Craft

PORTABLE AIRCRAFT RECEIVER

Jefferson-Travis Radio Mfg. Corp.
380 2nd Ave., New York, N. Y.

THIS model PR-5 battery portable is designed for the needs of the growing number of light-plane owners and flyers. Frequency range of this unit is 200 to 400 kc.; the control tower frequency of 278 kc. is marked on the dial. Fingertip controls permit quick change from radio range frequencies to control tower frequencies. Headphone reception. Total wgt., 10 lbs.—Radio-Craft

Where to Buy It! —

SECTION VI (REVISED)

CLASSIFIED RADIO DIRECTORY

Handy Buying Guide, by Products and Companies' Names and Addresses, for the entire Radio Industry

There is no charge for regular light-face listings in the Classified Radio Directory. However, if dominant bold-face listings are desired, we make a charge of \$2 for concern names and \$1 for trade names for each bold-face listing. Please write to the Advertising Dept., Radio-Craft, 20 Vesey St., New York, N. Y., for details.

This DIRECTORY is published in sections—1 section per month. This method of publication permits the DIRECTORY to be constantly up-to-date since necessary revisions and corrections can be made monthly. All names preceded by an asterisk (*) indicate that they are trade names.

If you cannot find any item or manufacturer in this section or in previously-published sections, just drop us a line for the information. Canadian radio manufacturers are unable to purchase any merchandise from the States, Radio-Craft is advised. Our readers, however, may wish to make Canadian purchases, and hence, current listings are being continued.

Presented here is Section VI of the completely revised Second Edition of the CLASSIFIED RADIO DIRECTORY.

While every precaution is taken to insure accuracy, Radio-Craft cannot guarantee against the possibility of occasional errors and omissions in the preparation of this Classified Directory. Manufacturers and readers are urged to report all errors and omissions at the earliest moment to insure corrections in the very next issue.

TOOLS



- Alignment tools A
- Benches (and/or stools) B
- Bench lamps BL
- Blow torches BT
- Chassis racks & supports C
- Clamps CL
- Clips (test & battery) CS
- Drills (electric) DE
- Files (Swiss pattern) F
- Furnaces FN
- Fuse pullers FP
- Fuses FS
- Generator servicing kits GK
- Grinders GR
- Hand-drills H
- Hole cutters HO
- Hotplates HT
- Lathes (& equipment) L
- Lubricators (graphite) LG
- Lubricators (oil) LO
- Melting pots M
- Nut-drivers ND
- Pliers PL
- Punches PU
- Rotary hacksaws R
- Saws S
- Screwdrivers SC
- Screwdrivers (Phillips) SP
- Shims (speaker) SH
- Solder SD
- Soldering flux SF
- Soldering irons (electric) SE
- Soldering-iron stands SI
- Soldering-iron tips SL
- Soldering paste SO
- Solder pots SS
- Staple drivers ST
- Test lights (flexible) T
- Tool boxes (wood and/or steel) TB
- Wax pots W
- Welders WD
- Wire strippers WI
- Wrenches WR

- AMERICAN RADIO HARDWARE CO., INC., 476 Broadway, New York, N. Y.—A, C, CL, CS, HO, ND, PL, PU, SC, SE, SP, SL, WR
- AMERICAN SWISS FILES & TOOL CO., 410 Trumbull St., Elizabeth, N. J.—F, ND, PU, SC, WR
- E. C. ATKINS & CO., 402 S. Illinois St., Indianapolis, Ind.—S
- THE "BLUE WIZARD" COMPANY, 2431 E. Slauson Ave., Huntington Park, Calif.—HO
- BOND PRODUCTS CO., 13139 Hamilton Ave., Detroit, Mich.—SE
- L. S. BRACH MFG. CORP., 55 Dickerson St., Newark, N. J.—SD, SE
- BUD RADIO, INC., 5205 Cedar Ave., Cleveland, Ohio—A
- COLE RADIO WORKS, 86 Westville Ave., Caldwell, N. J.—SE, SI
- CRUMPACKER DISTRIB. CORP., 1801 Fannin St., Houston, Tex.—A, ND, PL, PU, SC, SD, SE, SI, SO, WR
- HAROLD DAVIS, INC., 428 W. Capitol St., Jackson, Miss.—A, ND, PL, PU, SC, SD, SE, SI, SO, WR
- DOW RADIO SUPPLY CO., 1759 E. Colorado St., Pasadena, Calif.—A, DE, HO, ND, PL, PU, SC, SD, SE, SI, SO, WR
- DUAL REMOTE CONTROL CO., INC., 31776 W. Warren Ave., Wayne, Mich.—SD, SE, SI, SO
- ELECTRIC SOLDERING IRON CO., INC., W. Elm St., Deep River, Conn.—SE, SI
- FEDERAL SCREW PRODUCTS CO., 24-26 S. Jefferson St., Chicago, Ill.—SD, SO
- FEDERATED PURCHASER, INC., 80 Park Pl., New York, N. Y.—A, C, DE, H, HO, ND, PL, PU, SC, SD, SE, SI, SO, WR
- FISCHER DISTRIB. CORP., 222 Fulton St., New York, N. Y.—A, C, DE, H, HO, ND, PL, PU, SC, SD, SE, SI, SO, WR
- THE FORSBERG MFG. CO., 425 Seaview Ave., Bridgeport, Conn.—DE, H, SC, SP
- GARDINER METAL CO., 4820 S. Campbell Ave., Chicago, Ill.—SD
- GENERAL CEMENT MFG. CO., 919 Taylor Ave., Rockford, Ill.—A, B, BL, C, LO, LG, ND, SC, SF, SH, SD (plastic), SL, SO, ST, WI, WR
- GENERAL ELECTRIC CO., Schenectady, N. Y. & Bridgeport, Conn.—SE
- HARRISON RADIO CO., 12 W. Broadway, New York, N. Y.—A, DE, H, HO, ND, PL, PU, SC, SD, SE, SI, SO, WR
- HERBERT H. HORN, 1201 S. Olive St., Los Angeles, Calif.—A, HO, ND, PL, SC, SD, SE, SI, SO, WR
- IDEAL COMMUTATOR DRESSER CO., 3067 Park Ave., Sycamore, Ill.—SE
- INDEPENDENT PNEUMATIC TOOL CO., 600 W. Jackson Blvd. Chicago, Ill.—DE, HO, ND, SC
- INSULINE CORP. OF AMERICA, 30-30 Northern Blvd., Long Island City, N. Y.—A, C, DE, H, HO, ND, PL, PU, SC, SD, SE, SI, WR
- KELLOGG SWITCHBOARD & SUPPLY CO., 6650 S. Cicero Ave., Chicago, Ill.—SE
- *KNIGHT—Allied Radio Corp.
- KRAEUTER & CO., INC., 585 18th Ave., Newark, N. J.—PL, PU
- LAFAYETTE RADIO CORP., 100 6th Ave., New York, N. Y.—A, C, DE, H, HO, ND, PL, PU, SC, SD, SE, SI, SO, WR
- LECTROHM, INC., 5133 W. 25th Pl., Cicero, Ill.—SS
- LeJAY MANUFACTURING CO., 1406 W. Lake St., Minneapolis, Minn.—GK, WD
- MEISSNER MANUFACTURING CO., Mt. Carmel, Ill.—A, HO, PU
- MISENER MANUFACTURING CO., 1747 58th St., Brooklyn, N. Y.—HO, ND, PL, PU, R, SC, WR
- MONTGOMERY WARD & CO., INC., 619 W. Chicago Ave., Chicago, Ill., *Airline"—A, HO, ND, PL, PU, SC, SD, SE, SI, SO, WR
- NATIONAL SAFETY DEVICE CO., 836 Hubbard St., Chicago, Ill.—BT
- OFFENBACH ELECTRIC CO., 1452 Market St., San Francisco, Calif.—A, DE, H, HO, ND, PL, PU, SC, SD, SE, SI, SO, WR
- PARK METALWARE CO., INC., Orchard Park, N. Y.—ND, PL, SC, WR
- HENRY PAULSON & CO., 37 S. Wabash Ave., Chicago, Ill.—BL, BT, DE, F, H, L, PL, PU, S, SC, SD, SO
- PHILCO RADIO & TELEVISION CORP., Tioga & "C" Sts., Phila., Pa.—A, C, SD, WR
- RAEYH W. POE, 44 White Ct., P.O. Box 159, Canton, Ill.—HO
- PYRAMID PRODUCTS CO., 2224 S. State St., Chicago, Ill.—WI
- RADIO ELECTRIC SERVICE CO., INC., N.W. Cor. 7th & Arch Sts., Phila., Pa.—A, C, DE, H, HO, ND, PL, PU, SC, SD, SE, SI, SO, WR
- RADIO EQUIPMENT CORP., 326 Elm St., Buffalo, N. Y.—A, C, DE, H, HO, ND, PL, PU, SC, SD, SE, SI, SO, WR
- RADOLEK COMPANY, 601 W. Randolph St., Chicago, Ill.—A, C, DE, H, HO, ND, PL, PU, SC, SD, SE, SI, SO, WR
- RCA MANUFACTURING CO., INC., Camden, N. J.—A
- ALBERT F. ROSS & CO., 2341 Wolfram St., Chicago, Ill.—SE, SL
- RUBY CHEMICAL CO., 68-70 McDowell St., Columbus, Ohio, *Rubyfluid"—SD, SF, SO
- *RUBYFLUID—Ruby Chemical Co.
- WALTER S. SCHOTT CO., 5266-70 W. Pico Blvd., Los Angeles, Calif., *Walsco"—ST
- MAURICE SCHWARTZ & SON, 710-712 Broadway, Schenectady, N. Y.—A, C, DE, H, HO, ND, PL, PU, SC, SD, SE, SI, SO, WR
- SEATTLE RADIO SUPPLY CO., INC., 2117 2nd Ave., Seattle, Wash.—A, C, HO, ND, PL, PU, SC, SD, SE, SI, SO, WR
- SHELLEY RADIO CO., 1841 S. Flower St., Los Angeles, Calif.—DE, H, HO, PL, SC, SD, SE, SI, SO, WR
- SIERRA AIRCRAFT, P.O. Box A, Sierra Madre, Calif.—T
- SOUTH BEND LATHE WORKS, 425 E. Madison St., South Bend, Ind.—L
- SPEEDWAY MANUFACTURING CO., 1834 S. 52nd Ave., Cicero, Ill.—GR
- STEVENS-WALDEN, INC., 475 Shrewsbury St., Worcester, Mass.—A, HO, PL, SC, WR
- STROMBERG-CARLSON TELEPHONE MFG. CO., 100 Carlton Rd., Rochester, N. Y.—A
- SUN RADIO CO., 212 Fulton St., New York, N. Y.—A, C, DE, H, HO, ND, PL, PU, SC, SD, SE, SI, SO, WR
- THE WM. A. THOMAS CO., 321 Caroline St., Neenah, Wis.—C
- HAROLD E. TRENT CO., 55th & Wyalusing Ave., Phila., Pa.—FN, HT, SS, W
- TRICO FUSE MFG. CO., 2948 N. 5th St., Milwaukee, Wis.—CL, FP, FS, LG, LO
- UNION STEEL CHEST CORP., 54 Church St., Le Roy, N. Y.—TB
- VACO PRODUCTS CO., 1603 S. Michigan Ave., Chicago, Ill.—ND, SC
- THE VALPEY CRYSTALS, Box 321, Holliston, Mass.—HO
- VANATTA MANUFACTURING CO., 516 Monterey Ave., Ontario, Calif. SE (automatic)
- VASCO ELECTRICAL MFG. CO., 4116 Avalon Blvd., Los Angeles, Calif.—SE, SI
- *WALSCO—Walter S. Schott Co.
- WARD MANUFACTURING CO., 1813 Winona St., Chicago, Ill.—SE
- EARL WEBBER CO., 4350 W. Roosevelt Rd., Chicago, Ill.—PU

ACRO TOOL & DIE WORKS, 2815 Montrose Ave., Chicago, Ill.—C

*AIRLINE—Montgomery Ward & Co., Inc. ALLEN ELECTRIC & EQUIPMENT CO., 2101 N. Pitcher St., Kalamazoo, Mich.—WD

ALLIED RADIO CORP., 833 W. Jackson Blvd., Chicago, Ill., *Knight"—A, C, DE, H, HO, ND, PL, PU, SC, SD, SE, SI, SO, WR

AMERICAN PHENOLIC CORP., 1250 W. Van Buren St., Chicago, Ill.—A, HO, PU

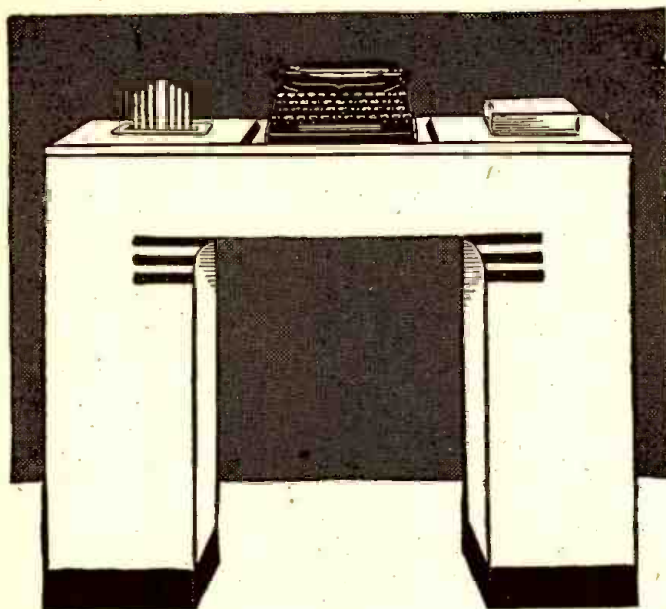

**THIS
BEAUTIFUL DESK
for only \$1.00 EXTRA**

**WITH ANY
REMINGTON
PORTABLE TYPEWRITER**

The
COMBINATION
FOR AS LITTLE AS
10¢ A DAY

How easy it is to pay for this combination of desk and Remington Deluxe Noiseless Portable Typewriter! Just imagine, a small good will deposit with terms as low as 10c a day to get this combination at once! You will never miss 10c a day. Yet this small sum can actually make you immediately the possessor of this amazing office at home combination. You assume no obligations by sending the coupon.

A beautiful desk in a neutral blue-green which will fit into the decorations of any home—trimmed in black and silver—and made of sturdy fibre board—is now available for only one dollar (\$1.00 extra) to purchasers of a Remington Noiseless Portable Typewriter. The desk is so light that it can be moved anywhere without trouble—it is so strong that it will hold six hundred (600) pounds. With this combination of desk and Noiseless Deluxe Portable Typewriter, you will have a miniature office at home. Learn the complete details of this offer. Mail the coupon today.

THESE TWO EXTRA FOR YOU

LEARN TYPING FREE

To help you even further, you get free with this special offer a 32-page booklet, prepared by experts, to teach you quickly how to typewrite by the touch method. When you buy a Noiseless you get this free Remington Rand gift that increases the pleasure of using your Remington Noiseless Deluxe Portable. Remember, the touch typing book is sent free while this offer holds.



SPECIAL CARRYING CASE

The Remington Deluxe Noiseless Portable is light in weight, easily carried about. With this offer Remington supplies a sturdy, beautiful carrying case which rivals in beauty and utility the most attractive luggage you can buy.



SPECIFICATIONS

ALL ESSENTIAL FEATURES of large standard office machines appear in the Noiseless Portable—standard 4-row keyboard; back spacer; margin stops and margin release; double shift key and shift lock; two color ribbon and automatic ribbon reverse; variable line spacer; paper fingers; makes as many as seven carbons; takes paper 9.5" wide; writes lines 8.2" wide. There are also extra features like the card writing attachment, black key cards and white letters, touch regulator, rubber cushioned feet. These make typing on a Remington Deluxe Noiseless Portable a distinct pleasure. Thousands of families now using the Remington Deluxe Noiseless Portable know from experience how wonderful it is!

MONEY BACK GUARANTEE
The Remington Noiseless Portable Typewriter is sold on a trial basis with a money back guarantee. If, after ten days trial, you do not wish to keep the typewriter, we will take it back, paying all shipping charges. You risk nothing in buying a Remington Portable Typewriter on terms as low as 10c a day.



**MAIL
COUPON
NOW!**

Remington Rand Inc., Dept. 189-9
465 Washington St., Buffalo, N. Y.

Tell me, without obligation, how to get a Free Trial of a new Remington Deluxe Noiseless Portable, including Carrying Case and Free 32-page Typing Instruction Booklet on terms as low as 10c a day. Send Catalogue.

Name.....
Address.....
City..... State.....

• CLASSIFIED RADIO DIRECTORY •

TRANSFORMERS & CHOKES



Amateur transmitting	A
Audio (receiving)	AR
Autotransformers	AT
Chokes (receiving)	C
Coils and windings	CW
Commercial & broadcast trans.	CB
Current-regulating	CR
Frequency filters	F
High-fidelity	H
Ignition	I
Power (receiving)	P
Saturable reactors	S
Small-space	SP
Specification equipment	SE
Swinging chokes	SC
Variable matching	V
Voltage regulating	VR

ACME ELECTRIC & MFG. CO., 14 Water St., Cuba, N. Y.—AT, P, VR
 THE ACME WIRE CO., 1255 Dixwell Ave., New Haven, Conn.—CW
 *AC—National Company, Inc.

*AIRLINE—Montgomery Ward & Co., Inc.
 ALLIED RADIO CORP., 833 W. Jackson Blvd., Chicago, Ill. *Knight—A, AR, AT, C, P, VR
 AMERICAN TRANSFORMER CO., 178 Emmet St., Newark, N. J.—A, AR, AT, C, CB, P, VR
 AMPLIFIER CO. OF AMERICA, 17 W. 20th St., New York, N. Y.—A, AR, AT, C, CW, CB, P, VR
 ARLAVOX MANUFACTURING CO., 430 S. Green St., Chicago, Ill.—AR, AT, C, CW
 AUDIO DEVELOPMENT CO., 123 Bryant Ave. N., Minneapolis, Minn.—A, AR, AT, C, CW, CB, P
 BANK'S MANUFACTURING CO., 5019 N. Winthrop Ave., Chicago, Ill.—AR, C, P
 DAVID BOGEN COMPANY, 663 Broadway, New York, N. Y.—AR
 BOND PRODUCTS CO., 13139 Hamilton Ave., Detroit, Mich.—AR, C
 *BROWN DEVILS—Ohmite Manufacturing Co.
 CANADIAN MARCONI CO., 211 St. Sacrament St., Montreal, Can.—AR, AT, C, CW, CB, P, VR
 CANADIAN RADIO CORP., LTD., 622 Fleet St. W., Toronto, Ont., Can.—AR, C, P
 CHICAGO TRANSFORMER CORP., 3501 Addison St., Chicago, Ill.—A, AR, AT, C, CW, CB, P, VR
 CONSOLIDATED WIRE AND ASSOCIATED CORP., Peoria and Harrison Sts., Chicago, Ill.—C, CW
 CRUMPACKER DISTRIB. CORP., 1801 Fannin St., Houston, Tex.—AR, C, P, VR
 HAROLD DAVIS, INC., 428 W. Capitol St., Jackson, Miss.—A, AR, AT, C, CW, CB, P, VR
 DELTA RADIO CORP., 115 Worth St., New York, N. Y.—C, CW
 *DETERMOM—Ohmite Manufacturing Co.
 DOW RADIO SUPPLY CO., 1759 E. Colorado St., Pasadena, Calif.—A, AR, C, CW
 EISLER ENGINEERING CO., 750 S. 13th St., Newark, N. J.—AT, CW
 ELECTRONIC APPLICATIONS, Brunswick, Me.—A, AR, AT, C, CW, CB, P, VR
 FEDERATED PURCHASER, INC., 80 Park Pl., New York, N. Y.—A, AR, AT, C, CW, CB, P, VR
 FISCHER DISTRIB. CORP., 222 Fulton St., New York, N. Y.—A, AR, AT, C, CW, CB, P, VR
 GARDNER ELECTRIC MFG. CO., Specialty Div., 4227 Hollis St., Oakland, Calif.—A, AT, CW, CB, P, VR
 GENERAL ELECTRIC CO., Schenectady, N. Y. & Bridgeport, Conn.—CB, VR
 GENERAL TRANSFORMER CORP., 1250 W. Van Buren St., Chicago, Ill.—AR, AT, C, CW, P, VR
 EDWIN I. GUTHMAN & CO., INC., 400 S. Peoria St., Chicago, Ill.—CW
 ROBERT M. HADLEY CO., 709 E. 61st St., Los Angeles, Calif.—A, AR, AT, C, CW, CB, P, VR
 THE HALLDORSON CO., 4500 Ravenswood Ave., Chicago, Ill.—A, AR, C, CW, P, VR
 HAMMOND MANUFACTURING CO., 40 Wellington St. W., Guelph, Ont., Can.—A, AR, AT, C, CW, CB, P
 HARRISON RADIO CO., 12 W. Broadway, New York, N. Y.—A, AR, AT, C, CW, CB, P, VR
 HILET ENGINEERING CO., 34 S. Park Dr., W. Orange, N. J.—A, AR, AT, C, CW, CB, P, VR
 HOLLYWOOD TRANSFORMER CO., 5334 Hollywood Blvd., Hollywood, Calif.—A, AR, AT, C, CW, CB, P, VR
 HERBERT H. HORN, 1201 S. Olive St., Los Angeles, Calif.—AR, AT, C, P
 INSULINE CORP. OF AMERICA, 30-30 Northern Blvd., Long Island City, N. Y.—A, C, CW
 INTERNATIONAL TRANSFORMER CO., 17 W. 20th St., New York, N. Y.—A, AR, AT, C, CW, CB, P, S, VR
 JEFFERSON ELECTRIC CO., Bellwood, Ill.—A, AR, AT, C, CB, P

KELLOGG SWITCHBOARD & SUPPLY CO., 6650 S. Cicero Ave., Chicago, Ill.—C, CW, P
 KENYON TRANSFORMER CO., INC., 840 Barry St., Bronx, N. Y.—A, AR, AT, C, CW, CB, F, P, S, SP, SE, SC, V, VR
 *KNIGHT—Allied Radio Corp.
 LAFAYETTE RADIO CORP., 100 6th Ave., New York, N. Y.—A, AR, AT, C, CW, CB, P, VR
 M & H SPORTING GOODS CO., 512 Market St., Phila., Pa.—A, AR, AT, C, CW, CB, P, VR
 MAGNETIC WINDINGS CO., 16th & Butler Sts., Easton, Pa.—AR, AT, C, CW, CB, P
 MAJESTIC RADIO & TELEVISION CORP., 2600 W. 50th St., Chicago, Ill.—AR, AT, C, CW
 MARINE RADIO CORP., 117-19 168th St., Jamaica, N. Y.—A, AR, AT, C, CW, CB, P, VR
 MONTGOMERY WARD & CO., INC., 619 W. Chicago Ave., Chicago, Ill., *Airline—A, AR, AT, C, P
 *MULTIVOLTS—Ohmite Manufacturing Co.
 NATIONAL COMPANY, INC., 61 Sherman St., Malden, Mass., *National, *AC—AR, C, P
 *NATIONAL—National Company, Inc.
 NORTHERN ELECTRIC CO., LTD., 1261 Shearer St., Montreal, Que., Can.—CB
 NORWALK TRANSFORMER CORP., 50 Day St., S. Norwalk, Conn.—A, AR, AT, C, CW, CB, P
 OFFENBACH ELECTRIC CO., 1452 Market St., San Francisco, Calif.—A, AR, AT, C, CB, P, VR
 OHMITE MANUFACTURING CO., 4835 W. Flournoy St., Chicago, Ill., *Ohmite, *Brown Devils, *Multivolts, *Determohm, *Riteohm—A
 *OHMITE—Ohmite Manufacturing Co.
 PHILCO RADIO & TELEVISION CORP., Tioga & "C" Sts., Phila., Pa.—AR, AT, C, CW, P
 RADEX CORPORATION, 1733 Milwaukee Ave., Chicago, Ill.—C, CW
 RADIO ELECTRIC SERVICE CO., INC., N.W. Cor. 7th & Arch Sts., Phila., Pa.—A, AR, AT, C, CW, CB, P, VR
 RADIO EQUIPMENT CORP., 326 Elm St., Buffalo, N. Y.—A, AR, AT, C, CW, CB, P, VR
 RADOLEK COMPANY, 601 W. Randolph St., Chicago, Ill.—A, AR, C, CW, P, VR
 RAYTHEON PRODUCTION CORP., 190 Willow St., Waltham, Mass.—AR, AT, VR
 *RITEOHM—Ohmite Manufacturing Co.
 ROGERS-MAJESTIC CORP., LTD., 622 Fleet St., Toronto, Can.—AT, C, CW, P
 MAURICE SCHWARTZ & SON, 710-712 Broadway, Schenectady, N. Y.—A, AR, AT, C, CW, CB, P, VR
 SEATTLE RADIO SUPPLY CO., INC., 2117 2nd Ave., Seattle, Wash.—A, AR, AT, C, CW, CB, P, VR
 SHELLEY RADIO CO., 1841 S. Flower St., Los Angeles, Calif.—A, AR, AT, C, CW, P, VR
 SOLA ELECTRIC CO., 2525 Clybourn Ave., Chicago, Ill.—VR
 STANDARD ELECTRICAL PRODUCTS CO., 417 1st Ave. N., Minneapolis, Minn.—AT, VR
 STANDARD TRANSFORMER CORP., 1500 N. Halsted St., Chicago, Ill.—A, AR, AT, C, CW, CB, P, VR
 SUN RADIO CO., 212 Fulton St., New York, N. Y.—A, AR, AT, C, CW, CB, P, VR
 TELERADIO ENGINEERING CORP., 484 Broome St., New York, N. Y.—C, CW
 THE WM. A. THOMAS COMPANY, 321 Caroline St., Neenah, Wis.—AT, C, CW, P
 THORDARSON ELECTRIC MFG. CO., 500 W. Huron St., Chicago, Ill.—A, AR, AT, C, CW, CB, P, VR
 TILTON ELECTRIC CORP., 15 E. 26th St., New York, N. Y.—AR, C, P
 UNITED TRANSFORMER CORP., 150 Varick St., New York, N. Y.—A, AR, AT, C, CW, CB, CR, H, P, SP, SC, V, VR
 UTAH RADIO PRODUCTS CO., 812 Orleans St., Chicago, Ill.—A, AR, C, P
 WEBSTER ELECTRIC CO., Clark & DeKoven Ave., Racine, Wis.—AR, AT, C, CW, CB, J, P, VR
 WESTINGHOUSE ELEC. & MFG. CO., E. Pittsburgh, Pa.—AT, CB, VR

TRANSMITTERS (& EQUIPMENT)



Amateur (transmitters)	A
Amateur kits	AM
Antenna and feeder spreaders	AS
Antenna measuring equipment	AT
Antennas	AN
Aviation (transmitters; plane and/or airport)	AV
Broadcast (transmitters)	B
Code practice sets	CP
Commercial (transmitters)	C
Condensers	CN
Control consoles	CO
Crystals	CR
Facsimile	F

F.M. (transmitters) (see Frequency Modulation)	
Frequency control equipment	FE
Frequency measurements	FR
Frequency Modulation equipment	FM
Frequency monitors	FT
Insulators	IN
Keys (see Switches & Relays)	
Light plants	L
Marine radiophones	M
Marine (transmitters)	MA
Masts (see Towers, below)	
Police (transmitters)	PO
Rotary beam antennas	R
Rotary converters	RC
Spark (ignition) coils	SC
Speech amplifiers	S
Television	TE
Towers	TO
Transceiver handsets	TH
Transmission monitor equipment	TR
Vertical radiators	V

*AC—National Company, Inc.
 *AIRLINE—Montgomery Ward & Co., Inc.
 ALLIED ENGINEERING INSTITUTE, 85 Warren St., New York, N. Y.—AM, PO
 ALLIED RADIO CORP., 833 W. Jackson Blvd., Chicago, Ill. *Knight—A, AM, AN
 *ALSMAG—American Lava Corp.
 AMERICAN COMMUNICATIONS CORP., 123 Liberty St., New York, N. Y.—A, AN, AV, B, C, CO, MA, PO
 AMERICAN LAVA CORP., Cherokee Blvd. & Manufacturers Rd., Chattanooga, Tenn., *AISIMAG, *Lava—IN
 AMERICAN PHENOLIC CORP., 1250 W. Van Buren St., Chicago, Ill.—AS, IN
 AMERICAN RADIO HARDWARE CO., INC., 476 Broadway, New York, N. Y.—AS, AN, IN
 AMERICAN TELEVISION CORP., 130 W. 56th St., New York, N. Y.—TE
 AMPLIFIER CO. OF AMERICA, 17 W. 20th St., New York, N. Y.—S
 *ANTENEX—M. M. Fleron & Son, Inc.
 BARKER & WILLIAMSON, Ardmore, Pa.—A, TR, V, C, F, FE, FM, FR, IN, MA, PO, S, TE, TO, AV, B
 REX BASSETT, INC., 214 Star Bldg., Niles, Mich.—A, AN, AV, MA, PO
 BENDIX RADIO CORP., 920 E. Fort Ave., Baltimore, Md.—AV
 *BIRNBACH—Birnbach Radio Co., Inc.
 BIRNBACH RADIO CO., INC., 145 Hudson St., New York, N. Y., *Birnbach—IN
 BLAW-KNOX COMPANY, Pittsburgh, Pa.—TO, V
 L. S. BRACH MFG. CORP., 55 Dickerson St., Newark, N. J.—AN
 BROWNING LABORATORIES, INC., 750 Main St., Winchester, Mass.—AM, FM, FR
 BUD RADIO, INC., 5205 Cedar Ave., Cleveland, Ohio—A, AM
 WM. W. L. BURNETT RADIO LAB., 4814 Idaho St., San Diego, Calif.—A, AV, B, C, CR, FE, FR, FT, MA, PO, TR
 CANADIAN MARCONI CO., 211 St. Sacrament St., Montreal, Can.—A, AV, B, C, CO, CR, F, FE, FM, FR, IN, MA, PO, S, TE, TO, TR, V
 ALLEN D. CARDWELL MFG. CORP., 81 Prospect St., Brooklyn, N. Y.—AM
 *CLARION—Transformer Corp. of America
 CONSOLIDATED WIRE AND ASSOCIATED CORP., Peoria and Harrison Sts., Chicago, Ill.—AN, IN
 HAROLD DAVIS, INC., 1128 W. Capitol St., Jackson, Miss.—A, AM, AN, AV, B, C, CR, FE, FM, PO, S, TO, V
 DOOLITTLE RADIO, INC., 7421 Loomis Blvd., Chicago, Ill.—C, CO, FE, FM, FR, PO, TR
 DOW RADIO SUPPLY CO., 1759 E. Colorado St., Pasadena, Calif.—AM, AN, C, CR, IN
 ELECTRONIC APPLICATIONS, Brunswick, Me.—S
 FARNSWORTH TELEVISION & RADIO CORP., 3700 E. Pontiac St., Ft. Wayne, Ind.—FM, TE
 FEDERAL TELEGRAPH CO., 200 Mt. Pleasant Ave., Newark, N. J.—AV, B, C, CO, MA, PO
 FINCH TELECOMMUNICATIONS, INC., 1819 Broadway, New York, N. Y.—F
 FISHER RESEARCH LAB., 1961 University Ave., Palo Alto, Calif.—A, AV, C, CR, FM, MA, PO
 *FLERON—M. M. Fleron & Son, Inc.
 M. M. FLERON & SON, INC., 113 N. Broad St., Trenton, N. J., *Antennex, *Fleron, *Softest, *Signaler—CP, IN
 GALVIN MANUFACTURING CORP., 4545 W. Augusta Blvd., Chicago, Ill., *Motorola—AV, FM, PO
 GENERAL CERAMICS CO., PLANT No. 3, Keasbey, N. J.—IN
 GENERAL ELECTRIC CO., Schenectady, N. Y. & Bridgeport, Conn.—CO (FM), CR, FE, FM, PO, S (FM), TE, TR (FM), V (FM)
 GENERAL RADIO CO., 30 State St., Cambridge, Mass.—AT, FT, TR
 GRAY RADIO CO., 730 Okeechobee Rd., West Palm Beach, Fla.—M, MA
 EDWIN I. GUTHMAN & CO., INC., 400 S. Peoria St., Chicago, Ill.—SC

• CLASSIFIED RADIO DIRECTORY •

THE HALLICRAFTERS, INC., 2611 Indiana Ave., Chicago, Ill.—A, B, C, FM, MA
HAMMARLUND MFG. CO., INC., 424 W. 33rd St., New York, N. Y.—A, AM
D. H. HARRELL 1527 E. 74th Pl., Chicago, Ill.—AN, V
HARRISON RADIO CO., 12 W. Broadway, New York, N. Y.—A, AM, AN, CR, FE, FM, FR, IN, MA, S, V
HARVEY RADIO LABS, INC., 25 Thorndike St., Cambridge, Mass.—A, AV, B, CR, FE, MA, PO
HARVEY-WELLS COMMUNICATIONS, INC., North St., Southbridge, Mass.—A, AM, AV, B, C, CR, FE, FM, MA, PO, S
HIPOWER CRYSTAL CO., 205 W. Wacker Dr., Chicago, Ill.—CR
HYTRONIC LABORATORIES, 23 New Derby St., Salem, Mass.—PO
INSULINE CORP. OF AMERICA, 30-30 Northern Blvd., Long Island City, N. Y.—AN, IN
RAY JEFFERSON, INC., 182 Milburn Ave., Baldwin, N. Y.—*Mansley—MA, PO
KAAR ENGINEERING CO., 619 Emerson St., Palo Alto, Calif.—AN, AV, CR, MA, PO
KATO ENGINEERING CO., 530 N. Front St., Menasha, Minn.—L, RC
KELLOGG SWITCHBOARD & SUPPLY CO., 6650 S. Cicero Ave., Chicago, Ill.—AV, MA, PO
KENYON TRANSFORMER CO., INC., 840 Barry St., Bronx, N. Y.—AM
 *KNIGHT—Allied Radio Corp.
LAFAYETTE RADIO CORP., 100 6th Ave., New York, N. Y.—A, AM, AN, CR, FE, FM, FR, IN, MA, S, TE, TR, V
 *LAVA—American Lava Corp.
LEARADIO—Lear Avia, Inc.
LEAR AVIA, INC., Dayton, Ohio & 30 Rockefeller Plaza, New York, N. Y.—*Learadio—AV
JOHN E. LINGO & SON, INC., 28th St. & Van Buren Ave., Camden, N. J.—AN, TO, V
FRED M. LINK, 125 W. 17th St., New York, N. Y.—AN, B, C, CR, FM, PO, TR
T. R. McELROY, 100 Brookline Ave., Boston, Mass.—A, AM, C, F, TR
M & H SPORTING GOODS CO., 512 Market St., Phila., Pa.—A, AM, AN, CR, FE, IN, MA, V
 *MANSLEY—Ray Jefferson, Inc.
MARINEPHONE, INC., 123 Liberty St., New York, N. Y.—MA
MARINE RADIO CORP., 117-19 168th St., Jamaica, N. Y.—A, AN, AV, B, C, CO, FE, FM, MA, PO, S, TR
MARINE RADIO SERVICE, INC., 438 N. Avalon Blvd., Wilmington, Calif.—M
MEISSNER MANUFACTURING CO., Mt. Carmel, Ill.—AM, FR
JAMES MILLEN MFG. CO., INC., 150 Exchange St., Malden, Mass.—C, FE, FM, FR
MIMS RADIO CO., P. O. Box 504, Texarkana, Ark.—R
MONTGOMERY WARD & CO., INC., 619 W. Chicago Ave., Chicago, Ill.—*“Airline”—A, AM, AN, CR, MA, S
 *MOTOROLA—Galvin Manufacturing Corp.
MUSIC MASTER MFG. CO., 508 S. Dearborn St., Chicago, Ill.—A, AM, AN, FE, FR, S
NATIONAL COMPANY, INC., 61 Sherman St., Melrose, Mass.—*“National”—AC—A, AM, IN, S
 *NATIONAL—National Company, Inc.
NORTHERN ELECTRIC CO. LTD., 1261 Shearer St., Montreal, Que., Can.—AN, AV, B, C, CR, FE, FM, IN, PO, S, TO, TR, V
OFFENBACH ELECTRIC CO., 1452 Market St., San Francisco, Calif.—A, AM, AN, AV, B, C, CR, IN, MA, S, V
PIERSON-DeLANE, INC., 2345-47 W. Washington Blvd., Los Angeles, Calif.—AV, C, FE, FR, PO
PREMAX PRODUCTS DIV., CHISHOLM-RYDER CO., INC., Drawer F, Bridge Sta., Niagara Falls, N. Y.—AN, IN, TO, V
RADIO ELECTRIC SERVICE CO., INC., N.W. Cor. 7th & Arch Sts., Phila., Pa.—A, AM, AN, CR
RADIO ENGINEERING LABS, INC., 35-54 36th St., Long Island City, N. Y.—FM, MA, PO
RADIO EQUIPMENT CORP., 326 Elm St., Buffalo, N. Y.—A, AM, AN, AV, B, C, CR, FE, MA, S, V
RADIO NAVIGATIONAL INSTRUMENT CORP., 500 5th Ave., New York, N. Y.—AV, MA
RADIO RECEPTOR CO., INC., 251 W. 19th St., New York, N. Y.—AV, B, C, MA, PO, S, TO, V
RADIO TRANSCEIVER LABS., 8627-115th St., Richmond Hill, N. Y.—A, AM, AN, C
RADOLEK COMPANY, 601 W. Randolph St., Chicago, Ill.—A, AM, AN, CR, F, FE, FM, FR, IN, S, TO
RCA MANUFACTURING CO., INC., Camden, N. J.—A, AN, AV, B, C, CO, CR, F, FE, FM, FR, MA, PO, S, TE, TR
ROWE INDUSTRIES, INC., 3120 Monroe St., Toledo, Ohio—AV, S
 *SAFEST—M. M. Fleron & Son, Inc.
MAURICE SCHWARTZ & SON, 710-712 Broadway, Schenectady, N. Y.—A, AM, AN, AV, B, C, CO, CR, F, FE, FM, FR, IN, MA, PO, S, TE, TO, TR, V
SEATTLE RADIO SUPPLY CO. INC., 2117 2nd Ave., Seattle, Wash.—A, AM, AN, B, C, CR, FE, FM, FR, IN, MA, PO, S, TR
SHELLEY RADIO CO., 1841 S. Flower St., Los Angeles, Calif.—A, AM, AN, C
 *SIGNALER—M. M. Fleron & Son, Inc.
STANDARD PIEZO CO., Cedar & Louthers Sts., Carlisle, Pa.—CR, FE, FR
SUN RADIO CO., 212 Fulton St., New York, N. Y.—A, AM, AN, B, C, CR, FE, FM, FR, IN, MA, PO, S, TE, TO, TR, V

TAY BERN EQUIPMENT CO., INC., 135 Liberty St., New York, N. Y.—AV, C, MA, PO
TECHNICAL PRODUCTS INTERNATIONAL, 135 Liberty St., New York, N. Y.—A, AM, AN, AV, B, C, MA, PO, S, TO
TELEVISO PRODUCTS, INC., 1135 N. Cicero Ave., Chicago, Ill.—FE, FR
THORDARSON ELECTRIC MFG. CO., 500 W. Huron St., Chicago, Ill.—A, AM, S
TRANSFORMER CORP. OF AMERICA, 69 Wooster St., New York, N. Y.—*“Clarion”—S
TRANSMARINE RADIO INC., 1184 Broadway, Hewlett, L. I., N. Y.—A, AV, B, C, MA, PO, TE, V
UNITED TRANSFORMER CORP., 150 Varick St., New York, N. Y.—AM, S
UNIVERSAL MICROPHONE CO., LTD., 424 Warren Lane, Inglewood, Calif.—TH
VERTI-FLEX ILLINOIS SEATING CO., 2138 N. Racine Ave., Chicago, Ill.—AN
WEBSTER ELECTRIC CO., Clark & DeKoven Ave., Racine, Wis.—S
WEBSTER ELECTRIC CO., INC., 300 Central Ave., Kearny, N. J.—AV, B, CO, CR, MA, PO, S
WESTINGHOUSE ELEC. & MFG. CO., E. Pittsburgh, Pa.—B, CO
WILCOX ELECTRIC CO., 40th & State Line, Kansas City, Mo.—AV, B, C, CO, F, PO
WINCHARGER CORPORATION, Sioux City, Iowa—AN, TO, V

THE H. R. KIRKLAND CO., INC., 10 King St., Morristown, N. J.—*“Bulls-I-Units”, “Kirkland”—P
 *KIRKLAND—The H. R. Kirkland Co., Inc.
 *KNIGHT—Allied Radio Corp.
LAFAYETTE RADIO CORP., 100 6th Ave., New York, N. Y.—BR, C, CC, IN, M, P, RR, TX, V
T. R. McELROY, 100 Brookline Ave., Boston, Mass.—BR, P
MAC-ADAMS EQUIPMENT CO., INC., 507 W. 56th St., New York, N. Y.—M, RR
MONTGOMERY WARD & CO., INC., 619 W. Chicago Ave., Chicago, Ill.—*“Airline”—BR, C, CC, RR, TX, V
NATIONAL UNION RADIO CORP., 57 State St., Newark, N. J.—C, M, P, RR
NORTHERN ELECTRIC CO. LTD., 1261 Shearer St., Montreal, Que., Can.—BR, C, CC, IN, M, P, RR, TX, V
OFFENBACH ELECTRIC CO., 1452 Market St., San Francisco, Calif.—BR, C, CC, IN, M, P, RR, TX, V
PHILCO RADIO & TELEVISION CORP., Tioga & “C” Sts., Phila., Pa.—P, RR
PHOTOBELL CORPORATION, 123 Liberty St., New York, N. Y.—IN, P
PHOTOSWITCH, INC., 21 Chestnut St., Cambridge, Mass.—P
RADIO ELECTRIC SERVICE CO., INC., N. W. Cor. 7th & Arch Sts., Phila., Pa.—BR, C, CC, IN, M, P, RR, TX, V
RADIO EQUIPMENT CORP., 326 Elm St., Buffalo, N. Y.—BR, C, CC, IN, M, P, RR, TX, V
RADOLEK COMPANY, 601 W. Randolph St., Chicago, Ill.—BR, C, CC, IN, M, P, RR, TX, V
RAYTHEON PRODUCTION CORP., 55 Chapel St., Newton, Mass.—BR, IN, RR, TX
RCA MANUFACTURING CO., INC., Camden, N. J.—BR, C, CC, IN, M, P, RR, TX, V
ROGERS-MAJESTIC CORP., LTD., 622 Fleet St., Toronto, Can.—C, RR, TX
MAURICE SCHWARTZ & SON, 710-712 Broadway, Schenectady, N. Y.—BR, C, CC, IN, M, P, RR, TX, V
SEATTLE RADIO SUPPLY CO., INC., 2117 2nd Ave., Seattle, Wash.—BR, C, CC, IN, M, P, RR, TX, V
SHELLEY RADIO CO., 1841 S. Flower St., Los Angeles, Calif.—BR, C, CC, P, RR, V
S.O.S. CINEMA SUPPLY CORP., 636 11th Ave., New York, N. Y.—P
SUN RADIO CO., 212 Fulton St., New York, N. Y.—BR, C, CC, IN, M, P, RR, TX, V
TAYLOR TUBES, INC., 2341 Wabansia Ave., Chicago, Ill.—IN, TX
TILTON ELECTRIC CORP., 15 E. 26th St., New York, N. Y.—BR
TUNG-SOL LAMP WORKS, INC., Radio Tube Div., 95 8th Ave., Newark, N. J.—RR
UNITED ELECTRONICS CO., 42 Spring St., Newark, N. J.—IN, TX
 *WESTON—Weston Electrical Instrument Corp.
WESTINGHOUSE ELEC. & MFG. CO., E. Pittsburgh, Pa.—IN, P, TX
WESTON ELECTRICAL INSTRUMENT CORP., 614 Frelinghuysen Ave., Newark, N. J.—*“Weston”—P

TUBES (& PARTS)

Ballast (regulating)	BR
Cathode-ray	C
Current-control	CC
Getters	G
Industrial	IN
Miniatures (hearing-aid and/or radio receiving)	M
Photocells	P
Pilotlights	PL
Receiving (including rectifiers)	RR
Transmitting	TX
Voltage control	V

*AIRLINE—Montgomery Ward & Co., Inc.
ALLIED RADIO CORP., 833 W. Jackson Blvd., Chicago, Ill.—*“Knight”—BR, C, CC, IN, M, P, RR, TX, V
AMERICAN TELEVISION CORP., 130 W. 56th St., New York, N. Y.—C
AMPERITE COMPANY, 561 Broadway, New York, N. Y.—BR
ARCO TUBE CO., 227 Central Ave., Newark, N. J.—BR, C, CC, IN, M, P, RR, TX, V
 *BAREX—King Laboratories, Inc.
 *BULLS-I-UNITS—The H. R. Kirkland Co., Inc.
CANADIAN MARCONI CO., 211 St. Sacramento St., Montreal, Can.—BR, C, CC, IN, M, P, RR, TX, V
CANADIAN RADIO CORP., LTD., 622 Fleet St., W., Toronto, Ont., Can.—M, RR, TX
 *CHAMPION—Champion Radio Works
CHAMPION RADIO WORKS, 88 Holten St., Danvers, Mass.—*“Champion”—BR, RR
CONTINENTAL ELECTRIC CO., Geneva, Ill.—IN, P
CRUMPACKER DISTRIB. CORP., 1801 Fannin St., Houston, Tex.—BR, P, RR
HAROLD DAVIS, INC., 428 W. Capitol St., Jackson, Miss.—BR, C, CC, IN, M, P, RR, TX, V
DIRECT OUTLET SALES, 4002 6th Ave., Brooklyn, N. Y.—BR, RR
DOW RADIO SUPPLY CO., 1759 E. Colorado St., Pasadena, Calif.—BR, RR, TX
ALLEN B. DUMONT LABS., INC., Passaic, N. J.—C
EITEL-McCULLOUGH, INC., San Bruno, Calif.—TX
ELECTRONIC CONTROL CORP., 2667 E. Grand Blvd., Detroit, Mich.—P
ELECTRONS, INC., 127 Sussex Ave., Newark, N. J.—IN
FARNSWORTH TELEVISION & RADIO CORP., 3700 E. Pontiac St., Ft. Wayne, Ind.—C, P
FEDERAL TELEGRAPH CO., 200 Mt. Pleasant Ave., Newark, N. J.—TX
FEDERATED PURCHASER, INC., 80 Park Pl., New York, N. Y.—BR, C, CC, M, P, RR, TX, V
FISCHER DISTRIB. CORP., 222 Fulton St., New York, N. Y.—BR, C, M, P, RR
GENERAL ELECTRIC CO., Schenectady, N. Y. & Bridgeport, Conn.—BR, C, IN, M, P, RR, TX
G-M LABORATORIES, INC., 4326 N. Knox Ave., Chicago, Ill.—P
GOLDENTONE RADIO CO., 15123 Warren Ave., Dearborn, Mich.—RR
HARRISON RADIO CO., 12 W. Broadway, New York, N. Y.—BR, C, CC, IN, M, P, RR, TX, V
HEINTZ & KAUFMAN, LTD., S. San Francisco, Calif.—TX
HERBERT H. HORN, 1201 S. Olive St., Los Angeles, Calif.—BR, CC, IN, M, V
HYGRADE SYLVANIA CORP., 500 5th Ave., New York, N. Y.—BR, C, M, RR
HYTRON CORPORATION, 76 Lafayette St., Salem, Mass.—BR, M, RR
HYTRONIC LABORATORIES, 23 New Derby St., Salem, Mass.—C, CC, IN, TX, V
J. F. D. MANUFACTURING CO., 4111 Ft. Hamilton Pkwy., Brooklyn, N. Y.—BR
KEN-RAD TUBE & LAMP CORP., INC., 316 E. 9th St., Owensboro, Ky.—M, RR
KING LABORATORIES, INC., 205 Oneida St., Syracuse, N. Y.—*“Barex”—G

VIBRATORS

(Also see Battery Chargers, Eliminators & Rectifiers)

Auto-radio	AV
Farm-radio	FV
Inverters	I
Neon lighting	N

ALLIED RADIO CORP., 833 W. Jackson Blvd., Chicago, Ill.—*“Knight”—AV, FV, I
AMERICAN TELEVISION & RADIO CO., 300 E. 4th St., St. Paul, Minn.—AV, FV, I
CANADIAN MARCONI CO., 211 St. Sacramento St., Montreal, Can.—AV, FV, I
CANADIAN RADIO CORP., LTD., 622 Fleet St., W., Toronto, Ont., Can.—AV, FV
CRUMPACKER DISTRIB. CORP., 1801 Fannin St., Houston, Tex.—AV, FV, I
HAROLD DAVIS, INC., 428 W. Capitol St., Jackson, Miss.—AV, FV, I
DOW RADIO SUPPLY CO., 1759 E. Colorado St., Pasadena, Calif.—AV
ELECTRONIC CONTROL CORP., 2667 E. Grand Blvd., Detroit, Mich.—I
ELECTRONIC LABORATORIES, INC., 122 W. New York St., Indianapolis, Ind.—I
FEDERATED PURCHASER, INC., 80 Park Pl., New York, N. Y.—AV, FV, I
FISCHER DISTRIB. CORP., 222 Fulton St., New York, N. Y.—AV, I
GALVIN MANUFACTURING CORP., 4545 W. Augusta Blvd., Chicago, Ill.—*“Motorola”—AV
HARRISON RADIO CO., 12 W. Broadway, New York, N. Y.—AV, FV, I
HARTMAN ELECTRICAL MFG. CO., 31 E. 5th St., Mansfield, Ohio—N
HERBERT H. HORN, 1201 S. Olive St., Los Angeles, Calif.—AV, FV, I
KAAR ENGINEERING CO., 619 Emerson St., Palo Alto, Calif.—AV
LAFAYETTE RADIO CORP., 100 6th Ave., New York, N. Y.—AV, FV, I
FRED M. LINK, 125 W. 17th St., New York, N. Y.—AV
M & H SPORTING GOODS CO., 512 Market St., Phila., Pa.—AV, I
MAC-ADAMS EQUIPMENT CO., INC., 507 W. 56th St., New York, N. Y.—AV
P. R. MALLORY & CO., INC., 3029 E. Washington St., Indianapolis, Ind.—AV, FV

CLASSIFIED RADIO DIRECTORY

10 BEST RADIO BOOKS 10¢ ea.

RADIO FANS EVERYWHERE—these fine ten cent text books give you an excellent foundation for the study of RADIO. They are clearly written, profusely illustrated and contain over 15,000 words in each book. You'll be

amazed at the wealth of information contained in these handy books. Excellent for reference—ideal for every technical library. YOUR MONEY BACK if you are not satisfied. PROMPT SHIPMENTS



No. 1
HOW TO BUILD FOUR DOERLE SHORT WAVE SETS
Thousands of radio fans have built the famous DOERLE Short Wave Radio Receivers. So insistent has been the demand for these receivers, not only as construction details, that this book has been specially published. Contains EVERYTHING that has ever been printed on these famous receivers.

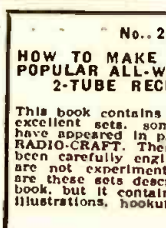

No. 2
HOW TO MAKE THE MOST POPULAR ALL-WAVE 1 and 2-TUBE RECEIVERS
This book contains a number of excellent sets, some of which have appeared in past issues of RADIO-CRAFT. These sets have been carefully engineered. They are not experiments. Not only are these sets described in this book, but it contains all of the illustrations, hookups, etc.



No. 3
ALTERNATING CURRENT FOR BEGINNERS
This book gives the beginner a foothold in electricity and Radio. Electric circuits are explained. Ohm's Law, one of the fundamental laws of radio, is explained; the generation of alternating current; sine waves; the units—volts, amperes, and transformers; A. C. instruments, motors and generators.

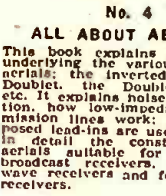

No. 4
ALL ABOUT AERIALS
This book explains the theory underlying the various types of aerials; the inverted "L", the Doublet, the Double Doublet, etc. It explains noise-free reception, how low-impedance transmission lines work; why transposed lead-ins are used. It gives in detail the construction of aerials suitable for long-wave broadcast receivers, for short-wave receivers and for all-wave receivers.

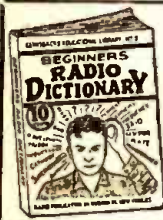

No. 5
BEGINNERS' RADIO DICTIONARY
Are you puzzled by radio language? Can you define frequency? Kilocycle? Tetrode? Screen grid? Baffle? Anode? Triode? Pole? Ionization? Qui's Law? Harmonic? Gravity Cell? If you cannot define these very common radio words and dozens of other, more technical terms used in all radio magazines and instruction books, you need this book in your library.



No. 6
HOW TO HAVE FUN WITH RADIO
Stunts for parties, practical jokes, scientific experiments and other amusements which can be done with your radio set are explained in this fascinating volume. It tells how to make newspaper talk—how to produce silent music for dances—how to make a "silent radio" unit usable by the deafened—how to make toys which dance to radio music, etc., etc.

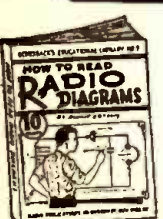

No. 7
HOW TO READ RADIO DIAGRAMS
All of the symbols commonly used in radio diagrams are presented in this book, together with pictures of the apparatus they represent and explanations giving an easy method to memorize them. This book by Robert Eichberg, the well-known radio writer and member of the editorial staff of RADIO-CRAFT Magazine, also contains two dozen picture-wiring diagrams of simple radio sets that you can build.



No. 8
RADIO FOR BEGINNERS
Hugo Gernsback, the internationally famous radio pioneer, author and editor, whose famous magazines, RADIO AND TELEVISION and RADIO-CRAFT are read by millions, scores another triumph with this new book. An beginner who reads it will get a thorough ground work in radio theory, clearly explained in simple language, and through the use of many illustrations. Analogies are used to make the mysteries of radio clear.



No. 9
SIMPLE ELECTRICAL EXPERIMENTS
Over 100 interesting and practical electrical experiments are described in this book, covering every branch of electricity—from simple experiments with magnets to high frequency "stunts". All of the experiments described can be carried out with simple apparatus, most of which can be found about the home.

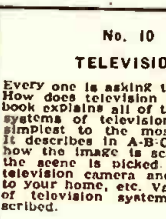

No. 10
TELEVISION
Every one is asking the question: How does television work? This book explains all of the different systems of television in the simplest to the most complex. It describes in A-B-C style just how the image is scanned, how the scene is picked up by the television camera and broadcast to your home, etc. Various types of television systems are described.

BOOKS ARE ALL UNIFORM

Every book in the GERNSBACK EDUCATIONAL LIBRARY has 32 pages—with illustrations varying from 80 to 68 in number. Each title volume contains over 15,000 words. Positively radio's greatest book buy! If you do not think these books worth the price asked, return them in 24 hours and your money will be instantly refunded.

Win \$10

by suggesting a title for a new Gernsback book! Each of the above books gives full details.

PRIZE WINNERS

- ALFRED CETTIE, Seattle, Wash. Title: ALL ABOUT AERIALS. Book 4
- REDDY RUIZICKA, St. Louis, Mo. Title: BEGINNERS' RADIO DICTIONARY. Book 5
- KENNETH WARNER, Burbank, Cal. Title: HOW TO READ RADIO DIAGRAMS. Book 7
- CLYDE SORRELL, Rockyford, Colo. Title: RADIO FOR BEGINNERS. Book 8

RADIO PUBLICATIONS • 20 VESEY STREET • NEW YORK, N. Y.

RADIO PUBLICATIONS, Dept. RC-9-41
20 VESEY STREET, NEW YORK, N. Y.

Gentlemen: Please send immediately, POSTPAID, the book numbers circled below. I am enclosing cents—each book being 10c.

Send FREE listing of 48 new 10c publications.

Name Address

City State

Remit by check or money order—register letter if you send cash or unused U. S. postage stamps.

MAIL COUPON TODAY!

- MEISSNER MANUFACTURING CO., Mt. Carmel, Ill. AV, FV
- *MOTOROLA—Galvin Manufacturing Corp.
- *KNIGHT—Allied Radio Corp.
- OAK MANUFACTURING CO., 1260 Clybourn Ave., Chicago, Ill.—AV, FV
- OFFENBACH ELECTRIC CO., 1452 Market St., San Francisco, Calif.—AV, FV
- PHILCO RADIO & TELEVISION CORP., Tioga & "C" Sts., Phila., Pa.—AV, FV
- RADIO ELECTRIC SERVICE CO., INC., N. W. Cor. 7th & Arch Sts., Phila., Pa.—AV, FV
- RADIO EQUIPMENT CORP., 326 Elm St., Buffalo, N. Y.—AV, FV
- RADOLEK COMPANY, 60 W. Randolph St., Chicago, Ill.—AV, FV
- MAURICE SCHWARTZ & SON, 710-712 Broadway, Schenectady, N. Y.—AV, FV
- SEATTLE RADIO SUPPLY CO., INC., 2117 2nd Ave., Seattle, Wash.—AV, FV
- SETCHELL CARLSON, INC., 2233 University Ave., St. Paul, Minn.—AV, FV
- SHELLEY RADIO CO., 1841 S. Flower St., Los Angeles, Calif.—AV
- SUN RADIO CO., 212 Fulton St., New York, N. Y.—AV, FV
- THE TURNER COMPANY, 909 17th St., Cedar Rapids, Iowa. "Turner"—AV, FV
- *TURNER—The Turner Company
- UTAH RADIO PRODUCTS CO., 812 Orleans St., Chicago, Ill.—AV, FV
- JAMES VIBRAPOWR CO., INC., 341 N. Crawford Ave., Chicago, Ill.—AV, FV
- VICTOR ANIMATOGRAPH CORP., Davenport, Iowa

WIRE

- Antenna (receiving) A
- Antenna (transmitting) AN
- Antenna, Transmission (receiving) AR
- Antenna, Transmission (transmitting) AT
- Coaxial (concentric) cable C
- Conduit CO
- Cords (attachment) CA
- Flat woven cable FC
- Guy GU
- Headphone cords (tinsel) H
- Hookup HO
- Insulated cable (multi-conductor) I
- Litzendraht ("Litz.") LW
- Magnet MA
- Microphone cable MI
- Radio harness R
- Resistance RE
- Resistance cords RS
- Shielded SH
- Shielded ignition SN
- Wire shielding W

- THE ACME WIRE CO., 1255 Dixwell Ave., New Haven, Conn.—LW, MA
- ACORN INSULATED WIRE CO., INC., 225 King St., Brooklyn, N. Y.—AR, HO, I, SH
- *AIRLINE—Montgomery Ward & Co., Inc.
- ALDEN PRODUCTS CO., 715 Center St., Brockton, Mass.—FC, H, HO, I, MI, SH, SN, W
- ALLIED RADIO CORP., 833 W. Jackson Blvd., Chicago, Ill. "Knight"—A, AN, AR, AT, C, CA, FC, GU, HO, I, LW, MA, MI, RE, RS, SH, SN, W
- ALPHA WIRE CORP., 50 Howard St., New York, N. Y.—A, AN, AR, AT, C, CA, FC, GU, HO, I, LW, MA, MI, R, RS, SH, SN, W
- AMERICAN PHENOLIC CORP., 1250 W. Van Buren St., Chicago, Ill.—AR, AT, C, CO, SH
- VICTOR J. ANDREW CO., 6429 S. Laverne Ave., Chicago, Ill.—C
- *ANTENEX—M. M. Fleron & Son, Inc.
- ATLAS SOUND CORP., 1451 39th St., Brooklyn, N. Y.—MI, SH
- BANK'S MANUFACTURING CO., 5019 N. Winthrop Ave., Chicago, Ill.—C, HO, MI, SH
- BELDEN MANUFACTURING CO., 4647 W. Van Buren St., Chicago, Ill.—A, AN, AR, AT, C, CA, FC, HO, I, LW, MA, MI, R, RS, SH, SN, W
- *BIRNBACH—Birnbach Radio Co., Inc.
- BIRNBACH RADIO CO., INC., 145 Hudson St., New York, N. Y. "Birnbach"—A, AN, AR, AT, CA, FC, GU, HO, I, MA, MI, R, RS, SH, SN, W
- L. S. BRACH MFG. CORP., 55 Dickerson St., Newark, N. J.—A, AN, AR, AT
- BUD RADIO, INC., 5205 Cedar Ave., Cleveland, Ohio—MA
- CANADIAN MARCONI CO., 211 St. Sacramento St., Montreal, Can.—A, AN, AR, AT, C
- CANADIAN RADIO CORP., LTD., 622 Fleet St., W., Toronto, Ont., Can.—A, AR, HO
- CONSOLIDATED WIRE & ASSOCIATED CORP., 512 S. Peoria St., Chicago, Ill.—A, AN, AR, AT, C, CA, FC, HO, I, LW, MA, MI, R, RE, RS, SH, SN, W
- CORNISH WIRE CO., INC., 15 Park Row, New York, N. Y.—A, AN, AR, AT, C
- CRUMPACKER DISTRIB. CORP., 1801 Fannin St., Houston, Tex.—A, AR, CA, HO, I, MA, MI, RE, RS, SH, SN, W
- HAROLD DAVIS, INC., 428 W. Capitol St., Jackson, Miss.—HO, I, LW, R, RE, RS, SH, SN, W

DOW RADIO SUPPLY CO., 1759 E. Colorado St., Pasadena, Calif.—A, AN, AR, AT, C, CA, HO, I, MA, MI, RE, RS, SH, SN, W
 DRIVER-HARRIS CO., Harrison, N. J.—RE
 EAGLE ELECTRIC MFG. CO., INC., 59 Hall St., Brooklyn, N. Y.—CA
 THE ELECTRIC AUTO-LITE CO., WIRE DIV., Port Huron, Mich.—A, AN, AR, AT, CA, HO, MA, R, SH, SN, W
 ESSEX WIRE CORP., 14310 Woodward Ave., Detroit, Mich.—A, CA, FC, HO, I, LW, MA, MI, R, RS, SH, SN, W
 FEDERATED PURCHASER, INC., 80 Park Pl., New York, N. Y.—A, AN, AR, AT, CA, FC, GU, HO, I, LW, MA, MI, R, RE, RS, SH, SN, W
 FISCHER DISTRIB. CORP., 222 Fulton St., New York, N. Y.—A, AN, AR, AT, C, CA, FC, GU, HO, I, LW, MA, MI, R, RE, RS, SH, SN, W
 *FLERON—M. M. Fleron & Son, Inc.
 M. M. FLERON & SON, INC., 113 N. Broad St., Trenton, N. J., "Antennex," "Fleron," "Safest," "Signaler"—A
 GENERAL CEMENT MFG. CO., Rockford, Ill.—CA, HO
 GENERAL ELECTRIC CO., Schenectady, N. Y. & Bridgeport, Conn.—AN, AT, C, CA, I, MA
 GENERAL INSULATED WIRE CO., 53 Park Pl., New York, N. Y.—C, CA, HO, I, MI, SH, SN
 THE JAMES GOLDMARK WIRE CO., 116 West St., New York, N. Y.—FC, LW, MA, RE, W
 EDWIN I. GUTHMAN & CO., INC., 400 S. Peoria St., Chicago, Ill.—LW, MA
 HARRISON RADIO CO., 12 W. Broadway, New York, N. Y.—A, AN, AR, AT, C, CA, FC, GU, HO, I, LW, MA, MI, RS, SH, SN, W
 HOLYOKE WIRE & CABLE CORP., 720 Main St., Holyoke, Mass.—A, CA, HO, I, R, RE, RS, SH, W
 HOPE WEBBING CO., P. O. Box 1495, Providence, R. I.—A, AR, FC
 HERBERT H. HORN, 1201 S. Olive St., Los Angeles, Calif.—A, CA, HO, I, MI, W
 HOSKINS MANUFACTURING CO., 4445 Lawton Ave., Detroit, Mich.—RE
 INSULINE CORP. OF AMERICA, 30-30 Northern Blvd., Long Island City, N. Y.—A, AR, C, CA, RE, RS, SH
 E. F. JOHNSON COMPANY, Waseca, Minn.—AN, AR, AT, C, I
 KELLOGG SWITCHBOARD & SUPPLY CO., 6650 S. Cicero Ave., Chicago, Ill.—GU, HO, I, MA, MI
 *KNIGHT—Allied Radio Corp.
 LAFAYETTE RADIO CORP., 100 6th Ave., New York, N. Y.—A, AN, AR, AT, C, CA, FC, GU, HO, I, LW, MA, MI, RE, RS, SH, SN, W
 FRED M. LINK, 125 W. 17th St., New York, N. Y.—C
 LOWELL INSULATED WIRE CO., 171 Lincoln St., Lowell, Mass.—A, AN, AR, AT, CA, H, HO, I
 T. R. McELROY, 100 Brookline Ave., Boston, Mass.—CA
 M. & H. SPORTING GOODS CO., 512 Market St., Phila., Pa.—A, AN, AR, AT, C, CA, FC, GU, HO, I, LW, MA, MI, RE, SH, SN, W
 MEISSNER MANUFACTURING CO., Mt. Carmel, Ill.—LW, MA
 MONTGOMERY WARD & CO., INC., 619 W. Chicago Ave., Chicago, Ill., "Airline"—A, AN, AR, AT, C, HO, I, MA, MI, SH, W
 NEW ENGLAND ELECTRICAL WORKS, Lisbon, N. H.—LW, MA, W
 NORTHERN ELECTRIC CO., LTD., 1261 Shearer St., Montreal, Que., Can.—A, AN, AR, AT, C, CA, FC, GU, HO, I, MA, MI, R, RE, SH
 OFFENBACH ELECTRIC CO., 1452 Market St., San Francisco, Calif.—A, AN, AR, AT, C, CA, FC, GU, HO, I, LW, MA, MI, RE, RS, SH, SN, W
 OLSON MANUFACTURING CO., 362 Wooster Ave., Akron, Ohio—RS
 PHILCO RADIO & TELEVISION CORP., Tioga & "C" Sts., Phila., Pa.—A, CA, HO, I, MI, SH
 RADIO ELECTRIC SERVICE CO., INC., N. W. Cor. 7th & Arch Sts., Phila., Pa.—A, AN, AR, AT, C, CA, FC, GU, HO, I, LW, MA, MI, R, RE, RS, SH, SN, W
 RADIO EQUIPMENT CORP., 326 Elm St., Buffalo, N. Y.—A, AN, AR, AT, FC, GU, HO, I, MA, MI, RS, SH, SN, W
 RADIO RECEPTOR CO., INC., 251 W. 19th St., New York, N. Y.—AR, AT, C
 RADOLEK COMPANY, 601 W. Randolph St., Chicago, Ill.—A, AN, AR, AT, C, CA, FC, HO, I, LW, MA, MI, RE, RS, SH, SN, W
 R.B.M. MANUFACTURING CO., DIV. ESSEX WIRE CORP., Hanna & Chestnut Sts., Logansport, Ind.—CA, HO, I, LW, MA, R, SH, SN
 REA MAGNET WIRE CO., INC., E. Pontiac St., Extended, Fort Wayne, Ind.—MA
 THE RIVERSIDE METAL CO., Pavilion Ave., Riverside, N. J.—RE (18% & 30% Nickel Silver)
 JOHN A. ROEBLING'S SONS CO., 640 S. Broad St., Trenton, N. J.—A, AN, C, FC, GU, HO, I, MA, MI, SH, SN, W
 RUPP'S ASSEMBLING & MFG. WORKS, 2341 Seminary Ave., Chicago, Ill.—CA
 *SAFEST—M. M. Fleron & Son, Inc.
 MAURICE SCHWARTZ & SON, 710-712 Broadway, Schenectady, N. Y.—A, AN, AR, AT, C, CA, FC, GU, HO, I, LW, MA, MI, R, RE, RS, SH, SN, W
 SEATTLE RADIO SUPPLY CO., INC., 2117 2nd Ave., Seattle, Wash.—A, AN, AR, AT, C, GU, HO, I, LW, MA, MI, R, RE, SH, SN, W
 SELECTAR MANUFACTURING CORP., 30 W. 15th St., New York, N. Y.—MI
 SHELLEY RADIO CO., 1841 S. Flower St., Los Angeles, Calif.—A, CA, HO, I, MI, SH, SN
 *SIGNALER—M. M. Fleron & Son

CORDLESS SOLDERING IRON

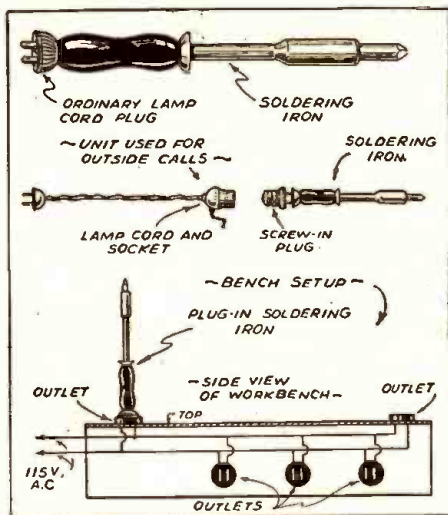

● I AM sending you a kink for the Radio Kinks department which I find very handy for the shop and also for calls, as it does away with that kinky cord in the shop and makes use of it on calls. You will find the drawing self-explanatory.

WM. A. BEASLEY,
Red Boiling Springs, Tenn.

CAPACITY PRODS

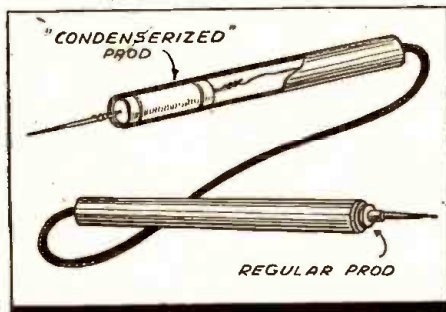

● WHEN my receiver analyses indicate the probability of condenser failure, I use the prod assembly here illustrated. Both prods were made by fitting bushings in one end of each of 2 tubes and fitting tips, of No. 14 copper wire, in the other ends. One of the prods, however, contains a fixed condenser of 0.01-mf. capacity and 500 W.V. rating. The usual capacity test technique of connecting the (prod) condenser across suspected components is followed, an open or intermittent condenser immediately being indicated (by the radio set starting to function properly) when the prod condenser is connected in shunt.

JOSEPH SERRET,
New York City.

PHONO NOISE FILTER

● I WOULD suggest that some of your readers try the circuit shown here. The usual approach to the solution of noise

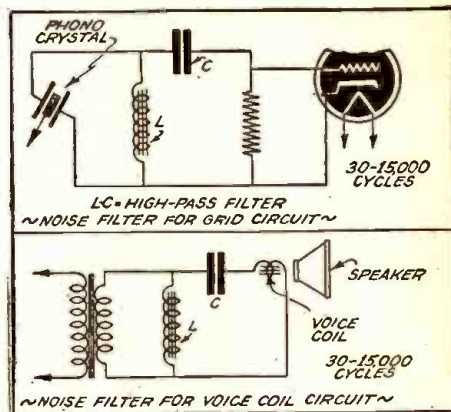

generated by the phonograph pickup resolves itself into slicing-off the high audio frequencies. In practice this means of reducing noise seems to work out fairly well, but the evidence is not that the noise is in the high frequencies but that it is greater in amplitude than the high-frequency sounds, while the low-frequency sounds mask it out. This would offer the conclusion that deliberate over-emphasis of the high notes would mask the noise. That would cause audio distortion to the extent that high-pitched sounds would be disagreeably strong.

Observing the needle scratch on an oscilloscope, I came to the conclusion that the noise is a sound of only 1-cycle frequency, and that if a high-pass filter were inserted between the crystal pickup and the amplifier the noise would be cut down. Also, static surges in a receiver should similarly be cut down if the response is limited to frequencies above 30 cycles. Inductance L should be 30 henries and have as low a distributed capacity as possible. Condenser C should have a capacity of 0.01-microfarad. These values are for the grid circuit. For the voice coil, C should be 6 mf.; the choke should be 30 henries.

WILLARD MOODY,
New York, N. Y.

MORE POWER FROM YOUR POWER SUPPLY

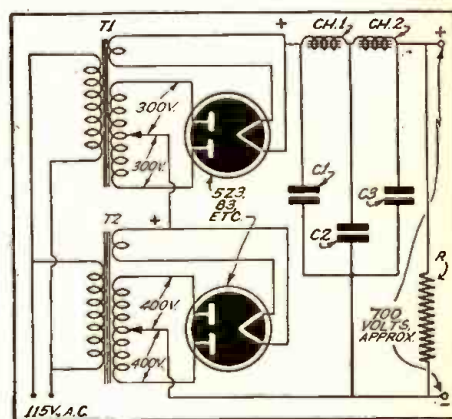

● THE circuit shown here illustrates an idea of increasing the output of your power supply with 2 transformers of different A.C. output. If a transformer has to be bought this idea will present no advantages. If however, one has 2 transformers available it will be found useful. The idea is founded on the use of separate rectification and a common filter. The voltage values are used only as an example. If the 2 transformers have equal A.C. output, a common rectifier tube can be used.

J. H. DOBLE ("Jim" VE3ACC),
Ashburn, Ont., Canada.

• BOOK REVIEWS •

GEOPHYSICAL PROSPECTING PRINTS (TREASURE FINDERS)



50c EACH

BLUE PRINTS and INSTRUCTIONS For Building the Following Treasure Finders and Prospecting Outfits

- Folder No. 1. The "Radiolector Pilot"—consists of a 2-tube transmitter and 3-tube receiver. Principle: radiated Wave from transmitter loop is reflected back to receiver loop. Emits visual and aural signals.
- Folder No. 2. The "Harmonic Frequency Locator"—Transmitter radiates low frequency wave to receiver, tuned to one of Harmonics of transmitter. Using regenerative circuit. Emits aural signals.
- Folder No. 3. The "Beat-Note Indicator"—Two oscillators so adjusted as to produce beatnote. Emits visual and aural signals.
- Folder No. 4. The "Radio-Balance Surveyor"—a modulated transmitter and very sensitive loop receiver. Principle: Balanced loop. Emits visual and aural signals. By triangulation depth of objects in ground can be established.
- Folder No. 5. The "Variable Inductance Monitor"—a single tube oscillator generating fixed modulated signals and receiver employing two stages R.F. amplification. Works on the inductance principle. Emits aural signals.
- Folder No. 6. The "Hughes Inductance-Balance Explorer"—a single tube Hartley oscillator transmitter and sensitive 3-tube receiver. Principle: Wheatstone bridge. Emits aural signals.
- Folder No. 7. The "Radiodyne Prospector"—a completely shielded instrument. Principle: Balanced loop. Transmitter, receiver and batteries enclosed in steel box. Very large field of radiation and depth of penetration. Emits aural signals.

With any one of the modern geophysical methods described in the Blue-Print patterns, radio outfits and instruments can be constructed to locate metal and ore deposits (prospecting); finding lost or buried treasures; metal war relics; sea and land mines and "duds"; mineral deposits; subterranean water veins; oil deposits (under certain circumstances); buried gas and water pipes; tools or other metallic objects sunken in water, etc., etc.

Each set of blueprints and instructions enclosed in heavy envelope (9 1/2" x 12 1/2"). Blueprints 22" x 34"; eight-page illustrated 8 1/2" x 11" fold. 50c or of instructions and construction data. Add 5c for postage

The complete set of seven folders \$3.00
Shipping weight 2 lbs. (add 25c for shipping anywhere in U.S.A.)

TECHNIFAX

RC-941

1917 S. STATE ST. CHICAGO, ILL.

TECHNIFAX 1917 So. State, Chicago, Ill.

Enclosed herewith \$..... for which mail to address below:

- Treasure Finder No. 1, 2, 3, 4, 5, 6, 7.
- Complete set of seven folders.

NAME

ADDRESS

CITY STATE

RC-941

RADIO ENGINEERING HANDBOOK, 3rd Edition, by Keith Henney (1941). Published by McGraw-Hill Book Company. Size 4 1/2 x 7 3/16 ins., leatherette covers, 945 pages. Price \$5.

The justly popular reception this "essential" reference book for the professional radio man has received in earlier editions will be accentuated with the publication of this book in its 3rd Edition.

"Radio Engineering Handbook" saves time, trouble and money, by presenting charts, tables, circuits, diagrams and formulas covering the most needed subjects for engineers and technicians from fundamental to specialized applications. Note that every section is prepared by one or more specialists and embraces a great deal of consistently-needed reference material covering all fields and aspects of radio engineering.

The new material which makes this 3rd Edition especially valuable includes the following: data on crystal-control circuits, ultra-high frequency apparatus, modulation systems, audio frequency transformer design, vibrator power supplies, long-line oscillators, etc.; completely rewritten sections on aircraft radio, television, detection, loudspeakers, facsimile, oscillators, etc.; and, revision throughout to make the book as useful as possible in modern practice.

RADIO ANNUAL—1941 (RADIO DAILY). Published by John W. Alicoate. Size 6 x 9 1/4 ins., white leather-grain covers, 1,024 pages. Subscription premium of *Radio Daily*.

This trade directory of the broadcast industry contains reference listings for every branch of the business including stations of Canada and the United States, station representatives, radio advertising agencies, radio research firms, radio production firms, radio publications, organizations dealing in radio matters—Federal Communications Commission, National Association of Broadcasters, etc.

In addition to these listings, "Radio Annual" presents articles by leaders in every branch of the industry which review the current year and predict the trends of the forthcoming 12 months.

The volume follows no set format but generally is laid out in the following manner: (1) Articles by leading authorities; (2) The business side of radio advertising agencies and networks; (3) F.C.C. and N.A.B. sections; (4) U.S. Census Data Section (1941 volume); (5) National and regional networks; (6) Stations (Canada and U.S.); (7) Production side; (8) Talent listing; (9) Program listing for the year; (10) Promotion; (11) Television and facsimile; (12) Cultural side; (13) Foreign stations.

RUBBER AND ITS USES, by Harry L. Fisher (1941). Published by Chemical Publishing Company. Size 5 x 8 1/4 ins., cloth covers, 128 pages. Price \$2.25.

This book, by the Director of Organic Research, U. S. Industrial Chemicals, Inc., and Air Reduction Co., and formerly Research Chemist, The B. F. Goodrich Co., and United States Rubber Co., is based upon the experience of the author gained during 17 years as a research chemist. It discusses the details of rubber from its history and source to its manufacture and use. Synthetic rubber also is given a place in this book. With the present exceptional importance of natural and synthetic rubber, both hard and soft, in all the fields of radio, this compilation of basic information holds interest for advanced technicians. Note, however, that the electrical characteristics of rubber receive little treatment.

YOUR CAREER IN RADIO, by Norman V. Carlisle and Conrad C. Rice (1941). Published by E. P. Dutton & Co., Inc. Size 5 1/2 x 8 1/4 ins., cloth covers, 189 pages. Price \$2.

Every so often a book makes its appearance, which has for its avowed purpose the education of laymen who may anticipate making radio their livelihood. "Your Career in Radio" follows this general pattern, but authors Carlisle and Rice have their own way of making palatable to young folks of grammar and high school age the modus operandi mainly of broadcasting, television and Frequency Modulation, and the opportunities for employment presented in these fields. The story is built around the travels of 3 school boys on a tour of a large broadcast station. The things they see and things they learn make interesting reading for almost anyone.

Index to advertisers

PUBLISHERS

Audel, Publishers.....	135
Data Print Co.....	152
National Plans Inst.....	150
Radcraft Publications, Inc., 136, 160, 161, 174	
Radio & Technical Pub. Co.....	152
Radio Publications.....	190
Technifax.....	133, 192

RADIO PARTS

Amperite Co.....	153
Hammarlund Mfg. Co.....	153
International Resistance Co.....	151
Meissner Mfg. Company.....	150
Solar Mfg. Corp.....	150

RADIO RESEARCH

RCA Laboratories.....	Inside Back Cover
-----------------------	-------------------

RADIO SETS

Hallicrafters Co.....	Back Cover
Harrison Radio Co.....	Inside Front Cover
Michigan Radio Products.....	169
Midwest Radio Corporation.....	171

RADIO SUPPLY HOUSES

Allied Radio Corp.....	163
Burstein-Applebee Co.....	165
Radolek Co.....	163

SCHOOLS

Capitol Radio Eng. Inst.....	135
Commercial Radio Institute.....	135
Coyne Radio School.....	131
Lincoln Engineering School.....	133
National Radio Institute.....	129
National Schools.....	135
New York Y.M.C.A. Schools.....	135
Port Arthur College.....	133
Radio Training Assoc.....	135
RCA Institutes.....	131
Sprayberry Academy of Radio.....	131

SOUND & RECORDING EQUIPMENT

Amplifier Co. of America.....	165
John Meck Industries.....	165
Universal Microphone Co., Ltd.....	165
University Laboratories.....	165

TEST EQUIPMENT

National Union Radio Corp.....	143
Readrite Meter Works.....	174
Supreme Instruments Corp.....	171
Triplett Electrical Instruments Co.....	153

TUBES

Hygrade Sylvania Corp.....	147
----------------------------	-----

MISCELLANEOUS

Classified Section.....	177
Flight Magazine.....	162
Henry Hudson Hotel.....	162
Lancaster, Allwine & Rommel.....	177
Laughlin Mfg. Co.....	169
Remington Rand, Inc.....	187
Woodstock Typewriter Co.....	177

(While every precaution is taken to insure accuracy, we cannot guarantee against the possibility of an occasional change or omission in the preparation of this index.)

RCA's sudden success with its experiments for transmitting radiophotos from Moscow surprised the chief photo agencies. Believing radio transmission impossible, they had been rushing elaborate plans for getting pictures by plane.
 —Newsweek, July 21



RADIOPHOTOS HURLED ACROSS THE WORLD!

BUT it would have taken a plane traveling 21,300 miles an hour to match radio's speed of delivery! It takes only 13 minutes for a complete picture to flash across the 4,615-mile curve that has made an invisible picture chute of the Great Circle Route between Russia and New York. It bends over the spinning world across Finland, Sweden, Norway, Iceland, Labrador and on to the United States.

As a result, American newspaper readers have been looking at war photographs soon after they were snapped on the eastern battle fronts. The newspaper credit lines have read, "RCA test transmission radiophoto." The pictures dated July 8 were the first America ever saw from Moscow by radio.

During the first World War there were weeks of delay before Americans saw pictures from the Russian sector. The radiophoto was but a dream of scientists. But they became master of the dream and in 1941, when Russia was ready to put pictures in the air, American apparatus developed by RCA Laboratories was ready on this side of the sea to receive them.

The Russian pictures enter the United States at the antennas of R.C.A. Communications, Inc., at "Radio Central," River-

head, Long Island. Automatically the impulses are relayed to the radiophoto machines at R.C.A. Communications' headquarters, 66 Broad Street, New York. That is the terminal of the 4,615-mile chute through space.

How is it done? In Russia the picture is wrapped on a cylinder, which as it revolves enables a pinpoint of light to release the lights and shadows of the picture to actuate a short-wave radio transmitter. The radio impulses, therefore, correspond to the shadings of the picture. In New York a similar cylinder is turning, and around it is wrapped a sensitized paper or "negative." It revolves in step with the Russian cylinder and as it does another needle of light, controlled by the incoming picture-carrying impulses, acts as a pen. It reconstructs or "paints" the picture line by line.

New York is the world-center of radiophoto reception, with the picture circuits now extending to London, Berlin, Tokyo, Buenos Aires and Moscow. It is RCA Laboratories apparatus at the headquarters of R.C.A. Communications, Inc., on the tip of Manhattan Island, that puts the pictures back on paper after they are etched electrically in space between the hemispheres.



RCA LABORATORIES

A Service of the Radio Corporation of America

The Services of RCA: • RCA Manufacturing Co., Inc. • Radiomarine Corporation of America • National Broadcasting Co., Inc. • R.C.A. Communications, Inc. • RCA Institutes, Inc.



ONCE again Hallicrafters lead the amateur communications field with quality and performance in one of the greatest values ever offered. The New 1941 15-Tube Super Sky-rider, "the best selling quality communications receiver," gives you *all* the features, even the ones usually found on higher priced receivers, including electrical band-spread over entire range of the receiver.

Check these points: Rigid girder construction chassis, 15 tubes — 6 Bands—Frequency range 550 kc. to 43 mc.—Large, calibrated main dial—Band-spread dial calibrated for the

10, 20, 40, 80 meter amateur bands also on the International short wave Broadcast Channels—Tone Control—Send-Receive Switch—ANL Switch—RF Gain Switch—AVC-BFO Switch—2 stages preselection — Improved adjustable noise limiter—Beat Frequency Oscillator — antenna trimmer —AF Gain switch—6 position selectivity control—Bass boost switch—Wide Angle "S" meter — Band pass audio filter — Phone jack! Cabinet dimensions: 20½" x 14½" x 9½" — Complete with crystal and tubes. (Hallicrafters - Jensen Bass Reflex Speakers Available.)

THE BEST SELLING *Quality* **RECEIVER**

the hallicrafters inc.
CHICAGO, U. S. A.

USED BY 33 GOVERNMENTS
SOLD IN 89 COUNTRIES