

RADIO-CRAFT

HUGO GERNSBACK, Editor

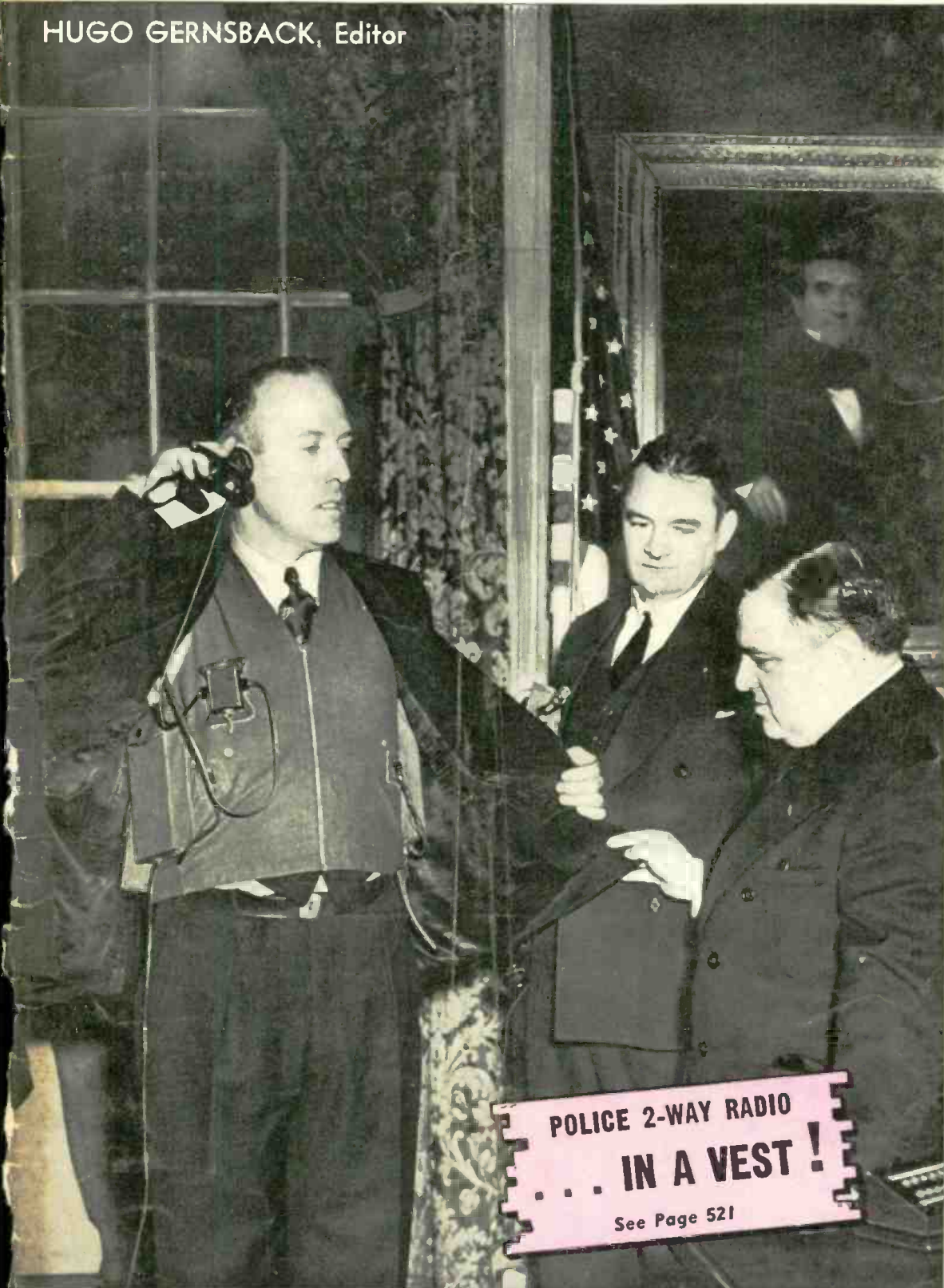

**POLICE 2-WAY RADIO
... IN A VEST !
See Page 521**



ACOUSTICS CONTROL



BONE "HEARING" TEST



"ACCELETRON"



SONOVOX

MARCH

25c

CANADA 30c

1941

RADIO'S GREATEST MAGAZINE

F.M. ADVANCES • V.-T. OSCILLATORS • FIXING FLUORESCENT LIGHTS

V.-T. VOLTMETERS • NEW UTILITY TESTER • HOME RECORDING HINTS

Sensation

OF THE INDUSTRY!..



and, so far, we've hardly even mentioned its **GREATER METER PROTECTION!**



Is this your D-C Voltmeter?

Not only is the RCA Junior Volt-Ohmyst one of the handiest, most versatile and amazingly efficient instruments on the market today... Not only does it pave the way for faster, more accurate resistance and both a-c and d-c voltage readings... Equally important, special protective features remove much of the danger of a costly meter burnout should you grab hold of more voltage than you had expected or accidentally check a "hot" resistor. Extremely rugged meter construction also guards against mechanical damage. This means that, besides giving you more for your money in the first place, this sensational little instrument *protects your investment*. What's more, the Junior VoltOhmyst will quickly pay for itself in the time it saves on a wide variety of jobs.

A LONG-TIME INVESTMENT IN BETTER, FASTER WORK

The RCA Junior VoltOhmyst is a "junior" in price alone. In actual use it is an instrument that does a man's-size job *plus*. Costing only a little more than you'd pay for an ordinary volt-ohmmeter, it gives you Electronic Push-Pull operation with all the time- and trouble-saving features of the famous Rider VoltOhmyst circuits and with the addition of an isolated A-C Rectifier-type Voltmeter with 1000 ohms per volt sensitivity.

It measures d-c voltages with constant meter impedance of 11,000,000 ohms on all ranges. *This means a sensitivity up to 3,666,666 ohms per volt!* Yet it is extremely stable! It will not disrupt operation of sensitive circuits.

It has six full scale voltage ranges from 3 to 1000 volts and measures resistances from 0.1 to 1,000,000,000 ohms! It eliminates time-taking shorting of leads and zero re-settings when changing ohmmeter scales. One wide-spread ohms scale assures extreme accuracy and easy readability. In brief, the RCA Junior VoltOhmyst provides you with a quick, accurate and easy-to-use means of checking every conceivable A.V.C., A.F.C., FM discriminator circuit, or Oscillator Grid Voltage, *with the signal present*, checking bias cells or insulation resistance, obtaining practically any needed resistance and d-c voltage reading... as well as handling any a-c voltage checking job that might pop up in your work—at an absolute minimum price.

See it at your nearest RCA distributors—or write for bulletin. It is an instrument that no wide-awake technician can afford to miss! Sooner or later, why not now?

RCA Junior
VOLTOHMYST

\$34.95

Net Price Complete. Stock No. 165

SOMETHING TO REMEMBER WHEN YOU BUY TEST EQUIPMENT

Although moderately priced, RCA Test Equipment is not built down "to a price." Instead, it is built up to a standard of efficiency—the highest in the field today. It is designed in the firm belief that the "cheapest" equipment any service technician can buy is the equipment which is quickest to pay for itself in the time it saves him, plus the extra jobs it permits him to handle. Moreover, RCA Test Equipment is built around the famous and pioneer Rider "Signal Tracing" system which replaces old-style, hit-or-miss service methods with a quick, systematic course of procedure. "Signal Tracing" has proved its tremendous value, not only to leading technicians, but to leading laboratories and manufacturing plants as well. It is your safest, surest road to faster, more accurate work with consequent greater profits—and the RCA-Rider Chanalyst, that originally made this system possible, is your "Open Sesame!" to its many benefits.

Not what you pay for your Test Equipment—but what your Test Equipment pays you. That's what really counts. And RCA's policy of "Minimized Obsolescence" protects your investment!



Test Equipment

YOUR KEY TO SYSTEMATIC
SERVICING FOR GREATER PROFITS

RCA MANUFACTURING CO., INC., CAMDEN, N. J. • A Service of The Radio Corporation of America. In Canada: RCA Victor Company Limited, Montreal

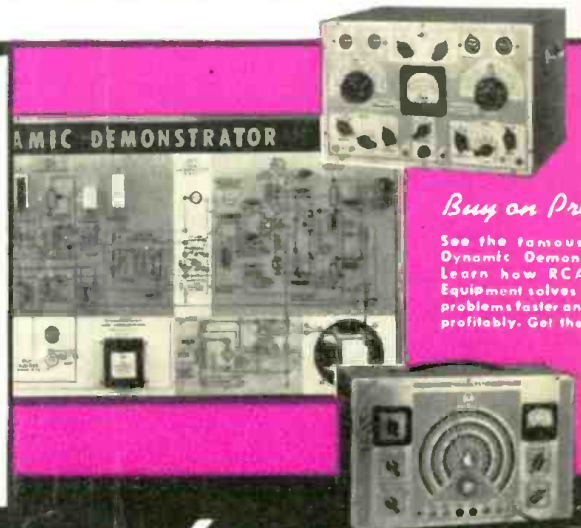

Buy on Proof!

See the famous RCA Dynamic Demonstrator. Learn how RCA Test Equipment solves service problems faster and more profitably. Get the facts!





Be a RADIO Technician

Many make \$30 \$40 \$50 a week

I will train you at home for many Good Spare Time and Full Time Radio Jobs

J. E. SMITH, President, National Radio Institute
Established 25 years
He has directed the training of more men for the Radio Industry than anyone else.



Set Servicing pays many Radio Technicians \$30, \$40, \$50 a week. Others hold their regular jobs and make \$5 to \$10 extra a week in spare time.

Broadcasting Stations employ operators, installation, maintenance men and Radio Technicians in other capacities and pay well.



Loudspeaker System building, installing, servicing and operating is another growing field for well trained Radio Technicians.

I Trained These Men



\$10 to \$20 a Week in Spare Time
I repaired some Radio sets when I was on my tenth lesson. I really don't see how you can give so much for such a small amount of money. I made \$600 in a year and a half, and I have made an average of \$10 to \$20 a week—just spare time.
JOHN JERRY, 1529 Arapahoe St., Denver, Colo.



Makes \$50 to \$60 a Week
"I am making between \$50 and \$60 a week after all expenses are paid, and I am getting all the Radio work I can take care of, thanks to N. E. I." **H. W. SPANGLER, 126 1/2 S. Gay St., Knoxville, Tenn.**



Operates Public Address System
"I have a position with the Los Angeles Civil Service, operating the Public Address System in the City Hall Council. My salary is \$170 a month." **R. H. HOOD, R. 136, City Hall, Los Angeles, Calif.**

Sample Lesson Free

I want to send you a sample lesson, "Broadcast, All-Wave Television Superheterodyne Receiver Principles." It covers the basic interferences in superhets and how they are rectified. It brings out the importance of the preselector, mixed first-detector, local oscillator, intermediate frequency I.F. amplifier, tracking, peak and band pass adjustments, band switching and modification for adapting to Television reception. All subjects covered with special emphasis on servicing. You can get this lesson FREE. Just mail the coupon.

Radio is a young, growing field with a future. It offers many good pay spare time and full time job opportunities. And you don't have to give up your present job, go away from home, or spend a lot of money to become a Radio Technician. I train you at home nights in your spare time.

Jobs Like These Go to Men Who Know Radio

Radio broadcasting stations employ Radio Technicians as operators, maintenance men and pay well for trained men. Radio manufacturers employ testers, inspectors, servicemen in good pay jobs with opportunities for advancement. Radio jobbers and dealers employ installation and servicemen. Many Radio Technicians open their own Radio sales and repair businesses and make \$30, \$40, \$50 a week. Others hold their regular jobs and make \$5 to \$10 a week fixing Radios in spare time. Automobile, police, aviation, commercial Radio, loudspeaker systems, electronic devices, are newer fields offering good opportunities to qualified men. And my Course includes Television, which promises to open many good jobs soon.

Why Many Radio Technicians Make \$30, \$40, \$50 a Week

Radio is already one of the country's large industries even though it is still young and growing. The arrival of Television, the use of Radio principles in industry, are but a few of many recent Radio developments. More than 28,000,000 homes have one or more Radios. There are more Radios than telephones. Every year millions of Radios go out of date and are replaced. Millions more need new tubes, repairs, etc. Over 5,000,000 auto Radios are in use and thousands more are being sold every day. In every branch Radio is offering more opportunities for which I give you the required knowledge of Radio at home in your spare time. Yes, the few hundred \$30, \$40, \$50 a week jobs of 20 years ago have grown to thousands.

Many Make \$5 to \$10 a Week Extra in Spare Time While Learning

The day you enroll, in addition to my regular Course, I start sending you Extra Money Job Sheets—start showing you how to do actual Radio repair jobs. Throughout your Course I send plans and directions which have helped many make \$5 to \$10 a week in spare time while learning. I send special Radio equipment; show you how to conduct experiments, build circuits. My Course includes Television, too.

You Get This Professional Servicing Instrument



This instrument makes practically any test you will be called upon to make in Radio service work on both spare time and full time jobs. It can be used on the test bench, or carried along when out on calls. It measures A.C. and D.C. voltages and currents; tests resistances; has a multi-band oscillator for aligning any set, old or new. You get this instrument to keep as part of your N. R. I. Course.

DRAFT REGISTRANTS

If you ARE called and are then a Radio Technician, you'll be eligible for a communications branch of the service; in line for technical ratings with extra pay. If you ARE NOT called, you now have an opportunity to get into Radio at a time when the Government is pouring millions of dollars into the Radio industry to buy Defense equipment, on top of boom civilian Radio business. Either way—it's smart to train for RADIO NOW!

Find Out How N. R. I. Teaches You Radio and Television— Mail Coupon

Act today. Mail coupon now for Sample Lesson and 64-page Book. They're FREE. They point out Radio's spare time and full time opportunities and those coming in Television; tell about my Course in Radio and Television; show more than 100 letters from men I trained, telling what they are doing and earning. Read my money back agreement. Find out what Radio offers you. Mail coupon in envelope or paste on penny postcard—NOW.

J. E. SMITH, President, Dept. 1CX, National Radio Institute Washington, D. C.



Good for Both 64 PAGE BOOK Free

J. E. SMITH, President, Dept. 1CX National Radio Institute, Washington, D. C.

Without obligating me, mail your Sample Lesson and 64-page Book FREE.

I am particularly interested in the branch of Radio checked below. (No salesman will call. Write plainly.)

- Radio Service Business of My Own
- Service Technician for Retail Stores
- Spare Time Radio Repair Work
- Broadcasting Station Operator
- Loudspeaker Systems, Installations and Service
- Auto Radio Installations and Service
- Television
- All-around Servicing Technician

(If you have not decided which branch you prefer—mail coupon now, for information to help you decide.)

Name Age

Address

City State 23FR2

RADIO-CRAFT

HUGO GERNSBACK, *Editor-in-Chief*

N. H. LESSEM
Associate Editor

THOS. D. PENTZ
Art Director

R. D. WASHBURN, *Managing Editor*

In the
NEXT ISSUE!

- Radio Interference from Electromedical Apparatus
- N.Y.A. Offers Radio Training to America's Youth
- Modernize Your Tester
- Signal-Tracing Amplifier
- F.M.-Receiver I.F. Channel Design

Contents MARCH, 1941 Issue

VOLUME XII -- NUMBER 9

Mailbag	515
Editorial: Utility Radios	Hugo Gernsback 519
The Radio Month in Review	520

SERVICING

New Circuits in Modern Radio Receivers—No. 42	F. L. Sprayberry 522
Operating Notes	523, 525
Fluorescent Lighting—Latest Sideline for Servicemen—Part II Radio Interference	John T. Bailey 524
RADIO SERVICE DATA SHEETS:	
No. 302—National Union Model W2	526
No. 303—Crosley "Glamour-Tone" Model 26BB (Chassis Model 26)	528

F.M.

Recent Improvements in F.M. Receiver Design	J. A. Worcester, Jr. 530
---------------------------------------------------	--------------------------

TEST INSTRUMENTS

A General Utility Tester for Servicing Electrical Appliances	Shepherd Litt 535
Vacuum-Tube Voltmeters—Theory and Practice	Willard Moody 537
Build Your Own Versatile Modern Multi-Tester	Milton Reiner 540

SOUND

Sound Engineering—No. 15	Conducted by A. C. Shaney 544
Home Recording—Theory and Practice of Sound-on-Disc	I. Queen 547
Modern Microphone Technique—Part II, The Microphone and Its Relation to the Amplifier	H. S. Manney 552
Independent Power Supplies Improve Audio Output	Joel Julie 555

ELECTRONICS

Vacuum-Tube Oscillators and How They Work	J. A. Dowie 557
-------------------------------------------------	-----------------

RADIO DEVELOPMENTS

The "Acceletron" Generates Energy of 2,300,000 Volts!	561
Robeson Technique of Acoustics Control	561

DEPARTMENTS, ETC.

Mailbag	515
The Radio Month in Review	520
New Circuits in Modern Radio Receivers—No. 42	F. L. Sprayberry 522
Operating Notes	523, 525
RADIO SERVICE DATA SHEETS:	
No. 302—National Union Model W2	526
No. 303—Crosley "Glamour-Tone" Model 26BB (Chassis Model 26)	528
Sound Engineering—No. 15	Conducted by A. C. Shaney 544
Latest Radio Apparatus	563
Classified Radio Directory—Section VI (Conclusion of 1st Edition)	569
Shop Notes—Kinks—Circuits	575
Book Reviews	525, 576

★

Published by Radcraft Publications, Inc. Publication office: 29 Worthington Street, Springfield, Mass. Editorial and Advertising Offices: 20 Vesey Street, New York City. Chicago Advertising Office: RADIO-CRAFT, 520 North Michigan Avenue, Chicago, Ill.

RADIO-CRAFT is published monthly, on the first of the month preceding that of date; subscription price is \$2.50 per year in U. S. (In foreign countries, 75c additional per year to cover postage; Canada, 50c additional.) Entered at the post office at Springfield as second-class matter under the act of March 3, 1879.

★

Foreign Agents:

London—Gorrings's American News Agency, 9A Green St., Leicester Square, W. C. 2, England.
Paris—Messageries Dawson, 4 Rue Faubourg, Poissonniere, France.
Melbourne—McGill's Agency, 179 Elizabeth St., Australia.
Dunedin—James Johnston, Ltd., New Zealand.

★

Text and illustrations of this magazine are copyright and must not be reproduced without permission of the copyright owners.

★

Copyright 1941 Radcraft Publications, Inc.

REGARDING HEARING-AIDS

Dear Editor:

I have just finished reading Earl Russell's presumptive and faintly amusing letter in the February issue of *Radio-Craft*. I feel that this calls for a reply, as some of your readers may take this gem of stupidity seriously.

As the old saying goes "Where ignorance is bliss, 'tis folly to be wise." However, it is more than folly and just plainly ridiculous, for the ignorant to assume the cloak of wisdom, as Mr. Russell does when he presumes to give advice to others on the subject of hearing-aids. A case, one might say, of the deaf leading the deaf (astray).

Mr. Russell "advises" the near-deaf that the hearing-aid amplifiers described by the writer and by Mr. A. C. Shaney do not have nearly enough volume to be of real service. Although Mr. Russell has been repairing radio sets for 20 years, it is evident that he has no conception of the difference between power amplification and voltage amplification.

In designing an amplifier for hearing-aid work, the object to be attained is voltage amplification. The minute voltages generated by the crystal must be amplified enormously so that high sensitivity will be obtained. Such a device is then suitable for the use of a hard-of-hearing person.

Of course, there are some people who are practically stone-deaf. Many of these people like to refer to themselves as "near-deaf." Presumably, Mr. Russell falls into this category. Such people have no use whatsoever for a sensitive hearing-aid. They turn on a 10-watt amplifier full blast, put their ear against the loudspeaker and complain that the outfit does not have nearly enough volume to be of any real service to them.

Such people need great power amplification. They require an amplifier capable of delivering large amounts of power to the translating device. In such amplifiers, the A.C. plate current of the last tube must be large so that sufficient power is delivered to actuate the speaker or earphone with plenty of volume.

Of course most nearly stone-deaf people (near-deaf) know very well that a power amplifier must be large. That's why Mr. Russell says "Hearing is the objective, not size. Too much emphasis has been put on size. Why?"

He then answers his own question by stating that the customer wants an 'aid that can be concealed. In the case of the nearly stone-deaf person, the hearing-aid cannot be concealed, but in the case of the average hard-of-hearing person, the hearing-aid can be concealed to a great extent and therefore it should be, especially as most persons so afflicted are extremely sensitive regarding their infirmity.

Mr. Russell's unwarranted attack upon the medical profession furnishes further evidence of his lack of knowledge. In his opinion, a man who has spent 20 years fixing radio sets is far better qualified as a hearing-aid specialist, than a man who studied 6 years at a university, specializing on the structure and troubles of the human ear and who spent years after graduation serving his fellow men to bring them better hearing.

Mr. Russell considers the carbon microphone far superior to the crystal mike. Of course, that is his privilege. He also thinks that the magnetic earphone is much better than the crystal earphone. As he so quaintly phrases it, "the crystal hasn't got it." I do not know exactly what he means by "it," but if he means that the crystal lacks sensitivity in comparison with the carbon mike or the

INFORMATION You've BEEN LOOKING FOR!
SERVICE MEN! RETAILERS! STUDENTS!

Get Started Now!

Full or Spare Time
... without leaving home

These Ghirardi
Books Will
Help You

—at unbelievably
low cost!



ALFRED A. GHIRARDI, the author of these books, is one of the foremost writers of practical radio texts and is an outstanding authority on radio instruction. His wide experience as a radio engineer, radio instructor, radio magazine editor and technical consultant to many prominent radio manufacturing firms and servicing organizations has built for him an unusually wide background of radio knowledge that is reflected in these three books. Every one of them is acclaimed as being outstandingly superior to anything in its field. They have earned for themselves an enviable reputation for thoroughness, and the ability to make every phase of the subject clear and easy to learn for even the merest beginner. That is why they are the favorites of radio beginners, servicemen and experts alike, and are used as the main texts in the basic radio theory and servicing courses of leading radio schools in every English-speaking country in the world. They have had to be "tops" to earn such honors!

MODERN Radio SERVICING

LEARN SERVICING
with This!

This inexpensive, big 1300-page book gives you the complete famous Ghirardi training course in practical radio service work. The only book in the world that teaches you everything you need to know right in your own home—easily, and in your spare time.

Theory from A to Z
• Test Equipment—First, a thorough 420-page course in Test Instruments—Theory, Descriptions, Diagrams of all Commercial Instruments. How they Work, Construction Data, etc.
• Trouble-Shooting—Next, all newest short-cut factory methods for Trouble-shooting and Testing all makes of radio sets (and electronic equipment)—explained clearly and step-by-step.

• Repairing—Then how to Align and Adjust receivers; how to Repair or Replace faulty parts. Advanced "Factory" Methods explained fully.
• Business Promotion—How to Manage, Promote and Advertise a radio service shop for greatest profits.

MODERN RADIO SERVICING brings you an illustrated gold mine of servicing knowledge—all based on practical servicing experience! 720 Self-Examination Review Questions check every step of your study progress. Order yours now—costs you only \$4 to learn radio service work THIS EASY way! Money back if not satisfied after 5-Day Trial.



1300 PAGES \$4
708 ILLUS.
720 REVIEW
QUESTIONS

RADIO PHYSICS COURSE

LEARN FUNDAMENTALS
with This!

Here in one inexpensive volume is a complete Radio Education for you—all the Basic Fundamentals clearly explained and illustrated—right from elementary Electricity and Sound up through the entire field of Radio and Television—the equivalent of a 36-Book Radio Course all condensed into 1 big volume.

YOU LEARN AT HOME!

Ghirardi will train you quickly—right in your own easy chair at home. His explanations are crystal-clear, interesting, easy to understand. And because it's so easy to learn Radio from it, the U. S. Army and Navy and radio schools everywhere use this very same book in their radio training course. No math—no previous training is necessary. Here's a \$50.00 course that you get complete for only \$4. Order your copy NOW—money back if not satisfied.

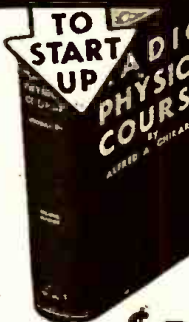

972 PAGES \$4
508 ILLUS.
856 REVIEW
QUESTIONS

RADIO Trouble-Shooter's HANDBOOK

SAVE SERVICING
TIME with This!

Time is Money... Save It! Regardless of what radio set you are called upon to repair, this new "Ghirardi" Handbook is guaranteed to save you Time. Check full of factory-checked "bench data" that will speed up every service job you do. That means More Money for you!

518 BIG 8 1/2x11 PAGES—134 ILLUS., DRAWINGS, CHARTS, TABLES—Give Vital Information on:

Time-Saving Trouble Case Histories for 3,313 receivers compiled from actual service records—177 Tests for 15,000 Superhets—Trouble-Shooting Charts—Auto Radio Gear Ratios—Auto Radio Installation, Servicing, Interference Suppression Charts—Servicing Sound Recorders and Intercommunicators—Condenser & Resistor Charts—Grid Bias Resistors—Color Codes—Wire Tables—Coils—Transformers—Formulas—Calculations—Decibel Charts—Tube Charts—Dist Lamps—Ballast Resistors—Filters. Used by thousands of service shops. Order yours now! Money back if not satisfied!



518 PAGES
134 ILLUS.
MANUAL SIZE

Books Shipped Postpaid Anywhere

USE THEM 5 DAYS

Send for any or all of these books today. Keep them 5 days to look over at your leisure. Then if not fully satisfied, return them in good condition and we will refund your full purchase price immediately. You can't lose.

FREE CIRCULARS

Send for FREE, descriptive, illustrated circulars SPECIAL MONEY-SAVING \$6.50 FOR BOTH SERVICING BOOKS—IF COMBINATION OFFER PURCHASED TOGETHER

ORDER NOW before prices GO UP!

RADIO & TECHNICAL PUBL. CO.
45 Astor Pl., New York, Dept. RC-31
Enclosed find payment for, and rush to me postpaid with your 5-Day Money-Back Guarantee:
 No. 1—MODERN RADIO SERVICING at \$4. (\$4.50 foreign).
 No. 2—RADIO TROUBLE-SHOOTER'S HANDBOOK at \$3. (\$3.50 foreign).
 BOTH SERVICING BOOKS at \$6.50 Special Money-Saving Combination Price (\$7 foreign).
 No. 3—RADIO PHYSICS COURSE at \$4. (\$4.50 foreign).

LES A. HENRY
Correspondence Courses in
RADIO and ELECTRICAL ENGINEERING
ELECTRICAL ENGINEERING Get good grasp of electrical field. Prepare yourself, at Low Cost, for secure future. Modern, simplified, you can understand quickly.
RADIO ENGINEERING Extra fine course in radio, public address, photo-electric work. Trains you to be super-service man, real vacuum tube technician. Expert, kits furnished. Diploma on completion.
FREE Get copies of school catalogs, student magazines, complete details. SEND NOW!
LINCOLN ENGINEERING SCHOOL, Box 931-C27, LINCOLN NEBR.

It's Your Job Today
to prepare for a better radio job tomorrow!
Today's opportunities go to radiomen with TECHNICAL TRAINING. CREI advanced technical training has been tried and approved by more than 5000 radiomen. CREI will equip you with the ability to go after—and get—a better radio job. Free book gives details. Write today.
CAPITOL RADIO ENGINEERING INSTITUTE
Dept. RC-3 3224-16th St., N.W. Washington, D. C.

RADIO OPERATORS WANTED
The National Defense Program is creating innumerable openings for Commercial Radio Operators—Now is the time to capitalize on your radio training and experience by obtaining a Commercial Radio Operator's License and taking advantage of the many opportunities presented. My recent publication "RADIO OPERATOR'S LICENSE GUIDE" has been especially prepared as a Guide for those radio men having the necessary training and experience but who are unaware of the exact requirements for a Commercial Radio Operator's License—Containing over 1,250 questions and answers to the new type examinations, it will enable you to successfully pass the examinations.
Only \$3.00 Postpaid—Send check or Money Order.
WAYNE MILLER
205 West Wacker Drive
Chicago, Illinois



LEARN RADIO
SERVICING COURSE—8 WEEKS
OPERATING INCLUDES SERVICING—5 MONTHS

H. C. Lewis
I'LL FINANCE YOUR TRAINING
Mail coupon today for free book showing how you can learn Radio Operating, Servicing, Sound and Television in a few short weeks in Coyne Shops and also how you can pay tuition in easy monthly payments after graduation.

LEARN BY DOING
On real Radio receiving and transmitting equipment at Coyne. Simple, easy method of practical shop training. You don't need previous experience. Prepare for Radio Operators' Government license Exam. and for good jobs in Broadcast, Police Radio, Aircraft Radio, Ships, Commercial Radio stations, or in service shops and radio factories. "Learn by doing", the quick, modern way, at Coyne Shops in Chicago.

EARN WHILE LEARNING
Job Help After Graduation
We assist you in getting part-time work to help pay living expenses and give you real employment service after you graduate.

SEND COUPON TODAY

H. C. LEWIS, Pres., COYNE RADIO SCHOOL,
500 So. Paulina St., Dept. 31-414, Chicago, Ill.

Please send me your free book and details of easy Pay-After-Graduation Plan.

NAME _____
ADDRESS _____
CITY _____ STATE _____



Be a RADIO SERVICE EXPERT
LEARN AT HOME IN SPARE TIME

The demand for radio experts grows every day. Learn this paying profession under personal guidance of qualified engineer and educator. Clear, fascinating instruction and experimental kits make learning easy. Leaders in the radio industry endorse R.T.A. methods. Spare time profits soon pay for training.

NOW IS A FINE TIME TO START
New National defense program requires radio trained men in radio factories and every branch of U. S. Service. Opportunities for advancement almost limitless.

FREE Write today for complete information and radio book telling what R.T.A. training can do for you.

RADIO TRAINING ASS'N. OF AMERICA
1559 Devon Ave. Dept. RC-21 Chicago, Ill.

RADIO-TELEVISION

Oldest, largest Radio-Television school in West trains you for good pay job. Complete instruction including Radio Construction and Service, Broadcast Operating, Sound, Talking Pictures, Television, Public Address, etc. Flexible plan to meet specific needs of those with or without jobs. Transportation allowed to L.A. Earn room and board while learning. Request Free Catalog.

NATIONAL SCHOOLS, Dept. 3-RC
Los Angeles

RADIO COURSES

Mid-Term Classes Now Starting
RADIO OPERATING—BROADCASTING
● RADIO SERVICING—a practical course
● RADIO AMATEUR CODE ● TELEVISION
● ELECTRONICS—1 yr. day course 2 yrs. eve. Day and Evening Classes. Booklet Upon Request.

New York Y.M.C.A. Schools
4 W. 64th Street New York City

PATENTS—TRADE MARKS

Booklet concerning Inventions & Patents Form "Evidence of Conception" with instructions for use and "Schedule of Government and Attorneys Fees"—Free

LANCASTER, ALLWINE & ROMMEL
Registered Patent Attorneys.

436 Bowen Bldg. Washington, D. C.

RADIO TECHNOLOGY



RCA Institutes offer an intensive course of high standard embracing all phases of Radio and Television. Practical training with modern equipment at New York and Chicago schools. Also specialized courses in Aviation Communications, Radio Servicing and Commercial Operating. Catalog Dept. RC-41.

RCA INSTITUTES, Inc.
A Radio Corporation of America Service
75 Varlek St., New York, 1154 Merchandise Mart, Chicago

magnetic earphone, I leave it to your readers to judge as to the extent of his technical knowledge.

With further reference to the sensitivity of the "Miniature Tube Audio Amplifier" which I described in the October, 1940, issue, I might remind you that I demonstrated this amplifier to the editors of *Radio-Craft* and showed them that it was possible to hear the ticking of a high-grade watch more than a foot away from the microphone. In fact, everyone who listened to the performance of this amplifier was amazed at its extremely high sensitivity.

Incidentally, practically all the well-known manufacturers of high-quality deaf-aids are now turning out compact hearing-aids using—guess what—miniature tubes and crystal mikes. It certainly looks as though all the world is out of step but Earl.

H. G. CISIN,
New York, N. Y.

RE: "BURGLAR ALARM"

Dear Editor:

I'm just a beginner in this popular business of radio and maybe I'm all wrong. In your January issue of *Radio-Craft* in the "Shop Notes—Kinks—Circuits" section there is a diagram for a very good burglar alarm.

In its present wiring form, wouldn't the transformer always be using current? Why not connect the "tripping" device, in the primary of the transformer? Then there would be current being used while the alarm was disturbed.

Am I wrong? If so I would appreciate the help of all who can show me why I'm wrong. (No pun intended, Mr. Kuntz.)

JOSEPH C. SEYER,
Forest City, Pa.

You are not entirely wrong. The method you suggest will work, but generally is not preferred. The reason is that your method requires high voltage (110V.) being carried through long leads from the transformer to the metal gate. This in itself is a disadvantage and probably against the safety code of many localities. Then, too, a high voltage would have to be broken at the gate contacts, resulting in excessive sparking. Finally, there would always be the possibility of live voltage on the metal gate which would prove dangerous to any person touching it. Mr. Kuntz's method is safe all-around and the generally accepted one.—Editor

LIKES "RADIO-CRAFT" ALMOST VERY MUCH

Dear Editor:

Speaking lightly about the *Radio-Craft* magazine as a whole, I find it always interesting and worth more than its price. I like very much each and every article published in the magazine, especially of Messrs. A. C. Shaney's, Sprayberry's, etc. I like also the way you "streamline" it.

Your present way of binding is a very cheap one good only for 5-cent magazines. I am hoping that someday you would give back the magazine its former way of binding.

By the way, I wish to know if the kink of Mr. James Allen, appearing in the *Radio-Craft* for this month's issue, page 255, is appropriately illustrated.

I am a subscriber to *Radio-Craft* for about 3 years now. I am determined to stick always to *Radio-Craft*. My only regret is that I wish I had subscribed to *Radio-Craft* much earlier. (Thank you!—Editor)

MANUEL MADRIDANO,
Sta. Cruz, Manila, Philippine Is.

The binding of *Radio-Craft* was changed for a good reason. "Handiness" is the an-

swer. It has been found that a technical magazine or one that is often referred to opens better with the present binding because it lies flat. Most of the radio magazines are now bound in this fashion.

Incidentally, we would like to point out to Sr. Madridano that not only 5c magazines use this type of binding. There is for instance, *Life*, a 10c magazine, and more important than this—*The Reader's Digest*, a 25c magazine, with the identical binding, and with the largest circulation in the world!

James Allen's kink on "Locating Breaks in Leads" appeared in the Oct. 1940 issue with the wrong illustration. The illustration shown there was for an "Improvised Beat-Frequency Oscillator" published in the November issue.

The illustration for James Allen's kink is so simple that we did not think it necessary to run it as a correction. It merely consists of a 1,500 V. transformer, the primary of which is connected to the 110V. A.C. line and the high-voltage secondary terminating in well-insulated test leads.—Editor

THE VERSATILE AMPLIFIER

Dear Editor:

I am attempting to build the "Versatile Amplifier," described in the Oct. 1940 issue of *Radio-Craft*, as a hearing-aid for a friend of mine. He now has one of the old type using a carbon mike and bone conductor. He said the bone conductor gave him better results with that type, but far from satisfactory. What I want to know is what would be the best way to couple the output to a bone conductor if the Xtal Phones prove unsatisfactory.

J. W. BAKE,
Kansas City, Mo.

This letter was sent to the author whose reply follows.

In order to couple the bone conductor to the output of the amplifier in place of the crystal phones it will be necessary for you to obtain a coupling transformer having a primary impedance of 8,000 ohms and a secondary impedance which will match that of your bone conductor. Naturally, the primary of the output transformer will be in the plate circuit of the 1S4 tube.

H. G. CISIN,
New York, N. Y.

LIKES OUR SIGNAL CHASER

Dear Editor:

We built the signal chaser shown in the Sept. issue of "R.-C." It performed better than our expectations of it were. It was built into a case which measured 10½ ins. high, 9 ins. wide, and 4 ins. deep. The only changes were in using a 5Z4 and a 1,700-ohm speaker field.

The tuning eye failed to close at first. After we changed the "B+" lead from plate to target the tuning eye operated OK from then on. So we came to the absolute conviction that the "B+" lead was shown connected to the wrong terminal on the 6E5.

This is our first trip into the Mailbag. If you have any all-wave signal generator circuits that are as good as that of the Signal Chaser, send them along with "R.-C." So long, and thanks a million for the Signal Chaser and *Radio-Craft* and, we hope, a signal generator.

PAGEL BROS.,
Radio Service,
Bloomington, Ill.

A "P.A. BROADCAST"

How do you do, Gentlemen of the P.A. Audience: This is Stanley Dowgiala speaking to you over Station PAS (Public Address System) and bringing valuable information to all you P.A. men to help you to get better P.A. jobs.

On October 12, 1940, at 8:30 P.M., the Democratic National Committee in Jersey City rented a P.A. system from me. I installed this on their decorated truck and their meeting began. Many speakers had spoken and it came to my attention that the President was to speak on the air, so I notified the chairman and he announced the surprise to a large audience.

In the meantime, I got a small A.C.-D.C. radio set, with a built-in antenna, and I tuned-in the station. I waited for the President to speak while the meeting was going on. Then I used a special dynamic mike and relayed the President over the P.A. system. I merely put the mike close to the radio loudspeaker, tuned-in the radio set full-volume, and then the P.A. system at 9 P.M. The President was heard distinctly for over 3 blocks and the people were amazed at how it was done. It also won me a tip and many favors. I made the President speak for himself at that meeting. Some of you gentlemen ought to try it sometime.

I also rent my P.A. system for bus rides and supply them with recording music. I also run dances sometimes at a charge of 25c a couple and also use records. Then again, I am called out to weddings to play record music. I buy all types of nationally-sold records. I cover the political meetings every year from October to election. Many clubs invite me to play music for them at their dances or other affairs. I also cover theatres for special occasions such as announcements, prizes, amateur hours, etc., and I have installed many in theatres for their own use which they bought from me. I even had an application from a Funeral Parlor to install equipment for a special occasion and to play organ music for special funerals when their equipment went haywire. I mix with all types of people. My business name is: The Society Radio and P.A. Service.

Always remember this: never try to get rich fast; and, treat your customers with respect. Give them what they want; always satisfy them and you will be richly rewarded. Remember their recommendations get results. Be honest in your work and most of all, be presentable and show your personality and smile to people. Most of all, advertise your business by printing your name and address on your P.A. speaker cases and carry some of your business cards with you.

I hope all of this information is of value to you as it is to me. This is Stanley Dowgiala now signing off, and wishing you the best of luck.

STANLEY DOWGIALA,
Jersey City, N. J.

LIKES OUR NEW BINDING
ALMOST

Dear Editor:

Recently I visited the Buhl Planetarium in Pittsburgh. There I saw an experiment on Cosmic Rays. I would like to know what is known about these rays to date, their effect on radio waves, and the simplest circuit diagram of the receiver used to receive them. (*)

May I go on to say (changing the subject) that I very much dislike the present method of binding.

To better appreciate my opinion, slightly dampen thumb and forefinger. Place maga-

zine between these with stitch about 1/2-inch away. Now twist thumb and forefinger. The cover will tear away from the stitch just as it would if you have a few dozen magazines in a pile on a high table and they fall on to the floor. Magazine sliding on magazine with disgusting results.

Now take the old binding and give it the finger test. The binding will not budge. All of my old magazines have their covers. Many of the new type do not. A big advantage of the old type is that it has an index on its edge. I think it's about time to get back to the good binding.

ANDREW M. ELLIOTT,
Ingram, Pa.

(*) See "Cosmic Rays Shortest Wavelength in the World," *Radio-Craft*, Sept. 1937; more detailed information appears in the book "Earth, Radio and the Stars," by Prof. Harlan True Stetson.

May we refer the matter of binding to the reply given in this issue to Senor Madridano.

FROM PORTLAND TO
PORTLAND

Dear Editor:

On page 658, of the May, 1940, issue of *Radio-Craft*, is a problem (No. 159), submitted by Mr. Ettinger of Portland, Pa., telling about the trouble he was having with code interference on the broadcast band of a receiver. The description of the type of interference as given by him, brings to mind a quite similar happening that I experienced a while back. The answer given by you, to his trouble, in my estimation does not present a solution to his problem. My reason for contesting you is best explained by the following relation of my experience in question:

In June 1940, while aboard the S.S. *Mauna Kea* off the Pacific Coast of Guatemala, a small Emerson receiver (I don't recall the model number, but it was an A.C.-D.C. 5-tube model of about 1939. It was one of those whose cabinet was mounted in an extra stand to tip the whole receiver back in order to gain a better view of the dial from above) suddenly began bringing in London, Berlin, and other 49-meter stations on the high-frequency end of the standard broadcast band, in the vicinity of 1,400-1,500 kc. At the same time, semi-local standard broadcast stations (among them TGQ in Quezaltenango, Guatemala) were coming through as well, at their proper places on the dial.

There was no shortwave band on the receiver, merely the single-band standard broadcast. The mixing-up of 49-meter short-wave signals and standard broadcasters resulted in a rather serious mess of image whistles. Images, involving the 3rd-harmonic of the high-frequency oscillator, is what I took them to be. My explanation was:

Suppose the receiver used a 460-kc.-I.F., and the dial was set at 1,400 kc. Then the H.F. oscillator would be working at 1,860 kc. The 3rd-harmonic of the H.F. oscillator at that time would be 5,580 kc. Then a signal 460 kc. higher, or 6,040 kc., would appear as an image on the original 1,400 kc.

And that's just what happened. The 49-meter stations were held long enough, and with plenty volume, to identify them and establish their frequency. The ship's radio operator, when told the receiver was bringing in London on the broadcast band wouldn't believe it and had to come aft where the receiver was, and operate the controls himself, before he'd be convinced. He brought in London, Berlin, and several code stations which he identified and knew their

(Continued on page 545)

Use Meissner

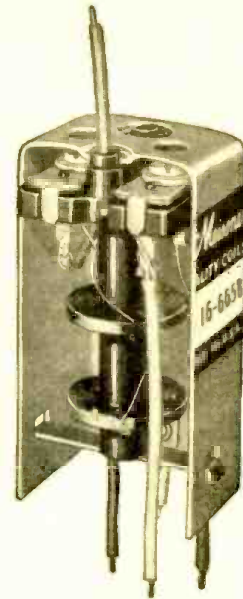

PRECISION-BUILT PRODUCTS
FOR PERFECT PERFORMANCE
Progressively Engineered
FOR THE EXPERIMENTER

- Complete Receiver Kits
- "Essential" Kits for Receivers
- F-M Parts and Receivers
- Television Receiver Kits
- All-Wave Tuning Assemblies
- Antenna, R-F and Oscillator Coils
- Wireless Phono Oscillator Unit
- I-F Transformers of all kinds
- Tuning Condensers, Dials, Switches

FOR THE SERVICEMAN

- New ANALYST
- Wave Traps
- Audio Filter
- Replacement Antenna, R-F and Oscillator Coils
- Replacement I-F Transformers
- Exact Duplicate Replacement Coils
- I-F Transformer Replacement Guide
- Coil Repair and Rewinding Service
- SIGNAL CALIBRATOR
- Line Filter
- Primary Windings

FOR THE AMATEUR

- SIGNAL SHIFTER
- SIGNAL SPOTTER
- TRAFFIC-MASTER
- TRAFFIC SCOUT
- MC 28-56 Converter
- R-F Relays
- SIGNAL BOOSTER
- SIGNAL SPLICER
- SIGNAL RESONATOR
- UNI-SIGNAL SELECTOR
- Antenna Relay
- Insulators

FOR THE SOUND ENGINEER

- High-Fidelity P-A Tuner
- "Utility" TRF P-A Tuner
- Dual-Band Super P-A Tuner
- Specially Designed Assemblies
- Custom Engineered Equipment
- Portable Phono-Recorder Unit

WRITE FOR FREE CATALOG NOW!

Brand new Meissner General Catalog for 1941—now being mailed. A postal card will bring you this valuable guide to dependable Precision-Built parts and equipment. You can't afford to be without it so mail your request TODAY!

Dept. C-3



SERVICEMEN SAY:—For Bigger Profits— For Better Servicing—USE GERNSBACK MANUALS

Since 1931 more and more Servicemen have been buying GERNSBACK OFFICIAL RADIO SERVICE MANUALS year after year. The authentic material, easily accessible diagrams and complete service data make them invaluable to dealers and radio Servicemen. Without a Gernsback Manual with you on a repair job, there's time and profit lost. Your service kit or laboratory is incomplete without all the GERNSBACK OFFICIAL RADIO SERVICE MANUALS. There are GERNSBACK MANUALS also for servicing auto-radios, refrigeration and air conditioning equipment.

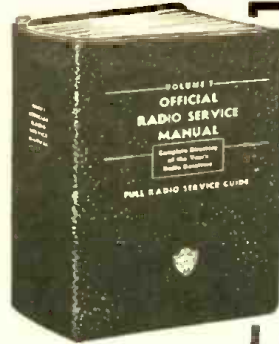

VOLUME 7 OFFICIAL RADIO SERVICE MANUAL

The newest and most outstanding GERNSBACK Manual published since 1931. Contains many features never previously published in any service guide. ● OVER 1,300 PAGES ● OVER 3,000 ILLUSTRATIONS ● OVER 1,600 SETS REPRESENTED ● Complete Service Data ● Includes 1938 Models Not Found in Other Manuals ● All New Material—No Reprint or Rehash ● Master Index of 74 Pages Includes Sets Listed in All Other Gernsback Manuals ● Stiff, Leatherette Looseleaf Covers ● Size 9 x 12 Inches ● Net Weight 10½ lbs.

Price \$10.00



1935 OFFICIAL AUTO-RADIO SERVICE MANUAL

If you are overlooking servicing auto radios, then you are missing a great deal of business. The great number of car radios in use require constant servicing and you can make it a profitable sideline to your regular servicing business. This complete Manual contains schematic diagrams,

chassis layouts, mounting instructions and trouble shooting hints. ● OVER 240 PAGES ● OVER 500 ILLUSTRATIONS ● Flexible, Leatherette Looseleaf Covers ● Size 9 x 12 Inches ● Net Weight 1¾ lbs.

Price \$2.50

1936 OFFICIAL RADIO SERVICE MANUAL

Just packed with service data of sets manufactured during 1935 and 1936. Schematic diagrams show speaker connections, power-transformer connections, R.F. and I.F. coil connections, phonograph connections and other information. ● OVER 1,200 PAGES ● OVER 1,500 SETS SHOWN ● OVER 2,500 ILLUSTRATIONS ● Index of Trade Names ● Complete Tube Chart ● Stiff, Leatherette, Looseleaf Covers ● Size 9 x 12 Inches ● Net Weight 8 lbs.

Price \$7.00

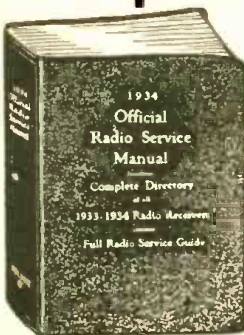

1934 OFFICIAL RADIO SERVICE MANUAL

This manual contains values of I.F. transformers on superheterodyne receivers, valuable tube data, complete list of American broadcast stations, free question and answer service, service material and schematic diagrams. ● OVER 400 PAGES ● OVER 2,000 ILLUSTRATIONS ● Flexible, Leatherette, Looseleaf Covers ● Size 9 x 12 Inches ● Net Weight 2¼ lbs.

Price \$3.50

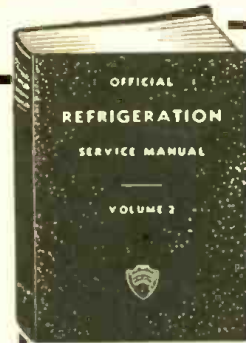

OFFICIAL REFRIGERATION SERVICE MANUAL

Volume 2

This is the only complete refrigeration service manual ever published. Contains detailed information on servicing, outlines of theory and methods of operation, instructions for the handling of refrigerants, charging systems, diagnosing troubles, charts, electrical hook-ups and a wealth of other necessary data. ● OVER 352 PAGES ● OVER 300 DIAGRAMS ● Flexible, Leatherette, Looseleaf Covers ● Size 9 x 12 Inches ● Net Weight 1½ lbs.

Price \$5.00

1932 OFFICIAL RADIO SERVICE MANUAL

Here is the volume which shows a step-by-step analysis of how to service any receiver. It is one of the early editions and covers many old sets, thousands of which are still in use throughout the country. ● OVER 1,000 PAGES ● OVER 2,000 ILLUSTRATIONS ● Flexible, Leatherette, Looseleaf Covers ● Size 9 x 12 Inches ● Net Weight 4½ lbs.

Price \$5.00



OFFICIAL AIR CONDITIONING SERVICE MANUAL

This manual is edited by L. K. Wright, who is an expert and leading authority on air conditioning and refrigeration. Nearly every page is illustrated, every modern installation and individual part carefully explained, diagrams furnished of all known equipment, special care given to the servicing and installation end. Necessary tools are illustrated and explained, etc. ● OVER 352 PAGES ● OVER 600 ILLUSTRATIONS ● Flexible, Leatherette, Looseleaf Covers ● Size 9 x 12 Inches ● Net Weight 2¼ lbs.

Price \$5.00



RADCRAFT PUBLICATIONS, Inc., 20 VESEY ST., NEW YORK, N. Y.

Gentlemen: Enclosed find my remittance of \$..... for which send me, POSTPAID, the Manuals indicated below by a cross (x) in the panel.

- () Volume 7 @ \$10.00 () 1936 Manual @ \$7.00 () 1934 Manual @ \$3.50
 () 1935 Auto-Manual @ \$2.50 () 1932 Manual @ \$5.00
 () Refrigeration Manual (Vol. 2) @ \$5.00 () Air Conditioning Manual @ \$5.00

Name Address

City State

(Send remittance in form of check or money order; register your letter if you send cash or unused U. S. Postage Stamps.)

RC-341

To order these famous Manuals, see or write to your jobber or favorite mail order house. If more convenient, mail coupon directly to publishers.

RADCRAFT PUBLICATIONS, Inc.
20 VESEY STREET NEW YORK, N. Y.

RADIO-CRAFT

"RADIO'S GREATEST MAGAZINE"

UTILITY RADIOS

By the Editor — HUGO GERNSBACK

... novelty radio sets if
they also have utility will
be more marketable

It is an established fact that among the 35 million-odd radio receivers in use in America today there has always been an excellent market for so-called "novelty" radio sets. For years, there have been crops of odd radios, many of which were designed primarily with the idea of novelty, and their appeal for sales was based mainly on novelty rather than utility.

Years ago, in his magazine, *SHORT-WAVE CRAFT*, the writer designed what was then the first briefcase radio. It was described in the June, 1932, issue of that magazine. It was completely self-contained, including loudspeaker, built in an ordinary briefcase. Many experimenters constructed this set from the design given at that time. It took the radio industry exactly 6 years to catch up with this idea; subsequently they were manufactured in quantities and still are. Here was a novelty set which at the same time had utility. Nor was it a freak set.

Of course, there have been many novelty sets and every month brings numerous new ones. To mention only a few of them, we have had *globe* sets where the radio receiver was installed inside a terrestrial globe. We have *lamp* radios where the radio set is contained in the foot of the lamp, the shade being the loudspeaker. We have had *book* radios; and *bed* radios combined with lamps. We have had radio sets where the casing was made entirely of plate-glass mirror. The list is really endless. Some of these sets come and go; others have a certain popularity which is maintained for many years.

The writer here wishes to make the observation that constructors who have sudden inspirations as to either novelty or utility radio sets often rush into production without consulting a *stylist*. This to the writer's mind is the most important deficiency of these sets. A radio set, no matter how good, will fall by the wayside and can never attain a real sale unless it is not only designed right but is styled right.

Nevertheless, few radio constructors are stylists. They may know all about radio but do not understand what pleasing lines, what decorative effects or modernistic touches should be added to make a radio set a fast-selling product. It takes an artist and a stylist to do this and if he has the knack for this sort of thing, he should be left severely alone and allowed to do the designing. It is one thing—to give a homely analogy—to be a good manufacturer of felt but quite another to be a good fashion modiste and make a beautiful hat from a common piece of felt.

There should also always be a distinction between the *gadget-novelty* type of radio set and well-styled *utility-novelty* type of set; the latter usually will sell well whereas the former will not.

There are any number of utility radio sets which as yet await big markets—believe it or not. *By utility, I refer to a radio set that not only performs as a radio set but has a separate utility in addition.* There have been, for instance, a number of clock radio sets. Here we have the utility of a time-piece combined with radio. The great trouble with these sets has been that the clock usually has been of inferior quality. Usually such clocks are not self-starting and if the current is turned off momentarily, the clock stops and must be hand started. The best utility idea of these sets is the type where the clock can be set by means of a mechanism, so that the set will be turned on or off at a pre-determined time. Thus, many people dislike alarm clocks but like a clock-operated radio which turns on at a given time in the morning and wakes them up by pleasant music rather than by a shrill alarm. Again the manufacturers of these devices have fallen far short, in that with few exceptions, the time-setting device is difficult to manage and is not reliable. We know of several of these types which we had in our own home and which tended to go off at the weirdest hours of the night, waking us up at the wrong time, mainly due to faulty contacting arrangements.

But the most stupid part of such devices is that clock makers still persist in believing that the day has 12 hours instead of 24! Rather than making 24-hour clocks, they give us 12-hour clocks. So if we set the alarm for 7 o'clock in the morning and the radio robot dutifully wakes us up, at that hour, it will just as dutifully go off at 7 P.M. with no further ado. That means that we have to hand-set it in some way and trust to our memory that next morning it will be set right or we will oversleep. A 24-hour clock with half of the dial dark, and half of it in a light color, is the answer to the problem. Then if a cheap clock mechanism with a good timing device that can be set easily is produced, many radio manufacturers no doubt will adopt it.

Speaking of utility sets, I can think of any number of these, but I will only give a few examples for which I know there will be a good market. There is for instance, the *Ladies' Boudoir Radio*, small but stylish, with modern perfume bottles at each side and other attachments of use to any woman, of which there are many. For the he-man, I can readily imagine a *Den Radio* which we might also call *Smokers' Delight Radio*. Executed in the modern manner, the radio set has pipe holders on each side to hold a number of pipes conveniently. There can be an electric lighter with cord attached, ash tray, even a cigarette drawer or case can be provided for. If styled correctly, it will sell well.

Some years ago, I designed an *Executive's Desk Radio* which has on top a lamp with a green shade, pen and pen holders on each side, and front space for clips, pencils, etc. There was also a clock provided on the face of the radio set. It was described in Feb. and March, 1937, *Radio-Craft*. This was a project for home construction, and for this reason, it was of course not styled properly. I still believe if styled right there is a market for it.

Most midget sets in use today can be provided with an attractive lamp on the top for very little additional cost. It seems rather strange that the midget-set manufacturers have not turned to this *Midget-Lamp Radio* utility so far, but rest assured sooner or later, they will.

Then there is the *Kitchen Radio*. Here we also need a clock arrangement as the woman of the house needs a timer which will turn on either the radio set or an alarm when a given time is up so that the roast or the cake will not burn or get overdone. There could be, in addition, several pencil holders; also a place for a recipe book and one of those gadgets dear to every woman's heart—a mechanical list of what to buy.

And for the bedroom, we need a good *Bedroom Radio* done in the modern manner, which should have a clock arrangement to wake you up in the morning. It can be provided handsomely with a night-light on top of the radio receiver which can be used whenever wanted. Many people like to sleep with a small neon night-light and this is easily included as utility on a midget set. Then the male member of the household who always thinks of something during the night, can easily use a memo pad which is also incorporated into the set. This can be lifted from a small rack, molded into the casing and at the same time, you pull out a pencil which has a tiny electric light attached at its end. You write your memo without turning on any light in the room except for the stream of light directed against the end of the pencil while you write.

Then going to the children's room, we can have the *Children's Radio* set made in gay colors, as indeed they are even being made now. BUT we provide them with the following utility: a savings bank can be incorporated readily into a midget receiver which does not operate unless you put in a nickel or a dime, when it will play for a determined number of hours, say 3. This is a simple utility, that will appeal to children and parents alike, and will provide another good radio seller.

•THE RADIO MONTH IN REVIEW•

The "radio news" paper for busy radio men. An illustrated digest of the important happenings of the month in every branch of the radio field.



COLOR TELEVISION BY WIRED-RADIO

Illustrated here is the new "off-side" television camera designed for use in Columbia Broadcasting System's method of Color Television. A demonstration of this direct pick-up system last month, which was attended by *Radio-Craft*, disclosed many improvements over the indirect pick-up system demonstrated a little over a month previously. "Cold light" illumination with fluorescent lights, for example, was a stellar feature. Proper phasing of the 3-color, 6-sector, motor-driven color-disc in the receiver, with its companion at the transmitter (across the street), was obtained by means of a receiver pushbutton control.

ABROAD

DEATH snuffed out the lives of 7 members of the British Broadcasting Co.'s staff at the B.B.C. Headquarters in London, last month, when a Nazi bomb traced its lethal path into the building during a broadcast.

The Associated Press reports that, according to the "Princeton (N. J.) listening center" Germany in recent months has been waging an increasingly intense propaganda war against the U.S. via S.-W. radio.

A U.P. report from Alexandria, Egypt, mentions the use of a "secret weapon" in an air attack against the Italian Navy;

in the opinion of the *New York Daily News* it may be the "Queen Bee flying torpedo." The only authoritative advice which *Radio-Craft* has to report on these *Queen Bees*—and this readers will recall—is the use of these radio-controlled airplanes as robot gunnery targets. The *News* gives this data on their type of construction: biplane, about 18 ft. long and 20 ft. span.

From China comes an A.P. report that the broadcast of one of President Roosevelt's fireside addresses over XMHA, American station in Shanghai, allegedly was jammed by Japanese interference.

An issue of *PM* newspaper, last month, uses a column to tell how C.B.S. recordings

of B.B.C. broadcasts show that an English nightly program to America aims to de-bunk German news broadcasts.

The proprietor of a bar in Padua was fined \$25, and had to park a month in jail, for listening to a British news broadcast, A.P. reported from Rome last month.

A U.P. report from London tells of the execution last month, at Pentonville Prison, of 2 German spies caught with a portable radio transmitter said to have been intended to be used to send information to Germany.

The current hit show "The Corn Is Green," was broadcast to its author in London because the war prevented his seeing the show in New York, columnist Charles A. Wagner last month reported in *The Mirror* (New York).

DEFENSE

AMERICA'S defenses were strengthened last month when Major Edward ("Amateur Hour") Bowes passed over to the Navy full title to his 61-ft. yacht *Edmar*, and 30-ft. light-cruiser *Edmar, Jr.*

Radio amateurs, who may have occasion to contact the War Department, now can call the Department's radio net control station WAR. Frequencies for amateur contact are: 4.025 mc., 8.5 to 4. mc., 13.32 mc., and 14. to 14.4 mc.

Chairman Stephen Voorhees of the Advisory Board of Industrial Education last month urged radio manufacturers in the Metropolitan area to aid employees to obtain the free instruction being given by New York vocational schools, in radio servicing, code, and theory.

Last month the American Radio Relay League announced the appointment of a representative and 6 regional advisors to the Amateur Radio Committee of the Defense Communications Board. Other groups represented on this Committee: Federal Communications Commission, Army, Navy, and the National Youth Administration.

Commercial cooperation in the Defense Program includes the following: Crosley



SONOVOX—SPEECH FOR THE DUMB!

Motion picture fans and broadcast listeners, alike were amazed, when they witnessed recent talking picture and heard broadcast programs, in which a person dumb—unable to utter a word for many years—was able to make himself perfectly understood! A vibrator, somewhat like an electric shaver, when held to his throat supplied the necessary "artificial larynx." shown here are Kay Kyser, Jinny Sims, and (right) inventor Gilbert Wright.



REFUGEE RADIO

It was indeed a "Merry Christmas" and a "Happy New Year" for little Allan Whittaker, a refugee from war-torn Europe, here shown exchanging Season's Greetings with his "mommy" during an N.B.C. broadcast to and from Europe last month. Many parents "back home" thus heard the voices of their loved ones for the first time since they had been parted.



POLICE 2-WAY VEST-RADIO!
(Cover Feature)

New York City's Police Commissioner Lewis Valentine (left), and Mayor LaGuardia, help Patrolman William Proctor model the 2-way vest-radio set developed by Gerald S. Morris, Supt. of the Police Telegraph Bureau. Cost: \$165; range, about 1,000 ft.; weight, about 11 lbs.

Photo—Wide World Photos.



"HEARING" RUBBER IMPURITIES

The above photo shows the set-up in Bell Telephone Laboratories for testing the dielectric properties of "pigmented" rubber containing not only coloring matter but also fillers and reinforcing agents. A capacity-inductance bridge and D.C.-resistance galvanometer are used in taking measurements.

Radio Corp. has opened an office in Washington, D. C., to speed production by better cooperation with Government depts. . . . Air Radio and Instrument Co. is conducting special classes designed to train enrollees for Defense jobs paying \$125 to \$200 per mo. . . . National Union Radio Corp. has agreed to give a month's salary, carry group insurance, and re-employ staff members, who join the Colors voluntarily or by draft. . . . Hygrade Sylvania Corp. will carry the group insurance of its enlisted employees, will re-employ them, and in addition to giving a month's salary to 1-year enrollees, offers an additional, equivalent sum to enrollees for 3 to 6 years' Service in the Army or Navy. . . . In a full-page advertisement in newspapers, last month, American-owned and American-controlled R.C.A. called attention to the manner in which its 27,000 employees are serving in the Defense Program.

"Cavalcade of America," special recordings of 12 outstanding historical dramas, is available at nominal cost to schools from the Association of School Film Libraries in New York City.

Each jar of Dorothy Gray, Ltd., Throat Cream now has packed with it a 2-sided transparent phono record. Played-back, it spouts instructions.

Latest idea by Muzak for getting its advertising-free music into private homes, profitably (for Muzak), involves the use of an "injector box" which connects to the master antenna of apartment houses. Apartment leasees merely tune to Muzak's wavelength for all-music programs; and perhaps pay a slightly higher rental.

SOUND

ONE of the newest uses of Public Address systems: a "drive-in" church, in St. Petersburg, Florida, where patrons remain in their car-seats and honk their "Amen's."

F. W. Woolworth's Xmas attraction (at its Church and Vesey Sts. store in New York City), a Talking "Santa," deserves special mention. An interphone system enabled a remote commentator to listen-in, via a transducer (loudspeaker operable as a microphone) concealed in the body of a 3-foot-high Santa Claus doll, to comments of persons who came upon the figure, unexpectedly, at the foot of a flight of stairs, and to startle the natives out of their aplomb by a well-put quip or two; or even to hold a conversation, from his place of concealment on another floor, with the more hardy customers who ventured to reply to leading questions, as for example the



NEW ELECTRON MICROSCOPE

The new streamlined version of the RCA Electron Microscope, shown here, was demonstrated to the Institute of Radio Engineers last month. Magnifying up to 100,000 times, it exceeds by 20 to 50 times the magnification possible with any optical microscope; instead of glass lenses it uses lens-effects obtained electronically. The Gold Medal of the American Institute of the City of New York is scheduled to be given to Dr. Wendell M. Stanley, in February, for his work in demonstrating the properties of the "tobacco mosaic virus," a particle (seemingly neither molecule nor organism) so tiny it is invisible except to the Electron Microscope.

BONE "HEARING" TEST

An important part of the work of the New York League for the Hard-of-Hearing, Inc., is the giving of hearing tests. The "bone conduction" test of this little girl's hearing has just been completed and the verdict is: OK!



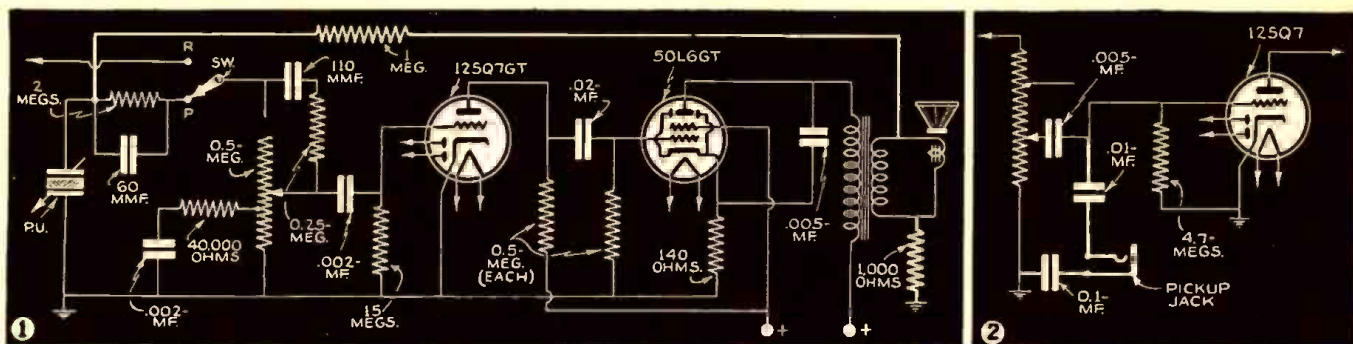

NEW CIRCUITS IN MODERN RADIO RECEIVERS

In this series, a well-known technician analyzes each new improvement in radio receiver circuits. A veritable compendium of modern radio engineering developments.

F. L. SPRAYBERRY

NO. 42



(FIG. 1.) INDIVIDUAL DEGENERATION APPLIED TO PHONO PICKUP CHANNEL

EMERSON MODEL ET.—A degenerative circuit couples the speaker voice coil to the (crystal) pickup so that the degenerative action applies over the entire pickup channel without regard to any other means used in the A.F. amplifier alone.

It is well known that every component in the signal circuit is capable of contributing something to the harmonic content or distortion of reproduction. Hence by including every possible item in the electrical part of the signal circuit within the degenerative action it is possible to minimize the distortion to the greatest degree. The circuit shown in Fig. 1, as applied to the pickup has a special advantage, in that it greatly improves the linearity or "flatness" of the audio response. In this way the attenuation of high frequencies due to the pickup would be compensated-for to some degree.

(FIG. 2.) DIRECT "PHONO" CONNECTION MADE IN SMALL RECEIVER

RCA MODEL 10X.—The phonograph jack is wired permanently in the 1st audio input requiring no switching to change from radio to phonograph operation.

For phonograph operation the phono terminals are simply plugged into the jack

and the radio tuner is detuned so that no signals will be received. The radio volume control with the usual grid coupling condensers then serves as a tone control and the volume must be controlled at the pickup unit. The circuit is shown in Fig. 2. Provided that the pickup circuit makes use of a high series resistor, the pickup need not be removed from the circuit for radio reception because the grid circuit is not shunted with too low an impedance for satisfactory volume.

(FIG. 3.) RECTIFIER ELEMENT USED AS FLOATING FILAMENT STABILIZER

SILVERTONE (SEARS, ROEBUCK & Co.) MODEL 6721 AND 6761.—One of the elements of the power supply rectifier (25Z6GT) is placed in series with the filament system thus acting simply as a series resistor and having slight voltage regulating qualities.

This circuit represents an improvement in efficiency as the 2 rectifier elements are in series thus reducing slightly the resistance required in series with the filament circuits. Moreover the resistance changes in the plate circuit of the rectifier element in the filament circuit as in Fig. 3, are in the same direction as the voltage changes, that is, they both increase and decrease at the same time. This, of course, tends to stabilize the current in the circuit, makes the voltage at

the filaments easier to filter, and permits a much simpler connection for battery operation.

(FIG. 4.) VARIABLE TREBLE AND BASS COMPENSATORS AS TONE CONTROLS

STEWART-WARNER MODELS 11-8D1 TO 11-8D9 AND 11-8D1-Z TO 11-8D9-Z.—By-passing the high frequencies across the upper section of the volume control by means of condenser (4) in Fig. 4 provides high-frequency compensation. Varying the impedance to the top of the volume control by means of a potentiometer (67) permits continuous control of the treble range of response.

As the condenser section (53) of the bass compensator is made more or less effective by means of another potentiometer (68) the degree of bass compensation naturally changes. As the impedance across (53) reduces, the ratio between the high and low frequencies becomes more nearly normal. This same adjustment increases the impedance from plate to ground of the 1st A.F. amplifier and reduces the phase angle of this impedance (58 and 68) practically to zero so that there is little or no frequency discrimination. Thus tone is controlled by 2 potentiometer actions acting on different parts of the audio spectrum.

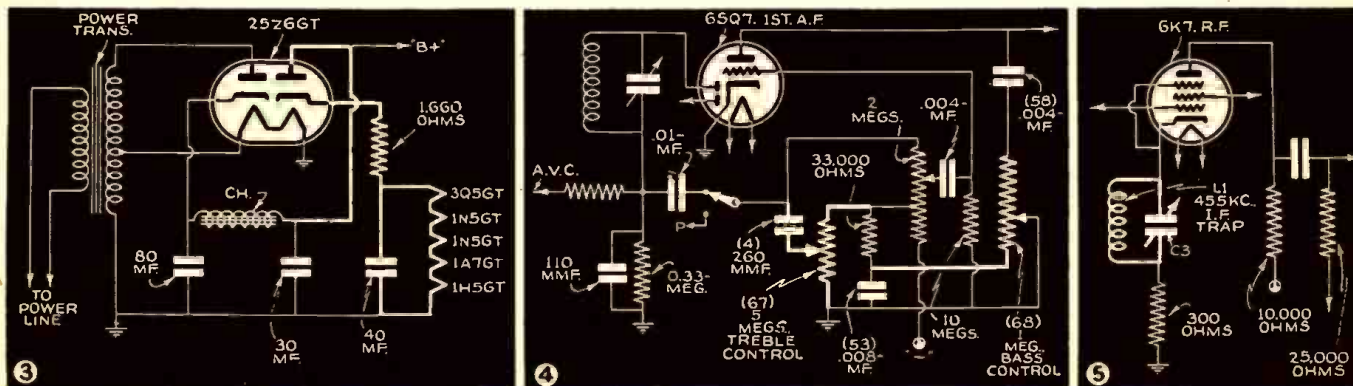

(FIG. 5.) WAVETRAPH PLACED IN R.F. CATHODE CIRCUIT

EMERSON MODELS FA-374 AND FA-408.—As a parallel resonant circuit in series with the cathode of the R.F. tube the wavetrapp for 455 kc. (I.F.) acts as an R.F. degenerative circuit at 455 kc. As the cathode variations are substantially those of the grid at 455 kc. there is no essential net voltage to be

transmitted at this frequency to the detector tube.

This circuit shown in Fig. 5, permits full effectiveness of the trap without detuning the antenna, or R.F. plate circuits, without making any adverse impedance changes in the R.F. plate circuit, or in the antenna. It permits resistance coupling of the R.F. and detector tubes with less than the usual danger of I.F. interference.

(Continued from bottom of 2nd column) ing, keep the chassis away from the loop or oscillation may occur.

This change cannot be made on any of the plastic cabinet 5R sets (5R1 and 5R3). The plastic cabinet sets of this series will exhibit circuit oscillation if they are stepped-up beyond the present limit of sensitivity by this means.

STEWART-WARNER CORP.

OPERATING NOTES

Trouble in . . .

... CROSLY MODEL 159—32-VOLT RECEIVER

When one of these come in you can bet your shirt (almost) that it will be one or more of the common ailments that we have usually found. Squealing and oscillation, while tuning, is usually due to the 8-mf., 200-V. condenser in the chassis (vibrator unit is separate from chassis). This is connected from "B+" to ground. Loss of volume and tone is caused by the 6-mf., 25-V. condenser connected from the type 43 tube cathode to ground. When replacing these open condensers use types of a higher voltage rating. Common too is the need for setting-up the vibrator points after they have been in service for about 3 years. The vibrator is of the synchronous type, and usually, it will be found that with a little filing the points can be adjusted again by means of the 4 adjustment nuts provided.

... ALL 2-VOLT SETS USING ON-OFF SWITCHES THAT GROUND THROUGH SHAFT

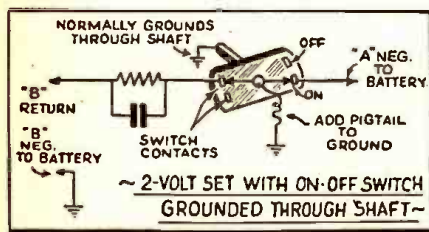

A common fault in these sets is intermittent fading, and then blaring out, at intervals of about a minute, after the volume has been turned up. The shaft becomes a poor conductor to ground on these switches, after they have been in use for a year, due to oil and oxidized metal. Best repair is to solder a pigtail connection from the movable switch arm to ground directly. These switches usually ground the "A-" battery lead and the "B-" return (which is through a bias resistor).

... 1937 PHILCO FORD RADIOS

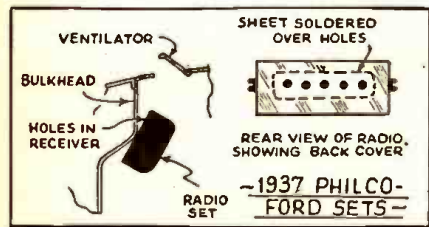

A common complaint is no reception, or possibly, reception of only 1 strong local station. This complaint usually comes in after a heavy rain! If you remove the front cover of the machine you are usually greeted by a shower of water. The whole trouble lies in the fact that the cowl ventilator rubber gasket becomes "dead" on the '37 cars

and allows water to leak in which will run into the set through the small holes in the back cover. The set and the bulkhead of the car form a natural trough. The holes mentioned are seats for grounding straps on the inside of the cover.

The remedy I used was to remove the set, dry it out very thoroughly, realign, and then before installing, scrape the paint away from around the holes on the back cover and solder the holes shut.

M. C. TURNER,
Langdon, N. Dak.

... ATWATER KENT 55

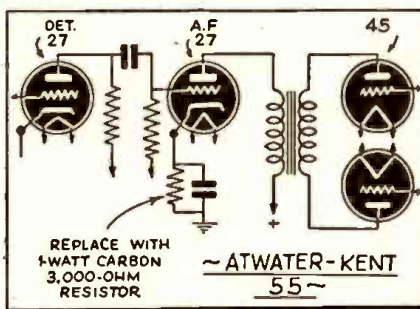

If this set is "dead" and no click is heard when the 27 A.F. driver is pulled out of its socket, check for an open cathode resistor (shown in sketch).

WILLARD MOODY,
New York, N. Y.

... MIDGETS (Using 35Z5GT Rectifier)

When the set is inoperative and the pilot light burned out, check the 35Z5GT before replacing the pilot. This tube has a tapped heater, which furnishes voltage for the pilot. One side of the heater often burns out, thus placing a high voltage across the pilot light, and burning it out instantly.

THOMAS PREWITT,
Plainfield, Ind.

... STEWART-WARNER (models 5R4, 5R5, 5R6 and 5R7)

Increasing sensitivity of 5R chassis in wood cabinets. In those locations where extreme sensitivity is necessary in a radio set, the 5R wood cabinet models (5R4, 5R5, 5R6 and 5R7) can be stepped up by the introduction of a slight amount of regeneration. This change can easily be made as follows:

Disconnect the 0.05-mf. condenser No. 23 from the suppressor-grid terminal of the 12SK7 socket. In the Underwriters-approved sets (model 03-5R, etc.) connect it instead to the "B-" terminal of the volume control. This is the terminal nearest the 12SQ7 socket, and is clearly indicated in the tube socket voltage layout of the service manual. In non-approved models (07-5R, etc.) connect condenser No. 23 to ground.

After the condenser change has been made, re-align the receiver. It is especially important to re-adjust trimmer No. 9, the broadcast oscillator padder, exactly as explained in the service manual. When align-

... GENERAL ELECTRIC A63

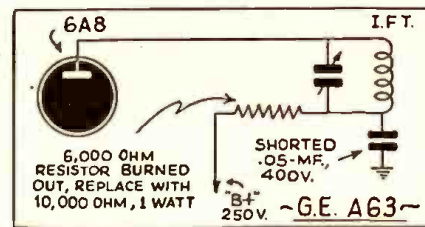

Symptoms: set hums, audio section is operative, but no stations are received. Trouble very likely is a shorted condenser as shown in the sketch.

... A.C.-D.C. SETS IN GENERAL

(a) This set would work OK for hours at a time and then suddenly burst out in a strong 60-cycle A.C. hum. A quick but casual check of tubes, filter condensers, etc., showed nothing wrong, but a jar test of the 43 tube showed a cathode-to-heater short which was intermittent.

(b) There is a custom, slavishly followed, of inserting a 0.006-mf. condenser from plate-to-ground of the output tube. Yet I have found in several sets using 43-type tubes that reception is cleared up, tone rendered more life-like and background hash eliminated by taking out this condenser.

(c) Many of these sets have circuits which oscillate from 1,000 kc. to 1,600 kc. because there is not enough load in the antenna circuit. This condition is remedied by removing the small (usually 0.001-mf.) condenser between antenna and primary coil and substituting one from 0.02- to 0.05-mf. condenser.

(d) Most of these sets have a limiting resistor of 150 to 600 ohms between the cathode of the R.F. tube and the volume control. The trouble is that sometimes these resistors limit too much and you cannot get that last bit of "umph" when listening to a weak station. The remedy is to take this resistor out and connect the volume control direct to the cathode.

J. C. RAVELLE,
Newark, N. J.

... ZENITH (Chassis 5709)

I recently had this model in for service with a complaint of weak and noisy reception and the tuning eye 6T5 also did not work.

I first checked the 6T5 socket and found the 1 meg. resistor between the plate and target open. Replacing the resistor only caused the eye to work very weakly on a strong signal. I next checked the A.V.C. resistors and condensers and found them OK. The rather unusual trouble was found in a leaky coupling condenser that connects the antenna coil with the preselector coil. (Please note that this is not the 1st R.F. coil.) Replacing this condenser with a 0.000025-mf. mica condenser completely cured the trouble.

The defective condenser is white and looks like a resistor, and is mounted inside the preselector coil.

C. R. PRESTON,
Grafton, W. Va.

FLUORESCENT LIGHTING

Latest Sideline for Servicemen

This is the 2nd in a series of articles on fluorescent lighting as it applies to the radio Serviceman. Part I in the January issue deals with the theory of these lamps, their characteristics and the circuits used in their application. Part II, presented here, pays special attention to the interference which may be created in radio receivers by the mercury arc between the lamp electrodes; and to means of combating this interference.

PART II

RADIO INTERFERENCE

JOHN T. BAILEY

EVERY wide-awake radio Serviceman is on the watch for new fields of service from which he can derive some extra revenue, provided that these new fields do not require him to buy new test instruments, stock special parts, interfere with his regular work schedule, require too much study in some phase of electrical work inharmonious with his present knowledge and experience in the radio or electronic field.

BUSINESS PROSPECTS

The suppression of radio interference is an activity that the Serviceman has accepted as his legitimate professional responsibility, and since he is well qualified by experience in this field and has the necessary equipment to cope with this problem, it is natural that the advent of new electrical devices, oil burners in the past, electric razors recently and now fluorescent lamps, should mean added business for him.

The public has been quick to recognize the many benefits of fluorescent lighting, the result being that new lighting installations are being installed everywhere. Inasmuch as fluorescent lighting is a new and specialized method of producing illumination, the sale of fluorescent equipment may best be left to experienced representatives of the lamp and fixture manufacturers but after the installation is made there may be a few instances, such as in restaurants,

Note how placing the radio set a few feet more distant from a noise-producing fluorescent lamp may completely eliminate noise pick-up.

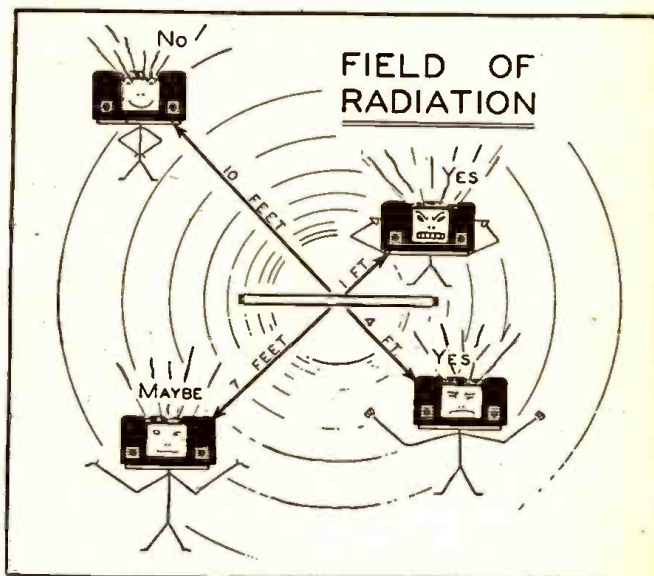

night clubs, stores, residences and similar establishments where artificial illumination and radio are desired simultaneously, of radio interference complaints. This is the opportunity for the radio man and although

the revenue from this work may not justify its solicitation, it will no doubt lead to future radio repair and sales work.

MERCURY-ARC INTERFERENCE

It is well known to all radio Servicemen that when a circuit is interrupted, the spark generated will oftentimes create a frying sound in nearby radio receivers. A fluorescent lamp when operated on 60-cycle alternating current is, by the nature of its operation, turned on and off 120 times per second. The mercury arc established between the lamp electrodes causes sparking at the electrodes where the circuit is interrupted, thus giving rise to radio interference which may be radiated in one of 3 ways:

- (1) Direct radiation to antenna or lead-in from lamp bulb.
- (2) Direct radiation to antenna or lead-in from power line supplying lamp.
- (3) Line feedback from the lamp to radio set by way of power line.

Oftentimes, interference may be traced not to only one of the above-mentioned forms of radiation but may be found to come from a combination of any or all of them.

While the fluorescent lamp can justly be praised for the efficient way in which it transfers ultra-violet energy into visible radiation for the use of the human race, it should be reprimanded for shifting a small amount of energy into that part of the spectrum which we would like to have free for radio reception. A graph plotted with relative interference against frequency would reveal that the broadcast frequencies from 550 to 1,600 kilocycles are most affected. For higher frequencies, the noise is not

It is evident by reference to the animated illustration at left that unavoidable radiation of interference from fluorescent lamps may be greatly mitigated if proper attention is given to the location of the radio set's lead-in with respect to the offending lamp; and proper placement of a line noise filter.

TYPES OF RADIATION AND REMEDIES

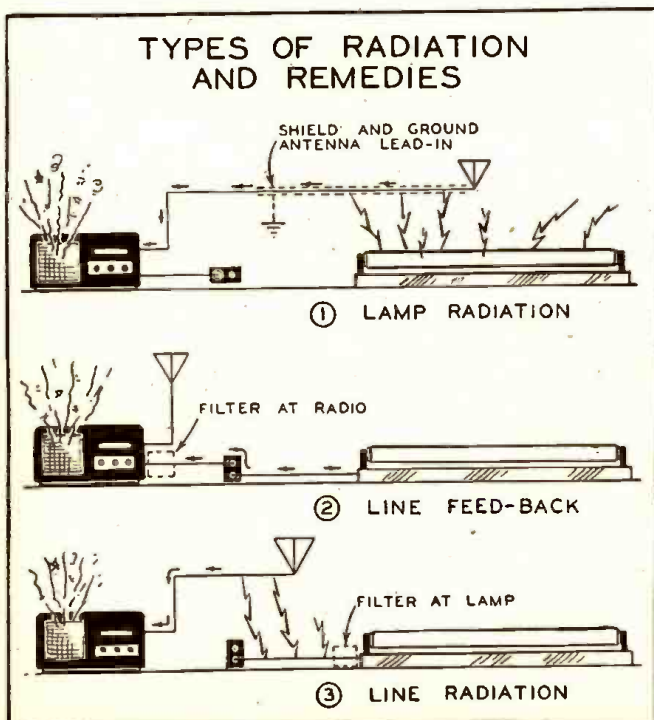

usually objectionable because of the low field strength and because the energy is confined to narrow bands.

In addition to the radiation set up by the arc stream, during the starting period, the starter device may give rise to some electrical noise. The condenser included in the starter (dubbed a "jitterbug" by the trade because of its lively efforts to establish the arc in the lamp) to minimize noise originating at this point is quite effective and unless the condenser is defective no trouble should be expected from the starter.

To check this condenser, remove the starter from its socket after the lamp has started. If the noise increases, then the condenser is not defective. When the starter is located under one end of the lamp it may be impossible to remove the starter without removing the lamp. In these cases, remove lamp and starter, replace the lamp and with a short, insulated wire stripped about 1/4-inch on each end short the 2 terminals in the starter socket for several seconds. Then remove the wire and the lamp will start. If the noise level remains the same it may or may not be defective and a new starter should be tried. A shorted condenser will cause the lamp electrodes to glow without allowing the arc to strike.

BULB RADIATION

Direct radiation from the lamp bulb is of a low order of strength and falls off rapidly as the distance between the lamp and radio is increased. Although the magnitude of this bulb radiation varies with the watts consumption of the lamp, bulb radiation or radiation emanating from the supply lines feeding the lamp can be avoided by separating the lamp and radio set by at least 10 feet.

If separation by 10 feet is not feasible then it will be necessary to take these precautions:

(1) Shield (and ground) the lead-in where it passes within 10 feet of the lamp or install a noise-reducing antenna system.

(2) Provide a good ground for the radio. If the radio is of the A.C.-D.C. type, an external ground is not required because the chassis is usually connected to one side of

the line thus acquiring a ground potential.

(3) Surround the lamp with a grounded wire-mesh screen. This, of course, can be done only in certain instances where the appearance of a screen would not be objectionable. The mesh should be large enough so as not to reduce the transmission of light materially. In some fixtures where the lamps are enclosed by glassware or plastic it is possible to install a screen cylinder between the glass and lamp. If this is done, provisions must be made for relamping.

(4) For radio receivers with built-in directional antenna systems, adjust the position of the radio set to pick up a minimum of noise.

A portable, battery-type radio set is handy for bulb radiation sleuthing since the line feedback factor is eliminated by this method of probing for noise*.

LINE RADIATION

The power lines feeding the lamps may serve as a source of radiation to the radio set or to the antenna system unless the separation is about 10 feet as explained under the discussion of bulb radiation. The same general precautions apply about shielding the lead-in but, in addition, noise reduction can be obtained by applying a grounded shield to that part of the power line near the radio set. In many instances this is not possible because the wires are inaccessible within the walls or ceiling but for extension cords in residences this remedy could be easily applied. If the power lines are run in metal conduit or are of the BX type make sure that good high-frequency bonding is in effect at all junction boxes.

Line radiation can be reduced also by inserting a filter in the line at the lamp. This procedure shunts the noise to ground before it can enter the line and be radiated through the air to the radio receiver or antenna lead-in.

LINE FEEDBACK

If noise energy is allowed to enter the power lines from the lamp, it may feed

*Also see "How to Make a Modern Interference Locator," Radio-Craft, January, 1941.—Editor

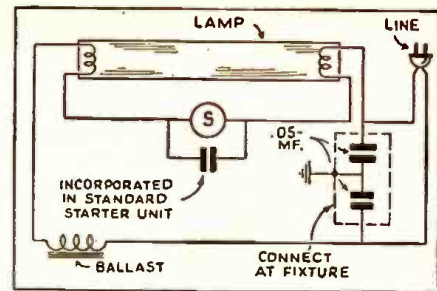

back to the radio set through its power supply circuit. This energy may never reach the radio set if the length of the line is large because of the line impedance, therefore when the line is short the possibility of feedback is greater.

Line feedback can be eliminated by the use of filters either at the lamp or at the radio set. The method of filtering at the lamp may require many filters if many lamps are contributing to the general noise level. However, if individual filters are applied to the nearest lamps, noise trouble should abate. Applying a filter at the radio receiver is positive in protection against feedback but requires greater high-frequency attenuation and probably will require greater current-carrying capacity than individual filters at the lamps. As in any power line noise reduction work, inductive - capacitive filters are more effective than merely capacitive reactances, but the cost is greater.

The generation of noise radiation by fluorescent lamps is inherent in the operation of all discharge-type lamps but it is felt that as improvements are continued in the manufacture of this new light source, material reductions can be expected in the problem of radio interference.

This article has been prepared from data supplied by courtesy of Westinghouse Electric & Mfg. Co., Lamp Division.

Watch for Part III, the concluding installment, of this series of important articles on Fluorescent Lighting from the Serviceman's viewpoint.

OPERATING NOTES

Trouble in . . .

STEWART-WARNER R136

Have just finished repairing a Stewart-Warner R136 which faded badly and came back with a bang. After replacing the 110,000-ohm 1/4-watt, and 260,000-ohm 1/4-watt resistors, the trouble entirely cleared up. This may aid some Servicemen.

A. M. HORATER,
Bridgeport, Conn.

RCA V-130, HF-1, HF-2; WESTINGHOUSE WR-370

A rather puzzling and unusual case was recently encountered, where the receiver would cut off if a certain pushbutton set for an especially strong signal were pressed. This very strong signal, or any heavy burst of static, would temporarily disable the set. It was found that by removing the 1st I.F. tube's grid connection, or reducing gain by using a shorter antenna, or turning the set off and on, would restore operation. A vacuum-tube voltmeter indicated that the grid voltage of the 2nd I.F. 6K7 was -35 volts. Removing the 1st I.F. tube reduced gain and the -35 changed to -3. The changes shown in the diagram were made, breaking the lead at X and using the parts

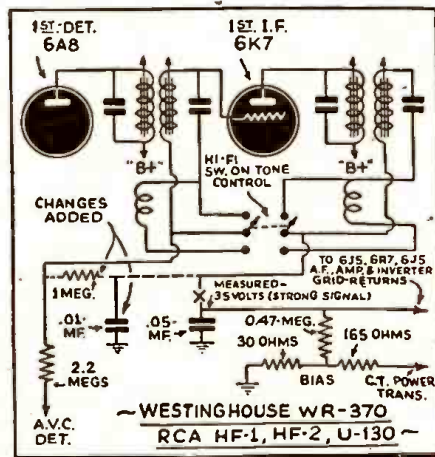

shown. The 2-pole, double-throw switch is a changeover from normal to high fidelity band-pass. Apparently the fixed-bias 6K7 drew grid current with high input voltages, cutting off. No further trouble was had when the change shown was made. The 6K7 then was A.V.C.-controlled.

WILLARD MOODY,
New York, N. Y.

BOOK REVIEWS

PHOTOTUBES (1940). Published by RCA Mfg. Co., Inc. Size 8 1/2 x 11 ins., soft paper cover, illustrated, 16 pages. (Single copies available gratis.)

In "Phototubes," are given detailed descriptions and diagrams for the use of phototubes in light-operated relays, for light measurements, and in sound reproduction. Commercial types of one manufacture are illustrated, and working diagrams complete with electrical values and design data are given. This booklet is a valuable working manual for the electronic specialist and experimenters.

PHOTO RELAYS. THEIR THEORY AND APPLICATION (1940), by F. H. Shepard, Jr. Copyright by John M. Coffeen. Size 6 x 9 ins., paper cover, well illustrated, 28 pages. Price, 25c.

The author, a consulting engineer on electronic applications and formerly industrial electronic application engineer in one of the largest radio companies, has prepared "Photo Relays, Their Theory and Application," with a view to presenting a description, of photoelectric devices, graduated from the elements of the subject to the eventual conclusion of practical applications.

Essentially practical in its treatment, this book presents a compilation of valuable information on the use of photocells, exciter systems, and glow discharge tubes.

Chapter I, Photoelectric Phenomena; Chap. II, Amplifiers; Chap. III, Glow Discharge Tubes; Chap. IV, Light Sources; Chap. V, Applications.

NATIONAL UNION MODEL W-2

5-Tube Superhet.; 110-V. A.C./D.C.; Automatic Volume Control; Tuning Range 528 to 1,730 kc.; Average Sensitivity 35 Microvolts (for 0.05-Watt Output); Power Output 0.8-Watt, Undistorted; Power Consumption 28 Watts; Built-in Loop Antenna.

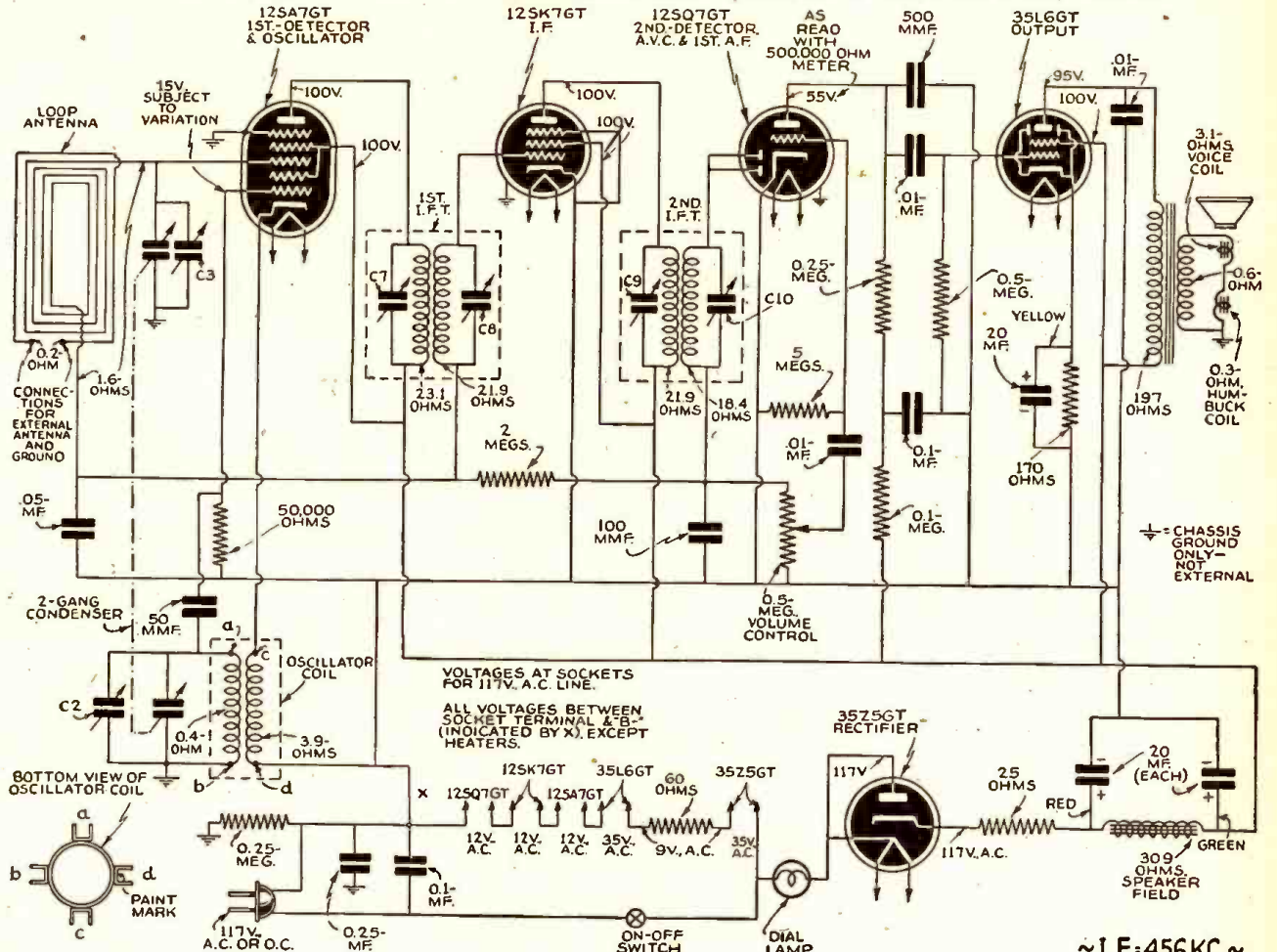

Complete schematic diagram of the National Union Model W-2, 5-tube, A.C./D.C. Loop Antenna Receiver. I.F.-456 kc.

ALIGNMENT PROCEDURE

The following equipment is required for aligning:
 Signal generator which will provide an accurately calibrated signal at the test frequencies as listed.
 Output indicating meter; non-metallic screwdriver.
 Dummy antenna—0.1-mf. and 200 mmf.

Volume control—Maximum for all adjustments. Allow chassis and signal generator to "heat up" for several minutes. Connect ground post of signal generator to "B-" (12SK7GT—prong No. 3) in chassis.

SIGNAL GENERATOR FREQUENCY	CONNECTION AT RADIO SET	DUMMY ANTENNA SETTING	CONDENSER SETTING	ADJUST TRIMMERS TO MAXIMUM (See trimmer illustration)
466 KC.	Signal grid of 1st-det. Connect at stator of large gang section.	0.1-mf.	Turn rotor to full open	1st I.F. (C7 and C8) 2nd I.F. (C9 and C10)

1,730 KC.	Antenna clip	200 mmf.	Turn rotor to full open	Oscillator (C2)
1,500 KC.	Antenna clip	200 mmf.	Turn rotor to max. output	Antenna (C3)

NOTE—To obtain dial scale calibration, tune-in an 800 kc. signal. The pointer should be at the 800 kc. mark on the dial. If it is not, first remove the celluloid crystal by taking out the 4 buttons at the corner. Hold the tuning knob and shift the pointer to the 800 kc. mark.

Caution

The metal chassis is connected to one side of the line through a 0.2-mf. condenser. Both A.C. and D.C. power lines are generally grounded on one side. If the side of the line not connected to the metal chassis through this condenser is grounded and the metal chassis comes in contact with an external ground, this condenser will be connected across the line and there will be an increase in hum.

Therefore, in any service work on the chassis, keep it on a wood or other insulated surface to avoid contacts with ground. The person working on the set should avoid getting in contact with any ground.

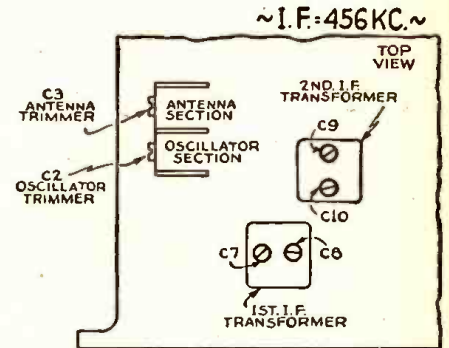

Sketch showing locations of main components and trimmers.



National Union Model W-2 Receiver.



HERE'S A BIG SAVING for Any Serviceman Who Makes Frequent Volume Control Replacements

WHAT IS IT?

This IRC Master Radiotrician's Control Kit, factory packed with 18 Type D Universal Controls, 6 switches and 5 extra shafts of special design (1) Enables you to give better, faster service; (2) Saves time and cost by eliminating frequent need for ordering special controls; (3) Avoids frequent trips to your jobber; and (4) Helps systematize your shop by supplying a good-looking container that enables you to tell at a glance just what controls should be re-ordered. *You can actually meet from 60% to 75% of your replacement needs with this Kit!*

CAN I AFFORD IT?

No serviceman who uses controls frequently can afford to be without it. You pay only the standard net price of the controls, switches and shafts. The All-Metal Cabinet (worth \$2.50) is included free.

DOES IT CONTAIN THE CONTROLS I NEED?

The carefully selected control assortment is based on a nation-wide survey of servicemen's needs. It includes only popular controls, widely universal in application, thanks to the Tap-in Shafts. If you find by experience, however, that, due to some local predominance of certain sets, you would prefer any other IRC Type D Universal Controls, your jobber will gladly make the exchange *at any time.*

HOW WILL I KNOW WHAT CONTROLS TO USE?

Included free with your Cabinet is the latest IRC Volume Control Guide. This indicates exactly what controls to use for practically all sets you may be called upon to repair.

WHAT ABOUT OBSOLESCENCE?

The only things that *could* become obsolete are the shafts and, as fast as new shaft styles are required, IRC will have them—of Tap-in design and constructed for use with the Type D Controls contained in your cabinet.

ARE "MIDGET" CONTROLS ANY GOOD?

Don't call IRC Type D Universal Controls "Midgets"! Actually, they are small-size replicas of the larger IRC Type CS Controls—the only small controls that are exact mechanical reproductions of a manufacturer's larger controls. You can use them satisfactorily wherever Type CS or old-style larger controls have been used in the past.



WHAT ABOUT TAP-IN SHAFTS?

IRC Tap-in Shafts make controls easier to install in a crowded chassis by obviating the necessity for removing other parts. They won't pull or vibrate loose. A variety of special shafts enables you to make the 18 Controls handle an amazing variety of jobs, standard and special.

WHY HURRY?

Well, why postpone getting your Cabinet and starting to collect dividends on a good-paying investment? And don't forget the re-allocation of broadcast station wave lengths! Countless customers will want you to re-adjust their push-button tuning. Carry your IRC Control Cabinet on these jobs. You'll be surprised how many control replacement jobs you can also sell—and do the work right then and there!

WHAT'S THE BAD NEWS?

There is none! Your total investment is only \$14.97 net (List, \$24.95). This equips you for the big majority of control replacements—and you get the \$2.50 Cabinet free. Many IRC jobbers are glad to extend easy terms and otherwise cooperate in making your IRC Control Kit actually pay for itself in the time, money and effort it saves during the first few months you own it!

See it at your IRC jobber's today, or write to us for folder.

INTERNATIONAL RESISTANCE COMPANY
401 North Broad St., Philadelphia, Pa.

TYPE D UNIVERSAL VOLUME CONTROLS WITH TAP-IN SHAFTS

CROSLY "GLAMOUR-TONE" MODEL 26BB (Chassis Model 26)

8-Tube A.C. Superhet.; 3 Bands (550 to 1,600 kc.; 1,600 to 5,000 kc.; 6 to 18 mc.); Broadcast-band Built-in Adjustable Loop Antenna; Stage of R.F.; Electric Pushbutton Tuning, Variable Bass Compensation; 12-in. Speaker; Push-Pull Output; Tone Control; A.V.C.

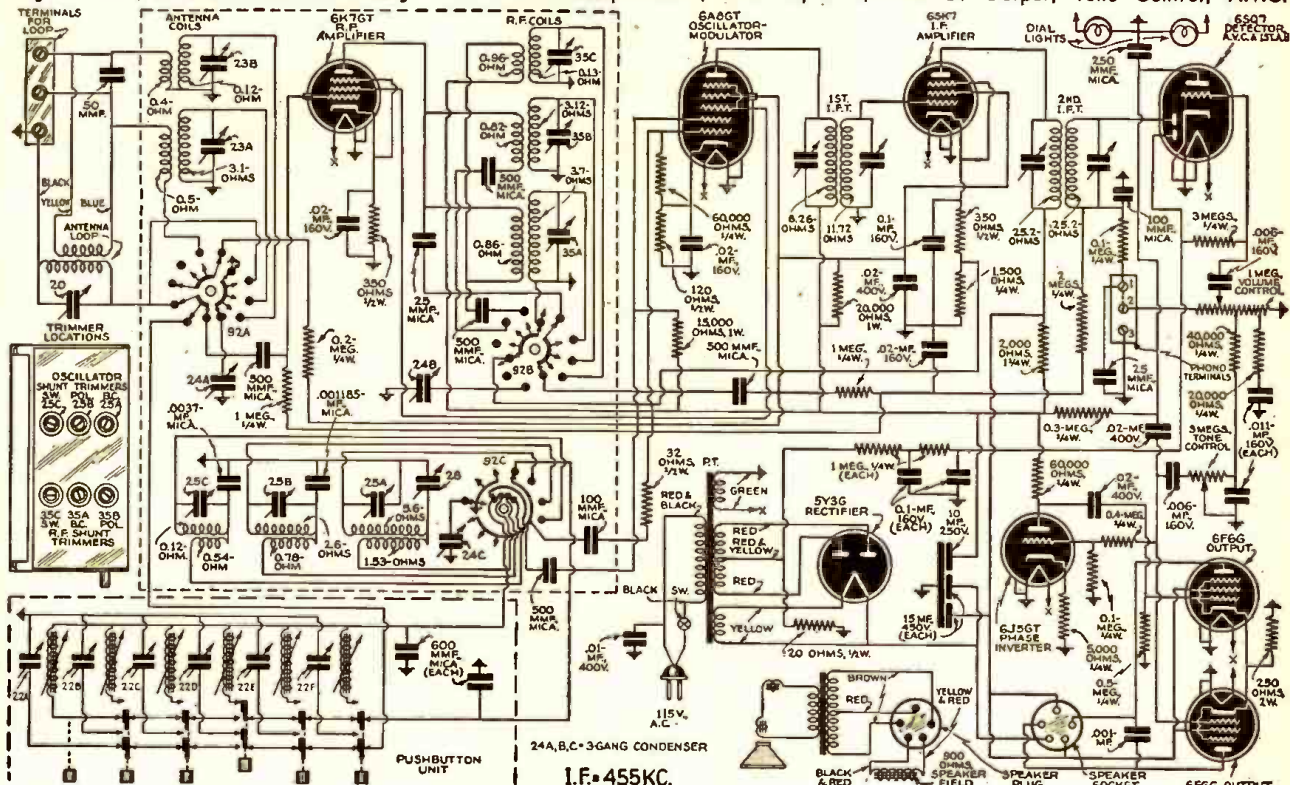

Complete schematic diagram of the Crosley Model 26BB Chassis. The inset shows how to connect a phono pickup to the circuit.

ALIGNMENT PROCEDURE

- Preliminary
 Output meter connections Plate to plate of 6F6s
 Generator ground connection . . . To chassis or ground lead
 Dummy antenna to be in series with generator output . . .
 Position of volume control Full on
 Position of tone control Treble or Speech

IMPORTANT ALIGNMENT NOTES

When aligning the shortwave bands, "OSC" trimmers care must be exercised to see that the circuits are aligned on the correct frequency and not on the image which is approximately 910 kilocycles less as indicated on the dial. To check, increase generator output, tune-in the generator frequency and then tune-in the image frequency which should be weaker than the fundamental and come in approximately 910 kilocycles lower on the dial than the fundamental. If image cannot be tuned-in, the "OSC" trimmer is adjusted to the wrong peak. (Correct peak is the 2nd peak on trimmer from the closed position.)

Repeat the original alignment procedure for more accurate adjustments. Always keep signal generator output as low as possible to prevent action of the A.V.C. circuit.

Signal Generator

Alignment Sequence	Dummy Antenna	Frequency Setting	Input Connection to Receiver	Band Switch	Tuning Cond. Setting	Trimmer Adjusted	Remarks
1.	0.02-mf.	455 kc.	Grid of 6A8GT	B.C.	Full open	2nd I.F. (2) 1st I.F. (2)	Adjust for maximum. Adjust for maximum. Adjust for peak; gang does not have to tune through signal.
2.	200 mmf.	1,650 kc.	Ant. lead (Blue)	B.C.	Full open	B.C. "OSC" Trimmer	Adjust for maximum output while rocking gang through signal.
3.	200 mmf.	600 kc.	Ant. lead (Blue)	B.C.	Approx. 60 on dial	B.C. "ANT" Trimmer	Adjust for maximum output; do not touch B.C. Osc. trimmer.
4.	Repeat Step No. 2				to check possible shift due to series adjustment		
5.	200 mmf.	1,400 kc.	Ant. lead (Blue)	B.C.	Approx. 140 on dial	B.C. "R.F." Trimmer	Adjust for maximum output.
6.	400 ohms (carbon)	5.3 mc.	Ant. lead (Blue)	Police	Full open	Pol. "OSC" Trimmer	Adjust for maximum output while rocking gang through signal.
7.	400 ohms (carbon)	5.0 mc.	Ant. lead (Blue)	Police	Approx. 5.0	Pol. "ANT" and Pol. "R.F." Trimmers	Adjust for maximum output while rocking gang through signal.
8.	400 ohms (carbon)	18.3 mc.	Ant. lead (Blue)	S.W.	Full open	S.W. "OSC" Trimmer	Adjust for peak. Gang does not have to tune through signal.
9.	400 ohms (carbon)	18.0 mc.	Ant. lead (Blue)	S.W.	Approx. 18	S.W. "ANT" and "R.F." Trimmer	Adjust for maximum output while rocking gang through signal.

SOCKET-TO-CHASSIS VOLTAGES (117.5 V. LINE; 1,000 OHMS/VOLT METER, ON 500 V. SCALE) ±10%

Component	1	2	3	4	5	6	7	8
6K7GT—R.F. Amp.	0	0	187	75	0	J.B.	*6.3	2
6A8GT—Osc.-Mod.	0	0	187	75	0	J.B.	*6.3	1
6SK7—I.F. Amp.	0	0	2.3	0	2.3	J.B.	*6.3	228.0
6SQ7—Det. A.V.C.-A.F.	0	0	0	0	0	J.B.	*6.3	0
835—Phase Invert.	0	0	120	0	0	J.B.	*6.3	5.3
6F6—Output	0	0	220	230	0	J.B.	*6.3	14.5
6F6—Output	0	0	220	230	0	J.B.	*6.3	14.5
5Y3G—Rectifier	0	0	220	230	0	J.B.	*6.3	14.5
Drop across speaker field	95 V.	NC	329.0	J.B.	*358.0	J.B.	358	J.I.I.

NOTES
 *Measure with A.C. Vm.
 J.B.—Junction Block
 Max. power output, 117V.
 line, 8W.; power consumption, 117 V. line, 85 W.; drop across speaker field, 95 V.

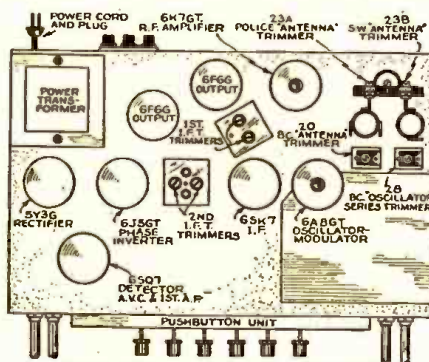

Chassis view showing main components.

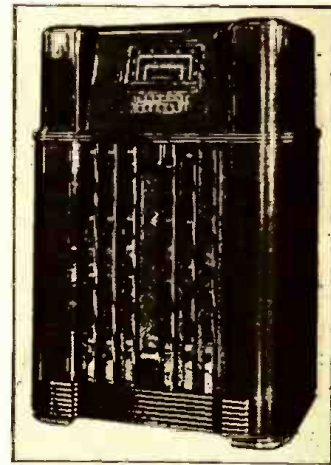

Crosley "Glamour-tone" console model 26BB (Chassis 26), an 8-tube superhet. covering broadcast, police and short-wave frequencies in 3 bands.

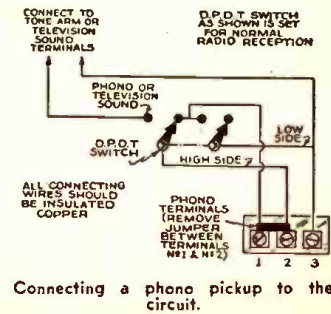

Connecting a phono pickup to the circuit.

REPAIRING OPEN MAGNETIC COILS

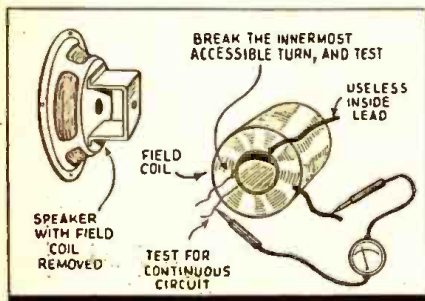

● WHEN magnetic coils burn out they invariably open at the innermost layer. Electric clock coils, A.F. transformers and dynamic speaker coils can be made as serviceable as ever by making contact with one of the inner layers, inasmuch as the loss of the dead end will never be noticed. Magnetic coils will retain their form if one of the side winding forms is removed.

With a needle and tweezers, the innermost accessible turn is broken and the end that makes continuous circuit with the good part of the coil is determined and unwound enough to make contact with the dead end contact. Sometimes it is advisable to coat the exposed side of the coil with collodion before the operation is attempted. Often it is easier to remove the pasteboard tubing at the center of the coil, and pull out the exposed wire until the break is discovered.

C. ELROY,
Philadelphia, Pa.

LOCATING "OPENS" IN VOICE COILS

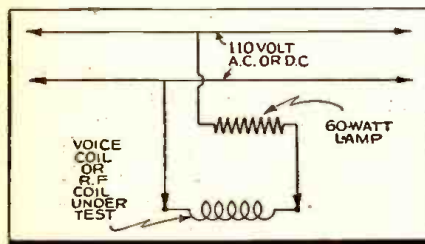

● I WOULD like to take this opportunity of contributing a small time- and trouble-saving wrinkle.

This has to do with locating an open-circuit in the voice coil or voice coil leads of a dynamic speaker, particularly those cones glued to the speaker frame or those with wires interwoven with the spider support.

This open can be determined by a check of continuity but the exact location of the break usually means pulling the cone off the frame and then tracing the wire to the break. Now here's the kink. Place a 60-watt lamp in series with the voice coil and 110 volts, and as the cone is moved up and down in the speaker, a spark will designate the exact break. In extreme cases a larger lamp may be necessary to provide a larger arc but care must then be taken that the voice coil is not left in the circuit too long as the wire is seldom large enough to carry heavy current.

EARLE B. KIMBLE,
Service Manager for
Pudney Bros.,
London, Ontario, Canada

NEXT MONTH:

Part I of the CLASSIFIED RADIO DIRECTORY completely revised. Reserve your copy at your local newsdealer today. (See listing of classifications, by months, on page 574.)

Unbeatable and Easy to Own



SUPREME MODEL 504

MORE than 3,000 SUPREME Model 504 Tube & Set Testers in constant and profitable service prove it to be the unbeatable value in the test equipment field. There are many combination tube and set testers but only SUPREME offers those necessary and desirable advantages found in the Model 504.

Take SPEED, for instance. As a multimeter, 31 ranges and functions are at your finger tips. Only two pin jacks and two rows of quick acting push buttons are necessary to give you complete control. Functional switches are on one side of the panel and range switches on the other side of the panel. All that is necessary is to press one button on the left hand row for the function desired and one button on the right hand row for the range desired.

As a tube tester, merely rotate the smooth acting roller chart to the type desired and "follow the arrows." Leakage tests are equally simple. With the same set-up just press one button after another on the right hand side of the panel.

Protection against OBSOLESCENCE is important. The Model 504 is built to be modern today, to stay modern tomorrow. It provides for all filament voltages from 1.4 volts to the full line voltage, of course, but much more than that—it is the only instrument having the PATENTED DOUBLE FLOATING FILAMENT RETURN SELECTOR SYSTEM which automatically re-connects every tube socket to the proper arrangement while the

instrument is being set up from the roller tube chart. Tube base connections on future tubes may change to any of the many hundreds of POSSIBLE arrangements and the 504 will take care of it—automatically—even unknown to the operator. That's why the 504 has only one socket for each type of tube—it is impossible to put a tube in the wrong socket.

Speed in testing electrolytic condensators too. All electrolytic capacitors, including high voltage filter capacitors and low voltage—high capacity by-pass condensers are checked at their CORRECT WORKING VOLTAGE on an English reading scale.

These are just a few of the many PLUS advantages you have when you own a Model 504 Tube & Set Tester. It is beautiful in appearance, sturdily built, carries a year's free tube setting service, and best of all, it is EASY TO OWN. If you can afford a telephone or if you can afford your cigarettes, you can afford the Model 504. This complete laboratory, combining a 7-way tube tester, a 31-range set tester and a complete condenser analyzer, costs you no more than 18c a day on the world's easiest installment terms.

THE MODEL 543 is one of those rare values in a completely self-contained multimeter. A single rotary switch provides automatic operation of the four basic functions, OHMS, AC VOLTS, DC MILLIAMPERES, DC VOLTS at 1000 ohms per volt standard sensitivity. This handy



SUPREME MODEL 543 MULTIMETER

little instrument uses a full size 3" meter and beautiful bakelite case measuring only 3"x5 3/4"x2".

This is truly a tester that will fit your pocket and your pocket-book.

THE MODEL 542 is a regular little pocket laboratory with five multimeter functions including: AC VOLTS, DECIBELS, DC VOLTS, DC MILLIAMPERES, and OHMS-MEGOHMS. The unit is complete in every respect requiring no external batteries for the ohms and megohms ranges. A full size 3" meter with a sensitivity of 5000 ohms per volt (200 microampere movement) indicates the readings for 24 carefully selected ranges. This is a value that is not being overlooked by those who desire an ultra portable instrument that possesses the accuracy and utility of the larger testers.



SUPREME MODEL 542 MULTIMETER

SUPREME

SUPREME INSTRUMENTS CORP. GREENWOOD, MISSISSIPPI, U. S. A.

ASSURE YOURSELF OF GREATER PROFITS BY DOING RADIO SERVICE JOBS MORE QUICKLY. USE GERNSBACK MANUALS. SEE PAGE 518.

SAVE UP TO 50%
30 DAYS TRIAL
15-TUBE MIDWEST RADIO
FACTORY-TO-YOU
PUT THIS CHASSIS IN YOUR PRESENT CABINET
PUSH-BUTTON TUNING
LIBERAL TRADE-IN ALLOWANCE on many new models shown in FREE catalog—from 6 to 18 tubes—up to 5 bands—including automatic record-changing radio phones... Home Recorder, etc. (User Agents Wanted)
UP TO \$25.00 TRADE-IN ALLOWANCE
EASY TERMS
MIDWEST RADIO CORPORATION DEPT. 12-GG CINCINNATI, OHIO

WAY TO REPLACE
Simplest BALLASTS
4 STANDARD TYPES of Amperite Regulators replace over 200 types of AC-DC Ballast Tubes now in use... Has patented automatic starting resistor.
List \$1.00
WRITE FOR REPLACEMENT CHART "S"
Amperite Co. 561 Broadway, N. Y. C.
AMPERITE

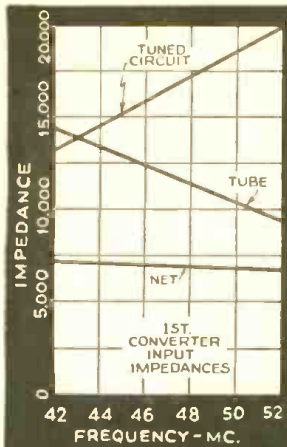

FIG. 2

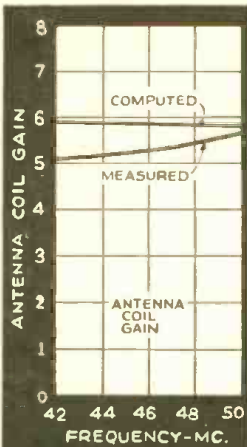

FIG. 3

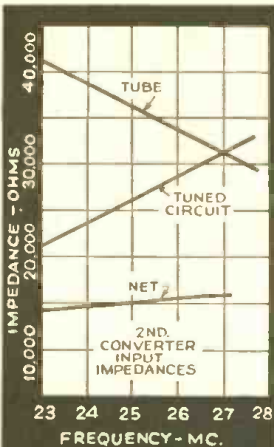

FIG. 4

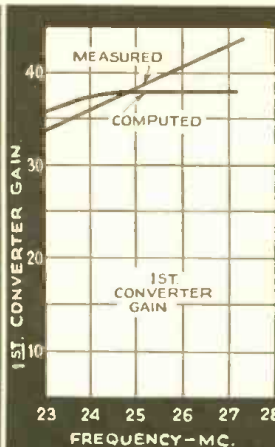

FIG. 5

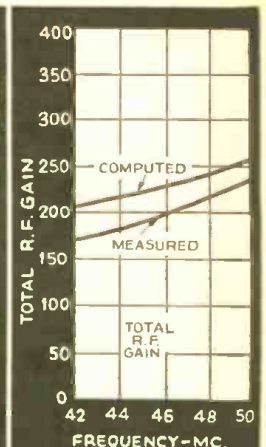

FIG. 6

RECENT IMPROVEMENTS IN F.M. RECEIVER DESIGN

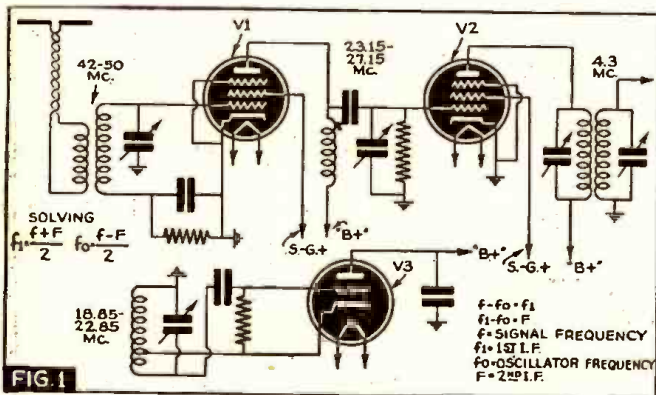

FIG. 1

By special arrangement with the Engineering Department of the Radio Manufacturers' Association an engineer here analyzes new developments in Frequency Modulation embodied in a late-model F.M. set.

J. A. WORCESTER, JR.

◀ The G.E. model JFM-90 is an F.M. "double superhet," utilizing only 1 oscillator.

NOW that the Federal Communications Commission has permitted Frequency Modulation on a nation-wide commercial basis, it is important that certain improvements be made in F.M. receiver design, from 2 important standpoints:

(1) *Greater sensitivity*, to permit adequate quieting on all signal inputs down to the ultimate limit imposed by receiver tube noise; and,

(2) *More satisfactory quieting*, by effecting better limiter operation.

Both of these receiver improvements are necessary if the full noise-reducing properties of F.M. are to be demonstrated and effectively employed to permit the realization of satisfactory full-range reproduction.

SENSITIVITY

It is proposed to consider initially the requirement of adequate sensitivity. It can be shown that the receiver inherent noise level is approximately 1 microvolt r.m.s., when referred to the antenna input. This is determined by computing the thermal agitation noise in the grid circuit and the shot noise in the plate circuit of the first tube. The shot noise is referred to the grid circuit by dividing by the first tube gain. These 2 noise voltages are then combined by taking the square root of the sum of their squares. This total noise voltage is then referred to the antenna input by dividing by the antenna coil gain.

It can also be determined experimentally that a signal at the limiter input of approxi-

mately 4 volts r.m.s., is required for 20 db. (or 10 to 1) noise reduction. It is thus seen that a minimum voltage gain of 4,000,000 times is required to the limiter input and since a limiter amplification of at least 5 is required for adequate deviation sensitivity, the required total voltage gain, exclusive of audio amplification is 20,000,000 times.

The limitations on the voltage gain that can be realized at the intermediate frequency will be investigated followed by a study of the difficulties involved in completing the required total gain at the signal frequency. The solution to the problem as incorporated in the JFM-90 General Electric Frequency Modulation Translator (or adapter—*Editor*) will then be described. This, incidentally, is a complete frequency modulation receiver, except for audio amplification and is designed to plug into the phono jack of an ordinary receiver.

The amplification that can be realized at the intermediate frequency is, of course, limited by feedback tending to cause instability or oscillation. Feedback may occur in any or all of the ways enumerated.

(a) Through common plate, screen-grid, A.V.C., or heater circuits.

(b) Overall or stage-to-stage stray inductive coupling.

(c) Overall or stage-to-stage stray capacitive coupling.

All of these feedback paths can be theoretically eliminated by filter networks and extensive shielding except the capacitive

feedback through the plate-to-grid capacity of the tubes themselves. Formulas for determining the maximum gain of single and multi-stage amplifiers before oscillation from plate-to-grid tube capacity occurs have been developed in the literature. Experience indicates that 2 stages of intermediate frequency amplification prior to the limiter are capable of supplying all the amplification that can be obtained with stability. The theoretical maximum stage gain of such an amplifier is given by the equation

$$\text{Gain} = \sqrt{\frac{g_m}{2\pi c f}}$$

where g_m is the mutual conductance of the tube

c is the grid-to-plate capacity of the tube

and f is the intermediate frequency. It will be noted that the gain factor of the tube is g_m/c . The 6SK7 is somewhat superior to the 6AB7 (1853) in this respect and hence will be considered in the computations. The 6AC7 (1852) is slightly superior to both, but is not preferred due to its high cost and somewhat questionable reliability.

The remaining factor influencing the amplification is the intermediate frequency. Since the voltage gain per stage decreases as the square root of the intermediate frequency it is desirable to employ as low a value as possible. It should not, however, be reduced to the point where image difficulties are encountered. For a 42-50 megacycle frequency modulation band, the intermediate frequency should preferably equal or exceed 4 megacycles in order to preclude the possibility of images occurring within the frequency range covered. Another factor to consider is direct I.F. pick-up. This renders 4 megacycles undesirable since it would pick up the 80-meter amateur

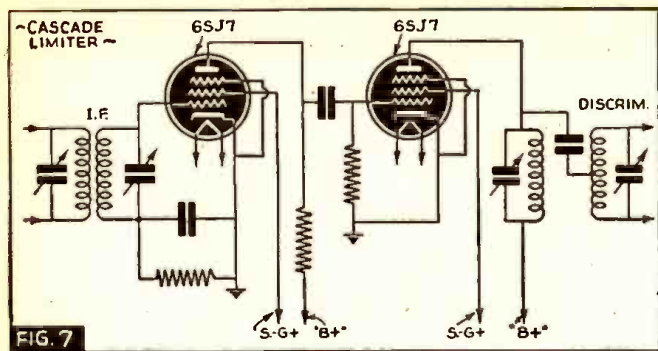

The use of 2 type 6SJ7 tubes, as in the G.E. model JFM-90 Frequency Modulation receiver, affords better latitude of grid-bias control and also increases the effectiveness against impulse noise.

phone band. Many other considerations are involved in the selection of a suitable intermediate frequency which are outside the scope of this article. Many of these factors have been considered by the Radio Manufacturers' Association and they have as a result recommended an intermediate frequency of 4.3 megacycles.

EFFECTIVE I.F. GAIN

With this as a basis it is found that a theoretical I.F. gain of 122 per stage is possible. This figure is, however, subject to 2 revisions.

The first of these is a factor of 2 required to prevent oscillation during the aligning process. This assumes the use of critically-coupled, 2-coil transformers and comes about from the fact that until tuned to the same frequency the individual circuits of each transformer have approximately twice their normal impedance and hence represent a condition much more susceptible to oscillation. This then reduces the theoretical gain to 61 per stage.

The second revision is to provide some safety factor for variations in tubes, inductances, line voltage, power transformers, rectifier drops and tolerances in other components. The difficulty in obtaining useful information from this formula lies in the proper evaluation of this second factor. Indications are that it should be at least 2, thus resulting in a theoretical stable gain per stage of approximately 30. Hence, the gain of the I.F. amplifier prior to the limiter is about 900 exclusive of the converter gain.

The converter voltage gain is normally included as I.F. amplification, but since the converter input represents essentially zero impedance to I.F. it is not involved in stability considerations. It is obvious, therefore, that the converter gain should be made as large as possible. This indicates the use of a high- g_m pentode such as the 6AB7. Operated under suitable conditions as a converter this tube will provide about 1.25 times the gain of a 6SK7 operated as an amplifier. Thus the converter voltage gain should be about 37.5 providing a total theoretical I.F. voltage gain of 33,800.

It should be emphasized at this point that the above voltage gain figure assumes that all sources of feedback except that through the plate-to-grid capacity of the tubes have been eliminated. This is never entirely true especially when an additional I.F. amplification of 5 exists subsequent to the limiter. Practical experience dictates that I.F. voltage gains at 4.3 megacycles appreciably in excess of 15,000 to the limiter input are decidedly risky from a production standpoint. It is possible that receivers made on a custom-built basis could be designed with a total I.F. voltage gain lying somewhere between the theoretical 33,800 and the maximum practical production value of 15,000. Suppose for the sake of argument that the maximum I.F. voltage gain permissible ahead of the limiter is 20,000. We previously have found that a total amplification of

4,000,000 was necessary. This leaves a gain of 200 to be supplied by the R.F. amplifier.

R.F. GAIN

The antenna coil gain that can ordinarily be obtained can be computed with a fair degree of accuracy from the formula

$$\text{Ant. coil gain} = .707 \sqrt{\frac{Z_s}{Z_p}}$$

where Z_s is the equivalent secondary impedance

Z_p is the primary transmission line impedance of 100 ohms.

The factor of .707 is necessary since the reactance in the primary circuit is not normally tuned out. Z_s is represented by the parallel combination of the tuned circuit impedance and the input impedance of the tube. At 46 megacycles, the former is about 15,600 ohms with a well-designed antenna coil and the latter about 6,650 ohms for a 6AB7 tube. This gives a net secondary impedance of 4,600 ohms.

Hence

$$\text{Ant. coil gain} = .707 \sqrt{\frac{4600}{100}} = .707 \times 6.8 = 4.8$$

$$\text{The required R.F. gain is then } \frac{200}{4.8} = 41.5$$

The theoretical voltage gain of a single-stage R.F. amplifier when all sources of feedback except that due to plate-to-grid tube capacity have been eliminated can be computed in a similar manner to that previously employed for the I.F. amplifier. The formula for a single-stage amplifier is given by

$$G_{max} = \sqrt{\frac{g_m}{\pi c f}}$$

G_m = Mutual conductance of tube = $5,000 \times 10^{-6}$

c = Grid-to-plate capacity of tube = $.015 \times 10^{-12}$

f = Radio frequency = 50×10^{-6}

A 6AB7 tube is assumed in this instance since the computed gain can not be readily obtained with the lower g_m , 6SK7, tube. A frequency of 50 megacycles is assumed since the highest frequency would be most susceptible to oscillation from this feedback source, therefore

$$\text{Gain} = \sqrt{\frac{5,000}{3.14 \times .015 \times 50}} = \sqrt{2,120} = 46$$

As in the case with the I.F. amplifier this figure is subject to revision. There are no coupled circuits in the R.F. amplifier but a reduction in amplification is necessary to take account of variations in tubes and other components, variations in line voltage, etc., as enumerated previously.

As before, the factor should be at least 2 to prevent manufacturing and field difficulties. This reduces the theoretical gain to 23. Again, it should be emphasized that this gain figure assumes that all sources of feedback except plate-to-grid tube feedback have been eliminated. In an R.F. amplifier it is even more difficult to approach this

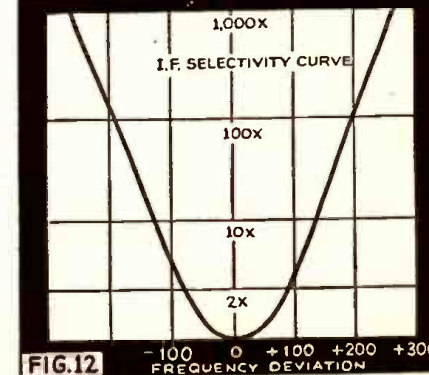
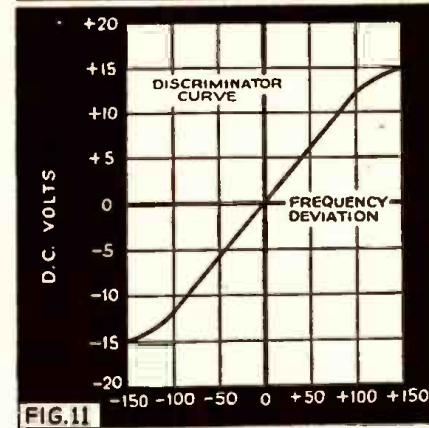
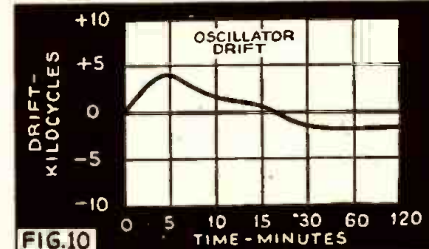
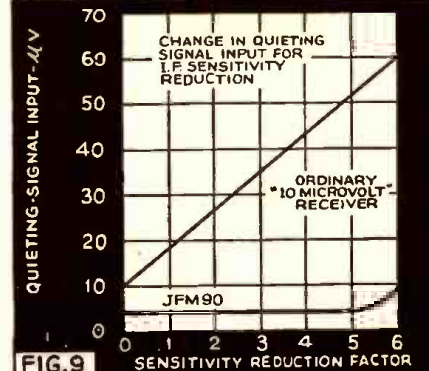
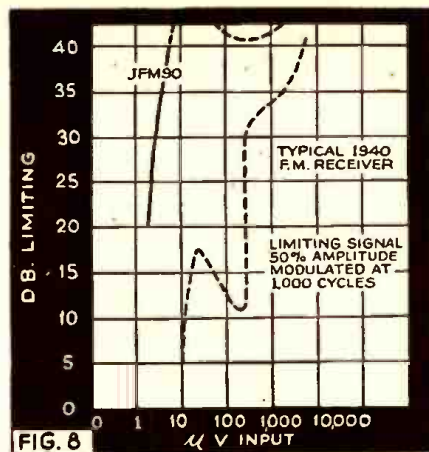

YOU'RE THE DOCTOR

... and you can prove it!



HERE IS Sylvania's latest sales-builder... a radio chassis chart that will discourage the most optimistic home tinkerer.

More clearly than any other promotion piece we've ever seen, "What Is Wrong with Your Radio" convinces your customer that only an expert can make radio repairs... and YOU'RE THE EXPERT.

Write Hygrade Sylvania Corp., Dept. RC31, Emporium, Pa., for a free copy of this mailing piece... and for full information on the 25 other silent salesmen Sylvania offers you either free, or at substantial savings.

Sylvania's Silent Salesmen

- | | |
|-----------------------------------------------------------------------|----------------------------------------------|
| 1. Window Displays, dummy tube cartons, timely window streamers, etc. | 15. Service hints booklets |
| 2. Counter displays | 16. Technical manual |
| 3. Electric Clock signs | 17. Tube base charts |
| 4. Electric Window signs | 18. Price cards |
| 5. Outdoor metal signs | 19. Sylvania News |
| 6. Window cards | 20. Characteristics Sheets |
| 7. Personalized postal cards | 21. Interchangeable tube charts |
| 8. Imprinted match books | 22. Tube complement books |
| 9. Imprinted tube stickers | 23. Floor model cabinet |
| 10. Business cards | 24. Large and small service carrying kits |
| 11. Doorknob hangers | 25. Customer card index files |
| 12. Newspaper mats | 26. Service Garments |
| 13. Store stationery | 27. 3-in-1 business forms |
| 14. Billheads | 28. Job record cards (with customer receipt) |

SYLVANIA

SET-TESTED RADIO TUBES

Also makers of Hygrade Lamp Bulbs, Hygrade Fluorescent Lamps, and Miralume Fluorescent Light Fixtures.

condition. The actual plate-to-grid capacity is considerably enhanced by the capacity between the antenna and R.F. sections of the gang condenser as well as by the leads associated with the same. These leads also provide inductive coupling which is difficult to entirely eliminate. Indications are that even with considerable shielding the effective plate-to-grid capacity is more than doubled by these external contributing sources. An approximation, therefore, we can assume that the practical stable gain is reduced to a value of not more than 10.

The realizable gain is reduced still further by an additional source of feedback in the gang condenser of the conventional common rotor type. This results from common impedance coupling in the ground-returns and cannot be eliminated at these frequencies by the expedient of employing individual wipers for each gang section. In practice this feedback source reduces the stable R.F. tube gain obtainable to a value of approximately 6. It is possible, of course, to eliminate this latter source of feedback by using a gang condenser construction with insulated rotor sections and individual wipers insulated from the frame. This construction is difficult, however, from the condenser manufacturer's standpoint and results in a considerable cost increase.

It is evident that the R.F. tube voltage gain of 6, which appears to be the highest obtainable with conventional gang construction without inviting production difficulties from oscillation, or the gain of 10 obtainable with a special gang rotor construction falls far short of the 41.5 figure we found necessary to complete our required gain.

DOUBLE SUPERHET. (2 oscillators)

A possible solution that suggests itself is the *double superheterodyne*. In this circuit the R.F. tube becomes the 1st converter which may be designed to produce an I.F. in the neighborhood of 10 megacycles. The original converter tube now heterodynes this 10 megacycle signal to the normal I.F. of 4.3 megacycles.

It is thus seen that the oscillator section of the 2nd converter operates at a fixed frequency while the oscillator of the 1st converter must be ganged with the antenna tuning condenser in the usual manner to produce the fixed 1st I.F. of 10 megacycles.

Herein lies the main difficulty with this circuit. We have 1 variable oscillator and 1 fixed oscillator whose fundamentals and harmonics produce innumerable beats, many of which will produce I.F. signals. If these spurious I.F. signals are greater than the equivalent of a 3 or 4 microvolt signal on the antenna they will seriously affect the usable sensitivity. It is generally possible to substantially eliminate this difficulty by choosing the 1st I.F. so that none of the harmonics of the fixed oscillator fall within the frequency band covered; and by employing rather exhaustive shielding and isolation of the fixed oscillator to minimize second and higher order heterodyne effects. The complication involved in this latter precaution unfortunately prevents its utilization in the small chassis space permitted by the usual commercial receiver designs.

DOUBLE SUPERHET. (1 oscillator)

This brings us to the variation of the double superheterodyne circuit employed in the JFM-90 which utilizes only 1 oscillator. Figure 1 is a schematic diagram of the circuit employed. The tuning condensers for antenna, R.F., and oscillator are ganged together as usual. The antenna circuit tunes the F.M. band from 42 to 50 megacycles, the R.F. circuit tunes from 23.15 to 27.15

megacycles, and the oscillator from 18.85 to 22.85 megacycles.

The oscillator voltage is inductively coupled to the grid of the first tube V1. Alternatively this coupling may be accomplished capacitatively. This produces by heterodyne action a signal to which the plate circuit is tuned. The tube also provides a gain of approximate unity for the oscillator frequency. Accordingly, oscillator voltage is also applied to the grid of V2. This operates as a 2nd converter and produces in its plate circuit the I.F. of 4.3 megacycles.

To illustrate the action by an example consider the signal frequency of 42 megacycles. The oscillator frequency of 18.85 megacycles produces a new frequency in the 1st converter plate circuit of 23.15 megacycles. This, in turn, beats with the oscillator voltage on tube V2 producing the I.F. of 4.3 megacycles. Formulas for determining the oscillator frequency and 1st I.F. for any signal and 2nd I.F. may be obtained as follows:

Let

f = signal frequency, f_1 = 1st I.F.

f_o = oscillator frequency and F = 2nd I.F. then

$f - f_o = f_1$ and $f_1 - f_o = F$

$$\text{solving } f_1 = \frac{f + F}{2} \text{ and } f_o = \frac{f - F}{2}$$

The performance of this circuit as used in the JFM-90 will now be considered in some detail. Figure 2 indicates the computed input impedance of the 6AB7 tube and the computed tuned circuit impedance both plotted against frequency. The input conductance of the 6AB7 was first computed as an amplifier using the formula $g = .3f + .065f^2$. This conductance was then halved since the tube operated as a converter has only half its normal mutual conductance. The reciprocal was then taken to obtain input impedance and the result plotted. The tuned circuit impedance was computed knowing the inductance to be 0.45-microhenry and the effective circuit Q to be 120 with the primary loaded with 100 ohms. The net result of these 2 parallel impedances is shown and is seen to be nearly constant at 7,000 ohms.

The antenna coil gain can now be computed in the manner previously discussed and the result is shown in Fig. 3. The actual measured antenna coil gain is also plotted. The computed gain is nearly constant at 5.8 while the actual gain varies from 5.2 to 5.6. The agreement is seen to be reasonably close. It should be noted that the antenna gain computed previously assuming the 6AB7 tube to be operated as an amplifier was 4.8. The difference, of course, is due to the higher input impedance of the tube when operated as a converter.

The impedance of the 1st converter tuned circuit and the 6AB7 2nd converter input impedance are plotted against the 1st I.F. and are shown in Fig. 4. The net equivalent of these 2 impedances is plotted and seems to be approximately constant at 15,000 ohms. The first converter gain can then be computed assuming the g_o of the 1st converter to be 2,500 micromhos. This is shown in Fig. 5 along with the amplification as actually measured. It is again seen that the agreement is good, the computed voltage gain varying from 36 to 38 and the actual voltage gain from 34 to 42.5.

The total voltage gain ahead of the 2nd converter is shown in Fig. 6. The computed gain is seen to vary from 210 to 240 and the actual gain varies from 182 to 228. It is readily evident, from this, that we can essentially realize the amplification of 200

which we found necessary to provide the total required voltage gain of 4,000,000 prior to the limiter input.

Having disposed of the problem of obtaining sufficient voltage gain to produce a signal large enough to provide adequate limiting on any input down to the actual receiver noise level we are in a position to undertake the 2nd required improvement of more satisfactory limiting.

SINGLE-TUBE LIMITER

The limiter used in previously available production receivers is the conventional "single tube grid-bias" type. As is well known, this merely consists of a grid condenser-resistor combination in conjunction with a sharp cut-off pentode such as the 6SJ7. The limiter also generally operates at reduced screen-grid voltage to provide as small an active-grid voltage swing as possible. By "active-grid voltage swing" is meant grid voltage variation active in changing plate current.

The control-grid bias limiter though simple in appearance is somewhat complicated in operation. Its purpose, of course, is to remove amplitude modulation. In order to describe its operation, first assume a constant-amplitude signal applied to the limiter grid having a peak-to-peak amplitude several times the active voltage swing of the tube. The positive peaks of this signal will then charge the condenser sufficiently to provide the required negative bias which is nearly equal to the peak amplitude of the signal. Since the condenser discharges relatively slowly through the grid resistor which may have a value from 50,000 to 250,000 ohms and charges rapidly through the tube grid resistance which is of the order of only 2,000 ohms, it is evident that only a small portion of the signal is required to drive positive and draw grid current. The smaller the grid leak the more positive the signal has to go since the condenser then discharges more rapidly.

It is seen that with a limiter operating in this manner the plate current flows in pulses produced by part of each positive grid cycle. The remaining part of the positive grid cycle as well as the entire negative half drives the grid beyond cut-off. Now assume that some amplitude modulation in the form of an increase in signal amplitude occurs. It is evident that the grid will be driven more positive by this increase in signal and the plate current will tend to increase. However, the plate circuit pulse also becomes slimmer since a smaller percentage of the total positive grid cycle produces plate current. This tends to reduce the average plate current. The trick is to select a value of grid resistor so that these 2 effects produce no net change in the fundamental component of the plate pulse. The difficulty is, however, that this balance will only hold over a small input range. If a signal having 10 times or 1/10 the amplitude of the one considered is applied to the limiter this balance will no longer hold and a new value of grid resistor will have to be found for each case.

This is one of the major difficulties with the single-tube grid bias limiter. The other concerns its operation on impulse noise for which it is notoriously ineffective. This is due to the time constant of the grid condenser-resistor combination which is too slow to properly follow short-duration impulse noises. The grid condenser can only be reduced to a point where it begins to seriously affect the sensitivity. In practice the grid condenser is reduced as much as possible and then a severe compromise made by reducing the grid leak from 20,000 to 50,000 ohms. This is much too low a value

AS CHIEF CONDENSER BLOWER OUTER OTTO OOMPH WAS A FLOPPEROO

Ever since Otto Oomph was a boy, he suffered from a strange disease. Smashophobia, the doctor called it—the horror of breaking things—but there was nothing to be done about it. When he broke a Christmas tree ornament one year, poor Otto cried for two days. When he grew up, he wouldn't shoot as much as a clay pigeon and even the thought of denting the fender of his car would make him sick.



Eventually, however, Otto became an electrical expert. That got him a job in the Sprague laboratories and Otto was really happy for the first time—that is, until someone made him Chief Condenser Blower Outer in the Test Division.

Now, voltage in the electric chair at Sing Sing is 1,200 volts. In contrast, controllable AC voltages in the Sprague lab run as high as 7,200 (and much higher in the special high voltage lab) for here is where Sprague condensers really get "the works." They are torn apart, blown apart, tortured and blasted, not only to see how good they are, but how to make 'em even better.

WHAM! Poor Otto jumped six feet when a can condenser, deliberately loaded with supercharge to determine its break-down point, exploded in a cage.

BAM! SNAPPETY-CRACK. Otto shivered as another condenser gave its life under 4,000 volts of DC.

CLICKETY-CLICK in monotonous regularity as AC refrigerator motor starting condensers were switched tortuously on and off 150 times an hour.

SIZZ-SIZZLE and SISS as vapor streams played on condensers to prove their moisture-proof ability.

In a massive oven, dozens of units were undergoing life tests at 200° F. Elsewhere, Television condensers were telling their story under 3,000 to 10,000 volts of DC; tiny electric razor condensers were getting the equivalent of 14 years of the hardest kind of use; and, almost every minute some condenser gave up the ghost and another fact was added to the science of constructing condensers that excel in the rough and tumble usage of the field.

"I can't stand it—I can't stand it," wailed Otto at last, weeping over the remains of an 8 mfd. 450 V. Atom midget dry electrolytic.

"Gosh, Otto," consoled an engineer. "What you worrying about? That condenser is only rated at 450 V. We had to smack it with a surge of almost 700 V. before it went."

"Sure," sobbed Otto. "But I can't stand this business of busting things. It ain't fair to treat such swell condensers so downright mean. It makes me sick. I—I wanna quit." And quit Otto did.

'Twas a year before we heard from him again and then he wrote:

"Dear Boss: Maybe you think I was silly to quit my job, but it just isn't my nature to bust things up. I'd go home nights and dream about condensers on those torture racks—the finest condensers in the world just waiting to be blown up even if it took all the power in Massachusetts to do it.

"But all's well that ends well. I'm in the radio service business and doing fine. I use Sprague Condensers—and boy, are they real! Not a blow-out in a carload. No failures from moisture—or anything else in fact. I realize it's largely because of the work you guys are doing back there in the lab, but I still say blowing up condensers is a helluva job for a sensitive man like me. Love and Kisses.

OTTO OOMPH"

SPRAGUE PRODUCTS COMPANY
North Adams, Mass.

to permit the desired balance for normal amplitude modulation as previously explained which requires grid resistance of the order of 125,000 to 200,000 ohms.

CASCADE LIMITER

These difficulties are essentially removed by the use of a cascade limiter. Figure 7 shows the cascade limiter employed in the JFM-90. It will be noted that 2 6SJ7 limiter tubes are employed in cascade utilizing resistance coupling between the stages. This produces a gain in the 1st limiter of approximately 3. It will be noted, therefore, that the maximum signal that can be applied to the 2nd limiter is only 3 times the active grid voltage swing of the 1st limiter. If the active grid swings of the 2 tubes are equal, the 2nd limiter only has to handle a 3-to-1 signal ratio. This permits the choice of a grid resistor which will provide an excellent balance of increased peak current vs. reduced transit angle for all signal inputs. The grid resistor of the 1st limiter is 50,000 ohms and picked to provide a short time constant and consequently good limiting on impulse noise.

The large reduction of impulse noise in the 1st limiter makes time constant considerations for the 2nd limiter much less important, and the 2nd limiter grid resistor can be chosen substantially without regard to time constant. A value of 180,000 ohms is chosen in this instance. On direct listening tests this cascade grid bias limiter has been found superior on impulse noises to the non-grid bias and direct-coupled limiters that have been tested.

The combination of greater sensitivity and better limiting can be shown by a single curve showing the amount of limiting in decibels plotted against signal input.

Build YOUR OWN MULTI-TESTER

You'll save money. Here's everything you need to build your own versatile, modern multi-tester—at typical Lafayette low prices! Rush your check or money order today! Ask for FREE 196 page Lafayette Catalog No. 82 when you order.

LAFAYETTE \$6.81
0-200 MICROAMPERE FOUNDATION METER
K10546
AC & DC volts to 5,000, amperes, milliamperes, microamperes, ohms. Capacity and inductance from charts furnished.

LAFAYETTE \$8.77
PARTS KIT
only K10547
Panel, knobs, jacks, multipliers, shunts, rectifier, batteries, all parts, diagram and instructions.

LAFAYETTE HARDWOOD CASE. Finely finished \$142 open-face case, with leather handle. K10530.....

Lafayette Radio

NEW YORK, N. Y. 100 Sixth Ave.
CHICAGO, ILL. 901 W. Jackson Blvd.
ATLANTA, GA. 215 Peachtree Street
BOSTON, MASS. BOSTON, N. Y. NEWARK, N. J. JAMAICA, L. I.

LAFAYETTE RADIO CORP.
Dept. 3C1—901 W. Jackson Blvd., Chicago, Ill.
or 100 Sixth Avenue, New York, N. Y.

I enclose \$..... Rush my order.
 Please rush FREE catalog.

NAME.....
ADDRESS.....
CITY..... STATE.....

TRIPLET

Ultra Sensitive TESTER

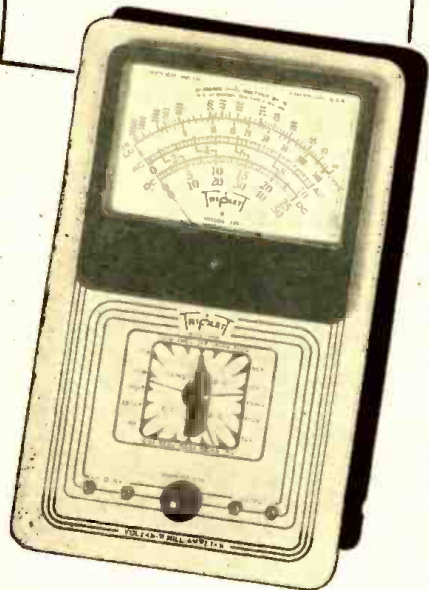

MODEL 1600-E

DEALER NET PRICE **\$21⁰⁰**

DC scales of the instrument read: Voltage 0-10-50-250-1000 (25,000 ohms per volt); 0-1-10-50-250-500 milliamperes; Resistance, low ohms, backup circuit, 1/2 to 500 high ohms, 20,000-200,000 ohms and 2 and 20 megohms. Batteries included for all ranges but 20 megohms. 22 1/2 volt battery for that range can be mounted inside the tester case; brackets provided. AC Voltage 0-10-50-250-1000 at 2000 ohms per volt. A plug-in copper-oxide rectifier, easily replaced in case of overload, is used to obtain AC readings. Model 1600-E, less case for mounting in panel. . . . Dealer Net Price.....\$21.00
In case with handle for portable use—
Dealer Net Price.....\$25.50

MODEL 1620

This is a counter type, lever switch operated tube tester. Four "quick change" non-obsolete features, including RED • DOT Lifetime Guaranteed Instrument. Speed Roll Chart, New socket panel and Switching Section can all be replaced should unanticipated changes make it necessary.



Dealer Net Price **\$37.84**

WRITE FOR CATALOG—SECTION 163 HARMON AVE.

TRIPLET ELECTRICAL INSTRUMENT CO.
Bluffton, Ohio

Figure 8 shows such a curve for the JFM-90 receiver and also includes a curve for a representative receiver of last year's production which employs an R.F. amplifier, 2 stage I.F., and single-tube grid bias limiter. The tremendous improvement in the new receiver on both counts is immediately evident.

"COMMERCIAL" SENSITIVITY

It will be noted that it requires approximately a 4-microvolt signal to produce 20 db. quieting. This is due to the presence of peaks of random noise which have about 4 times the r.m.s. amplitude of 1 μ v. The question might be raised of whether a 4-microvolt sensitivity might not have been just as good as the 1-microvolt value we were endeavoring to obtain. It is felt that this latter sensitivity is desirable to take care of the variations of sensitivity in production and possible later misalignment. Manufacturing final test limits are generally about 3 times that of a representative normal receiver and *additional reductions in sensitivity are likely to occur in storage, shipment and normal use.* It is thus evident that some receivers in actual use will be deficient in sensitivity possibly by a factor of 3 to 5 times.

The effect of such sensitivity loss on quieting signal input was determined for the JFM-90 by adding adjustable bias to the I.F. amplifier to reduce the I.F. sensitivity by the desired amounts and then the quieting signal input measured. The result of these measurements is shown in Fig. 9 and for comparison a similar measurement was made on an ordinary type of F.M. receiver requiring a quieting signal input of 10 microvolts. It will be noted that the required quieting input does not change for the JFM-90 with gain reductions of as much as 5 to 1 while that of the ordinary receiver increases in linear fashion.

IMAGE REJECTION

It is obviously impossible in an article of this nature to cover in such detail all the features of the JFM-90 translator. In view of the new type of superheterodyne circuit used a brief review of its performance as regards *image rejection* may be of interest.

In the usual double superheterodyne 2 sets of images have to be considered, one differing from the signal by twice the 2nd I.F. and the other differing by twice the 1st I.F. In the common-oscillator double-superheterodyne circuit used in the JFM-90, however, the 1st I.F. is variable making the

image frequency fixed at the same frequency as the 2nd I.F., namely 4.3 megacycles. Although this means that the 1st tuned circuit alone is effective in providing I.F. rejection a value of 800 is obtained in the JFM-90. It is felt that this is entirely adequate from a commercial standpoint.

OSCILLATOR DRIFT

The importance of good oscillator stability requires no comment. This problem, normally quite serious in an F.M. receiver, has been alleviated in the JFM-90 by the reduced frequency at which the oscillator operates, namely, 18.85 to 22.85 megacycles. The oscillator circuit is shown on the schematic diagram, Fig. 1.

To further reduce drift a 7A4 loctal-type tube is employed using a mica-filled bakelite socket. Hard-rubber stator insulation is used on the gang condenser, and the oscillator coil is wound on a ceramic form. Trimming is accomplished with an air condenser and the grid condenser is of the zero-temperature-coefficient ceramic type. The remaining drift is substantially removed with a shunt ceramic condenser having a suitable negative coefficient. The resulting drift is indicated in Fig. 10.

Drift precautions are maintained throughout the remainder of the circuit. The I.F. trimmers are of a composite construction having the major portion of the capacity in a fixed silver-mica unit and only that necessary to compensate for manufacturing and tube tolerances in the adjustable unit. All R.F. and I.F. coils throughout the translator are wound on ceramic forms. The discriminator has wider peak separation than in some previous designs to further alleviate the effects of drift and to provide less critical tuning. The discriminator curve is shown in Fig. 11.

The I.F. selectivity curve of the JFM-90 is shown in Fig. 12. It will be noted that approximate critical coupling is employed with 75 kc. deviation down about 2 times from normal input. The I.F. system was somewhat over-designed to cope with the situation existing until Jan. 1 where adjacent-channel operation of F.M. stations was prevalent in the same locality. Eight tuned circuits were provided in this connection by making the first 2 transformers of 3-coil construction.

Concluding, the writer wishes to express his appreciation to Messrs L. M. Ewing and W. W. Moe for the various performance data presented and to Mr. R. B. Dome whose lecture material was utilized in the computations included in this article.

RECOLLECTIONS OF BROADCASTING'S EARLY DAYS

Versatile was the word for a radioman back in the early days of the broadcasting business recalls announcer John B. Gambling, for 15 years a familiar WOR voice. John likes to remember:

... When he was often announcer, engineer, newscaster, physical training instructor, all in the space of an hour and a half.
... When he used to go out on "remote" assignments to hotels and night clubs, with an amplifier under one arm, "B" batteries under the other, a coil of wire on his neck, and huge batteries in his hands which dripped acid on his Tuxedo pants. WOR had only one set of remote broadcast equipment in those days, so John had to lug his load to as many as three places during a night.
... When he was pinch-hitting for "The Man in the Moon," the first kiddie's broadcaster ("Little Sylvia of 999 Newark Avenue has been a very good girl, so Sylvia I'm

going to pin a big, bright star right over your house.")

... When mike fright was so common that a famous actress "froze" and couldn't utter a word, and when in the midst of a commercial program a speaker got so frightened she fainted in his arms.

... When he interviewed the late Queen Marie in her boudoir in a special train en route to New York from Washington, D. C.

... When he took two parts in WOR's first dramatic show, "Step on the Stairs," a mystery thriller, announced and engineered as well. He would monitor the program, then dash out for his lines, then rush back into the control-room again.

... When most programs consisted of either/and/or a pianist and singer, and the staff pianist used to do four consecutive fifteen minute programs under four different names.

A GENERAL UTILITY TESTER

For Servicing Electrical Appliances

Radio men looking for new fields to profitably explore, will do well to consider the possibilities afforded by Electrical Appliances, as Mr. Litt here capably shows. The design and use of an A.C.-D.C. "appliance tester", measuring up to 100 amperes, 1,000 volts and 5,000 watts, and down to 1/50th ohm, and especially devised for this service, is described in this article. Circuit features incorporated in the instrument are diagrammed and analyzed.

SHEPHERD LITT

RADIO SERVICEMEN in recent years have been looking for newer equipment so that fields associated with radio, which their knowledge of electricity and radio covers, could be serviced. Appliance repairs, a field very close to radio repairing, has been sorely neglected. It is true that most radio Servicemen have fixed small defective equipment such as toasters and electric irons. However the larger electrical appliances have been usually neglected. This is not because the Servicemen do not know how to repair such appliances but rather because of a lack of suitable equipment. With a simple tester such as described below, motors, electric ranges, heaters, irons, washers, sun lamps, vacuum cleaners, electric refrigerators and even air conditioning equipment may be successfully serviced. Further, the cost of operation of these various appliances may be easily computed and estimates given, all based on the prevailing price per kilowatt-hour rate.

The Utility Tester here described (see Fig. 5 for circuit diagram) operates on simple electrical laws and is basically a multi-range voltmeter reading both A.C. and D.C. By taking each section of the instrument separately, a better understanding of the instrument can be had.

D.C. VOLTMETER

The voltmeter section uses a simple voltmeter circuit known to every Serviceman. It consists of a 0-1 ma. meter and a group of series resistors to give the proper voltage ranges. Six D.C. ranges are available, viz., 0/1/10/50/100/500/1,000 volts. They are selected by 6 positions on a 2-deck, 7-position rotary switch. The sensitivity of the meter is 1,000 ohms/volt. (See Fig. 1.)

A.C. VOLTMETER

The A.C. voltmeter is not so conventional. It makes use of the same 0-1. ma. move-

ment but with a half-wave rectifier across it. A current-limiting resistor is placed between the half-wave rectifier and the meter. This resistor determines the amount of linearity of the A.C. scale. The higher this resistance, the more linear the A.C. scale. An 800-ohm resistor is used in this instrument to give a fairly linear scale and at the same time eliminate needle vibration. The multiplier resistors are placed between the source of voltage and the rectifier.

Because of the amount of current taken by the rectifier, the A.C. sensitivity of the meter is approximately 400 ohms/volt. This relatively low sensitivity is of no importance since most A.C. voltage readings are taken of low-impedance lines. Therefore the meter movement need not be as highly sensitive as for D.C. use. The A.C. ranges are taken from the lower deck of the 7-point 2-deck switch. Six voltage ranges are available, viz., 0/1/10/50/100/500/1,000 volts. This allows a very wide range of voltage measurements. (See Fig. 1.)

AMMETER

The ammeter circuit (Fig. 2) is also unconventional. It consists of a single shunt across which a voltage drop is measured. The ordinary ammeter uses multiple resistances placed across the meter movement itself. These resistances carry a large current necessitating a switch with very large contacts which is impractical on ranges over 1 ampere. The circuit used here eliminates the need of a large switch since only a small amount of current flows through the switch contacts. It makes use of the fact that the voltage drop across a resistor rises in proportion to the current through that resistor, in other words, Ohm's law. If this resistance is made 1 ohm, the voltage drop across this resistance will be equal to the current passing through the resistance. By connecting a multi-range voltmeter across this resist-

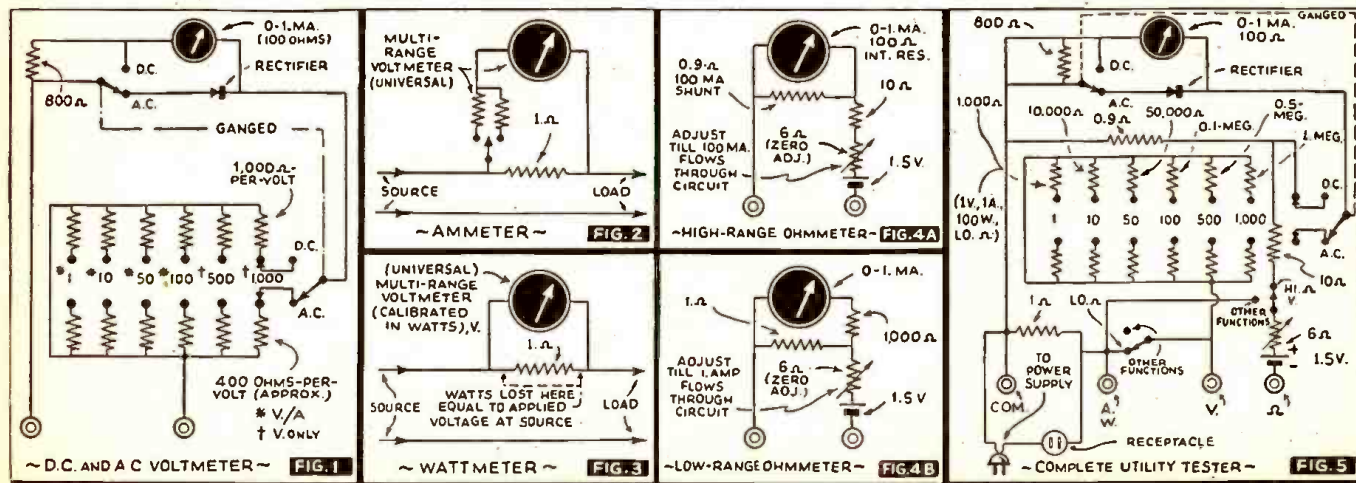

Illustration of the completed General Utility Tester.

ance a very simple ammeter can be had. This resistor will have to be of high watts rating so that the high current passing through it will not burn it out. The voltmeter across this resistor should have a high resistance so that the amount of current drawn from the circuit will be small.

WATTS

If the amount of current flowing through the circuit is multiplied by the voltage across the circuit, watts or power consumption results. Since this instrument contains both a direct-reading voltmeter and an ammeter, the watts drawn by any appliance can easily be measured. (See Fig. 3.) The scale of the instrument has all the necessary computations on it, but since there is a power loss in the 1-ohm resistor, this power loss must be added to the scale reading to indicate the power drawn.



TEST INSTRUMENTS



money
in the
bank!

and you'll enjoy building
your own test equipment
with **RCP** Kits

Save money on an up-to-the-minute tester in just a few hours spare time. It's instructive, and you'll get a kick out of it, too. These RCP Kits have every latest feature in test equipment. They're complete — no extras to buy!

MODEL L
411K
SUPERTESTER
COMPLETE KIT
\$17.35



SPECIFICATIONS
0/10/100/250/1000/5000 volts DC; 0/10/100/250/1000/5000 volts AC; 0/200 microamperes DC; 0/10/100/1000 milliamperes DC; 0/1/10/25 amperes DC; 0/500 milliamperes AC; 0/2.5/5/25 amperes AC; 0/400/40,000/4 megohms; (40 megs with extra battery); Db. meter, 5 ranges -10 to +69; Capacity from .002 to 1 Mfd.; Inductance from .3 to 70 Henries; (direct reading from charts); 4½" square D'Arsonval meter; Hardwood carrying case; All necessary parts.

MODEL
446K



MULTITESTER **\$8.49**
COMPLETE KIT

SPECIFICATIONS
0/5/50/250/500/2500 volts DC; 0/1/10/100/1000 milliamperes DC; 0/10 amperes DC; 0/10/100/500/1000 volts AC; 0/500/100,000/1 megohm; (will read as low as 1 ohm); Four Db. ranges, -8 to +55; Output meter four ranges; 3" square D'Arsonval meter; Walnut finish case; All necessary parts.

YOU NEED a modern meter that tests Television and FM sets, fluorescent lamps, neon signs, household equipment, motors and lots of other money-making service work. See both of these latest type, value-priced RCP Kits at your Jobber—or send for Catalog 124 Today!

RCP
dependable
TEST
instruments

RADIO CITY

PRODUCTS COMPANY, INC.

88 PARK PLACE • NEW YORK, N. Y.

If a toaster is connected to the appliance tester and the meter scale reads 440 watts, and the applied voltage to this toaster is 110 volts, the sum total will be 550 watts drawn. Since the power loss in the resistor is equal to the voltage applied, then the applied voltage can easily be added to the scale for correct readings. This is true irrespective of the line voltage used. An outlet on the front panel of the tester facilitates measuring the power in watts drawn by any appliance having a standard plug at its end. All other tests including the watts drain of equipment not having standard plugs are made by inserting the test leads into the proper tip-jacks. The A.C. readings on the wattmeter are read the same way as the D.C.; however, the accuracy on A.C. will be slightly off if a large inductive load is in the circuit. This is due to the out-of-phase relationship of the current and voltage. For ordinary work this can be disregarded. The cost of running equipment can be computed by multiplying the power drawn by the amount of time the appliance is used. This in turn is changed to kilowatt-hours by dividing by 1,000 and then multiplying by the prevailing rate per kilowatt-hour.

OHMMETER

The high-range ohmmeter (Fig. 4A) uses a conventional circuit and consists of a 1.5-volt drycell, a zero-adjusting resistor and a 100-milliamperere meter. The 100-ohm, zero to 1 ma. movement is shunted by a 0.9-ohm resistor to obtain the 100-milliamperere range. By using this method, a value of 15 ohms appears in the center of the scale and the scale reads up to and including 3,000 ohms. This is more than enough for all appliance work.

The low-range ohmmeter (Fig. 4B) is unconventional as it consists of a 0-1.0 volt voltmeter across which a 1-ohm resistor is placed. A current of 1 ampere or less is passed through this 1-ohm resistor and the corresponding voltage drop is read. With this method a center-scale reading of 1.5 ohms can be had. The useful range of this low-range ohmmeter is up to 300 ohms. A feature of this circuit is that 1/50 of an ohm is the first scale division and can easily be read. This is a "must" as windings on transformers and motors often approach this value of resistance.

This article has been prepared from data supplied by courtesy of Superior Instruments Co.

AGAIN, HEARING-AIDS

Dear Editor:

In the May, 1940, issue of your magazine you have an article on hearing-aids in which I am very much interested, as I am very hard of hearing (so-called "deaf"), and have a great deal of trouble with hearing-aids as I am classed in group 4 with 85% deafness. I do not believe the circuits you have described will be strong enough for me, and if you can send me the more powerful layout you spoke of in the article I will be very grateful.

Thanks for this favor.

EDW. J. GEAR,
Los Angeles, Calif.

Mr. Shaney advised in this connection as below.

A higher-powered hearing-aid can not be conveniently made wearable. If you would have no objection to having this unit designed to fit a space of approximately a 4-in. cube, I shall be pleased to present such a design in a future issue of *Radio-Craft*.

BUILD the RADIO CITY PRODUCTS CO. MULTI-RANGE TESTER

Complete Kit of parts as described \$16.99

Special sale on Radio City Products #446, as featured in December issue of *RADIO-CRAFT*, Complete Kit of Parts \$8.32

Both Kits now ready for immediate delivery.

ADSON RADIO
201 Greenwich St., New York City

110 VOLTS AC ANYWHERE

With **KATOLIGHT**. Furnish standard 60-cycle AC for operating sound truck equipment, AC radios, transmitters, flood lights, motors, moving picture projectors, etc.

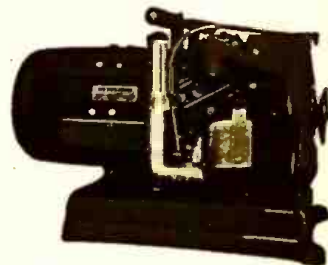

A complete line of light and power plants ranging up to 10,000 watts capacity. Also 6, 12 and 32 volt battery charging plants. Diesel plants, rotary converters, and frequency changers.

List prices \$50.00 and up

Jobbers and Dealers Write for Latest Catalog

Kato Engineering Co., Inc.
MANKATO, MINN., U.S.A.



ELEMENTARY MATHEMATICS

• EASY — SIMPLIFIED — PRACTICAL •

HERE is a book for the business man, the technician and craftsman explaining and answering every operation and meaning with interpreting illustrations and examples.

It is the key to a simple understanding of many perplexing problems in daily life.

In clear, positive and definite language, the author popularizes and clarifies every subject and helps the reader to overcome any apparent difficulty in the study of mathematics.

A real home study-course in mathematics for the student or the man who wants to achieve proficiency or desires to brush-up on his knowledge.

Entire Chapter on Special Mathematics for the Radio Technician

CONTENTS OF BOOK

CHAPTER I. Arithmetic—Addition—Subtraction—Multiplication—Division.

CHAPTER II. Factoring and Cancellation—Fractions—Decimals—Percentage—Ratio and Proportion.

CHAPTER III. The Metric System.

CHAPTER IV. How to Measure Surfaces and Capacity (Geometry).

CHAPTER V. Powers and Involution—Roots and Evolution.

CHAPTER VI. Mathematics for the Manual and Technical Craftsman—Thermometers—Conversions—Graphs or Curve Plotting—Logarithms—Use of the Slide Rule.

CHAPTER VII. Special Mathematics for the Radio Technician.

CHAPTER VIII. Commercial Calculations—Interest—Discount—Short Cut Arithmetic.

CHAPTER IX. Weights and Measures—Useful Tables.

"Elementary Mathematics" can be carried readily in your pocket.

Send Stamps, Cash or Money Order.

TECHNIFAX

1917 S. State St. Chicago, Ill.

ONLY
50c
POSTPAID

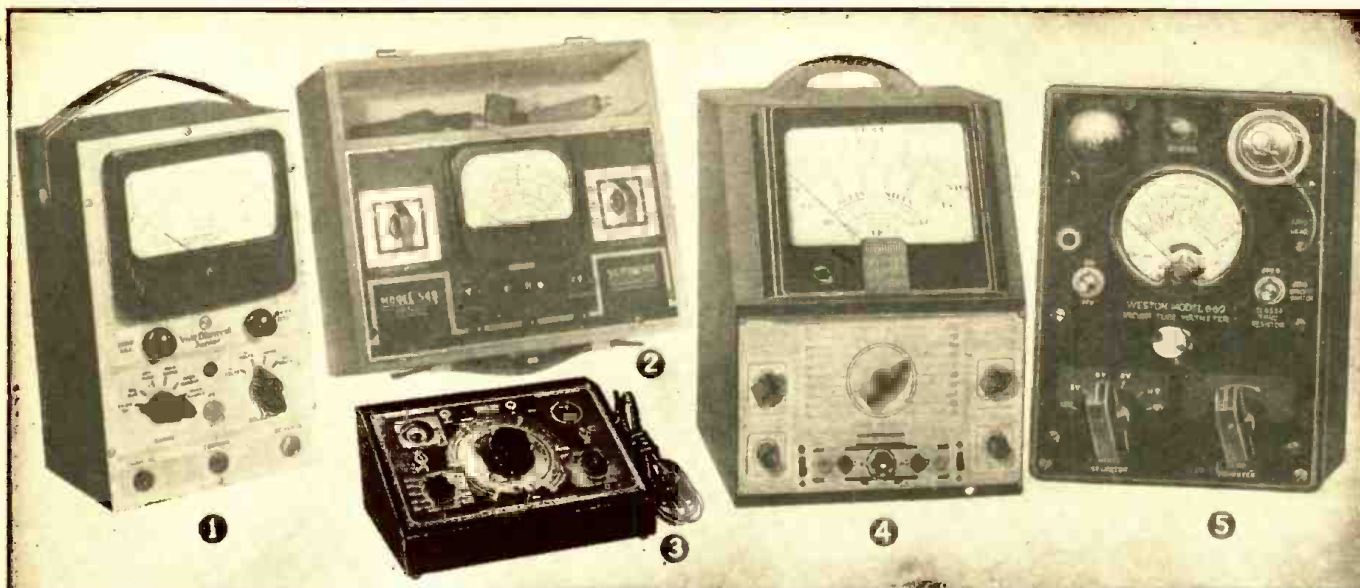

Vacuum-Tube Voltmeters are of many different types, and in commercial designs present quite different appearances, as here illustrated. The instruments in the above photo layout are identified as follows: (1) RCA Junior VoltOhmyst; (2) Supreme Instruments Co. model 549 Electronic Voltmeter; (3) Radio City Products model 660 Electronic Multifester; (4) Superior Instruments Corp. Dynamometer; and, (5) Weston Electrical Instrument Corp. model 669 Vacuum-Tube Voltmeter.

V.-T. VOLTMETERS

Theory and Practice

A GREAT deal of material has been printed with reference to the basic design and use of the V.-T. Voltmeter, or "V.-T.Vm.," so that now it may be in order briefly to review what we have learned and to take stock of the methods available to those unable or unwilling to pay the prices asked for such equipment, prices which range from about \$20 to over \$100 of hard-earned money. (A number of V.-T. voltmeters have been described in construction articles in past issues of *Radio-Craft*.—Editor)

Fundamentally, as has been so often remarked, the "V.-T.Vm." is a detector of alternating current, or in other words, it is a direct current amplifier. There is an essential difference in the operation of the instrument according to whether it is to be used on A.C. or D.C. and there is a further classification possible of the A.C. instrument, which is one concerned with the fact of its mode of operation on (a) peak, (b) effective or (c) mean values of alternating current.

SLIDE-BACK

The classic example, and one which you will find in many texts on measurement of

A Serviceman casts an expert eye over published descriptions of vacuum-tube voltmeters, discusses their pros and cons, and concludes with the construction details of a "V.-T.Vm." he finds exceptionally suitable in his everyday service work.

WILLARD MOODY

electrical quantities, is that of the slide-back type of voltmeter depicted in Fig. 1 (*). This type, while accurate, is apt to give trouble, since a stable source of bias supply is required, and, in addition, stray currents may flow through the grid-circuit meter. Also, it generally has low sensitivity unless an expensive galvanometer is used in the plate circuit at a sacrifice of ruggedness and maintenance of calibration. Of course, a D.C. amplifier could be used, but there still would remain the necessity for adjusting the meter for every single voltage test.

The main advantage of such a peak voltmeter is its very high input impedance, which is essentially that of the grid to

cathode of the tube. Also, it measures the peak value of an alternating current, a useful feature in determining, for example, the overload point in an audio amplifier grid circuit.

The connection from the voltmeter to the receiver circuit being tested should, of course, be shielded, and the shielding insulated to prevent the possibility in the case of an A.C.-D.C. receiver of shorting the power line; or in the case of an ordinary A.C. receiver of shorting, through allowing the cable to touch the wiring, of any section of the set.

For stability, a high resistance, of the order of 10 megohms, should always be connected across the input circuit to provide a constant path for the flow of direct cur-

(*) A.R.R.L. "Amateur Handbook," 1940 Edition, p. 268.

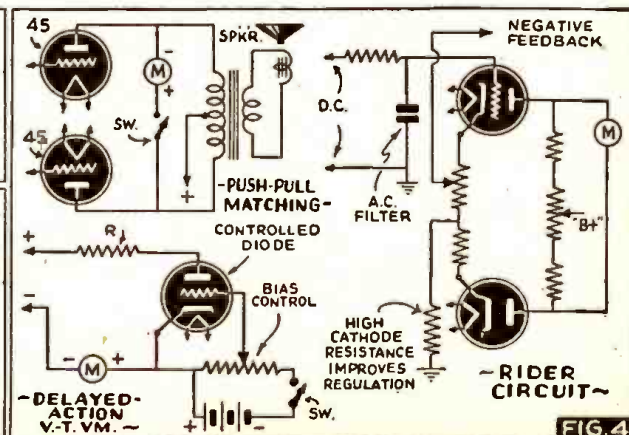
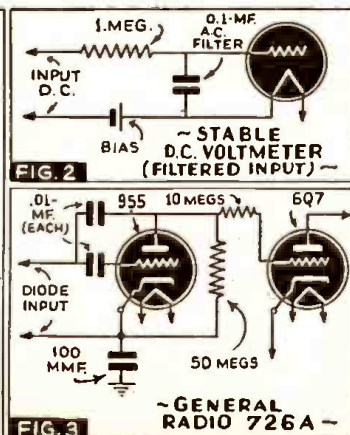
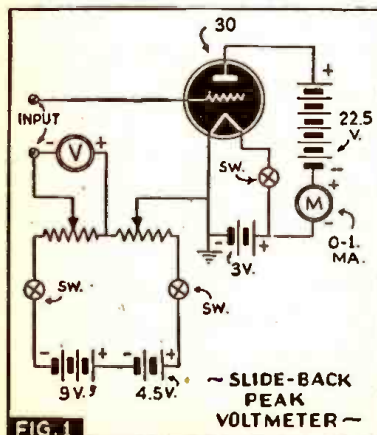

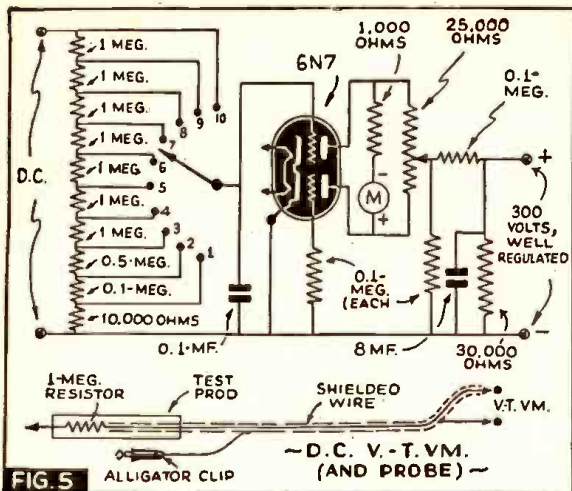

FIG. 5

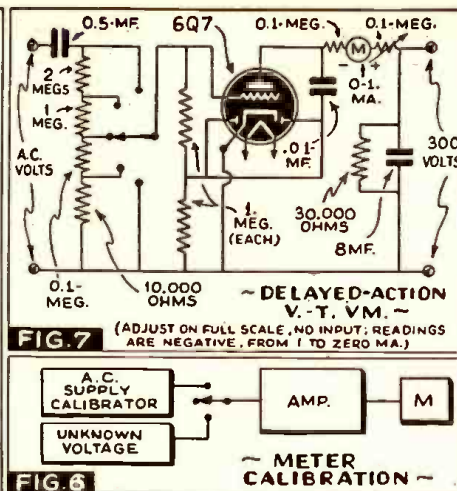

FIG. 6

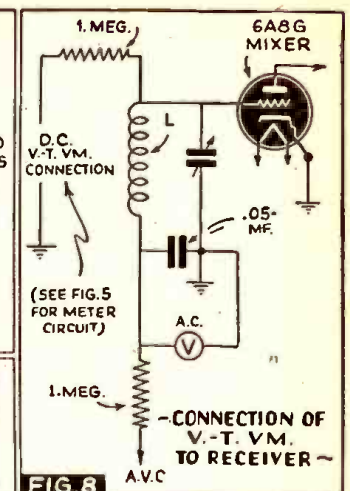

FIG. 7

rent from the grid of the tube in the V-T.Vm. to its filament or cathode, depending on the type tube used. This will remove the possibility of meaningless fluctuations of the meter in the plate circuit. In the case of the instrument designed to work on D.C. a condenser across the input will filter out the A.C. with a resultant stability, precautions being taken of course that the design of the instrument is such that if the V-T.Vm. is connected to a circuit in which A.C. is flowing there will be no disturbance of its value, except as concerns the meter and not the circuit itself. This is clearly shown in Fig. 2.

The grid leak and power detector have their counterpart in the family of vacuum-tube voltmeter circuits. The first has great sensitivity, but slightly loads the circuit. The second has negligible loading effect upon the tested circuit, but the sensitivity is not as great. At present, most commercially-made V-T. voltmeter circuits are of the "plate detection" type, although in the case of one expensive instrument⁽²⁾ a "diode-type" rectifier is used in conjunction with a D.C. amplifier arrangement.

In this circuit advantage is taken of the fact that a condenser will charge up to the maximum value of an applied voltage, in a relatively short instant of time, and thus there will be only a momentary loading of the circuit. The further advantage is that in the diode rectification circuit, independence of frequency variation is achieved with considerably greater accuracy of operation. This is shown graphically in Fig. 3.

INVERTED TRIODE

There is still another type of voltmeter, the *inverted triode*, used for high power measurements. This is shown in Fig. 4. The flashover voltage of the tube should be high enough to prevent damaging the meter, in the case of high voltage tests. This type may be used for not-too-high (television) resistance circuits, or for amateur transmitter checking.

There are also a variety of other circuits, most of them having no great importance, which it is necessary to inspect to get a clear picture of the entire field of this type instrument⁽³⁾. A study of the operation of these circuits again reminds the Serviceman or amateur of the basic principles of vacuum-tube operation⁽⁴⁾ which are vital to the complete and useful understanding of the procedure to be followed in testing with the V-T.Vm. as well as grasping its fundamental design principles.

An elementary explanation and a simple circuit, depicting chiefly the use of the volt-

meter as a very sensitive output meter, is available⁽⁵⁾ and will be of assistance to the beginner in servicing.

"DUAL-TRIODE" BALANCE V-T.Vm.

An easy-to-understand analysis of the V-T.Vm. is given by Terry in his "Advanced Laboratory Practice." This discussion involves a slight acquaintance with integral calculus. A less mathematical treatment is given in the "Radio Engineering" of F. E. Terman.

In the "Communication Engineering," by W. L. Everitt, there is given a splendid chapter on the subject of *detection*, a real aid to complete understanding of the V-T.Vm. since it is closely related to rectification of alternating current as in the detector of a receiver.

In the "Radio Engineering Handbook," chapter by R. F. Field on Measurements, there is given a circuit which is of particular interest, since a form of it is today being used, with some improvements, in the Rider VoltOhmyst, a very good commercially-made V-T.Vm. Turner and McNamara, in a 1930 issue of the *Proceedings of the Institute of Radio Engineers*, first published the data. The circuit is of the "dual-triode" balance type, and is similar in principle to the old-style test circuit used for checking the matching of type 45 tubes in push-pull, as shown some years ago in *Popular Mechanics*. The modern circuit, by Rider, uses a high resistance in the cathode lead, as shown in Fig. 4.

SERVICING-TYPE VACUUM-TUBE VOLTMETER

The circuit which I am using, while not so complicated, is satisfactory for my purpose, as it will be for most other Servicemen or amateurs. See Fig. 5. The amplification, as given in the *Proc., I.R.E.*, is in the vicinity of 100. This high value in combination with modern high- μ tubes renders unnecessary the use of complicated bridge circuits or D.C. amplifiers to achieve sensitivity.

Also, the instrument can be made to check accurately voltages and conditions which are not so well dealt with by employment of the oscilloscope with its manifold problems; the V-T.Vm. is a time saver, not time consumer. For flat-top alignment the oscilloscope is best in adjusting the I.F. as far as receiver servicing goes. For checking A.F.C. or A.V.C., the V-T.Vm. is my favorite instrument. Eventually, I believe, portable instruments of this type will supersede and thereby render obsolete our present antiquated meters of 1,000 to 20,000 ohms/volt.

The advantage of the V-T.Vm. extends

also to the measurement of resistance at low current values. This is a distinct advantage, as you can get knocked on your ear with some of the present-day equipment using high voltage on the Megohm ranges of the tester.

REFLEX V-T.Vm.

For measurement of A.C. the V-T.Vm. may consist simply of an amplifier with output meter calibrated in volts or db. and a suitable source of calibrating voltage under control, which may be checked against the unknown, as shown in Fig. 6. A less complicated circuit is shown in Fig. 7. This circuit is of the *reflex* type, using the gain of the triode to supply the A.C. voltage necessary to allow current flow in the diode which in turn supplies a negative bias for the triode grid, reducing the plate current by the amount or in accordance with the value of the unknown applied voltage. This circuit appeared some time ago in the pages of *Electronics* magazine, and has been slightly modified.

TESTING A.V.C. CIRCUITS

One of the most useful features of the V-T.Vm. is the ability it has for checking the A.V.C. circuit of modern radio receivers. This is shown in Fig. 8, where we have a typical A.V.C. circuit. The test prod may be placed across the circuit consisting of the 0.05-mf. condenser to ground, to check the amount of A.C. across it. If audio voltage appears here, it indicates that the condenser is open or leaky and should be replaced. If with the D.C. instrument the bias to the controlled tubes does not vary according to the strength of the received carrier, being low off resonance, increasing to the maximum value of perhaps 20 volts when tuned to a strong station, then the A.V.C. supply is at fault and may be checked by the usual routine resistance measurements.

For the final result, the resistance measurements must usually be made; why, then, should we use the V-T.Vm.? Because, it saves the time that might so often have been spent in checking the separate parts of the network; by localizing the trouble it enables the tester to service only that part of the A.V.C. which is likely to be at fault. The first condenser, in the A.V.C., might have been shorted partially, without affecting to any extent, the rest of the circuit. The V-T.Vm. confirms this, before allowing you to rip the parts out for test.

It is also useful in determining dynamically if the controlled tubes are receiving proper bias, a point particularly important where detuning is experienced as the result of a change in the input capacity of A.V.C.-controlled tubes. In this connection, refer-

(2) General Radio Co.

(3) *Sylvania News*, January, 1938.

(4) "Vacuum Tube Voltmeters," R. Lorenzen, Service, January, 1939.

(5) "Modern Radio Servicing," Ghiardi, p. 155.



GREAT NEWS!! . . . THE NEW **UTILITY TESTER**

The Utility Tester is a new kind of instrument for testing all electrical appliances—WASHERS, IRONERS, REFRIGERATORS, RANGES, VACUUM-CLEANERS, TOASTERS, PERCOLATORS, HEATERS, SUN LAMPS, AIR-CONDITIONING, MOTORS, etc. The Utility Tester enables every possible measurement necessary to service any electrical appliance.

Mr. Radio Serviceman, here is a new source of revenue for you. The UTILITY TESTER will enable you to accept and economically service electrical and industrial jobs you have been compelled to pass up in the past. You already possess the fundamental electrical knowledge necessary to service electrical and industrial utilities, and now you can have the instrument which will enable you to apply this knowledge to a new and lucrative source of extra income.

SPECIFICATIONS:

3 WATTAGE RANGES: A.C. AND D.C. 0-100 Watts, 0-1000 Watts, 0-5000 Watts. The UTILITY TESTER reads the actual wattage consumption of any appliance, motor, etc., while it is in operation. Thus you can actually prove to the layman the actual consumption of any appliance and compute the actual cost per hour operation, basing your calculation on the local current cost. This is a feature never before obtainable in any instrument selling for less than \$50.

6 VOLTAGE RANGES: A.C. AND D.C. 0-1 Volt, 0-10 Volts, 0-50 Volts, 0-100 Volts, 0-500 Volts, 0-1000 Volts.

4 CURRENT RANGES: A.C. AND D.C. 0-1 Ampere, 0-10 Amperes, 0-50 Amperes, 0-100 Amperes. As far as we know, no instrument selling for less than \$50 has ever enabled current measurements up to 100 Amperes. The UTILITY TESTER provides this service on both A.C. and D.C.

2 RESISTANCE RANGES: 0-300 Ohms, 0-3000 Ohms. The UTILITY TESTER reads all resistances commonly used in electrical appliances and in addition reads extremely low resistances. For instance, $1\frac{1}{2}$ ohms appears on the center of the low ohms scale and resistances as low as $1/50$ th of an ohm are easily read. This is a feature never before obtainable in an instrument selling for less than \$50.

The Utility Tester comes complete with portable cover, self-contained battery, test leads, and all necessary instructions. Shipping Weight 11 lbs.

\$11⁸⁵

SUPERIOR INSTRUMENTS CO., 136 Liberty St., Dept. S.T., New York, N. Y.

ence may be made to RCA Patent Note No. 101, which deals with the subject exhaustively. The main point is that for very large values of bias, due to the non-linearity of the tube characteristics, and to cathode lead inductance within the tubes, 3rd-order demodulation effects and changed input impedance may result, with consequent detuning and distortion.⁽⁶⁾

The V.-T.Vm. is also useful for checking the amount of hum voltage across filter condensers, or the A.C. across any condenser, which is a positive indication of the efficiency of the particular condenser under examination. It gives illuminating knowledge of the function of parts, refreshes the lagging memory with constant evidences of how a circuit should operate, refers you continuously to basic theory and radio fundamentals, allowing you to service all makes of radio receivers with more certainty, since knowing tube characteristics, you become ever more concerned with the heart and soul of the receiver: its tubes. Less dependence is thereby placed upon circuit diagrams, which while extremely convenient and desirable, may not always be available. This is particularly true in the case of the Serviceman who does not live near the "big city" and does not have access to as many diagrams as his more fortunate city dweller. If he will concentrate on basic circuit data, and tubes, he will be able to service radio receivers with a good deal more precision than would be expected under the conditions described.

ACCURACY

The V.-T.Vm. is also a satisfactory if not a better substitute for the oscilloscope in

⁽⁶⁾ Radio Today, Service, and RCA "Patent Note No. 101."

the work on A.V.C. and power circuits. For one thing, the input impedance is higher, and because of the meter scale the precision greater. The oscilloscope has the advantage of enabling you to see the voltage being measured, but the scale on the tube affords only qualitative measurement and therefore is not as accurate as a meter scale. In this regard, let us say that the tubes such as the 6E5 and 6U5 are not, in our opinion, desirable as indicating instruments in the V.-T.Vm., as the zero setting is none too clear and there is the disadvantage of having no intermediate points between the widest opening and the narrowest of the

green shadow of the tubes. In the meter scale, there are definite points to which one may refer. For R.F. tests the oscilloscope is useless, while the V.-T.Vm. comes into its own. In the Rider Chanalyst, in the Supreme Audolyzer or the Meissner Analyst, some form of vacuum-tube voltmeter is employed to check the various stages in the receiver, while in the Weston V.-T.Vm. one instrument serves all functions. The choice that may be made is limited only by your willingness, or your ability to spend. I should say: if possible, buy commercial equipment; but it is more fun building your own.

SOUND IS BOOMING! . . .

. . . so Radio-Craft goes to town

The May issue of RADIO-CRAFT will be a "Sound Special." Home Recording and Phono-Radio Combinations have taken the public by storm, so RADIO-CRAFT is going to town! The May issue will be devoted mainly to Sound. This, of course, includes public address as well as home recording and phono-radio combinations.

In addition to the usual departments on this topic, there will be special articles and construction projects which will be of considerable value to Servicemen, Sound Specialists, and radio men in general;—not the ordinary run of articles but specially-prepared material for this issue.

In addition to this, there will be the usual departments devoted to Servicing, Test Instruments, Electronics, Radio Developments, etc.

Reserve your copy NOW!

(C) of the 3-deck, 12-position selector switch is not employed and is therefore not shown.

Considering the meter circuit alone for the moment, it will be seen that it represents a closed loop of 1,000 ohms, consisting of the 500-ohm resistance of the meter itself, and the sum of 7 other resistors in the circuit. There are actually only 6 such resistors shown but the A.C.-D.C. switch has a resistance of 0.02-ohm which must be included in the calculations.

When current is applied across any portion of this resistance part will flow directly through this shunt and the balance through the meter. Where the resistance of the meter branch is high as compared with the shunt branch, then the current through the meter will be small. In the 10-ma. position of the switch, for instance, the shunt is 20 ohms while the resistance of the meter branch is 980 ohms. Only 1/50th of the total current will flow through the meter and 10 ma. would therefore have to be applied to the circuit to drive the meter to its full 200-microampere limit.

The division of the current is inversely proportional to the ratio of the resistance of the two branches. A more simple way to determine the extent by which the meter range is multiplied by any given shunt, is to find the ratio of the shunt to the total circuit resistance, then multiply the normal meter range by this value, inverted. Thus in the example cited the ratio is 20/1,000ths or 1/50th. Inverting and multiplying we have 200 microamperes x 50 equals 10,000 microamperes, or 10 milliamperes. In the 1-ampere position of the switch the resistance included in the shunt is 0.2-ohm. The ratio is 0.2/1,000 or 1/5,000. This gives 200 microamperes x 5,000 equals 1 ampere.

While there is no marked switch position utilizing the maximum sensitivity of the meter, the 0-200 microampere scale can nevertheless be used. This is accomplished by setting the A.C.-D.C. switch in the A.C. position and the Range Selector switch in the "1 Amp." position. With the test prods in the D.C. jacks the measurement range will be that of the meter itself. While there is some resistance in series with the meter, with this arrangement, its effect is negligible.

In the A.C. ranges (Fig. 3) the principles and arrangement are similar except that in this case the normal current range of the meter is no longer 200 microamperes. Due to the rectifier in series efficiency is reduced nearly 60%, the sensitivity of the meter becoming 476 microamperes as a result. Further, in this instance, the meter is shunted with a fixed value of 178 ohms, so that the effective sensitivity of this meter and fixed shunt combination decreases to about 1.8 ma.

A.C.-D.C. CONSIDERATIONS

Calculations become a little complicated where a rectifier is employed and for that reason it is often considered more simple to select some convenient value for the shunt network, dividing this up into units in inverse proportion to the desired current ranges. Then if the fixed shunt is selected to provide the correct meter reading for any one of the desired ranges it will be correct for all. In this case, the shunt network totals 1 ohm. The correct fixed shunt was found to be 178 ohms.

It might be added here that the 2 low-value resistors in series with the meter have no part in the functioning of this circuit. Their value is too small to influence the total series value appreciably. They are actually used in the D.C. positions and for A.C. measurements it was more simple to leave them in than to arrange to switch them out.

In order to use the same meter scale and multipliers for both D.C. and A.C. voltage measurements it is necessary to shunt the meter during D.C. applications to make its sensitivity the same as when the rectifier is in the circuit. It is for this reason that the 362-ohm shunt is employed in the D.C. voltage measurement circuit of Fig. 4. As before, the 2 small resistors in series with the 362 ohms have no place in the circuit but are left in as a matter of convenience.

With the meter shunted to sensitivity of 476 microamperes (2,100 ohms-per-volt in voltage measurements) the multiplier values work out as shown in Fig. 4.

In the A.C. circuit, for voltage measurements, Fig. 5, the ohms/volt sensitivity is the same as for D.C. measurements. Here, however, there is no shunt across the meter for reasons already explained. It might be well to point out here that the full-wave rectifier is conductive through the meter only on one-half of each cycle, the other half-cycle being bypassed around the meter by the other side of the rectifier. The purpose of this latter branch is to prevent high inverse voltages developing across the rectifier during the inoperative half-cycle—voltage which on the higher ranges would be sufficient to cause the rectifier to arc over.

OHMMETER

In Fig. 6 are shown the ohmmeter circuits. In the 40,000-ohm position of the switch we have the standard ohmmeter circuit. In this case the meter is shunted by 5.05 ohms, reducing its sensitivity to 20 ma. The internal series resistance is 275 ohms plus approximately 5 ohms represented by the meter and its shunt, plus whatever is added from the variable "Ohms Adjust" resistor. With the 7.5-volt battery this results in a total of 375 ohms but as the battery drops the variable resistor provides means for compensating the drop in order that the ohms scale still will remain accurate. This will hold true until the battery has dropped to 5.5 volts. Beyond this figure the "Ohms Adjust" knob will no longer permit full-scale deflection and the battery should be discarded.

The 4-megohm circuit is similar to the one just described except that the shunt is eliminated, allowing the meter its full sensitivity in order that high resistance values may be measured without resorting to higher battery voltage.

The Low Ohms circuit varies materially from the others in that the resistance under measurement is shunted across the meter, instead of being in series with it. In this instance the meter is again also shunted with 5.05 ohms, making its total resistance 5 ohms and its sensitivity 20 milliamperes. The battery, its variable series resistance and the fixed 275-ohm series resistor, also constitute another shunt across the meter. Because this latter combination will be adjusted for a resistance of about 375 ohms it has no material bearing on the overall resistance of the meter circuit.

When the resistance to be measured is connected to the input jacks its shunting effect will decrease the meter current. If it is 5 ohms, for instance, it will cut the meter reading to half-scale. Thus very low values of resistance can be measured with accuracy—down to less than 1/10th-ohm.

CAPACITY METER

The capacity measuring range of Fig. 7 utilizes the ability of condensers to pass alternating current and the fact that the amount of current passed varies with the capacity. For this measurement the usual A.C. tip-jacks are connected across the A.C. line as though this line voltage were to be measured. The switch is set in the 250 V. position but with the separate "Capacity" switch in the circuit the 250-volt multiplier

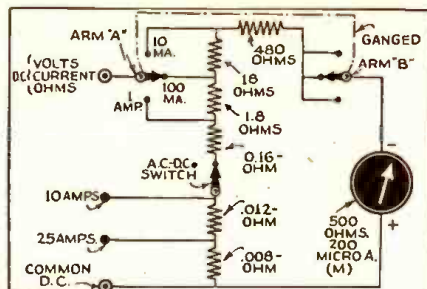

FIG. 2 ~ CURRENT RANGES (D.C.) ~

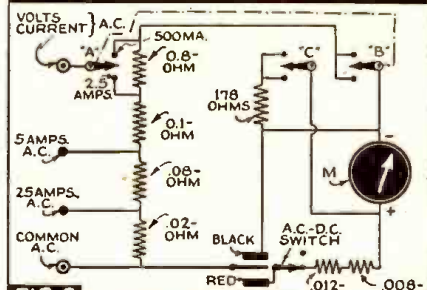

FIG. 3 ~ CURRENT RANGES (A.C.) ~

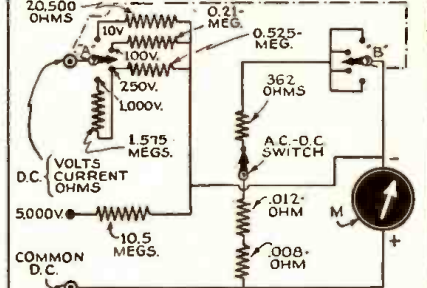

FIG. 4 ~ VOLTAGE RANGES (D.C.) ~

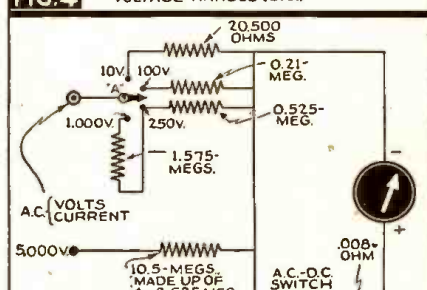

FIG. 5 ~ VOLTAGE RANGES (A.C.) ~

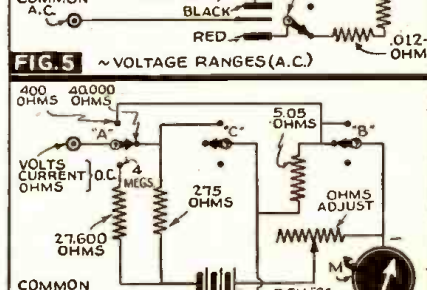

FIG. 6 ~ OHMS RANGES ~

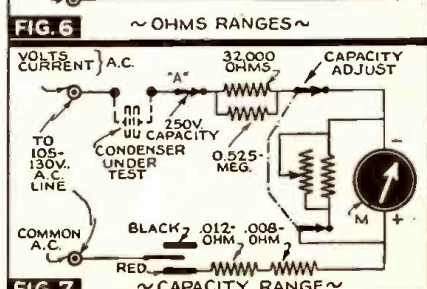

FIG. 7 ~ CAPACITY RANGE ~

Elements of the complete schematic circuit, of the Modern Multi-Tester, shown in Fig. 1.

•TEST INSTRUMENTS•

BUY DIRECT FROM THE MANUFACTURER AND SAVE

THE NEW MODEL 1240 TUBE TESTER

- Instantaneous snap switches reduce actual testing time to absolute minimum.
- Tests all tubes 1.4 to 117 volts.
- Sockets for all tubes—No Adapters.

Superior is proud to offer the newest and most practical tube tester ever designed. Unbelievably low in price—unbelievably high in performance.

- ★ Tests all tubes, 1.4 to 117 Volts, including 4, 5, 6, 7, 7L, octals, octals, Bantam Jr., Peanut, single ended, floating filament, Mercury Vapor Rectifiers, the new S series. In fact, every tube designed to date.
 - ★ Spare socket included on front panel for any future tubes.
 - ★ Tests by the well-established emission method for tube quality directly read on the GOOD ? BAD scale of the meter.
 - ★ Jewel protected neon.
 - ★ Tests shorts and leakages up to 2 megohms in all tubes.
 - ★ Tests leakages and shorts in all elements AGAINST all elements in all tubes.
 - ★ Tests BOTH plates in rectifiers.
 - ★ Tests individual sections such as diodes, triodes, pentodes, etc., in multi-purpose tubes.
 - ★ Latest type voltage regulator.
 - ★ Features an attractive etched aluminum panel.
 - ★ Works on 90 to 125 volts 60 cycles A.C.
- Model 1240 comes complete with instructions and tabular data for every known type of receiving tube. Shipping weight 12 pounds. Size 6" x 7½" x 10¾". Our Net Price

Portable cover \$1.00 additional



\$11.85



THE NEW MODEL 1230 SIGNAL GENERATOR WITH FIVE STEPS OF SINE-WAVE AUDIO

SPECIFICATIONS

RADIO FREQUENCIES from 100 K.C. to 80 Mc/cycles in 7 bands by front panel switch manipulation. All direct reading and accurate to within 1% on I.F. and Broadcast bands, 2% on higher frequencies. The R.F. is obtainable separately or modulated by any one of the five Audio Frequencies.

AUDIO FREQUENCIES: 5 steps of SINE-WAVE audio 200, 400, 1000, 5000 and 7500 cycles WITH OUTPUT OF OVER 1 VOLT. Any one of the above frequencies obtainable separately for servicing P.A., hard-of-hearing aids, etc.

ATTENUATOR: Late design, full-range attenuator used for controlling either the pure I.F. or modulated R.F.

CIRCUIT: The Model 1230 employs an improved electron coupled oscillator circuit for the R.F. affording positive protection against frequency drift and a Hartley oscillator circuit for the A.F. section.

DIAL MANIPULATION: Large 5½" dial etched directly on front panel, using a new mechanically perfected drive for perfect vernier control.

APPEARANCE: The front panel is etched by a recently perfected process which results in a life-long attractive finish and the instrument comes housed in a streamlined shielded cabinet.

CURRENT SOURCE: The Model 1230 operates on 90 to 130 volts A.C. or D.C. any frequency.

The Model 1230 comes complete with tubes, shielded cables, moulded carrying handle and instructions. Size 14" x 6" x 11". Shipping weight 15 pounds. ONLY **\$12.85**

SUPERIOR INSTRUMENTS CO. 136 Liberty St., Dept. S.T. NEW YORK, N. Y.

FLIGHT

THE PICTORIAL FLYING REVIEW

Brings you all the phases of world aviation and aeronautics in a non-technical yet educational manner—exciting articles which catch your breath, yet give you the fundamentals of flying and ALL related subjects. FLIGHT keeps you abreast of all the major developments as fast as they appear anywhere.

Now, when planes and flying are of vital importance to all, you just can't do without this highly absorbing, instructive publication. You must be "in the know."

Attractive three-color cover, numerous illustrations. **15¢** copy

Subscription price \$1.50 a year (Canada and foreign \$2.00).

Partial Contents of the March Issue: Stratosphere Fighting! Armament of Modern Bombers. The Secret of the "Rocket" Pinne. AIR WAR as Seen Through German Eyes. The HE 111-K Nazi Bomber. Details of the RAF Spitfire. Bombing by Stop-Watch. So You Want to Fly! Question Box. Flight Digest. Bombers vs. Submarines. Formation Flying.

FLIGHT MAGAZINE
20-R Vesey St., New York, N.Y.



Amazing New "WALSCO" STAPLE DRIVER

for radio men, electricians, or anyone doing stapling. Makes wire and cable installations twice as easy—much neater—saves half the time. Wires can be stapled in corners, behind pipes, into moldings—places never accessible with a hammer and ordinary staples. Drives staples even into walls, brick, mortar, etc. Magazine works automatically and holds strips of staples which come in several colors. Ask your jobber for demonstration and catalogue 41-R of all WALSCO PRODUCTS

or write **WALTER L. SCHOTT CO.**
5264 W. Pico Boulevard, Los Angeles, California

SOLAR RED-CAPS

Smaller Diameter Dry Electrolytics

SPEED Servicing

Write for Catalog



SOLAR MFG. CORP. Bayonne, New Jersey

resistor is shorted out and one of 32,000 ohms substituted. At the same time this "Capacity" switch cuts in a variable "Cap. Adjust" shunt across the meter so that full-scale deflection is obtainable for any value of line voltage by a simple adjustment of this shunt. When this adjustment has been made, the condenser to be measured is connected by means of another pair of test probes across the "Capacity" jacks. These jacks are a special circuit-closing type which connect the condenser in series with the circuit, but when no tips are plugged in automatically close the circuit. Capacity readings are made on the regular 0-50 volts scale in conjunction with a conversion chart provided in the instructions which accompany the kit. Another such conversion chart permits inductance measurements with this same circuit.

To obtain readings in decibels the instrument is used exactly as when measuring A.C. Voltages, except that the values are read from the separate "Decibel" scale on the face of the meter. The decibel calibration is for a 500-ohm line. For lines of other impedance, a table of correction factors for lines of from 5 to 1,000 ohms is available.

LIST OF PARTS

BRIGHT STAR BATTERY COMPANY

One 4½-V., No. 51-17;

One 3-V., No. 50-1.

AMERICAN PHENOLIC CORP.

Eight Amphenol tip-jacks (6 red—2 black);

Two Amphenol high-voltage tip-jacks (red).

WIRT COMPANY

One D.P.D.T. slide switch.

YAXLEY MANUFACTURING CO.

One twin series closed-circuit jack.

RADIO CITY PRODUCTS COMPANY

One copper-oxide rectifier;

One tapered rheostat (and switch), 18,750 ohms;

One 3-gang 12-position selector switch;

One tapered rheostat 2,250 ohms;

One wire-wound molded resistor, 100 ohms;

One large bar knob;

One 4½ in. microammeter 0-200 microA., model L 411;

Eleven flexible wire-wound resistors, 2½% accuracy, 1 each of the following resistance (ohms) values: 275, 5.05, 480, 18, 1.8, 0.18, 0.8, 0.08, 10, 362, 178;

Three shunt resistors, 2% accuracy, 1 each of the following resistance (ohms) values: 0.02, 0.012, 0.008;

Four metallized resistors (2 matched pairs, 5.25 megs. per pair), 1% accuracy;

Four special molded carbon resistors, 2% accuracy, 1 each of the following resistance (ohms) values: 20,500, 210,000, 525,000, 1,575,000;

One carbon resistor, 5% accuracy, 32,000 ohms;

One carbon resistor, 5% accuracy, 27,600 ohms;

Two bakelite resistor mounting strips;

One drilled and etched panel model L 411K size;

One hardwood case (with battery compartment and handle).

MISC.

One small round knob;

One small round knob with pointer.

(A kit of parts for the Modern Multi-Tester can be supplied by leading Parts jobbers and radio mailorder houses.)

This article has been prepared from data supplied by courtesy of Radio City Products Co.

Due to unforeseen circumstances, a number of interesting articles scheduled to appear in this issue of RADIO-CRAFT had to be held over for the next issue. WATCH FOR THEM IN THE APRIL NUMBER!

America's Greatest Radio Value

HOWARD

1941 COMMUNICATION RECEIVER

THE FIRST TIME!

\$29.95 and \$39.95 "Ham" Receivers With Tuned R.F. on All Bands

Again HOWARD leads the field with a new line of communication receivers that are outstanding in both performance and value. Foreign and weak signals are tuned in with surprising ease. Selectivity, sensitivity and signal-to-noise ratio are equal to radios costing twice as much. All models tune from 540 K.C. to 43 M.C. (556 to 7 meters) on four overlapping bands. Designed and built in the famous HOWARD factory, the oldest in America.

The HOWARD Progressive Series Plan permits you to start with the Model "435-A" 7-Tube Receiver, and later add to it in easy stages until you have a complete 15-tube receiving station that will rival laboratory equipment.



MODEL 43-A—7-TUBE communication receiver, built for amateurs and short-wave listeners who desire reception from all parts of the world. Has highly efficient stage of tuned R.F. on all four bands, iron core transformer I. F. stage, broad band spread tuning that can be logged. Has built-in 6 1/2" Howard-Jensen electro-dynamic speaker, with connections for extra speaker. Front panel has headphone jack, AVC "Off-On" switch, BFO "Off-On" switch and pitch control, AF Gain volume control and Main Tuning and Band Spread tuning dials. Supplied complete with tubes.
Net Price **\$29⁹⁵**
to Amateurs

Terms: \$5.99 Down Payment, \$2.12 per month for 12 months.

"490" 14-Tube Professional



The finest receiver built for either communication or entertainment reception. Has two stages of tuned R.F., large calibrated band spread dial, air tuned I.F. transformers, variable I.F. selectivity, temperature compensated oscillator, split stator tuning condensers with ceramic (steatite) insulation, variable audio fidelity, 8 watt push-pull output, automatic noise limiter, and every other worth while feature. The Model 490 is the result of years of engineering and development. Never before, outside of laboratories, was a radio of this quality available. Foreign and weak signals whip in with ease. On broad fidelity the reception of music is equal to reproduction by finest home radios.

Complete with 14 tubes, large external speaker in matching cabinet, and complete crystal filter.
Net Price **\$149⁵⁰**
to Amateurs

Terms: \$29.90 Down Payment, \$10.56 per month for 12 months

MODEL 436-A—8-TUBE receiver. Identical to above Model 435-A, but has a built-in automatic noise limiter that practically eliminates auto ignition interference and greatly reduces static. Model 436-A also has the famous HOWARD Inertia Tuning Knobs for fast, fly-wheel action on both main and band spread tuning dials.
Net Price **\$39⁹⁵**
to Amateurs

Terms: \$7.93 Down Payment, \$2.83 per month for 12 months



MODEL 437-A—9-TUBES. Has all the features of Models 435-A and 436-A, plus an additional stage of I.F. and Crystal Phasing Control to eliminate all unwanted signals. Complete, less crystal.
Net Price **\$54⁵⁰**
to Amateurs

Terms: \$10.90 Down Payment, \$3.85 per month for 12 months

MODEL 437-A complete with crystal. (Note: It is recommended that crystal be purchased with receiver to assure proper alignment.)
Net Price to Amateurs **\$62.00**

Write me for any amateur or shortwave radio equipment in any catalog or advertisement. Or send me your order and I guarantee that you can't buy for less or on better terms elsewhere. Write and tell me what you want and how you want everything handled. Your inquiries invited.

Bob Henry, W9ARA

HENRY RADIO SHOP (W9ARA) BUTLER, MISSOURI

**SEND FOR THESE FREE CATALOGS
AND SAVE TRANSPORTATION COSTS
ON ALL YOUR RADIO EQUIPMENT**

Check This Map—and See How You Save
You Pay Shipping Charges Only From
Your Nearest Sears Mail Order House



Free!

Send for these FREE books Today!
If you want the Public Address
Equipment book, write for F732RC-3,
... or the Radio Equipment and
Supplies book, write for F117RC-3.

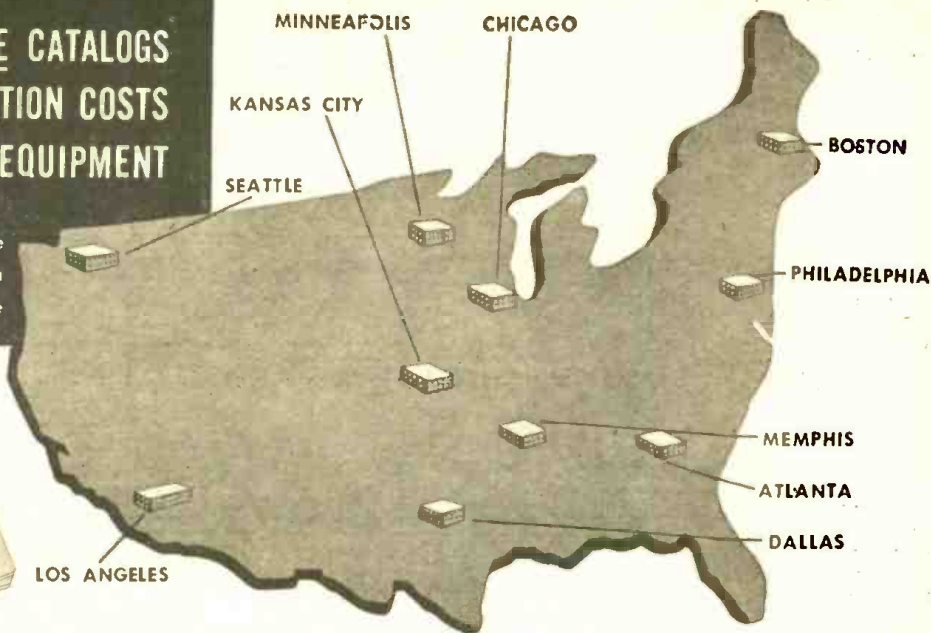

Chances are you're a Service Man or "Ham" who's "sweet" on good Radio Equipment but don't much care for high prices.

If you are, then you're in for a treat when you get your new Public Address or Radio Equipment book from Sears.

You'll see the most complete and up-to-date assortment that anyone could ask for —top-quality Equipment at those low prices

Sears are famous for. What's more, you can buy it all on Sears Easy Payment Plan!

And don't forget—when you buy from Sears, you pay shipping charges *only from your nearest Sears Mail Order House!* You'll save Time—you'll save Money—and you'll be Satisfied! Sears-Roebuck's famous Money-Back Guarantee absolutely protects you.

SEARS, ROEBUCK AND CO.

Chicago, Philadelphia, Boston, Kansas City, Minneapolis, Atlanta, Memphis, Dallas, Seattle, Los Angeles

The growth of the electronic musical instrument field has brought forth a need for such a system, and I would like to have your assistance in designing one for an Electronic Orchestra which I am organizing.

I intend to use this with a standard amplifier. I will need 3 microphone inputs and at least 5 input channels for high-output electronic instruments. Each input must be controlled separately without having any effect on the other input channels. This is necessary, as foot-control units will be used. I intend to build it on a separate chassis so a power supply can be included with it, if necessary.

CHARLES FREY,
Ottawa, Ohio

The Answer . . .

The type of circuit you require is illustrated in Fig. 3. You will note that electronic mixing is used throughout. Four twin triodes (6SC7s) are employed to provide 8 grids, each one of which connects to its independent volume control and associated channels. Three 6SC7s are used as preamplifiers for the microphone input channels. While independent volume controls for the high-level inputs are connected in this circuit, these may be eliminated if the foot controls of each electronic instrument are to be used only. On the other hand, it might be desirable to use both controls. The one on the instrument for the musician to adjust, and the one on the preamplifier for some pre-determined maximum setting.

Some economy could be effected by using 1 common cathode resistor and bypass condenser for all 6SC7 tubes, this would require a 500-ohm resistor and a 100-mf. bypass condenser. You will note that ¼-meg. isolating resistors are employed in the plate

circuits of the 6SC7, so as to avoid undue shunting between channels. All resistors may be of the carbon ½-watt type, excepting those otherwise indicated. Reasonable care should be exercised in placing the power transformer and filter chokes away from any of the input circuits so as to avoid hum pick-up. The electronic mixer should feed into a voltage amplifier which employs a tube having a comparatively low input capacity. Otherwise, appreciable loss of high frequencies may result. A 6C5 is excellent for this application.

frequencies, and so changed his mind about their being rebroadcast from local broadcast band stations, as he previously claimed they were.

Now I'd like to aid Mr. Ettinger with his troubles, and I believe this will explain them. But I'm at a loss as to how to go about correcting the trouble. It would lie, I believe,

**Keep a Weather Eye Peeled! . . .
... for the May Issue of RADIO-CRAFT.**

It is the big issue of the year, devoted in the main to Sound. In addition to the usual material, it will contain special theoretical and constructional articles on Home Recording, Phono-Radio Combinations, Public Address Systems, Amplifiers, etc. Sound is booming! . . . so RADIO-CRAFT is going to town!

RESERVE YOUR MAY ISSUE NOW

MAILBAG

(Continued from page 517)

in some method of suppressing all harmonics above the fundamental of the H.F. oscillator.

I hope this may prove of some help to some one, and that I may receive some word on how to cure this trouble.

J. W. DEMKE,
Portland, Ore.

NEWS SHORTS

Requests for F.M. licenses last month included Muzak Corp. (New York), and Seaboard Broadcasting Corp. (Glenside, Pa.), thus bringing the total of applications for station licenses to 58; 7 construction permits for F.M. stations in the New York area have been granted by the F.C.C.

The 20th Anniversary of Radio has come and gone. It leaves in its wake this indelible fact: as of Jan. 1, 1941, there are in the United States a total of 50,100,000 radio sets

(a National Association of Broadcasters estimate).

New York City is contemplating the use of 2-way radio equipment aboard ferries as a convenience to the boat-travelers, Mayor LaGuardia acknowledged last month.

The \$4,500,000 Edison Memorial Bridge over the Raritan River at Trenton, N. J., was dedicated last month.

THE FINEST RADIO BOOK FREE WE EVER OFFERED :- the 1940-41 Radio-Television Reference Annual With \$1.00 subscription to RADIO-CRAFT

WITH our compliments, we want to send a copy of the 1940 RADIO-TELEVISION REFERENCE ANNUAL to you FREE, if you will simply take advantage of RADIO-CRAFT magazine's special subscription offer NOW. This offer is being made for a limited time only.

The 1940 RADIO-TELEVISION REFERENCE ANNUAL has 68 pages, large size 8½ x 11½, with over 170 illustrations. The contents of this book has never appeared before in handy book form. Its pages cover practically every branch of radio sound, public address, servicing, television, construction articles for advanced radio men and technicians, time and money-saving kinks, wrinkles, useful circuit information, "ham" transmitters and receivers, and a host of other data.

The Annuals have always been regarded as a standard reference work for every practical branch of radio operation and service. This 1940 edition ably sustains this reputation. Every radio man wants a copy of this valuable book. Just as this book will be of unquestionable value to you, so, too, will every monthly issue of RADIO-CRAFT. This magazine brings you big value every month. It keeps you intelligently informed about new developments in radio and television. You want the news, want it fully but concisely, want it first—that is why you should read RADIO-CRAFT regularly.

This very special offer is made for just one purpose—we want you as a regular subscriber. The Annual, whose contents appears at the right, is not sold, but a copy is FREE to you if you subscribe now.

**SAME SIZE AS
RADIO-CRAFT**

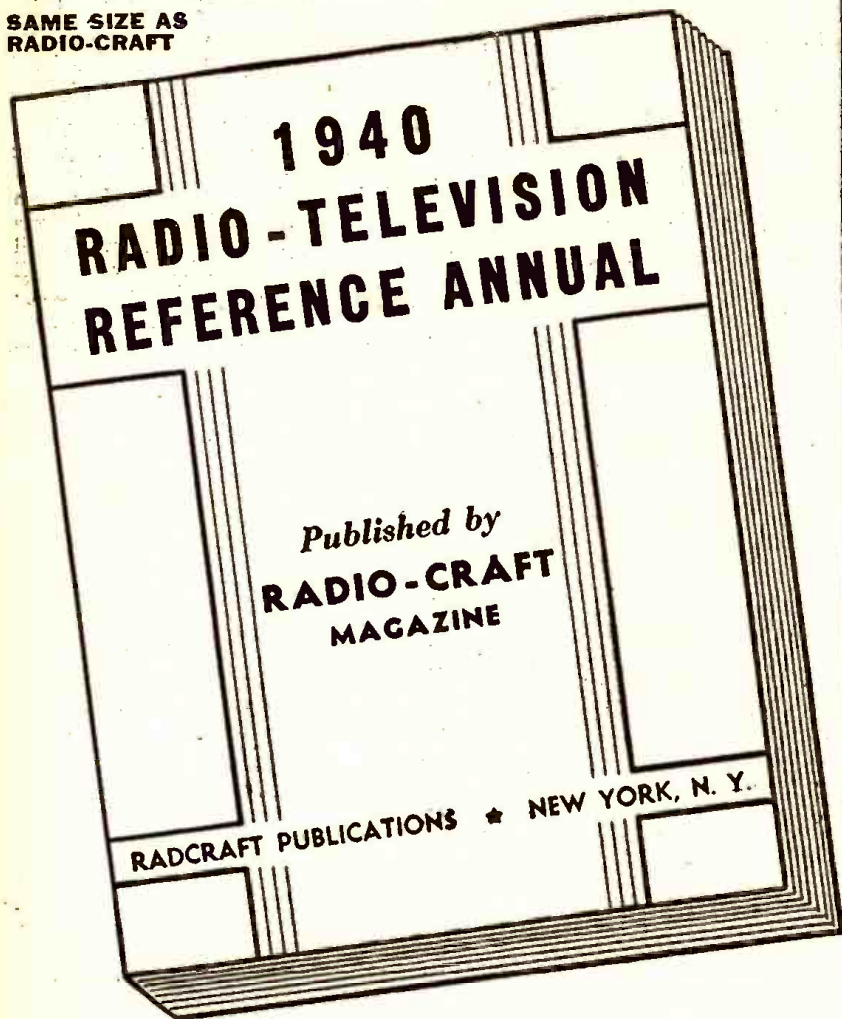

THIS COUPON BRINGS YOU THE ANNUAL

RADIO-CRAFT • 20 VESEY STREET • NEW YORK, N. Y.

Gentlemen: Enclosed you will find One Dollar for which enter my subscription to RADIO-CRAFT Magazine for Eight Months. Send me ABSOLUTELY FREE and POSTPAID, my copy of 1940 RADIO-TELEVISION REFERENCE ANNUAL.

This is a new order Extend My Present Subscription

NAME ADDRESS

CITY STATE

DON'T DELAY — MAIL TODAY! RC-341

Read the summary of contents in this FREE BOOK!

THE 1940 RADIO-TELEVISION REFERENCE ANNUAL contains a collection of the best and most important articles. Covering as they do nearly every branch of radio, they form a handy reference works. In addition, many time and labor-saving kinks, circuits and wrinkles, tried and tested by practicing Servicemen, experimenters and radio fans have been included. This book cannot be bought anywhere at any price. Yet it is yours by merely subscribing. Use the convenient coupon below.

BEGINNER'S SIMPLE INEXPENSIVE CONSTRUCTION ARTICLES

Beginner's Breadboard Special - a 1-Tube High-Gain All-Wave Receiver—Wiring Pointers for Radio Beginners—A Watch Charm Size 1-Tube Set—Beginner's Simple Volt-Milliammeter—Making a 1-Tube Broadcast Loop Receiver—A.C.-D.C. Power Supply for Battery Portables—A 1-Tube Short-Waver with Band Coil Switching.

MORE ADVANCED SET CONSTRUCTION

The "High-Seas 4" Broadcast Lamp Radio—How to Build a 6-Tube 1.4-Volt Short-Wave Superhet for the "Ham" or Short-Wave Fan—Build the "Lunch Box 5" Super Set - a Broadcast Battery Portable—How to Build a Plug-Together 8 Tube Broadcast Set—The "5-in-4" All-Wave Radio for A.C. Operation—An Easily-Built 3-Tube Midget Broadcast Superheterodyne Receiver.

THE SERVICEMEN'S SECTION

Bass Tone Control—Simplified Variable Selectivity—Practical Servicing Pointers—Servicing Universal A.C.-D.C. Receivers—Killing the "Intermittent" Bug—A Service Shop A.C. to D.C. Power Supply—Sideline Money for Servicemen—Adding A.V.C. to any Screen-Grid T.B.F. Receiver—Iron Particles in Speaker Air Gap.

TEST INSTRUMENTS

A Useful Neon Lamp Tester—An Inexpensive Output Meter—Making Milliammeter Multipliers—Home-Made Frequency Modulator—The Busy Servicemen's V.T. Volt-Meter.

PUBLIC ADDRESS AND AMPLIFIERS

Build this Combination A.C.-D.C. Radio and Inter-Communicator—Speaker Placement in P.A. Work—The Design and Construction of an Inexpensive All-Push-Pull 10-Watt Amplifier—Obscure Sources of Hum in High-Gain Amplifiers—How to Build a High-Fidelity 5-Watt Versatile Amplifier.

"HAM" SECTION

Ultra-High Frequency Antennas—The Beginner's Low-Cost Xmitter—Modulator Meter—Phone Monitor—The Beginner's "Ham" Receiver—2½ Meter Acorn Transceiver.

TELEVISION

How to Build a 441 Line T.R.F. Television Receiver—Useful Notes on Television Antennas.

MISCELLANEOUS

Simple Photo-Cell Relay Set Up—Making a Burglar Alarm—How to Build A.C.-D.C. Capacity Relay—How to Make a Modern Radio Treasure Locator.

USEFUL KINKS, CIRCUITS AND WRINKLES

Making a Flexible Coupler—Two-Timing Chime—A Simple Portable Aerial—An Improvised Non-Slip Screw-Driver. NOTE: The book contains numerous other useful Kinks, Circuits and Wrinkles, not listed here.

(approximately)

45 ARTICLES

(approximately)

170 ILLUSTRATIONS

68 BIG PAGES

**RADIO-CRAFT
20 VESEY STREET
NEW YORK, N. Y.**

RADIO-CRAFT for MARCH, 1941

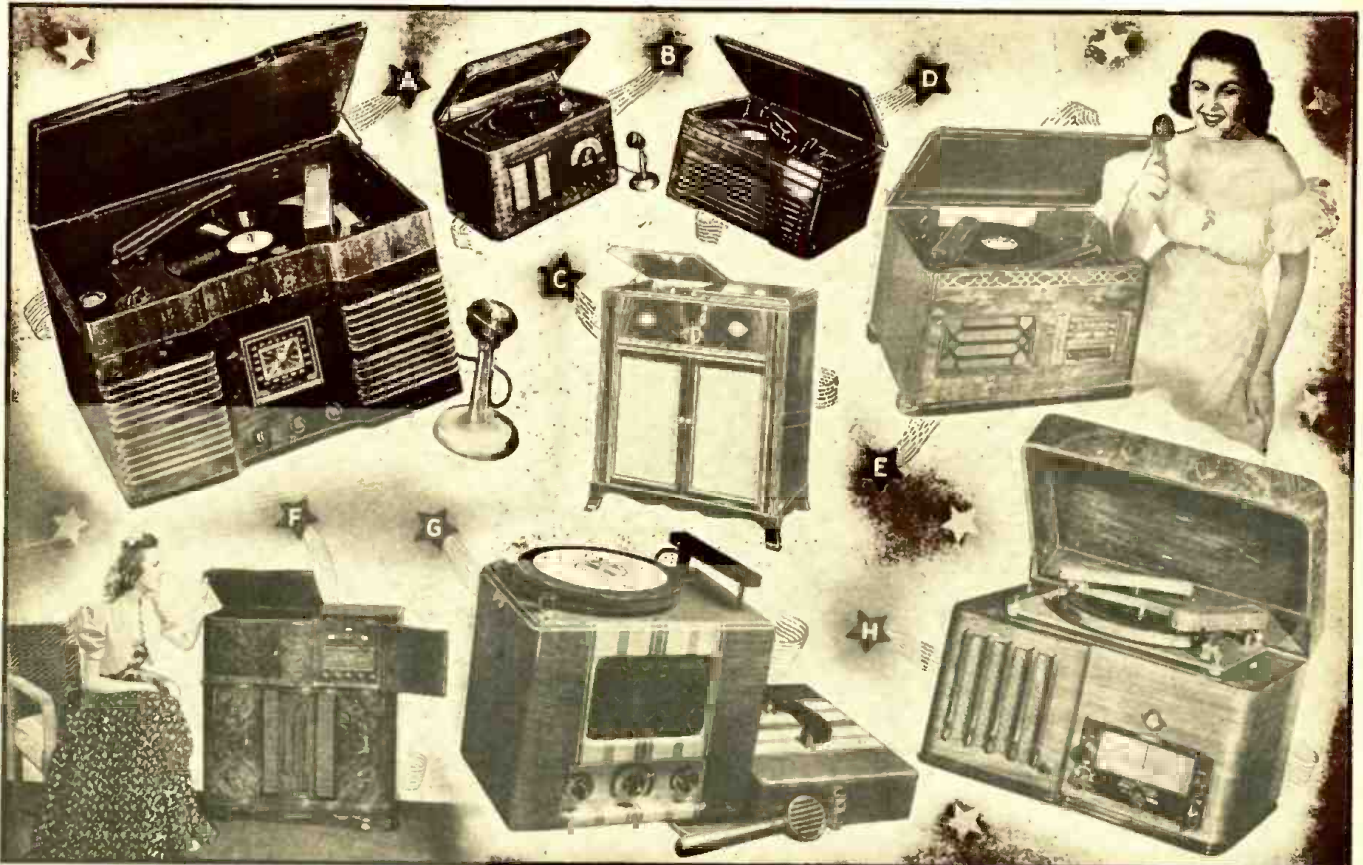

Representative Phono-Radio-Recording sets for 1941. Shown above are newest products of the following companies: A, Emerson Radio & Phonograph Company; B, Lafayette Radio Corp.; C, Radolek Co.; D, Allied Radio Corp.; E, General Electric Company; F, RCA Mfg. Co.; G, Wilcox-Gay Corp.; H, Howard Radio Co.

HOME RECORDING

Theory and Practice of Sound-on-Disc

Sound recording equipment introduced in 1940 enabled radio men generally—Servicemen, experimenters, etc.—to “feel their oats” in this new field. Radio manufacturers finding wide acceptance of modern sound recording facilities have gone to town in incorporating sound recording equipment in their new lines for 1941. Mr. Queen draws on his wide practical experience as a sound recordist to tell RADIO-CRAFT readers short-cuts and recommended procedures for obtaining best results with sound recording equipment. A useful bibliography on sound recording concludes this article.

I. QUEEN

MANY of the current lines of radio sets are featuring a *sound-on-disc recorder* as part of the combination, so that it is possible to make recordings either from the radio set's output, from a microphone, or from both simultaneously. There is also available on the market separately various types of cutting heads, screw feeds, motors and pickups so that the experimenter may assemble his own recorder utilizing his own ideas in the building. The response from the public this past year shows definitely that home recording is here to stay and is becoming an entertainment and educational necessity. This has been made possible by modern developments whereby a result may be obtained comparing favorably with many professional discs and with the expenditure of far less time, effort and money.

PROSPECTS

The progressive radio salesman and Serviceman would do well to gain a firm knowledge of the principles which are involved so as to be able to solve difficulties which may arise in this new branch of radio. An enterprising technician will find dozens of practical ways in which to profit by selling accessories, and repairing and setting up apparatus for recording enthusiasts.

The first sounds of the baby, a child's musical accomplishment, and family harmony groups, may be recorded and placed away in an album to be brought out time and again for entertainment or to refresh the memory. The historic broadcasts of these critical times will become invaluable in the future, while favorite broadcasts may entertain again and again. “Special occasion” greetings recorded and sent on to dis-

tant relatives and friends take on a new personal meaning. There is no surer way of checking on code-sending ability or musical study than by listening to oneself over and over again.

The business opportunities involved are many. Sales messages may be sent from headquarters to branch personnel, and store demonstrations become far more effective when accompanied by a spoken sales message. Small sound-effects records may be made up and sold to dramatic groups or parties.

To aid the radio man to take advantage of these opportunities, only a few of which have been enumerated, this article will describe the principles involved, the systems used, and how to surmount the difficulties which may be encountered. It should prove of interest to both beginner and to those

who may have had some experience with home recording.

THEORY

Thomas A. Edison found when he spoke into a horn directly connected to a needle, that the latter vibrated in accordance with his speech. He wound a metal foil about a revolving cylinder and placed the fixed needle in contact with the foil. The vibrating needle scratched-in lines in the foil, and when the needle was again allowed to move over the foil, the original sounds were reproduced. Because the cylinder was inconvenient to handle and difficult to make use of when duplicates were required, the disc is now commonly used (except for machines such as the Ediphone). Also, the disc allows recording on both sides. The grooves along which the vibrations take place are in the form of a spiral from the outside towards the center of the disc.

The usual cutter takes the form of Fig. 1 which shows the scheme of a magnetic cutter. The soft-iron armature is placed between the poles of a powerful permanent magnet on the pivot P. Turns of wire are wound about the armature and on passing audio currents through the winding, the movement of the armature is passed on to the needle at the end, causing a lateral vibration of the latter about its central position. Damping is required to bring the needle back to its neutral position when no modulation is applied, and this may take the form of rubber or oil damping, the latter being more efficient but expensive.

Assuming for the moment that the unmodulated or "silent" groove approaches a straight line such as at the edge of the record, a high frequency will look like Fig. 2A while a low frequency of the same power level will be as in Fig. 2B.

It is seen at once that the amplitude of the lateral movement depends directly upon the voltage applied to the cutter and that the limit is reached when this is sufficient for the needle to swing from its groove into the adjacent one, ruining the record. There is also a limit to the high frequency which can be recorded, since the higher we go the more the tendency of the needle to move at right-angles to its groove, which is impossible.

Edison's invention used the vertical cut in which the needle vibrated up and down along its groove as against the common lateral cut which is being described. While the first was unsuitable for common electrical recording, its one big advantage was that its volume level was not limited by the proximity of the grooves. It is desirable to put on the disc the maximum lateral swing possible; and, on the other hand, it is economical and practical to place as much sound on one record as we can. For ordinary home recordings it is customary to use a cut of approximately 100 lines or grooves per inch. The spacing is determined by a screw feed which carries the cutter slowly while the turntable revolves.

A magnetic cutter needle assembly possesses a fair amount of inertia and so tends to move at a constant speed along the groove. For example, let us apply a given power at different frequencies to the cutting head. At 100 cycles then, the needle will have half the amplitude as at 50 cycles, since at the former frequency it is changing direction twice as much. The distance traveled therefore will be the same for both. This is called a "constant velocity" characteristic.

Playing-back with a magnetic head will be normal since the higher frequency, causing a more rapid fluctuation, will develop half the voltage, but since the amplitude is half, the voltage for both recordings will be equal at the playback output.

A serious difficulty will take place in re-

ording since the lower frequencies will cut over the grooves long before the higher ones, and the space available will be wasted when recording the latter. To solve this, cutters are purposely restricted in their low-frequency response in assembly and made to follow a "constant voltage" characteristic from about 350 cycles down, that is, in this range, the amplitude is governed only by the voltage and not the frequency. In the playback, of course, means are taken to raise the "lows" considerably to make up for their deficiency. In cutters there is also a deliberate cutting down of the extreme high frequencies since it has already been shown that such frequencies at high amplitude cannot be cut by a needle.

Crystal cutters are also used to some extent. These are worked on the same principle as crystal microphones and have the same limitations as to humidity and temperature. They cannot stand much overload, but have good frequency response. Uncorrected crystal cutters follow a constant voltage characteristic and the input must be corrected electrically if an ordinary cutting is to be made.

DISC SPEED

There are 2 general speeds now in use, 78 r.p.m. and 33 1/3 r.p.m., the former being common for home recording. Diameter sizes are usually 10 ins. and 12 ins. although smaller ones are available. Considering linear speed along a groove, it can be seen that near the edge of the disc the diameter is much greater than near the center. From the previous discussion, it is readily understood that the greater the linear speed, the better will higher frequencies be cut, so that near the center of the disc there is a falling off of fidelity. This is usually not very noticeable unless the grooves are very close to the center, and could be remedied by gradual manual control as the arm moves along. An ordinary tone control could be utilized.

While it is unlikely that the experimenter or home recordist will encounter 33 1/3 r.p.m. recordings as often as the faster ones, a description of the system used will be given.

This slow speed is used extensively for transcriptions and formerly for movie work. A 16-in. record rotating at 33 1/3 r.p.m. gives a full 15-minute recording when cut at approximately 125 lines-per-inch. Because of the close groove spacing, the maximum modulation applied must be below that of home recordings, but due to the fact that the discs are made of a special low surface-noise-level material, more amplification may be used in playing back. The slow speed shows that with the same equipment poorer fidelity will be obtained. However, proper equalization of the "highs" brings them up when playing back so that high fidelity results.

Near the center of the disc, however, the fidelity is decidedly poorer due to very slow speeds. To overcome this, several steps must be taken. First, the equalization of the highs must proceed progressively while the disc is in motion; that is, while cutting, the highs must be boosted far above normal while the inside is being cut and not so much as the grooves nearer the edge are cut. Secondly, since the needle will dull after a few minutes' use, and since it cannot be changed while the recording or playback is taking place, it is started at the inside and allowed to work out towards the edge. While the needle is new and can best follow the high frequencies, it is near the center grooves; after the point has rounded off slightly, it is following the grooves nearer the outside, thus balancing the result. Proper equalization may take place automatically

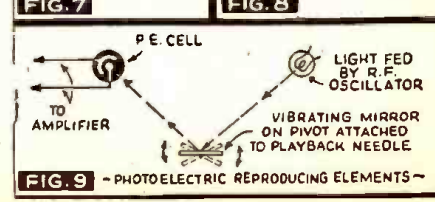
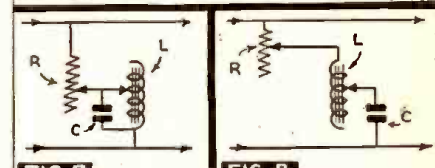
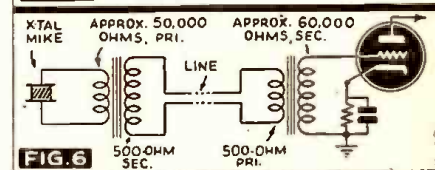
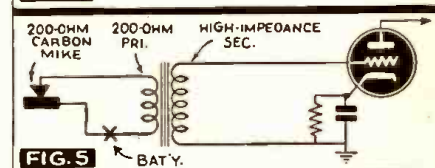
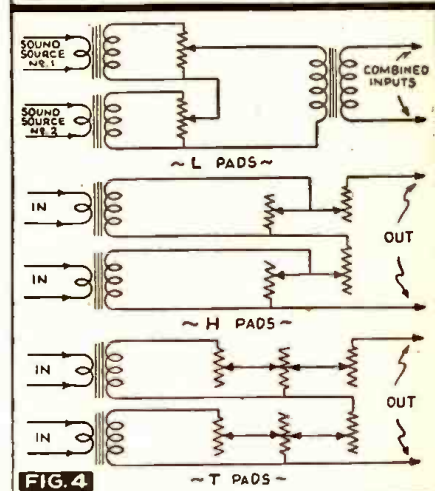
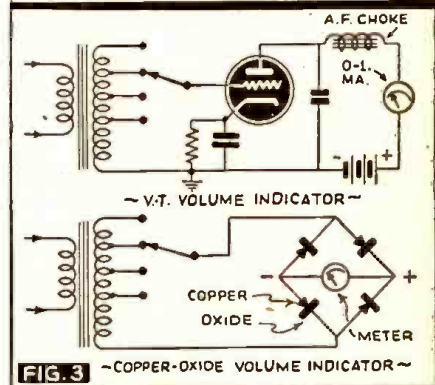
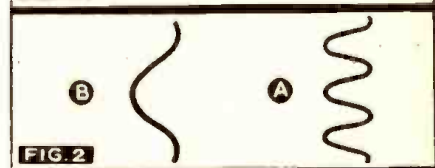
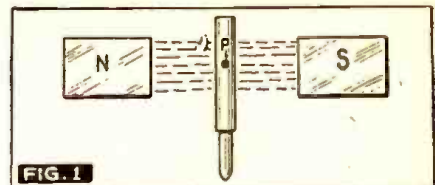

(as governed by the position of the arm), or manually.

WAX VS. INSTANTANEOUS

Professional and commercial recordings entail intricate processes, which are available only to manufacturing concerns which specialize in them. A brief description will be given.

The cutting takes place on a heavy, thick disc made of a wax-like material. The wax is then sent to be processed as follows:

It is "painted" with an exceedingly fine copper powder which makes it conducting. On immersion in a copper-plating bath a thin copper layer is deposited upon the wax and the two are then separated. The copper layer is backed up with suitable metal and is known as a master. It is the reverse of the wax, and every fine ridge in one has a corresponding depression in the other. The master may be used to stamp out playback records in a press. If records are required in large quantities, the master undergoes additional, similar processes which give a "mother" similar to the wax and a "stamper" similar to the master. This safeguards the master against damage.

The home recordist on the other hand is interested in only one or possibly a few playback discs. There are several types of blanks available for such instantaneous recordings. The oldest type is the aluminum disc which is sometimes pre-grooved, that is, it requires no feed screw. The cutter simply widens the groove and modulates it. The present-day and most satisfactory blanks are those made either of heavy eard or thin metal and coated on both sides with celluloid. The latter may be either nitrate or acetate. The former is highly inflammable and should be handled with care, while the latter being absolutely safe is widely used. Both are excellent materials; they have low surface noise, and they cut easily, thus requiring less needle pressure. With good care such records may be played-back hundreds of times. In cutting celluloid-coated discs, a thin thread of material is cut from the surface and means are provided with recorders to have this pushed out of the way of further cutting. Because no additional processes are involved with these type discs, the quality is excellent and noise low.

Three general types of needles may be used with instantaneous recordings: (1) steel, (2) alloy, and (3) sapphire. The first is very inexpensive, but wears quickly, so that the beginning of the record is better than further on, though good results may be obtained. The alloy needle is long-lasting and can be resharpened inexpensively, giving economical and satisfactory service. The sapphire is the most satisfactory in service since it may be used a comparatively long time before resharpening is in order. It should, however, be handled carefully because it is brittle and therefore susceptible to damage.

Additional copies of instantaneous discs are best made by re-recording the first from a second turntable, the output of the playback being fed into the amplifier and the output of the amplifier supplying the cutter. Because of the fact that the noise in the "master" will be present in all the others, it is advisable to make these duplicates before the first has been played more than a few times. If quite a few copies are wanted, it is best for the individual to decide whether to make all the discs from one, or after a while, to choose one of the duplicates for further re-recording. With care, and the use of new needles all along the line, very little additional noise will be introduced.

The turntable used for both cutting and playback should be free from slight variations of speed under varying load. For in-

15 WATT AMPLIFIER at \$9.75 GIVES 3100 HOURS Continuous SERVICE —AND STILL GOING STRONG!



Read This Amazing Letter

MUELLER-O'NEIL COMPANY
Amplifier Engineers
5740 Broadway Avenue
St. Louis, Mo.

Regal Amplifier Mfg. Co.
14 West 17th St.
New York City

CHECK THESE FEATURES

- EXTRA HEAVY CHASSIS
- COMPLETELY SHIELDED
- ALL OVERSIZED COMPONENTS
- SIX TUBE CLASS A PUSH-PULL
- FIFTEEN WATT OUTPUT
- THREE INPUT POSITIONS
2 Microphone, 1 Phono Input
- 2-4-8-500 OHM OUTPUTS
- HIGH GAIN, WIDE FREQUENCY RESPONSE
- CONTINUOUS, VARIABLE TONE CONTROL
- FOUR STAGES OF AMPLIFICATION
- TUBE LINEUP 1-6SJ7, 2-SC7, 2-6N6, 1-83V
- OPERATION ON 110-120 Volts, 50-60 CYCLE
- LIST PRICE \$24.50—YOUR COST ONLY \$9.75 (less tubes)

BUY THE BEST FOR LESS!

Don't let our low price fool you! When you buy a TokFone Amplifier you're buying QUALITY. Mr. O'Neil's letter and many others like it prove that you need not pay high prices to get High Quality.

9.75
FOR AMPLIFIER
Less Tubes F.O.B., N.Y.
(Kit of Matched Tubes add \$4.50)

A COMPLETE ALL-PURPOSE SOUND SYSTEM FOR ONLY \$32.50

The amplifier described above may be purchased alone or as part of the Complete TokFone Sound System. Here's what you get:

15 Watt Amplifier as Described	LIST PRICE \$24.50
2 12" Speakers @ \$7.50 each	15.00
2 Wooden Speaker Baffles @ \$10.00 each	20.00
1 Crystal Microphone with Desk Stand	12.50
1 Kit of 6 Matched Tubes	9.30

TOTAL \$81.30
For amplifier screen cover add \$2.25

MAIL COUPON TODAY!

For WIRED MUSIC OPERATORS



Breastplate "Dispatcher" type. Leaves hands free. Handsome dialetric black finish. Adj. fabric neck-band. Choice of single or double headset, high or low impedance. Available total of 12 dif. types and imp. incl. 7 1/2 ft. flex. cord. Wt. 8 oz. Most attractive, lightweight rugged, practical chest mike yet devised for operators of wired music units. At your dealer or jobber.

UNIVERSAL MICROPHONE CO., LTD.
INGLEWOOD, CAL., U. S. A.



IT PAYS TO USE THE BEST!
University's "Non-Resonant" high efficiency "Reflex" Loudspeakers will always prove most economical in the long run.

University LABORATORIES
195 Chrystie St.
New York City

Regal Amplifier Mfg. Co.
14 West 17th St.
New York City

- Send me 15 watt amplifiers at \$9.75 (less tubes)
- Send me 15 watt sound systems @ \$32.50 (less tubes)
- Send me kits of matched tubes @ \$4.50
- Send me screen covers @ \$2.25
- Send me complete illustrated catalog and price list.

Name

Address

City State

POPULAR PRICE WITH REAL MUSICAL QUALITY!



It has everything you need to bring customers into your store for records and keep them coming back for more. Quality crystal pickup, self-starting silent rim drive motor (also in 25, 50 cycle and AC-DC) built in high fidelity amplifier and speaker. Even though model illustrated retails at \$14.95 the excellence of tone is so good that dealers use it as counter or booth record demonstrator. SEE and HEAR the MUSIC MASTER. Dealers write for proposition. MUSIC MASTER MANUFACTURING CO.
508 South Dearborn St. Chicago, Illinois



For the Best of Service

OHMITE RESISTANCE UNITS

It's extra assurance for the job when you use these famous Ohmite Parts. Servicemen and Engineers everywhere have standardized on Ohmite Resistance Units for dependable, trouble-free performance.

See Your Jobber for:

Cordohms—replace internal voltage dropping resistor in A.C.-D.C. radio sets. Tapped Cords for pilot light also available. **Dividohm Resistors**—Easily adjusted to resistance you want—or tapped where needed. Sizes from 10 to 200 watts in complete range of resistance values. **Brown Devils**—10 and 20 watt vitreous-enameled resistors for voltage dropping, bias units, bleeders, etc. Resistance values from 1 to 100,000 ohms. Also Power Line Chokes, Rheostats, and other Ohmite Units.



**NEW!
OHMITE
OHM'S LAW
CALCULATOR**

Solves any Ohm's Law problem with one setting of the slide! No slide rule knowledge required! All direct readings. Only 10c to cover handling cost. At your Jobber or send coupon.

OHMITE MANUFACTURING CO.
4896 Flournoy St., Chicago, U.S.A.

10c enclosed. Send Ohm's Law Calculator. (Please Print Clearly)

Name

Address

City State

Occupation

Radio-Craft—Mar.

OHMITE

RHEOSTATS RESISTORS TAP SWITCHES

stance, the cutting stylus when fed high-level sounds must cut through more disc material, and unless the turntable can supply this load, there will be momentary variations. In playing-back, these changes of speed will manifest themselves as "wows." A momentary decrease in the recording turntable will result in a momentary increase of frequency in the playback, and vice versa. The average ear will detect a 1% change in frequency.

MICROPHONES

The recordist will in general use either of 3 types of microphones: (1) the crystal, (2) dynamic, or (3) velocity. The crystal is a very good talking mike and has a high output so that it requires no special preamplifier. Certain models come in directional types and are valuable where room reverberation is likely to be met. Being a high-impedance mike, it cannot be used very far from the amplifier unless transformers are used to and from the line. They may be susceptible to humidity and high temperatures.

The velocity microphone is a very low level device but has an excellent frequency and directional characteristic. It may be spoken to from either front or back, its sensitivity dropping off gradually and at the sides it has practically no response. Its low impedance makes possible long lines to the amplifier (which must be equipped with a matching transformer). The velocity type cannot be used out-of-doors due to wind.

The dynamic microphone is probably the most rugged of all and can be used under practically all conditions. It is somewhat directional especially to voice frequencies. It is usually of low impedance, and though its sensitivity is somewhat low, its output can easily be amplified to proper level.

The power level of electrical devices such as microphones is measured in decibels (db.). The definition of the decibel is 10 times the logarithm of the ratio between 2 given power levels. In practice one level is chosen as reference or zero decibel and the given level is compared with it. For those little acquainted with mathematical procedure it may be stated that tables of logarithms are readily available and require no calculation. Suppose we wish to know the level of a power 10 times greater than that of the reference value. The logarithm (from the tables) of 10 is 1, and 10 times this value is 10, resulting in an answer of 10 db. To simplify calculations it may be remembered that every time we multiply a power by 10 we add 10 to the db. value. The level may be so many db. plus or minus depending upon whether it is higher or lower than the zero value. In most instances the zero level is 0.006-watt. Because a vacuum tube is a voltage-operated device, when microphones are concerned, it is usual to choose reference value as 1 volt per bar, the bar being a unit of air pressure (created by the sound). The bar is equal to a megadyne per square centimeter.

MONITORING—MIXING

There are 3 distinct purposes of monitoring the sound input as the recording is taking place. First, we wish to check-up on the quality of the sound and make sure that nothing has gone wrong as far as mike and amplifier are concerned. Second, we wish to make sure that the level is as high as possible for high ratio of sound-to-noise without overcutting. Third, we must obtain proper balance between the several sound sources (assuming more than one).

To accomplish the first purpose it is necessary to listen to the sound either on headphones or on a speaker. Since the

latter would interfere with the original sounds (if a microphone is being used), the headphone method is recommended. Incidentally, the latter excludes sounds which may be present but which are not being picked up by the mike, so that only the sounds actually recorded are heard. Most complete recorders do not come equipped for headphone operation. It is possible to place a high-resistance 'phone across a low-impedance cutting head (assuming the D.C. is excluded from the circuit) for there will be only slight change in resultant impedance; or, a pair of headphones may be connected into the amplifier at the detector output, and some switching arrangement made for shutting off the speaker.

When using the microphone in anything but a small, well-furnished room it may be noticed that a distinct echo or reverberation is present. This is due to the fact that the sound is being reflected from walls, floor and ceiling. A heavy rug on the floor will decrease the difficulty while curtains and drapes will help as far as the walls are concerned. Since close mike talking increases the sound input without producing a corresponding increase in reverberation, this may be tried, although with some mikes it is not good policy to talk too closely, breath noises being accentuated.

It must be understood that what we normally hear in a room and what a mike will hear in the very same room may be two entirely different things! With 2 ears, we have the faculty of being able to concentrate on wanted sounds, subconsciously rejecting interfering noises. We may, for instance, be able to carry on a conversation in a room filled with other voices, even when the latter are loud compared with the first. A mike, however, not having this characteristic, picks up sound only in relation to their strengths. A room which may seem correct for microphone use may give poor results when actually monitoring on the 'phones, and on the finished record, due to reverberation or outside noises. A directional mike will greatly decrease reverberation troubles.

As stated above, we wish to cut the record at as high a level as possible for best results. For this it is best to have a visible means of control, the eye being more sensitive to intensity changes than the ear. It is common practice to utilize a "tuning eye" or electronic visual indicator for this purpose. Several tries will determine how far the eye closes for maximum modulation and this amount must not be exceeded at any time. A more precise arrangement would be one using a meter to show the power level. Two general methods are in use: (1) the vacuum-tube voltmeter; and, (2) the copper-oxide rectifier. One of the figures shows the connections involved.

The vacuum-tube voltmeter is biased almost to cut-off, and as a result, the D.C. meter in the plate circuit will indicate relative voltage inputs. Its advantage is that it takes no power from the input, but on the other hand, it requires a filament and plate voltage supply.

The other method uses a rectifier in conjunction with a D.C. milliammeter. The audio frequencies are changed to D.C. The rectifier usually takes the form of copper washers, one side of each of which is oxidized. The pure copper is connected to the positive side of the output.

The bridge connection shown in the diagram will give the greatest output with least strain on the rectifier elements for a given voltage input. The elements are somewhat sensitive to temperature and humidity, breakdown occurring at about 150 deg. F. The diagram shows a tapped sec-

ondary in each case, so that maximum modulation on the meter will be obtained at a convenient scale setting (somewhat past half-way). The needle is unable to follow the peak of each individual frequency and will simply follow the average contour of the envelope. A little practice will enable the recordist to obtain maximum cutting stylus vibration without danger of over-cutting.

To obtain proper balance between several inputs, it is an absolute necessity to listen-in to the output of the amplifier. It may be necessary to increase or decrease the radio set's output in relation to the microphone sounds. If two or more performers are being used on the microphone their relative positions from the mike may have to be adjusted until they are nearly equal (unless one is simply an accompanist). Only monitoring will determine this.

Varying the power levels of electrical circuits until they can be combined at the desired volumes is known as "mixing." The devices used for this purpose are known as pads. The levels are not increased but the stronger ones are brought down to the level of the lower ones in every case. The 3 general types, in the order of their effectiveness, are the L, H and T.

The diagrams show pads arranged for 2 inputs, but more may be used, of course. In following their hookup it can be seen that only a portion of the input voltage is applied to the output. The 2 horizontal arms shown in the T-pad are varied simultaneously. Only in the latter is the impedance of either circuit unchanged by variation.

MATCHING IMPEDANCES

The impedance of all electrical circuits must be matched as to impedance for maximum power transfer and minimum distortion. For example, having a 200-ohm microphone, we cannot connect this directly to the tube input, since the latter is of very high impedance. Figure 5 shows the procedure. The mike is connected to a 200-ohm primary and the tube input is connected to a very-high-impedance secondary. The transformer then would be known as a 200-ohm-to-tube input transformer.

A high-impedance crystal mike could be connected directly to the tube but since a long line entails electrical losses, we would in the latter case use the procedure of Fig. 5. Long lines may efficiently carry energy when at low impedance such as approximately 500 ohms. Two transformers will thus be needed. Crystal cutters being of high impedance require a high-impedance transformer secondary with the primary matching the impedance of the output tube.

Magnetic cutters are usually (a) 8, (b) 500, or (c) high-impedance, and should be connected to the output tube accordingly. A high impedance may be connected directly across the output-tube transformer primary using merely a large condenser in series with the cutter to keep D.C. out. An 8-ohm cutter may be substituted for the voice coil of a speaker, since the latter is also 8 ohms. Both cannot be connected at once because the resultant impedance is then 4 ohms. If the speaker transformer secondary has a tap for 4 ohms this can be done, however.

One principle not well understood even by some technicians in regard to impedance matching is the following. Suppose we have a transformer marked 500 ohms on the primary and 200 on the secondary. It is perfectly permissible to connect to the primary a device with a 1,000-ohm impedance if we also double the impedance connected to the secondary (400 ohms). Likewise, if we use an impedance of 1½ times the

Airline SOUND SYSTEMS

Greatest Value Ever Offered

... Say Sound System Men

If you want the most for your money in a sound system, note these few expressions, typical of hundreds, about the Ward Airline from men out on the firing line: "Far better than others!" "Exceeds expectations!" "Best I ever heard, and I have owned several!" "Compares with others twice its price!" "Easily the best for the money!" "Surpasses other equipment that costs much more!" WHY? They say it's because of Airline's marvelous tone quality, its volume without distortion, its adaptability to any use, indoors or outdoors, its low upkeep!

Get new Catalog for more of the Facts

The Airline Sound System Catalog is packed with additional facts you'll be interested in knowing. Shows sound systems for every purpose, and how to select the proper amplifiers, speakers and mikes for your own needs. Offers you tremendous savings because of Wards direct selling plan . . . savings PLUS performance. Send for this FREE Catalog NOW!! Mail the Coupon!

PROFIT BY WARDS

Time Payments — 15-Day Trial — Money-Back Guarantee



RUSH COUPON

Montgomery Ward

9 GREAT MAIL ORDER HOUSES
MORE THAN 600 RETAIL STORES

MONTGOMERY WARD & CO.
Dept. RZ-43, Chicago, Ill.

Please send me your FREE Sound Systems Catalog at once!

Name _____

Address _____

City _____ State _____

marked value on the primary we must do the same at the secondary, and so on. It is not advisable for most transformers to more than double the marked value as above, for best response. When choosing a transformer, its frequency characteristic should be kept in mind.

EQUALIZERS

An equalizer as its name suggests is used to equalize the frequency response when, due to inherent characteristics, such need is necessary. It is simply an elaborate tone control. The calculation of constants for specific equalization is very complicated, so it is best to judge by listening to what is proper equalization in any given case. Figure 7 shows the fundamental circuit involved. When the circuit is tuned to the desired frequency range, a high voltage is built up at this frequency band and the others more or less bypassed. Variation of the resistor determines the amount of equalization. Figure 8 shows another method whereby a band of frequencies may be bypassed when the circuit is tuned to it and the other frequencies are passed on without much attenuation. Both circuits may be used to simultaneously drop some frequencies and bring up others.

PLAYBACKS

The finished record is the only test as to how our best efforts have resulted, and certain precautions and care must be taken so that the discs may be played back a great number of times faithfully. Just as in recording, there are 2 general types of playback apparatus in use: the crystal; and, the magnetic. The crystal pickup is in wide use, offering very-high-fidelity results and a large voltage output. The highs are espe-

cially good, thus bringing out needle scratch, and a scratch filter is sometimes used in this connection. Since this filter eliminates not only scratch but also the higher sound frequencies, it is a question whether it is desirable where high fidelity is a requisite.

Since a crystal assembly is much lighter than a magnetic one, it is possible to manufacture such a device with a pressure on the disc of only 1 oz., or so. This light pressure results in exceedingly long life for both records and needles, and in fact, the life of a sapphire needle in such a device will be indefinite.

When steel needles are used in the average pickup, it is advisable to change needles often, since a dull needle will wear the grooves down quickly besides greatly adding to the noise level.

Several models among the pickup arms available feature a device for securing tangent tracking of the groove no matter what the position of the arm is with respect to the record. This is desirable from the standpoint of long life of needle and disc and a minimum of noise. The arm must always be free to move easily from side to side, as it follows the grooves from the edge to the center, or otherwise more wear will occur on one side of the groove and needle.

If trouble is had from an "echo" at certain places, it is due to the needle pushing the walls of the groove from one groove to the next as it moves, that is the variations along one groove will be partly reproduced along the next. This may be due to excessively high modulation applied to the cutter which, however, has not quite overcut into the next groove. Improper depth of cut will also cause this. Insufficient

(Continued on page 560)

MODERN MICROPHONE TECHNIQUE

This is the 2nd article in a series of 3 designed to answer many questions on the choice and use of microphones (and on amplifier input considerations) in Public Address work, and Home and Semi-Professional Home Recording. Sound specialists in every branch of the field were consulted during the preparation of this article in an effort to present concrete, applicational information on this topic. Part I, last month, analyzed Crystal, Dynamic, Velocity and Cardioid microphones.

PART II—The Microphone and Its Relation to the Amplifier

H. S. MANNEY



Recording the children's growth audibly in records for the family album is the latest use made of home recording equipment. Junior and sister are shown here preparing for a recording with Philco's professionally-designed home recording apparatus while mother sets the blank disc in place. Note P.M. dynamic microphone (arrow).

THE basic requirements outlined in Part I of this series may help the technician to select a particular type of microphone for his application. The next step involves the technique of connecting the microphone to the amplifier. Specific types of installation will necessitate the selection of a particular kind of basic microphone. The academic conception of "connecting" a microphone to an amplifier simply means running the two wires from the microphone output to the amplifier input. In actual practice, however, a number of factors tend to complicate this apparently simple procedure.

BASIC CLASSIFICATIONS

Electrically, microphones may be classified into 3 distinct groups:

- (1) Resistive
- (2) Inductive
- (3) Capacitative

Resistive microphones are those types in which the prime moving element is resistive in nature. This is particularly true of the carbon-type microphones, wherein carbon granules are employed. Its impedance is exactly equal to its resistance. When this microphone is coupled to a low-impedance transformer, the output terminals of the microphone are resistive because of the reflected resistance connected to its primary. When the carbon unit is coupled to a high-impedance transformer the output terminals of the microphone become predominately inductive because the coefficient of coupling is usually low (in high-impedance transformations).

Inductive microphones are those types in

which the prime moving element is inductive in nature. This is particularly true of dynamic microphones, wherein a moving coil is employed. Its impedance is practically equivalent to its inductive reactance. Its D.C. resistance usually is negligible. When this moving coil is coupled to a transformer, the output terminals of the microphone are inductive, because of the reflected inductance connected to its primary.

Capacitative microphones are those types in which the prime moving element is capacitative in nature. This is particularly true of the crystal-type microphone. Its impedance is equivalent to its capacitative reactance. When this crystal unit is coupled to a transformer, the output terminals of the microphone become capacitative, because of the reflected capacity connected to its primary.

THE MICROPHONE LINE

Although microphone lines, per se., may appear to be a prosaic item for discussion, a brief analysis of the types and their characteristics will disclose some unusual problems.

Microphone lines may broadly be classified into *long* and *short*. While there is no arbitrary classification of the two, 100 feet is popularly regarded as the dividing line. In other words, microphone lines up to 100 feet are usually construed as short lines. Those exceeding 100 feet are considered long. This terminology, of course, is confined to microphone lines only as discussed within the scope of this series of articles.

Microphone lines may also be *shielded* or *unshielded*. If shielded, the lines may be composed of 2 wires and a shield, or a single wire with a surrounding shield. The shields of such lines may or may not have an external insulating cover.

Microphone lines may further be classified as *high impedance* or *low impedance*. While no official line of demarcation differentiates either type, popular terminology has restricted the use of "low impedance" to all lines up to and including 600 ohms. All other higher impedance lines are simply classified as "high impedance." They may range up to 100,000 ohms.

Most popular high-impedance velocity microphones are terminated at 10,000 ohms; others at 5,000 ohms, and some as low as 2,000 ohms. The relative importance of these terminal impedances will be discussed after the various characteristics of lines have been covered.

LINE RESISTANCE

Microphone lines display 3 electrical characteristics:

- (1) Resistance.
- (2) Inductance.
- (3) Capacity.



Brush "Sound-Cell" Crystal Microphones: AR 26 (with transformer); AR 43, R43; BR25, R22; B1.

The quantity of these characteristics is determined by the length and type of line. The relative importance of each of these 3 characteristics will greatly affect the selection of the output impedance of the microphone as well as the input circuit of the amplifier.

The resistance of a line is proportional to its length, and therefore, actual resistance of any microphone line can be found by either direct measurement or by referring to copper-wire tables. This resistance plays no important part in high-impedance lines. In a low-impedance line, such as 50 ohms or 25 ohms, the resistance of a long microphone line can introduce a considerable loss.

This is illustrated in Fig. 1 where E is the voltage generated by the microphone, ZL, its terminal impedance, RL, the resistance of the line, and ZL', the input transformer. Although ZL may equal ZL', the loss becomes appreciable when RL approaches ZL. The loss in db. may be expressed mathematically as follows:

$$\text{Loss db.} = 10 \text{ Log } \frac{ZL + RL + ZL'}{ZL}$$

It will be noted that the loss becomes smaller as ZL and ZL' become large, with a given fixed value of RL. This simply means that the line resistance may be neglected in high-impedance circuits. In calculating the line resistance, 2 wires should be taken into consideration, that is the one going from the microphone to the amplifier, and its return lead, so that the actual wire length would be double the distance of the microphone cable.

Another point to remember in employing long low-impedance circuits is that frequency discrimination will occur when line losses become large. This phenomenon is brought about by the fact that the inductive generator is feeding the resistive-inductance network. The resistance displaying a non-frequency discriminating characteristic while the load may display a frequency discriminating characteristic. This condition would bring about a loss of low frequencies, which may sometimes be desirable.

LINE CAPACITY

It is apparent that a shielded wire will have some capacity. It is also obvious that the longer the shielded line, the more the total capacity. Likewise, the less the distance separating the wires (the center wire and its shield or each of the twisted wires), the smaller will be the capacity of the line. This line capacity is of a negligible value in low-impedance lines, but may assume an appreciable value in a high-impedance line.

The capacitive characteristic of lines is of great importance when dealing with crystal microphones, because the crystal microphone is a capacitive generator, as illustrated in Fig. 2. This device has effectively no series resistance. Any capacity connected in parallel with it will only reduce the voltage output, but will not introduce any frequency discrimination.

This can easily be analyzed by referring to Fig. 3 wherein a crystal microphone is connected to a cable having measurable capacity Zc. The voltage which appears across

Zc will be proportional to $\frac{Zc}{Zc + Zx}$. As Zc

and Zx are both capacitive in nature, their relative impedance will remain proportional through the entire audio spectrum thereby accounting for the fact that no discrimination occurs when long, capacitive lines are used in conjunction with crystal microphones (which do not employ internal step-down transformers).

This capacitive nature of a long, high-impedance line, however, will greatly impair the original characteristics of an in-

ductive microphone. It may, under some conditions, actually resonate at some audio frequency, and thereby produce a very undesirable peak. Furthermore, it will nearly always introduce an appreciable frequency discriminating characteristic, usually a predominant loss of high frequencies.

Therefore any high-impedance inductive or resistive microphone will lose high frequencies when coupled into a long, capacitive line. Capacitive microphones, on the other hand, will not display frequency discriminating characteristics when coupled to such lines, but will suffer reduction in output.

LINE INDUCTANCE

When a twisted pair of wires are run for an appreciable distance, the line may display, in addition to resistive and capacitive characteristics, an inductive reactance, which is effectively placed in series with the generator, as illustrated in Fig. 4. If the microphone is of an inductive nature and the amplifier input of an equivalent inductance, no frequency discrimination will occur, but a drop in effective voltage will be noticed at the amplifier input.

It will be noted that this nicety of frequency balance is only maintained when the characteristics of the line are similar to those of the microphone and the amplifier input. When variations exist between these 3 elements, some form of discrimination will occur. The usual end result is a loss of high or low frequencies.

These phenomena are outlined for the technician so that he may affect suitable remedial measures and correct any noticeable discrimination in the coupling link between microphone and amplifier.

AMPLIFIER INPUT TERMINALS

Input terminals of all amplifiers can broadly be classified into 2 groups:

- (1) High Impedance
- (2) Low Impedance

The high-impedance type may be further classified into *resistive* or *inductive*.

All low-impedance inputs employ transformers for matching the line impedance to the input grid circuit. Some high-impedance inputs similarly employ transformers. This is particularly true of *bridging* amplifiers, wherein a 5,000-ohm input is bridged across a 500-ohm line so as to provide minimum loading effect. All ordinary high-impedance inputs are terminated directly into the grid circuit of an amplifier without any intervening component.

If an amplifier employs an input transformer, the characteristics of this latter unit are just as important as those of the transformer employed within the microphone. The frequency response of any inductive microphone can be no better than the frequency of the transformer into which it feeds. As most input transformers must be built small to avoid excessive hum pick-up, an appreciable amount of loss is usually encountered because of transformer inefficiency.

When it is difficult to decide whether or not to use high- or low-impedance lines, the disadvantages of an additional input transformer within the amplifier should always be taken into consideration. Its response and efficiency are of vital importance. Furthermore, a low-impedance microphone necessitates the use of 2 transformers, one within the microphone and one within the amplifier. On the other hand, high-impedance crystal microphones require no transformer, while high-impedance velocity or dynamic microphones require a single transformer within the microphone itself, and none in the amplifier.

For a non-frequency-discriminating match, it is important that the inductive micro-

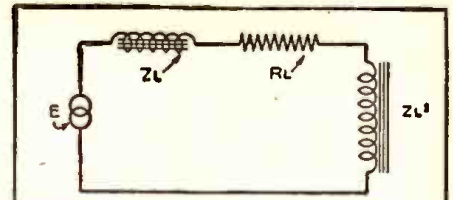

FIG. 1 ~ EQUIVALENT CIRCUIT OF LOW-IMPEDANCE MIKE LINE AND RESISTANCE LOSS ~

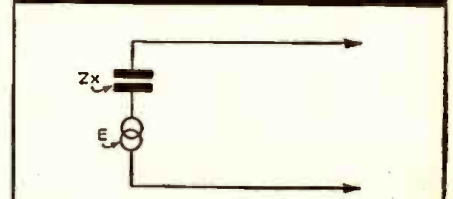

FIG. 2 ~ EQUIVALENT CIRCUIT OF CRYSTAL MICROPHONE ~

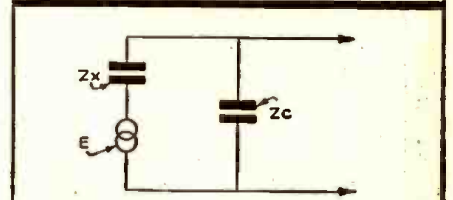

FIG. 3 ~ EQUIVALENT CIRCUIT OF CRYSTAL MIKE AND LINE CAPACITY ~

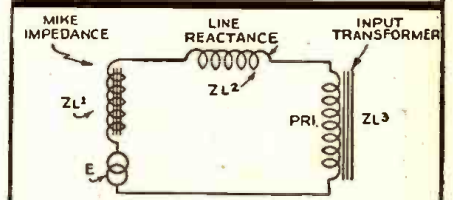

FIG. 4 ~ EQUIVALENT SERIES INDUCTANCE OF LONG LINES ~

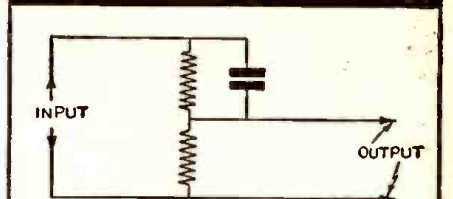

FIG. 5 ~ BASIC H.F. ACCENTUATOR ~

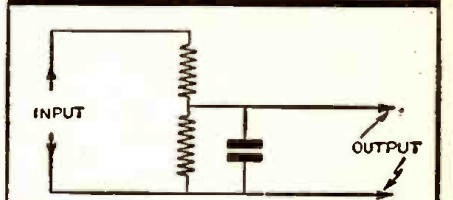

FIG. 6 ~ BASIC H.F. ATTENUATOR ~

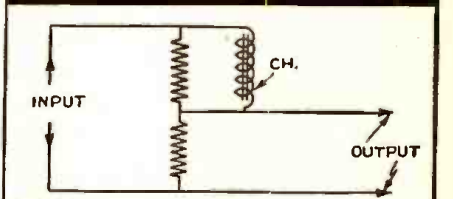

FIG. 7 ~ BASIC L.F. ACCENTUATOR ~

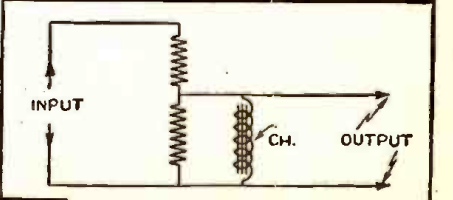

FIG. 8 ~ BASIC L.F. ATTENUATOR ~

DUAL Speaker JHP-51



A Two-Way System Complete with Integral Dividing Network



Providing faithful wide-range reproduction obtainable only with a Two-Way System . . . Presented for the first time in a compact UNIT including PM high- and low-frequency speakers, frequency-dividing network and impedance-matching facilities . . . at remarkably low cost! For high quality receivers, phonographs . . . wherever a BETTER speaker is needed, use Jensen JHP-51. List Price \$46.50. Also available in complete Reproducers with Jensen Bass-Reflex. Write for free Data Sheet #19.

Jensen
RADIO MFG. CO., 6601 SOUTH LARAMIE AVENUE, CHICAGO

response of a complete system. In all practical work, however, a competent technician can easily judge what type of discrimination is taking place, so that fundamentally, the problem evolves itself into incorporating an equalizer within the amplifier, which will attenuate or accentuate either one or both the high or low end of the audio spectrum.

A simple high-impedance *accentuating circuit*, which can easily be interposed between 2 high-impedance stages, is illustrated in Fig. 5. Likewise, a high-frequency *attenuator* is illustrated in Fig. 6. Basic low-frequency accentuation and attenuation circuits are given in Figs. 7 and 8, respectively. The degree of equalization desired will determine the values of the various resistors, inductances, and capacities.

Some experimentation will usually provide the desired degree of equalization. Where a complex frequency discrimination occurs, as when the frequency response characteristic is composed of predominant hills and valleys, the design of a suitable equalizer becomes involved, and unless absolutely necessary, should not be attempted by the layman.

EVALUATING THE FREQUENCY DEFICIENCIES

When a system is being judged for lack or presence of any portion of the spectrum, care should be taken not to be misled in the wrong direction. For example, a system that has a predominant bass boost can sound as though high frequencies were lacking. On the other hand, a system that accentuates high frequencies, may appear to be lacking in lows. It is obvious that the best corrective method is to eliminate the source of trouble and not introduce an additional source of discrimination.

For example, the system which has excessive highs and appears to lack lows may be subjectively corrected by introducing a bass accentuating circuit. This is not the most desirable procedure to follow, for it is usually much simpler and more economical to reduce the excessive high frequencies. This latter method will not introduce any secondary troubles, such as increase of hum when low frequencies are accentuated. It is hoped that this discussion will bring to the attention of technicians, many conditions with relation to the use of microphones which affect the overall response of the system and that better judgement will be exercised in the selection of various components in view of the characteristics outlined.

The following, concluding article will outline several points which should be considered when actually using the microphone.

RADIO DIAGRAMS

MOST - OFTEN - NEEDED

MOST OFTEN NEEDED RADIO DIAGRAMS

ALL MAKES 1926-1938

In this one low-priced manual you have all the circuits you really need. 427 diagrams of most often serviced radios is the help you want for easier, faster, and better repairs. You will find 4 out of 5 diagrams \$1.95 needed in this manual. 244 pages, large 8 1/2 x 11 in. size. Special price

HOW TO SAVE TIME

Service hints, diagrams, alignment data, test charts, and parts lists included will prove time-savers and money-makers for you. Get these handy "on-the-job" handbooks. No need to work blind-folded. The time saved in two days will more than pay for these manuals.

1939-1940 DIAGRAMS

This single manual will give you over 80% of all 1939-40 circuits ever needed, acquaint you with recent radio developments, and teach you how to service quickly millions of sets sold last year. Models of 43 manufacturers. 212 large pages, 8 1/2 x 11 inches. Limited quantity at

FREE EXAMINATION

SUPREME PUBLICATIONS, Room 645
3727 W. 134th St., Chicago, Illinois
Ship the manuals checked. I must be satisfied or you will refund my money in full.

Most Often-Needed Diagrams, 1926-1938, @ \$1.95

Most Popular 1940 Radio Diagrams, @ \$1.50

I am enclosing \$ send postpaid

Send C.O.D. I will pay the mailman.

NAME _____
(Write address below and send this corner)

phone feed into an inductive input having similar impedance-frequency characteristic.

This general rule holds true for all ideal coupling circuits between microphone and amplifier. When a cross-match is made, that is, a capacitance microphone coupled into a resistive input, or a resistive microphone coupled into an inductive input, some form of frequency discrimination is sure to occur. Under some conditions, this type of discrimination may be desirable and used to full advantage. In most cases, however, the technician is unaware of, and therefore does not control, the discriminating characteristics introduced by the link which couples the microphone to the amplifier.

MICROPHONE EQUALIZATION

Frequency discrepancies which may exist in a microphone, its coupling link, amplifier input, or speaker, and its acoustic environment may be compensated for by suitable selection of equalizer circuits within the amplifier proper.

For varied applications, it is usually advisable to provide a variable set of equalizers so that any predetermined frequency response characteristic may be obtained from the entire system from microphone to speaker or recording head. The design of equalizers is both varied and complex. Design details are beyond the scope of this discussion. Some fundamental principles, however, will be outlined in the hope that technicians may be able to correct for some frequency discrepancies.

The most distorted form of discrimination occurs when the character of the original sound is altered to a noticeable degree. This usually occurs when the system attenuates or accentuates either or both high and low frequencies. Ordinarily, elaborate equipment would be required to check the overall

Feature Articles in the MARCH RADIO & TELEVISION

- CBS Demonstrates Color Television with "Live" Subjects
- New Frequency Modulation Transmitter and Receiver for Amateurs—Ricardo Muniz, E.E., Donald & Warren Oestreicher
- Electronic Music Through Your Radio Set—H. G. Cisin, M.E.
- Adapting Mobile Amateur Equipment to the New Regulations—Howard G. McEntee, W2FHP
- "CQ"—Latest News of "Ham Doings"—Larry LeKashman, W2IOP
- Principles of Frequency Modulation Explained—F. L. Sprayberry
- International Radio Review, Including Circuits of Foreign Receivers
- An FM Receiver for the "Home Constructor"—L. M. Dezettel, W9SFW
- "Question and Answer" Box
- Latest Radio Patents
- Radio Hook-Up Department
- Experimental Radio Section
- Interference Prevention in Television Reception—Thornton Chew, Television Engineer
- A Simple "Signal Tracer"
- NYA Do Fine Radio Job in Maine

INDEPENDENT POWER SUPPLIES

Improve Audio Output

Fixed bias, an important feature in audio amplifiers, has been thus far supplied by either expensive or inconvenient devices. The author of this article has developed very unusual and economical circuits to be used in their stead.

JOEL JULIE

IN MANY receivers and in many audio amplifiers it is often advantageous to have more than one independent power supply. Changes of current in one part of the circuit affect the voltages of other parts of the circuit. Generally in radio receivers all the voltages are obtained from one power supply, since this is the cheapest method of obtaining the desired result. However this situation has its advantages for the Serviceman inasmuch as it affords him an opportunity to suggest to customers improvement in operation through the addition of a separate power supply, as for example one of those here described, to achieve greater operating efficiency (primarily, greater amplifier power output—greater dynamic range—for a given input), and hence, improved tone quality.

Let us concern ourselves in this article only with the factors affecting the power output. The power output of an audio stage depends largely upon the plate supply and grid supply voltage of that stage and the stability of those voltages under different loads; this stability is what is usually called the regulation of the power supply.

REGULATION

As far as class A operation is concerned where the operating point is chosen on the straight part of the characteristic we would have no trouble with the regulation of the power supply, since the plate current remains practically constant under varying signal strength. In class A then, we can get along successfully with one power supply, obtaining the grid voltage as a voltage drop on a cathode bias resistor or on a resistor placed between the minus (-) terminal of the plate supply and the ground. These ar-

This circuit, by eliminating the extra winding of the transformer, makes possible the use of a standard-type transformer. It suggests a less expensive equivalent of the circuit shown in Fig. 2.

rangements are known as *self-bias* since the plate current is fed through a resistor, providing its own bias. *Fixed-bias* is a bias voltage supplied by an independent source.

The great majority of output tubes will work with practically the same degree of efficiency with fixed-bias or self-bias under class A operation. Significantly, most tubes, though, operate more efficiently if fixed-bias is applied, even though operated in class A only.

SELF-BIAS EFFICIENCY

In class AB operation, where the operating point is chosen near the cut-off point of the characteristic, the plate current of the output stage varies considerably with the variation of the signal strength. If self-bias were used the variations of the plate current would cause variations of grid voltage, thus causing displacement of the operating point of the output stage. A class AB stage operated in such a manner would not work very efficiently. In fact a pair of 2A3s will supply 15 watts output at 300 volts plate voltage with fixed-bias as compared with only 10 watts output with self-bias; a pair of 6L6s will supply 40 watts at its maximum

ratings with self-bias as compared with 60 with fixed-bias. The same ratio of power outputs holds true with almost all the output tubes. Strangely enough there are some tubes, like the 6F6, operated as a pentode, that will work as efficiently with self-bias as with fixed-bias even in class AB. The number of these tubes, though, is very small.

For those cases where an independent power supply for grid bias is necessary, various arrangements were used in the past, which were either inconvenient or expensive, or both. These are still being used today—bulky "C" batteries or expensive, completely independent "C" power supplies. In Figs. 1, 2, and 3, is shown a convenient and cheap method of obtaining a fixed "C" supply voltage, which is adaptable to many conditions of service.

SINGLE-ENDED OUTPUT

In Fig. 1 we have the design applied to a condition of *transformerless* operation (A.C. only). We use a voltage doubler operated as 2 independent power supplies. One section of the rectifier supplies the plate and screen-grid voltages; the other section, control-grid voltage. The field of the speaker is utilized as a filter choke for the control-grid voltage. Provided that the capacity of condenser C1 is large enough the plate voltage of the output tube can be taken

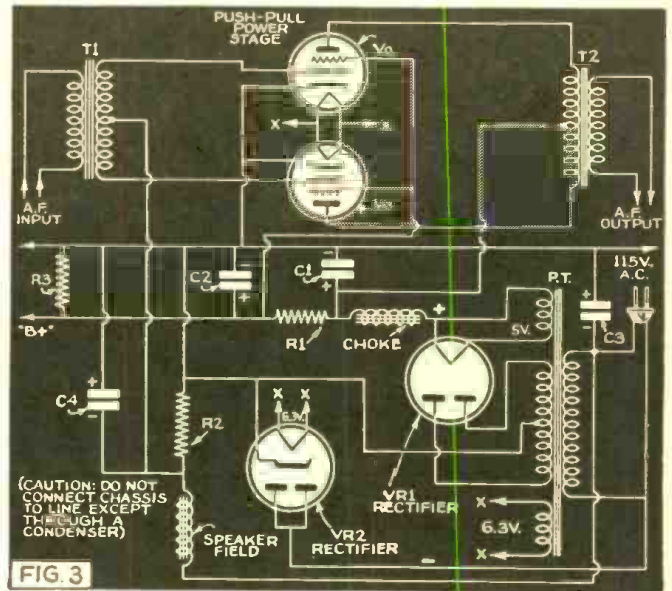

FIG. 3

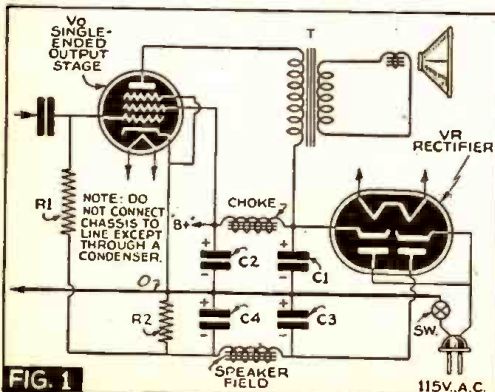

FIG. 1

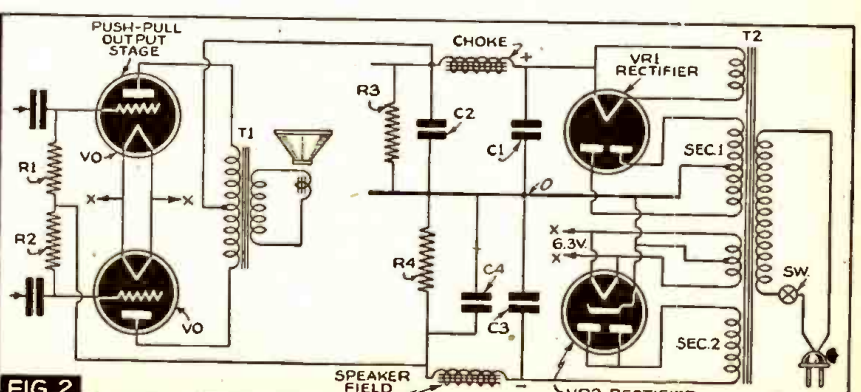

FIG. 2

NEW FM AUDIO AMPLIFIERS

Designed by A. C. Shaney

FREQUENCY RANGE: 13-30,000 c.p.s. ± 1 db
 POWER RANGE: 0.003 to 30,000 Milliwatts
 MUSICAL RANGE: 11 Octaves
 DYNAMIC RANGE: 80 db

Outstanding in their performance, construction, and appearance. These amplifiers were specifically designed for use with frequency modulation tuners, standard amplitude modulation receivers, and absolute fidelity phono reproducers. Lead by a wide margin in the very finest resistance, impedance or transformer-coupled amplifiers. Incorporate two basic AC and DC balancing circuits (pat. app. for) which provide greater circuit stability than conventional amplifiers.

Guaranteed for FIVE YEARS

Write for literature describing our FM Amplifiers

AMPLIFIER CO. of AMERICA

17 WEST 20th STREET NEW YORK, N. Y.

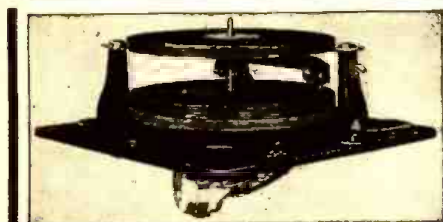

Use this Simpler Better Selling Record Changer

GI-C120 easy to operate—sells better. Record changer is simple and ONE lever adjusts for 10" or 12" records or for manual playing. Easy to install—saves labor. Complete unit (changer, turntable, motor, tangent-tracking crystal pickup) mounted on base plate, ready for your cabinet. Order one to test, from your Jobber.

The GENERAL INDUSTRIES CO.
 Dept. 20 Elyria, Ohio

NEW AUDIOGRAPH Sound Catalog

AUDIOGRAPH Sound Systems represent the latest in Sound Engineering and Design—a complete line plus pre-tested accessories.

NEW LOWER PRICES

Outstanding quality and performance at prices that help you meet any competition.

WRITE FOR FREE COPY

JOHN MECK INDUSTRIES
 1313 W. Randolph St., Chicago, Ill.

GOLDENTONE .. 50% OFF

DEAL DIRECT FACTORY PRICES to choose from—4 to 12 tubes. Portables \$8.08 up. Farm sets \$8.98 up. Car sets \$8.98 up. Foreign band sets \$8.08 up. Samples 50% off. Quantity discounts. Free 1941 Bulletin catalog. Free details of 10-day FREE trial. agent's proposition and discounts. Mail postcard. GOLDENTONE RADIO CO., DEPT. RC, DEARBORN, MICH.

Free Catalog RCA LICENSED

10 DAY TRIAL \$4.95 UP TO PLAY YEAR GUARANTEE

Miles FILMGRAPH VOICE AND MUSIC RECORDINGS

Lengthy or continuous recordings now possible with newly patented "FILMGRAPH." Over 13 hours of indexed voice, radio, code, telephone recording on a single 500 ft. reel of film costing \$3.00 and up. No other expense. INSTANTANEOUS and PERMANENT play-back. Can easily be synchronized with Motion pictures. Bulletins free. MILES REPRODUCER CO., INC., Dept. RCB 812 Broadway New York City

from the cathode of the rectifier.

That arrangement will provide for better regulation and also will make available to the output stage, the maximum voltage obtainable, or 120 volts.

The appropriate values of resistance and capacity when using a type 43 power amplifier and 25Z5 rectifier, for example, would be about as follows:

RESISTORS

- R1, 75,000 to 100,000 ohms, ½-w.;
- R2, 400 ohms, 10 W.;

CONDENSERS

- C1, 40 mf. or more, 150 V.;
- C2, 16 mf., 150 V.;
- C3, 30 mf., 150 V.;
- C4, 25 mf., 25 V.;

MISC.

- Field, 2,000 ohms;
- Choke, 400 ohms, 12 hy., 30 ma.;
- Transformer T, output, 4,500 ohms (impedance).

A type 43 tube operated in such a manner would deliver about 1½ watts; a 25B6 would deliver as much output as a 6F6 having 250 volts on its plate. It can readily be seen that in small A.C. receivers, the cost of the power transformer can be saved while we may still obtain as much power as we could with the transformer. As compared with the regular voltage doubler this circuit has many advantages, the most important of which is better regulation and of course, the welcome feature of a fixed "C" bias supply.

This circuit makes possible for the first time, the attainment of fixed-bias in transformerless-operated apparatus, without the necessity of using batteries.

PUSH-PULL TRIODES

In Fig. 2, a circuit of 2 independent power supplies is shown using a single transformer of exactly the same size as if 1 power supply were used. The only difference is that the high-voltage winding is divided into 2 parts; one that supplies 315 volts for the plate voltage, and one that supplies 140 volts for the control-grid and field excitation—if for example we are considering a pair of 6A3s. The rectifier VR2 is heated from the same source as the receiver tubes. Its cathode is connected to ground. As a result we may increase the output of the amplifier from 10 to 15 watts without increasing the size of the transformer.

As a 2nd advantage the lower operating voltage for C1 may be mentioned. Ordinarily for this case if field, plate and control-grid voltages were to be obtained from 1 power supply, the operating voltage for C1 would have to be about 455 volts, necessitating the use of a high-voltage condenser, or better yet, 2 condensers in series. A 3rd advantage is better regulation since the field excitation is obtained from the bias voltage supply, thus making the resistance of the plate supply circuit as low as possible.

Under these conditions we would have for the values of the component parts—

using, for example, a pair of 6A3s as the power tubes, a 5T4 rectifier, and an 84 grid and field supply rectifier—the following:

RESISTORS

- R1, R2, 50,000 ohms, ½-W.;
- R3, 20,000 ohms, 15 W.;
- R4, 600 ohms, 10 W.;

CONDENSERS

- C1, C2, 8-mf., 350 V.;
- C3, 30 mf., 150 V.;
- C4, 30 mf., 100 V.;

MISC.

- Field, 750 ohms;
- Choke, 100 ohms, 12 hy., 125 ma.;
- Transformer T1, output 3,000 ohms plate-to-plate;
- Transformer T2, power, 5 V., 2 A.; 6.3 V., 4 A.; Sec. 1, 125 ma., 275 V. r.m.s.; Sec. 2, 100 ma., 125 V. r.m.s.

PUSH-PULL PENTODES

Fig. 3 is almost identical with Fig. 2, the only difference being that here we do away with the extra winding of the transformer and make possible the use of just one ordinary-type transformer. The bias-supply rectifier VR2 gets the A.C. plate voltage directly from the A.C. line. Here too we use the field as a filter for the "C" supply.

Those who desire to build a 60-watt amplifier will find the following data useful. The values are approximate, as a result of calculation. Tubes used are taken to be 2 6L6s in the output; as a plate voltage rectifier an 83 is used; the bias voltage rectifier VR2 is an 84.

CONDENSERS

- C1, 8 mf., 450 V.;
- C2, 16 mf., 350 V.;
- C3, 30 mf., 125 V.;
- C4, 25 mf., 25 V.;

RESISTORS

- R3, 20,000 ohms, 20 W.;
- R2, 240 ohms, 10 W.;

MISC.

- Transformer T1, input, for class AB₂ for 6L6s;
- Transformer T2, output, 3,800 ohms plate-to-plate;
- Transformer P.T., power, 5 V., 3A.; 6.3 V., 4A.; 490-0-490 V. r.m.s., 250 ma.

The value for resistor R1 can not be determined without the exact knowledge of the current taken from off the point "B+." Its value should be calculated to deliver 300 volts at the point "B+."

The circuit of Fig. 3 means something special to the Serviceman who builds his own audio amplifiers, and to the amateur who wants an efficient plate modulator. You can actually get 60 watts out of a pair of 6L6s without the need of using 2 power transformers or 1 special transformer expensive for its extra windings.

There is a very important item to be remembered in making such a change. That is, whenever fixed-bias is used the total resistance in the grid circuit should under no circumstances exceed 50,000 ohms.

The application in Fig. 3 combines most efficiently the factors of economy, simplicity and versatility that typify our new circuit. As a means of obtaining satisfactory, fixed "C" bias it is far in advance of previous methods, and those designs presented here can be used to good advantage in the construction of most receivers and power amplifiers.

It should be mentioned as a precaution that no direct ground connection should be used in sets employing circuits of Figs. 1 and 3, since one terminal of the line is connected to the chassis. If grounding is necessary, it should only be done through a condenser.

Note: The author reserves all rights to the commercial application of the material contained in this article.

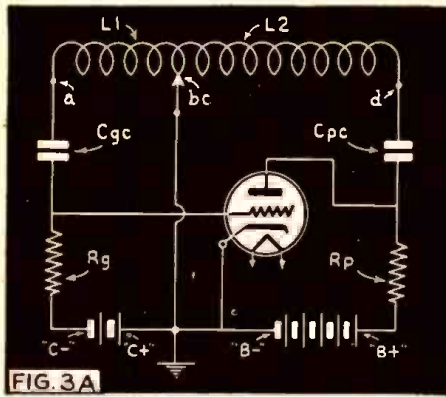

FIG. 3A

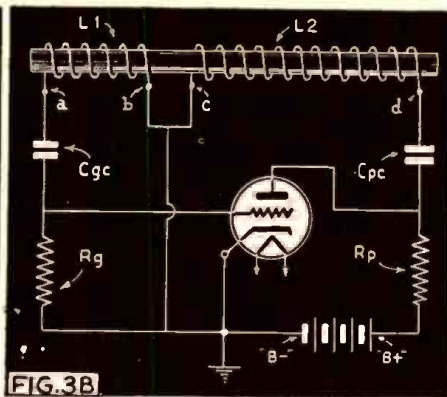

FIG. 3B

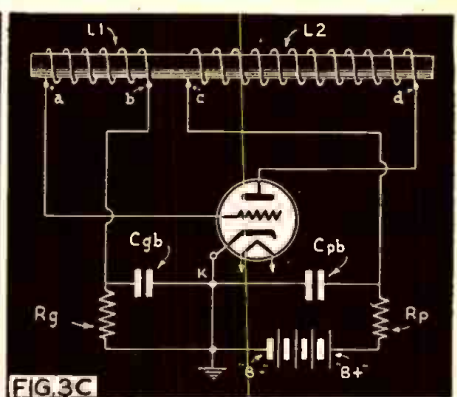

FIG. 3C

The Oscillator may take any one of 3 basic circuit arrangements: A, shunt feed, using a tap on a single winding or autotransformer; B, shunt feed, using 2 separate coils electrically connected; and C, series feed, by means of separate coils. Compare these working diagrams with the theoretical oscillator circuit, Fig. 1A.

VACUUM-TUBE OSCILLATORS

And How They Work

What are the factors which enable a vacuum tube to generate alternating current, i.e., function as an oscillator; and, frequently of more immediate importance to Servicemen, which may cause an oscillator circuit to cease operating? These fundamentals are here given microscopic examination. Any radio man reading this article, if he takes care to absorb the information it presents, cannot fail to have a firmer grasp on one of the basic building blocks of modern radio transmission and reception. This article, by the Chief Instructor of a well-known radio school, has been reprinted by special permission from National Radio News.

J. A. DOWIE

In every radio transmitter, in every super-heterodyne receiver and in radio servicing equipment, we find oscillators producing the signal. It is this oscillator that supplies the signal that is so essential in carrying out our work. Since it is so important in radio, let's study in greater detail how it works. That is, how does an oscillator operate in generating the signal and how does it continue to develop a signal after it is placed into operation?

OSCILLATOR CIRCUITS

There are a large number of different types of oscillators in operation. There are

oscillators which maintain oscillation by ionization of gas and by the projection of electrons through chambers where the rate of travel of the electron determines the frequency of oscillation. In this discussion I am going to cover only the operation of the better-known oscillator circuits.

The oscillators that are used most extensively in the radio field are, for example, the tuned-grid, the tuned-plate, the Armstrong, the Meissner, the Hartley, the Colpitts, the ultra-audion, the push-push and the push-pull types with either the tuned-grid or tuned-plate, or both.

In my discussion I will cover these circuits and their operating characteristics. It will be pointed out that when you understand the characteristics of oscillator circuits which depend upon capacitive or inductive feedback that you will understand the operating characteristics of all of the conventional types of oscillator circuits mentioned above.

PHASE RELATIONSHIPS

It can be stated that the primary requirement in order to sustain oscillations in either an inductive or a capacitive feedback circuit is that the applied grid-to-cathode voltage must be approximately 180° out-of-phase with the plate-to-cathode voltage.

This means that when the grid-to-cathode voltage is rising in a positive direction the plate-to-cathode voltage must be dropping in a negative direction. That is, the tube itself acts as an amplifier. Then, too, if the reversal is of a sine wave character the waveform of the signal generated will be a pure sine wave. Remember that the voltage applied to the control-grid of a tube which is not overloaded controls the plate circuit output waveform and that the triode tube is easily adapted to the inductive or capacitive feedback types of oscillating circuits.

In an oscillatory circuit the tube does not become an oscillator—it continues to act as an amplifier—amplifying the voltage which is applied to its grid circuit and sending it through the circuit coupled to its plate. When the plate circuit is properly coupled to its respective grid circuit so that it continues to amplify the signal it excites itself, the circuit and the tube become an oscillator. Since the tube continues to operate as an amplifier even though it is in an oscillatory circuit let us study some of the important characteristics of vacuum-tube amplifiers.

BASIC CIRCUITS

In Fig. 1A is shown a triode having electrode supply voltages. Its operating point being at *a* on the *E_g-I_p* characteristic curve shown at *B*.

It can be shown that as the grid voltage of the tube is driven in a positive direction by some force that this will result in a decrease in plate voltage between *P* and *K*. This is due to the increase in plate current, the voltage drop being in the plate load and the polarity or phase of the voltage in this circuit being in a negative direction.

Now when the grid is driven in a negative direction in the grid circuit the plate circuit voltage goes in a positive direction.

This can be proven by Fig. 1B. Point 1 on the grid voltage moves positive to point 2 and the plate current increases from point 3 to point 4. An increase in plate current means a drop in plate-to-cathode voltage; and from a high positive value to a less positive value with respect to the cathode. It is therefore evident that the voltage applied to the grid-cathode circuit must always be 180° out-of-phase with the change taking place in the plate circuit of the tube in order to have the tube excite itself and thus maintain oscillation.

So long as the signal voltage on the grid of the tube does not swing beyond points *b* and *c* on the *E_g-I_p* curve there will be

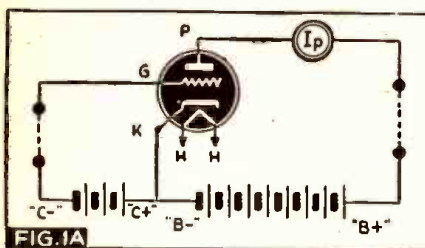

FIG. 1A

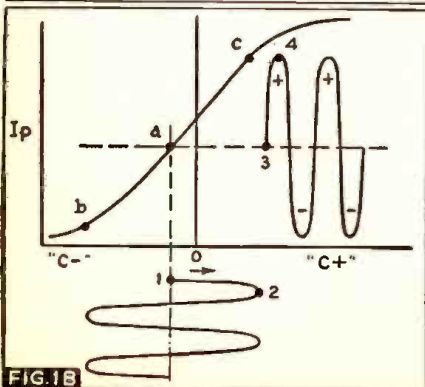

FIG. 1B

no waveform distortion introduced and if the coupling between the grid and plate circuit permits uniform waveform changes, then a sine wave will be developed in the plate circuit and consequently at the output of the oscillator. This condition of operation is known as "class A" amplification.

AMPLIFIER CHARACTERISTICS

The efficiency of an oscillator is dependent to a large extent upon the class of operation. As in the case of the various classes of amplifiers used, the class A, B and C, the efficiency of the oscillator tube is the same as if it were an amplifier insofar as the tube is concerned. Figure 2 shows the relationship between the grid bias voltage, grid swing and plate current for the 3 fundamental types of amplifiers all of which may be used in the operation of an oscillator.

The outstanding operating characteristics of a properly-operated class A amplifier is the fact that the variations in excitation do not produce a change in the average D.C. plate current. That is, the increases in plate current are equal to the decreases and for this reason the average current taken from the power supply does not change. The grid excitation signal never drives the grid positive with respect to the cathode of the tube.

In the class B amplifier increases in grid excitation produce proportional increases in the average D.C. plate current, that is, an increase in excitation raises the output of the oscillator. The grid excitation is sufficient to drive the grid positive but not off the straight portion of the E_g - I_p curve.

The class C amplifier is operated so that further increases in grid excitation show no further increases in the average plate current. This condition of operation can only exist with the flow of grid current. The grid is driven positive and far enough to cause plate current saturation. It can also be stated that an oscillator employing a class C amplifier has very high harmonic content as the plate current exceeds the saturation point as can be seen at the upper-right in Fig. 2.

HOW PHASING IS OBTAINED

As stated there must always exist a 180° phase shift in the voltages between the grid and plate circuits in order to use a triode as an amplifier tube in an oscillator circuit. This required phase shift can be obtained by means of a transformer or through the aid of a phase-shifting network or phase inverter consisting of another tube.

Most oscillatory circuits use a transformer consisting of either 1 winding having a tap on it or 2 separate windings. For example, Fig. 3A shows a tapped transformer, often referred to as an autotransformer. The position of the tap being selected to give the required excitation voltage for the class of amplification desired.

The transformer winding gives us the desired phase shift because one end of the winding will always be of opposite polarity with respect to the other. No coil or winding on a transformer can have the same polarity when the winding is wound in one direction. One end will always be positive while the other is negative. This is the condition when all turns are linked together by the same electromagnetic field.

If we use an oscillator coil having 2 windings then the windings must be connected so that the grid end of one winding will be of opposite polarity with respect to the plate end of the other, thus keeping the 180° phase shift. The connections will be as shown in Fig. 3B.

COIL POLARITY

Oftentimes the Serviceman is required to make an oscillator coil replacement and he

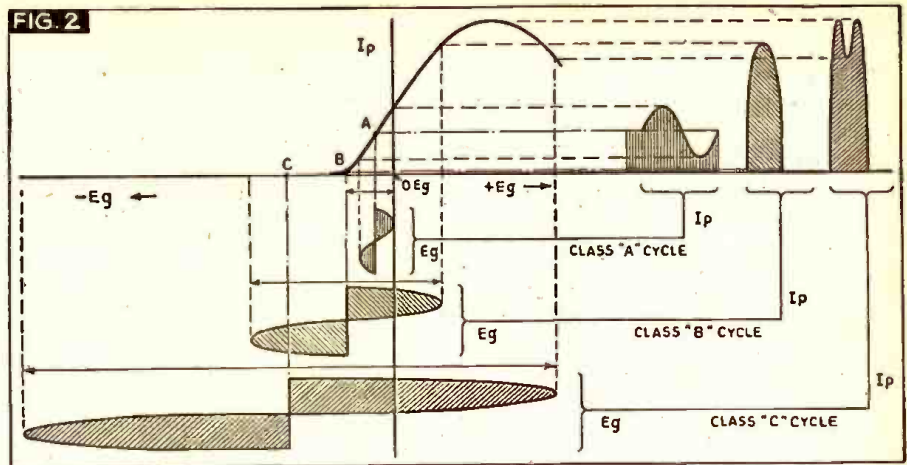

Fig. 2. Relationship between control-grid bias voltage, grid swing and plate current for class A, B and C amplifiers. In class A, the grid never swings positive; in class B the grid swings positive only over the linear region of the plate current characteristic; in class C the grid swings beyond the plate current saturation point.

is confronted with the job of connecting the unmarked leads of an oscillator coil to produce oscillations.

In order to connect the coils of an oscillator so the phase will be correct, refer to Fig. 3B. Note that *a* and *d* are at opposite ends of the oscillator coil. If lead *c* is connected to the plate coupling condenser C_{pc} then to insure proper polarity lead *b* must be connected to the grid coupling condenser C_{gc} . It isn't difficult to remember this requirement. I always says that "when the grid is at one end of a coil form having 2 windings then the plate must be at the other end of the coil form when the 2 coils are wound in the same direction." That is, these 2 leads are always on the opposite ends of the 2 coils or at the 2 inside terminals.

This rule holds good regardless of the placement of the tuning condenser or condensers or the method used in supplying power to the oscillator circuit. The tuning condenser or condensers do not shift the phase of the voltage across the coils sufficiently to stop oscillation.

FEEDING POWER TO OSCILLATORS

Figure 3B shows how the power or electrode voltages are supplied to the tube so it can amplify by what is known as the shunt or "parallel" feed method. The signal voltage generated is in parallel with the path taken by the power to the tube electrodes.

In Fig. 3C the same circuit components are shown but connected to give us the series feed method of supplying power to the tube electrodes. Note that the coupling condensers are now bypass condensers and are connected to the cathode of the tube.

It is, of course, possible to use the series feed in the grid circuit and the parallel or shunt feed method in the plate circuit or shunt feed in the grid circuit and series feed in the plate circuit. The method of feed selected by the engineer in the construction of the device may be any one of these combinations. The series plate feed method being somewhat more efficient than the shunt feed method as this method prevents R_p from shunting the plate circuit of the oscillator.

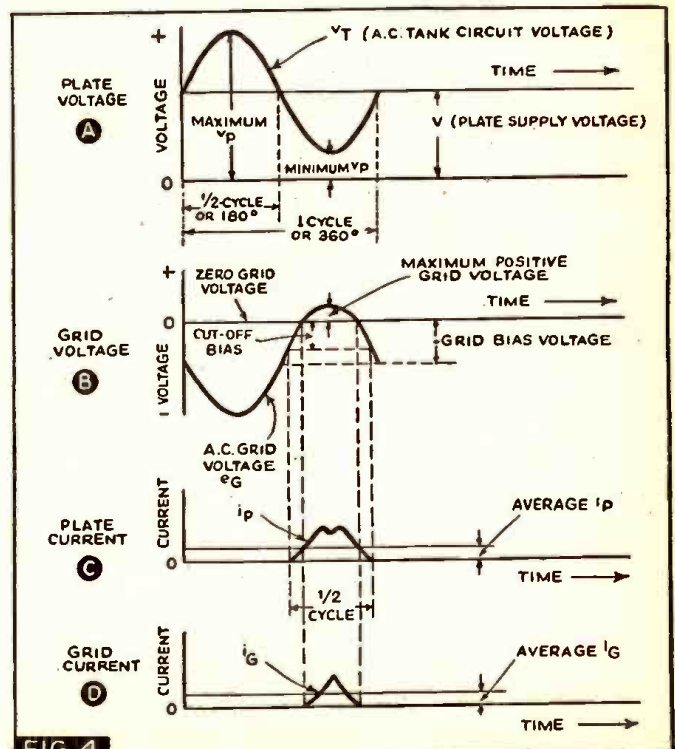

Fig. 4. These plate and grid currents and voltages represent operating conditions in the oscillator circuit of Fig. 3. Remember that graphs like these are always read from left to right. When comparing 2 voltages, that one which reaches a positive peak closest to the vertical reference line is said to lead the other; thus, v_t in A leads e_g in B.

FIG. 4

AUTOMATIC "C" BIAS

Although the circuit shown in Fig. 3A has a "C" battery to enable class A operation of the tube at a given point on its Eg-*I_p* curve, it is possible to obtain class B and C operation by omitting the battery.

This latter is possible because the upper end of the resistor R_g will become negative when the grid is driven positive by the excitation signal. The grid serves as the anode and the cathode of the tube as the cathode, of a rectifier tube. The positive end of the resistor R_g being connected to the cathode R_g may be considered the load on the rectifier. The voltage across R_g is dependent upon its current and resistance.

Now that we know how the proper polarity of the winding can be ascertained, how power may be fed to the tube and how the grid bias can be obtained automatically, let's determine how oscillations are developed and maintained.

GENERATING OSCILLATIONS

Assume that the cathode of the tube in Fig. 3B is at its operating temperature and that the "B" battery voltage is applied instantly.

Upon application condenser C_{pc} will start to charge up to the value of the D.C. voltage dropped in the resistor R_p. Plate current will start to flow through winding L₂. This causes a magnetic field to be present about coil L₂. This field would appear to be of a steady value because the flow of the D.C. plate current is assumed to be constant. This is not, however, the case. The moment the plate voltage is applied the magnetic field about coil L₂ starts to expand, which according to the electromagnetic law would link the coil L₁ (due to its inductive relation), and would consequently induce an e.m.f. or a difference of potential across it.

If then, the coils L₁ and L₂ are wound as stated above where coil L₁ would produce a positive potential at the terminal *a* and a negative potential at *b*, the grid which is connected to *a* would receive a positive charge. This immediately partly neutralizes the "space charge" between the cathode and plate and allows more plate current to flow and at the same time causes the production of a negative grid bias. This causes a greater field to exist around coil L₂ and results in a greater positive charge on the grid. The plate current then increases and in turn applies a greater positive potential to the grid.

Of course this action continues until the plate current is limited by the emission characteristics of the tube or by the automatic "C" bias voltage which is developed by the rectified grid current which is across the resistor R_g. The turns ratio and amplification factor of the tube will also affect the peak value of plate current.

When the peak plate current value has been reached, the magnetic field collapses and as a result the grid is driven negative. This causes a reduction in plate current which tends to aid in making the grid more negative. The grid may be driven so far negative that the plate current is completely cut off as shown in Fig. 4C. No further changes will then occur in the negative direction and again the magnetic field collapses. Then the complete cycle of operation will be reversed and as before the operation will start all over again.

Thus it can be seen that the polarity of the coils L₁ and L₂ must be correct to cause the proper changes in plate current.

URNS RATIO

It should also be evident that the greater the turns ratio of L₁ to L₂, the higher the voltage across terminals *ab*. That is, the

voltage across winding L₁ should be high and naturally the greater the number of turns in coil L₁, the higher the voltage developed. This will mean more excitation voltage and also a greater plate current as more power will be required to supply the extra excitation. These facts also apply to the operation of the circuit shown in Figs. 3A and B.

The turns ratio factor is also present and holds true when the *interelectrode capacity* of the tube is used in tuning the entire circuit and when the tuning condenser is connected between terminals *a* and *d* in Figs. 3A, B and C. When the tuning condenser is connected across either coils L₁ or L₂ then the coil without the condenser across it has the least number of turns. This is due to the fact that the condenser tunes the circuit to resonance and allows a higher voltage to exist across the coil and naturally with a larger magnetic field.

EXCITATION REGULATION

For a given plate supply voltage it is possible to find the correct excitation voltage by either selecting the proper num-

WARNING!

Unless you reserve your copy of the May issue of RADIO-CRAFT NOW, your dealer may be all sold out. This is because the May issue is going to be a special one on SOUND.

In addition to the usual material, this issue will contain special theoretical and constructional articles on Home Recording, Phono-Radio Combinations, Public Address, Amplifiers, etc. It is going to be an important issue for Sound Specialists, radio Servicemen and radio men in general.

Sound is booming! . . . so RADIO-CRAFT is going to town! RESERVE YOUR MAY ISSUE NOW.

ber of turns or regulating the coupling, or both, in an oscillator circuit. The excitation voltage is also affected by the automatic bias voltage placed on the oscillator tube and the load coupled to the output circuit.

For efficient operation of the oscillator circuit and for a given power output we must select the correct amount of excitation to give the class of operation consistent with the type of performance we desire. This value will usually be for the least amount of plate current that will give the most power output. There are other factors such as frequency stability and waveform that must be taken into consideration in the selection of the circuit values. It is the work of the radio engineer to select the proper operating characteristics of an oscillator circuit.

The output of the oscillator is affected by a change in the oscillator plate voltage for a given turns ratio or coupling between the grid and plate circuits. It is also a fact that an increase in the D.C. plate voltage causes an increase in the D.C. plate current, the generated R.F. tank voltage, the R.F. tank current, the R.F. grid and plate current as well as the self-adjusting grid biasing voltage.

These factors are all related to the power supplied to the oscillator for a fixed amount of coupling. It can also be stated that for a given supply voltage it is impossible to change any of the other currents or voltages in the oscillator circuit without changing all other values. This means that an increase in the coupling of the load to the oscillator circuit will affect all of the values of currents and voltages, that is, their relationship to the other values.

GENERAL DISCUSSION

In discussing how oscillations are maintained we stated that the plate current increased to a value established by the emission characteristics of the tube. An oscillator tube functioning in this manner will not operate very long as it will lose its emission and become defective. It is for this reason desirable to provide a self-biasing resistor having a value of resistance which causes the production of the automatic "C" bias voltage that will give class B or C operation of the oscillator tube. Lower efficiency of operation is obtained when using either class B or A operation.

The self-biasing grid voltage thus developed should limit the peak plate current rather than the emission characteristics of a tube in a well-designed oscillator circuit. The ability of the self-bias voltage developed to limit the plate current flow is often referred-to as a "braking action" that limits the grid A.C. voltages for a fixed amount of excitation and prevents them from reaching unsafe values of operation. I will add that if we get a clear picture of what takes place in an oscillator, the effects of changing any factor in the circuit can be explained very easily. Let us see what is the basic action in an oscillator circuit.

When the oscillator reaches its final oscillating condition, we know that the grid is driven sufficiently positive to produce grid current which in turn develops across the grid resistor a definite negative "C" bias voltage. This voltage establishes a new operating point on the Eg-*I_p* characteristic curve. The A.C. grid voltage drives the grid positive and negative with respect to the operating "C" bias value as shown in Fig. 1B, always sufficiently positive so it creates this "C" bias voltage. The plate current flows only during that portion of the grid cycle when the grid voltage is less than the cut-off value. This is the point where the grid voltage stops the flow of plate current. The higher the excitation the smaller the operating angle for the plate current. For class B operation the operating angle for the plate current will be less than 180°.

WAVEFORM ANALYSES

In Figs. 4A and B we find the plate and grid voltage curves respectively. Note that the A.C. grid voltage decreases to a maximum while the A.C. tank circuit or plate voltage increases to a maximum. This is the correct phase relationship between the input and output voltages of a tube used in an oscillator. The plate current as shown in Fig. 4C, and as pulse *i_p* represents the driving power to sustain oscillations, it is this change in current that is fed back into the tank circuit to set this resonant circuit into natural oscillation.

The area of this pulse when we view it as a graph represents available oscillating power, the greater the area of the plate current pulse the more the power available. Technically speaking any increase in peak current, any increase in the operating angle, and any trend to make the size of this pulse steeper and more flattened on top indicates more operating power; for all of these factors increase the area of the plate current pulse *i_p*.

The amount of power consumed by the oscillator has a number of important functions to perform. It must overcome the losses in the tank circuit (resonant circuit), overcome the power lost in the grid resistor, the power lost in the grid cathode of the tube, overcome the power dissipated in the plate cathode circuit of the tube supply power to the load and any other incidental circuit losses as well as to develop enough excitation to drive the grid circuit of the

BIG BOY

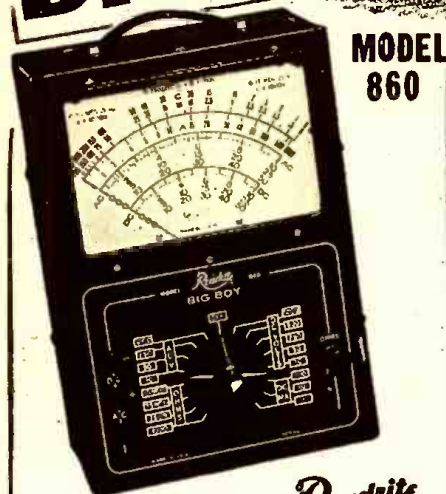

Performance . . . Eye Appeal . . . Value . . .
Sensationally Priced at \$17.85, Dealer Net Price.

Here is an AC-DC Volt-Ohm-Milliammeter with all the ranges you want . . . easily readable on the large 7" instrument with extra-long 6" scale, in a new up-to-the-minute three-tone case. DC Volts 0-10-50-250-500-1000 at 5000 Ohms per volt DC; 1000 ohms per volt AC. AC Volts 0-10-50-250-1000 at 400 ohms per volt; DC Ma. 0-1-10-100; Resistance ranges: 0-1500 Low Ohms: 0-150,000 Ohms and 0-7.5 and 0-15 Megohms. Maroon case with red and silver panel, attached handle.

Dealer Net Price, \$17.85.

For Catalog Write—Section 316, College Drive

READRITE METER WORKS, Bluffton, Ohio

EVERYTHING IN RADIO



This big book serves your entire needs. It includes sets, parts and supplies, public address, amateur equipment, testers, kits, fluorescent lighting. Nationally known favorites at lowest possible prices. Write today for your copy of this

BIG FREE CATALOG

BURSTEIN-APPLEBEE COMPANY

1012-14 McGEE STREET, KANSAS CITY, MISSOURI

FREE!

HAMMARLUND NEW "41" RADIO CATALOG

The latest Hammarlund catalog with complete data, illustrations, drawings and curves on the entire Hammarlund line. Address Department RC-3-1 for your free copy.

HAMMARLUND MFG. CO., INC.
424-438 West 33rd Street, New York City

DUMONT

Precision Built Condensers at your nearest jobber or write to

DUMONT ELECTRIC CO., INC.
514-516 BROADWAY NEW YORK, N. Y.
PAPER — MICA — ELECTROLYTIC

tube in order to produce the correct amount of plate current.

MAINTAINING OSCILLATION

If we assume that there is a tendency for the A.C. grid voltage to increase, then immediately, the grid current increases and consequently the bias voltage becomes greater. This in turn reduces the operating angle of the plate current pulse, even though the current peak may tend to rise. Less power will then be available for oscillation and the braking action takes place preventing more power from reaching the circuit and consequently preventing the grid excitation to increase. If the grid A.C. voltage drops, the "C" biasing voltage is automatically reduced as the grid current is reduced and in turn the plate current flows over a greater portion of the cycle, resulting in the application of more power to overcome losses and again drive the grid up to a point where all losses are supplied and the grid excitation is sufficient to sustain the oscillating condition.

The basic braking action is the inability of the oscillator circuit to draw enough power to take care of all current demands, and as a result the circuit sets itself to a definite operating condition and balance.

For example, if we increase the grid resistor value from a low value to a slightly higher value the initial action results in an increased "C" bias voltage. As this takes place the operating point on the Eg-*I_p* curve of the tube is further negative. The grid, however, must draw current to supply automatic "C" bias voltage, and to do this the A.C. grid excitation increases. Because of this grid circuit action the peak plate current goes up slightly but at the same time the operating angle decreases. The power drawn by the circuit depends on both the operating angle and the peak plate current. If we increase one and decrease the other by a small amount the circuit will draw more power increasing both the grid excitation and "C" bias voltage. Again the peak plate current increases but it is perfectly possible for the operating angle to decrease so much that the amount of power drawn starts to decrease at the point where maximum power is drawn from the supply; balance then occurs and the circuit conditions are stabilized. Of course we can make the grid resistor so high in its (ohmic) value that this condition of maximum power is far below any condition which would exist for normal circuit values, and a large-value grid resistor may actually produce less power in the oscillator circuit than normal low grid resistor values. Increasing the grid excitation (using a given grid resistor), may also decrease the power developed, because the operating angle is decreased more than the peak increase in plate current.

If we increase the D.C. plate voltage, the Eg-*I_p* characteristic instead of being held at the operating point as shown in Fig. 1B will move toward the operating point b. Therefore for an increase in plate voltage the grid current will be greater as the grid voltage is increased, and consequently a higher negative "C" bias will be produced, as it will be required in order to cut off plate current. Since the grid A.C. voltage must always drive the grid positive to produce the automatic "C" bias voltage, and as this "C" bias voltage is greater than the cut-off bias, the result is a much stronger current pulse; the plate current increases, as explained above. Under this condition more oscillating power is available and greater power will be received from the oscillator.

With the usual testing instruments available to Servicemen, only the D.C. plate voltage, the D.C. plate current and the self-

biasing grid voltage can be measured with a voltmeter having a "high-resistance per volt" rating. When there is any increase in the automatic D.C. grid voltage for a given value of grid resistance we have an indication of more A.C. tank voltage. This fact should be remembered and taken into consideration when servicing oscillators.

The author of this article is on the teaching staff of National Radio Institute.

HOME RECORDING Theory and Practice of Sound-on-Disc

(Continued from page 551)

depth of cut may cause difficulty in tracking and the playback will slide from groove to groove. If the cutter has adjustments for varying the angle of needle and depth of cut, experiment will show that one adjustment will give a cleaner cut and a minimum of scratch. The best way to check-up on finished records is to examine the grooves by means of a high-power magnifying glass. A light coming at an angle on the disc will show the grooves as dark and the surface or "lands" as white. Unusual wear on records may be detected in this way before the discs are entirely ruined.

An ingenious device for playing-back records, due to Philco, is the photoelectric cell reproducer.* The assembly consists of a bulb, a vibrating mirror attached to the needle, and a photoelectric cell as shown in the diagram. The vibrations of the mirror modulate the light passed to the cell. The light is supplied with an R.F. current well beyond audibility. The result is that the needle assembly possesses very little inertia, having no work to do but move the tiny mirror.

The principle of creation of sounds by a vibrating mirror modulating a steady light source is in a few respects similar to the galvanometer method of recording on film which the writer described in a 3-part article in *Radio-Craft* beginning November, 1937. In these articles there is also a full account of monitoring, mixing and studio procedure which the reader will find helpful for recording on disc. It is hoped that this present article has been of help to all readers who now own recorders or who contemplate acquiring such apparatus in the near future.

Technicians interested in sound recording may also wish to look up one or more of the following articles which have appeared in past issues of *Radio-Craft*.

- "Correct Playback of Spot Recordings," Part I, Oct. '37; Part II, Nov. '37.
- "How to Conduct a Sound-on-Film Recording Studio," Part IA, Nov. '37; Part IB, Dec. '37; Part II, Jan. '38.
- "Phono Pickups on Parade," Part I, May '38; Part II, June '38.
- "A Modern Amplifier for Recording and Playback," April '39.
- "Simple Technique for Making Home Talkies," Part I, March '39; Part II, April '39.
- "Scratch Filter Design," Feb. '40.
- "A Low-Cost Amplifier for Recording and Playback," April '40.
- "Profits in Recording," Part I, May '39; Part II, June '39.
- "Constant Groove-Speed Recording," Aug. '40.
- "Recording - Playback Amplifier Has Direct-Coupled Output Circuit and Equalized 30-Watt Output," Nov. '40.
- "Recording Pointers," Jan. '41.

*See "Photoelectric Phono Pickup," *Radio-Craft*, Sept. '40

THE "ACCELETRON"

*Generates Energy of
2,300,000 Volts!*

AN Induction Electron Accelerator, a new device which gives electrons the smallest negatively charged particles of matter known to science, almost the 186,000-mile-a-second speed of light in a glass doughnut of less than a foot in diameter, was described to the American Physical Society last month by Dr. D. W. Kerst of the General Electric Research Laboratory at Schenectady, N. Y.

In the course of their whirling the electrons gain 2,300,000 volts of energy, something hitherto requiring much larger apparatus and great insulation, Dr. Kerst disclosed. The device is expected to make possible the easier performance of experiments in physics.

The accelerator looks like a miniature atom smasher of the cyclotron type but unlike cyclotrons, which can handle only positive ions at great speeds, it accelerates electrons.

Instead of being made of solid iron as in the cyclotron, the accelerator's magnet, which surrounds the glass vacuum chamber, is composed of thousands of pieces of iron so that it can be used on alternating current. Instead of the electrons encircling the magnetic core by following a coil of wire, as they do in a power transformer, elec-



Electroscopic study, of the radiations by the "Acceletron," or Induction Electron Accelerator, by Dr. D. W. Kerst of the General Electric Research Laboratory. The "spot" illustration on the cover of *Radio-Craft* shows Dr. Kerst examining the doughnut-shaped vacuum-tube—or "race-track" for electrons—in which electrons gain almost the speed of light; and develop millions of volts for use in atom-smashing and other fundamental physics experiments.

trons in the induction accelerator do not travel on wires but are free to circulate about the magnetic core in the doughnut-shaped vacuum tube.

Hence they make many revolutions, the equivalent of a many-turned winding in an ordinary transformer. In 200,000 revolutions the electrons gain about 2,300,000 volts energy and travel approximately 60 miles.

At the end of this long flight the electrons are directed against a target. The present laboratory model of the accelerator, small

enough for use on a table, produces radiation equivalent in intensity to that of 10 millicuries of radium. Larger models, which can be constructed on the same principle, are expected to give more energy.

Dr. Kerst is a native of Madison, Wis., and a graduate of the University of Wisconsin. He later was a member of the faculty at the University of Illinois and while there did the initial work on the induction electron accelerator (or "Acceletron," as *Radio-Craft* calls it).



← Paul Robeson, concert vocalist, is shown here (and on *Radio-Craft's* cover) with the equipment he uses to control concert-hall acoustics.

Photo — Courtesy The Evening Bulletin (Philadelphia, Pa.).

ROBESON TECHNIQUE OF ACOUSTICS CONTROL

SOUND control apparatus developed at Stevens Institute of Technology has been used experimentally during recent rehearsal periods at the Metropolitan Opera, according to an announcement made last month by Edward Johnson, General Manager.

The experiments have been devoted primarily to creating acoustic conditions on the stage which are as satisfactory to the artists as the acoustics of the theatre are to the audience. Through the use of several elements of this "Robeson Technique," it is now possible for offstage choruses and upstage singers to hear the orchestra as easily as if they were standing by the footlights. Orchestral balance can be preserved backstage in a manner not possible by traditional methods. Soloists are being assisted by the use of the acoustic envelope announced recently at the Chicago meeting of the Acoustical Society of America. By the use of this technique, a singer on the stage is able to hear himself as if he were

in a small, highly reverberant room. The audience is totally unaware that the Technique is in operation.

The experiments which have been in progress since October are being undertaken as a cooperative enterprise by the Metro-

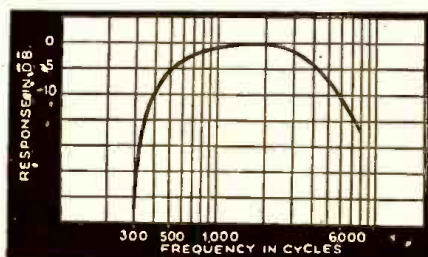

Fig. 2. Frequency characteristic of equipment used in the Robeson Technique. Only "significant" frequencies are fed back to the performer. The selected frequency band constitutes a highly directional beam, at an optimum intensity level, which only the performer can hear.

politan Opera Association, Stevens Institute of Technology, The Rockefeller Foundation, and Theatrical Protective Union Local No. 1. They are being conducted under the supervision of Harold Burriss-Meyer of Stevens Institute of Technology, who pioneered much of the sound control technique now used in radio, motion pictures, concert and the legitimate theatre. The Robeson Technique has yet to be tried out for recording or radio but the desirability of its use seems probable.

Concert singers and instrumentalists perform by choice in small, highly reverberant rooms since in them they are able to hear

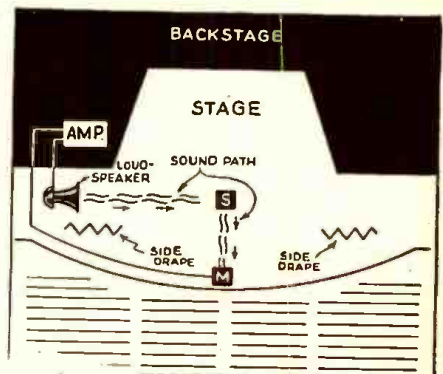

Fig. 1. Diagram showing instrument placement on concert stage for Robeson Technique. The letter S indicates the position of the singer; M represents the microphone (located in the footlights trough); the audio amplifier and loudspeaker are off-stage, out of sight.

RADIO DEVELOPMENTS

STEP UP YOUR SHOP PROFITS with Atlas EQUIPMENT



EASY TO OPERATE

It's easy to turn out your own machine work on an Atlas Lathe—and make for yourself the profits you now have to pay others.

Radio Servicemen in all sections find that the Atlas Lathe makes quick work of dial shafts and drums, knobs, special screws and studs; service tools, microphones, special dies and molds. Operating instructions show correct gear set-ups for winding R.F., choke, and short wave coils, transformers.

Send Coupon for FREE 1941 Catalog

See the many operations you can do in your own shop with Atlas Equipment. Send the coupon below today for full details.

Atlas

LATHES • ORILL PRESSES • ARBOR PRESSES
METAL SHAPERS • VISES • CIRCULAR SAWS

ATLAS PRESS CO.
345 N. Pitcher St., Kalamazoo, Mich.

Please send me Your 1941 Catalog on 6" Metal Lathes 10" Metal Lathes New Milling Machine 7" Metal Shaper Drill Presses Arbor Presses.

Name

Address

City and State

Turn to Page 570
for the BEST BOOK ON SOUND!



WOODSTOCK TYPEWRITERS

themselves easily. However, they deplore the acoustic conditions of most large concert halls and auditoriums. The nature of the complaint is that the artist cannot hear himself.

The results of not being able to hear are the catalogue of the artist's woes: tension, inability to relax, a feeling of being ill at ease, of low vocal efficiency, forcing the voice in an effort to project, using a higher key than is best for the song in an effort to get out more volume and fill up the house.

Several years ago, Mr. Paul Robeson discovered that if he stood in front of the speaker of a public address system which was being used in the concert, he enjoyed some of the desirable acoustic conditions usually associated with the small studio. Last winter, on the occasion of the stereophonic recording of the first Forest Scene from *The Emperor Jones*, technicians of Stevens Institute discovered the possibility of using this phenomenon to surround the performer by an "acoustic envelope" tailored to his demands. Experiments were conducted in the Maplewood (New Jersey) Theatre which has many acoustic limitations. A simple set of equipment was then devised for Mr. Robeson and used by him on a concert tour.

The first step in devising the system was to find out what it was about the acoustics of the small, reverberant room that was significant as far as the artist is concerned. It was found that the artist hears himself if he can perceive a difference in any characteristic of sound between the original sound as it leaves him and the reproduced sound as it comes back. It is the *difference* which counts.

Time differences are most useful. If the artist hears the reproduced sound later than the original one, he is perfectly satisfied that he is hearing himself, and he is able to do this even though the reproduced sound be of much less intensity than the original one. It seems entirely logical that time difference should be satisfactory since time difference is a characteristic of long reverberation or room resonance.

Time difference is achieved by placing a directional speaker 50 feet or more from the artist, or by pointing it at a surface which will reflect the sound to the artist so that the path from the speaker to the artist is more than 50 feet. See Fig. 1.

Low frequencies lack directional characteristics; are not readily absorbed by wall surfaces or audience; and, when a footlight microphone is used, the system will pick-up low-frequency sounds transmitted by the floor if the system responds to low frequencies. High frequencies, on the other hand, are directional enough to be kept away from the audience and are absorbed readily enough so that they are below background if they ever do get out.

The response curve is not particularly critical, and as shown in Fig. 2, is cut off below 500 cycles, has a flat peak at 2,000 cycles from which it drops off slowly, and is down 10 decibels at 6,000. Thus only the significant harmonics are projected to the artist.

The Technique is fully effective when the sound level, at the position of the artist, is not measurably affected by turning the system on or off. A level set well below the point of regeneration for the empty house is safe, and more than adequate for the full house.

In the first concert in which the Technique was tried at Carnegie Hall, Mr. Robeson was able to sing "Water Boy" in a lower key than he had ever used before for that number in concert. "The enthusiasm of the artists who have tried it beats anything of the sort I have encountered," comments Professor Burris-Meyer.

OPPORTUNITY AD-LETS

Advertisements in this section cost 15 cents a word for each insertion. Name, address and initials must be included at the above rate. Cash should accompany all classified advertisements unless placed by an accredited advertising agency. No advertisement for less than ten words accepted. Ten percent discount on six issues, twenty percent for twelve issues. Objectionable or misleading advertisements not accepted. Advertisements for April, 1941, issue must reach us not later than February 7th.

Radio-Craft • 20 Vesey St. • New York, N. Y.

BOOKS AND MAGAZINES

ASSURE YOURSELF OF GREATER PROFITS BY doing radio service jobs more quickly. Authentic service guides show you the way to locate and correct troubles in any radio receiver. Gernsback Official Radio Service Manuals show you how to complete more repair jobs in less time—how to earn more money by faster servicing. Radecraft Publications, 20 Vesey St., New York City.

WE HAVE A FEW HUNDRED RADIO ENCYCLOPEDIAS, by S. Gernsback, second edition, originally sold at \$3.98. Book has 352 pages, weight 3 lbs., size 9 x 12 inches. Red morocco—keratol flexible binding. Send \$2.49 in stamps, cash or money order and book will be forwarded express collect. Technifax, 1915 So. State Street, Chicago, Illinois.

WHAT DO YOU KNOW ABOUT AMPLIFIERS AND SOUND SYSTEMS? The Amplifier Handbook and Public Address Guide covers P.A. from A to Z. Most complete and authentic book published on the subject. Contains 80 pages of vital information on Amplifiers, P.A. Systems, Speakers, Accessories, Pickups, Microphones, etc. Printed on fine coated stock, with numerous photographic illustrations and explanatory diagrams, and only 25c. See page 570.

EDUCATIONAL COURSES

CORRESPONDENCE COURSES AND EDUCATIONAL books, slightly used. Sold, Rented, Exchanged. All subjects. Satisfaction guaranteed. Cash paid for used courses. Complete details and bargain catalog FREE. Write Nelson Company, 500 Sherman, Dept. C-242, Chicago.

MANUSCRIPTS WANTED

WANTED—MANUSCRIPTS, PDEMS, SDNGS FOR publication. Fortunys, 87 Fifth Ave., New York.

PATENT ATTORNEYS

INVENTORS—TAKE PROMPT STEPS TO PROTECT your invention. Delays are dangerous. Get new FREE book, "How to Protect Your Invention" and "Invention Record" form. Preliminary information free. Reasonable fees. Conscientious counsel. Easy payment plan. Learn how to protect and sell your invention. Write us today. McInerney and Sherman, Registered Patent Attorneys, 176-C Barrister Building, Washington, D. C.

PHOTOGRAPHY

1/100,000 OF A SECOND SPEED FLASH UNIT FOR Stroboscopic Photography, \$200.00. Apt. 63, 782 West End Ave., New York City.

RADIO

WE BUY AND SELL USED RADIO TESTING EQUIP-ment. Time payments if desired. Harold Davis, Inc., Jackson, Miss.

WANTED: ELECTROLYTIC DETECTOR, SLIDE-PLATE variable condenser (preferably United), Magnavox model TRF-5 set, early studio-type carbon microphone in case, rotary spark gap and Thordarson "Flexible" transformer, Tuska "Superdyne," Adams-Morgan wooden case brass-plate condenser, "Grant" loudspeaker. Will swap home radio set, car-radio set, meters, etc. B. Bernard, 40 Manning Ave., No. Plainfield, N. J.

RADIO KITS

RADIO KITS—\$3.95 UP. SINGLE BAND; ALL WAVE. 5-10 tubes. Fluorescent lighting. Save 50%. McGoo Radio, P-2035, K.C., Mo.

TECHNICAL ART SERVICE

DRAFTING AND ART SERVICE—A COMPLETE Service for the Industrial and Commercial Marketers. If your business or plant can't afford a designing or drafting staff, don't let this stop you from going ahead with that new product you intend marketing, or that catalog of mechanical or electrical items which needs fine detailed drawings and highly retouched photographs. Any mechanical, electrical or radio problem can be solved for you by our associated staff of designers, draftsmen and artists, and technical copywriters. Write for any additional information as to methods and price for this service. Tec-Art Drafting Service, 228 Charlotte Terrace, Roselle Park, N. J.

DRAFTING SCHEMATIC DIAGRAMS SEND US A rough sketch of your circuit. Estimates by return mail. Our prices are moderate; our work guaranteed. No jobs too big or small. Wm. Kadiceck, Jr., 440 East 85th St., New York, N. Y.

TEST INSTRUMENTS

SUPREME 590—\$24.00. TRIPLETT 1177 OSCILLATOR and Tester, \$14.50. 133 Vine St., Plymouth, Pa.

If you subscribe now to RADIO-CRAFT you receive valuable premiums absolutely FREE! A Genuine Electric Dry Shaver—see page 567. The Radio-Television Reference Annual—see page 546.

• LATEST RADIO APPARATUS •

Social Security Name Plate



Only 35¢

Bronze Plate with your Name & Number on it and This GENUINE LEATHER BILLFOLD without Extra Charge.



For the nominal amount of 35c we will send you the following values:

1. One duo-tone imperishably etched Bronze Name Plate, size 3x1 1/2 inches with your Social Security number and name permanently stamped upon it.
2. One Genuine Leather Billfold, size 8 1/4 x 3 inches in natural brown color, with four compartments, as per illustration above.

This Pocketbook is our free present to you. Absolutely no strings of any kind. We make you this gift because we expect you to do us a favor by showing your name plate to your friends. So interest them in ordering one for themselves. That's all. Help us and you will profit yourself.

ACT NOW! Mail the coupon below and enclose 35c in Billfold will be forwarded to you at once.

PREMIUM DISTRIBUTING SERVICE
Wrigley Bldg., Chicago, Dept. RC-341

Enclosed find 35c for which mail to the address below, my Social Security Bronze Plate and the Genuine Leather Billfold without extra cost, as per your offer.

My Social Security Number is

NAME

ADDRESS

CITY

STATE

FREE

300 Ways to Make Money

Cash In!

MAIL ORDER PLANS
TESTED MONEY MAKERS
BUSINESS SECRETS
SUCCESS SCHEMES

25 CENTS

68 PAGES

MARVEL BOOK OF THE YEAR!
40,000 WORDS in TEXT!

In "CASH IN" you get ALL the real money-makers — dozens of profitable tested mail order plans, confidential business secrets, dozens of practical tested formulas, successful tested schemes—actual experiences of men who have started on a shoestring—with less than \$10 capital.

Buyers of This Book Tell Us—

"Biggest value I've yet to see. Book is worth at least a dollar." — S. Buda, B'klyn, N. Y.

"Your book is as good if not better than others selling at \$1.00." — George Brunet, Montreal, Can.

"CASH IN" is the best value I have yet to see in the mail order field." — Lawrence Fox, Brooklyn, N. Y.

"CASH IN" contains only tested ideas covering every type of full- or spare-time enterprise—It's a "master-piece" in business ventures.

BOOK CONTAINS NO ADVERTISING. SENT FREE TO YOU. NO STRINGS TO THIS OFFER. NO FURTHER OBLIGATIONS TO YOU!

Send 3c U. S. stamp to pay for mailing charges

NATIONAL PLANS INSTITUTE
246-R Fifth Ave., N.Y.C.

IMPROVED TRACEOMETER

The Hickok Electrical Instrument Co.
10302 Dupont Ave., Cleveland, Ohio

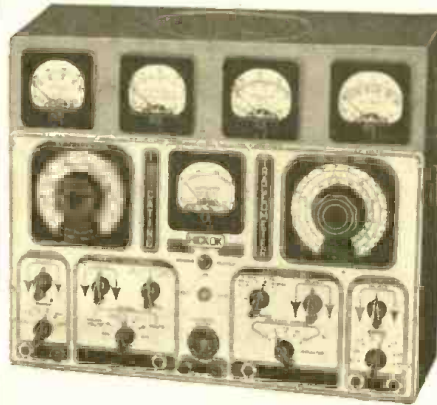

THE addition of a self-contained speaker increases the versatility of this instrument by permitting the monitoring of R.F., I.F. and A.F. channels. Other measurements permitted by this instrument are signal strength in microvolts in the R.F. and I.F. sections; oscillator voltages throughout entire range; all D.C. voltages, A.V.C. and A.F.C. voltages; power in watts up to 300 watts. All measurements do not disturb normal operation of circuits under test. May be used on F.M., A.M. and television receivers. Known as model 155 Traceometer.—Radio-Craft

INTERFERENCE LOCATOR

Sprague Products Co.
North Adams, Mass.



MODEL IL-2 serves the purpose of locating and isolating radio interference. It operates either from self-contained batteries or from the A.C. and/or D.C. lines. Equipped with a directional loop antenna as well as an extensible pole antenna, as illustrated. Its 3 tuning ranges are: 500 to 700 kc.; 1.7 to 5 mc.; and 15 to 32 mc. Its sensitivity is such that an input signal of less than 2 microvolts will produce a deflection of 10% on the output meter scale. Indication is both visual and aural. Size, 15 x 11 x 8 ins. Weight, 23 lbs.—Radio-Craft

LINE-NOISE FILTER

Sprague Products Co.
North Adams, Mass.



Should be installed at the power outlet of any interference-creating electrical appli-

MODEL LF-2 is a multiple section inductance and capacity filter of the plug-in type for use on very troublesome sources of radio interference.

ance drawing up to 1/2-amp. Measures but 2 1/2 x 1 3/4 x 1 7/16 ins. and designed for 115-volt A.C. and/or D.C. lines.—Radio-Craft

CABINET KIT

New England Radiocrafters
Brookline, Mass.

THIS kit contains 2 aluminum ends supporting 4 super-masonite sides, to make a cabinet 6x6x9 ins., easily cut, drilled or stamped with simple tools, or reduced in size to fit compact assemblies. Extremely light weight, but rugged. Extra parts available at low cost for rebuilding. Useful to the amateur, experimenter, Serviceman or custom-builder of radio or electronic equipment.—Radio-Craft

RECORDING BLANKS

Howard Radio Company
1731 Belmont Ave., Chicago, Ill.

FEATURES of these blanks are: flame-proof; shearing qualities claimed better than "nitrate" materials, permitting cleaner groove cuts without tearing; the special coating on the heavy metal cores are very hard, assuring long life and reproduction of high frequencies; there are claimed to be no layer definitions, as shown by a cross-section examined under a microscope. This prevents any stresses being set up between layers which, with time, cause groove distortion. Discs are available to dealers in an attractive display cabinet.—Radio-Craft

MAGNETIC RECORDING HEAD

Shure Brothers
225 W. Huron St., Chicago, Ill.



MODEL 44A is a wide-range magnetic record cutter recommended for use with home recording equipment. Operates directly from the voice-coil winding of the output transformer. Stiff moving element permits recording on practically all recording materials. May be used with almost any radio set. Impedance 10 ohms at 400 cycles; resistance 4 ohms D.C.; suitable for output circuits of 4 to 8 ohms. May be used with steel, alloy-tipped or sapphire recording stylus.—Radio-Craft

"PEN-OSCIL-LITE" R.F.-I.F.-A.F. SERVICE OSCILLATOR

General Test-Equipment Co.
213 Crosby Ave., Kenmore, N. Y.



THE uniqueness of the vest-pocket Pen-Oscil-Lite lies not so much in the circuit as in the electro-mechanical design that makes possible such a mechanism in so small a space and with such low power requirements.

Circuit-wise, according to the manufacturer, the Pen-Oscil-Lite consists of an interrupter which creates a square topped wave followed by an extremely steep wave-front pulse. On a peak vacuum-tube voltmeter this pulse measures in excess of 125 volts

into a 10-megohm load. Because of the steepness of the wave-front of this pulse, transients are created which cover the spectrum from the audio to extremely high radio frequencies. These transients are modulated at the interrupter frequency of about 700 cycles.

Receiver circuits, to which the Pen-Oscil-Lite is coupled, are shock-excited into oscillation or response at their natural frequency. Can be used in R.F., I.F. and A.F. circuits.—*Radio-Craft*

PORTABLE P.A. SYSTEMS

Webster-Chicago Corporation
5622 Bloomingdale Ave., Chicago, Ill.



ECONOMY, performance and portability" is, according to the manufacturer, probably the best way of describing this new economy line of P.A. equipment. Available in 3 power sizes, this new line is the answer to the smaller bands, traveling shows, carnival's, etc., demand for a complete portable P.A. system priced within the scope of their limited budgets. The entire system, consisting of amplifier, two 12-in. speakers, microphone and connecting cable, is housed in a single carrying case.—*Radio-Craft*

18-W. BATTERY/ELECTRIC MOBILE AMPLIFIER

Thorderson Electric Mfg. Co.
500 W. Huron St., Chicago, Ill.



AN 18-watt amplifier and phono-player operated from either 6 volts D.C. or 115 volts A.C. Suited for all mobile and portable applications. Plays either 10- or 12-in. records at constant speed with either battery or A.C. operation. All controls and connections are on the front panel. Has phono and voice channels, and provisions for mixing both. Known as model T-30W18.—*Radio-Craft*

PROFESSIONAL DISC RECORDER

Phonofone Laboratories, Inc.
Washington, Indiana

THIS professional disc recorder consists of three units; viz., a motor driven recorder with high-fidelity cutting head; weighted turntable; crystal pickup and volume control; 15 watt amplifier for recording and reproducing and for use as a P.A. sys-

COMPLETE RADIO COURSE \$1.95
POSTPAID

How 8,749 Servicemen Obtained Their Training

You may also get exact reprint of the regular \$39.00 Radio Technical Institute course for only \$1.95, the full price. This is the latest radio servicing course complete in every way and exactly the same as the much higher priced original lessons.



WILL HELP YOU GET A RADIO JOB

"I think your course is tops." Leonard D. Robinson, Toronto, Canada.



FINE COURSE

"I would like to say you have a very fine Radio Course." Wilford Sanders, Jr., Parrish, Ala. You can get started in Radio with a total investment of only \$1.95. This is the lowest priced radio training. Act today.



GREAT HELP

"I consider the course a most valuable addition to my radio library. Also, my diploma impresses my customers and, thereby, helps my business. I would not part with my course for any sum if I could not secure another. It is a gold mine of useful information." Frank Courtney, Augusta, Ga.



RECOMMENDED FOR BEGINNERS AND EXPERTS

"I would recommend your Radio Technical Institute course to any radio man." R. J. Helihan, Claremont, N. H.

AMAZING REDUCED PRICE

Repair all radio sets expertly, learn new speed-tricks of servicing, short-cuts, profit making ideas. Brush up on latest servicing methods. A single time-saving hint will more than pay for the special \$1.95 price for the complete course and all supplementary material. Make certain of your Place in Radio. Learn to repair all radios quickly and properly.

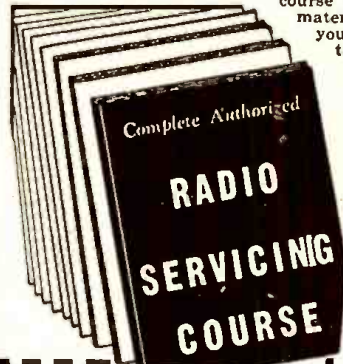

LIMITED OFFER

Write to us today while this offer is in effect. Only a limited quantity of courses printed to sell at the reduced price.

FOR HOME-STUDY

Get ahead in Radio with this practical training. The lessons are clear, interesting, easy to understand and use. Final exam and diploma available after course is finished. Look the course over without any risk.

10 DAYS FREE EXAMINATION

SUPREME PUBLICATIONS, Room 635
3727 W. 13th St., Chicago, Ill.

Ship the complete course on approval without any obligation to buy. I may keep the course for 10 days. If, for any reason, I am not pleased, you guarantee to refund my money.
 I will give \$1.95 and 15c postage to the postman.
 I am sending \$1.95, the full price, ship postpaid.

Name: _____
Address: _____

A NEW BOOK TO ADD TO YOUR TECHNICAL LIBRARY

AUTOMOBILE RADIO — Principles & Practice

by B. Baker Bryant



A COMPLETE compilation of pertinent data on how to install and service the modern automobile radio receiver. All of the non-essential details which have crept into the profession have been weeded out. Each topic is treated so as to contain a precise statement of the fundamental principle involved, to assure the reader's clear understanding of this principle, without distracting his attention by the discussion of a multitude of details and mathematical expressions, which are primarily for the engineer, and tend to confuse rather than clarify a statement for the auto-radio-technician. A practical treatise based on practical experience by practical radio people for the practical radio-technician.

Brief Outline of Contents—

- Introduction—The Auto-Radio Art.
- Features of the Modern Automobile Receiver.
- Installations of Automobile Radios and Antennas.
- The Automobile High and Low Tension Electrical Systems.
- Automobile Electrical Disturbances.
- Vibrator Converters and Motor Generators.
- Service Hints, Classified Automobile Installation Notes, and Conclusion.

Send 50c check, money order, unused U. S. stamps, or coin for your copy of "Automobile Radio—Principles & Practice"—it will be sent to you postpaid upon receipt of your remittance.

RADCRAFT PUBLICATIONS, Inc.
20 Vesey Street, New York, N. Y.

in cleaner, more positive contact on each swing. Piling and chattering are eliminated, R.F. hash reduced and mechanical noise lowered to a very low level.—Radio-Craft

IMPROVED CUTTING NEEDLES

Audio Devices, Inc.
1600 Broadway, New York, N. Y.

CUTTING needles with Stellite and Sapphire points further improved to provide improved frequency response and lower noise level. These features should be of interest to the critical home recordist as well as the studios and broadcast stations now using the newest type of extremely-wide-range cutters. For convenience in operation the thread throw has been increased and improved.—Radio-Craft

SUPERFINE LUBRICATING OIL

The Davenoil Co.
158 Summit St., Newark, New Jersey

THIS lubricating oil has been expressly prepared for delicate and precise instruments. It will not leave a residue of dirt or sticky gum. Recommended for laboratory test equipment, watches, cameras, microscopes, etc. Furnished with metallic applicator.—Radio-Craft

DYNAMIC "DISPATCHER" MICROPHONE

Universal Microphone Co.
Inglewood, Cal.

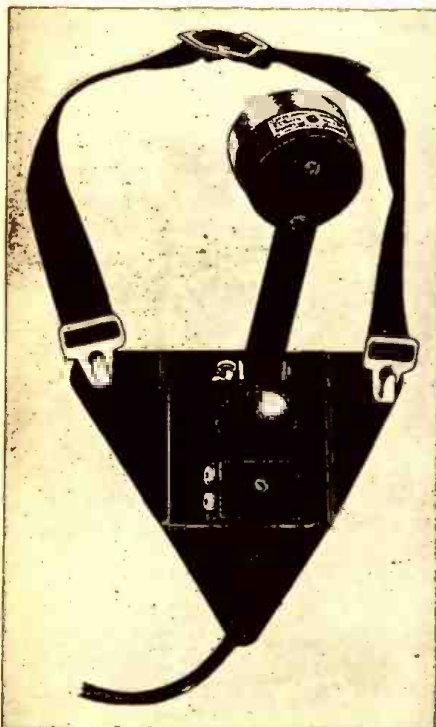

ENGINEERED primarily for operators of wired music systems who must have their hands free for operating phono-turntables and gain controls. This type microphone is being made available in 12 different models and impedances. The unit includes 7½ ft. of flexible cord, weighing a total of but ½-lb.—Radio-Craft

LIGHT AIRCRAFT RECEIVER

Harvey-Wells Communications, Inc.
Southbridge, Mass.

DESIGNED expressly for use on light aircraft, this receiver is designed functionally on the actual requirements of private aviation as found through actual flying experiences of the company's personnel, and by close contact with private pilots. Known as AR-2-A, this 4-tube receiver

weighs but 9 lbs. complete with heavy-duty batteries, battery case, cables and headphones. The size is 6 ins. wide x 4¾ ins. high x 4 ins. deep. The set is a superhet. with a continuously variable tuning range of from 198 to 405 kc.—Radio-Craft

FLUORESCENT DESK LAMP

Eagle Electric Mfg. Co., Inc.
59-79 Hall St., Brooklyn, N. Y.

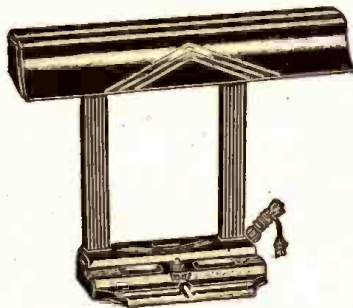

FLUORESCENT lighting is going over like hot cakes and there is no reason why the Serviceman who has a little store of his own or the Serviceman-Dealer should not cash-in by selling units such as the one illustrated here. This unit is an all-bakelite desk lamp, complete with starter switch. The base is heavy cast metal, lending ruggedness to the entire unit. Shade has baked white enamel reflector which is adjustable to focus light where desired. Known as the Fluralamp model 552, this lamp uses a No. T8 15-watt, 18-in. fluorescent bulb. Designed for use on 110-120 volts, 60 cycles A.C. Measures 15 ins. high by 18 ins. wide. Other models also available.—Radio-Craft

DATAPRINTS

TESLA-LOUDIN COILS



- 20c Ea. in order for 10 (Data and Drawings only.)
- 36" Sp'k Tesla-Oudin Coil 40c
- (1 K.W. Exc. Trf. Data incl.)
- 8" Sp'k Tesla-Oudin Coil 40c
- (¼ K.W. Exc. Trf. Data incl.)
- 8" Sp'k Oudin; 110 Vt. 40c
- "Kick Coil" type 40c
- 3" Tesla Works on Ford Coil 40c
- 1" Sp'k Vibrator Hi-Freq. Coil 40c

NEW! 5 ft. Sp'k. Oudin Coil & Exciter
Data 75c



Induction PIPE & ORE LOCATOR

- Induction Type, Data 40c
- Radio Type 40c

More DATAPRINTS 40c each!

- 5 Meter Superhet. 40c
- ½ Meter Tr. & Rec. 40c
- 20 A.C. Probs. & Ans. 40c
- 20 Telephone Hook-ups 40c
- 100 Mech. Movements 40c
- 20 Motor Hook-ups 40c
- Television Hook-up 40c
- 20 Elec. Party Tricks 40c
- Solenoids and Magnets 40c
- get list. 40c
- Fry Eggs on Ice! 40c
- Experimental Photo- phone 40c
- Radio Control for Models 40c
- Diathermy Apparatus 40c
- Inductor Organ 40c
- Electric Refrigerator 40c
- Wheatstone Bridge 40c
- Weld. Transf. 2 K.W. 40c
- Rewinding Armatures 40c
- String Galvanometer 40c
- 20 Simple Bell Circuits 40c
- Steel Wire Recorder! 40c
- Water Wheels 40c
- Water Turbines 40c
- Photo Cell and Relay 40c
- Ring 4 bells: 2 Wires 40c
- 20 Tesla Tricks 40c
- Polarized Relay 40c
- Induction Balance 40c
- Electric Pipe Thawer 40c

Special Prices: 4 prints \$1.00; 10 for \$2.00; Single, 40c each. Get New Catalog 100 A.

The DATAPRINT Co.

Lock Box 322D, Ramsey, N. J.

Get This Electric Dry Shaver

ABSOLUTELY FREE!



OPERATES ON
110-VOLT, 60-CYCLE
A.C. LINE

JUST THINK OF IT—you can get absolutely FREE, the useful DRY ELECTRIC SHAVER which is shown at the left. This ELECTRIC DRY SHAVER is sent to you by the publishers with a one-year subscription to RADIO-CRAFT.

Here Are the Features of The ELECTRIC DRY SHAVER

Constructed of metal with attractive red bronze finish. Scientifically constructed to give a perfectly clean shave. 5-foot rubber insulated cord and plug. Constructed to last for many years.

Operates from 110-volt, 60-cycle A.C. electric line. Carries a two-year manufacturer's guarantee. A fine quality, self-sharpening toilet necessity.

Send your subscription to RADIO-CRAFT for One Year (12 issues) and receive absolutely FREE one of these remarkable Electric Dry Shavers. New subscribers are accepted or you may extend your present subscription another twelve months. Mail your remittance of \$2.00 (plus 25c for shipping charges on Shaver) to the publishers. (Canada and foreign \$2.75.) You will receive your DRY ELECTRIC SHAVER immediately by return mail. Use coupon below to enter your subscription.

RADIO-CRAFT

20 Vesey Street, New York, N. Y.

RADIO-CRAFT, 20 Vesey Street, New York, N. Y.

Gentlemen: Enclosed find my remittance of \$2.00 for which enter my subscription to RADIO-CRAFT for one year (12 issues). Send me immediately FREE, ELECTRIC DRY SHAVER (Canada and foreign \$2.75). In U. S. add only 25c additional to cover shipping charges on Shaver.

New Subscriber Extend Present Subscription

Name

Address

City State

(Send remittance by check, money order or unused U.S. Postage Stamps. Register letter if you send cash or stamps.)

RC-341

WE SHIP ELECTRIC DRY SHAVER THE SAME DAY YOUR SUBSCRIPTION ORDER IS RECEIVED.

CLIP COUPON— AND MAIL!

• LATEST RADIO APPARATUS •

SEMI-COMMUNICATIONS RECEIVER

Echophone Radio Corp.
201 E. 26 St., Chicago, Ill.



MODEL EC-1 "Commercial" has features many of which are found in regular communications-type receivers. For instance, its tuning range is continuous from 545 kc. to 30.5 mc. The illuminated dial is large and fully calibrated for all bands and also includes a separate band-spread scale and pointer, actuated by a separately-controlled electric band-spread system. Other features include headphone - loudspeaker switch, beat-frequency oscillator switch (which cuts out the A.V.C. system automatically), and a stand-by switch. A 5-in. P.M. speaker is self-contained in cabinet.—Radio-Craft

NEW ANTENNA

Alesi & Fener
132 Nassau St., New York, N. Y.

THE Vertrod, claimed by manufacturer to eliminate most of the man-made static which has previously defied the best efforts

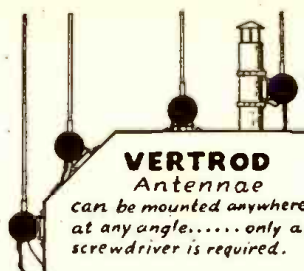

VERTROD
Antennae
can be mounted anywhere
at any angle..... only a
screwdriver is required.

of engineers, employs entirely new principle. Line interference is effectually prevented from reaching aerial. Supplied in convenient, compact package, Vertrod aerial can be quickly set up, wherever 4 ins. of space are available. Patented rotary base accommodates aerial to any surface or angle. Only a screwdriver is required for mounting. Solid duraluminum parts insure greatest efficiency and durability.—Radio-Craft

HOME RECORDER

General Electric Company
1285 Boston Ave., Bridgeport, Conn.



MODEL J-629 is a 6-tube A.C. receiver incorporating a combination phonograph and recording mechanism. Housed in a table-model cabinet, the instrument is compact and an entertainment unit complete in itself. Both pickup and cutting-head are of the crystal type. Turntable speed is 78 r.p.m. The receiver is a superhet. with a tuning range of 550 to 1,600 kc. and an undistorted output of 2 watts.—Radio-Craft.

NEWS OF TELEVISION

ALTHOUGH air television activity has been in the doldrums of late, laboratory work seems to have progressed almost unabated. One of the developments having exceptional portent was the installation, by N.B.C. last month, of a special filter unit which enables the antenna of station W2XWG to transmit both television and Frequency Modulation programs, and the cue signals from a 3rd transmitter, simultaneously and without any interference.

The U. S. Department of Commerce reports television set manufacturing amounting to a total of 4,091 sets, at an average price of \$200, during 1939.

Allen B. Du Mont Labs. announced that the delay television-tube, which affords 625-line flickerless scanning at 15 frames/second, now is available with a white screen (which therefore supersedes the earlier orange-screen type).

Important Announcement to All Servicemen! NOW YOU CAN JOIN THE NATIONAL RSA For Only \$1.00 a Year!



Every Serviceman can have a voice in his destiny in his own industry! The RSA extends its services and makes it possible now for all Servicemen to enjoy the advantages of membership in this national organization for only \$1.00 a year.

Yes—for as little as 2c a week you get the RSA Membership Certificate and receive the RSA House Organ. You have access to the RSA Technical Helps Bureau, and you are able to participate in all the other functions and benefits which the RSA offers.

RADIO SERVICEMEN OF AMERICA, INC.

"Reliable Service Assured"

JOE MARTY, JR., EXECUTIVE SECRETARY
304 S. DEARBORN ST., CHICAGO, ILLINOIS

As rapidly as local chapters are formed, protected territories will be established for them. Applicants in present chapter areas will be referred to the local chapter.

This is your opportunity. Don't let it slip away. Join now with thousands of your fellow Servicemen in this great organization—the organization that's doing things for you!

Fill out the coupon, attach a \$1.00 bill and mail it now!

RADIO SERVICEMEN OF AMERICA, INC.
304 S. Dearborn Street, Chicago, Illinois

\$1.00 enclosed for 1941 National Dues in RSA.

Name

Address

City State

Radio-Craft—Mar.

Where to Buy It! —

CLASSIFIED RADIO DIRECTORY

Handy Buying Guide, by Products and Manufacturers' Names and Addresses, for the Entire Radio Industry

There is no charge for regular light-face listings in the Classified Radio Directory. This service is absolutely free. However, if dominant bold-face listings are desired, we make a charge of \$2 for concern names and \$1 for trade names for each bold-face listing. Please write to the Advertising Dept., Radio-Craft, 20 Vesey St., New York, N. Y., for details.

This DIRECTORY is published in sections—1 section per month. This method of publication permits the DIRECTORY to be constantly up-to-date since necessary revisions and corrections can be made monthly. All names preceded by an asterisk (*) indicate that they are trade names.

If you cannot find any item or manufacturer in this section or in previously-published sections, just drop us a line for the information.

NOTE: Section I of this DIRECTORY was published in the October, 1940 issue, Section VI, presented here, concludes the 1st Edition of the DIRECTORY. Next month: Section I, Revised.

While every precaution is taken to insure accuracy, Radio-Craft cannot guarantee against the possibility of occasional errors and omissions in the preparation of this Classified Directory. Manufacturers and readers are urged to report all errors and omissions at the earliest moment to insure corrections in the very next issue.

TUBES (& PARTS)



- Ballast (regulating) BR
- Cathode-ray C
- Industrial IN
- Miniatues (hearing-aid and/or radio receiving) M
- Photocells P
- Receiving (including rectifiers) RR
- Transmitting TX
- Voltage control V

- AMERICAN TELEVISION CORP., 130 W. 56th St., New York, N. Y.—C
- AMPERITE COMPANY, 561 B'way., New York, N. Y.—BR
- ARCO TUBE CO., 227 Central Ave., Newark, N. J.—BR, C, IN, P, RR, TX, V, M
- CANADIAN MARCONI CO., Montreal, Quebec, Can.—BR, C, IN, P, RR, TX, V, M
- CLAROSTAT MFG. CO., INC., 285 N. 6th St., Brooklyn, N. Y.—BR
- CONTINENTAL ELECTRIC CO., Geneva, Ill.—IN, P
- CRUMPACKER DISTRIB. CORP., 1801 Fannin St., Houston, Tex.—BR, P, RR
- HAROLD DAVIS, INC., 428 W. Capital St., Jackson, Miss.—BR, C, IN, P, RR, TX, V, M
- DOW RADIO SUPPLY CO., 1759 E. Colorado, Pasadena, Calif.—BR, RR, TX
- ALLEN B. DU MONT LABS., INC., Passaic, N. J.—C
- EITEL-McCULLOUGH, INC., 799 San Mateo Ave., San Bruno, Calif.—TX
- ELECTRONIC CONTROL CORP., 2667 E. Grand Blvd., Detroit, Mich.—P
- ELECTRONS, INC., 127 Sussex Ave., Newark, N. J.—IN
- FARNSWORTH TELEVISION & RADIO CORP., 3702 E. Pontiac St., Fort Wayne, Ind.—C, IN, P, TX
- FEDERAL TELEGRAPH CO., 200 Mt. Pleasant Ave., Newark, N. J.—TX
- FISCHER DISTRIB. CORP., 222 Fulton St., New York, N. Y.—BR, C, P, RR, M
- GENERAL ELECTRIC CO., Schenectady, N. Y. & Bridgeport, Conn.—BR, C, IN, P, RR, TX, M
- G-M LABORATORIES, INC., 4326 N. Knox Ave., Chicago, Ill.—P
- GOLDENTONE RADIO CO., 15123 Warren Ave., Dearborn, Mich.—RR
- HARRISON RADIO CO., 12 W. B'way., New York, N. Y.—BR, C, IN, P, RR, TX, V, M
- HEINTZ & KAUFMAN, LTD., South San Francisco, Calif.—TX
- HERBERT H. HORN, 1201 S. Olive St., Los Angeles, Calif.—BR, IN, V, M
- HYGRADE SYLVANIA CORP., 500 5th Ave., New York, N. Y.—BR, C, RR, M
- HYTRON CORPORATION, 76 Lafayette St., Salem, Mass.—BR, C, IN, P, RR, TX, V, M
- J. F. D. MANUFACTURING CO., 4111 Ft. Hamilton Pkwy., Brooklyn, N. Y.—BR
- KEN-RAD TUBE & LAMP CORP., INC.—Owensboro, Ky.—RR, M
- T. R. McELROY, 100 Brookline Ave., Boston, Mass.—BR, P
- M. & G. HEARING AIDS CO., 30 N. Michigan Ave., Chicago, Ill.—M
- MONTGOMERY WARD & CO., 619 W. Chicago Ave., Chicago, Ill.—BR, C, RR, TX, M
- NATIONAL UNION RADIO CORP., 57 State St., Newark, N. J.—BR, C, P, RR, V

- NORTHERN ELECTRIC CO., LTD., 1261 Shearer St., Montreal, Que., Can.—BR, C, IN, P, RR, TX, V, M
- OFFENBACH ELECTRIC CO., 1452 Market St., San Francisco, Calif.—BR, C, IN, P, RR, TX, V, M
- PHILCO RADIO & TELEVISION CORP., Tioga & C Sts., Phila., Pa.—P, RR
- PHOTOBELL CORPORATION, 123 Liberty St., New York, N. Y.—IN, P
- RADIO ELECTRIC SERVICE CO., INC., N. W. Cor. 7th & Arch Sts., Phila., Pa.—BR, C, IN, P, RR, TX, V, M
- RADIO EQUIPMENT CORP., 326 Elm St., Buffalo, N. Y.—BR, C, IN, P, RR, TX, V, M
- RADOLEK COMPANY, 601 W. Randolph St., Chicago, Ill.—BR, C, IN, P, RR, TX, V, M
- RAYTHEON PRODUCTION CORP., 420 Lexington Ave., New York, N. Y.—IN, RR, TX, M
- RCA MFG. CO., INC., Front & Cooper Sts., Camden, N. J.—BR, C, IN, P, RR, TX, V, M
- ROGERS-MAJESTIC CORP., LTD., 622 Fleet St., Toronto, Can.—C, RR, TX
- MAURICE SCHWARTZ & SON, 710-712 B'way., Schenectady, N. Y.—BR, C, IN, P, RR, TX, V, M
- SHELLEY RADIO CO., 1841 S. Flower St., Los Angeles, Calif.—BR, C, P, RR, V
- S.O.S. CINEMA SUPPLY CORP., 636 11th Ave., New York, N. Y.—P
- SUN RADIO CO., 212 Fulton St., New York, N. Y.—BR, C, IN, P, RR, TX, V, M
- TAYLOR AIRPHONE PRODUCTS, Hangar 15, Long Beach Airport, Long Beach, Calif.—M
- TAYLOR TUBES, INC., 2341 Wabansia Ave., Chicago, Ill.—IN, TX
- TILTON ELECTRIC CORP., 15 E. 26th St., New York, N. Y.—BR
- UNITED ELECTRONICS CO., 42 Spring St., Newark, N. J.—IN, TX
- WESTINGHOUSE ELEC. & MFG. CO., East Pittsburgh, Pa.—C, IN, P, TX
- ZENITH RADIO CORP., 6001 Dickens Ave., Chicago, Ill.—R

- FISCHER DISTRIB. CORP., 22 Fulton St., New York, N. Y.—AV, I
- HARRISON RADIO CO., 12 W. Broadway, New York, N. Y.—AV, I
- HARTMAN ELECTRICAL MFG. CO., Mansfield, Ohio—N
- THE HICKOK ELECTRICAL INSTRUMENT CO., 10514 Dupont Ave., Cleveland, Ohio—AV
- HERBERT H. HORN, 1201 S. Olive St., Los Angeles, Calif.—AV, FV, I
- KAAR ENGINEERING CO., 619 Emerson St., Palo Alto, Calif.—RT
- LAFAYETTE RADIO CORP., 100 6th Ave., New York, N. Y.—AV, FV, I
- FRED M. LINK, 125 W. 17th St., New York, N. Y.—AV
- M. & H. SPORTING GOODS CO., 512 Market St., Phila., Pa.—AV, I
- P. R. MALLORY & CO., 3029 E. Washington St., Indianapolis, Ind.—AV, FV
- MEISSNER MFG. CO., Mt. Carmel, Ill.—AV
- MONTGOMERY WARD & CO., 619 W. Chicago Ave., Chicago, Ill.—I
- OAK MFG. CO., 1260 Clybourn Ave., Chicago, Ill.—AV, FV, I
- OFFENBACH ELECTRIC CO., 1452 Market St., San Francisco, Calif.—AV, FV, I
- PHILCO RADIO & TELEVISION CORP., Tioga & "C" Sts., Phila., Pa.—AV, FV
- RADIO ELECTRIC SERVICE CO., INC., N. W. Cor. 7th & Arch Sts., Phila., Pa.—AV, FV, I
- RADIO EQUIPMENT CORP., 326 Elm St., Buffalo, N. Y.—AV, FV, I
- RADOLEK COMPANY, 601 W. Randolph St., Chicago, Ill.—AV, FV, I
- MAURICE SCHWARTZ & SON, 710-712 Broadway, Schenectady, N. Y.—AV, FV, I
- SETCHELL CARLSON, INC., 2233 University Ave., St. Paul, Minn.—AV, FV
- SHELLEY RADIO CO., 1841 S. Flower St., Los Angeles, Calif.—AV
- SUN RADIO CO., 212 Fulton St., New York, N. Y.—AV, FV, I
- TAYLOR AIRPHONE PRODUCTS, Hangar 15, Long Beach Airport, Long Beach, Calif.—A
- UTAH RADIO PRODUCTS CO., 812 Orleans St., Chicago, Ill.—AV, FV
- JAMES VIBRAPOWR CO., INC., 341 N. Crawford Ave., Chicago, Ill.—AV, FV
- VICTOR ANIMATOGRAPH CORP., Davenport, Iowa

VIBRATORS

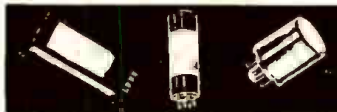

(Also see Battery Chargers, Eliminators & Rectifiers)

- Aircraft A
- Auto-radio AV
- Farm-radio FV
- Inverters I
- Neon Lighting N
- Radio transmitting RT

- AMERICAN TELEVISION & RADIO CO., 300 E. 4th St., St. Paul, Minn.—AV, FV, I
- THE BENWOOD-LINZEE COMPANY, 1838 Washington Ave., St. Louis, Mo.—I
- CANADIAN MARCONI CO., Montreal, Quebec, Can.—AV, FV, I
- CANADIAN RADIO CORP., LTD., Toronto, Ontario, Can.—AV, FV
- CRUMPACKER DISTRIB. CORP., 1801 Fannin St., Houston, Tex.—AV, FV, I
- HAROLD DAVIS, INC., 428 W. Capital St., Jackson, Miss.—AV, FV, I
- DOW RADIO SUPPLY CO., 1759 E. Colorado, Pasadena, Calif.—AV
- ELECTRONIC CONTROL CORP., 2667 E. Grand Blvd., Detroit, Mich.—I
- ELECTRONIC LABORATORIES, INC., 122 W. New York St., Indianapolis, Ind.—I
- ESPEY MFG. CO., INC., 305 E. 63rd St., New York, N. Y.—I

WIRE



- Antenna (receiving) AR
- Antenna (transmitting) AX
- Antenna, Transmission (receiving) ATR
- Antenna, Transmission (transmitting) ATX
- Concentric cable C
- Cords (attachment) CA
- Hookup H
- Insulated cable I
- Litzendraht ("Litz.") LW
- Magnet MW
- Microphone cable M
- Radio harness RH
- Resistance RES
- Resistance cords R
- Shielded SH

When writing to companies listed here please mention that you saw the listing in the Radio-Craft "Classified Radio Directory"

Order your copy NOW—the only

P. A. HANDBOOK



ONLY
25
CENTS
A COPY

THAT no book has yet been published which covers amplifiers and sound systems (also kindred systems), in one complete, authentic volume is almost unbelievable. Yet, it is a fact, there is no book in print which covers Public Address from A to Z. To bridge this wide-spread gap, RADIO-CRAFT will publish a complete, magnificent volume on Public Address of such magnitude—so complete and authoritative—that every man engaged in radio can have both a theoretical and practical knowledge of the function and operation of sound systems. The editorial pages are so filled with instruction and replete with illustrations that the volume fully justifies its title of 1940 AMPLIFIER HANDBOOK AND PUBLIC ADDRESS GUIDE. This great HANDBOOK on Public Address should be read and studied by those who constantly build, service and sell sound equipment.

A MATCHLESS VOLUME
As complete as you would expect to find any engineering handbook—this is how the radio or P. A. man finds the AMPLIFIER HANDBOOK AND PUBLIC ADDRESS GUIDE. With essential technical data compiled from an exceptionally large number of sources, the volume covers nearly a hundred different subjects coordinating every conceivable branch or sub-division of Public Address.

THE CONTENTS
To actually show the scope and magnitude of the AMPLIFIER HANDBOOK AND PUBLIC ADDRESS GUIDE, an analysis of the contents is found at the right, showing the breakdown of the material featured within each particular section. A thorough reading of the contents shows the completeness of this book.

RADCRAFT PUBLICATIONS ■ 20 VESEY STREET ■ NEW YORK, N. Y.

RADCRAFT PUBLICATIONS, INC. ★ 20 VESEY STREET ★ NEW YORK, N. Y. RC-341
Gentlemen: Enclosed find my remittance of 25c for which send me POSTPAID, one copy of your NEW—1940 AMPLIFIER HANDBOOK AND PUBLIC ADDRESS GUIDE.

Send me others, for friends, also POSTPAID @ 25c each.

Name Address

City State

Remit by check or money order; register letter if you send cash or unused U.S. Postage Stamps.

A Resume of the Contents of the AMPLIFIER HANDBOOK AND PUBLIC ADDRESS GUIDE

FOREWORD

INTRODUCTION

Definitions—decibels, frequency, input, output, impedance, etc.

SECTION I—SOURCE

Carbon microphones (single-button and double-button)
Condenser microphones
Velocity (ribbon) microphones
Dynamic microphones
Crystal microphones (sound-cell types, crystal diaphragm types)
Cardioid microphones
Contact microphones
Phonograph pickups (magnetic types, crystal types)

SECTION II—AMPLIFIERS

Voltage Amplification
Design of resistance-coupled voltage amplifiers
Commercial voltage amplifier
The Power Stage
Class A amplifiers
Class AB amplifiers
Class AB₁ amplifiers
Class AB₂ amplifiers
Class B amplifiers
When to apply class A, AB, and B amplification

Power Supplies
Half-wave rectification
Full-wave rectification
Voltage doublers

Filter Circuits

Power supply regulation, etc.
Practical Hints on Amplifier Construction

Microphonism
Placement of components
Tone compensation
Inverse feedback
Remote control methods

SECTION III—DISTRIBUTION

The Loudspeaker
Dynamic speakers
Speaker performance (frequency response, efficiency)
High-fidelity speakers
Speaker Baffles and Housings
Outdoor speaker installations
Power cone speakers
Radial (360° distribution) speaker baffles

SECTION IV—COORDINATION

Input impedance matching
Matching speakers to P.A. installations
Phasing speakers
Effect of mismatching speakers to amplifier output
A typical P.A. installation (in a skating rink)

SECTION V—USEFUL PUBLIC ADDRESS DATA AND INFORMATION

Speaker matching technique
The ABC of Db., VU, Mu, Gm and Sm
Charts and formulas useful to the practical P.A. sound man
Handy index to important articles on public address and sound

Order Your Copy NOW—

*Clip Coupon and
Mail Today!*

• CLASSIFIED RADIO DIRECTORY •

Shielded ignition S
Wire shielding SW

THE ACME WIRE CO., 1255 Dixwell Ave., New Haven, Conn.—AR, LW, MW
ACORN INSULATED WIRE CO., INC., 225 King St., Brooklyn, N. Y.—ATR, H, I, SH
ALDEN PRODUCTS CO., 715 Center St., Brockton, Mass.—AR, C, CA, WC, H, I, M, RH, SH, S, SW
ALLIED RADIO CORP., 833 W. Jackson Blvd., Chicago, Ill.—AR, AX, ATR, ATX, C, CA, WC, GU, H, I, LW, MW, M, RH, RES, R, SH, S, SW
ALPHA WIRE CORP., 50 Howard St., New York, N. Y.—AR, AX, ATR, ATX, C, CA, WC, GU, H, I, LW, M, RH, SH, S, SW
AMERICAN PHENOLIC CORP., 1250 Van Buren St., Chicago, Ill.—ATR, ATX, C
ATLAS SOUND CORP., 1451 39th St., Brooklyn, N. Y.—M
BANK'S MFG. CO., 5019 N. Winthrop Ave., Chicago, Ill.—C, H, M, SH
BELDEN MFG. CO., 4647 W. Van Buren St., Chicago, Ill.—AR, AX, ATR, ATX, C, CA, WC, H, I, LW, MW, M, RH, R, SH, S, SW
L. S. BRACH MFG. CORP., 55 Dickerson St., Newark, N. J.—AR, AX, ATR, ATX
BRUSH DEVELOPMENT CO., 3311 Perkins Ave., Cleveland, Ohio—M
BUD RADIO, INC., 5205 Cedar Ave., Cleveland, Ohio—MW
CANADIAN MARCONI CO., Montreal, Quebec, Can.—AR, AX, ATR, ATX, C, CA, H, I, LW, M, RH
CANADIAN RADIO CORP., LTD., Toronto, Ontario, Can.—AR, ATR, H
CLAROSTAT MFG. CO., INC., 285 N. 6th St., Brooklyn, N. Y.—RES, R
CONSOLIDATED WIRE & ASSOCIATED CORPS., 512 S. Peoria St., Chicago, Ill.—AR, AX, ATR, ATX, C, CA, WC, H, I, LW, MW, M, RH, RES, R, SH, S, SW
CORNISH WIRE CO., INC., 15 Park Row, New York, N. Y.—CA, GU, H, I
CRUMPACKER DISTRIB. CORP., 1801 Fannin St., Houston, Tex.—AR, ATR, CA, H, I, MW, RES, R, SH, S, SW
DOOLITTLE & FALKNER, INC., 7421 S. Loomis Blvd., Chicago, Ill.—C
HAROLD DAVIS, INC., 428 W. Capital St., Jackson, Miss.—AR, AX, ATR, ATX, C, CA, H, I, LW, RH, RES, R, SH, S, SW
DOW RADIO SUPPLY CO., 1759 E. Colorado, Pasadena, Calif.—AR, AX, ATR, ATX, C, CA, H, I, MW, M, RES, R, SH, S, SW
DRIVER-HARRIS COMPANY, Harrison, N. J.—RES
EAGLE ELECTRIC MFG. CO., INC., 59 Hall St., Brooklyn, N. Y.—CA
HUGH H. EBY, INC., 4700 Stanton Ave., Phila., Pa.—RH
THE ELECTRIC AUTO-LITE CO., American Wire Div., 3529 24th St., Port Huron, Mich.—AR, H, MW, S, SW
ESSEX WIRE CORP., 14310 Woodward Ave., Detroit, Mich.—AR, CA, WC, H, I, LW, MW, M, RH, R, SH, S, SW
FEDERAL SALES CO., 24-26 S. Jefferson St., Chicago, Ill.—H
FISCHER DISTRIB. CORP., 222 Fulton St., New York, N. Y.—AR, AX, ATR, ATX, C, CA, WC, GU, H, I, LW, MW, M, RH, RES, R, SH, S, SW
M. M. FLERON & SON, INC., 113 N. Broad St., Trenton, N. J.—AR, SH
GENERAL CEMENT MFG. CO., 919 Taylor Ave., Rockford, Ill.—H
GENERAL ELECTRIC CO., Schenectady, N. Y. & Bridgeport, Conn.—AR, AX, ATR, ATX, C, CA, WC, H, I, LW, MW, M, RH, RES, R, SH, S, SW
GENERAL INSULATED WIRE CORP., 53 Park Place, New York, N. Y.—C, CA, H, I, M, SH, S
E. I. GUTHMAN & CO., INC., 400 S. Peoria St., Chicago, Ill.—LW, MW
HARRISON RADIO CO., 12 W. Broadway, New York, N. Y.—AR, AX, ATR, ATX, C, CA, WC, GU, H, I, LW, MW, M, R, SH, S, SW
HOLYOKE WIRE AND CABLE CORP., 720 Main St., Holyoke, Mass.—AR, CA, H, I, RH, RES, R, SH, SW
HOPE WEBBING CO., P. O. Box 1495, Providence, R. I.—AR, ATR, WC
HERBERT H. HORN, 1201 S. Olive St., Los Angeles, Calif.—AR, CA, H, I, M, SW
HOSKINS MFG. CO., 4445 Lawton Ave., Detroit, Mich.—RES
E. F. JOHNSON COMPANY, Waseca, Minn.—AX, ATR, ATX, C
KELLOGG SWITCHBOARD & SUPPLY CO., 6650 S. Cicero Ave., Chicago, Ill.—H
LAFAYETTE RADIO CORP., 100 6th Ave., New York, N. Y.—AR, AX, ATR, ATX, C, CA, WC, GU, H, I, LW, MW, M, RES, R, SH, S, SW
FRED M. LINK, 125 W. 17th St., New York, N. Y.—C
LOWELL INSULATED WIRE CO., 171 Lincoln St., Lowell, Mass.—AR, CA, H, SH, S
T. R. McELROY, 100 Brookline Ave., Boston, Mass.—CA
M. & G. HEARING AIDS CO., 30 N. Michigan Ave., Chicago, Ill.—CA
M. & H. SPORTING GOODS CO., 512 Market St., Phila., Pa.—AR, AX, ATR, ATX, C, CA, WC, GU, H, I, LW, MW, M, R, SH, S, SW
MEISSNER MFG. CO., Mt. Carmel, Ill.—LW, MW
MONTGOMERY WARD & CO., 619 W. Chicago Ave., Chicago, Ill.—AR, AX, ATR, ATX, C, CA, H, I, MW, M, R, SH, SW
NEW ENGLAND ELECTRICAL WORKS, Lisbon, N. H.—LW, MW, SW

NORTHERN ELECTRIC CO., LTD., 1261 Shearer St., Montreal, Que., Can.—AR, AX, ATR, ATX, C, CA, WC, GU, H, I, MW, M, RH, RES, SH
OFFENBACH ELECTRIC CO., 1452 Market St., San Francisco, Calif.—AR, AX, ATR, ATX, C, CA, WC, GU, H, I, LW, MW, M, RES, R, SH, S, SW
PHILCO RADIO & TELEVISION CORP., Tioga & "C" Sts., Phila., Pa.—AR, CA, H, I, M, SH
RADIO ELECTRIC SERVICE CO., INC., N. W. Cor. 7th & Arch Sts., Phila., Pa.—AR, AX, ATR, ATX, C, CA, WC, GU, H, I, LW, MW, M, RH, RES, R, SH, S, SW
RADIO EQUIPMENT CORP., 326 Elm St., Buffalo, N. Y.—AR, AT, ATR, ATX, WC, GU, H, I, MW, M, R, SH, S, SW
RADOLEK COMPANY, 601 W. Randolph St., Chicago, Ill.—AR, AX, ATR, ATX, C, CA, WC, GU, H, I, LW, MW, M, RH, RES, R, SH, S, SW
REX BASSETT, INC., 214 Star Bldg., Miles, Mich.—C
REX RHEOSTAT CO., 37 W. 20th St., New York, N. Y.—RES
THE RIVERSIDE METAL CO., Pavilion Ave., Riverside, N. J.—RES
JOHN A. ROEBLING'S SONS CO., 640 S. Broad St., Trenton, N. J.—AR, AX, C, WC, GU, H, I, MW, M, SH, S, SW
RUPP'S ASSEMBLING & MFG. WORKS, 2341 Seminary Ave., Chicago, Ill.—CA
MAURICE SCHWARTZ & SON, 710-712 Broadway, Schenectady, N. Y.—AR, AX, ATR, ATX, C, CA, WC, GU, H, I, LW, MW, M, RH, RES, R, SH, S, SW
SELECTAR MFG. CORP., 30 W. 15th St., New York, N. Y.—M
SHELLEY RADIO CO., 1841 S. Flower St., Los Angeles, Calif.—AR, CA, H, I, M, SH, S
SUN RADIO CO., 212 Fulton St., New York, N. Y.—AR, AX, ATR, ATX, C, CA, WC, H, I, MW, M, RES, R, SH, S, SW
TECHNICAL APPLIANCE CORP., 17 E. 16th St., New York, N. Y.—AR, ATR, SH
TILTON ELECTRIC CORP., 15 E. 26th St., New York, N. Y.—R
UNIVERSAL MICROPHONE CO., LTD., 424 Warren Lane, Inglewood, Calif.—M
WINCHARGER CORPORATION, Sioux City, Iowa—GU

H. W. ACTON CO., INC., 370 7th Ave., New York, N. Y.—C, F, D, M, SS
ADVANCE ELECTRIC CO., 1260 W. 2nd St., Los Angeles, Calif.—C, F, A
AEROVOX CORPORATION, New Bedford, Mass.—C, HO, F, AR, D, E, G, M, S, SS
ALDEN PRODUCTS CO., 715 Center St., Brockton, Mass.—C, F, E, M, SS
ALLEN ELECTRIC & EQUIPMENT CO., 2101-2117 N. Pitcher St., Kalamazoo, Mich.—C, F, D, S
ALLIED RADIO CORP., 833 W. Jackson Blvd., Chicago, Ill.—C, F, A
ALLISON BAFFLE CO., 722 Berea Ave., Gadsden, Ala.—HO, F, A
ALPHA WIRE CORPORATION, 50 Howard St., New York, N. Y.—C, F, A
AMERICAN COMMUNICATIONS CORP., 123 Liberty St., New York, N. Y.—C, F, A
AMERICAN CONDENSER CORP., 2508 S. Michigan Ave., Chicago, Ill.—C, F, A
AMERICAN EMBLEM CO., INC., Utica, N. Y.—C, F, E, D, S, AR
AMERICAN GAS ACCUMULATOR CO., 1029 Newark Ave., Newark, N. J.—C, F, A
AMERICAN LAVA CORP., Cherokee Blvd. & Manufacturers Rd., Chattanooga, Tenn.—C, F, M, E
AMERICAN PHENOLIC CORP., 1250 W. Van Buren St., Chicago, Ill.—C, HO, F, M, E, J
THE AMERICAN ROLLING MILL CO., Middletown, Ohio—C, F, M, E
AMPERITE COMPANY, 561 Broadway, New York, N. Y.—C, F, A
AMPLIFIER CO. OF AMERICA, 37 West 20th St., New York, N. Y.—C, F, A
AMPRO CORPORATION, 2839 N. Western Ave., Chicago, Ill.—C, F, T
AMY, ACEVES & KING, INC., 11 W. 42nd St., New York, N. Y.—C, F, M, E, D, S
ANSLEY RADIO CORP., 4377 Bronx Blvd., New York, N. Y.—C, F, D
APPROVED TECHNICAL APPARATUS CO., 123 Liberty St., New York, N. Y.—C, F, A
ARCO TUBE CO., 227 Central Ave., Newark, N. J.—C, F, A
ARLAVOX MFG. CO., 430 S. Green St., Chicago, Ill.—C, F, M, E, D
ASTATIC MICROPHONE LABORATORY, INC., 830 Market St., Youngstown, Ohio—C, F, M, E, D, SS, G, AR
ATLAS CONDENSER PRODUCTS CO., 548 Westchester Ave., New York, N. Y.—C, F, M, D
ATLAS PRESS CO., Kalamazoo, Mich.—C, F, A
ATLAS SOUND CORP., 1447-39th St., Brooklyn, N. Y.—C, F, A
AUDIO DEVELOPMENT CO., 123 Bryant Ave. N., Minneapolis, Minn.—C, F, M, E
AUDIOGRAPH SOUND SYSTEMS, 1313 W. Randolph St., Chicago, Ill.—C, H, F, E, D, S, SS
D. J. AULD CO., 5th Ave., & 5th St., Columbus, Ohio—C, F, M
AUTOCRAT RADIO CO., 3855 N. Hamilton Ave., Chicago, Ill.—C, F, A
THE AUTOMATIC ELECTRICAL DEVICES CO., 324 E. 3rd St., Cincinnati, Ohio—C, F, A
BAKER & CO., INC., 113 Astor St., Newark, N. J.—C, F, A
BANK'S MFG. CO., 5019 N. Winthrop Ave., Chicago, Ill.—C, F, M, E, D, S, SS
BARKER & WILLIAMSON, Ardmore, Penna.—C, F, M, E, A
BELDEN MANUFACTURING CO., 4647 W. Van Buren Street, Chicago, Ill.—C, F, A
BELMONT RADIO CORP., 1257 Fullerton Ave., Chicago, Ill.—C, F, D
THE BENWOOD-LINZE CO., 1838 Washington Avenue, St. Louis, Mo.—C, F, M, E
A. BITTER CONSTRUCTION CORP., 27-01 Bridge Plaza N., L. J. City, N. Y.—C, F, D
BLAW-KNOX CO., Pittsburgh, Pa.—C, F, M, R
BILLEY ELECTRIC CO., 200 Union Station Bldg., Erie, Pa.—C, HO (to regular Billey distributors only) F, A
BOND PRODUCTS CO., 13139 Hamilton Ave., Detroit, Mich.—C, F, M, E, D
BOONTON-MOLDING CO., 326 Myrtle Ave., Boonton, N. J.—C, F, A
L. S. BRACH MFG. CORP., 55 Dickerson St., Newark, N. J.—C, F, A
ALLEN-BRADLEY CO., 1326 S. 2nd St., Milwaukee, Wisc.—C, F, M
L. S. BRACH MFG. CORP., 55 Dickerson St., Newark, N. J.—C, F, A
BRIGHT STAR BATTERY CO., Crooks & Getty Aves., Clifton, N. J.—C, F, A
BROWNING LABORATORIES, INC., 750 Main St., Winchester, Mass.—C, F, A
BROWN MFG. CO., 403 W. Baltimore, Detroit, Mich.—C, F, A
THE BRUSH DEVELOPMENT CO., 3311 Perkins Ave., Cleveland, Ohio—C, HO, F, A
BUD RADIO, INC., 5205 Cedar Ave., Cleveland, Ohio—C, F, AR, E, D, G, M, S, SS
BURGESS BATTERY CO., P. O. Box 121, Freeport, Ill.—C, F, E, D, S, SS, G
BUSSMANN MFG. CO., University at Jefferson, St. Louis, Mo.—C, F, M, E, D, S
CAMBRIDGE INSTRUMENT CO., INC., 3732 Grand Central Terminal, New York, N. Y.—C, F, M, E, SS, G
THE ALLEN D. CARDWELL MFG. CORP., 81 Prospect St., Brooklyn, N. J.—C, F, M, E, D, G, AR
CARRIER MICROPHONE CO., 439 S. La Brea Ave., Inglewood, Calif.—C, F, M, E, D, S, AR
CARRON MANUFACTURING CO., 415 S. Aberdeen St., Chicago, Ill.—C, F, E, D, S, SS, G, AR

LITERATURE

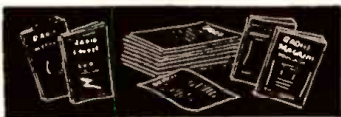

Following is a listing of those companies which publish catalogs, house organs (C, or HO, respectively), or both. Whether these publications are available gratis (F), or whether a nominal charge is made (C), is indicated. Finally, identifying letters signify the particular group to which this literature is directed (Engineers, Dealers, Servicemen, etc.). Please mention RADIO-CRAFT when writing to these organizations.

NATURE OF PUBLICATION

Catalog C
Construction Booklet CB
House Organ HO

CHARGES

Free F
Price C

AVAILABLE TO

Anyone (being all-inclusive, no other listings are given, if "A" is indicated) A
Amateurs (licensed radio) AR
Consumers CON
Dealers D
Distributors DIS
Electronic Specialists ES
Engineers E
General Experimenters G
Jobbers J
Manufacturers M
Marine Supply MS
Musicians MUS
Radio Stations R
Servicemen SS
Sound Specialists S
Talkies Owners T

THE ACME ELECTRIC & MFG. CO., Water St., Cuba, N. Y.—C, F, A
ACOUSTIC CONSULTANTS, INC., 1270 6th Ave., New York, N. Y.—C, F, AR, D, E, G, M, S, SS
ACRO TOOL & DIE WORKS, 2815 Montrose Ave., Chicago, Ill.—C, F, E, J, M

When writing to companies listed here please mention that you saw the listing in the Radio-Craft "Classified Radio Directory"

CLASSIFIED RADIO DIRECTORY

- CARTER MOTOR CO., 1608 Milwaukee Ave., Chicago, Ill.—C, F, M, E, SS, G
- CASTLEWOOD MANUFACTURING CO., 12th & Burnett Sts., Louisville, Ky.—C, F, A
- CHARGIT CORPORATION, Anderson, Ind.—C, F, A
- CHICAGO MOLDED PRODUCTS CORP., 1020 N. Kolmar Ave., Chicago, Ill.—HO, F, E
- CINCH MANUFACTURING CORP., 2335 W. Van Buren St., Chicago, Ill.—C, F, M, E, D
- CIRCLE F MANUFACTURING CO., 720 Monmouth St., Trenton, N. J.—C, F, M, E, SS
- CLAROSTAT MANUFACTURING CO., INC., 285-287 N. 6th St., Brooklyn, N. Y.—C, F, A
- THE CLOUGH-BREngle CO., 5501 Broadway, Chicago, Ill.—C, F, M, E, D, S, SS, G, AR
- COLE RADIO WORKS, 86 Westville Ave., Caldwell, N. J.—C, F, A
- CONDENSER PRODUCTS CO., 1375 N. Branch St., Chicago, Ill.—C, F, A
- CONSOLIDATED WIRE & ASSOCIATED CORP., 512 S. Peoria St., Chicago, Ill.—C, HO, F, M
- CONTINENTAL CARBON, INC., 13900 Lorain Ave., Cleveland, Ohio—C, F, A
- CONTINENTAL DIAMOND FIBRE CO., Newark, Dela.—C, F, M, E
- CONTINENTAL ELECTRIC CO., Gengva, Ill.—HO, F, D, E, M
- CORNING GLASS WORKS, Corning, N. Y.—C, F, A
- CORNISH WIRE CO., 15 Park Row, New York, N. Y.—C, F, M
- THE GEORGE F. CRAM CO., 730 E. Washington St., Indianapolis, Ind.—C, F, D, M
- CRESCENT TOOL & DIE CO., 4140 Belmont Ave., Chicago, Ill.—C, F, A
- CRUCIBLE STEEL CO. OF AMERICA, 405 Lexington Ave., New York, N. Y.—C, F, E, M
- CRUMPACKER DISTRIB. CORP., 1801 Fannin St., Houston, Tex.—C, F, AR, E, D, S, SS
- CRYSTAL EAR, INC., 2007 S. Michigan Ave., Chicago, Ill.—C, F, A
- DAYCO RADIO CORP., 915 Valley St., Dayton, Ohio—C, F, A
- DAYTON ACME CO., 2339 Gilbert Ave., Cincinnati, Ohio—C, F, A
- TOBE DEUTSCHMANN CORPORATION, Washington St., Canton, Mass.—C, F, M, E
- DeVRY CORPORATION, 1111 Armitage Ave., Chicago, Ill.—HO, F, A
- DeWALD RADIO MFG. CORP., 440 Lafayette St., New York, N. Y.—C, F, D, S
- DIAL LIGHT CO. OF AMERICA, INC., 90 West St., New York, N. Y.—C, F, M, E, D, SS, G, AR
- DOOLITTLE & FALKNER, INC., 7421 Loomis Blvd., Chicago, Ill.—C, F, A
- DRAKE MFG. CO., 1713 W. Hubbard St., Chicago, Ill.—C, F, M, E, D, SS, G, AR
- DREMEL MFG. CO., Racine, Wis.—C, HO, F, M, E, D, S, G, AR
- DRIVER-HARRIS CO., Harrison, N. J.—C, HO, F, M, E
- ALLEN B. DU MONT LABS., INC., Passaic, N. J.—C, HO, F, M
- E. I. DU PONT DE NEMOURS & CO., 626 Schuyler Ave., Arlington, N. J.—C, F, M, E, S, SS, G
- EAGLE ELECTRIC MFG. CO., INC., 57-79 Hall St., Brooklyn, N. Y.—C, F, M, D, DIS
- EASTERN MIKE-STAND CO., 56 Christopher Ave., Brooklyn, N. Y.—C, F, A
- HUGH H. EBY, 4700 Stenton Ave., Phila., Pa.—C, F, M, E
- EICOR, INC., 515 S. Laflin St., Chicago, Ill.—C, F, M, E, D
- EISLER ENGINEERING CO., 750 S. 13th St., Newark, N. J.—C, F, E, D, M
- EITEL-McCULLOUGH, INC., San Bruno, Calif.—C, F, AR, E, M
- ELECTRIC SOLDERING IRON CO., INC., West Elm St., Deep River, Conn.—C, F, A
- ELECTRONICS APPLICATIONS, Brunswick, Me.—HO, F, A
- ELECTRONIC LABORATORIES, INC., 122 W. New York St., Indianapolis, Ind.—C, F, M, E, AR
- ELECTRONIC PRODUCTS CO., St. Charles, Ill.—C, F, M, E, D, S
- ELECTRO PRODUCTS LABS., 549 W. Randolph St., Chicago, Ill.—C, F, M, E, D, S, SS, G, AR
- ELECTRO-VOICE MFG. COMPANY, INC., 1239 South Bend Ave., South Bend, Ind.—C, F, A
- GEORGE D. ELLIS & SONS, INC., 309 N. 3rd St., Phila., Pa.—C, F, M
- ENGINEERING RESEARCH CORP., 909 Giddens-Lane Bldg., Shreveport, La.—C, F, M, A
- ERIE RESISTOR CORP., 644 W. 12th St., Erie, Pa.—C, F, M, E, SS
- ERWOOD SOUND EQUIPMENT CO., 224 W. Huron St., Chicago, Ill.—C, F, A
- ESPÉY MANUFACTURING CO., INC., 305 E. 63rd St., New York, N. Y.—C, F, D, S
- THE ESTERLINE-ANGUS CO., INC., Box 596, Indianapolis, Ind.—C, HO, F, M, E, SS
- EVER-NU PRODUCTS, 919 N. Latrobe Ave., Chicago, Ill.—C, F, D, MUS
- EXECUTONE, INCORPORATED, 415 Lexington Ave., New York, N. Y.—C, HO, F, M, E, D, S, SS, G
- FAHNESTOCK ELECTRIC CO., 46-44 11th St., Long Island City, N. Y.—C, F, A
- FARNSWORTH TELEVISION & RADIO CORP., 3702 East Pontiac St., Fort Wayne, Ind.—C, F, A
- JOHN E. FAST & CO., 3123 N. Pulaski Ave., Chicago, Ill.—C, F, M, E, SS, G
- FEDERAL SALES CO., 24-26 S. Jefferson St., Chicago, Ill.—C, F, M, E, SS
- FEDERAL TELEGRAPH CO., 200 Mt. Pleasant Ave., Newark, N. J.—C, HO, F, M, E
- FINCH TELECOMMUNICATIONS, INC., 1819 B'way, New York, N. Y.—C, F, E, I, M
- FISCHER DISTRIB. CORP., 222 Fulton St., New York, N. Y.—C, F, A
- FISHER RESEARCH LABS., Palo Alto, Calif.—C, F, A
- A. B. FISHWICH RADIO CO., 139 West 4th St., Cincinnati, Ohio—C, F, M, E, D
- M. M. FLERON & SON, INC., 113 N. Broad St., Trenton, N. J.—C, F, D, S
- THE FORMICA INSULATION CO., 4614 Spring Grove Ave., Cincinnati, Ohio—C, F, M, E
- THE FORNSBERG MFG. CO., 125 Seaview Ave., Bridgeport, Conn.—C, F, M, E, D
- FOWLER MANUFACTURING CO., No. 9 Rutgers St., St. Louis, Mo.—C, F, A
- GARDINER METAL CO., 4820 S. Campbell Ave., Chicago, Ill.—C, F, M, E
- GAROD RADIO CORP., 70 Washington St., Brooklyn, N. Y.—C, F, M, D
- GELARDI, INC., 21-29 Washington St., Brooklyn, N. Y.—C, F, M, E, D, S, SS, G, AR
- GENERAL CEMENT MFG. CO., 919 Taylor Ave., Rockford, Ill.—C, F, M, E, D, S, SS, G, AR
- GENERAL CERAMICS CO., Plant No. 3, Keasbey, N. J.—C, F, M, E
- GENERAL COMMUNICATION PRODUCTS CO., 6245 Lexington Ave., Hollywood, Calif.—C, F, E, D, SS
- GENERAL DRY BATTERIES, INC., 13000 Athens Ave., Cleveland, Ohio—C, F, M, E, D, S
- GENERAL ELECTRIC CO., Schenectady, N. Y. & Bridgeport, Conn.—C, F, HO, D, S
- GENERAL INSULATED WIRE CO., 53 Park Place, New York, N. Y.—C, F, M, E
- GENERAL RADIO CO., 30 State St., Cambridge, Mass.—C, HO, F, M, E
- M. A. GERETT CORP., 2947 N. 30th St., Milwaukee, Wis.—C, F, A
- GLOBE PHONE MANUFACTURING CORP., Reading, Mass.—C, F, M, E, D, S, SS, G, AR
- GOLDENTONE RADIO CO., 15123 Warren Ave., Dearborn, Mich.—C, F, D, S, G, AR
- GORDON SPECIALTIES CO., 1104 S. Wabash Ave., Chicago, Ill.—C, F, M, E, D, S, SS, G, AR
- CARL GORR PRINTING CO., 2615 N. Ashland Ave., Chicago, Ill.—C, HO, F, M, E
- GRAY RADIO CO., 730 Okeechobee Rd., W. Palm Beach, Fla.—C, F, A
- GUARDIAN ELECTRIC MFG. CO., 1621-27 W. Walnut St., Chicago, Ill.—C, F, M, E, D, S, G, AR
- ROBERT M. HADLEY CO., 709-11 E. 61st St., Los Angeles, Calif.—C, F, A
- THE HALLDORSON CO., 4500 Ravenswood Ave., Chicago, Ill.—C, HO, F, D, S
- HALLICRAFTERS, 2611 Indiana Ave., Chicago, Ill.—C, F, A
- HAMMARLUND MFG. CO., INC., 424 W. 33rd St., New York, N. Y.—C, F, A
- HAMMOND INSTRUMENT CO., 2915 North Western Ave., Chicago, Ill.—C, HO, F, CON
- HAMMOND MANUFACTURING CO., Guelph, Ontario, Can.—C, F, A
- HARDWICK, HINDLE, INC., 40 Hermon St., Newark, N. J.—C, F, A
- D. H. HARRELL, 1527 East 74th Pl., Chicago, Ill.—C, F, E
- HARRISON RADIO CO., 12 W. Broadway, New York, N. Y.—C, F, M, E, G, AR
- HARVEY-WELLS COMMUNICATIONS, INC., Box 100, Southbridge, Mass.—C, F, A
- HEINEMANN CIRCUIT BREAKER CO., Penna. Ave. & Plum St., Trenton, N. J.—C, F, A
- HEINZ & KAUFMAN, LTD., South San Francisco, Calif.—C, F, A
- HEWLETT-PACKARD CO., 481 Page Mill Rd., Palo Alto, Calif.—C, F, A
- THE HICKOK ELECTRICAL INSTRUMENT CO., 10514 Dupont Ave., Cleveland, Ohio—C, F, A
- HERBERT H. HORN, 1201 S. Olive St., Los Angeles, Calif.—C, F, D
- HOWARD RADIO CO., 1735 Belmont Ave., Chicago, Ill.—C, F, E, D, S, AR
- HYGRADE SYLVANIA CORP., 500 5th Ave., New York, N. Y.—C, 35c; HO, A
- HYTRON CORP., 76 Lafayette St., Salem, Mass.—C, F, A
- HYTRON LABS., 76 Lafayette St., Salem, Mass.—C, F, A
- IDEAL COMMUTATOR DRESSER CO., Sycamore, Ill.—C, F, M, E, D, S
- ILLINOIS CONDENSER CO., 1160 N. Howe Street, Chicago, Ill.—C, F, A
- INDUSTRIAL CONDENSER CORP., 4049 Diversey Ave., Chicago, Ill.—C, F, A
- INDUSTRIAL INSTRUMENTS, INC., 156 Culyver Ave., Jersey City, N. J.—C, F, M, E, D, S, SS, G
- INSTRUMENT RESISTORS, INC., 25 Amity St., Little Falls, N. J.—C, F, M, E
- INSULATION MFG. CORP., 565 W. Washington Blvd., Chicago, Ill.—C, F, M, E, D, S, SS, G
- INSULINE CORP. OF AMERICA, 30-30 Northern Blvd., Long Island City, N. Y.—C, F, A
- INTERNATIONAL RESISTANCE CO., 401 N. Broad St., Phila., Pa. C, F, M, E, D, S, SS, G, AR
- CHARLES JACK MANUFACTURING CORP., 27 E. Philadelphia St., York, Pa.—C, F, A
- THE JACKSON ELECTRICAL INSTRUMENT CO., 129 Wayne Ave., Dayton, O.—C, F, M, E, D, S, SS, G, AR
- JADUR IMPORT CO., 21 W. 19th St., New York, N. Y.—C, F, A
- JANETTE MFG. CO., 556 W. Monroe St., Chicago, Ill.—C, F, A
- JEFFERSON ELECTRIC CO., Bellwood, Ill.—C, F, A
- RAY JEFFERSON, INC., 182 Milburn Ave., Baldwin, N. Y.—C, F, D, S, MS
- JENSEN RADIO MFG. CO., 6601 S. Laramie Ave., Chicago, Ill.—C, F, A
- J. F. D. MANUFACTURING CO., 4111 Ft. Hamilton Parkway, Brooklyn, N. Y.—C, F, A
- E. F. JOHNSON COMPANY, Waseca, Minn.—C, F, A
- HOWARD B. JONES, 2300 Wabansia Ave., Chicago, Ill.—C, F, A
- KAAR ENGINEERING CO., 619 Emerson St., Palo Alto, Calif.—C, F, M, D, S
- KATO ENGINEERING COMPANY, INC., 530 N. Front St., Mankato, Minn.—C, F, A
- KELLOGG SWITCHBOARD & SUPPLY CO., 6650 S. Cicero Ave., Chicago, Ill.—C, F, M
- KENYON TRANSFORMER CO., INC., 840 Barry St., Bronx, N. Y.—C, F, A
- KING LABORATORIES, INC., 205 Oneida St., Syracuse, N. Y.—C, F, M, E
- KRAEUTER & CO., INC., 585 18th Ave., Newark, N. J.—C, F, M, E, D, S
- KURZ-KASCH, INC., 1421 S. Broadway, Dayton, Ohio—C, F, M, E
- LAFAYETTE RADIO CORP., 100 8th Ave., New York, N. Y.—C, F, A
- LAMPKIN LABORATORIES, Bradenton, Fla.—C, F, A
- LAUREHK RADIO MFG. CO., 3918 Monroe Ave., Wayne, Mich.—C, F, M, E, D
- THE LAUSON COMPANY, New Holstein, Wis.—C, F, M, E, D, S
- LEACH RELAY CO., 5915 Avalon Blvd., Los Angeles, Calif.—C, F, A
- LECTROHM, INC., 5133 W. 25th Pl., Cicero, Ill.—C, F, A
- LEFEBURE CORPORATION, 716 Oakland Road, Cedar Rapids, Iowa—C, F, A
- LEOTONE RADIO CO., 63 Day St., New York, N. Y.—C, F, A
- LETERSTONE SALES CO., 2515 S. Wabash Ave., Chicago, Ill.—C, F, D, S
- LIBERTY ENGRAVING & MFG. CO., 2911 S. Central Ave., Los Angeles, Calif.—C, F, A
- THE LIFETIME CORP., 1825 Adams St., Toledo, Ohio—C, F, M, E, D, SS, G, AR
- THE LINCROPHONE CO., INC., 1661 Howard Ave., Utica, N. Y.—C, F, S
- JOHN E. LINGE & SON, INC., 28th St. & Buren Ave., Camden, N. J.—C, F, E
- LITTELFUSE, INCORPORATED, 4757 Ravenswood Ave., Chicago, Ill.—C, F, M, E, S, SS
- LOWELL NEEDLE CO., INC., Putnam, Conn.—C, F, D
- LUMENITE ELECTRIC CO., 407 S. Dearborn St., Chicago, Ill.—C, F, M, E, D, S, SS, G, AR
- M. & H. SPORTING GOODS CO., 512 Market St., Phila., Pa.—C, HO, F, A
- T. R. McELROY, 100 Brookline Ave., Boston, Mass.—C, F, A
- MAAS & WALDSTEIN CO., 438 Riverside Ave., Newark, N. J.—C, F, M, E
- MAGIC ART PAINT CO., Box 23, Hasbrouck Heights, N. J.—C, F, A
- MAJESTIC RADIO & TELEVISION CORP., 2600 W. 50th St., Chicago, Ill.—C, F, A
- P. R. MALLORY & CO., INC., 3029 E. Washington St., Indianapolis, Ind.—C, F, A
- MARINE RADIO CORP., 117-19 168 St., Jamaica, N. Y.—C, F, A
- MEISSNER MANUFACTURING CO., Mt. Carmel, Ill.—C, F, D, S, G, A
- MELLOPHONE CORP., 65 Atlantic Ave., Rochester, N. Y.—C, F, M, E, D, SS
- MICA INSULATOR CO., 200 Varick St., New York, N. Y.—C, F, A
- MICAMOLD RADIO CORP., 1087 Flushing Ave., Brooklyn, N. Y.—C, F, D, S, SS, G, AR
- CHARLES MICHELSON ELECTRICAL TRANSCRIPTIONS, 67 W. 44th St., New York, N. Y.—C, F, A
- MIDWEST RADIO CORP., 909 Broadway, Cincinnati, Ohio—C, F, A
- MILES REPRODUCER CO., INC., 812 B'way, New York, N. Y.—C, F, A
- JAMES MILLEN MFG. CO., INC., 150 Exchange St., Malden, Mass.—C, F, M, E, D, G, AR
- MIMS RADIO CO., P. O. Box 504, Texarkana, Ark.—C, F, M, E, D, AR
- MINOR RECORD CORP., 58 W. 25th St., New York, N. Y.—C, F, M, E, D, S, SS, G, AR
- MONTGOMERY WARD & CO., 619 W. Chicago Ave., Chicago, Ill.—C, F, A
- MUELLER ELECTRIC CO., 1583 E. 31st., Cleveland, Ohio—C, F, A
- MUSIC MASTER MFG. CO., 508 S. Dearborn St., Chicago, Ill.—C, F, D
- MUSICRAFT RECORDS, INC., 10 West 47th St., New York, N. Y.—C, F, A
- NATIONAL CARBON CO., INC., 30 E. 42nd St., New York, N. Y.—C, F, D
- NATIONAL DOBRO CORP., 400 S. Peoria St., Chicago, Ill.—C, F, A
- NATIONAL UNION RADIO CORP., 57 State St., Newark, N. J.—C, HO, F, CB, 10c; A
- NEW ART SPECIALTIES, INC., 816 W. Erie St., Chicago, Ill.—C, F, M, E

When writing to companies listed here please mention that you saw the listing in the Radio-Craft "Classified Radio Directory"

FREE!

RADIO PARTS AND ACCESSORIES

THIS IS YOUR OPPORTUNITY TO SUBSCRIBE TO RADIO-CRAFT'S SISTER PUBLICATION RADIO & TELEVISION AND RECEIVE VALUABLE PREMIUMS!

HERE is some real BIG NEWS for you! Through a fortunate arrangement which we have been able to make, we can now offer you FREE premiums of such extraordinary value that they overshadow anything we have ever offered in the past with subscriptions to RADIO & TELEVISION Magazine. NEVER BEFORE, in the 11 years' history of the magazine, have we offered such worthwhile premiums. All of these radio parts and accessories can be used to good advantage by the "ham" or constructor in his daily experiments.



TELEPHONE JACK

Substantial long frame phone jack, 2-circuit filament control type. opens 2 circuits, closes 3rd when plug is inserted. variety of control purposes in radio and telephone work. 2 3/4" long, 1" high. Ship. weight 4 oz.
Premium No. 1 (3 Pts.) Val. 35c.

PUNCHED CHASSIS



Heavy plated steel chassis with holes punched for 11 tubes, power transformer, speaker plug and tuning dial. Great for large experimental sets, transmitters, etc. Reinforced construction. 13"x7 1/2"x2 1/2". Ship weight 3 lbs.
Premium No. 2 (5 Pts.) Val. 25c.



TWO GANG POTENTIOMETER

Well-made Yaxley 2-gang wire wound potentiometer, 2 units are insulated from each other. One is 5000, the other 15,000 ohms. Used as dual action volume control (antenna and bias in broadcast receiver). Also useful in experimental circuits. Ship. weight 1 lb.
Premium No. 3 (5 Pts.) Val. 25c.

ALLOY CHASSIS



Medium weight alloy metal chassis punched for power transformer and 8 tubes as well as a numerous mounting holes. Easily drilled metal. Open ends. Well made 10 3/8"x6 3/8"x2 1/2". Ship. weight 2 lbs.
Premium No. 4 (5 Pts.) Val. 25c.

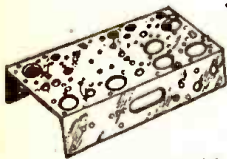

7 TUBE CHASSIS

Alloy metal chassis punched for 7 tubes, condensers, etc. Ideal for building small sets or simple apparatus. Metal is easy to drill. Size 10 1/2"x5 3/8"x2". Ship. wt. 2 lbs.
Premium No. 5 (5 Pts.) Val. 25c.

CONNECTING CABLE & TERMINAL

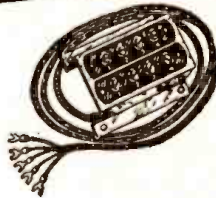

Unusually well made 5 wire cable with spade terminal and terminal block with 8 positions at other end. Wires color coded. Well insulated. May be used for remote control or battery connections, etc. Terminal block 3"x3"x3/4". Ship. weight 1 lb.
Premium No. 6 (6 Pts.) Val. 35c.

LOUDSPEAKER UNIT



Kellogg magnetic loudspeaker unit for use with horn speaker. Has adjustable diaphragm. May be used as pillow speaker or attached to acoustic phonograph. Also useful as sensitive microphone for voice reproduction. Threaded (7/8" diam.) phone for voice reproduction. 1 1/2" deep. Ship. wt. 2 lbs. throat. Size 2 1/2" diam. 1 1/2" deep. Ship. wt. 2 lbs.
Premium No. 7 (10 Pts.) Val. 75c.

These parts are given to you IN ADDITION to the cut-rate subscription prices we list below:

- 7 mos. for \$1 (saving you 75c over the single-copy price)
- 16 mos. for \$2 (saving you \$2 over the single-copy price)
- 24 mos. for \$3 (saving you \$3 over the single-copy price)

And, of course, the longer your subscription runs, the more merchandise you obtain FREE. As we expect a tremendous response to this offer, we would suggest that you send your remittance without delay, as our supply of parts is limited and we won't be able to duplicate this offer again.

IF YOU ARE A RADIO EXPERIMENTER, AMATEUR OR SERVICEMAN, TAKE ADVANTAGE OF THIS MARVELOUS OPPORTUNITY NOW!

A SHORT while ago we were informed that one of the largest surplus houses in the East was ready to sacrifice a huge quantity of radio parts and accessories which cost the original manufacturers thousands of dollars.

We entered into an agreement with this house whereby we suggested to them to allow us to offer these parts to our readers in connection with subscription offers.

The surplus house enthusiastically endorsed our plan. We—the publishers—pay the surplus house cash for each of these parts, and you—the reaper of this fortunate arrangement—will get these valuable radio parts and accessories ABSOLUTELY FREE.

This is positively the first time that we have been enabled to make such an unprecedented offer which in many ways sounds too good to be true. Nevertheless, we vouch for it in every way and we know you will not be disappointed.

This special arrangement enables us to offer you this valuable merchandise FREE with your subscription to RADIO & TELEVISION magazine, at a price which is already a tremendous saving over the newsstand cost.

This is how the plan works:—Next to the premium number of each item, we show its point value.

- For each 7 months' subscription (\$1.00) you receive 15 points' worth of merchandise free.
- For each 16 months' subscription (\$2.00) you receive 30 points' worth of merchandise free.
- For each 24 months' subscription (\$3.00) you receive 45 points' worth of merchandise free.

For instance, if you send us a seven months' subscription at \$1.00, you are entitled to 15 points' worth of free merchandise. You may order one No. 4 (5 points) and one No. 7 (10 points). Or if you wish, one each of numbers 2, 3 and 4 (each 5 points), or any other combination which totals 15 points.

Similarly, if you send us a 16 months' subscription (\$2.00) you may order any combination of merchandise which totals 30 points. On a 24 months' subscription (\$3.00), any combination totalling 45 points.

Due to the high cost of the merchandise, we cannot ship the articles

prepaid, therefore we show the weight of each piece, packed. If you wish your free parts sent by parcel post, please add to your remittance a sufficient amount to cover postage. Or, if you would rather have us send the parcel express charges collect, we will be glad to do so.

Please remember that we do not sell these articles. You cannot buy them from us at any price.

In order to make sure that you receive your parts promptly, ORDER TODAY. Fill out the coupon, clip and mail to us together with the proper remittance.

ALL RADIO PARTS ARE NEW AND UNUSED
Many are in their Original Packing

IMPORTANT TO PRESENT SUBSCRIBERS

If you are already a subscriber or have recently subscribed to the magazine, this offer still holds good for you, too. We merely will lengthen your subscription for either 7 months, 16 months or 24 months, as the case may be. There is a place on the coupon which provides for this.

RADIO & TELEVISION, 20 Vesey Street, New York, N. Y. RC-341

Please enter my subscription to RADIO & TELEVISION for

- 7 months—\$1.00. Plus 15 points' worth of FREE radio parts.
- 16 months—\$2.00. Plus 30 points' worth of FREE radio parts.
- 24 months—\$3.00. Plus 45 points' worth of FREE radio parts.

Canadian and foreign countries add 32 cents for \$1.00 subscription; 72 cents for \$2.00 subscription; \$1.08 for \$3.00 subscription.

- I enclose my remittance for \$....., which includes parcel post charges on the FREE parts I am ordering.
 - Please send the merchandise to me express charges collect.
 - I am a new subscriber. Extend my present subscription for months.
- I am circling the numbers of the parts I wish to have you send me Free.
Nos. 1 2 3 4 5 6 7

Name Address

City State

(Send remittance in form of check or money order. If you send cash or unused U. S. postage stamps, be sure to register four letter.)

DON'T MISS THIS OPPORTUNITY! WE ASSURE YOU THAT YOU WON'T BE DISAPPOINTED. ORDER TODAY! SIMPLY FILL OUT THE COUPON. PROMPT SHIPMENT ASSURED!

RADIO & TELEVISION
20 VESEY STREET
NEW YORK, N. Y.

• CLASSIFIED RADIO DIRECTORY •

NOBLITT-SPARKS INDUSTRIES, INC., Columbus, Ind.—C, F, M, E, D, S
 OAK MANUFACTURING CO., 1260 Clybourn Ave., Chicago, Ill.—C, F, M, E
 OHMITE MANUFACTURING CO., 4835 W. Flournoy St., Chicago, Ill.—C, HO, F, A
 OLSON MANUFACTURING CO., 362 Wooster Ave., Akron, Ohio—C, F, A
 D. W. ONANS & SONS, 43 Royalston Ave., Minneapolis, Minn.—C, F, A
 OPERADIO MFG. CO., St. Charles, Ill.—C, F, M, E, D, S, SS
 OXFORD-TARTAK RADIO CORP., 915 W. Van Buren St., Chicago, Ill.—C, F, S, SS, G, AR
 PACENT ENGINEERING CORP., 79 Madison Ave., New York, N. Y.—C, F, A
 PARAPHONE HEARING AID, INC., 4300 Euclid Ave., Cleveland, Ohio—C, F, D, S
 PAR-METAL PRODUCTS CORP., 32-62 49th St., Long Island City, N. Y.—C, F, M, E, D, S, SS, G, AR
 PAUL & BECKMAN, 4250 Wissahickon Ave., Phila., Pa.—C, F, M
 PEERLESS ALBUM CO., INC., 38 W. 21st St., New York, N. Y.—C, F, M, D, S
 PERMO PRODUCTS CORP., 6415 Ravenswood Ave., Chicago, Ill.—C, F, A
 PETERSEN RADIO CO., 205 N. 17th St., Council Bluffs, Iowa—C, F, A
 PHILMORE MANUFACTURING CO., 113 University Pl., New York, N. Y.—C, F, M, E, D, S, SS, G, AR
 PHONOTONE LABORATORIES, INC., S. E. 15th St., Washington, Ind.—C, HO, F, A
 PHOTOBELL CORPORATION, 123 Liberty St., N. Y.—C, F, M, E, D, S, G, AR
 PIERSON-DELANE, INC., 2345-47 W. Washington Blvd., Los Angeles, Calif.—C, F, AR, E
 PILOT RADIO CORP., 37-06 36th St., Long Island City, N. Y.—C, F, A
 PIONEER GEN-E-MOTOR CORP., 466 W. Superior St., Chicago, Ill.—C, F, A
 PIONEER SPECIALTY CO., 5100 St. Jean Ave., Detroit, Mich.—C, F, D, S
 PITTMAN ELECTRICAL DEVELOPMENTS CO., 127 Nippon St., Phila., Pa.—C, F, M, E, D, G, AR
 POINSETTIA, INC., Pitman, N. J.—C, F, A
 PRECISION APPARATUS CO., 647 Kent Ave., Brooklyn, N. Y.—C, F, A
 PRECISION CRYSTAL LABS., Springfield Airport, Springfield, Mass.—C, F, A
 PRECISION PEZO SERVICE, 427 Asia St., Baton Rouge, La.—C, F, A
 PREMAX PRODUCTS, Niagara Falls, N. Y.—C, F, M, E, D, S, SS, G, AR
 PREMIER CRYSTAL LABS., INC., 53 Park Row, New York, N. Y.—C, F, A
 PRESTO RECORDING CORP., 242 W. 55th St., New York, N. Y.—C, F, M, E, D, S, SS
 QUAM-NICHOLS COMPANY, 33rd Pl. & Cottage Grove Ave., Chicago, Ill.—C, F, A
 RACON ELECTRIC CO., INC., 52 E. 19th St., New York, N. Y.—C, F, A
 RADEX CORP., 1733 Milwaukee Ave., Chicago, Ill.—C, F, A
 RADIO DESIGN CO., 1353 Sterling Pl., Brooklyn, N. Y.—C, F, A
 RADIO ELECTRIC SERVICE CO., INC., N. W. Cor. 7th & Arch St., Phila., Pa.—C, F, A
 RADIO ENGINEERING LABS., INC., 35-54 36 St., Long Island City, New York, N. Y.—C, F, E
 RADIO MFG. ENGINEERING, INC., 111 Harrison St., Peoria, Ill.—C, F, A
 RADIO NAVIGATIONAL INSTRUMENT CORP., 500 5th Ave., New York, N. Y.—C, F, CON
 THE RADIOTECHNIC LABORATORY, 132B Sherman Ave., Evanston, Ill.—C, F, A
 RADIOTONE, INC., 7356 Melrose Ave., Hollywood, Calif.—C, F, A
 RADIO TRANSCEIVER LABS., 8627 115th St., Richmond Hill, N. Y.—C, F, A
 RADOLEK COMPANY, 601 W. Randolph St., Chicago, Ill.—C, F, A
 RAY-O-VAC COMPANY, No. 2317 Winnebago St., Madison, Wis.—C, F, S
 RCA MANUFACTURING CO., INC., Camden, N. J.—C, F, A
 READRITE METER WORKS, Bluffton, O.—C, F, A
 RECOTON CORP., 178 Prince St., New York, N. Y.—C, F, A
 REGAL AMPLIFIER MFG. CORP., 14 W. 17 St., New York, N. Y.—C, F, D, E, S, SS
 REMLER COMPANY LTD., 2101 Bryant St., San Francisco, Calif.—C, F, E, D
 REX RHEOSTAT CO., 37 W. 20th St., New York, N. Y.—C, F, A
 JOHN F. RIDER PUBLISHER, INC., 404 4th Ave., New York, N. Y.—C, HO, F, A
 THE RIVERSIDE METAL CO., Pavilion Ave., Riverside, N. J.—C, F, M, E
 ALBERT F. ROSS & CO., 2341 Wolfram St., Chicago, Ill.—C, F, M, D, S
 ROTOPHONE CORPORATION, 26 Journal Sq., Jersey City, N. J.—C, F, A
 ROWE INDUSTRIES, INC., 3120 Monroe St., Toledo, Ohio—C, F, D, E, S, SS
 WALTER L. SCHOTT CO., 5264 1/2 W. Pico Blvd., Los Angeles, Calif.—C, F, A
 MAURICE SCHWARTZ & SON, 710-712 Broadway, Schenectady, N. Y.—C, F, S, SS, G, AR
 E. H. SCOTT RADIO LABS., INC., 4450 Ravenswood Ave., Chicago, Ill.—C, HO, F, A
 SEATTLE RADIO SUPPLY CO., INC., 2117 2nd Ave., Seattle, Wash.—C, F, A
 SELECTAR MFG. CORP., 30 W. 15th St., New York, N. Y.—C, F, A
 SELF-VULCANIZING RUBBER CO., INC., 605 W. Washington Blvd., Chicago, Ill.—C, F, A

SENTINEL RADIO CORP., 2020 Ridge Ave., Evanston, Ill.—HO, F, D, S
 SHAKEPROOF LOCK WASHER CO., 2501 N. Keeler Ave., Chicago, Ill.—C, F, M, E
 SHALLCROSS MFG. CO., 10 Jackson Ave., Collingdale, Pa.—C, F, A
 H. B. SHERMAN MFG. CO., 22 Barney St., Battle Creek, Mich.—D, F, D, E, S
 SHURE BROTHERS, 225 W. Huron St., Chicago, Ill.—C, F, A

STANLEY TOOLS, New Britain, Conn.—C, F, M, E, D, S, AR
 STARK ELECTRICAL INSTRUMENT CO., 161A King St. W., Toronto, Ont., Can.—C, F, M, E, D, S, SS, G, AR
 THE STATES CO., 19 New Park Ave., Hartford, Conn.—C, F, M, E, D, S, G
 STEVENS WALDEN, INCORPORATED, 475 Shrewsbury St., Worcester, Mass.—C, F, A
 F. W. STEWART MFG. CORP., 340 W. Huron St., Chicago, Ill.—C, F, M, E, D
 STEWART STAMPING CORP., 621 E. 216th St., New York, N. Y.—C, F, E, M, S, SS
 STRUTHERS DUNN, INC., 1315 Cherry St., Phila., Pa.—C, F, A
 STUPAKOFF LABORATORIES, INC., 6627 Hamilton Ave., Pittsburgh, Pa.—C, F, M
 SUNDT ENGINEERING CO., 4656 Ravenswood Ave., Chicago, Ill.—C, F, D, S, SS
 SUN RADIO CO., 212 Fulton St., New York, N. Y.—C, F, A
 SUPERIOR INSTRUMENTS CO., 136 Liberty St., New York, N. Y.—C, F, AR, D, E, G, S, SS
 SUPREME INSTRUMENTS CORP., Howard St., Greenwood, Miss.—C, F, A
 TALK-A-PHONE MFG. CO., 1219 W. Van Buren St., Chicago, Ill.—C, F, D, J, S, SS
 TAY BERN EQUIPMENT CORP., 135 Liberty St., New York, N. Y.—C, F, A (special literature available to Police & Gov't Depts.)
 TAYLOR TUBES, INC., 2341 Wabansia Ave., Chicago, Ill.—F (at their distributors), 5c (from company direct); C, M, E, AR
 TELEVISION PRODUCTS, INC., 1135 N. Cicero Ave., Chicago, Ill.—C, F, M, E, D, S, SS, G
 TELEX PRODUCTS CO., Minneapolis, Minn.—C, F, M, E
 THORDARSON ELECTRIC MFG. CO., 500 W. Huron St., Chicago, Ill.—C, F, A
 TONK MFG. CO., 1912 N. Magnolia Ave., Chicago, Ill.—C, F, D
 THE TORK CLOCK CO., INC., 1 Grove St., Mt. Vernon, N. Y.—C, F, M, E, D, S
 TRANSFORMER CORPORATION OF AMERICA, 69 Wooster St., New York, N. Y.—C, F, M, E, D, S, SS, G
 TRANSMARINE RADIO, INC., 1184 Broadway, Hewlett, L. I., N. Y.—C, F, E, D, S
 TRAV-LER RADIO & TELEVISION CORP., 1036 Van Buren, Chicago, Ill.—C, F, D
 TRICO FUSE MFG. CO., 2948 N. 5th St., Milwaukee, Wis.—C, F, D, E, M, S
 THE TRIPLET ELECTRICAL INSTRUMENT CO., 286 Harmon Rd., Bluffton, Ohio—C, HO, F, M, E, D, S, SS, G, AR
 TROY RADIO & TELEVISION CO., 1144 S. Olive St., Los Angeles, Calif.—C, F, D
 THE TURNER CO., 909-17 Ave., Cedar Rapids, Iowa—C, F, M, E, D, S, SS, G, AR
 UNION STEEL CHEST CORP., 54 Church St., Le Roy, New York—C, F, M, D
 UNITED CINEPHONE CORP., Torrington, Conn.—C, F, A
 UNITED ELECTRONICS CO., 42 Spring St., Newark, N. J.—C, F, M, E
 UNITED SCIENTIFIC LAB., INC., 440 Lafayette St., New York, N. Y.—C, F, D, S
 UNITED STATES TELEVISION MFG. CORP., 220 E. 51st St., New York, N. Y.—C, F, D
 UNITED TELEPHONE CORP., 150 Varick St., New York, N. Y.—C, F, A
 UNITED TRANSFORMER CORP., 150 Varick St., New York, N. Y.—C, F, M, E, D, S, SS, G, AR
 UNIVERSITY LABORATORIES, 195 Chrystie St., New York, N. Y.—C, F, M, E, D, S, SS
 UTAH RADIO PRODUCTS CO., 812 Orleans St., Chicago, Ill.—C, F, M, E, D, S, SS, AR, J
 VAC-O-GRIP CO., 2023 Detroit Ave., Toledo, O.—C, F, A
 THE VALPEY CRYSTALS, Box 321, Holliston, Mass.—C, F, AR, D, E, G, M, SM, SS
 THE VEGA CO., 155 Columbus Ave., Boston, Mass.—C, F, A
 VERTI-FLEX ILLINOIS SEATING CORP., 2138 N. Racine Ave., Chicago, Ill.—C, F, D, S, SS, AR
 JAMES VIBRAPOW CO., INC., 341 N. Crawford Ave., Chicago, Ill.—C, F, A
 THE VIBROPLEX CO., INC., 832 B'way., New York, N. Y.—C, F, D, A
 VIVI TONE CO., 6321 Gratiot St., Detroit, Mich.—C, F, D
 WARD LEONARD ELECTRIC CO., 31 S. St., Mount Vernon, N. Y.—C, F, A
 WARD PRODUCTS CORP., 1523 E. 45 St., Cleveland, Ohio—C, F, M, E, D, S, AR
 WARWICK MFG. CORP., 1700 W. Washington Blvd., Chicago, Ill.—C, F, D, S
 WEBER MACHINE CORP., 59 Rutter St., Rochester, N. Y.—C, F, M, SS
 THE WEBSTER CO., 5622 W. Bloomingdale Ave., Chicago, Ill.—C, F, A
 WEBSTER ELECTRIC COMPANY, Racine, Wis.—C, F, A
 WESTERN SOUND & ELECTRIC LABORATORIES, INC., 311 W. Kilbourn Ave., Milwaukee, Wis.—C, F, A
 WESTON ELECTRICAL INSTRUMENT CORP., Newark, N. J.—C, HO, F, A
 WINCHARGER CORPORATION, Sioux City, Iowa—C, F, A
 WIRT COMPANY, 5221-27 Greene St., Phila., Pa.—C, F, M, E, D, S, SS, G, AR
 X-L RADIO LABORATORIES, 420 W. Chicago Ave., Chicago, Ill.—C, HO, F, A
 ZIERICK MFG. CORP., 385 Gerard Ave., New York, N. Y.—C, F, M, E, D, S, SS

Preceding Listings in RADIO-CRAFT'S CLASSIFIED RADIO DIRECTORY

Sec. I, Oct. '40:
 Antennas & Accessories
 Automatic Tuners & Parts
 Auto-Radio Controls
 Battery Chargers, Eliminators & Rectifiers
 Batteries, Dry & Wet
 Cabinets
 Coils & Transformers (R.F. & I.F.), & Accessories

Sec. II, Nov. '40:
 Condensers (Variable)
 Crystals (Quartz)
 Dials & Parts
 Electric Fence Controllers
 Electric-Generating Machines
 Electronics
 Electronic Musical Instruments & Parts
 Frequency Modulation Equipment
 Hardware—Connectors & Misc. Parts
 Headphones
 Hearing-Aids
 Hearing-Aid Parts
 Insulation
 Intercommunicating Systems
 Line Filters

Sec. III, Dec. '40:
 Magnets
 Metal & Special Fittings (for Radio)
 Metal, Ore & Oil Locators
 Microphones
 Noise Elimination Equipment
 Paint, Cement & Wax Products
 Plastics
 Plastic Molders
 Radio Logs, Maps & Globes
 Receiving Sets (including Adapters & Converters)
 Records & Record-Playing Equipment

Sec. IV, Jan. '41:
 Recording Equipment
 Resistors & Volume Controls (Attenuators & Networks)
 Schools
 Service Manuals, Books & Magazines
 Servicing Equipment
 Sound Systems, Amplifiers & Accessories

Sec. V, Feb. '41:
 Speakers (& Parts)
 Switches & Relays
 Television
 Test Equipment—Laboratory & Production
 Tools
 Transformers & Chokes
 Transmitters (& Equipment)

The above back-issues of *Radio-Craft* are available at the regular price of 25c per copy.

Next month: Section I of the Classified Radio Directory, revised, with new classifications, and new names and addresses added; and with obsolete listings removed. Reserve your copy, today, from your regular newsdealer.

MARK SIMPSON DISTRIBUTOR, INC., 16 Hudson St., New York, N. Y.—C, F, J
 SIMPSON ELECTRIC CO., 5216-18 W. Kintzie St., Chicago, Ill.—C, F, M, E, D, S, SS, G, AR
 SNYDER, INCORPORATED, Noble and Darien St., Phila., Pa.—C, F, D, S
 SOLA ELECTRIC CO., 2525 Clybourn Ave., Chicago, Ill.—C, F, M, E, D, S, SS, G, AR
 SOLAR MFG. CORP., Avenue A & 25th St., Bayonne, N. J.—C, F, A
 S. O. S. CINEMA SUPPLY CORP., 636 11th Ave., New York, N. Y.—C, F, M, E, D, S, SS
 SOUND APPARATUS CO., 150 W. 46th St., New York, N. Y.—C, HO, F, M, E, D, S, SS
 SPEAK-O-PHONE RECORDING & EQUIPMENT CO., 23 W. 60th St., New York, N. Y.—C, F, A
 SPEEDWAY MFG. CO., 1834 S. 52nd Ave., Cicero, Ill.—C, F, A
 SPENCER THERMOSTAT CO., 34 Forest St., Attleboro, Mass.—C, F, M
 SPRAGUE PRODUCTS CO., North Adams, Mass.—C, F, A
 STANDARD ELECTRICAL PRODUCTS CO., 317 Sibley St., St. Paul, Minn.—C, F, A
 STANDARD PIEZO CO., Cedar and Louthier Sts., Carlisle, Pa.—C, F, E, M
 STANDARD TRANSFORMER CORP., 1500 N. Halstead St., Chicago, Ill.—C, F, A

When writing to companies listed here please mention that you saw the listing in the Radio-Craft "Classified Radio Directory"

SMALL INDUCTION-TYPE A.C. MOTOR REPAIRS

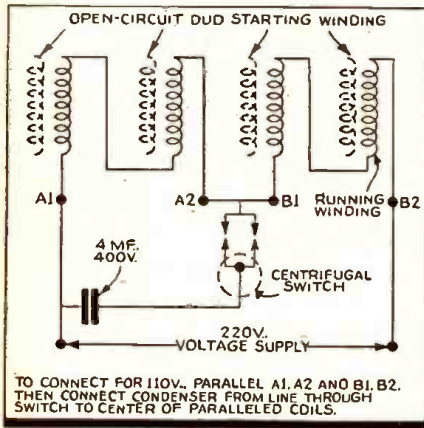

● RADIO Servicemen frequently have occasion to repair washing machine, refrigerator and small bench machine motors. The majority of these motors are of the induction type using a separate starting winding of a finer gauge wire than the main or running winding. About 80% of the failures of these motors are due to the starting winding burning out because of the centrifugal switch sticking. To rewind this winding takes time; too, there is always the danger of damaging the main winding during repair, resulting in a complete rewind. However, by connecting a condenser of from 2 mf. to 4 mf. capacity, and of the rated voltage of the motor; and also disconnecting the faulty starting winding from switch, the motor will now start as good as new, i.e., converting motor into a "capacitor" type. I have used 4-mf., radio-type condensers on several ¼-horsepower motors with successful results, saving time.

The exact type and size of condenser for any size motor may be calculated from the following formula:

$$(A) Z = \frac{E}{I} \text{ where}$$

Z=impedance of motor
V=line voltage
I=motor current in amps.

$$(B) C = \frac{1}{2\pi f Z}$$

where

C=Capacity in farads of required condenser.

$2\pi f = 6.28 \times$ frequency of line.

Z=from above formula (A).

R and X_L of motor may be neglected. Above, for a ¼-h.p. motor, works out to approx. 5 mf. but in practice even a 3-mf. condenser gives sufficient field phase displacement to start the motor.

WANDSWORTH,
Kotze Road,
Mowbray, Cape Town, South Africa

ELECTRIC BENCH FLASHLIGHT

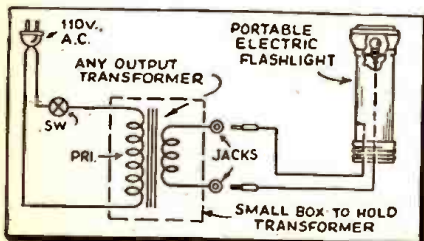

● IN order to save on flashlight batteries, I devised the power supply arrangement

here illustrated, for bench use.

An output transformer will frequently serve in this arrangement. The transformer may be enclosed in its own box, as a safety measure, as illustrated.

A. MARINO,
Staten Island, N. Y.

REPAIRING SPIDERS

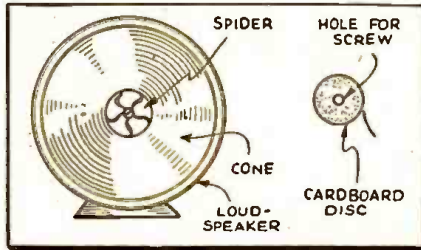

● WHEN the spider on dynamic loudspeakers which have the spider located in the center of the voice coil becomes weak, it may be strengthened in the manner here illustrated.

Cut a thin pasteboard disc with the same diameter as the spider. Coat the spider and one side of the disc with household cement. Place the two together and allow them to dry for at least an hour. When thoroughly dry, center the voice coil and the speaker is ready to use. The pasteboard disc serves also as a dust cap.

ROBERT ROBINSON,
Silver City, New Mexico

HANDY ANVIL

● HERE is an idea simple enough in its conception, yet an extremely useful substitute for a bench anvil, the idea for which

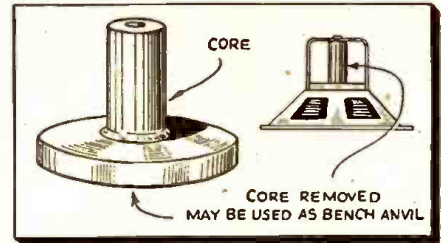

might not occur to some radio experimenters. I made my "anvil" from an RCA electrodynamic loudspeaker. I find it useful for clinching rivets by putting a rod in the center hole in the top. Of course not all speakers are constructed in exactly the same way.

WALTER C. MUELLER,
Chicago, Ill.

INTERFERENCE ELIMINATION HINT

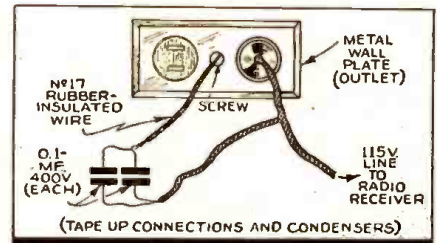

● NEXT time you fail to obtain satisfactory reception, try a pair of 0.1-mf. condensers across the line, as shown in the sketch. In a 15-story apartment house, with elevator and other noise, a Strömberg-Carlson table model played very well on a short

RADOLEK'S NEW 1941

FREE!

"RADIO PROFIT GUIDE"

Brings You Hundreds of BARGAINS Like This One!



GET THIS BIG FREE BOOK OF EVERYTHING NEW IN RADIO AT Bargain Prices!



Shows hundreds and hundreds of up-to-the-minute radio parts, sets, accessories, ham gear, electric appliances and supplies. Indispensable to every amateur, experimenter, set builder, sound engineer and serviceman. Keep up with radio and all its phases — send for the big FREE Radolek Profit Guide now! **DON'T WAIT—SAVE MONEY. AT RADOLEK. Address Dept. C-52.**

Special Value!

Professional Type HOME RECORDING DISCS (Heavy Metal Core—Non Flammable)

10" only 19c each

Made by foremost manufacturer. Proven equal or superior to any discs of this type regardless of cost. These blanks have very slight imperfections but guaranteed to make perfect recordings or your money back. Coated on both sides. Big savings! 6" Discs—10c; 8"—14c; 10"—19c; 1c less in 25 lots.

Send no money—shipped C.O.D. plus postage.

RADOLEK COMPANY

601 West Randolph Street
Chicago, Illinois

Order Today!

GEOPHYSICAL PROSPECTING OUTFITS



BLUE PRINTS and INSTRUCTIONS

For Building the Following Treasure Finders and Prospecting Outfits

- Folder No. 1. The "Radiolector Pilot"—consists of a 2-tube transmitter and 3-tube receiver. Principle: radiated Wave from transmitter loop is reflected back to receiver loop. Emits visual and aural signals. Tubes used: two 1A5G—two 1N5G—one 1H5G.
- Folder No. 2. The "Harmonic Frequency Locator"—Transmitter radiates low frequency wave to receiver, tuned to one of Harmonics of transmitter. Using regenerative circuit. Emits aural signals. Tubes used: one 1G6G—one 1N5G.
- Folder No. 3. The "Beat-Note Indicator"—Two oscillators so adjusted as to produce beat-note. Emits visual and aural signals. Tubes used: Three type '30.
- Folder No. 4. The "Radio-Balance Surveyor"—a modulated transmitter and very sensitive loop receiver. Principle: Balanced loop. Emits visual and aural signals. By triangulation depth of objects in ground can be established. Tubes used: Seven type '30.
- Folder No. 5. The "Variable Inductance Monitor"—a single tube oscillator generating fixed modulated signals and receiver employing two stages R.F. amplification. Works on the inductance principle. Emits aural signals. Tubes used: six type '30.
- Folder No. 6. The "Hughes Inductance-Balance Explorer"—a single tube Hartley oscillator transmitter and sensitive 3-tube receiver. Principle: Wheatstone bridge. Emits aural signals. Tubes used: two type '30—one type '32—one type '33.
- Folder No. 7. The "Radiodyne Prospector"—a completely shielded instrument. Principle: Balanced loop. Transmitter, receiver and batteries enclosed in steel box. Very large field of radiation and depth of penetration. Emits aural signals. Tubes used: two 1N5G—one 1G4G—one 1H5G—one 1Q5—one 1G4.

With any one of the modern geophysical methods described in the Blue-Print patterns. Radio outfits and instruments can be constructed to locate metal and ore deposits (prospecting); finding lost or buried treasures; metal war relics; sea and land mines and "duds"; mineral deposits; subterranean water veins; oil deposits (under certain circumstances); buried gas and water pipes; tools or other metallic objects sunken in water, etc., etc.

Each set of blueprints and instructions enclosed in heavy envelope (9 1/2" x 12 1/2"). Blueprints 22" x 34"; eight-page illustrated 8 1/2" x 11" fold. 50¢ of instructions and construction data. Add 5¢ for postage

The complete set of seven folders..... \$3.00
Shipping weight 2 lbs. (add 25¢ for shipping anywhere in U.S.A.)

TECHNIFAX

1917 S. STATE ST. CHICAGO, ILL.

TECHNIFAX 1917 So. State, Chicago, Ill.

Enclosed herewith \$..... for which mail to address below:

Treasure Finder No. 1, 2, 3, 4, 5, 6, 7.
Complete set of seven folders.

NAME

ADDRESS

CITY STATE
RC-341

antenna and ground connection. Without the filter there was a terrific racket. In a case in suburban territory, shortwave reception in the presence of a trolley, as well as apartment house elevator interference, was practically impossible.

In a second case the filter not only cleared reception but also raised the apparent signal strength of the overseas broadcaster. In still another instance, where a vibrator-type inverter was used for supplying power from D.C. to an A.C. phonograph-radio, the filter cut out the vibrator interference on Radio. The writer is convinced this kink will pay dividends, and it is obviously cheaper than a regular line filter. Only precaution is this: use plenty of tape for good insulation.

The condensers, in series, are shunted across the power line; the junction of the 2 condensers is connected to ground (the wall-plate).

WILLARD MOODY,
New York, N. Y.

BOOK REVIEWS

STUDY GUIDE AND REFERENCE MATERIAL FOR COMMERCIAL RADIO OPERATOR EXAMINATIONS (1939). Published by U. S. Government Printing Office. Size 5 1/4 x 9 ins. Flexible paper cover, 96 pages. Price 15¢.

Technicians who wish to learn the telegraphic code as revised last year in accordance with the Cairo Conference, should obtain a copy of "Study Guide."

This book contains questions which are representative of the scope of questions contained in the various elements of the Commercial Radio Operator's License Examination—by the Federal Communications Commission.

This book is divided into chapters as follows:

- Element I—Questions on Basic Law; Element II—Basic Theory and Practice; Element III—Radiotelephone; Element IV—Advanced Radiotelephone; Element V—Radiotelegraph; Element VI—Advanced Radiotelegraph.

ELEMENTS OF ACOUSTICAL ENGINEERING, by H. F. Olson (1940). Published by D. Van Nostrand Company, Inc. Size 6 x 9 ins., cloth cover, 430 pgs. Price, \$6.00.

The sound field at last has a book all its own. In "Elements" the Director of Acoustical Research of RCA, and lecturer in Electrical Engineering in Columbia University, has drawn upon his wide experience to prepare an exceptionally useful treatment of acoustical principles and their applications—which extend throughout nearly all fields of engineering. Complete working methods are given in this well-illustrated book.

The range embraces Radio Broadcasting, Radio Reception, Public Address, and Sound Motion Pictures. This book offers extensive treatment of the following topics: Sound Waves; Acoustical Radiating Systems; Mechanical Vibrating Systems; Electrical, Mechanical and Acoustical Analogies; Acoustical Elements; Driving Systems; Direct Radiator Loudspeakers; Horn Loudspeakers; Microphones; Miscellaneous Transducers; Measurements; Architectural Acoustics, and the Collection and Dispersion of Sound, Speech, Music and Hearing.

INTRODUCTION TO POLARIZED LIGHT AND ITS APPLICATION. (1940). Published by Polaroid Corporation, Cambridge, Mass., size 5 1/2 x 8 1/2 ins., paper cover, illustrated, 46 pgs. Price, 50¢.

Experimenters, and more particularly, electronic specialists, will be interested in this new book which discusses polarized light from first principles to its practical application through the medium of Polaroid.

Polarized light finds its application in radio as an important element in, for instance, certain types of television operation. For experimenters in this field, therefore, the page "Reference on Polarized Light" will be especially welcome.

Index to advertisers

PUBLIC ADDRESS EQUIPMENT

Amplifier Co. of America.....	566
General Industries Co.....	556
Jensen Radio Mfg. Co.....	554
John Meek Industries.....	556
Miles Reproducer Co.....	556
Music Master Mfg. Co.....	549
Regal Amplifier Mfg. Corp.....	549
Universal Microphone Co. Ltd.....	549
University Laboratories.....	549

PUBLISHERS

Data Print Co.....	567
Miller, Wayne.....	515
National Plans Inst.....	564
Radecraft Publications, Inc.....	518, 565, 570
Radio & Technical Pub. Co.....	515
Radio & Television.....	573
Radio Publications.....	566
Supreme Publications.....	554, 565
Technifax.....	536, 576

RADIO PARTS

Amperite Co.....	529
Dumont Electric Co., Inc.....	560
Hammarlund Mfg. Co.....	560
International Resistance Co.....	527
Meissner Mfg. Company.....	517
National Union Radio Corp.....	Back Cover
Ohmite Mfg. Company.....	550
Solar Mfg. Corp.....	542
Sprague Products Company.....	533

RADIO SETS

Goldentone Radio Co.....	556
Henry Radio Shop.....	543
Midwest Radio Corp.....	529

RADIO SUPPLY HOUSES

Adson Radio.....	536
Allied Radio Corp.....	563
Burstein-Applebee Co.....	560
Lafayette Radio Corp.....	533
Radolek Co.....	575
Sears, Roebuck & Company.....	545
Montgomery Ward & Co.....	551

SCHOOLS

Capitol Radio Eng. Inst.....	515
Coyne Radio School.....	516
Lincoln Engineering School.....	515
National Radio Institute.....	513
National Schools.....	516
New York Y.M.C.A. Schools.....	516
Radio Training Assoc.....	516
RCA Institutes.....	516
Sprayberry Academy of Radio.....	Inside Back Cover

TEST EQUIPMENT

Radio City Products Co.....	536
RCA Manufacturing Co., Inc.....	Inside Front Cover
Readrite Meter Works.....	560
Superior Instruments Corp.....	539, 542
Supreme Instruments Corp.....	529
Triplett Electrical Instrument Co.....	534

TUBES

Hygrade Sylvania Corp.....	532
----------------------------	-----

MISCELLANEOUS

Atlas Press Co.....	562
Classified Section.....	562
Flight Magazine.....	542
Kato Engineering Co., Inc.....	536
Lancaster, Allwine & Rommel.....	516
Premium Distributing Service.....	564
Radio Servicemen of America, Inc.....	568
Walter L. Schott Co.....	542
Woodstock Typewriter Co.....	562

(While every precaution is taken to insure accuracy, we cannot guarantee against the possibility of an occasional change or omission in the preparation of this index.)

FULL EQUIPMENT

Included WITH SPRAYBERRY RADIO TRAINING!

Experience Easily Acquired at Home!

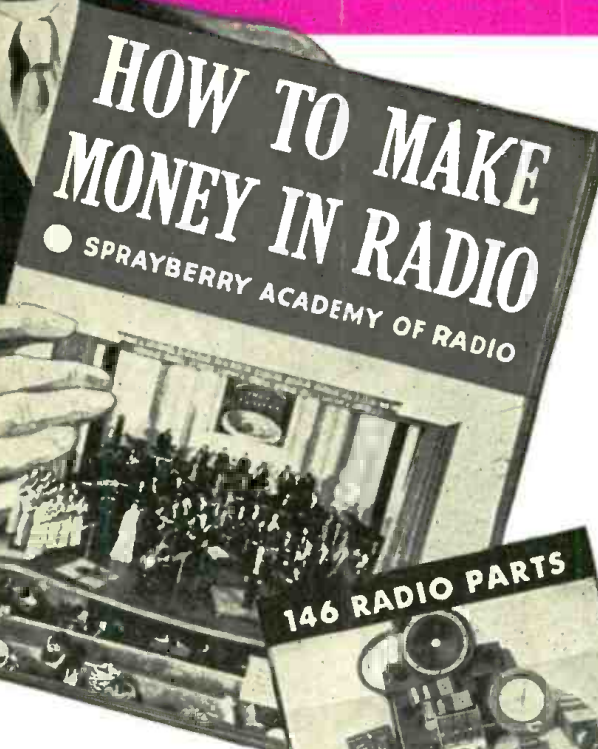

OVER 100 EXPERIMENTS

plus Many Other Special Features

ALL DESIGNED TO HELP YOU MAKE FAST PROGRESS!

SPRAYBERRY Training starts right at the beginning of Radio . . . unfolds each subject in a simplified, logical, understandable style. You easily learn Television, Frequency Modulation, Signal Tracing, Mobile Radio (Auto-Tank), Aviation Radio, Electronics, Facsimile Radio, Radio Set Repair and Installation Work. You learn quickly in your spare hours . . . AT HOME OR AT CAMP.

Training Prepares You for a Business of Your Own . . . Or Good Radio Jobs at Excellent Pay!

The great, fascinating and progressive field of Radio and Television offers many opportunities to the man who wants to get ahead. There is good money to be made. My Training is designed to give you quick access to these opportunities. SPRAYBERRY Methods are thorough and practical. Your Training will not interfere with your present work.

You Get Professional Test Equipment plus Experimental Outfits!

. . . Includes 146 RADIO PARTS for building a complete Receiver, RADIO TOOLS and a modern TESTER-ANALYZER. You also receive 8 BIG SHIPMENTS OF RADIO EQUIPMENT for conducting actual experiments with your own hands. I show you how to create Radio defects . . . how to correct them. This practical "beforehand" experience will come in handy again and again when you are called on to do actual Radio repair work later on.

READ WHAT THESE FELLOWS SAY ABOUT THE NEW PRACTICAL SPRAYBERRY TRAINING

EARNED \$250 SINCE STARTING
"I have only completed one-third of the Sprayberry Course and I find it very interesting, which makes it easy to learn. By devoting several hours of my spare time daily to studying and servicing, I have made about \$250 gross since starting the Course." Earl W. Hostetter, R. No. 4, Lebanon, Pa.

"SO MUCH FOR SO LITTLE"
"Now just a few words about your Course—the more I get on it, the more I wonder how you can give so much for so little. I believe it to be the finest of its kind obtainable, and would urge anyone wishing to study Radio seriously to take your Course." George W. Elliott, 521 Elwyn St., Nelson, C., Canada.

"MADE OVER \$300 NET IN SIX MONTHS"
"While I have not hung out my 'shingle' yet, I have made over \$300 net in the past six months, doing some full and some part time Radio servicing. I am completely satisfied in every way with your Course, and I am mighty glad I signed on the 'dotted line,' making me a student of the Sprayberry Academy of Radio." Wendell M. Caldwell, 93 Hickory St., Rochester, N. Y.



No Previous Experience Needed

It makes no difference what your education has been. I can fit you quickly for a good-paying Radio job. I make it easy for you to grasp Radio principles and remember them. Your success is my full responsibility.

EARN WHILE YOU LEARN

My BUSINESS BUILDERS show you how to put your equipment to actual use in handling money-making Radio Service Jobs shortly after you begin training.

Learn More About the SPRAYBERRY Method And How Easy It Is to Start
The complete details of my Fundamental Course and Advanced Training Course . . . all features are fully described in my new, valuable 52-page FREE Book. Send for your copy. No obligation.

All Equipment Becomes Your Personal Property

DON'T DELAY! ACT NOW!

SPRAYBERRY ACADEMY OF RADIO

F. L. Sprayberry, Pres.
420-C University Place, N. W.
Washington, D. C.

Please send my FREE copy of "HOW TO MAKE MONEY IN RADIO."

Name Age

Address

City State

Tear off this coupon, mail in envelope or paste on penny postcard.

REMEMBER — THE SPRAYBERRY COURSE IS SOLD UNDER A MONEY-BACK AGREEMENT

RUSH THIS COUPON for BIG FREE BOOK
GIVING COMPLETE FACTS

Be Sure To Get These N.U. Condenser Specials!

\$7.50

PACKED IN ONE CONTAINER

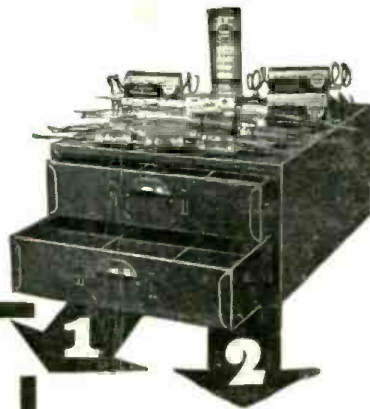

TWO DRAWER STEEL CABINET

Here's a honey of a steel utility cabinet with the drawers partitioned to make it easy for storing small parts. You'll find this cabinet a mighty useful addition to your shop equipment and best of all . . . you get it **FREE** on this limited offer. Don't delay, take advantage of this deal and get your **FREE** steel cabinet. Cabinet size is — length 11½", width, 9½", depth, 5".

NO DEPOSIT ON CABINET

You can buy the condenser assortment for \$7.50 plus a 30 N.U. point contract. Points can be added to present N.U. contract. You get the steel cabinet **FREE** now. There is no deposit. (The condenser assortment comes to you packed with the cabinet.)

Popular

CONDENSER ASSORTMENT

LIST

\$14.35 ★

This fine assortment of popular type N.U. condensers will move fast, give you a good profit and insure the good will of your customers. If you already using N.U. condensers, you'll be sure to snap up this offer in a hurry. If you don't know yet how really good N.U. condensers are, here's a great opportunity to try them! The assortment you get on this limited offer consists of:

3—JB8450 1—AT2015
1—JB8845 1—AT8250
1—SC8450 1—AT4450
1—AT8150 3—AT8450
1—AT1615 1—AT1645

3—T601
4—T602
3—T605
5—T610
2—T625



GET THIS NEW WALSCO STAPLER

\$7.00

\$5.00 For Condensers
\$2.00 as Deposit

EVERY RADIO SERVICE MAN NEEDS IT . . .

New automatic stapler for quick and easy installation of lead-ins—indoor antennae — running leads and power cords, P.A. installations and other shop use. Usual dealer price \$3.30.

CONTENTS —

KIT CONTAINS:

1 WALSCO STAPLER

TYPE	QUANTITY
JB 8450	1
SC 8450	1
AT 8150	1
1615	1
8250	1
4450	1
8450	2
1645	1
AT 1125	1
8845	1
T 601	2
602	2
605	2
610	3
625	1

List Value of N.U. Condensers In Kit, \$10.00. Dealer Price Walsco Stapler, \$3.30 (Packed Together) **YOURS FOR ONLY \$7.00**

YOURS FREE ON THIS N. U. CONDENSER DEAL

DEALER PAYS \$5.00 FOR CONDENSERS, THE ADDITIONAL \$2.00 IS REBATED WHEN DEAL REQUIREMENT IS COMPLETED.

HOW YOU GET IT

Just order from your N.U. distributor. Your total payment is \$7.00. You sign an agreement for 75 points and deposit is refunded when the 75 purchase points are completed. Points can be used on N.U. Tubes, Sound X/Tra Tubes, N.U. Radio Batteries or N.U. Condensers. The National Union Program on free equipment has helped thousands of dealers to own the "finest radio shop in town".

POINTS ARE COUNTED AS FOLLOWS:

1 Tube = 1 Point, 1 Electro Condenser = 1 Point, 10 Paper Condensers = 1 Point, 2 Numite Condensers = 1 Point, 1 Radio Battery = 1 Point.

See Your Jobber or Write

© 1940 N.U.R. Corp.

NATIONAL UNION RADIO Corporation
57 STATE STREET, NEWARK, N. J.